

EP-9321-g/g1 802.11g 54M Wireless LAN PCI Adapter

User Manual



Wireless



Content

1. Introduction	3
1.1 Feature	3
1.2 Specification	4
1.3 Package Contents	4
1.4 Systems Requirements	5
2. Hardware Installation	5
2.1 Connecting the PCI Card	5
2.2 Removing the PCI Card	6
3. Software Installation	7
3.1 Installing WLAN PCI Adapter Utility and Driver	7
3.2 Uninstalling the Driver and Utility	11
4. Configuration Utility	14
4.1 Using the configuration utility	14
4.1.1 Profile	15
4.1.1.1 System Configuration Edit profile Network Type	15
4.1.1.2 Edit Profile	17
4.1.1.3 Authentication and Security	19
4.1.2 Link Status	28
4.1.3 Site Survey	29
4.1.4 Statistics	30
4.1.5 Advance	31
4.1.6 About	32
5. Glossary	33
6. Tech Support	35

1 Introduction

The 54Mbps WLAN PCI Adapter provides greater performance than ever before. Incorporated with latest IEEE 802.11g technology, the PCI Card is not only compliant with other 802.11g products but allows you to connect with other 802.11b devices. With WPA (Wi-Fi Protected Access) and 64/128-bit WEP encryption, the PCI Card ensure the security of your network communication. All you need is laptop computer with one 32-bit PCI interface and Windows 98SE/2000/ME/XP operating system; the Plug-and-Play feature will enable you to complete the set up process within minutes. This wireless network PCI Card has been designed for both home and business users and it also enables you to communicate seamlessly with other wireless networking products wherever you are.

1.1 Features

1. IEEE 802.11b-DSSS (BPSK, QPSK, CCK)
2. IEEE 802.11g-OFDM (64-QAM, 16-QAM, QPSK,BPSK)
3. 54Mbps high Data Rate
4. Support 32bit PCI interface
5. Auto Rate fallback for optimizing communication possibility in worse channel conditions and over larger distances
6. 64/128bit WEP data encryption security
7. Compliant with Windows 98SE/2000/ME/XP
8. Power saving in infrastructure mode
9. One detachable reverse SMA Antenna
10. Plug-and-Play and easy to setup
11. Easy-to-Use Graphical Configuration utility saves detailed connectivity profiles for frequently accessed networks

1.2 Specification

Model: 54Mbps WLAN PCI Adapter

Radio: Complies with IEEE 802.11b/g

Frequency Band: 2.412-2.462GHz (U.S.)

2.412-2.484GHz (Japan)

2.412-2.472GHz (ETSI)

Modulation TYPE : BPSK,QPSK,CCK,16-QAM,64-QAM

Operating Channels: 11 channels (US) 13 channels (ETSI) 14 channels (Japan)

Data Rate: 1 / 2 / 5.5 / 6/9/11/12/24/36/48/54Mbps

Output Power: 18dBm@11Mbps;14dBm@54Mbps

Receive sensitivity: Min.80dBm for 11Mbps (@BER 8%) Min. -70dBm for 54 Mbps(@BER 10%)

Antenna Type: External detachable dipole antenna

Current Consumption: 3.3V, Tx mode 400 mA (Max.)

Rx mode 250 mA (Max.)

Certification: Radio – EU: ETS 300 328; USA: FCC Part 15C

EMC – EU ETS 300 826; USA: FCC Part 15B Safety: EN60950

Driver: Windows 98SE/2000/ME/XP

1.3 Package Contents

1. One 54Mbps WLAN PCI Adapter
2. One setup Utility CD-ROM (User Guide on CD)
3. Quick Installation Guide

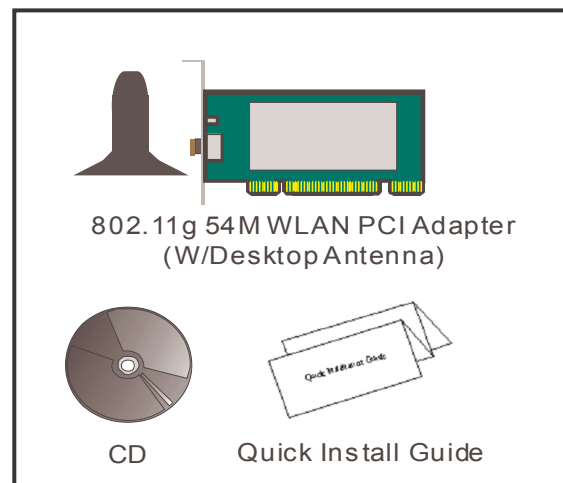
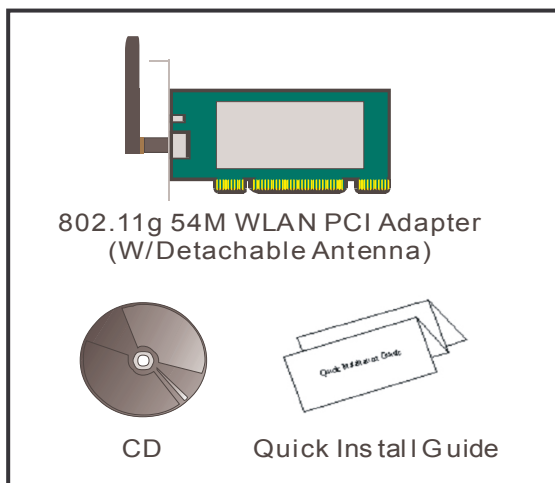

1.4 Systems Requirements

1. A Desktop computer with an available 32bit PCI slot.
2. Operating System: Windows 98SE/2000/ME/XP
3. 2M bytes free disk space for utility and driver installation.

Note: If you insert the WLAN PCI Adapter before installing the driver and utility, the operating system will detect a new device and start to configure the new device. Click Cancel to finish the wizard. Follow the instruction step by step to install the WLAN PCI Adapter.

2. Hardware Installation

2.1 Connecting the PCI Card

Insert the PCI Card into the PCI slot on your desktop, and push it until it is firmly seated.

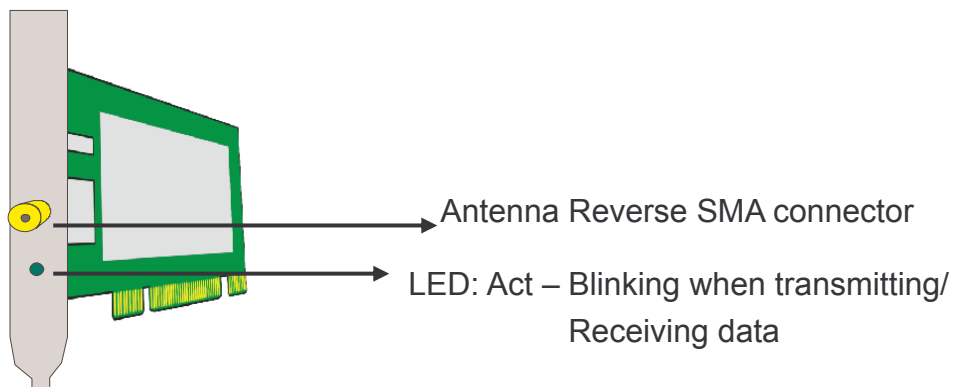
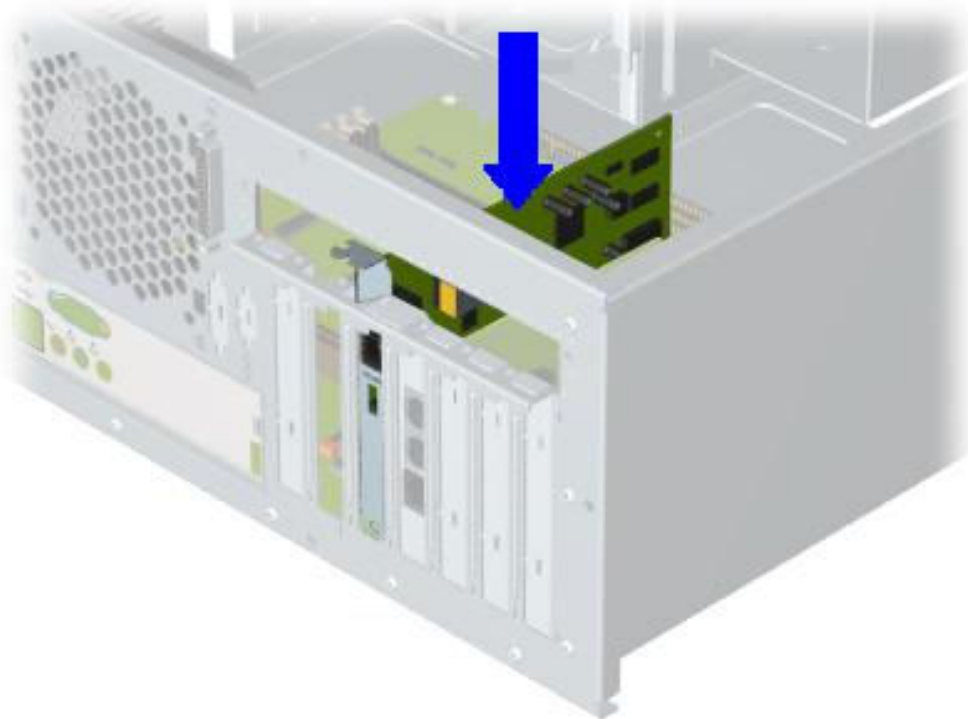

2.2 Removing the PCI Card

If you want to remove the PCI Card, Pull the PCI Card out and to the right to remove from the chassis.

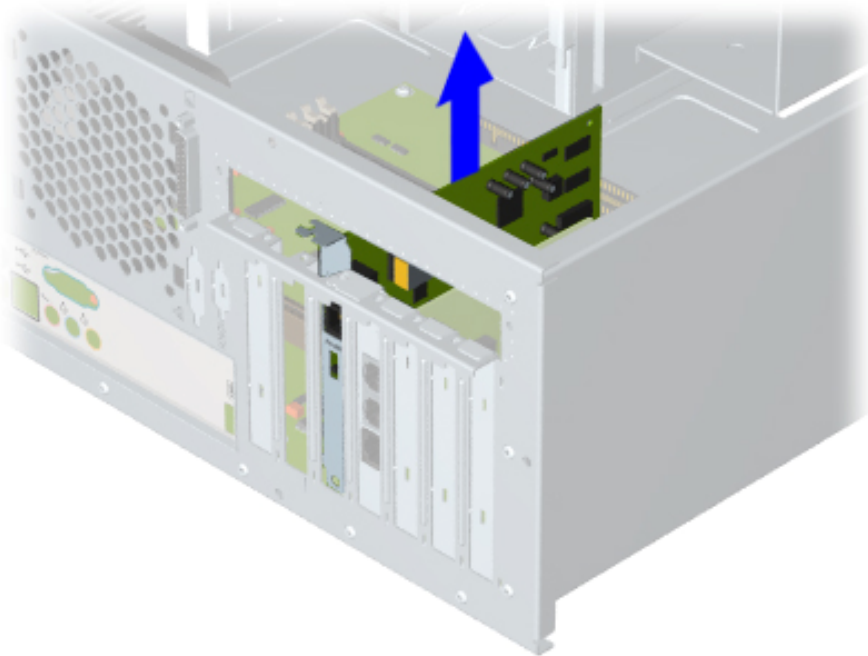

3. Software Installation

3.1 Installing WLAN PCI Adapter Utility and Driver

Insert the setup CD into your CD-ROM Drive. Then, the web page will pop up automatically and select the “Installing Driver and Utility”. If it does not launch automatically, Double-click setup.exe in your CD-ROM Drive.

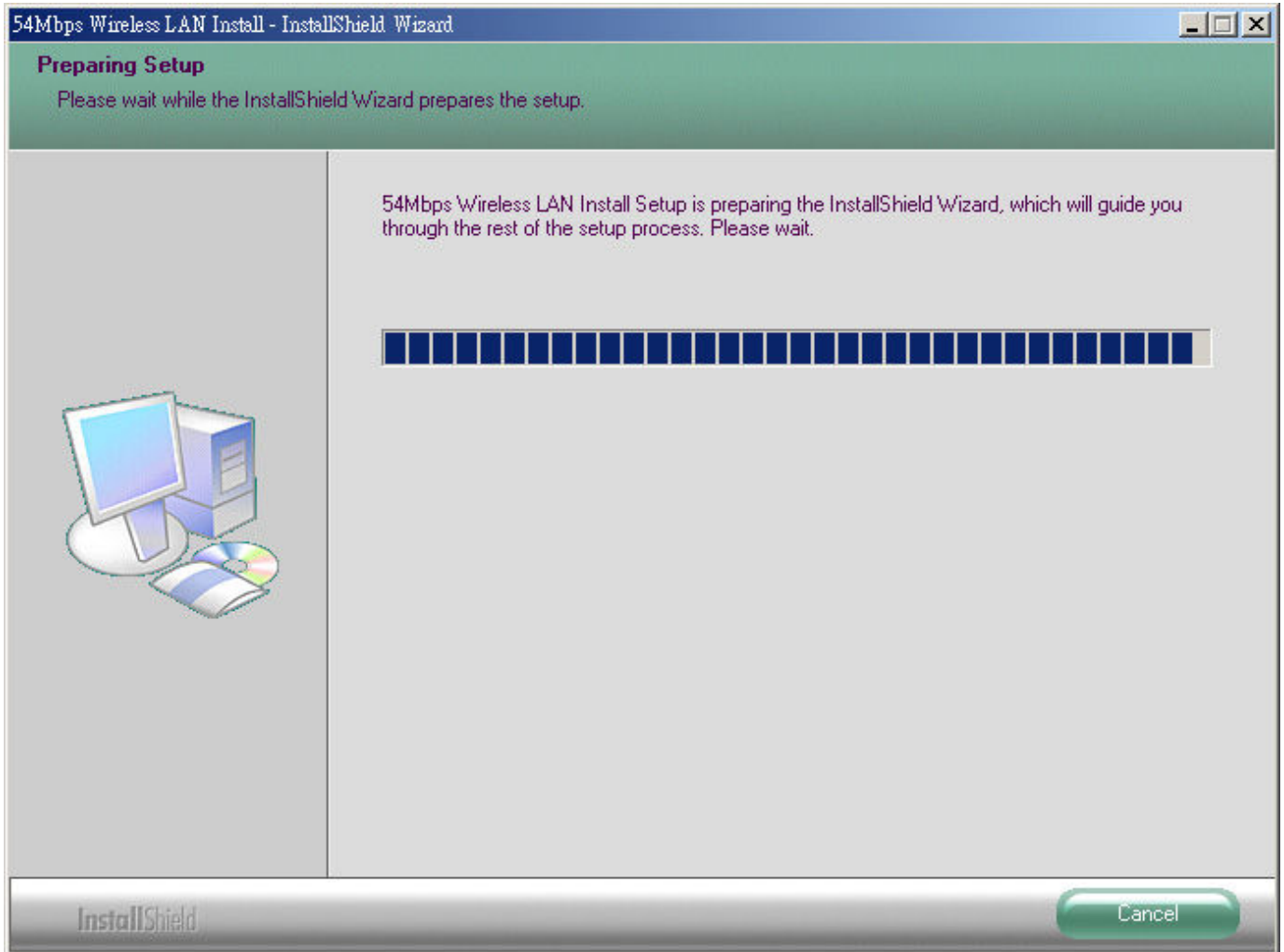

Click Next button in the following window.

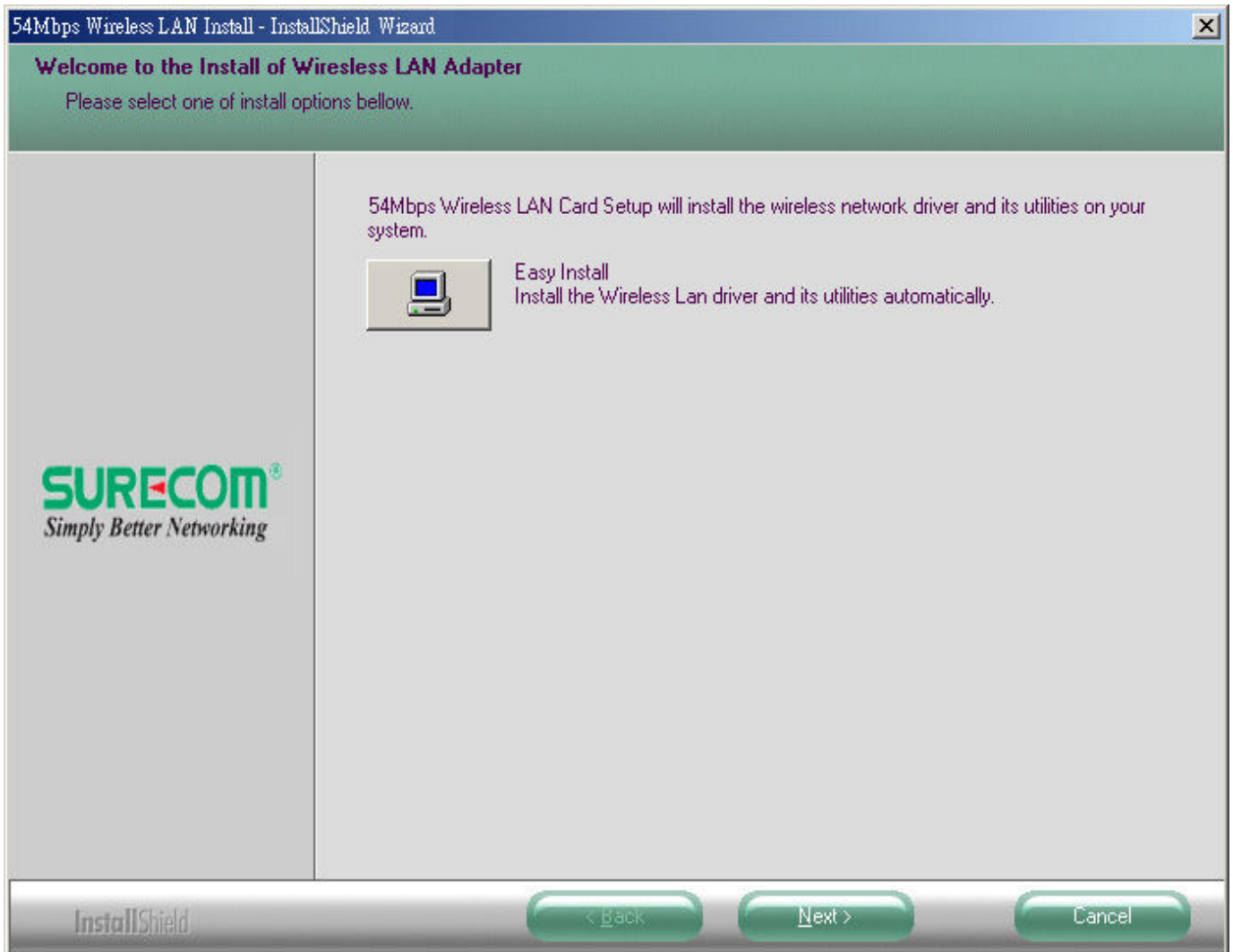

The Install Shield Wizard is copying the necessary files to the system. The progress indicator shows the installing status.

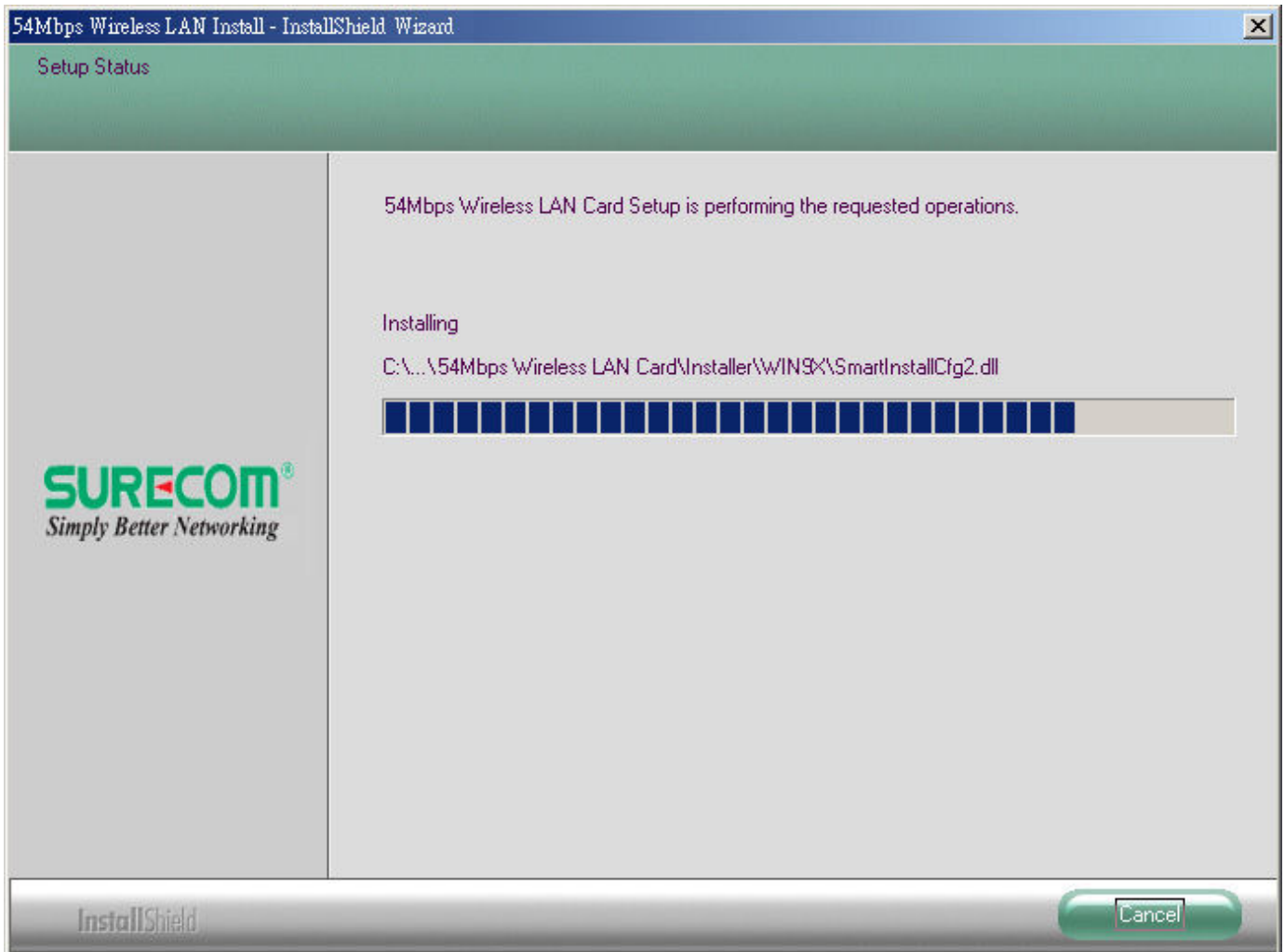

If this is the first time you install the software, the window below will appear. Select your current country region then click Next.

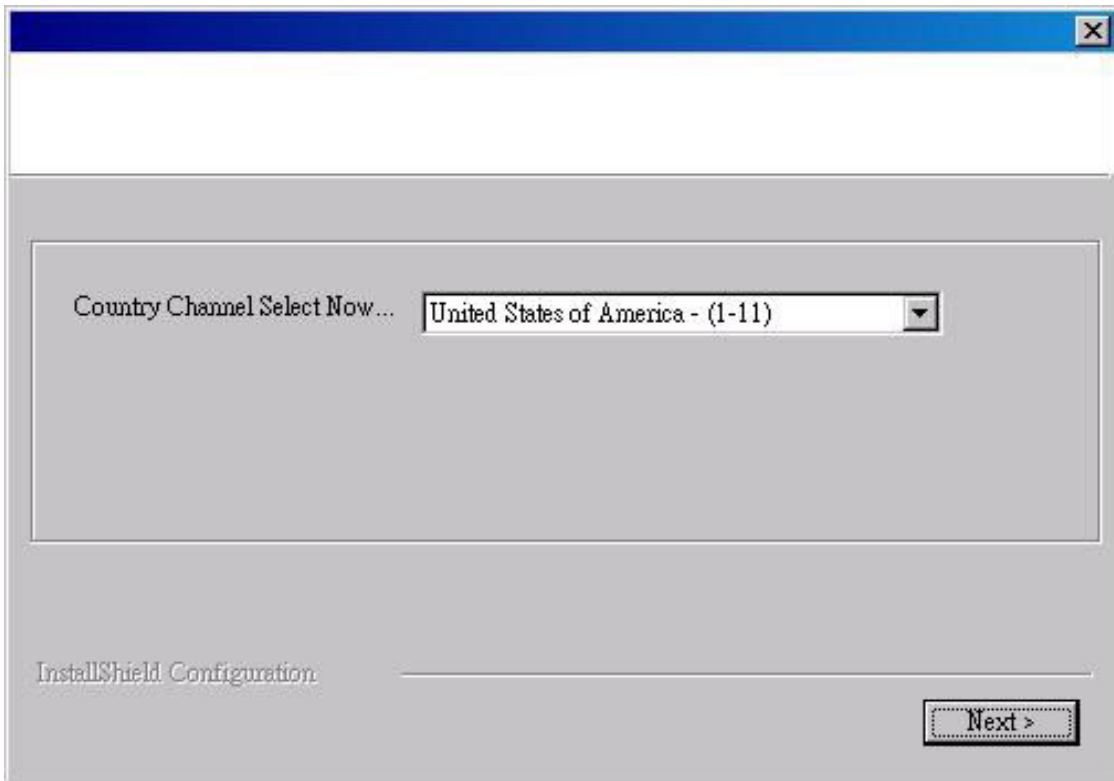

Click Finish, when the installation is completed.

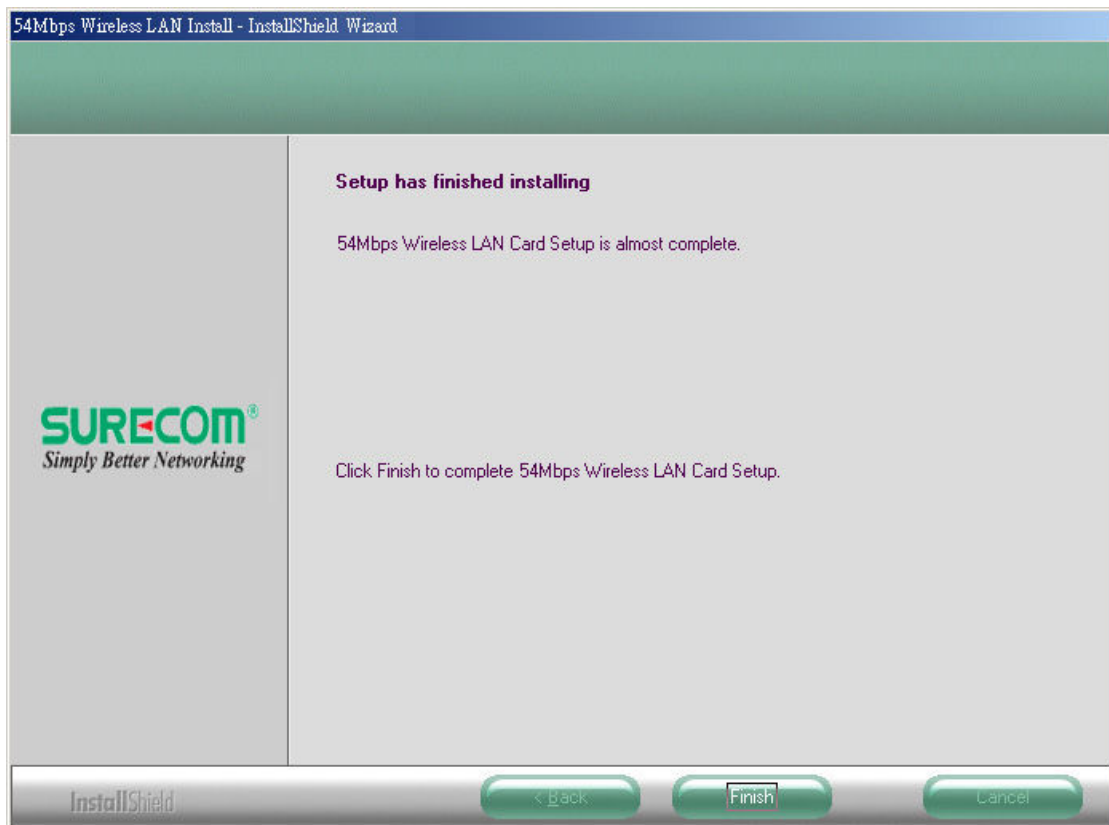

After completing the installation, the icon  will appear in the system tray. Double-click the icon to configure the WLAN PCI Adapter.



3.2 Uninstalling the Driver and Utility

You may follow the instruction step by step to uninstall the WLAN PCI Adapter completely. Insert the setup CD or execute the setup.exe again.

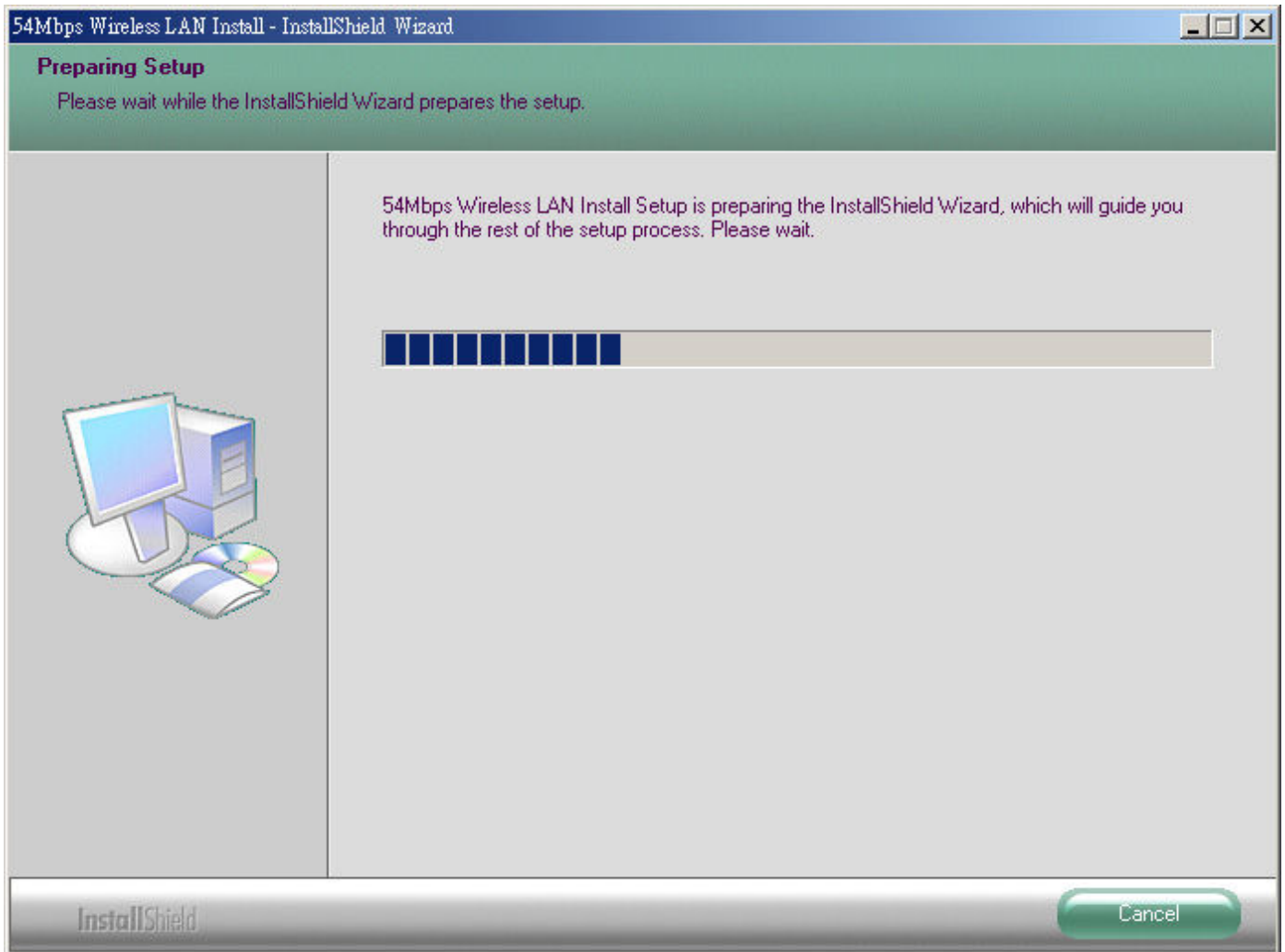

The following window should launch automatically. Select Remove, and click Next.

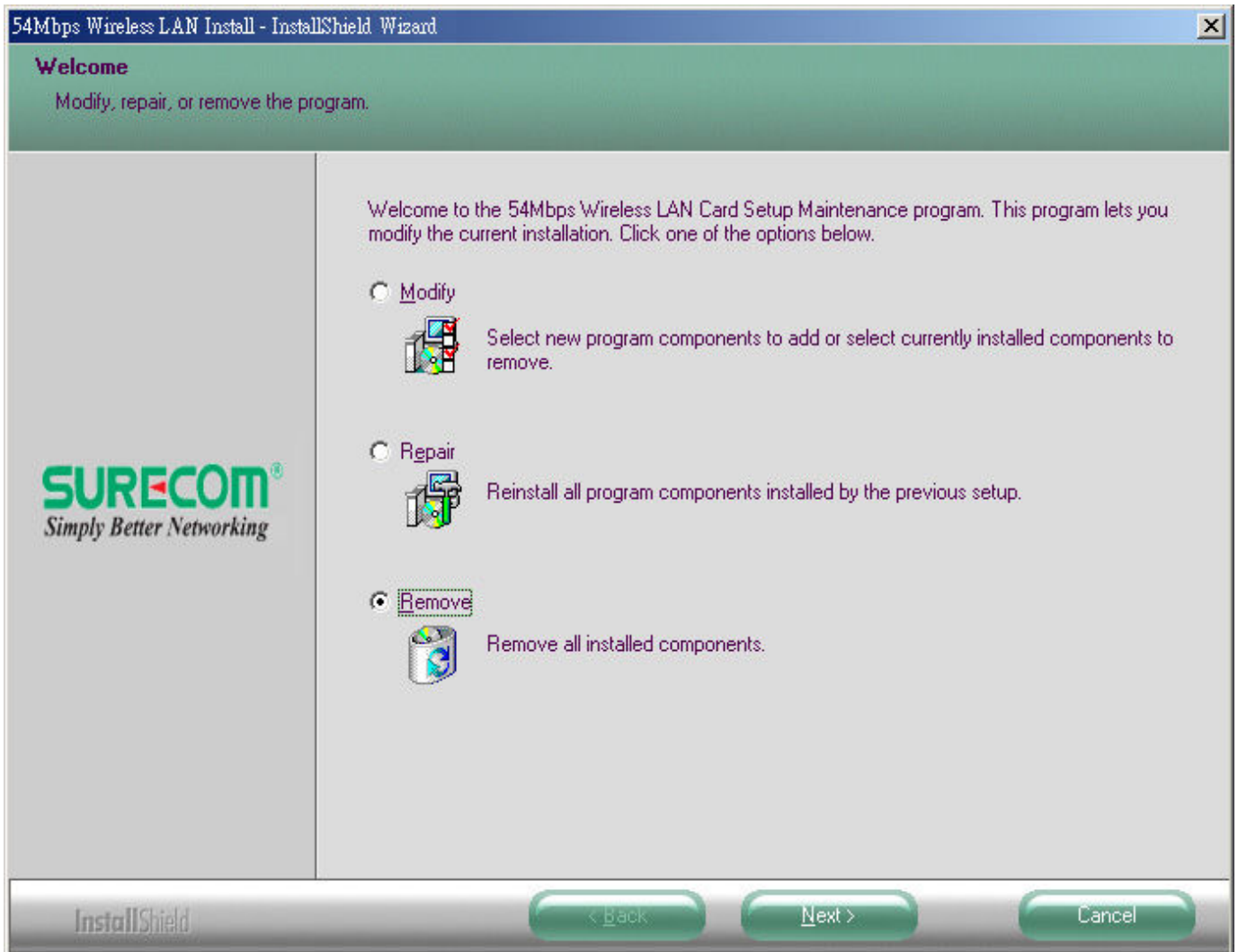

Select Yes to continue uninstallation.

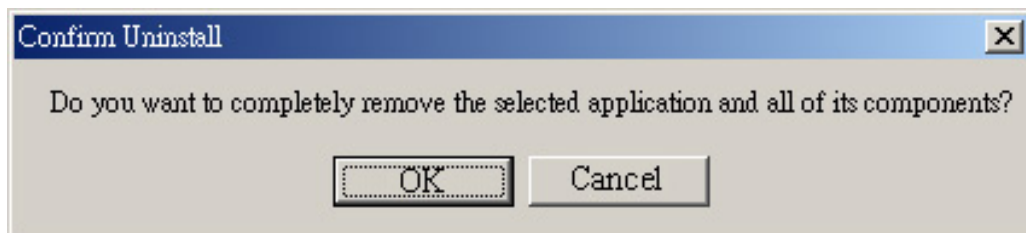

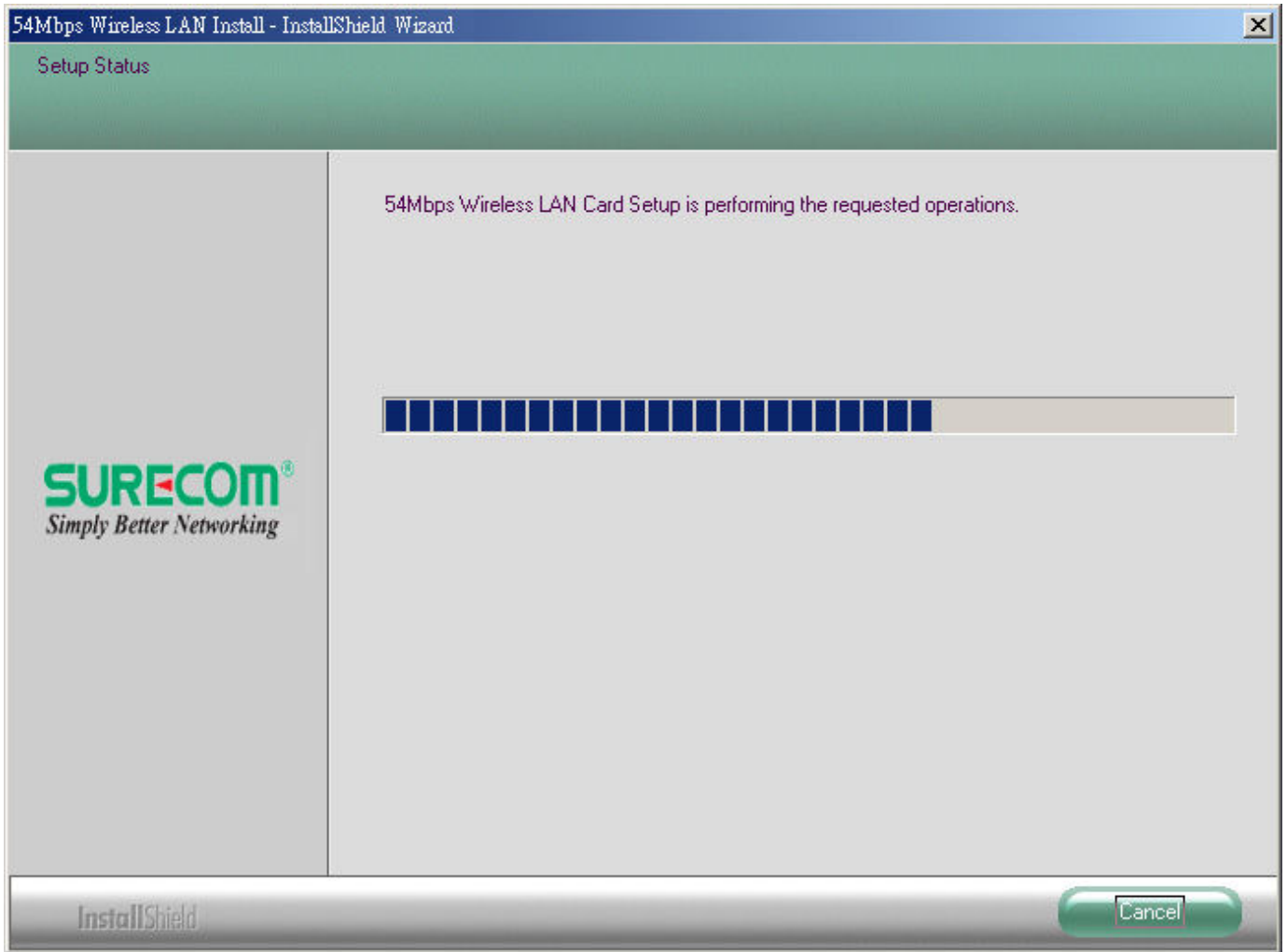

Click OK to finish, when the uninstallation is completed.



4. Configuration Utility

After the Configuration Utility has been installed, an icon will be placed in the system tray when the WLAN PCI Adapter is inserted. Click the icon and the configuration utility will pop up.

The utility has six tabs: Profile, Link Status, Site Survey, Statistics Advance, and About. You should change all your configuration settings for your WLAN PCI adapter using this utility.

4.1 Using the configuration Utility

After the Configuration Utility has been installed, an icon will be placed in the system tray when the WLAN PCI Adapter is inserted. Click the icon and the configuration utility will pop up.

The utility has six tabs: Profile, Link Status, Site Survey, Statistics Advance, and About. You should change all your configuration settings for your WLAN PCI adapter using this utility.

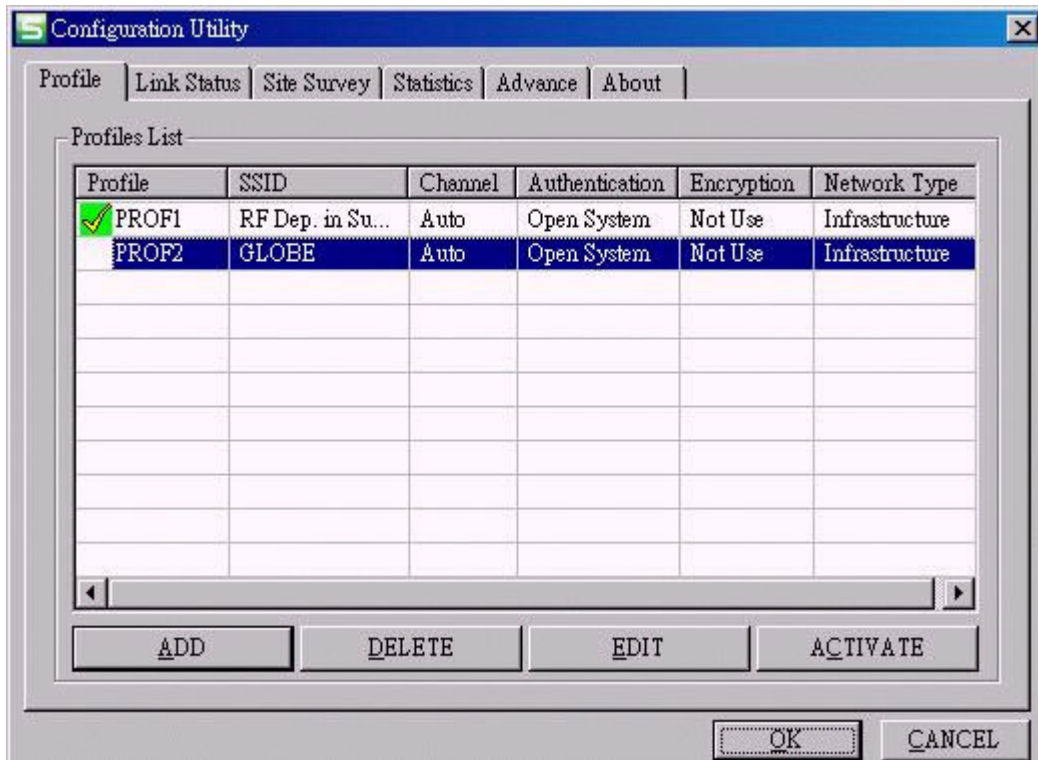

4.1.1 Profile

Specific different network profile settings used in various locations, such as your office, your home, the factory, or the airport. In each profile, you can specify a network type, network name, WEP and security setting parameters required for that operating location.

4.1.1.1 System Configuration Edit profile Network Type:

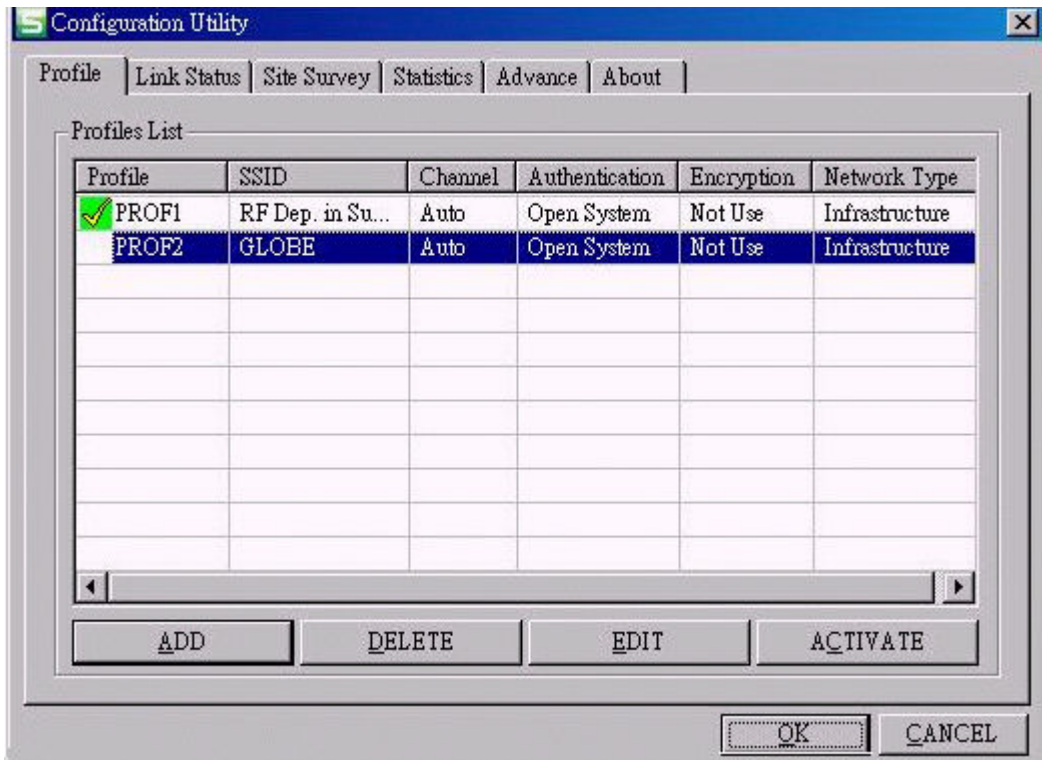

The column in Profile list from left to right is “Profile”、“SSID”、“Channel”、“Authentication”、“Encryption” and “Network Type”. Click “ACTIVATE” to excuse the profile.

SSID: All wireless devices within the ESS or extended wireless LAN use the SSID. This can be any alphanumeric value of up to 32 characters long. Use this to prevent cross communication between two or more WLAN in one area. The SSID should be changed in order to provide some minimum security.

Channel: Shows the selected channel that is currently used. (Available channels depend on the country or region you are located.)

Authentication: Defines authentication type of the wireless networks, including "Open System" and "Share Key" authentication. The wireless adapter will need to be set to the same authentication type to communicate.

Encryption: Indicates your WEP (Wired Equivalent Privacy) settings. WEP encryption can be used to ensure the security of your wireless network. If there is no Encryption exists, the column will show Not USE.

Network type: The network type of the wireless network. An **Ad-Hoc** wireless LAN is a group of computers each with wireless adapters, connected as an independent wireless LAN. An integrated wireless and wired LAN is called an **infrastructure configuration**.

4.1.1.2 Edit Profile

To add a new location profile name or to rename, delete, or select an existing profile, click **Edit**. The Edit Configurations screen appears as follows

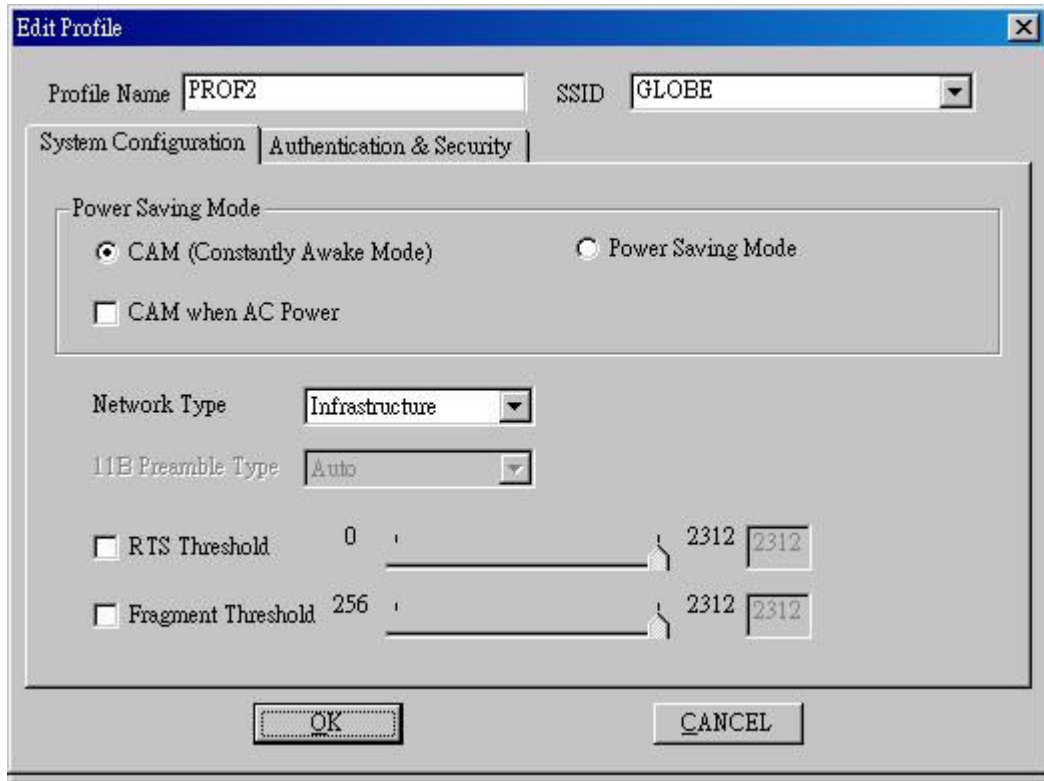

Power Saving Mode:

CAM: (Constant Awake Mode) CAM is the normal mode for desktop machines or other machines where power consumption is not an issue. It keeps the radio powered up continuously, so there is little latency for responding to messages.

Max_PSP: Maximum Power Save.

Fast_PSP: Fast Awake.

Network Type

The network type of the wireless network. An **Ad-Hoc** wireless LAN is a group of computers each with wireless adapters, connected as an independent wireless LAN. An integrated wireless and wired LAN is called an **infrastructure configuration**.

Preamble Type

Preamble is the first sub-field of PPDU, which is the appropriate frame format for transmission to PHY (Physical layer). There are two options, Short Preamble and Long Preamble. The Short Preamble option improves throughput performance.

RTS Threshold: The RTS Threshold sets an upper threshold at which point the device will issue an RTS packet. The RTS (Request To Send) packet is used for the purpose of avoiding data collisions on the wireless LAN. There are several trade offs to consider when setting this parameter. Setting this parameter to a small value causes RTS packets to be sent more often, consuming more of the available bandwidth, therefore reducing the apparent throughput of other network packets. However, the more often RTS packets are sent, the quicker the system can recover from interference or collisions. Refer to the IEEE 802.11 Standard for more information on the RTS/CTS mechanism.

Fragment Threshold: Fragment Threshold defines a threshold above, which the wireless packet will be split up, or fragmented. For a fragmented packet, if transmission of part of it were to be interfered with, only the portion that was successfully transmitted would need to be resent. Throughput will generally be lower for fragmented packets, since the fixed packet overhead consumes a higher portion of the RF bandwidth.

4.1.1.3 Authentication & Security

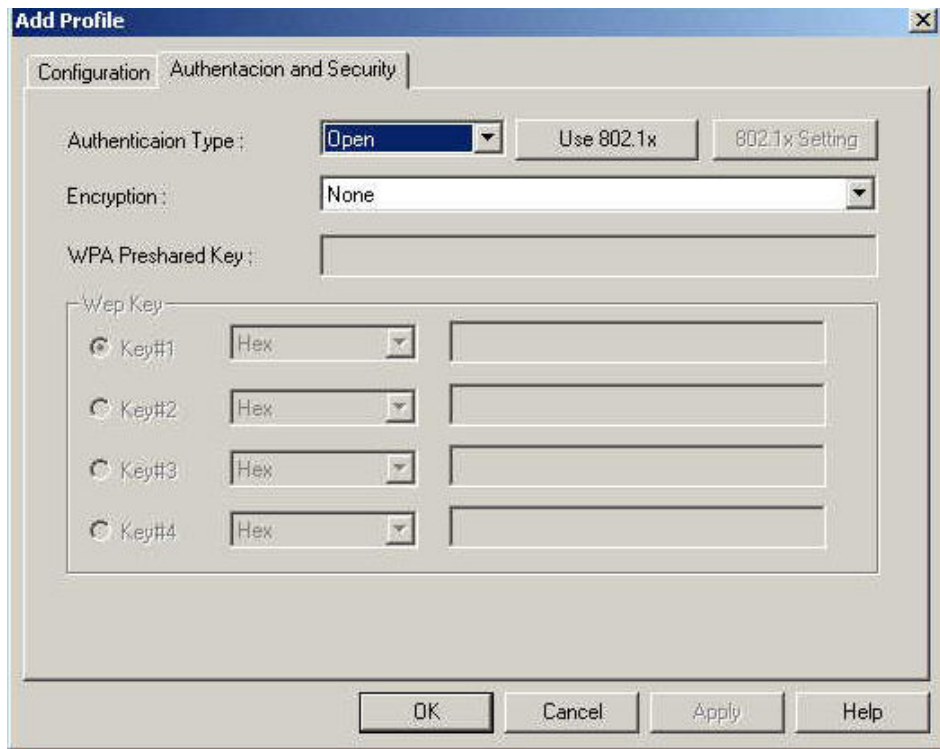

Authentication Type: Defines authentication type of the wireless networks. The wireless adapter will need to be set to the same authentication type to communicate. There are five options to choose as following:

Open System: With this setting any station in the Wireless LAN can associate with an Access Point to receive and to transmit data. You can choose non-encryption or WEP encryption under Open System setting. "WEP (Wired Equivalent Privacy)" is an optional feature of the IEEE 802.11 standard that is used to ensure the security of your wireless network. There are four groups of WEP key you can set.

Key 1 - Key 4: These four fields can be used to manually enter the encryption keys. This may be necessary if you wish this node to match keys in a different vendor's product.

WEP Key length: The 64 or 128-bits Wired Equivalent Privacy Algorithm. You can decide the network key to be encoded by ASCII characters or hexadecimal digitals. A key of 10 hexadecimal characters (0-9, A-F) is required if a 64-bit Key Length was selected. A key of 26 hexadecimal characters (0-9, A-F) is required if a 128-bit Key Length was selected.

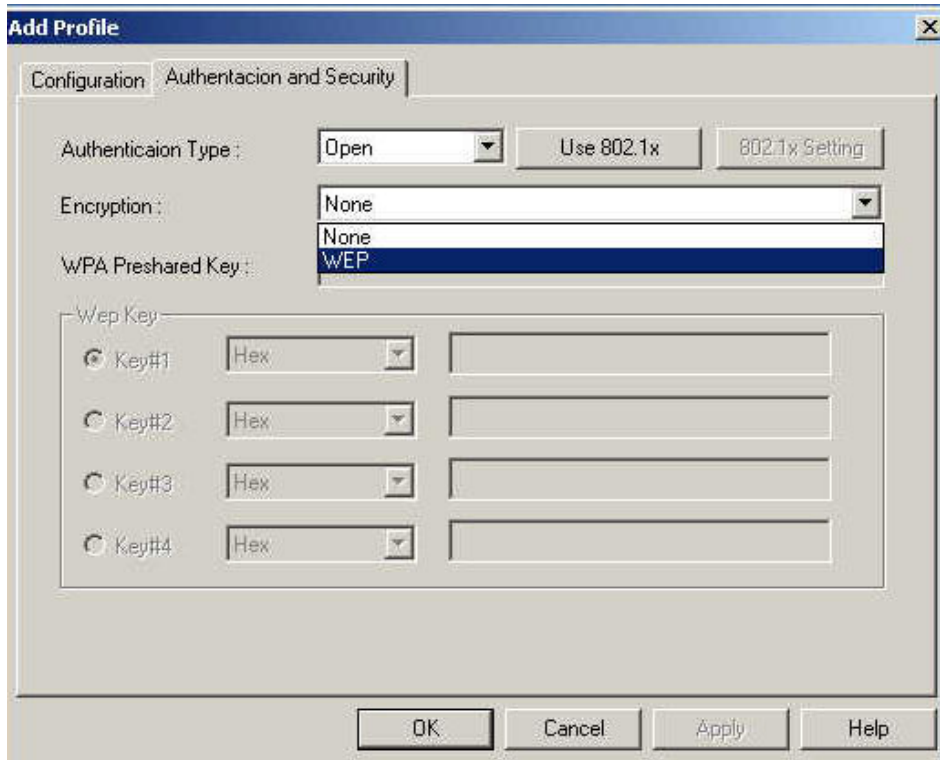

Share Key: Is when both the sender and recipient share a secret key. Both units use this key for an extended length of time, sometimes indefinitely. You also can choose non-encryption or WEP encryption under Shared setting.

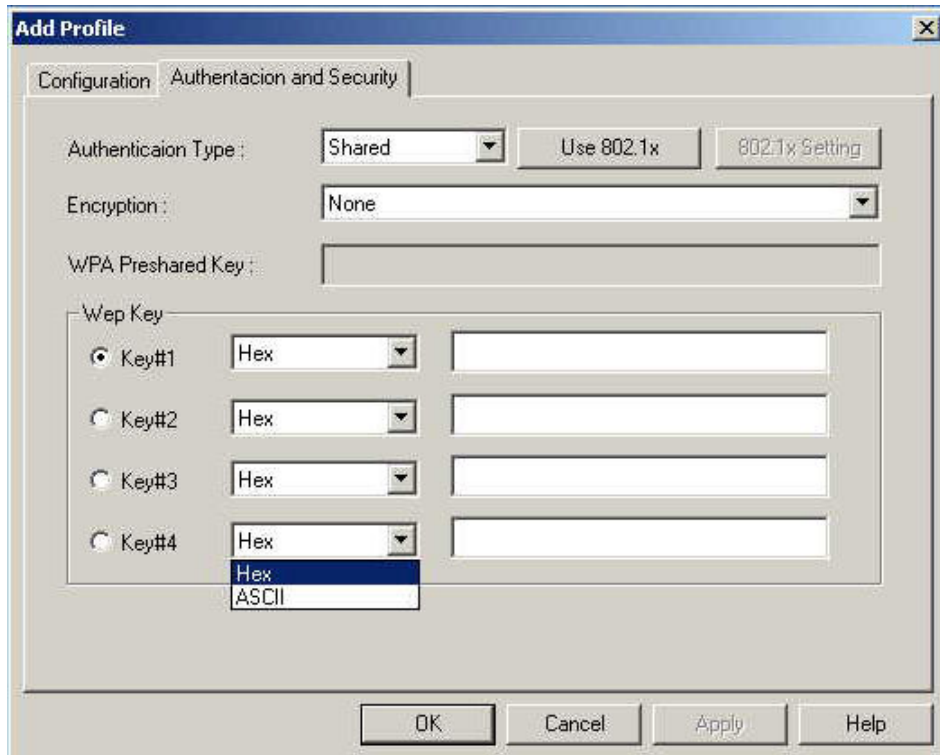

LEAP (Lightweight Extensible Authentication Protocol): Normally it's using on Cisco's networking devices.

You may need a Cisco ACS Server to do authentication.

After selecting LEAP, another setting window will pop up as following. Types in your "Identity Key" and "Password" then click Ok to complete setting.

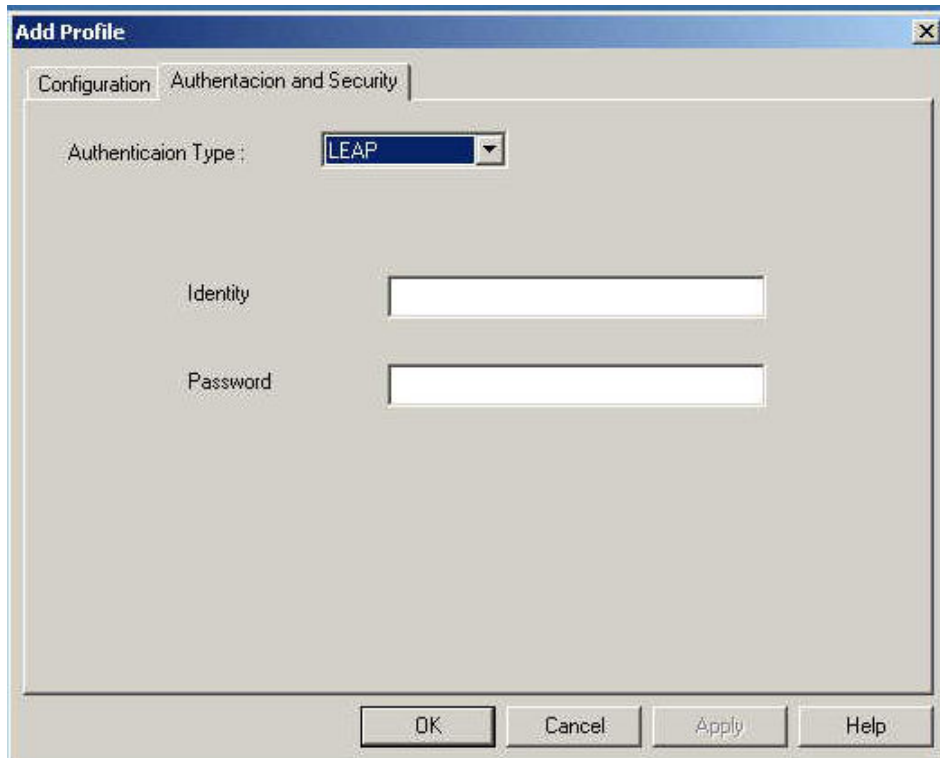

WPA (Wi-Fi Protected Access): WPA is an enhanced security algorithm in comparison with WEP. There are two types of encryption, “TKIP” and “AES”. TKIP stands for Temporal Key Integrity Protocol. AES stands for Advanced Encryption Standard.

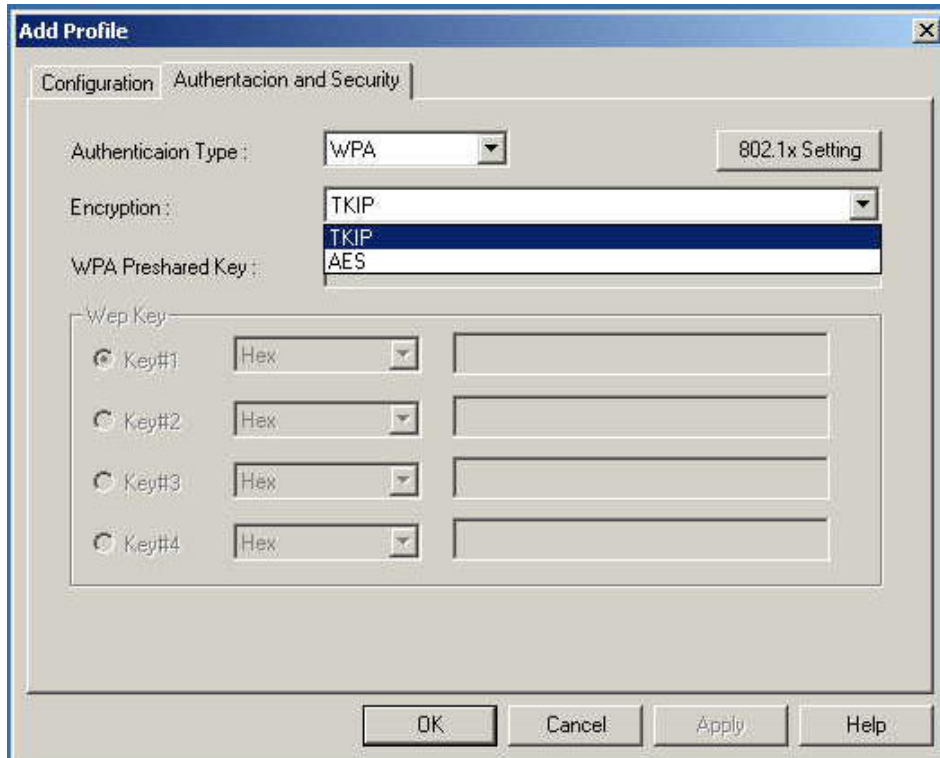

802.1x Settings: It's a standard made by IEEE in 1999. It is used on Ethernet Switch in the beginning. You will need an authentication server to apply. After clicking "802.1x Setting", another window will pop up.

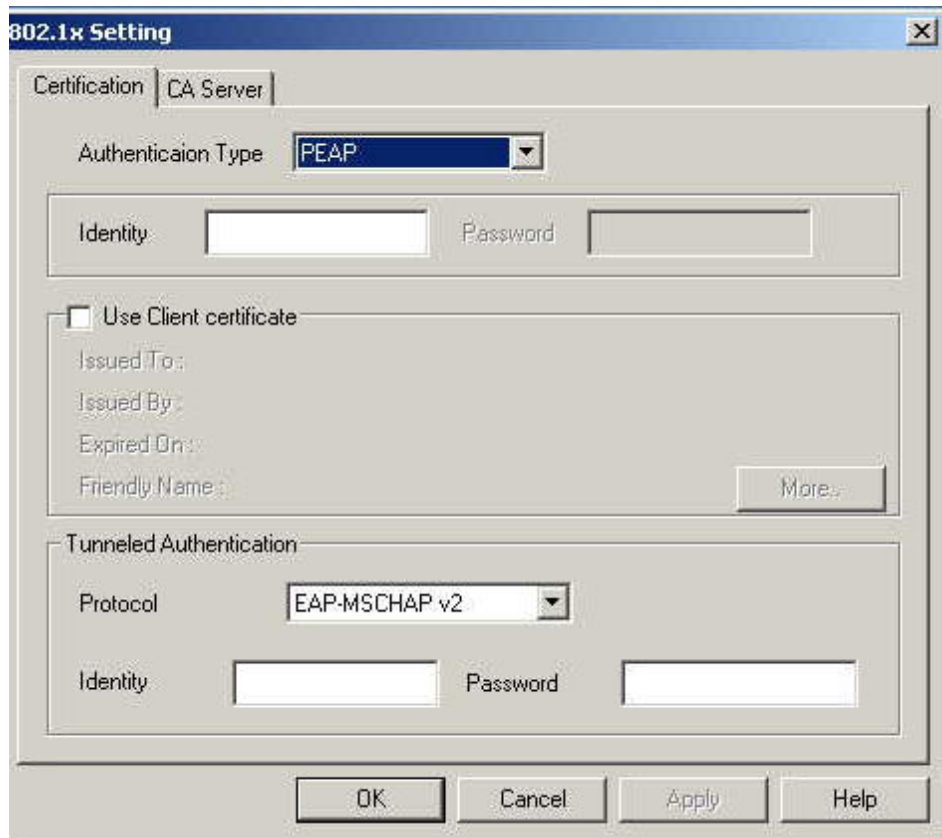

In the "Authentication Type", there are PEAP, TLS-Smart Card and TTLS. Select the type you want. PEAP stands for Protected EAP. TLS-Smart Card stands for Transport Layer Security-Smart Card. TTLS stands for Tunneled Transport Layer Security. The followings are the explanation of settings:

PEAP: When selecting PEAP, the following fills will be shown.

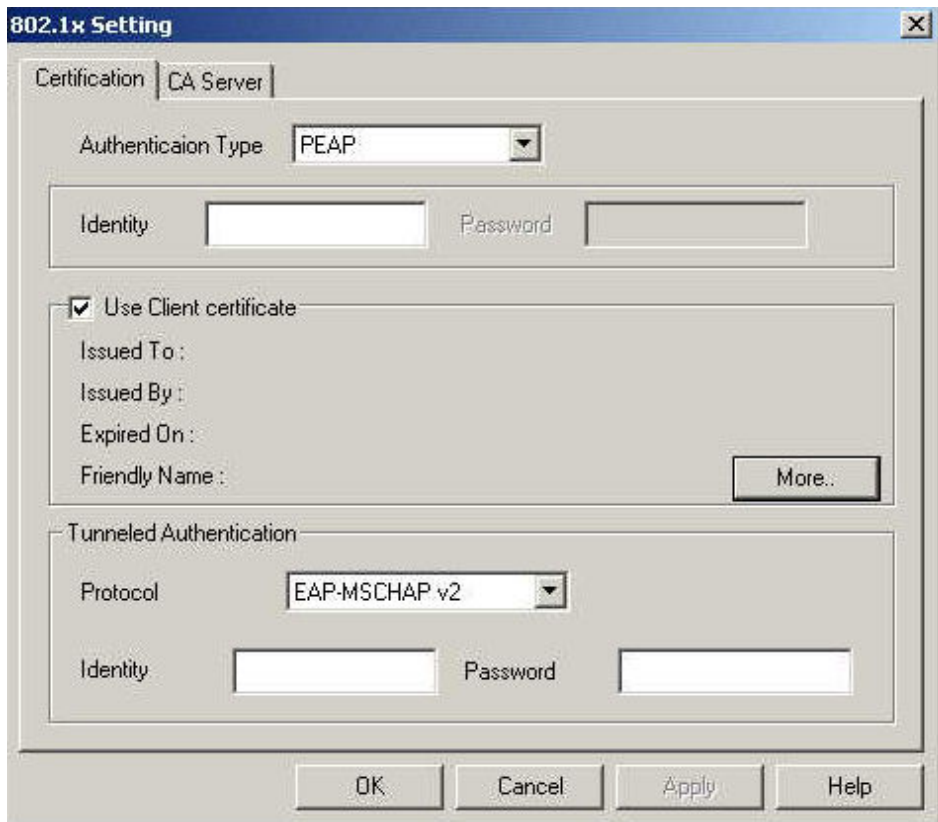

“Identity”: Type in your ID to access in authentication server.

“Client Certificate”: If you use other client certification, check this box. Then click “more”, another window will pop up. Select your certification.

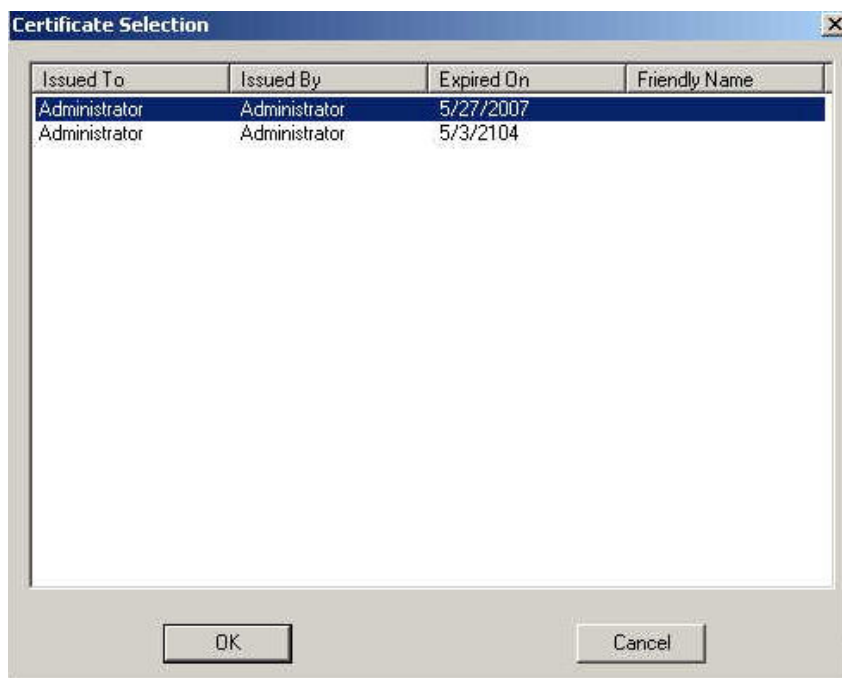

“Tunneled Authentication”: In this dialogue, select your authentication protocol type first. There are “EAP-MSCHAP v2”, “EAP-TLS/Smart Card” and “Generic Token Card” can be chosen. Then type in your “Identity” and “Password” to access in authentication server.

TLS-Smart Card: When selecting this authentication type, you have to type in your ID in the “Identity” fill.

TTLS: After selecting this authentication type, the fills “Identity”, “Client Certificate” and “Tunneled Authentication” also will be shown. The difference between PEAP and TTLS settings is the authentication protocol. The authentication protocol of TTLS has three types for choosing, “CHAP”, “MS-CHAP” and “MS-CHAP v2”.

CA Server: When using PEAP and TTLS authentication type, you need to select your authentication server’s certification type. Switch to the CA Server folder then select your certification issuer.

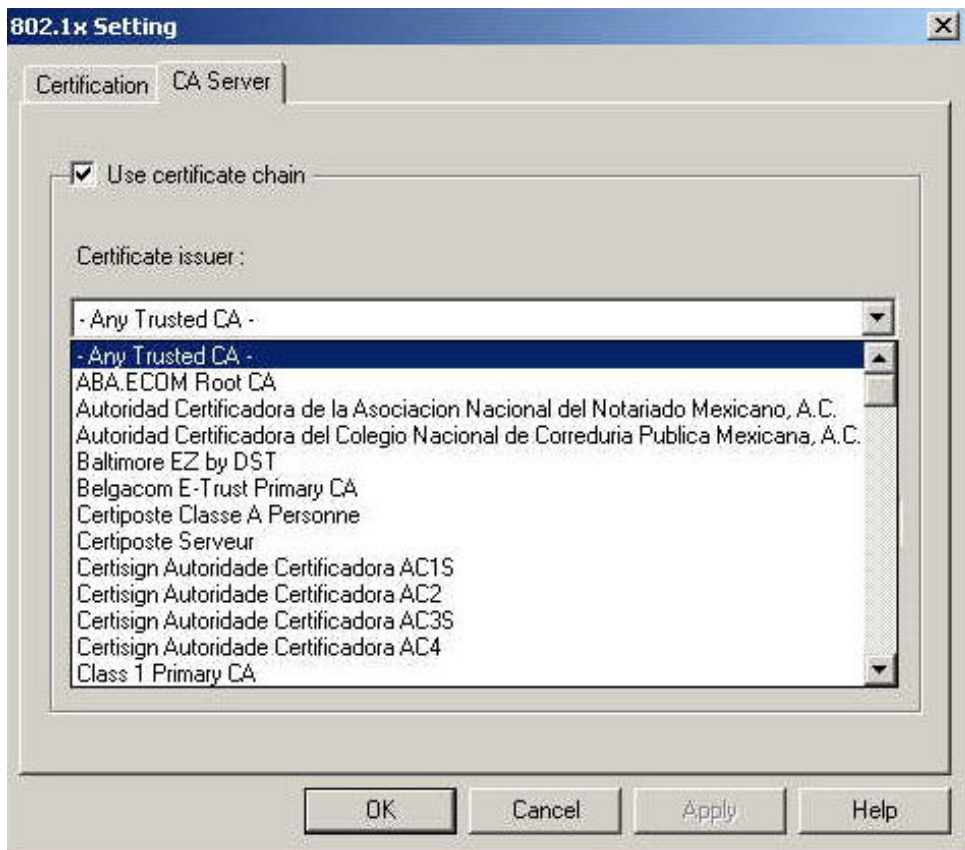

WPA-PSK (Wi-Fi Protected Access-Pre-shared Key): The difference between WPA and WPA-PSK setting is that WPA-PSK allows you to set “password” (We call Pre-shared Key here). And the “password” will use either “TKIP” or “AES” encryption. This is normally used on SOHO or Home Network.

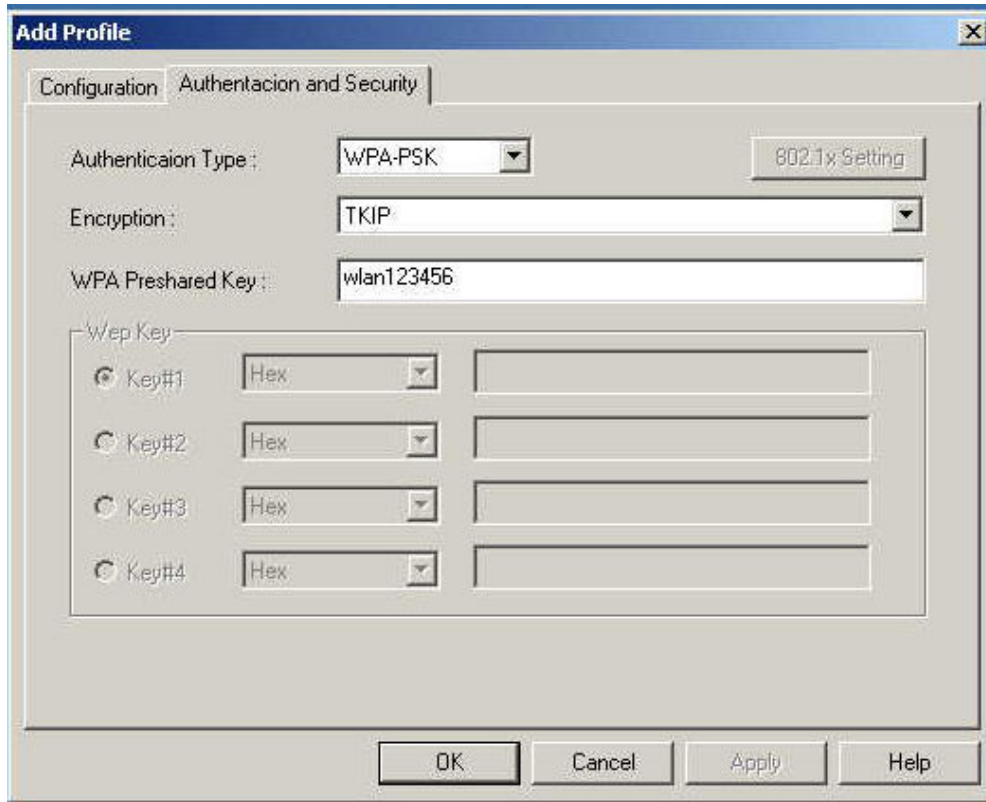

4.1.2 Link Status

You can see the below status: Status, Current Channel, Current TX Rate, throughput(Kbit/sec), Link Quality, Signal Strength.

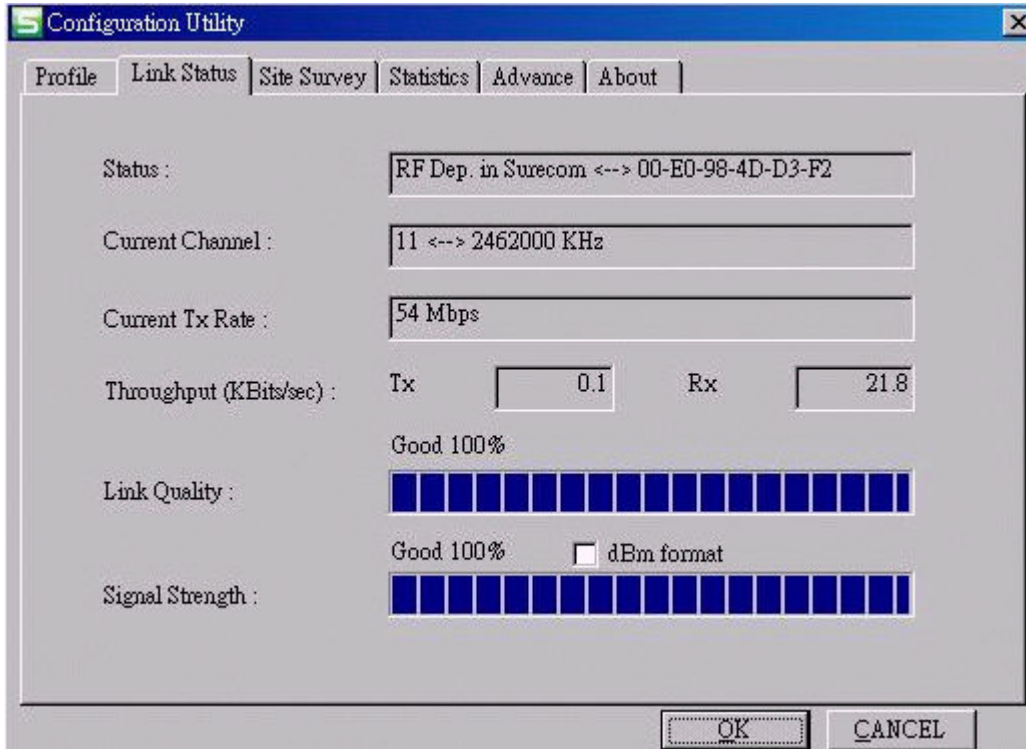

4.1.3 Site Survey:

Click the Site Survey; you can to see the signal strength, channel, Encryption, authentication and network type of available wireless network. The AP MAC address will also be displayed at the Preferred BSSID field. Select the AP you want to connect to and click connect to establish network.

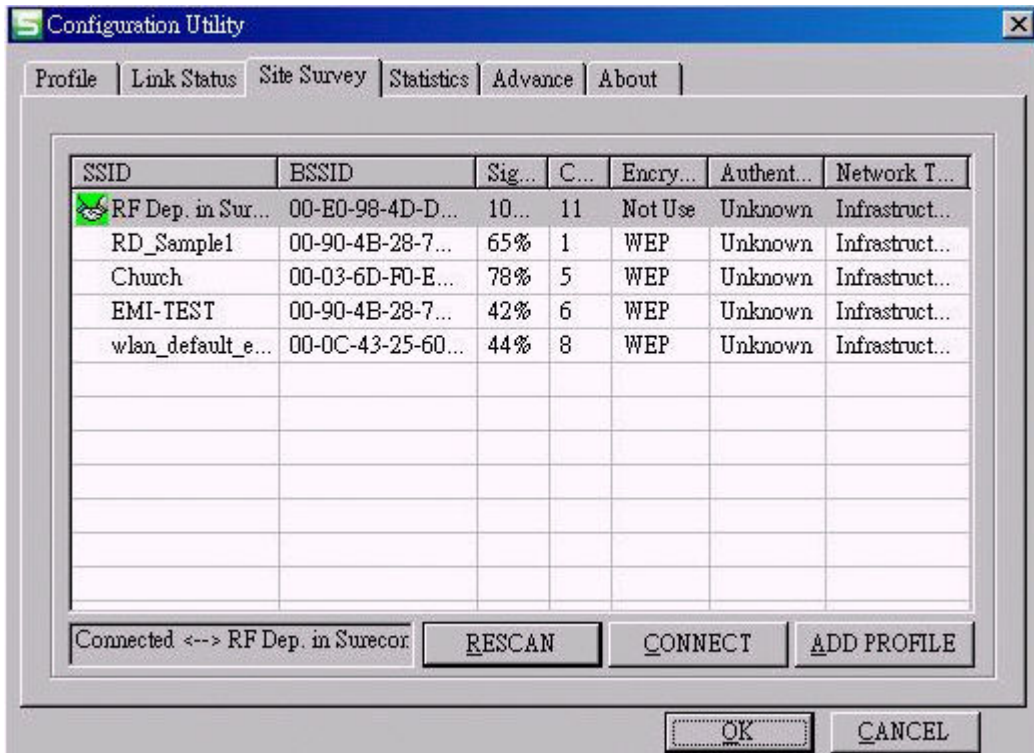

4.1.4 Statistics

You can see the information of transmit statistics and receive statistics in this screen :

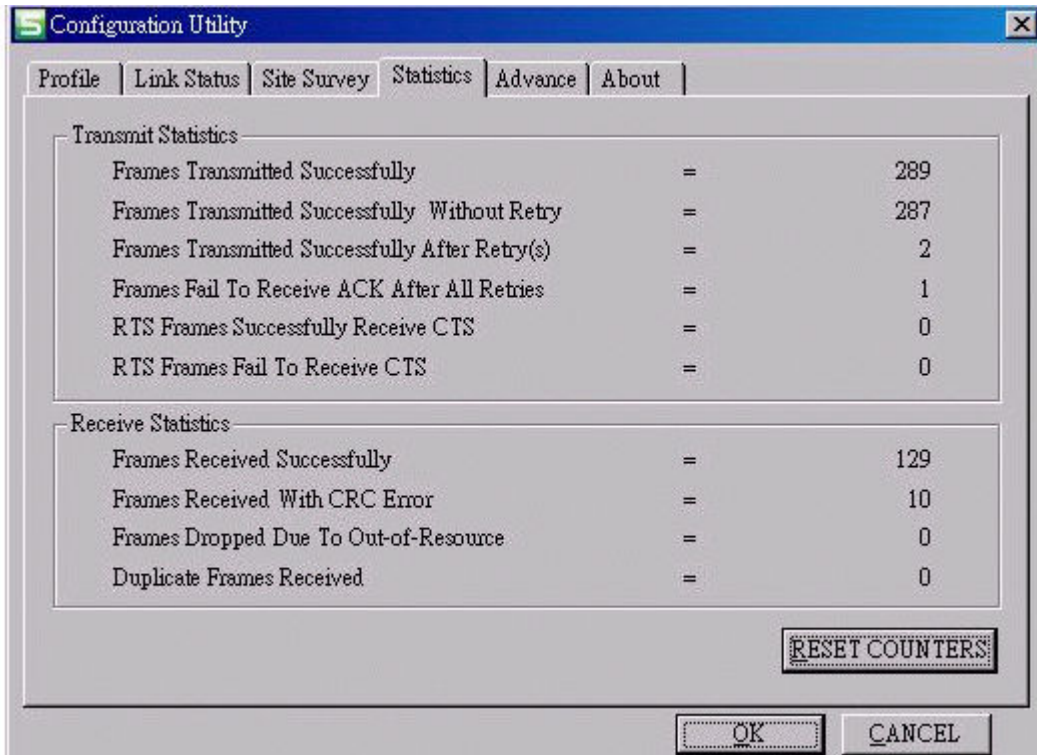

4.1.5 Advance:

Wireless Mode

If there are 802.11b devices in your wireless network, choose b+g mixed mode. If all the devices in your wireless network are 802.11g ones, choose 802.11g mode to get better transfer rate.

Tx Burst

Enable this function to burst the transmit speed, but it may affect signal quality.

Radio off

You can stop wireless transmission by clicking this icon. Click again to resume wireless connection.

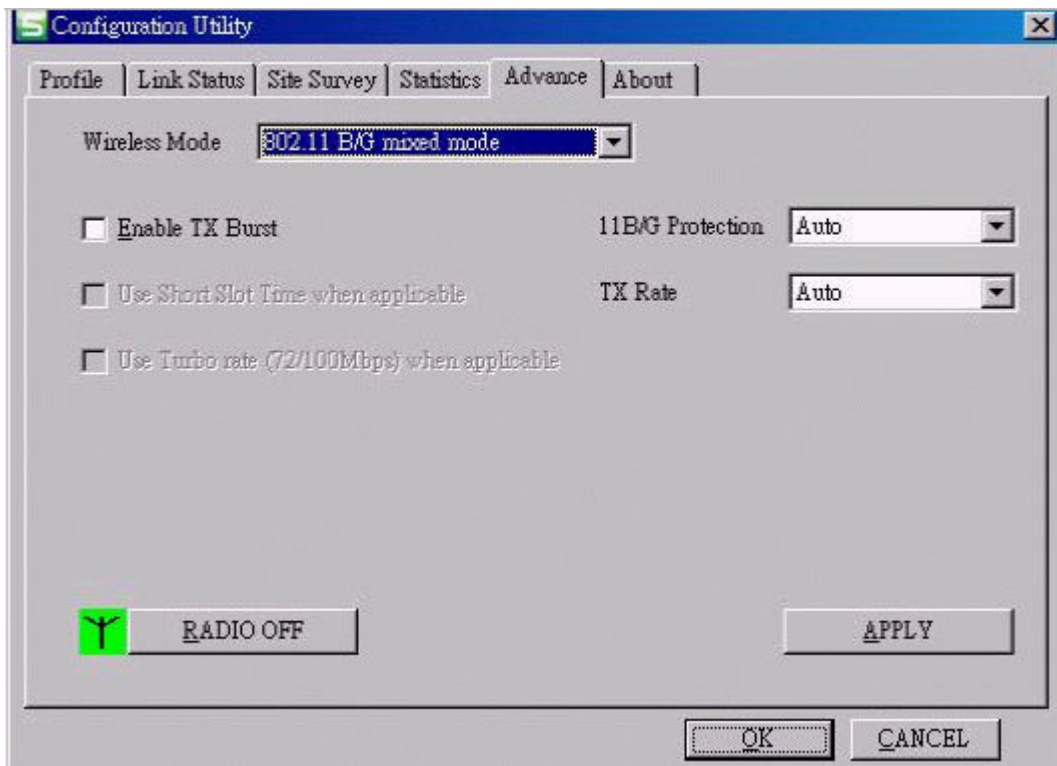

4.1.6 About

This screen shows copyright, Utility / Driver version and MAC Address of this wireless LAN Card.

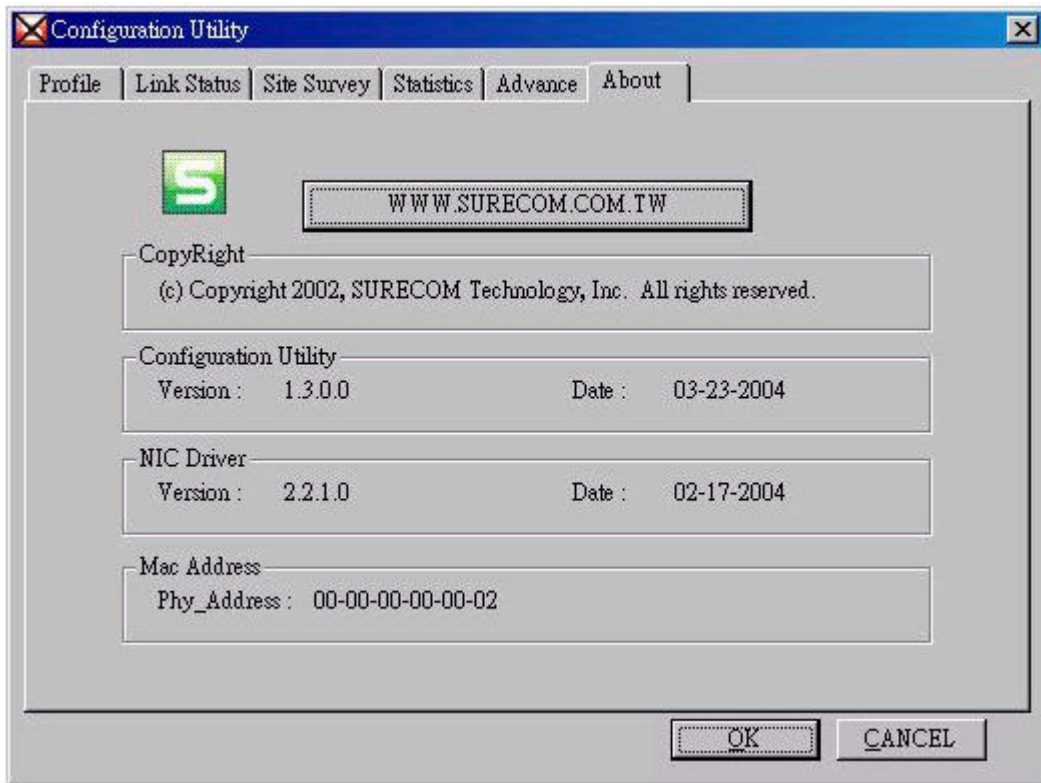

5. Glossary

Ad-Hoc Mode

An Ad-hoc integrated wireless LAN is a group of computers, each has a Wireless LAN adapter, Connected as an independent wireless LAN. Ad hoc wireless LAN is applicable at a departmental scale for a branch or SOHO operation.

BSS ID

A specific Ad hoc LAN is called a Basic Service Set (BSS). Computers in a BSS must be configured with the same BSS ID.

DSSS (Direct-Sequencing Spread-Spectrum)

DSSS operate over the radio airwaves in the unlicensed ISM band (industrial, scientific, medical). DSSS uses a radio transmitter to spread data packets over a fixed range of frequency band.

Encryption

It's a security method that applies a specific algorithm to data in order to alter the data appearance and prevent other devices from reading the information.

Firmware

Program that is inserted into programmable read-only memory (programmable read-only memory), thus becoming a permanent part of a computing device.

Fragmentation Threshold Value

Indicates how much of the network resources is devoted to recovering packet errors. The value should remain at its default setting of 2,432. If you experience high packet error rates, you can decrease this value but it will likely decrease overall network performance. Only minor modifications of this value are recommended.

Fragmentation

Breaking a packet into smaller units when transmitting over a network medium that cannot support the original size of the packet.

IEEE

The Institute of Electrical and Electronics Engineers

IEEE 802.11b/g standard

The IEEE 802.11b/g Wireless LAN standards subcommittee formulates standards for the industry. The objective is to enable wireless LAN hardware from different manufacturers to communicate.

Infrastructure Mode

A client setting provides connectivity to an Access Point. As compared to Ad-Hoc mode where PCs communicate directly with each other, clients set in Infrastructure mode all pass data through a central Access Point. The Access Point not only mediates Wireless network traffic in the immediate neighborhood but also provides communication with the wired network. An integrated wireless and wireless and wired LAN is called an Infrastructure configuration. Infrastructure is applicable to enterprise scale for wireless access to central database, or wireless application for mobile workers.

Roaming

The ability to use a wireless device is able to move from one access point range to another without losing the connection.

RTS/CTS Threshold Value

It should remain at its default setting of 2,347. A preamble is a signal used to synchronize the transmission timing between two or more systems. A series of transmission pulses is sent before the data to indicate that someone is about transmit data. This ensures that systems receiving the information correctly when the data transmission starts.

Shared Key

It's when both the sender and recipient share a secret key. Both units use this key for an extended length of time, sometimes indefinitely. Any eavesdropper that discovers the key may decipher all packets until the key is changed.

Signal Strength

The signal level indicates the strength of the signal as received at the wireless network interface.

SSID (Service Set Identifier)

It's the unique name shared among all points in a wireless network. The SSID must be identical for all points in the network. It is case sensitive and must not exceed 32 characters.

WEP (Wired Equivalent Privacy)

A data privacy mechanism based on a 40 bit shared key algorithm, as described in the IEEE 802 .11 standard. The optional cryptographic confidentiality algorithm specified by IEEE 802.11 used to provide data confidentiality that is subjectively equivalent to the confidentiality of a wired LAN medium that does not employ cryptographic techniques to enhance privacy.

WPA

Wi-Fi Protected Access, a specification to improve the security level of wireless networks. It uses 802.1x and EAP to control network access. Temporal Key Integrity Protocol (TKIP) is used to secure data during transmission.

6. Technical Support

You can find the most recent software and user documentation on the SURECOM website.

<http://www.surecom-net.com>

You also can contact SURECOM technical support through Web site, E-Mail, or by phone.

SURECOM Tech Support over the phone

886-2-8692-6200 (GMT+0800)

AM 09:00~PM 18:00, Monday~Friday

SURECOM Tech Support over Web site

<http://www.surecom-net.com/3-support.htm>

When contacting technical support, you will need the information below.

Serial number of the unit

Model number or product name

Software type and version number

FCC Statement

This device complies with FCC Rules Part 15. Operation is subject to the following two conditions:

1. This device may not cause harmful interference, and
2. This device must accept any interference received, including interference that may cause undesired operation.

This equipment has been tested and found to comply with the limits for a Class B digital device, pursuant to Part 15 of the FCC Rules. These limits are designed to provide reasonable protection against harmful interference in a residential installation. This equipment generates, uses and can radiate radio frequency energy and, if not installed and used in accordance with manufacturer's instructions, may cause harmful interference to radio communications. However, there is no guarantee that interference will not occur in a particular installation. If this equipment does cause harmful interference to radio or television reception, which can be determined by turning the equipment off and on, the user is encouraged to try to correct the interference by one or more of the following measures:

1. Re-orient or relocate the receiving antenna.
2. Increase the separation between the equipment and receiver.
3. Connect the equipment to an outlet on a circuit different from that to which the receiver is connected.
4. Consult the dealer or an experienced radio/TV technician for help.

WARNING! Any changes or modifications to this product not expressly approved by the manufacturer could void any assurances of safety or performance and could result in violation of Part 15 of the FCC Rules.

CE Declaration of conformity

This equipment complies with the requirements relating to electromagnetic compatibility, EN 55022 class B for ITE and EN 50082-1. This meets the essential protection requirements of the European Council Directive 89/336/EEC on the approximation of the laws of the Member States relating to electromagnetic compatibility.

Trademarks

All company, brand, and product names are trademarks or registered trademarks of their respective companies.

1-Year Limited Warranty

Subject to the terms and conditions set forth herein, SURECOM provides this Limited warranty for its product only to the person or entity that originally purchased the product from SURECOM or its authorized reseller or distributor. SURECOM warrants that the hardware portion of the SURECOM products described below will be free from material defects in workmanship and materials from the date of original retail purchase of the product, for the period set forth below applicable to the product type (warranty Period, except as otherwise stated herein.

1-Year Limited Warranty for the Product(s) is defined as follows:

- *Hardware (excluding power supplies and fans) One (1) Year
- *Power supplies, fans, and cables are covered by a standard one-year warranty from date of purchase.
- *Spare parts and spare kits Ninety (90) days
- *Software portion of the product (Software Ninety (90) days)