



EMI TEST REPORT

JQA APPLICATION NO. : 400-30690

Model No. : B41TG

Type of Equipment : RKE Transmitter

Regulations Applied : CFR 47 FCC Rules and Regulations Part 15

FCC ID : MOZB41TG

Applicant : Tokai Rika Co., Ltd.

Address : 260, Toyota 3-chome, Oguchi-cho, Niwa-gun,
Aichi-ken 480-0195, Japan

Manufacture : Tokai Rika Co., Ltd.

Address : 260, Toyota 3-chome, Oguchi-cho, Niwa-gun,
Aichi-ken 480-0195, Japan

Received date of EUT : December 9, 2003

Final Judgment : Passed

Test results in this report are obtained in use of equipment that is traceable to National Institute of Advanced Industrial Science and Technology (AIST) of Japan and Communication Research Laboratory (CRL) of Japan.

The test results only respond to the tested sample. This report should not be reproduced except in full, without the written approval of JQA EMC Engineering Dept. Testing Div.

TABLE OF CONTENTS

	Page
1 Documentation	
1.1 Test Regulation	<u>3</u>
1.2 General Information	<u>3</u>
1.3 Test Condition	<u>4 - 8</u>
1.4 EUT Modifications / Deviation from Standard	<u>9</u>
1.5 Test results	<u>10</u>
1.6 Summary	<u>11</u>
1.7 Test Configuration / Operation of EUT	<u>12</u>
1.8 EUT Arrangement(Drawing)	<u>13</u>
1.9 Preliminary Test and Test-setup (Drawings)	<u>14 - 19</u>
1.10 EUT Arrangement (Photographs)	<u>20 - 21</u>
2 Test Data	
2.1 AC Power Line Conducted Emission	<u>N/A</u>
2.2 Radiated Emission (Electric Field)	<u>22 - 25</u>
2.3 Frequency Stability	<u>N/A</u>
2.4 Occupied Bandwidth	<u>26 - 27</u>
3 Appendix	
Test instruments List	<u>28 - 31</u>

1 DOCUMENTATION**1.1 TEST REGULATION**

FCC Rules and Regulations Part 15 Subpart A and C Intentional Radiators

Test procedure :

AC power line conducted emission, radiated emission, frequency stability and occupied bandwidth tests were performed according to the procedures in ANSI C63.4-2001.

1.2 GENERAL INFORMATION**1.2.1 Test facility :**

- 1) Test Facility located at EMC Engineering Dept. Testing Div. :
 - No.2 and 3 Anechoic Chambers(3 meters Site).
 - Shielded Enclosure.

Expiration date of FCC test facility filing : May 27, 2005

- 2) EMC Engineering Dept. Testing Div. is recognized under the National Voluntary Laboratory accreditation Program for satisfactory compliance established in title 15, Part 285 Code of Federal Regulations.

NVLAP Lab Code : 200189-0 (Effective through : June 30, 2004)

1.2.2 Description of the Equipment Under Test (EUT) :

- | | |
|--------------------------------------|---------------------------------------|
| 1) Type of Equipment | : RKE Transmitter |
| 2) Product Type | : Production |
| 3) Category | : Security/Remote Control Transmitter |
| 4) EUT Authorization | : Certification |
| 5) FCC ID | : MOZB41TG |
| 6) Trade Name | : - |
| 7) Model No. | : B41TG |
| 8) Operating Frequency Range | : 312.15 MHz |
| 9) Highest Frequency Used in the EUT | : 312.15 MHz |
| 10) Serial No. | : None |
| 11) Date of Manufacture | : None |
| 12) Power Rating | : DC 3.0V(Battery) |
| 13) EUT Grounding | : None |

1.2.3 Definitions for symbols used in this test report :

- x - indicates that the listed condition, standard or equipment is applicable for this report.
- indicates that the listed condition, standard or equipment is not applicable for this report.

1.3 TEST CONDITION

1.3.1 The measurement of the AC Power Line Conducted Emission

- was performed in the following test site.

- was not applicable.

Test location :

Safety & EMC Center EMC Engineering Dept. Testing Div.
21-25, Kinuta 1-chome, Setagaya-ku, Tokyo 157-8573, Japan

- Shielded Enclosure

- Anechoic Chamber No. 2 (portable Type)

Used test instruments :

Type

Number of test instruments (Refer to Appendix)

Test Receiver

Spectrum Analyzer

Cable

AMN(for EUT)

AMN(for Peripheral)

Termination

COPY

1.3.2 The measurement of the Radiated Emission(9 kHz - 30 MHz)

 - was performed in the following test site.

 x - was not applicable.

Test location :

Safety & EMC Center EMC Engineering Dept. Testing Div.
21-25, Kinuta 1-chome, Setagaya-ku, Tokyo 157-8573, Japan

 - Anechoic Chamber No. 2 (3 meters)

 - Anechoic Chamber No. 3 (3 meters)

Validation of Site Attenuation :

1) Last Confirmed Date : N/A

2) Interval : N/A

Used test instruments :**Type**

Number of test instruments
(Refer to Appendix)

Test Receiver

Antenna

Cable

COPIED

1.3.3 The measurement of the Radiated Emission(30 MHz - 1000 MHz)

 x - was performed in the following test site.

 - was not applicable.

Test location :

Safety & EMC Center EMC Engineering Dept. Testing Div.
21-25, Kinuta 1-chome, Setagaya-ku, Tokyo 157-8573, Japan

 x - Anechoic Chamber No. 2 (3 meters)

 - Anechoic Chamber No. 3 (3 meters)

Validation of Site Attenuation :

1) Last Confirmed Date :March, 2003

2) Interval :1 year

Used test instruments :

Type	Number of test instruments (Refer to Appendix)
Test Receiver	TR05
Antenna	AN06, AN08
Cable	CA01
RF Amplifier	N/A

1.3.4 The measurement of the Radiated Emission(Above 1000 MHz)

 x - was performed in the following test site.

 - was not applicable.

Test location :

Safety & EMC Center EMC Engineering Dept. Testing Div.
21-25, Kinuta 1-chome, Setagaya-ku, Tokyo 157-8573, Japan

 x - No. 2 site (3 meters)

 - No. 3 site (3 meters)

Validation of Site Attenuation :

1) Last Confirmed Date :March, 2003

2) Interval :1 year

Used test instruments :**Type****Number of test instruments
(Refer to Appendix)**

Test Receiver

TR07

Spectrum Analyzer

N/A

Cable

CA09, CA13

Antenna

AN10

RF Amplifier

AM09

Band Reject Filter

N/A

High Pass Filter

N/A

1.3.5 The measurement of the Frequency Stability

 - was performed.

 x - was not applicable.

Used test instruments :

Type	Number of test instruments (Refer to Appendix)
Frequency Counter	
Oven	
DC Power Supply	

1.3.6 The measurement of the Occupied Bandwidth

 x - was performed.

 - was not applicable.

Used test instruments :

Type	Number of test instruments (Refer to Appendix)
Test Receiver	N/A
Spectrum Analyzer	SA04
Cable	CA09
Antenna	AN08

1.4 EUT MODIFICATION / Deviation from Standard

1.4.1 EUT MODIFICATION

- No modifications were conducted by JQA to achieve compliance to Class B levels.
 -To achieve compliance to Class B levels, the following changes were made by JQA during the compliance test.

The modifications will be implemented in all production models of this equipment.

Applicant :

Date :

Typed Name :

Position :

1.4.2 Deviation from Standard:

- No deviations from the standard described in clause 1.1.
 - The following deviations were employed from the standard described in clause 1.1:

1.6 SUMMARY**General Remarks :**

The EUT was tested according to the requirements of FCC Rules and Regulations Part 15 Subpart A and C under the test configuration, as shown in clause 1.7 to 1.10. The conclusion for the test items which are required by the applied regulation is indicated under the final judgment.

Final Judgment :

The "as received" sample;

- x - fulfill the test requirements of the regulation mentioned on clause 1.1.
- fulfill the test requirements of the regulation mentioned on clause 1.1, but with certain qualifications.
- doesn't fulfill the test regulation mentioned on clause 1.1.

Begin of testing : December 16, 2003

End of testing : December 16, 2003

- JAPAN QUALITY ASSURANCE ORGANIZATION -

Approved by:

Signatories:

Issued by:



Masaaki Takahashi
Senior Manager
JQA EMC Engineering Dept.



Shigeru Osawa
Assistant Manager
JQA EMC Engineering Dept.

1.7 TEST CONFIGURATION / OPERATION OF EUT**1.7.1 Test Configuration**

The equipment under test (EUT) consists of :

Item	Manufacturer	Model No.	FCC ID	Serial No.
RKE Transmitter	Tokai Rika Co., Ltd.	B41TG	MOZB41TG	None

1.7.2 Operating condition

Power supply Voltage : 3.0 VDC(Battery)

The tests have been carried out under the transmitting condition.

1.7.3 Generating and Operating frequency of EUT

312.15 MHz

COPY

1.8 EUT ARRANGEMENT (DRAWINGS)

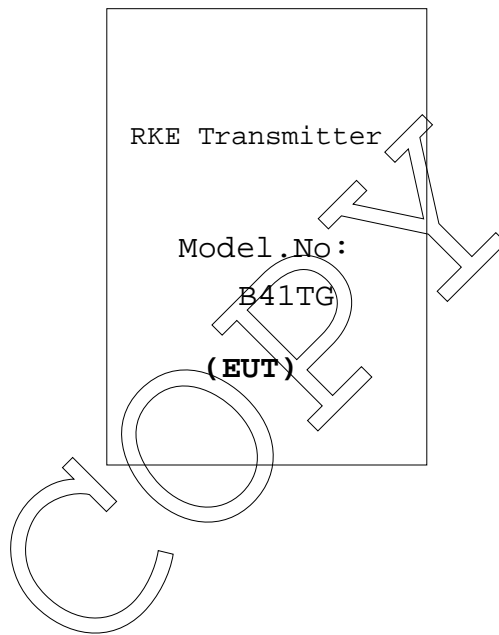

1.9 PRELIMINARY TEST AND TEST-SETUP (DRAWINGS)

1.9.1 AC Power Line Conducted Emission (150 kHz - 30 MHz) :

According to description of ANSI C63.4-2001 sec.13.1.3, the AC power line preliminary conducted emissions measurements were carried out.

The preliminary conducted measurements were performed using the spectrum analyzer to observe the emission characteristics of the EUT.

The EUT configuration, cable configuration and mode of operation were determined for producing the maximum level of emissions. These configurations were used for final AC power line conducted emissions measurements.

Shielded Enclosure

- Side View -

Vertical
Ground
Plane

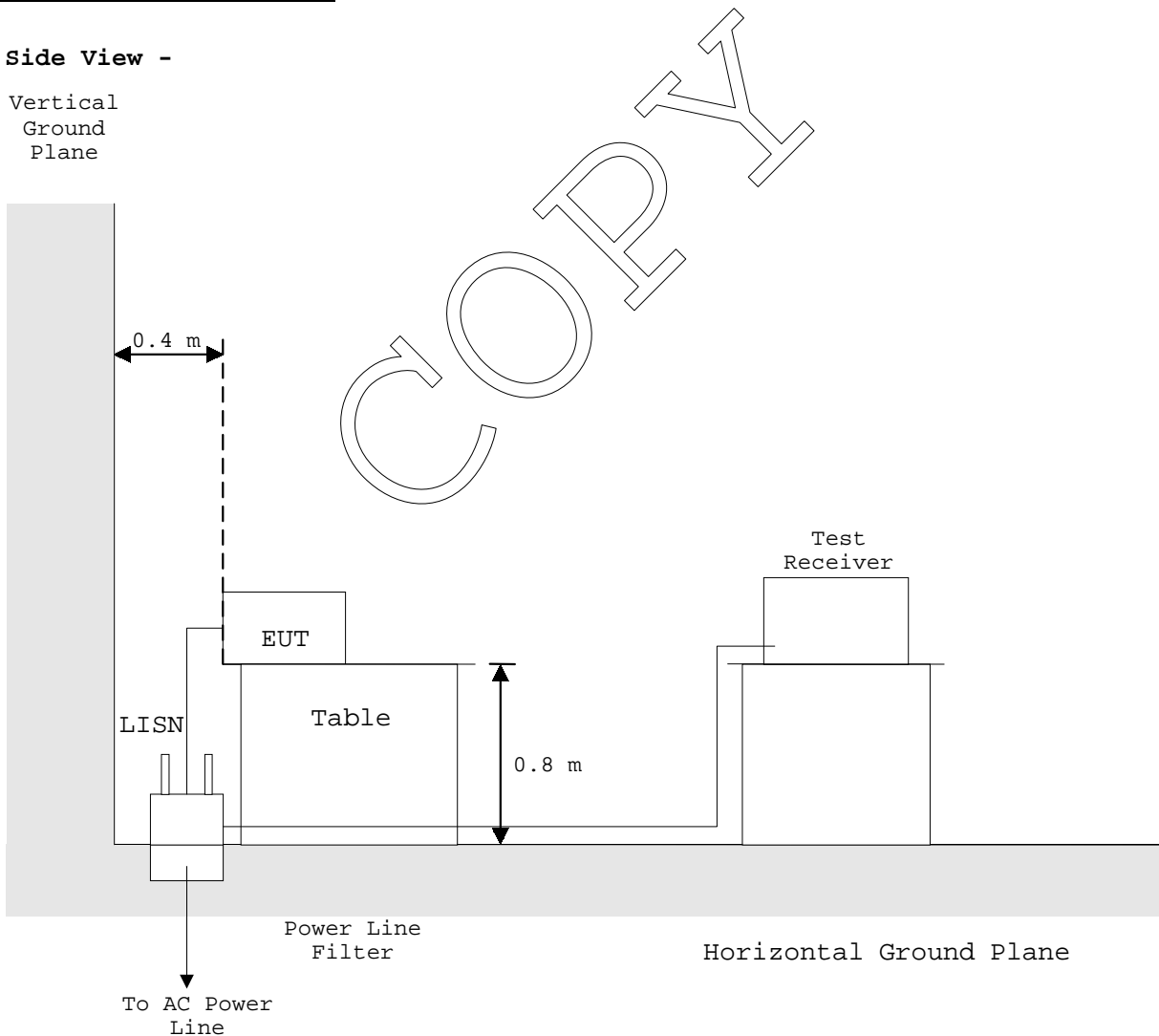

1.9.2 Radiated Emission (9 kHz - 30 MHz) :

According to description of ANSI C63.4-2001 sec.13.1.4, the preliminary radiated emissions measurement were carried out. The preliminary radiated measurements were performed at the measurement distance that specified for compliance to determine the emission characteristics of the EUT.

The EUT configuration, cable configuration and mode of operation were determined for producing the maximum level of emissions. These configurations were used for the final radiated emissions measurements.

- Side View -

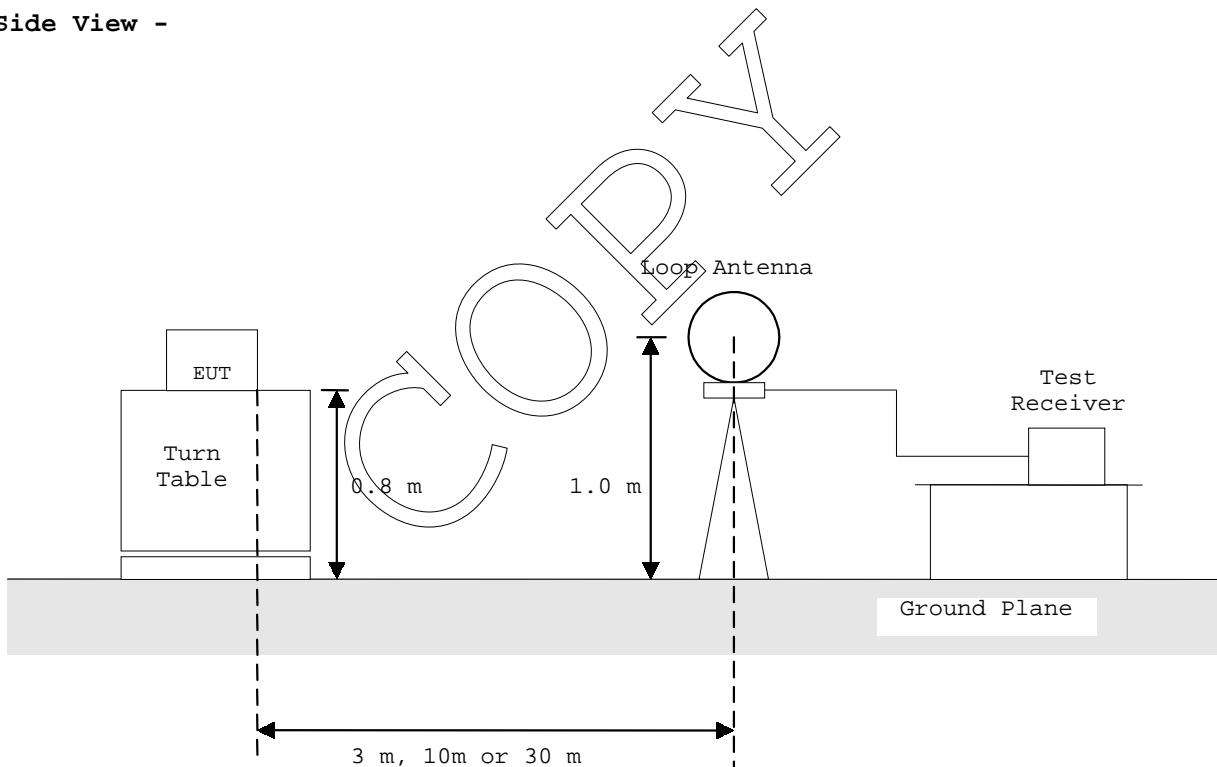

1.9.3 Radiated Emission (30 MHz - 1000 MHz) :

According to description of ANSI C63.4-2001 sec.13.1.4, the preliminary radiated emissions measurement were carried out. The preliminary radiated measurements were performed at the measurement distance that specified for compliance to determine the emission characteristics of the EUT.

The EUT configuration, cable configuration and mode of operation were determined for producing the maximum level of emissions. These configurations were used for the final radiated emissions measurements.

Anechoic Chamber

- Side View -

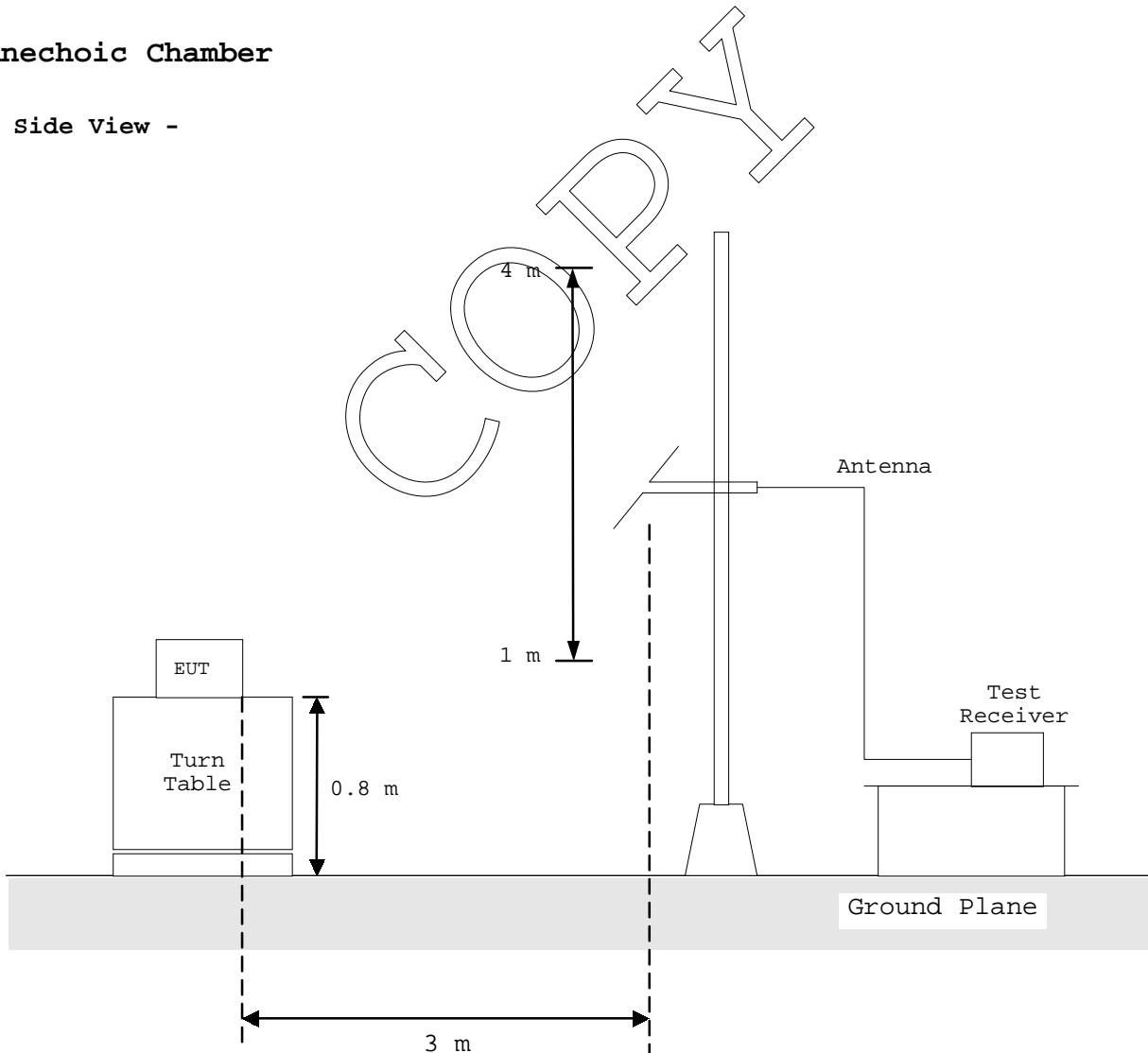

1.9.4 Radiated Emission (Above 1 GHz) :

According to description of ANSI C63.4-2001 sec.13.1.4, the preliminary radiated emissions measurements were carried out. The preliminary radiated measurements were performed at the measurement distance that specified for compliance to determine the emission characteristics of the EUT.

The EUT configuration, cable configuration and mode of operation were determined for producing the maximum level of emissions. These configurations were used for the final radiated emissions measurements.

Anechoic Chamber

- Side View -

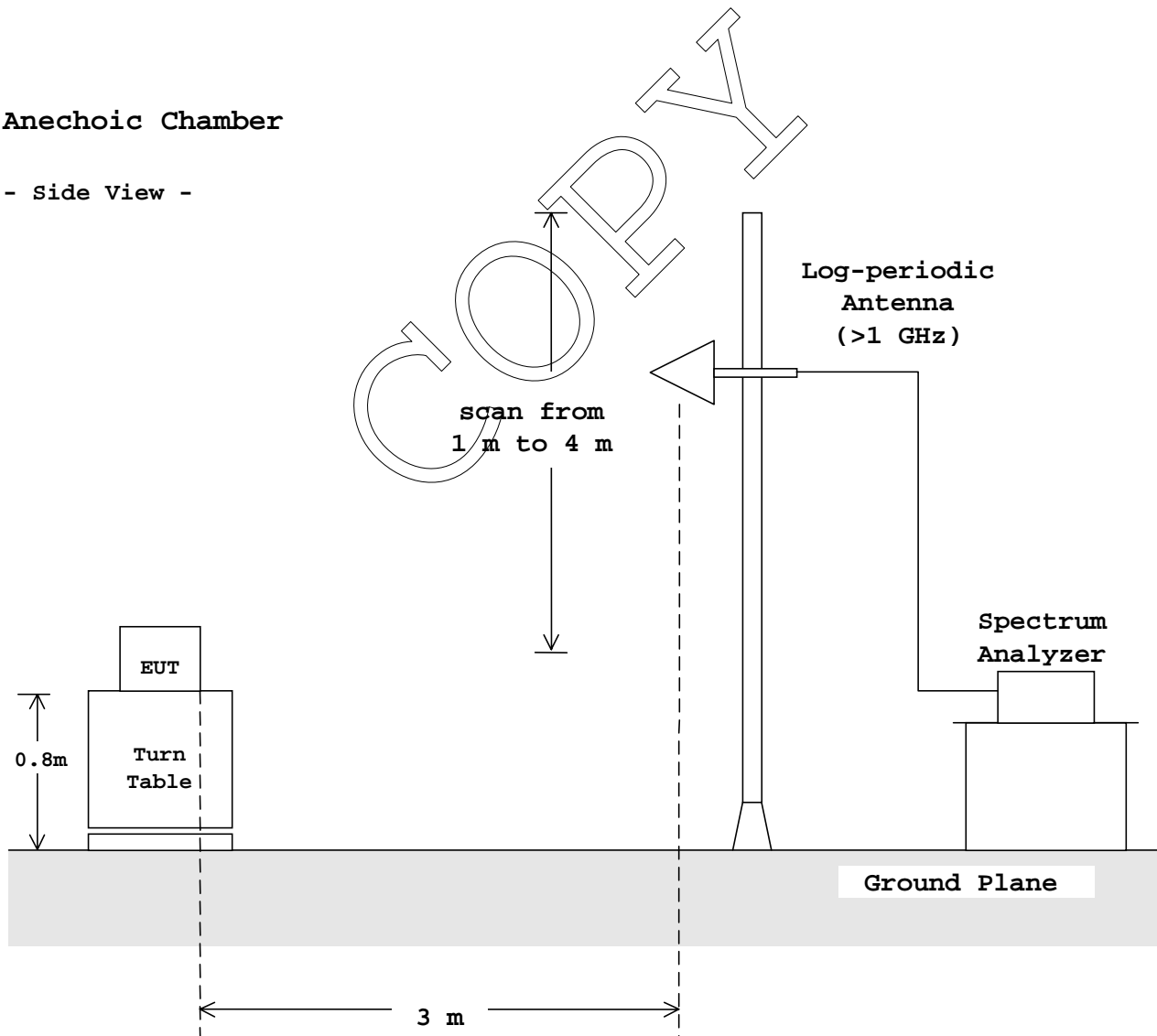

1.9.5 Frequency Stability :

According to description of ANSI C63.4-2001 sec.13.1.5 and sec.13.1.6, the frequency stability measurements were carried out. By using frequency counter with suitable RF amplifier, the carrier frequency of the transmitter under test was measured with a temperature variation of -20°C to $+50^{\circ}\text{C}$ at the normal supply voltage, and if required, with a variation in the primary voltage from 85 % to 115 % the rated supply voltage at the temperature of $+20^{\circ}\text{C}$.

These measurements were carried out after allow sufficient time (approximately 1 hour) for the temperature of the chamber to stabilize.

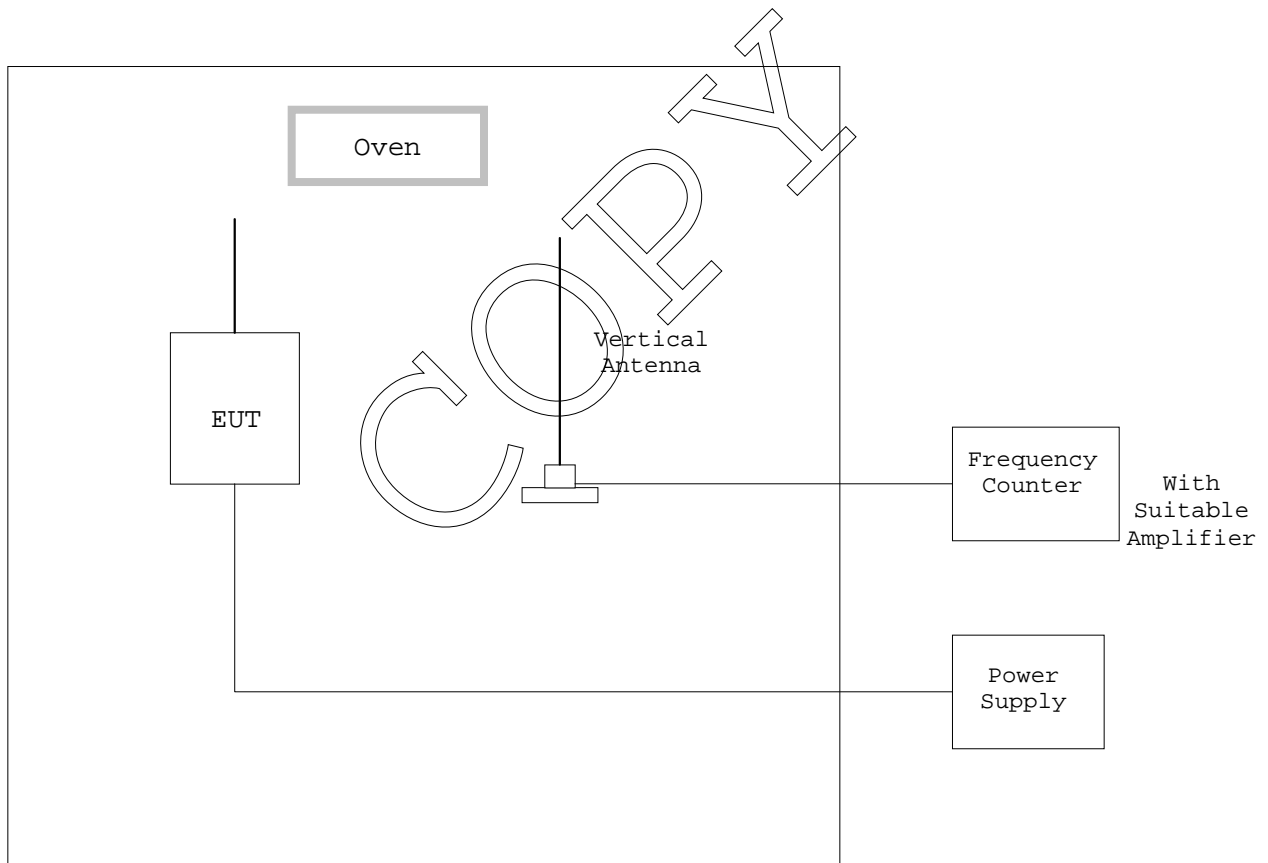

1.9.6 Occupied Bandwidth :

According to description of ANSI C63.4-2001 sec.13.1.7, the occupied bandwidth measurements were carried out. By using a spectrum analyzer with a vertical antenna for picking up the signal, the measurements of the emission were made under the transmitting modes of the EUT.

The resolution bandwidth of spectrum analyzer was set to the value specified in sec.13.1.7.

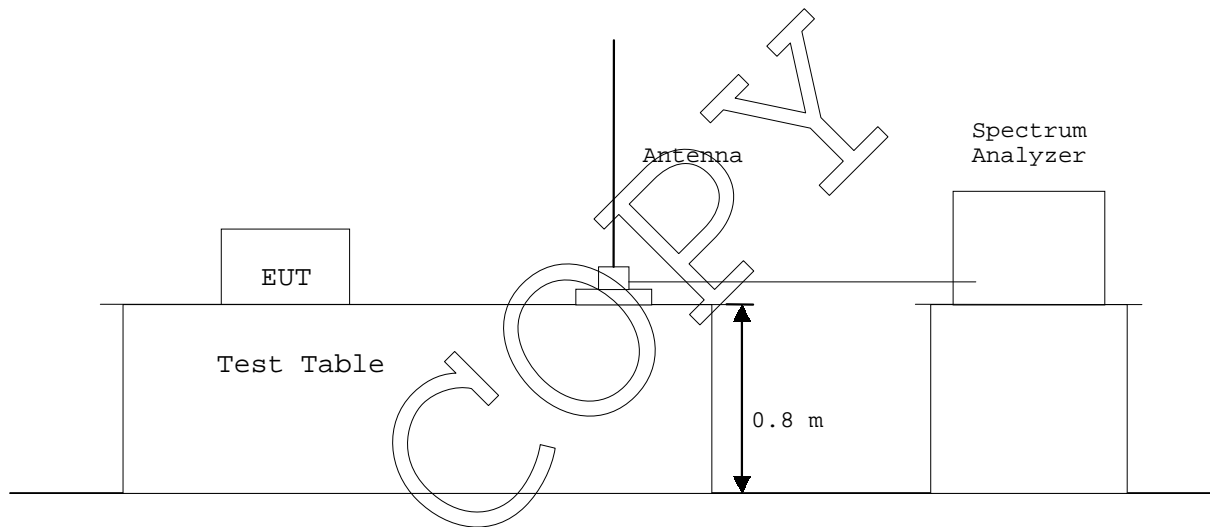

1.10 TEST ARRANGEMENT (PHOTOGRAPHS)**PHOTOGRAPHS OF EUT CONFIGURATION FOR RADIATED EMISSIONS MEASUREMENT**

Photograph present configuration with maximum emission





COPY

2.TEST DATA

2.1 AC Power Line Conducted Emissions

Note : This test was not applicable.

2.2 Radiated Emissions Measurement

Operating Frequency : 312.15 MHz
 Distance of Measurement : 3.0 meters

Date : December 16, 2003

Temp. : 23 °C Humi. : 43 %

Frequ- ency (MHz)	P-A Factor (dB)	Correction Factor (dB)	Polari- zation	Meter Reading (dBuV)			Limits (dBuV/m)		Emission Levels (dBuV/m)		Margins (dB)	
				QP	AV	Peak	QP/AV	Peak	QP/AV	Peak	QP/AV	Peak
312.2	-5.3	18.1	H	-	-	52.0	75.5	95.5	64.8	70.1	10.7	25.4
624.3	-5.3	23.6	V	-	-	26.5	55.5	75.5	44.8	50.1	10.7	25.4
936.5	-5.3	27.3	V	-	-	24.7	55.5	75.5	46.7	52.0	8.8	23.5

Notes :

- 1) The spectrum was checked from 30 MHz to 1000 MHz.
- 2) The cable loss, amp. gain and antenna factor are included in the correction factor.
- 3) The symbol of "<" means "or less".
- 4) The symbol of ">" means "or greater".
- 5) A sample calculation(QP/AV) was made at 312.15 (MHz).
 $PA + Af + Mr = -5.3 + 18.1 + 52(\text{Peak}) = 64.8 \text{ (dBuV/m)}$
 PA = Peak to Average Factor(P-A Factor)
 Af = Antenna Factor
 Mr = Meter Reading
- 6) Measuring Instrument Setting :

Detector function	Resolution Bandwidth	Video Bandwidth
Quasi-peak(QP)	120 kHz	-
Average(AV)	1 MHz	10 Hz
Peak	1 MHz	1 MHz

Frequency (GHz)	P-A Factor (dB)	Correction Factor (dB)	Polarization	Meter Reading (dBuV)		Limits (dBuV/m)		Emission Levels (dBuV/m)		Margins (dB)	
				AV	Peak	AV	Peak	AV	Peak	AV	Peak
1.2486	-5.3	-4.4	H	-	52.3	55.5	75.5	42.6	47.9	12.9	27.6
1.5608	-5.3	-1.6	H	-	45.3	54.0	74.0	38.4	43.7	15.6	30.3
1.8729	-5.3	-0.4	H	-	50.2	55.5	75.5	44.5	49.8	11.0	25.7
2.1851	-5.3	1.8	H	-	49.0	55.5	75.5	45.5	50.8	10.0	24.7
2.4972	-5.3	2.3	H	-	46.4	54.0	74.0	43.4	48.7	10.6	25.3
2.8094	-5.3	3.5	V	-	46.5	54.0	74.0	44.7	50.0	9.3	24.0
3.1215	-5.3	4.8	V	-	47.3	55.5	75.5	46.8	52.1	8.7	23.4

- Notes :
- 1) The spectrum was checked from 1.0 GHz to tenth harmonics.
 - 2) The cable loss, amp. gain and antenna factor are included in the correction factor.
 - 3) The symbol of "<" means "or less".
 - 4) The symbol of ">" means "or greater".
 - 5) A sample calculation(AV) was made at 1.2486 (GHz).
 $PA + Cf + Mr = -5.3 + -4.4 + 52.3(\text{Peak}) = 42.6 \text{ (dBuV/m)}$
 PA = Peak to Average Factor(P-A Factor)
 Cf = Correction Factor
 Mr = Meter Reading

6) Measuring Instrument Setting :

Detector function	Resolution Bandwidth	Video Bandwidth
Average(AV)	1 MHz	-
Peak	1 MHz	-

Tested by : Y. Nakajima
 Yoichi Nakajima
 Testing Engineer

RADIATED EMISSION MEASUREMENT

Model No. : B41TG

Standard : CFR 47 FCC Rules Part 15 QP/AV
Operating Frequency(MHz) : 312.15

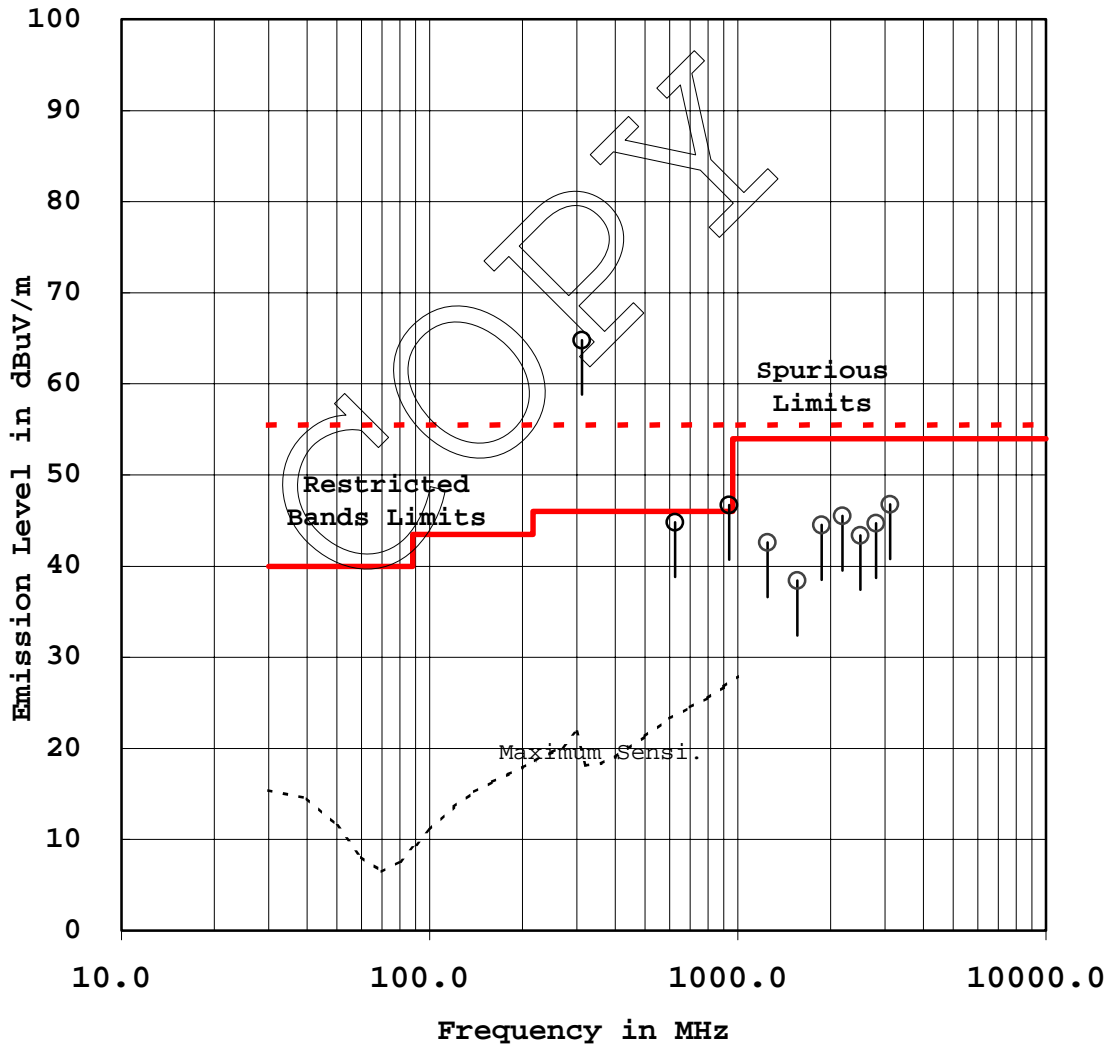

Holdover time after manual release[§15.231(a)(1)]

Max. 100.8 ms

(Manufacturer designed)

The encoded waveform in the time domain

FCC ID : MOZB41TG

Model : B41TG

Mode of EUT : Transmit

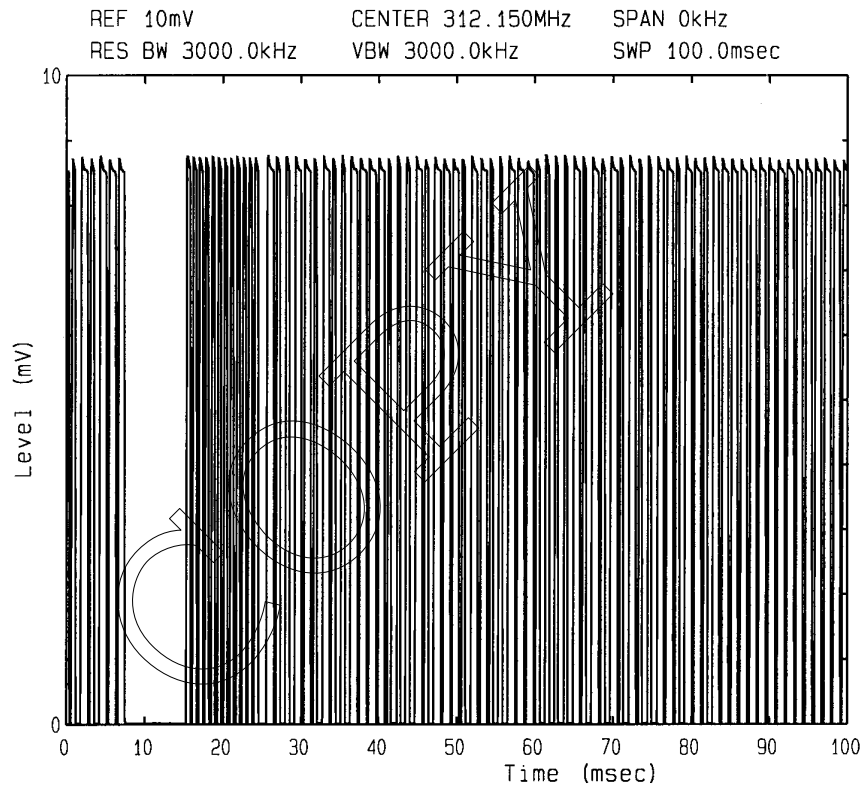

The above waveform indicates the case when field strength averaged over 100 milliseconds was maximum value. In order to obtain the peak to average factor, calculation of the period of total on-time was computed by personal computer. Results was obtained by following.

$$\begin{aligned} \text{Duty cycle} &= (\text{Maximum total on-time} / 100 \text{ msec}) \times 100 \\ &= (54.3 \text{ msec} / 100 \text{ msec}) \times 100 = 54.3 \% \end{aligned}$$

Therefore

$$\text{Factor is } 20\log(0.5430) = -5.3 \text{ dB}$$

2.3 Frequency Stability

Note : This test was not applicable.

2.4 Occupied Bandwidth Measurement

Date : December 16, 2003

Temp. : 20 °C Humi. : 40 %

Measurements Results :

Specified Limits : 0.25 % of the fundamental frequency
312.15 MHz x 0.0025 = 780.375 kHz

Refer to the attached graphs.

COPY

Tested by :

Shigeru Osawa

Shigeru Osawa

Testing Engineer

Emission Limitation

FCC ID : MOZB41TG

Model : B41TG

Mode of EUT : Transmit

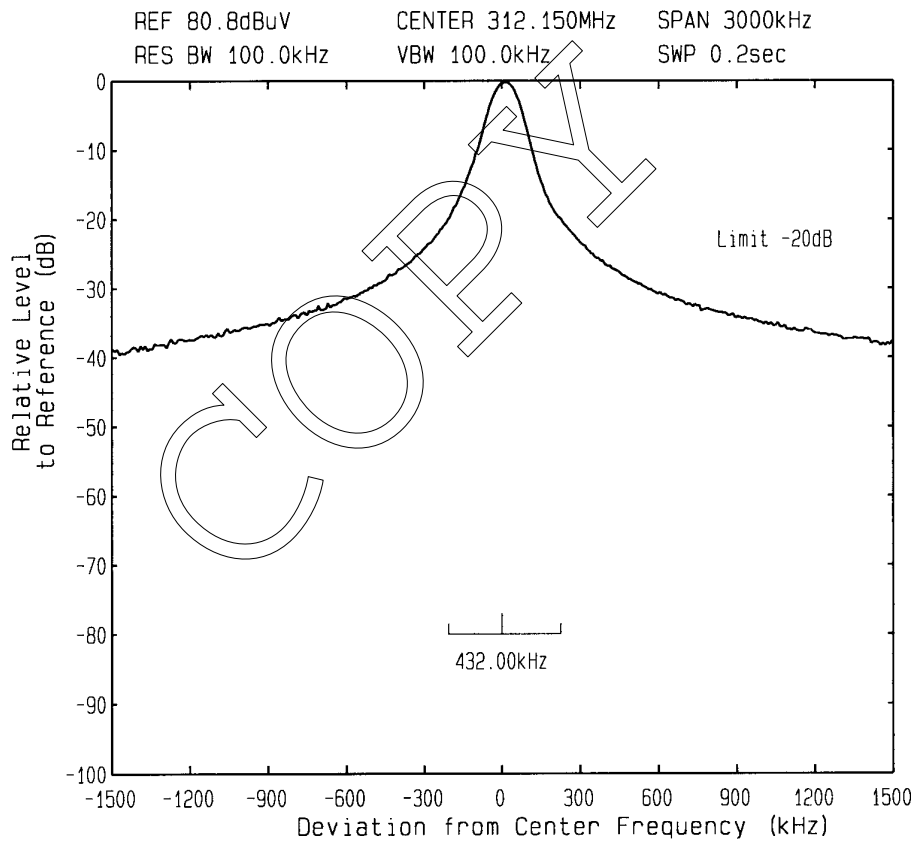

Appendix

Test Instruments List

COPY

December 13, 2003

Test Receivers

No.	Type	Model	Manufacturer	Serial	ID	Last Cal.	Interval
TR01	Test Receiver	ESH2	Rohde & Schwarz	880370/016	119-01-503E0	May 2003	1 Year
TR02	Test Receiver	ESH3	Rohde & Schwarz	881460/030	119-01-023E0	May 2003	1 Year
TR03	Test Receiver	ESHS10	Rohde & Schwarz	835871/004	119-01-505E0	May 2003	1 Year
TR04	Test Receiver	ESV	Rohde & Schwarz	872148/039	119-03-008E0	May 2003	1 Year
TR05	Test Receiver	ESVS10	Rohde & Schwarz	826148/002	119-03-504E0	May 2003	1 Year
TR06	Test Receiver	ESVS10	Rohde & Schwarz	832699/001	119-03-506E0	May 2003	1 Year
TR07	Test Receiver	ESI26	Rohde & Schwarz	100043	119-04-511E0	Aug. 2003	1 Year

Spectrum Analyzers

No.	Type	Model	Manufacturer	Serial	ID	Last Cal.	Interval
SA01	Spectrum Analyzer	8560E	Hewlett Packard	3240A00189	122-02-504E0	Oct. 2003	1 Year
SA02	Spectrum Analyzer	8566B	Hewlett Packard	2140A01091	122-02-501E0	Oct. 2003	1 Year
SA03	RF Pre-selector	85685A	Hewlett Packard	2648A00522	122-02-503E0	Oct. 2003	1 Year
SA04	Spectrum Analyzer	8566B	Hewlett Packard	2747A05855	122-02-517E0	Apr. 2003	1 Year
SA05	RF Pre-selector	85685A	Hewlett Packard	2901A00933	122-02-519E0	Apr. 2003	1 Year
SA06	Spectrum Analyzer	R3132	ADVANTEST	120500072	122-02-520E0	Sep. 2003	1 Year
SA07	Spectrum Analyzer	R3182	ADVANTEST	120600581	122-02-521E0	Feb. 2003	1 Year

Antennas

No.	Type	Model	Manufacturer	Serial	ID	Last Cal.	Interval
AN01	Loop Antenna	HFH2-Z2	Rohde & Schwarz	881058/62	119-05-033E0	Jun. 2003	1 Year
AN02	Dipole Antenna	KBA-511	Kyoritsu	0-170-1	119-05-506E0	Nov. 2003	1 Year
AN03	Dipole Antenna	KBA-511A	Kyoritsu	0-201-13	119-05-504E0	Nov. 2003	1 Year
AN04	Dipole Antenna	KBA-611	Kyoritsu	0-147-14	119-05-507E0	Nov. 2003	1 Year
AN05	Dipole Antenna	KBA-611	Kyoritsu	0-201-5	119-05-505E0	Nov. 2003	1 Year
AN06	Biconical Antenna	BBA9106	Schwarzbeck	VHA91031150	119-05-111E0	Nov. 2003	1 Year
AN07	Biconical Antenna	BBA9106	Schwarzbeck	-	119-05-078E0	Nov. 2003	1 Year
AN08	Log-peri. Antenna	UHALP9107	Schwarzbeck	-	119-05-079E0	Nov. 2003	1 Year
AN09	Log-peri. Antenna	UHALP9107	Schwarzbeck	-	119-05-110E0	Nov. 2003	1 Year
AN10	Log-peri. Antenna	HL025	Rohde & Schwarz	340182/015	119-05-100E0	Jan. 2003	1 Year
AN11	Horn Antenna	3115	EMC Test Systems	6442	119-05-514E0	Jan. 2003	1 Year
AN12	Horn Antenna	3116	EMC Test Systems	2547	119-05-515E0	May 2003	1 Year

Networks

No.	Type	Model	Manufacturer	Serial	ID	Last Cal.	Interval
NE01	LISN	KNW-407	Kyoritsu	8-833-6	149-04-052E0	Apr. 2003	1 Year
NE02	LISN	KNW-407	Kyoritsu	8-855-2	149-04-055E0	Apr. 2003	1 Year
NE03	LISN	KNW-407	Kyoritsu	8-1130-6	149-04-062E0	Apr. 2003	1 Year
NE04	LISN	KNW-242C	Kyoritsu	8-837-13	149-04-054E0	Apr. 2003	1 Year

Cables

No.	Type	Model	Manufacturer	Serial	ID	Last Cal.	Interval
CA01	RF Cable	5D-2W	Fujikura	-	155-21-001E0	Feb. 2003	1 Year
CA02	RF Cable	5D-2W	Fujikura	-	155-21-002E0	Feb. 2003	1 Year
CA03	RF Cable	3D-2W	Fujikura	-	155-21-005E0	Apr. 2003	1 Year
CA04	RF Cable	3D-2W	Fujikura	-	155-21-006E0	Apr. 2003	1 Year
CA05	RF Cable	3D-2W	Fujikura	-	155-21-007E0	Apr. 2003	1 Year
CA06	RF Cable	RG-213/U	Rohde & Schwarz	-	155-21-010E0	Apr. 2003	1 Year
CA07	RF Cable(10m)	S 04272B	Suhner	-	155-21-011E0	May 2003	1 Year
CA08	RF Cable(2m 18GHz)	SUCOFLEX 104	Suhner	-	155-21-012E0	May 2003	1 Year
CA09	RF Cable(1m 18GHz)	SUCOFLEX 104	Suhner	-	155-21-013E0	May 2003	1 Year
CA10	RF Cable(1m N)	S 04272B	Suhner	-	155-21-015E0	May 2003	1 Year
CA11	RF Cable(1m 26GHz)	SUCOFLEX 104	Suhner	182811/4	155-21-016E0	Dec. 2003	1 Year
CA12	RF Cable(4m 26GHz)	SUCOFLEX 104	Suhner	190630	155-21-017E0	Dec. 2003	1 Year
CA13	RF Cable(10m)	F130-S1S1-394	MEGA PHASE	10510	155-21-018E0	Dec. 2003	1 Year

Amplifiers

No.	Type	Model	Manufacturer	Serial	ID	Last Cal.	Interval
AM01	AF Amplifier	P-500L	Accuphase	BOY806	127-01-501E0	Feb. 2003	1 Year
AM02	RF Amplifier	8447D	Hewlett Packard	1937A02168	127-01-065E0	May 2003	1 Year
AM03	RF Amplifier	8447D	Hewlett Packard	2944A07289	127-01-509E0	May 2003	1 Year
AM05	RF Amplifier	DBP-0102N553	DBS Microwave	012	127-02-504E0	Jun. 2003	1 Year
AM06	RF Amplifier	WJ-6882-814	Watkins-Johnson	0414	127-04-017E0	Jun. 2003	1 Year
AM07	RF Amplifier	WJ-5315-556	Watkins-Johnson	106	127-04-006E0	Jun. 2003	1 Year
AM08	RF Amplifier	WJ-5320-307	Watkins-Johnson	645	127-04-005E0	Jun. 2003	1 Year
AM09	RF Amplifier	JS4-00102600 -28-5A	MITEQ	669167	127-04-502E0	Apr. 2003	1 Year

Signal Generators

No.	Type	Model	Manufacturer	Serial	ID	Last Cal.	Interval
SG01	Function Generator	3325B	Hewlett Packard	2847A03284	118-08-124E0	Jul. 2003	1 Year
SG02	Function Generator	VP-7422A	Matsushita Communication	050351E122	118-08-503E0	Jul. 2003	1 Year
SG03	Signal Generator	8664A	Hewlett Packard	3035A00140	118-03-014E0	Jun. 2003	1 Year
SG04	Signal Generator	8664A	Hewlett Packard	3438A00756	118-04-502E0	Jun. 2003	1 Year
SG05	Signal Generator	6061A	Gigatronics	5130593	118-04-024E0	Mar. 2003	1 Year

Auxiliary Equipment

No.	Type	Model	Manufacturer	Serial	ID	Last Cal.	Interval
AU01	Termination(50)	-	Suhner	-	154-06-501E0	Jan. 2003	1 Year
AU02	Termination(50)	-	Suhner	-	154-06-502E0	Jan. 2003	1 Year
AU03	Power Meter	436A	Hewlett Packard	1725A01930	100-02-501E0	Apr. 2003	1 Year
AU04	Power Sensor	8482A	Hewlett Packard	1551A01013	100-02-501E0	Apr. 2003	1 Year
AU05	Power Sensor	8485A	Hewlett Packard	2942A08969	100-04-021E0	Apr. 2003	1 Year
AU06	FM Linear Detector	MS61A	Anritsu	M77486	123-02-008E0	Oct. 2003	1 Year
AU07	Level Meter	ML422C	Anritsu	M87571	114-02-501E0	Jun. 2003	1 Year
AU08	Measuring Amplifier	2636	B & K	1614851	082-01-502E0	Jul. 2003	1 Year
AU09	Microphone	4134	B & K	1269477	147-01-503E0	May 2003	1 Year
AU10	Preamplifier	2639	B & K	1268763	127-01-504E0	May 2003	1 Year
AU11	Pistonphone	4220	B & K	1165008	147-02-501E0	Mar. 2003	1 Year
AU12	Artificial Mouth	4227	B & K	1274869	-	N/A	N/A
AU13	Frequency Counter	53131A	Hewlett Packard	3546A11807	102-02-075E0	May 2003	1 Year
AU14	Oven	-	Ohnishi	-	023-02-018E0	May 2003	1 Year
AU15	DC Power Supply	6628A	Hewlett Packard	3224A00284	072-05-503E0	Jun. 2003	1 Year
AU16	Band Reject Filter	BRM12294	Micro-tronics	003	149-01-501E0	Jan. 2003	1 Year
AU17	High Pass Filter	F-100-4000-5-R	RLC Electronics	0149	149-01-502E0	Feb. 2003	1 Year
AU18	Attenuator	43KC-10	Anritsu	-	148-03-506E0	Feb. 2003	1 Year
AU19	Attenuator	43KC-20	Anritsu	-	148-03-507E0	Feb. 2003	1 Year
AU20	Attenuator	355D	Hewlett Packard	219-10782	148-03-065E0	Apr. 2003	1 Year
AU21	FFT Analyzer	R9211C	Advantest	02020253	122-02-506E0	Jun. 2003	1 Year
AU22	Noise Meter	MN-446	Meguro	53030478	082-01-144E0	Apr. 2003	1 Year