

# TEST REPORT

<b>KOSTEC Co., Ltd.</b> 28(175-20, Annyeong-dong) 406-gil sejaro, Hwaseong-si, Gyeonggi-do, Korea Tel:031-222-4251, Fax:031-222-4252	Report No.: KST-FCR-220002(1)	 <b>KOSTEC Co., Ltd.</b> <a href="http://www.kostec.org">http://www.kostec.org</a>
---	-------------------------------	--

**1. Applicant**

- Name : Midland Radio Corporation
- Address : 5900 Parretta Drive Kansas City,MO 64120-2134

**2. Test Item**

- Product Name: FRS
- Model Name: T51R
- Brand: X-TALKER
- FCC ID: MMAT55R

**3. Manufacturer**

- Name : Midland Radio Corporation
- Address : 5900 Parretta Drive Kansas City,MO 64120-2134

**4. Date of Test :** 2022. 02. 03. ~ 2022. 02. 04.

FCC CFR 47, Part 95  
 KDB 888861 D01 Part 95 GMRS FRS v01

**5. Test Method Used :**  
 ANSI/TIA-603-E-2016  
 ANSI C63.4-2014

**6. Test Result :** Compliance

**7. Note:** None

**Supplementary Information**

The device bearing the brand name and FCC ID specified above has been shown to comply with the applicable technical standards as indicated in the measurement report and was tested in accordance with measurement procedures specified in ANSI/TIA-603-E-2016.

We attest to the accuracy of data and all measurements reported herein were performed by KOSTEC Co., Ltd. and were made under Chief Engineer's supervision. We assume full responsibility for the completeness of these measurements and vouch for the qualifications of all persons taking them.

The results shown in this test report refer only to the sample(s) tested unless otherwise stated.  
 This test report is not related to KOLAS accreditation.

Affirmation	Tested by Name : Jung, Ho-Cheol (Signature)	Technical Manager Name : Park, Gyeong-Hyeon (Signature)
-------------	--	--

2022. 02. 17.

**KOSTEC Co., Ltd.**

## Table of Contents

<b>1. GENERAL INFORMATION .....</b>	<b>3</b>
1.1 Test Facility .....	3
1.2 Location .....	3
1.3 Revision History of test report .....	4
<b>2. EQUIPMENT DESCRIPTION .....</b>	<b>5</b>
<b>3. SYSTEM CONFIGURATION FOR TEST .....</b>	<b>6</b>
3.1 Characteristics of equipment .....	6
3.2 Used peripherals list .....	6
3.3 Product Modification .....	6
3.4 Operating Mode .....	6
3.5 Test Setup of EUT .....	6
3.6 Table for Carrier Frequencies .....	7
3.7 Used Test Equipment List .....	8
<b>4. SUMMARY TEST RESULTS .....</b>	<b>10</b>
<b>5. MEASUREMENT RESULTS .....</b>	<b>11</b>
5.1 RF Output Power .....	11
5.2 Modulation Characteristics .....	14
5.3 Occupied Bandwidth .....	18
5.4 Emission Mask .....	21
5.5 Transmitter Radiated Unwanted Emissions .....	24
5.6 Frequency Stability .....	26

## 1. GENERAL INFORMATION

### 1.1 Test Facility

#### Test laboratory and address

KOSTEC Co., Ltd.

128(175-20,Annyeong-dong)406-gil sejaro, Hwaseong-si Gyeonggi-do, Korea

#### Registration information

KOLAS No. : 232

FCC/IC Designation No. : KR0041

### 1.2 Location

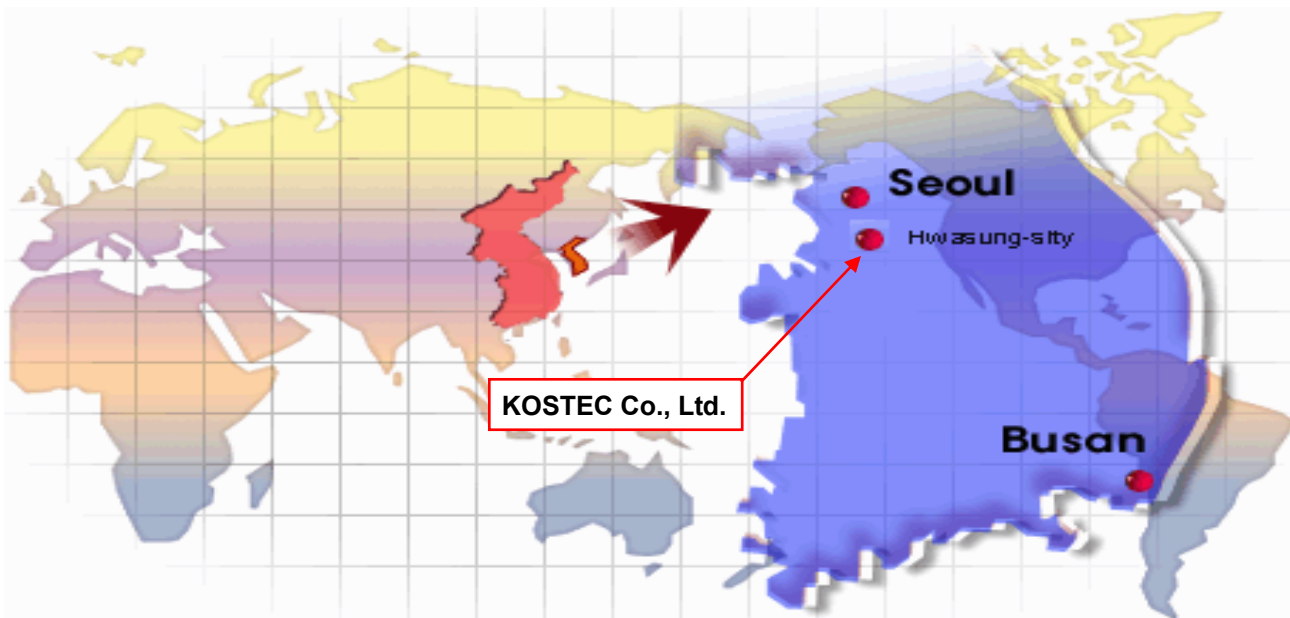

### 1.3 Revision History of test report

Rev.	Revisions	Effect page	Reviewed	Date
-	Initial issue	All	Gyeong Hyeon, Park	2022. 02. 07.
1	Revision Product Name Edit and delete	1 10, 28-30	Gyeong Hyeon, Park	2022. 02. 17.

## 2. EQUIPMENT DESCRIPTION

The product specification described herein was declared by manufacturer. And refer to user's manual for the details.

Equipment Name	GMRS/FRS
Model No	T51R
Usage	FRS held-near-face push-to-talk (PTT) portable device
Intended Operating Environment	General population/Uncontrolled exposure
Serial Number	1
Primary User Functions of EUT	2-Way Wireless Voice Communication
Rated output power	0.42 W
Max. E.R.P	0.47 W
Operating Frequency Range	462.562 5 MHz - 462.712 5 MHz, 467.562 5 MHz - 467.712 5 MHz, 462.550 0 MHz - 462.725 0 MHz
Channel Number	22 EA
Channel Spacing	12.5 kHz
Modulation	FM
Occupied Bandwidth (99%)	10.35 kHz
Emission Designation	10K35F3E
Power Source	Ni-MH battery pack / 3.6 VDC nominal / 700 mAh
Antenna Description	Helical antenna, 0.50 dBi
FCC ID	MMAT55R
Remark	The above DUT's information was declared by manufacturer. Please refer to the specifications or user manual for more detailed description.

### 3. SYSTEM CONFIGURATION FOR TEST

#### 3.1 Characteristics of equipment

GMRS/FRS

#### 3.2 Used peripherals list

Description	Model No.	Serial No.	Manufacture	Remark
Switching Power Supply	S005CAV0500100	None	Midland Radio Corporation	-
Rechargeable Battery	BATT3R	None	Midland Radio Corporation	-
Ear/Mic	None	None	Midland Radio Corporation	-
Desktop Charger	18CVP15	None	Midland Radio Corporation	-

#### 3.3 Product Modification

N/A

#### 3.4 Operating Mode

Constantly transmitting with a carrier at maximum power.

#### 3.5 Test Setup of EUT



### 3.6 Table for Carrier Frequencies

Channel	Freq. [MHz]	Description	Channel	Freq. [MHz]	Description
1	462.562 5	462 MHz Interstitial	12	467.662 5	467 MHz Interstitial
2	462.587 5	462 MHz Interstitial	13	467.687 5	467 MHz Interstitial
3	462.612 5	462 MHz Interstitial	14	467.712 5	467 MHz Interstitial
4	462.637 5	462 MHz Interstitial	15	462.550 0	462 MHz New
5	462.662 5	462 MHz Interstitial	16	462.575 0	462 MHz New
6	462.687 5	462 MHz Interstitial	17	462.600 0	462 MHz New
7	462.712 5	462 MHz Interstitial	18	462.625 0	462 MHz New
8	467.562 5	467 MHz Interstitial	19	462.650 0	462 MHz New
9	467.587 5	467 MHz Interstitial	20	462.675 0	462 MHz New
10	467.612 5	467 MHz Interstitial	21	462.700 0	462 MHz New
11	467.637 5	467 MHz Interstitial	22	462.725 0	462 MHz New

According to ANSI C63.26 section 5.1.2.1:

Measurements of transmitters shall be performed and, if required, reported for each frequency band in which the EUT can be operated with the device transmitting at the number of frequencies in each band specified in Table 2.

Frequency range over which EUT operates	Number of frequencies	Location in frequency range of operation
1 MHz or less	1	Middle
1 MHz to 10 MHz	2	1 near top and 1 near bottom
More than 10 MHz	3	1 near top, 1 near middle, and 1 near bottom

Description	Frequency Bands [MHz]	Test Channel	Test Frequency [MHz]
462 MHz	462.562 5~462.712 5	CH4	462.637 5
467 MHz	467.562 5~467.712 5	CH11	467.637 5
462 MHz	462.550 0~462.725 0	CH19	462.650 0

### 3.7 Used Test Equipment List

No.	Instrument	Model	S/N	Manufacturer	Next Cal Date	Cal interval	used
1	T & H Chamber	PL-3J	15003623	ESPEC CORP	2022.11.04	1 year	<input type="checkbox"/>
2	T & H Chamber	SH-662	93000067	ESPEC CORP	2022.08.27	1 year	<input checked="" type="checkbox"/>
3	T & H Chamber	SH-641	92006831	ESPEC CORP	2023.01.19	1 year	<input type="checkbox"/>
4	Spectrum Analyzer	8563EC	3046A00527	Agilent Technology	2023.01.17	1 year	<input type="checkbox"/>
5	Spectrum Analyzer	FSV30	104029	Rohde & Schwarz	2022.08.30	1 year	<input type="checkbox"/>
6	Spectrum Analyzer	FSV30	20-353063	Rohde & Schwarz	2023.01.17	1 year	<input checked="" type="checkbox"/>
7	Spectrum Analyzer	FSV40	101727	Rohde & Schwarz	2022.07.19	1 year	<input type="checkbox"/>
8	Signal Analyzer	FSW43	101294	Rohde & Schwarz	2023.01.19	1 year	<input type="checkbox"/>
9	Signal Analyzer	FSW85	101602	Rohde & Schwarz	2022.06.30	1 year	<input type="checkbox"/>
10	EMI Test Receiver	ESCI7	100823	Rohde & Schwarz	2023.01.17	1 year	<input checked="" type="checkbox"/>
11	EMI Test Receiver	ESI	837514/004	Rohde & Schwarz	2022.08.30	1 year	<input checked="" type="checkbox"/>
12	Vector Signal Analyzer	89441A	3416A02620	Agilent Technology	2023.01.19	1 year	<input type="checkbox"/>
13	Network Analyzer	8753ES	US39172348	AGILENT	2022.08.31	1 year	<input type="checkbox"/>
14	EPM Series Power meter	E4418B	GB39512547	Agilent Technology	2023.01.18	1 year	<input type="checkbox"/>
15	RF Power Sensor	E9300A	MY41496631	Agilent Technology	2023.01.18	1 year	<input type="checkbox"/>
16	Microwave Frequency Counter	5352B	2908A00480	Agilent Technology	2023.01.17	1 year	<input type="checkbox"/>
17	Audio Analyzer	8903B	3514A16919	Agilent Technology	2023.01.18	1 year	<input checked="" type="checkbox"/>
18	Audio Telephone Analyzer	DD-5601CID	520010281	CREDIX	2023.01.17	1 year	<input type="checkbox"/>
19	Modulation Analyzer	8901A	3041A05716	H.P	2023.01.18	1 year	<input checked="" type="checkbox"/>
20	Digital storage Oscilloscope	TDS3052	B015962	Tektronix	2022.08.30	1 year	<input type="checkbox"/>
21	ESG-D Series Signal Generator	E4436B	US39260458	Agilent Technology	2023.01.18	1 year	<input checked="" type="checkbox"/>
22	Vector Signal Generator	SMBV100A	257557	Rohde & Schwarz	2023.01.17	1 year	<input type="checkbox"/>
23	GNSS Signal Generator	TC-2800A	2800A000494	TESCOM CO., LTD.	2023.01.18	1 year	<input type="checkbox"/>
24	Signal Generator	SMB100A	179628	Rohde & Schwarz	2023.01.17	1 year	<input checked="" type="checkbox"/>
25	Signal Generator	N5173B	MY57280148	KEYSIGHT	2022.06.11	1 year	<input type="checkbox"/>
26	SLIDAC	None	0207-4	Myoung sung Ele.	2023.01.18	1 year	<input type="checkbox"/>
27	DC Power supply	DRP-5030	9028029	Digital Electronic Co.,Ltd	2023.01.18	1 year	<input type="checkbox"/>
28	DC Power supply	E3610A	KR24104505	Agilent Technology	2023.01.18	1 year	<input type="checkbox"/>
29	DC Power supply	UP-3005T	68	Unicon Co.,Ltd	2023.01.18	1 year	<input type="checkbox"/>
30	DC Power Supply	SM 3400-D	114701000117	DELTAELEKTRONIKA	2023.01.18	1 year	<input type="checkbox"/>
31	DC Power supply	6632B	MY43004005	Agilent Technology	2023.01.18	1 year	<input checked="" type="checkbox"/>
32	DC Power Supply	6632B	MY43004137	Agilent Technology	2023.01.18	1 year	<input type="checkbox"/>
33	Termination	1433-3	LM718	WEINSCHEL	2023.01.18	1 year	<input type="checkbox"/>
34	Termination	1432-3	QR946	AEROFLEX/WEINSCHEL	2023.01.18	1 year	<input type="checkbox"/>
35	Attenuator	24-30-34	BX5630	Aeroflex / Weinschel	2022.12.01	1 year	<input type="checkbox"/>
36	Attenuator	8498A	3318A09485	HP	2023.01.19	1 year	<input type="checkbox"/>
37	Step Attenuator	8494B	3308A32809	HP	2023.01.19	1 year	<input type="checkbox"/>
38	RF Step Attenuator	RSP	100091	Rohde & Schwarz	2023.01.18	1 year	<input type="checkbox"/>
39	Attenuator	18B50W-20F	64671	INMET	2023.01.19	1 year	<input type="checkbox"/>
40	Attenuator	10 dB	1	Rohde & Schwarz	2023.01.18	1 year	<input type="checkbox"/>
41	Attenuator	54A-10	74564	WEINSCHEL	2022.08.31	1 year	<input type="checkbox"/>
42	Attenuator	56-10	66920	WEINSCHEL	2023.01.19	1 year	<input type="checkbox"/>
43	Attenuator	48-30-33-LIM	BL5350	Weinschel Corp.	2023.01.18	1 year	<input type="checkbox"/>
44	Power divider	11636B	51212	HP	2023.01.19	1 year	<input type="checkbox"/>
45	3Way Power divider	KPDSU3W	00070365	KMW	2022.08.30	1 year	<input checked="" type="checkbox"/>
46	4Way Power divider	70052651	173834	KRYTAR	2023.01.19	1 year	<input type="checkbox"/>
47	3Way Power divider	1580	SQ361	WEINSCHEL	2023.01.19	1 year	<input type="checkbox"/>
48	OSP	OSP120	101577	Rohde & Schwarz	2022.01.19	1 year	<input type="checkbox"/>
49	White noise audio filter	ST31EQ	101902	SoundTech	2022.08.31	1 year	<input type="checkbox"/>
50	Dual directional coupler	778D	17693	HEWLETT PACKARD	2023.01.18	1 year	<input type="checkbox"/>
51	Dual directional coupler	772D	2839A00924	HEWLETT PACKARD	2023.01.18	1 year	<input type="checkbox"/>



No.	Instrument	Model	S/N	Manufacturer	Next Cal Date	Cal interval	used
52	Band rejection filter	3TNF-0006	26	DOVER Tech	2023.01.18	1 year	<input type="checkbox"/>
53	Band rejection filter	3TNF-0007	311	DOVER Tech	2023.01.18	1 year	<input type="checkbox"/>
54	Band rejection filter	WTR-BRF2442-84NN	09020001	WAVE TECH Co.,LTD	2023.01.19	1 year	<input type="checkbox"/>
55	Band rejection filter	WRCJV12-5695-5725-5825-5855-50SS	1	Wainwright Instruments GmbH	2023.01.19	1 year	<input type="checkbox"/>
56	Band rejection filter	WRCJV12-5120-5150-5350-5380-40SS	4	Wainwright Instruments GmbH	2023.01.19	1 year	<input type="checkbox"/>
57	Band rejection filter	WRCGV10-2360-2400-2500-2540-50SS	2	Wainwright Instruments GmbH	2023.01.18	1 year	<input type="checkbox"/>
58	Band rejection filter	CTF-155M-S1	001	RF One Electronics	2022.08.30	1 year	<input type="checkbox"/>
59	Band rejection filter	CTF-435M-S1	001	RF One Electronics	2022.08.30	1 year	<input checked="" type="checkbox"/>
60	Band rejection filter	CTF-5890M-70MS1	1	RF One Electronics	2023.01.19	1 year	<input type="checkbox"/>
61	Highpass Filter	WHJS1100-10EF	1	WAINWRIGHT	2023.01.19	1 year	<input checked="" type="checkbox"/>
62	Highpass Filter	WHJS3000-10EF	1	WAINWRIGHT	2023.01.19	1 year	<input type="checkbox"/>
63	Highpass Filter	WHNX6-5530-7000-26500-40CC	2	Wainwright Instruments GmbH	2023.01.19	1 year	<input type="checkbox"/>
64	Highpass Filter	WHNX6-2370-3000-26500-40CC	4	Wainwright Instruments GmbH	2023.01.19	1 year	<input type="checkbox"/>
65	WideBand Radio Communication Tester	CMW500	102276	Rohde & Schwarz	2023.01.18	1 year	<input type="checkbox"/>
66	WideBand Radio Communication Tester	CMW500	117235	Rohde & Schwarz	2023.01.18	1 year	<input type="checkbox"/>
67	WideBand Radio Communication Tester(with CMX500)	CMW500	167157	Rohde & Schwarz	2023.01.18	1 year	<input type="checkbox"/>
68	Bluetooth Tester	TC-3000B	3000B6A0166	TESCOM CO., LTD.	2023.01.18	1 year	<input type="checkbox"/>
69	Loop Antenna	6502	9203-0493	EMCO	2023.05.31	2 year	<input type="checkbox"/>
70	Loop Antenna	FMZB1513	#374	Schwarzbeck	2023.02.26	2 year	<input type="checkbox"/>
71	BiconiLog Antenna	3142B	1745	EMCO	2022.04.24	2 year	<input checked="" type="checkbox"/>
72	Trilog-Broadband Antenna <sub>(R)</sub>	VULB 9168	9168-606	SCHWARZBECK	2022.09.21	2 year	<input type="checkbox"/>
73	Biconical Antenna <sub>(T)</sub>	VUBA9117	9117-342	Schwarz beck	2022.03.24	2 year	<input checked="" type="checkbox"/>
74	Horn Antenna	3115	9605-4834	EMCO	2022.03.06	2 year	<input checked="" type="checkbox"/>
75	Horn Antenna	QMS-00208	21909	STEATITE ANTENNA	2022.12.04	2 year	<input type="checkbox"/>
76	Horn Antenna <sub>(R)</sub>	3117	00135191	ETS-LINDGREN	2022.04.29	2 year	<input type="checkbox"/>
77	Horn Antenna <sub>(T)</sub>	3115	2996	EMCO	2024.02.10	2 year	<input checked="" type="checkbox"/>
78	Horn Antenna <sub>(R)</sub>	BBHA 9170	9170-722	SCHWARZBECK	2024.01.20	2 year	<input type="checkbox"/>
79	Horn Antenna <sub>(T)</sub>	BBHA 9170	743	SCHWARZBECK	2023.01.21	2 year	<input type="checkbox"/>
80	AMPLIFIER(A_10)	TK-PA6S	120009	TESTEK	2023.01.17	1 year	<input type="checkbox"/>
81	AMPLIFIER(C_3)	TK-PA01S	200141-L	TESTEK	2022.08.31	1 year	<input checked="" type="checkbox"/>
82	PREAMPLIFIER(C_3)	8449B	3008A02577	Agilent	2023.01.17	1 year	<input checked="" type="checkbox"/>
83	RF PRE AMPLIFIER	SCU08F2	100762	Rohde & Schwarz	2022.12.01	1 year	<input type="checkbox"/>
84	AMPLIFIER	TK-PA18	150003	TESTEK	2023.01.17	1 year	<input checked="" type="checkbox"/>
85	AMPLIFIER	TK-PA1840H	160010-L	TESTEK	2023.01.18	1 year	<input checked="" type="checkbox"/>
86	Horn Antenna	M19RH	T01	OML, Inc.	2022.05.29	2 year	<input type="checkbox"/>
87	Horn Antenna	M19RH	R01	OML, Inc.	2022.05.29	2 year	<input type="checkbox"/>
88	Horn Antenna	M12RH	T02	OML, Inc.	2022.05.29	2 year	<input type="checkbox"/>
89	Horn Antenna	M12RH	R02	OML, Inc.	2022.05.29	2 year	<input type="checkbox"/>
90	Horn Antenna	M08RH	T03	OML, Inc.	2022.05.29	2 year	<input type="checkbox"/>
91	Horn Antenna	M08RH	R03	OML, Inc.	2022.05.29	2 year	<input type="checkbox"/>
92	Horn Antenna	M05RH	T04	OML, Inc.	2022.05.29	2 year	<input type="checkbox"/>
93	Horn Antenna	M05RH	R04	OML, Inc.	2022.05.29	2 year	<input type="checkbox"/>
94	Horn Antenna	M03RH	T05	OML, Inc.	2022.05.29	2 year	<input type="checkbox"/>
95	Horn Antenna	M03RH	R05	OML, Inc.	2022.05.29	2 year	<input type="checkbox"/>
96	Harmonic Mixer	M12HWD	200529-1	OML, Inc.	2022.07.12	1 year	<input type="checkbox"/>
97	Harmonic Mixer	M08HWD	200529-1	OML, Inc.	2022.07.12	1 year	<input type="checkbox"/>
98	Harmonic Mixer	M05HWD	200529-1	OML, Inc.	2022.07.12	1 year	<input type="checkbox"/>
99	Harmonic Mixer	M03HWD	200529-1	OML, Inc.	2022.07.12	1 year	<input type="checkbox"/>
100	Source Module	S19MS-A	200529-1	OML, Inc.	2022.07.02	1 year	<input type="checkbox"/>
101	Source Module	S12MS-A	200529-1	OML, Inc.	2022.07.02	1 year	<input type="checkbox"/>
102	Source Module	S08MS-A	200529-1	OML, Inc.	2022.07.02	1 year	<input type="checkbox"/>
103	Source Module	S05MS-A	200529-1	OML, Inc.	2022.07.02	1 year	<input type="checkbox"/>
104	Source Module	S03MS-A	200529-1	OML, Inc.	2022.07.02	1 year	<input type="checkbox"/>

#### 4. SUMMARY TEST RESULTS

Description of Test	FCC Rule	Reference Clause	Used	Test Result
RF Output Power	Part 95.567	Clause 5.1	<input checked="" type="checkbox"/>	Compliance
Modulation Characteristics	Part 95.575	Clause 5.2	<input checked="" type="checkbox"/>	Compliance
Occupied Bandwidth	Part 95.573 Part 2.1049	Clause 5.3	<input checked="" type="checkbox"/>	Compliance
Emission Mask	Part 95.579	Clause 5.4	<input checked="" type="checkbox"/>	Compliance
Transmitter Radiated Unwanted Emissions	Part 95.579	Clause 5.5	<input checked="" type="checkbox"/>	Compliance
Frequency Stability	Part 95.565 Part 2.1055	Clause 5.6	<input checked="" type="checkbox"/>	Compliance
<p>Compliance/pass : The EUT complies with the essential requirements in the standard.            Not Compliance : The EUT does not comply with the essential requirements in the standard.            N/A : The test was not applicable in the standard.</p>				
<p><b>Procedure Reference :</b>            FCC CFR 47, Part 95            KDB 888861 D01 Part 95 GMRS FRS v01            ANSI/TIA-603-E-2016            ANSI C 63.4-2014</p>				

## 5. MEASUREMENT RESULTS

### 5.1 RF Output Power

#### 5.1.1 Standard Applicable [FCC Part 95.567]

##### FCC Part 95.567

Each FRS transmitter type must be designed such that the effective radiated power (ERP) on channels 8 through 14 does not exceed 0.5 Watts and the ERP on channels 1 through 7 and 15 through 22 does not exceed 2.0 Watts.

#### 5.1.2 Test Environment conditions

- Ambient temperature : (21 ~ 22) °C
- Relative Humidity : (48 ~ 52) % R.H.

#### 5.1.3 Measurement Procedure

The EUT was setup according to ANSI/TIA-603-E-2016 for compliance to FCC 47CFR part 95 requirements.

As a below test procedure (①~⑧), The result value of measurement is performed to condition of the below; The EUT will operate in continuous transmission mode during the time necessary to perform the measured of the frequency. Substitution method was performed to determine the actual  $P_{erp}$ (or  $P_{eirp}$ ) emission levels of the EUT.

The following test procedure as below;

The test is performed in a fully pyramidal chamber to determine the accurate frequencies, after maximum emissions level will be checked on a test chamber and measuring distance is 3 m from EUT to test antenna.

- ① The EUT was set on with continuous transmission mode and placed on a 1.5 meter high non-conductive table on the chamber.
- ② The test antenna is used on Bi-Log antenna at above 30 MHz, and used on Horn antenna at 1 GHz and then the measurements are repeated with the test antenna for vertical and horizontal polarization. The output of the test antenna will be connected to a measuring receiver, and it is set to tuned over the required standard measuring frequency range.
- ③ At each frequency at which a relevant spurious component is detected, the test antenna will be raised and lowered through the specified range of heights until an maximum signal level is detected on the measuring receiver.
- ④ The EUT is position x, y, z axis on rotating through 360 degrees in the horizontal plane, until the Max. signal level is detected by the measuring receiver.
- ⑤ The receiver is scanned from requested measuring frequency band and then the maximum meter reading is recorded. The radiated emissions were measured with requested standard specification (detector and resolution bandwidth etc.)
- ⑥ The EUT was then removed and replaced with substitution antenna .The center of the antenna was approximately at the same location as the center of the EUT, and calibrated for the frequency of the spurious component detected.
- ⑦ Signal generator output port connected with substitution antenna input port. If necessary, may use shield cable between signal generator and substitution antenna
- ⑧ The frequency of the calibrated signal generator is set to frequency of the spurious component detected, and the input attenuator setting of the measuring receiver was adjust in order to increase the sensitivity of the measuring receiver, if necessary

- ⑨ The test antenna was raised and lowered through the specified range of heights to ensure that maximum signal is received.
- ⑩ The input signal to the substitution antenna was be adjusted until an equal or a known related level to that detected from the transmitter is obtained on the measuring receiver.
- ⑪ The input signal to the substitution antenna was be recorded as a power level and corrected for any change of input attenuator setting of the measuring receiver
- ⑫ The measure of  $P_{erp}$ (or  $P_{eirp}$ ) the spurious components is the larger of the two power levels recorded for each spurious component at the input to the substitution antenna, corrected for the gain of the substitution antenna, if necessary.
- ⑬ It is correction to signal generator's offset value. In this case of  $P_{erp}$ (or  $P_{eirp}$ ) shall calculated as follow as formula ;
  - $P_{erp}$ (or  $P_{eirp}$ ) = Signal generator level (dBm) – Cable loss(dB)

#### 5.1.4 Measurement Uncertainty

The measurement uncertainties shown below were calculated in accordance with the requirements of ANSI C63.10-2013. All measurement uncertainty values are shown with a coverage factor of  $k = 2$  to indicate a 95% level of confidence. The measurement uncertainty shown below meets or exceeds the UCISPR measurement uncertainty values specified in CISPR 16-4-2 and, thus, can be compared directly to specified limits to determine compliance.

Radiated Emission measurement: Below 1 GHz: 3.62 dB (CL: Approx 95 %,  $k=2$ )

Above 1 GHz: 4.18 dB (CL: Approx 95 %,  $k=2$ )

### 5.1.5 Test Setup

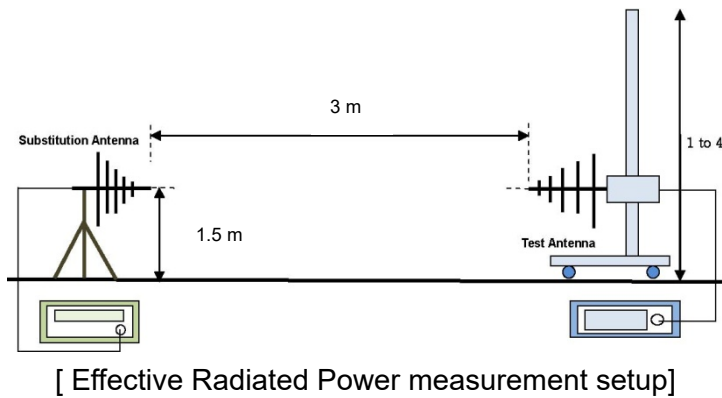
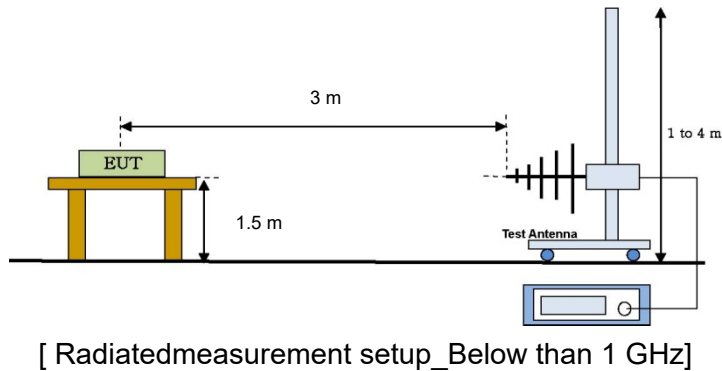

※ Above the test antenna is used on Horn antenna at above 1 GHz.

### 5.1.5 Measurement Result

Channel Description	CH	Frequency [MHz]	Effective Radiated Power		Limit [W]	Test Results
			[dBm]	[W]		
462 MHz Interstitial	4	462.637 5	26.23	0.42	2	Compliance
467 MHz Interstitial	11	467.637 5	26.03	0.40	0.5	Compliance
462 MHz New	19	462.650 0	25.97	0.40	2	Compliance

## 5.2 Modulation Characteristics

### 5.2.1 Standard Applicable [Part 95.575]

#### **Part 95.1775**

Each FRS transmitter type must be designed such that the peak frequency deviation does not exceed 2.5 kHz, and the highest audio frequency contributing substantially to modulation must not exceed 3.125 kHz.

### 5.2.2 Test Environment conditions

- Ambient temperature : (21 ~ 22) °C
- Relative Humidity : (48 ~ 52) % R.H.

### 5.2.3 Measurement Procedure

#### **•Modulation Limit**

The carrier frequency deviation was measured with the tone adjust the audio input for 60 % of rated system deviation at 1 kHz using this level as a reference (0 dB) and vary the input level from -20 to +20 dB. Record the frequency deviation obtained as a function of the input level at frequencies 0.1, 0.5, 1.0, 3.0 and 5.0 kHz. The maximum deviation was recorded at each test condition.

### 5.2.4 Test setup

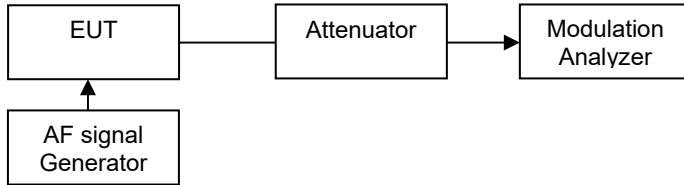

### 5.2.5 Measurement Result

- Modulation Limit

#### 462 MHz Interstitial (CH4 : 462.637 5 MHz)

Audio input Level (dB)	Frequency Deviation (kHz)			Limit (kHz)
	@ 300 Hz	@ 1 kHz	@ 3kHz	
-20	0.69	1.03	1.92	2.5
-15	0.80	1.42	2.14	2.5
-10	0.98	1.99	2.20	2.5
-5	1.34	2.20	2.22	2.5
0	1.93	2.32	2.24	2.5
5	2.00	2.36	2.25	2.5
10	2.01	2.37	2.26	2.5
15	2.09	2.38	2.27	2.5
20	2.23	2.39	2.27	2.5
Test Results			Compliance	

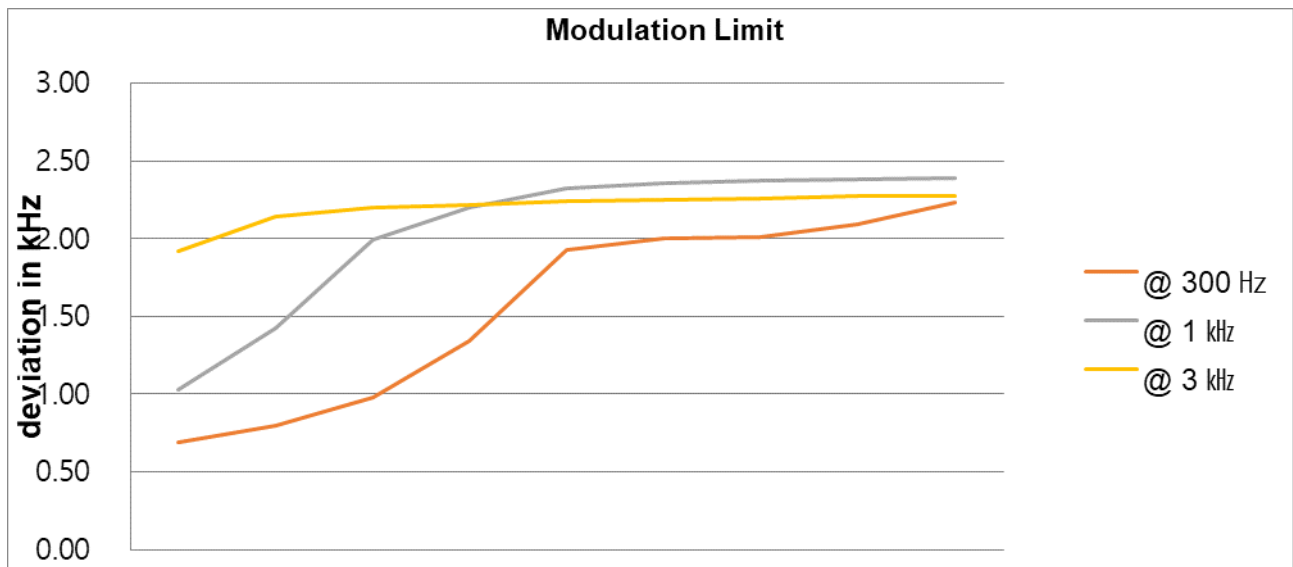

**467 MHz Interstitial (Ch11 : 467.637 5 MHz)**

Audio input Level (dB)	Frequency Deviation (kHz)			Limit (kHz)
	@ 300 Hz	@ 1 kHz	@ 3kHz	
-20	0.72	1.05	1.93	2.5
-15	0.81	1.42	2.15	2.5
-10	0.99	2.02	2.21	2.5
5	1.33	2.23	2.22	2.5
0	1.95	2.35	2.25	2.5
5	2.02	2.37	2.26	2.5
10	2.04	2.39	2.26	2.5
15	2.11	2.39	2.27	2.5
20	2.25	2.40	2.28	2.5
Test Results			Compliance	

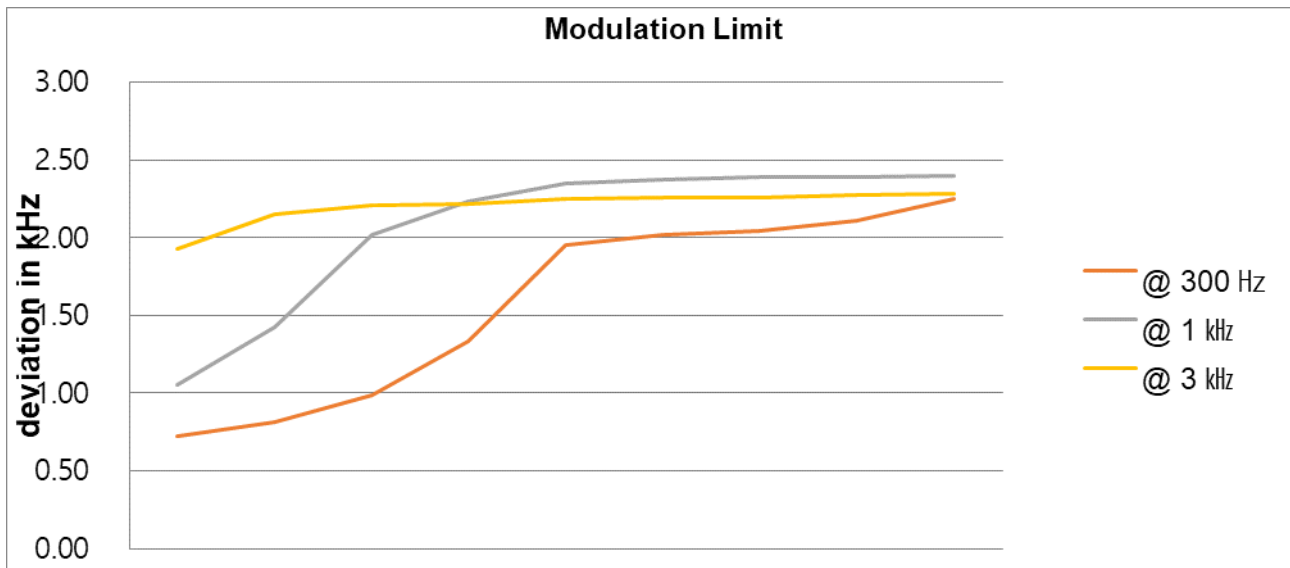



**462 MHz New (CH19 : 462.650 0 MHz)**

Audio input Level (dB)	Frequency Deviation (kHz)			Limit (kHz)
	@ 300 Hz	@ 1 kHz	@ 3kHz	
-20	0.70	1.02	1.91	2.5
-15	0.79	1.40	2.13	2.5
-10	0.97	2.00	2.19	2.5
5	1.30	2.21	2.21	2.5
0	1.92	2.32	2.24	2.5
5	2.00	2.35	2.25	2.5
10	2.02	2.37	2.26	2.5
15	2.10	2.38	2.26	2.5
20	2.23	2.39	2.27	2.5
Test Results			Compliance	



## 5.3 Occupied Bandwidth

### 5.3.1 Standard Applicable [FCC Part 95.573, Part 2.1049]

The Emission bandwidth, that is the frequency bandwidth such that, below its lower and above its upper frequency limits.

#### **FCC Part 95.573**

Each FRS transmitter type must be designed such that the occupied bandwidth does not exceed 12.5 kHz.

### 5.3.2 Test Environment conditions

- Ambient temperature : (21 ~ 22) °C
- Relative Humidity : (48 ~ 52) % R.H.

### 5.3.3 Measurement Procedure

1. The EUT was modulated by 2.5 kHz Sine wave audio signal, The level of the audio signal employed is 16 dB greater than that necessary to produce 50% of rated system deviation.
2. The transmitter output (antenna port) was connected to the spectrum analyzer in peak hold mode.
3. Measure the maximum width of the emission that is 26 dB down from the peak of the emission. The 99% occupied bandwidth is the frequency bandwidth of the signal power at the 99% channel power of occupied bandwidth.

The spectrum analyzer is set to the as follows :

- RBW : 300 Hz
- VBW : >3 x RBW
- Detector function : peak
- Trace : max hold

### 5.3.4 Test setup

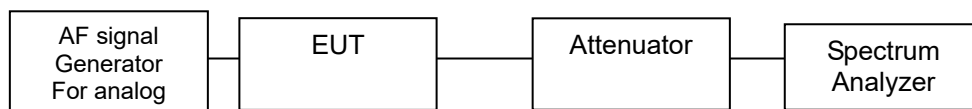

### 5.3.5 Measurement Result

Channel Description	CH	Frequency [MHz]	99 % Bandwidth [kHz]	26 dB Bandwidth [kHz]	Limit [kHz]	Test Results
462 MHz Interstitial	4	462.637 5	10.35	10.42	12.5	Compliance
467 MHz Interstitial	11	467.637 5	10.35	10.42	12.5	Compliance
462 MHz New	19	462.650 0	10.35	10.42	12.5	Compliance

### 5.3.6 Test Plot

#### 462 MHz Interstitial (CH4 : 462.637 5 MHz)

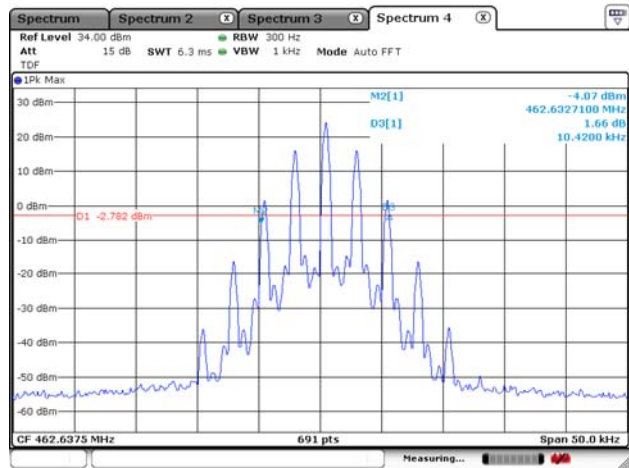
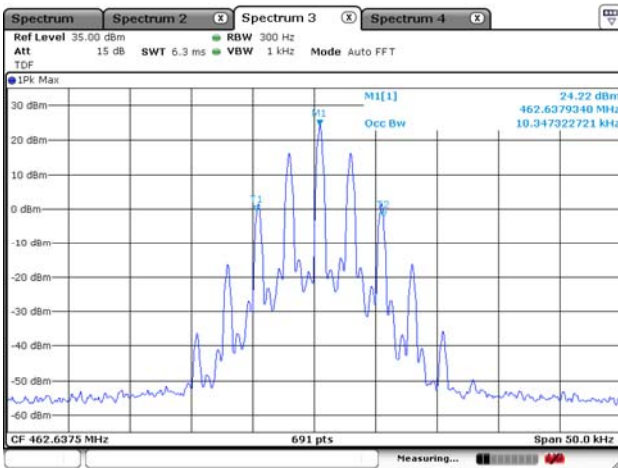

#### 467 MHz Interstitial (CH11 : 467.637 5 MHz)

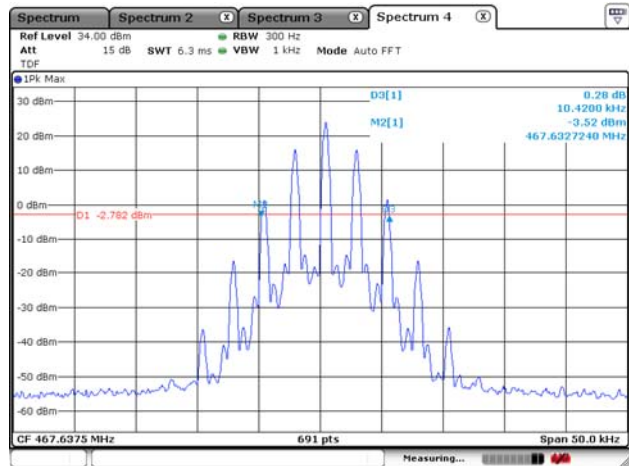
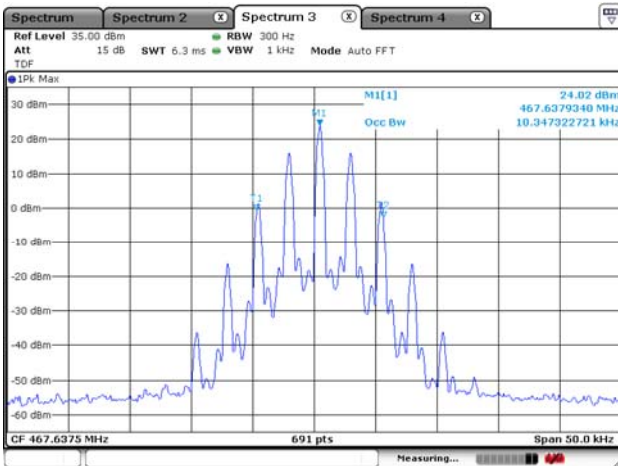

462 MHz New (CH19 : 462.650 0 MHz)

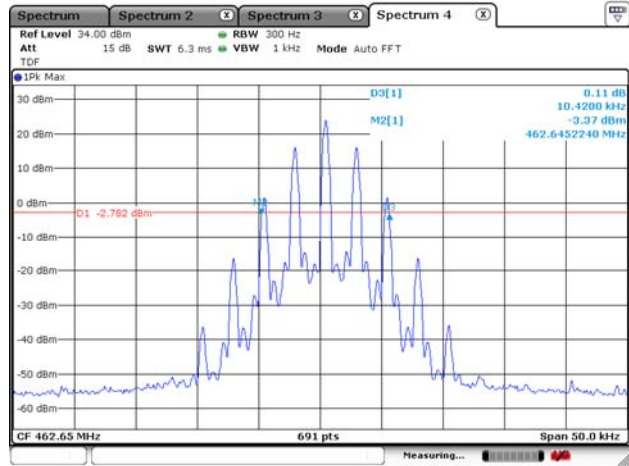
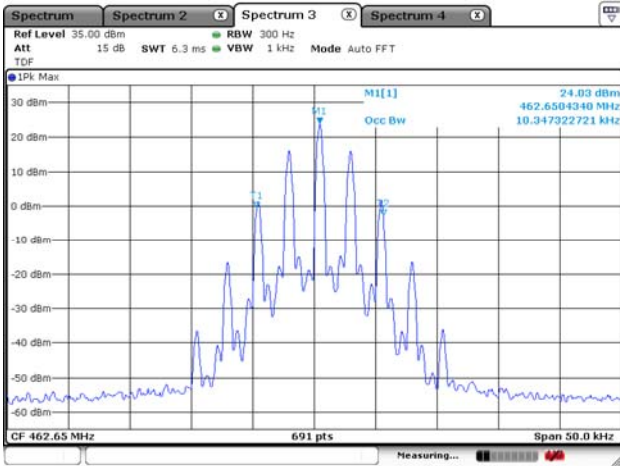

## 5.4 Emission Mask

### 5.4.1 Standard Applicable [FCC Part 95.579]

#### **FCC Part 95.579**

Each FRS transmitter type must be designed to satisfy the applicable unwanted emissions limits in this paragraph.

(a) Attenuation requirements. The power of unwanted emissions must be attenuated below the carrier power output in Watts (P) by at least:

- (1) 25 dB (decibels) in the frequency band 6.25 kHz to 12.5 kHz removed from the channel center frequency.
- (2) 35 dB in the frequency band 12.5 kHz to 31.25 kHz removed from the channel center frequency.
- (3)  $43 + 10 \log (P)$  dB in any frequency band removed from the channel center frequency by more than 31.25 kHz.

### 5.4.2 Test Environment conditions

- Ambient temperature : (21 ~ 22) °C
- Relative Humidity : (48 ~ 52) % R.H.

### 5.4.3 Measurement Procedure

The EUT was modulated by 2.5 kHz Sine wave audio signal; the level of the audio signal employed is 16 dB greater than that necessary to produce 50 % of rated system deviation. Rated system deviation is 2.5 kHz.

The spectrum analyzer is set to the as follows

- RBW = 300 Hz
- VBW: >3xRBW

### 5.4.4 Test setup

Please refer 5.3.4

### 5.4.5 Measurement Result

Compliance: please refer 5.4.6 for details

5.4.6 Test Plot

462 MHz Interstitial (CH4 : 462.637 5 MHz)

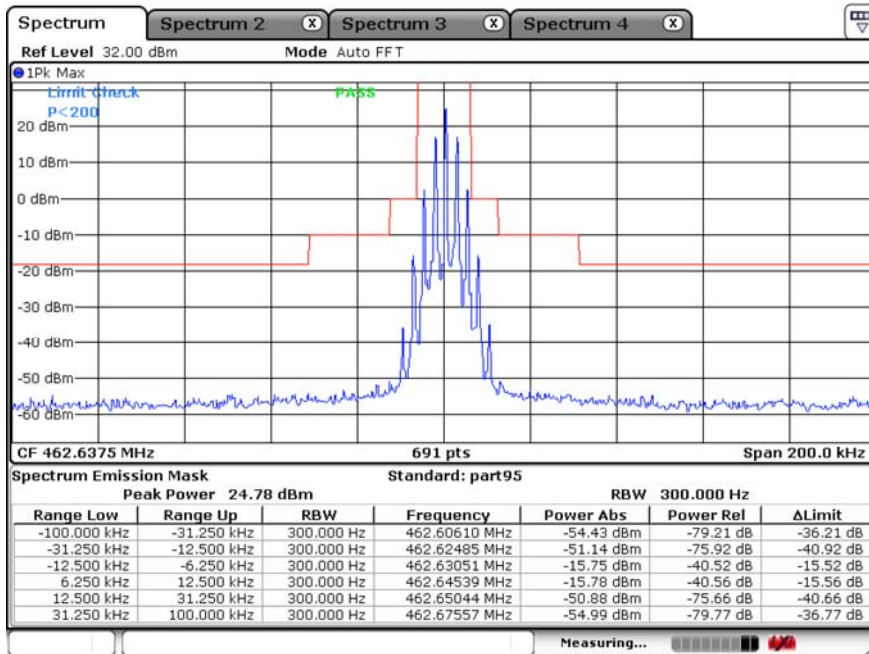

467 MHz Interstitial (CH11 : 467.637 5 MHz)

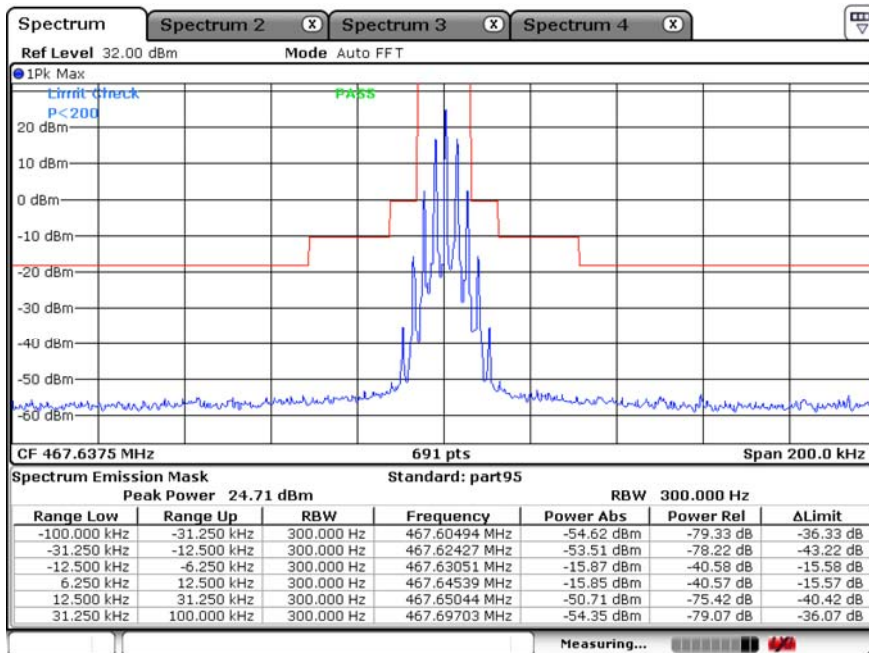



462 MHz New (CH19 : 462.650 0 MHz)

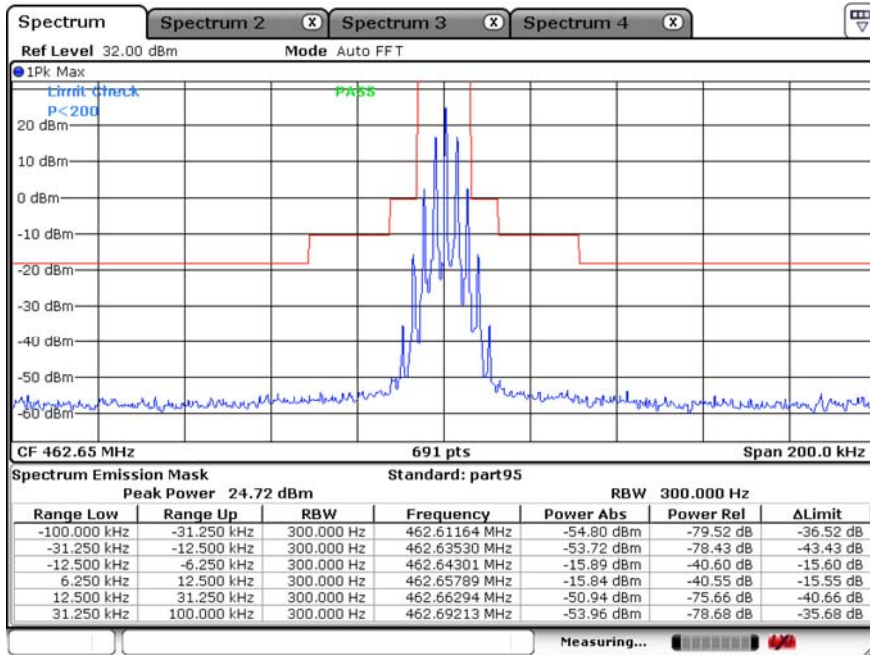

Test Results	Compliance
--------------	------------

## 5.5 Transmitter Radiated Unwanted Emissions

### 5.5.1 Standard Applicable [FCC Part 95.579]

According to FCC section 95.579, the unwanted emission should be attenuated below Transmitter output power(P) by at least  $43+10 \log(P)$  dB.

### 5.5.2 Test Environment conditions

- Ambient temperature : (20 ~ 21) °C
- Relative Humidity : (49 ~ 52) % R.H.

### 5.5.3 Measurement Procedure

Refer 5.1.3

### 5.5.4 Test Setup

Refer 5.1.4

### 5.5.5 Measurement Result

The following frequencies were selected based on the output power results.

Channel Description	CH	Freq. [MHz]	ERP power	
			[dBm]	[W]
462 MHz Interstitial	4	462.637 5	26.23	0.420

Emission Frequency [MHz]	Ant Pol	Level below Carrier [dBc]	Margin [dB]	Limit [dBc]	Test Results
50.527 9	V	85.15	45.92	39.23	Compliance
925.332 6	V	59.24	20.01	39.23	Compliance
1 385.659 9	H	49.86	10.63	39.23	Compliance
1 852.484 6	H	55.01	15.78	39.23	Compliance
2 311.949 7	H	46.57	7.34	39.23	Compliance
2 775.949 5	H	51.89	12.66	39.23	Compliance
3 237.949 4	H	52.54	13.31	39.23	Compliance

**Note:** The formula for limit is below;  
 $43+10 \log (P)$  where, P = EUT's output power in W  
 Therefore  $43+10\log(0.420) = 39.23$



Channel Description	CH	Freq. [MHz]	ERP power	
			[dBm]	[W]
467 MHz Interstitial	11	467.637 5	26.03	0.401

Emission Frequency [MHz]	Ant Pol	Level below Carrier [dBc]	Margin [dB]	Limit [dBc]	Test Results
50.527 7	V	84.58	45.55	39.03	Compliance
925.332 4	V	59.37	20.34	39.03	Compliance
1 385.658 6	H	49.71	10.68	39.03	Compliance
1 852.485 5	H	54.91	15.88	39.03	Compliance
2 311.948 8	H	49.68	10.65	39.03	Compliance
2 775.949 1	H	52.44	13.41	39.03	Compliance
3 237.948 7	H	53.44	14.41	39.03	Compliance

**Note:** The formula for limit is below;  
 $43+10 \log (P)$  where, P = EUT's output power in W  
 Therefore  $43+10\log(0.401) = 39.03$

Channel Description	CH	Freq. [MHz]	ERP power	
			[dBm]	[W]
462 MHz New	19	462.650 0	25.97	0.395

Emission Frequency [MHz]	Ant Pol	Level below Carrier [dBc]	Margin [dB]	Limit [dBc]	Test Results
50.524 6	V	84.4	45.43	38.97	Compliance
925.333 3	V	60.59	21.62	38.97	Compliance
1 385.659 6	H	48.61	9.64	38.97	Compliance
1 852.484 2	H	53.72	14.75	38.97	Compliance
2 311.949 3	H	49.63	10.66	38.97	Compliance
2 775.949 9	H	52.55	13.58	38.97	Compliance
3 237.949 7	H	52.63	13.66	38.97	Compliance

**Note:** The formula for limit is below;  
 $43+10 \log (P)$  where, P = EUT's output power in W  
 Therefore  $43+10\log(0.395) = 38.97$

## 5.6 Frequency Stability

### 5.6.1 Standard Applicable [FCC Part 95.565, Part 2.1055]

#### FCC Part 95.565

Each FRS transmitter type must be designed such that the carrier frequencies remain within  $\pm 2.5$  parts-per-million of the channel center frequencies specified in § 95.563 during normal operating conditions.

### 5.6.2 Test Environment conditions

- Ambient temperature : (21 ~ 22) °C
- Relative Humidity : (48 ~ 52) % R.H.

### 5.6.3 Measurement Procedure

EUT connect to Spectrum analyzer, test is performed in T&H chamber.

These measurements shall also be performed at normal and extreme test conditions.

- Test Method : ANSI/TIA-603-E-2016, clause 3.2.2 for frequency stability tests
  - Frequency stability with respect to ambient temperature
  - Frequency stability when varying supply voltage

### 5.6.4 Test setup

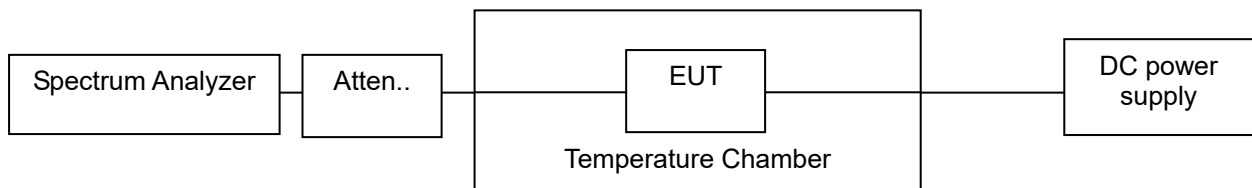

### 5.6.5 Measurement Result

#### 462 MHz Interstitial (CH4 : 462.637 5 MHz)

Temp(°C)	Power Supply	Measured Freq(MHz)	Freq Drift(ppm)
50	DC 3.6 (Vnom)	462.637 955	0.98
40	DC 3.6 (Vnom)	462.637 958	0.99
30	DC 3.6 (Vnom)	462.637 961	1.00
20	DC 3.6 (Vnom)	462.637 959	0.99
10	DC 3.6 (Vnom)	462.637 958	0.99
0	DC 3.6 (Vnom)	462.637 958	0.99
-10	DC 3.6 (Vnom)	462.637 959	0.99
-20	DC 3.6 (Vnom)	462.637 956	0.99
-30	DC 3.6 (Vnom)	462.637 955	0.98
Nom Temperature	DC 3.24 (Vmin)	462.637 946	0.96
Nom Temperature	DC 3.96 (Vmax)	462.637 965	1.01
Test Results		Compliance	



**467 MHz Interstitial (CH11 : 467.637 5 MHz)**

Temp(℃)	Power Supply	Measured Freq(MHz)	Freq Drift(ppm)
50	DC 3.6 (Vnom)	467.637 962	0.99
40	DC 3.6 (Vnom)	467.637 966	1.00
30	DC 3.6 (Vnom)	467.637 964	0.99
20	DC 3.6 (Vnom)	467.637 966	1.00
10	DC 3.6 (Vnom)	467.637 965	0.99
0	DC 3.6 (Vnom)	467.637 968	1.00
-10	DC 3.6 (Vnom)	467.637 963	0.99
-20	DC 3.6 (Vnom)	467.637 967	1.00
-30	DC 3.6 (Vnom)	467.637 968	1.00
Nom Temperature	DC 3.24 (Vmin)	467.637 958	0.98
Nom Temperature	DC 3.96 (Vmax)	467.637 971	1.01
Test Results		Compliance	

**462 MHz New (CH11 : 462.650 0 MHz)**

Temp(℃)	Power Supply	Measured Freq(MHz)	Freq Drift(ppm)
50	DC 3.6 (Vnom)	462.650 451	0.97
40	DC 3.6 (Vnom)	462.650 453	0.98
30	DC 3.6 (Vnom)	462.650 455	0.98
20	DC 3.6 (Vnom)	462.650 458	0.99
10	DC 3.6 (Vnom)	462.650 462	1.00
0	DC 3.6 (Vnom)	462.650 457	0.99
-10	DC 3.6 (Vnom)	462.650 458	0.99
-20	DC 3.6 (Vnom)	462.650 455	0.98
-30	DC 3.6 (Vnom)	462.650 456	0.99
Nom Temperature	DC 3.24 (Vmin)	462.650 449	0.97
Nom Temperature	DC 3.96 (Vmax)	462.650 466	1.01
Test Results		Compliance	