



MIDLAND RADIO CORPORATION

5900 Parretta Drive
Kansas City, MO 64120
Call 816.241.8500

We'd love to hear from you! Let us know what you think of your new Midland product at:



or by visiting us at:

midlandusa.com

Note: Features and Specifications are subject to change without notice. MIDLAND RADIO CORPORATION is not responsible for unintentional errors or omissions on its packaging.

MIDLAND

MICRO MOBILE® GMRS 2-WAY RADIO



MXT105B

midlandusa.com

Table of Contents 2

WELCOME TO THE WORLD OF MIDLAND RADIO 3

FEATURES 3

FCC NOTICE 4

Exposure To Radio Frequency Energy 4

INSTALLING YOUR RADIO 5

 Preparation for Installation 5

 Installing the Mounting Bracket 6

 Installing the Antenna 7

 Electrical and Rear Panel Connections 8

 Connecting the Microphone 8

 Using an External Speaker 9

CONTROLS AND INDICATORS 9

 Operating Controls 9

 LCD Display 10

 Rear Panel Connections 10

OPERATING YOUR RADIO 11

 About Range 11

 Power On/Off 12

 Selecting the Active Channel 12

 Transmitting and Receiving a Call 12

UTILITY FUNCTIONS 13

 Locking the Keypad 13

 Adjusting the Display Illumination 14

 Using Monitor Mode 14

 NOAA Wx Radio Scan 15

 Scanning for Active Channels 16

MENU™ MODE FUNCTIONS 17

 MXT105B “Menu” Mode Quick Reference Chart 17

 Selecting a Privacy Code 17

 Adjusting Squelch Sensitivity 19

 Silent Operation 19

 Selecting the Transmit (TX) Power Level 20

RESTORING THE DEFAULT SETTINGS 20

CARE AND MAINTENANCE 21

TROUBLESHOOTING GUIDE 21

SPECIFICATIONS 22

 GMRS Frequency Chart 22

 Wx Band Chart 22

 CTCSS Privacy Codes Frequency Chart 23

 DCS Privacy Codes Chart 23

LIMITED WARRANTY (United States) 26

WELCOME TO THE WORLD OF MIDLAND RADIO

Congratulations on your purchase of a high quality MIDLAND product. Your MXT105B 2-way radio represents state-of-the-art high tech engineering. Designed for General Mobile radio Service (GMRS) operation, this compact package is big on performance. It is a quality piece of electronic equipment, skillfully constructed with the finest components. The circuitry is all solid-state and mounted on a rugged printed circuit board. Your MXT105B radio is designed for reliable and trouble-free performance for years to come.

FEATURES

- 15 GMRS Channels
- 10 NOAA Weather Channels
- 142 Privacy Codes (38 CTCSS / 104 DCS)
- Monitor Function
- Keypad Lock
- Power HI/LO Settings
- External Speaker Jack

IMPORTANT!

Changes or modifications to this unit not expressly approved by MIDLAND RADIO CORPORATION could void your right to operate this unit. Your radio is set up to transmit a regulated signal on an assigned frequency. It is against the law to alter or adjust the settings inside the COMMUNICATOR to exceed those limitations. Any adjustment to your radio must be made by qualified technicians.

FCC NOTICE

The MXT105B operates on GMRS (General Mobile Radio Service) frequencies, which require a Federal Communications Commission (FCC) license. You must be licensed prior to operating on channels 1-7 or 15-22, which comprise the GMRS channels of the MXT105B. Serious penalties may result from unlicensed use of GMRS channels, in violation of FCC rules, as stipulated in the Communications Act's Sections 501 and 502 (amended). You will be issued a call sign by the FCC that should be used for station identification when operating your radio on GMRS channels. You should also cooperate by engaging in permissible transmissions only, avoiding channel interference with other GMRS users, and being prudent with the length of your transmission time.

To obtain a license or ask questions about the license application, contact the FCC at 1-888-CALL FCC or go to the FCC's website:

[http:// www.fcc.gov](http://www.fcc.gov) and request form **605**.

Exposure To Radio Frequency Energy

Your Midland radio is designed to comply with the following national and international standards and guidelines regarding exposure of human beings to radio frequency electromagnetic energy.

- United States Federal Communications Commission, Code of Federal Regulations: 47 CFR part 2 sub-part J
- American National Standards Institute (ANSI)/Institute of Electrical & Electronics Engineers (IEEE) C95. 1-1992
- Institute of Electrical and Electronics Engineers (IEEE) C95. 1-1999 Edition
- National Council on Radiation Protection and Measurements (NCRP) of the United States, Report 86, 1986
- International Commission on Non-Ionizing Radiation Protection (ICNIRP) 1998
- To control your exposure and ensure compliance with the general population or uncontrolled environment exposure limits, transmit no more than 50% of the time. The radio generates measurable RF energy exposure only when transmitting.
- The consumer must maintain a minimum safe separation distance of 42.8cm from the antenna.

INSTALLING YOUR RADIO

Preparation for Installation

This radio may be installed in any 12-volt negative ground system vehicle. Most current U.S. and Foreign vehicles use a negative ground system, but some older models and some newer large trucks may have a positive ground. Check the specifications for your vehicle before beginning installation. Generally, you have a negative-ground system if the negative (-) battery terminal is connected to the motor block. Contact your dealer if you are unable to determine your vehicle's polarity system.

1. Read these instructions completely before beginning installation
2. Read and follow all safety precautions in your vehicle's Service Manual.
3. Make sure all necessary tools, materials, and parts are on hand.
4. Disconnect the negative (-) battery cable before installing your radio. Be sure to reconnect the cable when installation is complete.
5. Determine a mounting location for your radio. The MXT105B is designed to be installed under the dash or vertically on the center console. Choose a location that does not impair visibility or interfere with driving. Also take into consideration the routing and length of the lead wires and cables to the power source, antenna, and/or optional external speaker.

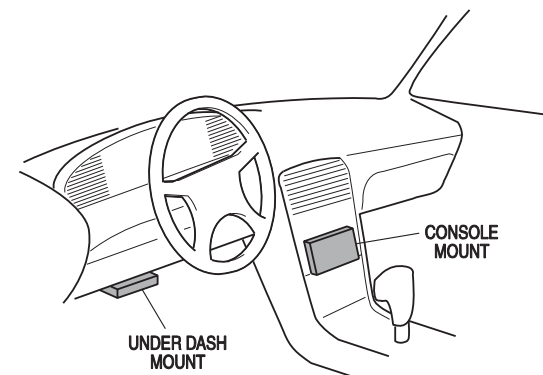

CAUTION: Extreme care should be exercised when drilling into the dash to avoid damage to under dash electronic ignition, cruise control, instrument and/or accessory wiring.

Installing the Mounting Bracket

1. Using the mounting bracket as a template, mark the location of each screw hole under the dash. Use a nail or other sharp pointed object to mark the hole locations.

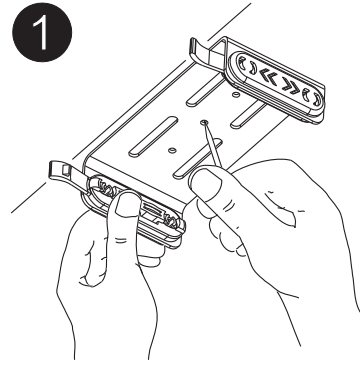

2. Attach the bracket to the dash with the Phillips head sheet metal screws provided. Tighten the screws securely. DO NOT OVER-TIGHTEN.

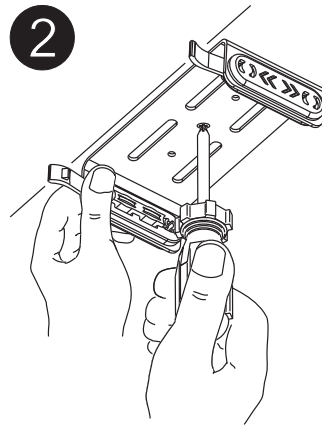

3. Slide the radio into the mounting bracket. BE SURE the mounting bracket retainers engage the slots in the sides of the radio to prevent movement while driving.

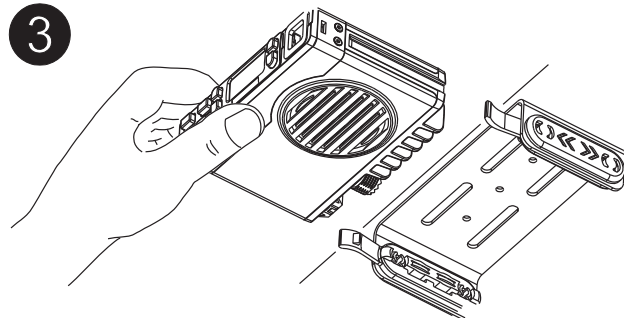

Installing the Antenna

The MXT105B includes a “magnetic mount” antenna, intended to be attached to the vehicle’s roof, trunk or similar location. Specific installation requirements vary between vehicles. Use the following guidelines to install the antenna.

Where you locate your antenna does make a difference.

1. Some general rules for antenna location that can aid radio performance.
2. Metal surfaces covered by fiberglass or vinyl may affect radio range. Avoid these locations.
3. Mount the antenna as high on the vehicle as possible. The higher the better.
4. If possible, mount the antenna in the center of whatever surface you choose.
5. The antenna cable is 19.7 feet (6 meters) long. Be sure the mounting location will allow for connection of the cable to the radio.
6. Be sure the mounting location is clean and dry before installing the antenna.
7. Route the antenna cable through an accessible entry point, such as a rear door or trunk opening.
8. When routing the antenna cable inside the vehicle, keep the cable away from noise sources, such as the ignition system, gauges, etc.
9. Exercise care to prevent cable damage. Make use of existing gaskets, grommets and weather stripping to protect the cable along its route.

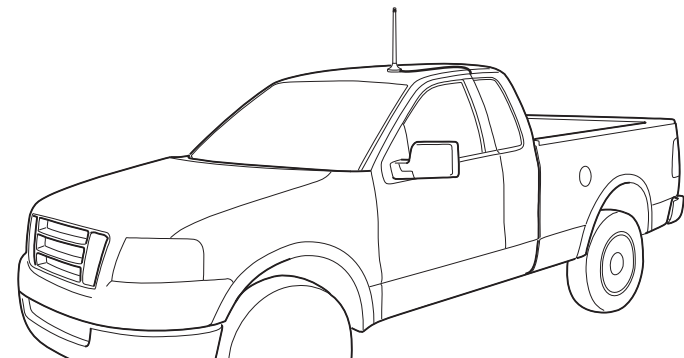

Electrical and Rear Panel Connections

Refer to **Rear Panel Connections** for rear panel connector locations.

NOTE: Radio antenna is installed separately.

1. The power cord supplied with the MXT105B is equipped with a cigarette lighter adapter for easy installation. Simply plug the connector into the vehicle's cigarette lighter. If a "hard-wired" installation is desired, connect the power cord to the vehicle's electrical system as follows:

- Cut the power cord just after the cigarette lighter adapter.
- Connect the positive lead (RED wire with in-line fuse holder) to either (a) the fuse block or (b) directly to the positive post of the vehicle's battery.

NOTE: The fuse block is usually the most convenient connection point. The power cord positive lead can also be connected to the Accessory terminal on the fuse block or ignition switch, so the radio automatically turns off when the ignition is turned off.

- Securely connect the ground lead (BLACK wire) directly to the vehicle's metal frame. A good direct metal-to-metal ground is essential for optimum performance.
2. Connect the 2-pin plug-in connector of the power cable to the **13.8V DC** jack on the rear panel.
 3. Attach the antenna cable to the **ANT** jack on the rear panel.
 4. If desired, an optional external speaker (purchased separately) can be connected to the **EXT SPKR** jack (see **Using an External Speaker**).

Connecting the Microphone

Insert the RJ11 connector into the front of the MXT105B. Once the microphone is connected, use a small tool to insert the strain relief.

The microphone bracket can then be attached to the vehicle dash or other convenient location in a manner similar to the mounting bracket.

Using an External Speaker

The MXT105B provides a rear-panel jack for connection of an optional external speaker (purchased separately).

When selecting an external speaker, ensure the speaker has 8-ohm impedance and is rated for 4.0 watts.

NOTE: When an external speaker is connected, the radio's internal speaker is automatically disabled.

CONTROLS AND INDICATORS

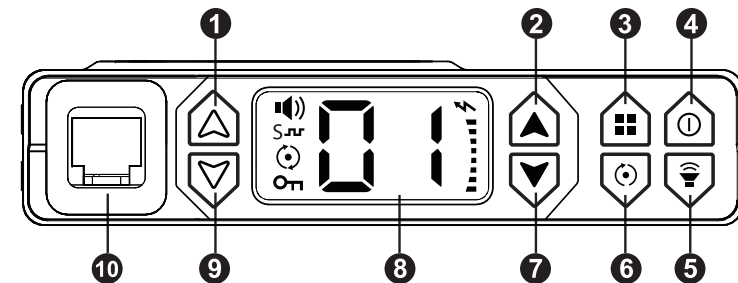

Operating Controls

1. ▲ Volume Up
2. ▲ Channel Up
3. ■■ Menu and 🔒 Lock
4. ⏻ Power On/Off and Display Brightness
5. 🔊 Monitor and 🌩 Weather Channel
6. 🔍 Scan
7. ▼ Channel Down
8. LCD Display
9. ▼ Volume Down
10. Microphone Jack

LCD Display

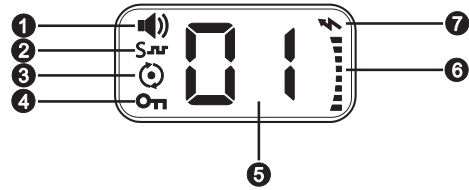

1. **Receiving Icon** - Indicates the radio is receiving transmission from another user.
2. - **CTCSS / DCS Icon** - Indicates a Continuous Tone Coded Squelch System (CTCSS) or Digitally Coded Squelch (DCS) Privacy Code has been enabled for the currently selected channel.
3. **Scanning Icon** - Indicates the “auto-scan” function is active.
4. **Keypad Lock Icon** - Indicates the keypad lock is currently enabled.
5. **Channel Icon** - Shows the selected transmit/receive channel.
6. **RX/TX Icon** - Indicates the strength of the current transmit or receive signal.
7. **Transmitting Icon** - Indicates the radio is transmitting to another user.

Rear Panel Connections

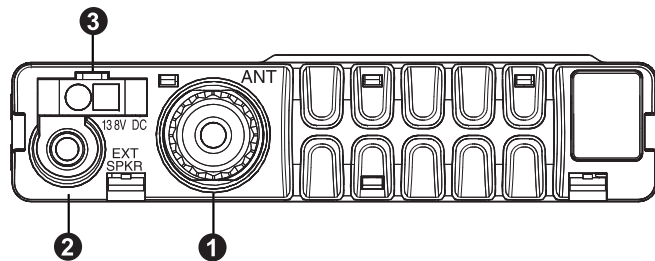

1. **ANT Jack** - SO-239 UHF connector for external antenna (included)
2. **EXT SPKR Jack** - 3.5mm Audio connector for optional external speaker (purchased separately) (see **Using an External Speaker** for specifications).
3. **13.8V DC Jack** - 2-pin DC connector for 12V DC nominal input power connection

OPERATING YOUR RADIO

About Range

Your MXT105B is designed to give you maximum operating range under optimum conditions.

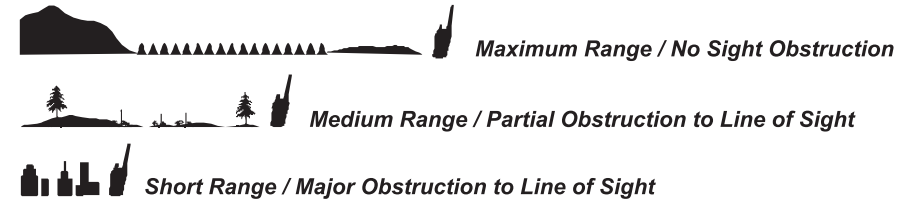

Optimum conditions for maximum operating range are:



- Over water
- In open rural areas without obstructions
- On flat areas where you can see the other radio user

To ensure you get maximum range:

- Be sure to mount the antenna (included) as high as possible on your vehicle
- Be sure to set your radio to use Hi power (see **Selecting the Transmit (TX) Power Level**)

Power On/Off



To turn the radio on and off:

1. With the radio off, press and hold the **Power On/Off**  button for two seconds to turn the radio on.
 - The LCD display will show all icons for one second and then display the most recently selected channel.
2. With the radio on, press and hold the **Power On/Off**  button for two seconds to turn the radio off.
 - The LCD display will go blank when the radio turns off.

Selecting the Active Channel

IMPORTANT! To communicate between two MXT105B radios, both radios must be set to the same channel and Privacy Code (see **Selecting a Privacy Code**) selections.

To select the active channel:

1. Be sure the radio is turned on (see Power On/Off)
2. Press the **Channel Up**  button to scroll forward through the available channels. Press the **Channel Down**  button to scroll backward through the available channels.
 - The **Channel** icon on the LCD display will show the currently selected channel.



Transmitting and Receiving a Call

IMPORTANT! To communicate between two MXT105B radios, both radios must be set to the same channel (see **Selecting a Privacy Code**) selections.

To transmit and receive a call:

1. Be sure the radio is turned on (see **Power On/Off**)
2. To transmit a call, press and hold the **PTT** button on the microphone, and speak into the microphone in a normal voice.

NOTE: For maximum clarity, hold the microphone 2 to 3 inches from your mouth when speaking.



- The **RX/TX**  icon will show continuously on the LCD display while transmitting.
3. To receive a call, release the **PTT** button on the microphone.
 - The **RX/TX icon** will show on the LCD display when your radio is receiving a transmission.
 4. If necessary, press the **Volume Up**  or **Volume Down**  button to increase or decrease radio volume.

UTILITY FUNCTIONS



Utility functions let you configure several operational parameters of the MXT105B to suit your personal preferences. For additional utility functions, “MENU” MODE FUNCTIONS.

Locking the Keypad

You can use the keypad “lock” function to prevent accidentally changing your radio’s settings. When the function is enabled, the current radio settings are “locked” in place.

NOTE: When the “lock” function is enabled, the **PTT** button on the microphone and the **Volume Up**  / **Volume Down**  buttons on the radio remain active.

To “lock” and “unlock” the keypad:

1. Be sure the radio is turned on (see **Power On/Off**)
2. Press and hold the **Menu**  button for two seconds.
 - The **Keypad Lock**  icon will show on the LCD display when the keypad is “locked.”
3. Repeat steps 1 and 2 to “unlock” the keypad.
 - The **Keypad Lock**  icon will turn off when the keypad is “unlocked.”

Adjusting the Display Illumination

You can adjust the illumination of the LCD display to ensure optimum visibility under various daytime and night-time lighting conditions. There are 6 levels of illumination, from dark to full brightness.

To adjust display brightness:



1. Be sure the radio is turned on (see **Power On/Off**)
2. Briefly press and release the **Power On/Off**  button.
 - Each time the button is pressed and released, the display illumination increases to the next brightness level.
 - When the maximum brightness level is reached and the button is pressed and released, the display illumination turns off.

Using Monitor Mode

Monitor mode lets you check for activity on the current active channel. You can also use Monitor mode to adjust the volume of your radio when not receiving a signal.

To enter and exit Monitor mode:



1. Be sure the radio is turned on (see **Power On/Off**)
2. Be sure you have selected the desired channel (see **Selecting the Active Channel**)
3. Briefly press and release the **Monitor/Quiet Channel**  button to enter Monitor mode.
 - You will hear any activity on the current selected channel.

4. Press the Volume Up  or Volume Down  button to increase or decrease radio volume.
5. Once the radio volume has been adjusted to the desired level, briefly press and release the Monitor/Quiet Channel  button to exit Monitor mode.

NOAA Weather Radio/Scan

Your MXT105B has a NOAA Weather Radio function, to enable the user to receive weather reports from designated NOAA stations. Your radio also has a NOAA Weather Scan function, to enable the user to scan all 10 channels of the NOAA Weather Radio.





To turn the NOAA Weather Band on, Long press the Monitor  button while in GMRS mode.

- The radio will go to WX Band mode and start scanning all 10 channels and stop on any active channel.
- When the channel becomes inactive for 1.5 seconds the radio will resume scanning.
 - To have radio re-scan all weather channels press and release the Scan  button
- To exit the Weather band, press the PTT button or press and hold the Monitor  button.



Scanning for Active Channels

Your MXT105B includes an “auto-scan” mode that continuously scans all 15 available channels for activity. Additionally, if desired, you can remove one or more channels from the list of scanned channels.

To enter and exit “auto-scan” mode:

1. Be sure the radio is turned on (see **Power On/Off**)
2. Quickly press and release the **Scan**  button to enter “auto-scan” mode.
 - The **Scanning**  icon will show on the LCD display when the radio is in “auto-scan” mode
 - Your radio will rapidly scan through the 15 available channels and will pause on any active channel.
 - “Auto-scan” will resume when there has been no activity on the current channel for four seconds.
3. To transmit during “auto scan,” press and hold the **PTT** button on the microphone while the radio is paused on the desired channel.
 - The radio will exit Auto Scan after the PTT button is released.
4. To exit the “auto-scan” mode, quickly press and release the **Scan**  button.
 - The **Scanning**  icon will turn off when the radio is no longer in “auto-scan” mode.

To remove a channel from “auto-scan” mode:

1. Be sure the radio is turned on (see **Power On/Off**)
2. Use the **Channel Up**  or **Channel Down**  button to scroll forward or backward through the available channels until the Channel icon for the channel you wish to remove shows on the LCD display.

3. Press and hold the **Scan**  button.
 - The selected channel is removed from the list of “scanned” channels and will not be included in “auto-scan.”

4. Repeat steps **1** through **3** to return a removed channel to the list of “scanned” channels.

“MENU”MODE FUNCTIONS

The “Menu” mode provides access to the features and functions shown in the chart below. For additional utility functions, see **UTILITY FUNCTIONS**.

MXT105B “Menu” Mode Quick Reference Chart

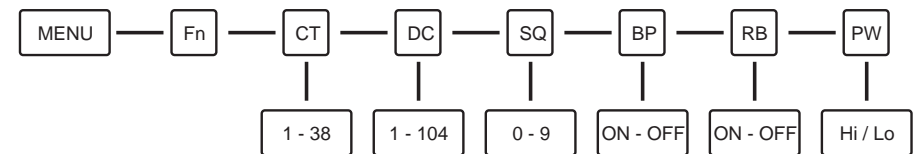

F1- CTCSS Codes. Use this option to select and assign a Continuous Tone Coded Squelch System (CTCSS) Privacy Code for the currently active channel.

F2- DCS Codes. Use this option to select and assign a Digitally Coded Squelch (DCS) Privacy Code for the currently active channel.

F3 - Squelch Sensitivity. Use this option to adjust squelch sensitivity.

F4 - Silent Operation. Use this option to set the option for the keypad audible “beep” tones.

F5 - Transmit Power Level. Use this option to change the transmit power level to HI or LO.

Selecting a Privacy Code







Continuous Tone Coded Squelch System (CTCSS) and Digitally Coded Squelch (DCS) are systems that allow several users to share the same channel without disturbing each other. When CTCSS or DCS are enabled for a selected channel, the channel is muted to all incoming signals unless they carry the correct CTCSS or DCS tone.

When a transmission with the correct tone is received, the mute is removed and the voice audio can be heard. When the transmission ends the channel is muted again. Transmissions that do not have the correct tone are not heard.

The MXT105B has 142 Privacy Codes (38 CTCSS codes and 104 DCS codes), which can be applied to any channel. If desired, you can select a different Privacy Code for each channel. See **CTCSS Privacy Codes Frequency Chart and DCS Privacy Codes Chart** for lists of available Privacy Codes.



IMPORTANT! To communicate between two MXT105B radios, both radios must be set to the same channel (see **Selecting the Active Channel**) and Privacy Code selections.

To select a Privacy Code:

1. Press the **Menu**  button to place the radio in “Menu” mode.
2. Use the **Channel Up**  or **Channel Down**  button to scroll the menu options until the LCD display shows **CT** (for CTCSS) or **DC** (for DCS), as desired.
3. Press the **Menu**  button again to confirm your selection.
 - The **S** (for CTCSS) or  (for DCS) icon will show on the LCD display, according to your selection.
4. Use the **Channel Up**  or **Channel Down**  button to scroll forward or backward through the available Privacy Codes until the desired Privacy Code is shown on the LCD display.

NOTE: DCS Privacy Codes 100-104 are shown on the LCD display as A0-A4.

NOTE: Selecting a Privacy Code of “oF” will disable the Privacy feature.









5. When the desired Privacy Code is shown on the LCD display, press the **Menu**  button to confirm your selection. **YOU MUST PRESS THE MENU  BUTTON TO CONFIRM YOUR SELECTION OR THE PRIVACY CODE WILL NOT BE CHANGED.**

NOTE: If you select a CTCSS Privacy Code, any pre-selected DCS Privacy Code will be cancelled, and vice-versa.

Adjusting Squelch Sensitivity

The MXT105B has adjustable squelch sensitivity. The minimum squelch level of 00 is the most sensitive, which allows the squelch to open on very weak signals. Setting the squelch to the maximum setting of 09 requires very strong signals to open the squelch.







To adjust the squelch sensitivity:

1. Press the **Menu**  button to place the radio in “Menu” mode.
2. Use the **Channel Up**  or **Channel Down**  button to scroll the menu options until the LCD display shows **SQ**.
3. Press the **Menu**  button again to confirm your selection.
4. Use the **Channel Up**  or **Channel Down**  button to scroll forward or backward to select the desired squelch level, from **00** to **09**.
 - The default squelch setting is **05**, which generally provides reliable squelch operation for most applications.
5. When the desired squelch level is shown on the LCD display, press the **Menu**  button to confirm your selection. **YOU MUST PRESS THE MENU  BUTTON TO CONFIRM YOUR SELECTION OR THE SQUELCH SENSITIVITY WILL NOT BE CHANGED.**

Silent Operation

The MXT105B has a SILENT OPERATION mode. In this mode, all “beeps” and “tones” are disabled.

To Set the Silent Operation:

1. Press the **Menu**  button to place the radio in “Menu” mode.
2. Use the **Channel Up**  or **Channel Down**  button to scroll the menu options until the LCD display shows **BP**.
3. Press the **Menu**  button again to confirm your selection.
4. Select “on” or “oF” by pressing the **Channel Up**  or **Channel Down** .
5. When your selection is made, press the **Menu**  button (or wait 3 seconds) to confirm your selection.

Selecting the Transmit (TX) Power Level

The MXT105B provides two transmit power levels; **HI** and **Lo**. the **Lo** power level is generally suitable when operating under optimum conditions (see **About Range**). The **HI** power level is recommended to ensure you get maximum range from your radio.

To adjust the transmit power level:

1. Press the **Menu** button to place the radio in “Menu” mode.
2. Use the **Channel Up** or **Channel Down** to scroll the menu options until the LCD display shows **PR**.
3. press the **Menu** button again to confirm your selection.
4. Use the **Channel Up** or **Channel Down** button to toggle the transmit power setting between **HI** and **Lo**.
5. When the desired transmit power level is shown on the LCD display, press the **Menu** button to confirm your selection. **YOU MUST PRESS THE MENU BUTTON TO CONFIRM YOUR SELECTION OR THE POWER LEVEL WILL NOT BE CHANGED.**

RESTORING THE DEFAULT SETTINGS

You can restore the original (factory default) settings for your MXT105B at any time.

To restore the default settings:

1. Be sure the radio is turned off (see **Power On/Off**).
2. Press and hold the **Channel Down** button.
3. Press and hold the **Power On/Off** button for two seconds to turn the radio on.
4. Release both buttons.
 - The radio will enter “standby” mode at channel 1, with no Privacy Code selected.

CARE AND MAINTENANCE

CAUTION: DO NOT use alcohol or cleaning solutions to clean the radio. DO NOT immerse the radio in water.

1. Use a soft cloth moistened with water to clean the radio.
2. Dry the radio with a dry lint-free cloth should it get wet.

TROUBLESHOOTING GUIDE

If you experience difficulties using your MXT105B, refer to the following chart to correct common operation problems. If you have a problem which you believe requires service, please call first and speak with a service technician at 816-241-8500. Many problems can be remedied over the phone without returning the unit for service.

PROBLEM	SOLUTION
No Power	Check vehicle power source (battery); replace as needed.
	Check input power connection and/or wires to vehicle power source.
Cannot Receive Messages	Verify both radios have the same channel selection and Privacy Code settings.
	Make sure you are within range of the other radio. Confirm communication is not affected by buildings and other structures (see About Range)
Keypad is not Responding	Make sure keypad “lock” is not on (see Locking the Keypad)
	Reset the radio (turn radio off then back on)
Display Backlight is Dim	Adjust the display illumination (see Adjusting the Display Illumination)

SPECIFICATIONS

Channels: 15 GMRS Channels and
 10 NOAA Weather Channels
Privacy Codes: 38 CTCSS; 104 DCS
Operating Frequency: UHF; 462.5500 ~ 462.725 MHz
Power Source: 13.8 VDC Nominal

GMRS Frequency Chart

Ch. No.	Ch. Freq. (MHz)	Ch. No.	Ch. Freq. (MHz)
1	462.5625	15	462.550
2	462.5875	16	462.575
3	462.6125	17	462.600
4	462.6375	18	462.625
5	462.6625	19	462.650
6	462.6875	20	462.675
7	462.7125	21	462.700
Ch 8 ~ 14 Reserved for FRS		22	462.725

WX Band Channels

Channel Number	Frequency (MHz)
1	162.550
2	162.400
3	162.475
4	162.425
5	162.450
6	162.500
7	162.525
8	161.650
9	161.775
10	163.275

CTCSS Privacy Codes Frequency Chart

Code	Freq.	Code	Freq.	Code	Freq.	Code	Freq.	Code	Freq.
1	67.0	9	91.5	17	118.8	25	156.7	33	210.7
2	71.9	10	94.8	18	123.0	26	162.2	34	218.1
3	74.4	11	97.4	19	127.3	27	167.9	35	225.7
4	77.0	12	100.0	20	131.8	28	173.8	36	233.6
5	79.7	13	103.5	21	136.5	29	179.9	37	241.8
6	82.5	14	107.2	22	141.3	30	186.2	38	250.3
7	85.4	15	110.9	23	146.2	31	192.8		
8	88.5	16	114.8	24	151.4	32	203.5		

DCS Privacy Codes Chart

No.	Code	No.	Code	No.	Code	No.	Code
1	23	27	165	53	413	79	731
2	25	28	172	54	423	80	732
3	26	29	174	55	431	81	734
4	31	30	205	56	432	82	743
5	32	31	223	57	445	83	754
6	43	32	226	58	464	84	36
7	47	33	243	59	465	85	53
8	51	34	244	60	466	86	122
9	54	35	245	61	503	87	145
10	65	36	251	62	506	88	212
11	71	37	261	63	516	89	225
12	72	38	263	64	532	90	246
13	73	39	265	65	546	91	252
14	74	40	271	66	565	92	255
15	114	41	306	67	606	93	266
16	115	42	311	68	612	94	274
17	116	43	315	69	624	95	325
18	125	44	331	70	627	96	332
19	131	45	343	71	631	97	356
20	132	46	346	72	632	98	446
21	134	47	351	73	654	99	452
22	143	48	364	74	662	100	454
23	152	49	365	75	664	101	455
24	155	50	371	76	703	102	462
25	156	51	411	77	712	103	523
26	162	52	412	78	723	104	526



Two-Way Radios



Weather Radios



Business 2-Way Radios



Two-Way Radios



Emergency Crank Radios



CB Radios

ACCESSORIES

Accessories can be purchased at midlandusa.com



MXTA25
3dB Gain Ghost
Antenna

\$39.99

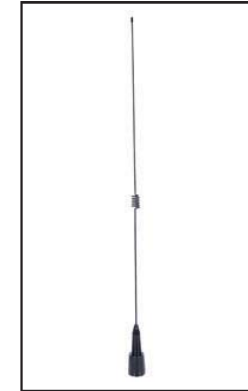

MXTA26
6dB Gain Whip
Antenna

\$49.99

For more MicroMobiles and accessories, please visit our website at midlandusa.com

LIMITED WARRANTY (United States)

Subject to the exclusions set forth below, Midland Radio Corporation will repair or replace, at its option without charge, any Midland FRS/GMRS which fails due to a defect in material or workmanship within One Year following the initial consumer purchase.

This warranty does not apply to water damage, battery leak, abuse or misuse of unauthorized accessories, unauthorized service or modification or altered products. Accessories have a 90 day warranty from date of purchase, including any charge cables or batteries.

ANY IMPLIED WARRANTIES, INCLUDING, WITHOUT LIMITATION THE IMPLIED WARRANTIES OF MERCHANTABILITY AND FITNESS FOR A PARTICULAR PURPOSE, SHALL BE LIMITED AS SET FORTH HEREIN AND TO THE DURATION OF THE LIMITED WARRANTY, OTHERWISE THE REPAIR OR REPLACEMENT AS PROVIDED UNDER THIS EXPRESS LIMITED WARRANTY IS THE EXCLUSIVE REMEDY OF THE CONSUMER AND IS PROVIDED IN LIEU OF ALL OTHER WARRANTIES, EXPRESS OR IMPLIED. IN NO EVENT SHALL MIDLAND BE LIABLE, WHETHER IN CONTRACT OR TORT (INCLUDING BUT NOT LIMITED TO NEGLIGENCE, GROSS NEGLIGENCE, BODILY INJURY, PROPERTY DAMAGE AND DEATH) FOR DAMAGES IN EXCESS OF THE PURCHASE PRICE OF THE PRODUCT OR ACCESSORY, OR FOR ANY INDIRECT, INCIDENTAL, SPECIAL OR CONSEQUENTIAL DAMAGES OF ANY KIND, OR LOSS OF REVENUE OR PROFITS, LOSS OF BUSINESS, LOSS OF INFORMATION OR DATA OR OTHER FINANCIAL LOSS ARISING OUT OF OR IN CONNECTION WITH THE ABILITY OR INABILITY TO USE THE PRODUCTS OR ACCESSORIES TO THE FULL EXTENT THESE DAMAGES MAY BE DISCLAIMED BY LAW.

For Product Purchased in the USA:

Performance of any obligation under this warranty may be obtained by returning the warranted product, prepaid freight, along with proof of purchase to:

**Midland Radio Corporation
Warranty Service Department
5900 Parretta Drive
Kansas City, MO 64120**

This warranty gives you specific legal rights, and you may also have other rights, which vary from state to state.

NOTE: *The above warranty applies only to merchandise purchased in the United States of America or any of the territories or possessions thereof, or from a U.S. Military exchange.*

**THIS PAGE IS
INTENTIONALLY
LEFT BLANK**