

DECLARATION OF COMPLIANCE SAR RF EXPOSURE EVALUATION

<p><u>Test Lab</u></p> <p>CELLTECH LABS INC. Testing and Engineering Services 1955 Moss Court Kelowna, B.C. Canada V1Y 9L3 Phone: 250-448-7047 Fax: 250-448-7046 e-mail: info@celltechlabs.com web site: www.celltechlabs.com</p>	<p><u>Applicant Information</u></p> <p>MIDLAND RADIO CORPORATION 1120 Clay Street North Kansas City, MO 64116</p>																										
<table style="width: 100%; border: none;"> <tr> <td style="width: 35%;">Rule Part(s):</td> <td>FCC 47 CFR §2.1093; IC RSS-102 Issue 1 (Provisional)</td> </tr> <tr> <td>Test Procedure(s):</td> <td>FCC OET Bulletin 65, Supplement C (01-01)</td> </tr> <tr> <td>Device Classification:</td> <td>Licensed Non-Broadcast Transmitter Held to Face (TNF)</td> </tr> <tr> <td>Device Type:</td> <td>Portable VHF PTT Radio Transceiver</td> </tr> <tr> <td>FCC IDENTIFIER:</td> <td>MMA80151</td> </tr> <tr> <td>Model(s):</td> <td>80-106</td> </tr> <tr> <td>Modulation:</td> <td>FM (VHF)</td> </tr> <tr> <td>Tx Frequency Range:</td> <td>148.025 - 173.975 MHz</td> </tr> <tr> <td>Max. RF Output Power Measured:</td> <td>37.90 dBm - Conducted (162.025 MHz)</td> </tr> <tr> <td>Antenna Type(s) Tested:</td> <td>Whip 150-161 MHz (P/N: ACC101VLB) Whip 162-174 MHz (P/N: ACC101VB)</td> </tr> <tr> <td>Battery Type(s) Tested:</td> <td>NiMH 7.2V, 1300mAh (P/N: 18-B02)</td> </tr> <tr> <td>Body-Worn Accessories Tested:</td> <td>1. Belt-Clip 2. Holster & Swivel Belt-Loop (P/N: QPA1491) 3. Speaker-Microphone (P/N: 70-M70)</td> </tr> <tr> <td>Max. SAR Measured:</td> <td>Face-held: 0.890 W/kg (50% Duty Cycle) Body-Worn: 1.27 W/kg (50% Duty Cycle)</td> </tr> </table>		Rule Part(s):	FCC 47 CFR §2.1093; IC RSS-102 Issue 1 (Provisional)	Test Procedure(s):	FCC OET Bulletin 65, Supplement C (01-01)	Device Classification:	Licensed Non-Broadcast Transmitter Held to Face (TNF)	Device Type:	Portable VHF PTT Radio Transceiver	FCC IDENTIFIER:	MMA80151	Model(s):	80-106	Modulation:	FM (VHF)	Tx Frequency Range:	148.025 - 173.975 MHz	Max. RF Output Power Measured:	37.90 dBm - Conducted (162.025 MHz)	Antenna Type(s) Tested:	Whip 150-161 MHz (P/N: ACC101VLB) Whip 162-174 MHz (P/N: ACC101VB)	Battery Type(s) Tested:	NiMH 7.2V, 1300mAh (P/N: 18-B02)	Body-Worn Accessories Tested:	1. Belt-Clip 2. Holster & Swivel Belt-Loop (P/N: QPA1491) 3. Speaker-Microphone (P/N: 70-M70)	Max. SAR Measured:	Face-held: 0.890 W/kg (50% Duty Cycle) Body-Worn: 1.27 W/kg (50% Duty Cycle)
Rule Part(s):	FCC 47 CFR §2.1093; IC RSS-102 Issue 1 (Provisional)																										
Test Procedure(s):	FCC OET Bulletin 65, Supplement C (01-01)																										
Device Classification:	Licensed Non-Broadcast Transmitter Held to Face (TNF)																										
Device Type:	Portable VHF PTT Radio Transceiver																										
FCC IDENTIFIER:	MMA80151																										
Model(s):	80-106																										
Modulation:	FM (VHF)																										
Tx Frequency Range:	148.025 - 173.975 MHz																										
Max. RF Output Power Measured:	37.90 dBm - Conducted (162.025 MHz)																										
Antenna Type(s) Tested:	Whip 150-161 MHz (P/N: ACC101VLB) Whip 162-174 MHz (P/N: ACC101VB)																										
Battery Type(s) Tested:	NiMH 7.2V, 1300mAh (P/N: 18-B02)																										
Body-Worn Accessories Tested:	1. Belt-Clip 2. Holster & Swivel Belt-Loop (P/N: QPA1491) 3. Speaker-Microphone (P/N: 70-M70)																										
Max. SAR Measured:	Face-held: 0.890 W/kg (50% Duty Cycle) Body-Worn: 1.27 W/kg (50% Duty Cycle)																										

Celltech Labs Inc. declares under its sole responsibility that this wireless portable device has demonstrated compliance with the Specific Absorption Rate (SAR) RF exposure requirements specified in FCC 47 CFR §2.1093 and Health Canada's Safety Code 6. The device was tested in accordance with the measurement standards and procedures specified in FCC OET Bulletin 65, Supplement C (Edition 01-01) and Industry Canada RSS-102 Issue 1 (Provisional) for the Occupational / Controlled Exposure environment. All measurements were performed in accordance with the SAR system manufacturer recommendations.

I attest to the accuracy of data. All measurements were performed by me or were made under my supervision and are correct to the best of my knowledge and belief. I assume full responsibility for the completeness of these measurements and vouch for the qualifications of all persons taking them.

This test report shall not be reproduced partially, or in full, without the prior written approval of Celltech Labs Inc. The results and statements contained in this report pertain only to the device(s) evaluated.



Russell W. Pipe
Senior Compliance Technologist
Celltech Labs Inc.



TABLE OF CONTENTS		
1.0	INTRODUCTION.....	3
2.0	DESCRIPTION OF DUT.....	3
3.0	SAR MEASUREMENT SYSTEM.....	4
4.0	MEASUREMENT SUMMARY.....	5
5.0	DETAILS OF SAR EVALUATION.....	6
6.0	EVALUATION PROCEDURES.....	6
7.0	SYSTEM PERFORMANCE CHECK.....	7
8.0	SIMULATED EQUIVALENT TISSUES.....	8
9.0	SAR SAFETY LIMITS.....	8
10.0	ROBOT SYSTEM SPECIFICATIONS.....	9
11.0	PROBE SPECIFICATION.....	10
12.0	PLANAR PHANTOM.....	10
13.0	VALIDATION PHANTOM.....	10
14.0	DEVICE HOLDER.....	10
15.0	TEST EQUIPMENT LIST.....	11
16.0	MEASUREMENT UNCERTAINTIES.....	12-13
17.0	REFERENCES.....	14
	APPENDIX A - SAR MEASUREMENT DATA.....	15
	APPENDIX B - SYSTEM PERFORMANCE CHECK DATA.....	16
	APPENDIX C - SYSTEM VALIDATION PROCEDURES.....	17
	APPENDIX D - PROBE CALIBRATION.....	18
	APPENDIX E - MEASURED FLUID DIELECTRIC PARAMETERS.....	19
	APPENDIX F - SAR TEST SETUP & DUT PHOTOGRAPHS.....	20

1.0 INTRODUCTION

This measurement report demonstrates compliance of the Midland Radio Corporation Model: 80-106 Portable VHF PTT Radio Transceiver FCC ID: MMA80151 with the SAR (Specific Absorption Rate) RF exposure requirements specified in FCC 47 CFR §2.1093 (see reference [1]) and Health Canada Safety Code 6 (see reference [2]) for the Occupational / Controlled Exposure environment. The test procedures described in FCC OET Bulletin 65, Supplement C (Edition 01-01) (see reference [3]) and IC RSS-102 Issue 1 (Provisional) (see reference [4]), were employed. A description of the product and operating configuration, detailed summary of the test results, methodology and procedures used in the evaluation, equipment used, and the various provisions of the rules are included within this test report.

2.0 DESCRIPTION OF DEVICE UNDER TEST (DUT)

FCC Rule Part(s)	FCC 47 CFR §2.1093		
IC Rule Part(s)	RSS-102 Issue 1 (Provisional)		
Test Procedure(s)	FCC OET Bulletin 65, Supplement C (01-01)		
Device Classification	Licensed Non-Broadcast Transmitter Held to Face (TNF)		
Device Type	Portable VHF PTT Radio Transceiver		
FCC ID	MMA80151		
Model No.(s)	80-106		
Serial No.(s)	Identical Prototype		
Modulation	FM (VHF)		
Tx Frequency Range	148.025 - 173.975 MHz		
Max. RF Output Power Measured	37.90 dBm	Conducted	162.025 MHz
Battery Type(s)	NiMH	7.2 V, 1300 mAh	P/N: 18-B02
Antenna Type(s)	Whip	150-161 MHz	Length: 144 mm P/N: ACC101VLB
	Whip	162-174 MHz	Length: 144 mm P/N: ACC101VB
Body-worn Accessories Tested	Belt-Clip		
	Holster & Swivel Belt-Loop (P/N: QPA1491)		
	Speaker-Microphone (P/N: 70-M70)		

3.0 SAR MEASUREMENT SYSTEM

Celltech Labs Inc. SAR measurement facility utilizes the Dosimetric Assessment System (DASY™) manufactured by Schmid & Partner Engineering AG (SPEAG™) of Zurich, Switzerland. The DASY4 measurement system is comprised of the measurement server, robot controller, computer, near-field probe, probe alignment sensor, specific anthropomorphic mannequin (SAM) phantom, and various planar phantoms for brain and/or body SAR evaluations. The robot is a six-axis industrial robot performing precise movements to position the probe to the location (points) of maximum electromagnetic field (EMF). A cell controller system contains the power supply, robot controller, teach pendant (Joystick), and remote control, is used to drive the robot motors. The Staubli robot is connected to the cell controller to allow software manipulation of the robot. A data acquisition electronic (DAE) circuit performs the signal amplification, signal multiplexing, AD-conversion, offset measurements, mechanical surface detection, collision detection, etc. is connected to the Electro-optical coupler (EOC). The EOC performs the conversion from the optical into digital electric signal of the DAE and transfers data to the DASY4 measurement server. The DAE4 utilizes a highly sensitive electrometer-grade preamplifier with auto-zeroing, a channel and gain-switching multiplexer, a fast 16-bit AD-converter and a command decoder and control logic unit. Transmission to the DASY4 measurement server is accomplished through an optical downlink for data and status information and an optical uplink for commands and clock lines. The mechanical probe-mounting device includes two different sensor systems for frontal and sidewise probe contacts. The sensor systems are also used for mechanical surface detection and probe collision detection. The robot uses its own controller with a built in VME-bus computer.



DASY4 SAR Measurement System with validation phantom



DASY4 SAR Measurement System with Plexiglas planar phantom

4.0 MEASUREMENT SUMMARY

SAR EVALUATION RESULTS														
Test Type	Freq (MHz)	Chan	Test Mode	Measured Conducted RF Output Power			Antenna Part No.	Body-worn Accessory	Separation Distance to Planar Phantom (cm)	Measured SAR 1g (W/kg)		SAR vs Time Power Drift (dB)	Scaled SAR 1g (W/kg)	
				Before (dBm)	After (dBm)	Drift (dB)				Duty Cycle			Duty Cycle	
										100%	50%		100%	50%
Face	162.025	Mid	CW	37.82	37.49	-0.33	ACC101VLB	--	2.5	1.63	0.815	-0.38	1.78	0.890
Face	162.025	Mid	CW	37.83	37.55	-0.28	ACC101VB	--	2.5	1.40	0.700	-0.38	1.53	0.765
Body	162.025	Mid	CW	37.86	37.62	-0.24	ACC101VLB	Belt-Clip Speaker-Mic	1.5	1.15	0.575	-0.38	1.26	0.630
Body	162.025	Mid	CW	37.82	37.48	-0.34	ACC101VB	Belt-Clip Speaker-Mic	1.5	2.32	1.16	-0.38	2.53	1.27
Body	162.025	Mid	CW	37.90	37.58	-0.32	ACC101VLB	Holster Belt-Loop Speaker-Mic	4.5	0.848	0.424	-0.38	0.926	0.463
Body	162.025	Mid	CW	37.78	37.49	-0.29	ACC101VB	Holster Belt-Loop Speaker-Mic	4.5	1.17	0.585	-0.38	1.28	0.640

ANSI / IEEE C95.1 1992 - SAFETY LIMIT					
BRAIN / BODY: 8.0 W/kg (averaged over 1 gram)					
Spatial Peak - Occupational / Controlled Exposure					

Dielectric Constant ϵ_r	150 MHz Brain		150 MHz Body		Ambient Temperature	Brain: 23.8 °C	Body: 25.0 °C
	IEEE Target	Measured	IEEE Target	Measured	Fluid Temperature	Brain: 23.9 °C	Body: 22.8 °C
	52.3 (\pm 5%)	54.2	61.9 (\pm 5%)	61.9	Atmospheric Pressure	Brain: 122.9 kPa	Body: 124.7 kPa
Conductivity σ (mho/m)	150 MHz Brain		150 MHz Body		Relative Humidity	32%	
	IEEE Target	Measured	IEEE Target	Measured	Fluid Depth	\geq 15 cm	
	0.76 (\pm 5%)	0.75	0.80 (\pm 5%)	0.83	ρ (Kg/m ³)	1000	

Note(s):

- The measurement results were obtained with the DUT tested in the conditions described in this report. Detailed measurement data and plots showing the maximum SAR location of the DUT are reported in Appendix A.
- If the SAR measurements performed at the mid channel were \geq 3dB below the SAR limit, SAR evaluation for the low and high channels was optional (per FCC OET Bulletin 65, Supplement C, Edition 01-01 (see reference [3])).
- The power drifts measured during the SAR evaluations were $>$ 5%. A SAR versus time evaluation was performed over the duration of the zoom scan for the highest SAR level test configuration (body-worn with belt-clip, speaker-microphone, antenna P/N: ACC101VB), with the radio in a "cold" state and without turn-on delay. The SAR versus time drift (dB) was subsequently added to the measured SAR values to report conservative worst-case results (see measured and scaled SAR values in the above test data table). The SAR versus time evaluation plot is shown in Appendix A (SAR Test Plots).
- The ambient and fluid temperatures were measured prior to, and during, the fluid dielectric parameter check and the SAR evaluation. The temperatures reported were consistent for all measurement periods.
- The dielectric parameters of the simulated tissues were measured prior to the evaluation using an 85070C Dielectric Probe Kit and an 8753E Network Analyzer (see Appendix E for printout of measured fluid dielectric parameters).

5.0 DETAILS OF SAR EVALUATION

The Midland Radio Corporation Model: 80-106 Portable VHF PTT Radio Transceiver FCC ID: MMA80151 was found to be compliant for localized Specific Absorption Rate (Occupational / Controlled Exposure) based on the test provisions and conditions described below. The detailed test setup photographs are shown in Appendix F.

1. The DUT was evaluated in a face-held configuration with the front of the radio placed parallel to the outer surface of the planar phantom. A 2.5 cm separation distance was maintained between the front side of the DUT and the outer surface of the planar phantom for the duration of the test.
2. The DUT was evaluated in a body-worn configuration with the back of the radio placed parallel to the outer surface of the planar phantom. The attached belt-clip was touching the planar phantom and provided a 1.5 cm separation distance between the back of the DUT and the outer surface of the planar phantom. The DUT was tested for body-worn SAR with the speaker-microphone accessory connected.
3. The DUT was evaluated in a body-worn configuration with the radio placed in the holster accessory, with the back of the holster and belt-loop placed parallel to the outer surface of the planar phantom. The back of the belt-loop accessory was touching the planar phantom and both the holster and belt-loop provided a total separation distance of 4.5 cm between the back of the DUT and the outer surface of the planar phantom. The DUT was tested for body-worn SAR with the speaker-microphone accessory connected.
4. The conducted power levels were measured before and after each test using a Gigatronics 8652A Universal Power Meter according to the procedures described in FCC 47 CFR §2.1046. The power drifts measured during the SAR evaluations were > 5%. A SAR versus time evaluation was performed over the duration of the zoom scan for the highest SAR level test configuration (body-worn with belt-clip, speaker-microphone, antenna P/N: ACC101VB), with the radio in a "cold" state and without turn-on delay. The SAR versus time drift (dB) was subsequently added to the measured SAR values to report conservative worst-case results (see measured and scaled SAR values listed on page 5). The SAR versus time evaluation plot is shown in Appendix A (SAR Test Plots).
5. The area scan evaluation was performed with a fully charged battery. After the area scan was completed the radio was cooled down to room temperature and the battery was replaced with a fully charged battery prior to the zoom scan.
6. The DUT was tested in unmodulated continuous transmit operation (Continuous Wave mode at 100% duty cycle) with the transmit key constantly depressed. For a push-to-talk device the 50% duty cycle compensation reported assumes a transmit/receive cycle of equal time base.
7. The SAR evaluations were performed using a Plexiglas planar phantom.
8. A stack of low-density, low-loss dielectric foamed polystyrene was used in place of the device holder.

6.0 EVALUATION PROCEDURES

- a. (i) The evaluation was performed in the applicable area of the phantom depending on the type of device being tested. For devices held to the ear during normal operation, both the left and right ear positions were evaluated using the SAM phantom.
(ii) For body-worn and face-held devices a planar phantom was used.
- b. The SAR was determined by a pre-defined procedure within the DASY4 software. Upon completion of a reference and optical surface check, the exposed region of the phantom was scanned near the inner surface with a grid spacing of 15mm x 15mm.

An area scan was determined as follows:

- c. Based on the defined area scan grid, a more detailed grid is created to increase the points by a factor of 10. The interpolation function then evaluates all field values between corresponding measurement points.
- d. A linear search is applied to find all the candidate maxima. Subsequently, all maxima are removed that are >2 dB from the global maximum. The remaining maxima are then used to position the cube scans.

A 1g and 10g spatial peak SAR was determined as follows:

- e. Extrapolation is used to find the points between the dipole center of the probe and the surface of the phantom. This data cannot be measured, since the center of the dipoles is 2.7 mm away from the tip of the probe and the distance between the surface and the lowest measuring point is 1.4 mm (see probe calibration document in Appendix D). The extrapolation was based on trivariate quadratics computed from the previously calculated 3D interpolated points nearest the phantom surface.
- f. Interpolated data is used to calculate the average SAR over 1g and 10g cubes by spatially discretizing the entire measured cube. The volume used to determine the averaged SAR is a 1mm grid (42875 interpolated points).
- g. A zoom scan volume of 32 mm x 32 mm x 30 mm (5 x 5 x 7 points) centered at the peak SAR location determined from the area scan is used for all zoom scans for devices with a transmit frequency < 800 MHz. Zoom scans for frequencies ≥ 800 MHz are determined with a scan volume of 30 mm x 30 mm x 30 mm (7 x 7 x 7) to ensure complete capture of the peak spatial-average SAR.

7.0 SYSTEM PERFORMANCE CHECK

Prior to the SAR evaluation a system check was performed using a large Plexiglas planar phantom with a 300MHz dipole (see Appendix C for system validation procedure). The dielectric parameters of the simulated brain tissue were measured prior to the system performance check using an 85070C Dielectric Probe Kit and an 8753E Network Analyzer (see Appendix E for printout of measured fluid dielectric parameters). A forward power of 250mW was applied to the dipole and the system was verified to a tolerance of $\pm 10\%$ (see Appendix B for system performance check test plot).

SYSTEM PERFORMANCE CHECK													
Test Date	300MHz Equiv. Tissue	SAR 1g (W/kg)		Dielectric Constant ϵ_r		Conductivity σ (mho/m)		ρ (Kg/m ³)	Amb. Temp. (°C)	Fluid Temp. (°C)	Fluid Depth (cm)	Humid. (%)	Barom. Press. (kPa)
		IEEE Target	Measured	IEEE Target	Measured	IEEE Target	Measured						
01/29/04	Brain	0.750 $\pm 10\%$	0.771 $+2.8\%$	45.3 $\pm 5\%$	46.7	0.87 $\pm 5\%$	0.90	1000	24.3	23.2	≥ 15	32%	122.0

Note(s):

- The ambient and fluid temperatures were measured prior to, and during, the fluid dielectric parameter check and the system performance check. The temperatures listed in the table above were consistent for all measurement periods.

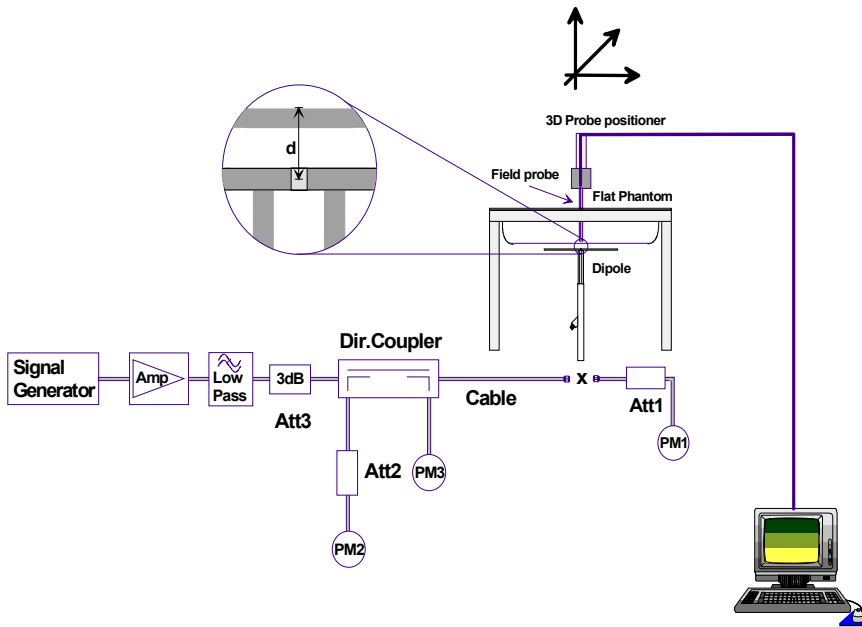

Figure 1. System Performance Check Setup Diagram



300 MHz Dipole Setup

8.0 SIMULATED EQUIVALENT TISSUES

The simulated tissue mixtures consist of a viscous gel using hydroxethylcellulose (HEC) gelling agent and saline solution. Preservation with a bactericide is added and visual inspection is made to ensure air bubbles are not trapped during the mixing process. The fluid was prepared according to standardized procedures and measured for dielectric parameters (permittivity and conductivity).

SIMULATED TISSUE MIXTURES			
INGREDIENT	300 MHz Brain (%) (System Check)	150 MHz Brain (%) (DUT Evaluation)	150 MHz Body (%) (DUT Evaluation)
Water	37.56	38.35	46.6
Sugar	55.32	55.5	49.7
Salt	5.95	5.15	2.6
HEC	0.98	0.9	1.0
Bactericide	0.19	0.1	0.1

9.0 SAR SAFETY LIMITS

EXPOSURE LIMITS	SAR (W/kg)	
	(General Population / Uncontrolled Exposure Environment)	(Occupational / Controlled Exposure Environment)
Spatial Average (averaged over the whole body)	0.08	0.4
Spatial Peak (averaged over any 1g of tissue)	1.60	8.0
Spatial Peak (hands/wrists/feet/ankles averaged over 10g)	4.0	20.0

Notes:

1. Uncontrolled environments are defined as locations where there is potential exposure of individuals who have no knowledge or control of their potential exposure.
2. Controlled environments are defined as locations where there is potential exposure of individuals who have knowledge of their potential exposure and can exercise control over their exposure.

10.0 ROBOT SYSTEM SPECIFICATIONS

Specifications

POSITIONER: Stäubli Unimation Corp. Robot Model: RX60L
Repeatability: 0.02 mm
No. of axis: 6

Data Acquisition Electronic (DAE) System

Cell Controller

Processor: AMD Athlon XP 2400+
Clock Speed: 2.0 GHz
Operating System: Windows XP Professional

Data Converter

Features: Signal Amplifier, multiplexer, A/D converter, and control logic
Software: DASY4 software
Connecting Lines: Optical downlink for data and status info.
 Optical uplink for commands and clock

DASY4 Measurement Server

Function: Real-time data evaluation for field measurements and surface detection
Hardware: PC/104 166MHz Pentium CPU; 32 MB chipdisk; 64 MB RAM
Connections: COM1, COM2, DAE, Robot, Ethernet, Service Interface

E-Field Probe

Model: ET3DV6
Serial No.: 1590
Construction: Triangular core fiber optic detection system
Frequency: 10 MHz to 6 GHz
Linearity: ± 0.2 dB (30 MHz to 3 GHz)

Evaluation Phantom

Type: Planar Phantom
Shell Material: Plexiglas
Bottom Thickness: 2.0 mm \pm 0.1 mm
Outer Dimensions: 75.0 cm (L) x 22.5 cm (W) x 20.5 cm (H); Back Plane: 25.7 cm (H)

Validation Phantom (≤ 450 MHz)

Type: Planar Phantom
Shell Material: Plexiglas
Bottom Thickness: 6.2 mm \pm 0.1 mm
Outer Dimensions: 86.0 cm (L) x 39.5 cm (W) x 21.8 cm (H)

11.0 PROBE SPECIFICATION (ET3DV6)

Construction:	Symmetrical design with triangular core Built-in shielding against static charges PEEK enclosure material (resistant to organic solvents, e.g. glycol)
Calibration:	In air from 10 MHz to 2.5 GHz In brain simulating tissue at frequencies of 900 MHz and 1.8 GHz (accuracy $\pm 8\%$)
Frequency:	10 MHz to > 6 GHz; Linearity: ± 0.2 dB (30 MHz to 3 GHz)
Directivity:	± 0.2 dB in brain tissue (rotation around probe axis) ± 0.4 dB in brain tissue (rotation normal to probe axis)
Dynamic Range:	5 μ W/g to > 100 mW/g; Linearity: ± 0.2 dB
Surface Detection:	± 0.2 mm repeatability in air and clear liquids over diffuse reflecting surfaces
Dimensions:	Overall length: 330 mm Tip length: 16 mm Body diameter: 12 mm Tip diameter: 6.8 mm Distance from probe tip to dipole centers: 2.7 mm
Application:	General dosimetry up to 3 GHz Compliance tests of mobile phone



ET3DV6 E-Field Probe

12.0 PLANAR PHANTOM

The planar phantom is constructed of Plexiglas material with a 2.0 mm shell thickness for face-held and body-worn SAR evaluations of handheld radio transceivers. The planar phantom is mounted on the side of the DASY4 system table.

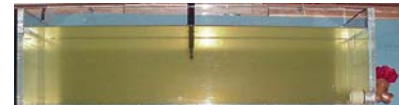

Plexiglas Planar Phantom

13.0 VALIDATION PLANAR PHANTOM

The validation planar phantom is constructed of Plexiglas material with a 6.0 mm shell thickness for SAR validations at 450MHz and below. The validation planar phantom is mounted in the table of the DASY4 compact system.



Validation Planar Phantom

14.0 DEVICE HOLDER

The DASY4 device holder has two scales for device rotation (with respect to the body axis) and the device inclination (with respect to the line between the ear openings). The plane between the ear openings and the mouth tip has a rotation angle of 65°. The bottom plate contains three pair of bolts for locking the device holder. The device holder positions are adjusted to the standard measurement positions in the three sections.



Device Holder

15.0 TEST EQUIPMENT LIST

TEST EQUIPMENT	SERIAL NO.	CALIBRATION DATE
Schmid & Partner DASY4 System	-	-
DASY4 Measurement Server	1078	N/A
-Robot	599396-01	N/A
-ET3DV6 E-Field Probe	1590	May 2003
-300MHz Validation Dipole	135	Oct 2003
-450MHz Validation Dipole	136	Nov 2003
-900MHz Validation Dipole	054	June 2003
-1800MHz Validation Dipole	247	June 2003
-2450MHz Validation Dipole	150	Sept 2003
-Plexiglas Planar Phantom	161	N/A
-Validation Planar Phantom	137	N/A
HP 85070C Dielectric Probe Kit	N/A	N/A
Gigatronics 8651A Power Meter	8650137	April 2003
Gigatronics 8652A Power Meter	1835267	April 2003
Power Sensor 80701A	1833542	Feb 2003
Power Sensor 80701A	1833699	April 2003
HP E4408B Spectrum Analyzer	US39240170	Dec 2003
HP 8594E Spectrum Analyzer	3543A02721	April 2003
HP 8753E Network Analyzer	US38433013	May 2003
HP 8648D Signal Generator	3847A00611	May 2003
Amplifier Research 5S1G4 Power Amplifier	26235	N/A

16.0 MEASUREMENT UNCERTAINTIES

UNCERTAINTY BUDGET FOR DEVICE EVALUATION						
Error Description	Uncertainty Value ±%	Probability Distribution	Divisor	C_i 1g	Standard Uncertainty ±% (1g)	v_i or v_{eff}
Measurement System						
Probe calibration	± 4.8	Normal	1	1	± 4.8	∞
Axial isotropy of the probe	± 4.7	Rectangular	√3	(1- c_p)	± 1.9	∞
Spherical isotropy of the probe	± 9.6	Rectangular	√3	(c_p)	± 3.9	∞
Spatial resolution	± 0.0	Rectangular	√3	1	± 0.0	∞
Boundary effects	± 5.5	Rectangular	√3	1	± 3.2	∞
Probe linearity	± 4.7	Rectangular	√3	1	± 2.7	∞
Detection limit	± 1.0	Rectangular	√3	1	± 0.6	∞
Readout electronics	± 1.0	Normal	1	1	± 1.0	∞
Response time	± 0.8	Rectangular	√3	1	± 0.5	∞
Integration time	± 1.4	Rectangular	√3	1	± 0.8	∞
RF ambient conditions	± 3.0	Rectangular	√3	1	± 1.7	∞
Mech. constraints of robot	± 0.4	Rectangular	√3	1	± 0.2	∞
Probe positioning	± 2.9	Rectangular	√3	1	± 1.7	∞
Extrapolation & integration	± 3.9	Rectangular	√3	1	± 2.3	∞
Test Sample Related						
Device positioning	± 6.0	Normal	√3	1	± 6.7	12
Device holder uncertainty	± 5.0	Normal	√3	1	± 5.9	8
Power drift	± 5.0	Rectangular	√3		± 2.9	∞
Phantom and Setup						
Phantom uncertainty	± 4.0	Rectangular	√3	1	± 2.3	∞
Liquid conductivity (target)	± 5.0	Rectangular	√3	0.6	± 1.7	∞
Liquid conductivity (measured)	± 5.0	Rectangular	√3	0.6	± 1.7	∞
Liquid permittivity (target)	± 5.0	Rectangular	√3	0.6	± 1.7	∞
Liquid permittivity (measured)	± 5.0	Rectangular	√3	0.6	± 1.7	∞
Combined Standard Uncertainty					± 13.3	
Expanded Uncertainty (k=2)					± 26.6	

Measurement Uncertainty Table in accordance with IEEE Standard 1528-200X (Draft - see reference [5])

MEASUREMENT UNCERTAINTIES (Cont.)

UNCERTAINTY BUDGET FOR SYSTEM VALIDATION						
Error Description	Uncertainty Value ±%	Probability Distribution	Divisor	C_i 1g	Standard Uncertainty ±% (1g)	v_i or v_{eff}
Measurement System						
Probe calibration	± 4.8	Normal	1	1	± 4.8	∞
Axial isotropy of the probe	± 4.7	Rectangular	√3	(1- c_p)	± 1.9	∞
Spherical isotropy of the probe	± 9.6	Rectangular	√3	(c_p)	± 3.9	∞
Spatial resolution	± 0.0	Rectangular	√3	1	± 0.0	∞
Boundary effects	± 5.5	Rectangular	√3	1	± 3.2	∞
Probe linearity	± 4.7	Rectangular	√3	1	± 2.7	∞
Detection limit	± 1.0	Rectangular	√3	1	± 0.6	∞
Readout electronics	± 1.0	Normal	1	1	± 1.0	∞
Response time	± 0.8	Rectangular	√3	1	± 0.5	∞
Integration time	± 1.4	Rectangular	√3	1	± 0.8	∞
RF ambient conditions	± 3.0	Rectangular	√3	1	± 1.7	∞
Mech. constraints of robot	± 0.4	Rectangular	√3	1	± 0.2	∞
Probe positioning	± 2.9	Rectangular	√3	1	± 1.7	∞
Extrapolation & integration	± 3.9	Rectangular	√3	1	± 2.3	∞
Dipole						
Dipole Axis to Liquid Distance	± 2.0	Rectangular	√3	1	± 1.2	∞
Input Power	± 4.7	Rectangular	√3	1	± 2.7	∞
Phantom and Setup						
Phantom uncertainty	± 4.0	Rectangular	√3	1	± 2.3	∞
Liquid conductivity (target)	± 5.0	Rectangular	√3	0.6	± 1.7	∞
Liquid conductivity (measured)	± 5.0	Rectangular	√3	0.6	± 1.7	∞
Liquid permittivity (target)	± 5.0	Rectangular	√3	0.6	± 1.7	∞
Liquid permittivity (measured)	± 5.0	Rectangular	√3	0.6	± 1.7	∞
Combined Standard Uncertainty					± 9.9	
Expanded Uncertainty (k=2)					± 19.8	

Measurement Uncertainty Table in accordance with IEEE Standard 1528-200X (Draft - see reference [5])

Test Report S/N:	012704-464MMA
Test Date(s):	January 29, 2004
Test Type:	FCC/IC SAR Evaluation

17.0 REFERENCES

- [1] Federal Communications Commission, "Radiofrequency radiation exposure evaluation: portable devices", Rule Part 47 CFR §2.1093: 1999.
- [2] Health Canada, "Limits of Human Exposure to Radiofrequency Electromagnetic Fields in the Frequency Range from 3 kHz to 300 GHz", Safety Code 6.
- [3] Federal Communications Commission, "Evaluating Compliance with FCC Guidelines for Human Exposure to Radio frequency Electromagnetic Fields", OET Bulletin 65, Supplement C (Edition 01-01), FCC, Washington, D.C.: June 2001.
- [4] Industry Canada, "Evaluation Procedure for Mobile and Portable Radio Transmitters with respect to Health Canada's Safety Code 6 for Exposure of Humans to Radio Frequency Fields", Radio Standards Specification RSS-102 Issue 1 (Provisional): September 1999.
- [5] IEEE Standards Coordinating Committee 34, Std 1528-200X, "DRAFT Recommended Practice for Determining the Spatial-Peak Specific Absorption Rate (SAR) in the Human Body Due to Wireless Communications Devices: Experimental Techniques".

Test Report S/N:	012704-464MMA
Test Date(s):	January 29, 2004
Test Type:	FCC/IC SAR Evaluation

APPENDIX A - SAR MEASUREMENT DATA

Date Tested: 01/29/04

DUT: Midland Radio Model: 80-106; Type: Portable VHF PTT Radio Transceiver; Serial: Identical Prototype

Ambient Temp: 23.8 °C; Fluid Temp: 23.9 °C; Barometric Pressure: 122.9 kPa; Humidity: 32%

7.2V NiMH Battery Pack

Communication System: FM VHF

Frequency: 162.025 MHz; Duty Cycle: 1:1

RF Output Power: 37.82 dBm (Conducted)

Medium: HSL150 ($\sigma = 0.75 \text{ mho/m}$; $\epsilon_r = 54.2$; $\rho = 1000 \text{ kg/m}^3$)

- Probe: ET3DV6 - SN1590; ConvF(9.6, 9.6, 9.6); Calibrated: 15/05/2003
- Sensor-Surface: 4mm (Mechanical Surface Detection)
- Electronics: DAE3 Sn353; Calibrated: 19/12/2003
- Phantom: Planar; Type: Plexiglas; Serial: 161
- Measurement SW: DASY4, V4.2 Build 12; Postprocessing SW: SEMCAD, V1.8 Build 94

Face-Held - Whip Antenna (P/N: ACC101VLB) - 2.5 cm Separation Distance

Mid Channel/Area Scan (7x20x1): Measurement grid: dx=15mm, dy=15mm

Face-Held - Whip Antenna (P/N: ACC101VLB) - 2.5 cm Separation Distance

Mid Channel/Zoom Scan (5x5x7)/Cube 0: Measurement grid: dx=8mm, dy=8mm, dz=5mm

Peak SAR (extrapolated) = 2.47 W/kg

SAR(1 g) = 1.63 mW/g; SAR(10 g) = 1.21 mW/g

Reference Value = 45.6 V/m

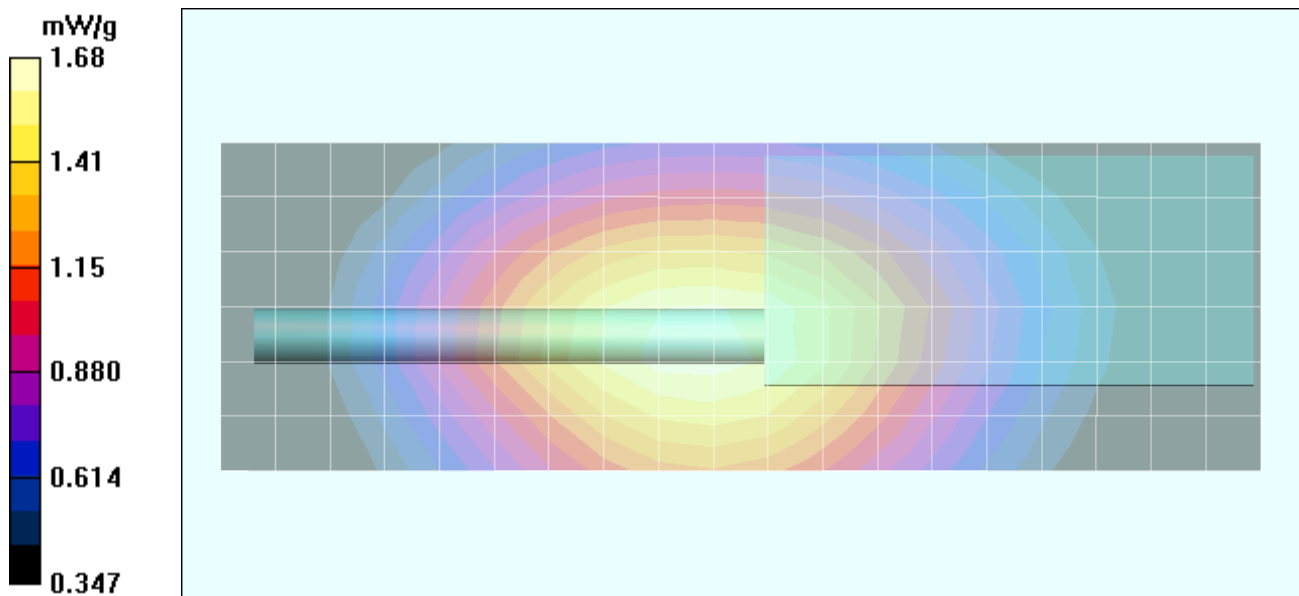

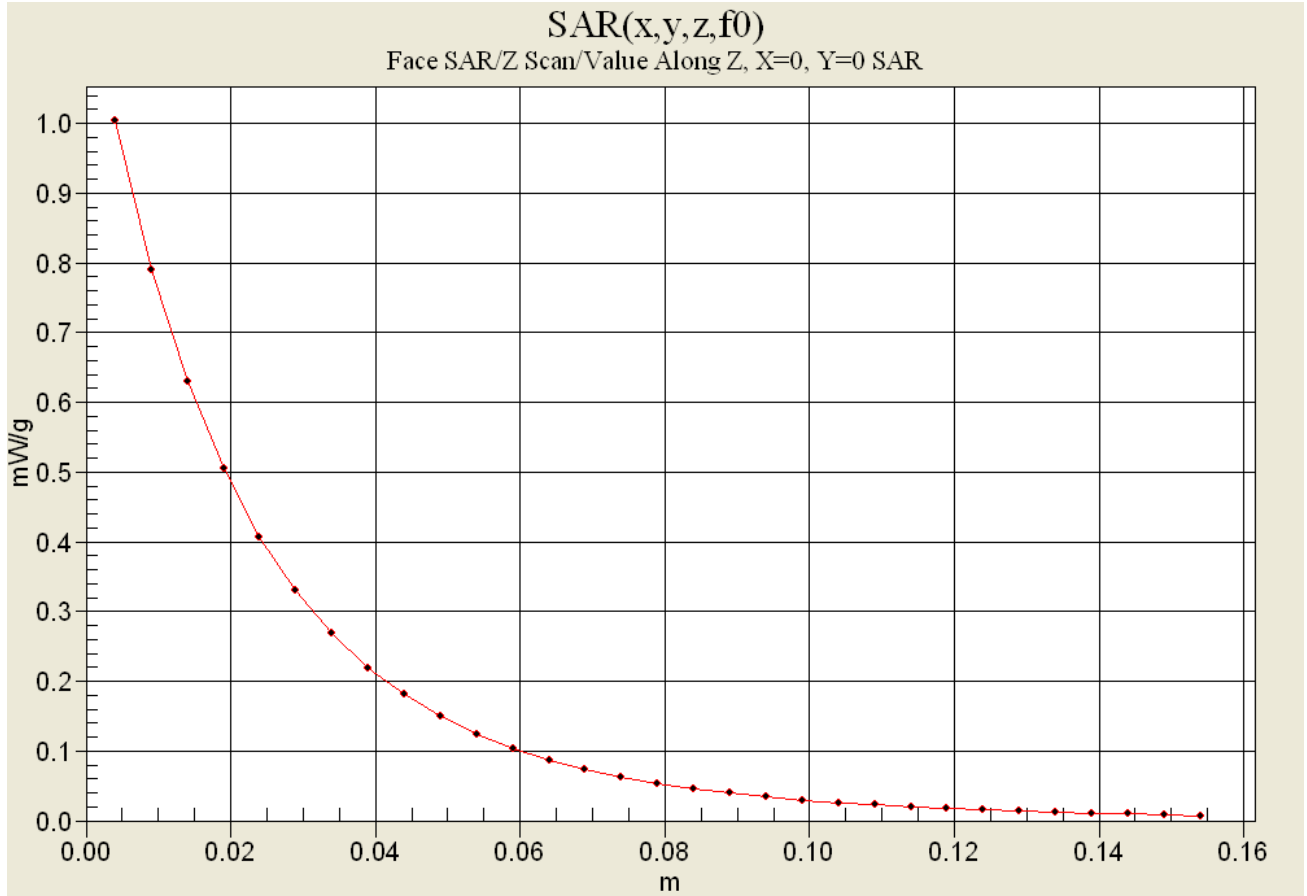

Date Tested: 01/29/04

DUT: Midland Radio Model: 80-106; Type: Portable VHF PTT Radio Transceiver; Serial: Identical Prototype

Ambient Temp: 23.8 °C; Fluid Temp: 23.9 °C; Barometric Pressure: 122.9 kPa; Humidity: 32%

7.2V NiMH Battery Pack

Communication System: FM VHF

Frequency: 162.025 MHz; Duty Cycle: 1:1

RF Output Power: 37.83 dBm (Conducted)

Medium: HSL150 ($\sigma = 0.75 \text{ mho/m}$; $\epsilon_r = 54.2$; $\rho = 1000 \text{ kg/m}^3$)

- Probe: ET3DV6 - SN1590; ConvF(9.6, 9.6, 9.6); Calibrated: 15/05/2003
- Sensor-Surface: 4mm (Mechanical Surface Detection)
- Electronics: DAE3 Sn353; Calibrated: 19/12/2003
- Phantom: Planar; Type: Plexiglas; Serial: 161
- Measurement SW: DASY4, V4.2 Build 12; Postprocessing SW: SEMCAD, V1.8 Build 94

Face-Held - Whip Antenna (P/N: ACC101VB) - 2.5 cm Separation Distance

Mid Channel/Area Scan (7x20x1): Measurement grid: dx=15mm, dy=15mm

Face-Held - Whip Antenna (P/N: ACC101VB) - 2.5 cm Separation Distance

Mid Channel/Zoom Scan (5x5x7)/Cube 0: Measurement grid: dx=8mm, dy=8mm, dz=5mm

Peak SAR (extrapolated) = 2.13 W/kg

SAR(1 g) = 1.40 mW/g; SAR(10 g) = 1.05 mW/g

Reference Value = 43.4 V/m

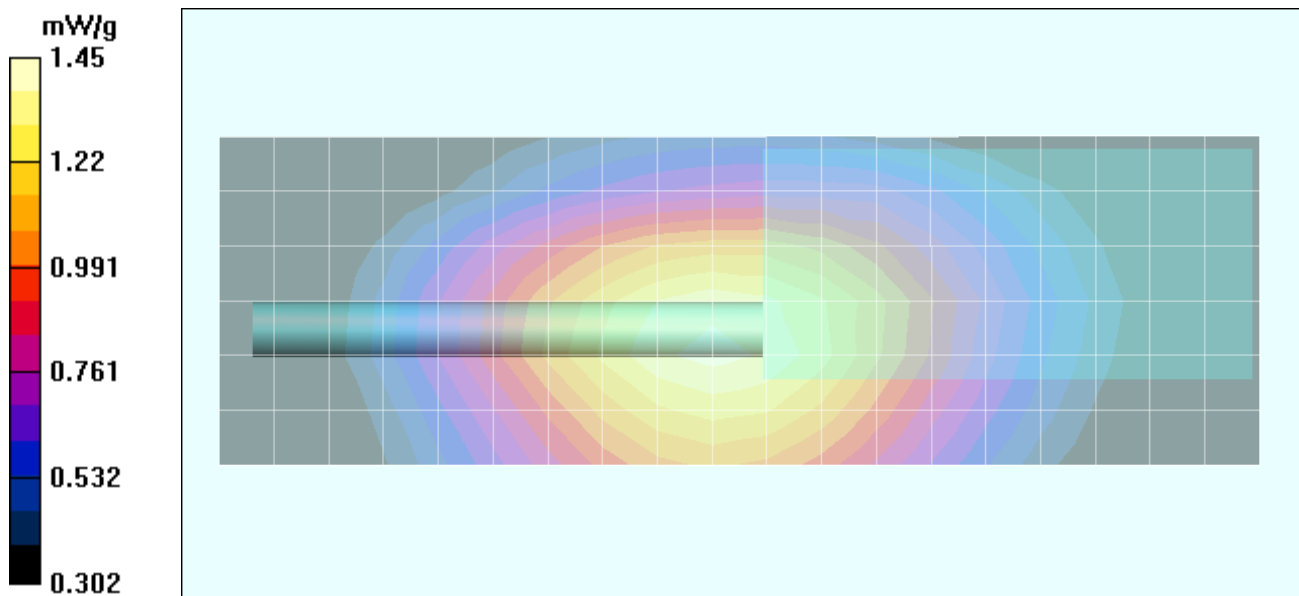

Date Tested: 01/29/04

DUT: Midland Radio Model: 80-106; Type: Portable VHF PTT Radio Transceiver; Serial: Identical Prototype

Ambient Temp: 25.0 °C; Fluid Temp: 22.8 °C; Barometric Pressure: 124.7 kPa; Humidity: 32%

Body-Worn Accessories: Belt-Clip, Speaker-Microphone (P/N: 70-M70)

7.2V NiMH Battery Pack

Communication System: FM VHF

Frequency: 162.025 MHz; Duty Cycle: 1:1

RF Output Power: 37.86 dBm (Conducted)

Medium: M150 ($\sigma = 0.83 \text{ mho/m}$; $\epsilon_r = 61.9$; $\rho = 1000 \text{ kg/m}^3$)

- Probe: ET3DV6 - SN1590; ConvF(9.2, 9.2, 9.2); Calibrated: 15/05/2003
- Sensor-Surface: 4mm (Mechanical Surface Detection)
- Electronics: DAE3 Sn353; Calibrated: 19/12/2003
- Phantom: Planar; Type: Plexiglas; Serial: 161
- Measurement SW: DAS4, V4.2 Build 12; Postprocessing SW: SEMCAD, V1.8 Build 94

**Body-Worn - Whip Antenna (P/N: ACC101VLB) - 1.5 cm Belt-Clip Separation Distance
Mid Channel/Area Scan (7x20x1):** Measurement grid: dx=15mm, dy=15mm

**Body-Worn - Whip Antenna (P/N: ACC101VLB) - 1.5 cm Belt-Clip Separation Distance
Mid Channel/Zoom Scan (5x5x7)/Cube 0:** Measurement grid: dx=8mm, dy=8mm, dz=5mm

Peak SAR (extrapolated) = 1.82 W/kg

SAR(1 g) = 1.15 mW/g; SAR(10 g) = 0.834 mW/g

Reference Value = 39.4 V/m

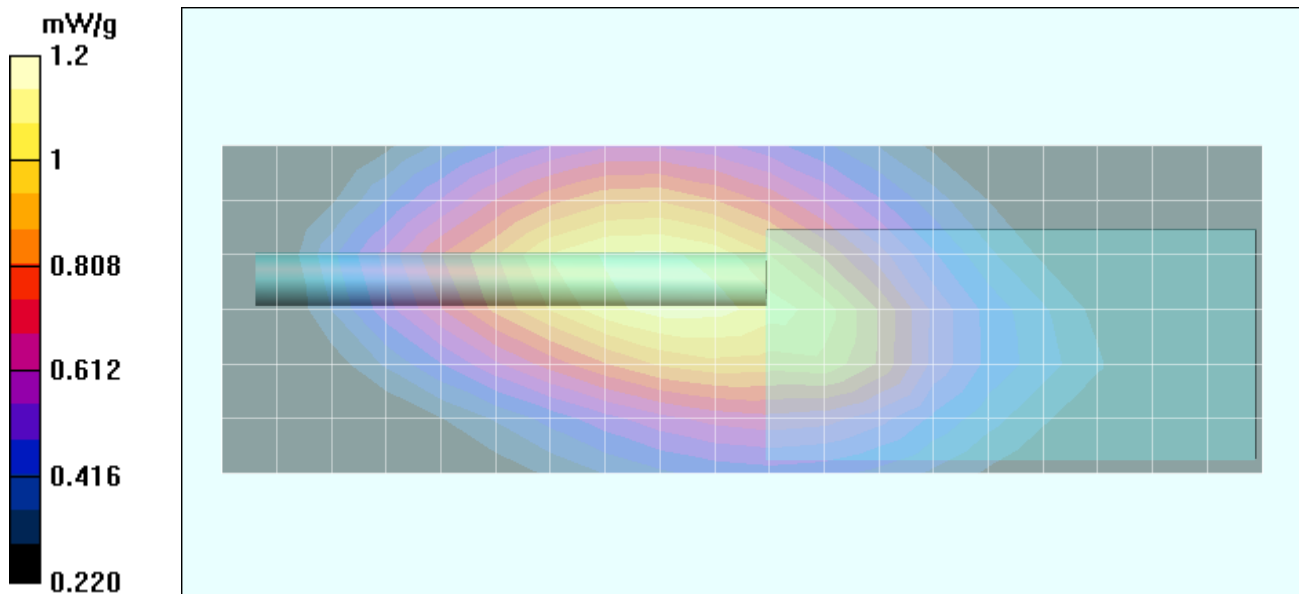

Date Tested: 01/29/04

DUT: Midland Radio Model: 80-106; Type: Portable VHF PTT Radio Transceiver; Serial: Identical Prototype

Ambient Temp: 25.0 °C; Fluid Temp: 22.8 °C; Barometric Pressure: 124.7 kPa; Humidity: 32%

Body-Worn Accessories: Belt-Clip, Speaker-Microphone (P/N: 70-M70)

7.2V NiMH Battery Pack

Communication System: FM VHF

Frequency: 162.025 MHz; Duty Cycle: 1:1

RF Output Power: 37.82 dBm (Conducted)

Medium: M150 ($\sigma = 0.83 \text{ mho/m}$; $\epsilon_r = 61.9$; $\rho = 1000 \text{ kg/m}^3$)

- Probe: ET3DV6 - SN1590; ConvF(9.2, 9.2, 9.2); Calibrated: 15/05/2003
- Sensor-Surface: 4mm (Mechanical Surface Detection)
- Electronics: DAE3 Sn353; Calibrated: 19/12/2003
- Phantom: Planar; Type: Plexiglas; Serial: 161
- Measurement SW: DAS4, V4.2 Build 12; Postprocessing SW: SEMCAD, V1.8 Build 94

**Body-Worn - Whip Antenna (P/N: ACC101VB) - 1.5 cm Belt-Clip Separation Distance
Mid Channel/Area Scan (7x20x1):** Measurement grid: dx=15mm, dy=15mm

**Body-Worn - Whip Antenna (P/N: ACC101VB) - 1.5 cm Belt-Clip Separation Distance
Mid Channel/Zoom Scan (5x5x7)/Cube 0:** Measurement grid: dx=8mm, dy=8mm, dz=5mm

Peak SAR (extrapolated) = 3.6 W/kg

SAR(1 g) = 2.32 mW/g; SAR(10 g) = 1.7 mW/g

Reference Value = 55 V/m

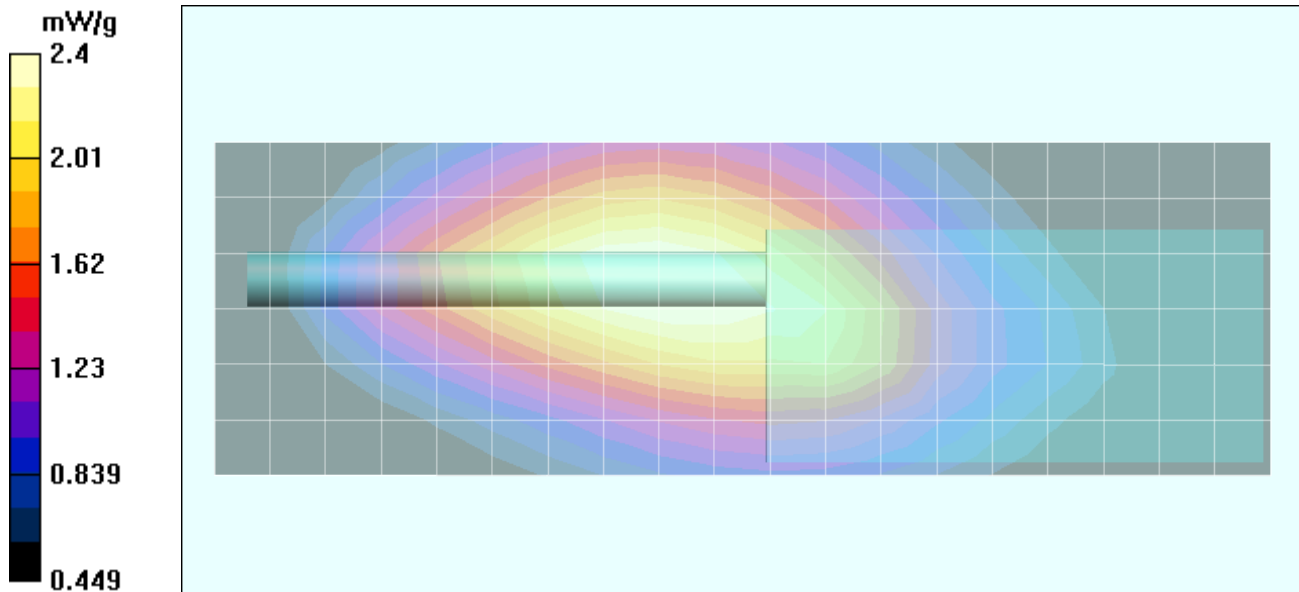

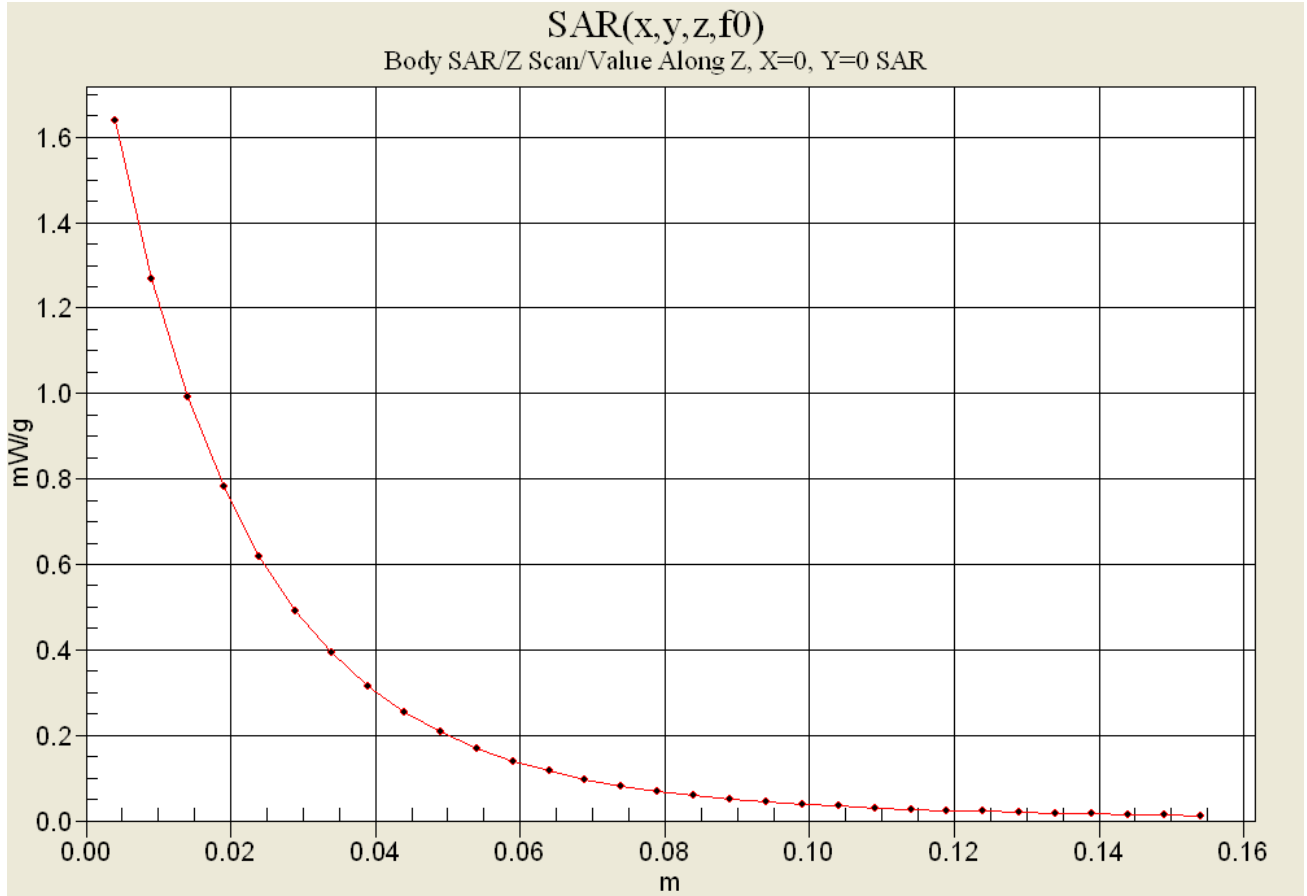

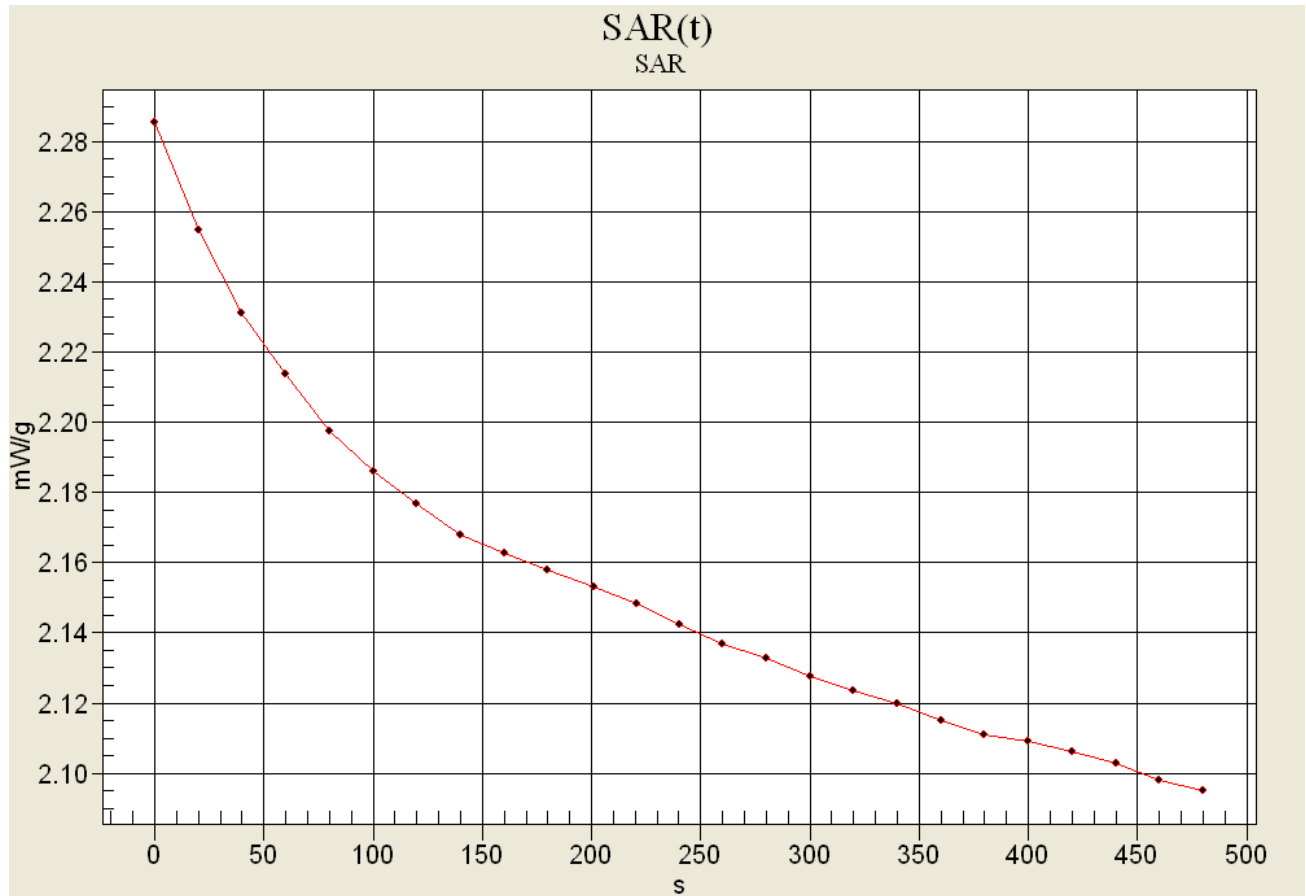

Date Tested: 01/29/04

DUT: Midland Radio Model: 80-106; Type: Portable VHF PTT Radio Transceiver; Serial: Identical Prototype

Ambient Temp: 25.0 °C; Fluid Temp: 22.8 °C; Barometric Pressure: 124.7 kPa; Humidity: 32%

Body-Worn Accessories: Holster & Swivel Belt-Loop (P/N: QPA1491), Speaker-Microphone (P/N: 70-M70)

7.2V NiMH Battery Pack

Communication System: FM VHF

Frequency: 162.025 MHz; Duty Cycle: 1:1

RF Output Power: 37.90 dBm (Conducted)

Medium: M150 ($\sigma = 0.83$ mho/m; $\epsilon_r = 61.9$; $\rho = 1000$ kg/m³)

- Probe: ET3DV6 - SN1590; ConvF(9.2, 9.2, 9.2); Calibrated: 15/05/2003
- Sensor-Surface: 4mm (Mechanical Surface Detection)
- Electronics: DAE3 Sn353; Calibrated: 19/12/2003
- Phantom: Planar; Type: Plexiglas; Serial: 161
- Measurement SW: DASY4, V4.2 Build 12; Postprocessing SW: SEMCAD, V1.8 Build 94

Body-Worn - Whip Antenna (P/N: ACC101VLB) - 4.5 cm Holster & Belt-Loop Separation Distance
Mid Channel/Area Scan (7x20x1): Measurement grid: dx=15mm, dy=15mm

Body-Worn - Whip Antenna (P/N: ACC101VLB) - 4.5 cm Holster & Belt-Loop Separation Distance
Mid Channel/Zoom Scan (5x5x7)/Cube 0: Measurement grid: dx=8mm, dy=8mm, dz=5mm

Peak SAR (extrapolated) = 1.27 W/kg

SAR(1 g) = 0.848 mW/g; SAR(10 g) = 0.641 mW/g

Reference Value = 34.2 V/m

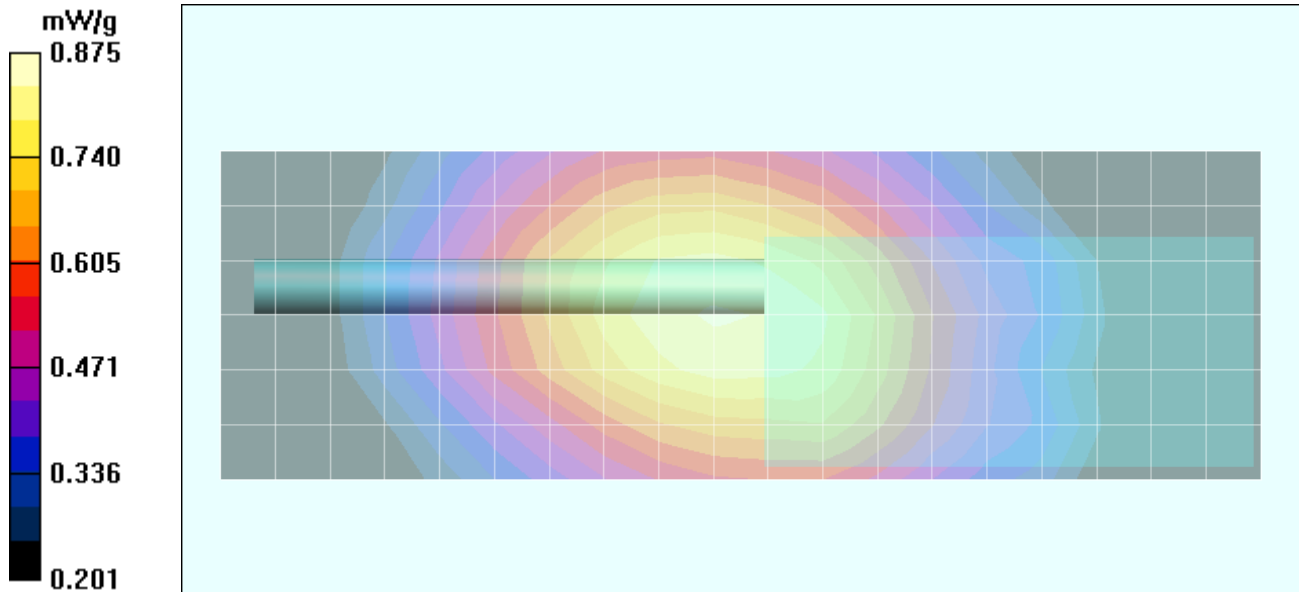

Date Tested: 01/29/04

DUT: Midland Radio Model: 80-106; Type: Portable VHF PTT Radio Transceiver; Serial: Identical Prototype

Ambient Temp: 25.0 °C; Fluid Temp: 22.8 °C; Barometric Pressure: 124.7 kPa; Humidity: 32%

Body-Worn Accessories: Holster & Swivel Belt-Loop (P/N: QPA1491), Speaker-Microphone (P/N: 70-M70)

7.2V NiMH Battery Pack

Communication System: FM VHF

Frequency: 162.025 MHz; Duty Cycle: 1:1

RF Output Power: 37.78 dBm (Conducted)

Medium: M150 ($\sigma = 0.83$ mho/m; $\epsilon_r = 61.9$; $\rho = 1000$ kg/m³)

- Probe: ET3DV6 - SN1590; ConvF(9.2, 9.2, 9.2); Calibrated: 15/05/2003
- Sensor-Surface: 4mm (Mechanical Surface Detection)
- Electronics: DAE3 Sn353; Calibrated: 19/12/2003
- Phantom: Planar; Type: Plexiglas; Serial: 161
- Measurement SW: DASY4, V4.2 Build 12; Postprocessing SW: SEMCAD, V1.8 Build 94

Body-Worn - Whip Antenna (P/N: ACC101VB) - 4.5 cm Holster & Belt-Loop Separation Distance
Mid Channel/Area Scan (7x20x1): Measurement grid: dx=15mm, dy=15mm

Body-Worn - Whip Antenna (P/N: ACC101VB) - 4.5 cm Holster & Belt-Loop Separation Distance
Mid Channel/Zoom Scan (5x5x7)/Cube 0: Measurement grid: dx=8mm, dy=8mm, dz=5mm

Peak SAR (extrapolated) = 1.73 W/kg

SAR(1 g) = 1.17 mW/g; SAR(10 g) = 0.884 mW/g

Reference Value = 37.9 V/m

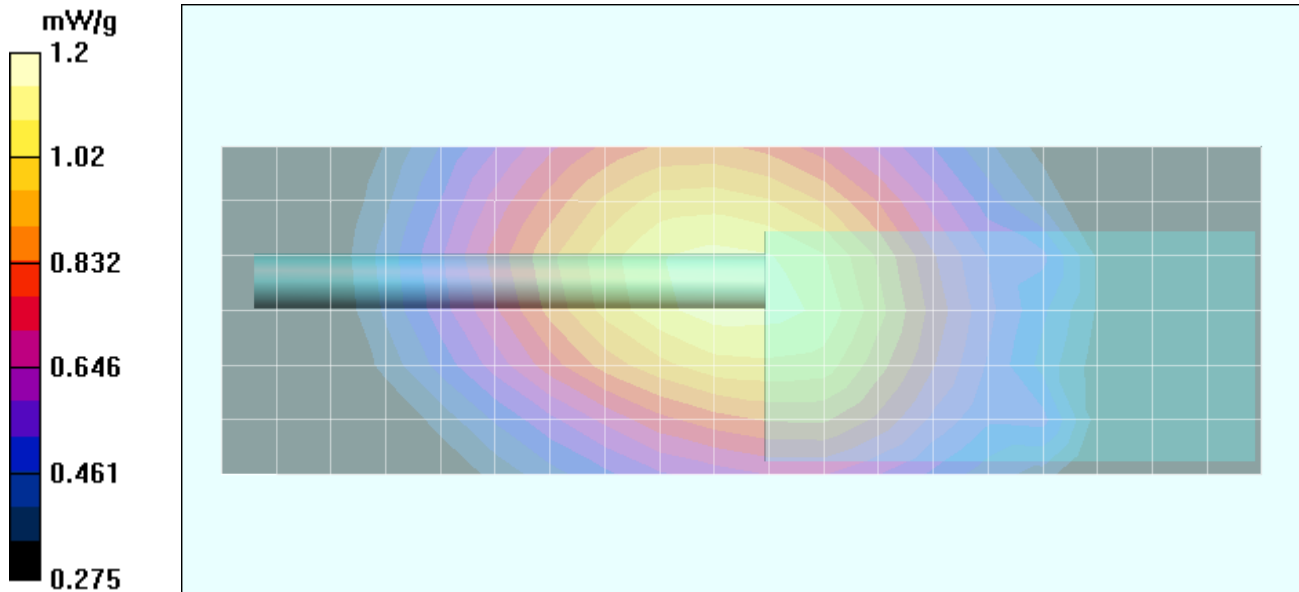

Test Report S/N:	012704-464MMA
Test Date(s):	January 29, 2004
Test Type:	FCC/IC SAR Evaluation

APPENDIX B - SYSTEM PERFORMANCE CHECK DATA

Dated Tested: 01/29/04

DUT: Dipole 300 MHz; Type: System Performance Check; Model: D300V2; Serial: 135

Ambient Temp: 24.3 °C; Fluid Temp: 23.2 °C; Barometric Pressure: 122.0 kPa; Humidity: 32%

Communication System: CW
 Forward Conducted Power: 250 mW
 Frequency: 300 MHz; Duty Cycle: 1:1
 Medium: 300 HSL ($\sigma = 0.90 \text{ mho/m}$; $\epsilon_r = 46.7$; $\rho = 1000 \text{ kg/m}^3$)

- Probe: ET3DV6 - SN1590; ConvF(8.3, 8.3, 8.3); Calibrated: 15/05/2003
- Sensor-Surface: 4mm (Mechanical Surface Detection)
- Electronics: DAE3 Sn353; Calibrated: 19/12/2003
- Phantom: Validation Planar; Type: Plexiglas; Serial: 137
- Measurement SW: DASY4, V4.2 Build 12; Postprocessing SW: SEMCAD, V1.8 Build 94

300 MHz System Performance Check/Area Scan (6x11x1):

Measurement grid: dx=15mm, dy=15mm

300 MHz System Performance Check/Zoom Scan (7x7x7)/Cube 0:

Measurement grid: dx=5mm, dy=5mm, dz=5mm
 Peak SAR (extrapolated) = 1.34 W/kg
SAR(1 g) = 0.771 mW/g; SAR(10 g) = 0.502 mW/g
 Reference Value = 30.3 V/m
 Power Drift = -0.0 dB

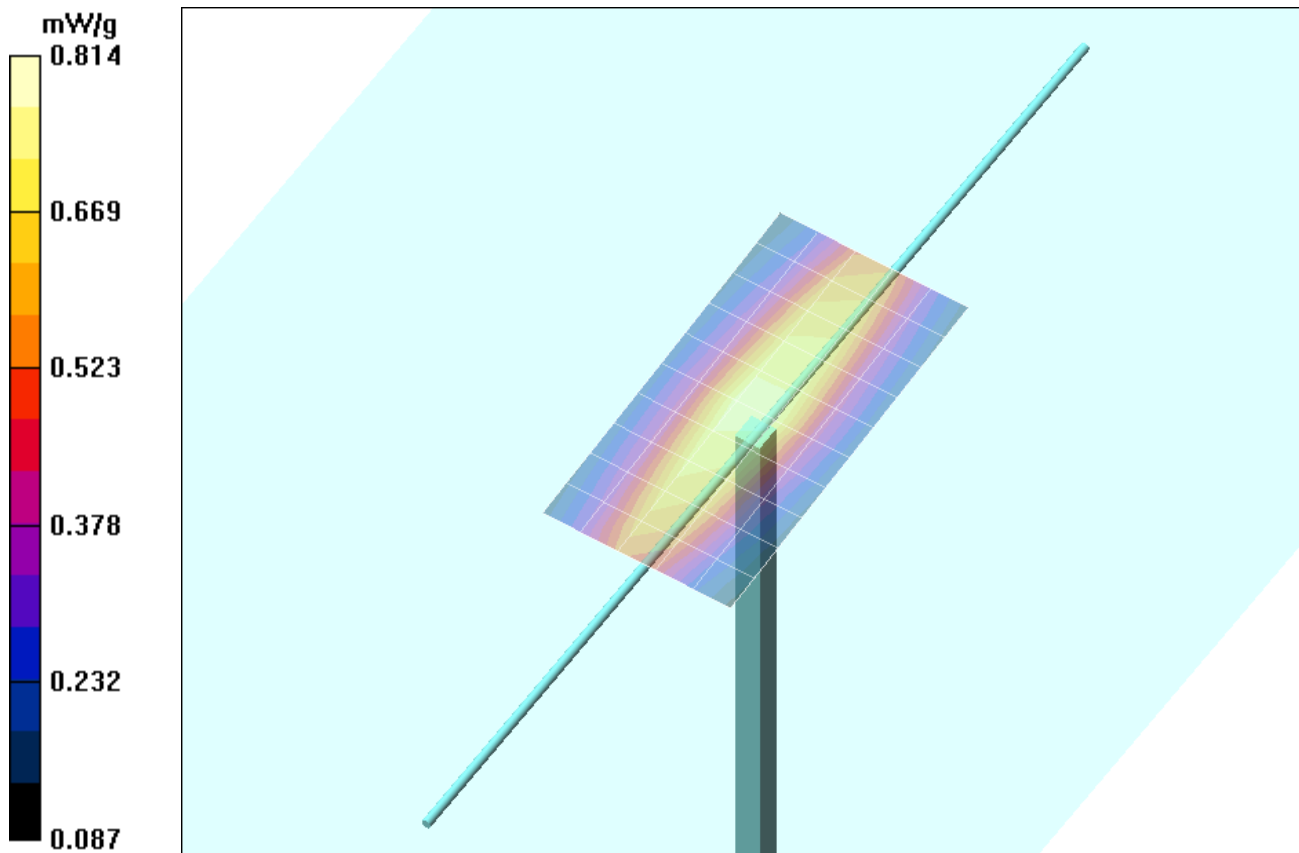

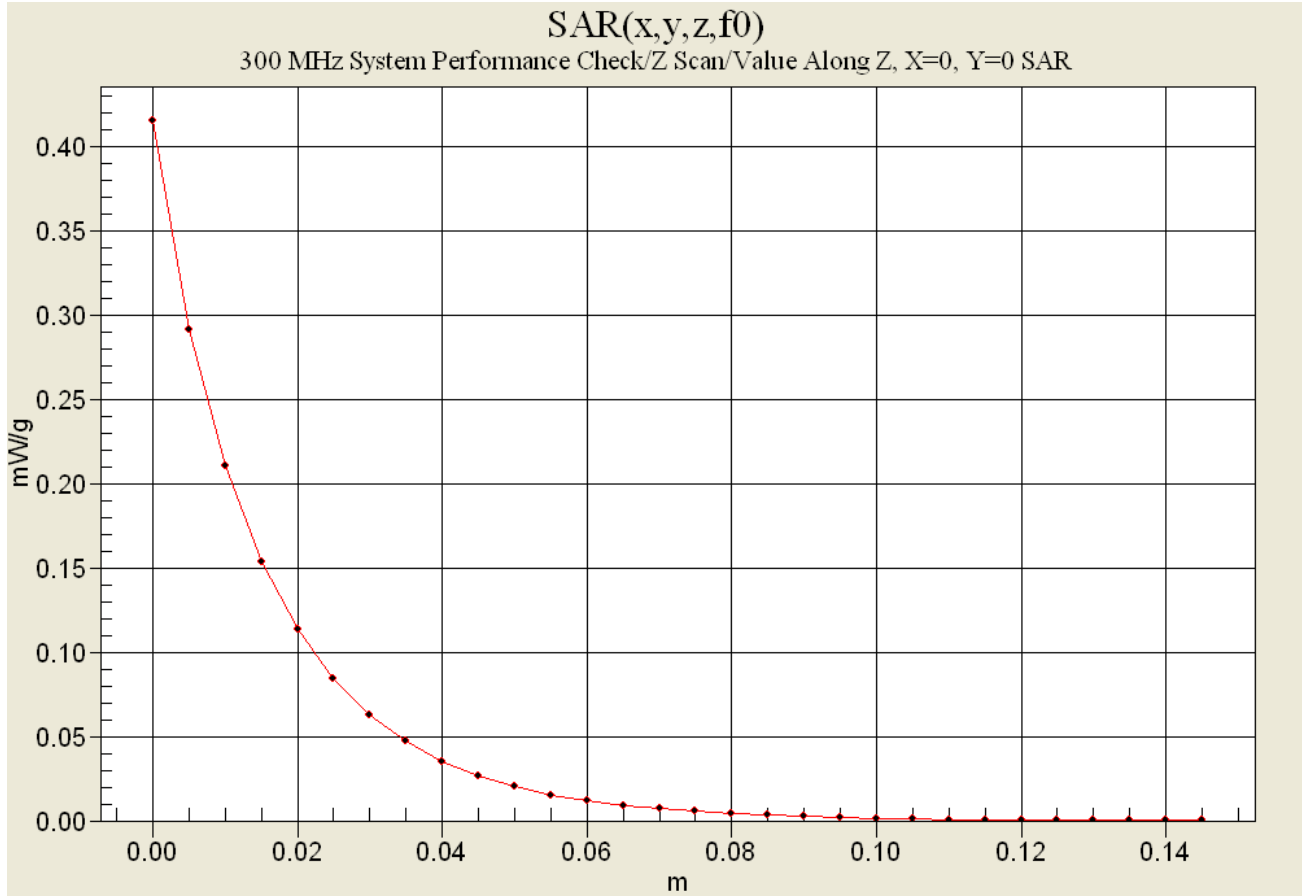

Test Report S/N:	012704-464MMA
Test Date(s):	January 29, 2004
Test Type:	FCC/IC SAR Evaluation

APPENDIX C - SYSTEM VALIDATION

300MHz SYSTEM VALIDATION DIPOLE

Type:

300MHz Validation Dipole

Serial Number:

135

Place of Calibration:

Celltech Labs Inc.

Date of Calibration:

October 30, 2003

Celltech Labs Inc. hereby certifies that this device has been calibrated on the date indicated above.

Calibrated by:

Spencer Watson

Approved by:

Russell W. Pipe

1. Validation Dipole Construction & Electrical Characteristics

The validation dipole was constructed in accordance with the IEEE Std. "Recommended Practice for Determining the Spatial-Peak Specific Absorption Rate (SAR) in the Human Body Due to Wireless Communications Devices: Experimental Techniques". The electrical properties were measured using an HP 8753E Network Analyzer. The network analyzer was calibrated to the validation dipole N-type connector feed point using an HP85032E Type N calibration kit. The dipole was placed parallel to a planar phantom at a separation distance of 15.0mm from the simulating fluid using a loss-less dielectric spacer. The measured input impedance is:

Feed point impedance at 300MHz	$\text{Re}\{Z\} = 43.586\Omega$
	$\text{Im}\{Z\} = -4.5313\Omega$
Return Loss at 300MHz	-21.693dB

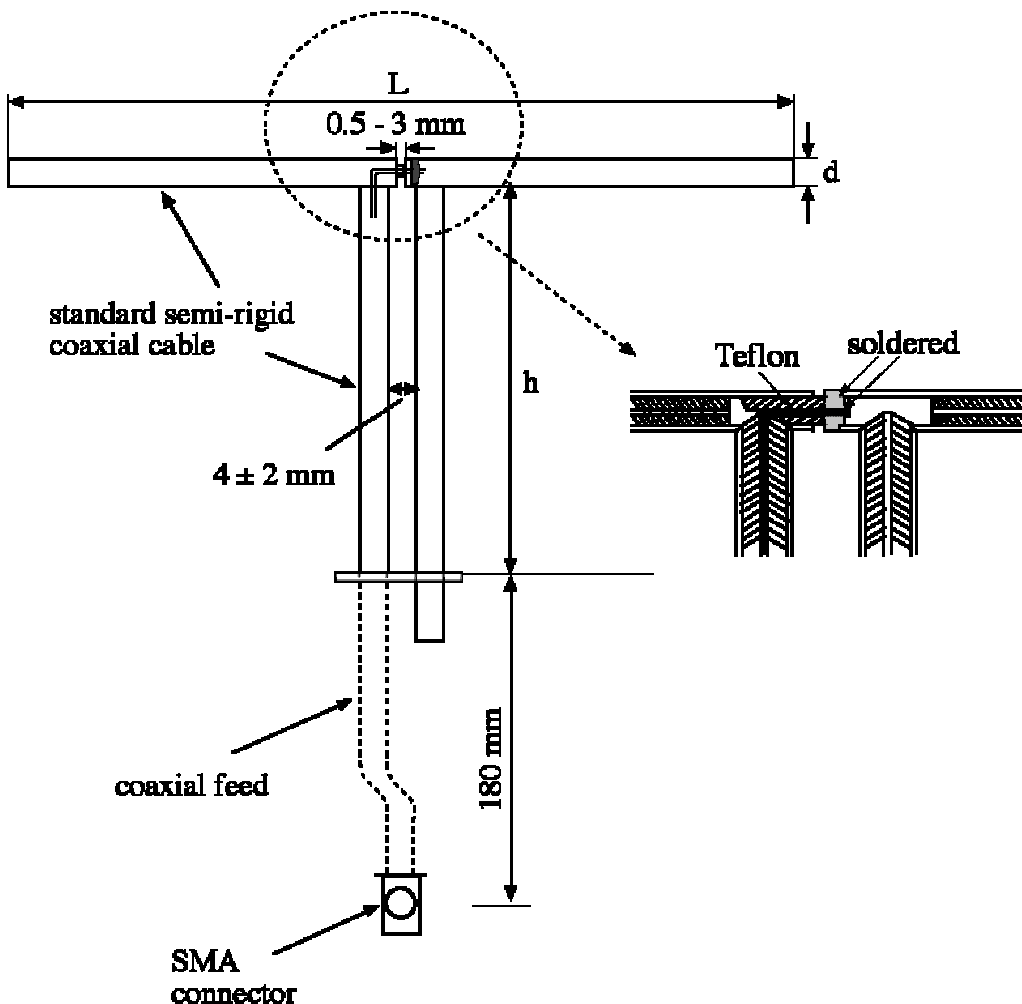

30 Oct 2003 15:40:15

CH1 S11 LOG 10 dB/REF 0 dB

1:-21.693 dB 300.000 000 MHz

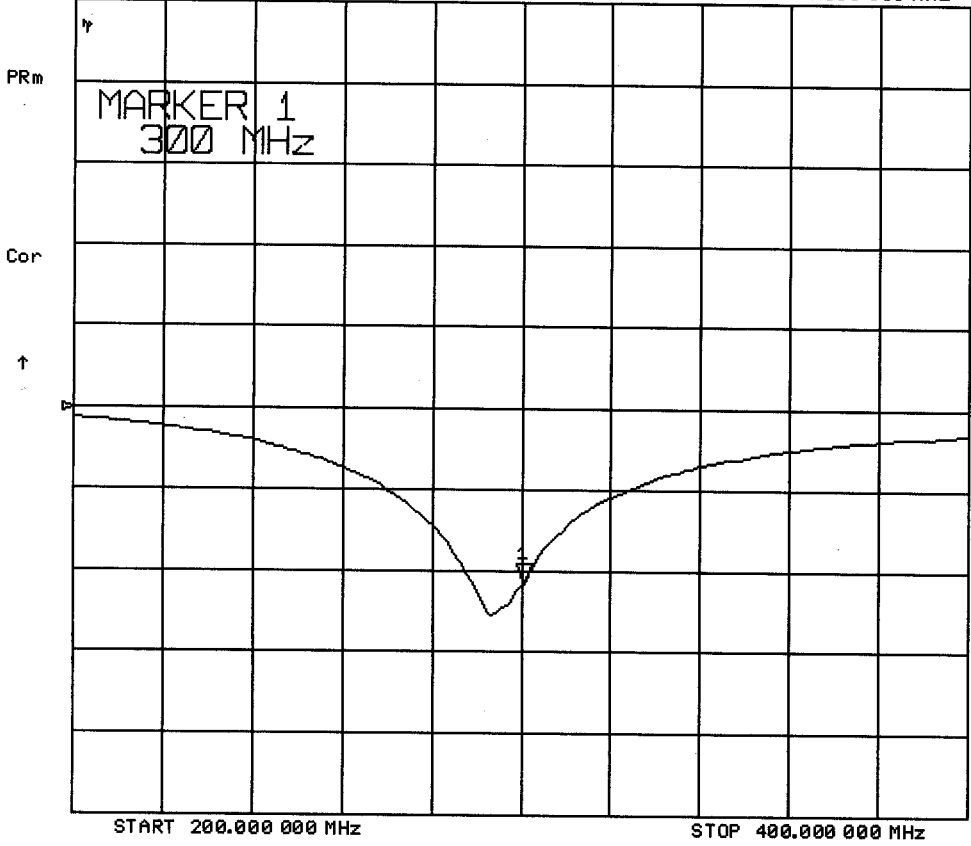

30 Oct 2003 15:41:51
CH1 S11 1 U FS 1: 43.586 Ω -4.5313 Ω 117.08 pF 300.000 000 MHz

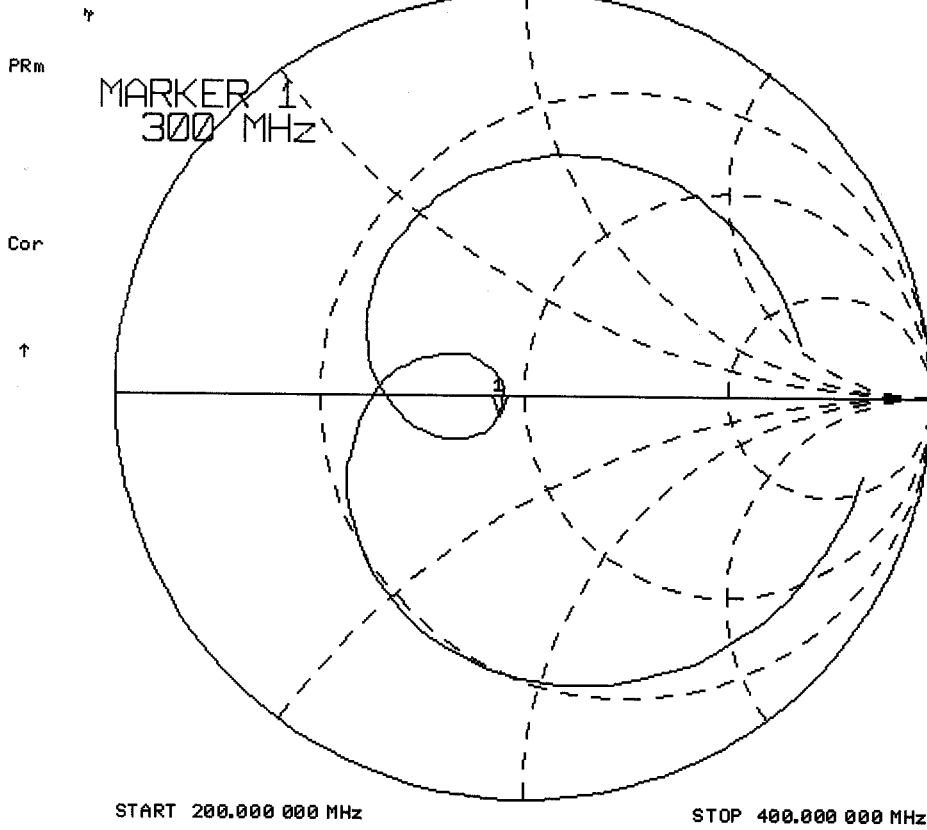

2. Validation Dipole Dimensions

Frequency (MHz)	L (mm)	H (mm)	D (mm)
300	420.0	250.0	6.2
450	288.0	167.0	6.2
835	161.0	89.8	3.6
900	149.0	83.3	3.6
1450	89.1	51.7	3.6
1800	72.0	41.7	3.6
1900	68.0	39.5	3.6
2000	64.5	37.5	3.6
2450	51.8	30.6	3.6
3000	41.5	25.0	3.6

3. Validation Phantom

The validation phantom was constructed using relatively low-loss tangent Plexiglas material. The inner dimensions of the phantom are as follows:

Length: 83.5 cm

Width: 36.9 cm

Height: 21.8 cm

The bottom section of the validation phantom is constructed of 6.2 ± 0.1 mm Plexiglas.

4. Dimensions of Plexiglas Planar Phantom

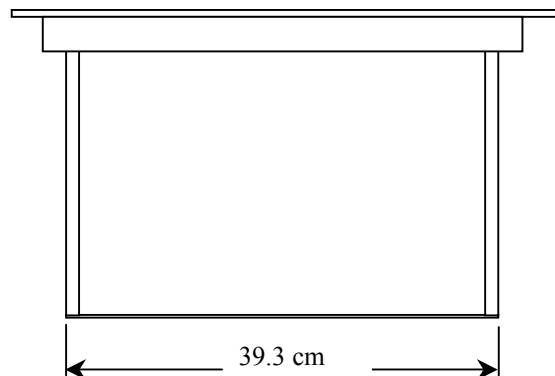
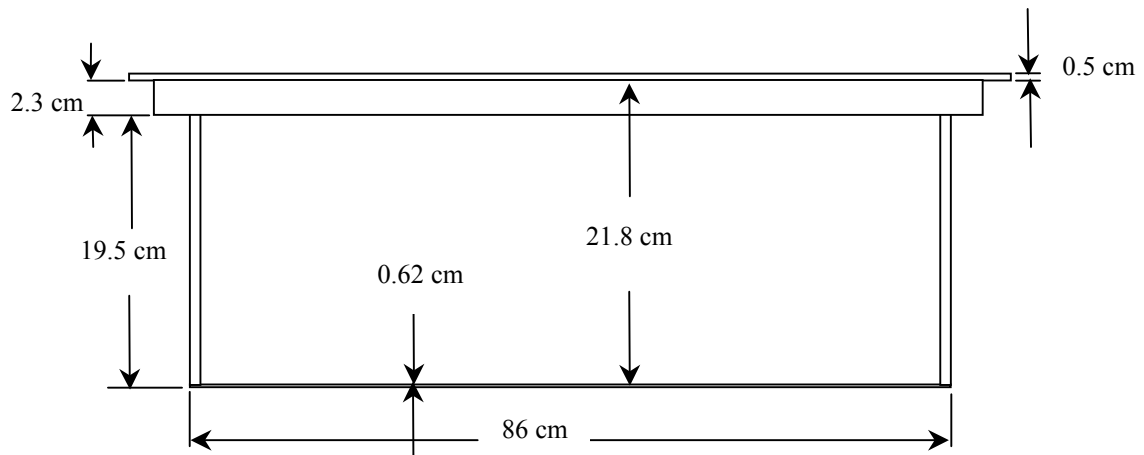
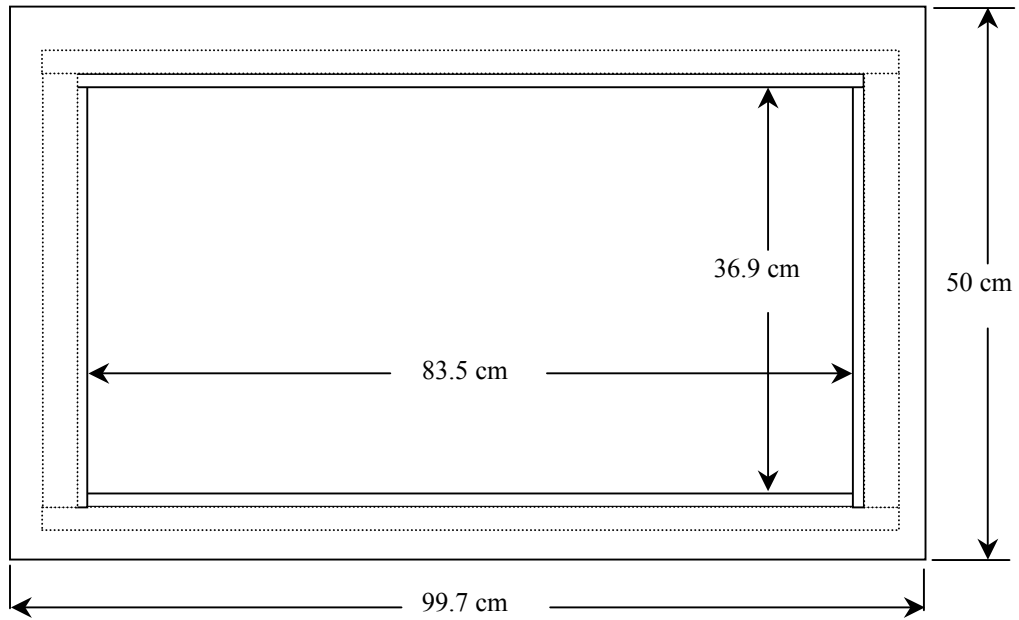

5. 300MHz System Validation Setup

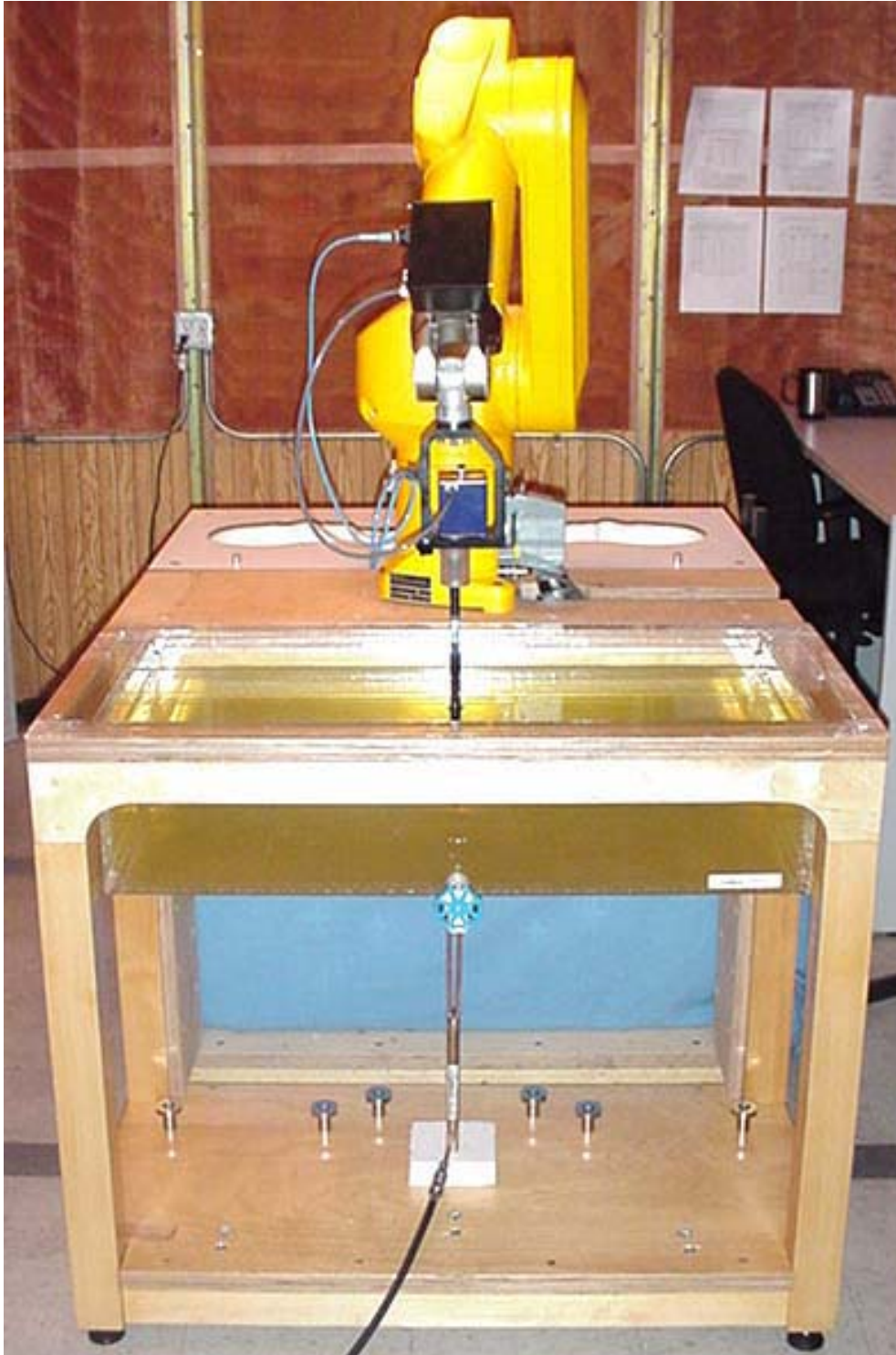

300MHz System Validation Setup



6. Measurement Conditions

The planar phantom was filled with simulated brain tissue having the following parameters at 300MHz:

Relative Permittivity:	45.7
Conductivity:	0.88 mho/m
Fluid Temperature:	22.2°C
Fluid Depth:	≥ 15cm

Environmental Conditions:

Ambient Temperature:	22.1°C
Humidity:	56%
Barometric Pressure:	103.4 kPa

The 300MHz simulated tissue mixture consists of the following ingredients:

Ingredient	Percentage by weight
Water	37.56%
Sugar	55.32%
Salt	5.95%
HEC	0.98%
Dowicil 75	0.19%
300MHz Target Dielectric Parameters at 22°C	$\epsilon_r = 45.3$ $\sigma = 0.87 \text{ S/m}$

7. SAR Measurement

The SAR measurement was performed with the E-field probe in mechanical detection mode only. The setup and determination of the forward power into the dipole was performed using the following procedures.

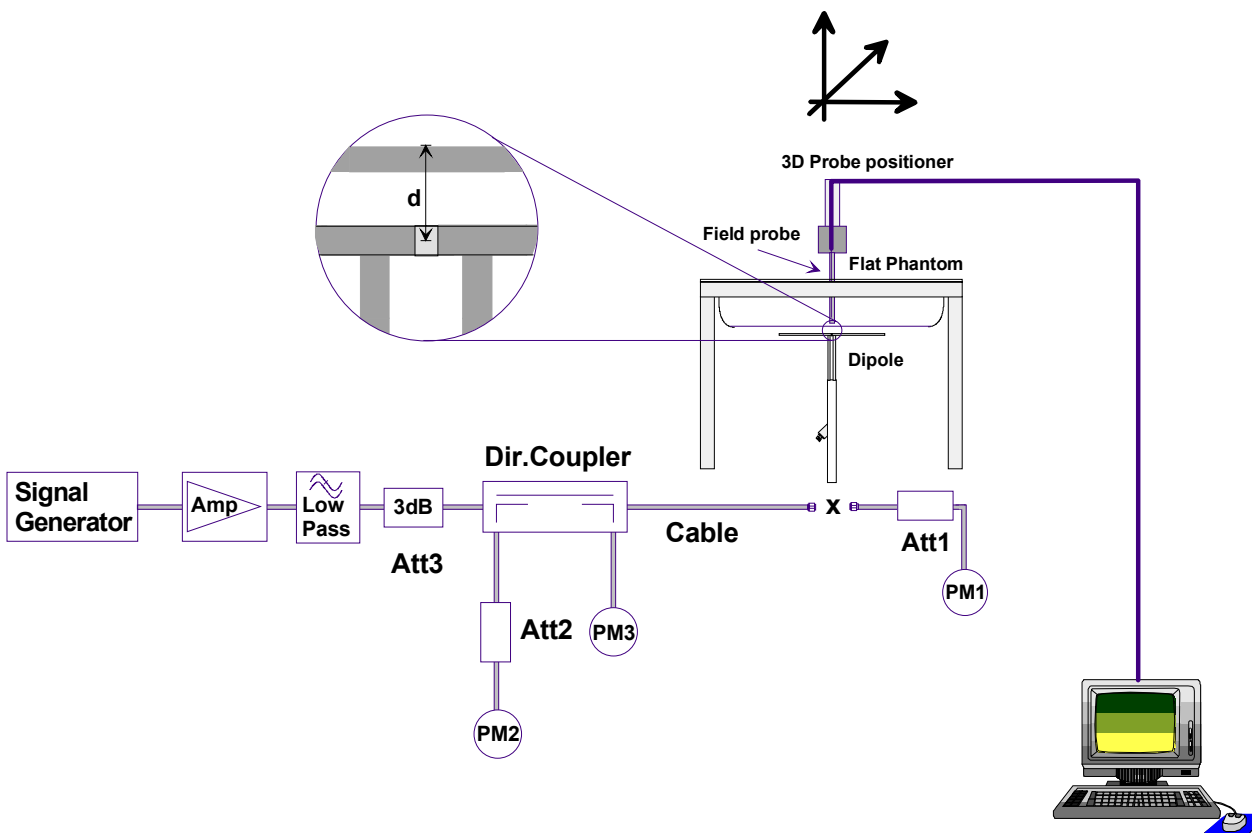

First the power meter PM1 (including attenuator Att1) is connected to the cable to measure the forward power at the location of the dipole connector (X). The signal generator is adjusted for the desired forward power at the dipole connector (taking into account the attenuation of Att1) as read by power meter PM2. After connecting the cable to the dipole, the signal generator is readjusted for the same reading at power meter PM2. If the signal generator does not allow adjustment in 0.01dB steps, the remaining difference at PM2 must be taken into consideration. PM3 records the reflected power from the dipole to ensure that the value is not changed from the previous value. The reflected power should be 20dB below the forward power.

8. Validation Dipole SAR Test Results

Ten SAR measurements were performed in order to achieve repeatability and to establish an average target value.

Validation Measurement	SAR @ 0.25W Input averaged over 1g	SAR @ 1W Input averaged over 1g	SAR @ 0.25W Input averaged over 10g	SAR @ 1W Input averaged over 10g	Peak SAR @ 0.25W Input
Test 1	0.781	3.12	0.497	1.99	1.39
Test 2	0.779	3.12	0.495	1.98	1.39
Test 3	0.780	3.12	0.496	1.98	1.38
Test 4	0.788	3.15	0.501	2.00	1.41
Test 5	0.787	3.15	0.498	1.99	1.39
Test 6	0.780	3.12	0.492	1.97	1.38
Test 7	0.776	3.10	0.494	1.98	1.37
Test 8	0.784	3.14	0.500	2.00	1.39
Test 9	0.785	3.14	0.500	2.00	1.39
Test 10	0.784	3.14	0.496	1.98	1.40
Average Value	0.782	3.13	0.497	1.99	1.39

The results have been normalized to 1W (forward power) into the dipole.

IEEE Target over 1cm³ (1g) of tissue: 0.750 mW/g (+/- 10%)

Averaged over 1cm³ (1g) of tissue: 3.13 mW/g

Averaged over 10cm³ (10g) of tissue: 1.99 mW/g

Test Date: 10/30/03

DUT: Dipole 300 MHz; Model: D300V2; Type: System Validation; Serial: 135

Ambient Temp: 22.1°C; Fluid Temp: 22.2°C; Barometric Pressure: 103.4 kPa; Humidity: 56%

Communication System: CW

Forward Conducted Power: 250 mW

Frequency: 300 MHz; Duty Cycle: 1:1

Medium: 300 HSL ($\sigma = 0.88$ mho/m, $\epsilon_r = 45.7$, $\rho = 1000$ kg/m³)

- Probe: ET3DV6 - SN1387; ConvF(7.9, 7.9, 7.9); Calibrated: 26/02/2003
- Sensor-Surface: 4mm (Mechanical Surface Detection)
- Electronics: DAE3 Sn370; Calibrated: 19/05/2003
- Phantom: Validation Planar; Type: Plexiglas; Serial: 137
- Measurement SW: DASY4, V4.1 Build 47; Postprocessing SW: SEMCAD, V1.6 Build 116

300 MHz Validation/Area Scan (6x11x1): Measurement grid: dx=15mm, dy=15mm

Reference Value = 30.4 V/m

Power Drift = -0.1 dB

300 MHz Validation/Zoom Scan (7x7x7)/Cube 0: Measurement grid: dx=5mm, dy=5mm, dz=5mm

Peak SAR (extrapolated) = 1.39 W/kg

SAR(1 g) = 0.781 mW/g; SAR(10 g) = 0.497 mW/g

Reference Value = 30.4 V/m

Power Drift = -0.1 dB

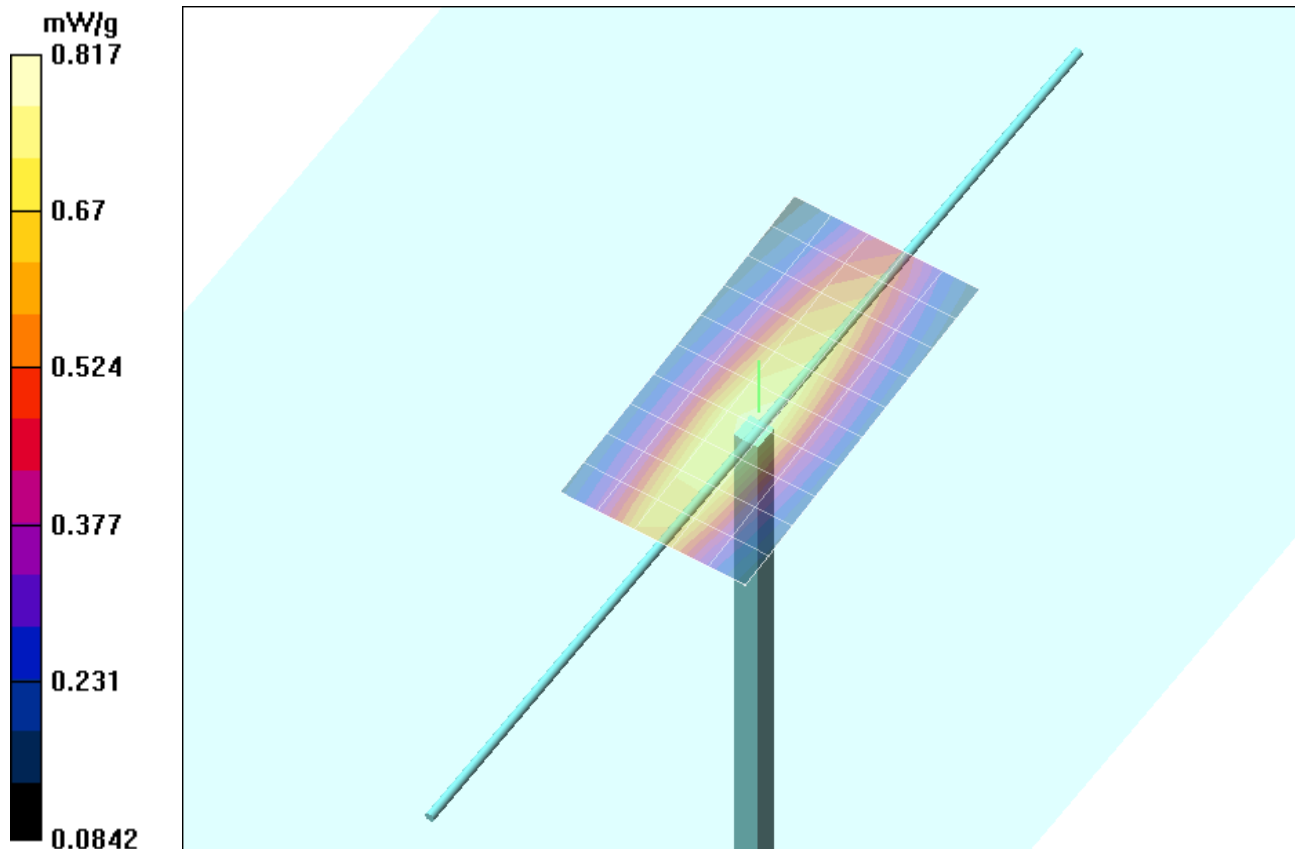

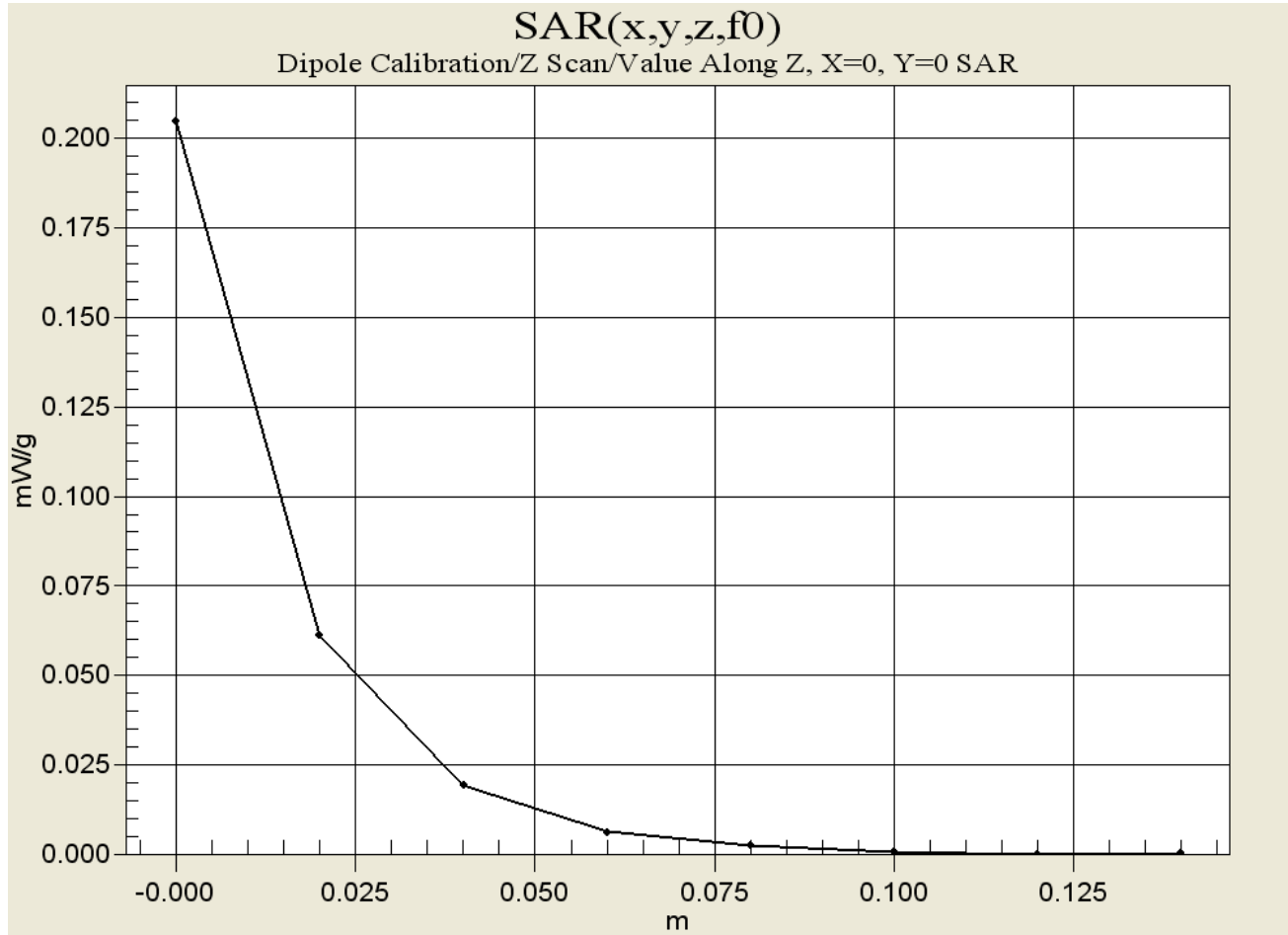

300MHz System Validation

Measured Fluid Dielectric Parameters (Brain)



October 30, 2003

Frequency	ϵ'	ϵ''
200.000000 MHz	49.8336	71.7361
210.000000 MHz	49.2398	69.1403
220.000000 MHz	48.9026	66.6656
230.000000 MHz	48.4363	64.3972
240.000000 MHz	47.9018	62.2373
250.000000 MHz	47.4646	60.4416
260.000000 MHz	47.0839	58.8112
270.000000 MHz	46.6772	57.3352
280.000000 MHz	46.4143	55.8759
290.000000 MHz	46.0204	54.5734
300.000000 MHz	45.6863	52.9882
310.000000 MHz	45.3261	51.7924
320.000000 MHz	44.9882	50.6430
330.000000 MHz	44.6549	49.5121
340.000000 MHz	44.3168	48.5356
350.000000 MHz	44.0824	47.5910
360.000000 MHz	43.7780	46.7661
370.000000 MHz	43.5461	45.8627
380.000000 MHz	43.3671	45.0444
390.000000 MHz	43.1052	44.2129
400.000000 MHz	42.8360	43.5735

Test Report S/N:	012704-464MMA
Test Date(s):	January 29, 2004
Test Type:	FCC/IC SAR Evaluation

APPENDIX D - PROBE CALIBRATION

Client **Celltech Labs**

CALIBRATION CERTIFICATE			
Object(s)	ET3DV6 - SN:1590		
Calibration procedure(s)	QA CAL-01.v2 Calibration procedure for dosimetric E-field probes		
Calibration date:	May 15, 2003		
Condition of the calibrated item	In Tolerance (according to the specific calibration document)		
This calibration statement documents traceability of M&TE used in the calibration procedures and conformity of the procedures with the ISO/IEC 17025 international standard.			
All calibrations have been conducted in the closed laboratory facility: environment temperature 22 +/- 2 degrees Celsius and humidity < 75%.			
Calibration Equipment used (M&TE critical for calibration)			
Model Type	ID #	Cal Date (Calibrated by, Certificate No.)	Scheduled Calibration
RF generator HP 8684C	US3642U01700	4-Aug-99 (SPEAG, in house check Aug-02)	In house check: Aug-05
Power sensor E4412A	MY41495277	2-Apr-03 (METAS, No 252-0250)	Apr-04
Power sensor HP 8481A	MY41092180	18-Sep-02 (Agilent, No. 20020918)	Sep-03
Power meter EPM E4419B	GB41293874	2-Apr-03 (METAS, No 252-0250)	Apr-04
Network Analyzer HP 8753E	US38432426	3-May-00 (Agilent, No. 8702K094602)	In house check: May 03
Fluke Process Calibrator Type 702	SN: 6295803	3-Sep-01 (ELCAL, No.2360)	Sep-03
Calibrated by:	Name Nicola Vetterli	Function Technician	Signature 
Approved by:	Name Katja Polovic	Function Laboratory Director	Signature 
Date issued: May 15, 2003			
This calibration certificate is issued as an intermediate solution until the accreditation process (based on ISO/IEC 17025 International Standard) for Calibration Laboratory of Schmid & Partner Engineering AG is completed.			

Probe ET3DV6

SN:1590

Manufactured:	March 19, 2001
Last calibration:	April 26, 2002
Recalibrated:	May 15, 2003

Calibrated for DASY Systems

(Note: non-compatible with DASY2 system!)

DASY - Parameters of Probe: ET3DV6 SN:1590**Sensitivity in Free Space****Diode Compression**

NormX	1.76 $\mu\text{V}/(\text{V}/\text{m})^2$	DCP X	92	mV
NormY	1.91 $\mu\text{V}/(\text{V}/\text{m})^2$	DCP Y	92	mV
NormZ	1.66 $\mu\text{V}/(\text{V}/\text{m})^2$	DCP Z	92	mV

Sensitivity in Tissue Simulating Liquid

Head 900 MHz $\epsilon_r = 41.5 \pm 5\%$ $\sigma = 0.97 \pm 5\%$ mho/m

Valid for f=800-1000 MHz with Head Tissue Simulating Liquid according to EN 50361, P1528-200X

ConvF X	7.0 $\pm 9.5\%$ (k=2)	Boundary effect:	
ConvF Y	7.0 $\pm 9.5\%$ (k=2)	Alpha	0.33
ConvF Z	7.0 $\pm 9.5\%$ (k=2)	Depth	2.56

Head 1800 MHz $\epsilon_r = 40.0 \pm 5\%$ $\sigma = 1.40 \pm 5\%$ mho/m

Valid for f=1710-1910 MHz with Head Tissue Simulating Liquid according to EN 50361, P1528-200X

ConvF X	5.5 $\pm 9.5\%$ (k=2)	Boundary effect:	
ConvF Y	5.5 $\pm 9.5\%$ (k=2)	Alpha	0.44
ConvF Z	5.5 $\pm 9.5\%$ (k=2)	Depth	2.69

Boundary Effect

Head 900 MHz Typical SAR gradient: 5 % per mm

Probe Tip to Boundary		1 mm	2 mm
SAR _{be} [%]	Without Correction Algorithm	8.7	5.0
SAR _{be} [%]	With Correction Algorithm	0.3	0.5

Head 1800 MHz Typical SAR gradient: 10 % per mm

Probe Tip to Boundary		1 mm	2 mm
SAR _{be} [%]	Without Correction Algorithm	12.3	8.5
SAR _{be} [%]	With Correction Algorithm	0.2	0.1

Sensor Offset

Probe Tip to Sensor Center	2.7	mm
Optical Surface Detection	1.4 \pm 0.2	mm

Receiving Pattern (ϕ), $\theta = 0^\circ$

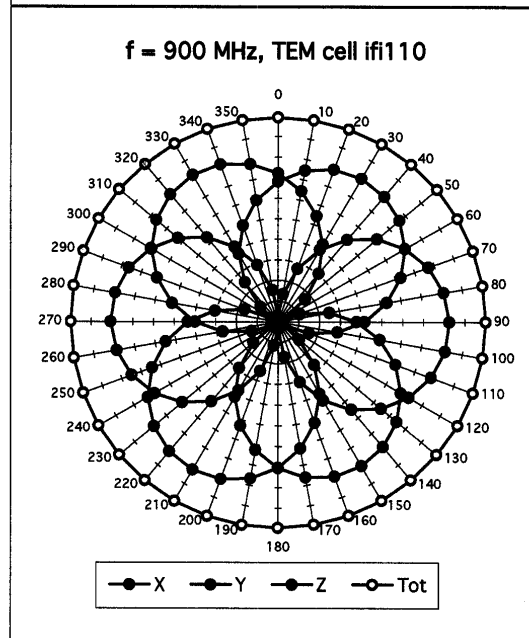
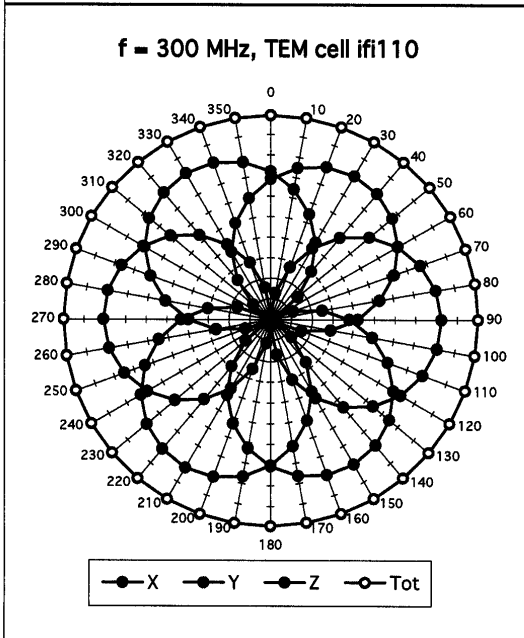
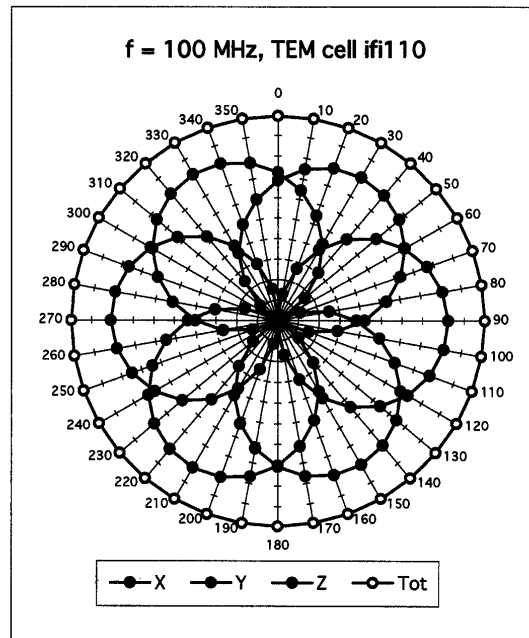
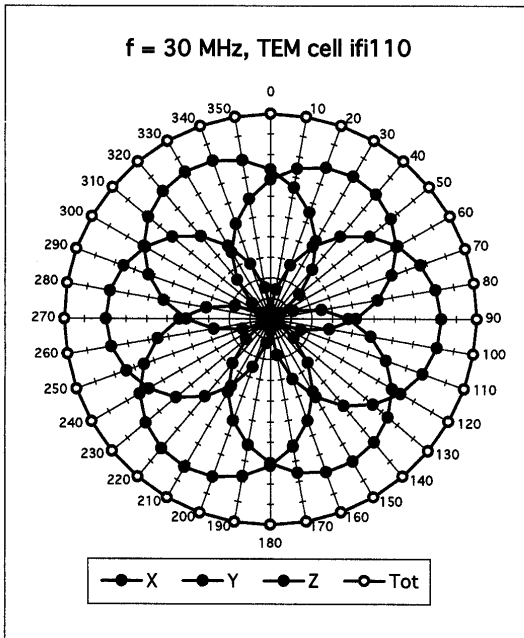

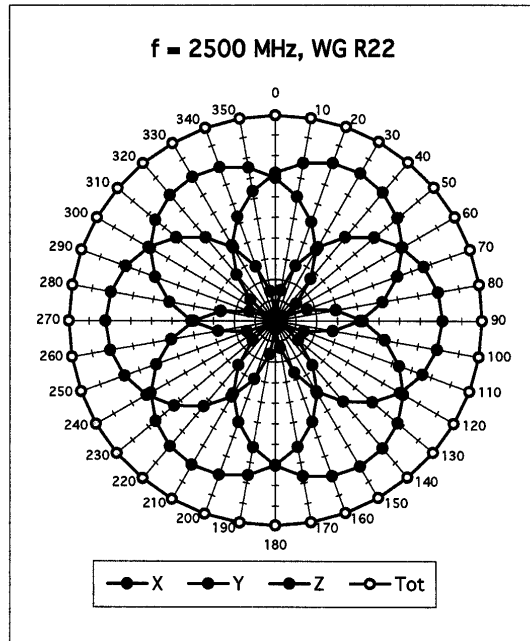
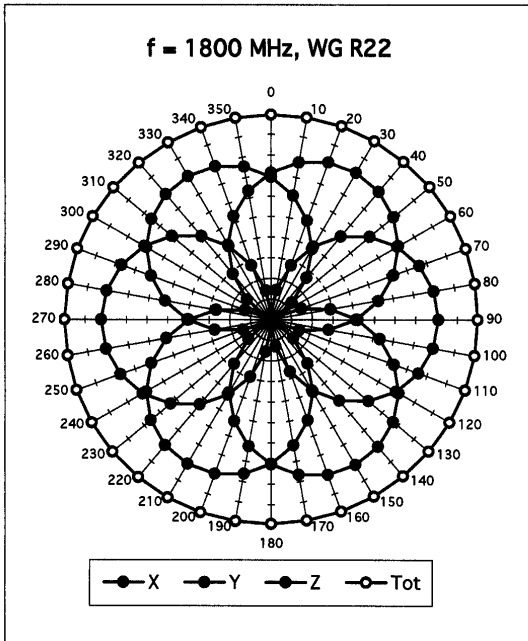

Isotropy Error (ϕ), $\theta = 0^\circ$

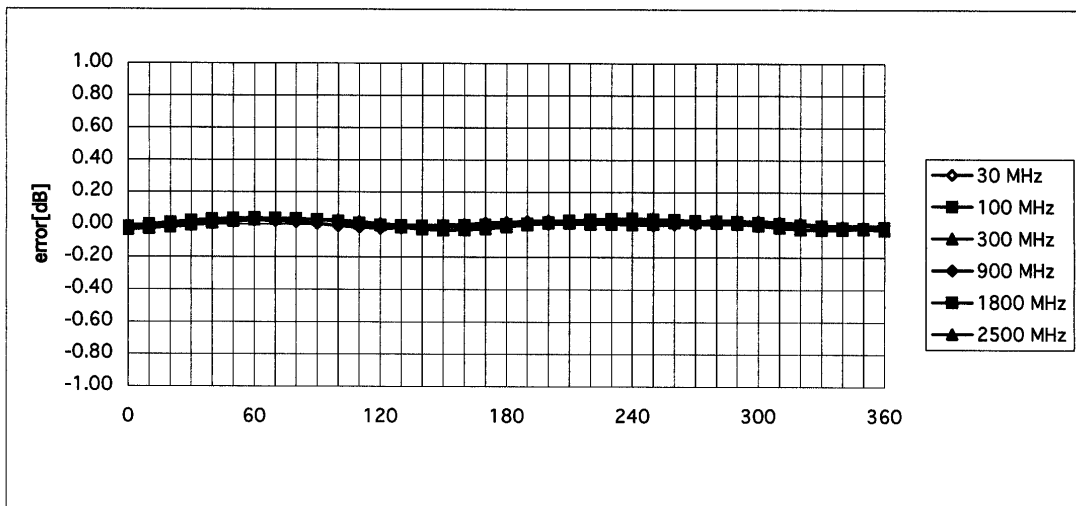

Frequency Response of E-Field

(TEM-Cell:ifi110, Waveguide R22)

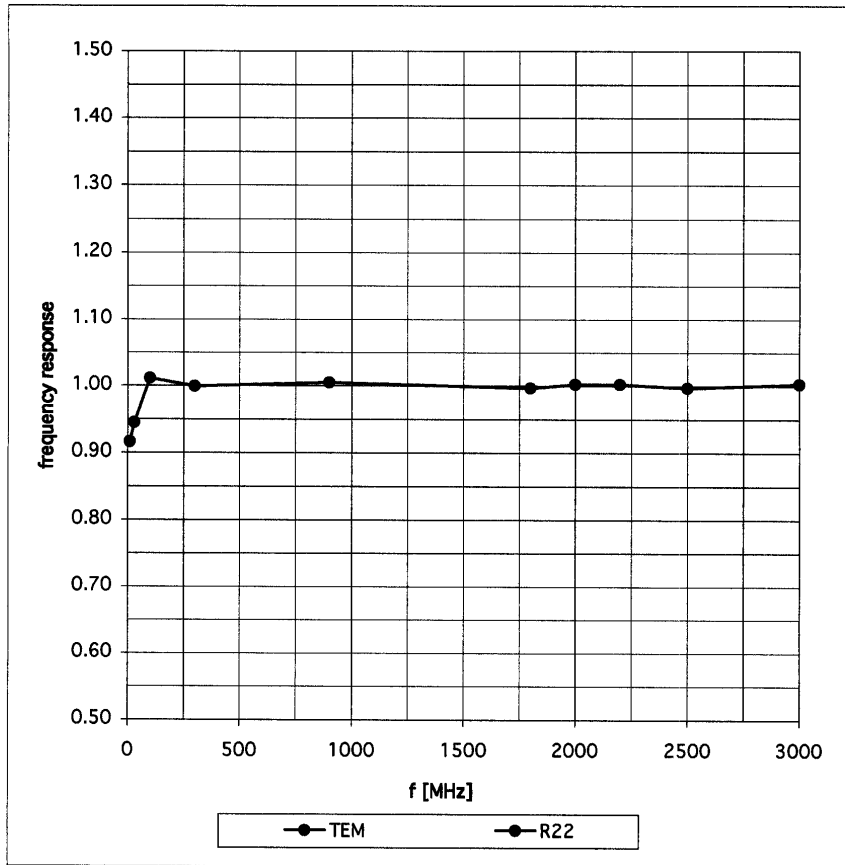

Dynamic Range f(SAR_{brain})

(Waveguide R22)

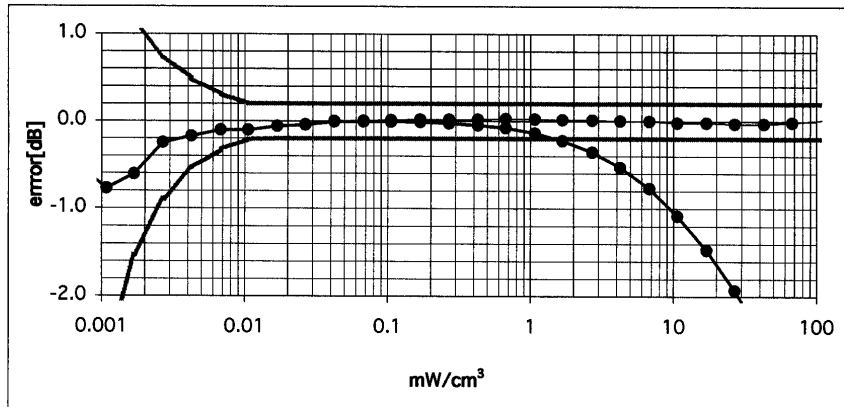
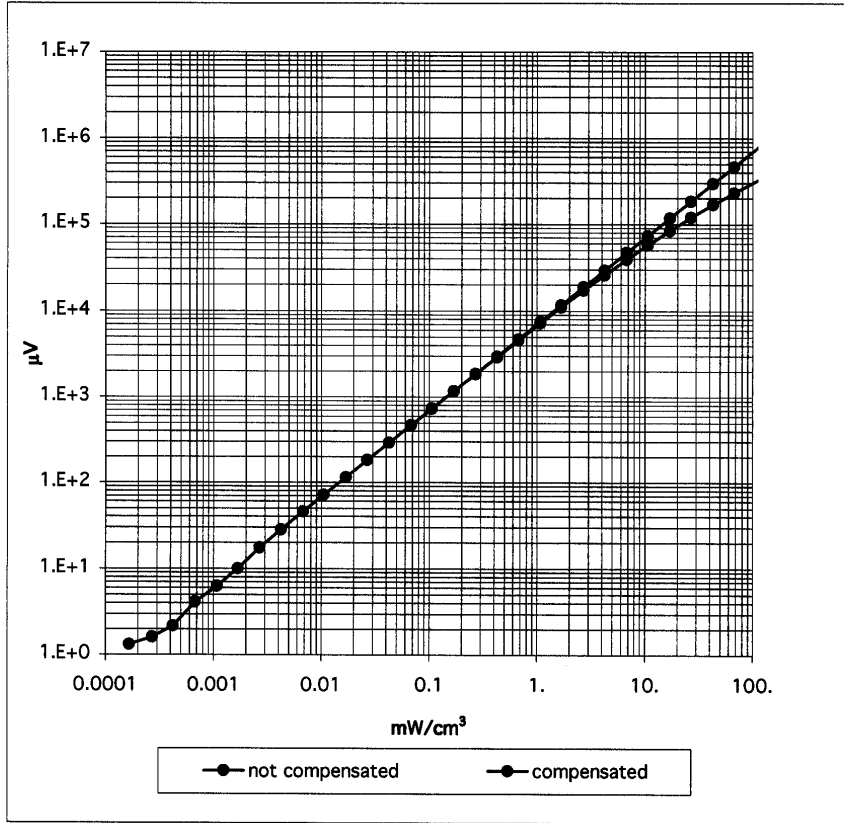

Conversion Factor Assessment

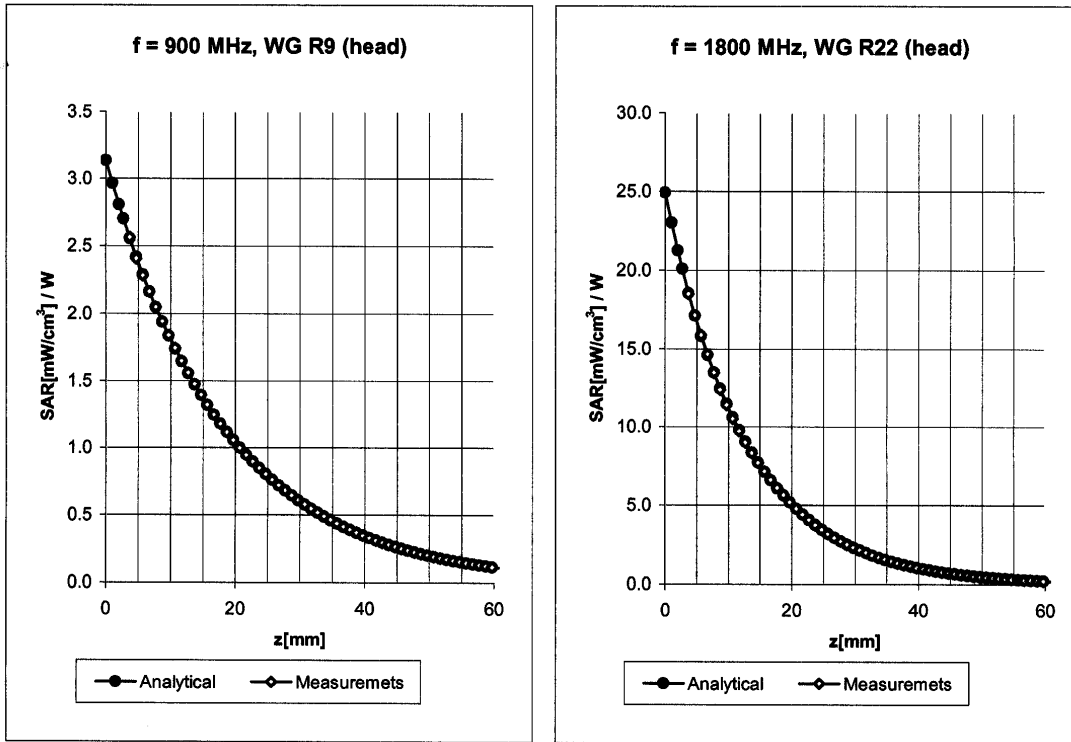

Head 900 MHz $\epsilon_r = 41.5 \pm 5\%$ $\sigma = 0.97 \pm 5\%$ mho/m

Valid for f=800-1000 MHz with Head Tissue Simulating Liquid according to EN 50361, P1528-200X

ConvF X	7.0 ± 9.5% (k=2)	Boundary effect:	
ConvF Y	7.0 ± 9.5% (k=2)	Alpha	0.33
ConvF Z	7.0 ± 9.5% (k=2)	Depth	2.56

Head 1800 MHz $\epsilon_r = 40.0 \pm 5\%$ $\sigma = 1.40 \pm 5\%$ mho/m

Valid for f=1710-1910 MHz with Head Tissue Simulating Liquid according to EN 50361, P1528-200X

ConvF X	5.5 ± 9.5% (k=2)	Boundary effect:	
ConvF Y	5.5 ± 9.5% (k=2)	Alpha	0.44
ConvF Z	5.5 ± 9.5% (k=2)	Depth	2.69

Conversion Factor Assessment

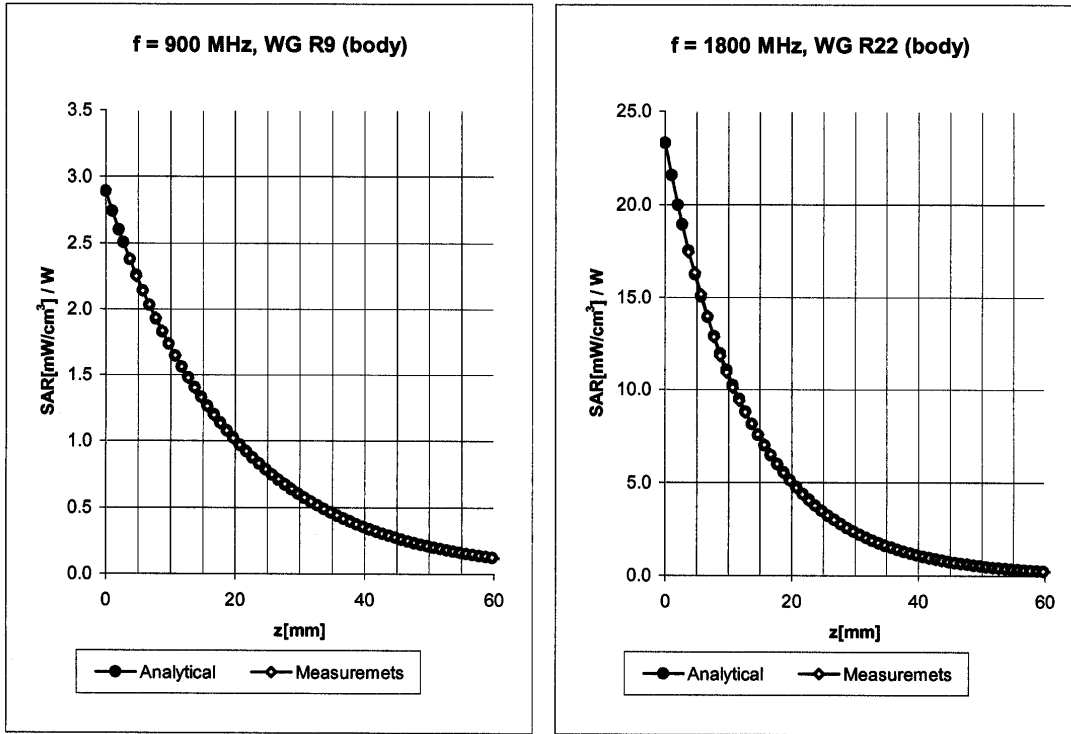

Body 900 MHz $\epsilon_r = 55.0 \pm 5\%$ $\sigma = 1.05 \pm 5\%$ mho/m

Valid for f=800-1000 MHz with Body Tissue Simulating Liquid according to OET 65 Suppl. C

ConvF X	6.8 $\pm 9.5\%$ (k=2)	Boundary effect:
ConvF Y	6.8 $\pm 9.5\%$ (k=2)	Alpha 0.34
ConvF Z	6.8 $\pm 9.5\%$ (k=2)	Depth 2.61

Body 1800 MHz $\epsilon_r = 53.3 \pm 5\%$ $\sigma = 1.52 \pm 5\%$ mho/m

Valid for f=1710-1910 MHz with Body Tissue Simulating Liquid according to OET 65 Suppl. C

ConvF X	5.0 $\pm 9.5\%$ (k=2)	Boundary effect:
ConvF Y	5.0 $\pm 9.5\%$ (k=2)	Alpha 0.52
ConvF Z	5.0 $\pm 9.5\%$ (k=2)	Depth 2.69

Conversion Factor Assessment

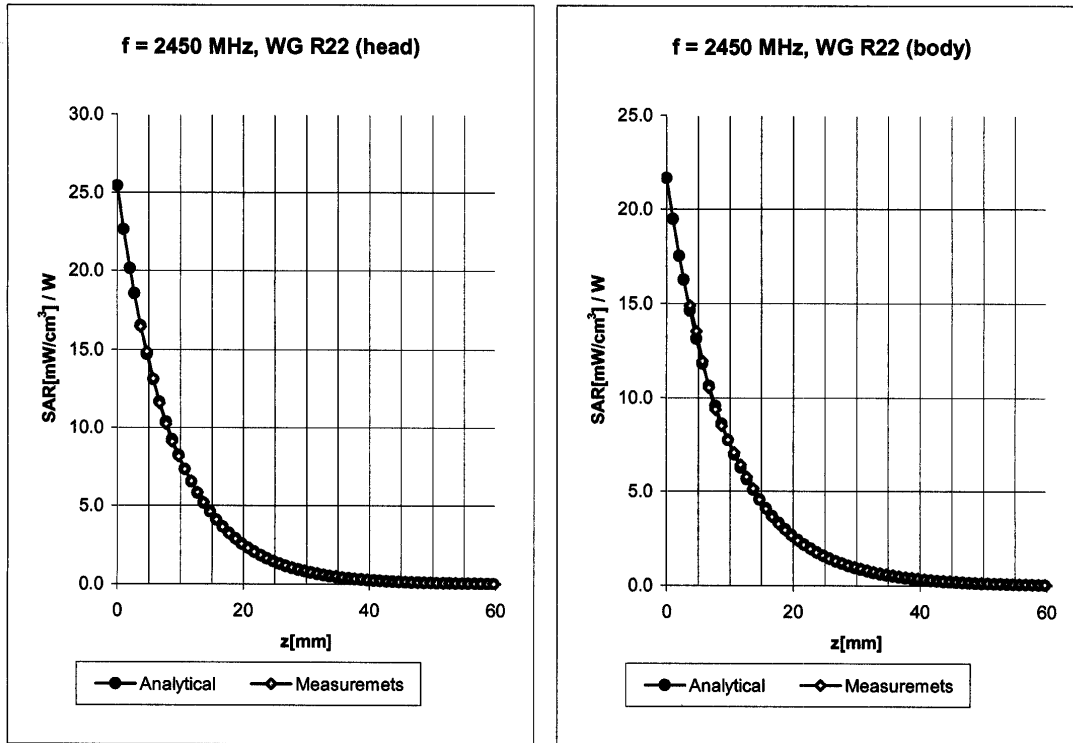

Head 2450 MHz $\epsilon_r = 39.2 \pm 5\%$ $\sigma = 1.80 \pm 5\%$ mho/m

Valid for f=2400-2500 MHz with Head Tissue Simulating Liquid according to EN 50361, P1528-200X

ConvF X	5.0 $\pm 8.9\%$ (k=2)	Boundary effect:
ConvF Y	5.0 $\pm 8.9\%$ (k=2)	Alpha 0.88
ConvF Z	5.0 $\pm 8.9\%$ (k=2)	Depth 1.92

Body 2450 MHz $\epsilon_r = 52.7 \pm 5\%$ $\sigma = 1.95 \pm 5\%$ mho/m

Valid for f=2400-2500 MHz with Body Tissue Simulating Liquid according to OET 65 Suppl. C

ConvF X	4.4 $\pm 8.9\%$ (k=2)	Boundary effect:
ConvF Y	4.4 $\pm 8.9\%$ (k=2)	Alpha 0.90
ConvF Z	4.4 $\pm 8.9\%$ (k=2)	Depth 1.87

Deviation from Isotropy in HSL

Error (θ, ϕ), $f = 900$ MHz

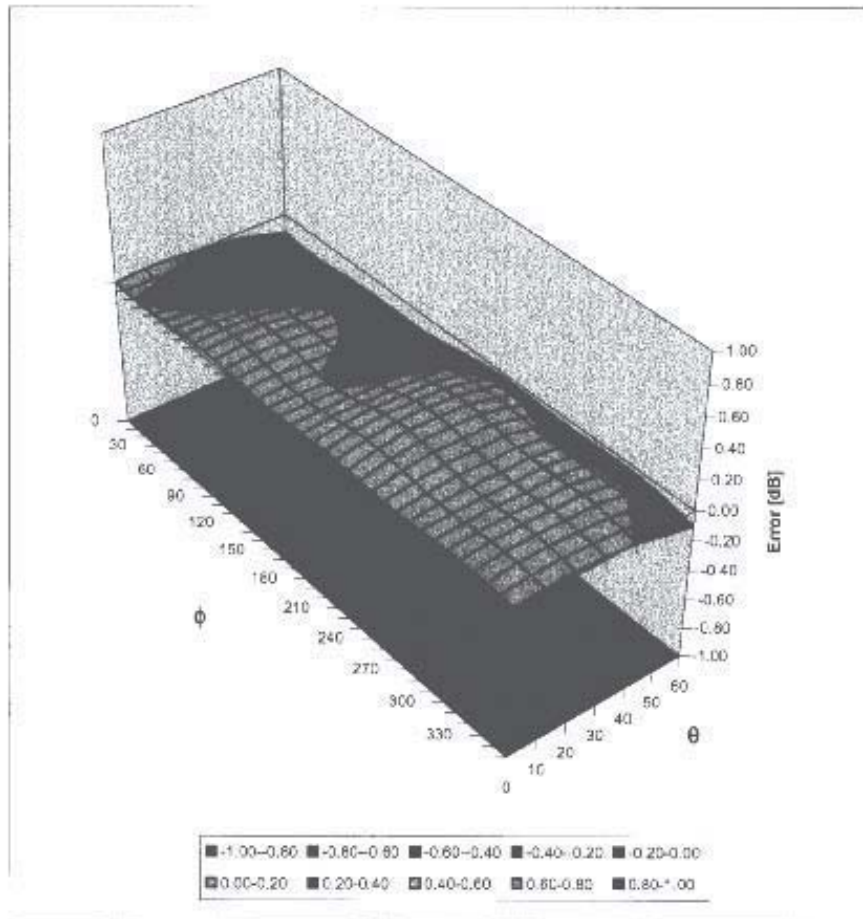

Additional Conversion Factors for Dosimetric E-Field Probe

Type:

ET3DV6

Serial Number:

1590

Place of Assessment:

Zurich

Date of Assessment:

May 19, 2003

Probe Calibration Date:

May 15, 2003

Schmid & Partner Engineering AG hereby certifies that conversion factor(s) of this probe have been evaluated on the date indicated above. The assessment was performed using the FDTD numerical code SEMCAD of Schmid & Partner Engineering AG. Since the evaluation is coupled with measured conversion factors, it has to be recalculated yearly, i.e., following the re-calibration schedule of the probe. The uncertainty of the numerical assessment is based on the extrapolation from measured value at 900 MHz or at 1800 MHz.

Assessed by:

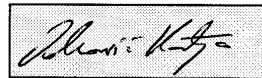

Dosimetric E-Field Probe ET3DV6 SN:1590Conversion factor (\pm standard deviation)

150 MHz	ConvF	9.6 \pm 8%	$\epsilon_r = 52.3 \pm 5\%$ $\sigma = 0.76 \pm 5\%$ mho/m (head tissue)
300 MHz	ConvF	8.3 \pm 8%	$\epsilon_r = 45.3 \pm 5\%$ $\sigma = 0.87 \pm 5\%$ mho/m (head tissue)
450 MHz	ConvF	7.9 \pm 8%	$\epsilon_r = 43.5 \pm 5\%$ $\sigma = 0.87 \pm 5\%$ mho/m (head tissue)
150 MHz	ConvF	9.2 \pm 8%	$\epsilon_r = 61.9 \pm 5\%$ $\sigma = 0.80 \pm 5\%$ mho/m (body tissue)
450 MHz	ConvF	8.1 \pm 8%	$\epsilon_r = 56.7 \pm 5\%$ $\sigma = 0.94 \pm 5\%$ mho/m (body tissue)

Test Report S/N:	012704-464MMA
Test Date(s):	January 29, 2004
Test Type:	FCC/IC SAR Evaluation

APPENDIX E - MEASURED FLUID DIELECTRIC PARAMETERS

300 MHz System Performance Check

Measured Fluid Dielectric Parameters (Brain)

January 29, 2004

Frequency	ϵ'	ϵ''
200.000000 MHz	51.5652	73.2101
210.000000 MHz	50.6779	70.5399
220.000000 MHz	49.6726	68.1650
230.000000 MHz	48.8725	66.0573
240.000000 MHz	48.0977	64.0059
250.000000 MHz	47.6081	62.1461
260.000000 MHz	47.1981	60.4872
270.000000 MHz	46.9671	58.8406
280.000000 MHz	46.9197	57.2909
290.000000 MHz	46.8226	55.7187
300.000000 MHz	46.6503	54.1157
310.000000 MHz	46.3272	52.8480
320.000000 MHz	46.0392	51.7609
330.000000 MHz	45.6528	50.5977
340.000000 MHz	45.1301	49.5079
350.000000 MHz	44.6671	48.6089
360.000000 MHz	44.2132	47.7021
370.000000 MHz	43.8936	46.8755
380.000000 MHz	43.5652	46.0496
390.000000 MHz	43.3841	45.1599
400.000000 MHz	43.2071	44.4202

150 MHz DUT Evaluation (Face)

Measured Fluid Dielectric Parameters (Brain)

January 29, 2004

Frequency	ϵ'	ϵ''
50.000000 MHz	70.9271	240.2118
60.000000 MHz	67.5495	203.0210
70.000000 MHz	63.6684	175.2661
80.000000 MHz	61.4072	155.3217
90.000000 MHz	60.1903	139.5001
100.000000 MHz	58.9587	127.1617
110.000000 MHz	57.9367	117.2756
120.000000 MHz	56.5581	109.1216
130.000000 MHz	55.7451	101.6284
140.000000 MHz	54.8703	95.5272
150.000000 MHz	54.2488	90.1133
160.000000 MHz	53.8551	85.5880
170.000000 MHz	53.2441	81.5087
180.000000 MHz	52.9545	77.5138
190.000000 MHz	52.4908	74.0335
200.000000 MHz	52.1235	71.1999
210.000000 MHz	51.3638	68.6276
220.000000 MHz	50.8338	66.3470
230.000000 MHz	50.2264	64.2363
240.000000 MHz	49.6922	62.1232
250.000000 MHz	49.2270	60.2397

150 MHz DUT Evaluation (Body)

Measured Fluid Dielectric Parameters (Muscle)

January 29, 2004

Frequency	ϵ'	ϵ''
50.000000 MHz	80.3663	278.0286
60.000000 MHz	76.2056	233.6352
70.000000 MHz	72.4557	201.1572
80.000000 MHz	69.3244	177.5601
90.000000 MHz	66.8996	159.1888
100.000000 MHz	64.9912	144.1029
110.000000 MHz	63.6851	132.1805
120.000000 MHz	62.5672	122.1628
130.000000 MHz	62.1698	113.6693
140.000000 MHz	62.1430	106.0840
150.000000 MHz	61.8804	99.9232
160.000000 MHz	61.9761	94.2582
170.000000 MHz	61.8071	89.6547
180.000000 MHz	61.7543	85.2398
190.000000 MHz	61.3183	81.0477
200.000000 MHz	60.8737	77.5612
210.000000 MHz	60.2414	74.4405
220.000000 MHz	59.8204	71.7519
230.000000 MHz	59.3617	69.2247
240.000000 MHz	58.7017	66.9105
250.000000 MHz	58.5287	64.7098

Test Report S/N:	012704-464MMA
Test Date(s):	January 29, 2004
Test Type:	FCC/IC SAR Evaluation

APPENDIX F - SAR TEST SETUP & DUT PHOTOGRAPHS

FACE-HELD SAR TEST SETUP PHOTOGRAPHS
2.5 cm Separation Distance from Front of Radio to Planar Phantom

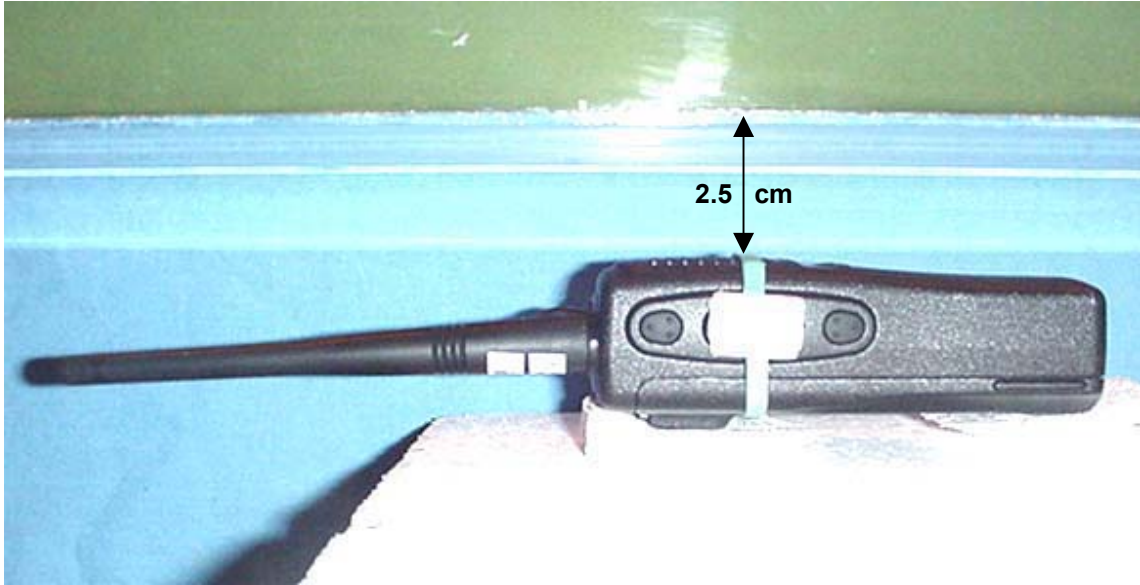

BODY-WORN SAR TEST SETUP PHOTOGRAPHS
1.5 cm Belt-Clip Separation Distance to Planar Phantom
with Speaker-Microphone Accessory (P/N: 70-M70)

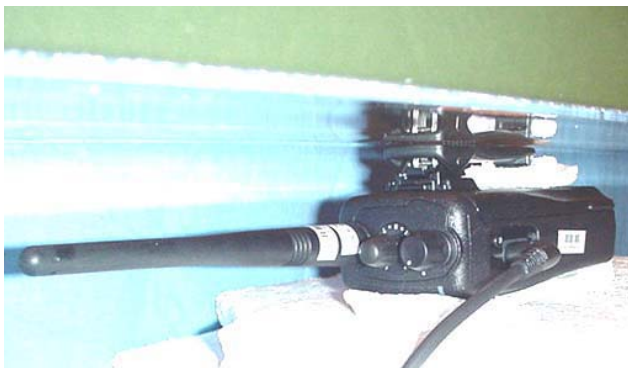
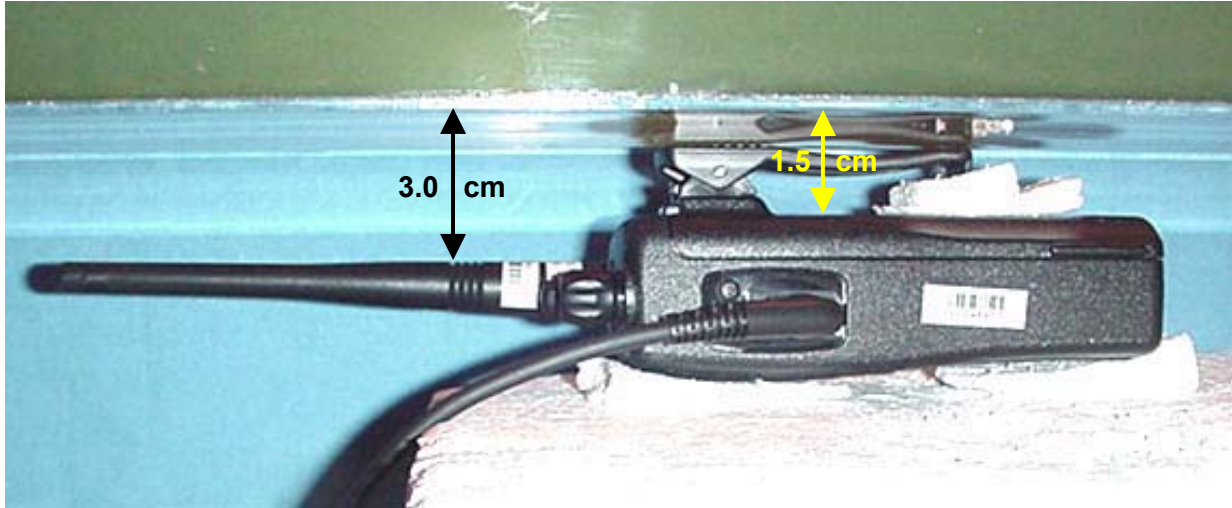

BODY-WORN SAR TEST SETUP PHOTOGRAPHS
4.5 cm Holster & Belt-Loop Separation Distance to Planar Phantom
with Speaker-Microphone Accessory (P/N: 70-M70)

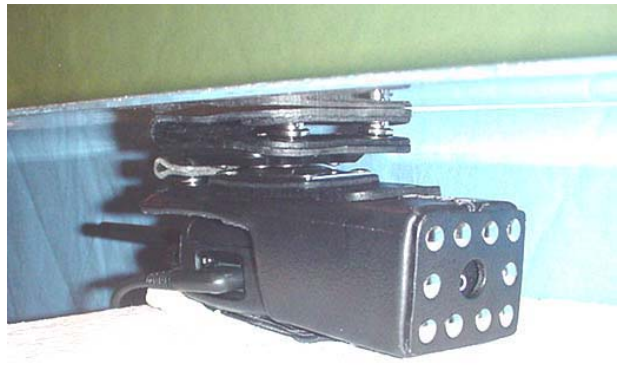
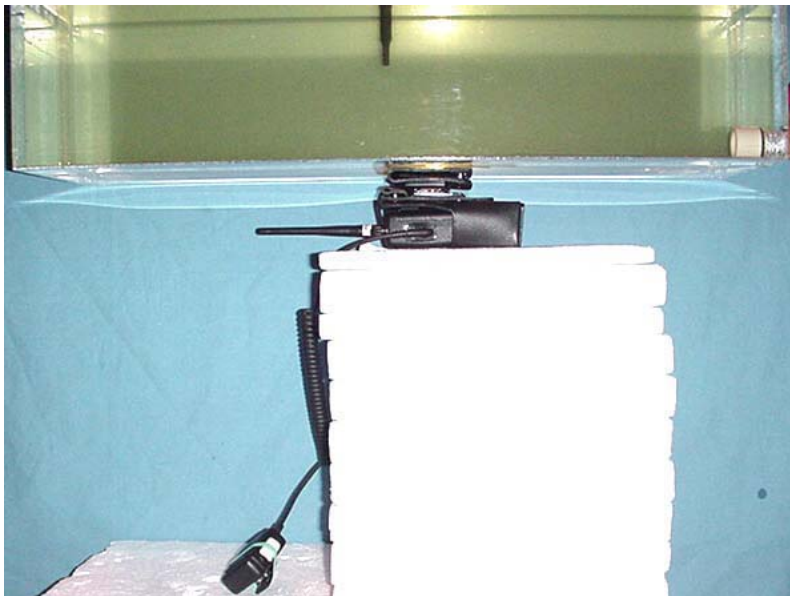
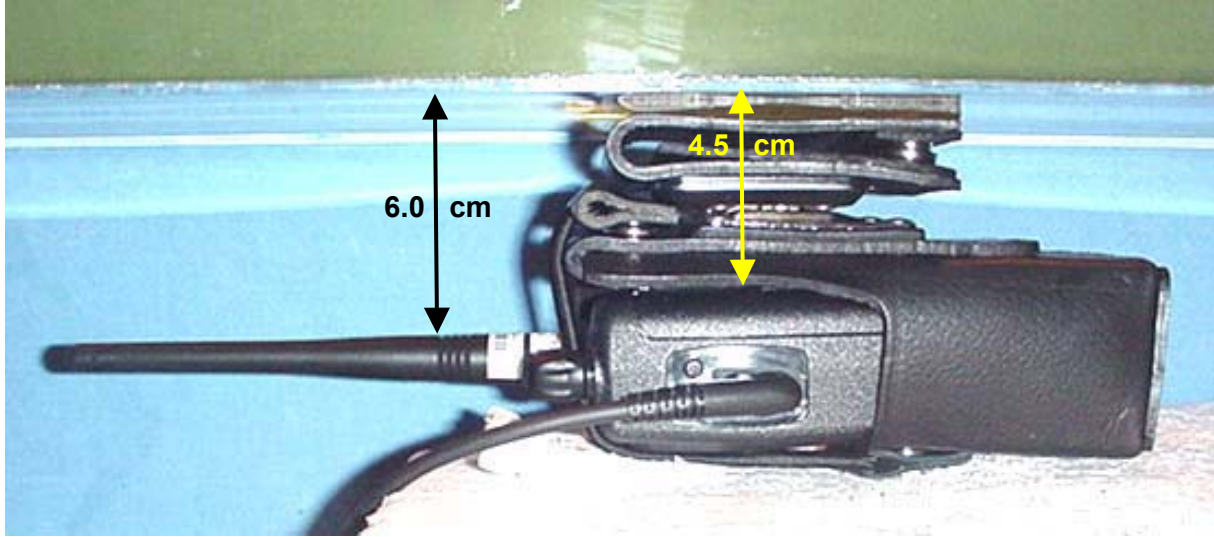

DUT PHOTOGRAPHS



Front of DUT



Back of DUT



Back of Radio with Belt-Clip

DUT PHOTOGRAPHS



Left Side of DUT



Right Side of DUT



Belt-Clip



Bottom of Radio



Top of Radio

DUT PHOTOGRAPHS



Radio without Battery Pack



NiMH Battery Pack



NiMH Battery Pack



Whip Antenna (150-161 MHz)

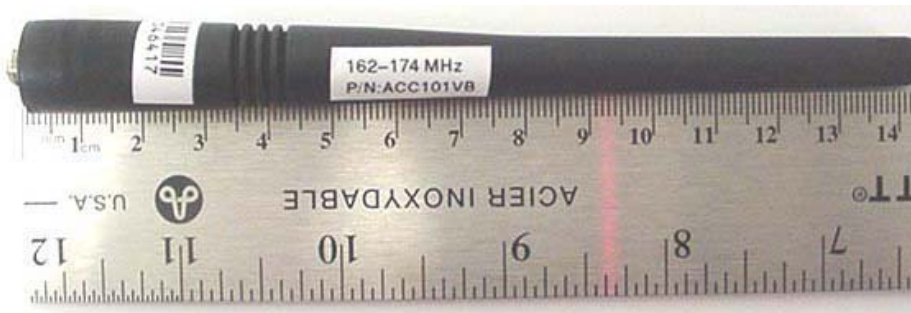

Whip Antenna (162-174 MHz)

DUT PHOTOGRAPHS



Front View of DUT in Holster with Belt-Loop Accessory



Back View of DUT in Holster with Belt-Loop Accessory



Left View of DUT in Holster with Belt-Loop Accessory



Right View of DUT in Holster with Belt-Loop Accessory

DUT PHOTOGRAPHS



**with Holster & Belt-Loop
& Speaker-Microphone Accessories**



with Speaker-Microphone Accessory