



# RADIO TEST REPORT

**Test Report No. : 11993429H**

**Applicant** : Honda Lock Mfg.Co.,Ltd.  
**Type of Equipment** : Smart system (ECU)  
**Model No.** : HLSS-2A  
**FCC ID** : MLBHLSS-2A  
**Test regulation** : FCC Part 15 Subpart C: 2017  
**Test Result** : Complied

1. This test report shall not be reproduced in full or partial, without the written approval of UL Japan, Inc.
2. The results in this report apply only to the sample tested.
3. This sample tested is in compliance with above regulation.
4. The test results in this report are traceable to the national or international standards.
5. This test report must not be used by the customer to claim product certification, approval, or endorsement by NVLAP, NIST, or any agency of the Federal Government.
6. This test report covers Radio technical requirements. It does not cover administrative issues such as Manual or non-Radio test related Requirements. (if applicable)

**Date of test:** October 26 and 31, 2017

**Representative test engineer:**

  
Masafumi Niwa  
Engineer  
Consumer Technology Division

**Approved by:**

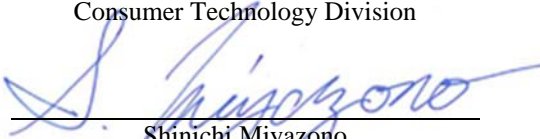
  
Shinichi Miyazono  
Engineer  
Consumer Technology Division

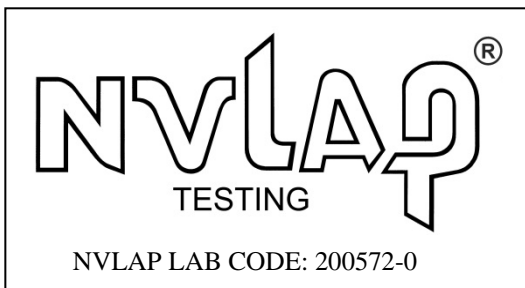

This laboratory is accredited by the NVLAP LAB CODE 200572-0, U.S.A. The tests reported herein have been performed in accordance with its terms of accreditation.  
\*As for the range of Accreditation in NVLAP, you may refer to the WEB address,  
[http://japan.ul.com/resources/emc\\_accredited/](http://japan.ul.com/resources/emc_accredited/)

**UL Japan, Inc.**

**Ise EMC Lab.**

4383-326 Asama-cho, Ise-shi, Mie-ken 516-0021 JAPAN

Telephone : +81 596 24 8999

Facsimile : +81 596 24 8124

13-EM-F0429



<b>CONTENTS</b>	<b>PAGE</b>
<b>SECTION 1: Customer information .....</b>	<b>4</b>
<b>SECTION 2: Equipment under test (E.U.T.).....</b>	<b>4</b>
<b>SECTION 3: Test specification, procedures &amp; results .....</b>	<b>5</b>
<b>SECTION 4: Operation of E.U.T. during testing .....</b>	<b>8</b>
<b>SECTION 5: Radiated emission (Fundamental and Spurious Emission) .....</b>	<b>9</b>
<b>SECTION 6: -26dB Bandwidth.....</b>	<b>11</b>
<b>SECTION 7: 99% Occupied Bandwidth.....</b>	<b>11</b>
<b>APPENDIX 1: Test data .....</b>	<b>12</b>
<b>Radiated Emission below 30 MHz (Fundamental and Spurious Emission) .....</b>	<b>12</b>
<b>Radiated Emission above 30 MHz (Spurious Emission).....</b>	<b>14</b>
<b>26 dB Bandwidth and 99% Occupied Bandwidth.....</b>	<b>15</b>
<b>APPENDIX 2: Test instruments .....</b>	<b>16</b>
<b>APPENDIX 3: Photographs of test setup .....</b>	<b>17</b>
<b>Radiated Emission.....</b>	<b>17</b>
<b>Worst Case Position (EUT: X-axis / Antenna: Y-axis) .....</b>	<b>18</b>

---

**UL Japan, Inc.**

**Ise EMC Lab.**

4383-326 Asama-cho, Ise-shi, Mie-ken 516-0021 JAPAN

Telephone : +81 596 24 8999

Facsimile : +81 596 24 8124

## **SECTION 1: Customer information**

Company Name : Honda Lock Mfg.Co.,Ltd.  
Address : 3700,Shimonaka, Sadowara-cho Miyazak-shi, Miyazaki Pref,880-0293  
Japan  
Telephone Number : +81-50-3757-5700  
Facsimile Number : +81-28-680-1045  
Contact Person : Sadanori Watarai

## **SECTION 2: Equipment under test (E.U.T.)**

### **2.1 Identification of E.U.T.**

Type of Equipment : Smart system (ECU)  
Model No. : HLSS-2A  
Serial No. : Refer to Clause 4.2  
Rating : DC 12 V  
Receipt Date of Sample : October 23, 2017  
Country of Mass-production : Vietnam  
Condition of EUT : Production prototype  
(Not for Sale: This sample is equivalent to mass-produced items.)  
Modification of EUT : No Modification by the test lab

### **2.2 Product Description**

Model No: HLSS-2A (referred to as the EUT in this report) is the Smart system (ECU).

#### **General Specification**

Clock frequency(ies) in the system : 21.948717 MHz (XTAL), 10 MHz (Ceramic Resonator)

#### **Radio Specification**

Radio Type : Transmitter  
Frequency of Operation : 125 kHz  
Type of Modulation : ASK  
Antenna Type : Ferrite coil antenna  
Operating voltage (inner) : DC 5.0 V

Radio Type : Receiver  
Frequency of Operation : 433.92 MHz \*1)

\*1) The test of receiver part was performed separately from this test report, and the conformability is confirmed.

---

**UL Japan, Inc.**

**Ise EMC Lab.**

4383-326 Asama-cho, Ise-shi, Mie-ken 516-0021 JAPAN

Telephone : +81 596 24 8999

Facsimile : +81 596 24 8124

## SECTION 3: Test specification, procedures & results

### 3.1 Test Specification

Test Specification : FCC Part 15 Subpart C  
FCC Part 15 final revised on November 2, 2017

Title : FCC 47CFR Part15 Radio Frequency Device Subpart C Intentional Radiators  
Section 15.207 Conducted limits  
Section 15.209 Radiated emission limits; general requirements.

\* The revision on November 2, 2017, does not affect the test specification applied to the EUT.

\* Also the EUT complies with FCC Part 15 Subpart B.

### 3.2 Procedures and results

No.	Item	Test Procedure	Specification	Remarks	Deviation	Worst margin	Results
1	Conducted Emission	<FCC> ANSI C63.10:2013 6 Standard test methods <IC> RSS-Gen 8.8	<FCC> Section 15.207 <IC> RSS-Gen 8.8	-	N/A *1)	N/A	N/A
2	Electric Field Strength of Fundamental Emission	<FCC> ANSI C63.10:2013 6 Standard test methods <IC> RSS-Gen 6.4, 6.12	<FCC> Section 15.209 <IC> RSS-210 4.4 RSS-Gen 8.9	Radiated	N/A	8.1 dB 125 kHz 0 deg. AV PK with Duty factor	Complied
3	Electric Field Strength of Spurious Emission	<FCC> ANSI C63.10:2013 6 Standard test methods <IC> RSS-Gen 6.4, 6.13	<FCC> Section 15.209 <IC> RSS-210 4.4 RSS-Gen 8.9	Radiated	N/A	19.0 dB (898.663 MHz, Horizontal, QP) (899.996 MHz, Vertical, QP)	Complied
4	-26dB Bandwidth	<FCC> ANSI C63.10:2013 6 Standard test methods <IC> -	<FCC> Reference data <IC> -	Radiated	N/A	N/A	N/A

Note: UL Japan, Inc.'s EMI Work Procedures No. 13-EM-W0420 and 13-EM-W0422.

\*1) The test is not applicable since the EUT is not the device that is designed to be connected to the public utility (AC) power line.

#### FCC 15.31 (e)

This EUT provides stable voltage (DC 5.0 V) constantly to RF part regardless of input voltage. Therefore, this EUT complies with the requirement.

#### FCC Part 15.203 Antenna requirement

It is impossible for end users to replace the antenna, because the antenna is mounted inside of the EUT. Therefore, the equipment complies with the antenna requirement of Section 15.203.

**UL Japan, Inc.**

**Ise EMC Lab.**

4383-326 Asama-cho, Ise-shi, Mie-ken 516-0021 JAPAN

Telephone : +81 596 24 8999

Facsimile : +81 596 24 8124

### 3.3 Addition to standard

No.	Item	Test Procedure	Specification	Remarks	Deviation	Worst margin	Results
1	99 % Occupied Band Width	RSS-Gen 6.6	-	Radiated	N/A	N/A	N/A

Other than above, no addition, exclusion nor deviation has been made from the standard.

### 3.4 Uncertainty

#### EMI

The following uncertainties have been calculated to provide a confidence level of 95% using a coverage factor k=2.

Test distance	Radiated emission (+/-)
	9 kHz to 30 MHz
3 m	3.8 dB
10 m	3.6 dB

\*Measurement distance

Polarity	Radiated emission (Below 1 GHz)			
	(3 m*)(+/-)		(10 m*)(+/-)	
	30 MHz to 200 MHz	200 MHz to 1000 MHz	30 MHz to 200 MHz	200 MHz to 1000 MHz
Horizontal	5.0 dB	5.3 dB	5.0 dB	5.0 dB
Vertical	5.2 dB	6.3 dB	5.0 dB	5.0 dB

Radiated emission (Above 1 GHz)				
(3 m*)(+/-)		(1 m*)(+/-)		(10 m*)(+/-)
1 GHz to 6 GHz	6 GHz to 18 GHz	10 GHz to 26.5 GHz	26.5 GHz to 40 GHz	1 GHz to 18 GHz
5.2 dB	5.5 dB	5.5 dB	5.4 dB	5.5 dB

\* Measurement distance

#### Radiated emission test(3 m)

The data listed in this test report has enough margin, more than the site margin.

**UL Japan, Inc.**

**Ise EMC Lab.**

4383-326 Asama-cho, Ise-shi, Mie-ken 516-0021 JAPAN

Telephone : +81 596 24 8999

Facsimile : +81 596 24 8124

### 3.5 Test Location

UL Japan, Inc. Ise EMC Lab.  
4383-326 Asama-cho, Ise-shi, Mie-ken 516-0021 JAPAN  
Telephone: +81 596 24 8999, Facsimile: +81 596 24 8124  
NVLAP Lab. code: 200572-0 / FCC Test Firm Registration Number: 199967

Test site	IC Registration Number	Width x Depth x Height (m)	Size of reference ground plane (m) / horizontal conducting plane	Other rooms	Maximum measurement distance
No.1 semi-anechoic chamber	2973C-1	19.2 x 11.2 x 7.7	7.0 x 6.0	No.1 Power source room	10 m
No.2 semi-anechoic chamber	2973C-2	7.5 x 5.8 x 5.2	4.0 x 4.0	-	3 m
No.3 semi-anechoic chamber	2973C-3	12.0 x 8.5 x 5.9	6.8 x 5.75	No.3 Preparation room	3 m
No.3 shielded room	-	4.0 x 6.0 x 2.7	N/A	-	-
No.4 semi-anechoic chamber	2973C-4	12.0 x 8.5 x 5.9	6.8 x 5.75	No.4 Preparation room	3 m
No.4 shielded room	-	4.0 x 6.0 x 2.7	N/A	-	-
No.5 semi-anechoic chamber	-	6.0 x 6.0 x 3.9	6.0 x 6.0	-	-
No.6 shielded room	-	4.0 x 4.5 x 2.7	4.0 x 4.5	-	-
No.6 measurement room	-	4.75 x 5.4 x 3.0	4.75 x 4.15	-	-
No.7 shielded room	-	4.7 x 7.5 x 2.7	4.7 x 7.5	-	-
No.8 measurement room	-	3.1 x 5.0 x 2.7	N/A	-	-
No.9 measurement room	-	8.8 x 4.6 x 2.8	2.4 x 2.4	-	-
No.11 measurement room	-	6.2 x 4.7 x 3.0	4.8 x 4.6	-	-

\* Size of vertical conducting plane (for Conducted Emission test) : 2.0 m x 2.0m for No.1, No.2, No.3, and No.4 semi-anechoic chambers and No.3 and No.4 shielded rooms.

### 3.6 Test data, Test instruments, and Test set up

Refer to APPENDIX.

## UL Japan, Inc. Ise EMC Lab.

4383-326 Asama-cho, Ise-shi, Mie-ken 516-0021 JAPAN  
Telephone : +81 596 24 8999  
Facsimile : +81 596 24 8124

## SECTION 4: Operation of E.U.T. during testing

### 4.1 Operating Modes

Test mode	Remarks
Transmitting (Tx) mode	-

Justification : The system was configured in typical fashion (as a user would normally use it) for testing.

### 4.2 Configuration and peripherals

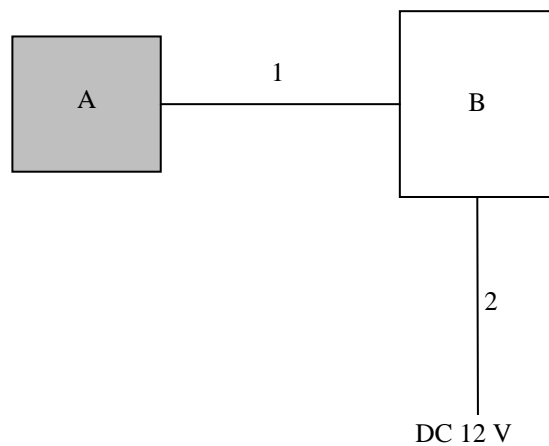

\* Cabling and setup were taken into consideration and test data was taken under worst case conditions.

#### Description of EUT and Support equipment

No.	Item	Model number	Serial number	Manufacturer	Remarks
A	Smart system (ECU)	HLSS-2A	2A-0001	Honda Lock Mfg.Co.,Ltd.	EUT
B	Checker box	-	-	-	-

#### List of cables used

No.	Name	Length (m)	Shield		Remark
			Cable	Connector	
1	Signal Cable	2.0	Unshielded	Unshielded	-
2	DC cable	2.5	Unshielded	Unshielded	-

**UL Japan, Inc.**

**Ise EMC Lab.**

4383-326 Asama-cho, Ise-shi, Mie-ken 516-0021 JAPAN

Telephone : +81 596 24 8999

Facsimile : +81 596 24 8124



## **SECTION 5: Radiated emission (Fundamental and Spurious Emission)**

### **Test Procedure**

EUT was placed on a urethane platform of nominal size, 1.0 m by 1.5 m, raised 0.8 m above the conducting ground plane.

The Radiated Electric Field Strength has been measured in a Semi Anechoic Chamber with a ground plane.

Frequency : From 9 kHz to 30 MHz

The EUT was rotated a full revolution in order to obtain the maximum value of the electric field intensity.

The measurements were performed for vertical polarization (antenna angle: 0 deg., 45 deg., 90 deg., and 135 deg.) and horizontal polarization.

\*Refer to Figure 1 about Direction of the Loop Antenna.

Frequency: From 30 MHz to 1 GHz

The measuring antenna height varied between 1 and 4 m and EUT was rotated a full revolution in order to obtain the maximum value of the electric field intensity.

The measurements were performed for both vertical and horizontal antenna polarization.

The test was made with the detector (RBW / VBW) in the following table.

When using Spectrum analyzer, the test was made with adjusting span to zero by using peak hold.

### **Test Antennas are used as below;**

Frequency	Below 30 MHz	30 MHz to 200 MHz	200 MHz to 1 GHz
Antenna Type	Loop	Biconical	Logperiodic

Frequency	From 9 kHz to 90 kHz and From 110 kHz to 150 kHz	From 90 kHz to 110 kHz	From 150 kHz to 490 kHz	From 490 kHz to 30 MHz	From 30 MHz to 1 GHz
Instrument used	Test Receiver				
Detector	PK / AV	QP	PK / AV	QP	QP
IF Bandwidth	200 Hz	200 Hz	9 kHz	9 kHz	120 kHz
Test Distance	3 m *1)	3 m *1)	3 m *1)	3 m *2)	3 m

\*1) Distance Factor:  $40 \times \log(3 \text{ m} / 300 \text{ m}) = -80 \text{ dB}$

\*2) Distance Factor:  $40 \times \log(3 \text{ m} / 30 \text{ m}) = -40 \text{ dB}$

Although these tests were performed other than open field test site, adequate comparison measurements were confirmed against 30 m open field test site. Therefore sufficient tests were made to demonstrate that the alternative site produces results that correlate with the ones of tests made in an open field based on KDB 414788.

These tests were performed in semi anechoic chamber. Therefore the measured level of emissions may be higher than if measurements were made without a ground plane.

However test results were confirmed to pass against standard limit.

- The carrier level and noise levels were confirmed at each position of X, Y and Z axes of EUT to see the position of maximum noise, and the test was made at the position that has the maximum noise.

The test results and limit are rounded off to one decimal place, so some differences might be observed.

**Measurement range : 9 kHz - 1 GHz**

**Test data : APPENDIX 1**

**Test result : Pass**

Date: October 26, 2017  
October 31, 2017

Test engineer: Masafumi Niwa  
Ken Fujita

**UL Japan, Inc.**

**Ise EMC Lab.**

4383-326 Asama-cho, Ise-shi, Mie-ken 516-0021 JAPAN

Telephone : +81 596 24 8999

Facsimile : +81 596 24 8124

**Figure 1: Direction of the Loop Antenna**

*Side View (Vertical)*

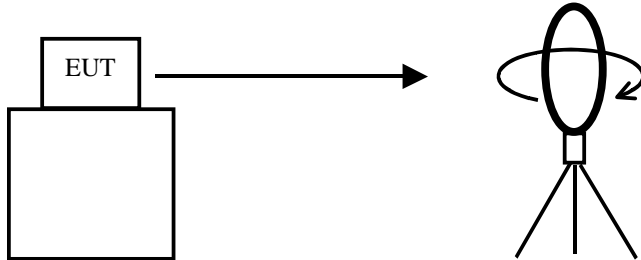

.....  
*Top View (Horizontal)*

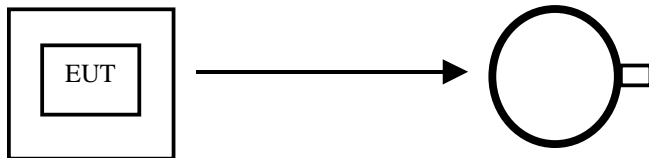

Antenna was not rotated.

.....

*Top View (Vertical)*

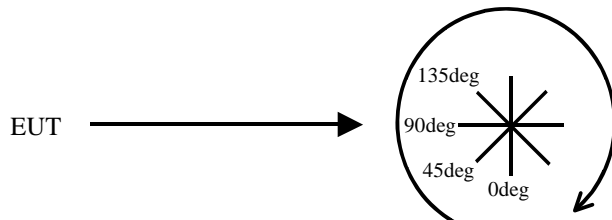

Front side: 0 deg.  
Forward direction: clockwise

## **SECTION 6: -26dB Bandwidth**

### **Test Procedure**

The test was measured with a spectrum analyzer using a test fixture.

Test	Span	RBW	VBW	Sweep	Detector	Trace	Instrument used
-26 dB Bandwidth	50 kHz	1 kHz	3 kHz	Auto	Peak	Max Hold	Spectrum Analyzer

Test data : APPENDIX 1  
Test result : Pass

## **SECTION 7: 99% Occupied Bandwidth**

### **Test Procedure**

The test was measured with a spectrum analyzer using a test fixture.

Test	Span	RBW	VBW	Sweep	Detector	Trace	Instrument used
99 % Occupied Bandwidth	Enough width to display emission skirts	1 to 5 % of OBW	Three times of RBW	Auto	Peak *1)	Max Hold *1)	Spectrum Analyzer

\*1) The measurement was performed with Peak detector, Max Hold since the duty cycle was not 100 %.  
Peak hold was applied as Worst-case measurement.

Test data : APPENDIX 1  
Test result : Pass

**APPENDIX 1: Test data**

**Radiated Emission below 30 MHz (Fundamental and Spurious Emission)**

Report No. 11993429H  
Test place Ise EMC Lab.  
Semi Anechoic Chamber No.2  
Date 2017/10/26  
Temperature / Humidity 23 deg. C / 44 % RH  
Engineer Masafumi Niwa  
Mode Tx 125 kHz

**PK or QP**

Ant Deg [deg]	Frequency [MHz]	Detector	Reading [dBuV]	Ant Factor [dB/m]	Loss [dB]	Gain [dB]	Duty Factor [dB]	Result [dBuV/m]	Limit [dBuV/m]	Margin [dB]	Remark
0	0.12500	PK	103.8	19.8	-73.9	32.2	-	17.5	45.6	28.1	Fundamental
0	0.25000	PK	63.2	19.7	-73.9	32.2	-	-23.2	39.6	62.8	
0	0.37500	PK	65.1	19.7	-73.9	32.2	-	-21.3	36.1	57.4	
0	0.50000	QP	35.4	19.7	-33.8	32.1	-	-10.8	33.6	44.4	
0	0.62500	QP	53.5	19.7	-33.8	32.2	-	7.2	31.7	24.5	
0	0.75000	QP	31.8	19.7	-33.8	32.2	-	-14.5	30.1	44.6	
0	0.87500	QP	46.2	19.7	-33.8	32.2	-	-0.1	28.7	28.8	
0	1.00000	QP	30.9	19.7	-33.8	32.2	-	-15.4	27.6	43.0	
0	1.12500	QP	41.0	19.7	-33.8	32.2	-	-5.3	26.5	31.8	
0	1.25000	QP	30.5	19.7	-33.7	32.2	-	-15.7	25.6	41.3	

Result = Reading + Ant Factor + Loss (Cable + Attenuator + D.Factor) - Gain(Amplifier)

**PK with Duty factor**

Ant Deg [deg]	Frequency [MHz]	Detector	Reading [dBuV]	Ant Factor [dB/m]	Loss [dB]	Gain [dB]	Duty Factor [dB]	Result [dBuV/m]	Limit [dBuV/m]	Margin [dB]	Remark
0	0.125	PK	103.8	19.8	-73.9	32.2	0.0	17.5	25.6	8.1	
0	0.250	PK	63.2	19.7	-73.9	32.2	0.0	-23.2	19.6	42.8	
0	0.375	PK	65.1	19.7	-73.9	32.2	0.0	-21.3	16.1	37.4	

Result = Reading + Ant Factor + Loss (Cable + Attenuator + D.Factor) - Gain(Amplifier) + Duty factor \*

\* Since the peak emission result satisfied the average limit, duty factor was omitted.

**Result of the fundamental emission at 3m without Distance factor**

**PK or QP**

Ant Deg [deg]	Frequency [MHz]	Detector	Reading [dBuV]	Ant Factor [dB/m]	Loss [dB]	Gain [dB]	Duty Factor [dB]	Result [dBuV/m]	Limit [dBuV/m]	Margin [dB]	Remark
0	0.12500	PK	103.8	19.8	6.1	32.2	-	97.5	-	-	Fundamental

Result = Reading + Ant Factor + Loss (Cable+Attenuator+Filter) - Gain(Amplifier)

\* All spurious emissions lower than this result.

\*The test result is rounded off to one or two decimal places, so some differences might be observed.

**UL Japan, Inc.**

**Ise EMC Lab.**

4383-326 Asama-cho, Ise-shi, Mie-ken 516-0021 JAPAN

Telephone : +81 596 24 8999

Facsimile : +81 596 24 8124

**Radiated Emission below 30 MHz (Fundamental and Spurious Emission)**  
**(Plot data, Worst case)**

Report No. 11993429H  
Test place Ise EMC Lab.  
Semi Anechoic Chamber No.2  
Date 2017/10/26  
Temperature / Humidity 23 deg. C / 44 % RH  
Engineer Masafumi Niwa  
Mode Tx 125 kHz

LIMIT : FCC15.209(a), 9-90kHz:PK, 110-490kHz:PK, other:QP  
FCC15.209(a), 9-90kHz:AV, 110-490kHz:AV, other:QP

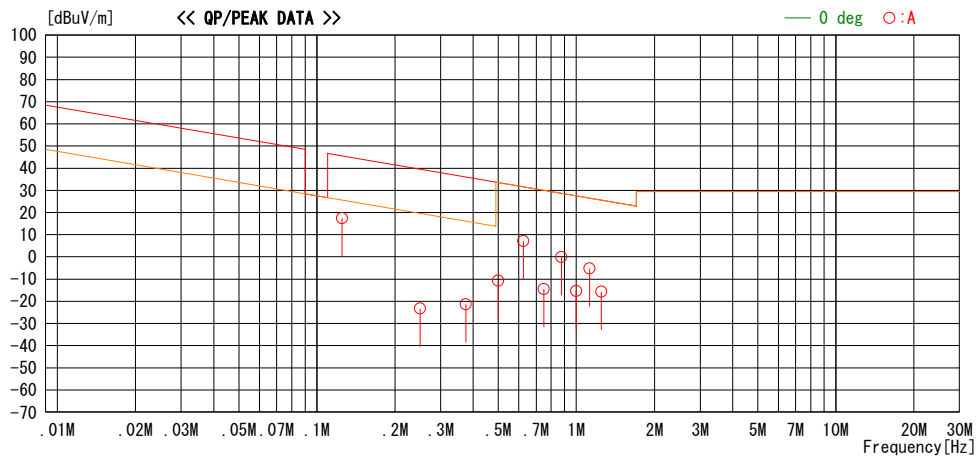

\*These plots data contains sufficient number to show the trend of characteristic features for EUT.

### Radiated Emission above 30 MHz (Spurious Emission)

Report No. 11993429H  
Test place Ise EMC Lab.  
Semi Anechoic Chamber No.2  
Date 2017/10/31  
Temperature / Humidity 21 deg. C / 45 % RH  
Engineer Ken Fujita  
Mode Tx 125 kHz

LIMIT : FCC15.209 3m, below 1GHz:QP, above 1GHz:PK  
All other spurious emissions were less than 20dB for the limit.

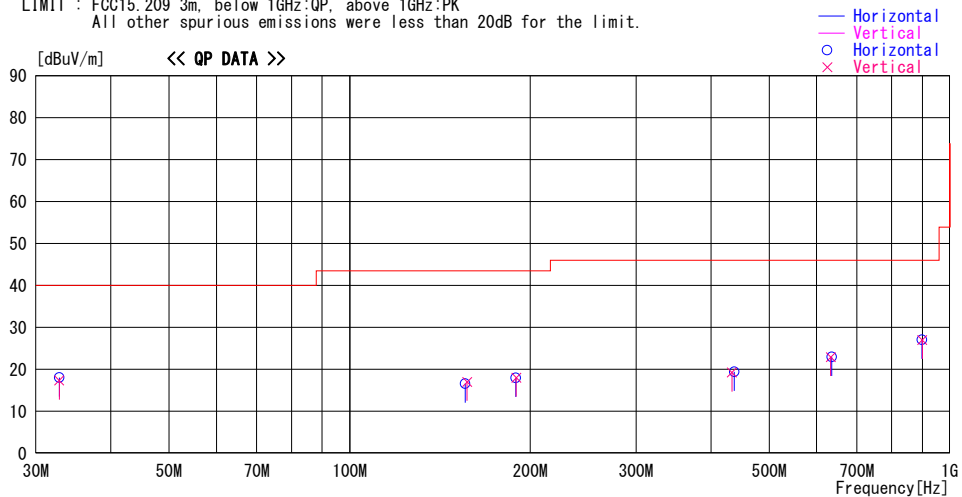

Frequency [MHz]	Reading [dBuV]	DET	Antenna	Loss&	Level	Angle	Height	Polar.	Limit	Margin	Comment
			Factor	Gain							
			[dB/m]	[dB]	[dBuV/m]	[Deg]	[cm]		[dBuV/m]	[dB]	
32.833	24.9	QP	16.8	-23.7	18.0	0	100	Hori.	40.0	22.0	
32.833	24.2	QP	16.8	-23.7	17.3	0	100	Vert.	40.0	22.7	
155.801	23.6	QP	15.1	-22.1	16.6	0	100	Hori.	43.5	26.9	
156.934	23.8	QP	15.2	-22.0	17.0	0	100	Vert.	43.5	26.5	
189.235	23.2	QP	16.3	-21.6	17.9	0	100	Hori.	43.5	25.6	
189.518	23.3	QP	16.3	-21.6	18.0	0	100	Vert.	43.5	25.5	
433.335	23.2	QP	16.4	-20.4	19.2	0	100	Vert.	46.0	26.8	
437.335	23.3	QP	16.5	-20.4	19.4	0	100	Hori.	46.0	26.6	
633.333	22.8	QP	19.3	-19.2	22.9	0	100	Vert.	46.0	23.1	
636.000	22.8	QP	19.3	-19.2	22.9	0	100	Hori.	46.0	23.1	
898.663	21.8	QP	22.1	-16.9	27.0	0	100	Hori.	46.0	19.0	
899.996	21.8	QP	22.1	-16.9	27.0	0	100	Vert.	46.0	19.0	

CHART: WITH FACTOR

ANT TYPE: - 30 MHz: LOOP, 30 MHz - 200 MHz: BICONICAL, 200 MHz - 1000 MHz: LOGPERIODIC, 1000 MHz -: HORN  
CALCULATION: RESULT = READING + ANT FACTOR + LOSS & GAIN (CABLE + ATT - GAIN(AMP))

\*The test result is rounded off to one or two decimal places, so some differences might be observed.

**UL Japan, Inc.**  
**Ise EMC Lab.**

4383-326 Asama-cho, Ise-shi, Mie-ken 516-0021 JAPAN  
Telephone : +81 596 24 8999  
Facsimile : +81 596 24 8124

### 26 dB Bandwidth and 99% Occupied Bandwidth

Report No. 11993429H  
 Test place Ise EMC Lab.  
 Semi Anechoic Chamber No.2  
 Date 2017/10/31  
 Temperature / Humidity 21 deg. C / 45 % RH  
 Engineer Ken Fujita  
 Mode Tx 125 kHz

-26 dB Bandwidth [kHz]	99% Occupied Bandwidth [kHz]
13.245	11.0469

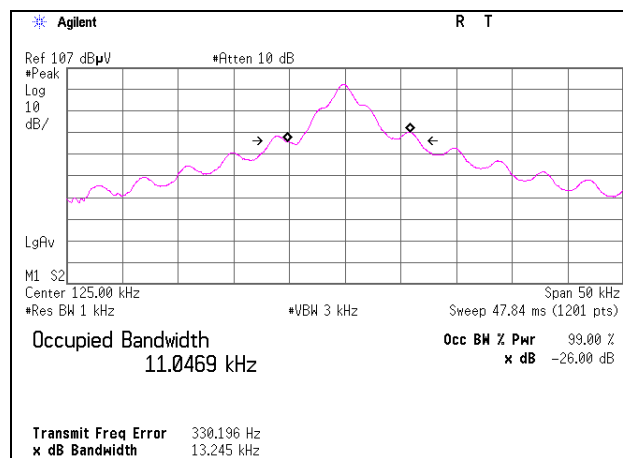

## **APPENDIX 2: Test instruments**

### **EMI test equipment**

<b>Control No.</b>	<b>Instrument</b>	<b>Manufacturer</b>	<b>Model No</b>	<b>Serial No</b>	<b>Test Item</b>	<b>Calibration Date * Interval(month)</b>
MAEC-02	Semi Anechoic Chamber(NSA)	TDK	Semi Anechoic Chamber 3m	DA-06902	RE	2017/08/31 * 12
MOS-22	Thermo-Hygrometer	Custom	CTH-201	0003	RE	2016/12/13 * 12
MJM-14	Measure	KOMELON	KMC-36	-	RE	-
COTS-MEMI	EMI measurement program	TSJ	TEPTO-DV	-	RE	-
MSA-04	Spectrum Analyzer	Agilent	E4448A	US44300523	RE	2016/11/10 * 12
MTR-03	Test Receiver	Rohde & Schwarz	ESCI	100300	RE	2017/08/21 * 12
MBA-08	Biconical Antenna	Schwarzbeck	VHA9103B	08031	RE	2017/09/13 * 12
MLA-21	Logperiodic Antenna(200-1000MHz)	Schwarzbeck	VUSLP9111B	911B-190	RE	2017/01/05 * 12
MCC-12	Coaxial Cable	Fujikura/Agilent	-	-	RE	2017/02/24 * 12
MAT-07	Attenuator(6dB)	Weinschel Corp	2	BK7970	RE	2016/11/28 * 12
MPA-09	Pre Amplifier	Agilent	8447D	2944A10845	RE	2017/09/27 * 12
MMM-01	Digital Tester	Fluke	FLUKE 26-3	78030611	RE	2017/08/07 * 12
MLPA-03	Loop Antenna	UL Japan	-	-	RE	Pre Check
MLPA-01	Loop Antenna	Rohde & Schwarz	HFH2-Z2	100017	RE	2017/10/11 * 12
MCC-13	Coaxial Cable	Fujikura	3D-2W(12m)/ 5D-2W(5m)/ 5D-2W(0.8m)/ 5D-2W(1m)	-	RE	2017/02/24 * 12
MCC-143	Coaxial Cable	UL Japan	-	-	RE	2017/06/12 * 12
MPA-14	Pre Amplifier	SONOMA INSTRUMENT	310	260833	RE	2017/03/27 * 12

**The expiration date of the calibration is the end of the expired month.**

**All equipment is calibrated with valid calibrations. Each measurement data is traceable to the national or international standards.**

**As for some calibrations performed after the tested dates, those test equipment have been controlled by means of an unbroken chains of calibrations.**

**Test Item:**

**RE: Spurious emission**

**UL Japan, Inc.**

**Ise EMC Lab.**

4383-326 Asama-cho, Ise-shi, Mie-ken 516-0021 JAPAN

Telephone : +81 596 24 8999

Facsimile : +81 596 24 8124