



# RADIO TEST REPORT

Report No.: STS2206043W02

Issued for

Orbit Irrigation Products Inc

845 Overland Road, North Salt Lake, Utah 84054 USA

|                       |                           |
|-----------------------|---------------------------|
| <b>Product Name:</b>  | Smart Hose Watering Timer |
| <b>Brand Name:</b>    | B-hyve/Orbit              |
| <b>Model Name:</b>    | HT25G2                    |
| <b>Series Model:</b>  | N/A                       |
| <b>FCC ID:</b>        | ML6HT25G2                 |
| <b>Test Standard:</b> | FCC Part 15.247           |

Any reproduction of this document must be done in full. No single part of this document may be reproduced without permission from STS, all test data presented in this report is only applicable to presented test sample.





### TEST RESULT CERTIFICATION

**Applicant's Name**..... : Orbit Irrigation Products Inc  
 Address ..... : 845 Overland Road, North Salt Lake, Utah 84054 USA  
**Manufacturer's Name** ..... : Pro-Mark, LLC  
 Address ..... : 845 Overland Road, North Salt Lake, Utah 84054 USA

#### Product Description

Product Name ..... : Smart Hose Watering Timer  
 Brand Name ..... : B-hyve/Orbit  
 Model Name ..... : HT25G2  
 Series Model ..... : N/A

**Test Standards**..... : FCC Part15.247  
 Test Procedure ..... : ANSI C63.10-2013

This device described above has been tested by STS, the test results show that the equipment under test (EUT) is in compliance with the FCC requirements. And it is applicable only to the tested sample identified in the report.

This report shall not be reproduced except in full, without the written approval of STS, this document may be altered or revised by STS, personal only, and shall be noted in the revision of the document.

**Date of Test**..... :  
 Date of receipt of test item ..... : 08 June 2022  
 Date (s) of performance of tests..... : 08 June 2022 ~ 25 June 2022  
 Date of Issue..... : 25 June 2022  
 Test Result..... : **Pass**

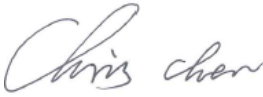
Testing Engineer :   
 \_\_\_\_\_  
 (Chris Chen)

Technical Manager :   
 \_\_\_\_\_  
 (Sean she)

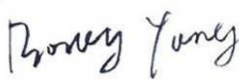
Authorized Signatory :   
 \_\_\_\_\_  
 (Bovey Yang)





## Table of Contents

|  |           |
|--|-----------|
| <b>1. SUMMARY OF TEST RESULTS</b>                            | <b>6</b>  |
| 1.1 TEST FACTORY   | 7         |
| 1.2 MEASUREMENT UNCERTAINTY                                  | 7         |
| <b>2. GENERAL INFORMATION</b>                                | <b>8</b>  |
| 2.1 GENERAL DESCRIPTION OF THE EUT                           | 8         |
| 2.2 DESCRIPTION OF THE TEST MODES                            | 10        |
| 2.3 TEST SOFTWARE AND POWER LEVEL                            | 10        |
| 2.4 BLOCK DIAGRAM SHOWING THE CONFIGURATION OF SYSTEM TESTED | 10        |
| 2.5 DESCRIPTION OF NECESSARY ACCESSORIES AND SUPPORT UNITS   | 11        |
| 2.6 EQUIPMENTS LIST  | 12        |
| <b>3. EMC EMISSION TEST</b>                                  | <b>14</b> |
| 3.1 CONDUCTED EMISSION MEASUREMENT                           | 14        |
| 3.2 TEST PROCEDURE   | 15        |
| 3.3 TEST SETUP   | 15        |
| 3.4 EUT OPERATING CONDITIONS                                 | 15        |
| 3.5 TEST RESULTS   | 16        |
| <b>4. RADIATED EMISSION MEASUREMENT</b>                      | <b>17</b> |
| 4.1 RADIATED EMISSION LIMITS                                 | 17        |
| 4.2 TEST PROCEDURE   | 19        |
| 4.3 TEST SETUP   | 20        |
| 4.4 EUT OPERATING CONDITIONS                                 | 20        |
| 4.5 FIELD STRENGTH CALCULATION                               | 21        |
| 4.6 TEST RESULTS   | 22        |
| <b>5. CONDUCTED SPURIOUS &amp; BAND EDGE EMISSION</b>        | <b>29</b> |
| 5.1 LIMIT  | 29        |
| 5.2 TEST PROCEDURE   | 29        |
| 5.3 TEST SETUP   | 29        |
| 5.4 EUT OPERATION CONDITIONS                                 | 29        |
| 5.5 TEST RESULTS   | 29        |
| <b>6. POWER SPECTRAL DENSITY TEST</b>                        | <b>30</b> |
| 6.1 LIMIT  | 30        |
| 6.2 TEST PROCEDURE   | 30        |
| 6.3 TEST SETUP   | 30        |



## Table of Contents

|  |           |
|--|-----------|
| 6.4 EUT OPERATION CONDITIONS                     | 30        |
| 6.5 TEST RESULTS                                 | 30        |
| <b>7. BANDWIDTH TEST</b>                         | <b>31</b> |
| 7.1 LIMIT  | 31        |
| 7.2 TEST PROCEDURE                               | 31        |
| 7.3 TEST SETUP                                   | 31        |
| 7.4 EUT OPERATION CONDITIONS                     | 31        |
| 7.5 TEST RESULTS                                 | 31        |
| <b>8. PEAK OUTPUT POWER TEST</b>                 | <b>32</b> |
| 8.1 LIMIT  | 32        |
| 8.2 TEST PROCEDURE                               | 32        |
| 8.3 TEST SETUP                                   | 33        |
| 8.4 EUT OPERATION CONDITIONS                     | 33        |
| 8.5 TEST RESULTS                                 | 33        |
| <b>9. ANTENNA REQUIREMENT</b>                    | <b>34</b> |
| 9.1 STANDARD REQUIREMENT                         | 34        |
| 9.2 EUT ANTENNA                                  | 34        |
| <b>APPENDIX 1-TEST DATA</b>                      | <b>35</b> |
| <b>1. DUTY CYCLE</b>                             | <b>35</b> |
| <b>2. MAXIMUM AVERAGE CONDUCTED OUTPUT POWER</b> | <b>38</b> |
| <b>3. MAXIMUM PEAK CONDUCTED OUTPUT POWER</b>    | <b>41</b> |
| <b>4. -6DB BANDWIDTH</b>                         | <b>44</b> |
| <b>5. MAXIMUM POWER SPECTRAL DENSITY LEVEL</b>   | <b>47</b> |
| <b>6. BAND EDGE</b>                              | <b>50</b> |
| <b>7. CONDUCTED RF SPURIOUS EMISSION</b>         | <b>53</b> |
| <b>APPENDIX 2- EUT TEST PHOTO</b>                | <b>57</b> |



**Revision History**

| Rev. | Issue Date   | Report NO.    | Effect Page | Contents      |
|------|--------------|---------------|-------------|---------------|
| 00   | 25 June 2022 | STS2206043W02 | ALL         | Initial Issue |
|      |              |               |             |               |





## 1. SUMMARY OF TEST RESULTS

Test procedures according to the technical standards:  
KDB 558074 D01 15.247 Meas Guidance v05r02.

| FCC Part 15.247, Subpart C        |   |          |        |
|-----------------------------------|---|----------|--------|
| Standard Section                  | Test Item                               | Judgment | Remark |
| 15.207                            | Conducted Emission                      | N/A      | --     |
| 15.247 (a)(2)                     | 6dB Bandwidth                           | PASS     | --     |
| 15.247 (b)(3)                     | Output Power                            | PASS     | --     |
| 15.209                            | Radiated Spurious Emission              | PASS     | --     |
| 15.247 (d)                        | Conducted Spurious & Band Edge Emission | PASS     | --     |
| 15.247 (e)                        | Power Spectral Density                  | PASS     | --     |
| 15.205                            | Restricted bands of operation           | PASS     | --     |
| Part 15.247(d)/<br>Part 15.209(a) | Band Edge Emission                      | PASS     | --     |
| 15.203                            | Antenna Requirement                     | PASS     | --     |

### NOTE:

- (1) 'N/A' denotes test is not applicable in this Test Report.
- (2) All tests are according to ANSI C63.10-2013.



### 1.1 TEST FACTORY

SHENZHEN STS TEST SERVICES CO., LTD

Add. : A 1/F, Building B, Zhuoke Science Park, No.190 Chongqing Road, HepingShequ, Fuyong Sub-District, Bao'an District, Shenzhen, Guang Dong, China

FCC test Firm Registration Number: 625569

IC test Firm Registration Number: 12108A

A2LA Certificate No.: 4338.01

### 1.2 MEASUREMENT UNCERTAINTY

The reported uncertainty of measurement  $y \pm U$ , where expanded uncertainty  $U$  is based on a standard uncertainty multiplied by a coverage factor of  $k=2$ , providing a level of confidence of approximately **95** %.

| No. | Item                             | Uncertainty          |
|-----|----------------------------------|----------------------|
| 1   | RF output power, conducted       | $\pm 0.87\text{dB}$  |
| 2   | Unwanted Emissions, conducted    | $\pm 2.895\text{dB}$ |
| 3   | All emissions, radiated 9K-30MHz | $\pm 3.80\text{dB}$  |
| 4   | All emissions, radiated 30M-1GHz | $\pm 4.09\text{dB}$  |
| 5   | All emissions, radiated 1G-6GHz  | $\pm 4.92\text{dB}$  |
| 6   | All emissions, radiated >6G      | $\pm 5.49\text{dB}$  |
| 7   | Conducted Emission (9KHz-30MHz)  | $\pm 2.73\text{dB}$  |



## 2. GENERAL INFORMATION

### 2.1 GENERAL DESCRIPTION OF THE EUT

|                         |  |                             |
|-------------------------|--|-----------------------------|
| Product Name            | Smart Hose Watering Timer              |                             |
| Trade Name              | B-hyve/Orbit                           |                             |
| Model Name              | HT25G2                                 |                             |
| Series Model            | N/A                                    |                             |
| Model Difference        | N/A                                    |                             |
| Product Description     | The EUT is a Smart Hose Watering Timer |                             |
|                         | Operation Frequency:                   | 2402~2480 MHz               |
|                         | Modulation Type:                       | GFSK                        |
|                         | Radio Technology:                      | BLE                         |
|                         | Bluetooth Configuration:               | LE (Support 1M PHY)         |
|                         | Number Of Channel:                     | 40                          |
|                         | Antenna Designation:                   | Please refer to the Note 3. |
|                         | Antenna Gain (dBi)                     | 0dBi                        |
| Channel List            | Please refer to the Note 2.            |                             |
| Rating                  | Input: 3VDC                            |                             |
| Battery                 | Rated Voltage: 2x AA, Not Included     |                             |
| Hardware version number | 001                                    |                             |
| Software version number | 0039                                   |                             |
| Connecting I/O Port(s)  | Please refer to the Note 1.            |                             |

Note:

1. For a more detailed features description, please refer to the manufacturer's specifications or the User Manual.





2.

| Channel List |                 |         |                 |         |                 |         |                 |
|--------------|-----------------|---------|-----------------|---------|-----------------|---------|-----------------|
| Channel      | Frequency (MHz) | Channel | Frequency (MHz) | Channel | Frequency (MHz) | Channel | Frequency (MHz) |
| 00           | 2402            | 10      | 2422            | 20      | 2442            | 30      | 2462            |
| 01           | 2404            | 11      | 2424            | 21      | 2444            | 31      | 2464            |
| 02           | 2406            | 12      | 2426            | 22      | 2446            | 32      | 2466            |
| 03           | 2408            | 13      | 2428            | 23      | 2448            | 33      | 2468            |
| 04           | 2410            | 14      | 2430            | 24      | 2450            | 34      | 2470            |
| 05           | 2412            | 15      | 2432            | 25      | 2452            | 35      | 2472            |
| 06           | 2414            | 16      | 2434            | 26      | 2454            | 36      | 2474            |
| 07           | 2416            | 17      | 2436            | 27      | 2456            | 37      | 2476            |
| 08           | 2418            | 18      | 2438            | 28      | 2458            | 38      | 2478            |
| 09           | 2420            | 19      | 2440            | 29      | 2460            | 39      | 2480            |

3.

Table for Filed Antenna

| Ant. | Brand        | Model Name | Antenna Type | Connector | Gain (dBi) | NOTE    |
|------|--------------|------------|--------------|-----------|------------|---------|
| 1    | B-hyve/Orbit | HT25G2     | PCB          | N/A       | 0dBi       | BLE ANT |

Note: The antenna information refer the manufacturer provide report, applicable only to the tested sample identified in the report. Due to the incorrect antenna information, a series of problems such as the accuracy of the test results will be borne by the customer.



## 2.2 DESCRIPTION OF THE TEST MODES

For conducted test items and radiated spurious emissions  
Each of these EUT operation mode(s) or test configuration mode(s) mentioned below was evaluated respectively.

| Worst Mode | Description      | Data/Modulation |
|------------|------------------|-----------------|
| Mode 1     | TX CH00(2402MHz) | 1 Mbps/GFSK     |
| Mode 2     | TX CH19(2440MHz) | 1 Mbps/GFSK     |
| Mode 3     | TX CH39(2480MHz) | 1 Mbps/GFSK     |

Note:

(1) We tested for all available U.S. voltage and frequencies (For 120V, 50/60Hz and 240V, 50/60Hz) for which the device is capable of operation, and the worst case of 120V/ 60Hz is shown in the report.

(2) The battery is fully-charged during the radiated and RF conducted test.

## 2.3 TEST SOFTWARE AND POWER LEVEL

During testing channel & power controlling software provided by the customer was used to control the operating channel as well as the output power level.

| RF Function | Type | Mode Or Modulation type | ANT Gain(dBi) | Power Class | Software For Testing |
|-------------|------|-------------------------|---------------|-------------|----------------------|
| BLE         | BLE  | GFSK                    | 0             | 4           | commGui              |

## 2.4 BLOCK DIAGRAM SHOWING THE CONFIGURATION OF SYSTEM TESTED

Radiated Spurious Emission Test

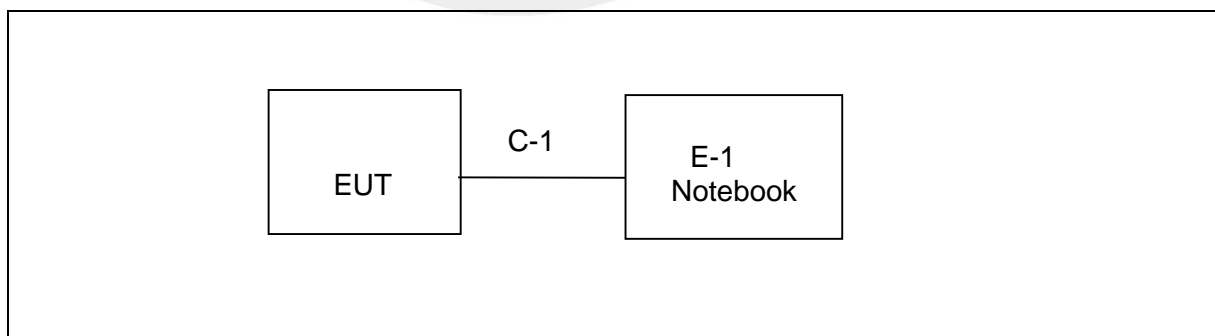



## 2.5 DESCRIPTION OF NECESSARY ACCESSORIES AND SUPPORT UNITS

The EUT has been tested as an independent unit together with other necessary accessories or support units. The following support units or accessories were used to form a representative test configuration during the tests.

### Necessary accessories

| Item | Equipment | Mfr/Brand | Model/Type No. | Length | Note |
|------|-----------|-----------|----------------|--------|------|
| N/A  | N/A       | N/A       | N/A            | N/A    | N/A  |
|      |           |           |                |        |      |
|      |           |           |                |        |      |
|      |           |           |                |        |      |

### Support units

| Item | Equipment | Mfr/Brand | Model/Type No. | Length | Note |
|------|-----------|-----------|----------------|--------|------|
| E-1  | Notebook  | LENOVO    | ThinkPad E470  | N/A    | N/A  |
| C-1  | USB Cable | N/A       | N/A            | 150cm  | NO   |
|      |           |           |                |        |      |
|      |           |           |                |        |      |

#### Note:

- (1) For detachable type I/O cable should be specified the length in cm in 『Length』 column.
- (2) "YES" is means "with core"; "NO" is means "without core".



## 2.6 EQUIPMENTS LIST

## Radiation Test equipment

| Kind of Equipment                | Manufacturer | Type No.                   | Serial No.   | Last calibration | Calibrated until |
|----------------------------------|--------------|----------------------------|--------------|------------------|------------------|
| Test Receiver                    | R&S          | ESCI                       | 101427       | 2021.09.30       | 2022.09.29       |
| Signal Analyzer                  | R&S          | FSV 40-N                   | 101823       | 2021.09.30       | 2022.09.29       |
| Active loop Antenna              | ZHINAN       | ZN30900C                   | 16035        | 2021.04.11       | 2023.04.10       |
| Bilog Antenna                    | TESEQ        | CBL6111D                   | 34678        | 2020.10.12       | 2022.10.11       |
| Horn Antenna                     | SCHWARZBECK  | BBHA 9120D                 | 02014        | 2021.10.11       | 2023.10.10       |
| SHF-EHF Horn Antenna (18G-40GHz) | A-INFO       | LB-180400-KF               | J211020657   | 2020.10.12       | 2022.10.11       |
| Pre-Amplifier (0.1M-3GHz)        | EM           | EM330                      | 060665       | 2021.10.08       | 2022.10.07       |
| Pre-Amplifier (1G-18GHz)         | SKET         | LNPA-01018G-45             | SK2018080901 | 2021.09.30       | 2022.09.29       |
| Pre-Amplifier (18G-40GHz)        | SKET         | LNPA-1840-50               | SK2018101801 | 2021.09.28       | 2022.09.27       |
| Temperature & Humidity           | HH660        | Mieo                       | N/A          | 2021.10.09       | 2022.10.08       |
| Turn table                       | EM           | SC100_1                    | 60531        | N/A              | N/A              |
| Antenna mast                     | EM           | SC100                      | N/A          | N/A              | N/A              |
| Test SW                          | FARAD        | EZ-EMC(Ver.STSLAB-03A1 RE) |              |                  |                  |

## Conduction Test equipment

| Kind of Equipment      | Manufacturer | Type No.                   | Serial No. | Last calibration | Calibrated until |
|------------------------|--------------|----------------------------|------------|------------------|------------------|
| Test Receiver          | R&S          | ESCI                       | 101427     | 2021.09.30       | 2022.09.29       |
| LISN                   | R&S          | ENV216                     | 101242     | 2021.09.30       | 2022.09.29       |
| LISN                   | EMCO         | 3810/2NM                   | 23625      | 2021.09.30       | 2022.09.29       |
| Temperature & Humidity | HH660        | Mieo                       | N/A        | 2021.10.09       | 2022.10.08       |
| Test SW                | FARAD        | EZ-EMC(Ver.STSLAB-03A1 CE) |            |                  |                  |



## RF Connected Test

| Kind of Equipment      | Manufacturer | Type No.                   | Serial No. | Last calibration | Calibrated until |
|------------------------|--------------|----------------------------|------------|------------------|------------------|
| Power Sensor           | Keysight     | U2021XA                    | MY55520005 | 2021.09.30       | 2022.09.29       |
|                        |              |                            | MY55520006 | 2021.09.30       | 2022.09.29       |
|                        |              |                            | MY56120038 | 2021.09.30       | 2022.09.29       |
|                        |              |                            | MY56280002 | 2021.09.30       | 2022.09.29       |
| Signal Analyzer        | Agilent      | N9020A                     | MY51110105 | 2022.03.01       | 2023.02.28       |
| Temperature & Humidity | HH660        | Mieo                       | N/A        | 2021.10.09       | 2022.10.08       |
| Test SW                | FARAD        | EZ-EMC(Ver.STSLAB-03A1 RE) |            |                  |                  |





### 3. EMC EMISSION TEST

#### 3.1 CONDUCTED EMISSION MEASUREMENT

##### 3.1.1 POWER LINE CONDUCTED EMISSION LIMITS

The radio frequency voltage that is conducted back onto the AC power line on any frequency or frequencies, within the band 150 kHz to 30 MHz, shall not exceed the limits in the following table.

| FREQUENCY (MHz) | Conducted Emission limit (dBuV) |           |
|-----------------|---------------------------------|-----------|
|                 | Quasi-peak                      | Average   |
| 0.15 -0.5       | 66 - 56 *                       | 56 - 46 * |
| 0.50 -5.0       | 56.00                           | 46.00     |
| 5.0 -30.0       | 60.00                           | 50.00     |

Note:

- (1) The tighter limit applies at the band edges.
- (2) The limit of “ \* ” marked band means the limitation decreases linearly with the logarithm of the frequency in the range.

The following table is the setting of the receiver

| Receiver Parameters | Setting  |
|---------------------|----------|
| Attenuation         | 10 dB    |
| Start Frequency     | 0.15 MHz |
| Stop Frequency      | 30 MHz   |
| IF Bandwidth        | 9 kHz    |

### 3.2 TEST PROCEDURE

- a. The EUT is 0.8 m from the horizontal ground plane and 0.4 m from the vertical ground plane with EUT being connected to the power mains through a line impedance stabilization network (LISN). All other support equipments are powered from additional LISN(s). The LISN provides 50 Ohm/ 50uH of coupling impedance for the measuring instrument.
- b. Interconnecting cables that hang closer than 40 cm to the ground plane shall be folded back and forth in the center forming a bundle 30 to 40 cm long.
- c. I/O cables that are not connected to a peripheral shall be bundled in the center. The end of the cable may be terminated, if required, using the correct terminating impedance. The overall length shall not exceed 1 m.
- d. LISN is at least 80 cm from the nearest part of EUT chassis.
- e. For the actual test configuration, please refer to the related Item –EUT Test Photos.

### 3.3 TEST SETUP

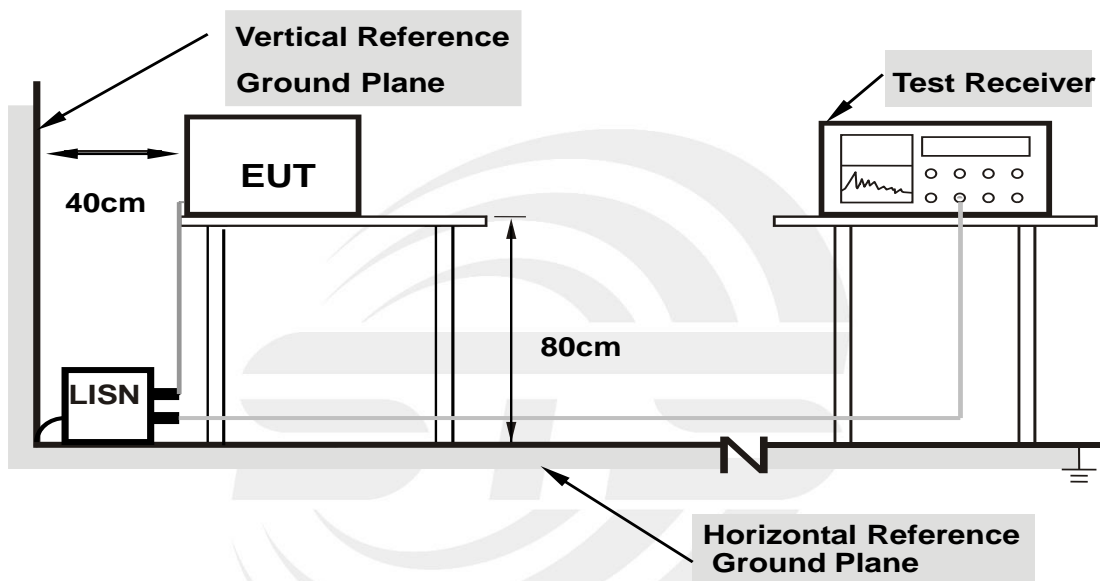

- Note: 1. Support units were connected to second LISN.**  
**2. Both of LISNs (AMN) are 80 cm from EUT and at least 80 cm from other units and other metal planes support units.**

### 3.4 EUT OPERATING CONDITIONS

The EUT was configured for testing in a typical fashion (as a customer would normally use it). The EUT has been programmed to continuously transmit during test. This operating condition was tested and used to collect the included data.



## 3.5 TEST RESULTS

|               |      |                    |       |
|---------------|------|--------------------|-------|
| Temperature:  | -(C) | Relative Humidity: | --%RH |
| Test Voltage: | N/A  | Phase:             | L/N   |
| Test Mode:    | N/A  |                    |       |

Note: EUT is only power by battery, So it is not applicable for this test.







#### 4. RADIATED EMISSION MEASUREMENT

##### 4.1 RADIATED EMISSION LIMITS

In any 100 kHz bandwidth outside the operating frequency band. In case the emission fall within the Restricted band specified on Part15.205(a)&209(a) limit in the table and according to ANSI C63.10-2013 below has to be followed.

LIMITS OF RADIATED EMISSION MEASUREMENT (Frequency Range 9kHz-1000MHz)

| Frequencies (MHz) | Field Strength (micorvolts/meter) | Measurement Distance (meters) |
|-------------------|-----------------------------------|-------------------------------|
| 0.009~0.490       | 2400/F(KHz)                       | 300                           |
| 0.490~1.705       | 24000/F(KHz)                      | 30                            |
| 1.705~30.0        | 30                                | 30                            |
| 30~88             | 100                               | 3                             |
| 88~216            | 150                               | 3                             |
| 216~960           | 200                               | 3                             |
| Above 960         | 500                               | 3                             |

LIMITS OF RADIATED EMISSION MEASUREMENT (Above 1000MHz)

| FREQUENCY (MHz) | (dBuV/m) (at 3M) |         |
|-----------------|------------------|---------|
|                 | PEAK             | AVERAGE |
| Above 1000      | 74               | 54      |

Notes:

- (1) The limit for radiated test was performed according to FCC PART 15C.
- (2) The tighter limit applies at the band edges.
- (3) Emission level (dBuV/m)=20log Emission level (uV/m).

##### LIMITS OF RESTRICTED FREQUENCY BANDS

| FREQUENCY (MHz)   | FREQUENCY (MHz)     | FREQUENCY (MHz) | FREQUENCY (GHz) |
|-------------------|---------------------|-----------------|-----------------|
| 0.090-0.110       | 16.42-16.423        | 399.9-410       | 4.5-5.15        |
| 0.495-0.505       | 16.69475-16.69525   | 608-614         | 5.35-5.46       |
| 2.1735-2.1905     | 16.80425-16.80475   | 960-1240        | 7.25-7.75       |
| 4.125-4.128       | 25.5-25.67          | 1300-1427       | 8.025-8.5       |
| 4.17725-4.17775   | 37.5-38.25          | 1435-1626.5     | 9.0-9.2         |
| 4.20725-4.20775   | 73-74.6             | 1645.5-1646.5   | 9.3-9.5         |
| 6.215-6.218       | 74.8-75.2           | 1660-1710       | 10.6-12.7       |
| 6.26775-6.26825   | 108-121.94          | 1718.8-1722.2   | 13.25-13.4      |
| 6.31175-6.31225   | 123-138             | 2200-2300       | 14.47-14.5      |
| 8.291-8.294       | 149.9-150.05        | 2310-2390       | 15.35-16.2      |
| 8.362-8.366       | 156.52475-156.52525 | 2483.5-2500     | 17.7-21.4       |
| 8.37625-8.38675   | 156.7-156.9         | 2690-2900       | 22.01-23.12     |
| 8.41425-8.41475   | 162.0125-167.17     | 3260-3267       | 23.6-24.0       |
| 12.29-12.293      | 167.72-173.2        | 3332-3339       | 31.2-31.8       |
| 12.51975-12.52025 | 240-285             | 3345.8-3358     | 36.43-36.5      |
| 12.57675-12.57725 | 322-335.4           | 3600-4400       | Above 38.6      |
| 13.36-13.41       |                     |                 |                 |



For Radiated Emission

| Spectrum Parameter                    | Setting   |
|---------------------------------------|---|
| Attenuation                           | Auto  |
| Detector                              | Peak/QP/AV  |
| Start Frequency                       | 9 KHz/150KHz(Peak/QP/AV)  |
| Stop Frequency                        | 150KHz/30MHz(Peak/QP/AV)  |
| RB / VB (emission in restricted band) | 200Hz (From 9kHz to 0.15MHz)/<br>9KHz (From 0.15MHz to 30MHz);<br>200Hz (From 9kHz to 0.15MHz)/<br>9KHz (From 0.15MHz to 30MHz) |

| Spectrum Parameter                    | Setting            |
|---------------------------------------|--------------------|
| Attenuation                           | Auto               |
| Detector                              | Peak/QP            |
| Start Frequency                       | 30 MHz(Peak/QP)    |
| Stop Frequency                        | 1000 MHz (Peak/QP) |
| RB / VB (emission in restricted band) | 120 KHz / 300 KHz  |

| Spectrum Parameter                    | Setting                                   |
|---------------------------------------|---|
| Attenuation                           | Auto                                      |
| Detector                              | Peak/AV                                   |
| Start Frequency                       | 1000 MHz(Peak/AV)                         |
| Stop Frequency                        | 10th carrier hamonic(Peak/AV)             |
| RB / VB (emission in restricted band) | 1 MHz / 3 MHz(Peak)<br>1 MHz/1/T MHz(AVG) |

For Restricted band

| Spectrum Parameter   | Setting  |
|----------------------|--|
| Detector             | Peak/AV  |
| Start/Stop Frequency | Lower Band Edge: 2310 to 2410 MHz<br>Upper Band Edge: 2475 to 2500 MHz |
| RB / VB              | 1 MHz / 3 MHz(Peak)<br>1 MHz/1/T MHz(AVG)                              |



| Receiver Parameter     | Setting                              |
|------------------------|--------------------------------------|
| Start ~ Stop Frequency | 9kHz~90kHz / RB 200Hz for PK & AV    |
| Start ~ Stop Frequency | 90kHz~110kHz / RB 200Hz for QP       |
| Start ~ Stop Frequency | 110kHz~490kHz / RB 200Hz for PK & AV |
| Start ~ Stop Frequency | 490kHz~30MHz / RB 9kHz for QP        |
| Start ~ Stop Frequency | 30MHz~1000MHz / RB 120kHz for QP     |

#### 4.2 TEST PROCEDURE

- a. The measuring distance at 3 m shall be used for measurements at frequency 0.009MHz up to 1GHz, and above 1GHz.
- b. The EUT was placed on the top of a rotating table 0.8 m (above 1GHz is 1.5 m) above the ground at a 3 m anechoic chamber test site. The table was rotated 360 degree to determine the position of the highest radiation.
- c. The height of the equipment shall be 0.8 m (above 1GHz is 1.5 m); the height of the test antenna shall vary between 1 m to 4 m. Horizontal and vertical polarization of the antenna are set to make the measurement.
- d. The initial step in collecting conducted emission data is a spectrum analyzer peak detector mode pre-scanning the measurement frequency range. Significant peaks are then marked and QuasiPeak detector mode will be re-measured.
- e. If the Peak Mode measured value is compliance with and lower than Quasi Peak Mode Limit, the EUT shall be deemed to meet QP Limits and no additional QP Mode measurement was performed.
- f. For the actual test configuration, please refer to the related Item –EUT Test Photos.

Note:

Both horizontal and vertical antenna polarities were tested and performed pretest to three orthogonal axis. The worst case emissions were reported.

### 4.3 TEST SETUP

#### (A) Radiated Emission Test-Up Frequency Below 30MHz

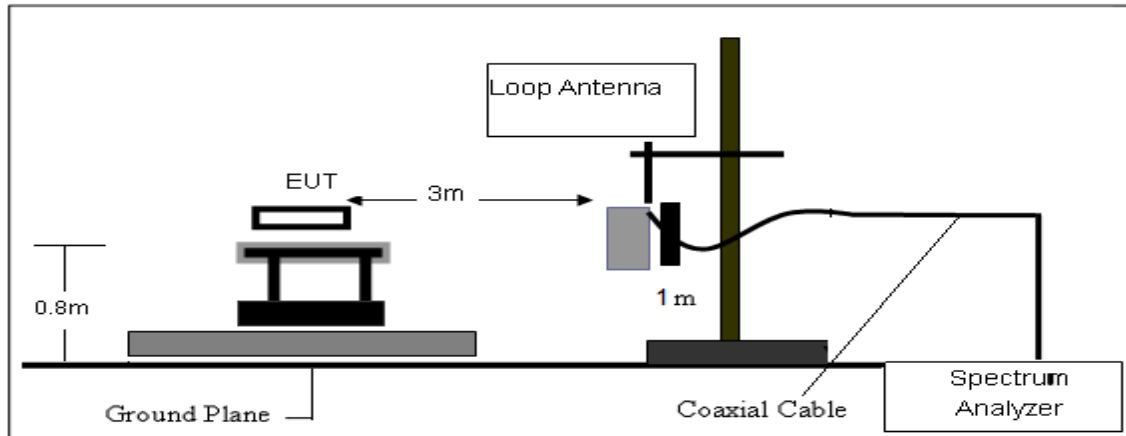

#### (B) Radiated Emission Test-Up Frequency 30MHz~1GHz

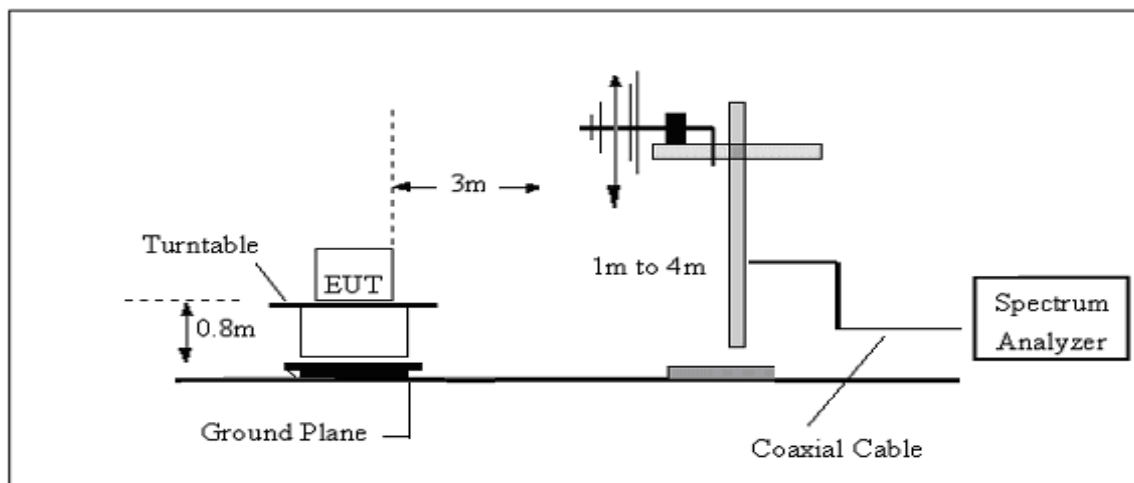

#### (C) Radiated Emission Test-Up Frequency Above 1GHz

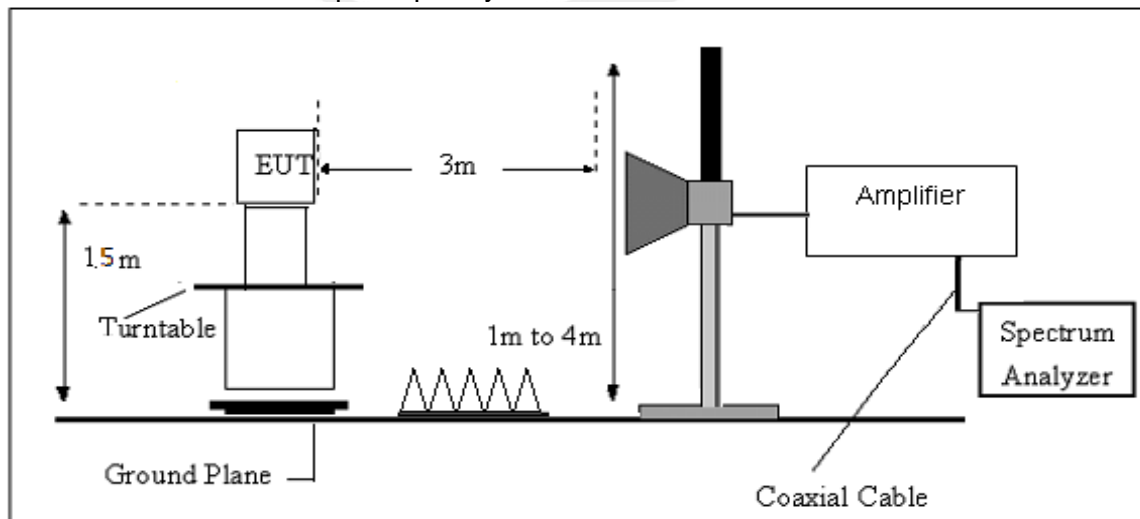

### 4.4 EUT OPERATING CONDITIONS

Please refer to section 3.4 of this report.



#### 4.5 FIELD STRENGTH CALCULATION

The field strength is calculated by adding the Antenna Factor and Cable Factor and subtracting the Amplifier Gain and Duty Cycle Correction Factor (if any) from the measured reading. The basic equation with a sample calculation is as follows:

$$FS = RA + AF + CL - AG$$

Where

FS = Field Strength

CL = Cable Attenuation Factor (Cable Loss)

RA = Reading Amplitude

AG = Amplifier Gain

AF = Antenna Factor

For example

| Frequency<br>(MHz) | FS<br>(dB $\mu$ V/m) | RA<br>(dB $\mu$ V/m) | AF<br>(dB) | CL<br>(dB) | AG<br>(dB) | Factor<br>(dB) |
|--------------------|----------------------|----------------------|------------|------------|------------|----------------|
| 300                | 40                   | 58.1                 | 12.2       | 1.6        | 31.9       | -18.1          |

$$\text{Factor} = \text{AF} + \text{CL} - \text{AG}$$





#### 4.6 TEST RESULTS

(Between 9KHz – 30 MHz)

|               |         |                    |       |
|---------------|---------|--------------------|-------|
| Temperature:  | 23.1(C) | Relative Humidity: | 60%RH |
| Test Voltage: | DC 3V   | Polarization:      | --    |
| Test Mode:    | TX Mode |                    |       |

| Freq.<br>(MHz) | Reading<br>(dBuV/m) | Limit<br>(dBuV/m) | Margin<br>(dB) | State<br>P/F |
|----------------|---------------------|-------------------|----------------|--------------|
| --             | --                  | --                | --             | PASS         |
| --             | --                  | --                | --             | PASS         |

**Note:**

The amplitude of spurious emissions which are attenuated by more than 20dB below the permissible value has no need to be reported.

Distance extrapolation factor =  $40 \log(\text{specific distance}/\text{test distance})(\text{dB})$ ;

Limit line = specific limits(dBuv) + distance extrapolation factor.

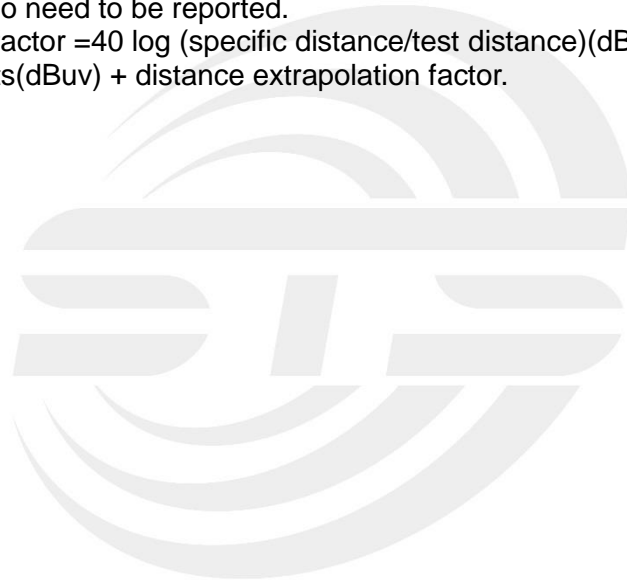



(30MHz -1000MHz)

|               |                                |                    |            |
|---------------|--------------------------------|--------------------|------------|
| Temperature:  | 23.1(C)                        | Relative Humidity: | 60%RH      |
| Test Voltage: | DC 3V                          | Phase:             | Horizontal |
| Test Mode:    | Mode 1/2/3 (Mode 2 worst mode) |                    |            |

| No. | Frequency (MHz) | Reading (dBUV) | Correct Factor(dB/m) | Result (dBUV/m) | Limit (dBUV/m) | Margin (dB) | Remark |
|-----|-----------------|----------------|----------------------|-----------------|----------------|-------------|--------|
| 1   | 94.9900         | 38.72          | -20.78               | 17.94           | 43.50          | -25.56      | peak   |
| 2   | 375.3200        | 30.98          | -12.37               | 18.61           | 46.00          | -27.39      | peak   |
| 3   | 617.8200        | 32.55          | -5.49                | 27.06           | 46.00          | -18.94      | peak   |
| 4   | 770.1100        | 30.88          | -2.33                | 28.55           | 46.00          | -17.45      | peak   |
| 5   | 867.1100        | 30.29          | -0.50                | 29.79           | 46.00          | -16.21      | peak   |
| 6   | 964.1100        | 32.55          | 1.86                 | 34.41           | 54.00          | -19.59      | peak   |

Remark:

- Margin = Result (Result =Reading + Factor )-Limit
- Factor= Antenna factor+Cable attenuation factor(cable loss)-Amplifier gain

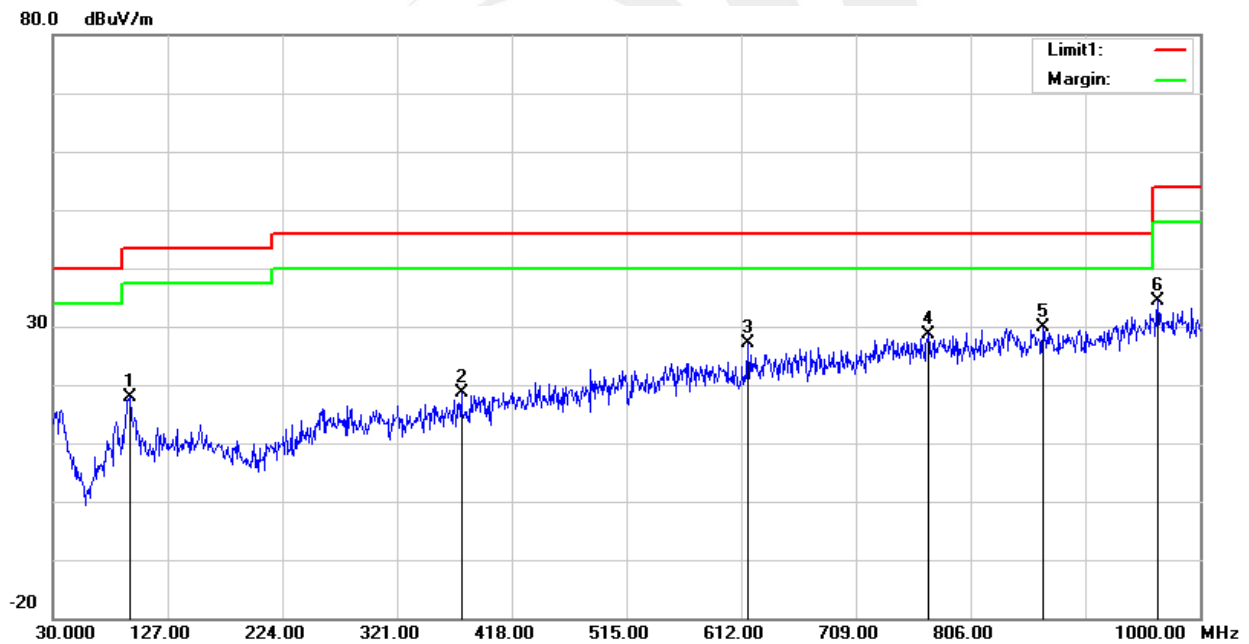



|               |                                |                    |          |
|---------------|--------------------------------|--------------------|----------|
| Temperature:  | 23.1(C)                        | Relative Humidity: | 60%RH    |
| Test Voltage: | DC 3V                          | Phase:             | Vertical |
| Test Mode:    | Mode 1/2/3 (Mode 2 worst mode) |                    |          |

| No. | Frequency (MHz) | Reading (dBuV) | Correct Factor(dB/m) | Result (dBuV/m) | Limit (dBuV/m) | Margin (dB) | Remark |
|-----|-----------------|----------------|----------------------|-----------------|----------------|-------------|--------|
| 1   | 35.8200         | 48.87          | -15.91               | 32.96           | 40.00          | -7.04       | peak   |
| 2   | 256.0100        | 35.22          | -15.24               | 19.98           | 46.00          | -26.02      | peak   |
| 3   | 488.8100        | 32.59          | -8.27                | 24.32           | 46.00          | -21.68      | peak   |
| 4   | 745.8600        | 32.72          | -2.14                | 30.58           | 46.00          | -15.42      | peak   |
| 5   | 834.1300        | 37.88          | -0.59                | 37.29           | 46.00          | -8.71       | peak   |
| 6   | 898.1500        | 39.40          | -0.49                | 38.91           | 46.00          | -7.09       | peak   |

Remark:

- Margin = Result (Result =Reading + Factor) –Limit
- Factor= Antenna factor+Cable attenuation factor(cable loss)-Amplifier gain

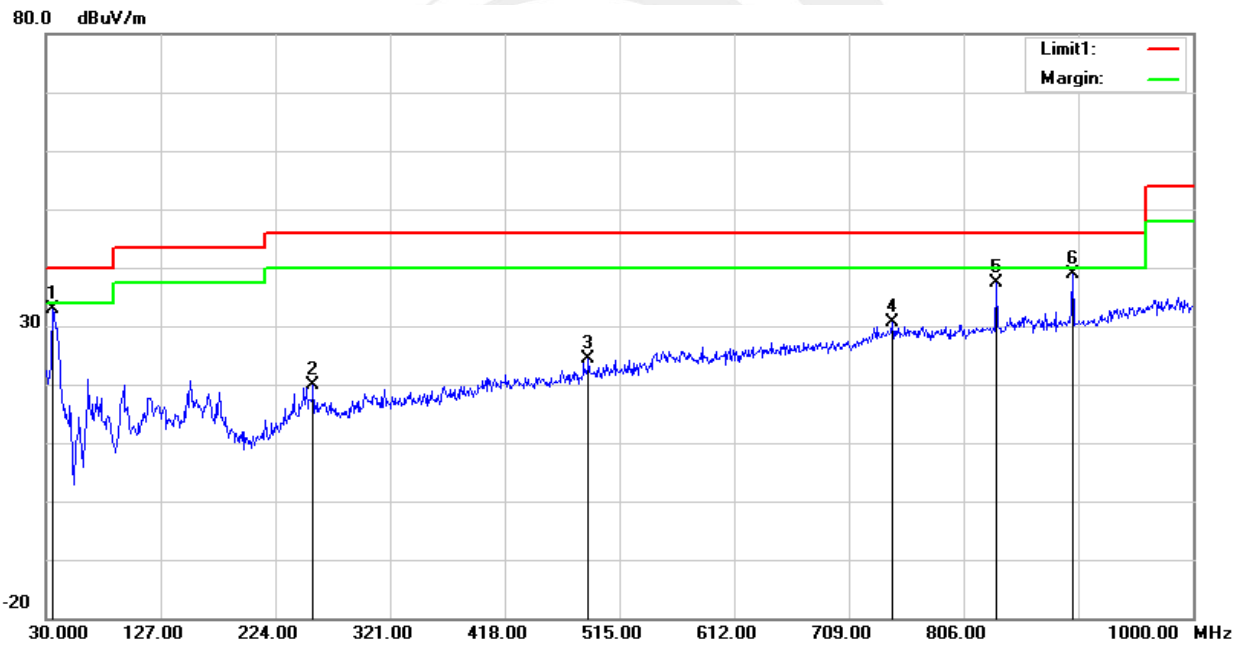





(1GHz-25GHz) Spurious emission Requirements

GFSK

| Frequency<br>(MHz)             | Meter Reading<br>(dBμV) | Amplifier<br>(dB) | Loss<br>(dB) | Antenna Factor<br>(dB/m) | Corrected Factor<br>(dB) | Emission Level<br>(dBμV/m) | Limits<br>(dBμV/m) | Margin<br>(dB) | Detector<br>Type | Comment    |
|--------------------------------|-------------------------|-------------------|--------------|--------------------------|--------------------------|----------------------------|--------------------|----------------|------------------|------------|
| Low Channel (GFSK/2402 MHz)    |                         |                   |              |                          |                          |                            |                    |                |                  |            |
| 3264.68                        | 61.19                   | 44.70             | 6.70         | 28.20                    | -9.80                    | 51.39                      | 74.00              | -22.61         | PK               | Vertical   |
| 3264.68                        | 51.13                   | 44.70             | 6.70         | 28.20                    | -9.80                    | 41.33                      | 54.00              | -12.67         | AV               | Vertical   |
| 3264.61                        | 62.02                   | 44.70             | 6.70         | 28.20                    | -9.80                    | 52.22                      | 74.00              | -21.78         | PK               | Horizontal |
| 3264.61                        | 50.01                   | 44.70             | 6.70         | 28.20                    | -9.80                    | 40.21                      | 54.00              | -13.79         | AV               | Horizontal |
| 4804.58                        | 58.48                   | 44.20             | 9.04         | 31.60                    | -3.56                    | 54.92                      | 74.00              | -19.08         | PK               | Vertical   |
| 4804.58                        | 50.05                   | 44.20             | 9.04         | 31.60                    | -3.56                    | 46.49                      | 54.00              | -7.51          | AV               | Vertical   |
| 4804.45                        | 59.21                   | 44.20             | 9.04         | 31.60                    | -3.56                    | 55.65                      | 74.00              | -18.35         | PK               | Horizontal |
| 4804.45                        | 49.56                   | 44.20             | 9.04         | 31.60                    | -3.56                    | 46.00                      | 54.00              | -8.00          | AV               | Horizontal |
| 5359.67                        | 48.24                   | 44.20             | 9.86         | 32.00                    | -2.34                    | 45.90                      | 74.00              | -28.10         | PK               | Vertical   |
| 5359.67                        | 38.97                   | 44.20             | 9.86         | 32.00                    | -2.34                    | 36.63                      | 54.00              | -17.37         | AV               | Vertical   |
| 5359.85                        | 48.08                   | 44.20             | 9.86         | 32.00                    | -2.34                    | 45.74                      | 74.00              | -28.26         | PK               | Horizontal |
| 5359.85                        | 39.37                   | 44.20             | 9.86         | 32.00                    | -2.34                    | 37.03                      | 54.00              | -16.97         | AV               | Horizontal |
| 7205.86                        | 53.89                   | 43.50             | 11.40        | 35.50                    | 3.40                     | 57.29                      | 74.00              | -16.71         | PK               | Vertical   |
| 7205.86                        | 43.93                   | 43.50             | 11.40        | 35.50                    | 3.40                     | 47.33                      | 54.00              | -6.67          | AV               | Vertical   |
| 7205.95                        | 53.53                   | 43.50             | 11.40        | 35.50                    | 3.40                     | 56.93                      | 74.00              | -17.07         | PK               | Horizontal |
| 7205.95                        | 44.81                   | 43.50             | 11.40        | 35.50                    | 3.40                     | 48.21                      | 54.00              | -5.79          | AV               | Horizontal |
| Middle Channel (GFSK/2440 MHz) |                         |                   |              |                          |                          |                            |                    |                |                  |            |
| 3263.02                        | 61.40                   | 44.70             | 6.70         | 28.20                    | -9.80                    | 51.60                      | 74.00              | -22.40         | PK               | Vertical   |
| 3263.02                        | 51.07                   | 44.70             | 6.70         | 28.20                    | -9.80                    | 41.27                      | 54.00              | -12.73         | AV               | Vertical   |
| 3262.93                        | 61.46                   | 44.70             | 6.70         | 28.20                    | -9.80                    | 51.66                      | 74.00              | -22.34         | PK               | Horizontal |
| 3262.93                        | 51.18                   | 44.70             | 6.70         | 28.20                    | -9.80                    | 41.38                      | 54.00              | -12.62         | AV               | Horizontal |
| 4879.96                        | 58.96                   | 44.20             | 9.04         | 31.60                    | -3.56                    | 55.40                      | 74.00              | -18.60         | PK               | Vertical   |
| 4879.96                        | 49.89                   | 44.20             | 9.04         | 31.60                    | -3.56                    | 46.33                      | 54.00              | -7.67          | AV               | Vertical   |
| 4880.15                        | 58.42                   | 44.20             | 9.04         | 31.60                    | -3.56                    | 54.86                      | 74.00              | -19.14         | PK               | Horizontal |
| 4880.15                        | 49.39                   | 44.20             | 9.04         | 31.60                    | -3.56                    | 45.83                      | 54.00              | -8.17          | AV               | Horizontal |
| 5357.08                        | 48.17                   | 44.20             | 9.86         | 32.00                    | -2.34                    | 45.83                      | 74.00              | -28.17         | PK               | Vertical   |
| 5357.08                        | 40.40                   | 44.20             | 9.86         | 32.00                    | -2.34                    | 38.06                      | 54.00              | -15.94         | AV               | Vertical   |
| 5357.39                        | 47.91                   | 44.20             | 9.86         | 32.00                    | -2.34                    | 45.57                      | 74.00              | -28.43         | PK               | Horizontal |
| 5357.17                        | 38.82                   | 44.20             | 9.86         | 32.00                    | -2.34                    | 36.48                      | 54.00              | -17.52         | AV               | Horizontal |
| 7320.85                        | 54.34                   | 43.50             | 11.40        | 35.50                    | 3.40                     | 57.74                      | 74.00              | -16.26         | PK               | Vertical   |
| 7320.85                        | 44.88                   | 43.50             | 11.40        | 35.50                    | 3.40                     | 48.28                      | 54.00              | -5.72          | AV               | Vertical   |
| 7320.27                        | 54.13                   | 43.50             | 11.40        | 35.50                    | 3.40                     | 57.53                      | 74.00              | -16.47         | PK               | Horizontal |
| 7320.27                        | 43.80                   | 43.50             | 11.40        | 35.50                    | 3.40                     | 47.20                      | 54.00              | -6.80          | AV               | Horizontal |



| High Channel (GFSK/2480 MHz) |       |       |       |       |       |       |       |        |    |            |
|------------------------------|-------|-------|-------|-------|-------|-------|-------|--------|----|------------|
| 3264.87                      | 62.03 | 44.70 | 6.70  | 28.20 | -9.80 | 52.23 | 74.00 | -21.77 | PK | Vertical   |
| 3264.87                      | 50.12 | 44.70 | 6.70  | 28.20 | -9.80 | 40.32 | 54.00 | -13.68 | AV | Vertical   |
| 3264.83                      | 62.11 | 44.70 | 6.70  | 28.20 | -9.80 | 52.31 | 74.00 | -21.69 | PK | Horizontal |
| 3264.83                      | 50.31 | 44.70 | 6.70  | 28.20 | -9.80 | 40.51 | 54.00 | -13.49 | AV | Horizontal |
| 4960.40                      | 59.29 | 44.20 | 9.04  | 31.60 | -3.56 | 55.73 | 74.00 | -18.27 | PK | Vertical   |
| 4960.40                      | 50.00 | 44.20 | 9.04  | 31.60 | -3.56 | 46.44 | 54.00 | -7.56  | AV | Vertical   |
| 4960.55                      | 58.46 | 44.20 | 9.04  | 31.60 | -3.56 | 54.90 | 74.00 | -19.10 | PK | Horizontal |
| 4960.55                      | 50.21 | 44.20 | 9.04  | 31.60 | -3.56 | 46.65 | 54.00 | -7.35  | AV | Horizontal |
| 5359.83                      | 49.01 | 44.20 | 9.86  | 32.00 | -2.34 | 46.67 | 74.00 | -27.33 | PK | Vertical   |
| 5359.83                      | 39.37 | 44.20 | 9.86  | 32.00 | -2.34 | 37.03 | 54.00 | -16.97 | AV | Vertical   |
| 5359.72                      | 48.38 | 44.20 | 9.86  | 32.00 | -2.34 | 46.04 | 74.00 | -27.96 | PK | Horizontal |
| 5359.72                      | 38.98 | 44.20 | 9.86  | 32.00 | -2.34 | 36.64 | 54.00 | -17.36 | AV | Horizontal |
| 7439.93                      | 54.36 | 43.50 | 11.40 | 35.50 | 3.40  | 57.76 | 74.00 | -16.24 | PK | Vertical   |
| 7439.93                      | 44.86 | 43.50 | 11.40 | 35.50 | 3.40  | 48.26 | 54.00 | -5.74  | AV | Vertical   |
| 7439.69                      | 54.09 | 43.50 | 11.40 | 35.50 | 3.40  | 57.49 | 74.00 | -16.51 | PK | Horizontal |
| 7439.69                      | 44.35 | 43.50 | 11.40 | 35.50 | 3.40  | 47.75 | 54.00 | -6.25  | AV | Horizontal |

Note:

1) Factor = Antenna Factor + Cable Loss – Pre-amplifier.

Emission Level = Reading + Factor

2) The frequency emission of peak points that did not show above the forms are at least 20dB below the limit, the frequency emission is mainly from the environment noise.



4.6 TEST RESULTS (Restricted Bands Requirements)

**GFSK-Low**  
Horizontal

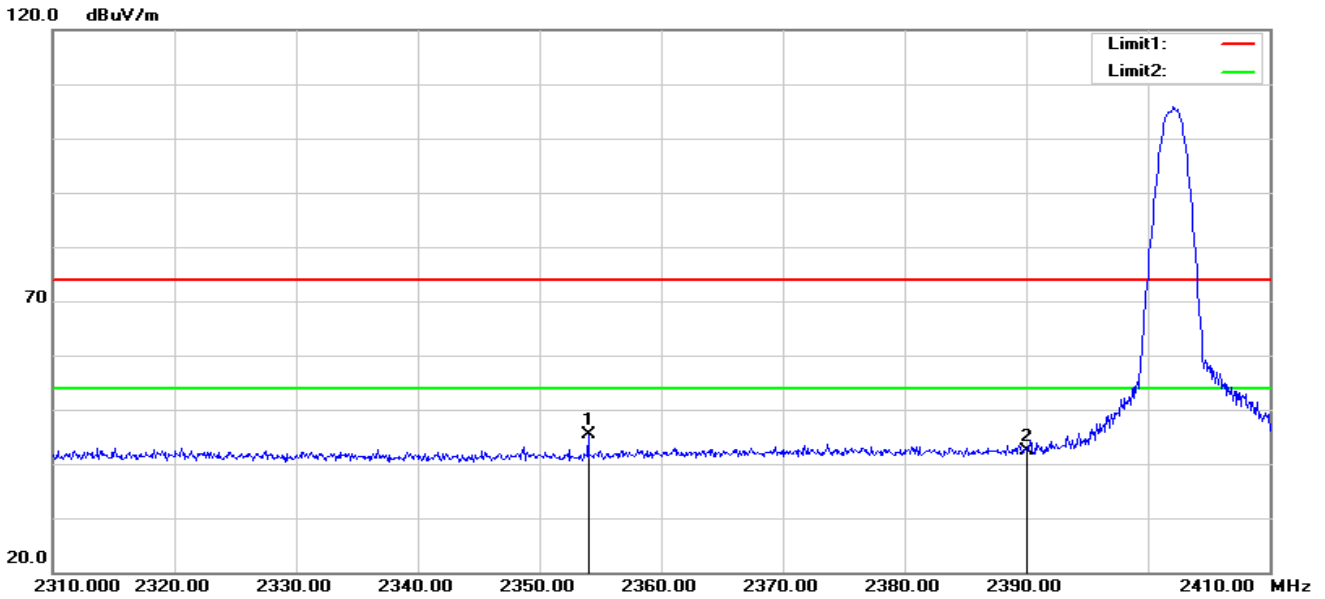

| No. | Frequency (MHz) | Reading (dBuV) | Correct Factor(dB/m) | Result (dBuV/m) | Limit (dBuV/m) | Margin (dB) | Remark |
|-----|-----------------|----------------|----------------------|-----------------|----------------|-------------|--------|
| 1   | 2354.000        | 41.48          | 3.80                 | 45.28           | 74.00          | -28.72      | peak   |
| 2   | 2390.000        | 38.04          | 4.34                 | 42.38           | 74.00          | -31.62      | peak   |

Vertical

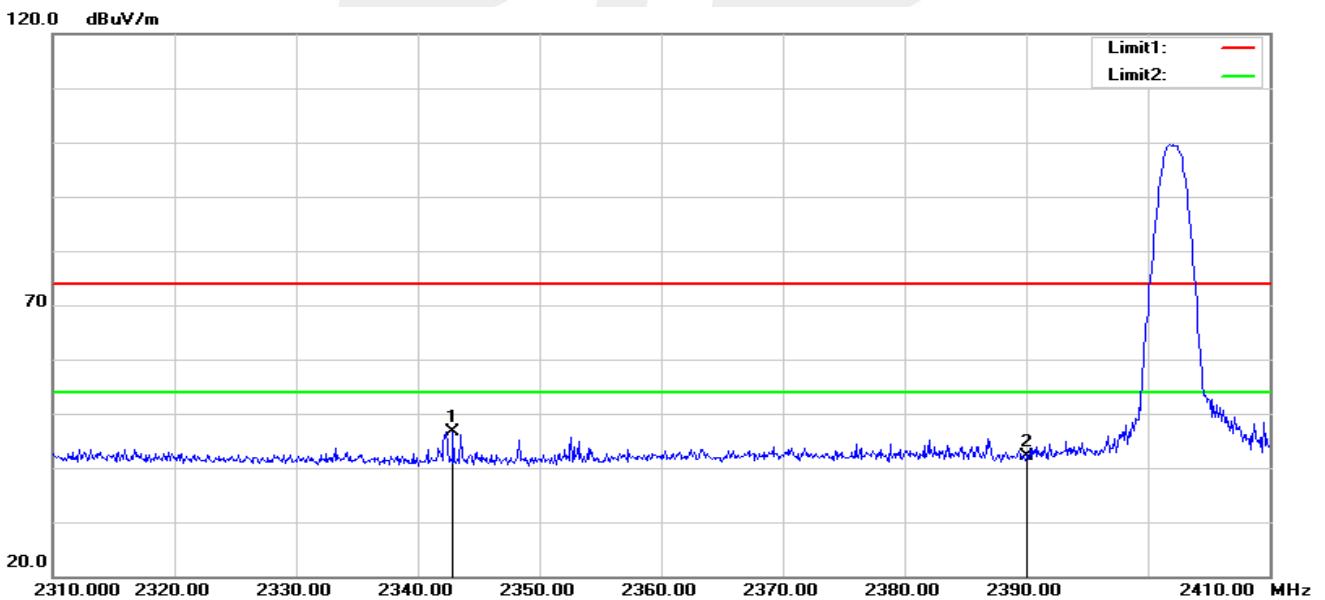

| No. | Frequency (MHz) | Reading (dBuV) | Correct Factor(dB/m) | Result (dBuV/m) | Limit (dBuV/m) | Margin (dB) | Remark |
|-----|-----------------|----------------|----------------------|-----------------|----------------|-------------|--------|
| 1   | 2342.900        | 43.01          | 3.71                 | 46.72           | 74.00          | -27.28      | peak   |
| 2   | 2390.000        | 37.74          | 4.34                 | 42.08           | 74.00          | -31.92      | peak   |



**GFSK-High**  
Horizontal

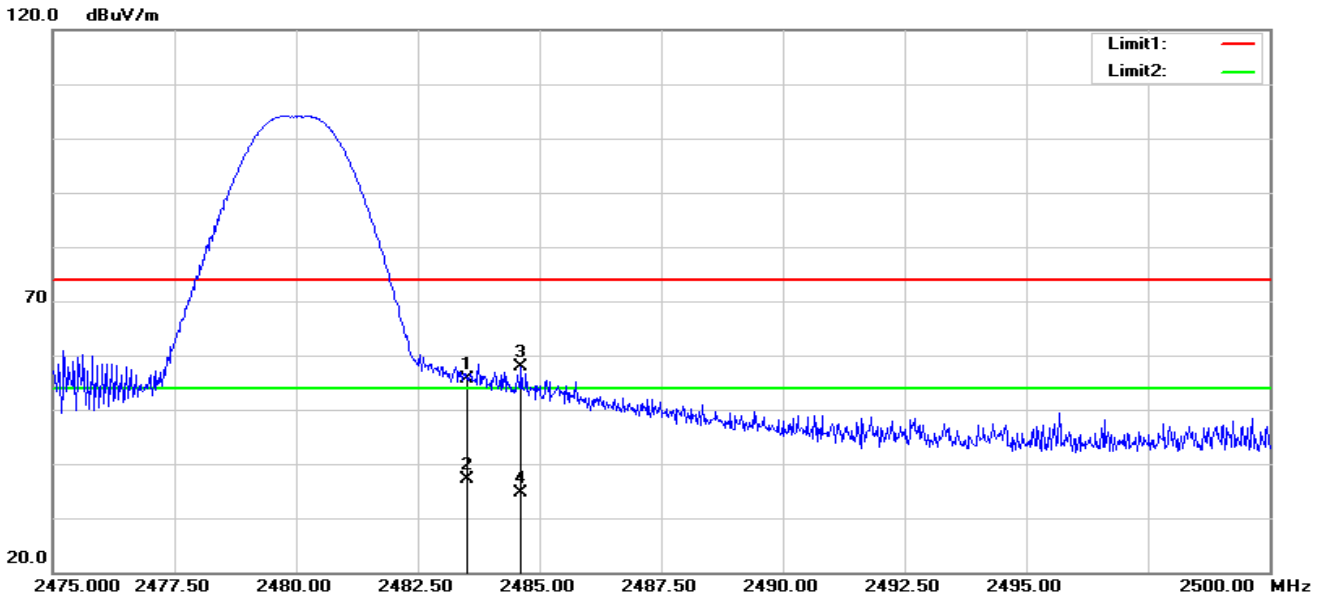

| No. | Frequency (MHz) | Reading (dBuV) | Correct Factor(dB/m) | Result (dBuV/m) | Limit (dBuV/m) | Margin (dB) | Remark |
|-----|-----------------|----------------|----------------------|-----------------|----------------|-------------|--------|
| 1   | 2483.500        | 51.11          | 4.60                 | 55.71           | 74.00          | -18.29      | peak   |
| 2   | 2483.500        | 32.65          | 4.60                 | 37.25           | 54.00          | -16.75      | AVG    |
| 3   | 2484.625        | 53.18          | 4.61                 | 57.79           | 74.00          | -16.21      | peak   |
| 4   | 2484.625        | 29.92          | 4.61                 | 34.53           | 54.00          | -19.47      | AVG    |

Vertical

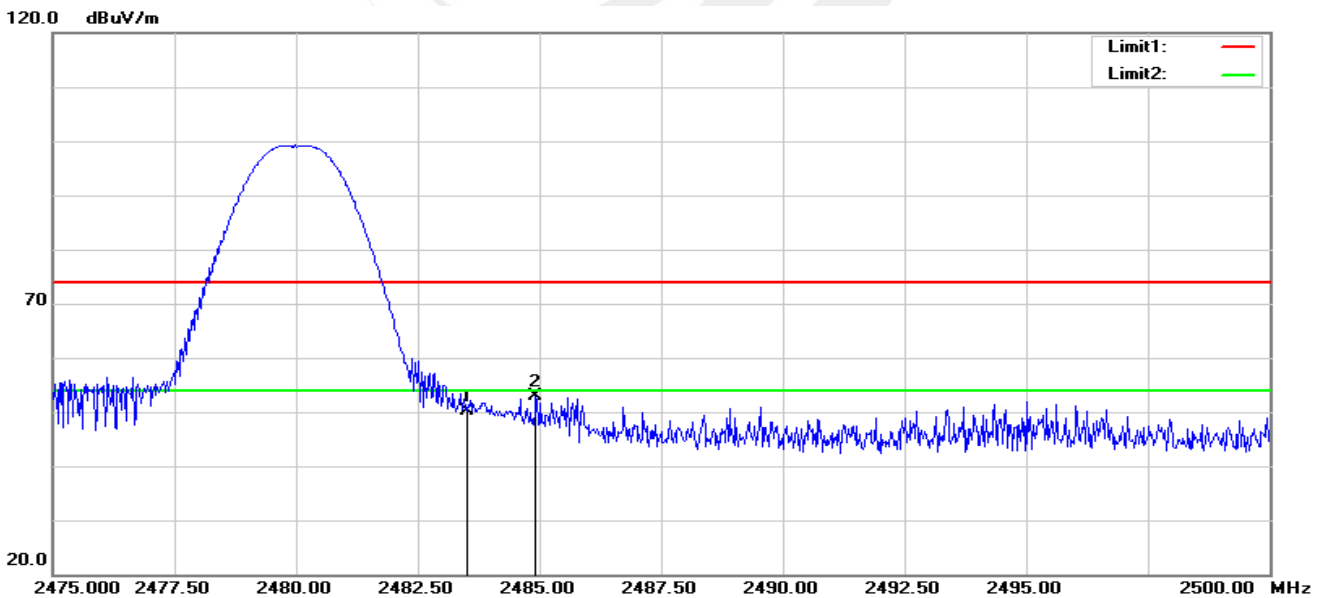

| No. | Frequency (MHz) | Reading (dBuV) | Correct Factor(dB/m) | Result (dBuV/m) | Limit (dBuV/m) | Margin (dB) | Remark |
|-----|-----------------|----------------|----------------------|-----------------|----------------|-------------|--------|
| 1   | 2483.500        | 45.42          | 4.60                 | 50.02           | 74.00          | -23.98      | peak   |
| 2   | 2484.925        | 48.34          | 4.61                 | 52.95           | 74.00          | -21.05      | peak   |

## 5. CONDUCTED SPURIOUS & BAND EDGE EMISSION

### 5.1 LIMIT

According to FCC section 15.247(d), in any 100kHz bandwidth outside the frequency band in which the spread spectrum or digitally modulated intentional radiator is operating, the radio frequency power that is produced by the intentional radiator shall be at least 20dB below that in the 100kHz bandwidth within the band that contains the highest level of the desired power, based on either an RF conducted or a radiated measurement.

### 5.2 TEST PROCEDURE

| Spectrum Parameter                    | Setting                         |
|---------------------------------------|---------------------------------|
| Detector                              | Peak                            |
| Start/Stop Frequency                  | 30 MHz to 10th carrier harmonic |
| RB / VB (emission in restricted band) | 100 KHz/300 KHz                 |
| Trace-Mode:                           | Max hold                        |

For Band edge

| Spectrum Parameter                    | Setting  |
|---------------------------------------|--|
| Detector                              | Peak   |
| Start/Stop Frequency                  | Lower Band Edge: 2300 – 2407 MHz<br>Upper Band Edge: 2475 – 2500 MHz |
| RB / VB (emission in restricted band) | 100 KHz/300 KHz  |
| Trace-Mode:                           | Max hold   |

### 5.3 TEST SETUP



The EUT is connected to the Spectrum Analyzer; the RF load attached to the EUT antenna terminals is 50 Ohm; the path loss as the factor is calibrated to correct the reading. Make the measurement with the spectrum analyzer's resolution bandwidth (RBW) = 100 kHz. In order to make an accurate measurement, set the span greater than RBW.

### 5.4 EUT OPERATION CONDITIONS

Please refer to section 3.4 of this report.

### 5.5 TEST RESULTS

Note: The test data please refer to APPENDIX 1.

## 6. POWER SPECTRAL DENSITY TEST

### 6.1 LIMIT

| FCC Part 15.247, Subpart C |                        |                                    |                       |        |
|----------------------------|------------------------|------------------------------------|-----------------------|--------|
| Section                    | Test Item              | Limit                              | Frequency Range (MHz) | Result |
| 15.247(e)                  | Power Spectral Density | $\leq 8$ dBm<br>(RBW $\geq 3$ KHz) | 2400-2483.5           | PASS   |

### 6.2 TEST PROCEDURE

1. Set analyzer center frequency to DTS channel center frequency.
2. Set the span to 1.5 times the DTS channel bandwidth.
3. Set the RBW to:  $100 \text{ kHz} \geq \text{RBW} \geq 3 \text{ kHz}$ .
4. Set the VBW  $\geq 3 \times \text{RBW}$ .
5. Detector = peak.
6. Sweep time = auto couple.
7. Trace mode = max hold.
8. Allow trace to fully stabilize.
9. Use the peak marker function to determine the maximum amplitude level.
10. If measured value exceeds limit, reduce RBW (no less than 3 kHz) and repeat.

### 6.3 TEST SETUP



### 6.4 EUT OPERATION CONDITIONS

Please refer to section 3.4 of this report.

### 6.5 TEST RESULTS

Note: The test data please refer to APPENDIX 1.

## 7. BANDWIDTH TEST

### 7.1 LIMIT

| FCC Part 15.247, Subpart C |           |   |                       |        |
|----------------------------|-----------|---|-----------------------|--------|
| Section                    | Test Item | Limit                                   | Frequency Range (MHz) | Result |
| 15.247(a)(2)               | Bandwidth | $\geq 500\text{KHz}$<br>(6dB bandwidth) | 2400-2483.5           | PASS   |

### 7.2 TEST PROCEDURE

The automatic bandwidth measurement capability of an instrument may be employed using the X dB bandwidth mode with X set to 6 dB, if the functionality described above (i.e., RBW = 100 kHz, VBW  $\geq 3\text{RBW}$ , peak detector with maximum hold) is implemented by the instrumentation function. When using this capability, care shall be taken so that the bandwidth measurement is not influenced by any intermediate power nulls in the fundamental emission that might be  $\geq 6$  dB.

### 7.3 TEST SETUP



### 7.4 EUT OPERATION CONDITIONS

Please refer to section 3.4 of this report.

### 7.5 TEST RESULTS

Note: The test data please refer to APPENDIX 1.



## 8. PEAK OUTPUT POWER TEST

### 8.1 LIMIT

| FCC Part 15.247, Subpart C |              |                 |                       |        |
|----------------------------|--------------|-----------------|-----------------------|--------|
| Section                    | Test Item    | Limit           | Frequency Range (MHz) | Result |
| 15.247(b)(3)               | Output Power | 1 watt or 30dBm | 2400-2483.5           | PASS   |

### 8.2 TEST PROCEDURE

One of the following procedures may be used to determine the maximum peak conducted output power of a DTS EUT.

RBW  $\geq$  DTS bandwidth

The following procedure shall be used when an instrument with a resolution bandwidth that is greater than the DTS bandwidth is available to perform the measurement:

- Set the RBW  $\geq$  DTS bandwidth.
- Set VBW  $\geq$  [3  $\times$  RBW].
- Set span  $\geq$  [3  $\times$  RBW].
- Sweep time = auto couple.
- Detector = peak.
- Trace mode = max hold.
- Allow trace to fully stabilize.
- Use peak marker function to determine the peak amplitude level.

Integrated band power method:

The following procedure can be used when the maximum available RBW of the instrument is less than the

DTS bandwidth:

- Set the RBW = 1 MHz.
- Set the VBW  $\geq$  [3  $\times$  RBW].
- Set the span  $\geq$  [1.5  $\times$  DTS bandwidth].
- Detector = peak.
- Sweep time = auto couple.
- Trace mode = max hold.
- Allow trace to fully stabilize.
- Use the instrument's band/channel power measurement function with the band limits set equal to the DTS bandwidth edges (for some instruments, this may require a manual override to select the peak detector). If the instrument does not have a band power function, then sum the spectrum levels (in linear power units) at intervals equal to the RBW extending across the DTS channel bandwidth.

PKPM1 Peak power meter method:

The maximum peak conducted output power may be measured using a broadband peak RF power meter. The power meter shall have a video bandwidth that is greater than or equal to the DTS bandwidth and shall use a fast-responding diode detector.



### 8.3 TEST SETUP

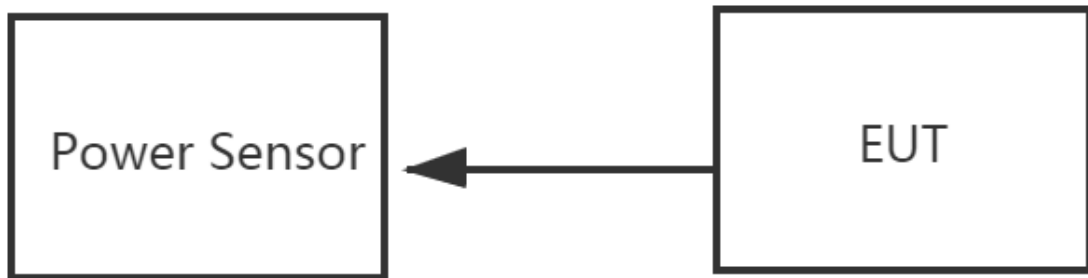

### 8.4 EUT OPERATION CONDITIONS

Please refer to section 3.4 of this report.

### 8.5 TEST RESULTS

Note: The test data please refer to APPENDIX 1.

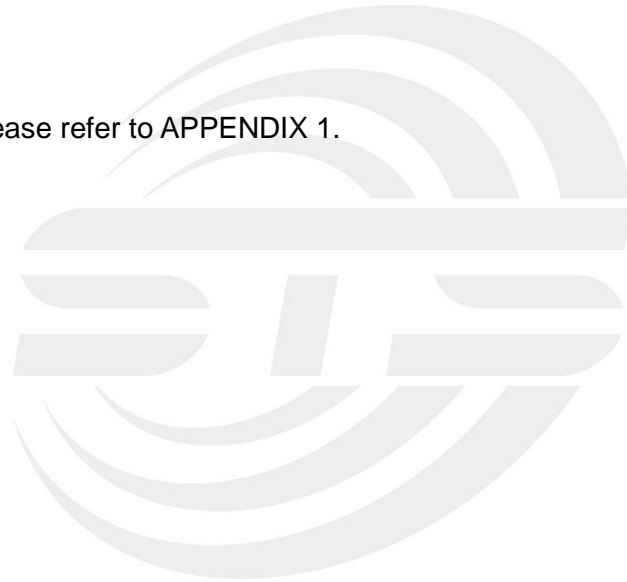



## 9. ANTENNA REQUIREMENT

### 9.1 STANDARD REQUIREMENT

15.203 requirement: For intentional device, according to 15.203: an intentional radiator shall be designed to ensure that no antenna other than that furnished by the responsible party shall be used with the device.

### 9.2 EUT ANTENNA

The EUT antenna is PCB Antenna. It comply with the standard requirement.





## APPENDIX 1-TEST DATA

## 1. Duty Cycle

| Condition | Mode   | Frequency (MHz) | Duty Cycle (%) | Correction Factor (dB) | 1/T (kHz) |
|-----------|--------|-----------------|----------------|------------------------|-----------|
| NVNT      | BLE 1M | 2402            | 100            | 0                      | 0         |
| NVNT      | BLE 1M | 2440            | 100            | 0                      | 0         |
| NVNT      | BLE 1M | 2480            | 100            | 0                      | 0         |



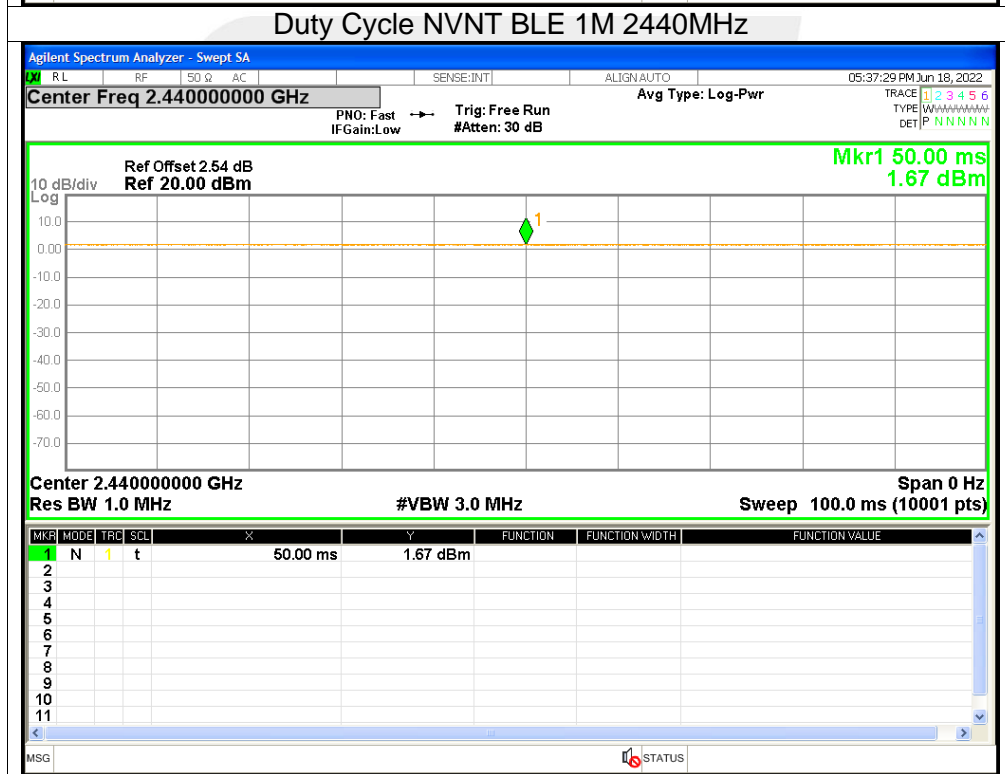
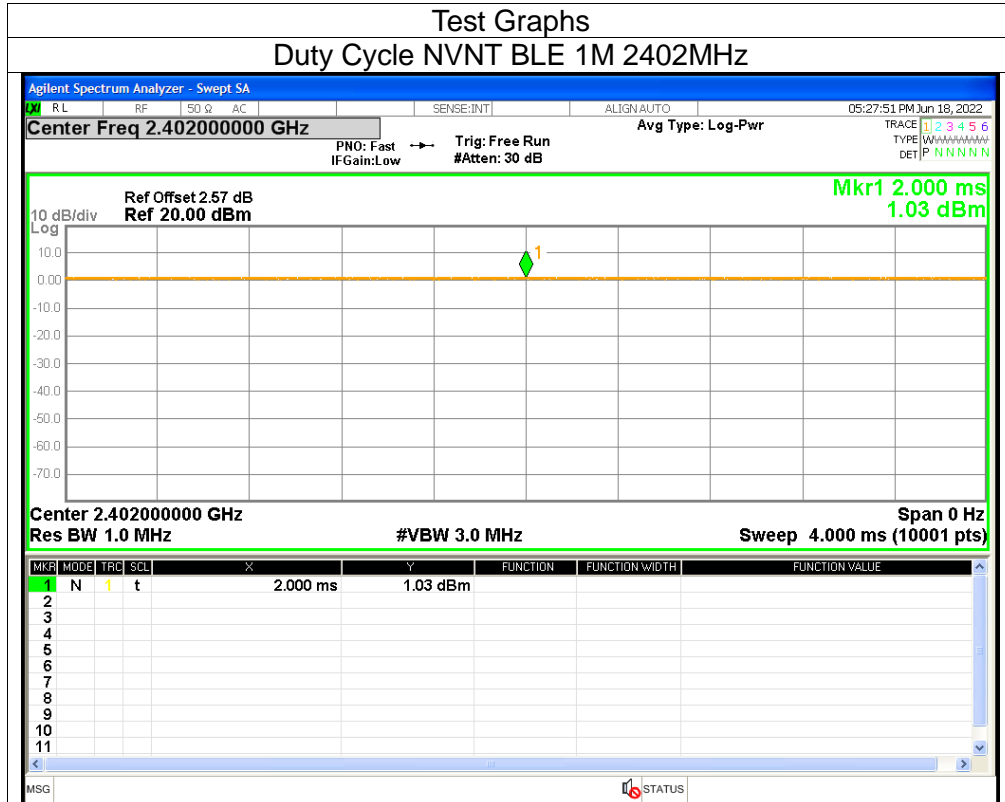

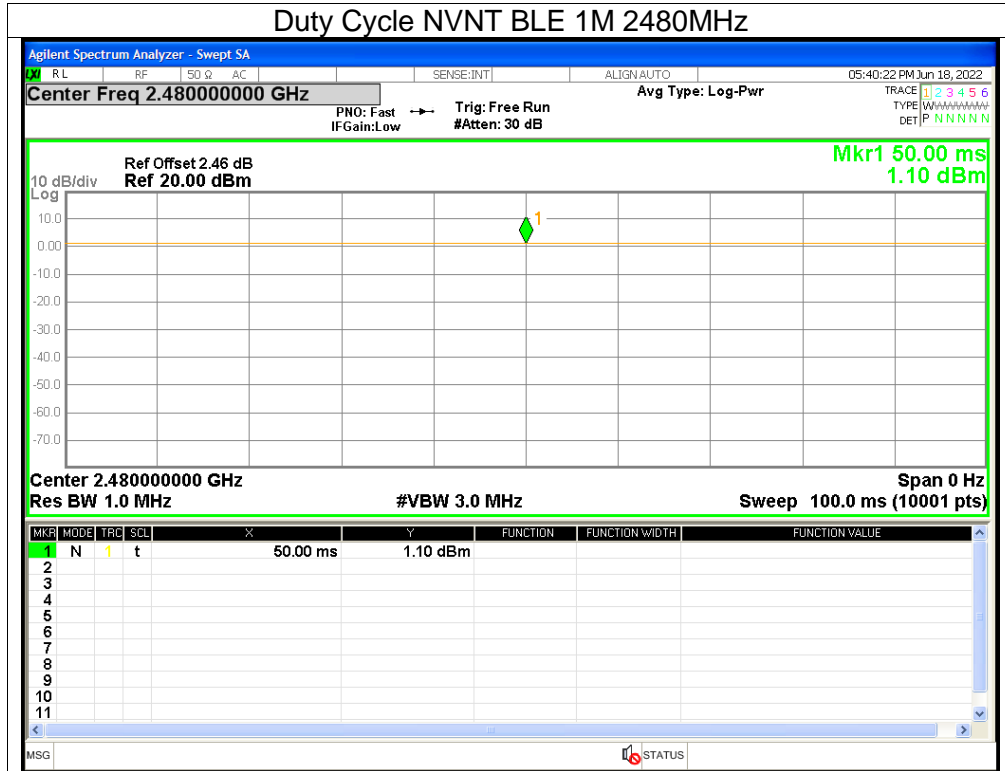



## 2. Maximum Average Conducted Output Power

| Condition | Mode   | Frequency (MHz) | Conducted Power (dBm) | Duty Factor (dB) | Total Power (dBm) | Limit (dBm) | Verdict |
|-----------|--------|-----------------|-----------------------|------------------|-------------------|-------------|---------|
| NVNT      | BLE 1M | 2402            | 1.05                  | 0                | 1.05              | $\leq 30$   | Pass    |
| NVNT      | BLE 1M | 2440            | 1.68                  | 0                | 1.68              | $\leq 30$   | Pass    |
| NVNT      | BLE 1M | 2480            | 1.13                  | 0                | 1.13              | $\leq 30$   | Pass    |



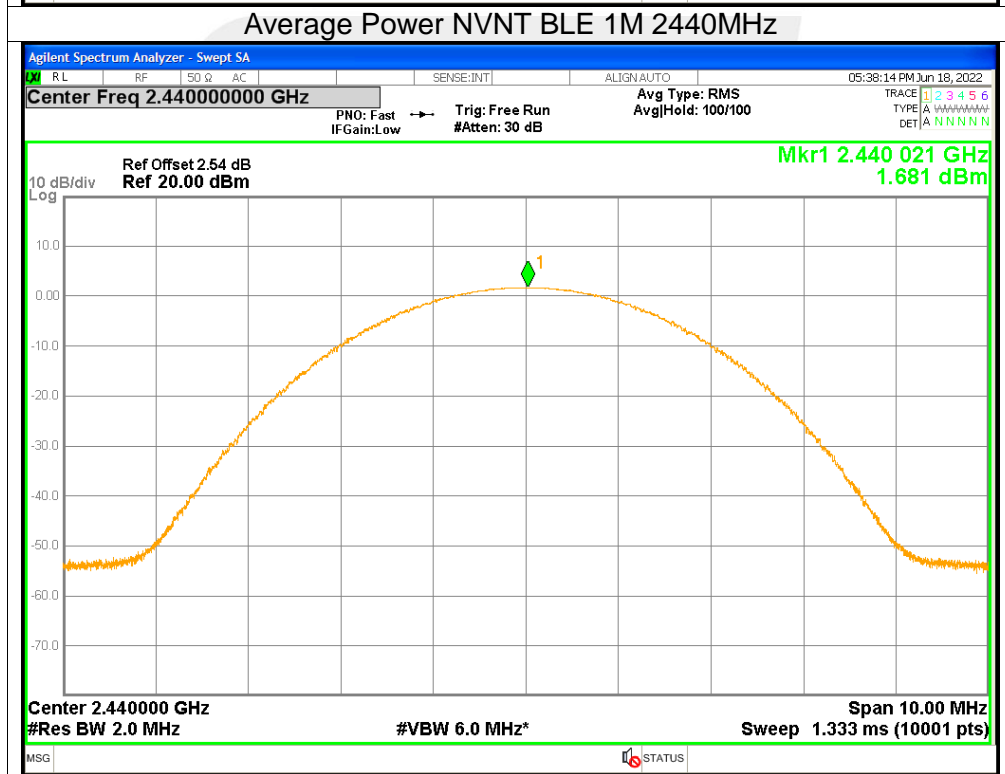
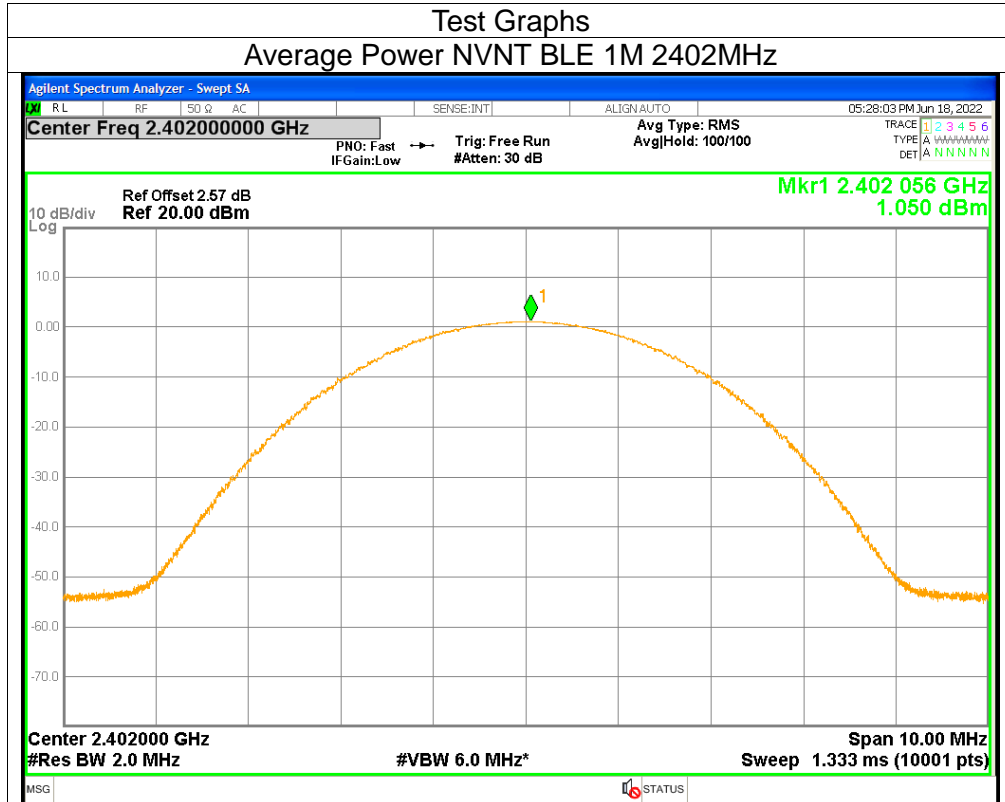

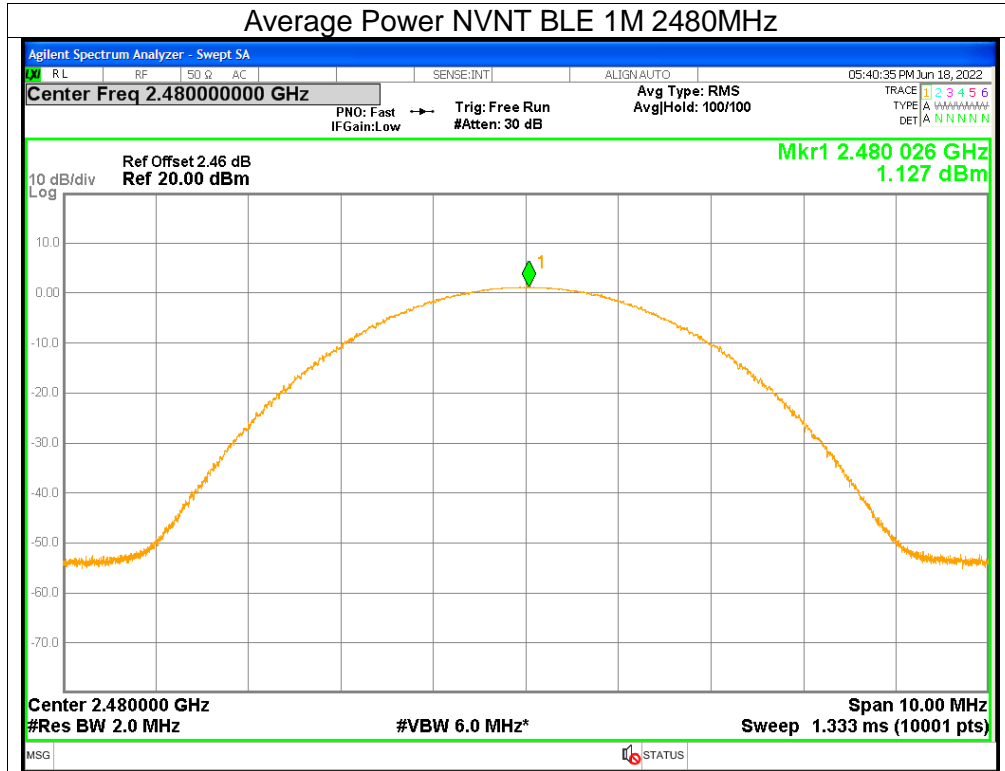





### 3. Maximum Peak Conducted Output Power

| Condition | Mode   | Frequency (MHz) | Conducted Power (dBm) | Limit (dBm) | Verdict |
|-----------|--------|-----------------|-----------------------|-------------|---------|
| NVNT      | BLE 1M | 2402            | 1.22                  | $\leq 30$   | Pass    |
| NVNT      | BLE 1M | 2440            | 1.85                  | $\leq 30$   | Pass    |
| NVNT      | BLE 1M | 2480            | 1.29                  | $\leq 30$   | Pass    |



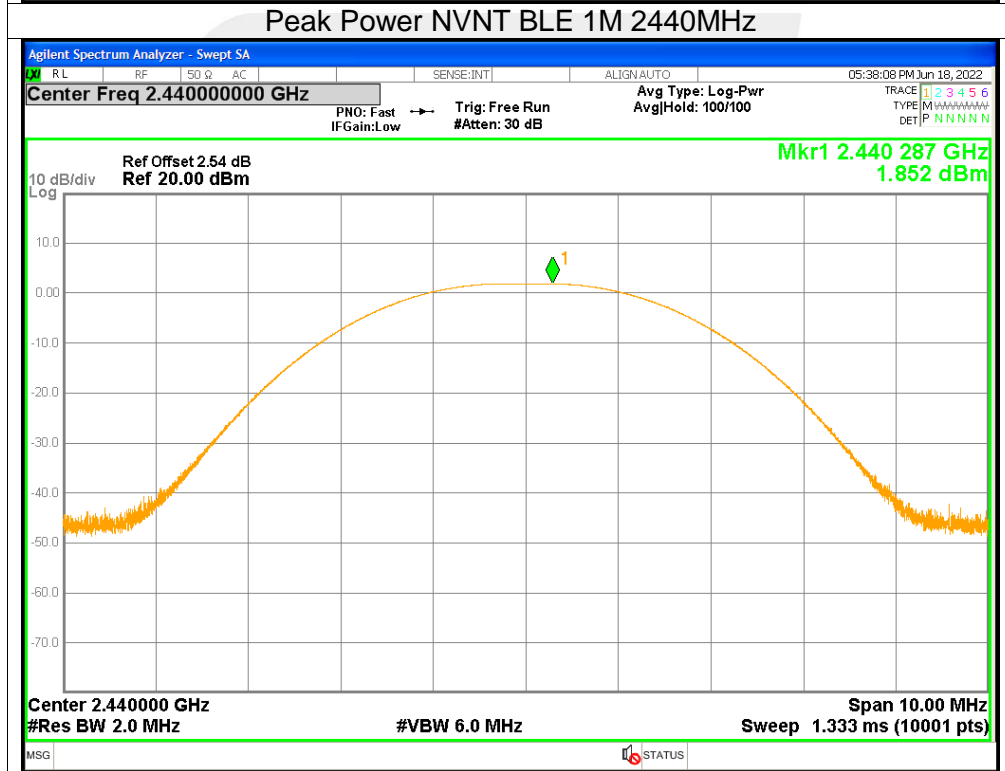
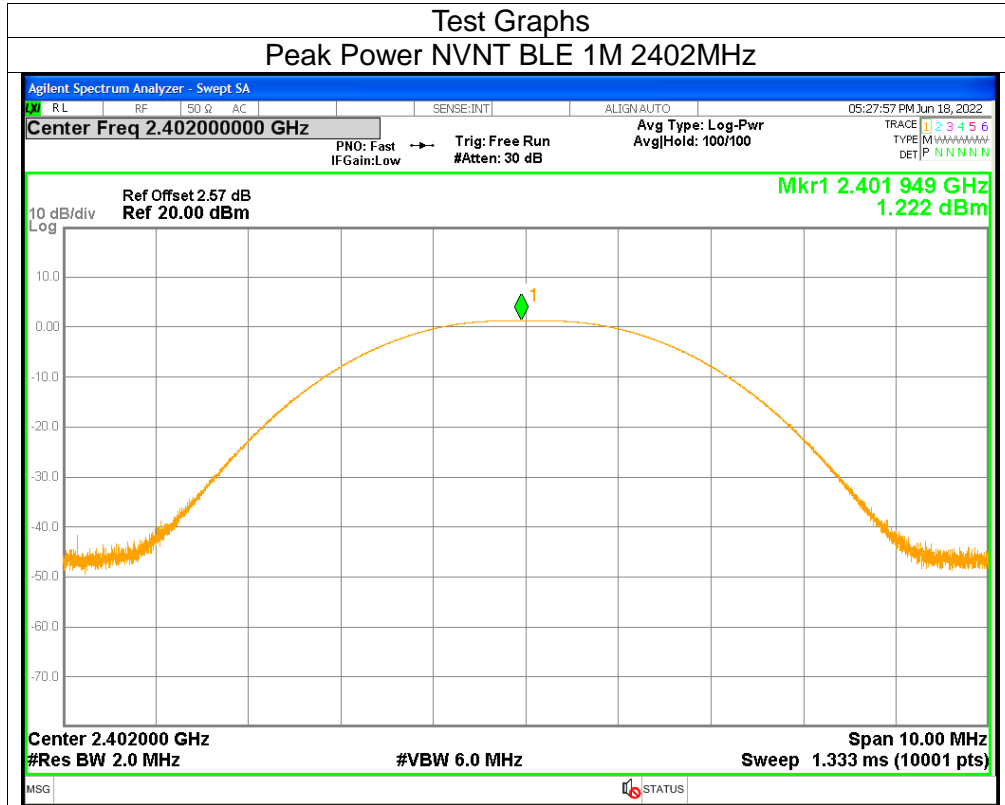

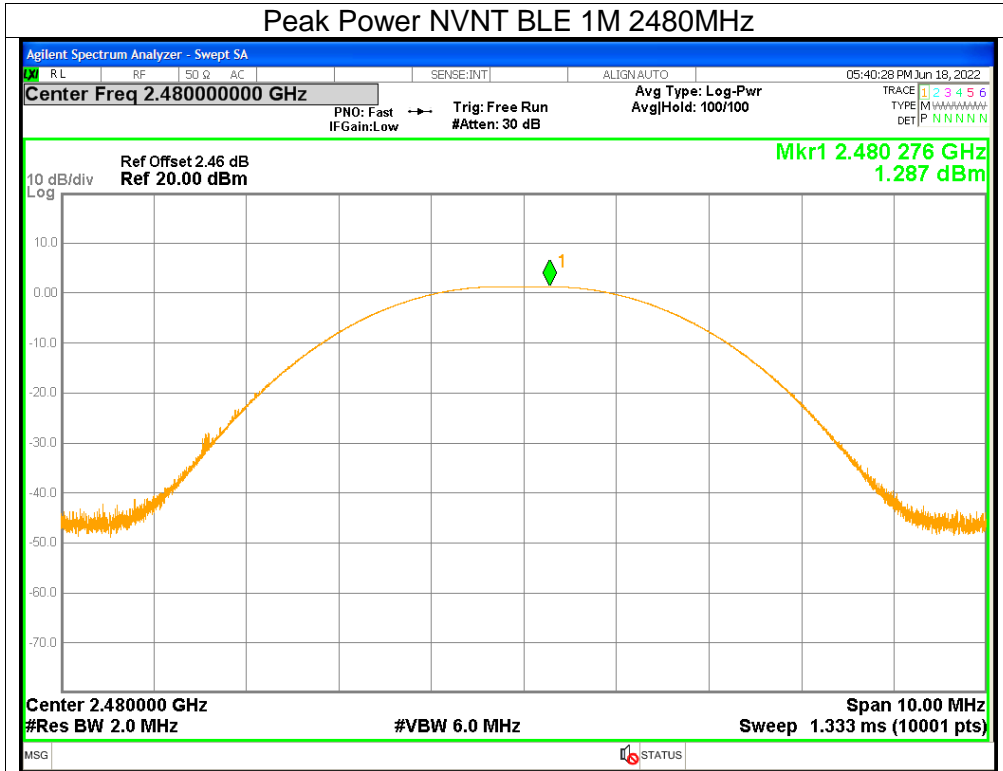



#### 4. -6dB Bandwidth

| Condition | Mode   | Frequency (MHz) | -6 dB Bandwidth (MHz) | Limit -6 dB Bandwidth (MHz) | Verdict |
|-----------|--------|-----------------|-----------------------|-----------------------------|---------|
| NVNT      | BLE 1M | 2402            | 0.713                 | $\geq 0.5$                  | Pass    |
| NVNT      | BLE 1M | 2440            | 0.712                 | $\geq 0.5$                  | Pass    |
| NVNT      | BLE 1M | 2480            | 0.725                 | $\geq 0.5$                  | Pass    |





### Test Graphs

#### -6dB Bandwidth NVNT BLE 1M 2402MHz

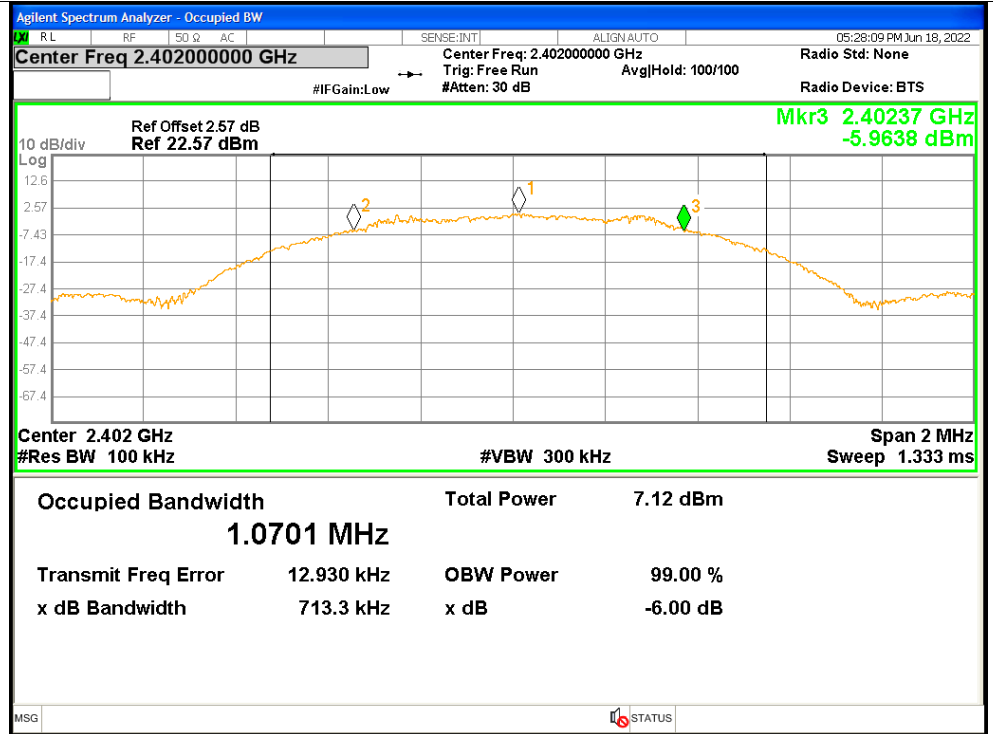

#### -6dB Bandwidth NVNT BLE 1M 2440MHz

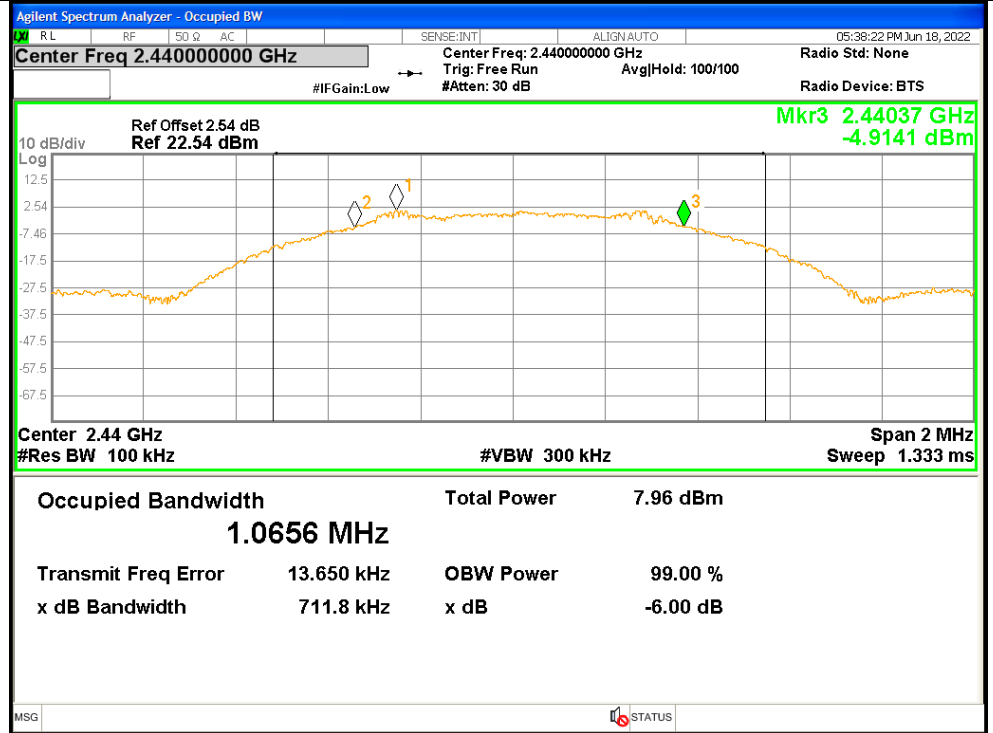

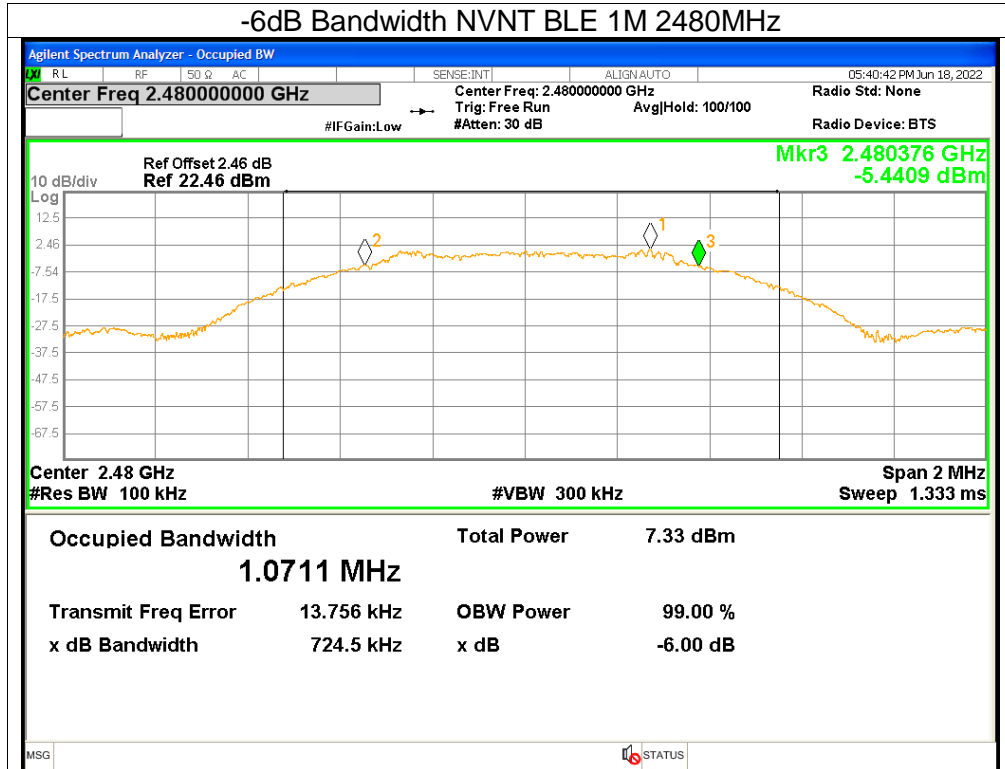



## 5. Maximum Power Spectral Density Level

| Condition | Mode   | Frequency (MHz) | PSD (dBm/3kHz) | Limit (dBm/3kHz) | Verdict |
|-----------|--------|-----------------|----------------|------------------|---------|
| NVNT      | BLE 1M | 2402            | -11.51         | $\leq 8$         | Pass    |
| NVNT      | BLE 1M | 2440            | -11.38         | $\leq 8$         | Pass    |
| NVNT      | BLE 1M | 2480            | -10.93         | $\leq 8$         | Pass    |



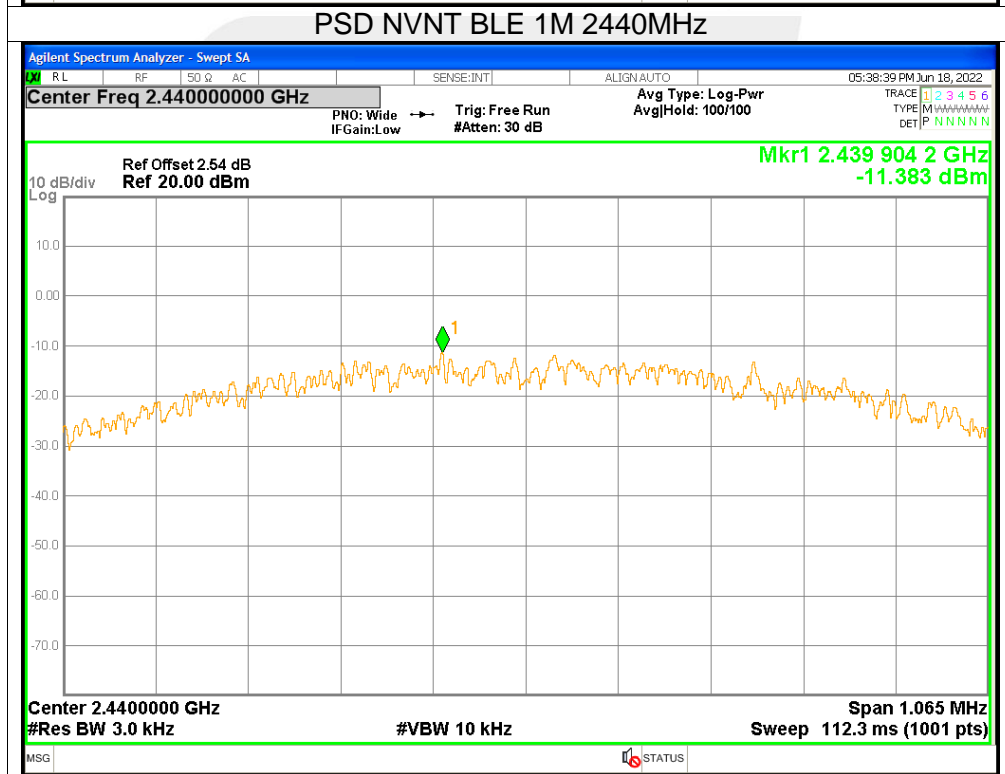
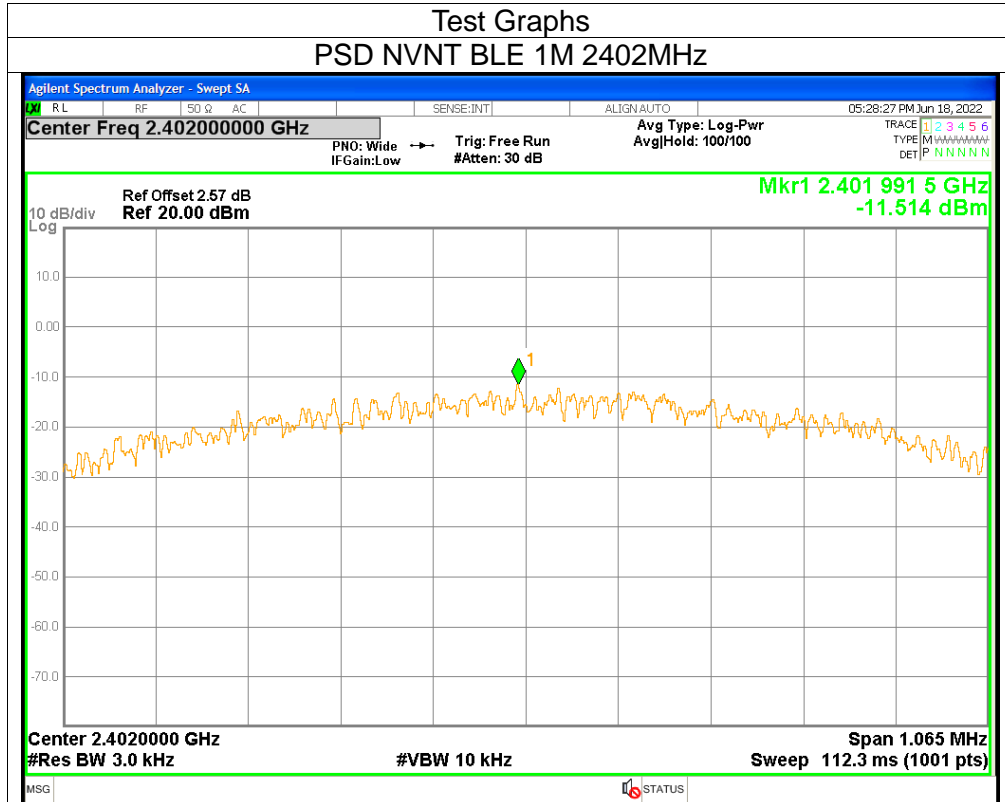



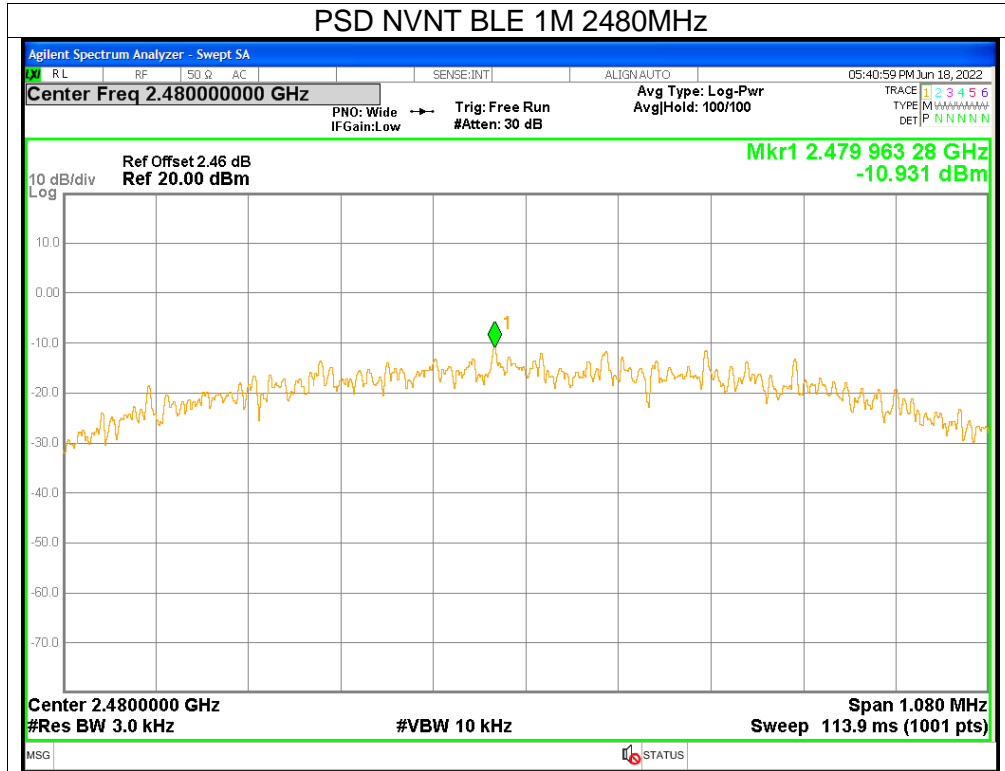



## 6. Band Edge

| Condition | Mode   | Frequency (MHz) | Max Value (dBc) | Limit (dBc) | Verdict |
|-----------|--------|-----------------|-----------------|-------------|---------|
| NVNT      | BLE 1M | 2402            | -54.9           | $\leq -20$  | Pass    |
| NVNT      | BLE 1M | 2480            | -55.69          | $\leq -20$  | Pass    |





Test Graphs

Band Edge NVNT BLE 1M 2402MHz Ref

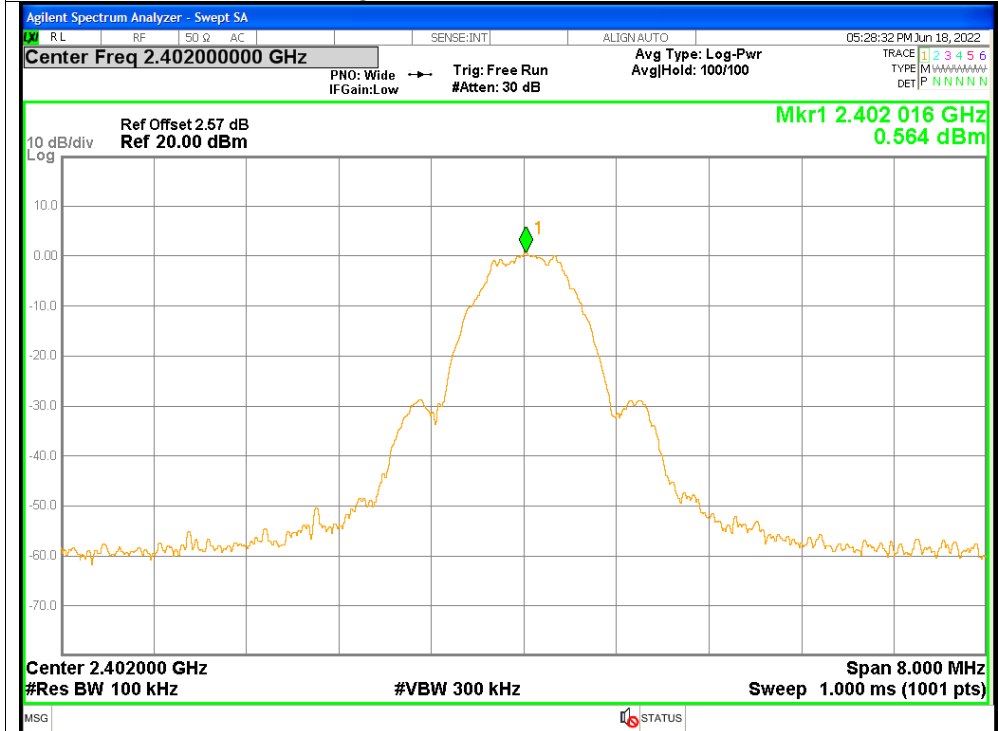

Band Edge NVNT BLE 1M 2402MHz Emission

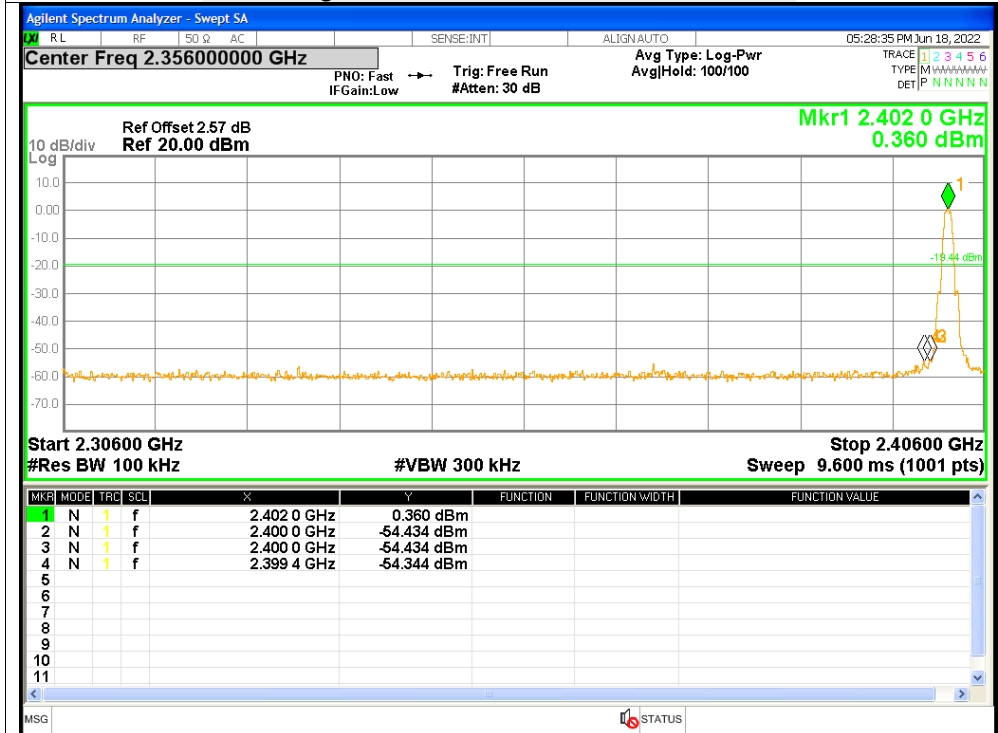

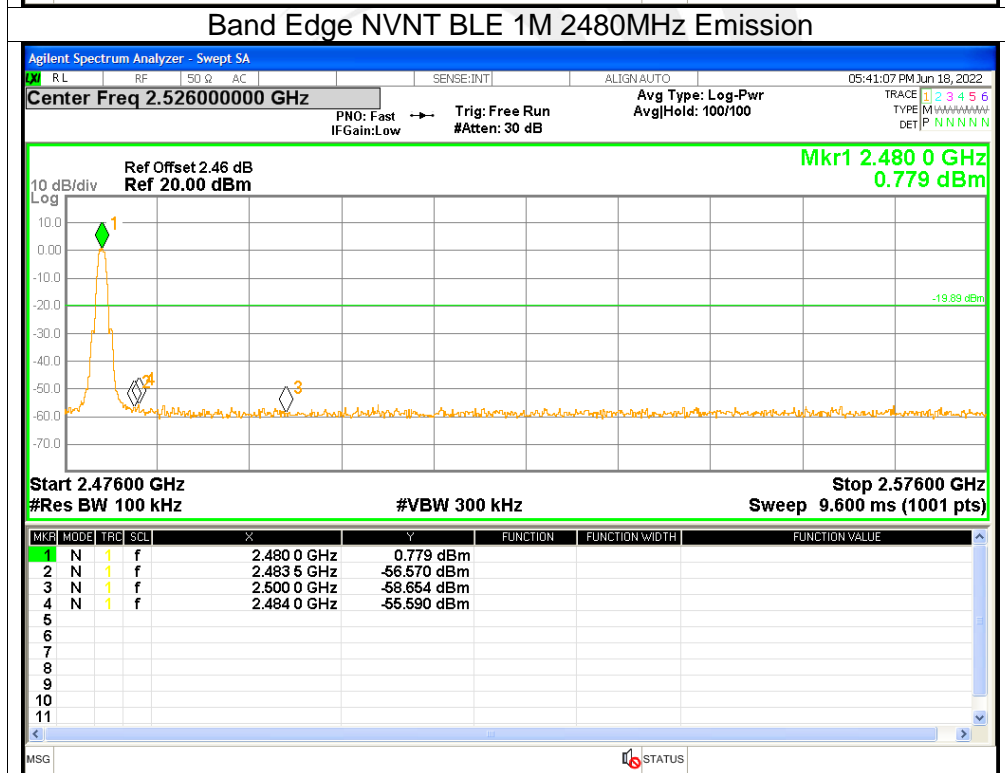
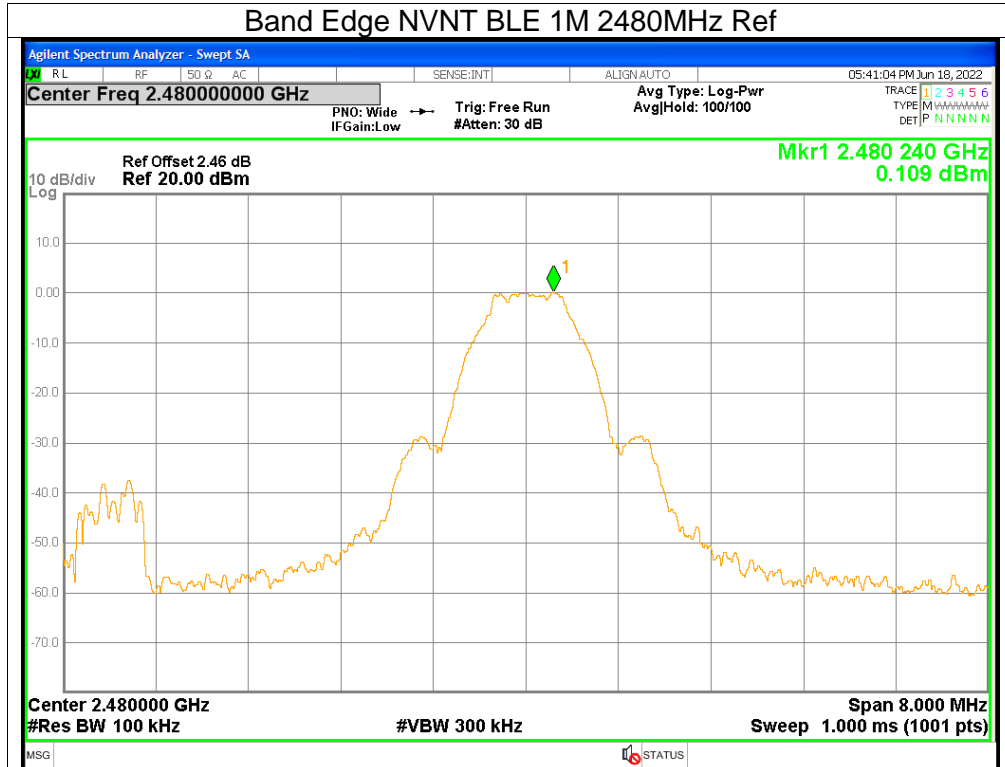



## 7. Conducted RF Spurious Emission

| Condition | Mode   | Frequency (MHz) | Max Value (dBc) | Limit (dBc) | Verdict |
|-----------|--------|-----------------|-----------------|-------------|---------|
| NVNT      | BLE 1M | 2402            | -52.86          | <=-20       | Pass    |
| NVNT      | BLE 1M | 2440            | -56.81          | <=-20       | Pass    |
| NVNT      | BLE 1M | 2480            | -55.91          | <=-20       | Pass    |





Test Graphs

Tx. Spurious NVNT BLE 1M 2402MHz Ref

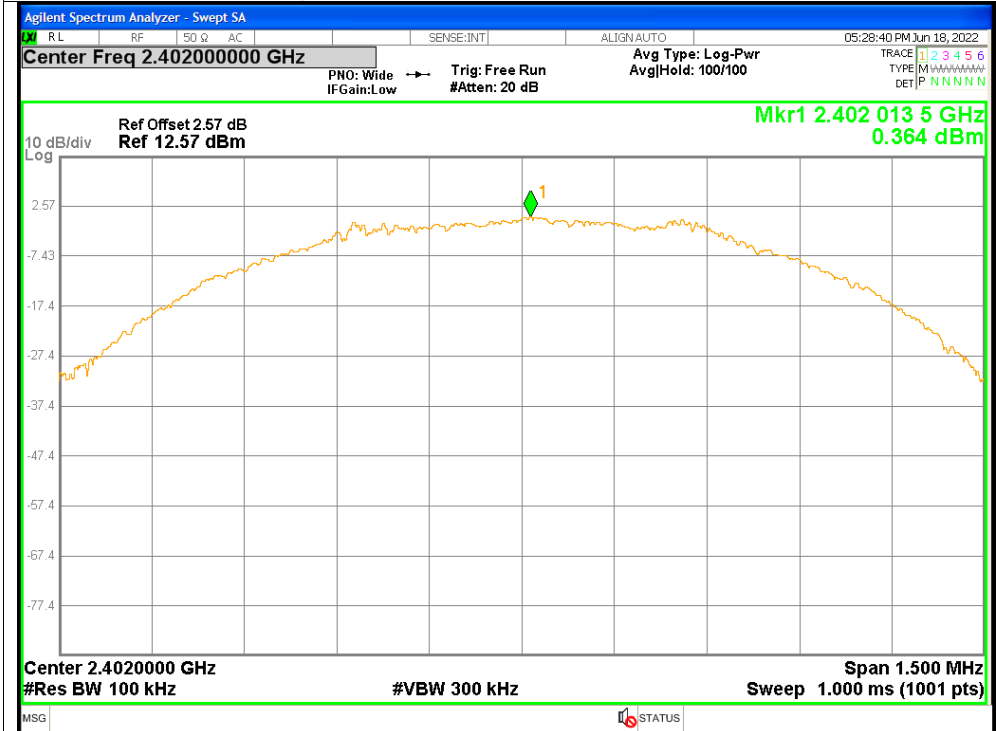

Tx. Spurious NVNT BLE 1M 2402MHz Emission

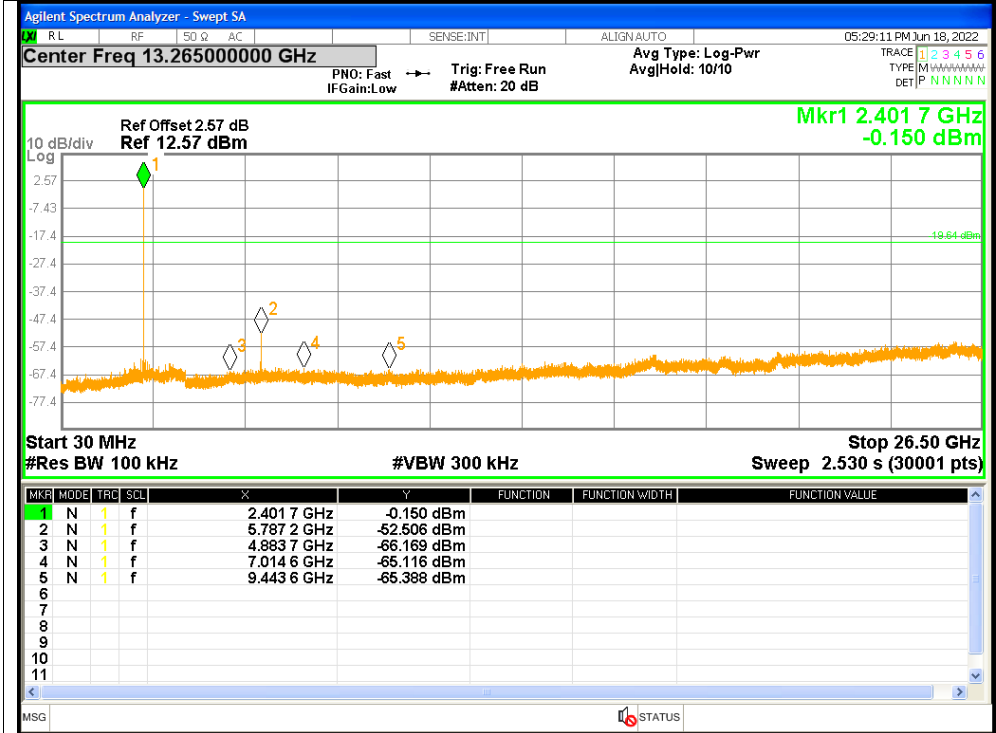



### Tx. Spurious NVNT BLE 1M 2440MHz Ref

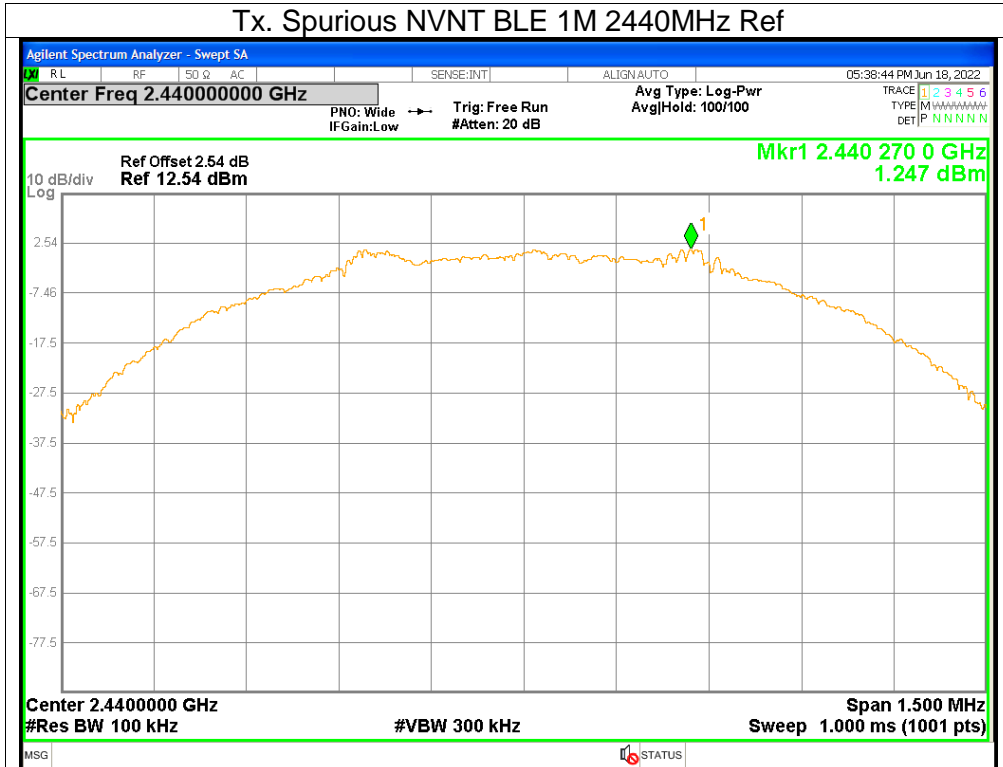

### Tx. Spurious NVNT BLE 1M 2440MHz Emission

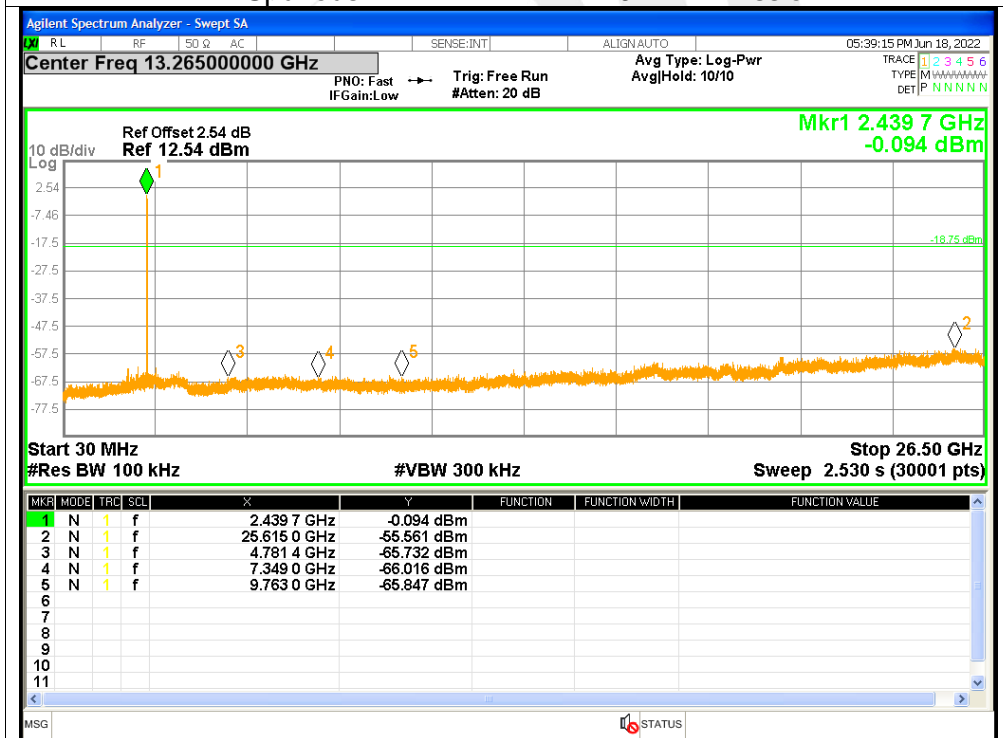



### Tx. Spurious NVNT BLE 1M 2480MHz Ref

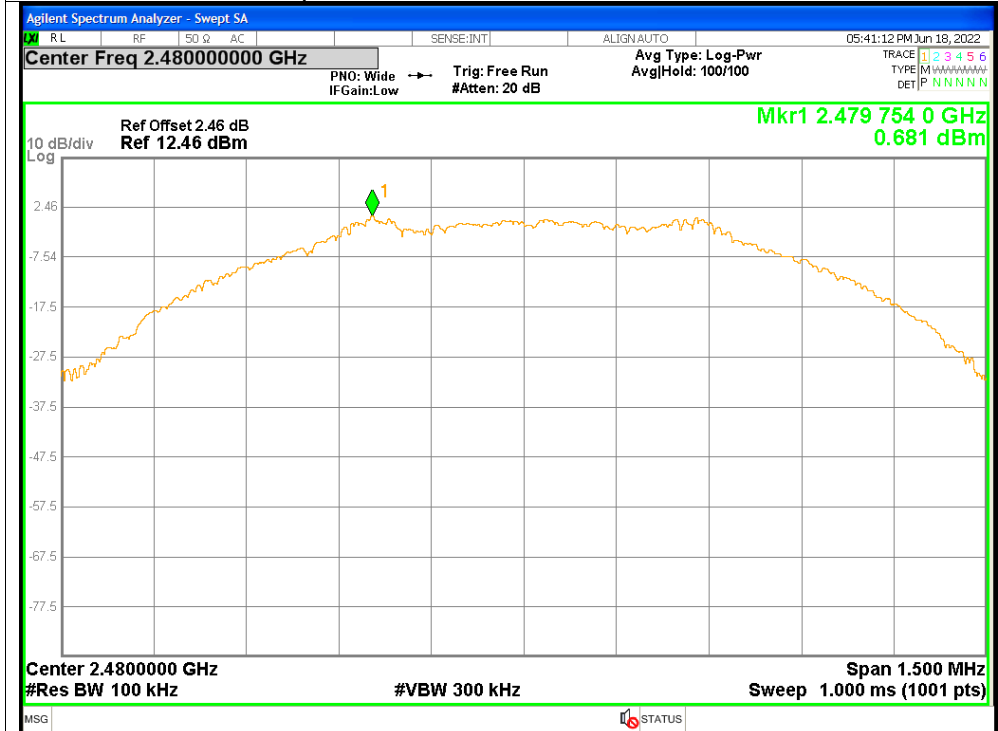

### Tx. Spurious NVNT BLE 1M 2480MHz Emission

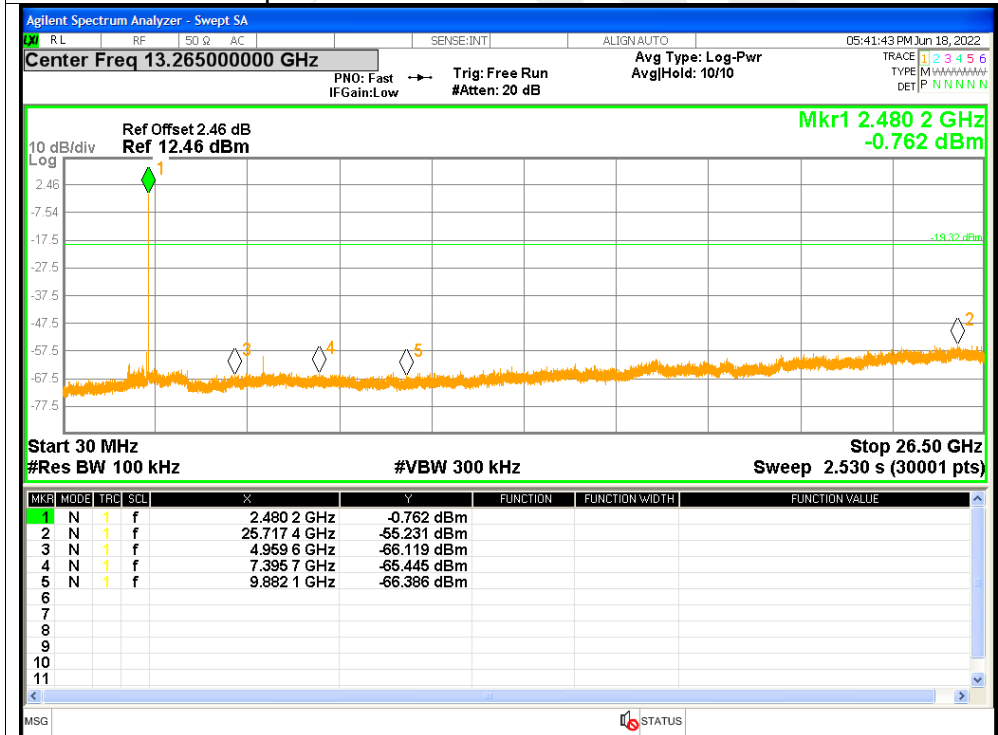





## APPENDIX 2- EUT TEST PHOTO

Note: See test photos in setup photo document for the actual connections between Product and support equipment.

\*\*\*\*\*END OF THE REPORT\*\*\*\*\*

