



Datasheet

Maximus

Part No:
FXUB66.07.0150C

Description:

Flexible Wide Band 5G/4G Antenna 600-6000MHz

Features:

Ground Plane Independent
600-6000MHz Wideband
5G/4G fully Operational on all Sub-6GHz bands
Efficiencies up to 80% on all cellular bands (600-6000MHz)
120.4x50.4x0.2 mm size
Connector: I-PEX MHF® I U.FL Compatible
Cable: 150mm of \varnothing 1.37
CE Certified
RoHS & REACH Compliant



1. Introduction	3
2. Specifications	4
3. Antenna Characteristics	6
4. 2D Radiation Patterns	9
5. Mechanical Drawing	18
6. Packaging	19
<hr/>	
Changelog	20

Taoglas makes no warranties based on the accuracy or completeness of the contents of this document and reserves the right to make changes to specifications and product descriptions at any time without notice. Taoglas reserves all rights to this document and the information contained herein.

Reproduction, use or disclosure to third parties without express permission is strictly prohibited.



1. Introduction



The patented Maximus FXUB66 flexible wideband antenna has been designed to cover all working frequencies in the 600-6000 MHz spectrum, including all Cellular(5G/4G/3G/2G), NB-IoT, Cat-M, Wi-Fi, ISM and GNSS bands. Its use in a device improves substantially the radiated power and sensitivity, and enables the highest throughput rates of today's broadband devices.

The antenna is delivered with a flexible body with ground breaking high efficiencies on all bands, ground-plane independent, with a cable and connector for easy installation. It is made of durable flexible polymer, with a peak gain of 5dBi, an efficiency of more than 60% across all cellular bands and is designed to be mounted directly onto a plastic or glass enclosure / cover.

At 120.4x50.4x0.2mm, the antenna is ultra thin. It is assembled by a simple “peel and stick” process, attaching securely to non-metal surfaces via 3M adhesive. It enables designers to use only one antenna that covers all frequencies and future proofs device design for 5G and 4G globally. It is also the ideal antenna to fit in devices that are being retrofitted with wireless functionality, as it will cover non cellular applications such as 868, 915MHz or Zigbee applications. Its inherently wide bandwidth is more resistant to detuning than traditional small but narrow-band legacy antennas.

The Maximus antenna has a unique hybrid design. Within one antenna structure the electromagnetic waves travel in two predominant propagation modes - one for lower frequencies, (e.g. 5G/4G at 600 MHz) and the other for higher 5G/4G and Wi-Fi frequencies up to 6GHz.

It is an ideal choice for any device maker that needs to keep manufacturing costs down over the lifetime of a product, as the same antenna can be used if the radio module is upgraded to work on a different frequency band.

Cables and Connectors are fully customizable, subject to MOQ, for further information please contact your regional Taoglas Customer support team.

2. Specifications

Electrical									
Frequency (MHz)	600-960	1390-1435	1575.42	1710-1990	1755-2170	2400-2500	2500-2700	3300-3800	4800-6000
Peak Gain (dBi)									
2mm ABS	0.2dBi	2.5dBi	4.1dBi	2dBi	1.6dBi	2.8dBi	2.6dBi	3.5dBi	4.8dBi
Average Gain (dB)									
2mm ABS	-2.7dB	-2.6dB	-1.3dB	-2.1dB	-2.5dB	-2dB	-1.8dB	-1.8dB	-2.4dB
Max VSWR									
2mm ABS	3.5:1	3.5:1	1.1:1	3:1	3.3:1	2.2:1	2:1	2.2:1	3:1
Max Return Loss(dB)									
2mm ABS	-5dB	-5dB	-20dB	-6dB	-5.5dB	-7dB	-10dB	-7dB	-6dB
Efficiency									
2mm ABS	60%	48%	73%	61%	56%	63%	65%	66%	57%
Impedance	50Ω								
Polarization	Linear								
Radiation Pattern	Omni-Directional								
Input Power	5 W								
Mechanical									
Dimensions	120.4 x 50.4 x 0.2 mm								
Material	Flexible Polymer								
Cable	150mm of Ø1.37 (Fully customizable)								
Connector	I-PEX MHF® I U.FL Compatible(Fully customizable)								
Environmental									
Operating Temperature	-40°C to 85°C								
Storage Temperature	-40°C to 85°C								
RoHS Compliant	Yes								

5G/4G Bands

Band Number	5G NR / FR1 / LTE / LTE-Advanced / WCDMA / HSPA / HSPA+ / TD-SCDMA		
	Uplink	Downlink	Covered
1	UL: 1920 to 1980	DL: 2110 to 2170	✓
2	UL: 1850 to 1910	DL: 1930 to 1990	✓
3	UL: 1710 to 1785	DL: 1805 to 1880	✓
4	UL: 1710 to 1755	DL: 2110 to 2155	✓
5	UL: 824 to 849	DL: 869 to 894	✓
7	UL: 2500 to 2570	DL: 2620 to 2690	✓
8	UL: 880 to 915	DL: 925 to 960	✓
9	UL: 1749.9 to 1784.9	DL: 1844.9 to 1879.9	✓
11	UL: 1427.9 to 1447.9	DL: 1475.9 to 1495.9	✓
12	UL: 699 to 716	DL: 729 to 746	✓
13	UL: 777 to 787	DL: 746 to 756	✓
14	UL: 788 to 798	DL: 758 to 768	✓
17	UL: 704 to 716	DL: 734 to 746	✓
18	UL: 815 to 830	DL: 860 to 875	✓
19	UL: 830 to 845	DL: 875 to 890	✓
20	UL: 832 to 862	DL: 791 to 821	✓
21	UL: 1447.9 to 1462.9	DL: 1495.9 to 1510.9	✓
22	UL: 3410 to 3490	DL: 3510 to 3590	✓
23	UL: 2000 to 2020	DL: 2180 to 2200	✓
24	UL: 1625.5 to 1660.5	DL: 1525 to 1559	✓
25	UL: 1850 to 1915	DL: 1930 to 1995	✓
26	UL: 814 to 849	DL: 859 to 894	✓
27	UL: 807 to 824	DL: 852 to 869	✓
28	UL: 703 to 748	DL: 758 to 803	✓
29	UL: -	DL: 717 to 728	✓
30	UL: 2305 to 2315	DL: 2350 to 2360	✓
31	UL: 452.5 to 457.5	DL: 462.5 to 467.5	✗
32	UL: -	DL: 1452 - 1496	✓
35		1850 to 1910	✓
38		2570 to 2620	✓
39		1880 to 1920	✓
40		2300 to 2400	✓
41		2496 to 2690	✓
42		3400 to 3600	✓
43		3600 to 3800	✓
48		3550 to 3700	✓
66	UL: 1710-1780	DL: 2110-2200	✓
71		617 to 698	✓
74/75/76		1427 to 1518	✓
78		3300 to 3800	✓
79		4400 to 5000	✓
85	698-716	728-746	✓

3. Antenna Characteristics

3.1 Return Loss

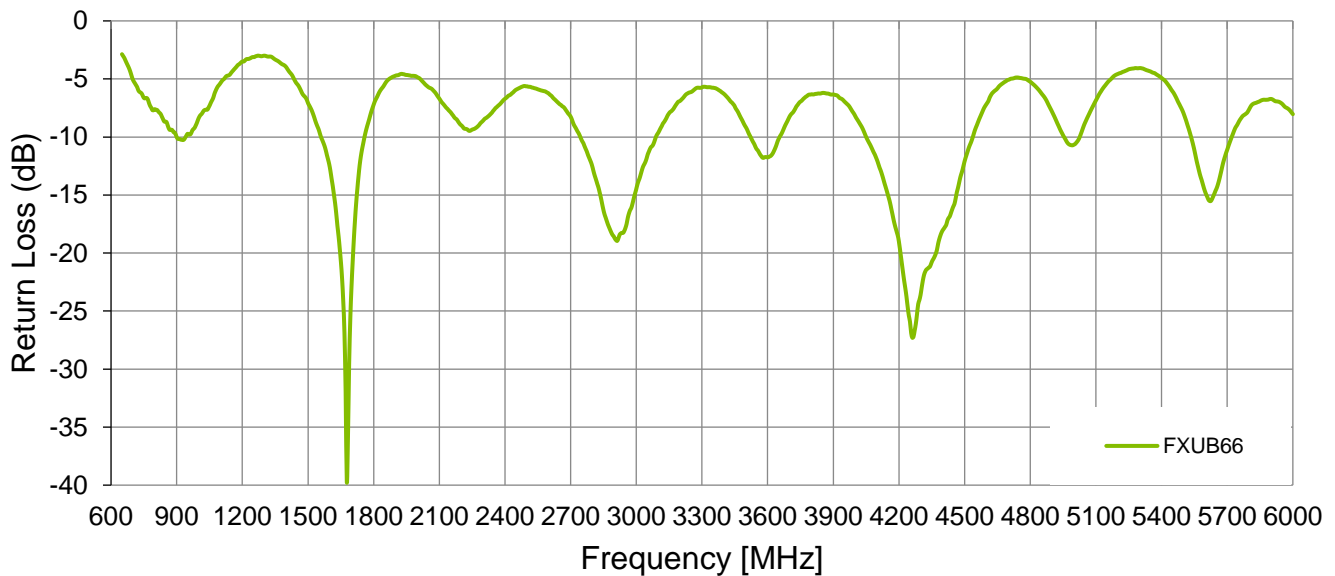

3.2 VSWR

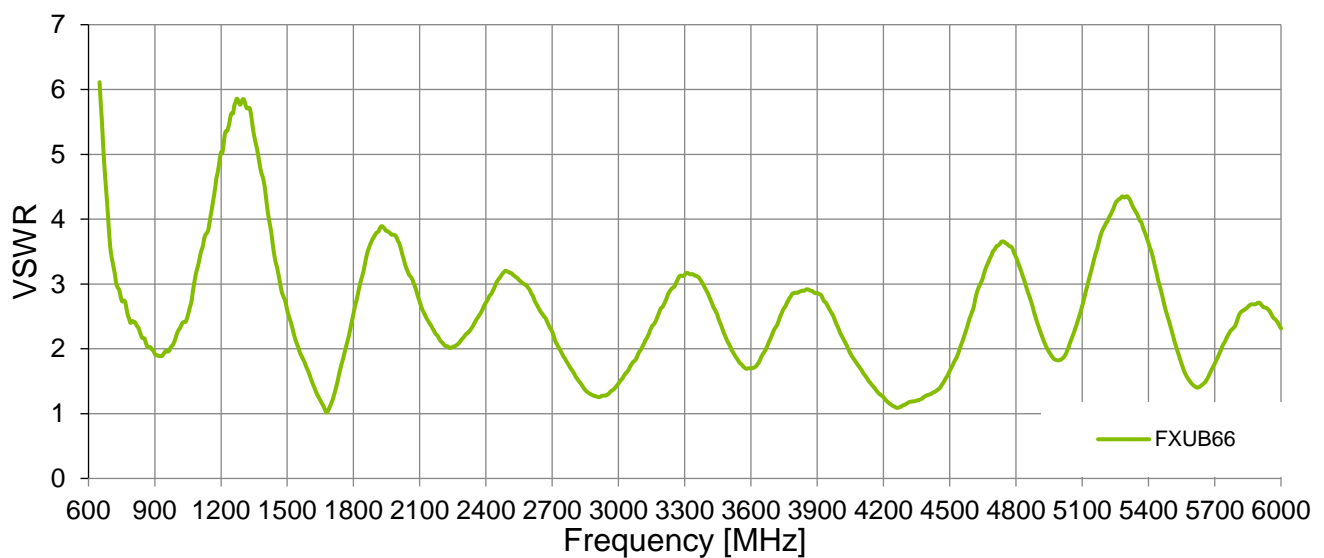

3.3 Efficiency

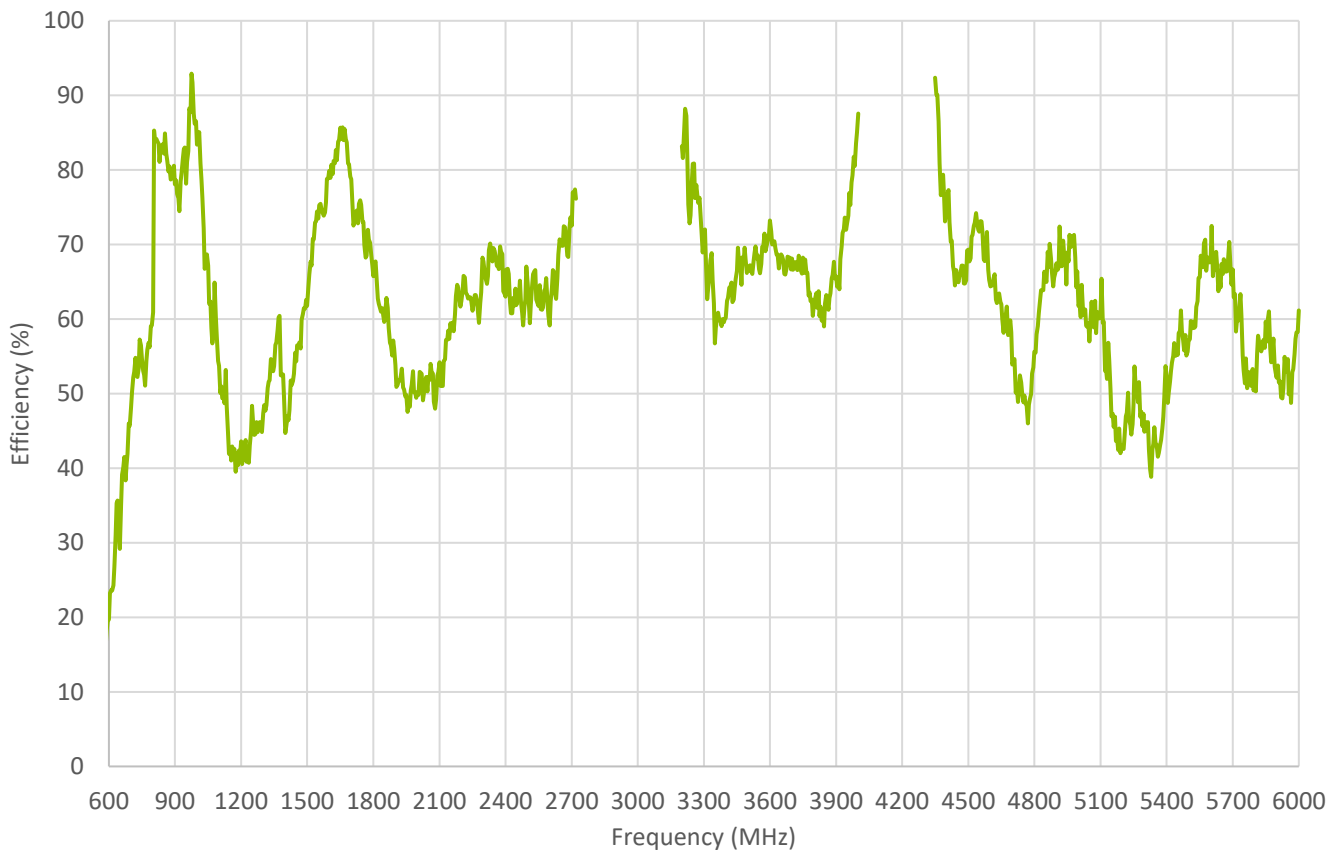

3.4 Peak Gain

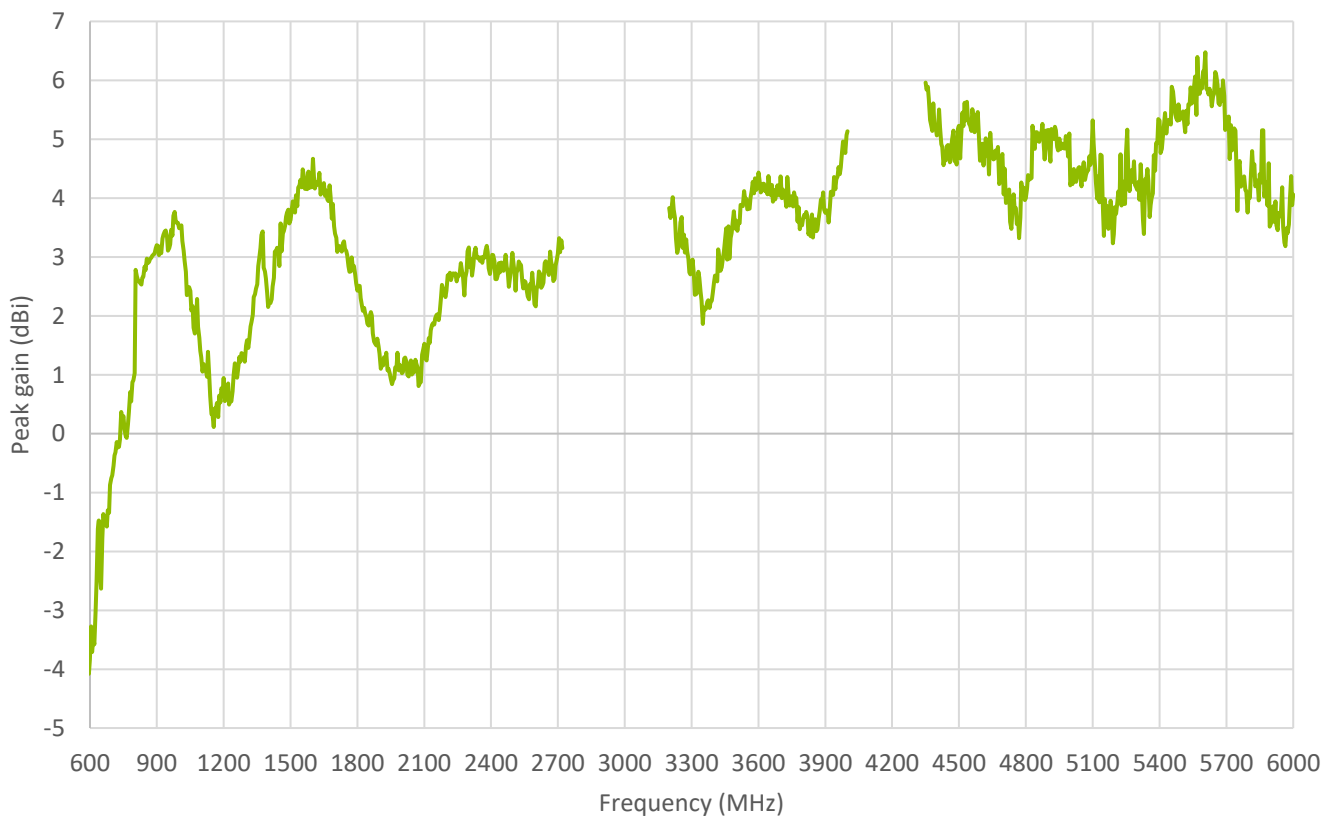

3.5 Average Gain

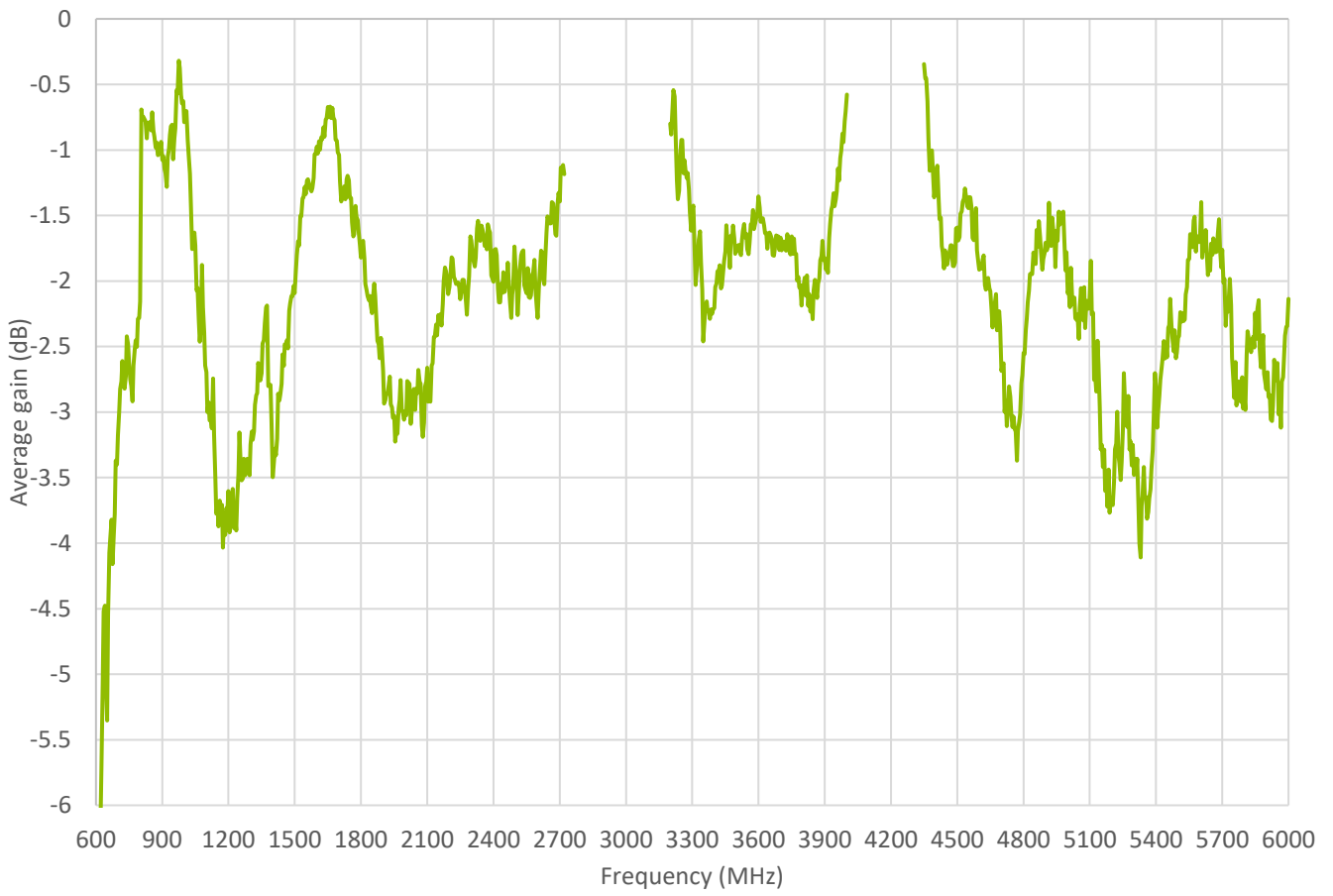

4. 2D Radiation Patterns

4.1 Test Setup



On 2mm ABS

XY Plane

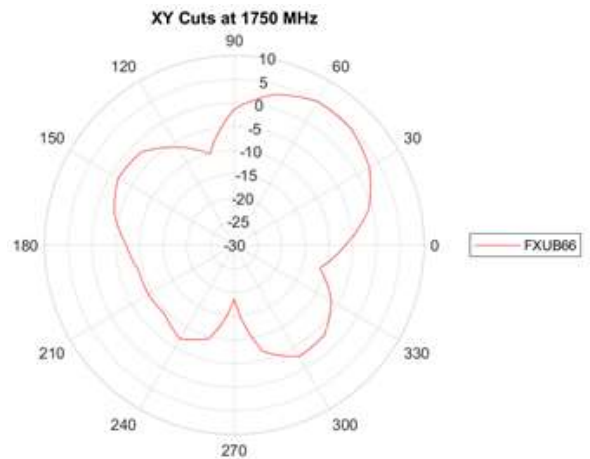
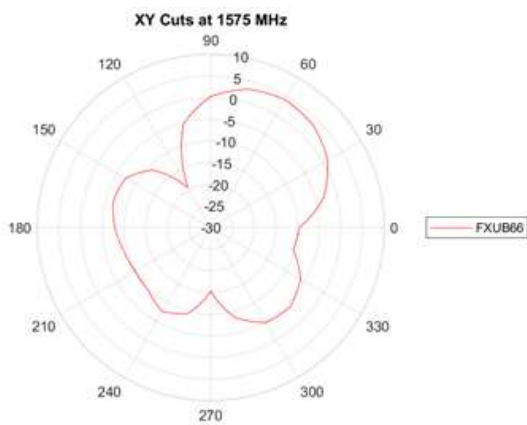
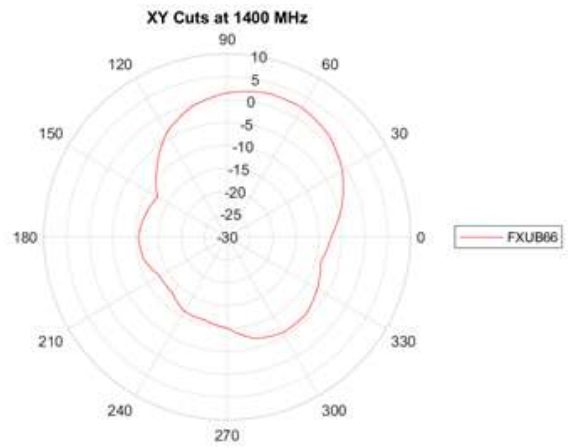
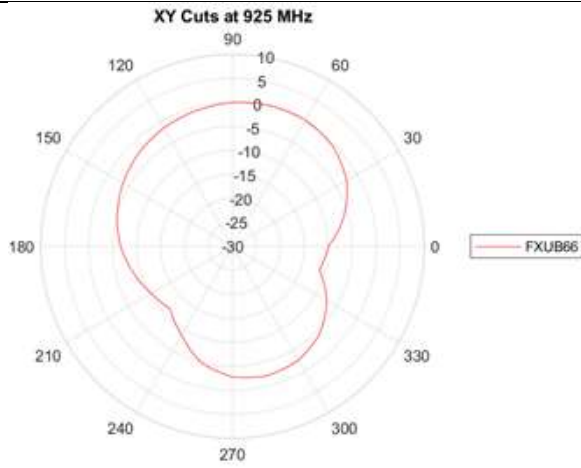
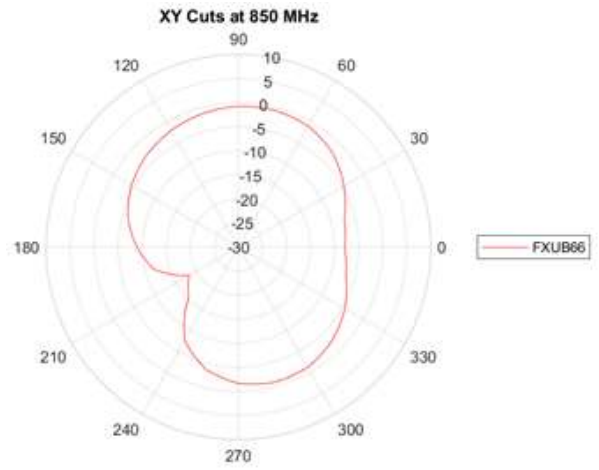
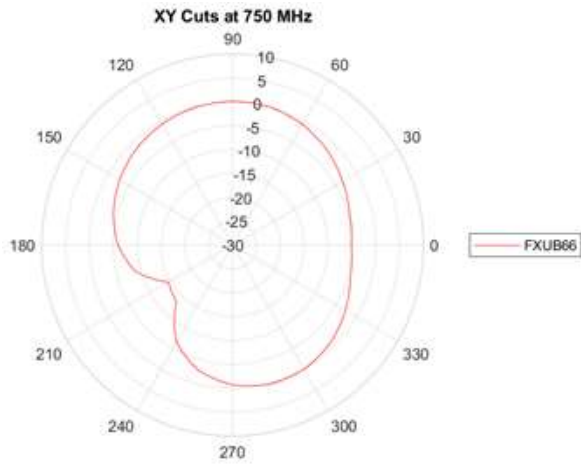

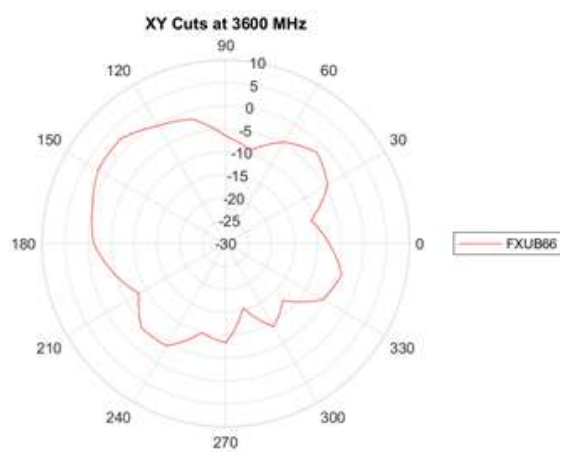
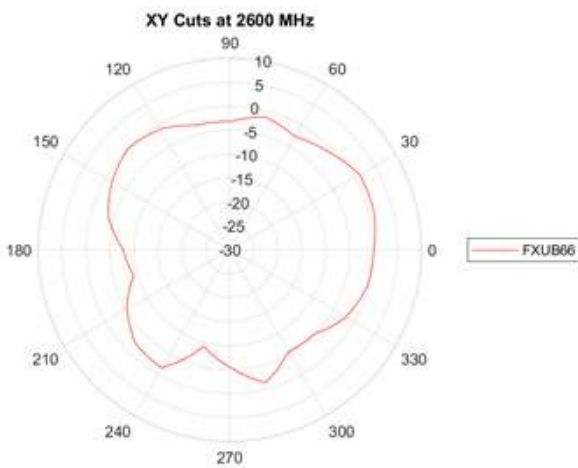
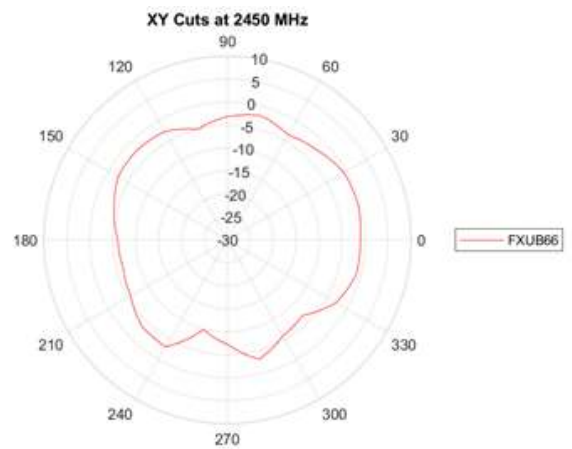
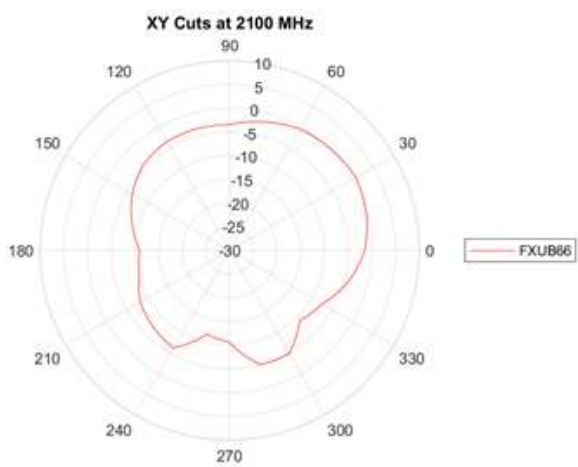
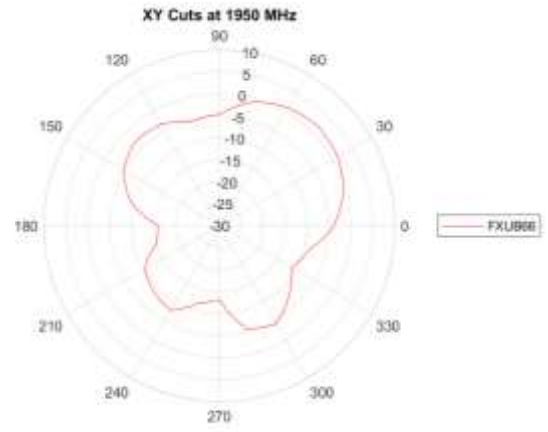
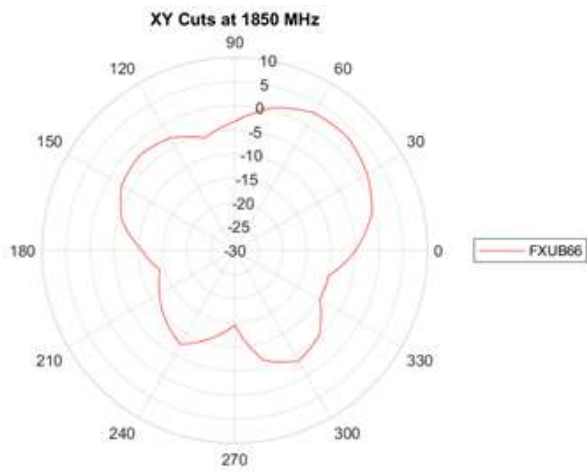

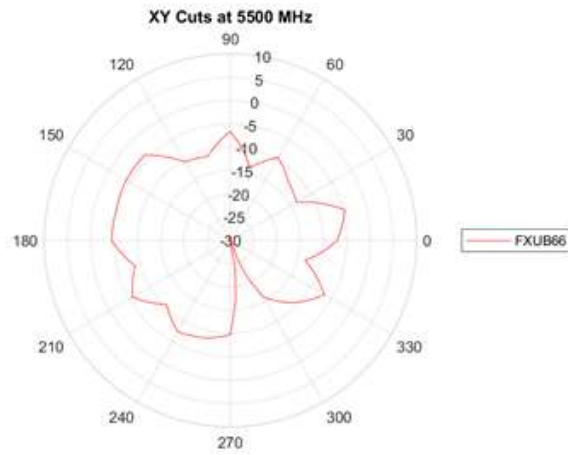

XZ Plane

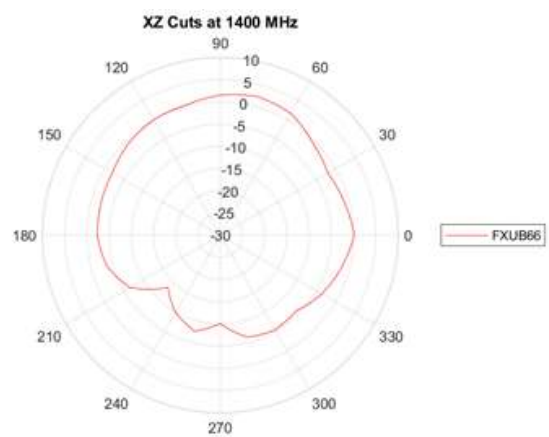
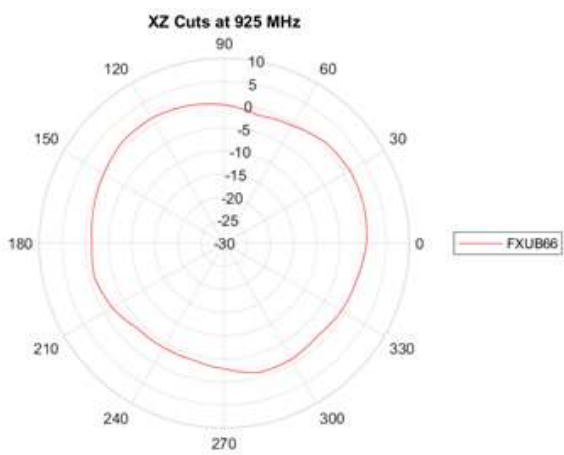
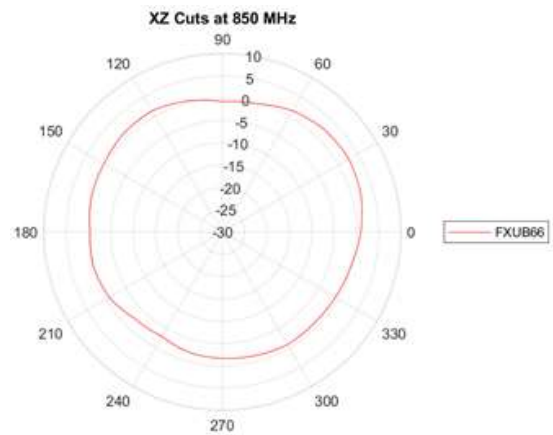
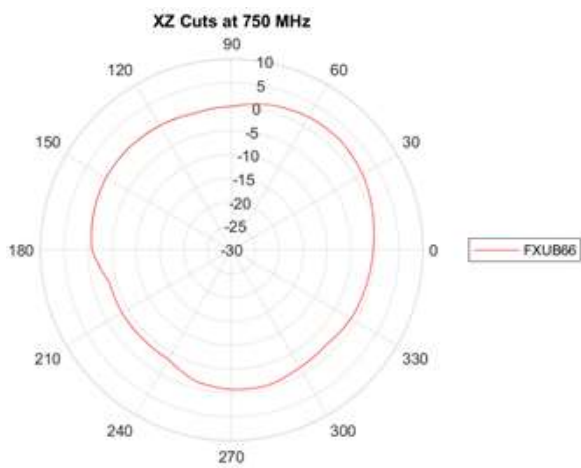

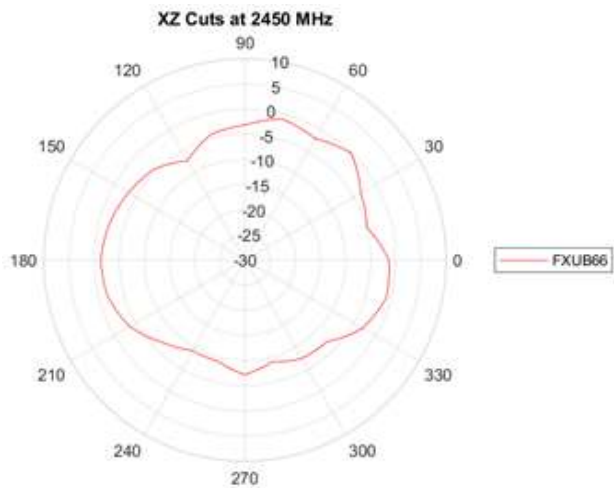
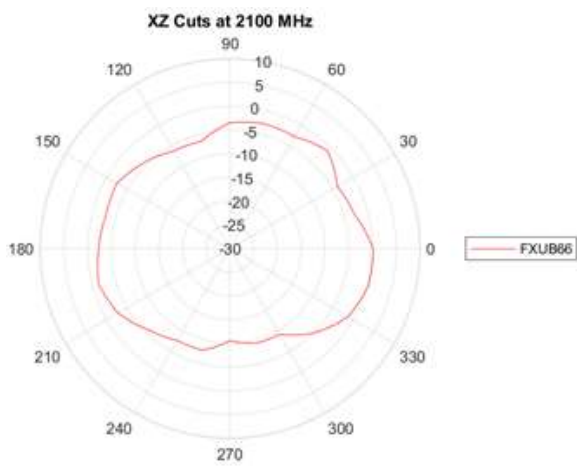
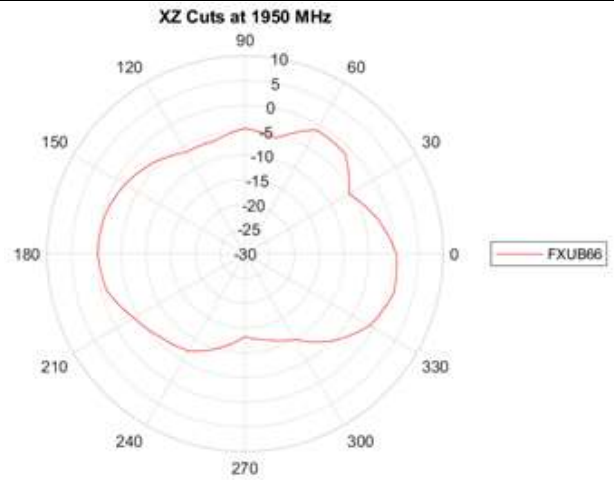
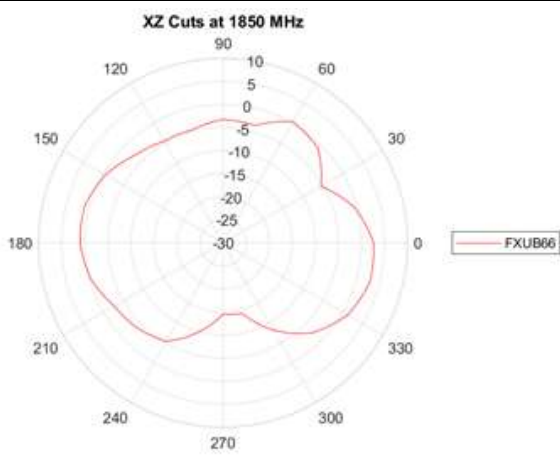
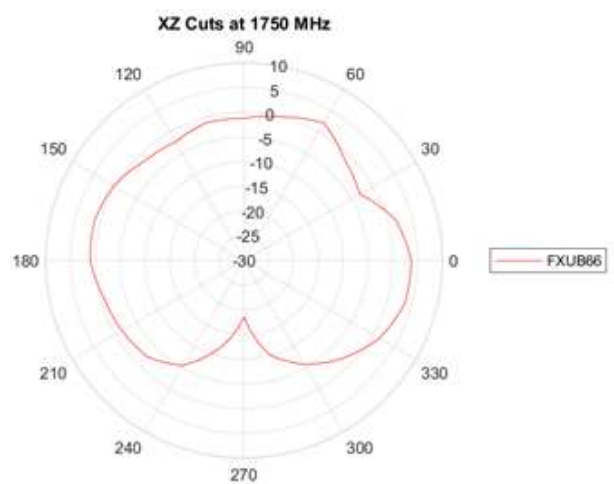
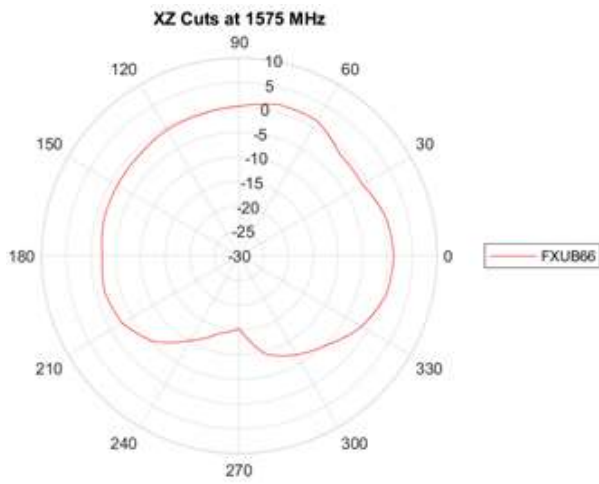

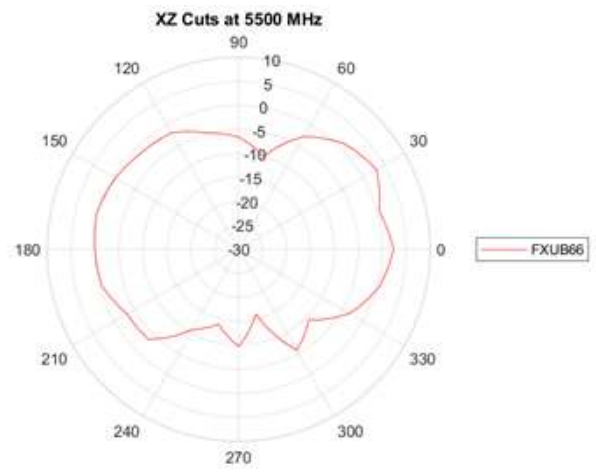
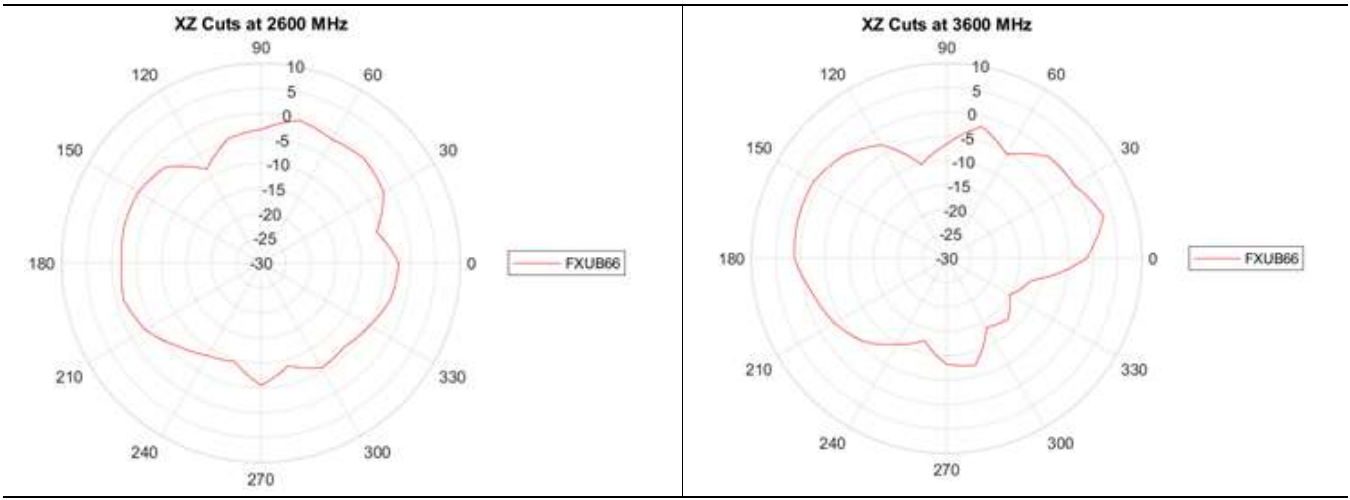

YZ Plane

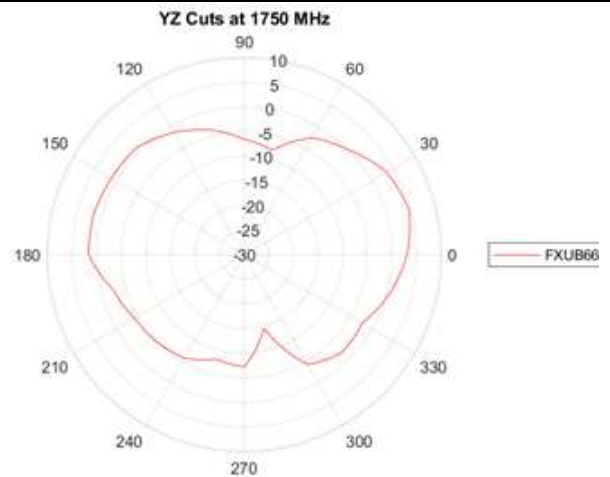
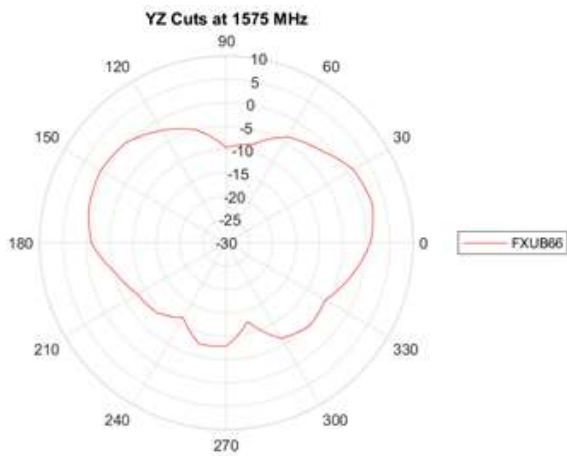
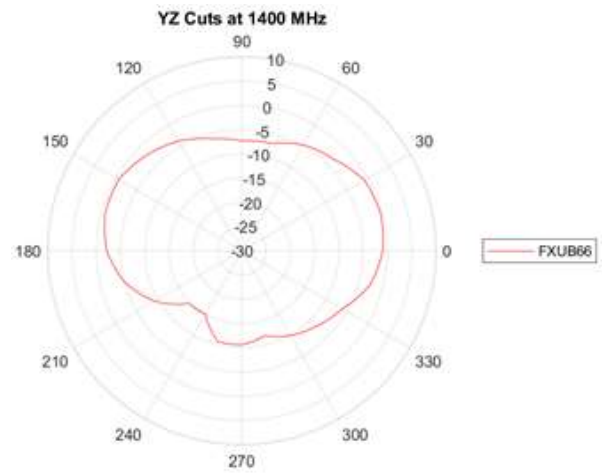
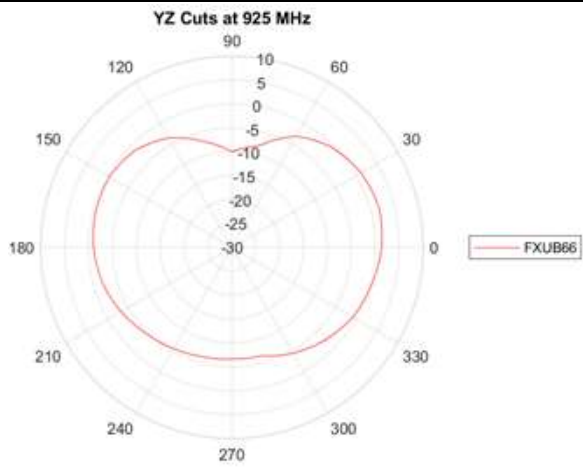
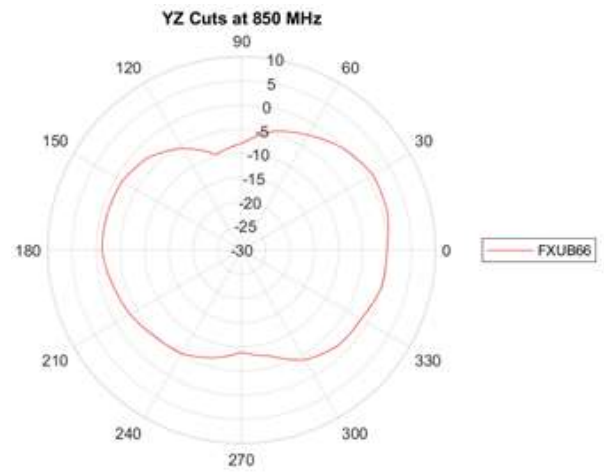
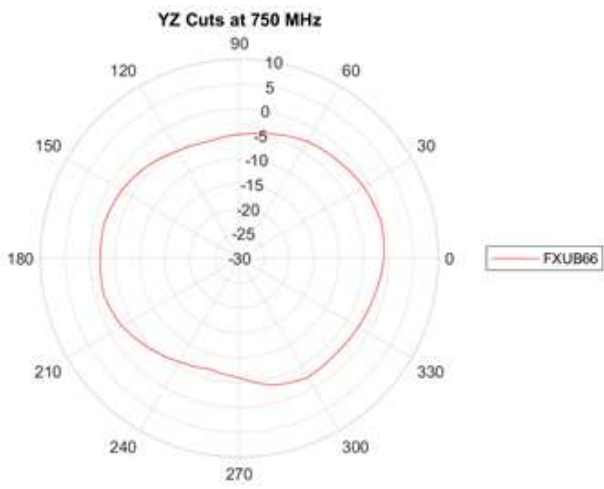

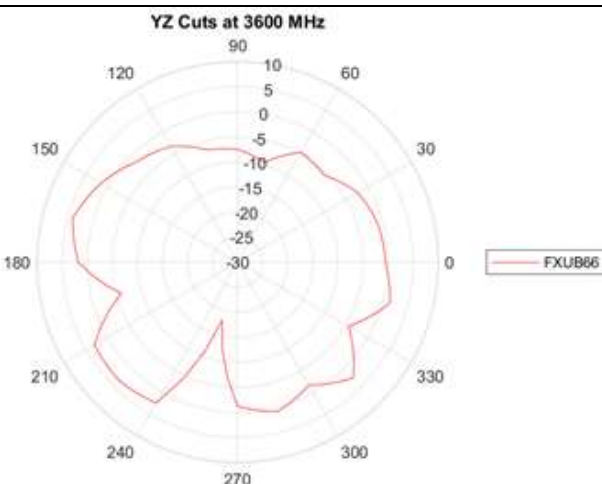
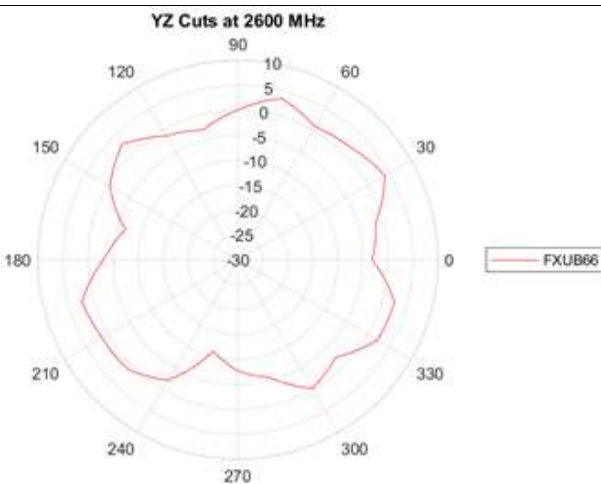
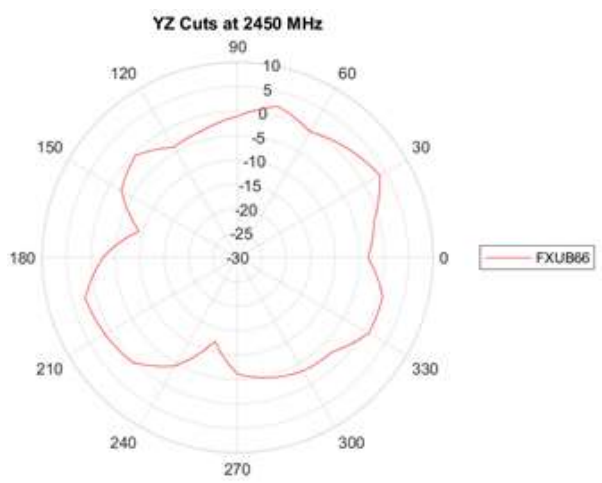
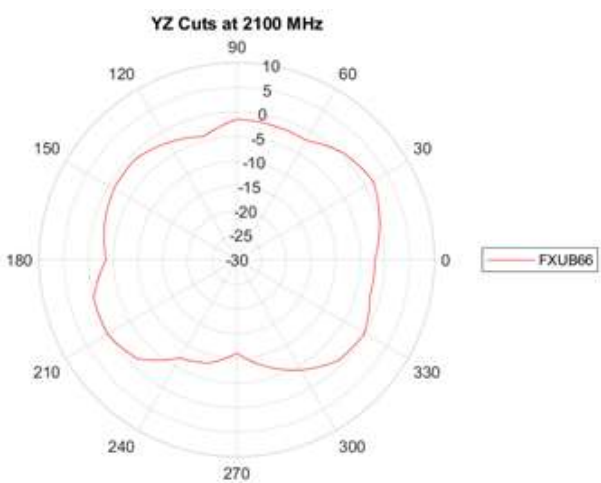
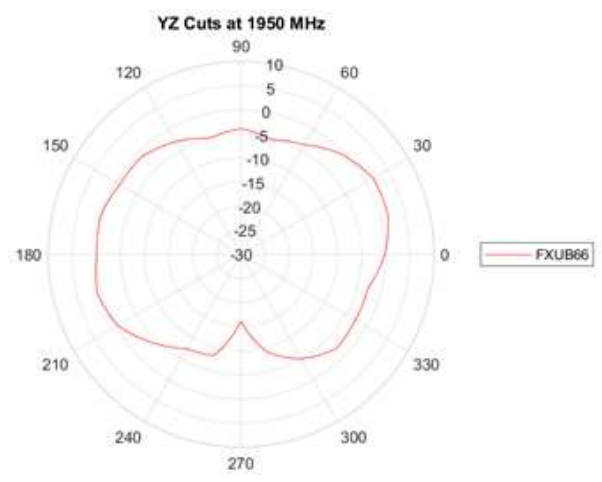
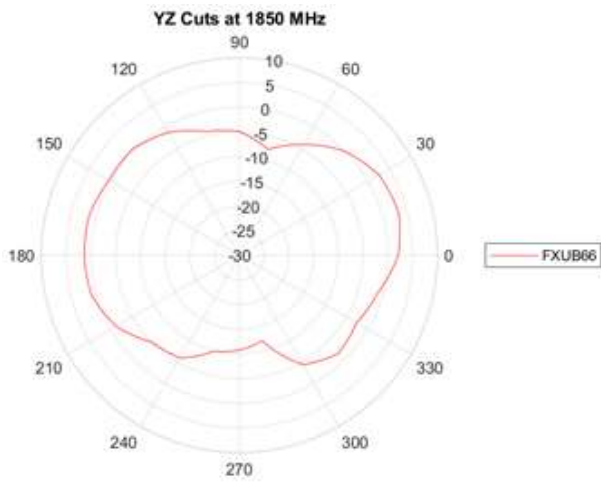

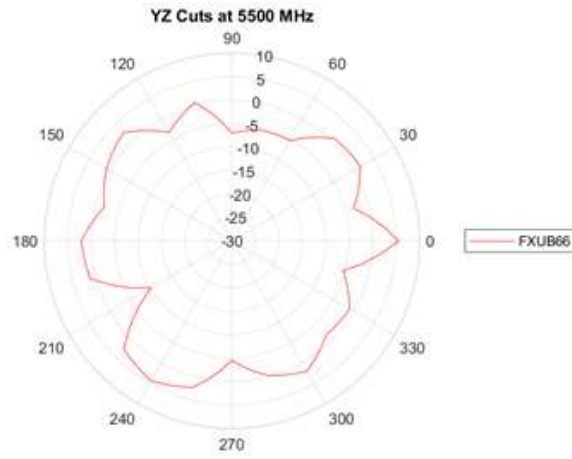

5. Mechanical Drawing (Units: mm)

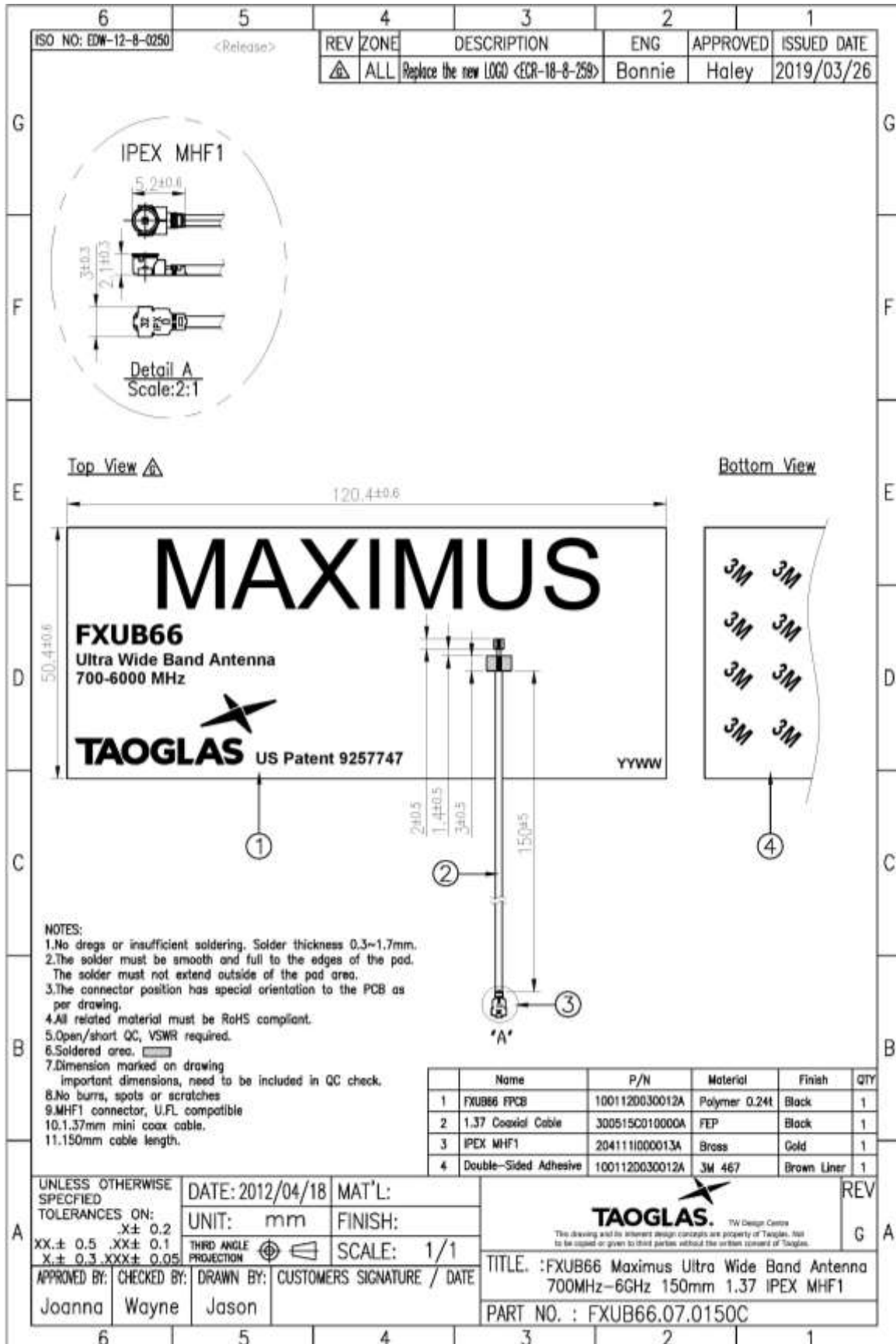

6. Packaging

100pcs FXUB66.07.0150C per PE Bag
 Bag Dimensions - 320 x 200mm
 Weight - 380g

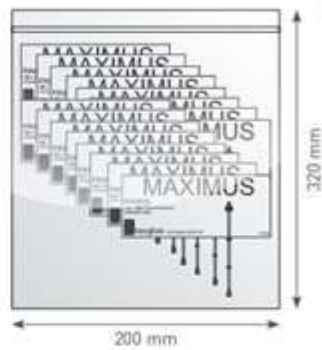

1,000 pcs FXUB66.07.0150C per carton
 Carton - 370 x 3200 x 180mm
 Weight - 4.01Kg

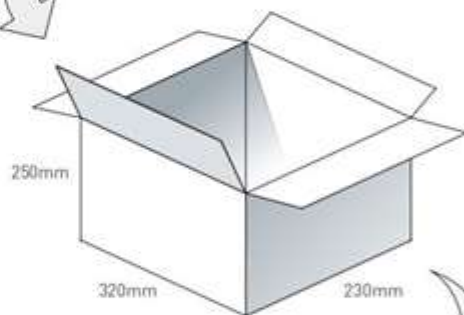

Pallet Dimensions 1200 x 1000 x 1460mm
 63 Cartons per Pallet
 9 Cartons per layer
 7 Layers

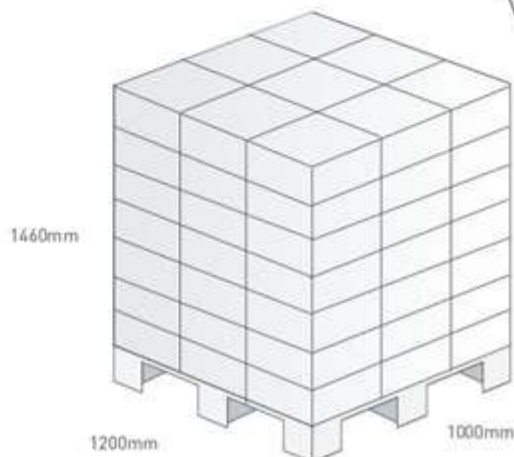

Changelog for the datasheet

SPE-12-8-040 – FXUB66.07.0150C

Revision: J (Current Version)

Date:	2020-10-20
Changes:	Updated Data
Changes Made by:	Jack Conroy

Previous Revisions

Revision: I

Date:	2019-03-26
Changes:	New data added
Changes Made by:	Jack Conroy

Revision: D

Date:	2012-09-27
Changes:	Packaging Details Updated
Changes Made by:	Aine Doyle

Revision: H

Date:	2019-03-26
Changes:	Data and Template Amended
Changes Made by:	Jack Conroy

Revision: C

Date:	2012-09-20
Changes:	Packaging Details Updated
Changes Made by:	Aine Doyle

Revision: G

Date:	2016-06-10
Changes:	Patent No. Added
Changes Made by:	Aine Doyle

Revision: B

Date:	2012-09-10
Changes:	Packaging Details Updated
Changes Made by:	Aine Doyle

Revision: F

Date:	2014-02-12
Changes:	Drawing and photo amended
Changes Made by:	Aine Doyle

Revision: A (Original First Release)

Date:	2012-04-24
Notes:	
Author:	Aine Doyle

Revision: E

Date:	2012-10-02
Changes:	Packaging Details Updated
Changes Made by:	Aine Doyle



www.taoglas.com

Mouser Electronics

Authorized Distributor

Click to View Pricing, Inventory, Delivery & Lifecycle Information:

[Taoglas:](#)

[FXUB66.07.0150C](#)