

TEST REPORT

Report Number: 19120526HKG-002

Application for Original Grant of 47 CFR Part 15 Certification

Single New Application of RSS-247 Issue 2 Equipment

This report contains the data of Bluetooth 4.0 BLE portion only.

FCC ID: ML6-BH1G2

IC: 3330A-BH1G2

Prepared and Checked by:

Approved by:

Signed On File
Wong Cheuk Ho, Herbert
Lead Engineer

Wong Kwok Yeung, Kenneth
Senior Lead Engineer
Date: February 04, 2020

TEST REPORT

GENERAL INFORMATION

Applicant Name:	Orbit Irrigation Product Inc.
Applicant Address:	845 North, Overland Road, North Salt Lake, Utah 84054 United States
FCC Specification Standard:	FCC Part 15, October 1, 2018 Edition
FCC ID:	ML6-BH1G2
FCC Model(s):	21008, 94992, 96992 (Generation 2 Hub)
IC Specification Standard:	RSS-247 Issue 2, February 2018 RSS-Gen Issue 5 Amendment 1, March 2019
IC:	3330A-BH1G2
PMN:	B-hyve WiFi hub
HVIN:	BH1G2
Type of EUT:	Spread Spectrum Transmitter
Description of EUT:	B-hyve Bluetooth to Wi-Fi Bridge
Serial Number:	N/A
Sample Receipt Date:	January 20, 2020
Date of Test:	January 20, 2020 to February 04, 2020
Report Date:	February 04, 2020
Environmental Conditions:	Temperature: +10 to 40°C Humidity: 10 to 90%
Conclusion:	Test was conducted by client submitted sample. The submitted sample as received complied with the 47 CFR Part 15 / RSS-247 Issue 2 Certification.

TEST REPORT

TABLE OF CONTENTS

1.0 TEST RESULTS SUMMARY & STATEMENT OF COMPLIANCE 4
 1.1 Summary of Test Results.....4
 1.2 Statement of Compliance.....4

2.0 GENERAL DESCRIPTION..... 5
 2.1 Product Description5
 2.2 Test Methodology6
 2.3 Test Facility6
 2.4 Related Submittal(s) Grants6

3.0 SYSTEM TEST CONFIGURATION..... 7
 3.1 Justification7
 3.2 EUT Exercising Software.....8
 3.3 Details of EUT and Description of Accessories.....9
 3.4 Measurement Uncertainty.....9

4.0 TEST RESULTS 10
 4.1 Maximum Conducted Output Power at Antenna Terminals10
 4.2 Minimum 6dB RF Bandwidth.....11
 4.3 Maximum Power Spectral Density14
 4.4 Out of Band Conducted Emissions17
 4.5 Field Strength Calculation.....22
 4.6 Transmitter Radiated Emissions in Restricted Bands and Spurious Emissions.....23
 4.6.1 Radiated Emission Configuration Photograph.....23
 4.6.2 Radiated Emission Data.....23
 4.6.3 Radiated Emission Test Setup.....28
 4.6.4 Transmitter Duty Cycle Calculation29
 4.7 AC Power Line Conducted Emission30
 4.8 Occupied Bandwidth34

5.0 EQUIPMENT LIST 35

TEST REPORT

1.0 TEST RESULTS SUMMARY & STATEMENT OF COMPLIANCE

1.1 Summary of Test Results

Test Items	FCC Part 15 Section	RSS-247/ RSS-Gen# Section	Results	Details See Section
Antenna Requirement	15.203	7.1.2#	Pass	2.1
Max. Conducted Output Power (Peak)	15.247(b)(3)&(4)	5.4(4)	Pass	4.1
Min. 6dB RF Bandwidth	15.247(a)(2)	5.2(1)	Pass	4.2
Max. Power Density (average)	15.247(e)	5.2(2)	Pass	4.3
Out of Band Antenna Conducted Emission	15.247(d)	5.5	Pass	4.4
Radiated Emission in Restricted Bands and Spurious Emissions	15.247(d), 15.209 & 15.109	5.5	Pass	4.6
AC Power Line Conducted Emission	15.207 & 15.107	7.2.4#	N/A	4.7

Note: Pursuant to FCC Part 15 Section 15.215(c), the 20dB bandwidth of the emission was contained within the frequency band designated (mentioned as above) which the EUT operated. The effects, if any, from frequency sweeping, frequency hopping, other modulation techniques and frequency stability over expected variations in temperature and supply voltage were considered.

1.2 Statement of Compliance

The equipment under test is found to be complying with the following standard:

FCC Part 15, October 1, 2018 Edition
RSS-247 Issue 2, February 2017
RSS-Gen Issue 5 Amendment 1, March 2019

TEST REPORT

2.0 GENERAL DESCRIPTION

2.1 Product Description

The Equipment Under Test (EUT) is a B-hyve Bluetooth to Wi-Fi Bridge that provides a means for Bluetooth BLE end devices to communicate to the b-hyve system 2.4GHz wifi servers. The Bluetooth BLE radio is for communication between end devices while the WIFI radio is for communication to access point. The Bluetooth BLE and WIFI radios will not be able to operate simultaneously as declared by the applicant.

For IC, the only Model is HVIN: BH1G2.

For FCC, the Model: 21008, 94992, 96992 (Generation 2 Hub) are the same as the IC HVIN: BH1G2 in hardware aspect. The difference in model number and brand name serves as marketing strategy.

The tested model is HVIN: BH1G2.

For 802.11b mode, it operates at frequency range of 2412.000MHz to 2462.000MHz with 11 channels. It transmits via Direct-sequence spread spectrum (DSSS) modulation. Maximum bit rate can be up to 11Mbps.

For 802.11g mode, it operates at frequency range of 2412.000MHz to 2462.000MHz with 11 channels. It transmits via Orthogonal Frequency Division Multiplexing (OFDM) modulation. Maximum bit rate can be up to 54Mbps.

For 802.11n (with 20MHz bandwidth) mode, it operates at frequency range of 2412.000MHz to 2462.000MHz with 11 channels. It transmits via Orthogonal Frequency Division Multiplexing (OFDM) modulation. Maximum bit rate can support up to 65Mbps.

For Bluetooth 4.0 BLE mode, it occupies a frequency range from 2402MHz to 2480MHz (40 channels with channel spacing of 2MHz). It transmits via GFSK modulation.

The EUT is power by AC/DC adaptor (5VDC output).

The antenna(s) used in the EUT is integral, and the test sample is a prototype.

The circuit description is saved with filename: descri.pdf.

This report covers the test result of Bluetooth BLE portion only.

TEST REPORT

2.2 Test Methodology

Both AC power line-conducted and radiated emission measurements were performed according to the procedures in ANSI C63.10 (2013). Preliminary radiated scans and all radiated measurements were performed in radiated emission test sites. All Radiated tests were performed at an antenna to EUT distance of 3 meters, unless stated otherwise in the "**Justification Section**" of this Application. Antenna port conducted measurements were performed according to ANSI C63.10 (2013) and KDB Publication No.558074 D01 v05r01 (11-February-2019) All other measurements were made in accordance with the procedures in 47 CFR Part 2 and RSS-Gen Issue 5 + Amendment 1, March 2019).

2.3 Test Facility

The radiated emission test site and antenna port conducted measurement facility used to collect the radiated data and conductive data are at Workshop No. 3, G/F., World-Wide Industrial Centre, 43-47 Shan Mei Street, Fo Tan, Sha Tin, N.T., Hong Kong SAR, China. This test facility and site measurement data have been fully placed on file with the FCC and Industry Canada No.: 2042H.

2.4 Related Submittal(s) Grants

This is a single application for certification of a transceiver (Bluetooth BLE portion).

TEST REPORT

3.0 SYSTEM TEST CONFIGURATION

3.1 Justification

For radiated emissions testing, the equipment under test (EUT) was setup to transmit / receive continuously to simplify the measurement methodology. Care was taken to ensure proper power supply voltages during testing. During testing, all cables (if any) were manipulated to produce worst case emissions.

The EUT was powered by AC/DC adaptor Model: SA9405-050100US (Input: 120-240VAC 50-60Hz 0.2A; Output 5V 1A).

For the measurements, the EUT was attached to a plastic stand if necessary and placed on the wooden turntable. If the base unit attached to peripherals, they were connected and operational (as typical as possible).

The signal was maximized through rotation and placement in the three orthogonal axes. The antenna height and polarization were varied during the search for maximum signal level. The antenna height was varied from 1 to 4 meters. Radiated emissions were taken at three meters unless the signal level was too low for measurement at that distance. If necessary, a pre-amplifier was used and/or the test was conducted at a closer distance.

For any intentional radiator powered by AC power line, measurements of the radiated signal level of the fundamental frequency component of the emission was performed with the supply voltage varied between 85% and 115% of the nominal rated supply voltage.

Radiated emission measurement for transmitter were performed from the lowest radio frequency signal generated in the device which is greater than 9 kHz to the tenth harmonic of the highest fundamental frequency or to 40 GHz, whichever is lower.

Emission that are directly caused by digital circuits in the transmit path and transmitter portion were measured, and the limit are according to FCC Part 15 Section 15.209 / RSS-247 2.5. Digital circuitries used to control additional functions other than the operation of the transmitter are subject to FCC Part 15 Section 15.109 / RSS-247 Section 5.5 Limits.

TEST REPORT

3.1 Justification – Cont'd

Detector function for radiated emissions was in peak mode. Average readings, when required, were taken by measuring the duty cycle of the equipment under test and subtracting the corresponding amount in dB from the measured peak readings. A detailed description for the calculation of the average factor can be found in section 4.8.3.

Determination of pulse desensitization was made according to *Hewlett Packard Application Note 150-2, Spectrum Analysis... Pulsed RF*. The effective period (Teff) was referred to Exhibit 4.8.3. With the resolution bandwidth 3MHz and spectrum analyzer IF bandwidth 3dB, the pulse desensitization factor was 0dB.

For AC line conducted emission test, the EUT along with its peripherals were placed on a 1.0m(W)x1.5m(L) and 0.8m in height wooden table and the EUT was adjusted to maintain a 0.4 meter space from a vertical reference plane. The EUT was connected to power mains through a line impedance stabilization network (LISN), which provided 50ohm coupling impedance for measuring instrument. The LISN housing, measuring instrument case, reference ground plane, and vertical ground plane were bounded together. The excess power cable between the EUT and the LISN was bundled.

All connecting cables of EUT and peripherals were manipulated to find the maximum emission.

Different data rates and operating mode have been tested. Worst case is reported only.

3.2 EUT Exercising Software

The EUT exercise program (if any) used during radiated and conducted testing was designed to exercise the various system components in a manner similar to a typical use.

TEST REPORT

3.3 Details of EUT and Description of Accessories

Details of EUT:

An AC/DC adaptor (provided with the unit) was used to power the device. The description is listed below.

- (1) AC/DC adaptor Model: SA9405-050100US (Input: 120-240VAC 50-60Hz 0.2A; Output 5V 1A)
(Provided by applicant)

Description of Accessories:

N/A

3.4 Measurement Uncertainty

When determining of the test conclusion, the Measurement Uncertainty of test at a level of confidence of 95% has been considered. The values of the Measurement uncertainty for radiated emission test and RF conducted measurement test are $\pm 5.3\text{dB}$ and $\pm 0.99\text{dB}$ respectively. The value of the Measurement uncertainty for conducted emission test is $\pm 4.2\text{dB}$.

Uncertainty and Compliance - Unless the standard specifically states that measured values are to be extended by the measurement uncertainty in determining compliance, all compliance determinations are based on the actual measured value.

TEST REPORT

4.0 TEST RESULTS

4.1 Maximum Conducted (peak) Output Power at Antenna Terminals

RF Conduct Measurement Test Setup

The figure below shows the test setup, which is utilized to make these measurements.

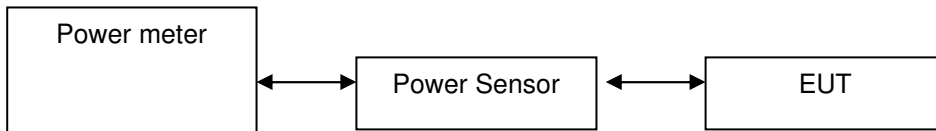

The antenna port of the EUT was connected to the input of a spectrum analyzer.

- The antenna power of the EUT was connected to the input of a power meter. Power was read directly and cable loss correction was added to the reading to obtain power at the EUT antenna terminals. The measurement procedure 9.1.2 was used.
- The EUT should be configured to transmit continuously (at a minimum duty cycle of 98%) at full power over the measurement duration. The measurement procedure AVG1 was used.

Antenna Gain = 0 dBi

Frequency (MHz)	Output in dBm	Output in mWatt
Low Channel: 2402	7.9	6.2
Middle Channel: 2440	8.3	6.8
High Channel: 2480	8.5	7.1

Cable loss : 0.5 dB External Attenuation : 0 dB

Cable loss, external attenuation: included in OFFSET function
 added to SA raw reading

Max. conducted (peak) output level = 8.5 dBm

Limits:

- 1W (30dBm) for antennas with gains of 6dBi or less
- ___W (___dBm) for antennas with gains more than 6dBi

TEST REPORT

4.2 Minimum 6dB RF Bandwidth

The antenna port of the EUT was connected to the input of a spectrum analyzer. The EBW measurement procedure was used. A PEAK output reading was taken, a DISPLAY line was drawn 6dB lower than PEAK level. The 6dB bandwidth was determined from where the channel output spectrum intersected the display line.

	Frequency (MHz)	6dB Bandwidth (MHz)
Low Channel:	2402	0.744
Middle Channel:	2440	0.738
High Channel:	2480	0.738

Limits

6 dB bandwidth shall be at least 500kHz

The plots of 6dB RF bandwidth are saved as below.

TEST REPORT

PLOTS OF 6dB RF BANDWIDTH

Lowest Channel

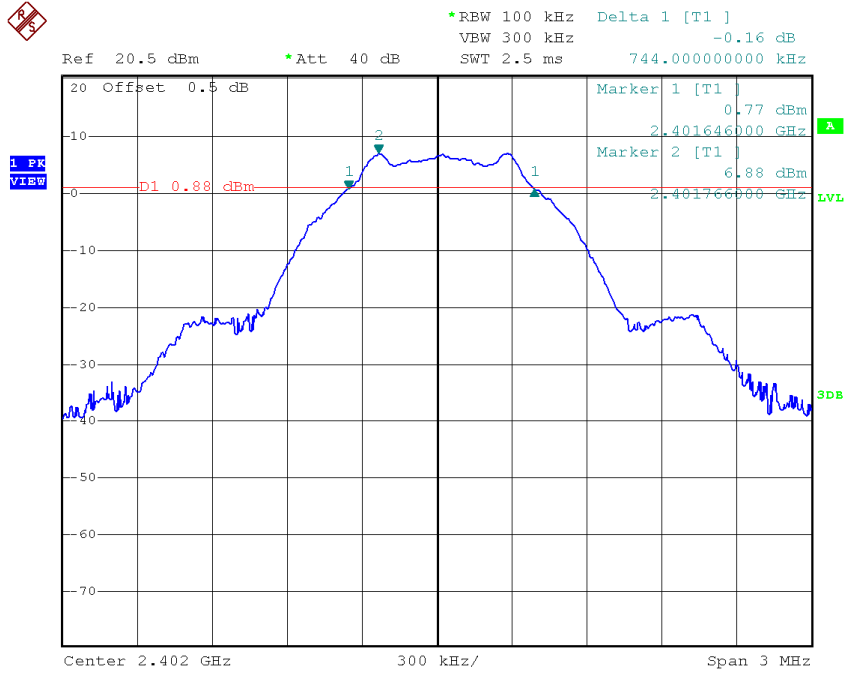

Middle Channel

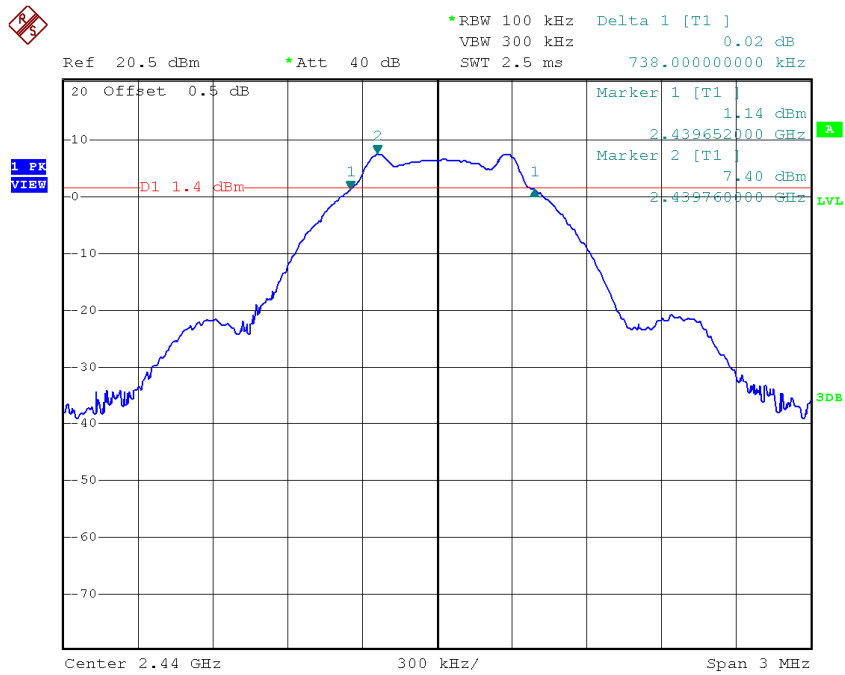

TEST REPORT

PLOTS OF 6dB RF BANDWIDTH

Highest Channel

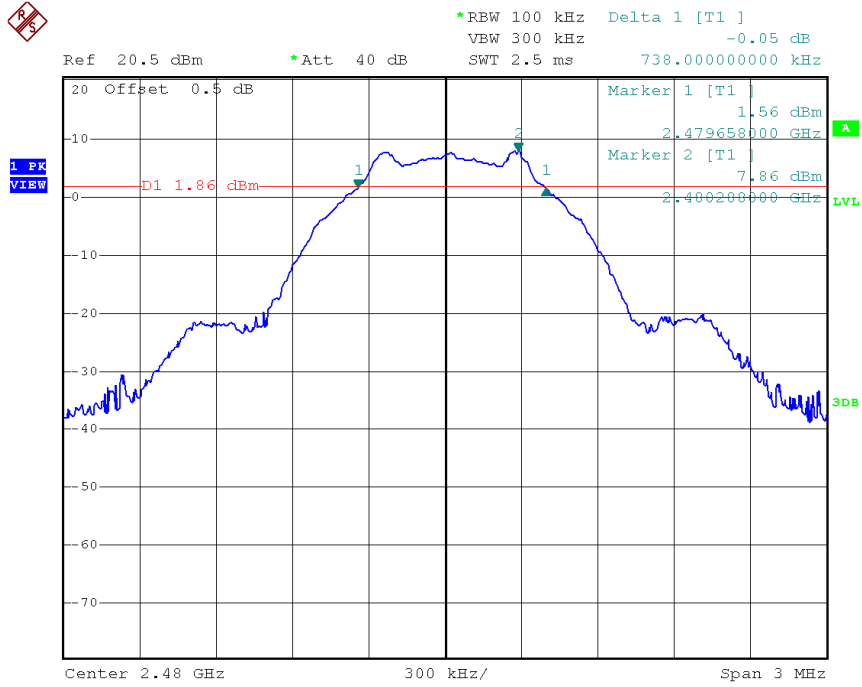

TEST REPORT

4.3 Maximum Power Spectral Density

Antenna output of the EUT was coupled directly to spectrum analyzer. The measurement procedure 10.2 PKPSD was used. If an external attenuator and/or cable was used, these losses are compensated for using the OFFSET function of the analyser.

Frequency (MHz)		PSD in 100kHz (dBm)
Low Channel:	2402	6.90
Middle Channel:	2440	7.58
High Channel:	2480	7.90

Cable Loss: 0.5 dB

Limit:
8dBm

The plots of power spectral density are as below.

TEST REPORT

PLOTS OF POWER SPECTRAL DENSITY

Lowest channel

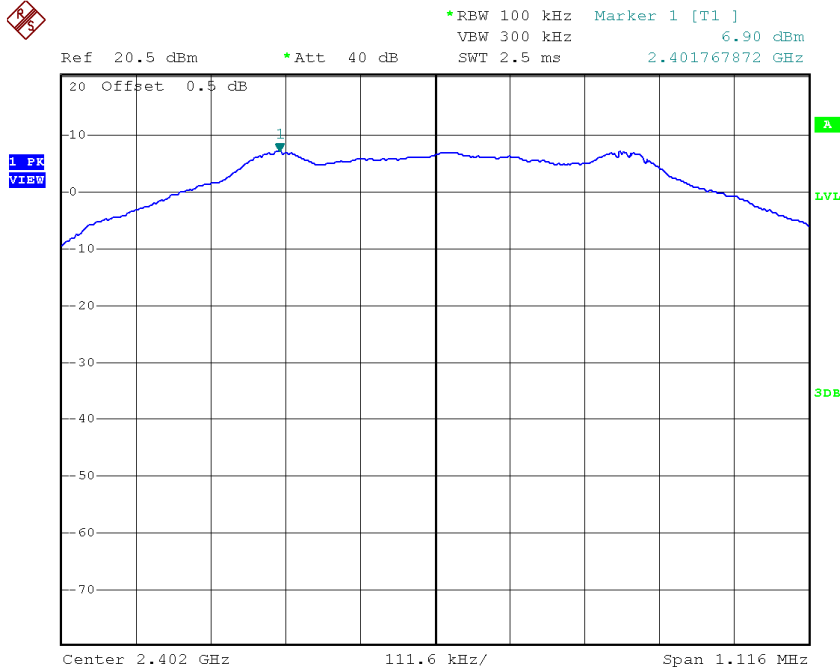

Middle channel

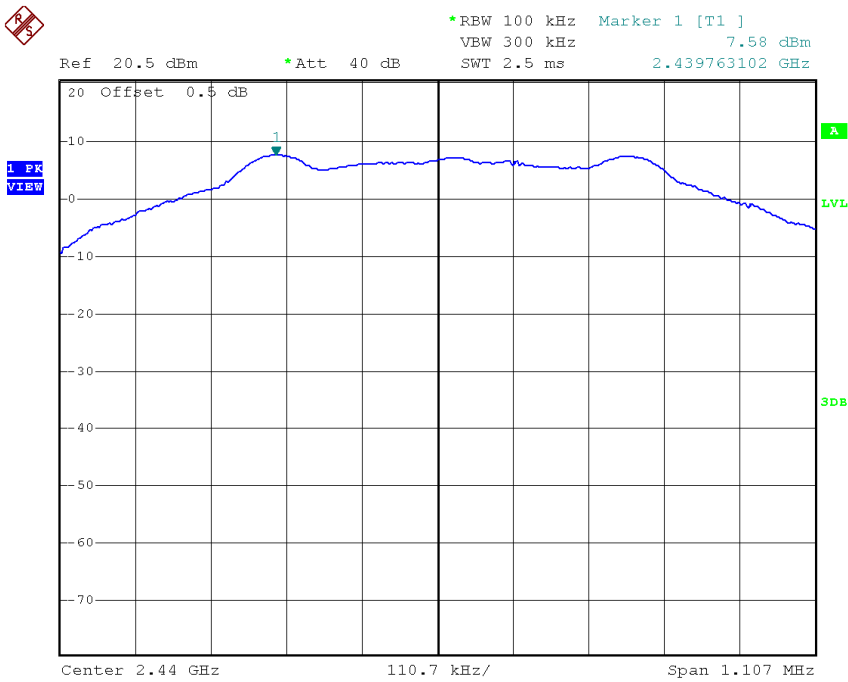

TEST REPORT

PLOTS OF POWER SPECTRAL DENSITY

Highest channel

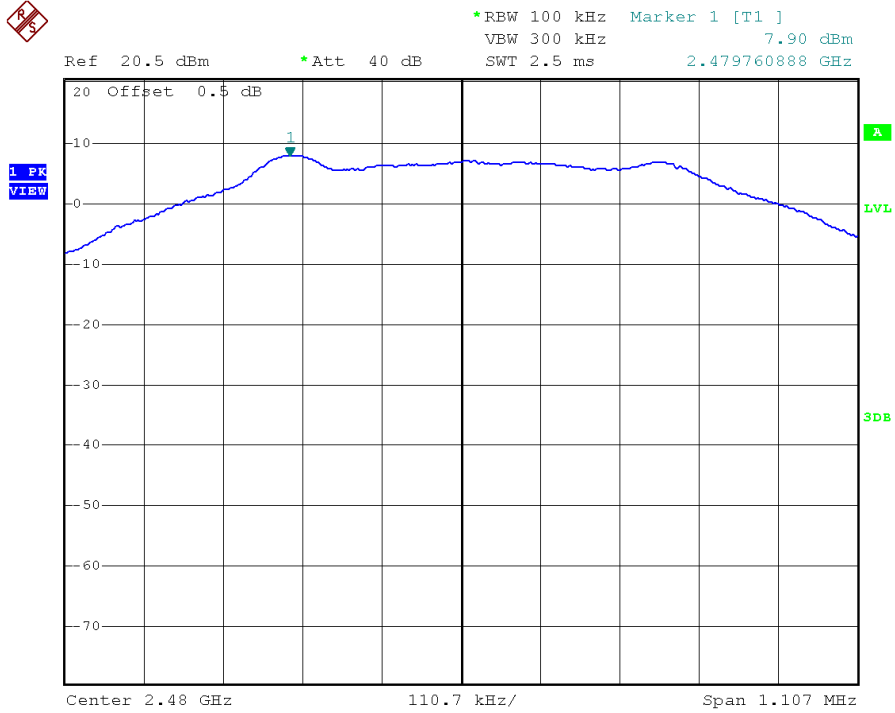

TEST REPORT

4.4 Out of Band Conducted Emissions

For Bluetooth 4.0 BLE, the maximum conducted (peak) output power was used to demonstrate compliance as described in 9.1. Then the display line (in red) shown in the following plots denotes the limit at 20dB below maximum measured in-band peak PSD level in 100 KHz bandwidth for Bluetooth 4.0 BLE.

The measurement procedures under sections 11 of KDB558074 D01 v05r01 (11-February-2019) were used.

Furthermore, delta measurement technique for measuring bandedge emissions was incorporated in the test of the edge at 2483.5MHz.

Limits:

All spurious emission and up to the tenth harmonic was measured and they were found to be at least for Bluetooth 4.0 BLE below the maximum measured in-band peak PSD level.

TEST REPORT

PLOTS OF OUT OF BAND CONDUCTED EMISSIONS

Lowest Channel, Bandedge

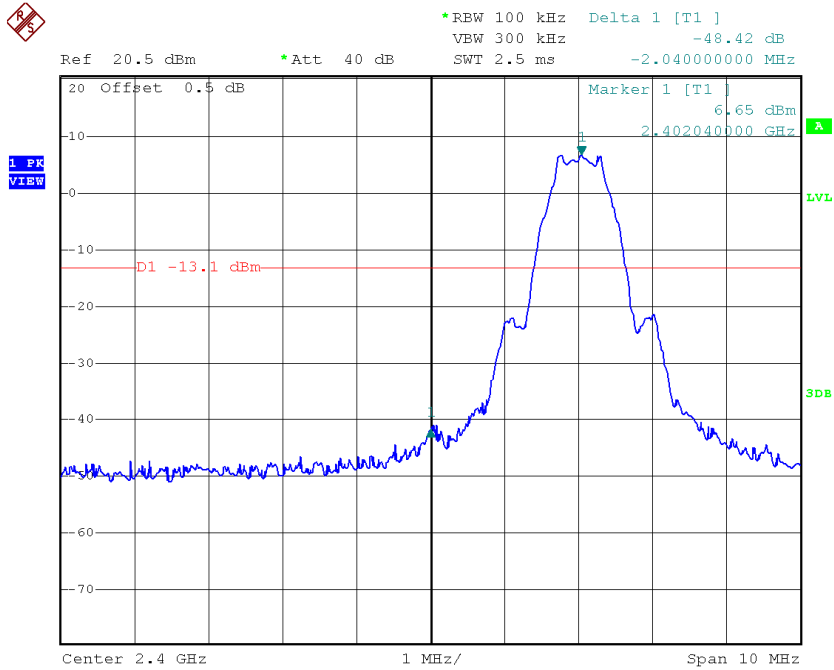

Highest Channel, Bandedge

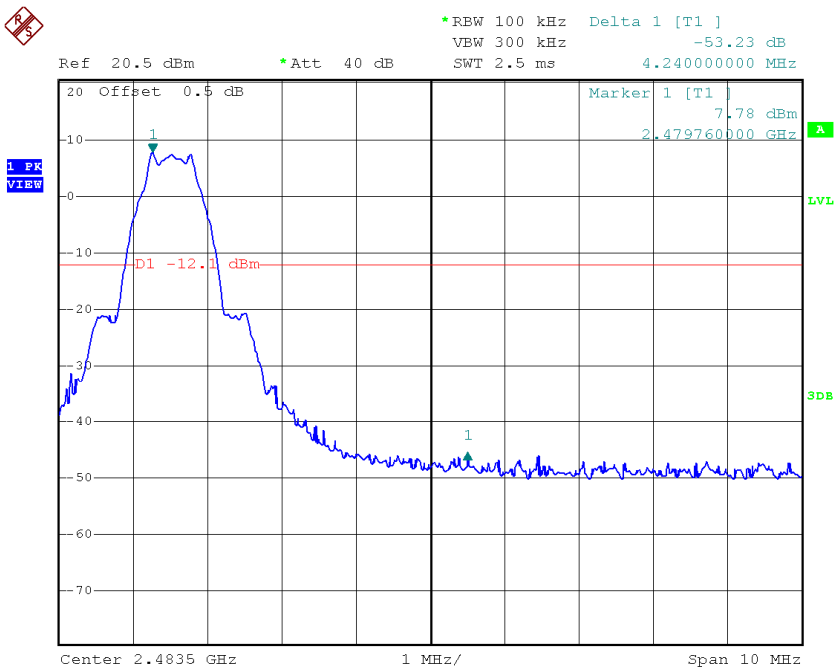

TEST REPORT

PLOTS OF OUT OF BAND CONDUCTED EMISSIONS

Lowest Channel, Plot A

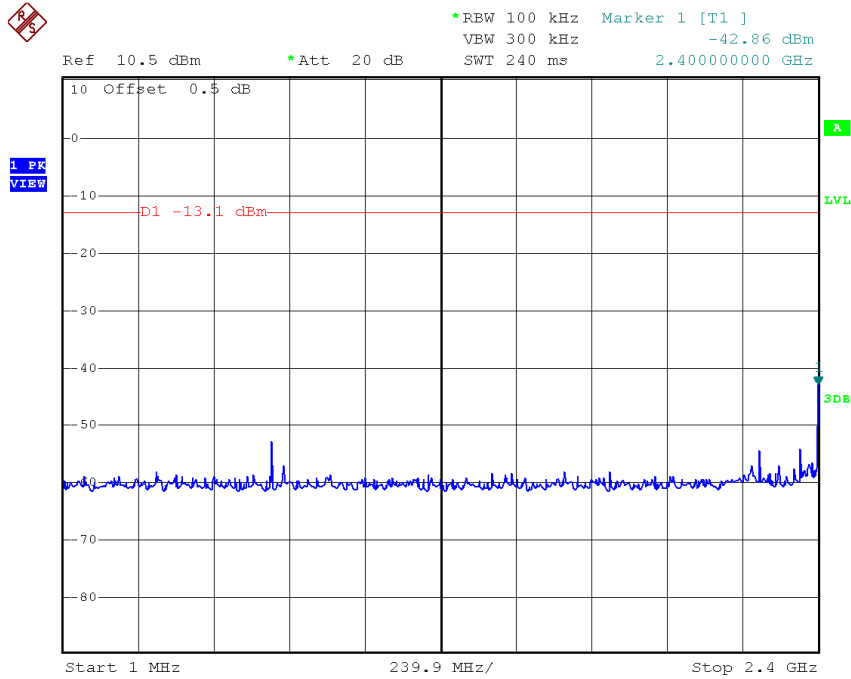

Lowest Channel, Plot B

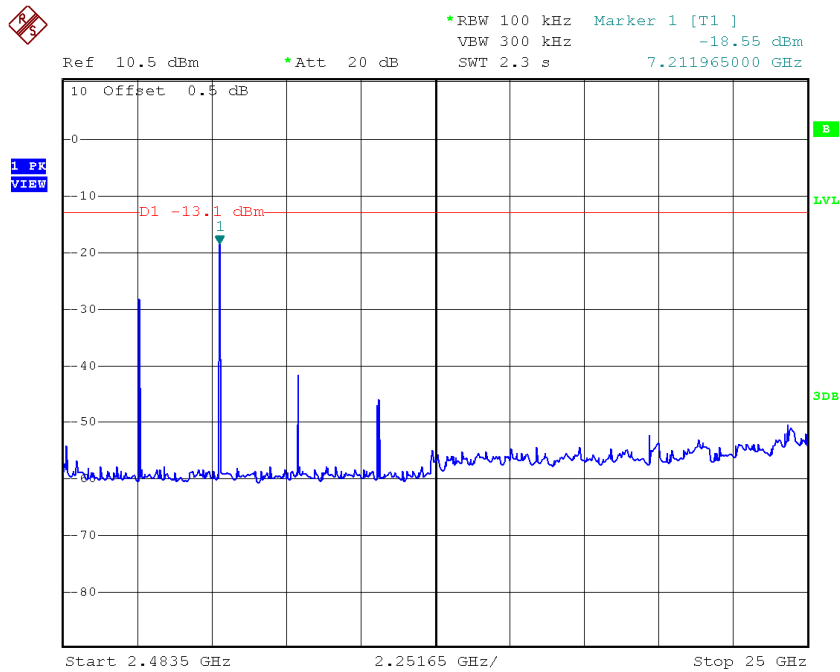

TEST REPORT

PLOTS OF OUT OF BAND CONDUCTED EMISSIONS

Middle Channel, Plot A

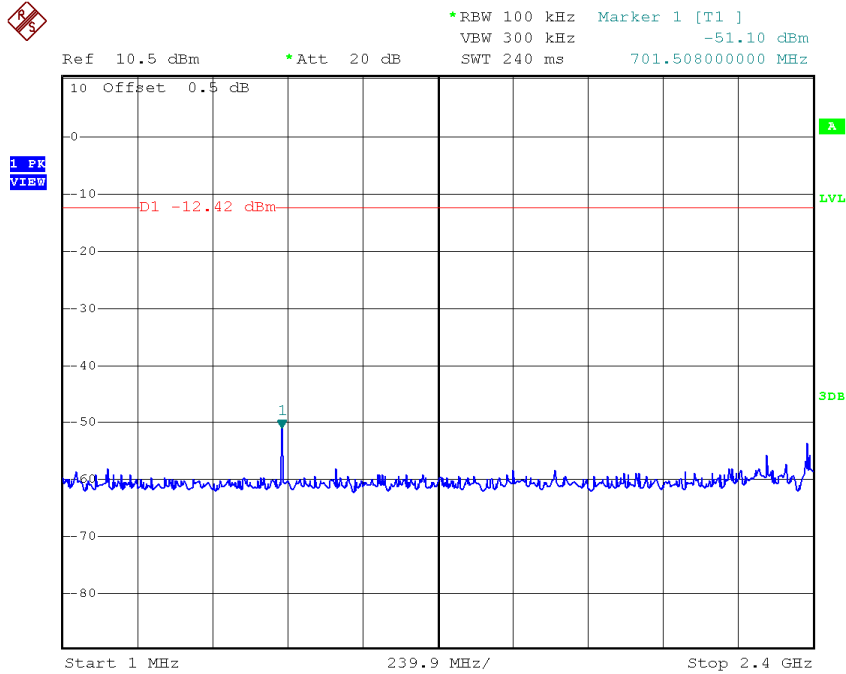

Middle Channel, Plot B

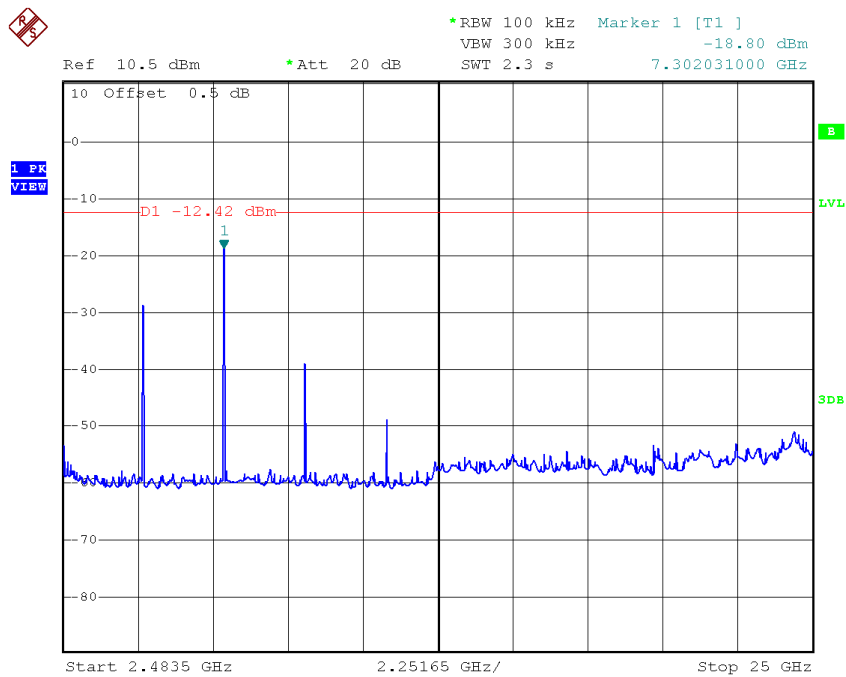

TEST REPORT

PLOTS OF OUT OF BAND CONDUCTED EMISSIONS

Highest Channel, Plot A

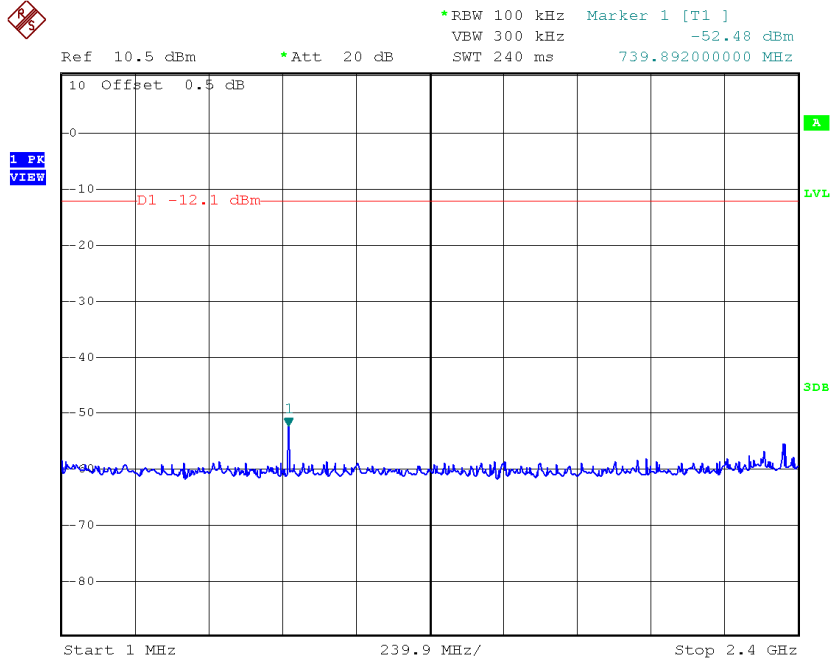

Highest Channel, Plot B

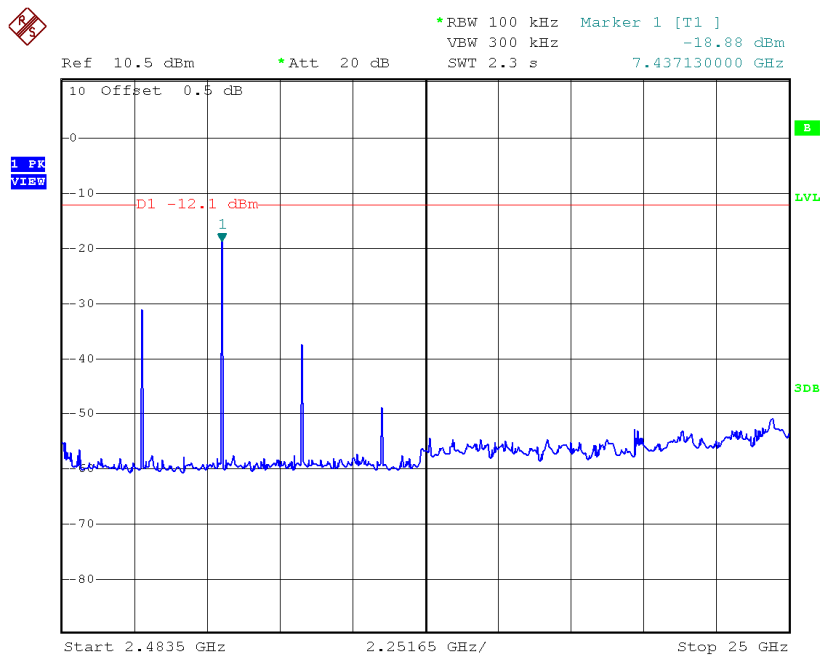

TEST REPORT

4.5 Field Strength Calculation

The field strength is calculated by adding the reading on the Spectrum Analyzer to the factors associated with preamplifiers (if any), antennas, cables, pulse desensitization and average factors (when specified limit is in average and measurements are made with peak detectors). A sample calculation is included below.

$$FS = RA + AF + CF - AG + PD + AV$$

Where FS = Field Strength in dB μ V/m

RA = Receiver Amplitude (including preamplifier) in dB μ V

CF = Cable Attenuation Factor in dB

AF = Antenna Factor in dB

AG = Amplifier Gain in dB

PD = Pulse Desensitization in dB

AV = Average Factor in -dB

In the radiated emission table which follows, the reading shown on the data table may reflect the preamplifier gain. An example of the calculations, where the reading does not reflect the preamplifier gain, follows:

$$FS = RA + AF + CF - AG + PD + AV$$

Example

Assume a receiver reading of 62.0 dB μ V is obtained. The antenna factor of 7.4 dB and cable factor of 1.6 dB is added. The amplifier gain of 29.0 dB is subtracted. The pulse desensitization factor of the spectrum analyzer is 0.0 dB, and the resultant average factor is -10.0 dB. The net field strength for comparison to the appropriate emission limit is 32.0 dB μ V/m. This value in dB μ V/m is converted to its corresponding level in μ V/m.

$$RA = 62.0 \text{ dB}\mu\text{V}$$

$$AF = 7.4 \text{ dB}$$

$$CF = 1.6 \text{ dB}$$

$$AG = 29.0 \text{ dB}$$

$$PD = 0.0 \text{ dB}$$

$$AV = -10 \text{ dB}$$

$$FS = 62.0 + 7.4 + 1.6 - 29.0 + 0.0 + (-10.0) = 32.0 \text{ dB}\mu\text{V/m}$$

$$\text{Level in } \mu\text{V/m} = \text{Common Antilogarithm } [(32.0 \text{ dB}\mu\text{V/m})/20] = 39.8 \mu\text{V/m}$$

TEST REPORT

4.6 Transmitter Radiated Emissions in Restricted Bands and Spurious Emissions

Data is included of the worst case configuration (the configuration which resulted in the highest emission levels). A sample calculation, configuration photographs and data tables of the emissions are included.

The data on the following pages list the significant emission frequencies, the limit and the margin of compliance.

4.6.1 Radiated Emission Configuration Photograph

Worst Case Restricted Band Radiated Emission
at

2390 MHz

The worst case radiated emission configuration photographs are saved with filename: config photos.pdf

4.6.2 Radiated Emission Data

The data in tables 1-4 list the significant emission frequencies, the limit and the margin of compliance.

Judgement -

Passed by 0.4 dB margin

TEST REPORT

RADIATED EMISSION DATA

Mode: TX-Channel 00

Table 1

Polarization	Frequency (MHz)	Reading (dBµV)	Pre-Amp Gain (dB)	Antenna Factor (dB)	Net at 3m - Average (dBµV/m)	Average Limit at 3m (dBµV/m)	Margin (dB)
V	2390.000	57.2	33	29.4	53.6	54.0	-0.4
V	4804.000	43.7	33	34.9	45.6	54.0	-8.4
V	12010.000	40.7	33	40.5	48.2	54.0	-5.8

Polarization	Frequency (MHz)	Reading (dBµV)	Pre-Amp Gain (dB)	Antenna Factor (dB)	Net at 3m - Peak (dBµV/m)	Peak Limit at 3m (dBµV/m)	Margin (dB)
V	2390.000	75.6	33	29.4	72.0	74.0	-2.0
V	4804.000	46.1	33	34.9	48.0	74.0	-26.0
V	12010.000	42.5	33	40.5	50.0	74.0	-24.0

- NOTES:
1. Peak detector is used for the emission measurement.
 2. All measurements were made at 3 meters. Radiated emissions not detected at the 3-meter distance were measured at 0.3-meter and an inverse proportional extrapolation was performed to compare the signal level to the 3-meter limit. No other radiated emissions than those reported were detected at a test distance of 0.3-meter.
 3. Negative value in the margin column shows emission below limit.
 4. Horn antenna is used for the emission over 1000MHz.
 5. Emission (the row indicated by **bold italic**) within the restricted band meets the requirement of FCC Part 15 Section 15.205 / RSS-Gen Section 8.10.

TEST REPORT

Mode: TX-Channel 20

Table 2

Polarization	Frequency (MHz)	Reading (dBµV)	Pre-Amp Gain (dB)	Antenna Factor (dB)	Net at 3m - Average (dBµV/m)	Average Limit at 3m (dBµV/m)	Margin (dB)
V	4880.000	42.5	33	34.9	44.4	54.0	-9.6
V	7320.000	41.9	33	37.9	46.8	54.0	-7.2
V	12200.000	42.3	33	40.5	49.8	54.0	-4.2

Polarization	Frequency (MHz)	Reading (dBµV)	Pre-Amp Gain (dB)	Antenna Factor (dB)	Net at 3m - Peak (dBµV/m)	Peak Limit at 3m (dBµV/m)	Margin (dB)
V	4880.000	46.3	33	34.9	48.2	74.0	-25.8
V	7320.000	48.9	33	37.9	53.8	74.0	-20.2
V	12200.000	43.3	33	40.5	50.8	74.0	-23.2

- NOTES:
1. Peak detector is used for the emission measurement.
 2. All measurements were made at 3 meters. Radiated emissions not detected at the 3-meter distance were measured at 0.3-meter and an inverse proportional extrapolation was performed to compare the signal level to the 3-meter limit. No other radiated emissions than those reported were detected at a test distance of 0.3-meter.
 3. Negative value in the margin column shows emission below limit.
 4. Horn antenna is used for the emission over 1000MHz.
 5. Emission (the row indicated by **bold italic**) within the restricted band meets the requirement of FCC Part 15 Section 15.205 / RSS-Gen Section 8.10.

TEST REPORT

Mode: TX-Channel 39

Table 3

Polarization	Frequency (MHz)	Reading (dBµV)	Pre-Amp Gain (dB)	Antenna Factor (dB)	Net at 3m - Average (dBµV/m)	Average Limit at 3m (dBµV/m)	Margin (dB)
V	<i>2483.500</i>	<i>48.2</i>	<i>33</i>	<i>29.4</i>	<i>44.6</i>	<i>54.0</i>	<i>-9.4</i>
V	<i>4960.000</i>	<i>44.9</i>	<i>33</i>	<i>34.9</i>	<i>46.8</i>	<i>54.0</i>	<i>-7.2</i>
V	<i>7440.000</i>	<i>41.3</i>	<i>33</i>	<i>37.9</i>	<i>46.2</i>	<i>54.0</i>	<i>-7.8</i>
V	<i>12400.000</i>	<i>42.1</i>	<i>33</i>	<i>40.5</i>	<i>49.6</i>	<i>54.0</i>	<i>-4.4</i>

Polarization	Frequency (MHz)	Reading (dBµV)	Pre-Amp Gain (dB)	Antenna Factor (dB)	Net at 3m - Peak (dBµV/m)	Peak Limit at 3m (dBµV/m)	Margin (dB)
V	<i>2483.500</i>	<i>62.0</i>	<i>33</i>	<i>29.4</i>	<i>58.4</i>	<i>74.0</i>	<i>-15.6</i>
V	<i>4960.000</i>	<i>47.7</i>	<i>33</i>	<i>34.9</i>	<i>49.6</i>	<i>74.0</i>	<i>-24.4</i>
V	<i>7440.000</i>	<i>47.4</i>	<i>33</i>	<i>37.9</i>	<i>52.3</i>	<i>74.0</i>	<i>-21.7</i>
V	<i>12400.000</i>	<i>43.1</i>	<i>33</i>	<i>40.5</i>	<i>50.6</i>	<i>74.0</i>	<i>-23.4</i>

- NOTES:
1. Peak detector is used for the emission measurement.
 2. All measurements were made at 3 meters. Radiated emissions not detected at the 3-meter distance were measured at 0.3-meter and an inverse proportional extrapolation was performed to compare the signal level to the 3-meter limit. No other radiated emissions than those reported were detected at a test distance of 0.3-meter.
 3. Negative value in the margin column shows emission below limit.
 4. Horn antenna is used for the emission over 1000MHz.
 5. Emission (the row indicated by ***bold italic***) within the restricted band meets the requirement of FCC Part 15 Section 15.205 / RSS-Gen Section 8.10.

TEST REPORT

Mode: Bluetooth BLE Operating

Table 4

Polarization	Frequency (MHz)	Reading (dBµV)	Pre-amp (dB)	Antenna Factor (dB)	Net at 3m (dBµV/m)	Limit at 3m (dBµV/m)	Margin (dB)
V	93.862	27.2	16	11.0	22.2	43.5	-21.3
V	119.210	24.6	16	14.0	22.6	43.5	-20.9
H	219.514	27.2	16	17.0	28.2	46.0	-17.8
V	413.172	27.0	16	25.0	36.0	46.0	-10.0
V	537.848	19.4	16	28.0	31.4	46.0	-14.6
V	683.614	21.8	16	29.0	34.8	46.0	-11.2

- NOTES:
1. Quasi-Peak detector is used for the emission measurement.
 2. All measurements were made at 3 meters. Radiated emissions not detected at the 3-meter distance were measured at 0.3-meter and an inverse proportional extrapolation was performed to compare the signal level to the 3-meter limit. No other radiated emissions than those reported were detected at a test distance of 0.3-meter.
 3. Negative value in the margin column shows emission below limit.
 4. Emission (the row indicated by **bold italic**) within the restricted band meets the requirement of FCC Part 15 Section 15.205 / RSS-Gen Section 8.10.

TEST REPORT

4.6.3 Radiated Emission Test Setup

The figure below shows the test setup, which is utilized to make these measurements.

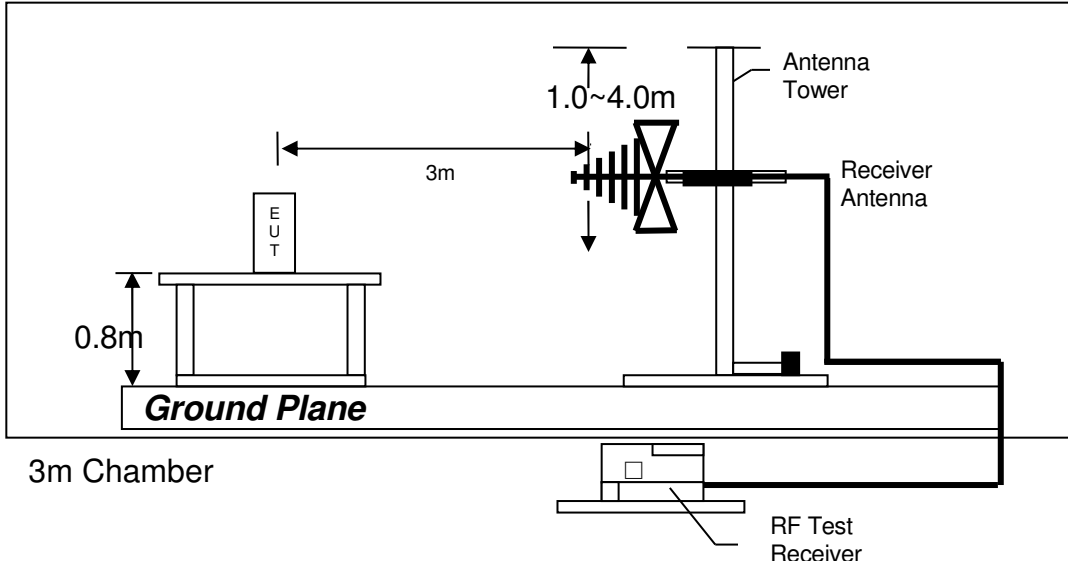

Test setup of radiated emissions up to 1GHz

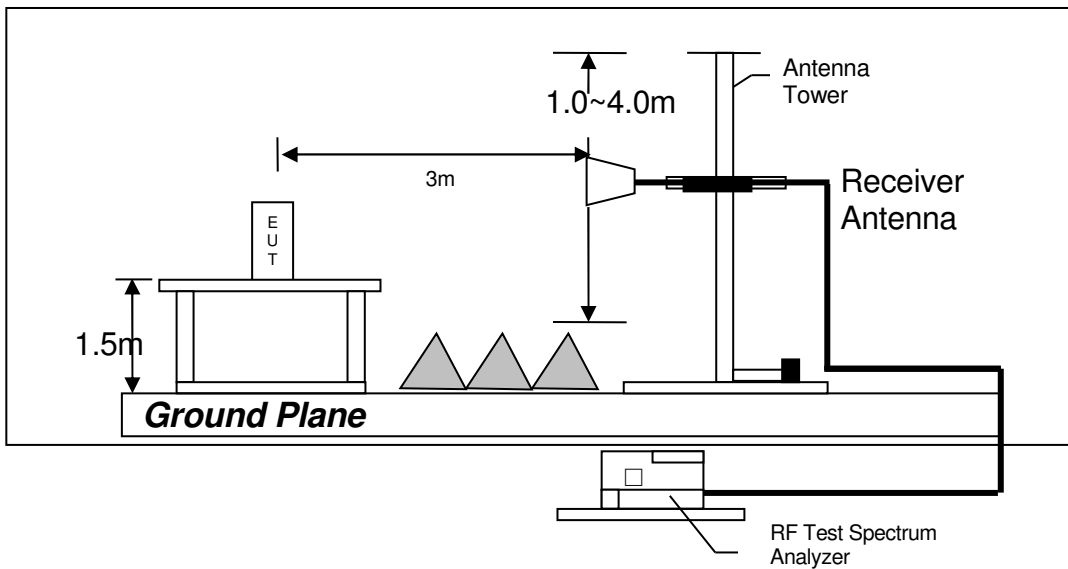

Test setup of radiated emissions above 1GHz

TEST REPORT

4.6.4 Transmitter Duty Cycle Calculation

Not applicable – No average factor is required.

TEST REPORT

4.7 AC Power Line Conducted Emission

- Not applicable – EUT is only powered by battery for operation.
- EUT connects to AC power line. Emission Data is listed in following pages.

- Base Unit connects to AC power line and has transmission. Handset connects to AC power line but has no transmission. Emission Data of Base Unit is listed in following pages.

4.7.1 AC Power Line Conducted Emission Configuration Photograph

Worst Case Line-Conducted Configuration
at

0.519 MHz

The worst case line conducted configuration photographs are attached in the Appendix and saved with filename: config photos.pdf

4.7.2 AC Power Line Conducted Emission Data

The plot(s) and data in the following pages list the significant emission frequencies, the limit and the margin of compliance.

Passed by 17.3 dB margin

TEST REPORT

AC POWER LINE CONDUCTED EMISSION

Worst Case: Bluetooth BLE Operating

EDIT PEAK LIST (Final Measurement Results)				
Trace1:	CF15MQP			
Trace2:	CF15MAV			
Trace3:	---			
TRACE	FREQUENCY	LEVEL dBµV		DELTA LIMIT dB
1 Quasi Peak	154.5 kHz	46.08 L1		-19.66
1 Quasi Peak	271.5 kHz	39.26 N		-21.81
1 Quasi Peak	298.5 kHz	38.21 L1		-22.07
2 CISPR Average	519 kHz	28.72 N		-17.27
1 Quasi Peak	523.5 kHz	36.73 L1		-19.27

Date: 4.FEB.2020 14:14:58

TEST REPORT

Worst Case: Bluetooth BLE Operating



RBW 9 kHz

MT 1 s

Att 10 dB AUTO PREAMP OFF

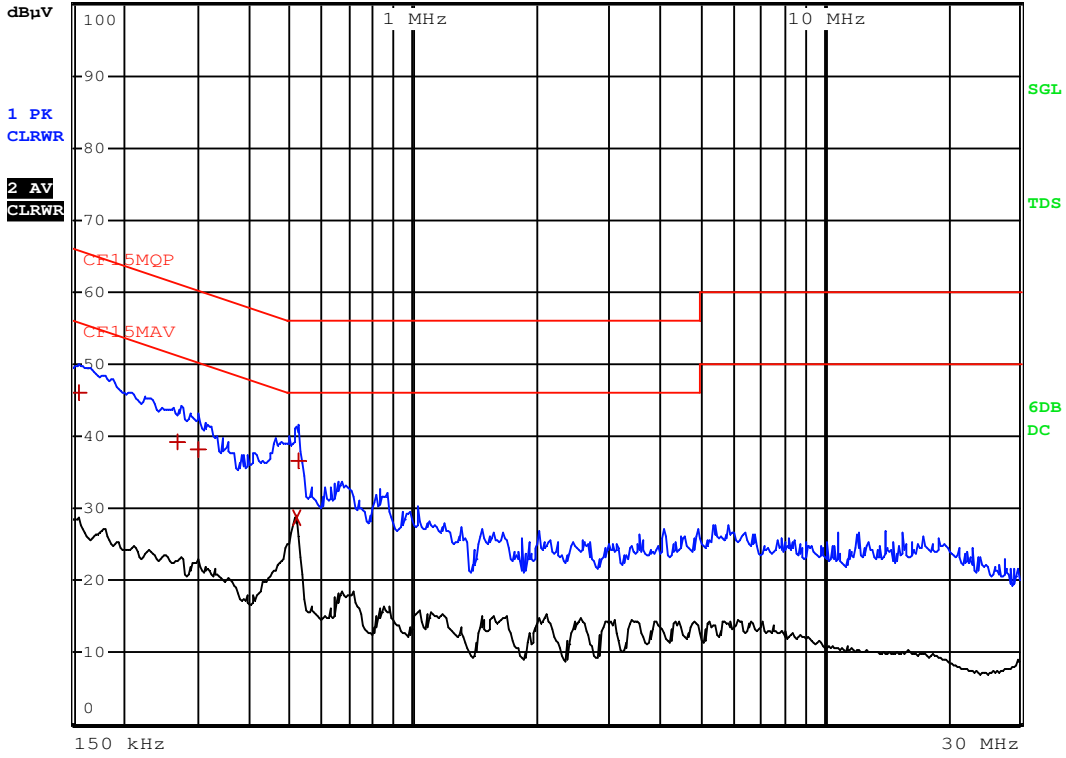

Date: 4.FEB.2020 14:15:32

TEST REPORT

4.7.3 Conducted Emission Test Setup

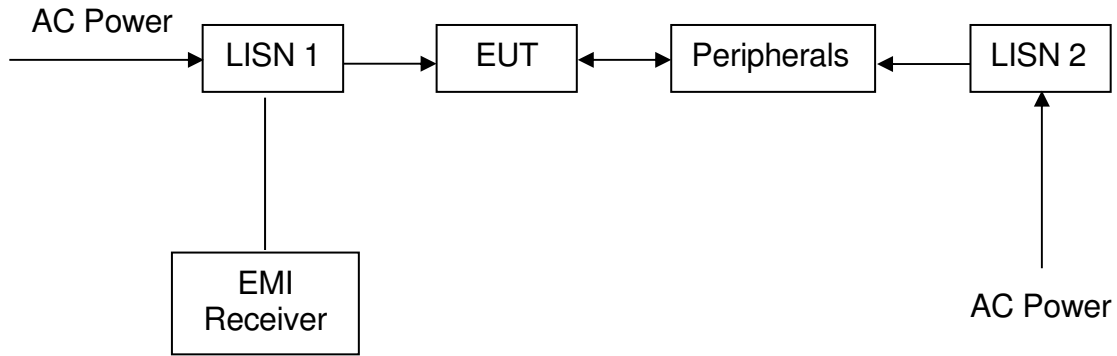

TEST REPORT

4.8 Occupied Bandwidth

Occupied Bandwidth Results:

Bluetooth (MHz)	Occupied Bandwidth (MHz)	
Low Channel:	2402	1.062
Middle Channel:	2440	1.068
High Channel:	2480	1.074

The worst case is shown as below

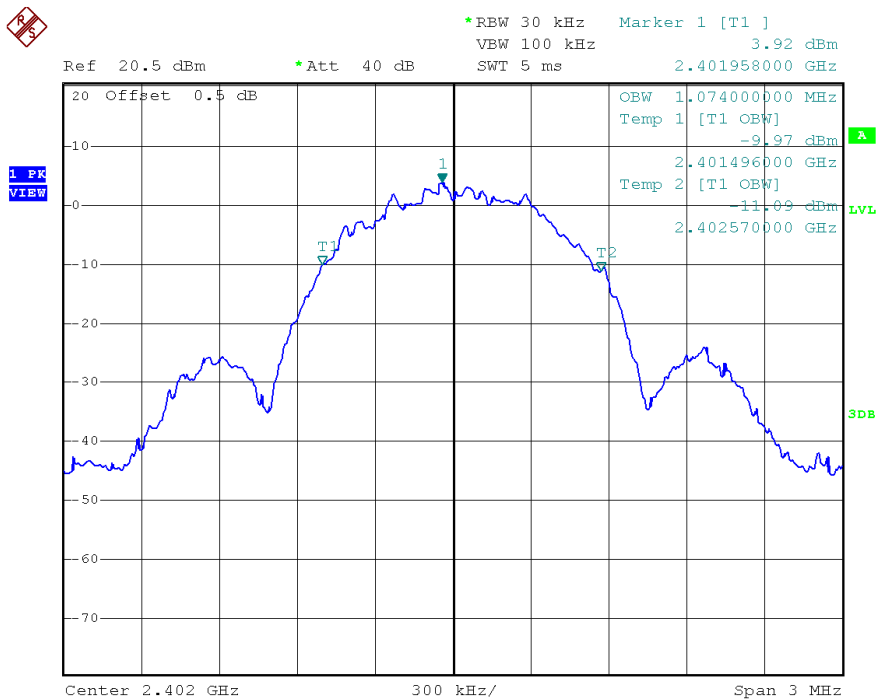

TEST REPORT

5.0 EQUIPMENT LIST

1) Radiated Emissions Test

Equipment	EMI Test Receiver	Spectrum Analyzer	Biconical Antenna
Registration No.	EW-3156	EW-2249	EW-0571
Manufacturer	R&S	ROHDESCHWARZ	EMCO
Model No.	ESR26	FSP30	3104C
Calibration Date	August 01, 2019	May 16, 2019	July 23, 2019
Calibration Due Date	August 01, 2020	May 16, 2020	July 23, 2021

Equipment	Log Periodic Antenna	Double Ridged Guide Antenna	14m Double Shield RF Cable (20MHz - 6GHz)
Registration No.	EW-0447	EW-1133	EW-2074
Manufacturer	EMCO	EMCO	RADIALL
Model No.	3146	3115	Nm-RG142-
Calibration Date	September 25, 2019	November 29, 2018	March 31, 2019
Calibration Due Date	March 25, 2021	May 29, 2020	March 31, 2020

Equipment	15m 40GHz indoor RF Cable	RF Preamp (9kHz to 6000MHz)	Solid State Low Noise Preamp (1 - 18)GHz
Registration No.	EW-3032	EW-3424	EW-3229
Manufacturer	GREATBILLION	SCHWARZBECK	BONN ELEKTRO
Model No.	SMA(m) St-SMA (m) St, 15m long	BBV9744	BLMA 0118-5G
Calibration Date	May 14, 2019	July 23, 2019	June 28, 2019
Calibration Due Date	May 14, 2020	July 23, 2020	June 28, 2020

Equipment	Pyramidal Horn Antenna	Notch Filter (cutoff frequency 2.4GHz to 2.5GHz) 2 pieces	Active Loop H-field (9kHz to 30MHz)
Registration No.	EW-0905	EW-2213	EW-3326
Manufacturer	EMCO	MICROTRONICS	EMCO
Model No.	3160-09	BRM50701-02	6502
Calibration Date	July 23, 2019	July 12, 2019	March 21, 2019
Calibration Due Date	January 23, 2021	May 13, 2020	September 21, 2020

TEST REPORT

2) Conductive Measurement Test

Equipment	Spectrum Analyzer	RF Power Meter with Power Sensor	40GHz 5m RF Cable
Registration No.	EW-2249	EW-2270	EW-2701
Manufacturer	R&S	AGILENTECH	GREATBILLION
Model No.	FSP30	N1911A	sma m-m 5m 40G
Calibration Date	May 16, 2019	March 09, 2019	May 14, 2019
Calibration Due Date	May 16, 2020	March 09, 2020	May 14, 2020

3) Bandwidth/Bandedge Measurement Test

Equipment	40GHz 5m RF Cable	Spectrum Analyzer
Registration No.	EW-2701	EW-2249
Manufacturer	GREATBILLION	R&S
Model No.	sma m-m 5m 40G	FSP30
Calibration Date	May 14, 2019	May 16, 2019
Calibration Due Date	May 14, 2020	May 16, 2020

4) Conducted Emissions Test

Equipment	RF Cable 80cm (RG142) (9kHz to 30MHz)	Artificial Mains Network	EMI Test Receiver
Registration No.	EW-2451	EW-2874	EW-3156
Manufacturer	RADIALL	ROHDESCHWARZ	R&S
Model No.	RF Cable 80cm (RG142) (9kHz to 30MHz)	ENV-216	ESR26
Calibration Date	December 08, 2019	July 05, 2019	August 01, 2019
Calibration Due Date	December 08, 2020	July 05, 2020	August 01, 2020

END OF TEST REPORT