



Ecom Sertech Corp.

Rm. 258, Bldg. 17, NO.195, Sec. 4 Chung Hsing Rd., ChuTung Chen, Hsinchu, Taiwan 310, R.O.C
TEL:886-3-5918012 FAX : 886-3-5825720

FCC ID : M4Y-XG-600
Report No. : ER03-04-075FRF
Page 1 of 40



TEST REPORT

Product Name : 2.4GHz 802.11g WLAN Mini PCI Card

Model Number : XG-601

Applicant : Z-Com, Inc.

Address : 7F-2, NO.9, Prosperity RD. I Science-Based Industrial Park Hsinchu,
300 Taiwan

Date Received : APR.19, 2003

Date Tested : APR.19~24, 2003

Notes :

1. This report will be invalid if duplicated or photocopied in part.
2. This report refers only to the specimen(s) submitted to testing, and be invalid as seperately used.
3. This report is invalid without examination stamp and signature of this institute.
4. The tested specimen(s) will be preserved for thirty days from the data issued.
5. The report must not be used to claim product certification, approval, or endorsement by NVLAP, NIST, or any agency of the federal government.





Ecom Sertech Corp.

Rm. 258, Bldg. 17, NO.195, Sec. 4 Chung Hsing Rd., ChuTung Chen, Hsinchu, Taiwan 310, R.O.C
TEL:886-3-5918012 FAX : 886-3-5825720

FCC ID : M4Y-XG-600
Report No. : ER03-04-075FRF
Page 2 of 40

Test Report Certification

Product Name : 2.4GHz 802.11g WLAN Mini PCI Card
Model Number : XG-601
Applicant : Z-Com, Inc.

Measurement Standard :

47 CFR Part 15, Subpart B and Subpart C (Section 15.247),
ANSI C63.4-2001

Tested By : K. P. Pang , **Date** : May 16, 2003
(K. P. Pang)

Reviewed By : M. C. Huang , **Date** : May 16, 2003
(M. C. Huang)

Approved By : Chieh-De Tsai , **Date** : May 20, 2003
(Chieh-De Tsai , Manager)

WE HEREBY CERTIFY THAT: The measurements shown in the attachment were made in accordance with the procedures indicated, and the energy emitted by the equipment was found to be within the limits applicable. We assume full responsibility for the accuracy and completeness of these measurements and vouch for the qualifications of all persons taking them.



TABLE OF CONTENTS

TITLE	PAGE NO.
1. GENERAL INFORMATION	5
1.1 GENERAL STATEMENT	5
1.2 GENERAL DESCRIPTION OF EUT & POWER.....	5
1.3 DESCRIPTION OF PERIPHERALS.....	6
1.4 EUT & PERIPHERALS SETUP DIAGRAM.....	7
1.5 EUT OPERATING CONDITION	7
1.6 DESCRIPTION OF TEST SITE.....	8
1.7 SUMMARY OF TEST RESULTS	8
2. CONDUCTED POWERLINE TEST	9
2.1 TEST EQUIPMENTS	9
2.2 TEST SETUP	9
2.3 CONDUCTED POWER LINE EMISSION LIMIT.....	10
2.4 TEST PROCEDURE.....	10
2.5 UNCERTAINTY OF CONDUCTED EMISSION	10
2.6 CONDUCTED RF VOLTAGE MEASUREMENT	11
2.7 PHOTOS OF CONDUCTION TEST.....	12
3. RADIATED EMISSION TEST.....	13
3.1 TEST EQUIPMENTS	13
3.2 TEST SETUP	13
3.3 RADIATION LIMIT	14
3.4 TEST PROCEDURES.....	15
3.5 UNCERTAINTY OF RADIATED EMISSION	15
3.6 RADIATED RF NOISE MEASUREMENT.....	16-24
3.7 PHOTOS OF OPEN SITE.....	25-26
4. 6dB BANDWIDTH MEASUREMENT.....	27
4.1 TEST EQUIPMENTS	27
4.2 TEST SETUP	27
4.3 LIMITS OF 6dB BANDWIDTH MEASUREMENT	27
4.4 TEST PROCEDURE.....	27
4.5 UNCERTAINTY OF CONDUCTED EMISSION	28
4.6 TEST RESULTS	28
4.7 PHOTO OF 6DB BANDWIDTH MEASUREMENT.....	29
5. MAXIMUM PEAK OUTPUT POWER.....	30
5.1 TEST EQUIPMENTS	30
5.2 TEST SETUP	30
5.3 LIMITS OF MAXIMUM PEAK OUTPUT POWER	30
5.4 TEST PROCEDURE.....	31
5.5 UNCERTAINTY OF CONDUCTED EMISSION	31
5.6 TEST RESULTS	31
6. POWER SPECTRAL DENSITY MEASUREMENT	32
6.1 TEST EQUIPMENTS	32
6.2 TEST SETUP	32
6.3 LIMITS OF POWER SPECTRAL DENSITY MEASUREMENT	32
6.4 TEST PROCEDURE.....	33
6.5 UNCERTAINTY OF CONDUCTED EMISSION	33
6.6 TEST RESULTS	33
6.7 PHOTO OF POWER SPECTRAL DENSITY MEASUREMENT.....	34



Ecom Sertech Corp.

Rm. 258, Bldg. 17, NO.195, Sec. 4 Chung Hsing Rd., ChuTung Chen, Hsinchu, Taiwan 310, R.O.C
TEL:886-3-5918012 FAX : 886-3-5825720

FCC ID : M4Y-XG-600
Report No. : ER03-04-075FRF
Page 4 of 40

TABLE OF CONTENTS

<u>TITLE</u>	<u>PAGE NO.</u>
7. OUT OF BAND MEASUREMENT	35
7.1 TEST EQUIPMENTS	35
7.2 TEST SETUP	35
7.3 LIMITS OF OUT OF BAND EMISSIONS MEASUREMENT.....	35
7.4 TEST PROCEDURE.....	36
7.5 UNCERTAINTY OF CONDUCTED EMISSION	36
7.6 TEST RESULTS	36
7.7 PHOTO OF OUT OF BAND MEASUREMENT.....	37
8. ANTENNA REQUIREMENT.....	38
8.1 STANDARD APPLICABLE	38
8.2 ANTENNA CONNECTED CONSTRUCTION.....	38
9. RF EXPOSURE EVALUATION	39
9.1 FRIIS FORMULA.....	39
9.2 EUT OPERATING CONDITION	39
9.3 TEST RESULT OF RF EXPOSURE EVALUATION.....	40
9.3.1 ANTENNA GAIN.....	40
9.3.2 OUTPUT POWER INTO ANTENNA & RF EXPOSURE EVALUATION DISTANCE	40



Ecom Sertech Corp.

Rm. 258, Bldg. 17, NO.195, Sec. 4 Chung Hsing Rd., ChuTung Chen, Hsinchu, Taiwan 310, R.O.C
TEL:886-3-5918012 FAX : 886-3-5825720

FCC ID : M4Y-XG-600
Report No. : ER03-04-075FRF
Page 5 of 40

1. GENERAL INFORMATION

1.1 GENERAL STATEMENT

MEASUREMENT DEVIATION : Comply with standard in full

TRACEABILITY : This test result is traceable to national or international std.

1.2 GENERAL DESCRIPTION OF EUT & POWER

MANUFACTURER : Z-Com, Inc.

SAMPLE NAME : 2.4GHz 802.11g WLAN Mini PCI Card

MODEL NO : XG-601

FREQUENCY RANGE : 2412 MHz TO 2462MHz

CHANNEL NUMBER : 11

AIR DATA RATE : 54Mbps (Highest Mode)

TYPE OF MODULATION : Orthogonal frequency division multiplex

FREQUENCY SELECTION : BY SOFTWARE

EUT Description : 2.4GHz (Orthogonal frequency division multiplex) Data
Transceiver for 2.4GHz 802.11g WLAN Mini PCI Card

ANTENNA TYPE : DIPOLE ANTENNA

POWER SOURCE : 12VDC(From Adaptor)



Ecom Sertech Corp.

Rm. 258, Bldg. 17, NO.195, Sec. 4 Chung Hsing Rd., ChuTung Chen, Hsinchu, Taiwan 310, R.O.C
TEL:886-3-5918012 FAX : 886-3-5825720

FCC ID : M4Y-XG-600
Report No. : ER03-04-075FRF
Page 6 of 40

1.3 DESCRIPTION OF PERIPHERALS

(1) Notebook PC

MANUFACTURER : DELL CORP.
MODEL NUMBER : PP01L
SERIAL NUMBER : CN-09C748-48155-1AP-6081
F.C.C. : DOC
POWER CORD : Unshielded, Detachable, 1.8m

(2) PRINT

MANUFACTURER : Hp Corp.
MODEL NUMBER : C6431D
SERIAL NUMBER : CN19T6S011
F.C.C. ID : DOC
POWER SOURCE : 100-240VAC,50/60Hz,0.7A
SIGNAL CABLE : Shielded , Undetachable , 1.8m

(3) MODEM

MANUFACTURER : ZYXEL communication Corp.
MODEL NUMBER : Omni 56K
SERIAL NUMBER : S1Z4107729
F.C.C. ID : 1880MN156K
POWER SOURCE : 9VAC(From Power Adapter)
SIGNAL CABLE : Shielded , Undetachable , 1.8m

(4) Notebook PC

MANUFACTURER : DELL CORP.
MODEL NUMBER : PP01L
SERIAL NUMBER : CN-09C748-48155-1AP-6630
F.C.C. : DOC
POWER CORD : Unshielded, Detachable, 1.8m

1.4 EUT & PERIPHERALS SETUP DIAGRAM

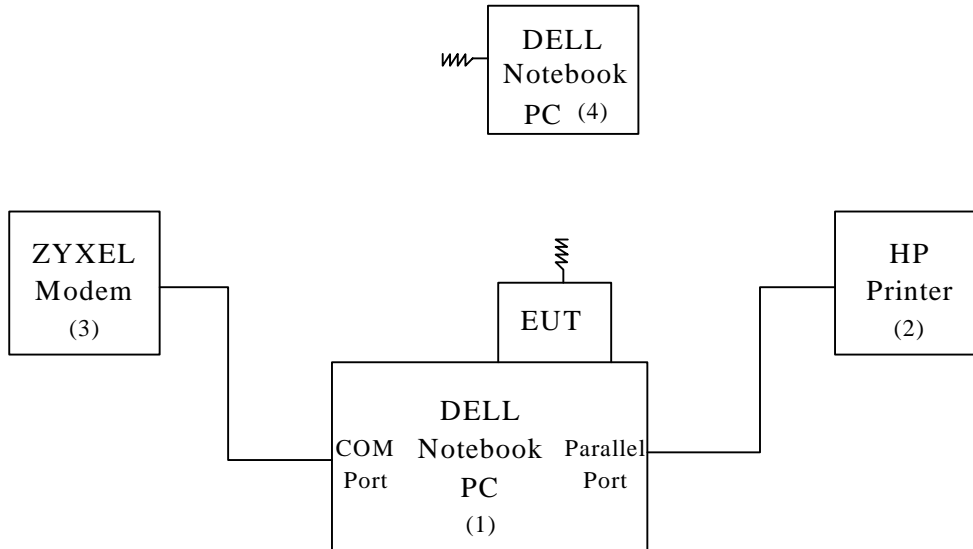

1.5 EUT OPERATING CONDITION

1. Set up all computers like the setup diagram.
2. NB (1) ping 192.168.1.90 -t -l 5000 to EUT
3. NB (4) ping 192.168.1.80 -t -l 5000 to NB(1)
4. All of the function are under run.
5. Start test.



Ecom Sertech Corp.

Rm. 258, Bldg. 17, NO.195, Sec. 4 Chung Hsing Rd., ChuTung Chen, Hsinchu, Taiwan 310, R.O.C
TEL:886-3-5918012 FAX : 886-3-5825720

FCC ID : M4Y-XG-600
Report No. : ER03-04-075FRF
Page 8 of 40

1.6 DESCRIPTION OF TEST SITE

SITE DESCRIPTION : FCC certificate NO. : 90585
BSMI certificate NO. : SL2-IN-E-0002
NVLAP Lab code : 200118-0
CNLA certificate NO. : CNLA-ZL97018
VCCI certificate NO. : R-1229, C-1250

NAME OF SITE : Ecom Sertech Corp. Hsinchu
(Spin-off from ITRI / ERSO on Apr. 01, 2003)

SITE LOCATION : R1500, 195-4 , sec. 4, Chung Hsing Rd., Chu-Tung Chen.
Hsin-Chu, Taiwan 310 R.O.C.

1.7 SUMMARY OF TEST RESULTS

The EUT has been tested according to the following specifications :

APPLIED STANDARD : 47 CFR Part 15, Subpart B and Subpart C			
Standard Section	Test Type and Limit	Result	REMARK
15.107 15.207	AC Power Conducted Emission Limit : Table 15.209	PASS	Meet the requirement of limit
15.247(a)(2)	Spectrum Bandwidth of a Direct Sequence Spread Spectrum System Limit : 6dB bandwidth > 500KHz	PASS	Meet the requirement of limit
15.247(b)	Maximum Peak Output Power Limit : max. 30dBm	PASS	Meet the requirement of limit
15.109 15.205 15.209	Transmitter Radiated Emissions Limit : Table 15.209	PASS	Meet the requirement of limit
15.247(d)	Power Spectral Density Limit : max. 8dBm	PASS	Meet the requirement of limit
15.247(c)	Out of Band Emission and Restricted Band Radiation Limit:20dB less than peak value of fundamental frequency Restricted band Limit:Table 15.209	PASS	Meet the requirement of limit



2. CONDUCTED POWERLINE TEST

2.1 TEST EQUIPMENTS

The following test equipments are used during the conducted powerline tests :

MANUFACTURER OR TYPE	MODEL No	SERIAL NO.	DATE OF CALIBRATION	CALIBRATION PERIOD	REMARK
SPECTRUM ANALYZER & DISPLAY	HP 8568A	2235A02320	APR. 01, 2003	1 Year	PRETEST
QUASI-PEAK ADAPTER	HP 85650 A	2341A00672	APR. 01, 2003	1 Year	PRETEST
ISOLATION TRANSFORMER	SOLAR 7032-1	N/A	N/A	N/A	FINAL
L.I.S.N.	EMCO 3850/2	9311-1025 9401-1028	JAN. 08, 2003 For Characteristic impedance MAY 18, 2002 For Insertion loss	1 Year	FINAL
TEST RECEIVER	R/S ESHS30	838550/003	JUN. 07, 2002	1 Year	FINAL
SHIELDED ROOM	KEENE 5983	NO.1	N/A	N/A	FINAL
PULSE LIMIT	R/S EHS3Z2	357.8810.52	JUL. 10, 2002	1 Year	FINAL
N TYPE COAXIAL CABLE	-----	-----	JUL. 10, 2002	1 Year	FINAL
50 TERMINATOR	-----	-----	JUL. 10, 2002	1 Year	FINAL

2.2 TEST SETUP

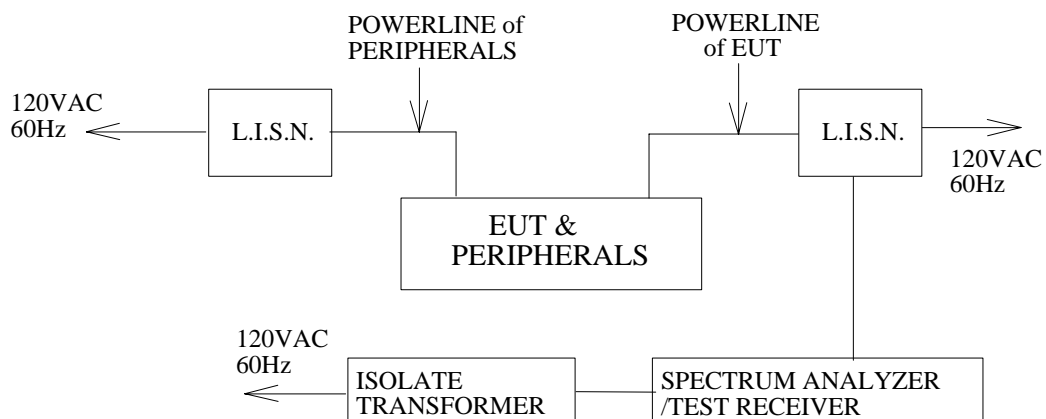



2.3 CONDUCTED POWER LINE EMISSION LIMIT

For unintentional device, according to § 15.107(a) Line Conducted Emission Limits is as following :

Frequency (MHz)	Maximum Rf Line Voltage (dB μ V)			
	CLASS A		CLASS B	
	Q.P.	Ave.	Q.P.	Ave.
0.15 - 0.50	79	66	66-56	56-46
0.50 - 5.00	73	60	56	46
5.00 - 30.0	73	60	60	50

For intentional device, according to § 15.207(a) Line Conducted Emission Limit is same as above table.

2.4 TEST PROCEDURE

The test procedure is performed in a 12ft \times 12ft \times 8ft(L \times W \times H) shielded room. the EUT along with its peripherals were placed on a 1.0m(W) \times 1.5m(L) and 0.8m in height wooden table and the EUT was adjusted to maintain a 0.4 meter space from a vertical reference plane. The EUT was connected to power mains through a line impedance stabilization network (LISN) which provides 50 ohm coupling impedance for measuring instrument and the chasis ground was bounded to the horizontal ground plane of shielded room. All peripherals were connected to the second LISN and the chasis ground also bounded to the horizontal ground plane of shielded room. The excess power cable between the EUT and the LISN was bundled. The power cables of peripherals were unbundled. All connecting cables of EUT and peripherals were moved to find the maximum emission.

2.5 UNCERTAINTY OF CONDUCTED EMISSION

The uncertainty of conducted emission is ± 1.36 dB.



Ecom Sertech Corp.

Rm. 258, Bldg. 17, NO.195, Sec. 4 Chung Hsing Rd., ChuTung Chen, Hsinchu, Taiwan 310, R.O.C
TEL:886-3-5918012 FAX : 886-3-5825720

FCC ID : M4Y-XG-600
Report No. : ER03-04-075FRF
Page 11 of 40

2.6 CONDUCTED RF VOLTAGE MEASUREMENT

The frequency spectrum from 0.45 MHz to 30 MHz was investigated. All emissions not reported below are more than 20 dB below the prescribed limits.

Temperature : 26

Humidity : 65 % RH

Frequency (MHz)	Loss(dB)		MEASUREMENT				L1 Emission (dB μ V)		L2 Emission (dB μ V)		LIMITS (dB μ V)	
			L1(dB μ V)		L2(dB μ V)		Q.P.	A.V.	Q.P.	A.V.	Q.P.	A.V.
	L1	L2	Q.P.	A.V.	Q.P.	A.V.						
0.150	0.1	0.2	*	*	*	*	*	*	*	66.00	56.00	
0.177	0.1	0.2	45.80	*	47.10	*	45.90	*	47.30	64.63	54.63	
0.294	0.1	0.2	31.60	*	*	*	31.70	*	*	60.41	50.41	
0.414	0.1	0.2	*	*	31.00	*	*	*	31.20	57.57	47.57	
1.047	0.1	0.2	25.20	*	24.80	*	25.30	*	25.00	56.00	46.00	
1.263	0.1	0.2	33.80	*	*	*	33.90	*	*	56.00	46.00	
1.296	0.1	0.2	*	*	32.50	*	*	*	32.70	56.00	46.00	
2.394	0.14	0.2	*	*	37.30	*	*	*	37.50	56.00	46.00	
2.487	0.15	0.2	39.20	*	*	*	39.35	*	*	56.00	46.00	
4.734	0.2	0.2	*	*	22.40	*	*	*	22.60	56.00	46.00	
4.914	0.2	0.2	26.30	*	*	*	26.50	*	*	56.00	46.00	
15.147	0.61	0.61	*	*	29.10	*	*	*	29.71	60.00	50.00	
15.213	0.62	0.62	29.30	*	*	*	29.92	*	*	60.00	50.00	
16.389	0.7	0.7	*	*	30.70	*	*	*	31.40	60.00	50.00	
18.072	0.9	0.99	25.80	*	*	*	26.70	*	*	60.00	50.00	
30.000	1.4	1.8	*	*	*	*	*	*	*	60.00	50.00	

REMARKS : 1. * Undetectable or the Q.P.values is lower than the limits of Ave.

2.7 PHOTOS OF CONDUCTION TEST



3. RADIATED EMISSION TEST

3.1 TEST EQUIPMENTS

The following test equipments are utilized in making the measurements contained in this report.

MANUFACTURER OR TYPE	MODEL NO	SERIAL NO	DATE OF CALIBRATION	CALIBRATION PERIOD	REMARK
CHASE BI-LOG ANTENNA	CBL6112B	2421	MAY 07, 2003	1 Year	FINAL
R/S TEST RECEIVER	ESMI	842088/005 841978/008	SEPT. 3, 2002	1 Year	FINAL
OPEN SITE	-----	No.1	JUL. 10~12, 2002	1 Year	FINAL
N TYPE COAXIAL CABLE	CHA9525	4	JUL. 13, 2002	1 Year	FINAL
Horn Antenna	AH-118	10089	FEB. 25, 2003	1 Year	FINAL
HP Pre-amplifier	8449B	3008A01471	OCT. 11, 2002	1 Year	FINAL
HP High pass filter	84300/80038	011	cal. on use	1 Year	FINAL
Horn Antenna	AH-840	03077	FEB. 25, 2003	1 Year	FINAL

3.2 TEST SETUP

The diagram below shows the test setup which is utilized to make these measurements.

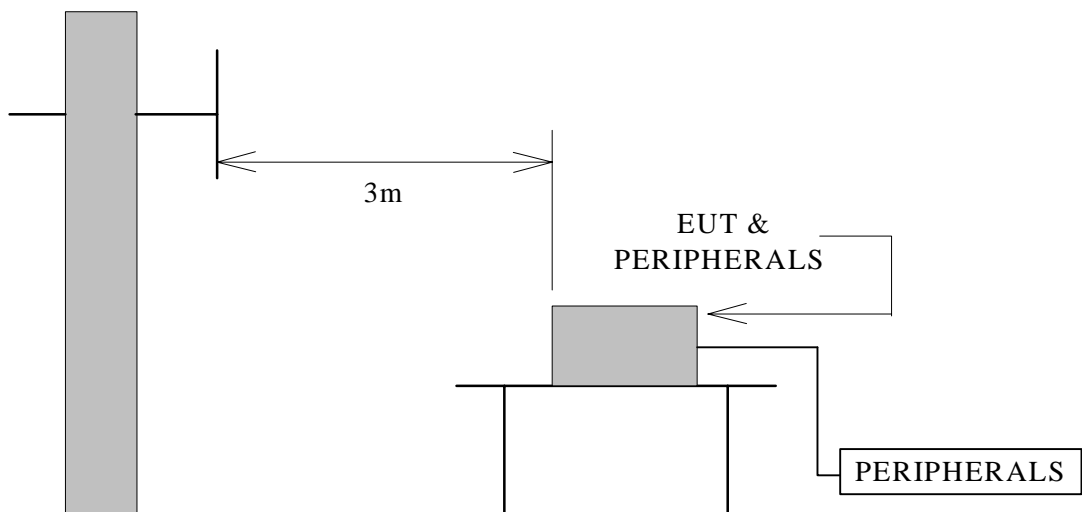

Antenna Elevation Variable



Ecom Sertech Corp.

Rm. 258, Bldg. 17, NO.195, Sec. 4 Chung Hsing Rd., ChuTung Chen, Hsinchu, Taiwan 310, R.O.C
TEL:886-3-5918012 FAX : 886-3-5825720

FCC ID : M4Y-XG-600
Report No. : ER03-04-075FRF
Page 14 of 40

3.3 RADIATION LIMIT

For unintentional device, according to § 15.109(a), except for Class A digital devices, the field strength of radiated emissions from unintentional radiators at a distance of 3 meters shall not exceed the following values :

FREQUENCY (MHz)	DISTANCE (METERS)	Radiated (dB μ V/M)	Radiated (μ V/M)
30-88	3	40.0	100
88-216	3	43.5	150
216-960	3	46.0	200
Above 960	3	54.0	500

For intentional device, according to § 15.209(a), the general requirement of field strength of radiated emissions from intentional radiators at a distance of 3 meters shall not exceed the above table.



3.4 TEST PROCEDURES

- a. The EUT was placed on the top of a rotating table 0.8 meters above the ground at a 10 meter open area test site. The table was rotated 360 degrees to determine the position of the highest radiation.
- b. The EUT was set 3 meters away from the interference-receiving antenna, which was mounted on the top of a variable-height antenna tower.
- c. The antenna is a broadband antenna, and its height is varied from one meter to four meters above the ground to determine the maximum value of the field strength. Both horizontal and vertical polarizations of the antenna are set to make the measurement.
- d. For each suspected emission, the EUT was arranged to its worst case and then the antenna was tuned to heights from 1 meter to 4 meters and the rotatable table was turned from 0 degrees to 360 degrees to find the maximum reading.
- e. The test-receiver system was set to Peak Detect Function and Specified Bandwidth with Maximum Hold Mode.
- f. If the emission level of the EUT in peak mode was 10 dB lower than the limit specified, then testing could be stopped and the peak values of the EUT would be reported. Otherwise the emissions that did not have 10 dB margin would be re-tested one by one using peak, quasi-peak or average method as specified and then reported in a data sheet.

NOTE :

1. The resolution bandwidth and video bandwidth of test receiver/spectrum analyzer is 120 KHz for Peak detection (PK) and Quasi-peak detection (QP) at frequency below 1GHz.
2. The resolution bandwidth and video bandwidth of test receiver/spectrum analyzer is 1 MHz for Peak detection and frequency above 1GHz.
3. The resolution bandwidth of test receiver/spectrum analyzer is 1 MHz and the video bandwidth is 10 Hz for Average detection (AV) at frequency above 1GHz.

3.5 UNCERTAINTY OF RADIATED EMISSION

The uncertainty of radiated emission is ± 2.72 dB.



3.6 RADIATED RF NOISE MEASUREMENT

Test Requirement: 15.109, 15.209

The frequency spectrum from 30 MHz to 1000 MHz was investigated. All emissions not reported below are more than 20 dB below the prescribed limits.

All readings are quasi-peak values.

Temperature : 31

Humidity : 53 % RH

FREQ- UENCY (MHz)	ANTENNA FACTOR (dB)	CABLE LOSS (dB)	METER READING AT3m(dB μ V/M)		LIMITS (dB μ V/M)	EMISSION LEVEL AT3m(dB μ V/M)	
			HORIZON- TAL	VERTICAL		HORIZON- TAL	VERTICAL
30.00	21.39	0.90	*	*	40.00	*	*
133.78	13.21	2.16	23.15	25.02	43.50	38.52	40.39
197.63	10.37	2.78	8.16	9.54	43.50	21.31	22.69
233.86	12.22	3.07	13.06	14.06	46.00	28.35	29.35
268.46	13.24	3.35	8.17	11.84	46.00	24.76	28.43
399.50	17.22	4.20	21.98	14.29	46.00	43.40	35.71
612.26	19.53	5.46	13.54	17.58	46.00	38.53	42.57
902.25	21.05	6.61	10.29	10.87	46.00	37.95	38.53
1000.00	21.58	7.00	*	*	54.00	*	*

REMARKS : 1. * Undetectable

2. Emission level (dB μ V/M) =Antenna Factor (dB/m) + Cable loss (dB)
+ Meter Reading (dB μ V).

3. According to technical experiences, all spurious emission at channel 1,6,11 are almost the same below 1GHz,so that the channel 1 was chosen as representation for the test.

4.Mode : Transmitting test

5.The test data marked in gray background means the EUT emission data is located in the margin uncertainty range of emission limits.



Ecom Sertech Corp.

Rm. 258, Bldg. 17, NO.195, Sec. 4 Chung Hsing Rd., ChuTung Chen, Hsinchu, Taiwan 310, R.O.C
 TEL:886-3-5918012 FAX : 886-3-5825720

FCC ID : M4Y-XG-600
 Report No. : ER03-04-075FRF
 Page 17 of 40

Test Requirement: 15.109 ,15.209

The frequency spectrum above 1 GHz was investigated. All emissions not reported below are more than 40 dB below the prescribed limits. Readings are both peak and

Company	Z-COM	Test Date :	2003/4/19
Product Name	Mini PCI	Test By:	M.C. Huang
Model Name	XG-601	TEMP&Humidity :	27C,65%

CH1-RX MODE

Freq.	Reading	AF	Closs	Pre-amp	Dist	Filter	Level	Limit	Margin	Mark	Pol.	Height
MHz	dBuV	dBuV	dB	dB	dB	dB	dBuV/m	dBuV/m	dB	P/Q/A	H/V	Meter
4824.16	49.26	34.4	2.78	35.38	9.5	0	42.59	74	-31.41	P	H	1
7236.45	41.21	39.8	3.94	35.56	9.5	0	40.90	74	-33.10	P	H	1
9647.79	53.04	38.5	4.10	35.67	9.5	0	51.50	74	-22.50	P	H	1
9647.79	49.64	38.5	4.10	35.67	9.5	0	48.10	54	-5.90	A	H	1
4824.16	49.79	34.4	2.78	35.38	9.5	0	43.12	74	-30.88	P	V	1
7236.45	42.12	39.8	3.94	35.56	9.5	0	41.81	74	-32.19	P	V	1
9647.79	52.31	38.5	4.10	35.67	9.5	0	50.77	74	-23.23	P	V	1
9647.79	48.62	38.5	4.10	35.67	9.5	0	47.08	54	-6.92	A	V	1

CH6-RX MODE

Freq.	Reading	AF	Closs	Pre-amp	Dist	Filter	Level	Limit	Margin	Mark	Pol.	Height
MHz	dBuV	dBuV	dB	dB	dB	dB	dBuV/m	dBuV/m	dB	P/Q/A	H/V	Meter
4874.25	50.28	34.8	2.80	35.40	9.5	0	42.95	74	-31.05	P	H	1
7309.85	43.2	39.8	4.00	35.57	9.5	0	41.91	74	-32.09	P	H	1
9748.08	52.46	38.5	4.02	35.72	9.5	0	49.78	74	-24.22	P	H	1
9749.08	48.68	38.5	4.02	35.72	9.5	0	46.00	54	-8.00	A	H	1
4874.25	50.68	34.8	2.80	35.40	9.5	0	43.35	74	-30.65	P	V	1
7309.85	43.1	39.8	4.00	35.57	9.5	0	41.81	74	-32.19	P	V	1
9748.08	51.11	38.5	4.02	35.72	9.5	0	48.43	74	-25.57	P	V	1
9749.08	46.14	38.5	4.02	35.72	9.5	0	43.46	54	-10.54	A	V	1

Note :

1. Measurement was up to 18GHz harmonic,“---” means that the emissions level is too low to be measured.
2. AF: Antenna Factor, Closs: Cable Loss,
3. Analyzer setting P(Peak): RBW=1MHz, VBW=1MHz, A(Average): RBW=1MHz,VBW=10Hz
4. Dist : correction to extrea plate reading to 3m specification distance 1m measurement
 distance = -9.5dB
5. The result basic equation calculation as follow :
 Level = Reading + AF + Closs - Preamp + Filtler - Dist, Margin = Level - Limit



Ecom Sertech Corp.

Rm. 258, Bldg. 17, NO.195, Sec. 4 Chung Hsing Rd.,ChuTung Chen, Hsinchu, Taiwan 310, R.O.C
TEL:886-3-5918012 FAX : 886-3-5825720

FCC ID : M4Y-XG-600
Report No. : ER03-04-075FRF
Page 18 of 40

Test Requirement: 15.109 ,15.209

The frequency spectrum above 1 GHz was investigated. All emissions not reported below are more than 40 dB below the prescribed limits. Readings are both peak and average values.

Company	Z-COM	Test Date :	2003/4/19
Product Name	mini pci	Test By:	M.C. Huang
Model Name	XG-601	TEMP&Humidity :	27C,65%

CH11-RX-MODE

Freq.	Reading	AF	Closs	Pre-amp	Dist	Filter	Level	Limit	Margin	Mark	Pol.	Height
MHz	dBuV	dBuV	dB	dB	dB	dB	dBuV/m	dBuV/m	dB	P/Q/A	H/V	Meter
4924.05	51.12	35.1	2.83	35.41	9.5	0	44.14	74	-29.86	P	H	1
7387.16	45.21	39.7	4.06	35.57	9.5	0	43.94	74	-30.06	P	H	1
9848.02	52.33	38.5	3.93	35.77	9.5	0	49.51	74	-24.49	P	H	1
9849.02	48.37	38.5	3.93	35.77	9.5	0	45.54	54	-8.46	A	H	1
4924.05	50.28	35.1	2.83	35.41	9.5	0	43.30	74	-30.70	P	V	1
7387.16	43.26	39.7	4.06	35.57	9.5	0	41.99	74	-32.01	P	V	1
9848.02	51.90	38.5	3.93	35.77	9.5	0	49.08	74	-24.92	P	V	1
9849.02	15.00	38.5	3.93	35.77	9.5	0	12.17	54	-41.83	A	V	1

Note :

1. Measurement was up to 18GHz harmonic,“---” means that the emissions level is too low to be measured.
2. AF: Antenna Factor, Closs: Cable Loss,
3. Analyzer setting P(Peak): RBW=1MHz, VBW=1MHz, A(Average): RBW=1MHz,VBW=10Hz
4. Dist : correction to extra plate reading to 3m specification distance 1m measurement
distance = -9.5dB
5. The result basic equation calculation as follow :
Level = Reading + AF + Closs - Preamp + Filtler - Dist, Margin = Level - Limit



Ecom Sertech Corp.

Rm. 258, Bldg. 17, NO.195, Sec. 4 Chung Hsing Rd., ChuTung Chen, Hsinchu, Taiwan 310, R.O.C
 TEL:886-3-5918012 FAX : 886-3-5825720

FCC ID : M4Y-XG-600
 Report No. : ER03-04-075FRF
 Page 19 of 40

Test Requirement: 15.205

The frequency spectrum above 1 GHz was investigated. All emissions not reported below are more than 40 dB below the prescribed limits. Readings are both peak and average values.

Operation Mode:	Transmitting	Test Date :	2003/5/1
Fundamental Frequency:	2412MHz (CH 1)	Test By:	M.C. Huang
Temperature :	30	Humidity :	65%

Freq. MHz	Reading dBuV	AF dBuV	Closs dB	Pre-amp dB	Dist dB	Filter dB	Level dBuV/m	Limit dBuV/m	Margin dB	Mark P/Q/A	Pol. H/V	Height Meter
2412.15**	105.15	31.788	2.36	35.31	9.5	0	94.48			P	H	1.0
2412.15**	97.24	31.788	2.36	35.31	9.5	0	86.57			A	H	1.0
4824.29	47.98	34.44	2.78	35.38	9.5	1	41.31	74	-32.69	P	H	1.0
7234.66	42.09	39.806	3.94	35.56	9.5	1	41.78	74	-32.22	P	H	1.0
9647.89	51.77	38.535	4.10	35.67	9.5	1	50.23	74	-23.77	P	H	1.0
9647.89	47.33	38.535	4.10	35.67	9.5	1	45.79	54	-8.21	A	H	1.0
12059.93*	---	42.60	15.20	35.30	9.5	1	---	---	---	---	H	1.0
14471.97*	---	43.40	16.80	34.00	9.5	1	---	---	---	---	H	1.0
16884.01	---	45.20	17.60	34.30	9.5	1	---	---	---	---	H	1.0
19296.05*	---	36.30	18.50	34.30	9.5	1	---	---	---	---	H	1.0
21708.09	---	36.20	19.20	34.60	9.5	1	---	---	---	---	H	1.0
24120.13	---	36.80	21.00	34.20	9.5	1	---	---	---	---	H	1.0

Note :

- The measurement was searched to 10th harmonic, Remark “---” means that the emissions level is too low to be measured.
- AF: Antenna Factor, Closs: Cable Loss, Pre-Amp: Preamp gain, Filter: High Pass Filter Insertion Loss (3.5GHz)
- Analyzer setting P(Peak): RBW=1MHz, VBW=1MHz, A(Average): RBW=1MHz, VBW=10Hz
- Remark “**” means that Restricted band.
- Dist : correction to extra plate reading to 3m specification distance 1m measurement
 $distance = -9.5dB$
- The result basic equation calculation is as follow:
 $Level=Reading+AF+Closs-Preamp+Filter-Dist, Margin=Level-Limit$
- The other emission levels were very low against the limit
- Remark“ * **” means that Fundamental frequency



Ecom Sertech Corp.

Rm. 258, Bldg. 17, NO.195, Sec. 4 Chung Hsing Rd., ChuTung Chen, Hsinchu, Taiwan 310, R.O.C
 TEL:886-3-5918012 FAX : 886-3-5825720

FCC ID : M4Y-XG-600
 Report No. : ER03-04-075FRF
 Page 20 of 40

Test Requirement: 15.205

The frequency spectrum above 1 GHz was investigated. All emissions not reported below are more than 40 dB below the prescribed limits. Readings are both peak and average values.

Operation Mode:		Transmitting					Test Date :		2003/5/1			
Fundamental Frequency:		2412MHz (CH 1)					Test By:		M.C. Huang			
Temperature :		30					Humidity :		65%			
Freq.	Reading	AF	Closs	Pre-amp	Dist	Filter	Level	Limit	Margin	Mark	Pol.	Height
MHz	dBuV	dBuV	dB	dB	dB	dB	dBuV/m	dBuV/m	dB	P/Q/A	H/V	Meter
2412.15**	103.26	31.788	2.36	35.31	9.5	0	92.59			P	V	1.0
2412.15**	94.23	31.788	2.36	35.31	9.5	0	83.56			A	V	1.0
4824.29	49.02	34.4403	2.78	35.38	9.5	1	42.35	74	-31.65	P	V	1.0
7234.66	42.43	39.8061	3.94	35.56	9.5	1	42.12	74	-31.88	P	V	1.0
9647.887	52.08	38.5352	4.10	35.67	9.5	1	50.54	74	-23.46	P	V	1.0
9647.887	48.22	38.5352	4.10	35.67	9.5	1	46.68	54	-7.32	A	V	1.0
12059.93*	---	42.60	15.20	35.30	9.5	1	---	---	---	---	V	1.0
14471.97*	---	43.40	16.80	34.00	9.5	1	---	---	---	---	V	1.0
16884.01	---	45.20	17.60	34.30	9.5	1	---	---	---	---	V	1.0
19296.05*	---	36.30	18.50	34.30	9.5	1	---	---	---	---	V	1.0
21708.09	---	36.20	19.20	34.60	9.5	1	---	---	---	---	V	1.0
24120.13	---	36.80	21.00	34.20	9.5	1	---	---	---	---	V	1.0
Note :												
1. The measurement was searched to 10th harmonic, Remark “---” means that the emissions level is too low to be measured.												
2. AF: Antenna Factor, Closs: Cable Loss, Pre-Amp: Preamp gain, Filter: High Pass Filter Insertion Loss (3.5GHz)												
3. Analyzer setting P(Peak): RBW=1MHz, VBW=1MHz, A(Average): RBW=1MHz, VBW=10Hz												
4. Remark “**” means that Restricted band.												
5. Dist : correction to extrea plate reading to 3mspecification distance 1m measurement distance = -9.5dB												
6.The result basic equation calculation is as follow: Level=Reading+AF+Closs-Preamp+Filter-Dist,Margin=Level-Limit												
7. The other emission levels were very low against the limit												
8. Remark“ * **” means that Fundamental frequency												



Ecom Sertech Corp.

Rm. 258, Bldg. 17, NO.195, Sec. 4 Chung Hsing Rd., Chu Tung Chen, Hsinchu, Taiwan 310, R.O.C
 TEL:886-3-5918012 FAX : 886-3-5825720

FCC ID : M4Y-XG-600
 Report No. : ER03-04-075FRF
 Page 21 of 40

Test Requirement: 15.205

The frequency spectrum above 1 GHz was investigated. All emissions not reported below are more than 40 dB below the prescribed limits. Readings are both peak and average values.

Operation Mode:		Transmitting					Test Date :		2003/5/1			
Fundamental Frequency:		2437MHz (CH 6)					Test By:		M.C. Huang			
Temperature :		30					Humidity :		65%			
Freq.	Reading	AF	Closs	Pre-amp	Dist	Filter	Level	Limit	Margin	Mark	Pol.	Height
MHz	dBuV	dBuV	dB	dB	dB	dB	dBuV/m	dBuV/m	dB	P/Q/A	H/V	Meter
2437.02**	103.26	31.763	2.42	35.32	9.5	0	92.63			P	H	1.0
2437.02**	96.15	31.763	2.42	35.32	9.5	0	85.52			A	H	1.0
4874.25	50.1	34.77	2.80	35.40	9.5	1	43.77	74	-30.23	P	H	1.0
7309.85	43.2	39.78	4.00	35.57	9.5	1	42.91	74	-31.09	P	H	1.0
9748.08	52.02	38.53	4.02	35.72	9.5	1	50.34	74	-23.66	P	H	1.0
9749.08	47.76	38.53	4.02	35.72	9.5	1	46.08	54	-7.92	A	H	1.0
12185.10*	---	32.14	4.53	35.24	9.5	1	---	---	---	---	H	1.0
14622.12	---	43.40	16.80	34.00	9.5	1	---	---	---	---	H	1.0
17059.14	---	45.20	17.60	34.30	9.5	1	---	---	---	---	H	1.0
19496.16*	---	36.30	18.50	34.30	9.5	1	---	---	---	---	H	1.0
21933.18	---	36.20	19.20	34.60	9.5	1	---	---	---	---	H	1.0
24370.2	---	36.80	21.00	34.20	9.5	1	---	---	---	---	H	1.0

Note :

- The measurement was searched to 10th harmonic, Remark “---” means that the emissions level is too low to be measured.
- AF: Antenna Factor, Closs: Cable Loss, Pre-Amp: Preamp gain, Filter: High Pass Filter Insertion Loss (3.5GHz)
- Analyzer setting P(Peak): RBW=1MHz, VBW=1MHz, A(Average): RBW=1MHz, VBW=10Hz
- Remark “**” means that Restricted band.
- Dist : correction to extra plate reading to 3m specification distance 1m measurement
 distance = -9.5dB
- The result basic equation calculation is as follow:
 Level=Reading+AF+Closs-Preamp+Filter-Dist, Margin=Level-Limit
- The other emission levels were very low against the limit
- Remark “ * * ” means that Fundamental frequency



Ecom Sertech Corp.

Rm. 258, Bldg. 17, NO.195, Sec. 4 Chung Hsing Rd., ChuTung Chen, Hsinchu, Taiwan 310, R.O.C
 TEL:886-3-5918012 FAX : 886-3-5825720

FCC ID : M4Y-XG-600
 Report No. : ER03-04-075FRF
 Page 22 of 40

Test Requirement: 15.205

The frequency spectrum above 1 GHz was investigated. All emissions not reported below are more than 40 dB below the prescribed limits. Readings are both peak and average values.

Operation Mode:	Transmitting	Test Date :	2003/5/1
Fundamental Frequency:	2437MHz (CH 6)	Test By:	M.C. Huang
Temperature :	30	Humidity :	65%

Freq. MHz	Reading dBuV	AF dBuV	Closs dB	Pre-amp dB	Dist dB	Filter dB	Level dBuV/m	Limit dBuV/m	Margin dB	Mark P/Q/A	Pol. H/V	Height Meter
2437.02**	104.26	31.763	2.42	35.32	9.5	0	93.63			P	V	1.0
2437.02**	95.18	31.763	2.42	35.32	9.5	0	84.55			V	V	1.0
4874.25	49.97	34.77	2.80	35.40	9.5	1	43.60	74	-30.36	P	V	1.0
7309.85	43.1	39.78	4.00	35.57	9.5	1	42.81	74	-31.19	P	V	1.0
9748.08	53.48	38.53	4.02	35.72	9.5	1	51.80	74	-22.20	P	V	1.0
9749.08	47.9	38.53	4.02	35.72	9.5	1	46.22	54	-9.54	A	V	1.0
12185.10*	---	32.14	4.53	35.24	9.5	1	---	---	---	---	V	1.0
14622.12	---	43.40	16.80	34.00	9.5	1	---	---	---	---	V	1.0
17059.14	---	45.20	17.60	34.30	9.5	1	---	---	---	---	V	1.0
19496.16*	---	36.30	18.50	34.30	9.5	1	---	---	---	---	V	1.0
21933.18	---	36.20	19.20	34.60	9.5	1	---	---	---	---	V	1.0
24370.20	---	36.80	21.00	34.20	9.5	1	---	---	---	---	V	1.0

Note :

- The measurement was searched to 10th harmonic, Remark “---” means that the emissions level is too low to be measured.
- AF: Antenna Factor, Closs: Cable Loss, Pre-Amp: Preamp gain, Filter: High Pass Filter Insertion Loss (3.5GHz)
- Analyzer setting P(Peak): RBW=1MHz, VBW=1MHz, A(Average): RBW=1MHz, VBW=10Hz
- Remark “*” means that Restricted band.
- Dist : correction to extra plate reading to 3m specification distance 1m measurement
 distance = -9.5dB
- The result basic equation calculation is as follow:
 Level=Reading+AF+Closs-Preamp+Filter-Dist, Margin=Level-Limit
- The other emission levels were very low against the limit
- Remark“ * * *” means that Fundamental frequency



Ecom Sertech Corp.

Rm. 258, Bldg. 17, NO.195, Sec. 4 Chung Hsing Rd., Chu Tung Chen, Hsinchu, Taiwan 310, R.O.C
 TEL:886-3-5918012 FAX : 886-3-5825720

FCC ID : M4Y-XG-600
 Report No. : ER03-04-075FRF
 Page 23 of 40

Test Requirement: 15.205

The frequency spectrum above 1 GHz was investigated. All emissions not reported below are more than 40 dB below the prescribed limits. Readings are both peak and average values.

Operation Mode:	Transmitting	Test Date :	2003/5/1
Fundamental Frequency:	2462MHz (CH 11)	Test By:	M.C. Huang
Temperature :	30	Humidity :	65%

Freq. MHz	Reading dBuV	AF dBuV	Closs dB	Pre-amp dB	Dist dB	Filter dB	Level dBuV/m	Limit dBuV/m	Margin dB	Mark P/Q/A	Pol. H/V	Height Meter
2462.74**	102.54	31.738	2.49	35.32	9.5	0	91.95			P	H	1.0
2462.74**	93.51	31.738	2.49	35.32	9.5	0	82.92			A	H	1.0
4924.05	50.74	35.10	2.83	35.41	9.5	1	44.76	74	-29.24	P	H	1.0
7387.18	45.21	39.75	4.06	35.57	9.5	1	44.94	74	-29.06	P	H	1.0
9848.02	54.12	38.52	3.93	35.77	9.5	1	52.30	74	-21.70	P	H	1.0
9849.02	48.52	38.52	3.93	35.77	9.5	1	46.69	54	-7.31	A	H	1.0
12310.04*	---	32.14	4.53	35.24	9.5	1	---	---	---	---	H	1.0
14772.06	---	43.40	16.80	34.00	9.5	1	---	---	---	---	H	1.0
17234.08	---	45.20	17.60	34.30	9.5	1	---	---	---	---	H	1.0
19696.1*	---	36.30	18.50	34.30	9.5	1	---	---	---	---	H	1.0
22158.12*	---	36.20	19.20	34.60	9.5	1	---	---	---	---	H	1.0
24620.14	---	36.80	21.00	34.20	9.5	1	---	---	---	---	H	1.0

Note :

- The measurement was searched to 10th harmonic, Remark “---” means that the emissions level is too low to be measured.
- AF: Antenna Factor, Closs: Cable Loss, Pre-Amp: Preamp gain, Filter: High Pass Filter Insertion Loss (3.5GHz)
- Analyzer setting P(Peak): RBW=1MHz, VBW=1MHz, A(Average): RBW=1MHz, VBW=10Hz
- Remark “**” means that Restricted band.
- Dist : correction to extrea plate reading to 3m specification distance 1m measurement
 distance = -9.5dB
- The result basic equation calculation is as follow:
 Level=Reading+AF+Closs-Preamp+Filter-Dist,Margin=Level-Limit
- The other emission levels were very low against the limit
- Remark“* *” means that Fundamental frequency



Ecom Sertech Corp.

Rm. 258, Bldg. 17, NO.195, Sec. 4 Chung Hsing Rd., ChuTung Chen, Hsinchu, Taiwan 310, R.O.C
 TEL:886-3-5918012 FAX : 886-3-5825720

FCC ID : M4Y-XG-600
 Report No. : ER03-04-075FRF
 Page 24 of 40

Test Requirement: 15.205

The frequency spectrum above 1 GHz was investigated. All emissions not reported below are more than 40 dB below the prescribed limits. Readings are both peak and average values.0

Operation Mode:	Transmitting	Test Date :	2003/5/1
Fundamental Frequency:	2462MHz (CH 11)	Test By:	M.C. Huang
Temperature :	30	Humidity :	65%

Freq. MHz	Reading dBuV	AF dBuV	Closs dB	Pre-amp dB	Dist dB	Filter dB	Level dBuV/m	Limit dBuV/m	Margin dB	Mark P/Q/A	Pol. H/V	Height Meter
2462.74**	103.21	31.738	2.49	35.32	9.5	0	92.06			P	V	1.0
2462.74**	94.06	31.738	2.49	35.32	9.5	0	83.05			A	V	1.0
4924.05	49.95	35.10	2.83	35.41	9.5	1	43.97	74	-30.03	P	V	1.0
7387.05	43.26	39.75	4.06	35.57	9.5	1	42.99	74	-31.01	P	V	1.0
9848.02	50.99	38.52	3.93	35.77	9.5	1	49.17	74	-24.83	P	V	1.0
9849.02	46.03	38.52	3.93	35.77	9.5	1	43.20	54	-10.80	A	V	1.0
12310.04*	---	32.14	4.53	35.24	9.5	1	---	---	---	---	V	1.0
14772.06	---	43.40	16.80	34.00	9.5	1	---	---	---	---	V	1.0
17234.08	---	45.20	17.60	34.30	9.5	1	---	---	---	---	V	1.0
19696.1*	---	36.30	18.50	34.30	9.5	1	---	---	---	---	V	1.0
22158.12*	---	36.20	19.20	34.60	9.5	1	---	---	---	---	V	1.0
24620.14	---	36.80	21.00	34.20	9.5	1	---	---	---	---	V	1.0

Note :

1. The measurement was searched to 10th harmonic, Remark “---” means that the emissions level is too low to be measured.
2. AF: Antenna Factor, Closs: Cable Loss, Pre-Amp: Preamp gain, Filter: High Pass Filter Insertion Loss (3.5GHz)
3. Analyzer setting P(Peak): RBW=1MHz, VBW=1MHz, A(Average): RBW=1MHz, VBW=10Hz
4. Remark “*” means that Restricted band.
5. Dist : correction to extrea plate reading to 3m specification distance 1m measurement distance = -9.5dB
6. The result basic equation calculation is as follow:
 $Level = Reading + AF + Closs - Preamp + Filter - Dist, Margin = Level - Limit$
7. The other emission levels were very low against the limit
8. Remark“ * **” means that Fundamental frequency

3.7 PHOTOS OF OPEN SITE





Ecom Sertech Corp.

Rm. 258, Bldg. 17, NO.195, Sec. 4 Chung Hsing Rd., ChuTung Chen, Hsinchu, Taiwan 310, R.O.C
TEL:886-3-5918012 FAX : 886-3-5825720

FCC ID : M4Y-XG-600
Report No. : ER03-04-075FRF
Page 26 of 40

3.7 PHOTOS OF OPEN SITE



4. 6dB BANDWIDTH MEASUREMENT

4.1 TEST EQUIPMENTS

Description & Manufacturer	Model No.	Serial No.	DATE OF CALIBRATION
ROHDE & SCHWARZ TEST RECEIVER	ESMI	842088/005 841978/008	SEPT. 3, 2002
HP ATTENUATOR	8496B	3247A18505	Cal. on use
HP PLOTTER	7750A	725A 852141	N/A

NOTE :

1. The measurement uncertainty is less than +/- 2.6dB, which is calculated as per the NAMAS document NIS81.
2. The calibration interval of the above test instruments is 12 months and the calibrations are traceable to NML/ROC and NIST/USA.

4.2 TEST SETUP

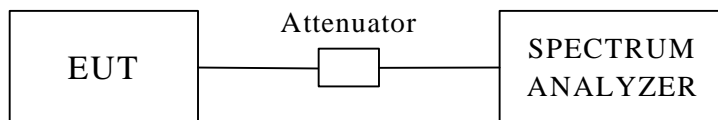

4.3 LIMITS OF 6dB BANDWIDTH MEASUREMENT

The minimum of 6dB Bandwidth Measurement is >500KHz

4.4 TEST PROCEDURE

The transmitter output was connected to the spectrum analyzer through an attenuator. The bandwidth of the fundamental frequency was measured by spectrum analyzer with 100 KHz RBW and 100 KHz VBW. The 6dB bandwidth is defined as the total spectrum the power of which is higher than peak power minus 6dB.



Ecom Sertech Corp.

Rm. 258, Bldg. 17, NO.195, Sec. 4 Chung Hsing Rd., ChuTung Chen, Hsinchu, Taiwan 310, R.O.C
TEL:886-3-5918012 FAX : 886-3-5825720

FCC ID : M4Y-XG-600
Report No. : ER03-04-075FRF
Page 28 of 40

4.5 UNCERTAINTY OF CONDUCTED EMISSION

The uncertainty of conducted emission is $\pm 200\text{KHz}$.

4.6 TEST RESULTS

EUT	2.4GHz 802.11g WLAN Mini PCI Card	MODEL	XG-601
INPUT POWER (SYSTEM)	3.3VDC(From PC)	ENVIRONMENTAL CONDITIONS	27 , 70%RH,
TESTED BY : M. C. Huang			

CHANNEL	CHANNEL FREQUENCY (MHz)	6dB BANDWIDTH (MHz)	MINIMUM LIMIT (MHz)	PASS / FAIL
1	2412	14.33	0.5	PASS
6	2437	14.61	0.5	PASS
11	2462	14.64	0.5	PASS



4.7 PHOTO OF 6DB BANDWIDTH MEASUREMENT

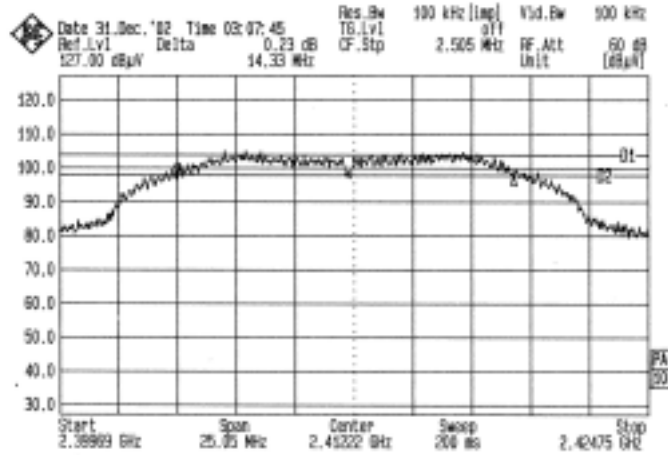

Channel 1

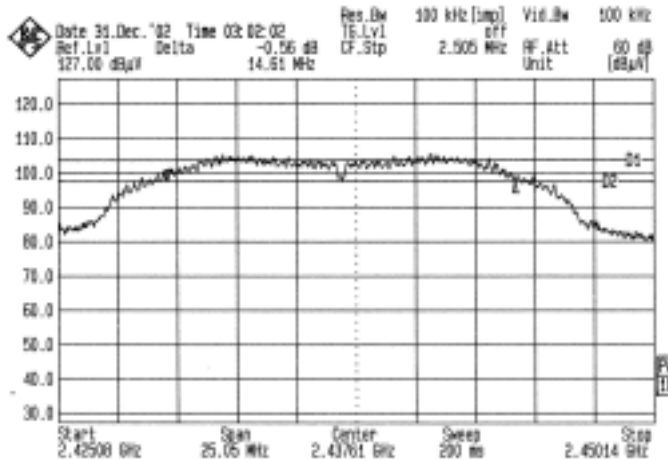

Channel 6

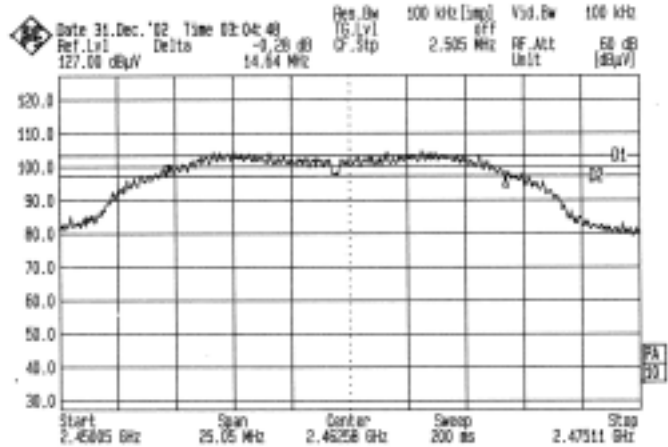

Channel 11



5. MAXIMUM PEAK OUTPUT POWER

5.1 TEST EQUIPMENTS

Description & Manufacturer	Model No.	Serial No.	DATE OF CALIBRATION
ROHDE & SCHWARZ TEST RECEIVER	ESMI	842088/005 841978/008	SEPT. 3, 2002
HP ATTENUATOR	8496B	3247A18505	Cal. on use
HP PLOTTER	7750A	725A 852141	N/A
GIGA-TRONICS Powre meter	8542	1828329	Sept.21,2002

NOTE :

1. The measurement uncertainty is less than +/- 2.6dB, which is calculated as per the NAMAS document NIS81.
2. The calibration interval of the above test instruments is 12 months and the calibrations are traceable to NML/ROC and NIST/USA.

5.2 TEST SETUP

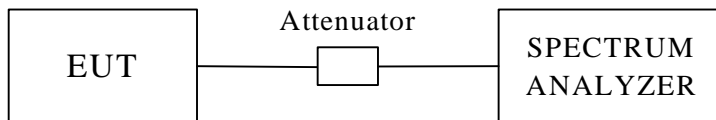

5.3 LIMITS OF MAXIMUM PEAK OUTPUT POWER

The Maximum Peak Output Power Measurement is 30dBm.



Ecom Sertech Corp.

Rm. 258, Bldg. 17, NO.195, Sec. 4 Chung Hsing Rd., ChuTung Chen, Hsinchu, Taiwan 310, R.O.C
TEL:886-3-5918012 FAX : 886-3-5825720

FCC ID : M4Y-XG-600
Report No. : ER03-04-075FRF
Page 31 of 40

5.4 TEST PROCEDURE

The RF power output was measured with a Power meter connected to the RF Antenna connector (conducted measurement) while EUT was operating in transmit mode at the appropriate center frequency.

5.5 UNCERTAINTY OF CONDUCTED EMISSION

The uncertainty of conducted emission is ± 1.82 dB.

5.6 TEST RESULTS

EUT	2.4GHz 802.11g WLAN Mini PCI Card	MODEL	XG-601
INPUT POWER (SYSTEM)	3.3VDC(From PC)	ENVIRONMENTAL CONDITIONS	27 , 70%RH,
TESTED BY : M. C. Huang			

CHANNEL	CHANNEL FREQUENCY (MHz)	PEAK POWER OUTPUT (dBm)	PEAK POWER LIMIT (dBm)	PASS / FAIL
1	2412	17.46	30	PASS
6	2437	17.38	30	PASS
11	2462	17.35	30	PASS

6. POWER SPECTRAL DENSITY MEASUREMENT

6.1 TEST EQUIPMENTS

Description & Manufacturer	Model No.	Serial No.	DATE OF CALIBRATION
ROHDE & SCHWARZ TEST RECEIVER	ESMI	842088/005 841978/008	SEPT. 3, 2002
HP ATTENUATOR	8496B	3247A18505	Cal. on use
HP PLOTTER	7750A	725A 852141	N/A

NOTE :

1. The measurement uncertainty is less than +/- 2.6dB, which is calculated as per the NAMAS document NIS81.
2. The calibration interval of the above test instruments is 12 months and the calibrations are traceable to NML/ROC and NIST/USA.

6.2 TEST SETUP

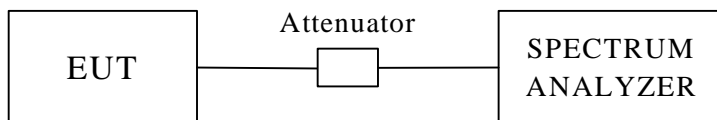

6.3 LIMITS OF POWER SPECTRAL DENSITY MEASUREMENT

The Maximum Power Spectral Density Measurement is 8dBm.



6.4 TEST PROCEDURE

The transmitter output was connected to the spectrum analyzer through an attenuator, the bandwidth of the fundamental frequency was measured with the spectrum analyzer using 3KHz RBW and 30KHz VBW, set sweep time=span / 3KHz.

The power spectral density was measured and recorded.

The sweep time is allowed to be longer than span / 3KHz for a full response of the mixer in the spectrum analyzer.

6.5 UNCERTAINTY OF CONDUCTED EMISSION

The uncertainty of conducted emission is ± 1.82dB.

6.6 TEST RESULTS

EUT	2.4GHz 802.11g WLAN Mini PCI Card	MODEL	XG-601
INPUT POWER (SYSTEM)	3.3VDC(From PC)	ENVIRONMENTAL CONDITIONS	27 , 70%RH,
TESTED BY : M. C. Huang			

CHANNEL	CHANNEL FREQUENCY (MHz)	Final RF Power Level IN 3KHz BW (dBm)	MAXIMUM LIMIT (dBm)	PASS / FAIL
1	2412	-6.66	8	PASS
6	2437	-7.45	8	PASS
11	2462	-13.55	8	PASS

Note:

- 1.The measurement value of RF Power Level + 10dB attenuator=Final RF Power Level



6.7 PHOTO OF POWER SPECTRAL DENSITY MEASUREMENT

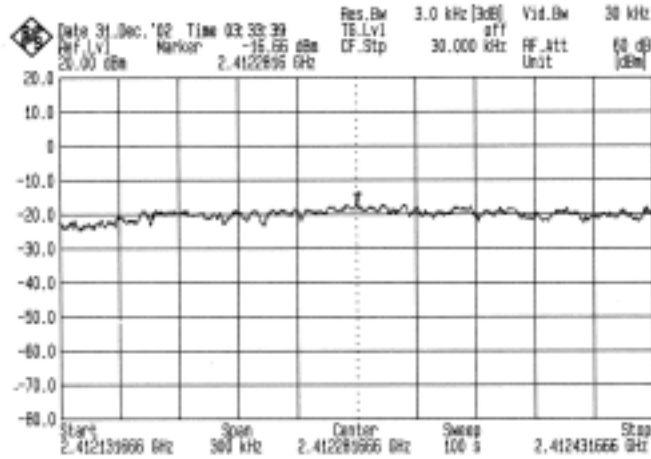

Channel 1

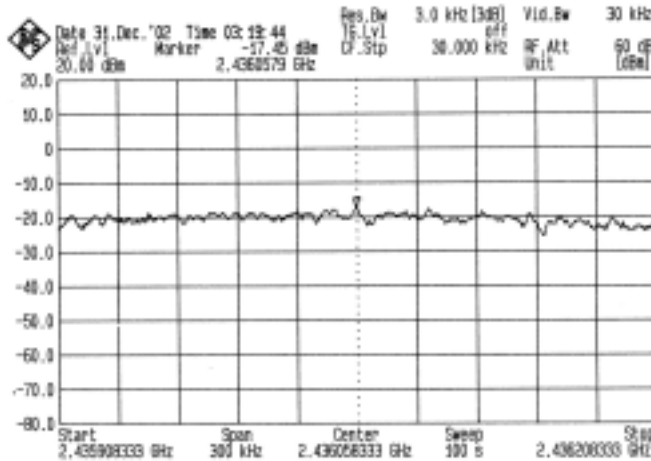

Channel 6

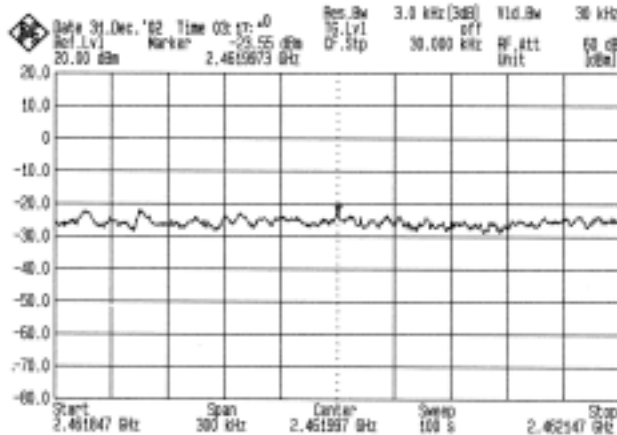

Channel 11



7. OUT OF BAND MEASUREMENT

7.1 TEST EQUIPMENTS

Description & Manufacturer	Model No.	Serial No.	DATE OF CALIBRATION
ROHDE & SCHWARZ TEST RECEIVER	ESMI	842088/005 841978/008	SEPT. 3, 2002
HP ATTENUATOR	8496B	3247A18505	Cal. on use
HP PLOTTER	7750A	725A 852141	N/A

NOTE :

3. The measurement uncertainty is less than +/- 2.6dB, which is calculated as per the NAMAS document NIS81.
4. The calibration interval of the above test instruments is 12 months and the calibrations are traceable to NML/ROC and NIST/USA.

7.2 TEST SETUP

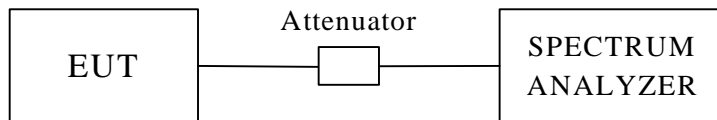

7.3 LIMITS OF OUT OF BAND EMISSIONS MEASUREMENT

1. Below -20dB of the highest emission level of operating band (in 100KHz Resolution Bandwidth).
2. Fall in the restricted bands listed in section 15.205. The maximum permitted average field strength is listed in section 15.209.



7.4 TEST PROCEDURE

The transmitter output was connected to the spectrum analyzer via a low lose cable. Set both RBW and VBW of spectrum analyzer to 100KHz with suitable frequency span including 100KHz bandwidth from band edge. The band edges was measured and recorded.

7.5 UNCERTAINTY OF CONDUCTED EMISSION

The uncertainty of conducted emission is ± 1.82 dB.

7.6 TEST RESULTS

A. Conducted

Refer to 7.7 photo of out band Emission measurement

B. Radiated

NOTE1: The band edge emission plot on the following first figure shows 42.11dB delta between carrier maximum power and local maximum emission in restrict band (2.3869GHz). The emission of carrier strength list in the test result of channel 1 at the item 3.6 is 86.57dBuV/m, so the maximum field strength in restrict band is $86.57-42.11=44.46$ dBuV/m which is under 54 dBuV/m limit.

NOTE2: The band edge emission plot on the following second figure shows 41.34dB delta between carrier maximum power and local maximum emission in restrict band (2.4891GHz). The emission of carrier strength list in the test result of channel 11 at the item 3.6 is 83.05dBuV/m, so the maximum field strength in restrict band is $83.05-41.34=41.71$ dBuV/m which is under 54 dBuV/m limit.

EUT	2.4GHz 802.11g WLAN Mini PCI Card	MODEL	XG-601
INPUT POWER (SYSTEM)	3.3VDC(From PC)	ENVIRONMENTAL CONDITIONS	27 , 70%RH,
TESTED BY : M. C. Huang			

CHANNEL FREQUENCY (MHz)	Required Limit (dBc)	PASS / FAIL
<2400	>20	PASS
>2483.5	>20	PASS



7.7 PHOTO OF OUT OF BAND MEASUREMENT

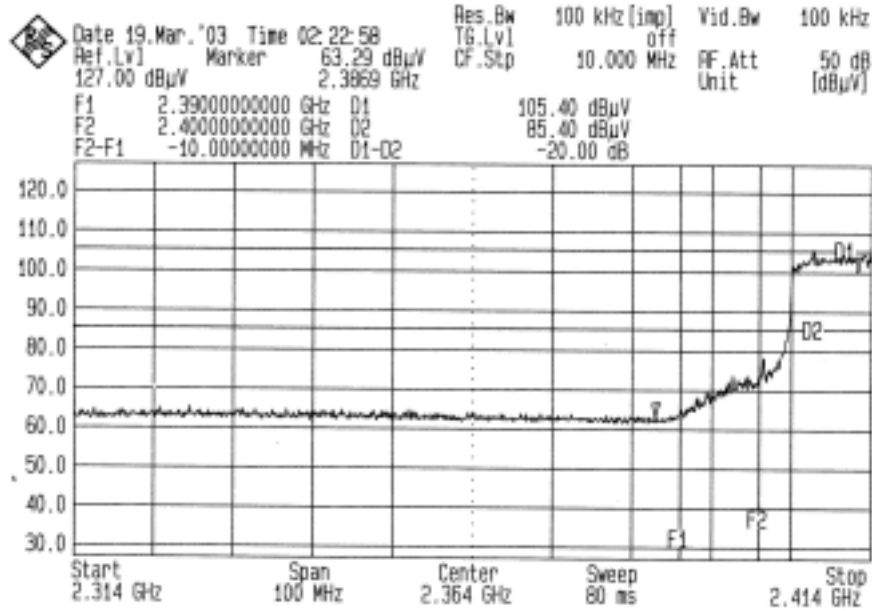

FRONT

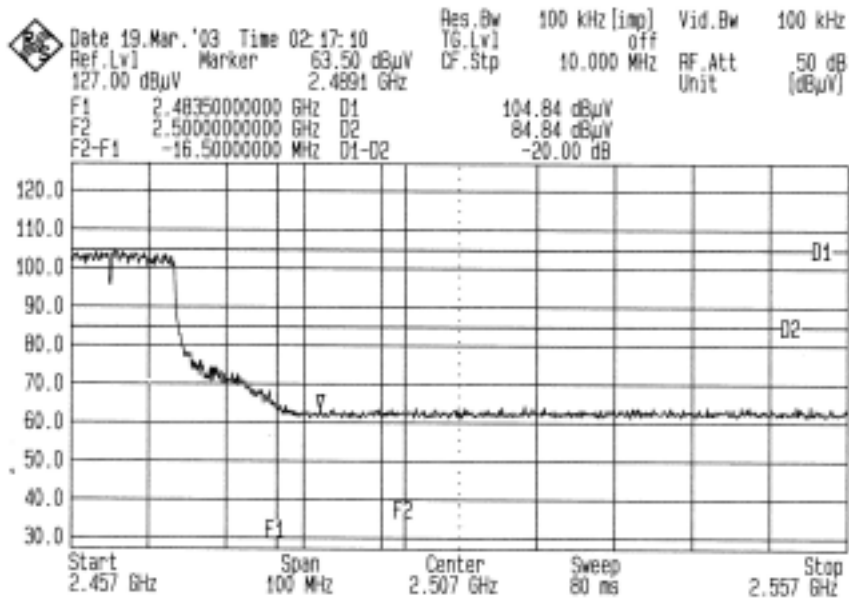

BACK



8. ANTENNA REQUIREMENT

8.1 STANDARD APPLICABLE

For intentional device, according to FCC 47 CFR Section 15.203, an intentional radiator shall be designed to ensure that no antenna other than that furnished by the responsible party shall be used with the device.

And according to FCC 47 CFR Section 15.247 (b), if transmitting antennas of directional gain greater than 6dBi are used, the power shall be reduced by the amount in dB that the directional gain of the antenna exceeds 6dBi.

8.2 ANTENNA CONNECTED CONSTRUCTION

The antenna used in this product is dipole antenna. The dipole antenna connector is U-FL-R-SMT And the maximum Gain of this antenna is only 2dBi.



9. RF EXPOSURE EVALUATION

According to FCC 1.1310 : The criteria listed in the following table shall be used to evaluate the environment impact of human exposure to radio frequency (RF) radiation as specified in 1.1307(b)
LIMITS FOR MAXIMUM PERMISSIBLE EXPOSURE (MPE)

Frequency Range (MHz)	Electric Field Strength (V/m)	Magnetic Field Strength (A/m)	Power Density (mW/cm ²)	Average Time
(A) Limits for Occupational / Control Exposures				
300-1,500	--	--	F/300	6
1,500-100,000	--	--	5	6
(B) Limits for General Population / Uncontrol Exposures				
300-1,500	--	--	F/1500	6
1,500-100,000	--	--	1	30

9.1 FRIIS FORMULA

Friis transmission formula : $Pd = (Pout * G) / (4 * pi * r^2)$

Where

Pd = power density in mW/cm²

Pout = output power to antenna in mW

G = gain of antenna in linear scale

Pi = 3.1416

R = distance between observation point and center of the radiator in cm

Pd is the limit of MPE, 1 mW/cm². If we know the maximum gain of the antenna and the total power input to the antenna, through the calculation, we will know the distance r where the MPE limit is reached.

9.2 EUT OPERATING CONDITION

A software provided by client enabled the EUT to transmit and receive data at lowest, middle and highest channel individually.



9.3 TEST RESULT OF RF EXPOSURE EVALUATION

Test Item : RF Exposure Evaluation Data

Test Mode : Normal Operation

9.3.1 ANTENNA GAIN

Antenna Gain : The maximum Gain measured in fully anechoic chamber is 2dBi linear scale.

9.3.2 OUTPUT POWER INTO ANTENNA & RF EXPOSURE EVALUATION DISTANCE

Channel	Channel Frequency (MHz)	Output Power to Antenna (dBm)	Power density in mW/cm ² at Friis formula when r=20cm(mW/cm ²)	LIMITS
CH1	2412.00	17.42	0.017407	1
CH6	2437.00	17.39	0.017287	1
CH11	2462.00	17.36	0.017168	1

The power density Pd (4th column) at a distance of 20cm calculated from the Friis transmission formula is far below the limit of 1 mW/cm². So, RF exposure limit warning or SAR test are not required.