



FCC CFR47 PART 15 CERTIFICATION

TEST REPORT

FOR

2.4 GHz 802.11b Radio Outdoor Unit with External Antenna

MODEL: AVCW-100/200

FCC ID: MKZ0208WODU0E

REPORT NUMBER: 02U1433-1

ISSUE DATE: September 19, 2002

Prepared for

**OTC WIRELESS, INC.
48507 MILMONT DRIVE
FREMONT, CA 94538
USA**

Prepared by

**COMPLIANCE CERTIFICATION SERVICES
561 F MONTEREY ROAD
MORGAN HILL, CA 95037, USA
TEL: (408) 463-0885
FAX: (408) 463-0888**

TABLE OF CONTENT

1. TEST RESULT CERTIFICATION	3
2. EUT DESCRIPTION	4
3. EUT MODIFICATION.....	4
4. TEST METHODOLOGY.....	5
5. TEST FACILITY	5
6. ACCREDITATION AND LISTING	5
6.1. LABORATORY ACCREDITATIONS AND LISTINGS	6
7. CALIBRATION AND UNCERTAINTY	7
7.1. MEASURING INSTRUMENT CALIBRATION.....	7
7.2. MEASUREMENT UNCERTAINTY	7
7.3. TEST AND MEASUREMENT EQUIPMENT	8
8. SUPPORT EQUIPMENT / EUT SETUP.....	8
9. APPLICABLE RULES AND BRIEF TEST RESULT	10
10. TEST SETUP, PROCEDURE AND RESULT	13
10.1. PEAK POWER OUTPUT.....	13
10.2. 6 dB BANDWIDTH MEASUREMENT	17
10.3. CONDUCTED SPURIOUS EMISSION	21
10.4. PEAK POWER SPECTRAL DENSITY.....	34
10.5. RADIATED EMISSION.....	38
10.5.1. RADIATED EMISSION, BANDEDGES & RESTRICTED BANDS.....	38
10.6. POWER LINE CONDUCTED EMISSION.....	68
10.7. SETUP PHOTOS	70

1. TEST RESULT CERTIFICATION

COMPANY NAME: OTC WIRELESS, INC.
48507 MILMONT DRIVE
FREMONT, CA 94538 USA

EUT DESCRIPTION: 2.4GHZ 802.11B RADIO OUTDOOR UNIT WITH EXTERNAL ANTENNA

MODEL NAME: AVCW-100/200

DATE TESTED: JULY 3, 2002 -SEPTEMBER 4, 2002

TYPE OF EQUIPMENT	INTENTIONAL RADIATOR
EQUIPMENT TYPE	2.4GHz RADIO
MEASUREMENT PROCEDURE	ANSI 63.4 / 1992, TIA/EIA 603
PROCEDURE	CERTIFICATION
FCC RULE	CFR 47 PART 15 Subpart C

Compliance Certification Services, Inc. tested the above equipment for compliance with the requirement set forth in CFR 47, PART 15 Subpart C. The equipment in the configuration described in this report, shows the measured emission levels emanating from the equipment do not exceed the specified limit.

Note: This document reports conditions under which testing was conducted and results of tests performed. This document may not be altered or revised in any way unless done so by Compliance Certification Services and all revisions are duly noted in the revisions section. Any alteration of this document not carried out by Compliance Certification Services will constitute fraud and shall nullify the document.

Approved & Released For CCS By:



MIKE HECKROTTE
CHIEF ENIGNEER
COMPLIANCE CERTIFICATION SERVICES

Tested By:



FRANK IBRAHIM
EMC ENGINEER
COMPLIANCE CERTIFICATION SERVICES

2. EUT DESCRIPTION

The Model AVCW-100/200, an outdoor unit, is a time-division-duplex wireless 802.11b Direct Sequence Spread Spectrum Transceiver that operates 2.4GHz-2.4835GHz for a computer data communication applications. The device functions both as a transmitter and a receiver. The transmitting and receiving operations are a time-domain duplexed. This unit provides a power output of 15.8dBm (38mW) and an omni antenna with 15dBi gain, or parabolic antenna with 24dBi gain.

3. EUT MODIFICATION

In order to comply with 15.209, there were modifications made to this Model AVCW-100/200. The modifications are listed below.

- Mod.#1: Add C103 (0.1uF), C104 (1000pf) on the digital board between Pin1 of U11 and Ground.
- Mod.#2: Add a ferrite bead on the location L10 (BLM21P300S) between Pin1 of U11 and Vccs.
- Mod.#3: Replace 0ohm resistor on location R24, R82 on the RF board with a ferrite bead (BLM21P300S).
- Mod#4: Filter, model F-30-3000-R, manufactured by RLC Electronics has to be used along with 24dBi Parabolic antenna in AVCW-100/200 applications.

4. TEST METHODOLOGY

Both conducted and radiated testing were performed according to the procedures documented on chapter 13 of ANSI C63.4 and FCC CFR 47 2.1046, 2.1047, 2.1049, 2.1051, 2.1053, 2.1055 and 2.1057.







5. TEST FACILITY

The open area test sites and conducted measurement facilities used to collect the radiated data are located at 561F Monterey Road, Morgan Hill, California, USA. The sites are constructed in conformance with the requirements of ANSI C63.7, ANSI C63.4 and CISPR Publication 22.

6. ACCREDITATION AND LISTING

The test facilities used to perform radiated and conducted emissions tests are accredited by National Voluntary Laboratory Accreditation Program for the specific scope of accreditation under Lab Code: 200065-0 to perform Electromagnetic Interference tests according to FCC PART 15 AND CISPR 22 requirements. No part of this report may be used to claim or imply product endorsement by NVLAP or any agency of the US Government. In addition, the test facilities are listed with Federal Communications Commission (reference no: 31040/SIT (1300B3) and 31040/SIT (1300F2))

6.1. Laboratory Accreditations and Listings

Country	Agency	Scope of Accreditation	Logo
USA	NVLAP*	FCC Part 15, CISPR 22, AS/NZS 3548, IEC 61000-4-2, IEC 61000-4-3, IEC 61000-4-4, IEC 61000-4-5, IEC 61000-4-6, IEC 61000-4-8, IEC 61000-4-11, CNS 13438	 200065-0
USA	FCC	3/10 meter Open Area Test Sites to perform FCC Part 15/18 measurements	 1300
Japan	VCCI	CISPR 22 Two OATS and one conducted Site	 R-1014, R-619, C-640
Norway	NEMKO	EN50081-1, EN50081-2, EN50082-1, EN50082-2, IEC61000-6-1, IEC61000-6-2, EN50083-2, EN50091-2, EN50130-4, EN55011, EN55013, EN55014-1, EN55104, EN55015, EN61547, EN55022, EN55024, EN61000-3-2, EN61000-3-3, EN60945, EN61326-1	 ELA 117
Norway	NEMKO	EN60601-1-2 and IEC 60601-1-2, the Collateral Standards for Electro-Medical Products. MDD, 93/42/EEC, AIMD 90/385/EEC	 ELA-171
Taiwan	BSMI	CNS 13438	 SL2-IN-E-1012
Canada	Industry Canada	RSS210 Low Power Transmitter and Receiver	 IC2324 A,B,C, and F

*No part of this report may be used to claim or imply product endorsement by NVLAP or any agency of the US Government

7. CALIBRATION AND UNCERTAINTY

7.1. Measuring Instrument Calibration

The measuring equipment, which was utilized in performing the tests documented herein, has been calibrated in accordance with the manufacturer's recommendations for utilizing calibration equipment, which is traceable to recognized national standards.

7.2. Measurement Uncertainty

Where relevant, the following measurement uncertainty levels have been estimated for tests performed on the apparatus:

Radiated Emission	
30MHz – 200 MHz	+/- 3.3dB
200MHz – 1000MHz	+4.5/-2.9dB
1000MHz – 2000MHz	+4.6/-2.2dB
Power Line Conducted Emission	
150kHz – 30MHz	+/-2.9

Any results falling within the above values are deemed to be marginal.

7.3. Test and Measurement Equipment

The following test and measurement equipment was utilized for the tests documented in this report:

TEST EQUIPMENTS LIST				
Name of Equipment	Manufacturer	Model No.	Serial No.	Due Date
Spectrum Display	HP	85662A	2152A03066	6/1/03
Spectrum Analyzer	HP100Hz - 22GHz	8566B	3014A06685	6/1/03
Quasi-Peak Detector	HP9K - 1GHz	85650A	3145A01654	6/1/03
Pre-Amplifier	MITEQ1-26GHz	NSP2600-44	646456	4/26/03
Horn Antenna	EMCO	3115	6717	1/31/03
Horn Antenna,(18 - 26GHz)	Antenna Research Associate	MWH 1826/B	1013	7/26/02 (Extended)
Spectrum Analyzer	HP	8593EM	3710A00205	3/18/04
Spectrum Analyzer	HP100Hz - 22GHz	8566B	2140A01296	5/23/03
Quasi-Peak Detector	HP9K - 1GHz	85650A	2811A01335	5/23/03
Spectrum Display	HP	85662A	3026A19146	5/23/03
Pre-Amplifier, 25dB	HP0.1-1300MHz	8447D(P5)	2944A06550	8/22/03
Antenna Bicon	Eaton30-200MHz	944455-1	1214	3/29/03
Antenna, LP	EMCO200-2000MHz	3146	2120	3/29/03
LISN	Solar Elec. Co.	8012-50-R-24-BNC	837990	4/25/03
LISN	Fischer 9k-100MHz	FCC-LISN-50/250-25-2	114	4/23/03
EMI Test Receiver	Rhode & Schwarz	ESHS 20	827129/002	4/17/03

8. SUPPORT EQUIPMENT / EUT SETUP

The following peripheral support equipment was utilized to operate the equipment under test:

- Was use for ITE devices minimum configuration requirement:

TEST PERIPHERALS				
Device Type	Manufacturer	Model Number	Serial Number	FCC ID
Laptop	Personal Computer	N340S8	PB344S811902382	DoC
AC/DC Adapter	LI SHIN CORP	LSE9802A2060	10810241	N/A
AC/DC Adapter	Not Provided	A10D1-05MP	A984606445	N/A
DC Injector	OTC Wireless	N/A	N/A	N/A

The following setup was used to operate the equipment under test:

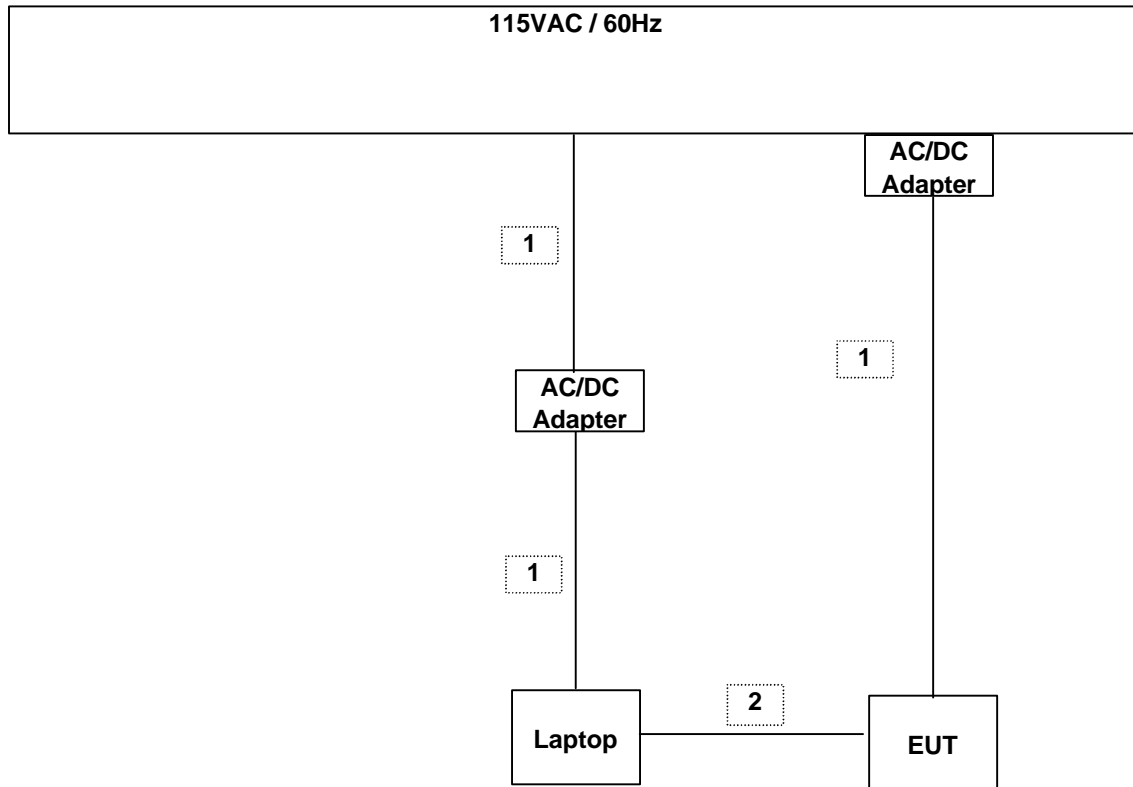

TEST I / O CABLES								
Cable No	I/O Port	# of I/O Port	Connector Type	Type of Cable	Cable Length	Data Traffic	Bundled	Remark
1	AC	3	US 115V	Un-shielded	1m	No	No	N/A
2	Networking	1	RJ45	Un-shielded	0.5m	Yes	No	N/A

9. APPLICABLE RULES AND BRIEF TEST RESULT

§15.247 (a) (2) - BANDWIDTH LIMITATION

(a) (2) For direct sequence systems, the minimum 6 dB bandwidth shall be at least 500 kHz.

§15.247 (b) (1) - POWER OUTPUT

(b) The maximum peak output power of the intentional radiator shall not exceed the following:

(1) For frequency hopping systems operating in the 2400-2483.5 MHz or 5725-5850 MHz band, and all direct sequence systems: 1 watt.

§15.247 (c) – SPURIOUS EMISSION

(c) In any 100 kHz bandwidth outside the frequency band in which the spread spectrum intentional radiator is operating, the radio frequency power that is produced by the intentional radiator shall be at least 20 dB below that in the 100 kHz bandwidth within the band that contains the highest level of the desired power, based on either an RF conducted or a radiated measurement. Attenuation below the general limits specified in §15.209(a) is not required. In addition, radiated emissions which fall in the restricted bands, as defined in §15.205(a), must also comply with the radiated emission limits specified in §15.209(a) (see §15.205(c)).

§15.247 (d) - PEAK POWER SPECTRAL DENSITY

(d) For direct sequence systems, the peak power spectral density conducted from the intentional radiator to the antenna shall not be greater than 8 dBm in any 3 kHz band during any time interval of continuous transmission.

§15.205- RESTRICTED BANDS OF OPERATIONS

(a) Except as shown in paragraph (d) of this section, only spurious emissions are permitted in any of the frequency bands listed below:

MHz	MHz	MHz	GHz
0.090 - 0.110	16.42 - 16.423	399.9 - 410	4.5 - 5.15
¹ 0.495 - 0.505	16.69475 - 16.69525	608 - 614	5.35 - 5.46
2.1735 - 2.1905	16.80425 - 16.80475	960 - 1240	7.25 - 7.75
4.125 - 4.128	25.5 - 25.67	1300 - 1427	8.025 - 8.5
4.17725 - 4.17775	37.5 - 38.25	1435 - 1626.5	9.0 - 9.2
4.20725 - 4.20775	73 - 74.6	1645.5 - 1646.5	9.3 - 9.5
6.215 - 6.218	74.8 - 75.2	1660 - 1710	10.6 - 12.7
6.26775 - 6.26825	108 - 121.94	1718.8 - 1722.2	13.25 - 13.4
6.31175 - 6.31225	123 - 138	2200 - 2300	14.47 - 14.5
8.291 - 8.294	149.9 - 150.05	2310 - 2390	15.35 - 16.2
8.362 - 8.366	156.52475 - 156.52525	2483.5 - 2500	17.7 - 21.4
8.37625 - 8.38675	156.7 - 156.9	2655 - 2900	22.01 - 23.12
8.41425 - 8.41475	162.0125 - 167.17	3260 - 3267	23.6 - 24.0
12.29 - 12.293	167.72 - 173.2	3332 - 3339	31.2 - 31.8
12.51975 - 12.52025	240 - 285	3345.8 - 3358	36.43 - 36.5
12.57675 - 12.57725	322 - 335.4	3600 - 4400	(²)
13.36 - 13.41			

¹ Until February 1, 1999, this restricted band shall be 0.490-0.510 MHz.

² Above 38.6

(b) Except as provided in paragraphs (d) and (e), the field strength of emissions appearing within these frequency bands shall not exceed the limits shown in Section 15.209. At frequencies equal to or less than 1000 MHz, compliance with the limits in Section 15.209 shall be demonstrated using measurement instrumentation employing a CISPR quasi-peak detector. Above 1000 MHz, compliance with the emission limits in Section 15.209 shall be demonstrated based on the average value of the measured emissions. The provisions in Section 15.35 apply to these measurements.

§15.207- CONDUCTED LIMITS

(a) For an intentional radiator which is designed to be connected to the public utility (AC) power line, the radio frequency voltage that is conducted back onto the AC power line on any frequency or frequencies within the band 450 kHz to 30 MHz shall not exceed 250 microvolts. Compliance with this provision shall be based on the measurement of the radio frequency voltage between each power line and ground at the power terminals.

FCC 15.207

FREQUENCY RANGE	FIELD STRENGTH (Microvolts)	FIELD STRENGTH (dBuV)/QP
450kHz-30MHz	250	48

§15.209- RADIATED EMISSION LIMITS; GENERAL REQUIREMENTS

(a) Except as provided elsewhere in this Subpart, the emissions from an intentional radiator shall not exceed the field strength levels specified in the following table:

Frequency (MHz)	Field Strength (micro volts/meter)	Measurement Distance (meters)
30 - 88	100 **	3
88 - 216	150 **	3
216 - 960	200 **	3
Above 960	500	3

** Except as provided in paragraph (g), fundamental emissions from intentional radiators operating under this Section shall not be located in the frequency bands 54-72 MHz, 76-88 MHz, 174-216 MHz or 470-806 MHz. However, operation within these frequency bands is permitted under other sections of this Part, e.g., Sections 15.231 and 15.241.

(b) In the emission table above, the tighter limit applies at the band edges.

FCC PART 15.209

MEASURING DISTANCE OF 3 METER		
FREQUENCY RANGE (MHz)	FIELD STRENGTH (Microvolts/m)	FIELD STRENGTH (dBuV/m)
30-88	100	40
88-216	150	43.5
216-960	200	46
Above 960	500	54

10. TEST SETUP, PROCEDURE AND RESULT

10.1. PEAK POWER OUTPUT

TEST SETUP



TEST PROCEDURE

The EUT is configured on a test bench as shown above in a continuously transmitting mode. While the transmitter is on, the Spectrum Analyzer captures the emission displaying the value on screen. Recorded the value on a template below.

<i>Channel</i>	<i>Frequency (MHz)</i>	<i>Output Power (watts)</i>
<i>LOW</i>	<i>2412</i>	<i>0.038 (15.8 dBm)</i>
<i>MID</i>	<i>2437</i>	<i>0.031 (14.9 dBm)</i>
<i>HIGH</i>	<i>2462</i>	<i>0.029 (14.6 dBm)</i>

See Plots Below:

LOW CHANNEL
CONDUCTED PEAK OUTPUT POWER CH1

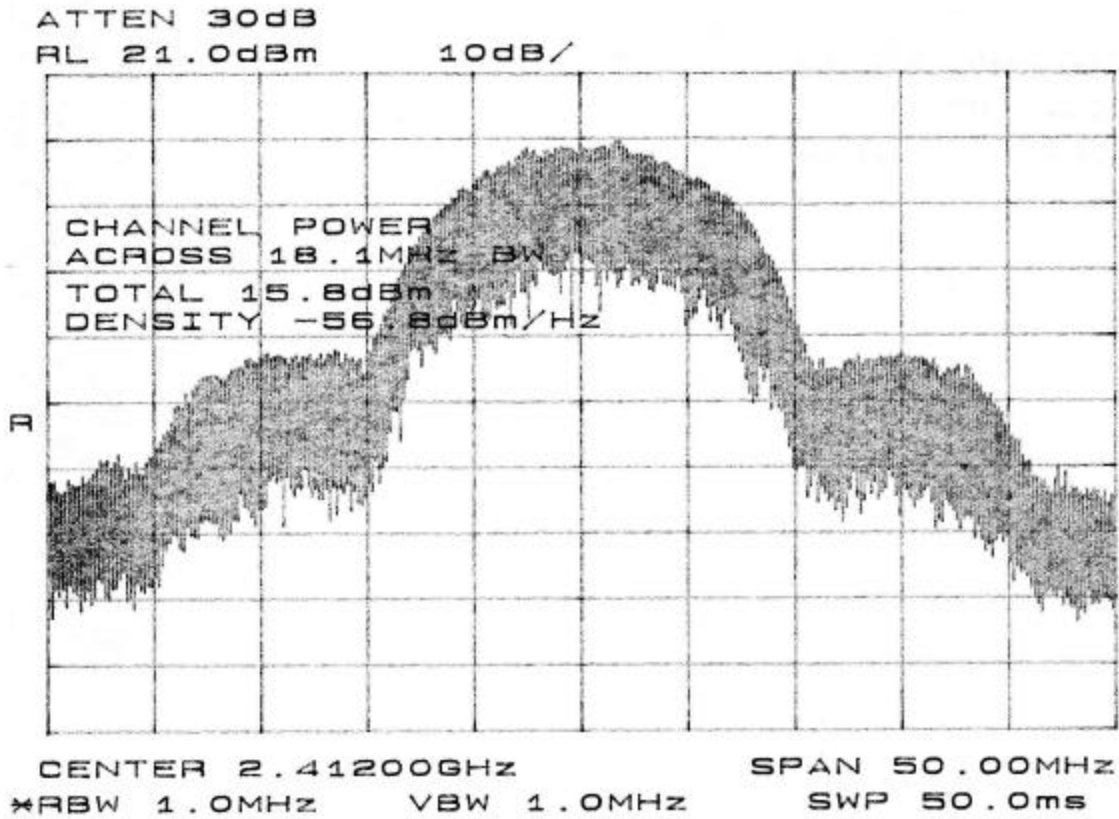

MIDDLE CHANNEL
CONDUCTED PEAK OUTPUT POWER CH6

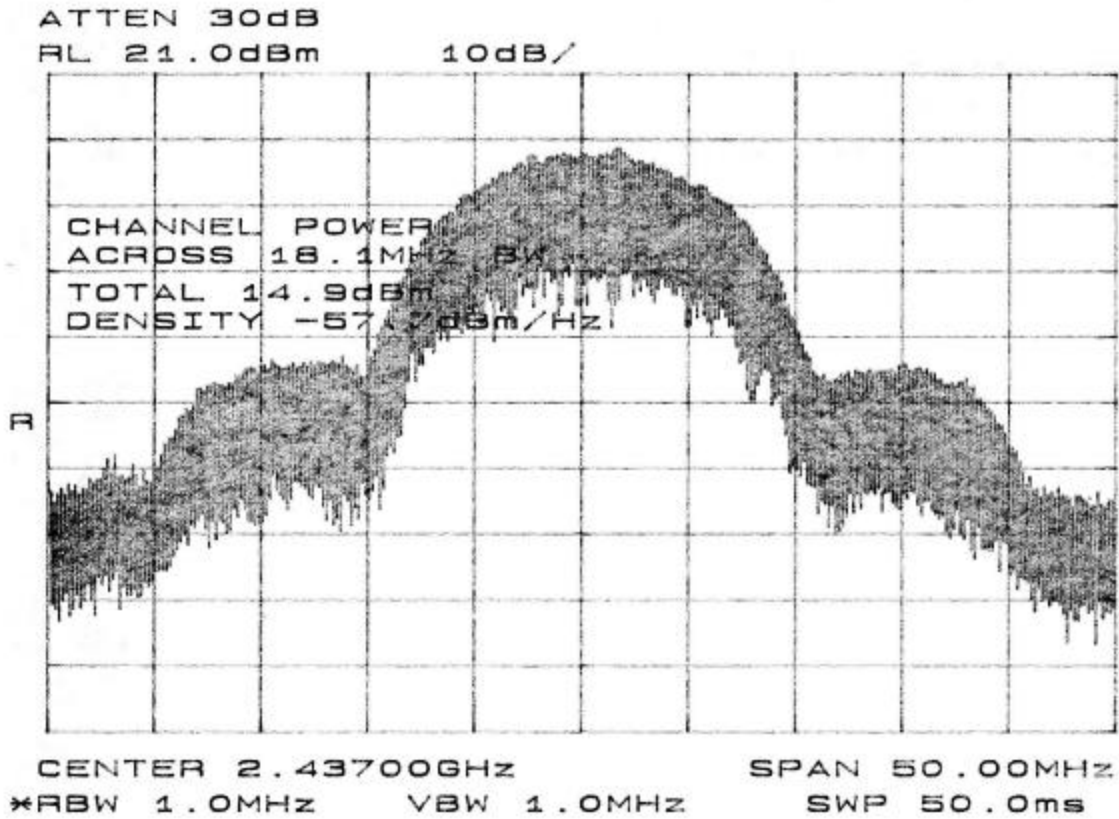

HIGH CHANNEL
CONDUCTED PEAK OUTPUT POWER CH11

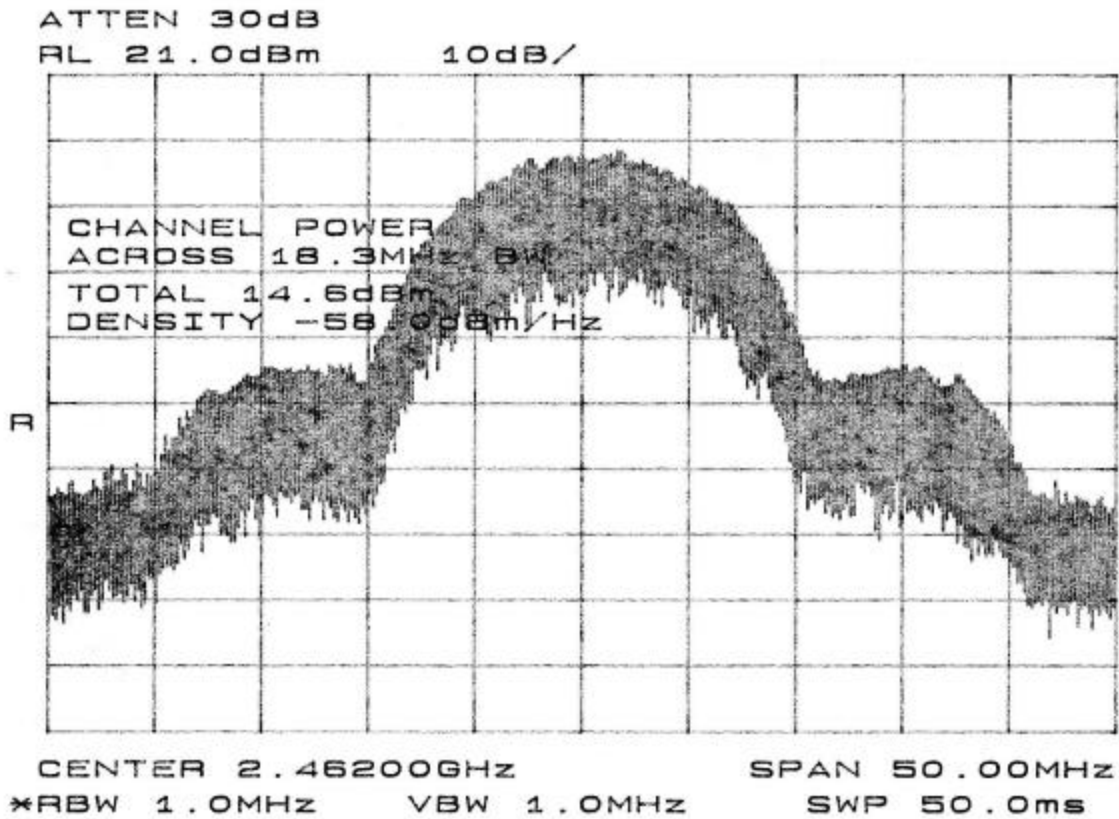

10.2. 6 dB BANDWIDTH MEASUREMENT

TEST SETUP

Detector Function Setting of Test Receiver

Frequency Range (MHz)	Detector Function	Resolution Bandwidth	Video Bandwidth
Above 1000	<input checked="" type="checkbox"/> Peak	<input checked="" type="checkbox"/> 100 kHz	<input checked="" type="checkbox"/> 100 kHz

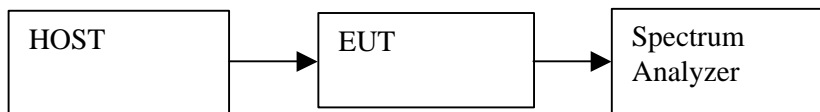

TEST PROCEDURE

The EUT transmitter output was connected to the spectrum analyzer. The bandwidth of the fundamental frequency was measured by spectrum analyzer with 100 kHz RBW and 100 kHz VBW.

RESULT

No non-compliance noted. See plots below.

LOW CHANNEL
6dB BANDWIDTH CH1

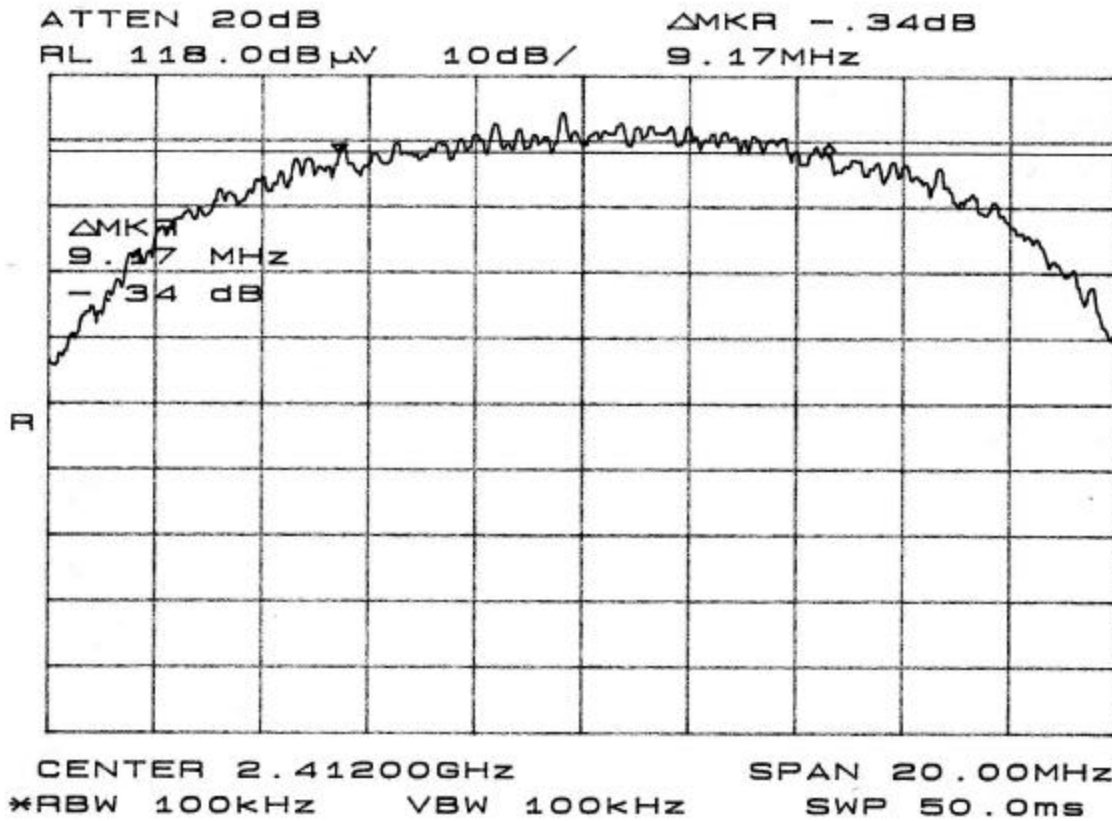

MIDDLE CHANNEL
6dB BANDWIDTH CH6

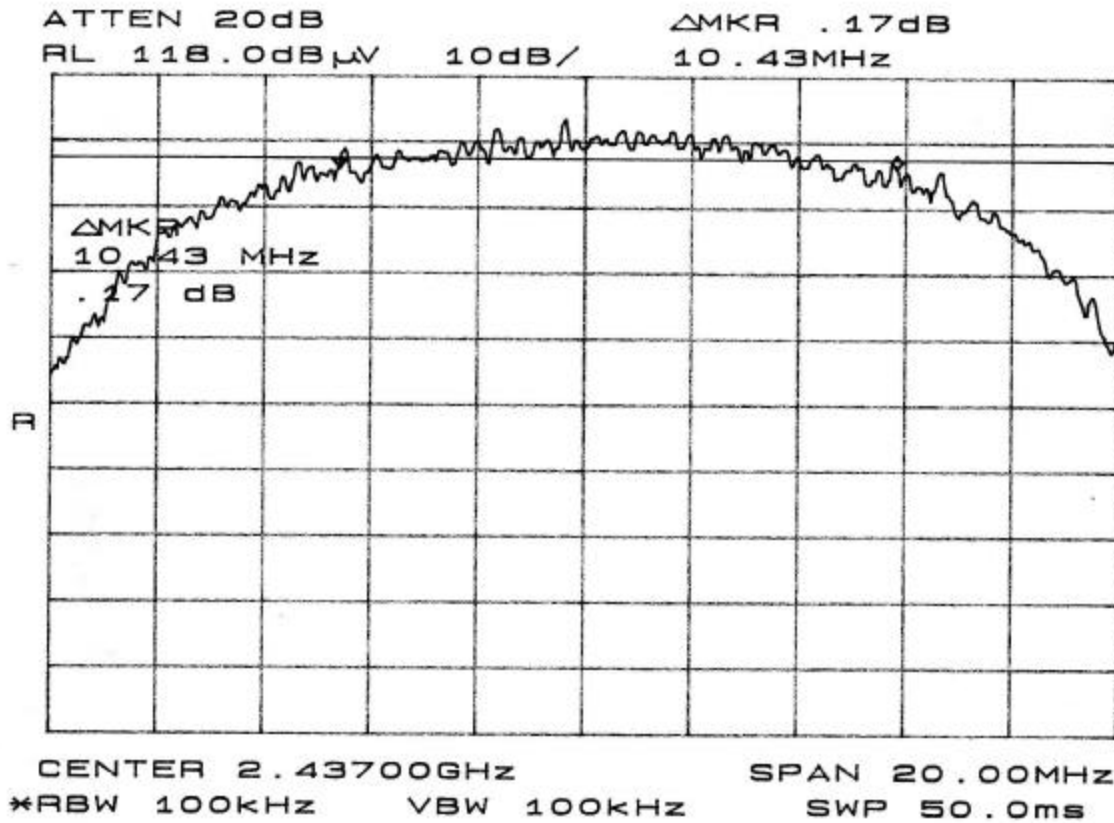

10.3. CONDUCTED SPURIOUS EMISSION

TEST SETUP

Detector Function Setting of Test Receiver

Frequency Range (MHz)	Detector Function	Resolution Bandwidth	Video Bandwidth
30 - 25000	<input checked="" type="checkbox"/> Peak	<input checked="" type="checkbox"/> 100 kHz	<input checked="" type="checkbox"/> 100 kHz

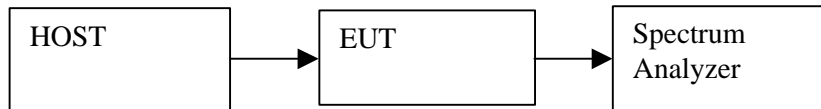

TEST PROCEDURE

Connect the Eut's antenna port to the Spectrum Analyzer's input port.
 Investigate the entire frequency of the carrier frequency, up to the tenth harmonic.

RESULT

No non-compliance noted. See below plots for LOW, MID, HIGH channels.

Channel	Ferq (MHz)	Field Strength (dBuV/m)	Limit (dBuV/m) -20dBc	Margin (dB)
Low	818.1	45.25 (Noise Floor)	87.4	-42.15
Low	2457	71.05	87.4	-16.35
Low	22880	62.69(Noise Floor)	87.4	-24.71
Middle	718.7	45.7(Noise Floor)	87.5	-41.8
Middle	2373	69.39	87.5	-18.11
Middle	23.16	62.54(Noise Floor)	87.5	-24.96
High	840	44.19(Noise Floor)	86.7	-42.51
High	2407	72.73	86.7	-13.97
High	22710	62.47(Noise Floor)	86.7	-24.23

LOW CHANNEL
CONDUCTED SPURIOUS EMISSIONS CH1 (FUNDAMENTAL)

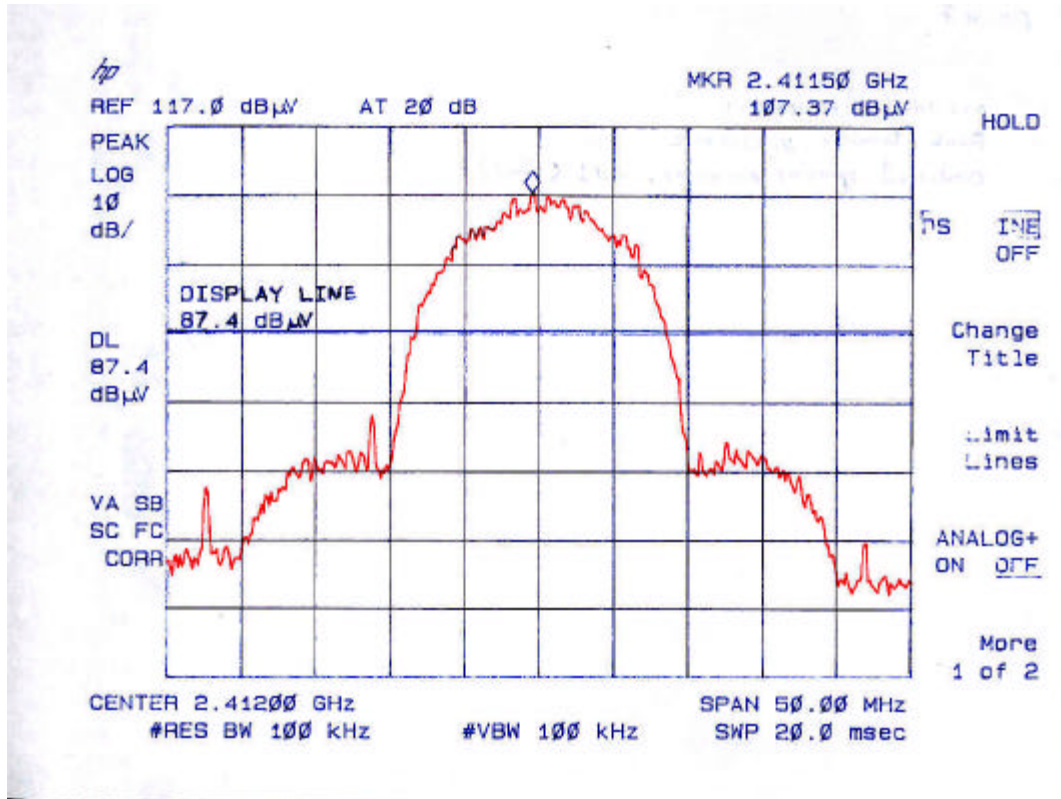

LOW CHANNEL
CONDUCTED SPURIOUS EMISSIONS CH1 (30-1000MHz)

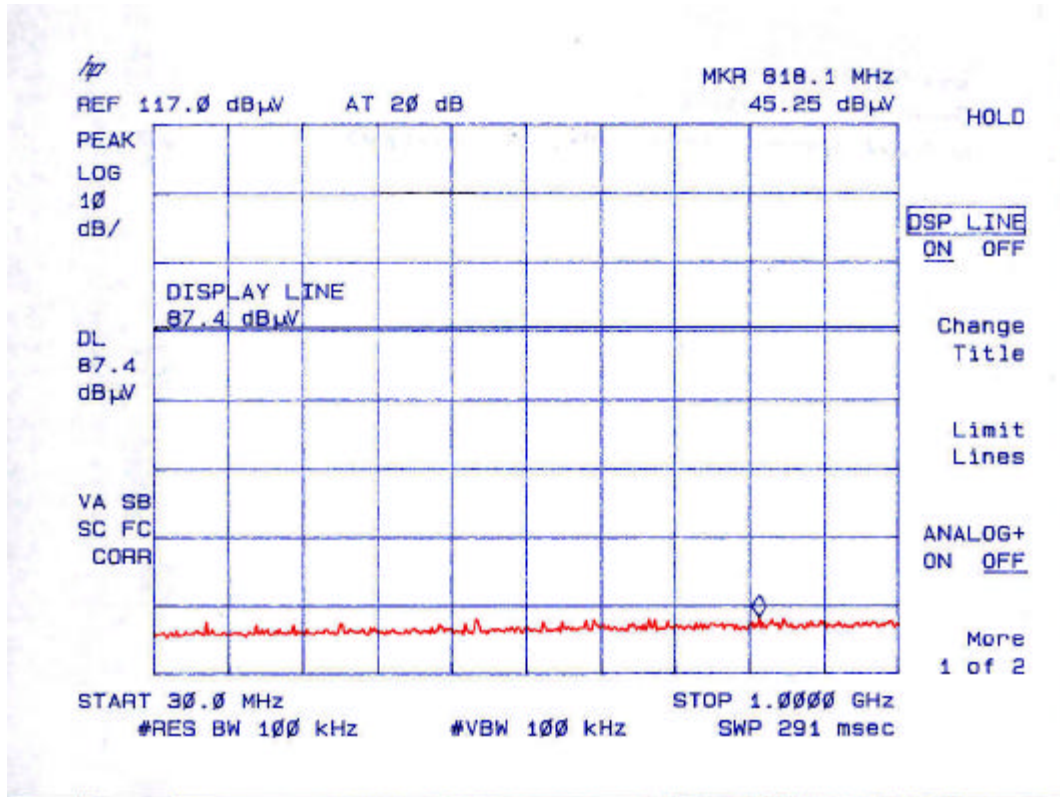

LOW CHANNEL
CONDUCTED SPURIOUS EMISSIONS CH1 (1-2.68GHz)

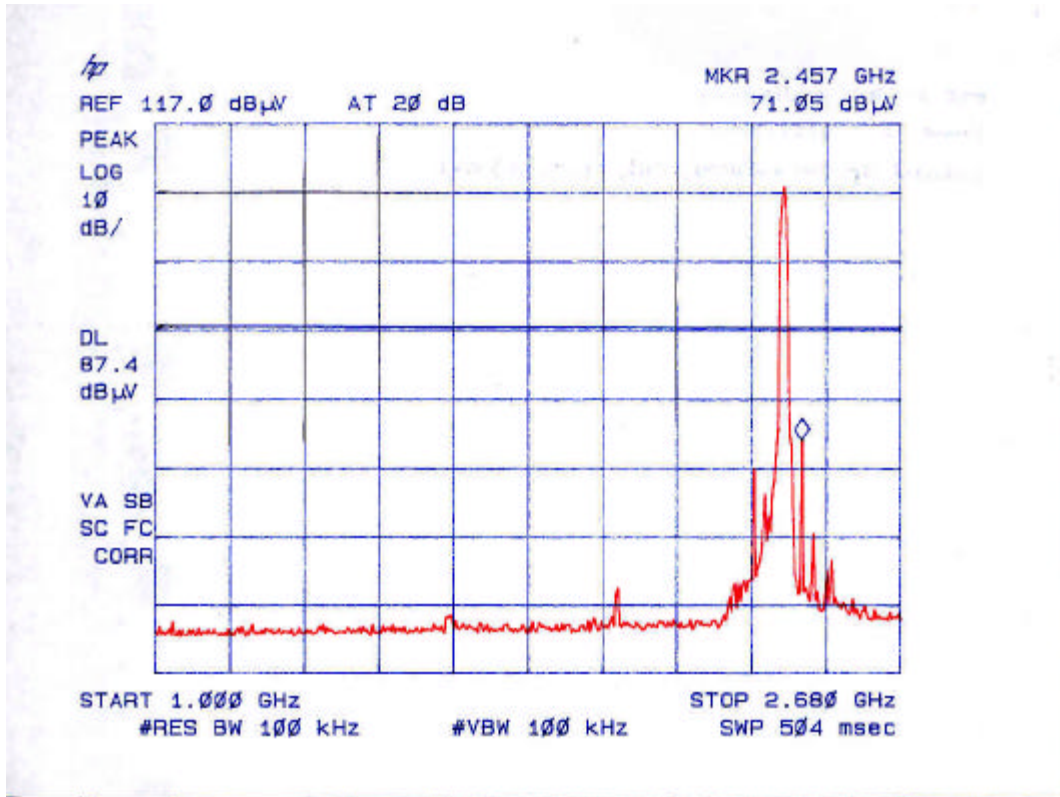

LOW CHANNEL
CONDUCTED SPURIOUS EMISSIONS CH1 (2.68-25GHz)

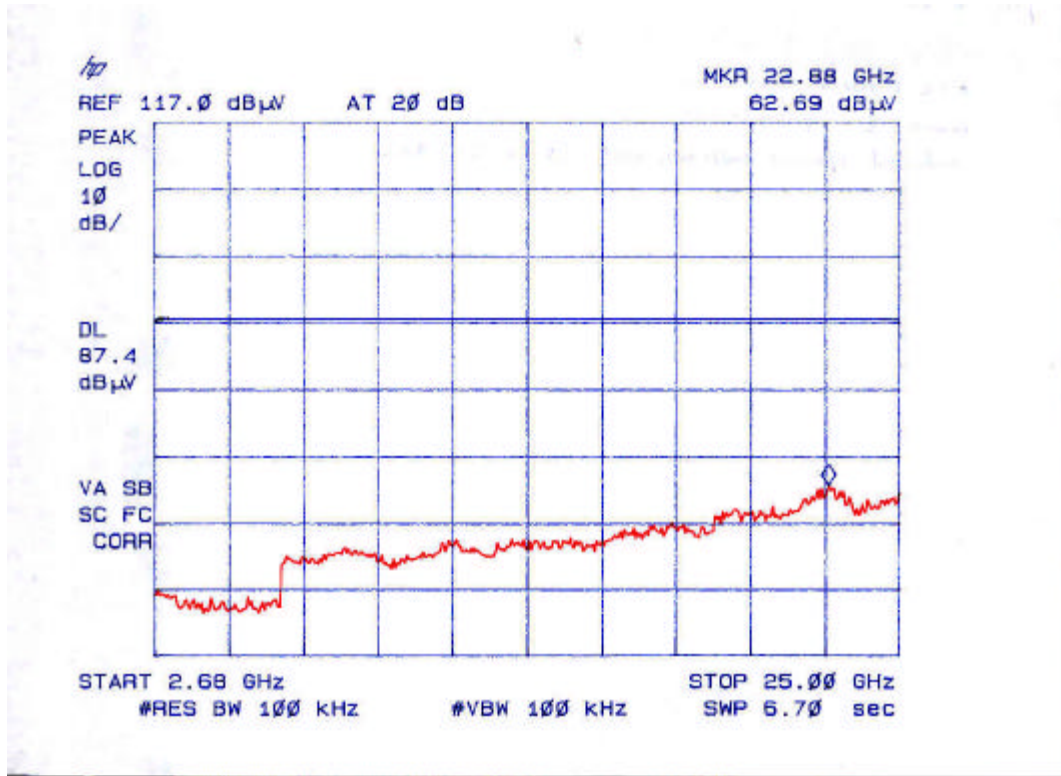

MIDDLE CHANNEL
CONDUCTED SPURIOUS EMISSIONS CH6 (FUNDAMENTAL)

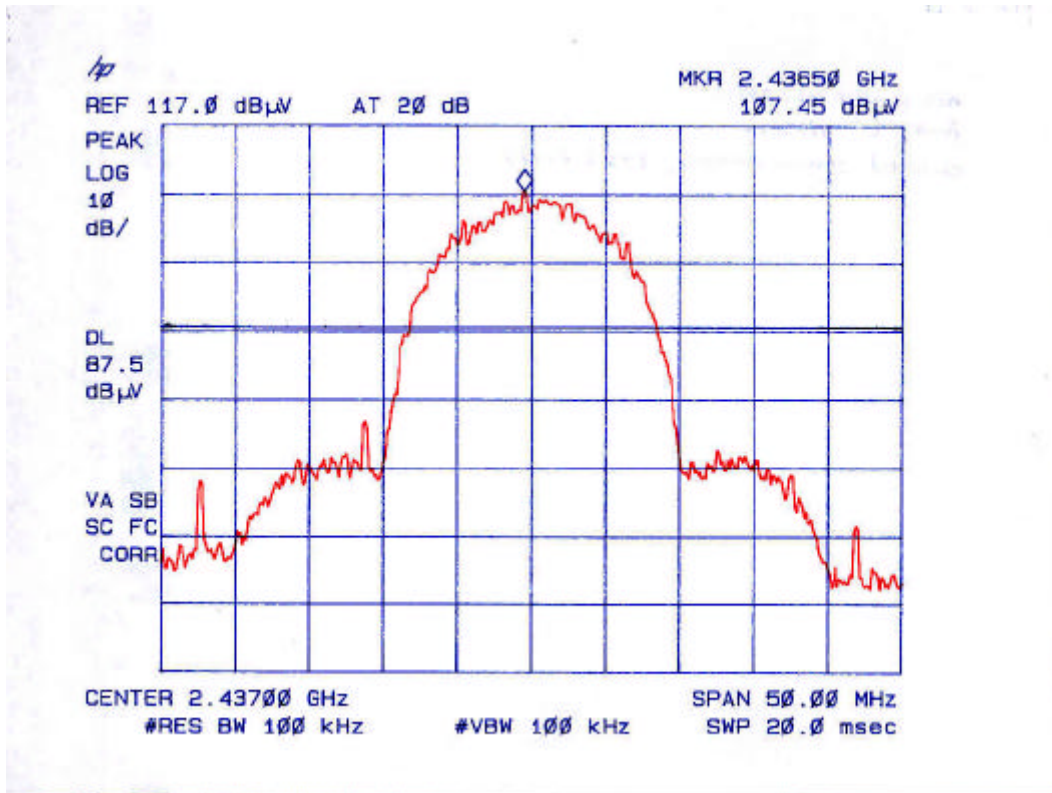

MIDDLE CHANNEL
CONDUCTED SPURIOUS EMISSIONS CH6 (30-1000MHz)

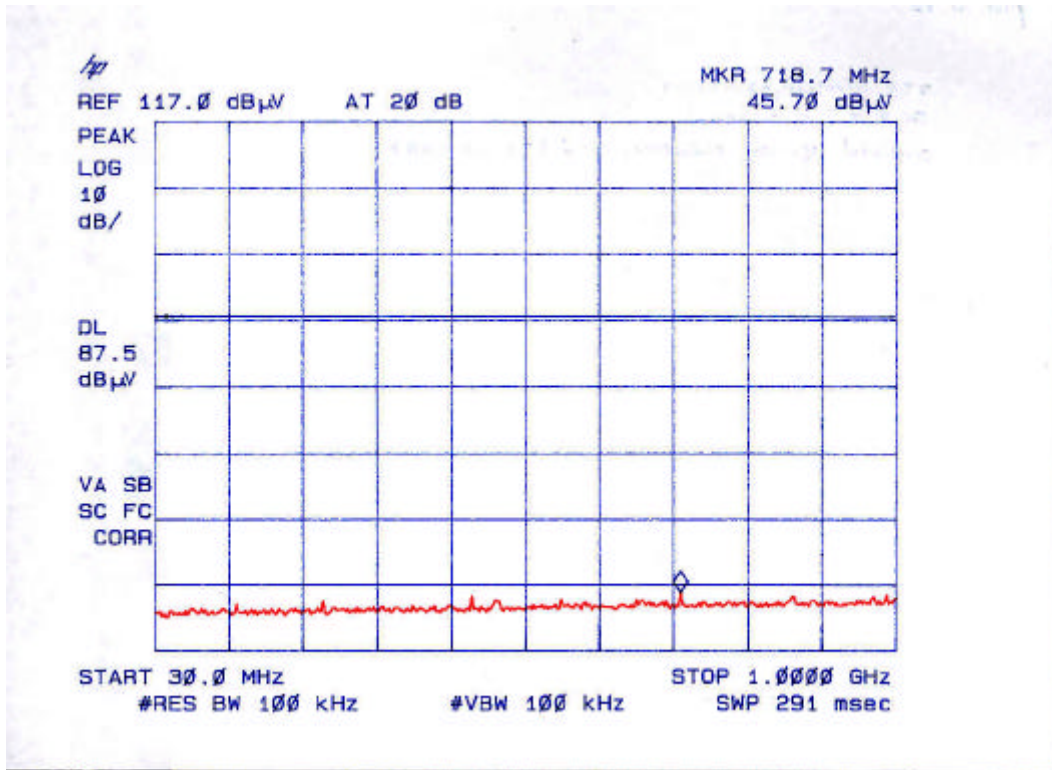

MIDDLE CHANNEL
CONDUCTED SPURIOUS EMISSIONS CH6 (1-2.68GHz)

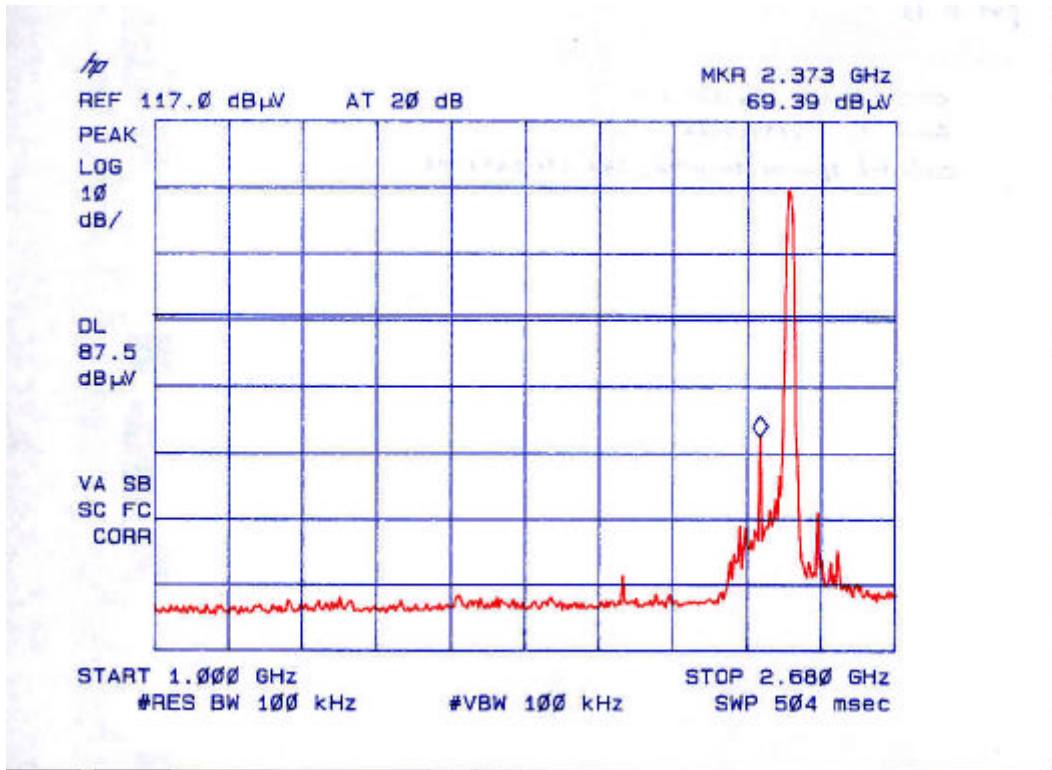

MIDDLE CHANNEL
CONDUCTED SPURIOUS EMISSIONS CH6 (2.68-25GHz)

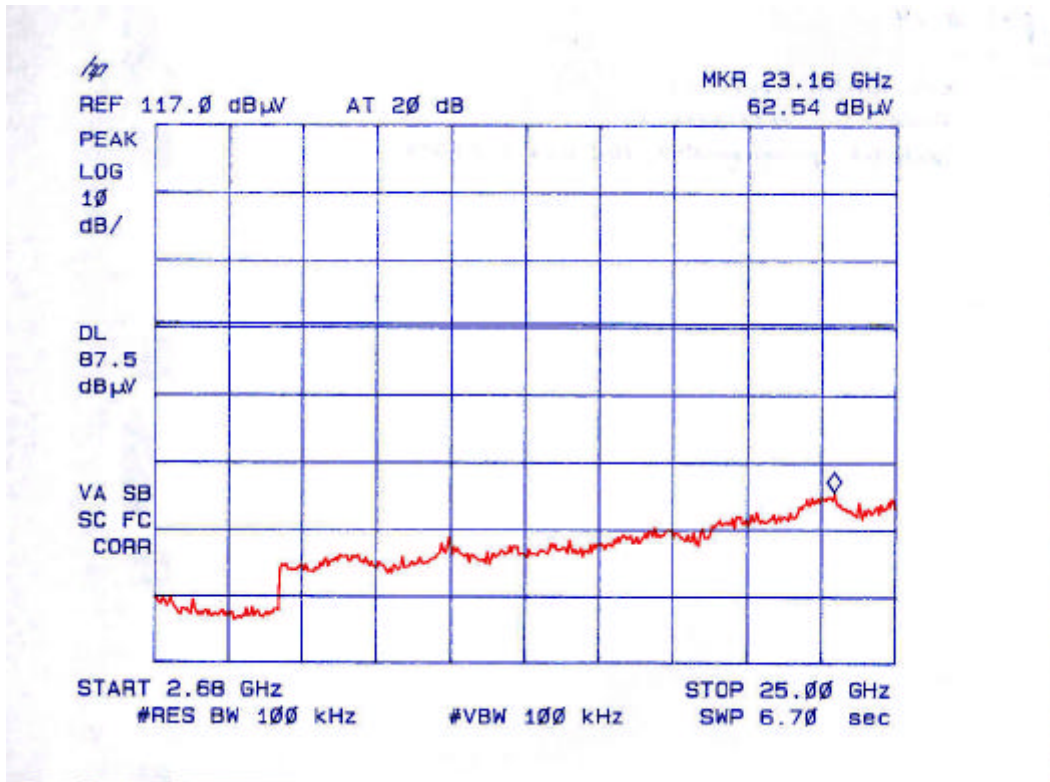

HIGH CHANNEL
CONDUCTED SPURIOUS EMISSIONS CH11 (FUNDAMENTAL)

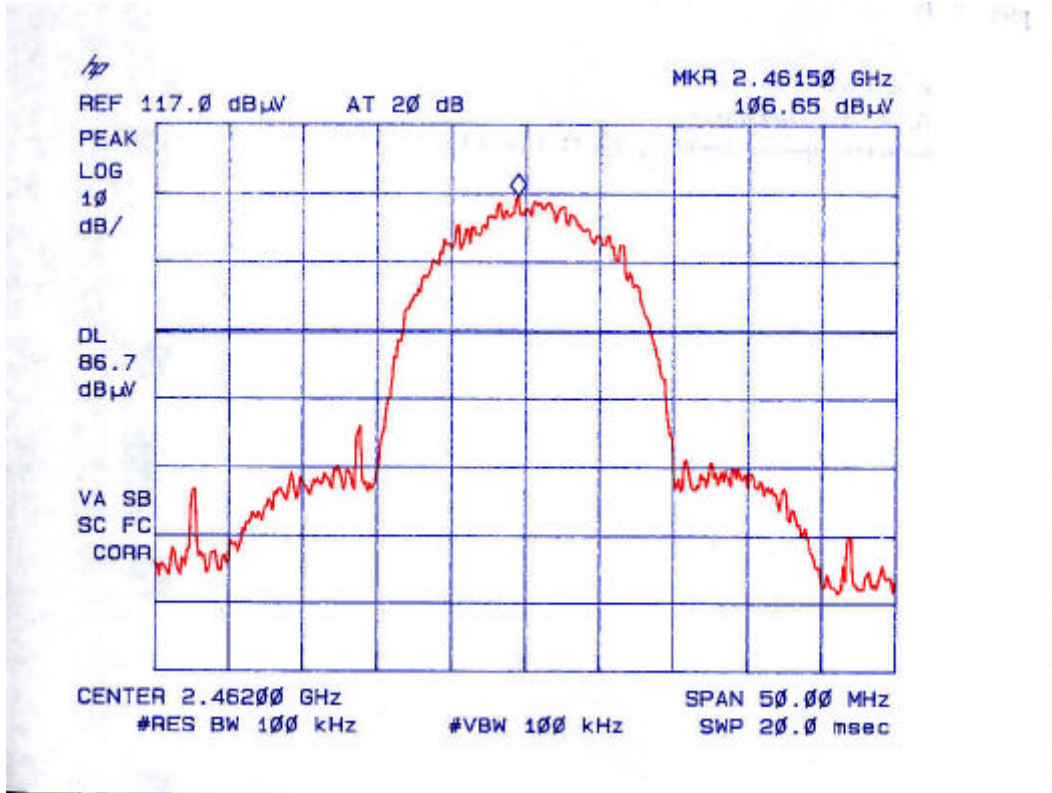

HIGH CHANNEL
CONDUCTED SPURIOUS EMISSIONS CH11 (30-1000MHz)

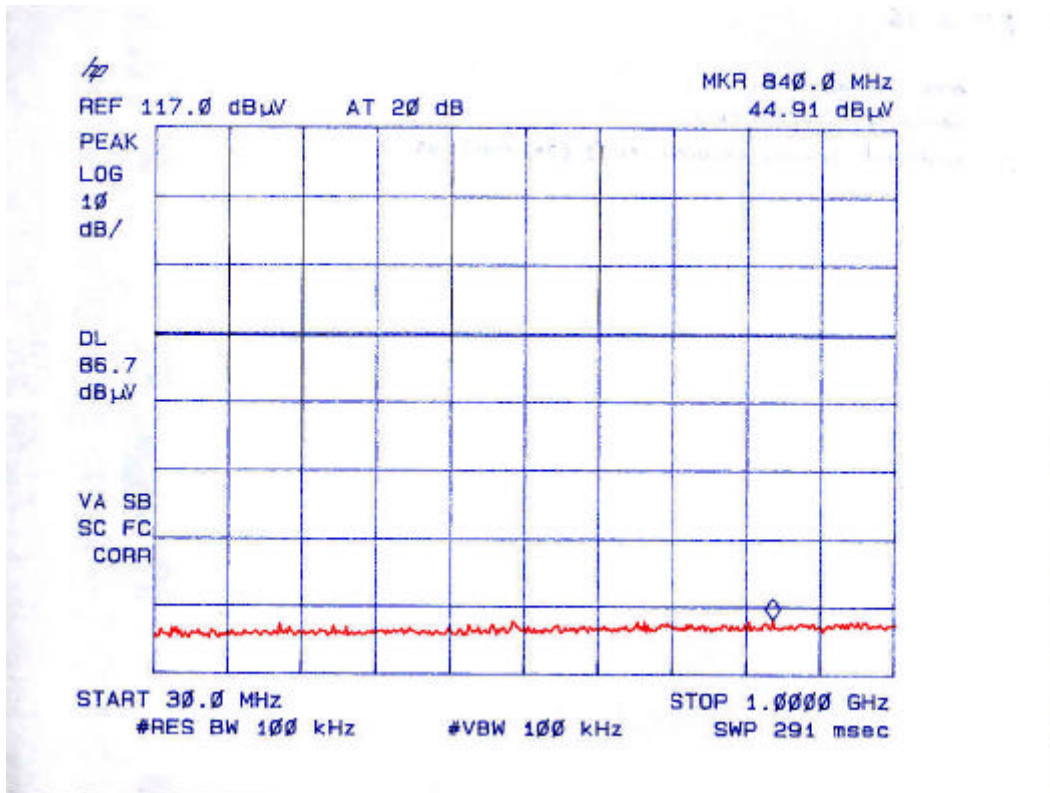

HIGH CHANNEL
CONDUCTED SPURIOUS EMISSIONS CH11 (1-2.68GHz)

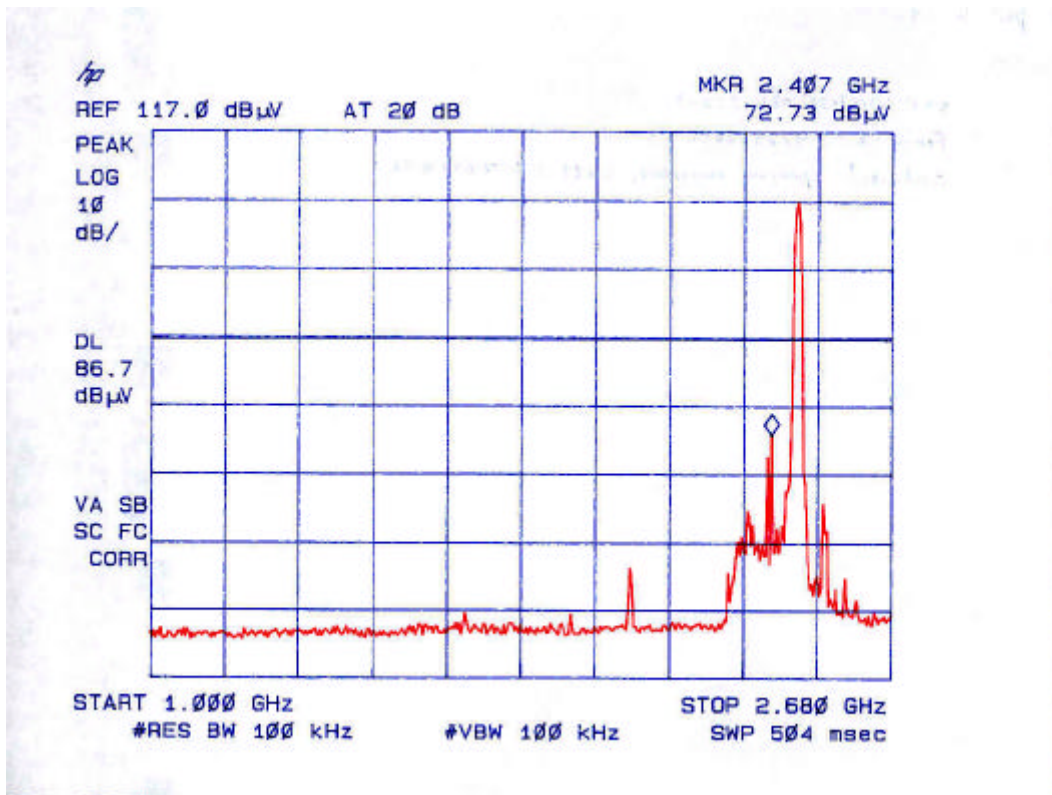

HIGH CHANNEL
CONDUCTED SPURIOUS EMISSIONS CH11 (2.68-25GHz)

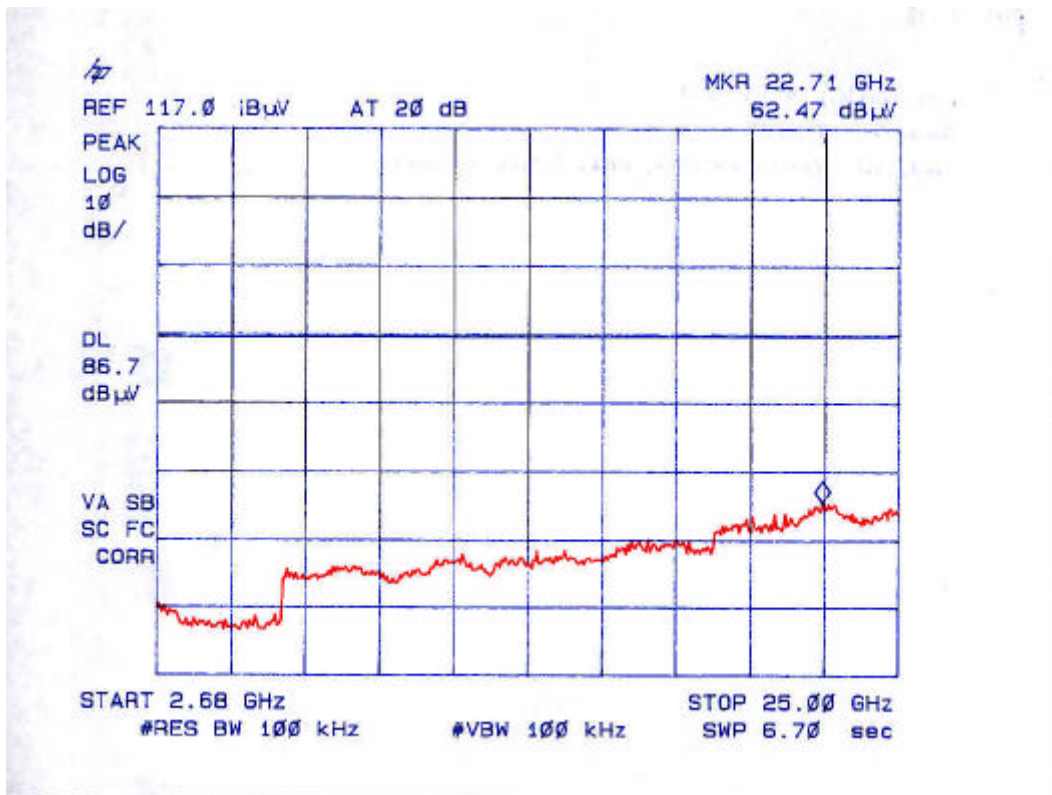

10.4. PEAK POWER SPECTRAL DENSITY

TEST SETUP

Detector Function Setting of Test Receiver

Frequency Range (MHz)	Detector Function	Resolution Bandwidth	Video Bandwidth
Above 1000	<input checked="" type="checkbox"/> Peak	<input checked="" type="checkbox"/> 3 kHz	<input checked="" type="checkbox"/> 10 kHz

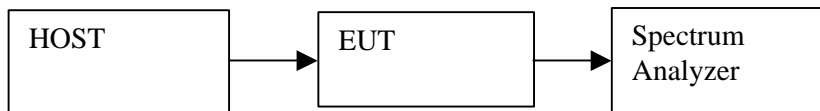

TEST PROCEDURE

The transmitter output was connected to the spectrum analyzer. The bandwidth of the fundamental frequency was measured with the spectrum analyzer using 3 kHz RBW and 10 kHz VBW, set sweep time=span/3kHz. The power spectral density was measured and recorded. The sweep time is allowed to be longer than span/3KHz for a full response of the mixer in the spectrum analyzer.

Result:

No non-compliance noted. See below plots for LOW, MID, HIGH channels

CHANNEL	FREQ (MHz)	RESULT (dBm)
LOW	2412	-14.6
MIDDLE	2437	-15.2
HIGH	2462	-15.2

LOW CHANNEL
PSD CH1

