

Measurement Report

Part 15 Subpart B & C (15.247)

Product: ***Compex Wireless-G Network Mini-PCI Adapter***
Applicant: ***Compex Inc.***
FCC ID: ***M8KCPX-05-WLM54G***
Trade Name: ***Compex***
Model No.: ***iWavePort WLM54G 1A / iWavePort WLM54G 1B***
Report No.: ***MLT0504P15006***
Issue Date: ***May 10,2005***

Test By

Max Light Technology Co.,Ltd.

*Room 5, 8F, No.125, Section 3 Roosevelt Road,
Taipei, Taiwan., R.O.C.*

Tel: 886-2-2363-2447 Fax: 886-2-2363-2597

The test report consists of 169 pages in total. It may be duplicated completely for legal use with the allowance of the applicant. It shall not be reproduced except in full, without the written approval of our laboratory.



Table of Contents :

| | |
|---|------|
| I. General | 4. |
| II. Conducted Emissions Requirements | 9. |
| III. Radiated Emissions Requirements | 20. |
| IV. Maximum Conducted Output Power Requirements | 46. |
| V. Minimum 6dB RF Bandwidth Requirements | 62. |
| VI. Maximum Power Density Requirements | 78. |
| VII. Out of Band Conducted Emissions Requirements | 94. |
| VIII. Band Edges Requirements | 161. |
| IX. Antenna Requirements | 167. |
| Appendix I (EUT Test Setup) | 168. |



CERTIFICATION

We here by verify that :

The test data, data evaluation, test procedures and equipment configurations shown in this report were made in accordance with the procedures given in ANSI C63.4:2001. All test were conducted by *MLT(Max Light Technology Co.,Ltd) Room 5, 8F, No.125, Section 3 Roosevelt Road, Taipei, Taiwan, R.O.C* Also, we attest to the accuracy of each.

We further submit that the energy emitted by the sample EUT tested as described in the report is in compliance with Class B radiated and conducted emission limit of FCC Rules Part 15 Subpart B & C (15.247).

EUT : Compex Wireless-G Network Mini-PCI Adapter

Applicant : Compex Inc.
840 Columbia Street, Suite B, Brea,
CA92821, USA

Manufacturer : Compex Inc.
840 Columbia Street, Suite B, Brea,
CA92821, USA

Model No : iWavePort WLM54G 1A / iWavePort WLM54G 1B

FCC ID : M8KCPX-05-WLM54G

Prepared by : *Country Huang* Approved by : *Roger Chen*
Country Huang Roger Chen



I. GENERAL

1.1 Introduction

The following measurement report is submitted on behalf of Compex Inc. . In support of a Class B Digital Device certification in accordance with Part2 Subpart J and Part 15 Subpart A And B&C of the Commission's and Regulations.

1.2 Description of EUT

EUT : Compex Wireless-G Network Mini-PCI Adapter

Applicant : Compex Inc.
840 Columbia Street, Suite B, Brea,
CA92821, USA

Manufacturer : Compex Inc.
840 Columbia Street, Suite B, Brea,
CA92821, USA

Model No : iWavePort WLM54G 1A / iWavePort WLM54G 1B

FCC ID : M8KCPX-05-WLM54G

Power Type : Powered by PC(Via +3.3Vdc)

Frequency of Channel: See Next page

Type of Modulation : Direct Sequence Spread Spectrum

Type of Antenna : 1/4 DIOPLE Antenna

During testing the EUT was operated at Tx or Rx mode for each emission measured. This was done in order to ensure that maximum emission levels were attained.



MAX LIGHT

MEASUREMENT REPORT

Frequency of Each Channel / 802.11b (Working Frequency)

| Channel No. | Frequency (MHz) |
|-------------|-----------------|
| 01 | 2412 |
| 02 | 2417 |
| 03 | 2422 |
| 04 | 2427 |
| 05 | 2432 |
| 06 | 2437 |
| 07 | 2442 |
| 08 | 2447 |
| 09 | 2452 |
| 10 | 2457 |
| 11 | 2462 |

Frequency of Each Channel / 802.11g (Working Frequency)

| Channel No. | Frequency (MHz) |
|-------------|-----------------|
| 01 | 2412 |
| 02 | 2417 |
| 03 | 2422 |
| 04 | 2427 |
| 05 | 2432 |
| 06 | 2437 |
| 07 | 2442 |
| 08 | 2447 |
| 09 | 2452 |
| 10 | 2457 |
| 11 | 2462 |

Frequency of Each Channel / 802.11 Super G (Working Frequency)

| Channel No. | Frequency (MHz) |
|-------------|-----------------|
| 6 | 2437 |

Note: The super G function only for iWavePort WLM54G 1B

1.3 Summary Of Tests

| 47 CFR Part 15 Subpart C | | | |
|--------------------------|---|---------|------|
| Reference | Test | Results | Note |
| 15.107 | AC Power Conducted Emission | PASS | (1) |
| 15.247(c) | Transmitter Radiated Emissions | PASS | (2) |
| 15.247(b) | Max. Output Power | PASS | |
| 15.247(a)(2) | 6dB RF Bandwidth | PASS | |
| 15.247(d) | Max. Power Density | PASS | |
| 15.247(c) | Out of Band Conducted Spurious Emission | PASS | |
| 15.247(c) | Band Edge Measurement | PASS | |
| 15.203 | Antenna Requirement | PASS | |

Note: (1) The EUT has two model numbers, the testing report only record the worst case (iWavePort WLM54G 1B).

(2) The iWavePort WLM54G 1A(CH01/CH06/CH11) & iWavePort WLM54G 1B(CH01/CH06/CH11) have been pretested.

For under 1GHz's Radiated Emissions, the testing report only record the worst cases which are WLM54G 1B(802.11B 's CH01) & WLM54G 1B(802.11G 's CH11)&WLM54G 1B(802.11 SuperG).

For above 1GHz's Radiated Emissions, the testing report only record the worst cases which are WLM54G 1B(802.11B 's CH01/CH06/CH11) & WLM54G 1B(802.11G 's CH01/CH06/CH11) &WLM54G 1B(802.11 SuperG).

1.4 Difference Description

(Model No.: iWavePort WLM54G 1A & iWavePort WLM54G 1B)

1. The circuit & Layout for these two models are identical.
2. Only main chip (U1) is different , the other components are identical.
3. The iWavePort WLM54G 1A supports 802.11B & 802.11G.
4. The iWavePort WLM54G 1B supports 802.11B & 802.11G & Super G.

1.4 Description of Support Equipment

In order to construct the minimum system which required by the ANSI C63.4-2001, following equipments were used as the support units.

Computer : Compaq
Model No. : 17XL360
Serial No. : CM2080
FCC ID : FCC DOC

Printer : PANASONIC
Model No. : KX-P1080I
Serial No. : TCKAKE93933
FCC ID : FCC ID: ACJ5Z6KX-P1080I

1.5 Configuration of System Under Test

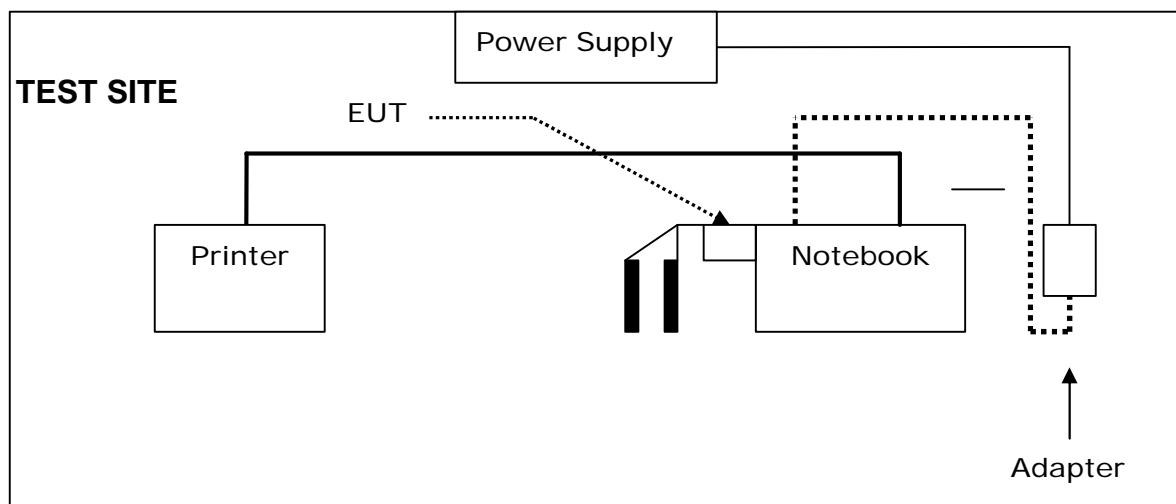

During testing the EUT(Wireless Adapter) 's Mini PCI interface via a PCMCIA to mini-PCI extender connected to the Notebook, and the printer connected to Notebook' printer port.



1.6 Test Procedure

All measurements contained in this report were performed according to the techniques described in Measurement procedure ANSI C63.4-2001 "Measurement of un-Intentional Radiators.

1.7 General Test Condition

The conditions under which the EUT operates were varied to determine their effect on the equipment's emission characteristics. The final configuration of the test system and the mode of operation used during these tests was chosen as that which produced the highest emission levels. However, only those conditions which the EUT was considered likely to encounter in normal use were investigated. The system's radiated and conducted emissions were investigated while the computer alternately transferred data to the EUT as well as to the monitor and printer. Using a test program which sent a continuous data and transferred data to and from the EUT was proven to worst case emissions. The system's physical layout and cabling was randomly arranged to ensure that maximum emission levels were attained.



II. Conducted Emissions Requirements

2.1 General & Setup :

The power line conducted emission measurements were performed in a shielded enclosure. The EUT was assembled on a wooden table which is 80 centimeters high, was placed 40 centimeters from the backwall and at least 1 meter from the sidewall.

Power was fed to the EUT from the public utility power grid through a line filter and EMCO Model 3825/2 Line Impedance Stabilization Networks (LISN). The LISN housing, measuring instrumentation case, ground plane, etc., were electrically bonded together at the same RF potential. The Spectrum analyzer was connected to the AC line through an isolation transformer. The 50-ohm output of the LISN was connected to the spectrum analyzer directly. Conducted emission levels were in the CISPER quasi-peak detection mode. The analyzer's 6 dB bandwidth was set to 9 KHz. No post-detector video filter was used.

The spectrum was scanned from 150 KHz to 30 MHz. The physical arrangement of the test system and associated cabling was varied (within the scope of arrangements likely to be encountered in actual use) to determine the effect on the unit's emanations in amplitude and frequency. All spurious emission frequencies were observed. The highest emission amplitudes relative to the appropriate limit were measured and have been recorded in paragraph 2.6.

2.2 Test Equipment List:

- A. EMCO 3825/2 LISN (S/N:2654)
- B. EMCO 3825/2 LISN (S/N:2658)
- C. HP 8591EM 9KHZ-1.8GHz Spectrum Analyzer (S/N:73412A00110)
- D. R&S ESH3 Test Receiver (S/N:892108/025)
- E. Shielded Room (MLT-SR1)

2.3 Test Configuration:



Front View of The Test Configuration



Rear View of The Test Configuration



2.4 Test condition:

EUT tested in accordance with the specifications given by the manufacturer , and exercised in the most unfavorable manner.

2.5 Conducted Emissions Limits:

| <i>Frequency range (MHz)</i> | <i>Limits (dBuV)</i> | |
|----------------------------------|----------------------|----------------|
| | <i>Quasi-peak</i> | <i>Average</i> |
| 0.15 to 0.50 | 66 to 56 | 56 to 46 |
| 0.50 to 5.0 | 56 | 46 |
| 5.0 to 30 | 60 | 50 |

2.6 Measurement Data Of Conducted Emissions:

2.6.1 Conducted Emissions (Subpart B & C)

The following table show a summary of the highest emissions of power line conducted emissions to the HOT and NATURAL conductor of the EUT power.

Applicant : *Complex Inc.*
 Model No : *iWavePort WLM54G 1B*
 EUT : *Complex Wireless-G Network Mini-PCI Adapter*
 Test Mode : *802.11b (CH01)*
 Test Date : *04/28/2005*

| Power Line Conducted Emissions (Class B) | | | | | |
|--|-----------------|-------------------|--------|----------------|--------|
| Conductor | Frequency (MHz) | Quasi-Peak (dBuV) | Limits | Average (dBuV) | Limits |
| L1 | 0.16 | 44.55 | 65.41 | -- | 55.41 |
| | 0.23 | 38.22 | 62.13 | -- | 52.13 |
| | 2.81 | 38.23 | 56 | -- | 46 |
| | 5.45 | 38.42 | 60 | -- | 50 |
| | 6.32 | 39.47 | 60 | -- | 50 |
| | 8.55 | 42.24 | 60 | -- | 50 |
| | 9.60 | 39.61 | 60 | -- | 50 |
| L2 | 0.17 | 38.30 | 64.82 | -- | 54.82 |
| | 0.28 | 35.15 | 60.64 | -- | 50.64 |
| | 2.75 | 34.52 | 56 | -- | 46 |
| | 3.76 | 35.92 | 56 | -- | 46 |
| | 5.25 | 39.48 | 60 | -- | 50 |
| | 8.41 | 44.07 | 60 | -- | 50 |
| | 19.95 | 37.42 | 60 | -- | 50 |

- Notes :
- 1.L1: One end & Ground L1: The other end & Ground
 - 2.Height of table on which the EUT was placed : 0.8 m.
 - 3.The Quasi-Peak Value have already met the Average Value Limit showed on above limits.
 - 4.The above test results are obtained under the normal condition.



2.6.2 Conducted Emissions (Subpart B & C)

The following table show a summary of the highest emissions of power line conducted emissions to the HOT and NATURAL conductor of the EUT power.

Applicant : *Compex Inc.*
 Model No : *iWavePort WLM54G 1B*
 EUT : *Compex Wireless-G Network Mini-PCI Adapter*
 Test Mode : *802.11b (CH06)*
 Test Date : *04/28/2005*

| Power Line Conducted Emissions (Class B) | | | | | |
|--|-----------------|-------------------|--------|----------------|--------|
| Conductor | Frequency (MHz) | Quasi-Peak (dBuV) | Limits | Average (dBuV) | Limits |
| L1 | 0.18 | 40.09 | 64.35 | -- | 54.35 |
| | 0.23 | 41.44 | 62.20 | -- | 52.20 |
| | 0.28 | 38.38 | 60.64 | -- | 50.64 |
| | 1.96 | 35.46 | 56 | -- | 46 |
| | 2.75 | 36.29 | 56 | -- | 46 |
| | 5.45 | 37.48 | 60 | -- | 50 |
| | 8.92 | 40.64 | 60 | -- | 50 |
| L2 | 0.18 | 40.52 | 64.39 | -- | 54.39 |
| | 0.23 | 41.37 | 62.13 | -- | 52.13 |
| | 0.33 | 38.16 | 59.30 | -- | 49.30 |
| | 2.84 | 36.58 | 56 | -- | 46 |
| | 5.08 | 37.07 | 60 | -- | 50 |
| | 6.59 | 37.17 | 60 | -- | 50 |
| | 9.35 | 41.13 | 60 | -- | 50 |

- Notes :
- 1.L1: One end & Ground L1: The other end & Ground
 - 2.Height of table on which the EUT was placed : 0.8 m.
 - 3.The Quasi-Peak Value have already met the Average Value Limit showed on above limits.
 - 4.The above test results are obtained under the normal condition.

2.6.3 Conducted Emissions (Subpart B & C)

The following table show a summary of the highest emissions of power line conducted emissions to the HOT and NATURAL conductor of the EUT power.

Applicant : *Compex Inc.*
 Model No : *iWavePort WLM54G 1B*
 EUT : *Compex Wireless-G Network Mini-PCI Adapter*
 Test Mode : *802.11b (CH11)*
 Test Date : *04/28/2005*

| Power Line Conducted Emissions (Class B) | | | | | |
|--|-----------------|-------------------|--------|----------------|--------|
| Conductor | Frequency (MHz) | Quasi-Peak (dBuV) | Limits | Average (dBuV) | Limits |
| L1 | 1.84 | 41.27 | 64.30 | -- | 54.30 |
| | 0.23 | 42.36 | 62.31 | -- | 52.31 |
| | 0.28 | 39.54 | 60.58 | -- | 50.58 |
| | 1.90 | 36.36 | 56 | -- | 46 |
| | 2.84 | 36.08 | 56 | -- | 46 |
| | 6.39 | 37.15 | 60 | -- | 50 |
| | 8.92 | 40.34 | 60 | -- | 50 |
| L2 | 0.18 | 39.76 | 64.39 | -- | 54.39 |
| | 0.24 | 39.85 | 62.13 | -- | 52.13 |
| | 1.96 | 35.47 | 56 | -- | 46 |
| | 3.82 | 36.30 | 56 | -- | 46 |
| | 5.45 | 38.18 | 60 | -- | 50 |
| | 8.92 | 38.88 | 60 | -- | 50 |
| | 9.60 | 37.51 | 60 | -- | 50 |

- Notes :
- 1.L1: One end & Ground L1: The other end & Ground
 - 2.Height of table on which the EUT was placed : 0.8 m.
 - 3.The Quasi-Peak Value have already met the Average Value Limit showed on above limits.
 - 4.The above test results are obtained under the normal condition.



2.6.4 Conducted Emissions (Subpart B & C)

The following table show a summary of the highest emissions of power line conducted emissions to the HOT and NATURAL conductor of the EUT power.

Applicant : *Compex Inc.*
 Model No : *iWavePort WLM54G 1B*
 EUT : *Compex Wireless-G Network Mini-PCI Adapter*
 Test Mode : *802.11g (CH01)*
 Test Date : *04/28/2005*

| Power Line Conducted Emissions (Class B) | | | | | |
|--|-----------------|-------------------|--------|----------------|--------|
| Conductor | Frequency (MHz) | Quasi-Peak (dBuV) | Limits | Average (dBuV) | Limits |
| L1 | 0.23 | 39.95 | 62.13 | -- | 52.13 |
| | 2.85 | 36.78 | 56 | -- | 46 |
| | 5.45 | 36.87 | 60 | -- | 50 |
| | 6.35 | 36.74 | 60 | -- | 50 |
| | 8.68 | 41.73 | 60 | -- | 50 |
| | 9.55 | 40.16 | 60 | -- | 50 |
| | 16.57 | 39.65 | 60 | -- | 50 |
| L2 | 0.18 | 38.73 | 64.21 | -- | 54.21 |
| | 0.33 | 36.73 | 59.40 | -- | 49.40 |
| | 1.92 | 34.76 | 56 | -- | 46 |
| | 2.81 | 36.47 | 56 | -- | 46 |
| | 3.84 | 35.48 | 56 | -- | 46 |
| | 5.39 | 37.92 | 60 | -- | 50 |
| | 8.68 | 40.93 | 60 | -- | 50 |

- Notes :
- 1.L1: One end & Ground L1: The other end & Ground
 - 2.Height of table on which the EUT was placed : 0.8 m.
 - 3.The Quasi-Peak Value have already met the Average Value Limit showed on above limits.
 - 4.The above test results are obtained under the normal condition.



2.6.5 Conducted Emissions (Subpart B & C)

The following table show a summary of the highest emissions of power line conducted emissions to the HOT and NATURAL conductor of the EUT power.

Applicant : *Compex Inc.*
 Model No : *iWavePort WLM54G 1B*
 EUT : *Compex Wireless-G Network Mini-PCI Adapter*
 Test Mode : *802.11g (CH06)*
 Test Date : *04/28/2005*

| Power Line Conducted Emissions (Class B) | | | | | |
|--|-----------------|-------------------|--------|----------------|--------|
| Conductor | Frequency (MHz) | Quasi-Peak (dBuV) | Limits | Average (dBuV) | Limits |
| L1 | 0.15 | 42.49 | 65.78 | -- | 55.78 |
| | 0.23 | 40.75 | 62.20 | -- | 52.20 |
| | 0.60 | 39.56 | 56 | -- | 46 |
| | 2.71 | 37.81 | 56 | -- | 46 |
| | 5.39 | 36.42 | 60 | -- | 50 |
| | 8.68 | 41.66 | 60 | -- | 50 |
| | 9.55 | 41.05 | 60 | -- | 50 |
| L2 | 0.18 | 39.12 | 64.21 | -- | 54.21 |
| | 0.23 | 38.85 | 62.13 | -- | 52.13 |
| | 0.33 | 36.77 | 59.40 | -- | 49.40 |
| | 2.75 | 36.07 | 56 | -- | 46 |
| | 3.86 | 36.12 | 56 | -- | 46 |
| | 5.39 | 39.23 | 60 | -- | 50 |
| | 8.73 | 40.46 | 60 | -- | 50 |

- Notes :
- 1.L1: One end & Ground L1: The other end & Ground
 - 2.Height of table on which the EUT was placed : 0.8 m.
 - 3.The Quasi-Peak Value have already met the Average Value Limit showed on above limits.
 - 4.The above test results are obtained under the normal condition.



2.6.6 Conducted Emissions (Subpart B & C)

The following table show a summary of the highest emissions of power line conducted emissions to the HOT and NATURAL conductor of the EUT power.

Applicant : *Compex Inc.*
 Model No : *iWavePort WLM54G 1B*
 EUT : *Compex Wireless-G Network Mini-PCI Adapter*
 Test Mode : *802.11g (CH11)*
 Test Date : *04/28/2005*

| Power Line Conducted Emissions (Class B) | | | | | |
|--|-----------------|-------------------|--------|----------------|--------|
| Conductor | Frequency (MHz) | Quasi-Peak (dBuV) | Limits | Average (dBuV) | Limits |
| L1 | 0.23 | 40.41 | 62.20 | -- | 52.20 |
| | 0.60 | 40.97 | 56 | -- | 46 |
| | 0.81 | 37.93 | 56 | -- | 46 |
| | 1.45 | 40.65 | 56 | -- | 46 |
| | 2.71 | 37.09 | 56 | -- | 46 |
| | 5.39 | 37.34 | 60 | -- | 50 |
| | 8.73 | 41.52 | 60 | -- | 50 |
| L2 | 0.18 | 39.23 | 64.30 | -- | 54.30 |
| | 0.23 | 37.79 | 62.31 | -- | 52.31 |
| | 1.92 | 34.66 | 56 | -- | 46 |
| | 2.71 | 36.57 | 56 | -- | 46 |
| | 4.65 | 37.84 | 56 | -- | 46 |
| | 5.45 | 37.53 | 60 | -- | 50 |
| | 8.73 | 42.29 | 60 | -- | 50 |

- Notes :
- 1.L1: One end & Ground L1: The other end & Ground
 - 2.Height of table on which the EUT was placed : 0.8 m.
 - 3.The Quasi-Peak Value have already met the Average Value Limit showed on above limits.
 - 4.The above test results are obtained under the normal condition.



2.6.7 Conducted Emissions (Subpart B & C)

The following table show a summary of the highest emissions of power line conducted emissions to the HOT and NATURAL conductor of the EUT power.

Applicant : *Compex Inc.*
 Model No : *iWavePort WLM54G 1B*
 EUT : *Compex Wireless-G Network Mini-PCI Adapter*
 Test Mode : *802.11 Super G (CH06)*
 Test Date : *04/28/2005*

| Power Line Conducted Emissions (Class B) | | | | | |
|--|-----------------|-------------------|--------|----------------|--------|
| Conductor | Frequency (MHz) | Quasi-Peak (dBuV) | Limits | Average (dBuV) | Limits |
| L1 | 0.23 | 40.95 | 62.31 | -- | 52.31 |
| | 0.60 | 39.56 | 56 | -- | 46 |
| | 0.81 | 40.29 | 56 | -- | 46 |
| | 1.91 | 36.49 | 56 | -- | 46 |
| | 2.75 | 37.85 | 56 | -- | 46 |
| | 8.02 | 37.90 | 60 | -- | 50 |
| | 19.43 | 41.90 | 60 | -- | 50 |
| L2 | 0.18 | 39.12 | 64.21 | -- | 54.21 |
| | 0.24 | 37.41 | 62.10 | -- | 52.10 |
| | 0.32 | 36.34 | 59.48 | -- | 49.48 |
| | 2.76 | 36.77 | 56 | -- | 46 |
| | 5.39 | 39.23 | 60 | -- | 50 |
| | 8.82 | 40.73 | 60 | -- | 50 |
| | 16.05 | 39.25 | 60 | -- | 50 |

- Notes :
- 1.L1: One end & Ground L1: The other end & Ground
 - 2.Height of table on which the EUT was placed : 0.8 m.
 - 3.The Quasi-Peak Value have already met the Average Value Limit showed on above limits.
 - 4.The above test results are obtained under the normal condition.



III. Radiated Emissions Requirements

3.1 General Configuration:

Prior to open-field testing, the EUT was placed in a shielded enclosure and scanned at a close distance to determine its emission characteristics. The physical arrangement of the EUT was varied (within the scope of arrangements likely to be encountered in actual use) to determine the effect on the unit's emanations in amplitude, directivity, and frequency. The exact system configuration which produced the highest emissions was noted so it could be reproduced later during the open-field tests. This was done to ensure that the final measurements would demonstrate the worst-case interference potential of the EUT.

3.2 General Configuration:

Final radiation measurements were made on a three-meter, open-field test site. The EUT system was placed on a nonconductive turntable which is 0.8 meters height, top surface 1.0 x 1.5 meter. The spectrum was examined from 250 MHz to 2.5 GHz in order to cover the whole spectrum below 10th harmonic which could generate from the EUT. During the test, EUT was set to transmit continuously & Measurements spectrum range from 30 MHz to 26.5 GHz is investigated.

For measurements below 1 GHz the resolution bandwidth is set to 100 kHz for peak detection measurements or 120 kHz for quasi-peak detection measurements. Peak detection is used unless otherwise noted as quasi-peak.

For measurements above 1 GHz the resolution bandwidth is set to 1 MHz, then the video bandwidth is set to 1 MHz for peak measurements and 10 Hz for average measurements.

A nonconductive material surrounded the EUT to supporting the EUT for standing on three orthogonal planes. At each condition, the EUT was rotated 360 degrees, and the antenna was raised and lowered from one to four meters to find the maximum emission levels. Measurements were taken using both horizontal and vertical antenna polarization.



MAX LIGHT

MEASUREMENT REPORT

Page: 21/169

The field strength below 1 GHz was measured by EMCO Biconilog Antenna (mode 3142) at 3 Meter and the SCHWARZBECK Double Ridged Guide Antenna (model BBHA9120D&9170) was used in frequencies 1 - 40 GHz at a distance of 1 meter. All test results were extrapolated to equivalent signal at 3 meters utilizing an inverse linear distance extrapolation Factor (20dB/decade).

For testing above 1GHz, the emission level of the EUT in peak mode was 20dB lower than average limit (that means the emission level in peak mode also complies with the limit in average mode), then testing will be stopped and peak values of EUT will be reported, otherwise, the emissions will be measured in average mode again and reported.

Appropriate preamplifiers were used for improving sensitivity and precautions were taken to avoid overloading or desensitizing the spectrum analyzer. No post - detector video filters were used in the test.

The spectrum analyzer's 6 dB bandwidth was set to 1 MHz, and the analyzer was operated in the peak detection mode, for frequencies both below and up 1 GHz. The average levels were obtained by subtracting the duty cycle correction factor from the peak readings.

The following procedures were used to convert the emission levels measured in decibels referenced to 1 microvolt (dBuV) into field intensity in microvolts per meter(uV/m).

The actual field intensity in decibels referenced to 1 microvolt in to field intensity in microcolts per meter (dBuV/m).

The actual field is intensity in referenced to 1 microvolt per meter (dBuV/m) is determined by algebraically adding the measured reading in dBuV, the antenna factor (dB), and cable loss (dB) and Subtracting the gain of preamplifier (dB) is auto calculate in spectrum analyzer.



(1) Amplitude (dBuV/m) = FI(dBuV) + AF(dBuV) + CL(dBuV) - Gain(dB)

FI = Reading of the field intensity.

AF = Antenna factor.

CL = Cable loss.

P.S Amplitude is auto calculate in spectrum analyzer.

(2) Actual Amplitude (dBuV/m) = Amplitude (dBuV) - Dis(dB)

The FCC specified emission limits were calculated according the EUT operating frequency and by following linear interpolation equations:

(1) For fundamental frequency :

Transmitter Output < +30dBm

(2) For spurious frequency :

Spurious emission limits = fundamental emission limit /10

3.2 Test Equipment List:

- A. HP 8591EM 9KHz-1.8GHz Spectrum Analyzer (S/N:73412A00230)
- B. HP 8447D Pre Amplifier (S/N:2944A08954)
- C. EMCO 3142 26MHz~2000MHz Biconilog Antenna (S/N:1184)
- D. R&S ESVP 20MHz~1300MHz Test Receiver (S/N:881121/01)
- E. Agilent E4407B 9KHz-26.5GHz Spectrum Analyzer (S/N:A872JS02291)
- F. HP 8449B 1GHZ~26.5GHZ PRE Amplifier (S/N:1982901A91)
- G. SCHWARZBECK BBHA 9120D 1GHz~18GHz Horn Antenna (S/N:141S3)
- H. SCHWARZBECK BBHA 9170 15GHz~40GHz Horn Antenna (S/N:192S5)

3.3 Test Configuration:



Front View of The Test Configuration



Rear View of The Test Configuration



3.4 Test condition:

EUT tested in accordance with the specifications given by the manufacturer , and exercised in the most unfavorable manner.

3.5 Radiated Emissions Limits:

| <i>Frequency range (MHz)</i> | <i>Peak(dBuV)</i> |
|------------------------------|-------------------|
| 30 to 88 | 40 |
| 88 to 216 | 43.5 |
| 216 to 960 | 46 |
| Above 960 | 54 |



3.6 Measurement Data Of Radiated Emissions:

3.6.1 Open Field Radiated Emissions (Subpart B & C)

The highest peak values of radiated emissions from the EUT at various antenna heights, antenna polarization, EUT orientation , etc. are recorded on the following

Applicant : *Compex Inc.*
Model No : *iWavePort WLM54G 1B*
EUT : *Compex Wireless-G Network Mini-PCI Adapter*
Test Mode : *802.11b (CH01)*
Test Date : *04/27/2005*

| Radiated Emissions (HORIZONTAL) | | | | | |
|---------------------------------|--------------------|----------|----------------|--------------------------|-------------|
| Frequency (MHz) | Amplitude (dBUV/m) | Ant. (m) | Table (Degree) | Limits(Class B) (dBUV/m) | Margin (dB) |
| 46.33 | 31.53 | 1.4 | 280 | 40 | -8.47 |
| 89.57 | 32.35 | 1.8 | 250 | 43.5 | -11.15 |
| 125.00 | 33.52 | 1 | 300 | 43.5 | -9.98 |
| 155.69 | 31.86 | 1.5 | 240 | 43.5 | -11.64 |
| 188.54 | 32.95 | 1.8 | 280 | 43.5 | -10.55 |
| 360.41 | 39.45 | 2 | 100 | 46 | -6.55 |
| 500.04 | 38.99 | 1.4 | 120 | 46 | -7.01 |
| 601.21 | 39.77 | 1 | 300 | 46 | -6.23 |
| 640.34 | 38.97 | 1 | 340 | 46 | -7.03 |
| 720.33 | 41.63 | 1.2 | 360 | 46 | -4.37 |
| 852.00 | 41.08 | 1 | 250 | 46 | -4.92 |

- Notes :
- 1.Margin= Amplitude - Limits
 - 2.Distance of Measurement : 3 Meter (30-1000MHz)
 - 3.Height of table for EUT placed: 0.8 Meter.
 - 4.ANT= Antenna height.
 - 5.Amplitude= Reading Amplitude -Amplifier gain+Cable loss +Antenna factor
(Auto calculate in spectrum analyzer)



3.6.2 Open Field Radiated Emissions (Subpart B & C)

The highest peak values of radiated emissions from the EUT at various antenna heights, antenna polarization, EUT orientation , etc. are recorded on the following.

Applicant : *Compex Inc.*
Model No : *iWavePort WLM54G 1B*
EUT : *Compex Wireless-G Network Mini-PCI Adapter*
Test Mode : *802.11b (CH01)*
Test Date : *04/26/2005*

| Radiated Emissions (VERTICAL) | | | | | |
|-------------------------------|--------------------|----------|----------------|--------------------------|-------------|
| Frequency (MHz) | Amplitude (dBuV/m) | Ant. (m) | Table (Degree) | Limits(Class B) (dBuV/m) | Margin (dB) |
| 35.72 | 31.55 | 1 | 240 | 40 | -8.45 |
| 86.83 | 31.02 | 1 | 310 | 40 | -8.98 |
| 124.11 | 31.98 | 2 | 200 | 43.5 | -11.52 |
| 151.44 | 33.11 | 1.5 | 120 | 43.5 | -10.39 |
| 185.40 | 32.58 | 1 | 280 | 43.5 | -10.92 |
| 339.10 | 39.63 | 1 | 110 | 46 | -6.37 |
| 562.85 | 39.35 | 2 | 240 | 46 | -6.65 |
| 610.30 | 39.64 | 1.4 | 300 | 46 | -6.36 |
| 640.50 | 41.54 | 1 | 360 | 46 | -4.46 |
| 700.51 | 41.05 | 1.6 | 270 | 46 | -4.95 |
| 842.22 | 40.63 | 2 | 240 | 46 | -5.37 |

- Notes :
- 1.Margin= Amplitude - Limits
 - 2.Distance of Measurement : 3 Meter (30-1000MHz)
 - 3.Height of table for EUT placed: 0.8 Meter.
 - 4.ANT= Antenna height.
 - 5.Amplitude= Reading Amplitude -Amplifier gain+Cable loss +Antenna factor
(Auto calculate in spectrum analyzer)

3.6.3 Open Field Radiated Emissions (Subpart B & C)

The highest peak values of radiated emissions from the EUT at various antenna heights, antenna polarization, EUT orientation , etc. are recorded on the following

Applicant : *Compex Inc.*
 Model No : *iWavePort WLM54G 1B*
 EUT : *Compex Wireless-G Network Mini-PCI Adapter*
 Test Mode : *802.11g (CH11)*
 Test Date : *04/27/2005*

| Radiated Emissions (HORIZONTAL) | | | | | |
|---------------------------------|--------------------|----------|----------------|--------------------------|-------------|
| Frequency (MHz) | Amplitude (dBuV/m) | Ant. (m) | Table (Degree) | Limits(Class B) (dBuV/m) | Margin (dB) |
| 44.96 | 32.37 | 2 | 340 | 40 | -7.63 |
| 89.53 | 33.41 | 2.5 | 200 | 43.5 | -10.09 |
| 125.18 | 32.78 | 1.5 | 290 | 43.5 | -10.72 |
| 154.21 | 33.62 | 2 | 250 | 43.5 | -9.88 |
| 189.47 | 33.95 | 1 | 340 | 43.5 | -9.55 |
| 361.69 | 40.25 | 1.4 | 280 | 46 | -5.75 |
| 500.42 | 40.21 | 1.9 | 200 | 46 | -5.79 |
| 519.27 | 39.63 | 1 | 120 | 46 | -6.37 |
| 641.43 | 40.66 | 1.5 | 140 | 46 | -5.34 |
| 725.44 | 40.46 | 1.4 | 180 | 46 | -5.54 |
| 851.41 | 40.62 | 1.2 | 290 | 46 | -5.38 |

- Notes :
- 1.Margin= Amplitude - Limits
 - 2.Distance of Measurement : 3 Meter (30-1000MHz)
 - 3.Height of table for EUT placed: 0.8 Meter.
 - 4.ANT= Antenna height.
 - 5.Amplitude= Reading Amplitude -Amplifier gain+Cable loss
 +Antenna factor
 (Auto calculate in spectrum analyzer)



3.6.4 Open Field Radiated Emissions (Subpart B & C)

The highest peak values of radiated emissions from the EUT at various antenna heights, antenna polarization, EUT orientation , etc. are recorded on the following.

Applicant : *Compex Inc.*
Model No : *iWavePort WLM54G 1B*
EUT : *Compex Wireless-G Network Mini-PCI Adapter*
Test Mode : *802.11g (CH11)*
Test Date : *04/27/2005*

| Radiated Emissions (VERTICAL) | | | | | |
|-------------------------------|--------------------|----------|----------------|--------------------------|-------------|
| Frequency (MHz) | Amplitude (dBuV/m) | Ant. (m) | Table (Degree) | Limits(Class B) (dBuV/m) | Margin (dB) |
| 34.73 | 32.54 | 1 | 200 | 40 | -7.46 |
| 124.30 | 32.47 | 1.2 | 240 | 43.5 | -11.03 |
| 151.45 | 32.91 | 1.6 | 220 | 43.5 | -10.59 |
| 185.40 | 33.61 | 1 | 360 | 43.5 | -9.89 |
| 235.63 | 38.55 | 2 | 150 | 46 | -7.45 |
| 339.15 | 39.58 | 2 | 320 | 46 | -6.42 |
| 562.85 | 38.97 | 1.5 | 100 | 46 | -7.03 |
| 610.29 | 41.04 | 1.7 | 200 | 46 | -4.96 |
| 640.14 | 41.47 | 1.3 | 350 | 46 | -4.53 |
| 700.50 | 40.56 | 2 | 300 | 46 | -5.44 |
| 842.87 | 41.66 | 1.6 | 270 | 46 | -4.34 |

- Notes :
- 1.Margin= Amplitude - Limits
 - 2.Distance of Measurement : 3 Meter (30-1000MHz)
 - 3.Height of table for EUT placed: 0.8 Meter.
 - 4.ANT= Antenna height.
 - 5.Amplitude= Reading Amplitude -Amplifier gain+Cable loss +Antenna factor
(Auto calculate in spectrum analyzer)

3.6.5 Open Field Radiated Emissions (Subpart B & C)

The highest peak values of radiated emissions from the EUT at various antenna heights, antenna polarization, EUT orientation , etc. are recorded on the following

Applicant : *Compex Inc.*
 Model No : *iWavePort WLM54G 1B*
 EUT : *Compex Wireless-G Network Mini-PCI Adapter*
 Test Mode : *802.11 Super G (CH06)*
 Test Date : *04/27/2005*

| Radiated Emissions (HORIZONTAL) | | | | | |
|---------------------------------|--------------------|----------|----------------|--------------------------|-------------|
| Frequency (MHz) | Amplitude (dBuV/m) | Ant. (m) | Table (Degree) | Limits(Class B) (dBuV/m) | Margin (dB) |
| 47.88 | 31.47 | 1.9 | 260 | 40 | -8.53 |
| 125.01 | 33.61 | 2 | 320 | 43.5 | -9.89 |
| 155.44 | 32.58 | 2.5 | 120 | 43.5 | -10.92 |
| 189.50 | 33.42 | 1.5 | 320 | 43.5 | -10.08 |
| 250.72 | 39.85 | 1 | 280 | 46 | -6.15 |
| 360.54 | 38.96 | 1.8 | 100 | 46 | -7.04 |
| 500.00 | 38.69 | 1.5 | 270 | 46 | -7.31 |
| 601.24 | 38.97 | 1 | 240 | 46 | -7.03 |
| 640.53 | 39.84 | 1.2 | 110 | 46 | -6.16 |
| 721.22 | 40.94 | 1.5 | 200 | 46 | -5.06 |
| 852.00 | 40.84 | 1 | 300 | 46 | -5.16 |

- Notes :
- 1.Margin= Amplitude - Limits
 - 2.Distance of Measurement : 3 Meter (30-1000MHz)
 - 3.Height of table for EUT placed: 0.8 Meter.
 - 4.ANT= Antenna height.
 - 5.Amplitude= Reading Amplitude -Amplifier gain+Cable loss
+Antenna factor
(Auto calculate in spectrum analyzer)



3.6.6 Open Field Radiated Emissions (Subpart B & C)

The highest peak values of radiated emissions from the EUT at various antenna heights, antenna polarization, EUT orientation , etc. are recorded on the following.

Applicant : *Compex Inc.*
Model No : *iWavePort WLM54G 1B*
EUT : *Compex Wireless-G Network Mini-PCI Adapter*
Test Mode : *802.11 Super G (CH06)*
Test Date : *04/27/2005*

| Radiated Emissions (VERTICAL) | | | | | |
|-------------------------------|--------------------|----------|----------------|--------------------------|-------------|
| Frequency (MHz) | Amplitude (dBuV/m) | Ant. (m) | Table (Degree) | Limits(Class B) (dBuV/m) | Margin (dB) |
| 36.98 | 32.73 | 1 | 270 | 40 | -7.27 |
| 124.47 | 32.54 | 1.5 | 240 | 43.5 | -10.96 |
| 150.57 | 34.06 | 1 | 300 | 43.5 | -9.44 |
| 189.88 | 32.83 | 1.6 | 320 | 43.5 | -10.67 |
| 230.88 | 39.58 | 2 | 360 | 46 | -6.42 |
| 337.45 | 38.98 | 1.4 | 220 | 46 | -7.02 |
| 500.01 | 38.99 | 1.5 | 120 | 46 | -7.01 |
| 610.35 | 41.25 | 1 | 100 | 46 | -4.75 |
| 640.55 | 40.65 | 1.3 | 360 | 46 | -5.35 |
| 700.42 | 40.67 | 1.8 | 120 | 46 | -5.33 |
| 842.45 | 40.89 | 1.5 | 240 | 46 | -5.11 |

- Notes :
- 1.Margin= Amplitude - Limits
 - 2.Distance of Measurement : 3 Meter (30-1000MHz)
 - 3.Height of table for EUT placed: 0.8 Meter.
 - 4.ANT= Antenna height.
 - 5.Amplitude= Reading Amplitude -Amplifier gain+Cable loss +Antenna factor
(Auto calculate in spectrum analyzer)



3.6.7 Open Field Radiated Emissions (Subpart C)

The highest peak values of radiated emissions from the EUT at various antenna heights, antenna polarization, EUT orientation , etc. are recorded on the following

Applicant : *Compex Inc.*
 Model No : *iWavePort WLM54G 1B*
 EUT : *Compex Wireless-G Network Mini-PCI Adapter*
 Test Mode : *802.11b(CH01)*
 Test Date : *04/26/2005*

| Radiated Emissions (HORIZONTAL) | | | | | | | | |
|---------------------------------|--------------------|----------|----------------|-----------|-----------|---------------------|----------------|-------------|
| Frequency (MHz) | Amplitude (dBuV/m) | Ant. (m) | Table (Degree) | Duty (dB) | Dist (dB) | Actual Amp (dBuV/m) | Limit (dBuV/m) | Margin (dB) |
| 1355.3 | 47.63 PK | 1 | 160 | 0 | 9.54 | 38.09 | 74.00 | -35.91 |
| 1778.6 | 44.97 PK | 1.2 | 320 | 0 | 9.54 | 35.43 | 74.00 | -38.57 |
| 4811.2 | 35.62 PK | 1 | 360 | 0 | 9.54 | 26.08 | 74.00 | -47.92 |
| 7211.7 | 39.68 PK | 1.1 | 280 | 0 | 9.54 | 30.14 | 74.00 | -43.86 |
| 9701.5 | 41.27 PK | 1 | 260 | 0 | 9.54 | 31.73 | 74.00 | -42.27 |
| 12052.8 | 40.11 PK | 1 | 90 | 0 | 9.54 | 30.57 | 74.00 | -43.43 |
| 14452.9 | 45.68 PK | 1 | 240 | 0 | 9.54 | 36.14 | 74.00 | -37.86 |

- Notes :
- 1.Margin= Amplitude - Limits
 - 2.Distance of Measurement : 1 Meter (1G-26.5GHz)
 - 3.Height of table for EUT placed: 0.8 Meter.
 - 4.ANT= Antenna height.
 - 5.Duty= Duty cycle correction factor.
 - 6.Dis= Distance extrapolation factor.
 - 7.Amplitude= Reading Amplitude - Amplifier gain+Cable loss
+Antenna factor
(Auto calculate in spectrum analyzer)
 - 8.Actual Amp= Amplitude - Duty - Dis.
 - 9.The other emission levels were very low against the limit.

3.6.8 Open Field Radiated Emissions (Subpart C)

The highest peak values of radiated emissions from the EUT at various antenna heights, antenna polarization, EUT orientation , etc. are recorded on the following.

Applicant : *Compex Inc.*
Model No : *iWavePort WLM54G 1B*
EUT : *Compex Wireless-G Network Mini-PCI Adapter*
Test Mode : *802.11b(CH01)*
Test Date : *04/26/2005*

| Radiated Emissions (VERTICAL) | | | | | | | | |
|-------------------------------|--------------------|----------|----------------|-----------|-----------|---------------------|----------------|-------------|
| Frequency (MHz) | Amplitude (dBuV/m) | Ant. (m) | Table (Degree) | Duty (dB) | Dist (dB) | Actual Amp (dBuV/m) | Limit (dBuV/m) | Margin (dB) |
| 1348.3 | 48.52 PK | 1 | 260 | 0 | 9.54 | 38.98 | 74.00 | -35.02 |
| 1784.1 | 46.79 PK | 1 | 320 | 0 | 9.54 | 37.25 | 74.00 | -36.75 |
| 3774.7 | 38.56 PK | 1 | 300 | 0 | 9.54 | 29.02 | 74.00 | -44.98 |
| 7242.0 | 42.05 PK | 1.1 | 280 | 0 | 9.54 | 32.51 | 74.00 | -41.49 |
| 9661.2 | 42.72 PK | 1.2 | 160 | 0 | 9.54 | 33.18 | 74.00 | -40.82 |
| 12062.3 | 42.14 PK | 1 | 270 | 0 | 9.54 | 32.60 | 74.00 | -41.40 |
| 14471.5 | 44.27 PK | 1 | 260 | 0 | 9.54 | 34.73 | 74.00 | -39.27 |

- Notes :
- 1.Margin= Amplitude - Limits
 - 2.Distance of Measurement : 1 Meter (1G-26.5GHz)
 - 3.Height of table for EUT placed: 0.8 Meter.
 - 4.ANT= Antenna height.
 - 5.Duty= Duty cycle correction factor.
 - 6.Dis= Distance extrapolation factor.
 - 7.Amplitude= Reading Amplitude - Amplifier gain+Cable loss +Antenna factor
(Auto calculate in spectrum analyzer)
 - 8.Actual Amp= Amplitude - Duty - Dis.
 - 9.The other emission levels were very low against the limit.



3.6.9 Open Field Radiated Emissions (Subpart C)

The highest peak values of radiated emissions from the EUT at various antenna heights, antenna polarization, EUT orientation , etc. are recorded on the following

Applicant : *Compex Inc.*
Model No : *iWavePort WLM54G 1B*
EUT : *Compex Wireless-G Network Mini-PCI Adapter*
Test Mode : *802.11b CH06)*
Test Date : *04/26/2005*

| Radiated Emissions (HORIZONTAL) | | | | | | | | |
|---------------------------------|--------------------|----------|----------------|-----------|-----------|---------------------|----------------|-------------|
| Frequency (MHz) | Amplitude (dBuV/m) | Ant. (m) | Table (Degree) | Duty (dB) | Dist (dB) | Actual Amp (dBuV/m) | Limit (dBuV/m) | Margin (dB) |
| 1352.7 | 45.14 PK | 1.1 | 160 | 0 | 9.54 | 35.60 | 74.00 | -38.40 |
| 1783.8 | 46.85 PK | 1 | 320 | 0 | 9.54 | 37.31 | 74.00 | -36.69 |
| 4865.2 | 37.42 PK | 1 | 360 | 0 | 9.54 | 27.88 | 74.00 | -46.12 |
| 7353.8 | 40.12 PK | 1 | 180 | 0 | 9.54 | 30.58 | 74.00 | -43.42 |
| 9767.5 | 43.88 PK | 1.2 | 260 | 0 | 9.54 | 34.34 | 74.00 | -39.66 |
| 12274.5 | 41.22 PK | 1 | 180 | 0 | 9.54 | 31.68 | 74.00 | -42.32 |
| 14664.8 | 45.69 PK | 1 | 160 | 0 | 9.54 | 36.15 | 74.00 | -37.85 |

- Notes :
- 1.Margin= Amplitude - Limits
 - 2.Distance of Measurement : 1 Meter (1G-26.5GHz)
 - 3.Height of table for EUT placed: 0.8 Meter.
 - 4.ANT= Antenna height.
 - 5.Duty= Duty cycle correction factor.
 - 6.Dis= Distance extrapolation factor.
 - 7.Amplitude= Reading Amplitude - Amplifier gain+Cable loss +Antenna factor
(Auto calculate in spectrum analyzer)
 - 8.Actual Amp= Amplitude - Duty - Dis.
 - 9.The other emission levels were very low against the limit.



3.6.10 Open Field Radiated Emissions (Subpart C)

The highest peak values of radiated emissions from the EUT at various antenna heights, antenna polarization, EUT orientation , etc. are recorded on the following.

Applicant : *Compex Inc.*
Model No : *iWavePort WLM54G 1B*
EUT : *Compex Wireless-G Network Mini-PCI Adapter*
Test Mode : *802.11b (CH06)*
Test Date : *04/26/2005*

| Radiated Emissions (VERTICAL) | | | | | | | | |
|-------------------------------|--------------------|----------|----------------|-----------|-----------|---------------------|----------------|-------------|
| Frequency (MHz) | Amplitude (dBuV/m) | Ant. (m) | Table (Degree) | Duty (dB) | Dist (dB) | Actual Amp (dBuV/m) | Limit (dBuV/m) | Margin (dB) |
| 1353.2 | 46.38 PK | 1 | 180 | 0 | 9.54 | 36.84 | 74.00 | -37.16 |
| 1786.3 | 48.27 PK | 1 | 220 | 0 | 9.54 | 38.73 | 74.00 | -35.27 |
| 3834.2 | 36.25 PK | 1 | 330 | 0 | 9.54 | 26.71 | 74.00 | -47.29 |
| 7341.2 | 39.42 PK | 1.1 | 180 | 0 | 9.54 | 29.88 | 74.00 | -44.12 |
| 9796.5 | 41.72 PK | 1.2 | 260 | 0 | 9.54 | 32.18 | 74.00 | -41.82 |
| 12240.1 | 42.15 PK | 1 | 150 | 0 | 9.54 | 32.61 | 74.00 | -41.39 |
| 14692.6 | 44.97 PK | 1 | 240 | 0 | 9.54 | 35.43 | 74.00 | -38.57 |

- Notes :
- 1.Margin= Amplitude - Limits
 - 2.Distance of Measurement : 1 Meter (1G-26.5GHz)
 - 3.Height of table for EUT placed: 0.8 Meter.
 - 4.ANT= Antenna height.
 - 5.Duty= Duty cycle correction factor.
 - 6.Dis= Distance extrapolation factor.
 - 7.Amplitude= Reading Amplitude - Amplifier gain+Cable loss +Antenna factor
(Auto calculate in spectrum analyzer)
 - 8.Actual Amp= Amplitude - Duty - Dis.
 - 9.The other emission levels were very low against the limit.



3.6.11 Open Field Radiated Emissions (Subpart C)

The highest peak values of radiated emissions from the EUT at various antenna heights, antenna polarization, EUT orientation , etc. are recorded on the following

Applicant : *Compex Inc.*
 Model No : *iWavePort WLM54G 1B*
 EUT : *Compex Wireless-G Network Mini-PCI Adapter*
 Test Mode : *802.11b (CH11)*
 Test Date : *04/26/2005*

| Radiated Emissions (HORIZONTAL) | | | | | | | | |
|---------------------------------|--------------------|----------|----------------|-----------|-----------|---------------------|----------------|-------------|
| Frequency (MHz) | Amplitude (dBuV/m) | Ant. (m) | Table (Degree) | Duty (dB) | Dist (dB) | Actual Amp (dBuV/m) | Limit (dBuV/m) | Margin (dB) |
| 1354.6 | 45.22 PK | 1 | 120 | 0 | 9.54 | 35.68 | 74.00 | -38.32 |
| 1784.5 | 45.96 PK | 1 | 220 | 0 | 9.54 | 36.42 | 74.00 | -37.58 |
| 4943.5 | 38.27 PK | 1 | 320 | 0 | 9.54 | 28.73 | 74.00 | -45.27 |
| 7355.9 | 40.52 PK | 1.1 | 180 | 0 | 9.54 | 30.98 | 74.00 | -43.02 |
| 9831.8 | 43.66 PK | 1.2 | 120 | 0 | 9.54 | 34.12 | 74.00 | -39.88 |
| 12385.2 | 43.53 PK | 1 | 180 | 0 | 9.54 | 33.99 | 74.00 | -40.01 |
| 14746.2 | 46.22 PK | 1 | 260 | 0 | 9.54 | 36.68 | 74.00 | -37.32 |

- Notes :
- 1.Margin= Amplitude - Limits
 - 2.Distance of Measurement : 1 Meter (1G-26.5GHz)
 - 3.Height of table for EUT placed: 0.8 Meter.
 - 4.ANT= Antenna height.
 - 5.Duty= Duty cycle correction factor.
 - 6.Dis= Distance extrapolation factor.
 - 7.Amplitude= Reading Amplitude - Amplifier gain+Cable loss
+Antenna factor
(Auto calculate in spectrum analyzer)
 - 8.Actual Amp= Amplitude - Duty - Dis.
 - 9.The other emission levels were very low against the limit.



3.6.12 Open Field Radiated Emissions (Subpart C)

The highest peak values of radiated emissions from the EUT at various antenna heights, antenna polarization, EUT orientation , etc. are recorded on the following.

Applicant : *Compex Inc.*
 Model No : *iWavePort WLM54G 1B*
 EUT : *Compex Wireless-G Network Mini-PCI Adapter*
 Test Mode : *802.11b (CH11)*
 Test Date : *04/26/2005*

| Radiated Emissions (VERTICAL) | | | | | | | | |
|-------------------------------|--------------------|----------|----------------|-----------|-----------|---------------------|----------------|-------------|
| Frequency (MHz) | Amplitude (dBuV/m) | Ant. (m) | Table (Degree) | Duty (dB) | Dist (dB) | Actual Amp (dBuV/m) | Limit (dBuV/m) | Margin (dB) |
| 1351.4 | 47.25 PK | 1.1 | 160 | 0 | 9.54 | 37.71 | 74.00 | -36.29 |
| 1785.3 | 45.98 PK | 1 | 220 | 0 | 9.54 | 36.44 | 74.00 | -37.56 |
| 3881.4 | 38.52 PK | 1 | 360 | 0 | 9.54 | 28.98 | 74.00 | -45.02 |
| 7385.2 | 39.45 PK | 1 | 180 | 0 | 9.54 | 29.91 | 74.00 | -44.09 |
| 9844.8 | 40.12 PK | 1 | 120 | 0 | 9.54 | 30.58 | 74.00 | -43.42 |
| 12348.2 | 42.55 PK | 1 | 240 | 0 | 9.54 | 33.01 | 74.00 | -40.99 |
| 14783.7 | 45.66 PK | 1 | 360 | 0 | 9.54 | 36.12 | 74.00 | -37.88 |

- Notes :
1. Margin= Amplitude - Limits
 2. Distance of Measurement : 1 Meter (1G-26.5GHz)
 3. Height of table for EUT placed: 0.8 Meter.
 4. ANT= Antenna height.
 5. Duty= Duty cycle correction factor.
 6. Dis= Distance extrapolation factor.
 7. Amplitude= Reading Amplitude - Amplifier gain+Cable loss +Antenna factor
(Auto calculate in spectrum analyzer)
 8. Actual Amp= Amplitude - Duty - Dis.
 9. The other emission levels were very low against the limit.

3.6.13 Open Field Radiated Emissions (Subpart C)

The highest peak values of radiated emissions from the EUT at various antenna heights, antenna polarization, EUT orientation , etc. are recorded on the following

Applicant : *Compex Inc.*
Model No : *iWavePort WLM54G 1B*
EUT : *Compex Wireless-G Network Mini-PCI Adapter*
Test Mode : *802.11g (CH01)*
Test Date : *04/26/2005*

| Radiated Emissions (HORIZONTAL) | | | | | | | | |
|---------------------------------|--------------------|----------|----------------|-----------|-----------|---------------------|----------------|-------------|
| Frequency (MHz) | Amplitude (dBuV/m) | Ant. (m) | Table (Degree) | Duty (dB) | Dist (dB) | Actual Amp (dBuV/m) | Limit (dBuV/m) | Margin (dB) |
| 1354.2 | 48.14 PK | 1 | 150 | 0 | 9.54 | 38.60 | 74.00 | -35.40 |
| 1779.2 | 45.77 PK | 1 | 180 | 0 | 9.54 | 36.23 | 74.00 | -37.77 |
| 4812.4 | 32.43 PK | 1.1 | 240 | 0 | 9.54 | 22.89 | 74.00 | -51.11 |
| 7212.8 | 38.47 PK | 1 | 270 | 0 | 9.54 | 28.93 | 74.00 | -45.07 |
| 9702.6 | 40.14 PK | 1.1 | 360 | 0 | 9.54 | 30.60 | 74.00 | -43.40 |
| 12051.4 | 39.66 PK | 1 | 210 | 0 | 9.54 | 30.12 | 74.00 | -43.88 |
| 14451.7 | 45.28 PK | 1 | 330 | 0 | 9.54 | 35.74 | 74.00 | -38.26 |

- Notes :
- 1.Margin= Amplitude - Limits
 - 2.Distance of Measurement : 1 Meter (1G-26.5GHz)
 - 3.Height of table for EUT placed: 0.8 Meter.
 - 4.ANT= Antenna height.
 - 5.Duty= Duty cycle correction factor.
 - 6.Dis= Distance extrapolation factor.
 - 7.Amplitude= Reading Amplitude - Amplifier gain+Cable loss
+Antenna factor
(Auto calculate in spectrum analyzer)
 - 8.Actual Amp= Amplitude - Duty - Dis.
 - 9.The other emission levels were very low against the limit.



3.6.14 Open Field Radiated Emissions (Subpart C)

The highest peak values of radiated emissions from the EUT at various antenna heights, antenna polarization, EUT orientation , etc. are recorded on the following.

Applicant : *Compex Inc.*
 Model No : *iWavePort WLM54G 1B*
 EUT : *Compex Wireless-G Network Mini-PCI Adapter*
 Test Mode : *802.11g (CH01)*
 Test Date : *04/26/2005*

| Radiated Emissions (VERTICAL) | | | | | | | | |
|-------------------------------|--------------------|----------|----------------|-----------|-----------|---------------------|----------------|-------------|
| Frequency (MHz) | Amplitude (dBuV/m) | Ant. (m) | Table (Degree) | Duty (dB) | Dist (dB) | Actual Amp (dBuV/m) | Limit (dBuV/m) | Margin (dB) |
| 1349.7 | 47.22 PK | 1.1 | 160 | 0 | 9.54 | 37.68 | 74.00 | -36.32 |
| 1783.5 | 46.98 PK | 1 | 220 | 0 | 9.54 | 37.44 | 74.00 | -36.56 |
| 3771.5 | 37.58 PK | 1 | 330 | 0 | 9.54 | 28.04 | 74.00 | -45.96 |
| 7243.1 | 41.42 PK | 1 | 180 | 0 | 9.54 | 31.88 | 74.00 | -42.12 |
| 9660.8 | 41.57 PK | 1.1 | 120 | 0 | 9.54 | 32.03 | 74.00 | -41.97 |
| 12064.5 | 42.15 PK | 1 | 240 | 0 | 9.54 | 32.61 | 74.00 | -41.39 |
| 14472.1 | 45.63 PK | 1 | 210 | 0 | 9.54 | 36.09 | 74.00 | -37.91 |

- Notes :
1. Margin= Amplitude - Limits
 2. Distance of Measurement : 1 Meter (1G-26.5GHz)
 3. Height of table for EUT placed: 0.8 Meter.
 4. ANT= Antenna height.
 5. Duty= Duty cycle correction factor.
 6. Dis= Distance extrapolation factor.
 7. Amplitude= Reading Amplitude - Amplifier gain+Cable loss +Antenna factor
(Auto calculate in spectrum analyzer)
 8. Actual Amp= Amplitude - Duty - Dis.
 9. The other emission levels were very low against the limit.

3.6.15 Open Field Radiated Emissions (Subpart C)

The highest peak values of radiated emissions from the EUT at various antenna heights, antenna polarization, EUT orientation , etc. are recorded on the following

Applicant : *Compex Inc.*
Model No : *iWavePort WLM54G 1B*
EUT : *Compex Wireless-G Network Mini-PCI Adapter*
Test Mode : *802.11g (CH06)*
Test Date : *04/26/2005*

| Radiated Emissions (HORIZONTAL) | | | | | | | | |
|---------------------------------|--------------------|----------|----------------|-----------|-----------|---------------------|----------------|-------------|
| Frequency (MHz) | Amplitude (dBuV/m) | Ant. (m) | Table (Degree) | Duty (dB) | Dist (dB) | Actual Amp (dBuV/m) | Limit (dBuV/m) | Margin (dB) |
| 1354.4 | 46.97 PK | 1 | 150 | 0 | 9.54 | 37.43 | 74.00 | -36.57 |
| 1784.6 | 47.60 PK | 1 | 240 | 0 | 9.54 | 38.06 | 74.00 | -35.94 |
| 4864.1 | 34.23 PK | 1 | 360 | 0 | 9.54 | 24.69 | 74.00 | -49.31 |
| 7352.7 | 42.14 PK | 1.1 | 120 | 0 | 9.54 | 32.60 | 74.00 | -41.40 |
| 9765.8 | 42.14 PK | 1.2 | 260 | 0 | 9.54 | 32.60 | 74.00 | -41.40 |
| 12272.0 | 40.14 PK | 1 | 240 | 0 | 9.54 | 30.60 | 74.00 | -43.40 |
| 14661.7 | 45.24 PK | 1 | 150 | 0 | 9.54 | 35.70 | 74.00 | -38.30 |

- Notes :
- 1.Margin= Amplitude - Limits
 - 2.Distance of Measurement : 1 Meter (1G-26.5GHz)
 - 3.Height of table for EUT placed: 0.8 Meter.
 - 4.ANT= Antenna height.
 - 5.Duty= Duty cycle correction factor.
 - 6.Dis= Distance extrapolation factor.
 - 7.Amplitude= Reading Amplitude - Amplifier gain+Cable loss
+Antenna factor
(Auto calculate in spectrum analyzer)
 - 8.Actual Amp= Amplitude - Duty - Dis.
 - 9.The other emission levels were very low against the limit.



MAX LIGHT

MEASUREMENT REPORT

3.6.16 Open Field Radiated Emissions (Subpart C)

The highest peak values of radiated emissions from the EUT at various antenna heights, antenna polarization, EUT orientation , etc. are recorded on the following.

Applicant : *Compex Inc.*
Model No : *iWavePort WLM54G 1B*
EUT : *Compex Wireless-G Network Mini-PCI Adapter*
Test Mode : *802.11g (CH06)*
Test Date : *04/26/2005*

| Radiated Emissions (VERTICAL) | | | | | | | | |
|-------------------------------|--------------------|----------|----------------|-----------|-----------|---------------------|----------------|-------------|
| Frequency (MHz) | Amplitude (dBuV/m) | Ant. (m) | Table (Degree) | Duty (dB) | Dist (dB) | Actual Amp (dBuV/m) | Limit (dBuV/m) | Margin (dB) |
| 1355.8 | 47.95 PK | 1 | 210 | 0 | 9.54 | 38.41 | 74.00 | -35.59 |
| 1785.2 | 46.30 PK | 1.1 | 220 | 0 | 9.54 | 36.76 | 74.00 | -37.24 |
| 3836.7 | 38.53 PK | 1 | 330 | 0 | 9.54 | 28.99 | 74.00 | -45.01 |
| 7342.7 | 38.76 PK | 1 | 150 | 0 | 9.54 | 29.22 | 74.00 | -44.78 |
| 9797.3 | 40.27 PK | 1 | 360 | 0 | 9.54 | 30.73 | 74.00 | -43.27 |
| 12239.2 | 41.75 PK | 1 | 150 | 0 | 9.54 | 32.21 | 74.00 | -41.79 |
| 14691.2 | 45.63 PK | 1 | 210 | 0 | 9.54 | 36.09 | 74.00 | -37.91 |

- Notes :
- 1.Margin= Amplitude - Limits
 - 2.Distance of Measurement : 1 Meter (1G-26.5GHz)
 - 3.Height of table for EUT placed: 0.8 Meter.
 - 4.ANT= Antenna height.
 - 5.Duty= Duty cycle correction factor.
 - 6.Dis= Distance extrapolation factor.
 - 7.Amplitude= Reading Amplitude - Amplifier gain+Cable loss +Antenna factor
(Auto calculate in spectrum analyzer)
 - 8.Actual Amp= Amplitude - Duty - Dis.
 - 9.The other emission levels were very low against the limit.



3.6.17 Open Field Radiated Emissions (Subpart C)

The highest peak values of radiated emissions from the EUT at various antenna heights, antenna polarization, EUT orientation , etc. are recorded on the following

Applicant : *Compex Inc.*
 Model No : *iWavePort WLM54G 1B*
 EUT : *Compex Wireless-G Network Mini-PCI Adapter*
 Test Mode : *802.11g (CH11)*
 Test Date : *04/26/2005*

| Radiated Emissions (HORIZONTAL) | | | | | | | | |
|---------------------------------|--------------------|----------|----------------|-----------|-----------|---------------------|----------------|-------------|
| Frequency (MHz) | Amplitude (dBuV/m) | Ant. (m) | Table (Degree) | Duty (dB) | Dist (dB) | Actual Amp (dBuV/m) | Limit (dBuV/m) | Margin (dB) |
| 1353.8 | 47.44 PK | 1 | 150 | 0 | 9.54 | 37.90 | 74.00 | -36.10 |
| 1783.7 | 46.90 PK | 1.1 | 220 | 0 | 9.54 | 37.36 | 74.00 | -36.64 |
| 4941.3 | 36.25 PK | 1 | 330 | 0 | 9.54 | 26.71 | 74.00 | -47.29 |
| 7352.7 | 38.75 PK | 1.1 | 180 | 0 | 9.54 | 29.21 | 74.00 | -44.79 |
| 9830.9 | 42.11 PK | 1.1 | 160 | 0 | 9.54 | 32.57 | 74.00 | -41.43 |
| 12386.2 | 42.18 PK | 1 | 240 | 0 | 9.54 | 32.64 | 74.00 | -41.36 |
| 14745.1 | 45.33 PK | 1 | 360 | 0 | 9.54 | 35.79 | 74.00 | -38.21 |

- Notes :
- 1.Margin= Amplitude - Limits
 - 2.Distance of Measurement : 1 Meter (1G-26.5GHz)
 - 3.Height of table for EUT placed: 0.8 Meter.
 - 4.ANT= Antenna height.
 - 5.Duty= Duty cycle correction factor.
 - 6.Dis= Distance extrapolation factor.
 - 7.Amplitude= Reading Amplitude - Amplifier gain+Cable loss +Antenna factor
(Auto calculate in spectrum analyzer)
 - 8.Actual Amp= Amplitude - Duty - Dis.
 - 9.The other emission levels were very low against the limit.



3.6.18 Open Field Radiated Emissions (Subpart C)

The highest peak values of radiated emissions from the EUT at various antenna heights, antenna polarization, EUT orientation , etc. are recorded on the following.

Applicant : *Compex Inc.*
 Model No : *iWavePort WLM54G 1B*
 EUT : *Compex Wireless-G Network Mini-PCI Adapter*
 Test Mode : *802.11g (CH11)*
 Test Date : *04/26/2005*

| Radiated Emissions (VERTICAL) | | | | | | | | |
|-------------------------------|--------------------|----------|----------------|-----------|-----------|---------------------|----------------|-------------|
| Frequency (MHz) | Amplitude (dBuV/m) | Ant. (m) | Table (Degree) | Duty (dB) | Dist (dB) | Actual Amp (dBuV/m) | Limit (dBuV/m) | Margin (dB) |
| 1352.8 | 46.55 PK | 1.1 | 120 | 0 | 9.54 | 37.01 | 74.00 | -36.99 |
| 1782.4 | 47.01 PK | 1 | 320 | 0 | 9.54 | 37.47 | 74.00 | -36.53 |
| 3882.7 | 37.85 PK | 1 | 330 | 0 | 9.54 | 28.31 | 74.00 | -45.69 |
| 7386.4 | 38.69 PK | 1 | 150 | 0 | 9.54 | 29.15 | 74.00 | -44.85 |
| 9845.1 | 38.79 PK | 1 | 12 | 0 | 9.54 | 29.25 | 74.00 | -44.75 |
| 12346.2 | 41.25 PK | 1 | 270 | 0 | 9.54 | 31.71 | 74.00 | -42.29 |
| 14782.1 | 45.62 PK | 1 | 180 | 0 | 9.54 | 36.08 | 74.00 | -37.92 |

- Notes :
- 1.Margin= Amplitude - Limits
 - 2.Distance of Measurement : 1 Meter (1G-26.5GHz)
 - 3.Height of table for EUT placed: 0.8 Meter.
 - 4.ANT= Antenna height.
 - 5.Duty= Duty cycle correction factor.
 - 6.Dis= Distance extrapolation factor.
 - 7.Amplitude= Reading Amplitude - Amplifier gain+Cable loss +Antenna factor
(Auto calculate in spectrum analyzer)
 - 8.Actual Amp= Amplitude - Duty - Dis.
 - 9.The other emission levels were very low against the limit.



3.6.19 Open Field Radiated Emissions (Subpart C)

The highest peak values of radiated emissions from the EUT at various antenna heights, antenna polarization, EUT orientation , etc. are recorded on the following

Applicant : *Compex Inc.*
Model No : *iWavePort WLM54G 1B*
EUT : *Compex Wireless-G Network Mini-PCI Adapter*
Test Mode : *802.11 Super G (CH06)*
Test Date : *04/26/2005*

| Radiated Emissions (HORIZONTAL) | | | | | | | | |
|---------------------------------|--------------------|----------|----------------|-----------|-----------|---------------------|----------------|-------------|
| Frequency (MHz) | Amplitude (dBuV/m) | Ant. (m) | Table (Degree) | Duty (dB) | Dist (dB) | Actual Amp (dBuV/m) | Limit (dBuV/m) | Margin (dB) |
| 1476.5 | 48.96 PK | 1 | 210 | 0 | 9.54 | 39.42 | 74.00 | -34.58 |
| 3726.1 | 36.05 PK | 1 | 320 | 0 | 9.54 | 26.51 | 74.00 | -47.49 |
| 6996.8 | 37.98 PK | 1 | 330 | 0 | 9.54 | 28.44 | 74.00 | -45.56 |
| 9531.8 | 41.57 PK | 1.1 | 280 | 0 | 9.54 | 32.03 | 74.00 | -41.97 |
| 10916.0 | 43.01 PK | 1.2 | 150 | 0 | 9.54 | 33.47 | 74.00 | -40.53 |
| 12052.5 | 42.78 PK | 1 | 240 | 0 | 9.54 | 33.24 | 74.00 | -40.76 |
| 14293.0 | 46.72 PK | 1 | 160 | 0 | 9.54 | 37.18 | 74.00 | -36.82 |

- Notes :
- 1.Margin= Amplitude - Limits
 - 2.Distance of Measurement : 1 Meter (1G-26.5GHz)
 - 3.Height of table for EUT placed: 0.8 Meter.
 - 4.ANT= Antenna height.
 - 5.Duty= Duty cycle correction factor.
 - 6.Dis= Distance extrapolation factor.
 - 7.Amplitude= Reading Amplitude - Amplifier gain+Cable loss +Antenna factor
(Auto calculate in spectrum analyzer)
 - 8.Actual Amp= Amplitude - Duty - Dis.
 - 9.The other emission levels were very low against the limit.

3.6.20 Open Field Radiated Emissions (Subpart C)

The highest peak values of radiated emissions from the EUT at various antenna heights, antenna polarization, EUT orientation , etc. are recorded on the following.

Applicant : *Compex Inc.*
Model No : *iWavePort WLM54G 1B*
EUT : *Compex Wireless-G Network Mini-PCI Adapter*
Test Mode : *802.11 Super G (CH06)*
Test Date : *04/26/2005*

| Radiated Emissions (VERTICAL) | | | | | | | | |
|-------------------------------|--------------------|----------|----------------|-----------|-----------|---------------------|----------------|-------------|
| Frequency (MHz) | Amplitude (dBuV/m) | Ant. (m) | Table (Degree) | Duty (dB) | Dist (dB) | Actual Amp (dBuV/m) | Limit (dBuV/m) | Margin (dB) |
| 1416.9 | 47.03 PK | 1 | 120 | 0 | 9.54 | 37.49 | 74.00 | -36.51 |
| 1789.2 | 45.31 PK | 1 | 220 | 0 | 9.54 | 35.77 | 74.00 | -38.23 |
| 3628.2 | 37.44 PK | 1.1 | 150 | 0 | 9.54 | 27.90 | 74.00 | -46.10 |
| 7311.5 | 38.74 PK | 1.1 | 280 | 0 | 9.54 | 29.20 | 74.00 | -44.80 |
| 9731.5 | 40.84 PK | 1.2 | 210 | 0 | 9.54 | 31.30 | 74.00 | -42.70 |
| 12066.0 | 43.07 PK | 1 | 330 | 0 | 9.54 | 33.53 | 74.00 | -40.47 |
| 14682.0 | 45.97 PK | 1 | 260 | 0 | 9.54 | 36.43 | 74.00 | -37.57 |

- Notes :
- 1.Margin= Amplitude - Limits
 - 2.Distance of Measurement : 1 Meter (1G-26.5GHz)
 - 3.Height of table for EUT placed: 0.8 Meter.
 - 4.ANT= Antenna height.
 - 5.Duty= Duty cycle correction factor.
 - 6.Dis= Distance extrapolation factor.
 - 7.Amplitude= Reading Amplitude - Amplifier gain+Cable loss
+Antenna factor
(Auto calculate in spectrum analyzer)
 - 8.Actual Amp= Amplitude - Duty - Dis.
 - 9.The other emission levels were very low against the limit.

IV. Maximum Conducted Output Power Requirements

4.1 Test Condition & Setup :

The tests below are run with the EUT's transmitter set at high power in TDD mode. A RJ-45 port from a computer to the EUT is needed to force selection of output power level and channel number. While testing, EUT was set to transmit continuously. Remove the Subjective device's antenna and connect the RF output port to spectrum analyzer. The maximum peak output power shall not exceed 1 watt.

Use a direct connection between the antenna port of transmitter and the spectrum Analyzer, for prevent the spectrum analyzer input attenuation 40-50 dB. Set the RBW Bandwidth of the emission or use a channel power meter mode .

For antennas with gains of 6 dBi or less , maximum allowed transmitter output is 1 watt (+30 dBm). For antennas with gains greater than 6 dBi, transmitter output level must be decreased by an amount equal to $(\text{GAIN} - 6)/3$ dBm.

The antenna port of the EUT was connected to the input of a power meter. Power was read directly and cable loss correction was added to the reading to obtain power at the EUT antenna terminals.

4.2 Test Instruments Configuration:

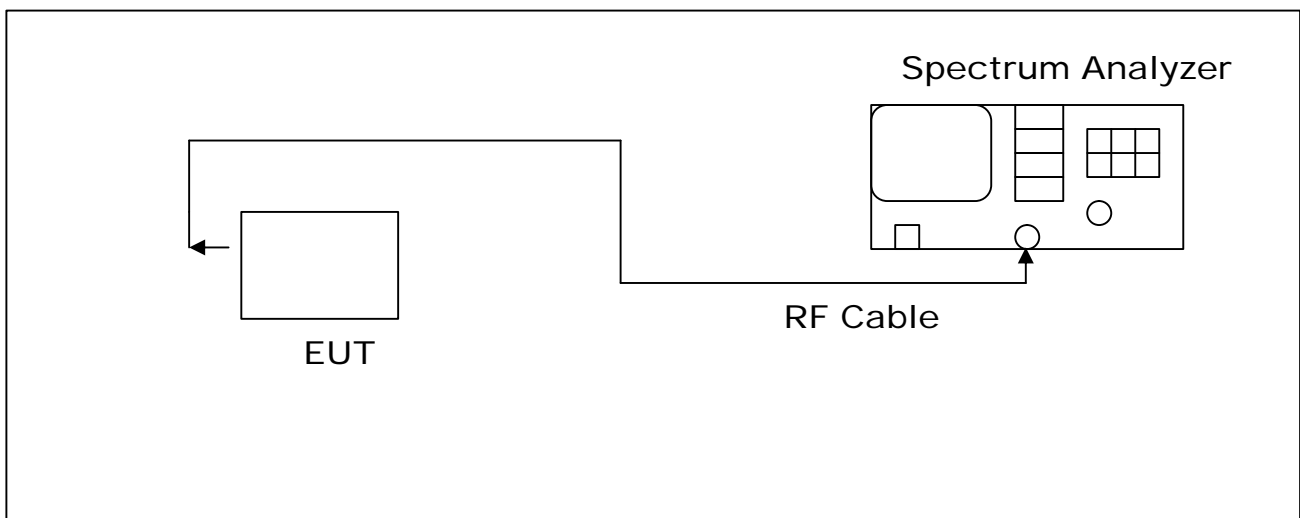



4.3 Test Equipment List:

- A. Agilent E4407B 9KHz-26.5GHz Spectrum Analyzer (S/N:A872JS02291)
- B. HP 8449B 1GHZ~26.5GHZ PRE Amplifier (S/N:1982901A91)
- C. Shielded Room (MLT-SR1)

4.4 Test Result:

iWAVEPORT WLM54G 1A

802.11b

| Frequency (MHz) | Output(dBm) | Required Limit |
|-----------------|-------------|----------------|
| 2412 | 15.33 | <30dBm |
| 2437 | 14.78 | <30dBm |
| 2462 | 14.39 | <30dBm |

802.11g

| Frequency (MHz) | Output(dBm) | Required Limit |
|-----------------|-------------|----------------|
| 2412 | 11.08 | <30dBm |
| 2437 | 10.95 | <30dBm |
| 2462 | 10.57 | <30dBm |



iWavePort WLM54G 1B

802.11b

| Frequency (MHz) | Output(dBm) | Required Limit |
|-----------------|-------------|----------------|
| 2412 | 16.02 | <30dBm |
| 2437 | 15.67 | <30dBm |
| 2462 | 15.09 | <30dBm |

802.11g

| Frequency (MHz) | Output(dBm) | Required Limit |
|-----------------|-------------|----------------|
| 2412 | 10.93 | <30dBm |
| 2437 | 10.69 | <30dBm |
| 2462 | 10.26 | <30dBm |

802.11 Super G

| Frequency (MHz) | Output(dBm) | Required Limit |
|-----------------|-------------|----------------|
| 2437 | 10.18 | <30dBm |

Note :Test Graphs See next page.

IWAVEPORT WLM54G 1A
802.11b (2412MHz)

REF 30.0 dBm *ATT 40dB A_wrt B_view
10dB/ Smpl Norm

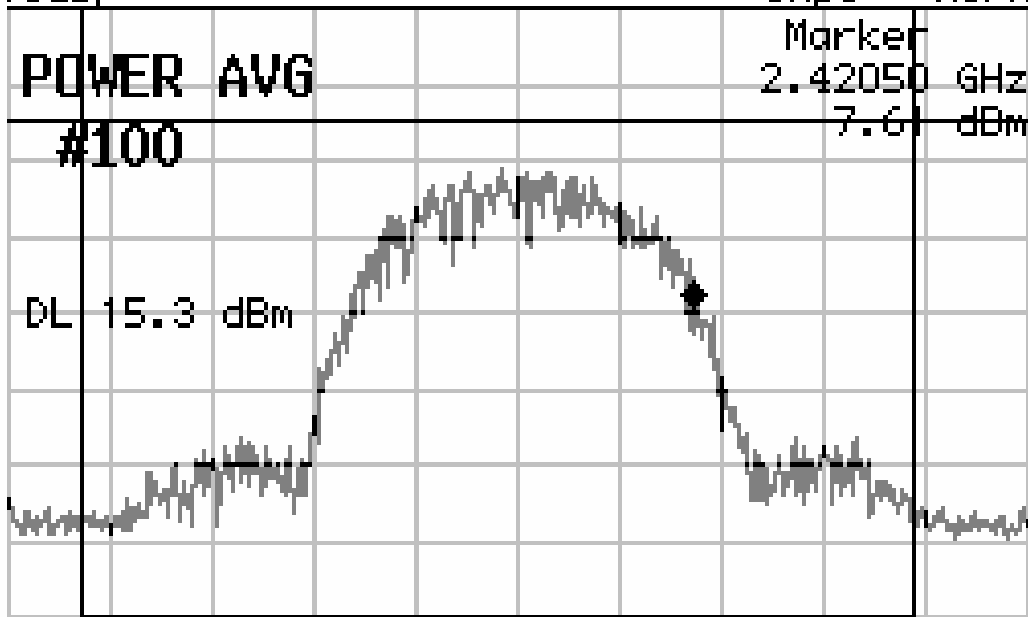

CH Power
CH Power
ON /OFF
CH BW
POS /WD
CH BW
SRT /STP

Channel 1 Power 100/100
15.33 dBm

CENTER 2.41200 GHz SPAN 50.0 MHz
*RBW 1 MHz *VBW 1 MHz *SWP 100 ms



MAX LIGHT

MEASUREMENT REPORT

iWAVEPORT WLM54G 1A
802.11b (2437MHz)

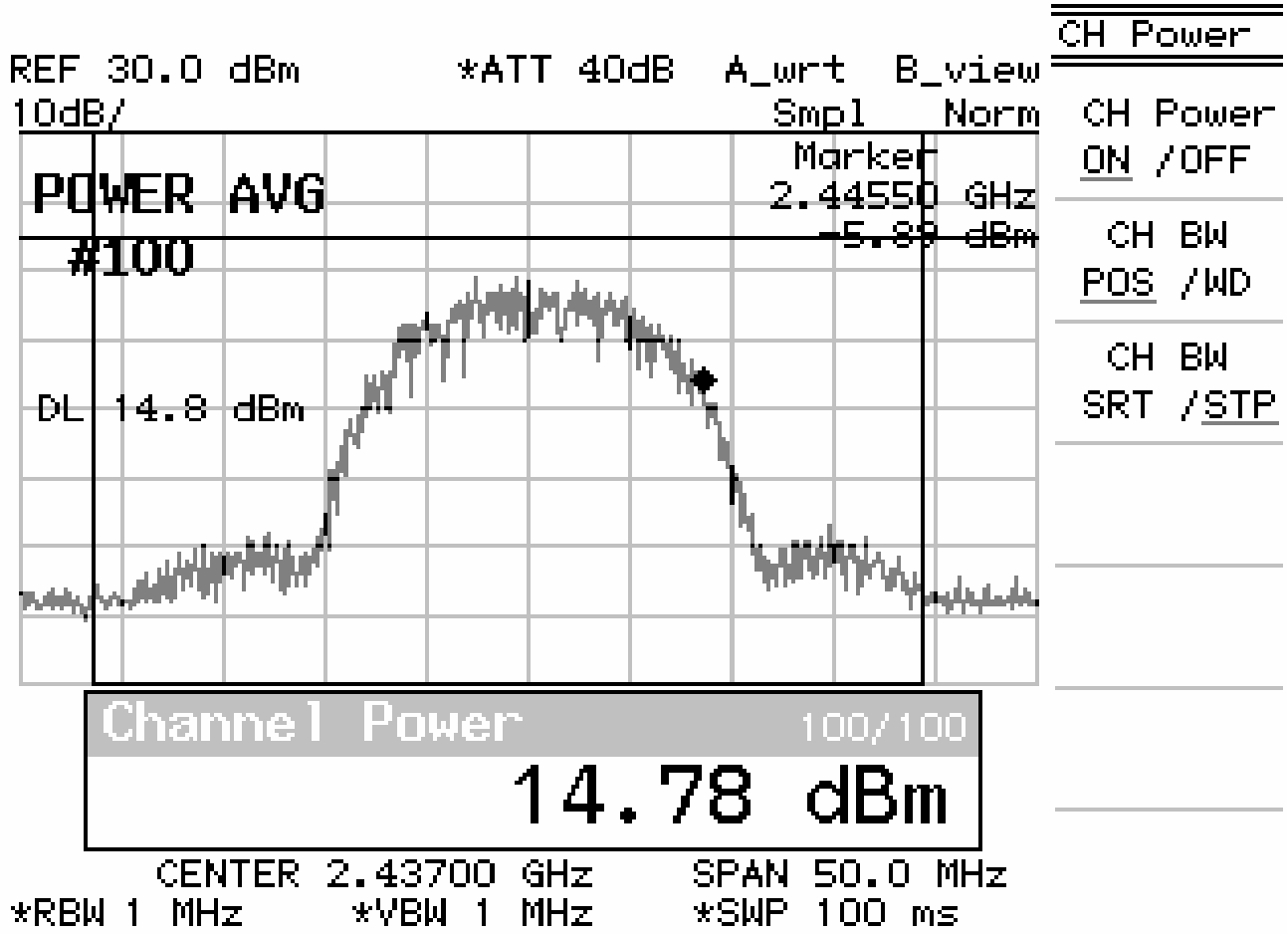



MAX LIGHT

MEASUREMENT REPORT

iWAVEPORT WLM54G 1A
802.11b (2462MHz)

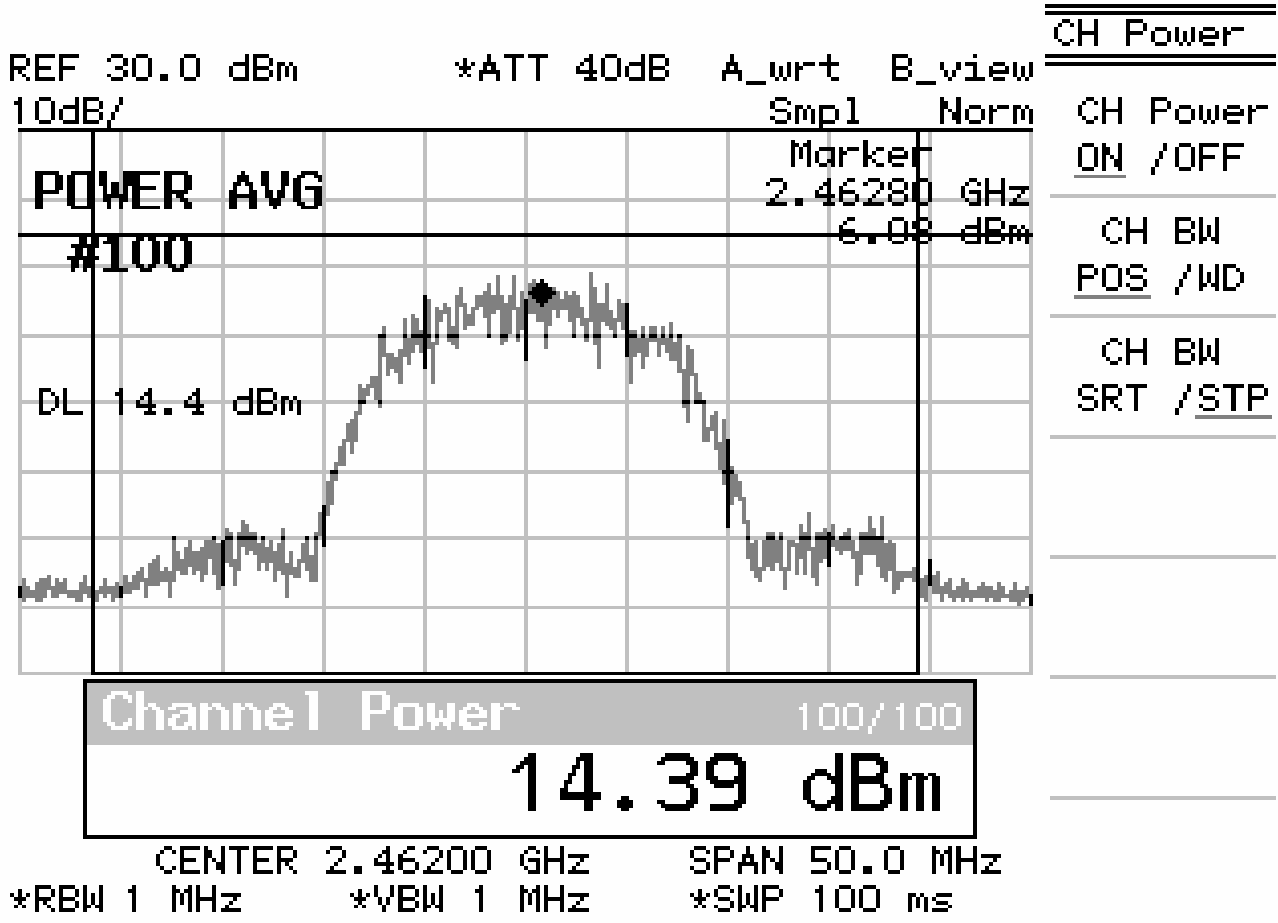



MAX LIGHT

MEASUREMENT REPORT

iWAVEPORT WLM54G 1A
802.11g (2412MHz)

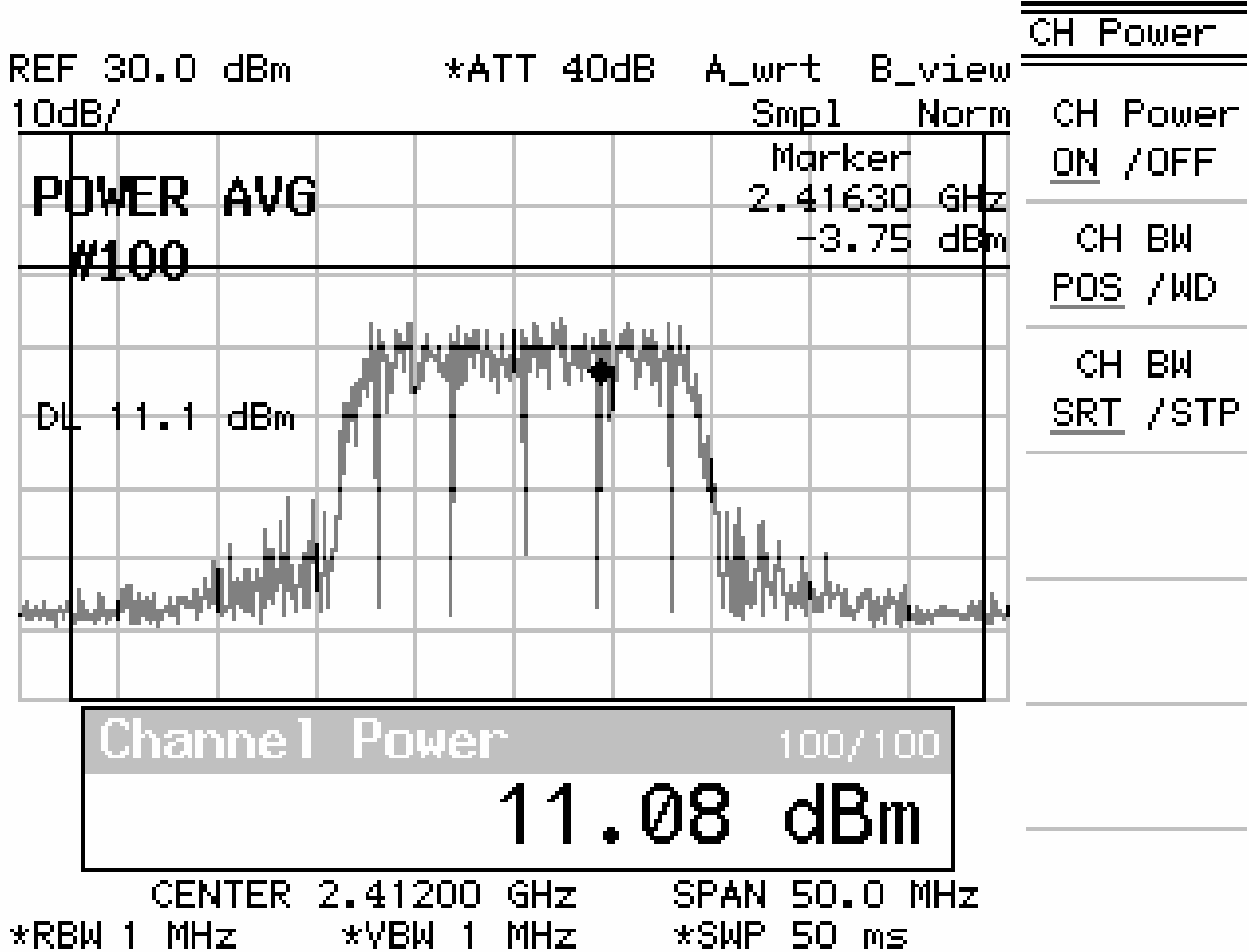



MAX LIGHT

MEASUREMENT REPORT

iWAVEPORT WLM54G 1A
802.11g (2437MHz)

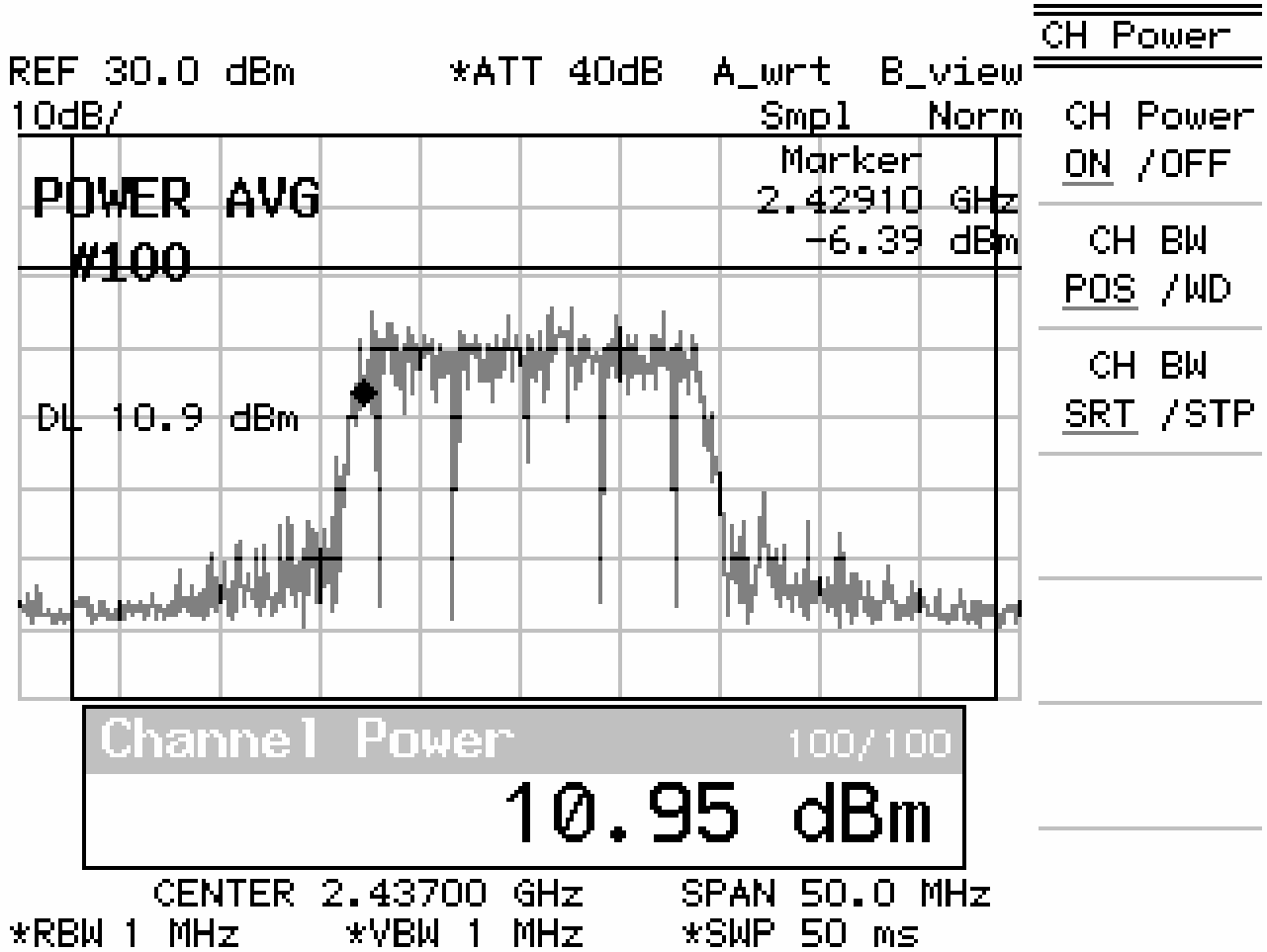



MAX LIGHT

MEASUREMENT REPORT

iWAVEPORT WLM54G 1A
802.11g (2462MHz)

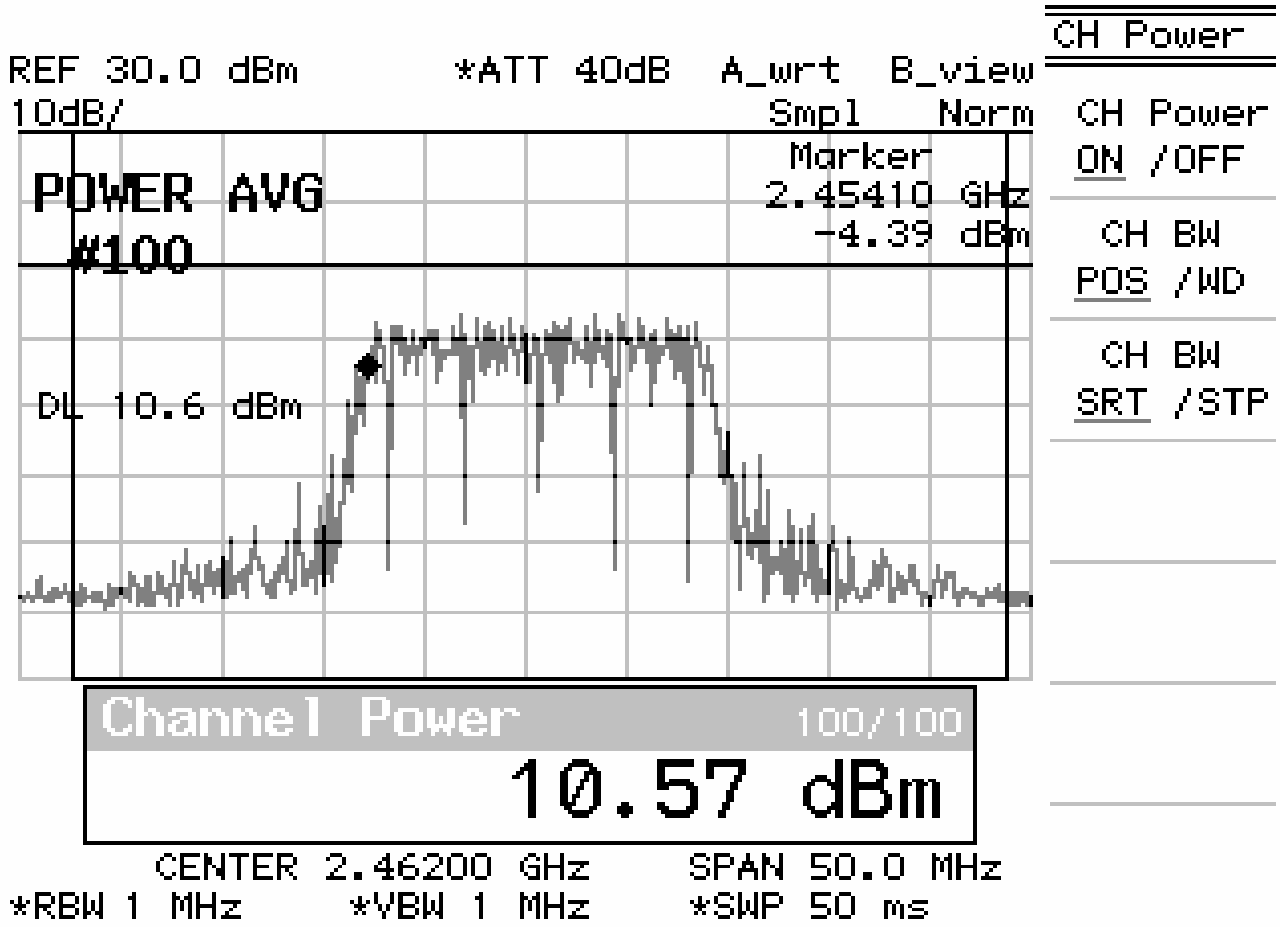



MAX LIGHT

MEASUREMENT REPORT

iWavePort WLM54G 1B
802.11b (2412MHz)

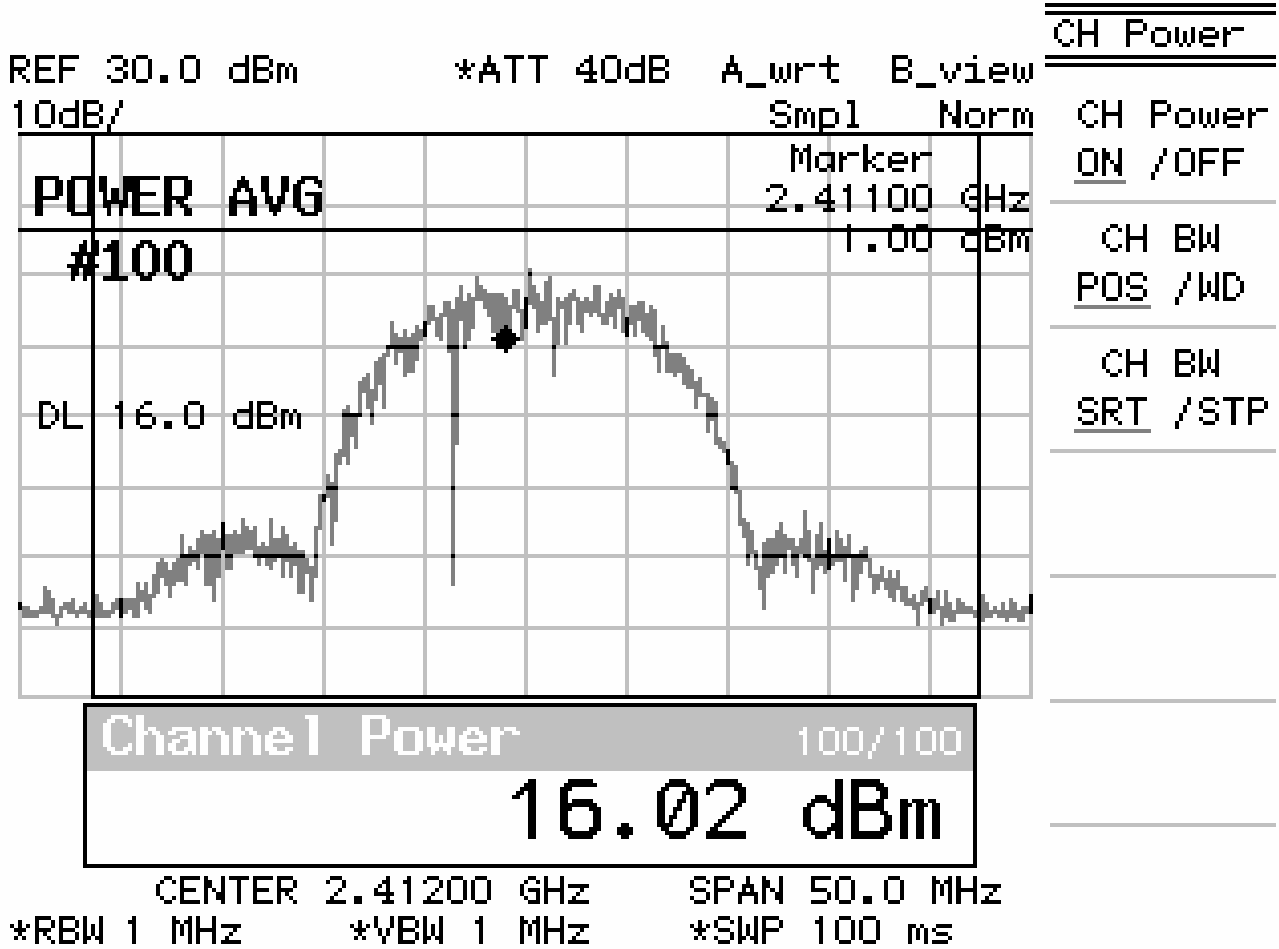



MAX LIGHT

MEASUREMENT REPORT

iWavePort WLM54G 1B
802.11b (2437MHz)

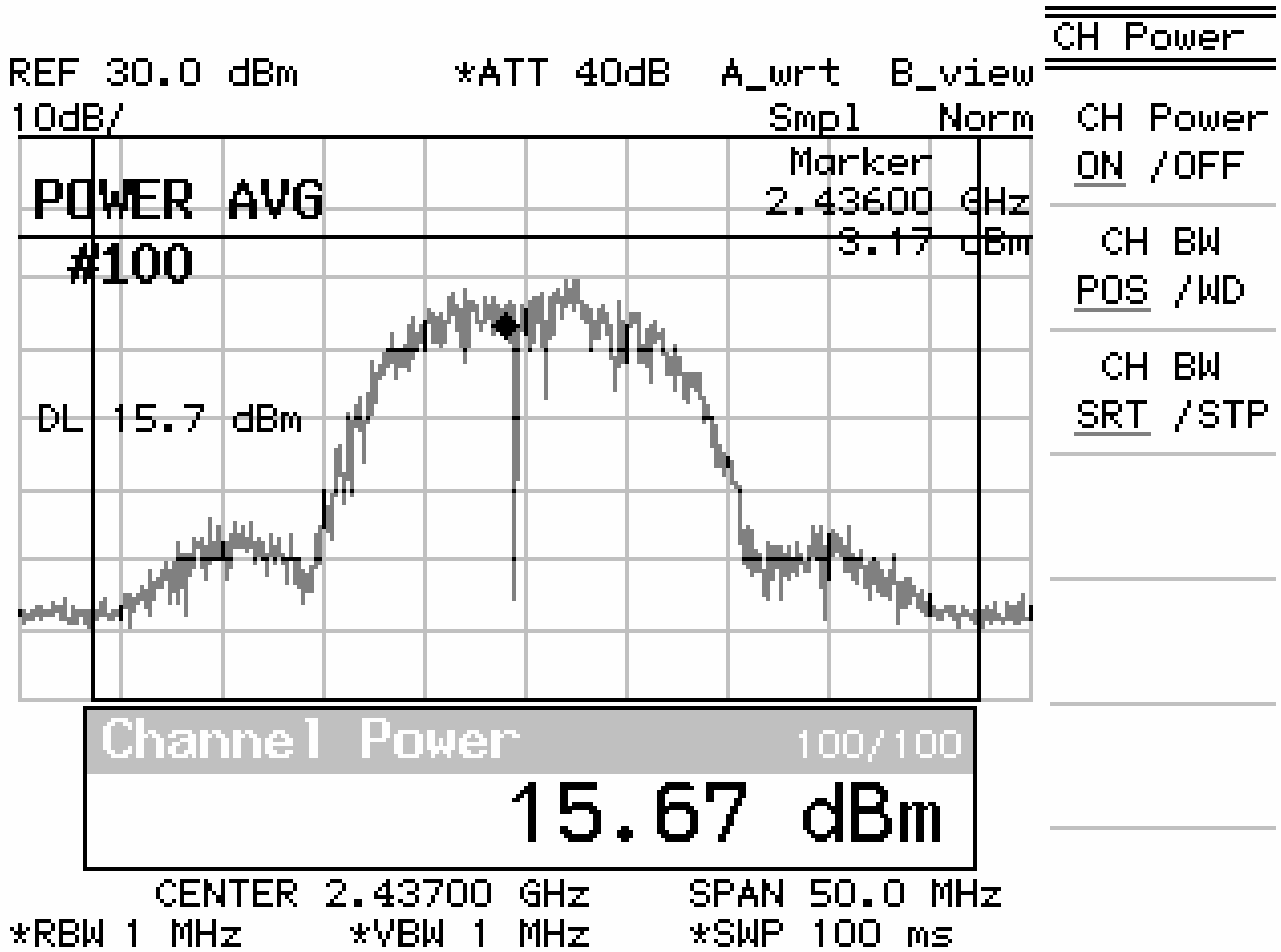



MAX LIGHT

MEASUREMENT REPORT

iWavePort WLM54G 1B
802.11b (2462MHz)

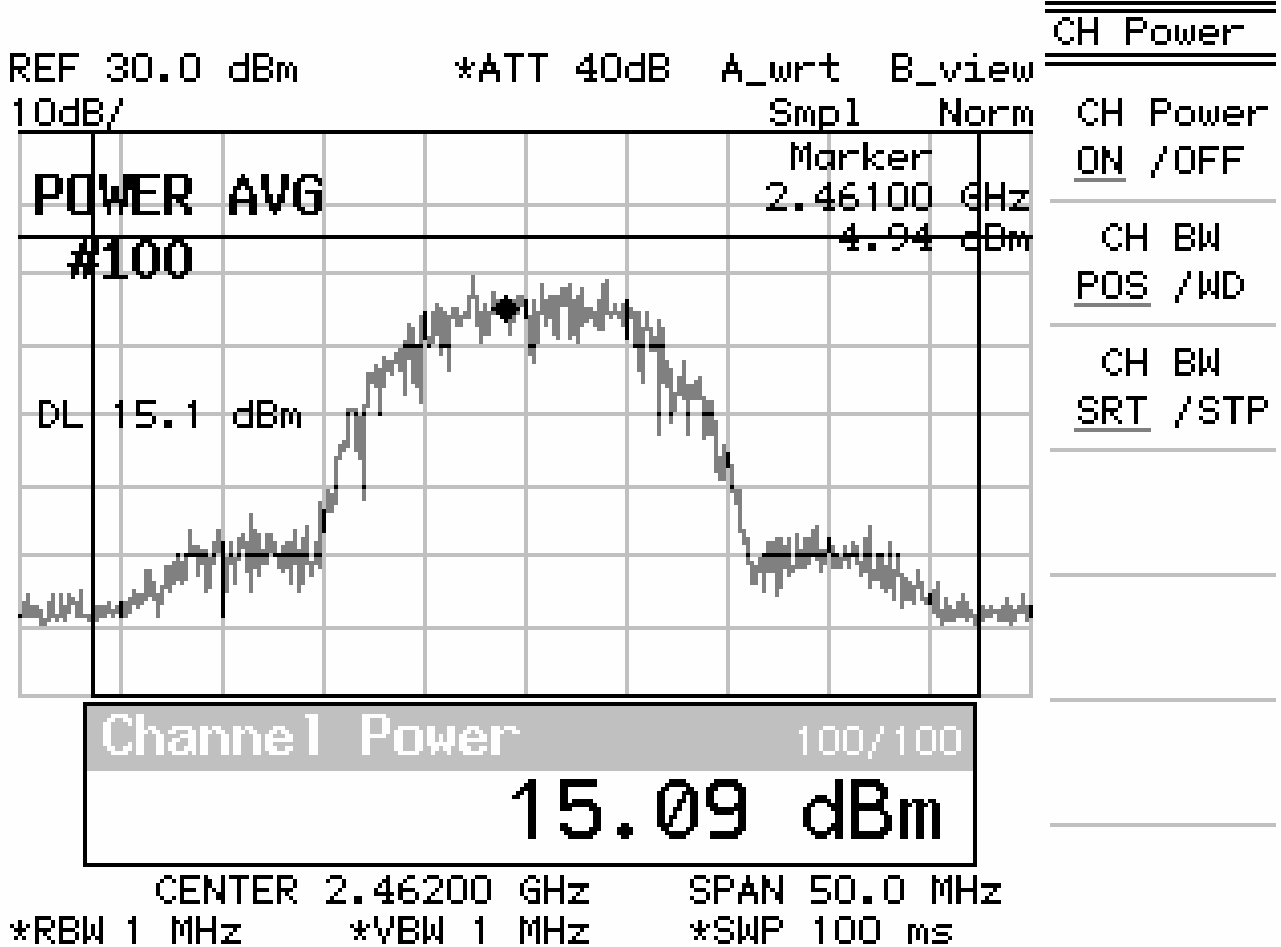



MAX LIGHT

MEASUREMENT REPORT

iWavePort WLM54G 1B
802.11g (2412MHz)

REF 30.0 dBm *ATT 40dB A_wrt B_view
10dB/ Smpl Norm

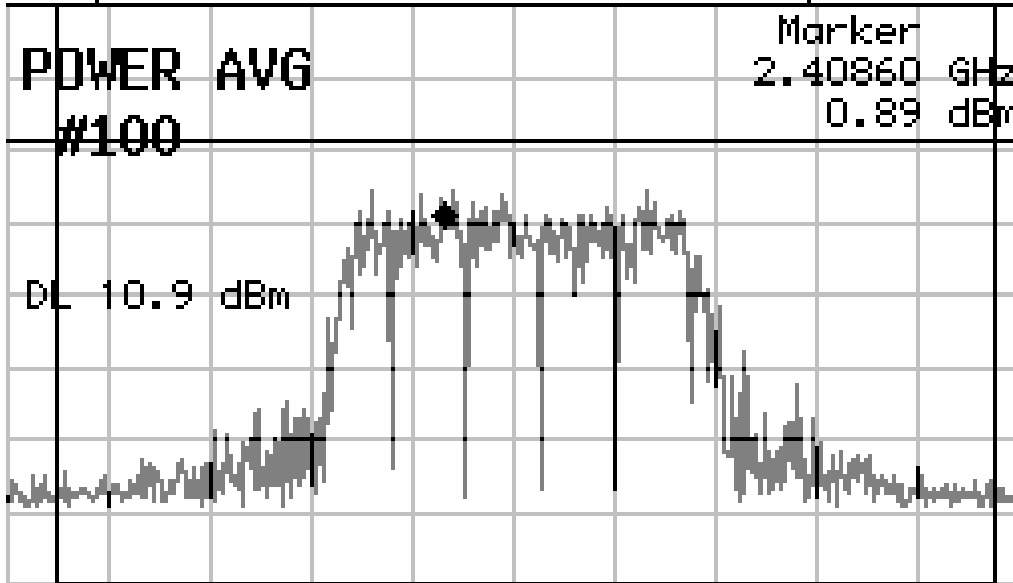

| |
|----------|
| CH Power |
| ON /OFF |
| CH BW |
| POS /WD |
| CH BW |
| SRT /STP |

POWER AVG #100

Marker
2.40860 GHz
0.89 dBm

DL 10.9 dBm

Channel Power 100/100

10.93 dBm

CENTER 2.41200 GHz SPAN 50.0 MHz
*RBW 1 MHz *VBW 1 MHz *SWP 50 ms



MAX LIGHT

MEASUREMENT REPORT

iWavePort WLM54G 1B
802.11g (2437MHz)

REF 30.0 dBm *ATT 40dB A_wrt B_view
10dB/ Smpl Norm

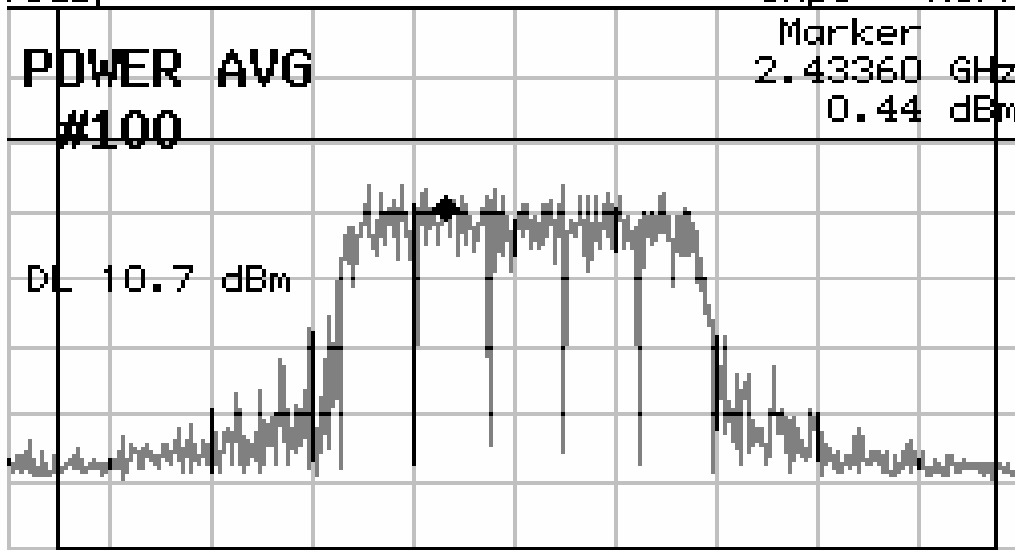

Channel Power 100/100
10.69 dBm

CENTER 2.43700 GHz SPAN 50.0 MHz
*RBW 1 MHz *VBW 1 MHz *SWP 50 ms

CH Power
CH Power
ON /OFF
CH BW
POS /WD
CH BW
SRT /STP



MAX LIGHT

MEASUREMENT REPORT

iWavePort WLM54G 1B
802.11g (2462MHz)

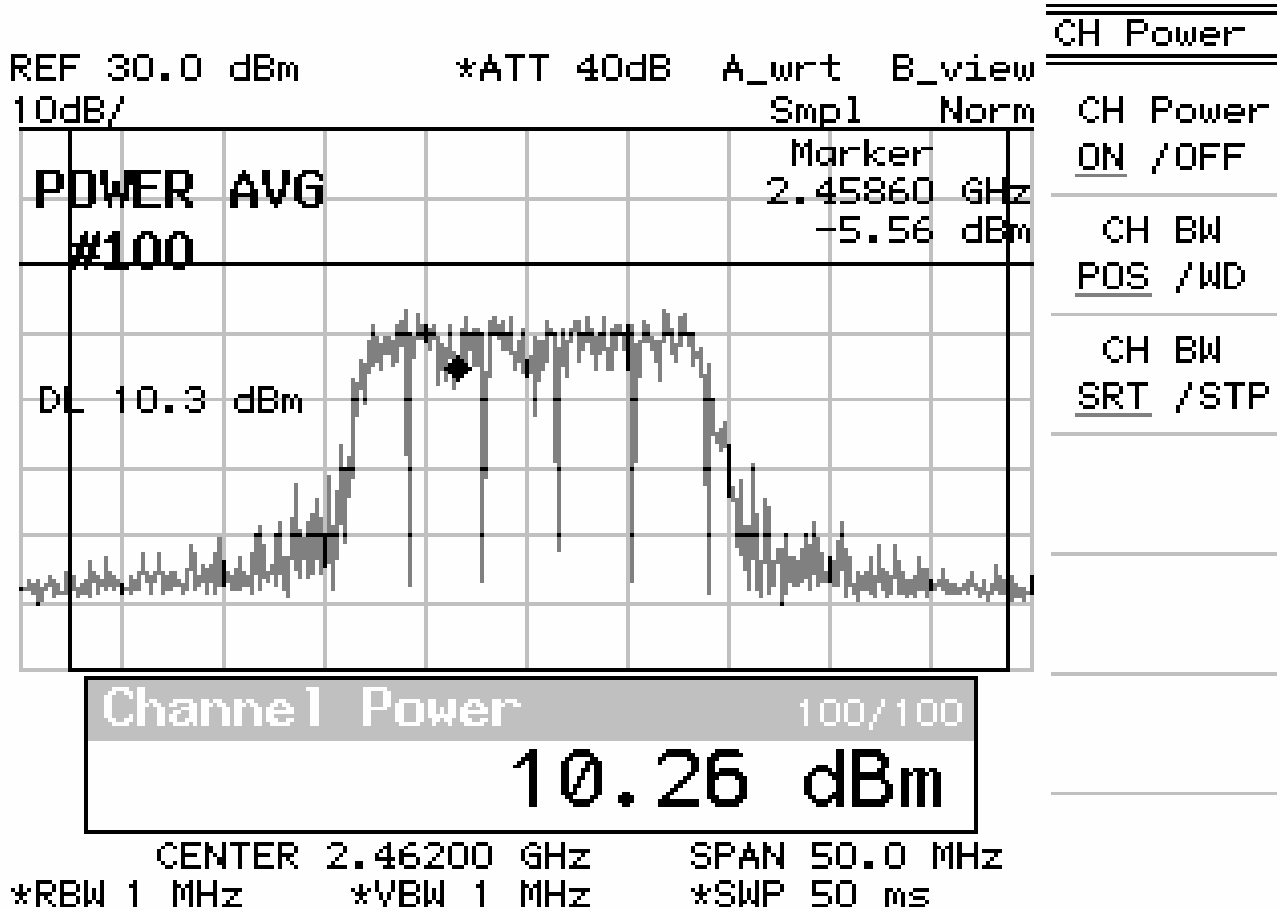



MAX LIGHT

MEASUREMENT REPORT

iWavePort WLM54G 1B
802.11 Super G (2437MHz)

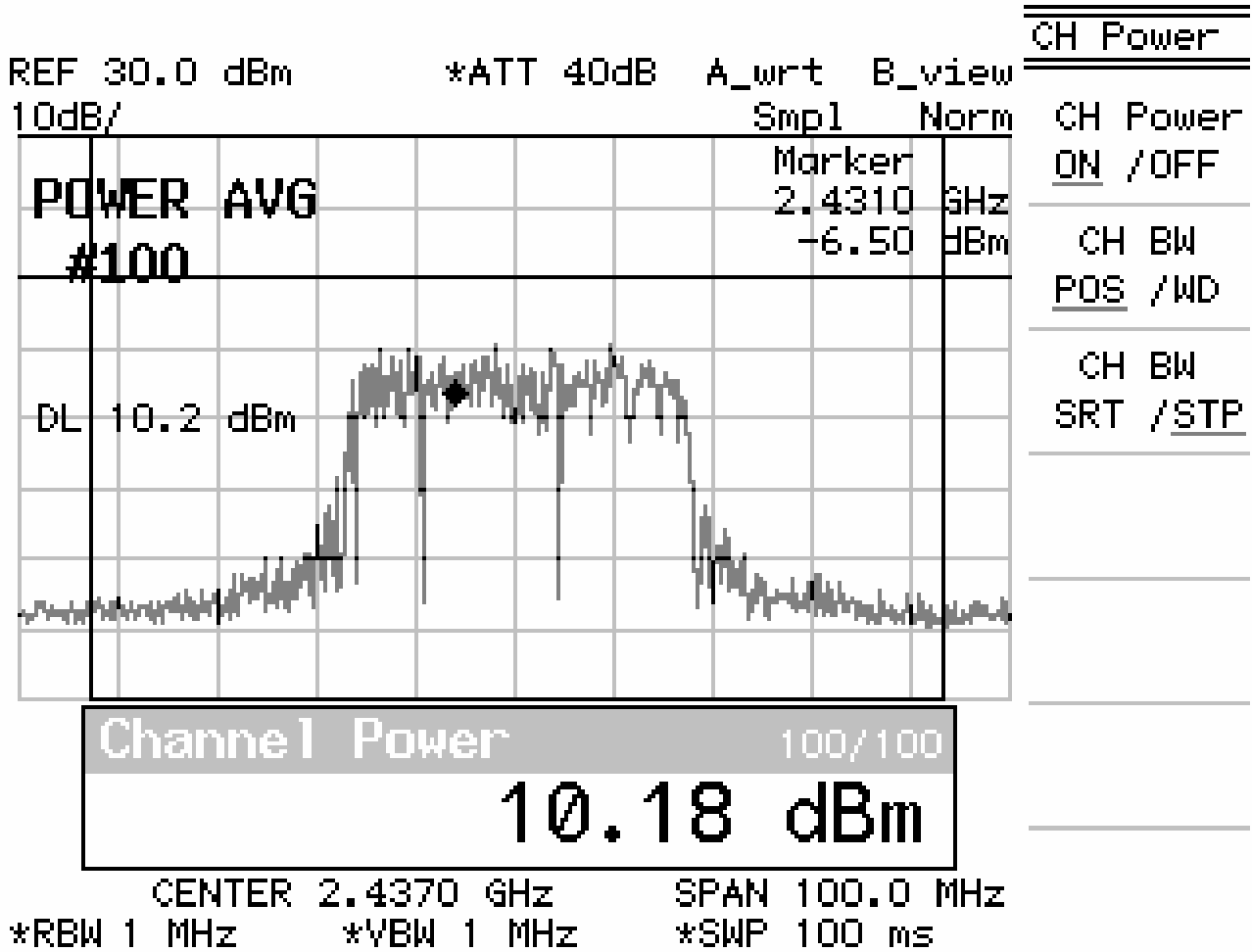

V. Minimum 6dB RF Bandwidth Requirements

5.1 Test Condition & Setup :

The antenna port of the EUT was connected to the input of a spectrum analyzer. Analyzer RES BW was set to 100 kHz. For each RF output channel investigated, the spectrum analyzer center frequency was set to the channel carrier. A PEAK output reading was taken, a DISPLAY line was drawn 6 dB lower than PEAK level. The 6 dB bandwidth was determined from where the channel output spectrum intersected the display line. The test was performed at 3 channels (Channel 1, 6,11)

5.2 Test Instruments Configuration:

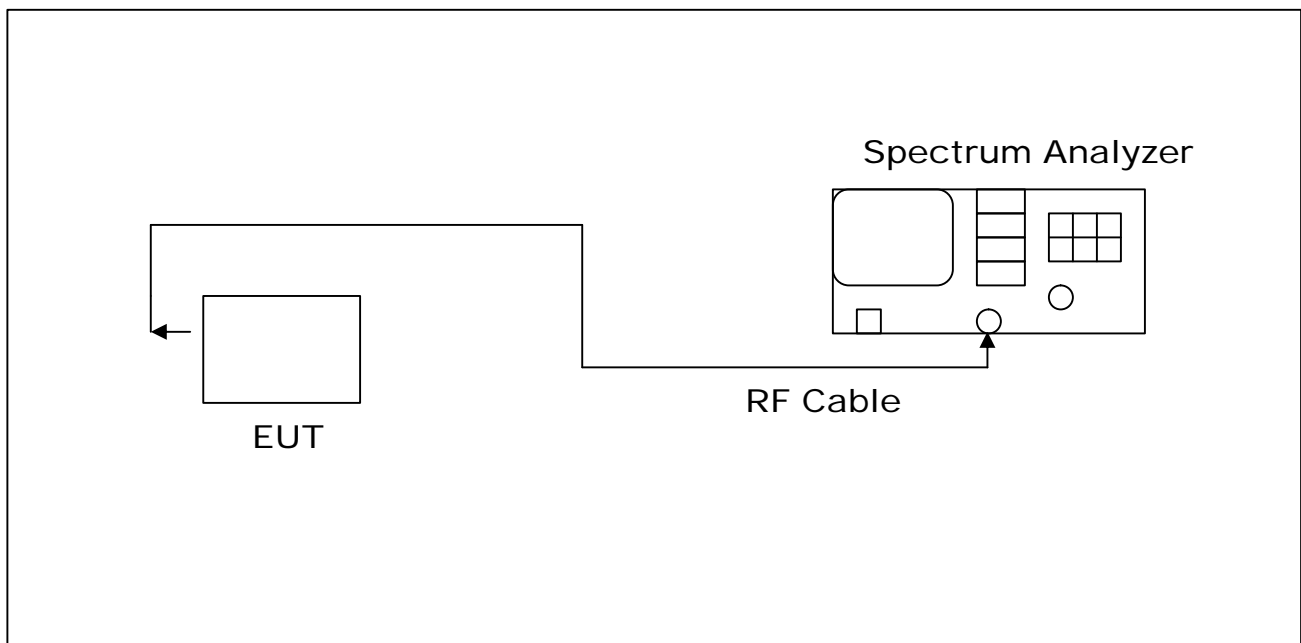



5.3 Test Equipment List:

- A. Agilent E4407B 9KHz-26.5GHz Spectrum Analyzer (S/N:A872JS02291)
- B. HP 8449B 1GHz-26.5GHz Pre Amplifier (S/N:1982901A91)
- C. Shielded Room (MLT-SR1)

5.4 Test Result:

iWavePort WLM54G 1A

802.11b

| Frequency (MHz) | Min. 6dB Bandwidth (MHz) | Required Limit |
|-----------------|--------------------------|----------------|
| 2412 | 12.5 | >500KHz |
| 2437 | 10.9 | >500KHz |
| 2462 | 10.9 | >500KHz |

802.11g

| Frequency (MHz) | Min. 6dB Bandwidth (MHz) | Required Limit |
|-----------------|--------------------------|----------------|
| 2412 | 16.7 | >500KHz |
| 2437 | 16.7 | >500KHz |
| 2462 | 16.7 | >500KHz |



iWavePort WLM54G 1B

802.11b

| Frequency (MHz) | Min. 6dB Bandwidth (MHz) | Required Limit |
|-----------------|--------------------------|----------------|
| 2412 | 11.5 | >500KHz |
| 2437 | 12.1 | >500KHz |
| 2462 | 12.1 | >500KHz |

802.11g

| Frequency (MHz) | Min. 6dB Bandwidth (MHz) | Required Limit |
|-----------------|--------------------------|----------------|
| 2412 | 16.7 | >500KHz |
| 2437 | 16.7 | >500KHz |
| 2462 | 16.7 | >500KHz |

802.11 Super G

| Frequency (MHz) | Min. 6dB Bandwidth (MHz) | Required Limit |
|-----------------|--------------------------|----------------|
| 2437 | 33.28 | >500KHz |

Note :Test Graphs See next page.



MAX LIGHT

MEASUREMENT REPORT

iWavePort WLM54G 1A
802.11b (2412MHz)

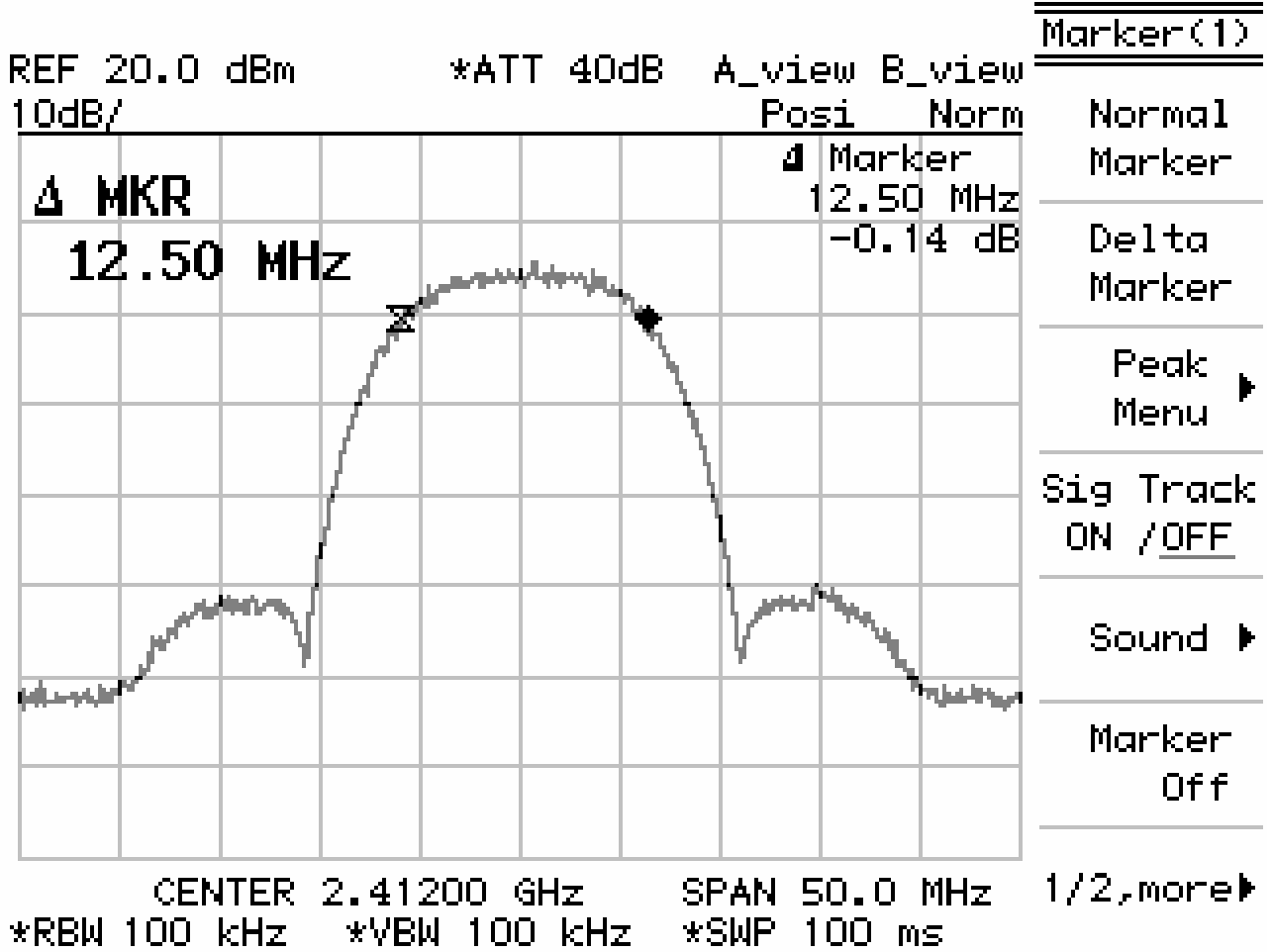



MAX LIGHT

MEASUREMENT REPORT

iWavePort WLM54G 1A
802.11b (2437MHz)

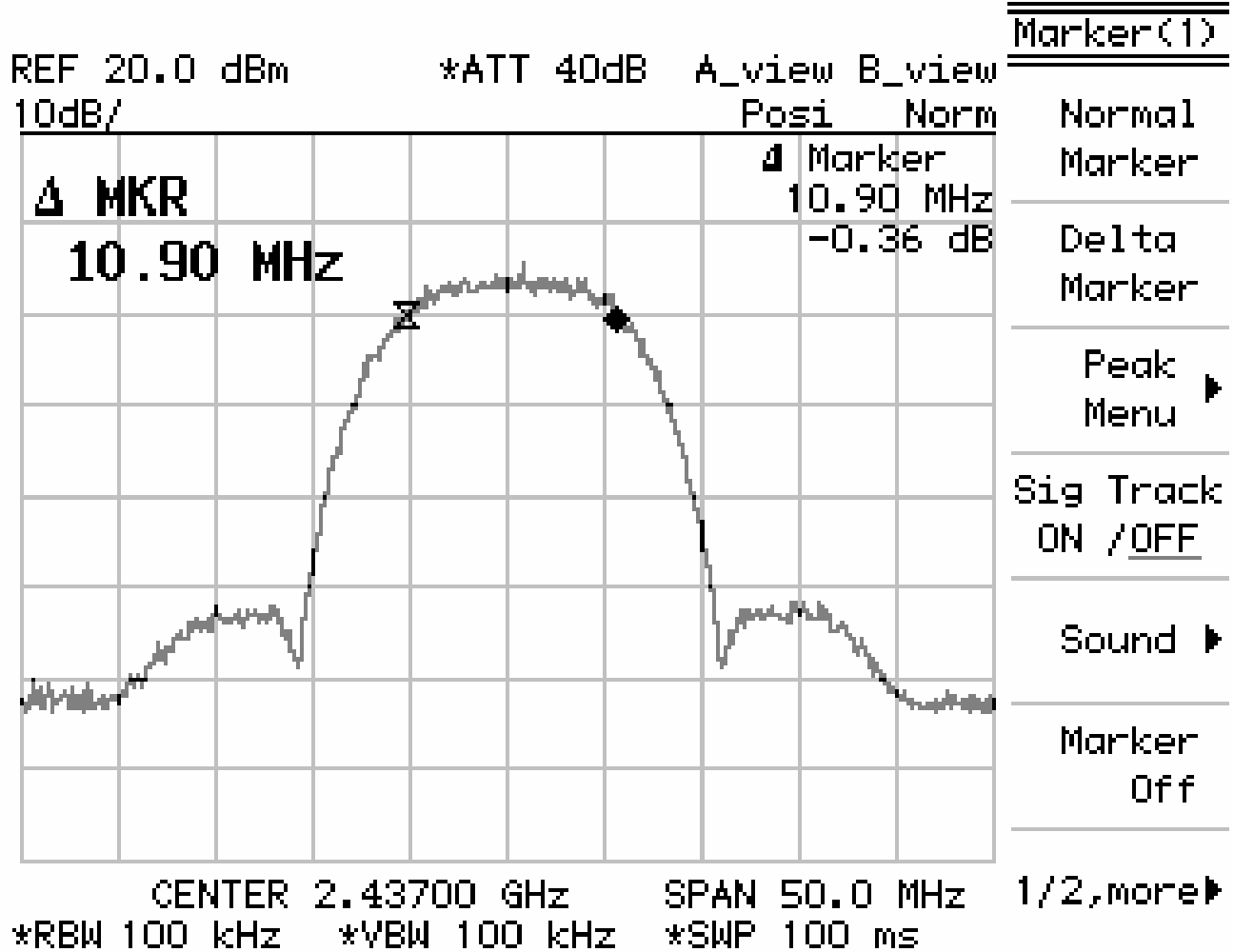



MAX LIGHT

MEASUREMENT REPORT

iWavePort WLM54G 1A
802.11b (2462MHz)

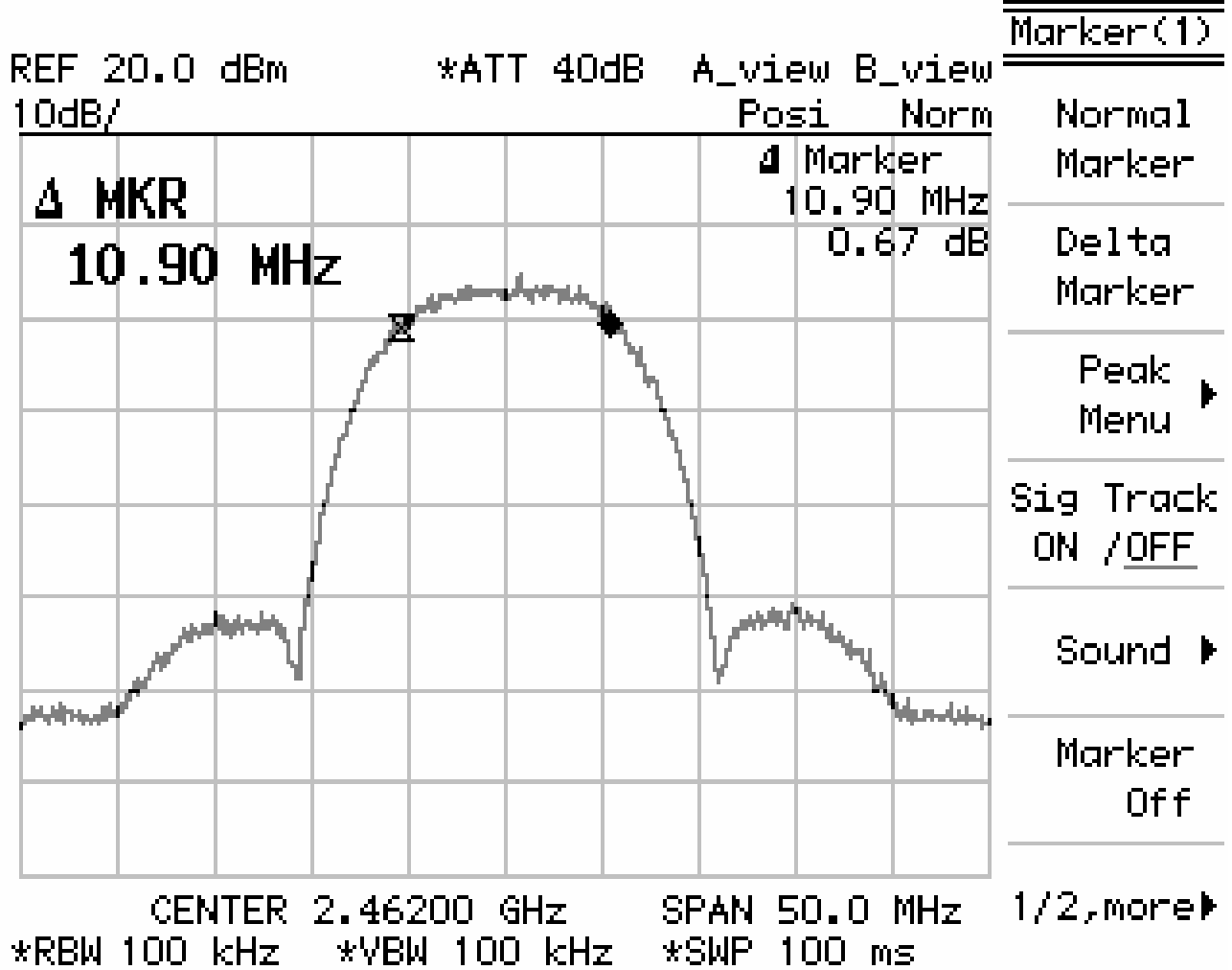



MAX LIGHT

MEASUREMENT REPORT

iWavePort WLM54G 1A
802.11g (2412MHz)

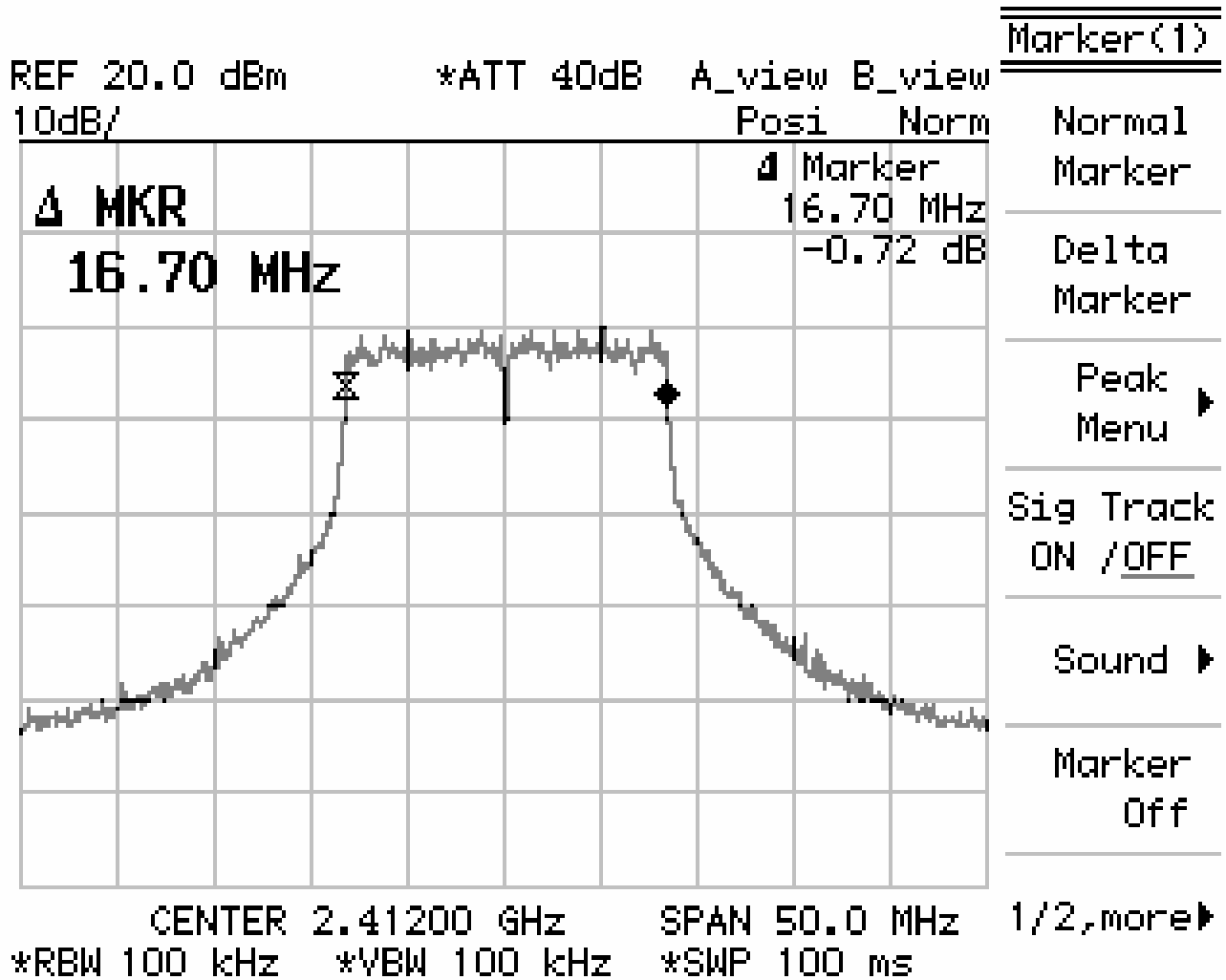



MAX LIGHT

MEASUREMENT REPORT

iWavePort WLM54G 1A
802.11g (2437MHz)

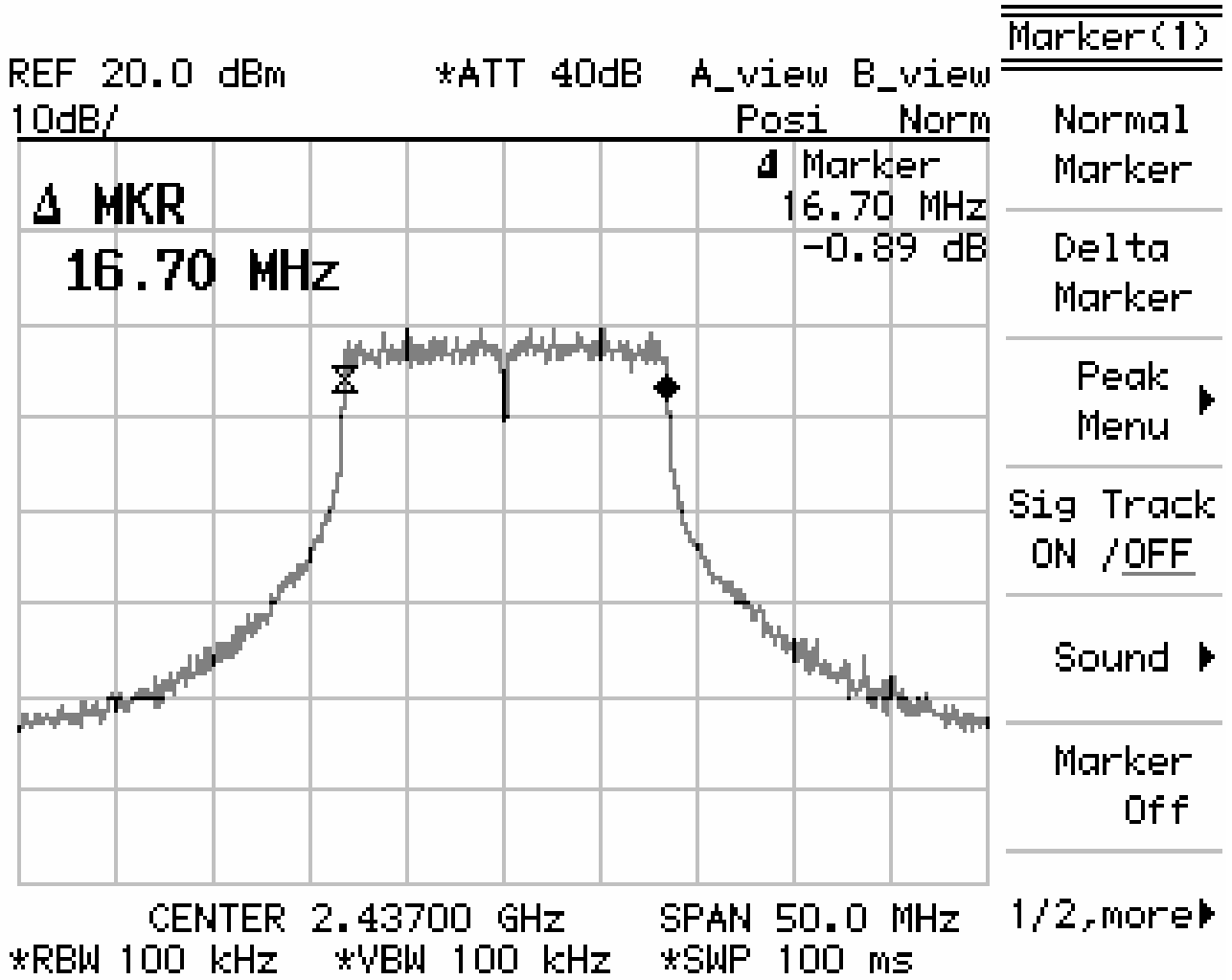



MAX LIGHT

MEASUREMENT REPORT

iWavePort WLM54G 1A
802.11g (2462MHz)

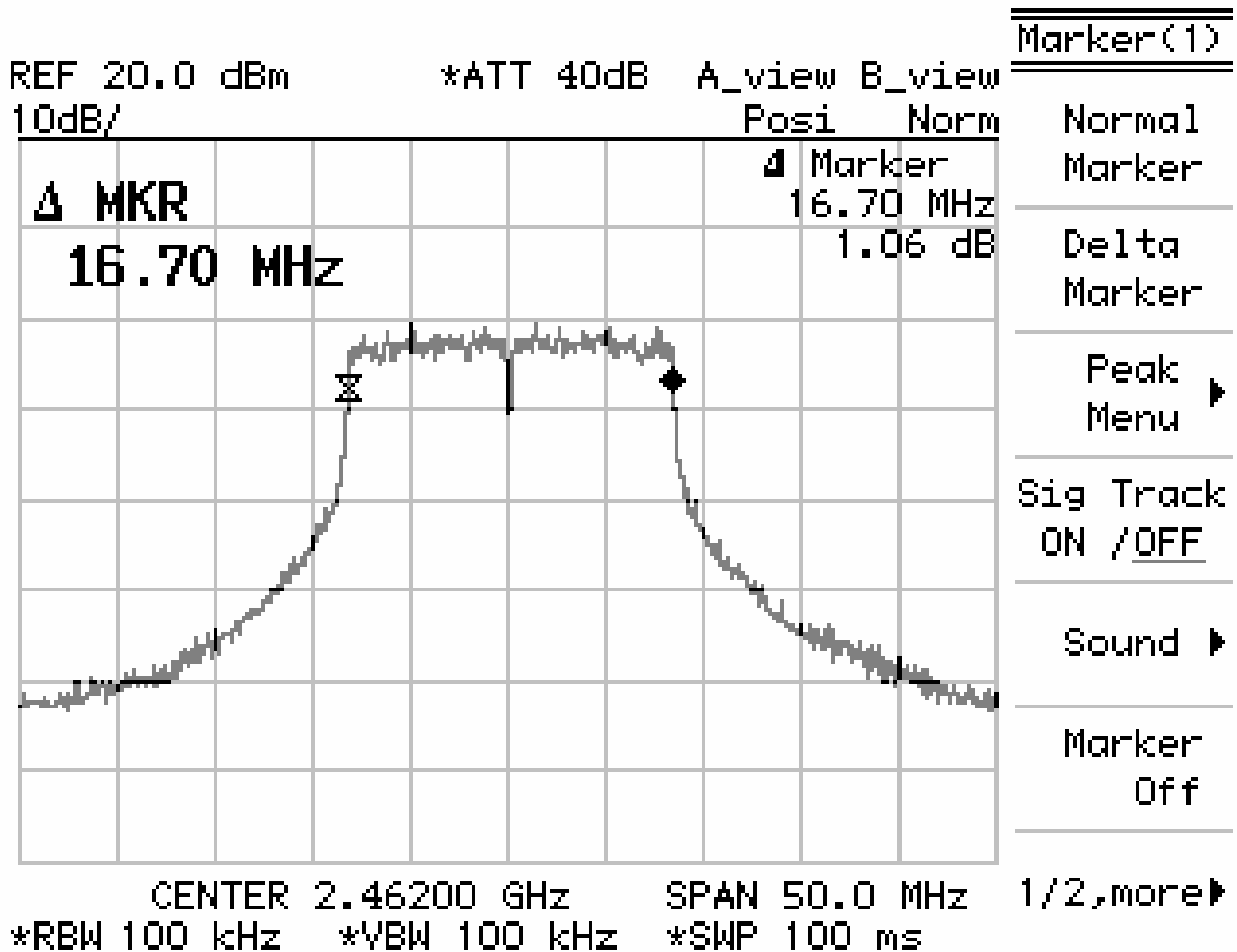



MAX LIGHT

MEASUREMENT REPORT

iWavePort WLM54G 1B
802.11b (2412MHz)

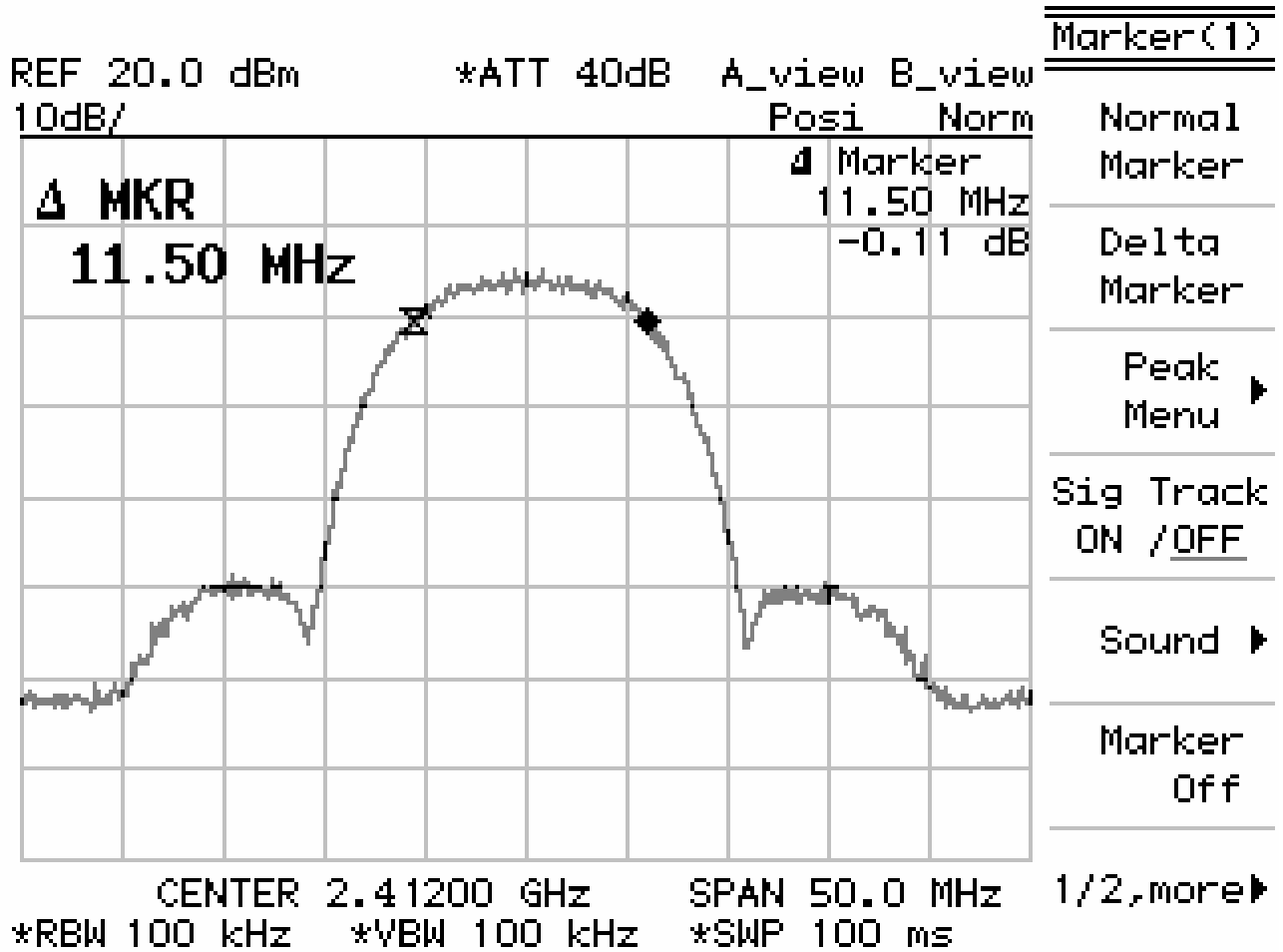



MAX LIGHT

MEASUREMENT REPORT

iWavePort WLM54G 1B
802.11b (2437MHz)

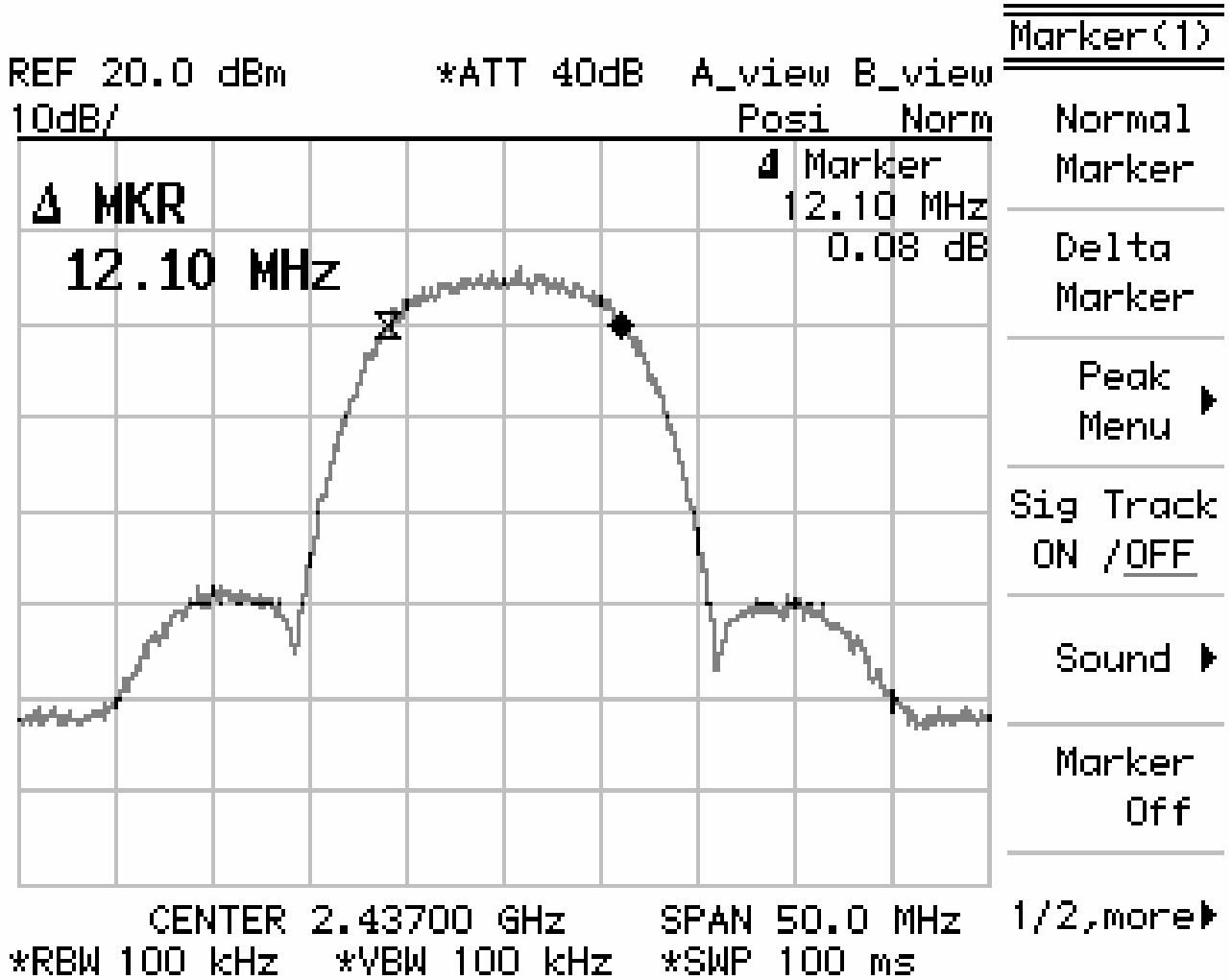



MAX LIGHT

MEASUREMENT REPORT

iWavePort WLM54G 1B
802.11b (2462MHz)

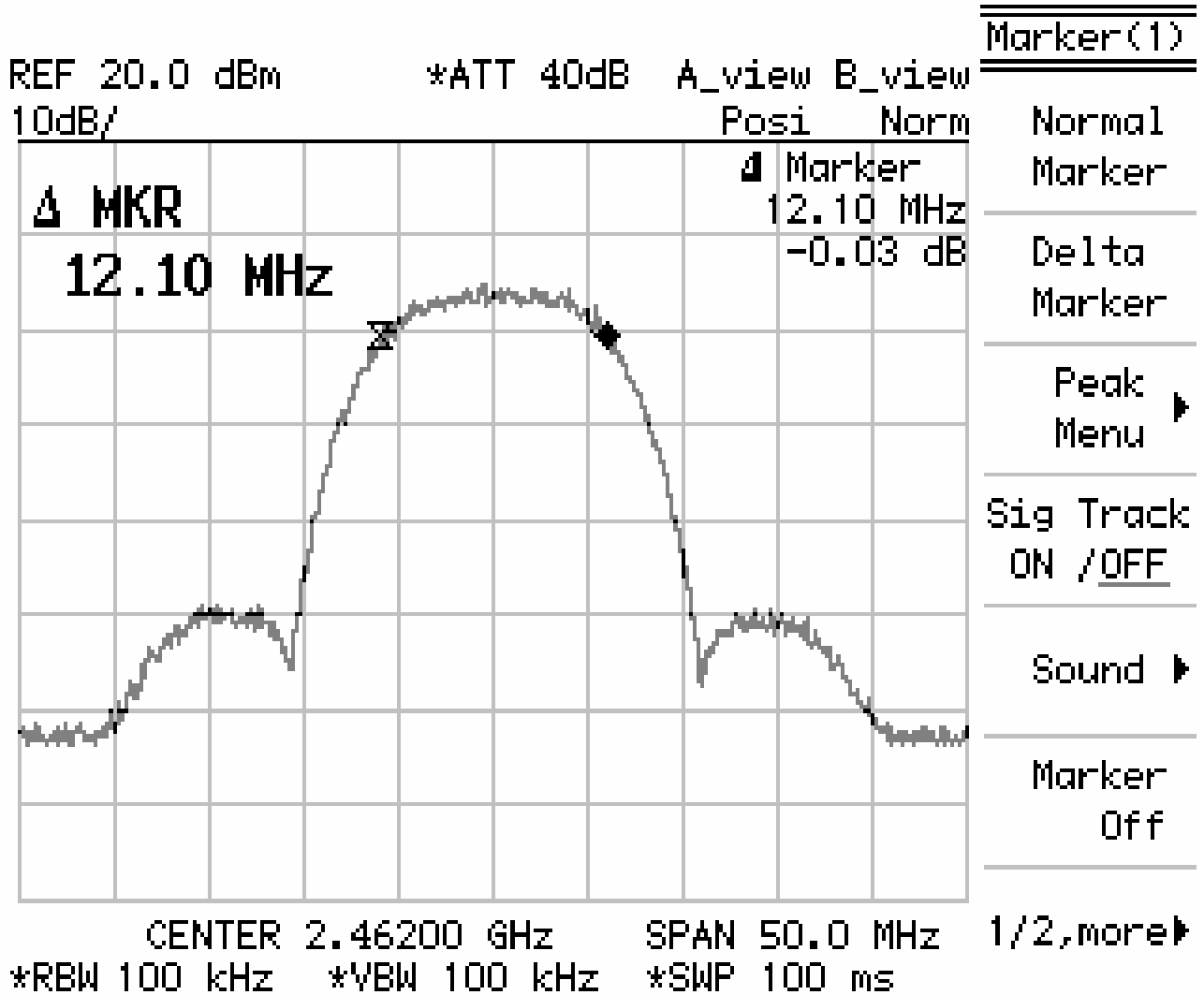



MAX LIGHT

MEASUREMENT REPORT

iWavePort WLM54G 1B
802.11g (2412MHz)

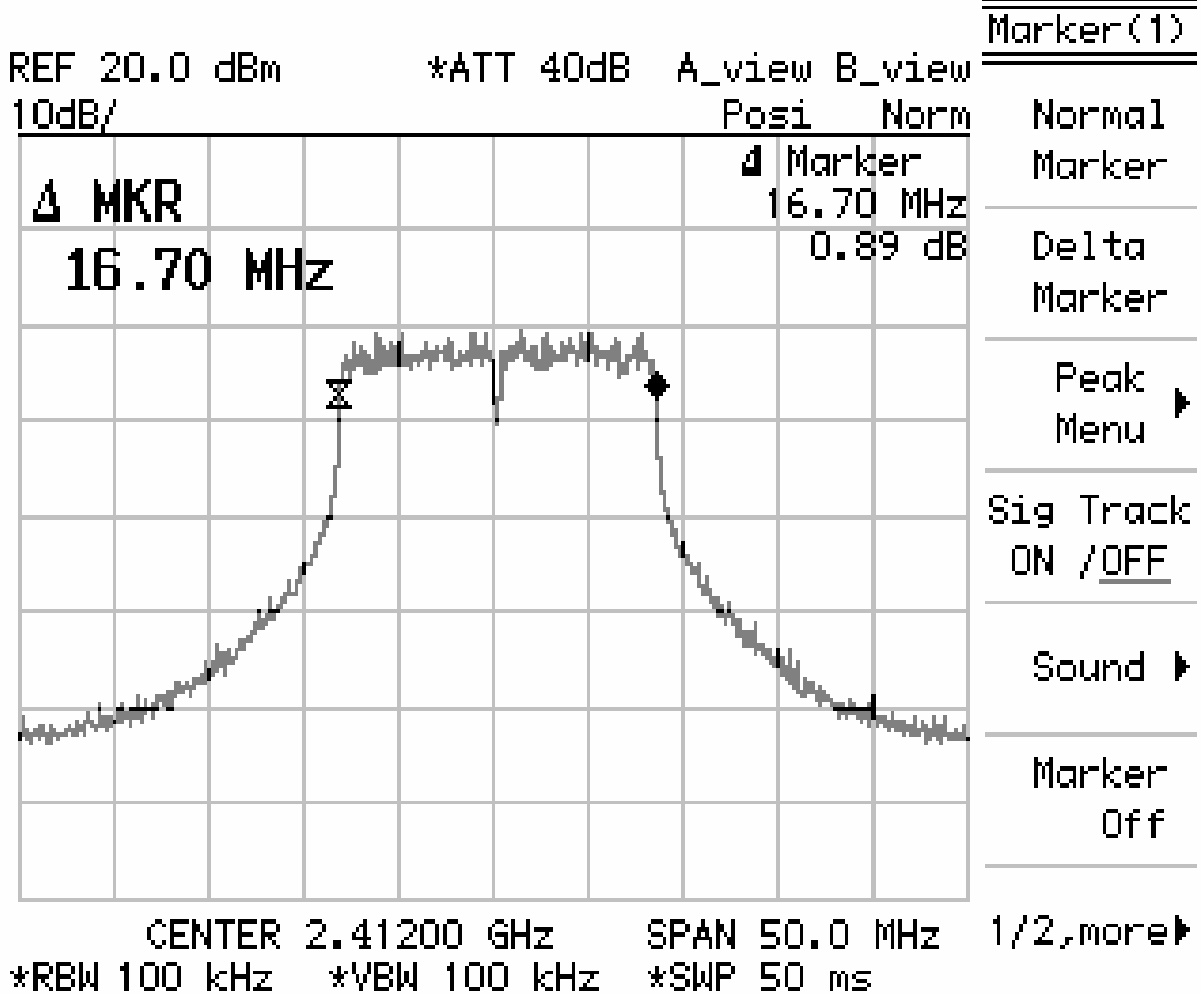



MAX LIGHT

MEASUREMENT REPORT

iWavePort WLM54G 1B
802.11g (2437MHz)

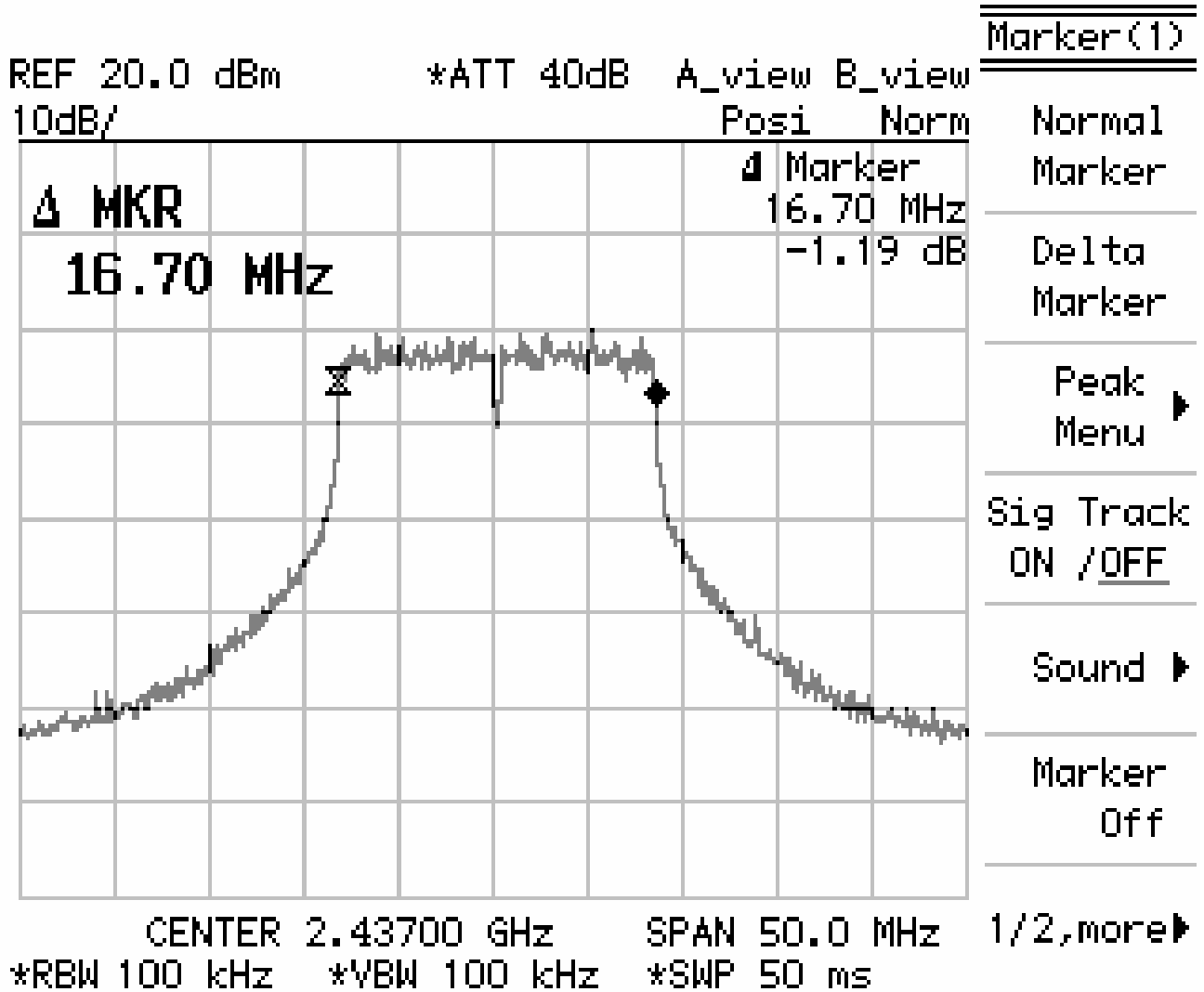



MAX LIGHT

MEASUREMENT REPORT

iWavePort WLM54G 1B
802.11g (2462MHz)

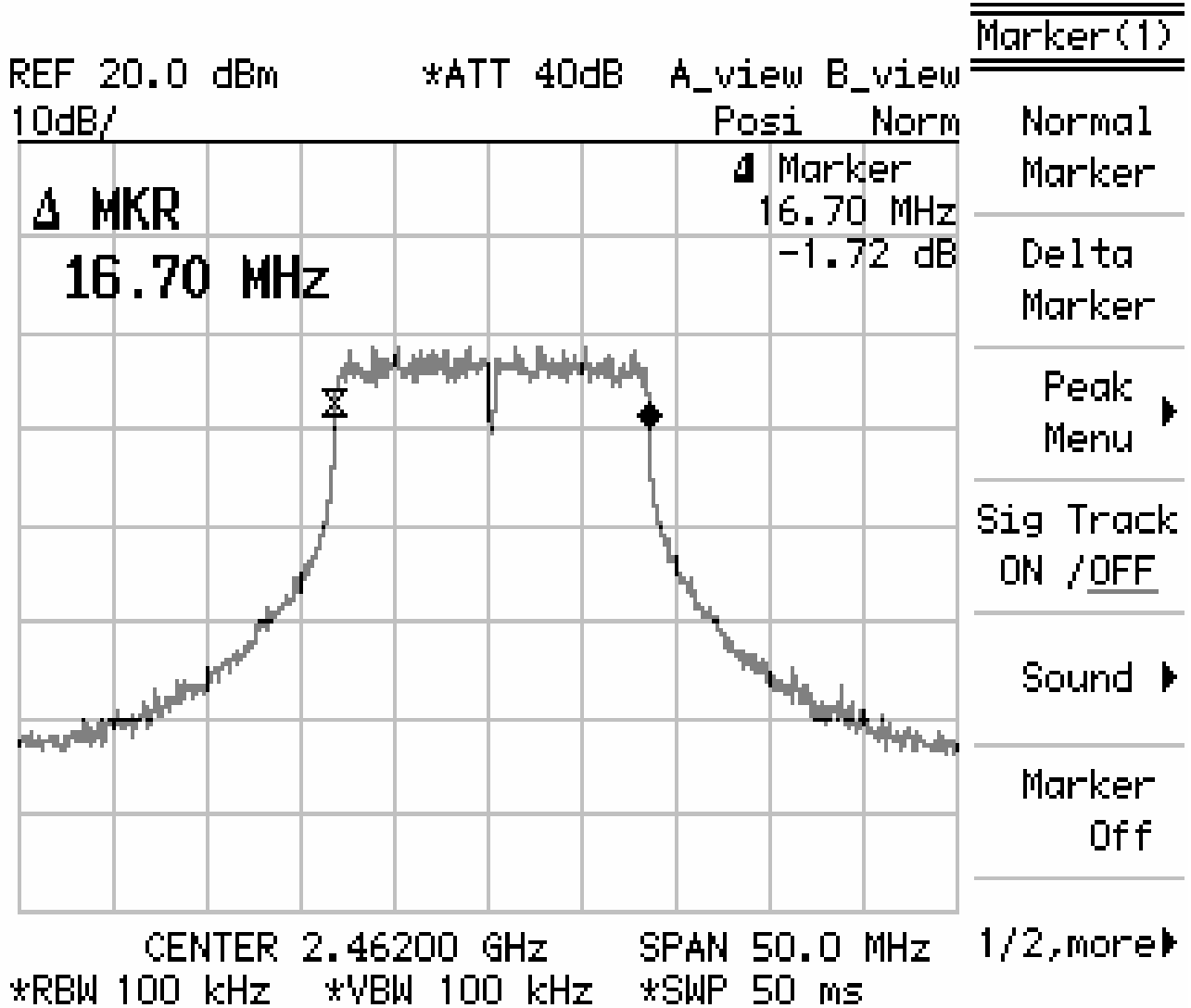



MAX LIGHT

MEASUREMENT REPORT

iWavePort WLM54G 1B
802.11 Super G (2437MHz)

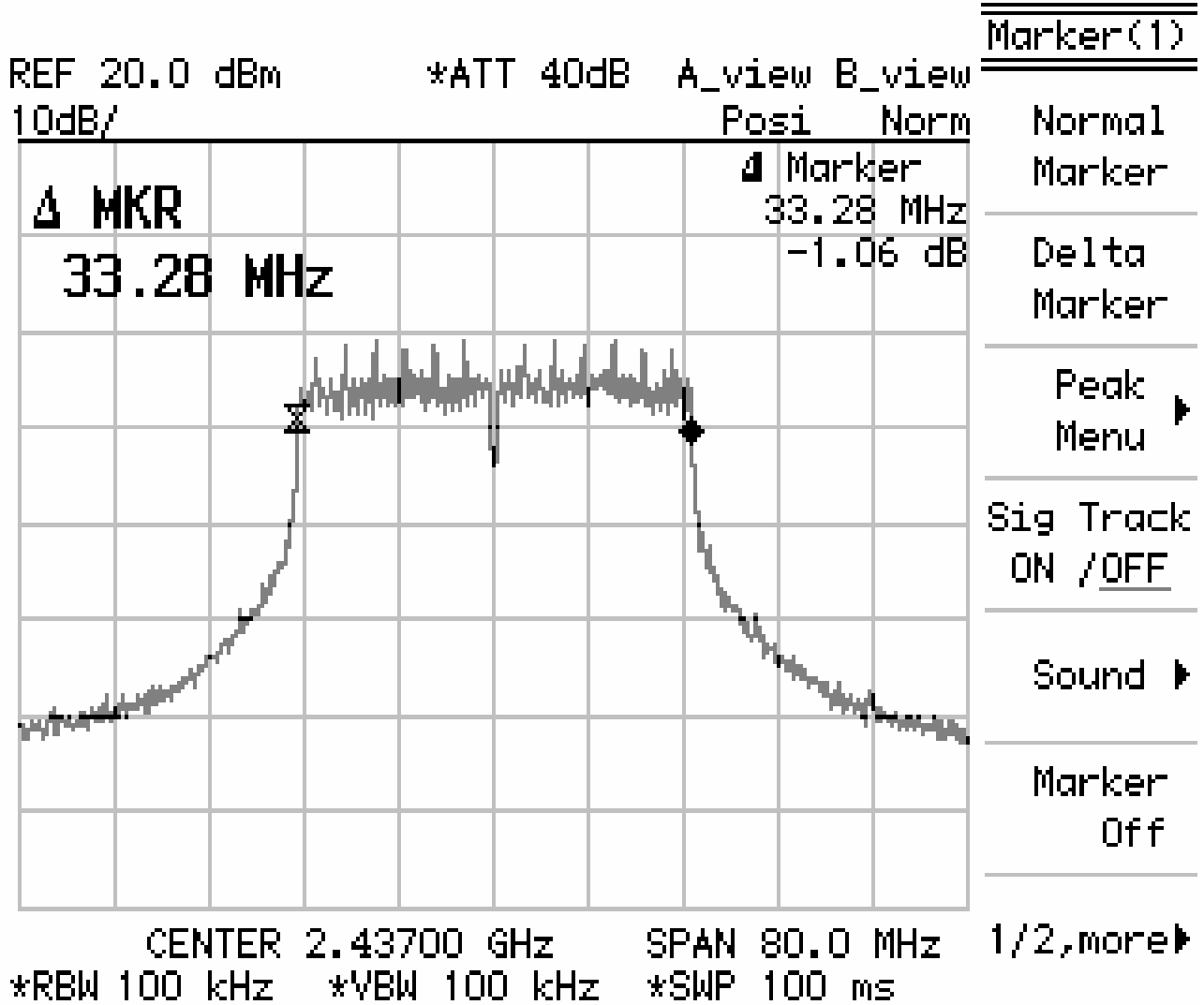

VI. Maximum Power Density Requirements

6.1 Test Condition & Setup :

The spectrum analyzer RES BW was set to 3 kHz. The START and STOP frequencies were set to the band edges of the maximum output passband. If there is no clear maximum amplitude in any given portion of the band, it may be necessary to make measurements at a number of bands defined by several START and STOP frequency pairs. The specification calls for a 1 second interval at each 3 kHz bandwidth; total SWEEP TIME is calculated as follows:

$$\text{SWEEP TIME (SEC)} = (\text{Fstop, kHz} - \text{Fstart, kHz}) / 3 \text{ kHz}$$

Antenna output of the EUT was coupled directly to spectrum analyzer; if an external attenuator and/or cable was used, these losses are compensated for with the analyzer OFFSET function.

6.2 Test Instruments Configuration:

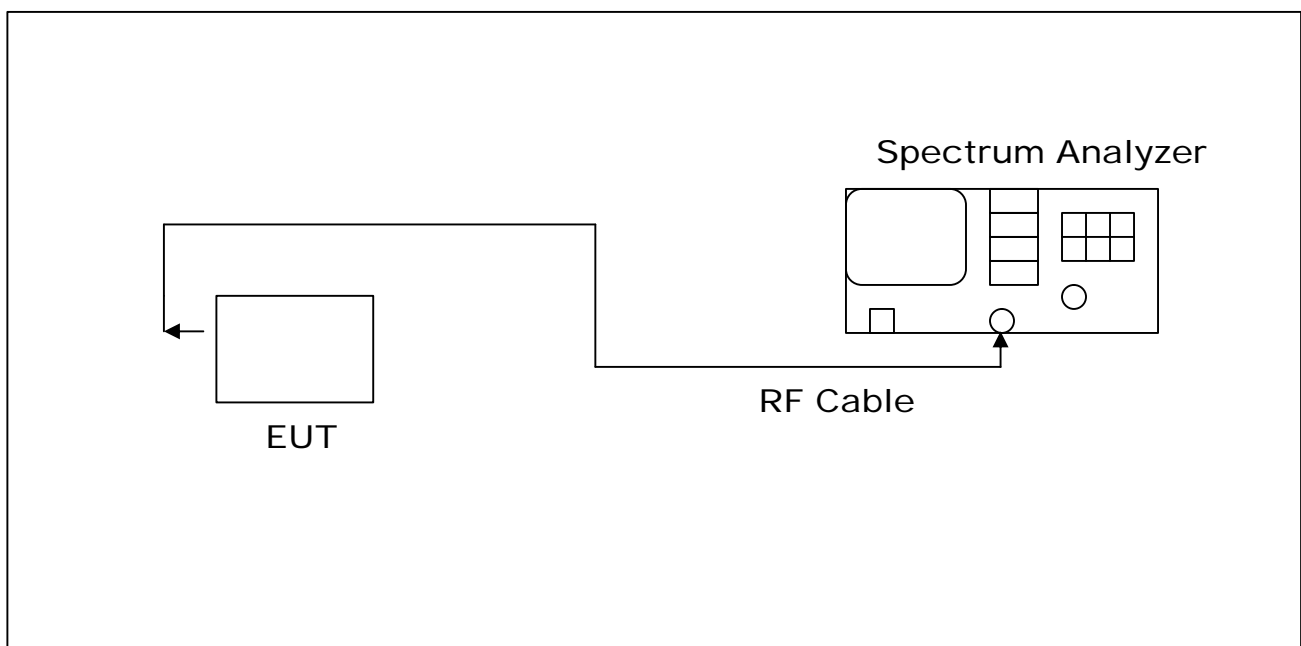



6.3 Test Equipment List:

- A. Agilent E4407B 9KHz-26.5GHz Spectrum Analyzer (S/N:A872JS02291)
- B. HP 8449B 1GHz-26.5GHz Pre Amplifier (S/N:1982901A91)
- E. Shielded Room (MLT-SR1)

6.4 Test Result:

iWavePort WLM54G 1A

802.11b

| Frequency (MHz) | Power Density (dBm) | Required Limit |
|-----------------|---------------------|----------------|
| 2412 | -8.81 | <8dBm |
| 2437 | -8.61 | <8dBm |
| 2462 | -9.56 | <8dBm |

802.11g

| Frequency (MHz) | Power Density (dBm) | Required Limit |
|-----------------|---------------------|----------------|
| 2412 | -13.69 | <8dBm |
| 2437 | -13.83 | <8dBm |
| 2462 | -14.14 | <8dBm |



iWavePort WLM54G 1B

802.11b

| Frequency (MHz) | Power Density (dBm) | Required Limit |
|-----------------|---------------------|----------------|
| 2412 | -7.41 | <8dBm |
| 2437 | -7.81 | <8dBm |
| 2462 | -9.31 | <8dBm |

802.11g

| Frequency (MHz) | Power Density (dBm) | Required Limit |
|-----------------|---------------------|----------------|
| 2412 | -13.50 | <8dBm |
| 2437 | -14.06 | <8dBm |
| 2462 | -14.36 | <8dBm |

802.11Super G

| Frequency (MHz) | Power Density (dBm) | Required Limit |
|-----------------|---------------------|----------------|
| 2437 | -20.5 | <8dBm |

Note : Test Graphs See next page.



MAX LIGHT

MEASUREMENT REPORT

iWavePort WLM54G 1A
802.11b (2412MHz)

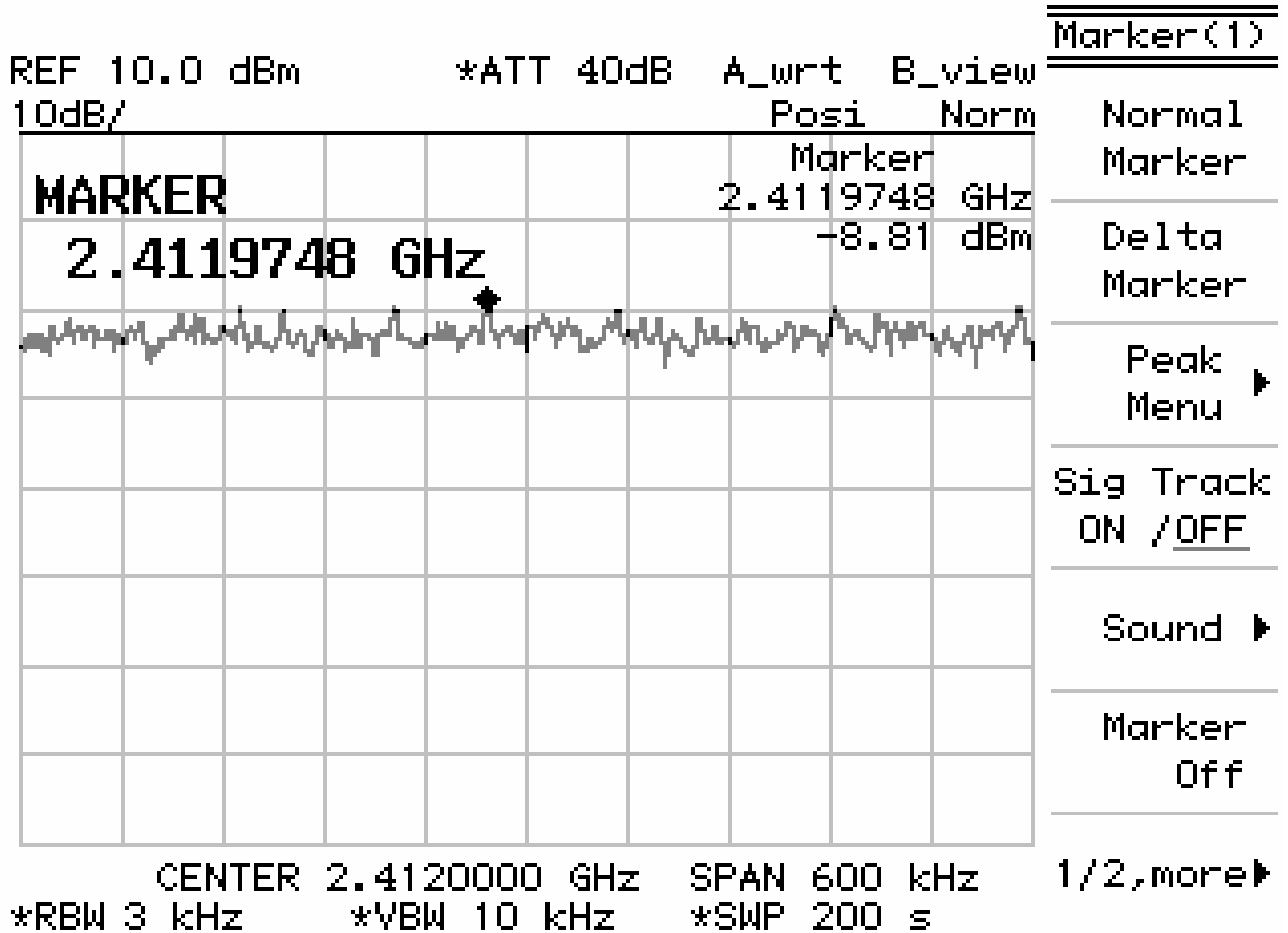



MAX LIGHT

MEASUREMENT REPORT

iWavePort WLM54G 1A
802.11b (2437MHz)

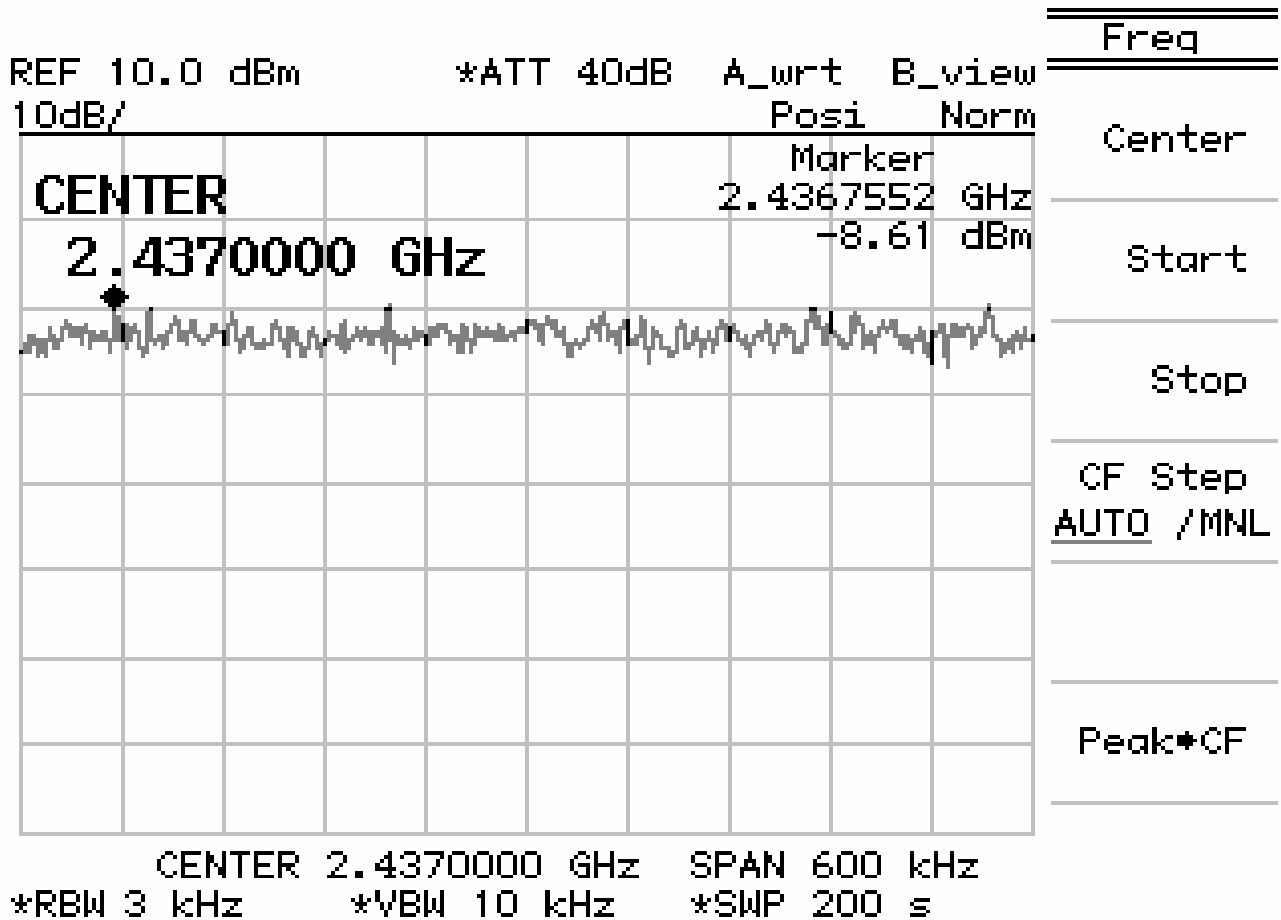



MAX LIGHT
MEASUREMENT REPORT

iWavePort WLM54G 1A
802.11b (2462MHz)

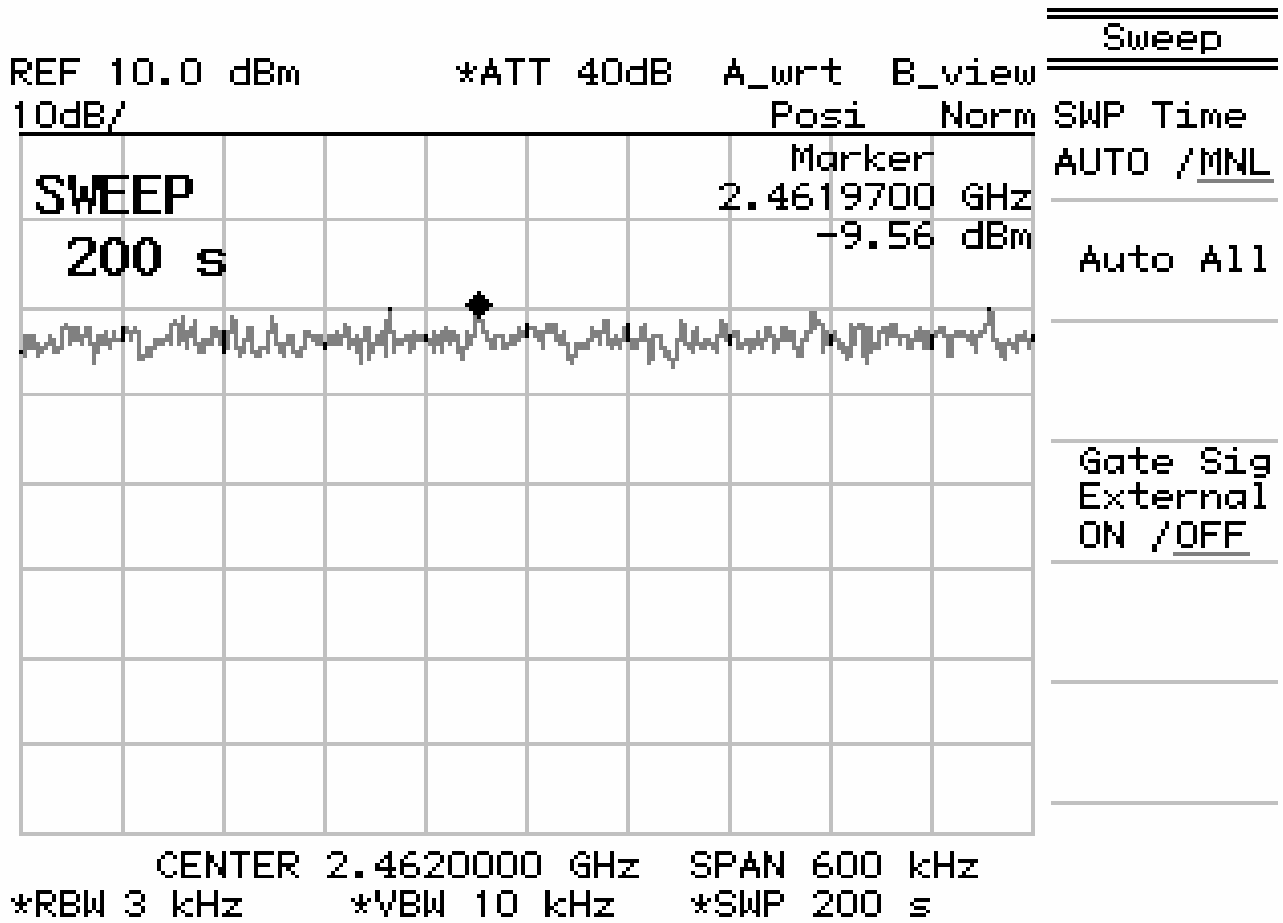



MAX LIGHT

MEASUREMENT REPORT

iWavePort WLM54G 1A
802.11g (2412MHz)

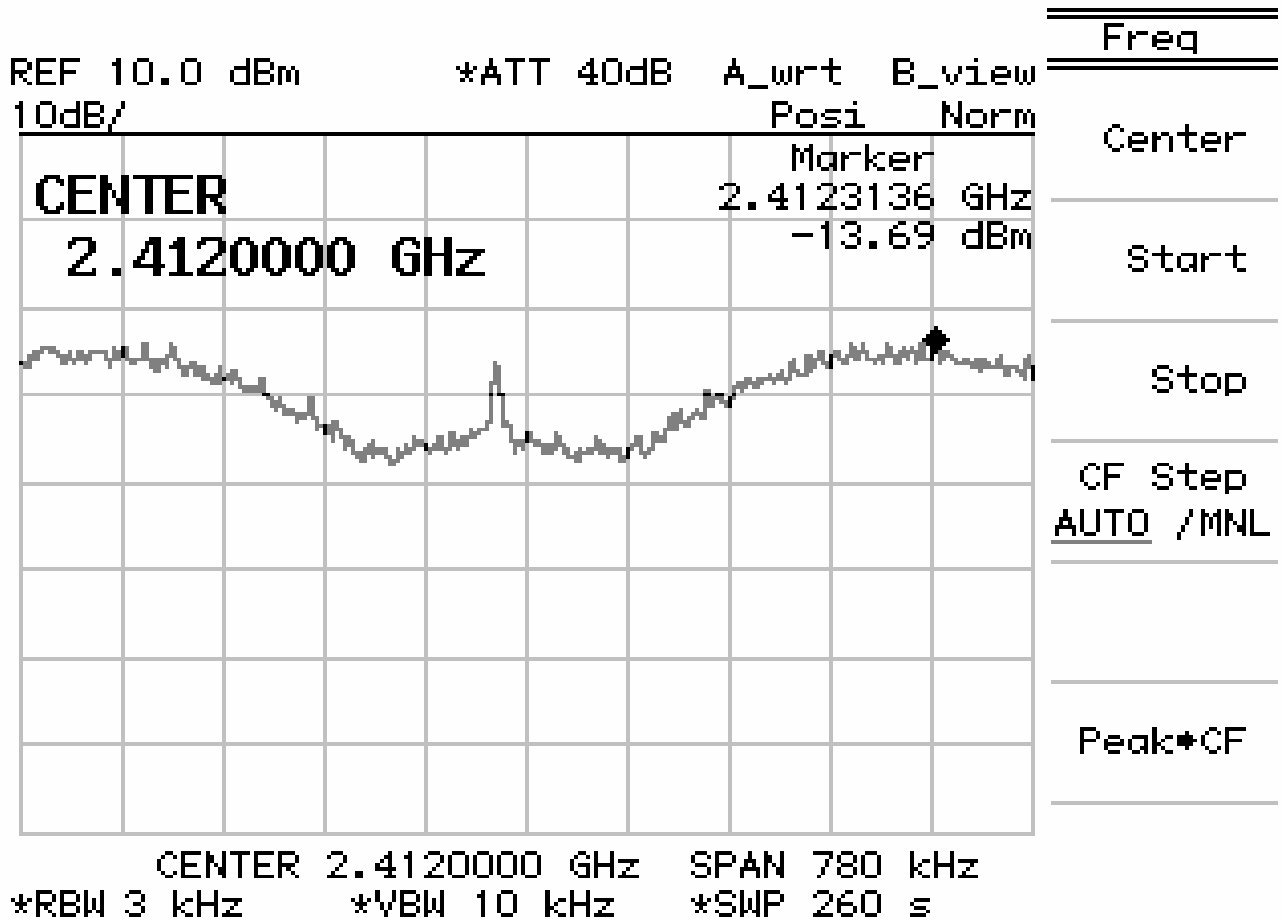



MAX LIGHT

MEASUREMENT REPORT

iWavePort WLM54G 1A
802.11g (2462MHz)

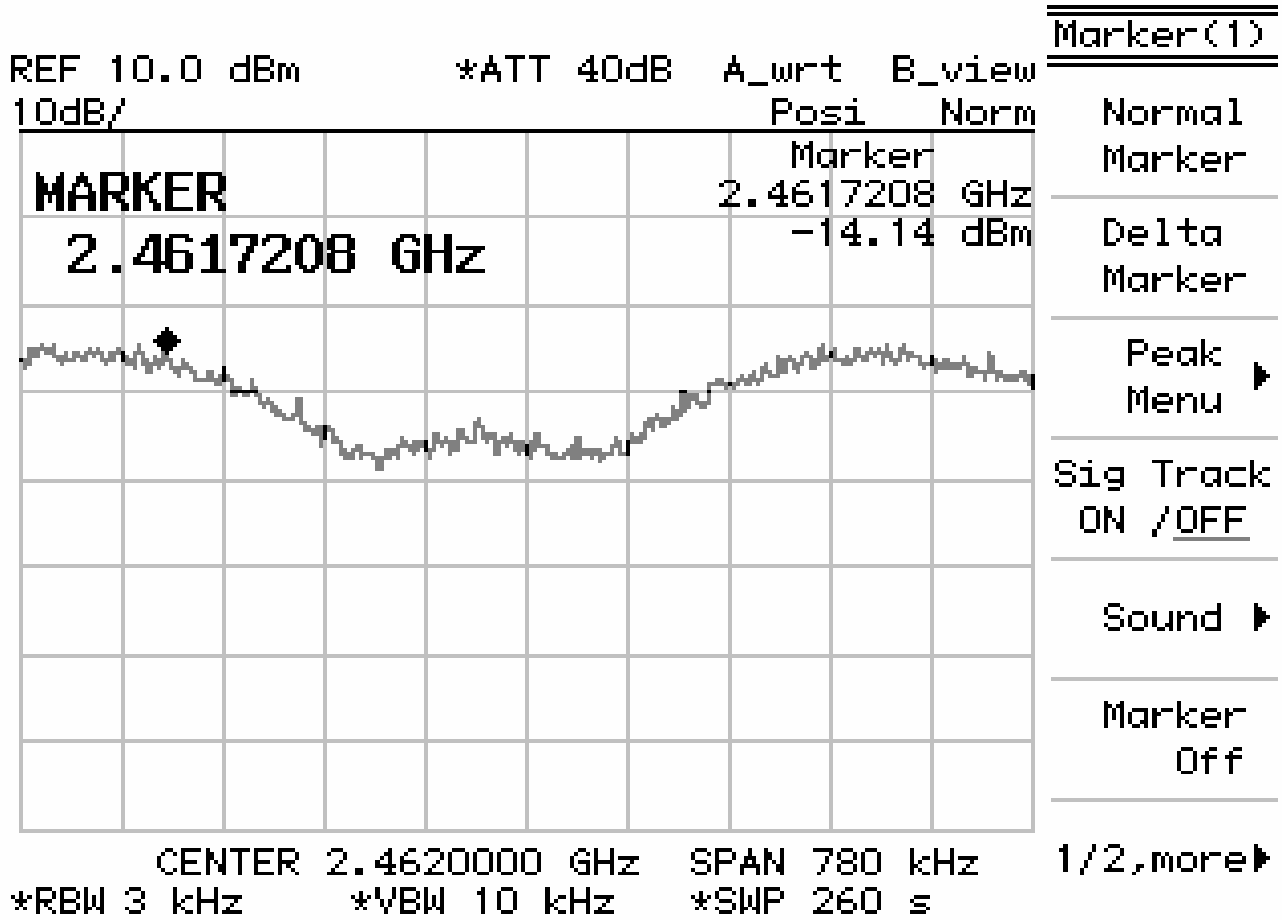



MAX LIGHT

MEASUREMENT REPORT

iWavePort WLM54G 1B
802.11b (2412MHz)

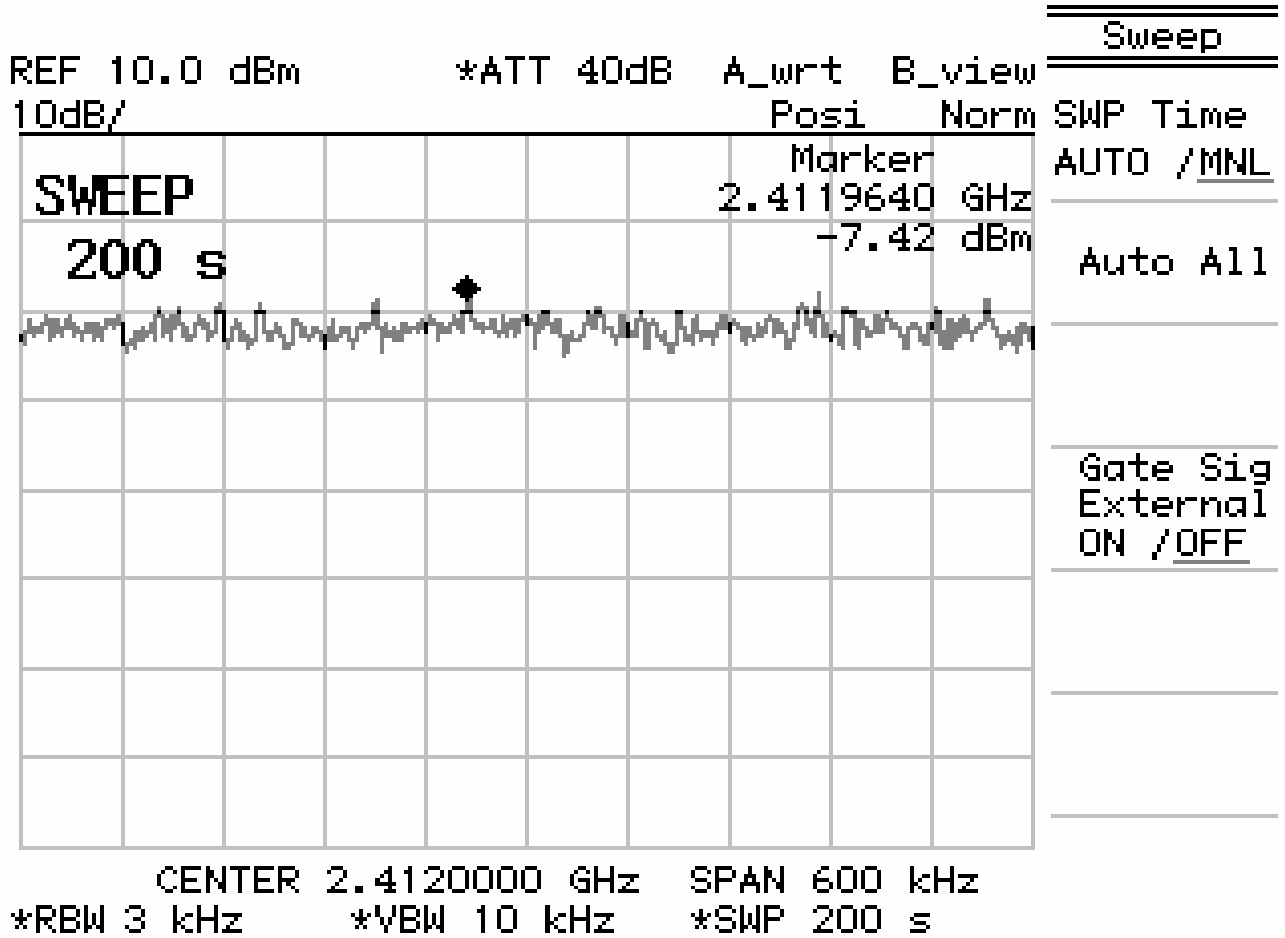



MAX LIGHT

MEASUREMENT REPORT

iWavePort WLM54G 1B
802.11b (2437MHz)

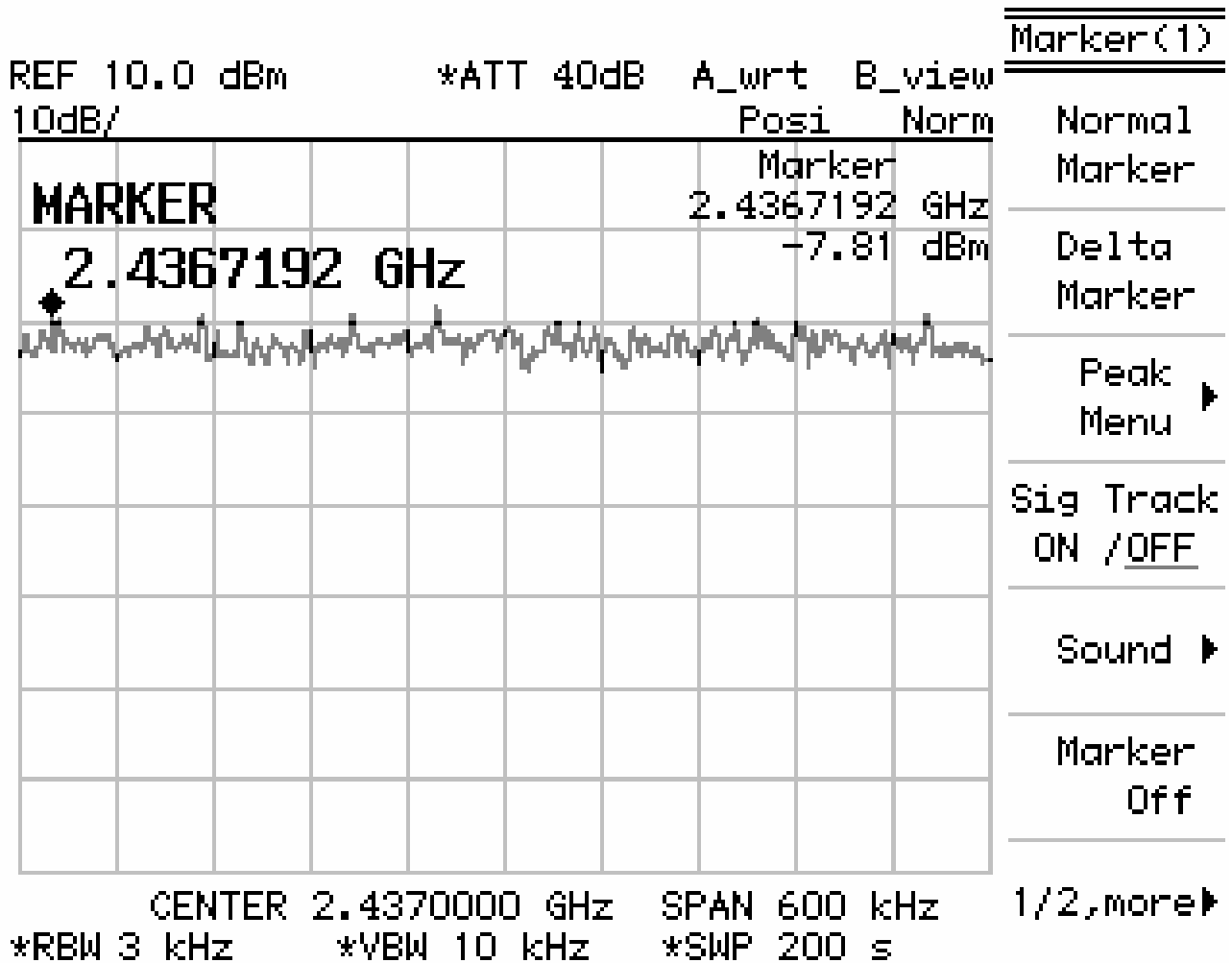



MAX LIGHT

MEASUREMENT REPORT

iWavePort WLM54G 1B
802.11b (2462MHz)

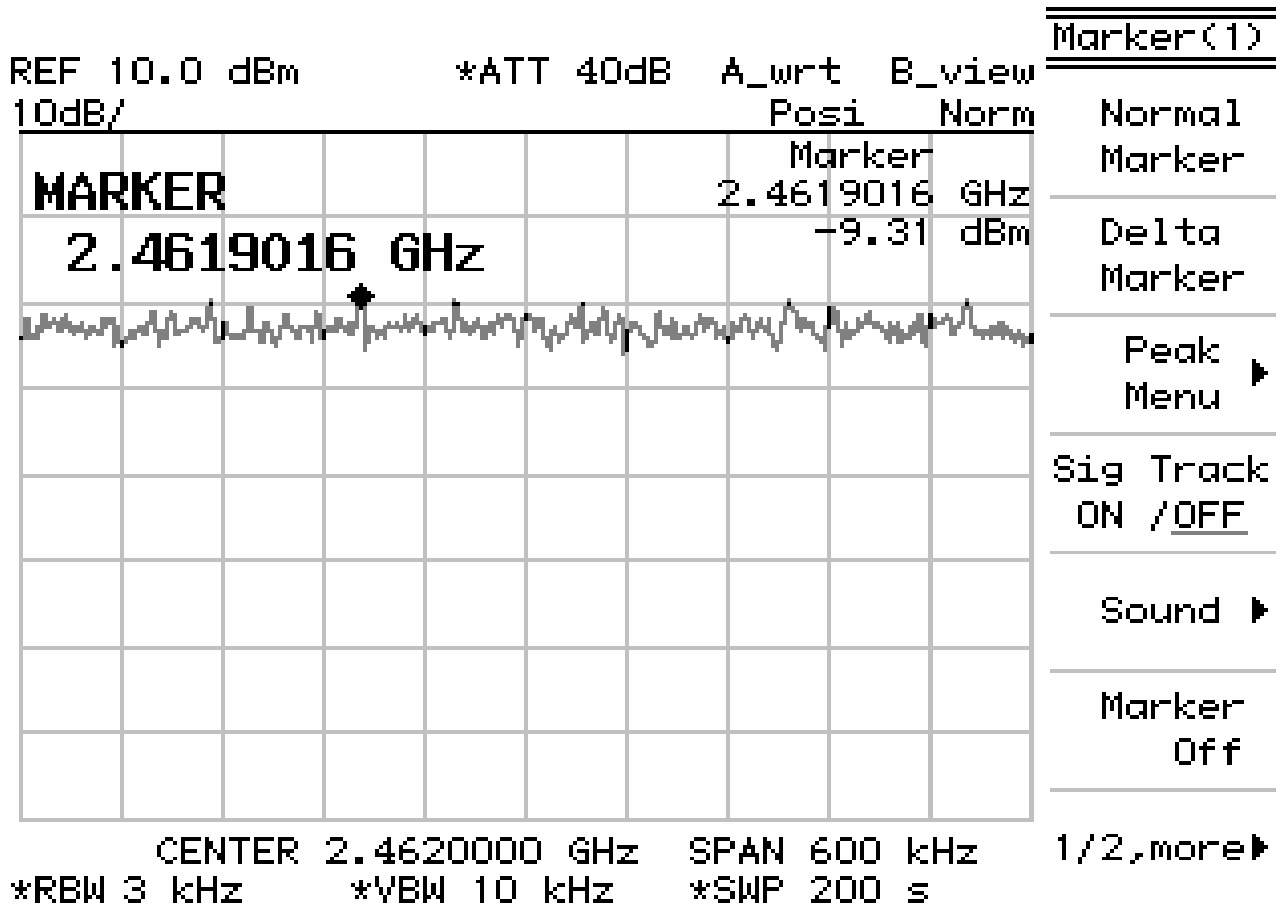



MAX LIGHT

MEASUREMENT REPORT

iWavePort WLM54G 1B
802.11g (2412MHz)

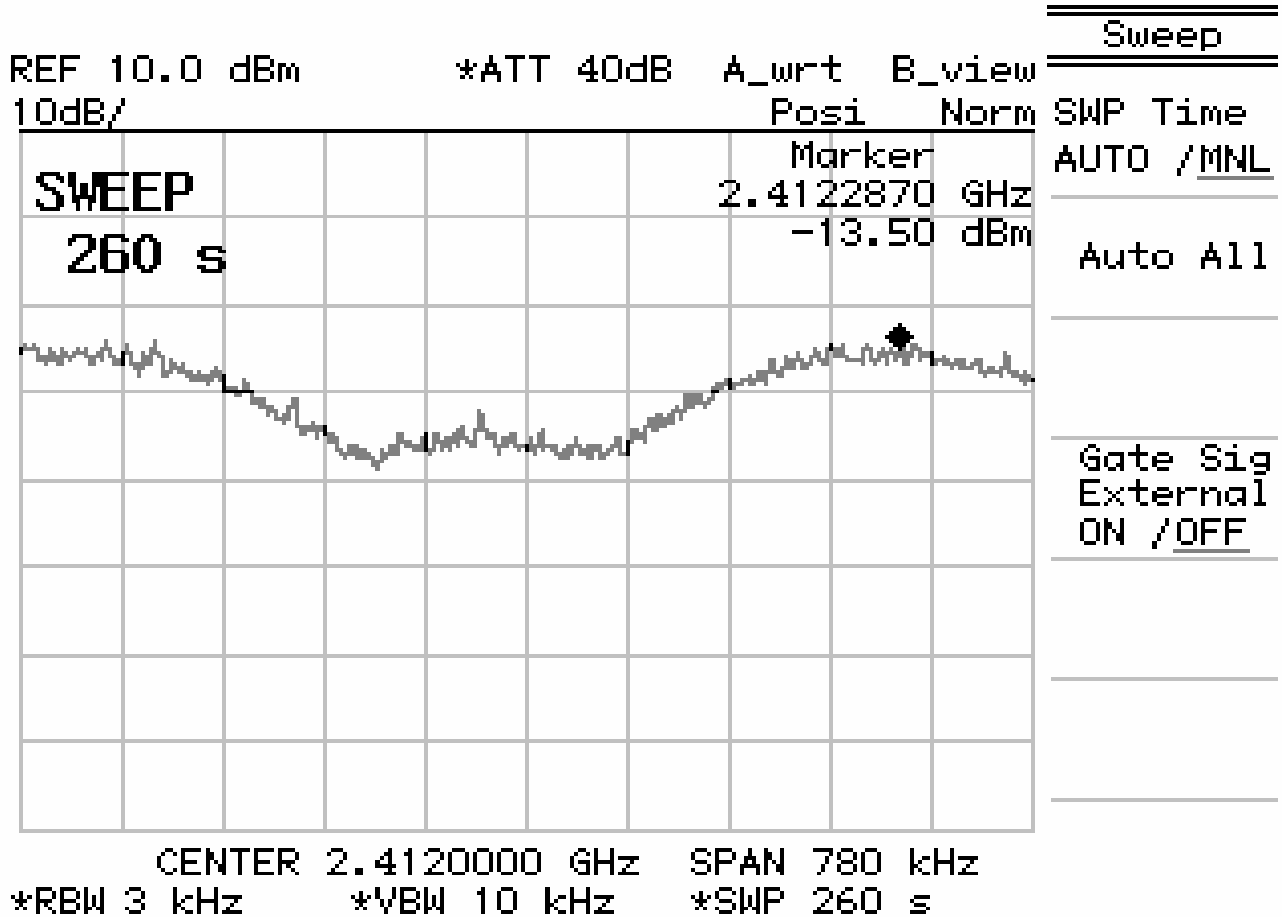



MAX LIGHT

MEASUREMENT REPORT

iWavePort WLM54G 1B
802.11g (2437MHz)

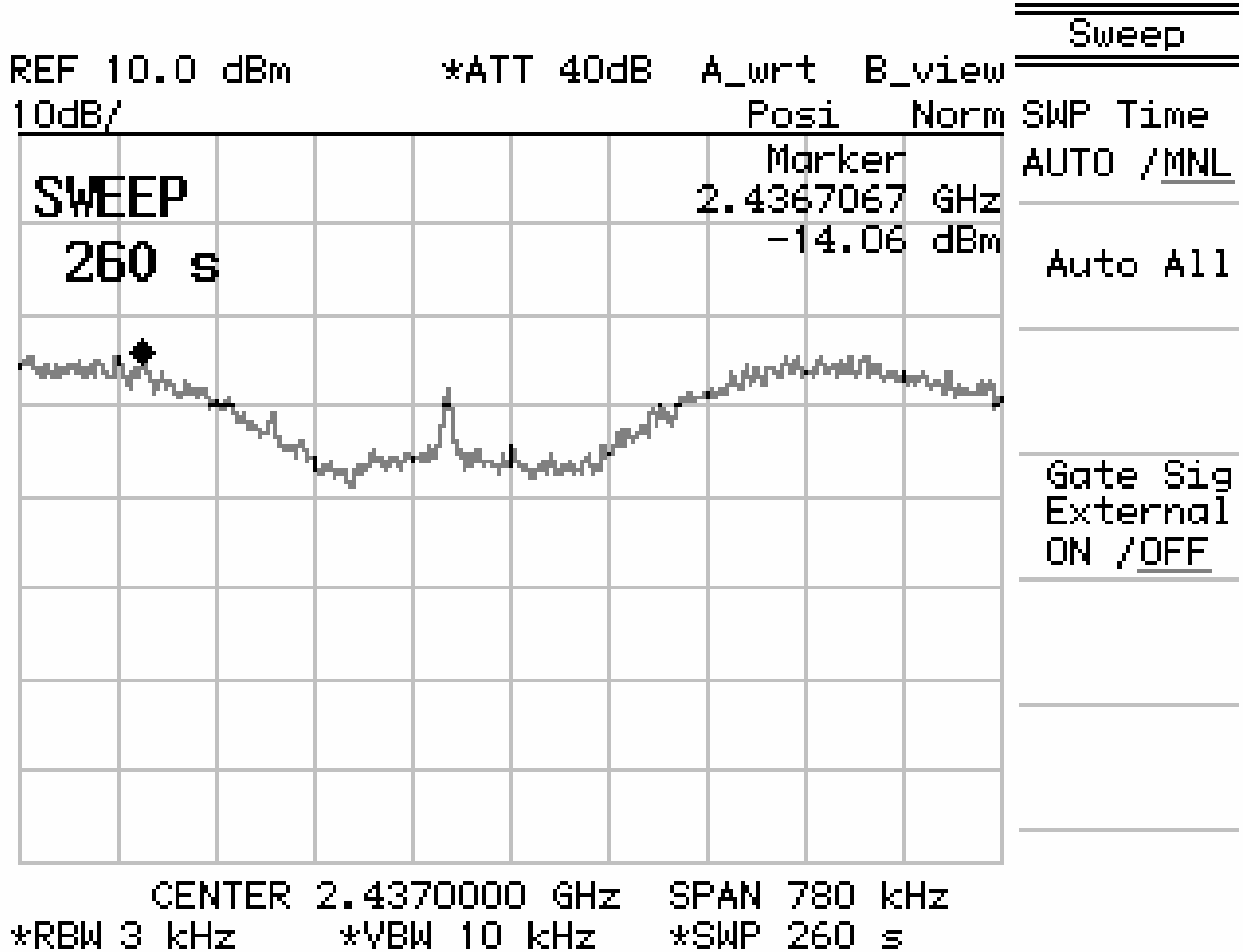



MAX LIGHT

MEASUREMENT REPORT

iWavePort WLM54G 1B
802.11g (2462MHz)

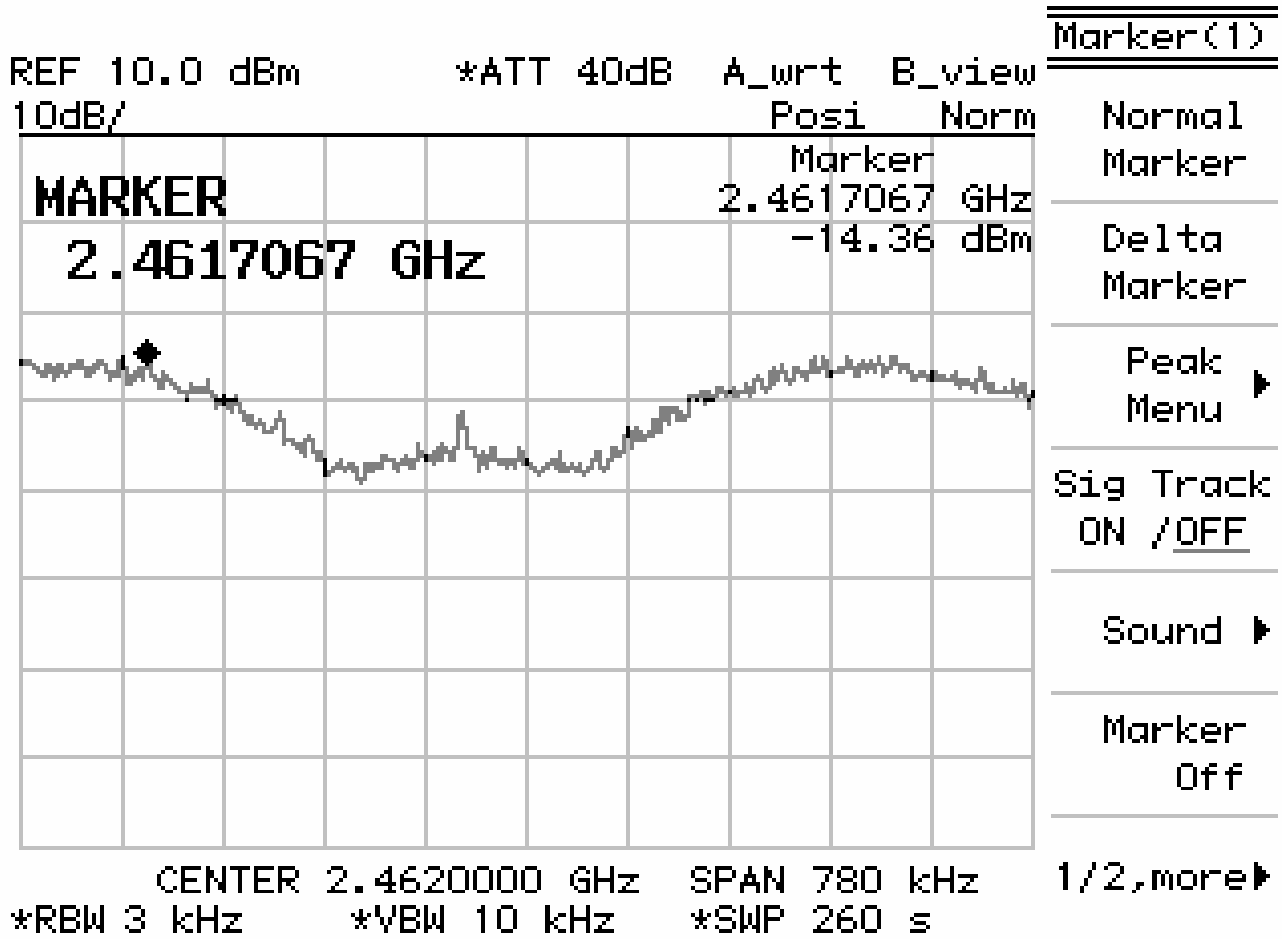



MAX LIGHT

MEASUREMENT REPORT

iWavePort WLM54G 1B
 802.11 Super G (2437MHz)

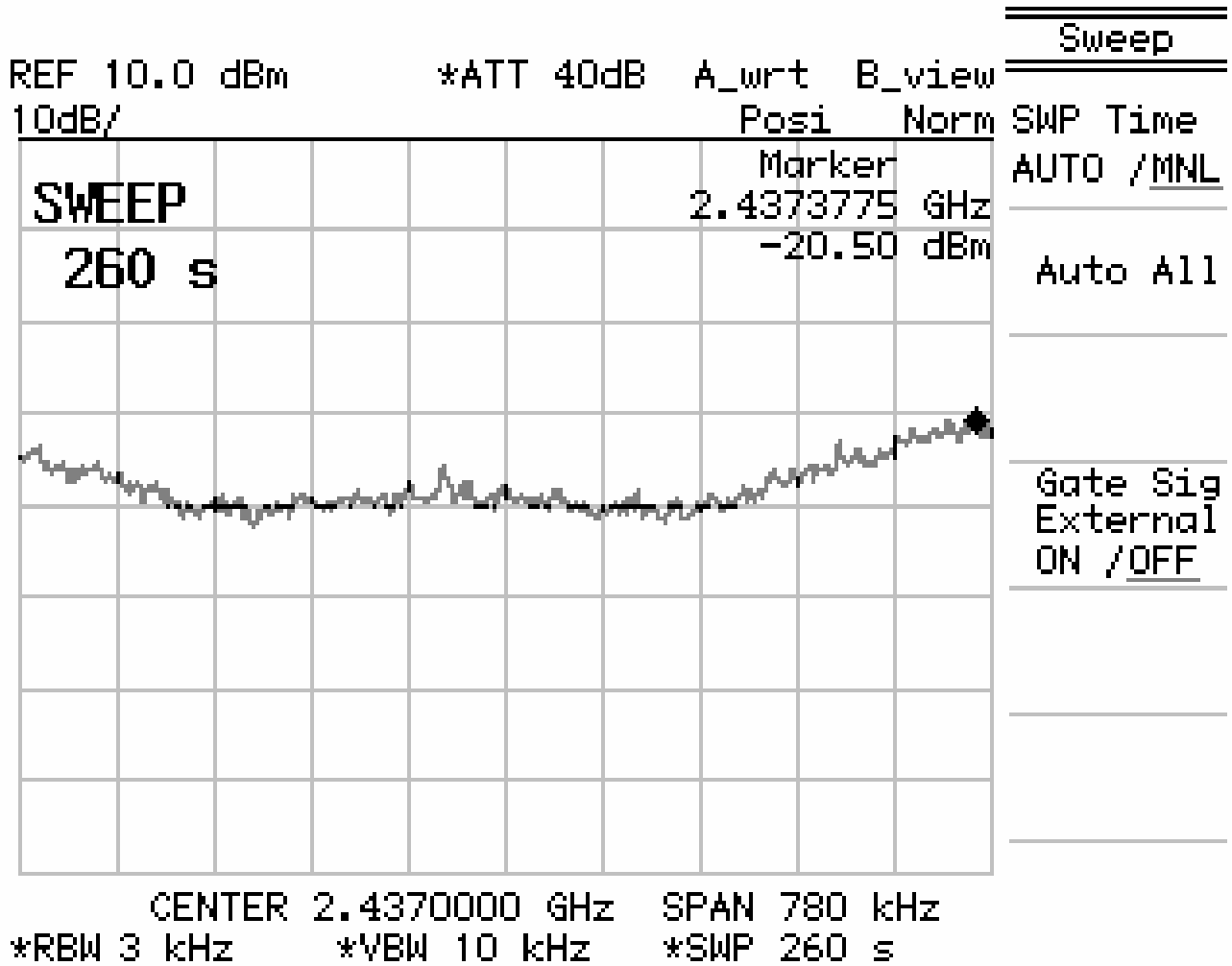

VII. Out of Band Conducted Emissions Requirements

7.1 Test Condition & Setup :

In any 100 kHz bandwidth outside the EUT passband, the RF power produced by the modulation products of the spreading sequence, the information sequence, and the carrier frequency shall be at least 20 dB below that of the maximum in-band 100 kHz emission, antenna output of the EUT was coupled directly to spectrum analyzer; if an external attenuator and/or cable was used, these losses are compensated for with the analyzer OFFSET function.

All other types of emissions from the EUT shall meet the general limits for radiated frequencies outside the passband. the test was performed at 3 channels (Channel 1, 6,11)

7.2 Test Instruments Configuration:

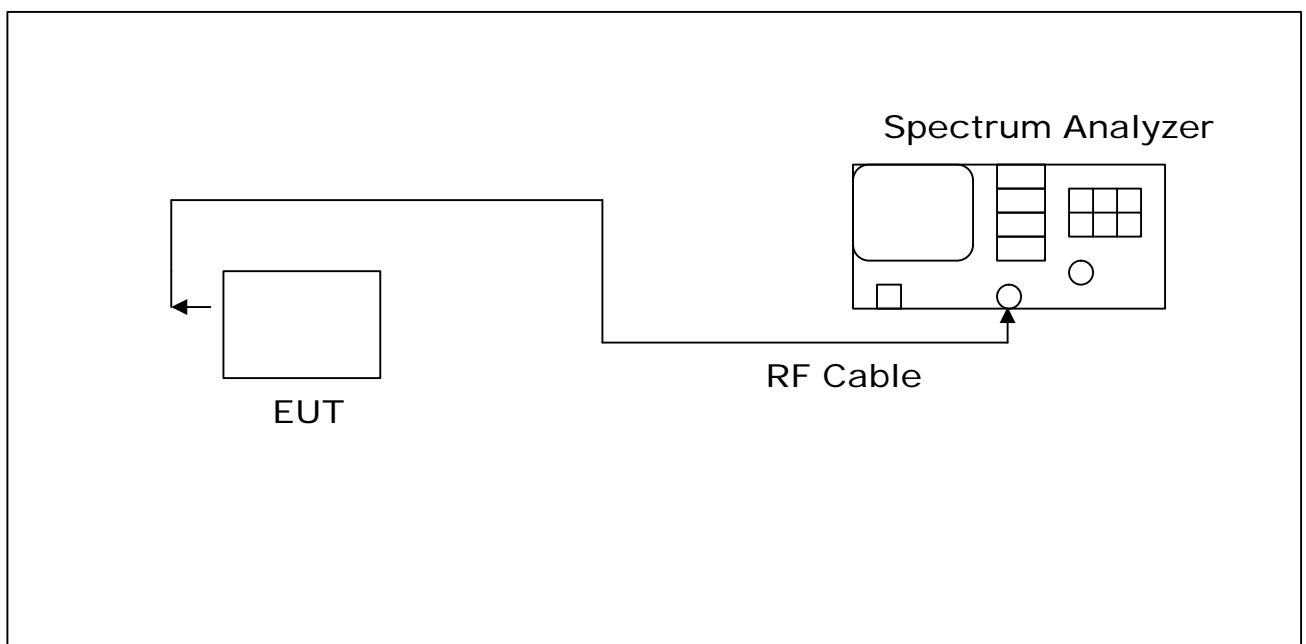



7.3 Test Equipment List:

- A. Agilent E4407B 9KHz-26.5GHz Spectrum Analyzer (S/N:A872JS02291)
- B. Shielded Room (MLT-SR1)

7.4 Test Result:

Refer to attached data sheets. Data shows out of band emissions are suppressed well below the -20 dBc minimum required by the Rules.

Note : Test Graphs See next page.



MAX LIGHT

MEASUREMENT REPORT

iWavePort WLM54G 1A
802.11b Channel 01 (1 of 5)

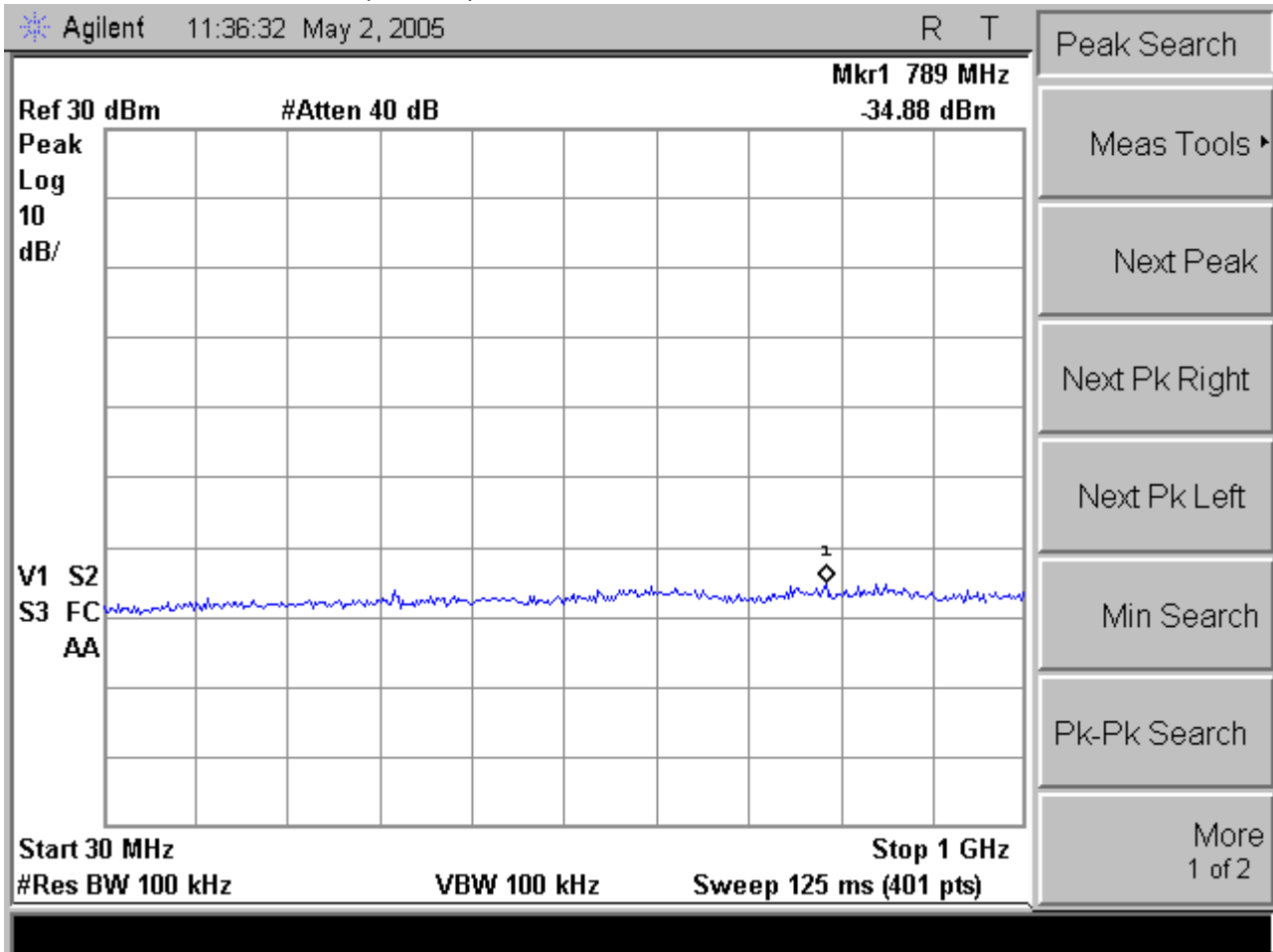



MAX LIGHT

MEASUREMENT REPORT

iWavePort WLM54G 1A
802.11b Channel 01 (2 of 5)

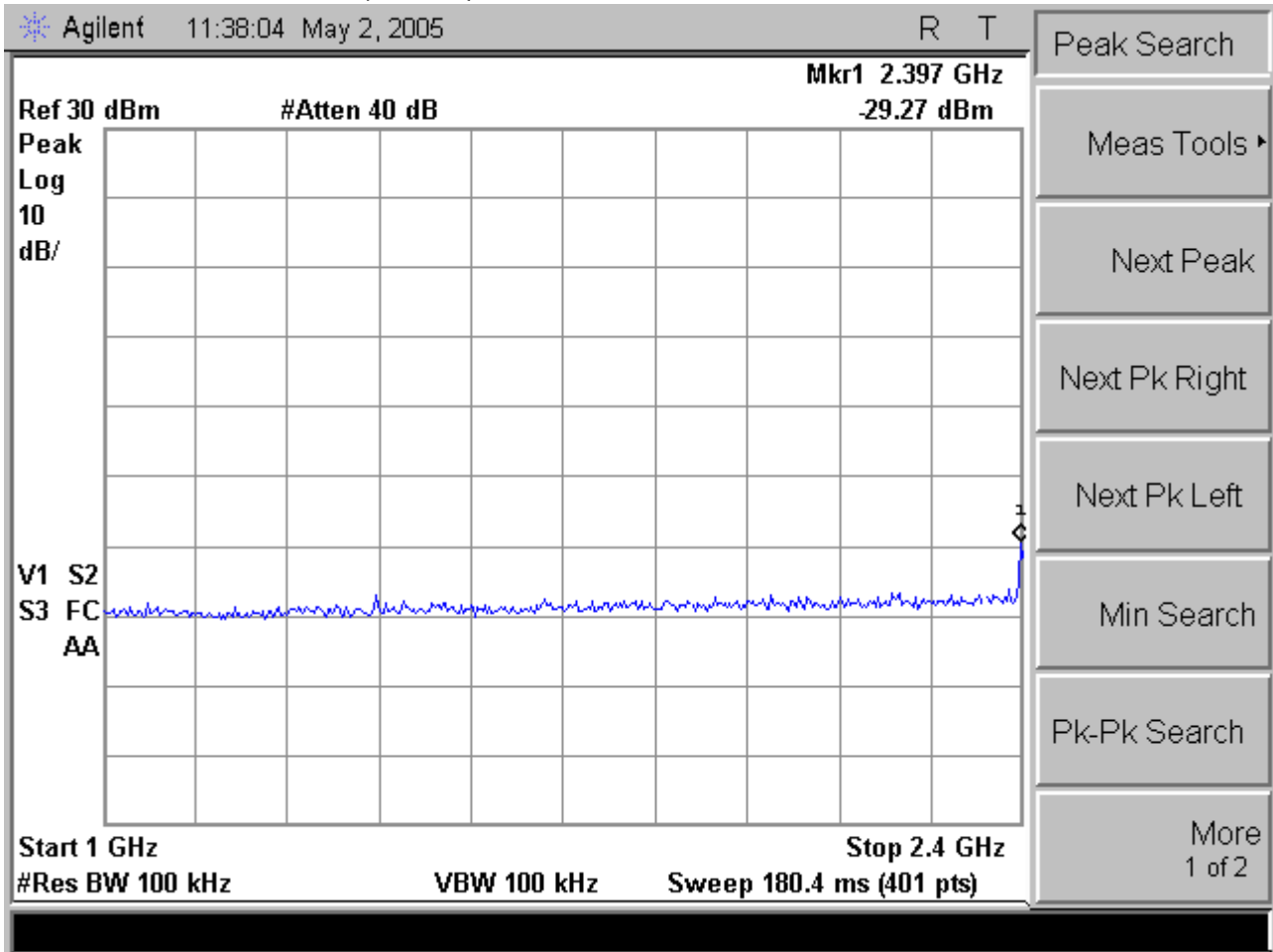



MAX LIGHT

MEASUREMENT REPORT

iWavePort WLM54G 1A
 802.11b Channel 01 (3 of 5)

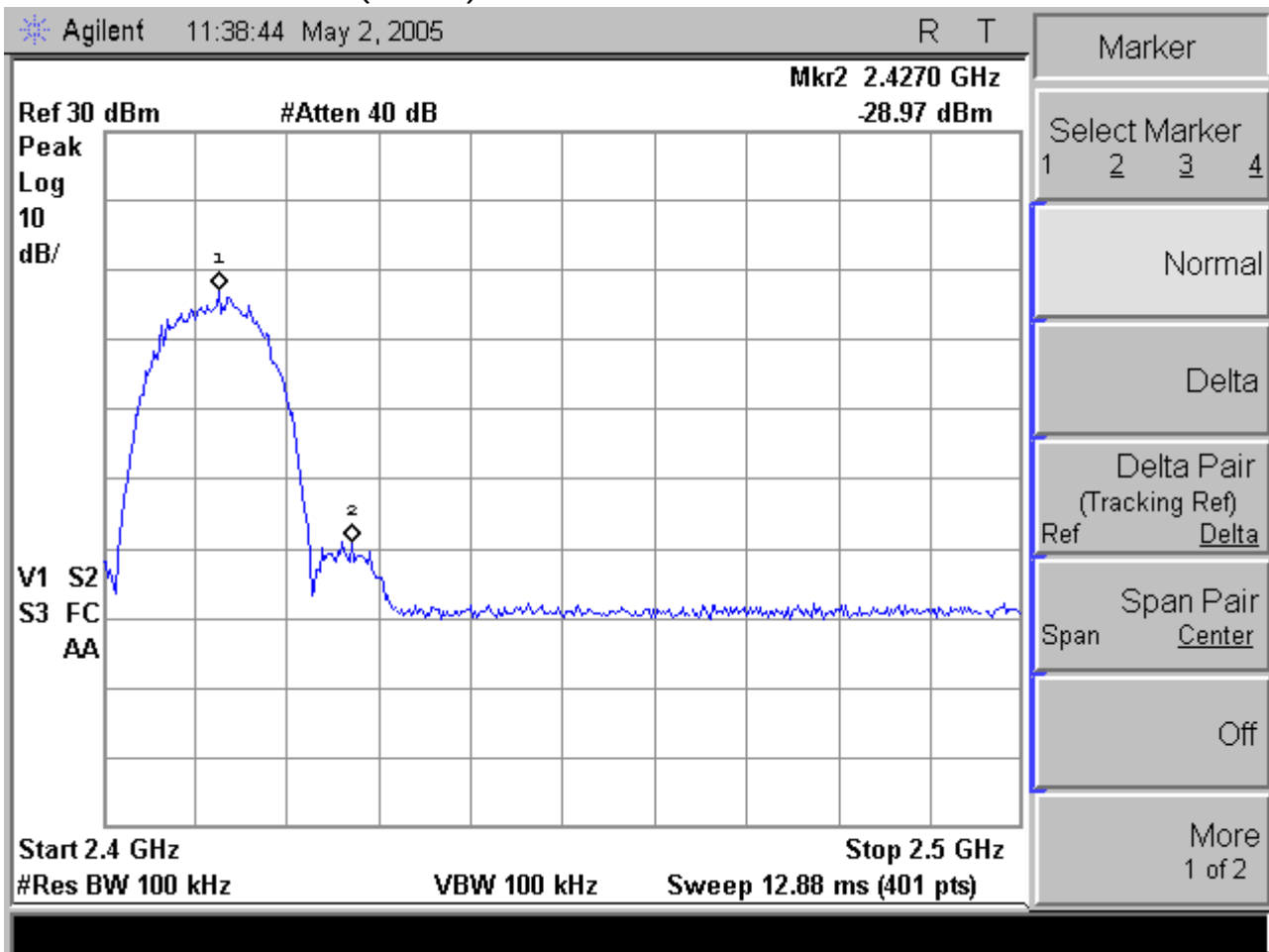



MAX LIGHT

MEASUREMENT REPORT

iWavePort WLM54G 1A
802.11b Channel 01 (4 of 5)

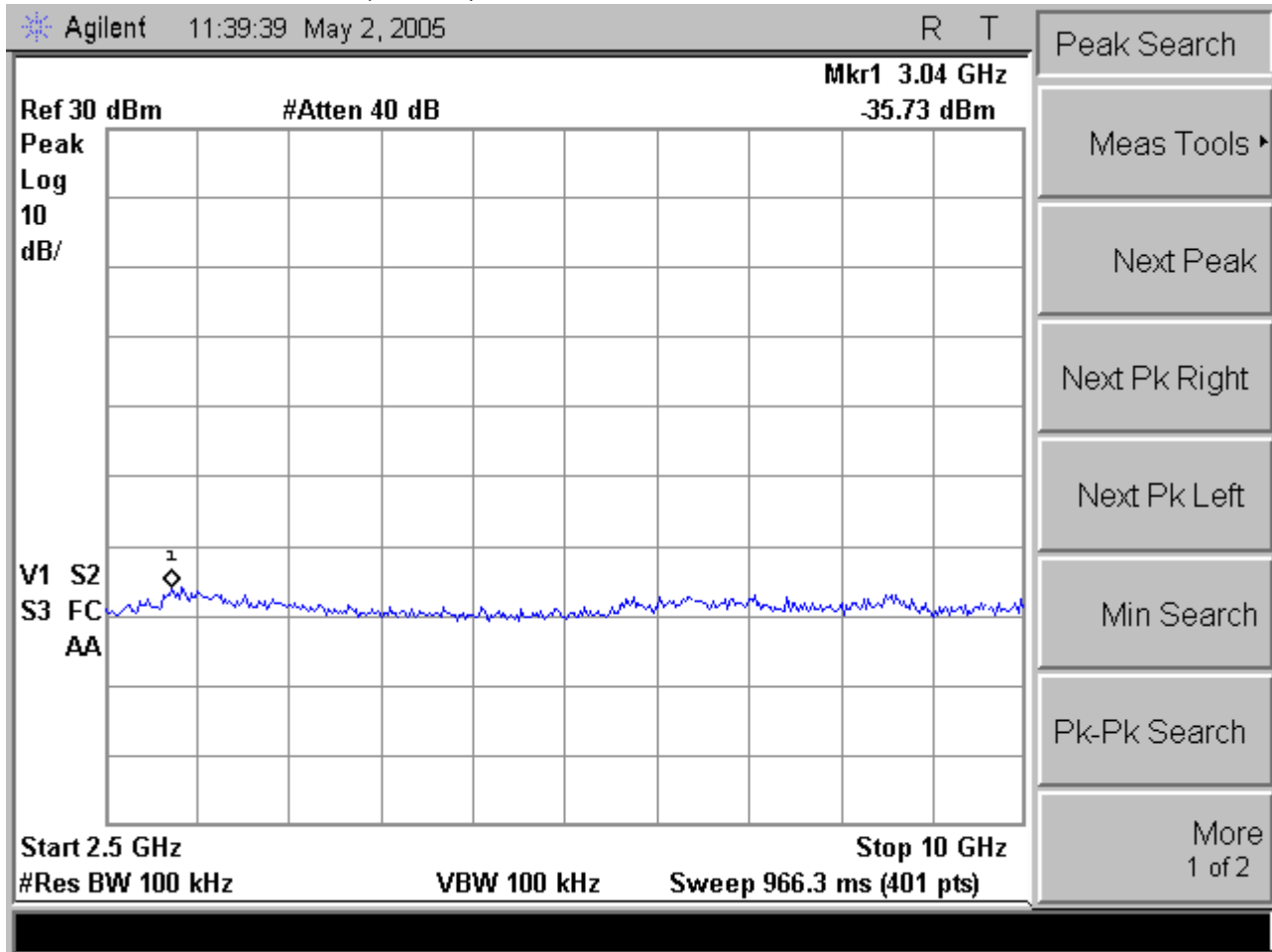



MAX LIGHT

MEASUREMENT REPORT

iWavePort WLM54G 1A
802.11b Channel 01 (5 of 5)

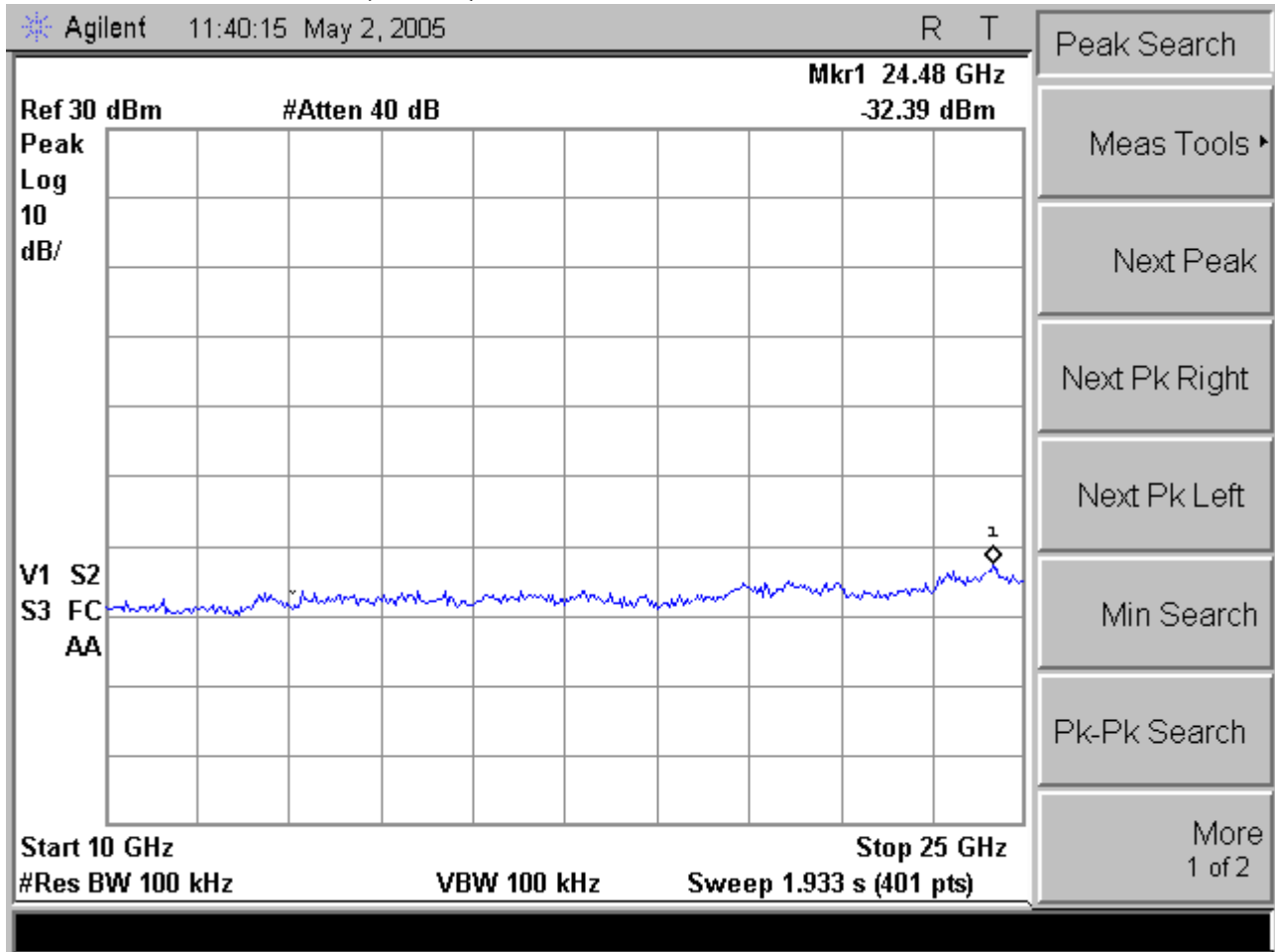



MAX LIGHT

MEASUREMENT REPORT

iWavePort WLM54G 1A
802.11b Channel 06 (1 of 5)

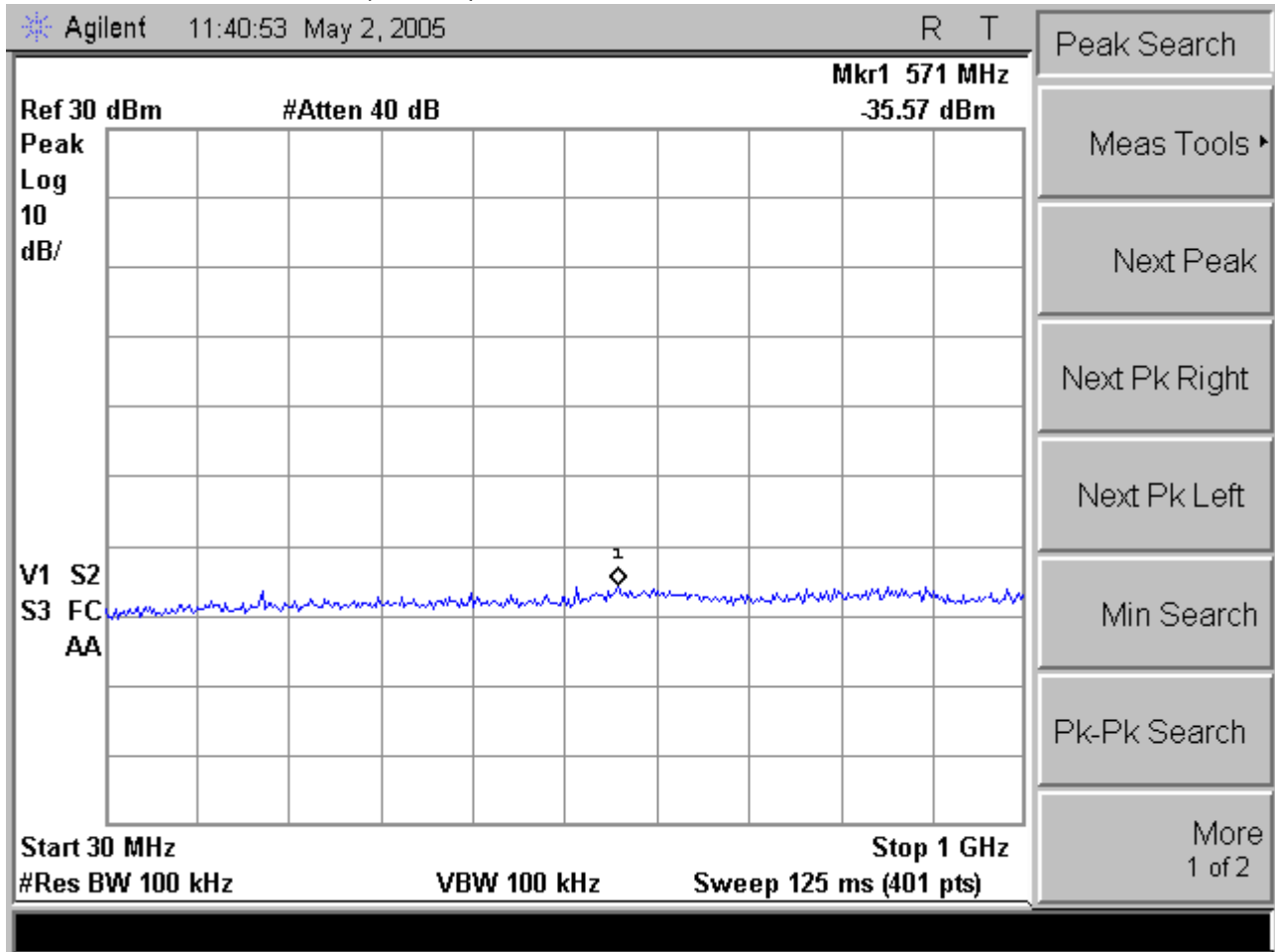



MAX LIGHT

MEASUREMENT REPORT

iWavePort WLM54G 1A
802.11b Channel 06 (2 of 5)

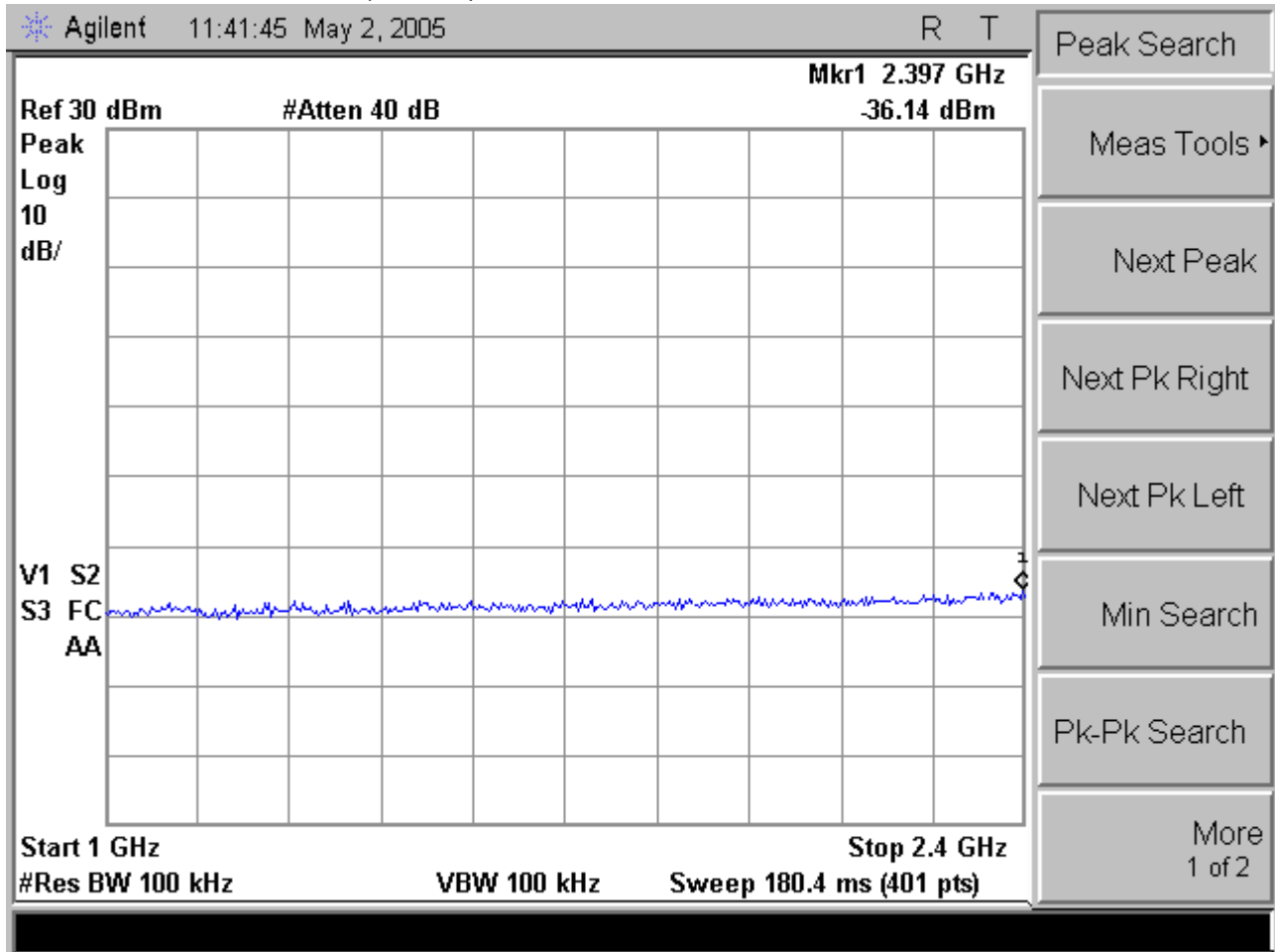

iWavePort WLM54G 1A
 802.11b Channel 06 (3 of 5)

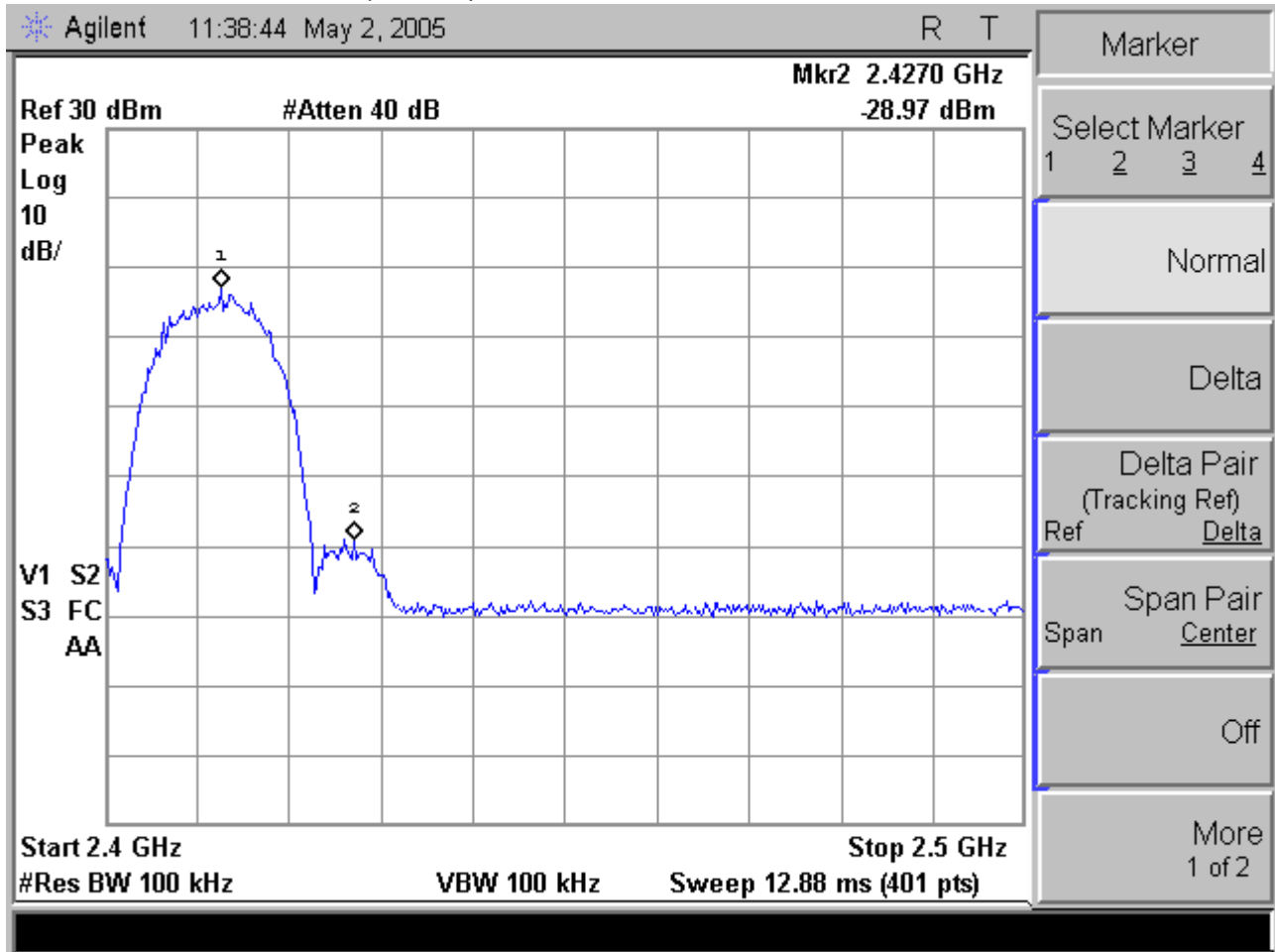



MAX LIGHT

MEASUREMENT REPORT

iWavePort WLM54G 1A
802.11b Channel 06 (4 of 5)

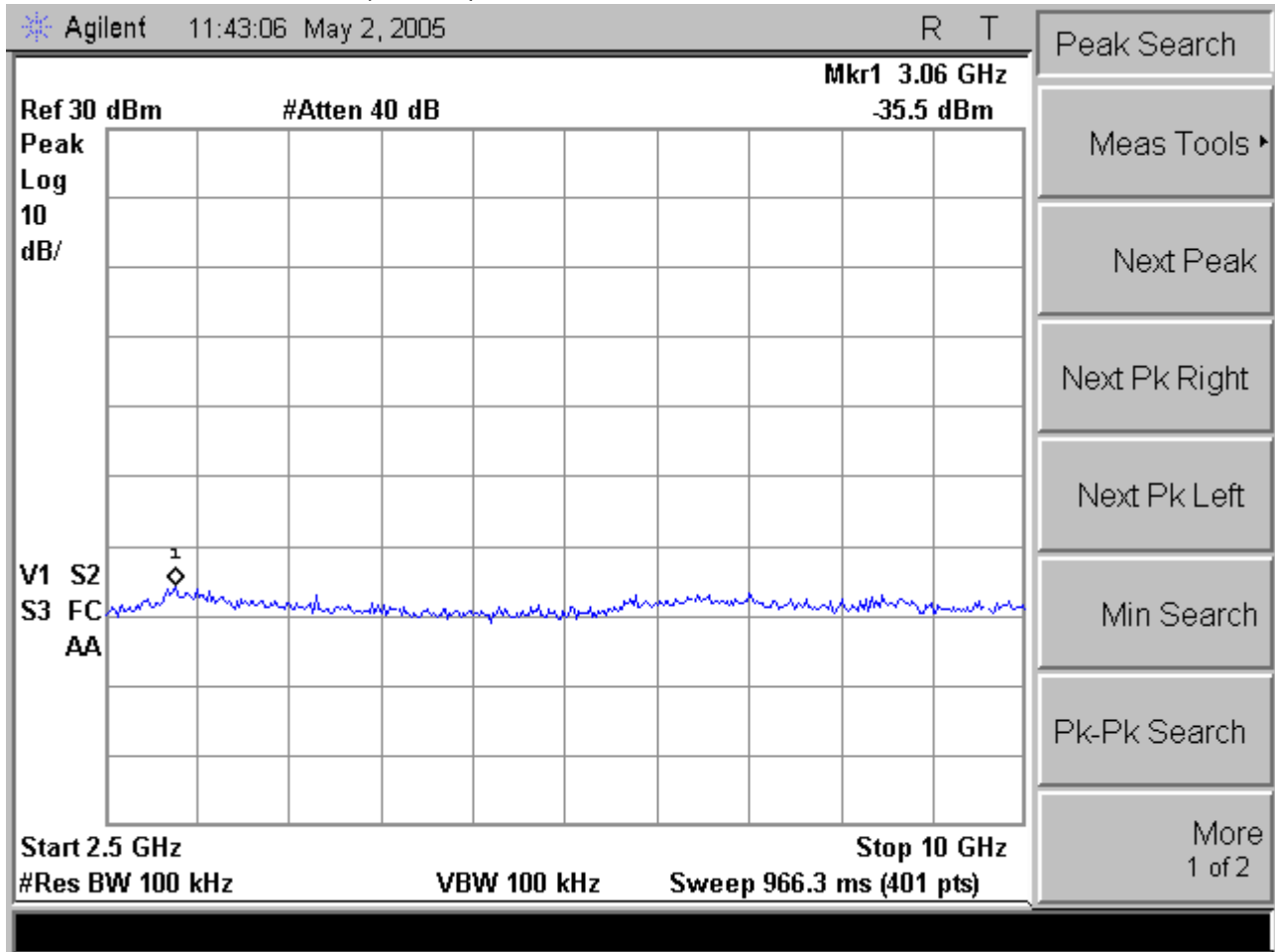



MAX LIGHT

MEASUREMENT REPORT

iWavePort WLM54G 1A
802.11b Channel 06 (5 of 5)

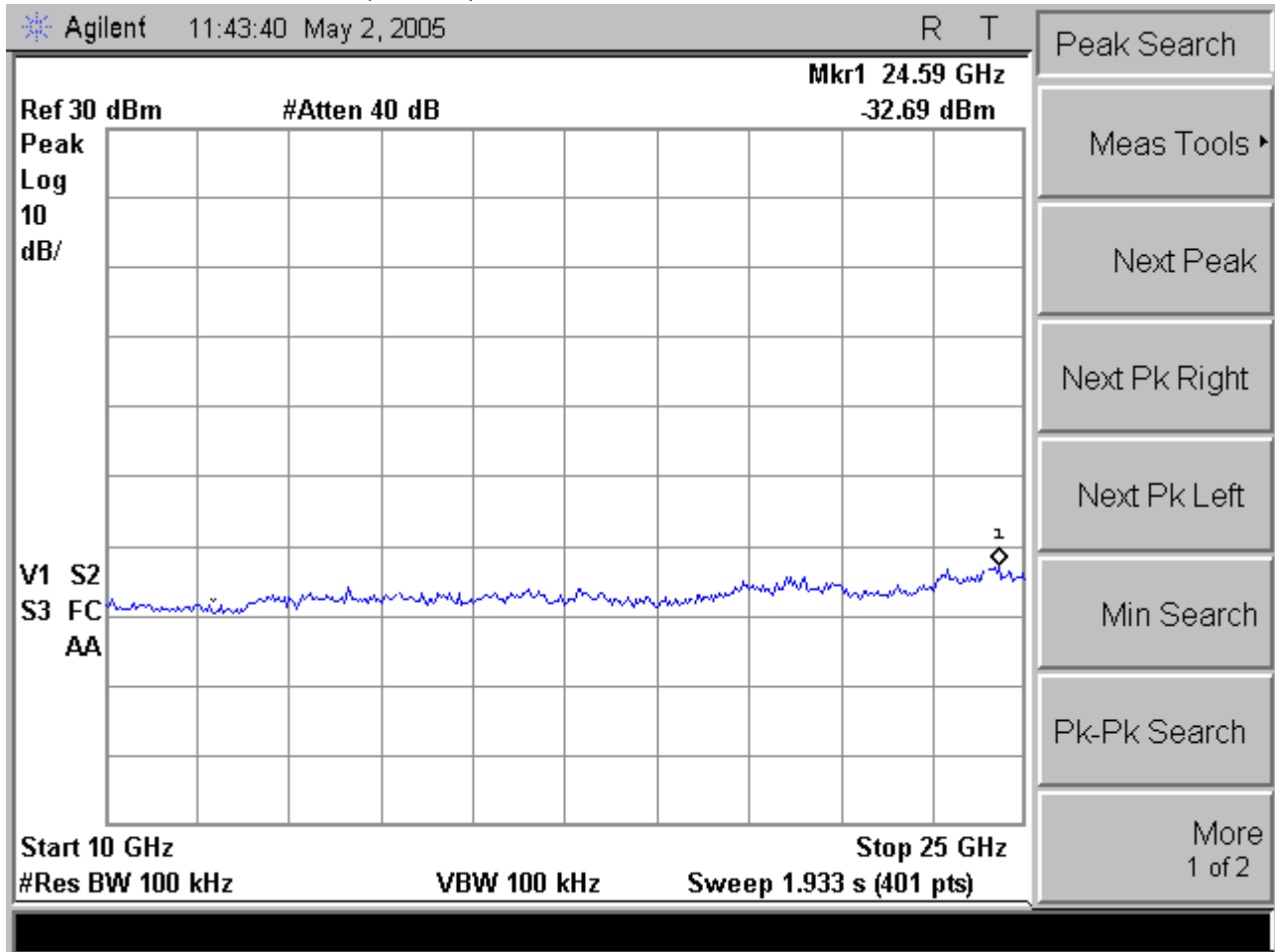



MAX LIGHT

MEASUREMENT REPORT

iWavePort WLM54G 1A
802.11b Channel 11 (1 of 5)

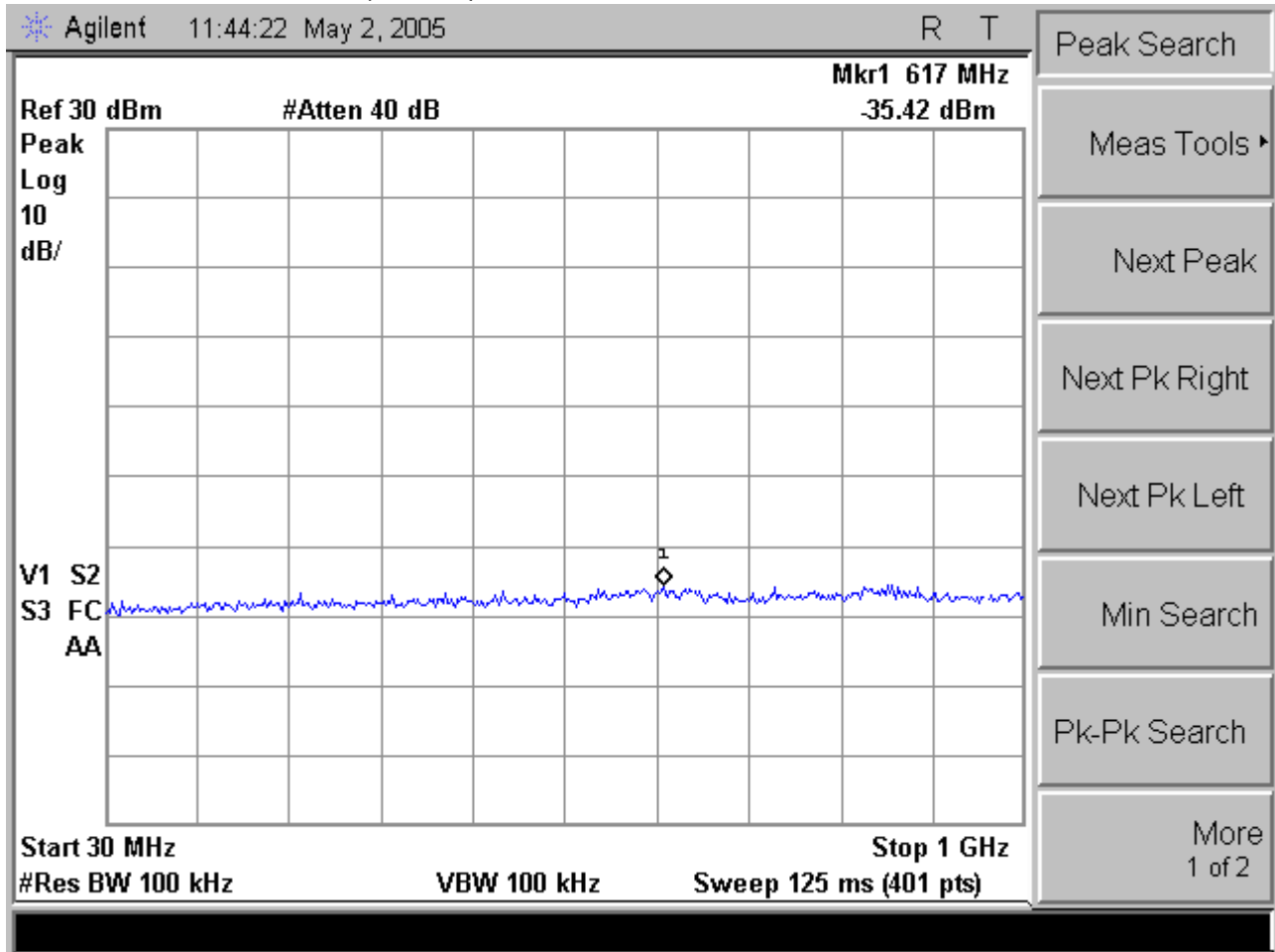



MAX LIGHT

MEASUREMENT REPORT

iWavePort WLM54G 1A
802.11b Channel 11 (2 of 5)

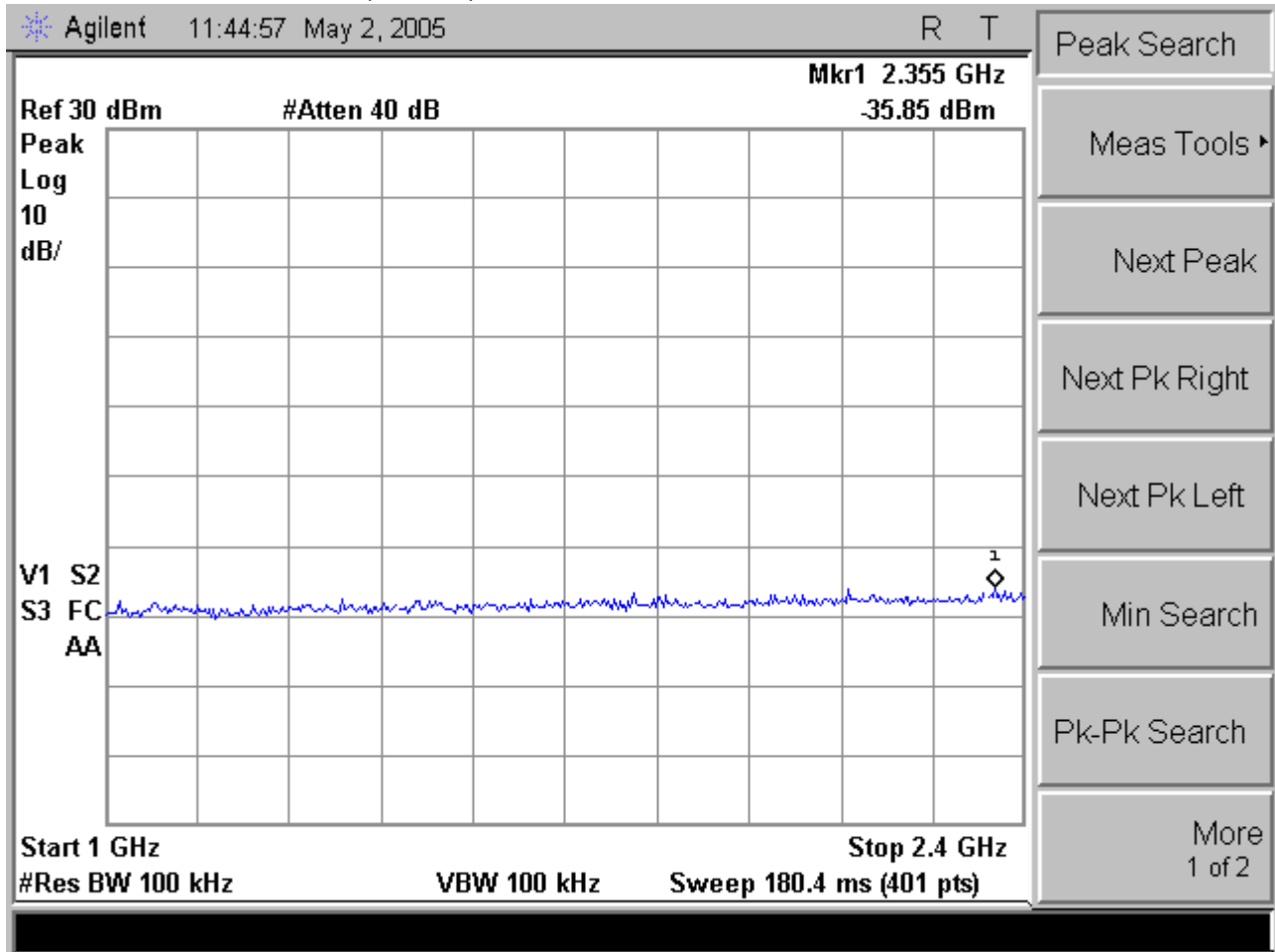

iWavePort WLM54G 1A
 802.11b Channel 11 (3 of 5)

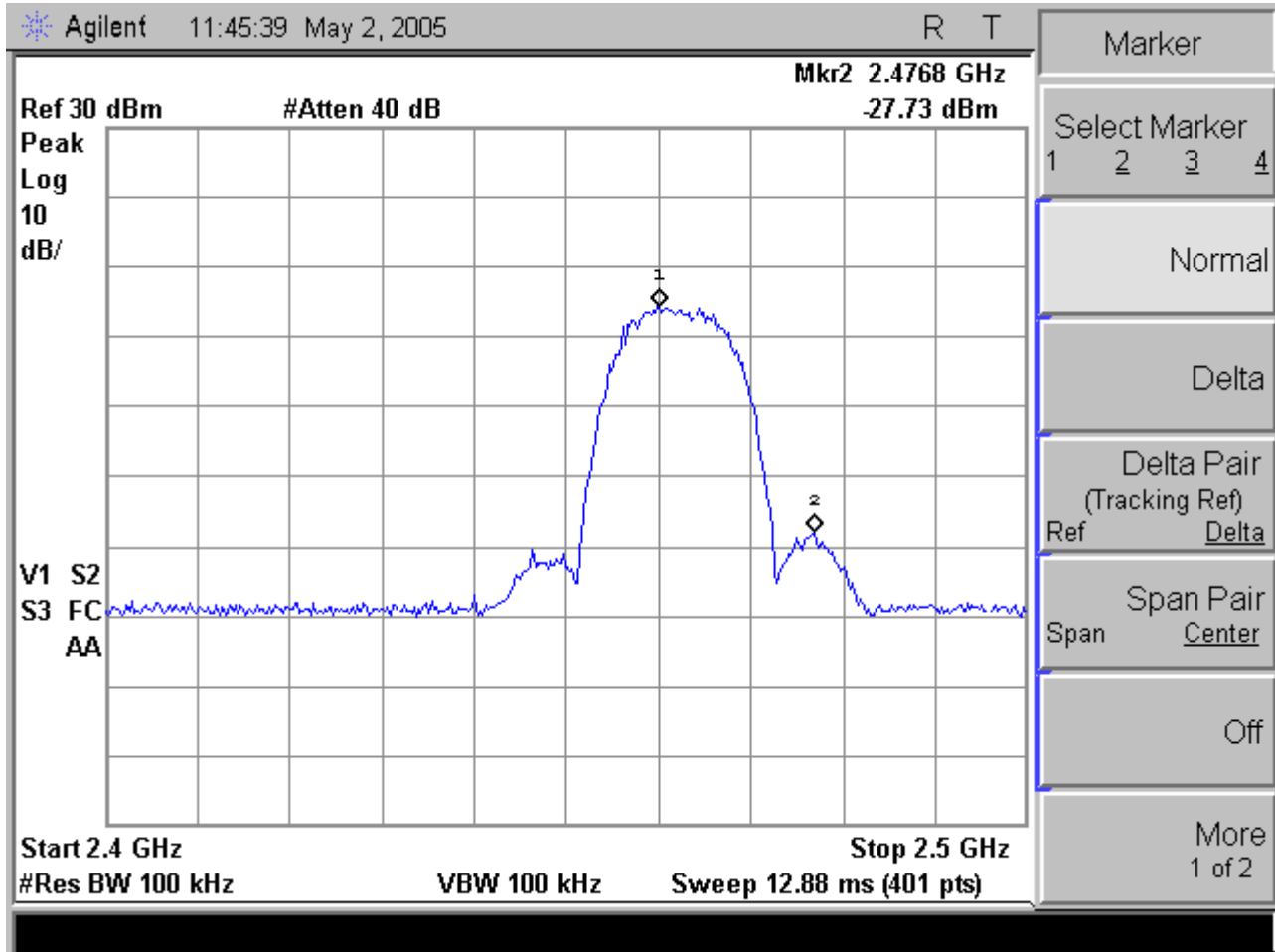



MAX LIGHT

MEASUREMENT REPORT

iWavePort WLM54G 1A
802.11b Channel 11 (4 of 5)

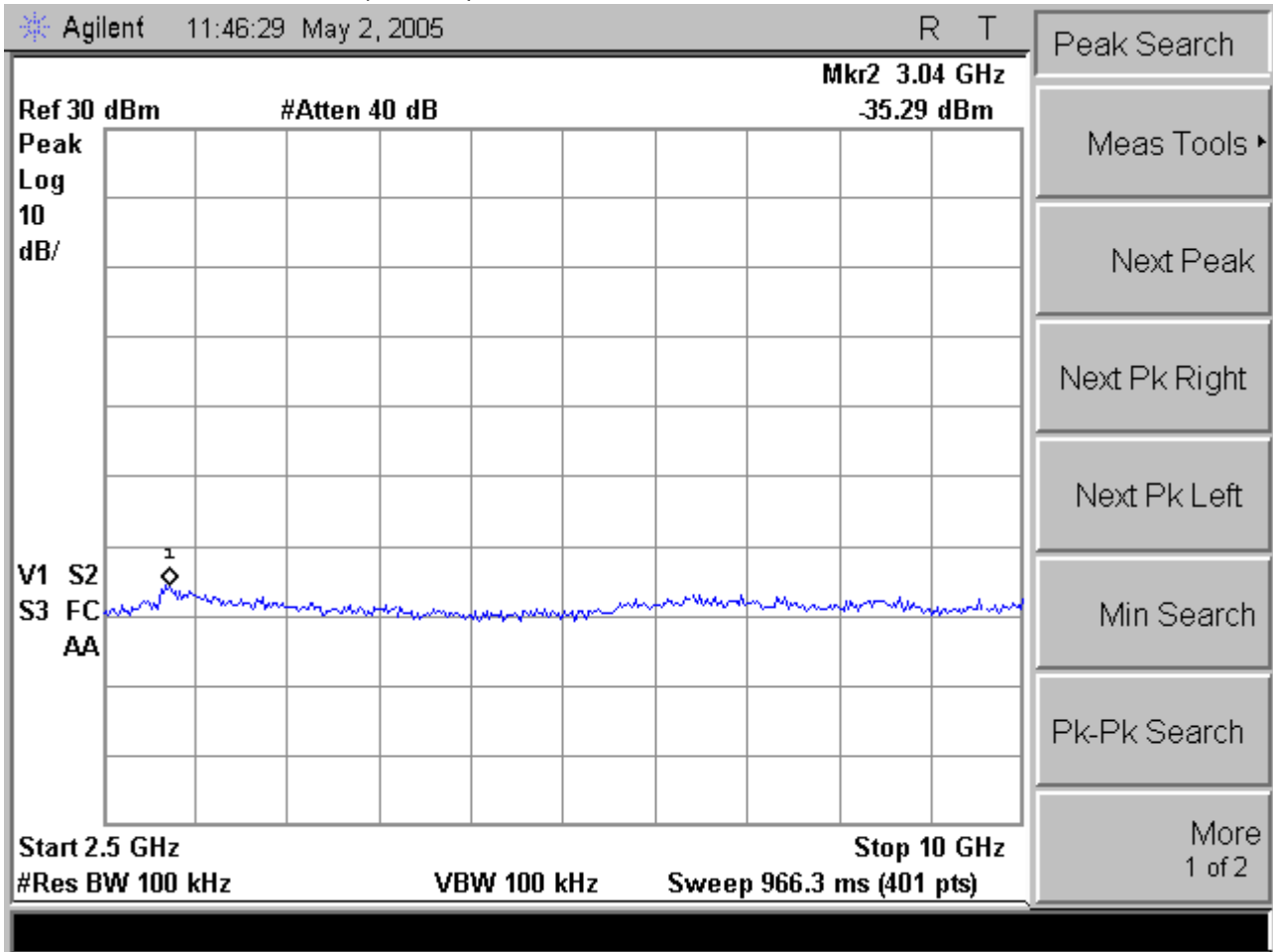



MAX LIGHT

MEASUREMENT REPORT

iWavePort WLM54G 1A
802.11b Channel 11 (5 of 5)

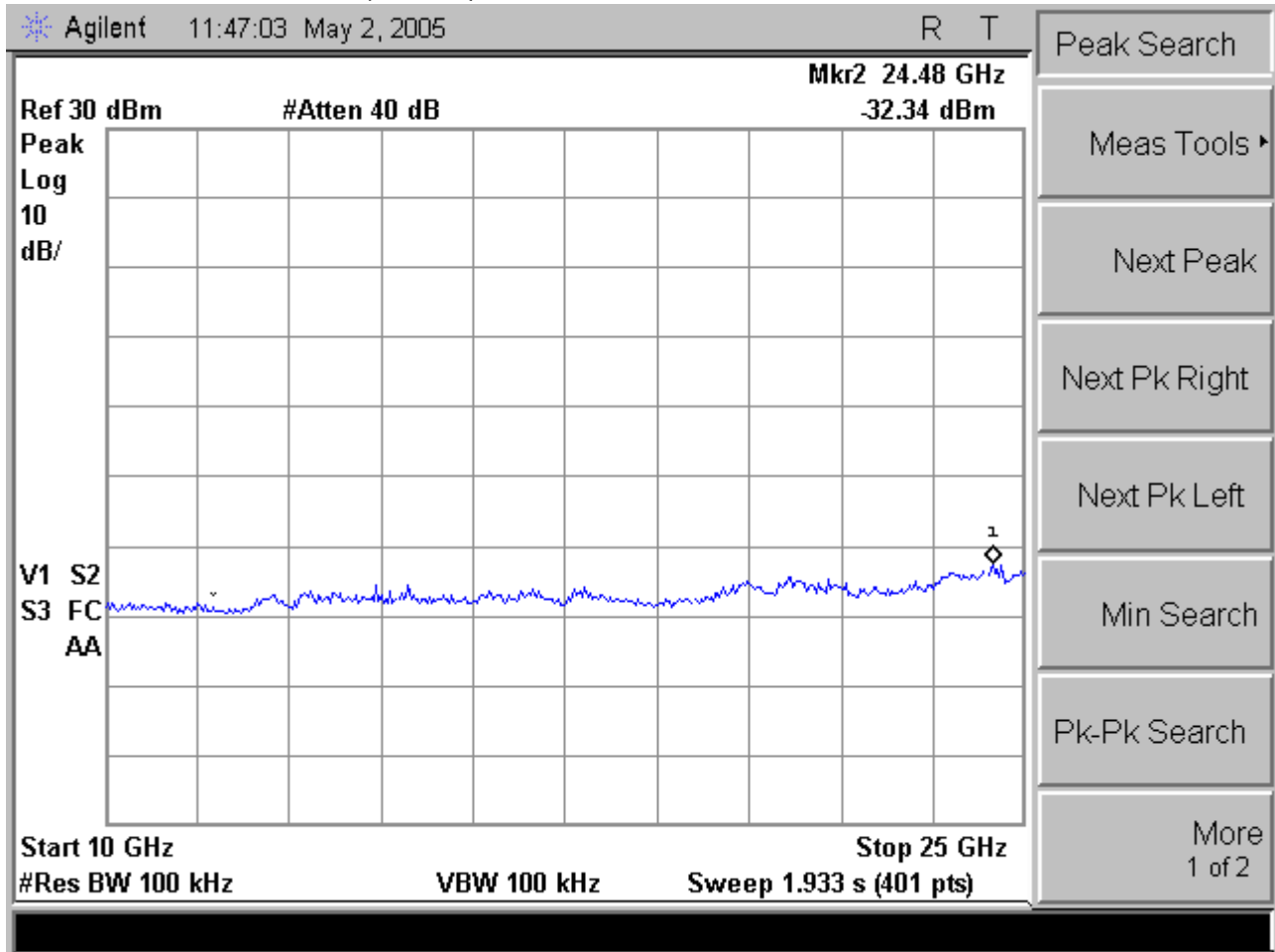



MAX LIGHT

MEASUREMENT REPORT

iWavePort WLM54G 1A
802.11g Channel 01 (1 of 5)

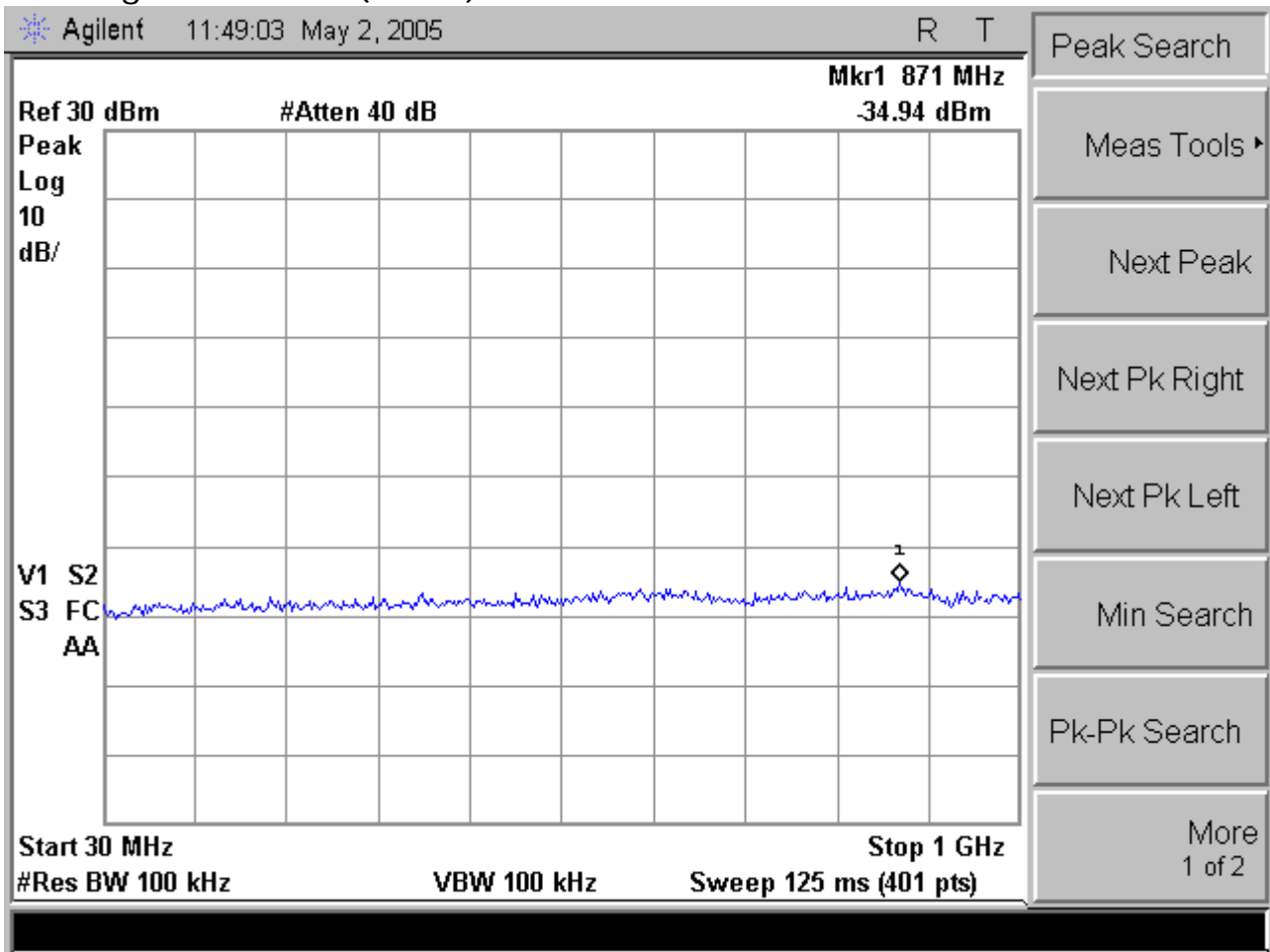



MAX LIGHT

MEASUREMENT REPORT

iWavePort WLM54G 1A
802.11g Channel 01 (2 of 5)

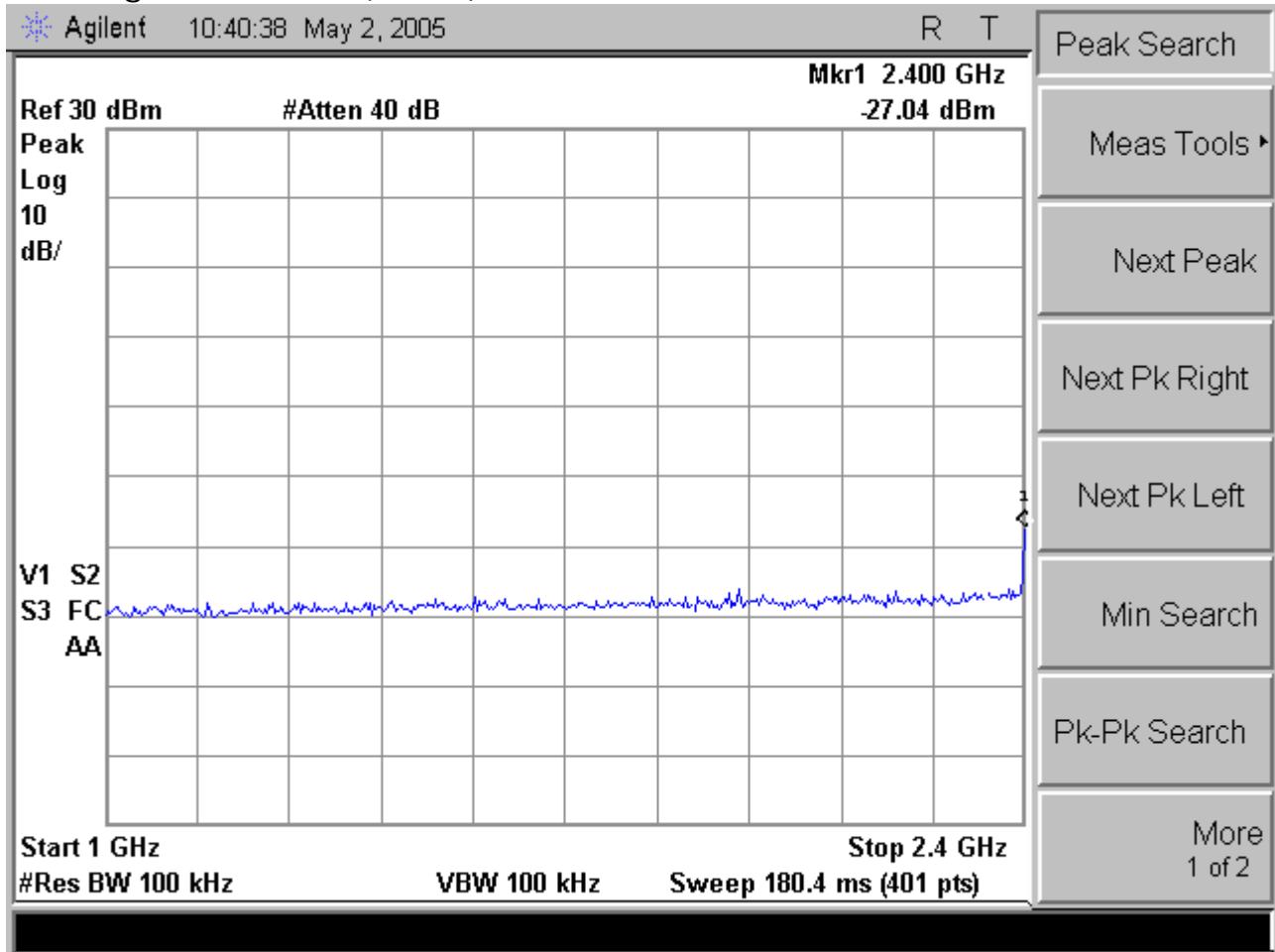



MAX LIGHT

MEASUREMENT REPORT

iWavePort WLM54G 1A
802.11g Channel 01 (3 of 5)

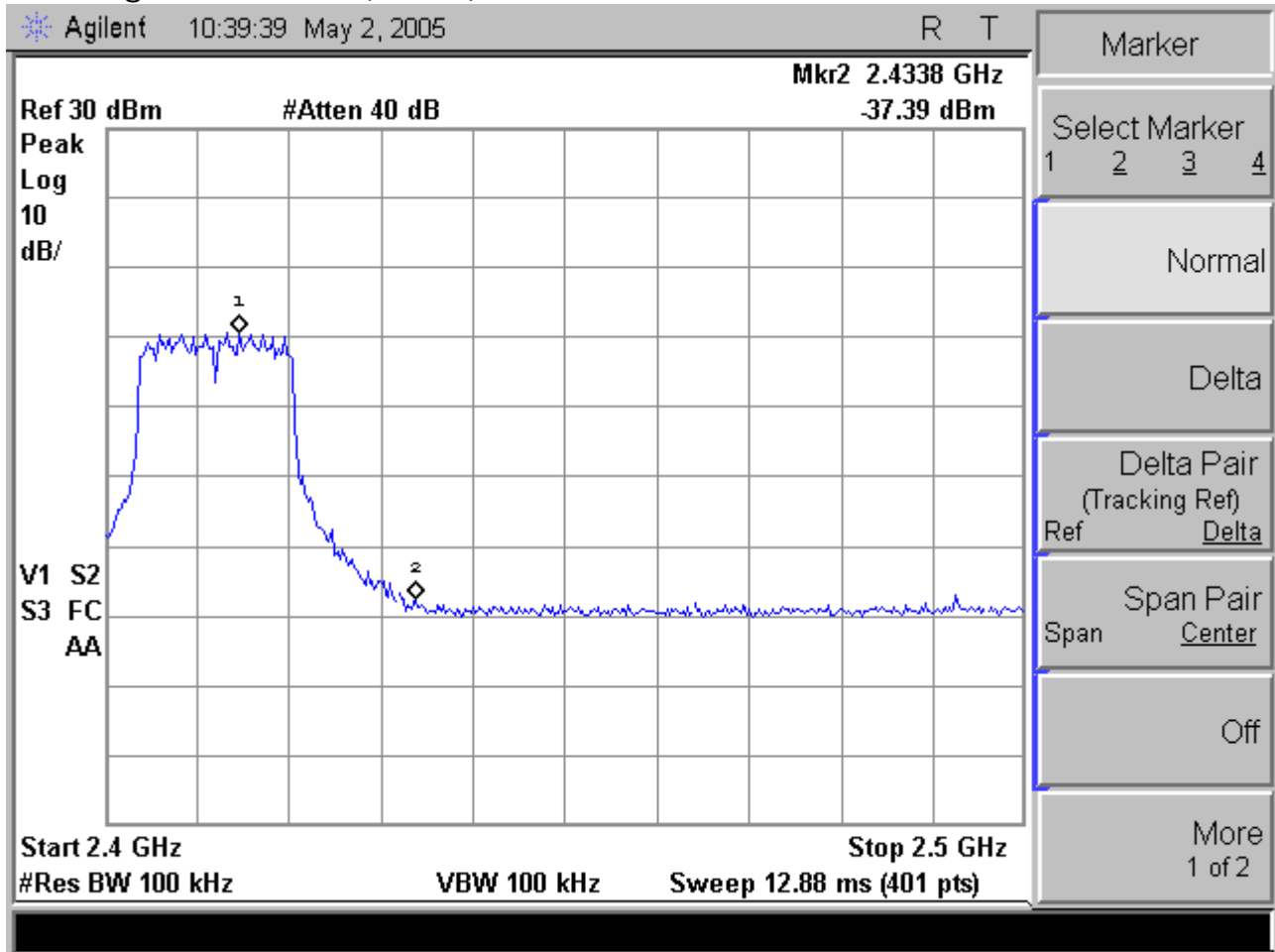



MAX LIGHT

MEASUREMENT REPORT

iWavePort WLM54G 1A
802.11g Channel 01 (4 of 5)

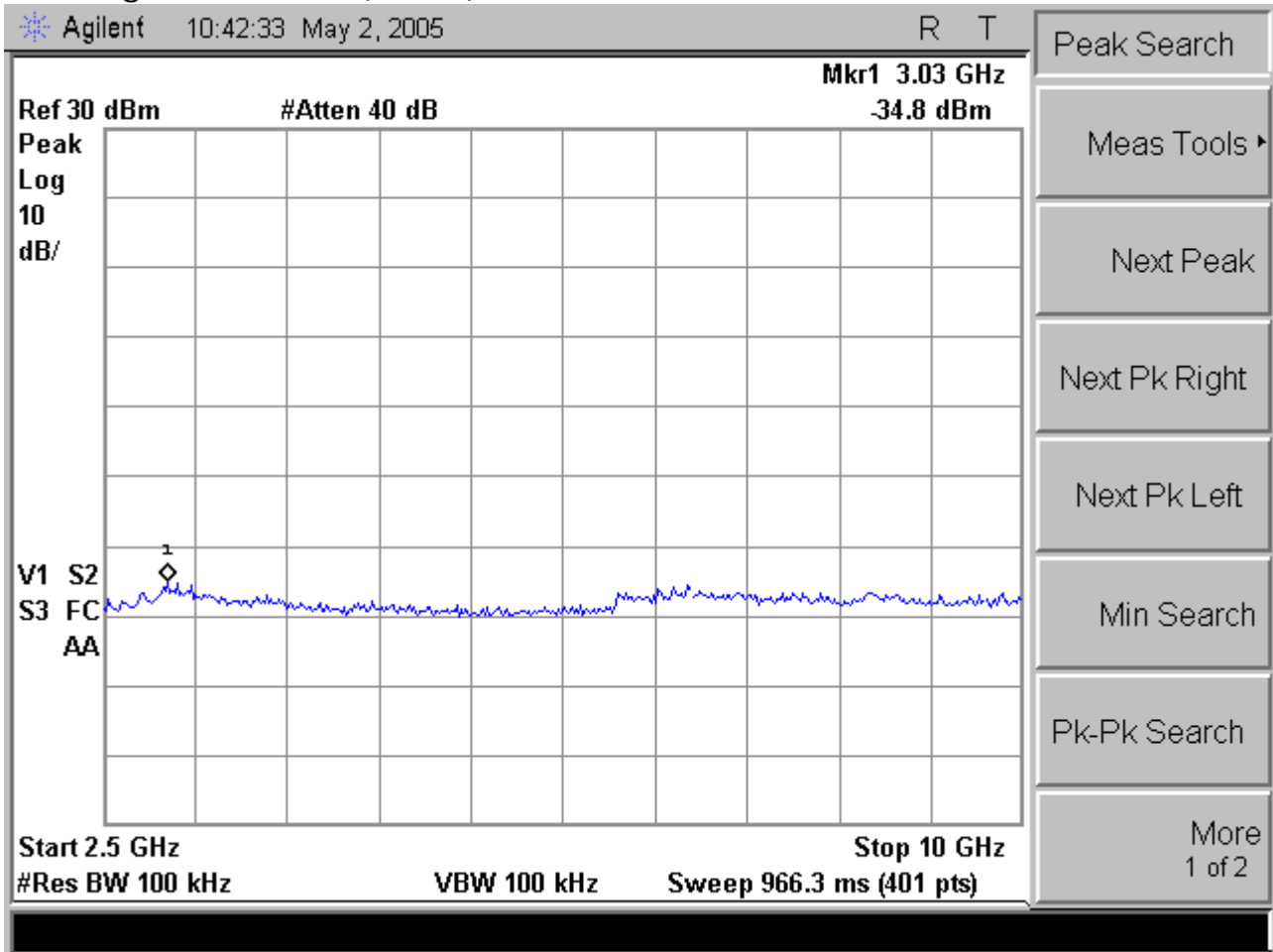



MAX LIGHT

MEASUREMENT REPORT

iWavePort WLM54G 1A
802.11g Channel 01 (5 of 5)

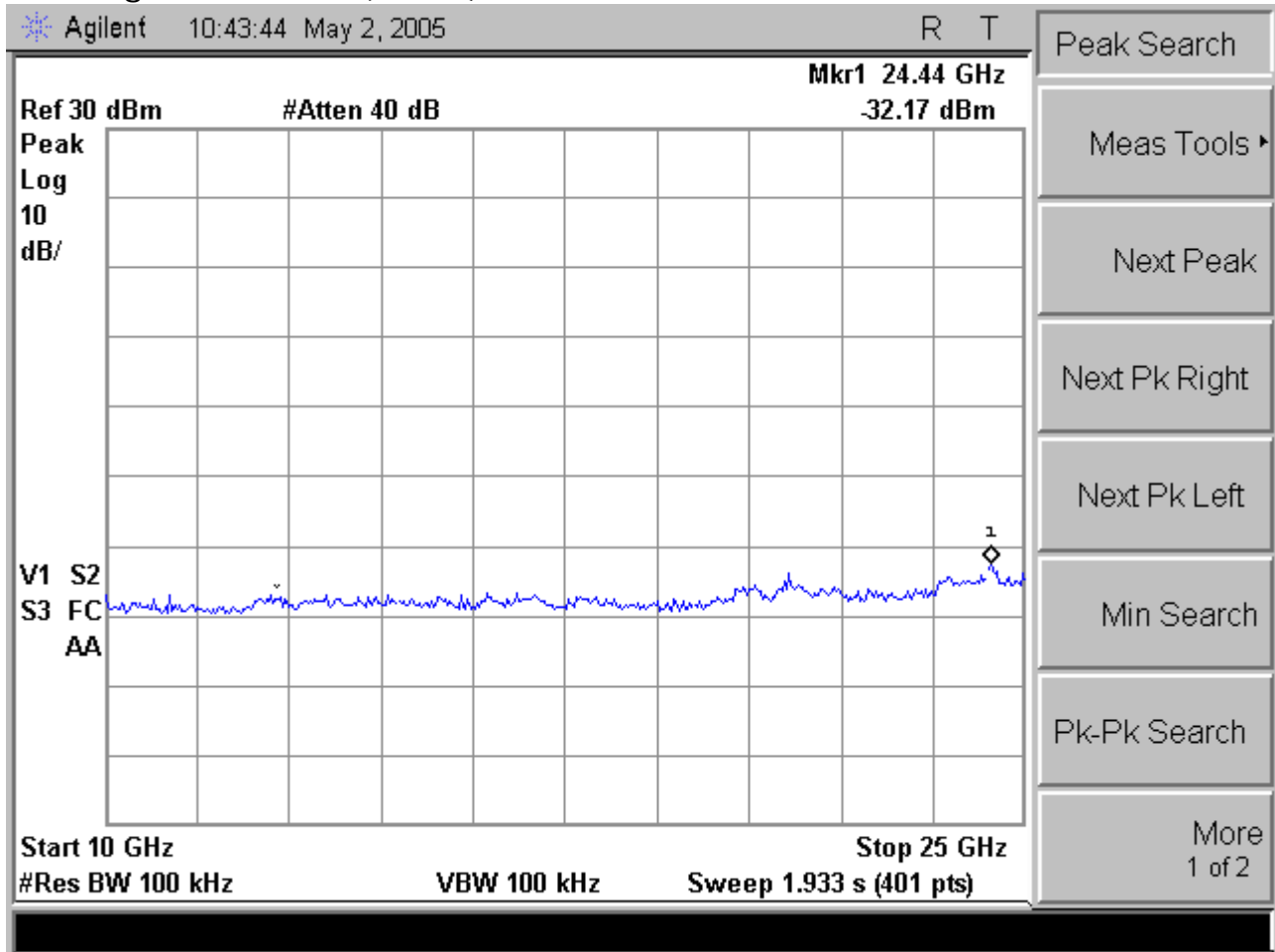



MAX LIGHT

MEASUREMENT REPORT

iWavePort WLM54G 1A
802.11g Channel 06 (1 of 5)

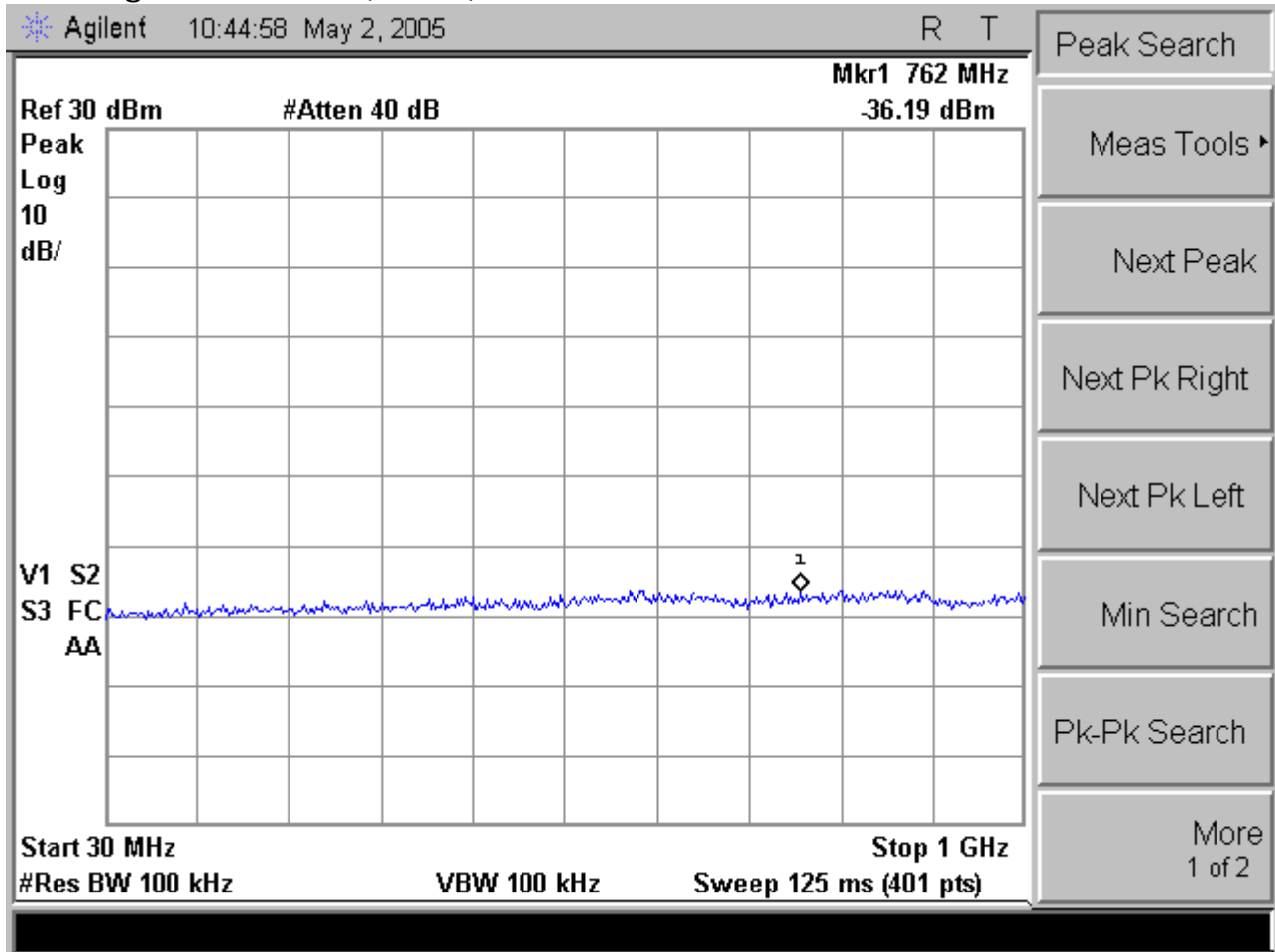



MAX LIGHT

MEASUREMENT REPORT

iWavePort WLM54G 1A
802.11g Channel 06 (2 of 5)

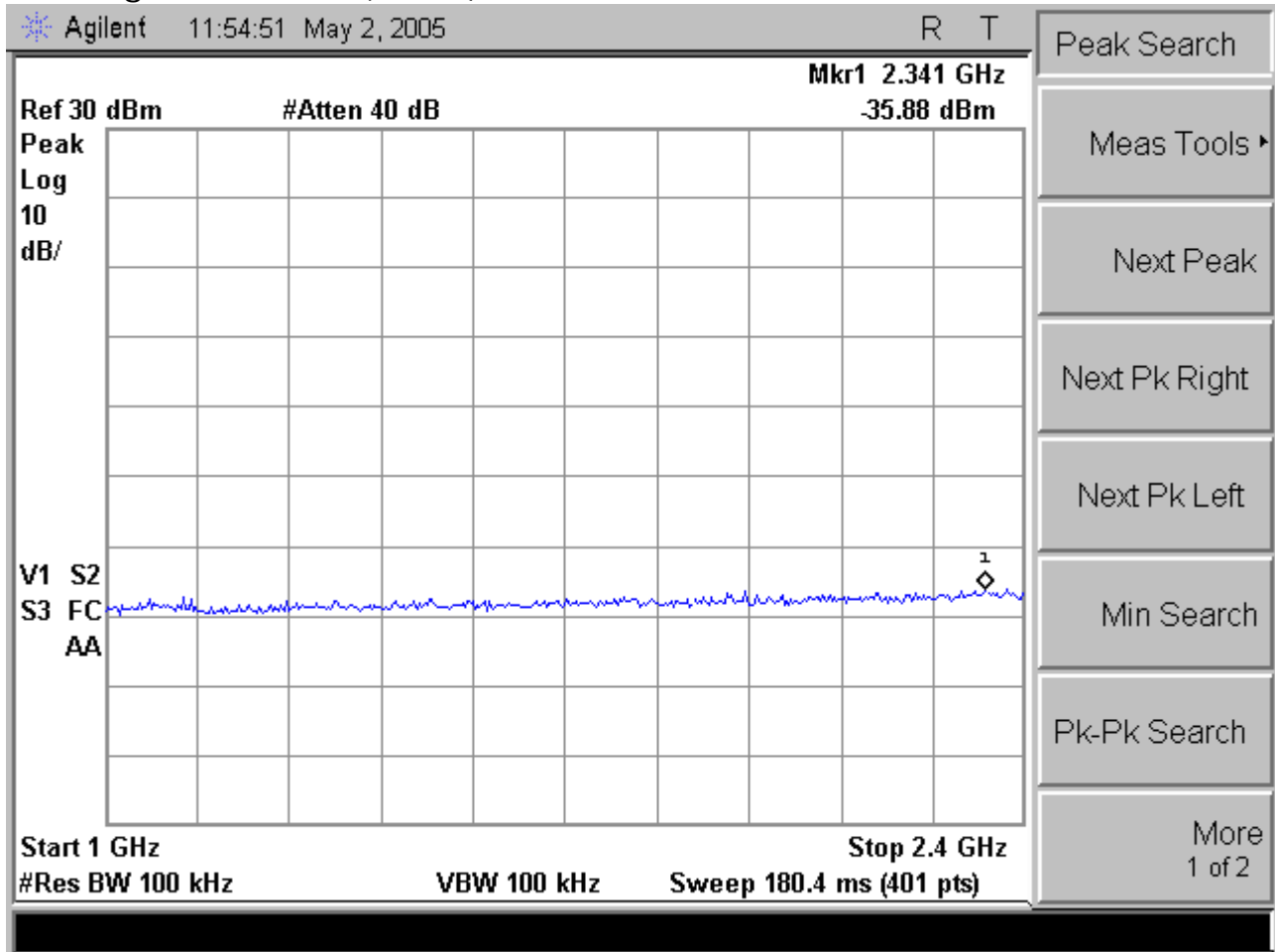



MAX LIGHT

MEASUREMENT REPORT

iWavePort WLM54G 1A
 802.11g Channel 06 (3 of 5)

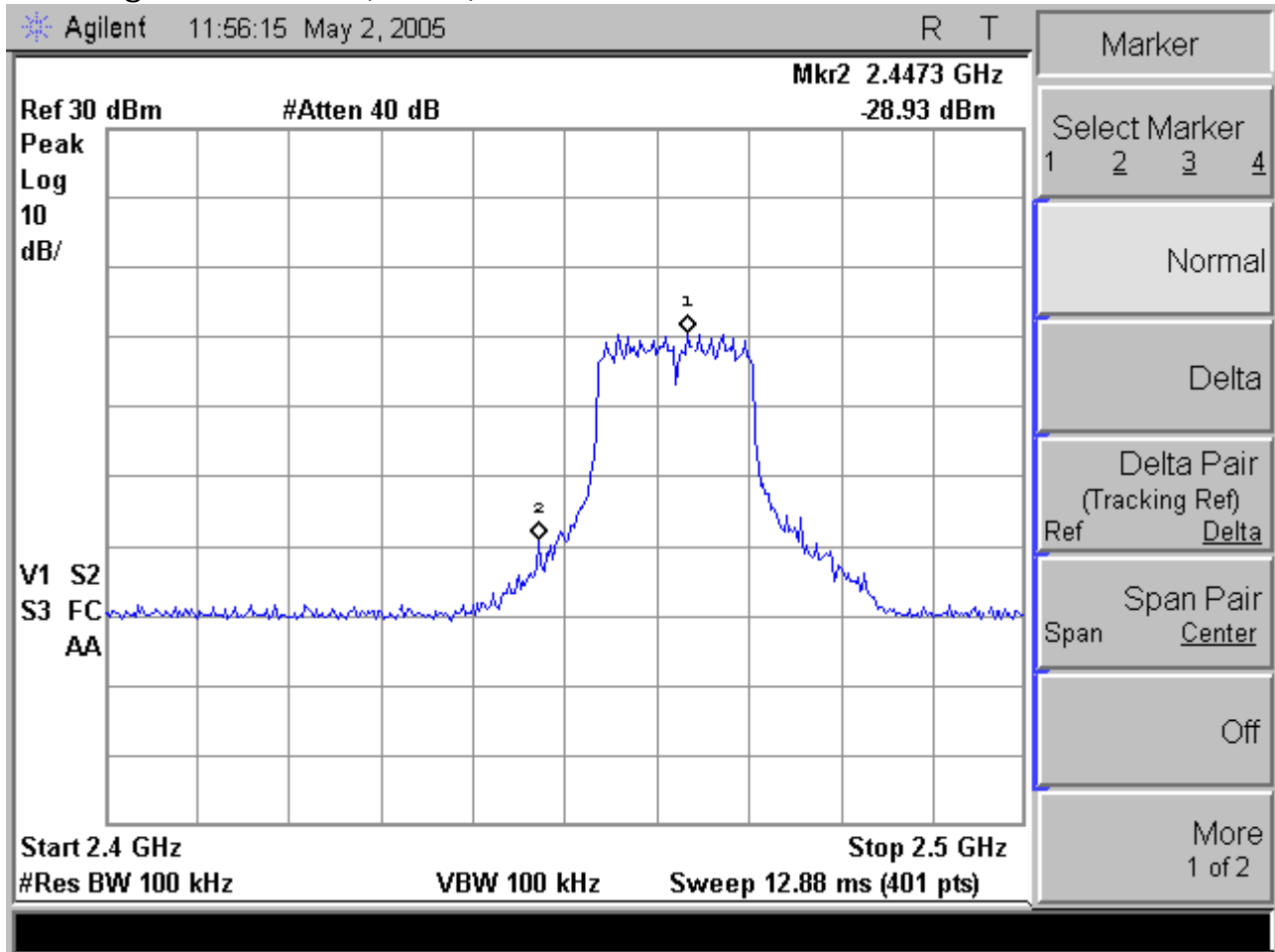



MAX LIGHT

MEASUREMENT REPORT

iWavePort WLM54G 1A
802.11g Channel 06 (4 of 5)

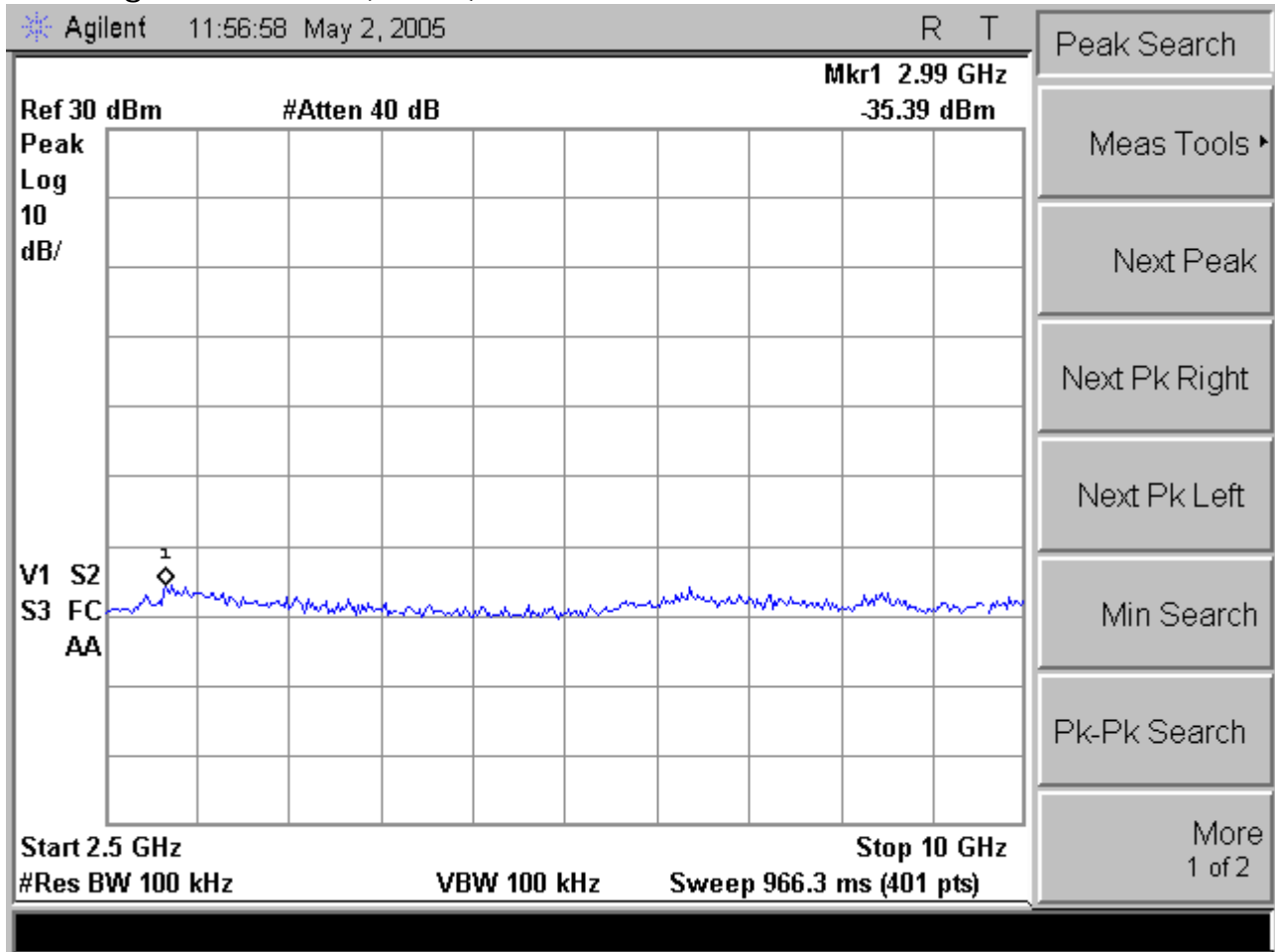



MAX LIGHT

MEASUREMENT REPORT

iWavePort WLM54G 1A
802.11g Channel 06 (5 of 5)

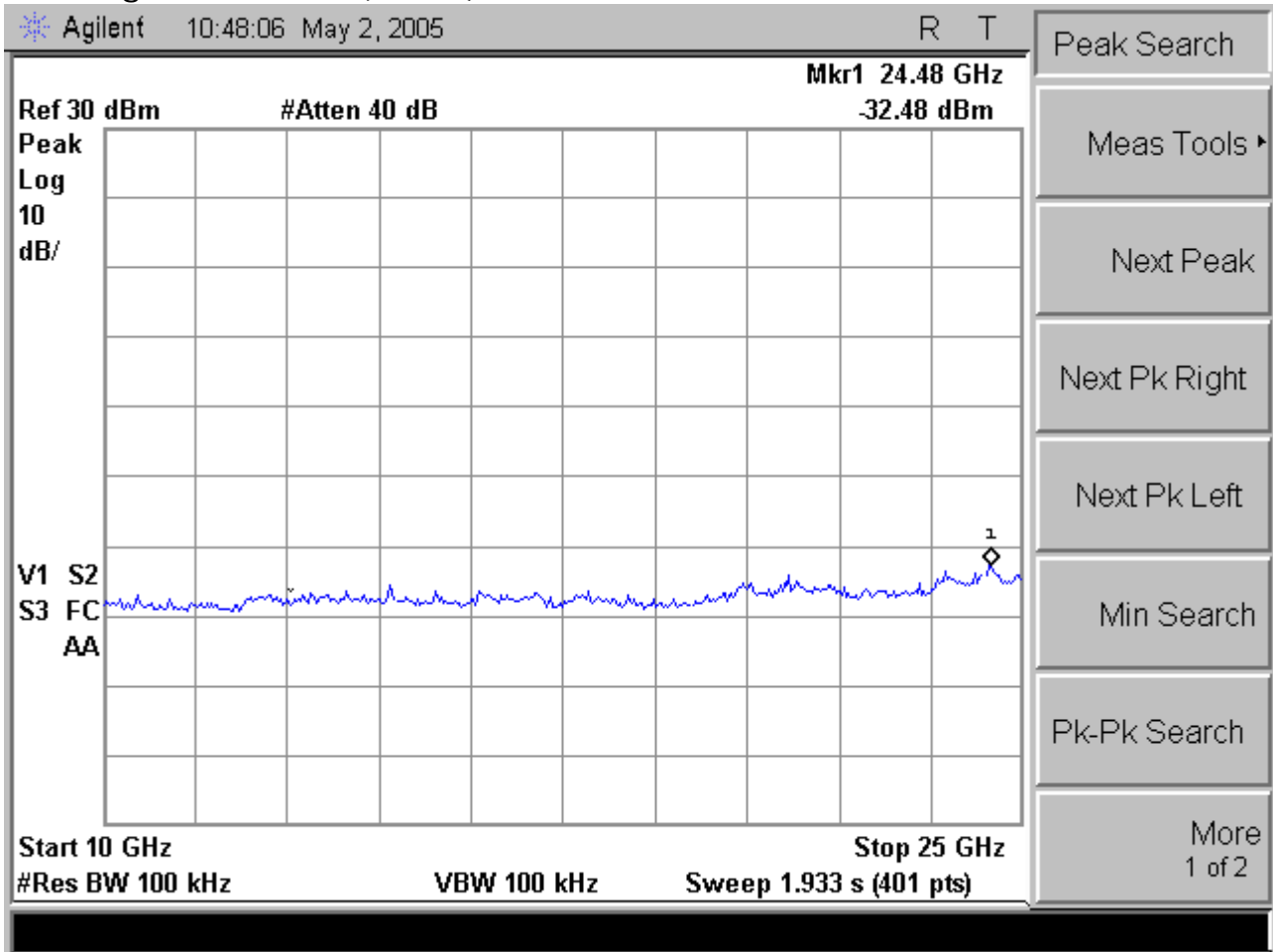



MAX LIGHT

MEASUREMENT REPORT

iWavePort WLM54G 1A
802.11g Channel 11 (1 of 5)

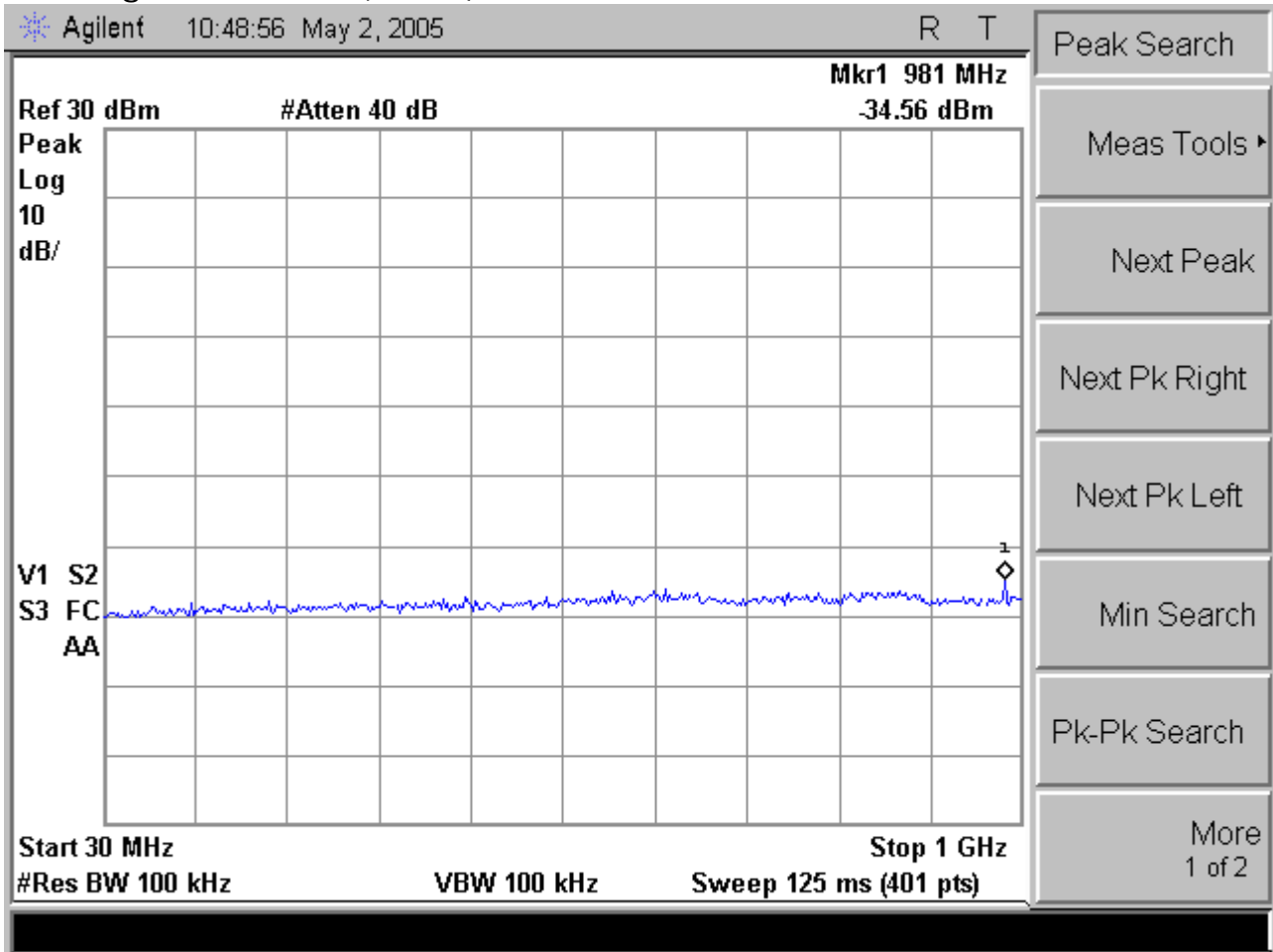



MAX LIGHT

MEASUREMENT REPORT

iWavePort WLM54G 1A
802.11g Channel 11 (2 of 5)

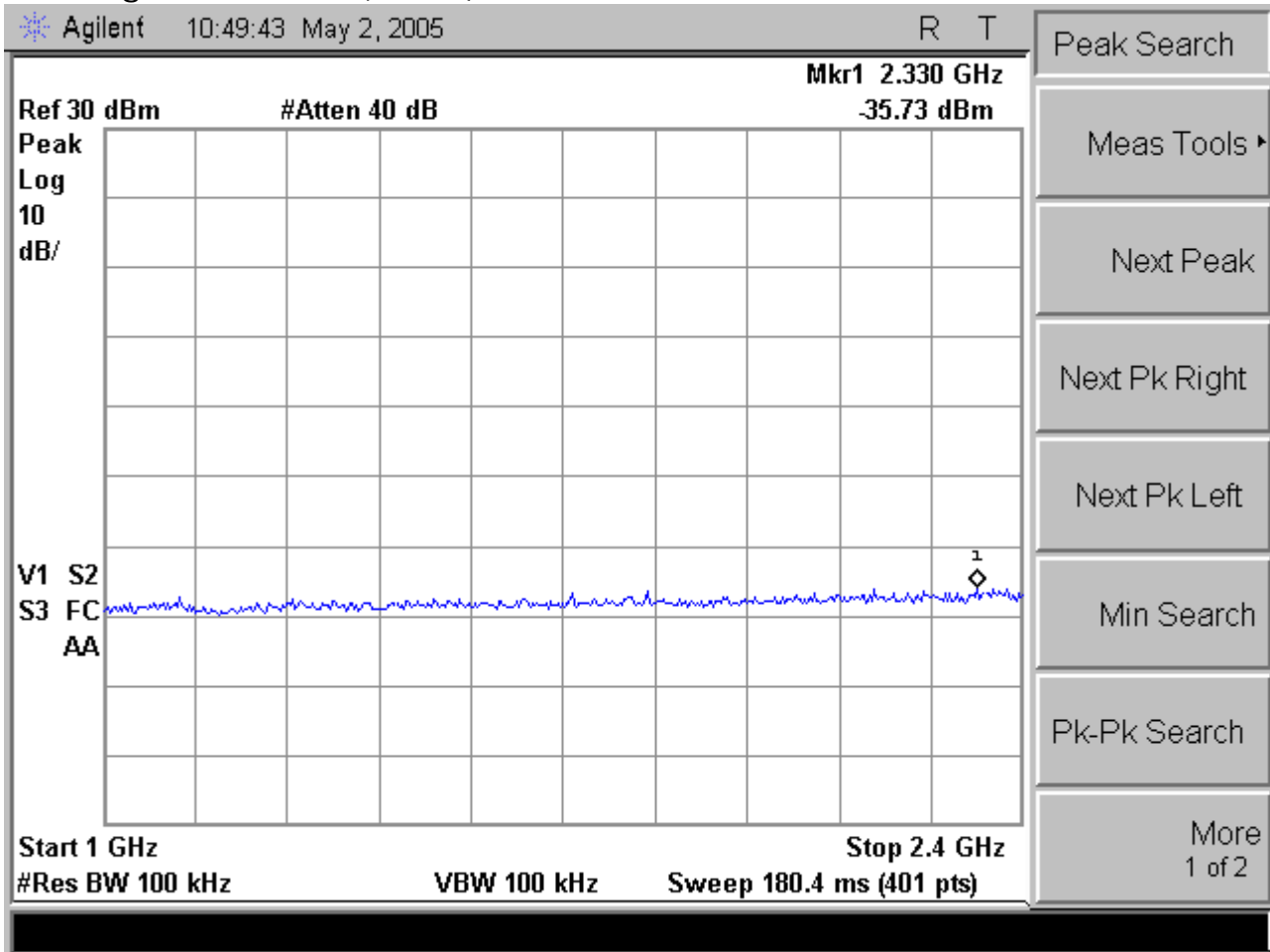

iWavePort WLM54G 1A
802.11g Channel 11 (3 of 5)

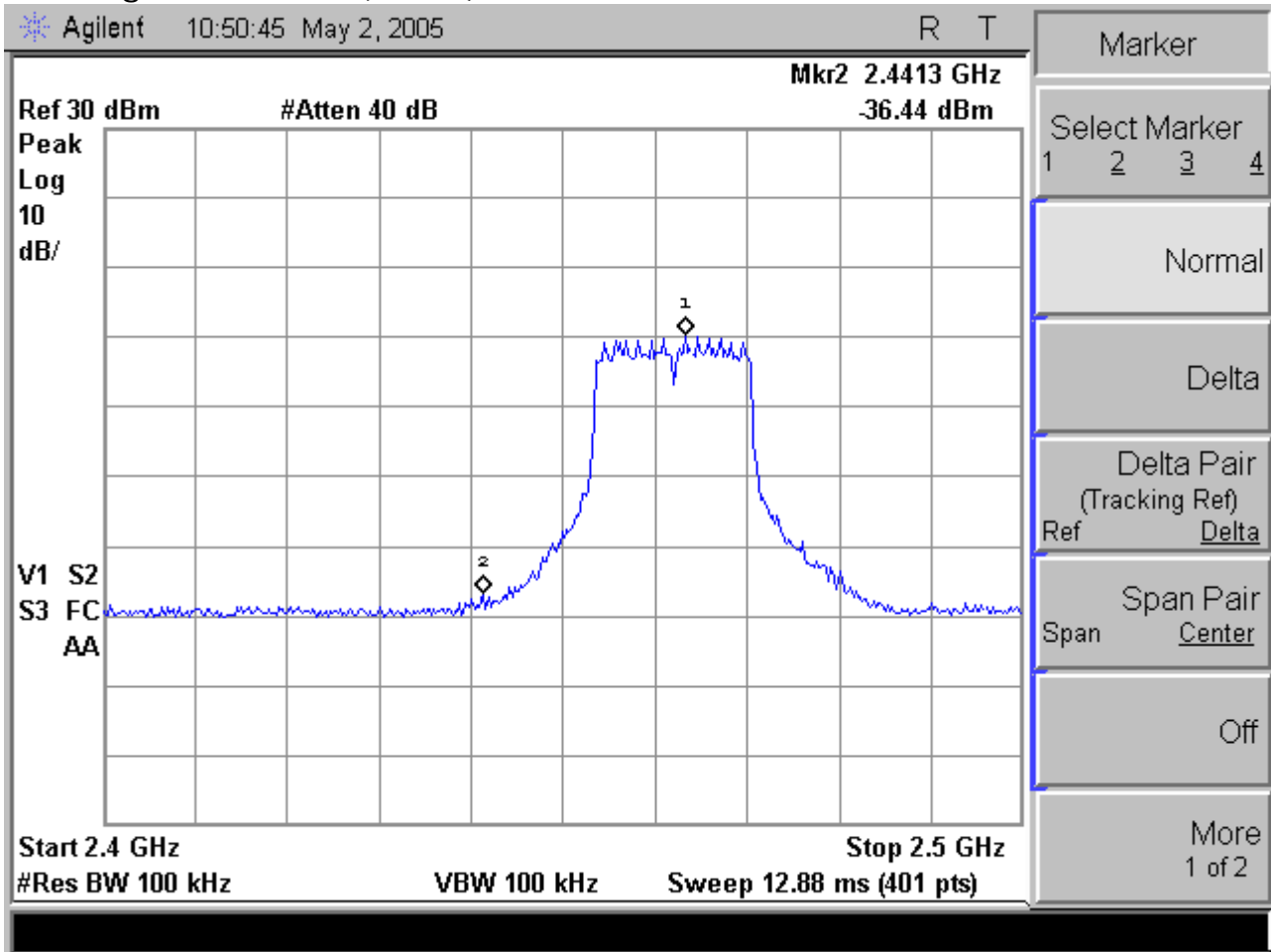



MAX LIGHT

MEASUREMENT REPORT

iWavePort WLM54G 1A
802.11g Channel 11 (4 of 5)

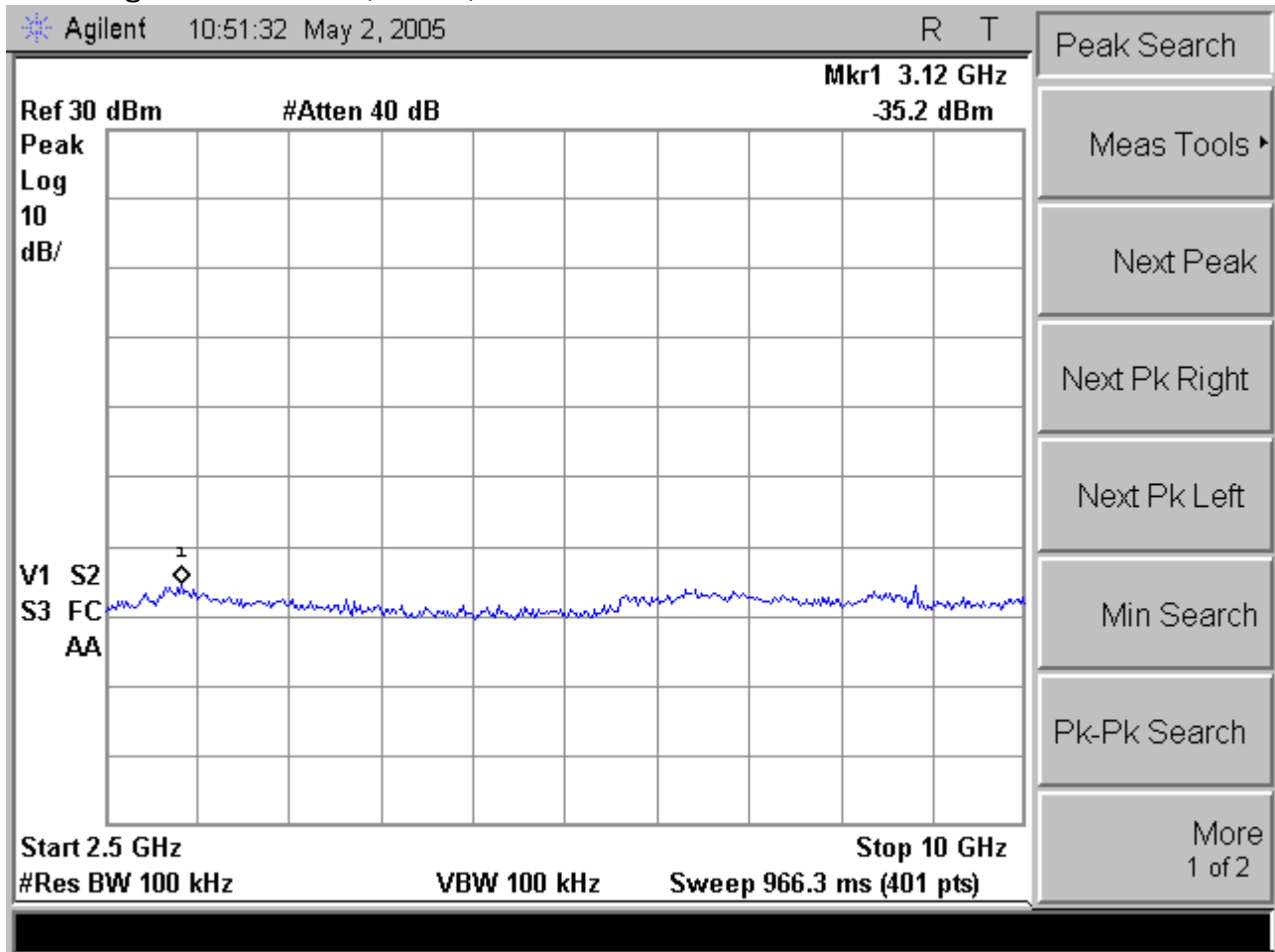



MAX LIGHT

MEASUREMENT REPORT

iWavePort WLM54G 1A
802.11g Channel 11 (5 of 5)

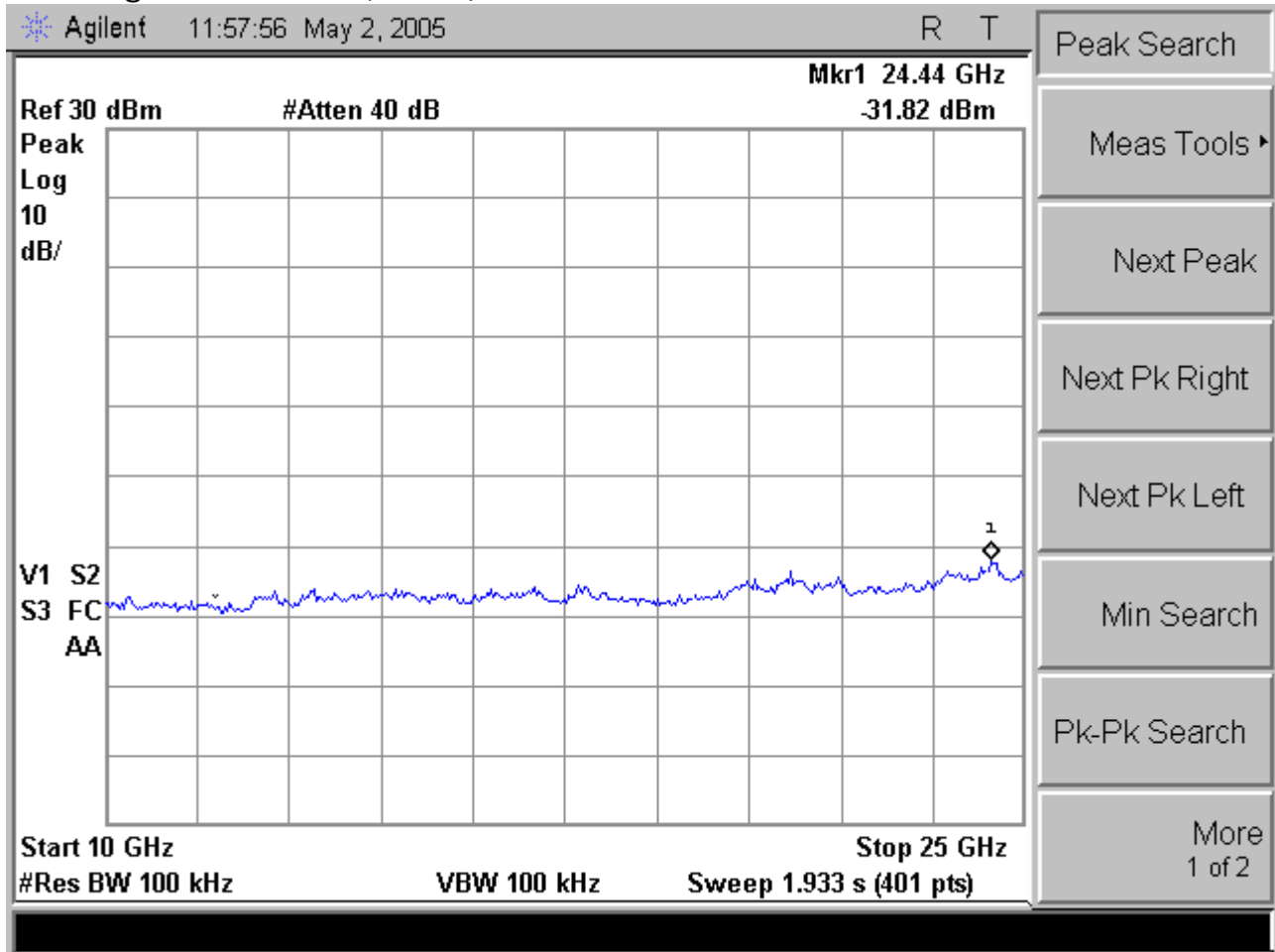



MAX LIGHT

MEASUREMENT REPORT

iWavePort WLM54G 1B
802.11b Channel 01 (1 of 5)

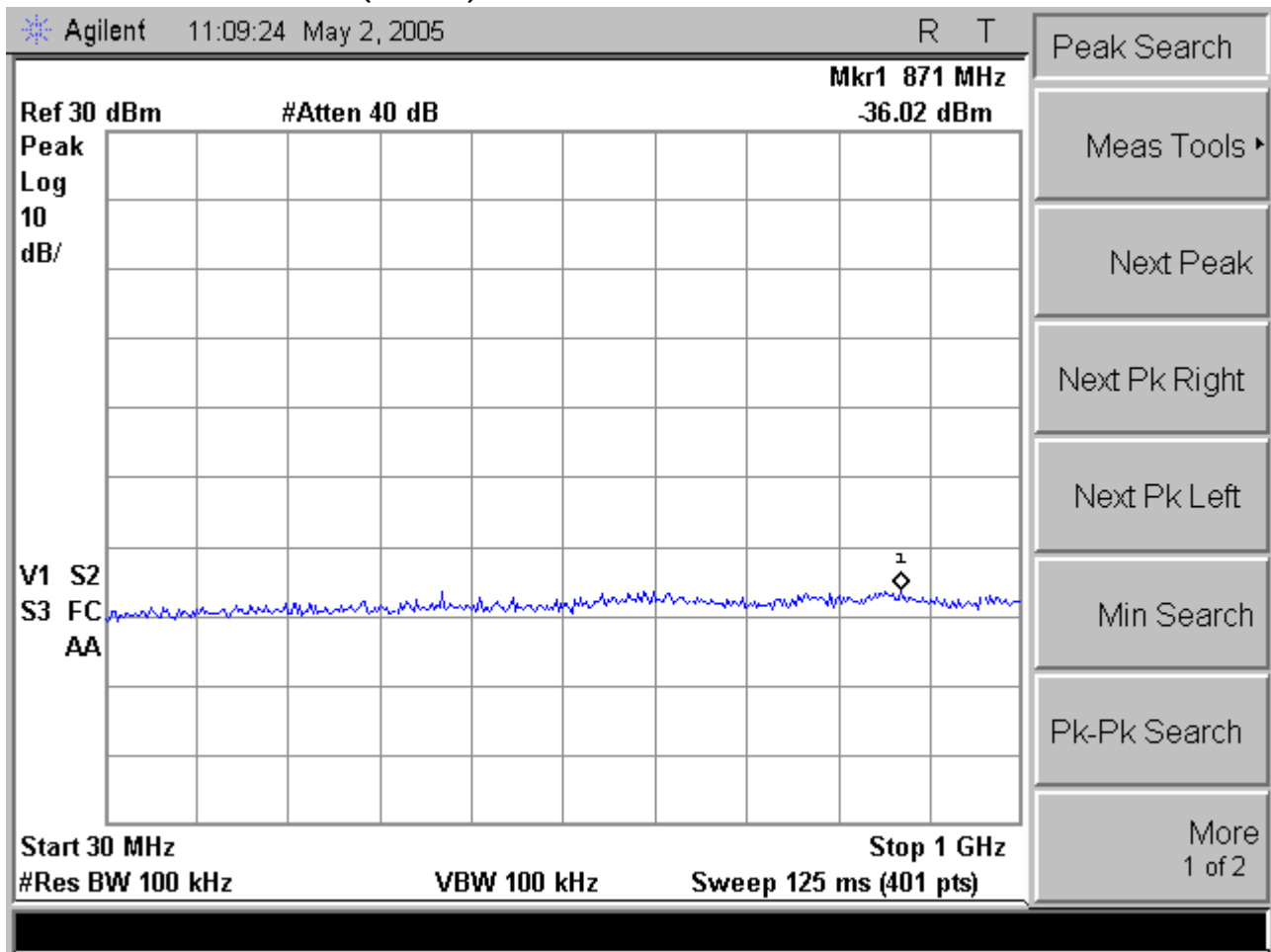



MAX LIGHT

MEASUREMENT REPORT

iWavePort WLM54G 1B
802.11b Channel 01 (2 of 5)

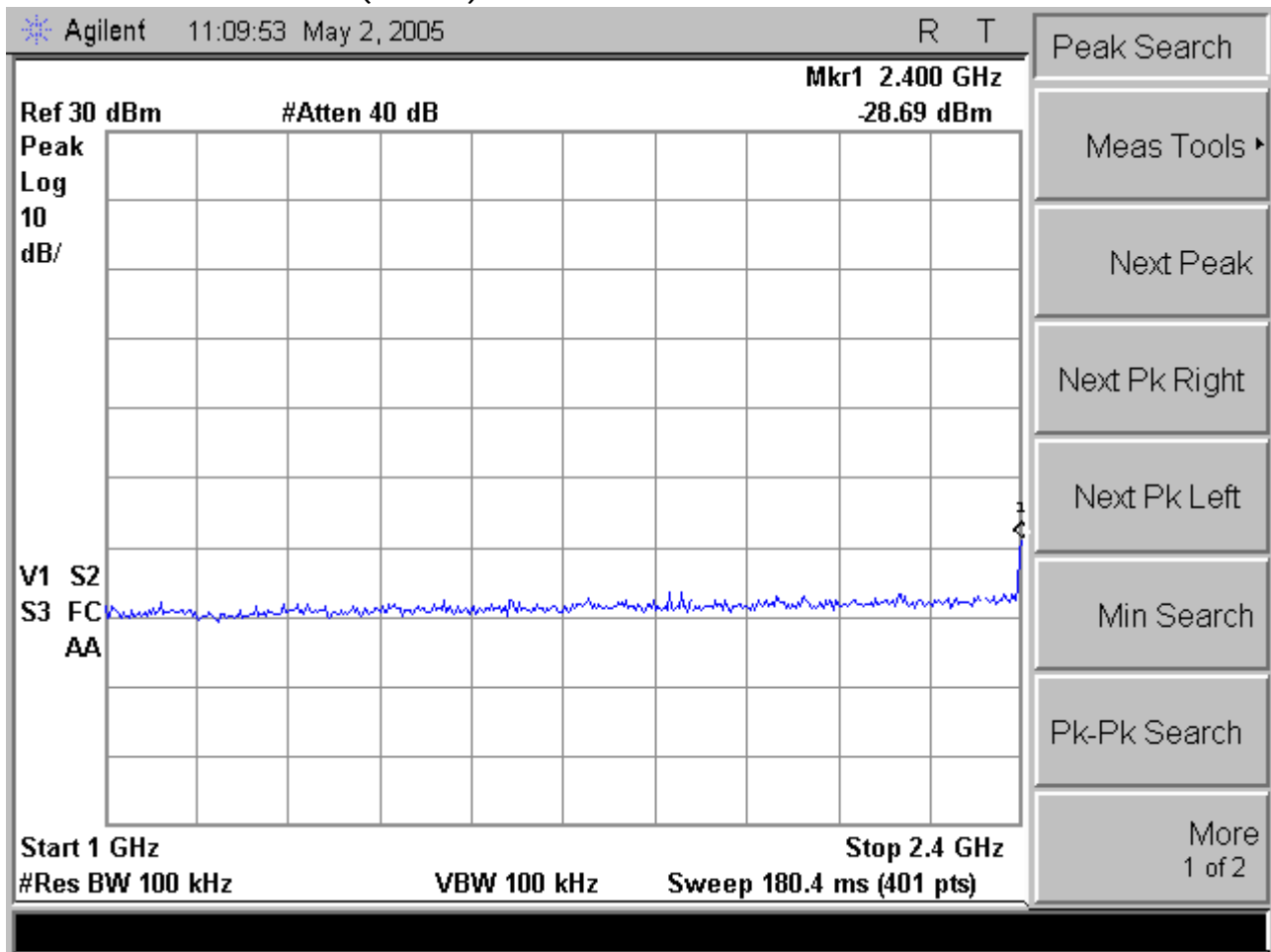

iWavePort WLM54G 1B
 802.11b Channel 01 (3 of 5)

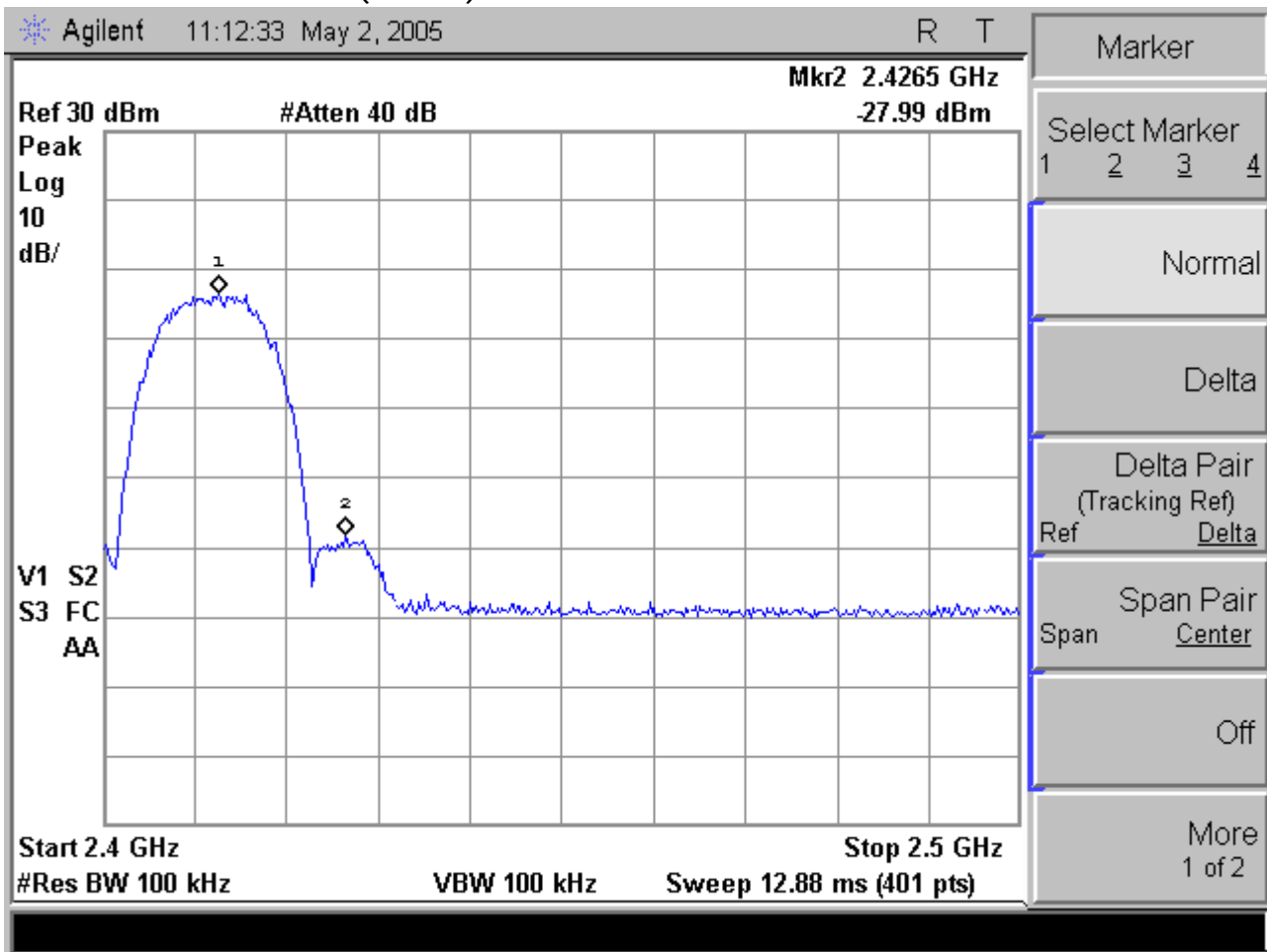



MAX LIGHT

MEASUREMENT REPORT

iWavePort WLM54G 1B
802.11b Channel 01 (4 of 5)

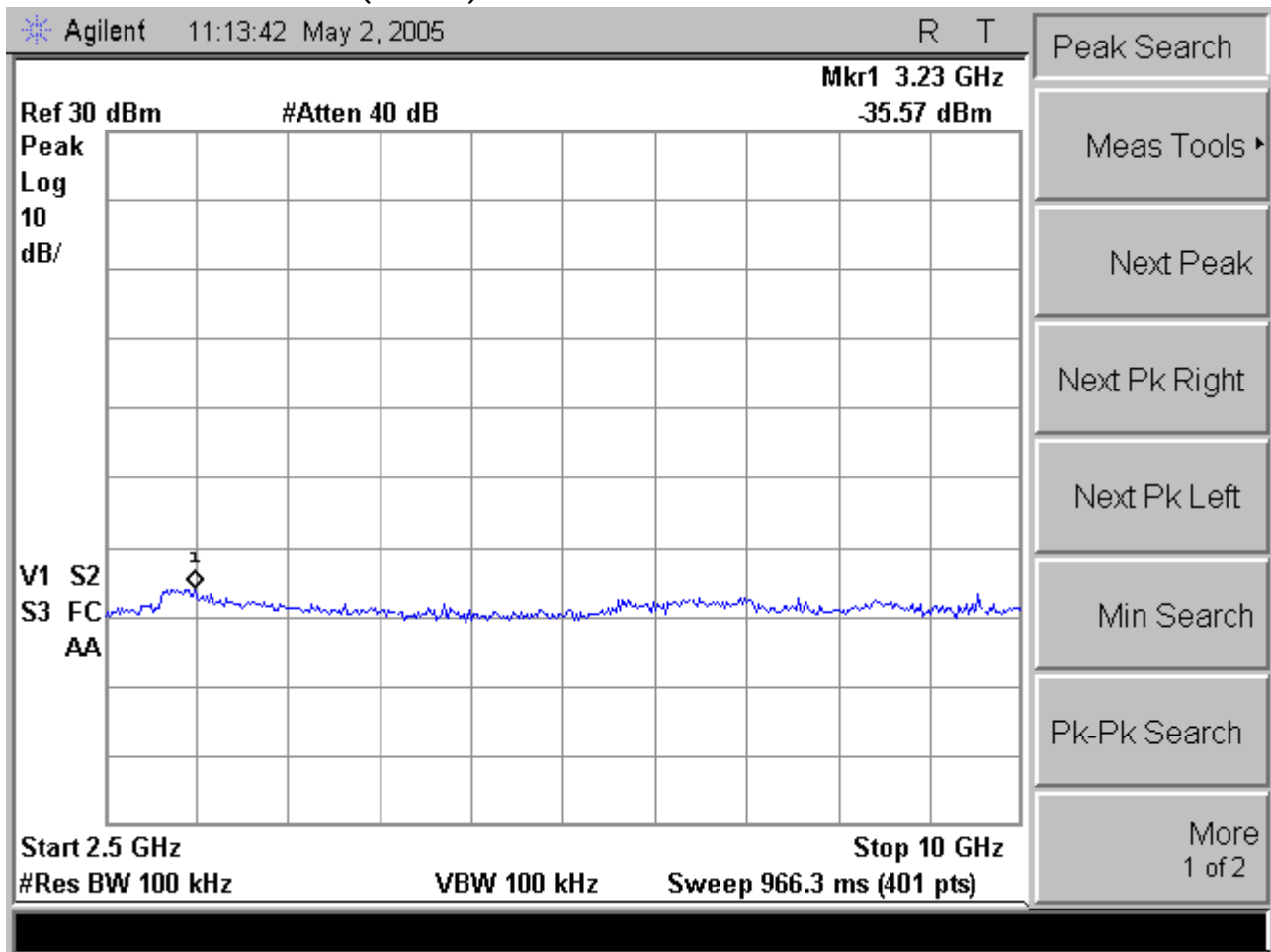



MAX LIGHT

MEASUREMENT REPORT

iWavePort WLM54G 1B
802.11b Channel 01 (5 of 5)

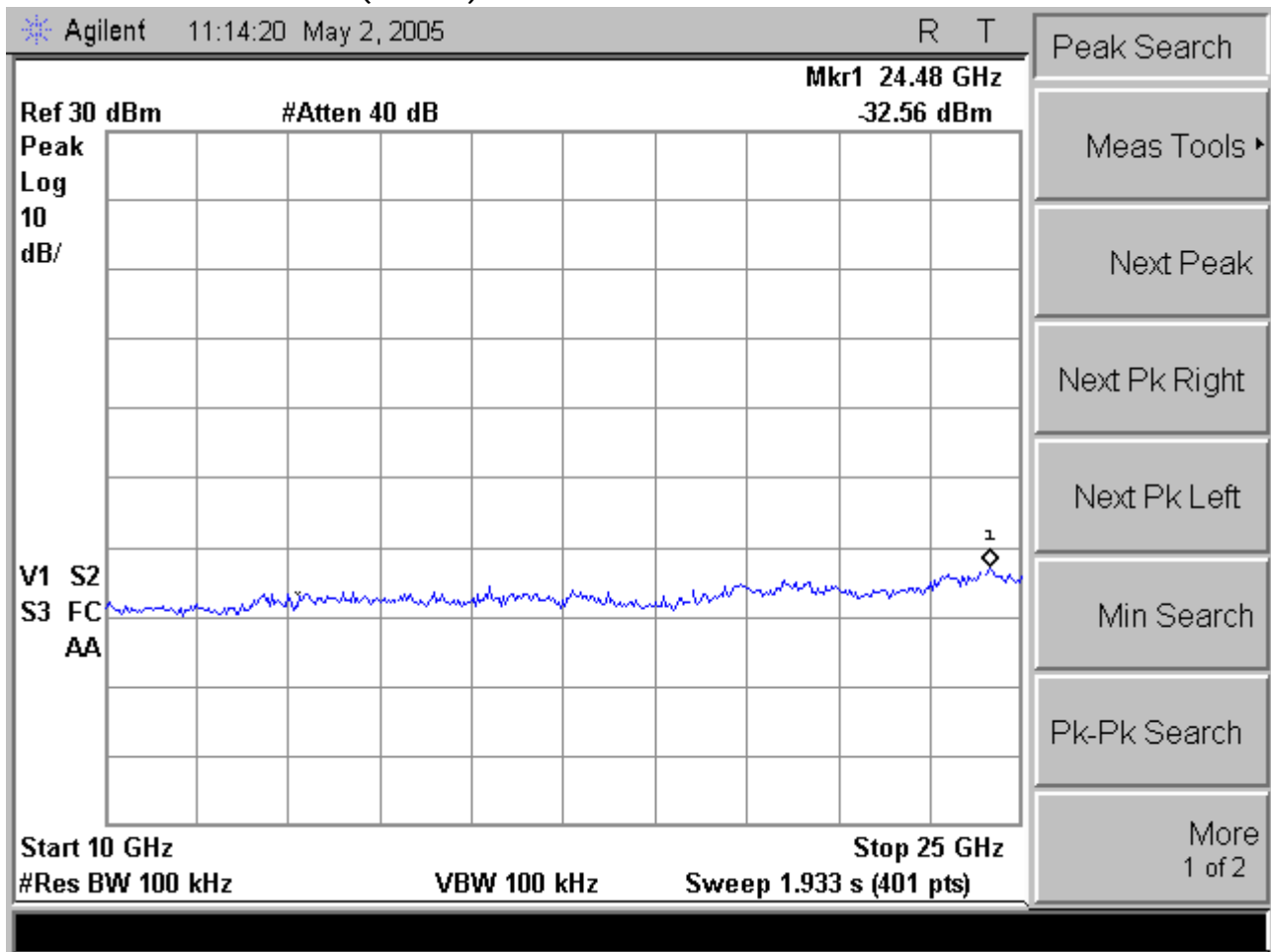



MAX LIGHT

MEASUREMENT REPORT

iWavePort WLM54G 1B
802.11b Channel 06 (1 of 5)

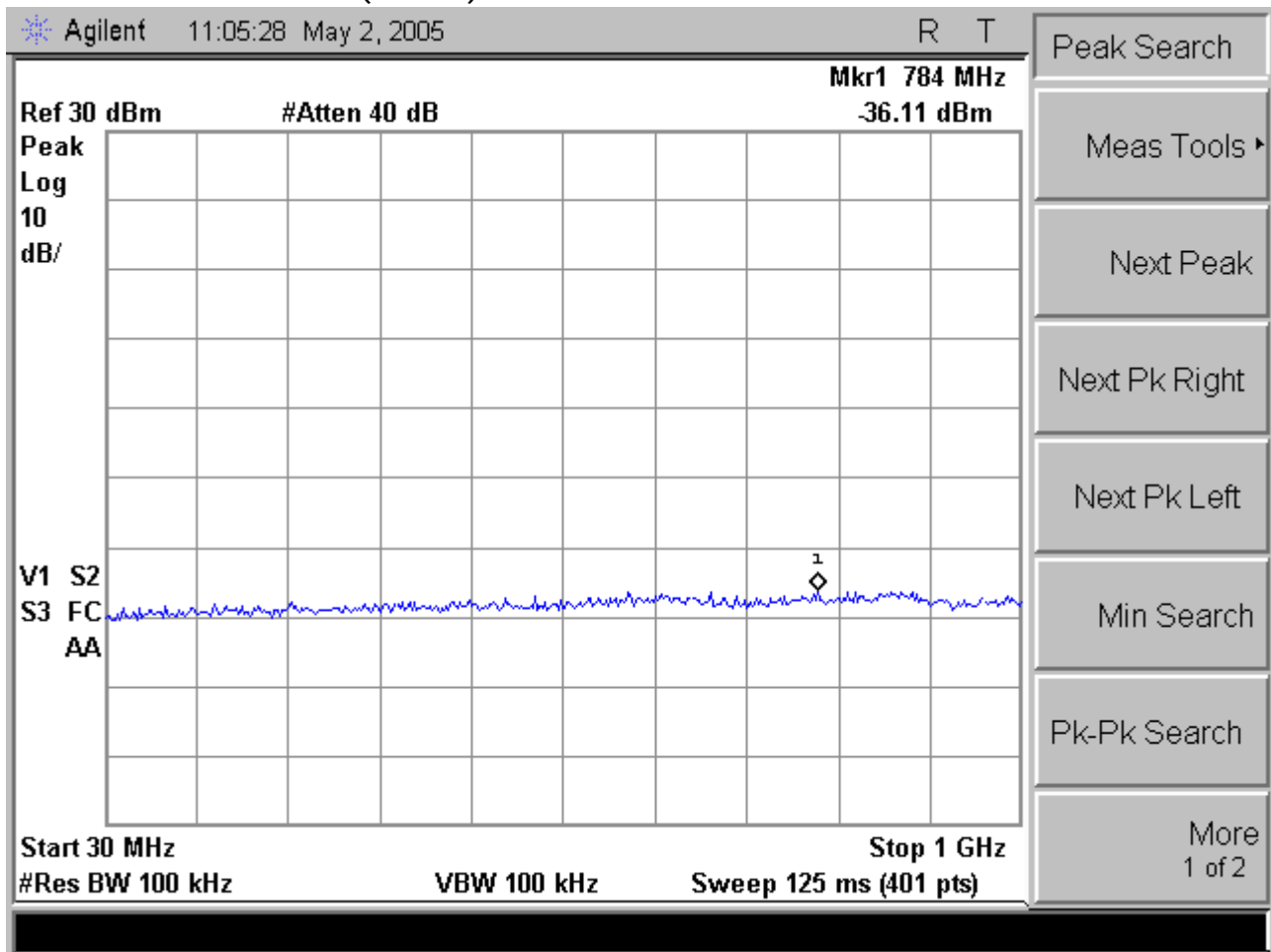



MAX LIGHT

MEASUREMENT REPORT

iWavePort WLM54G 1B
802.11b Channel 06 (2 of 5)

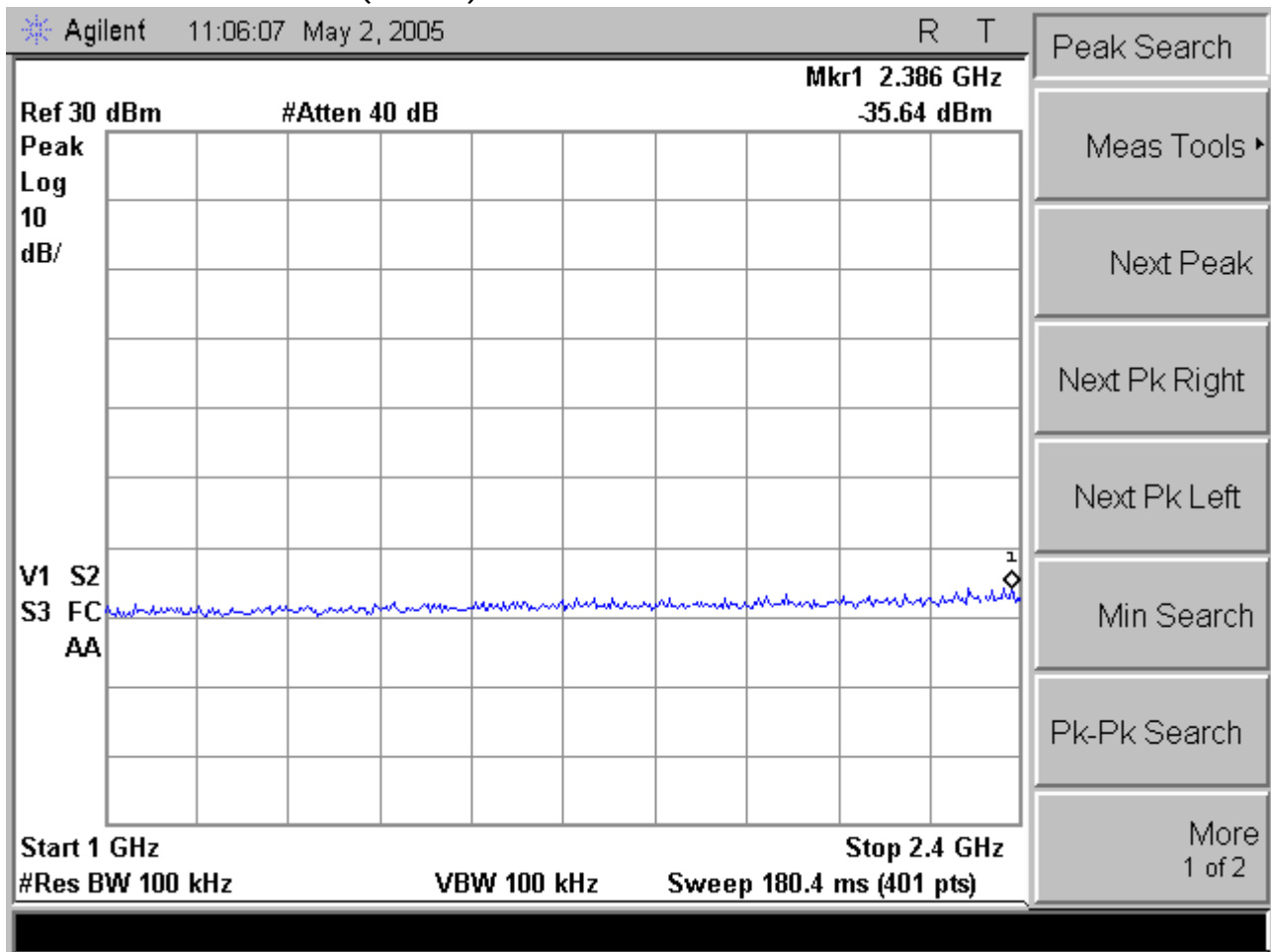

iWavePort WLM54G 1B
 802.11b Channel 06 (3 of 5)

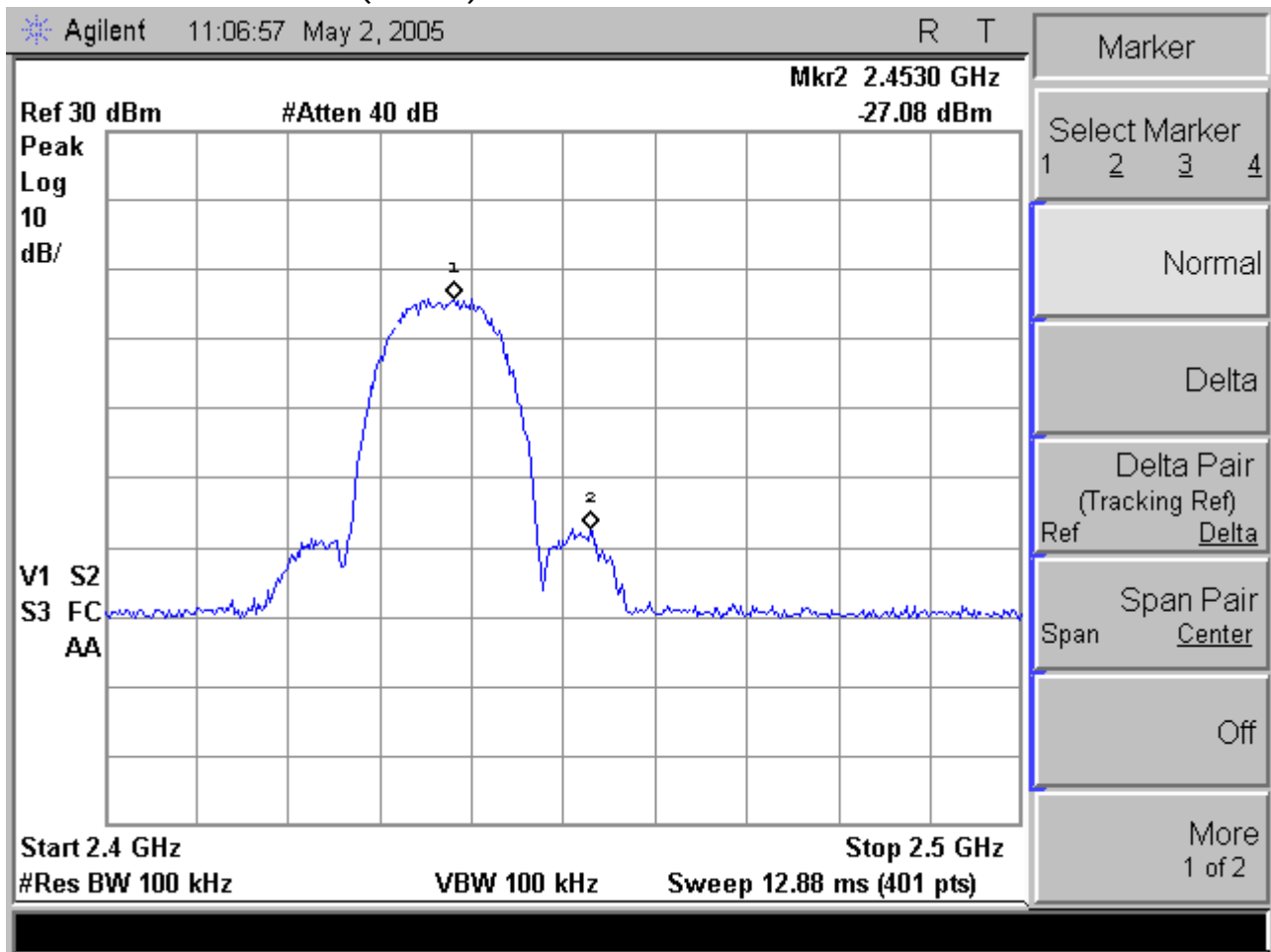



MAX LIGHT

MEASUREMENT REPORT

iWavePort WLM54G 1B
802.11b Channel 06 (4 of 5)

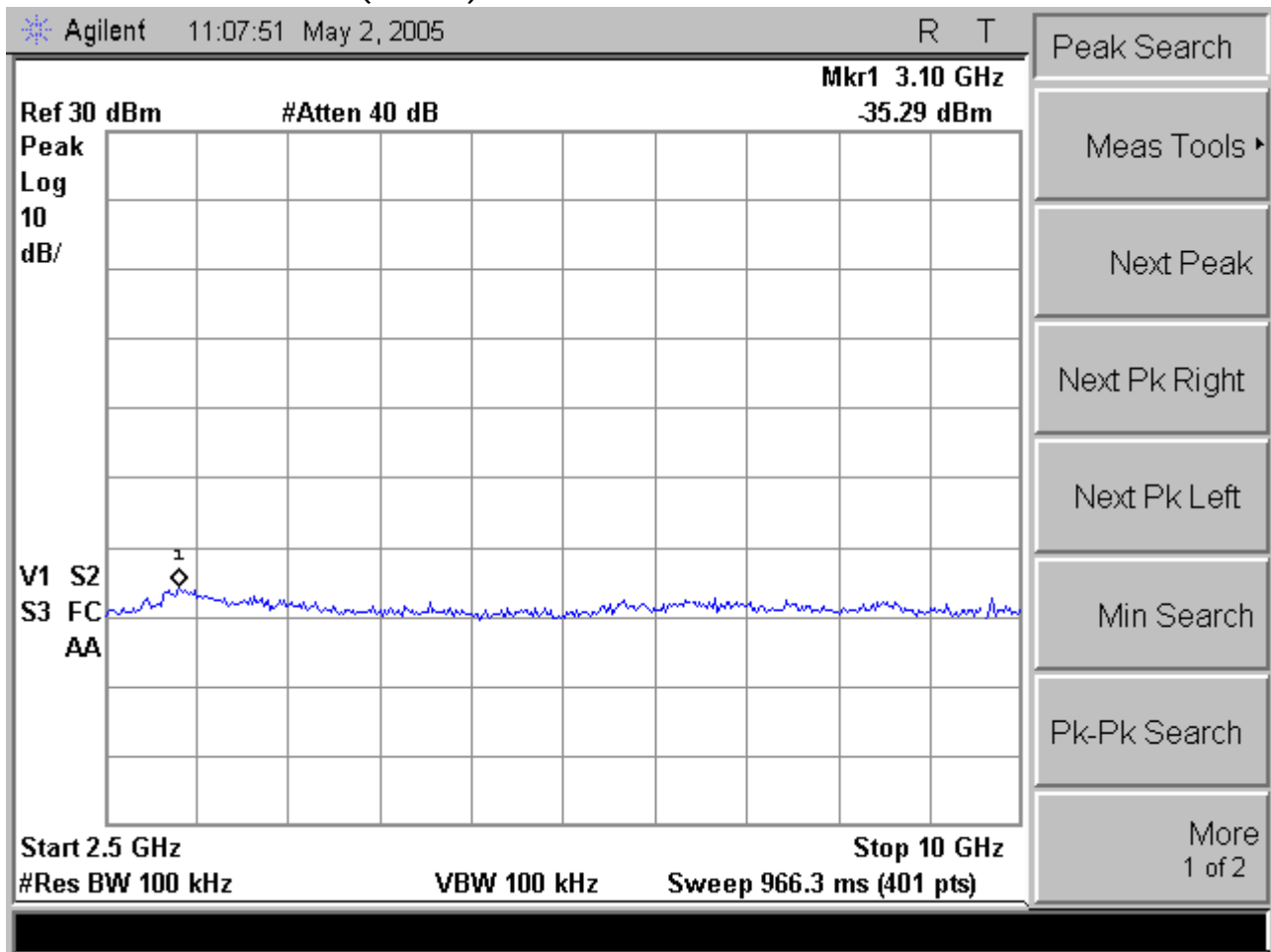



MAX LIGHT

MEASUREMENT REPORT

iWavePort WLM54G 1B
802.11b Channel 06 (5 of 5)

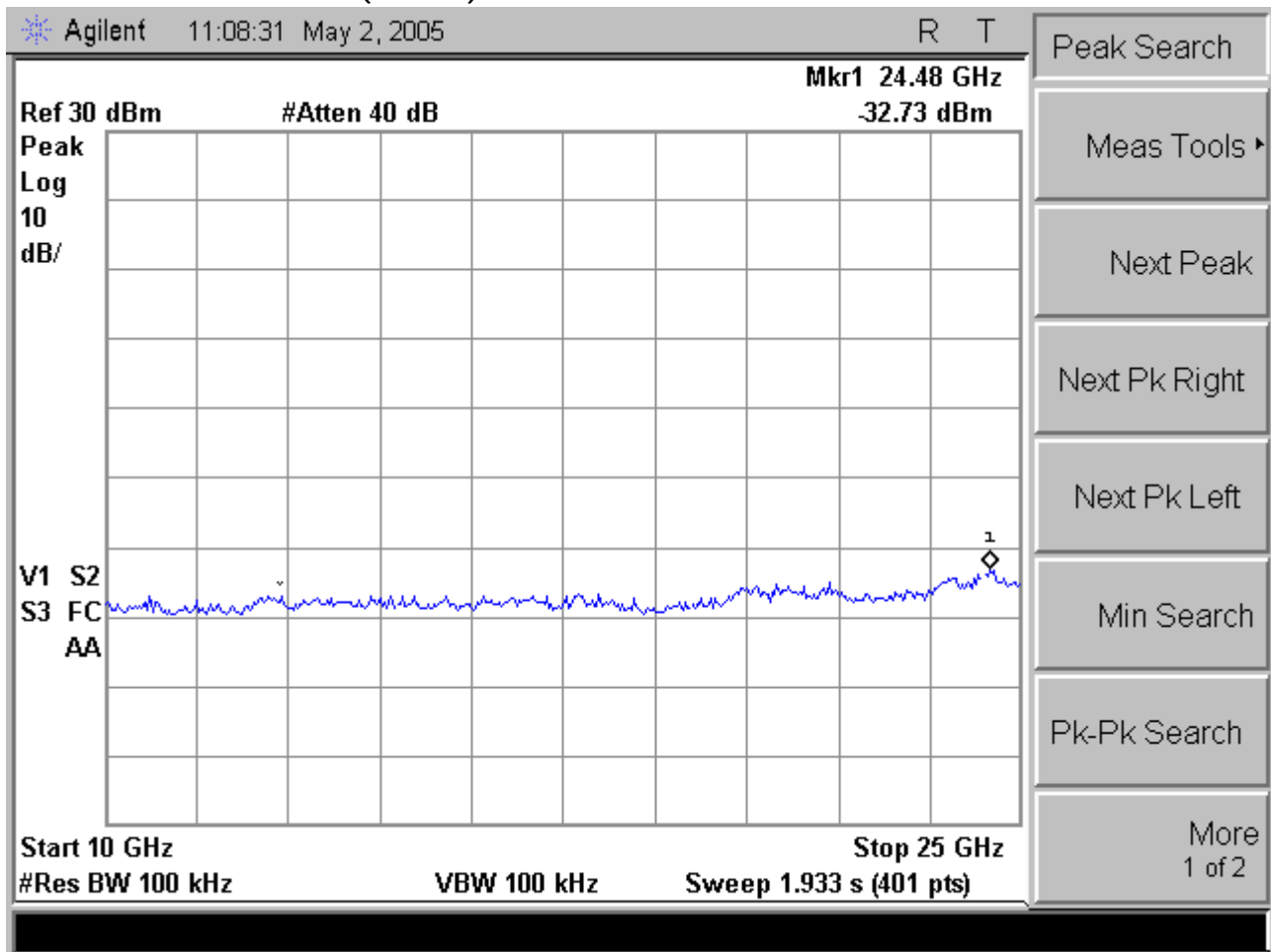



MAX LIGHT

MEASUREMENT REPORT

iWavePort WLM54G 1B
802.11b Channel 11 (1 of 5)

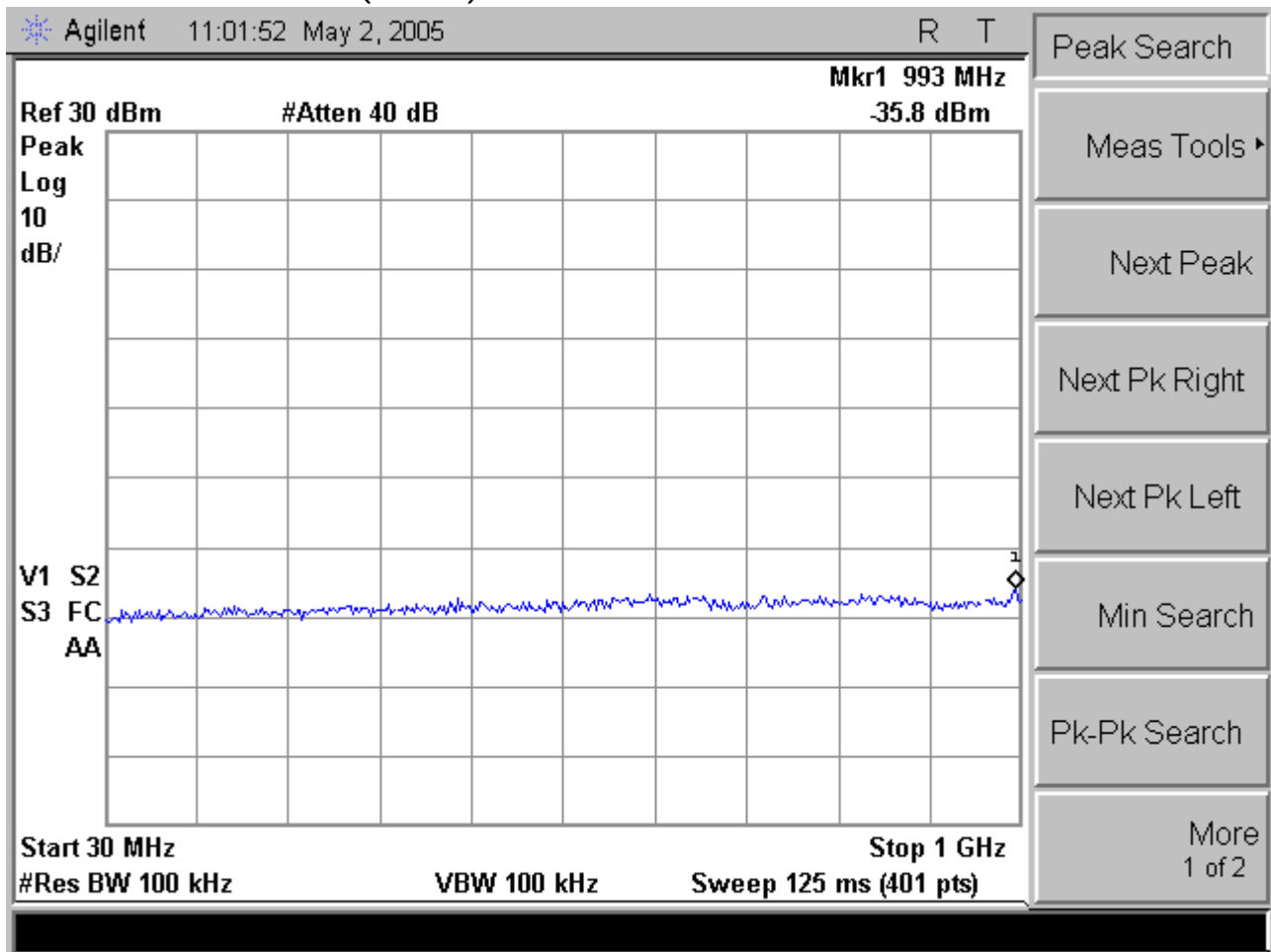



MAX LIGHT

MEASUREMENT REPORT

iWavePort WLM54G 1B
802.11b Channel 11 (2 of 5)

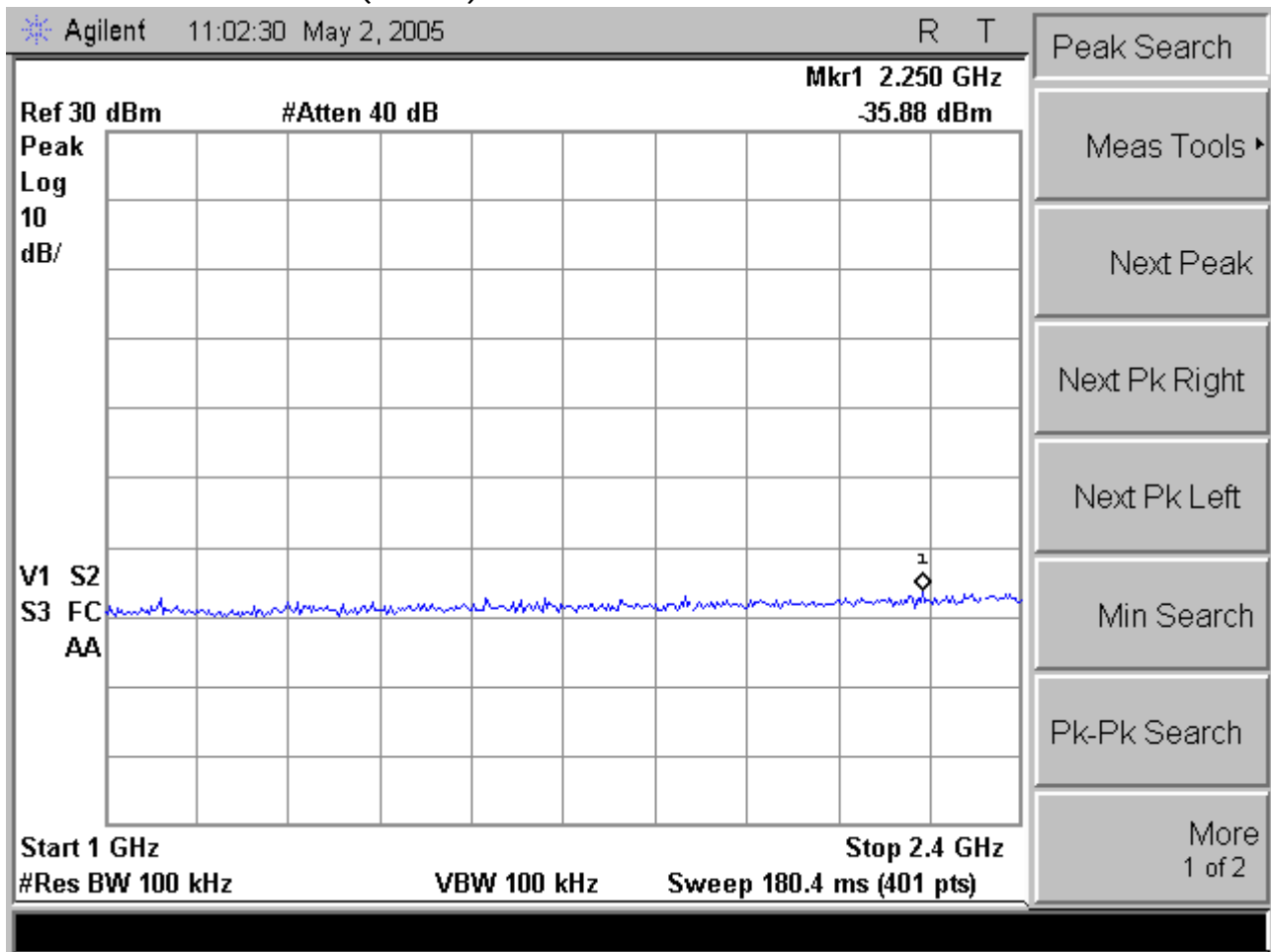

iWavePort WLM54G 1B
802.11b Channel 11 (3 of 5)

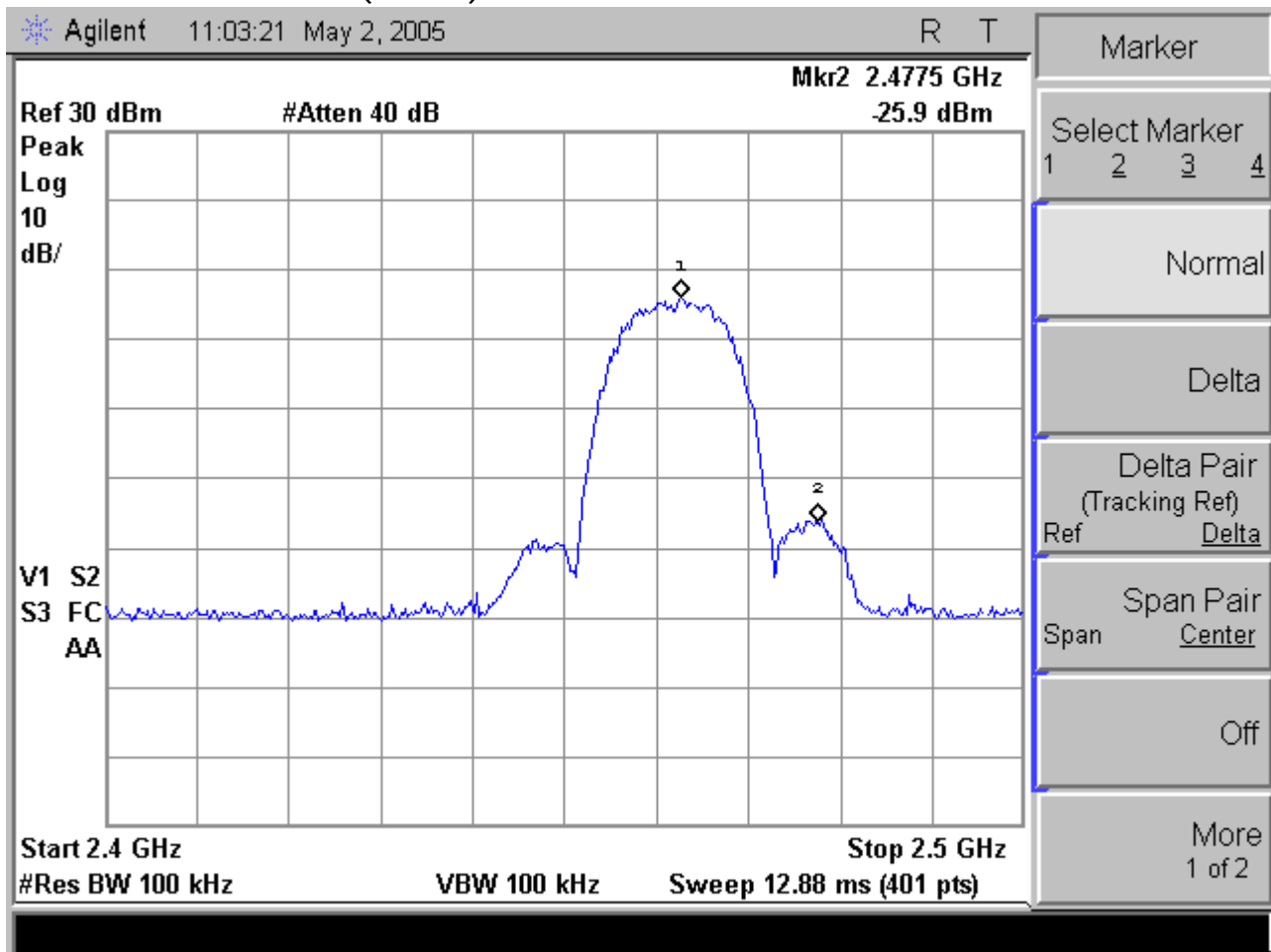

iWavePort WLM54G 1B
802.11b Channel 11 (4 of 5)

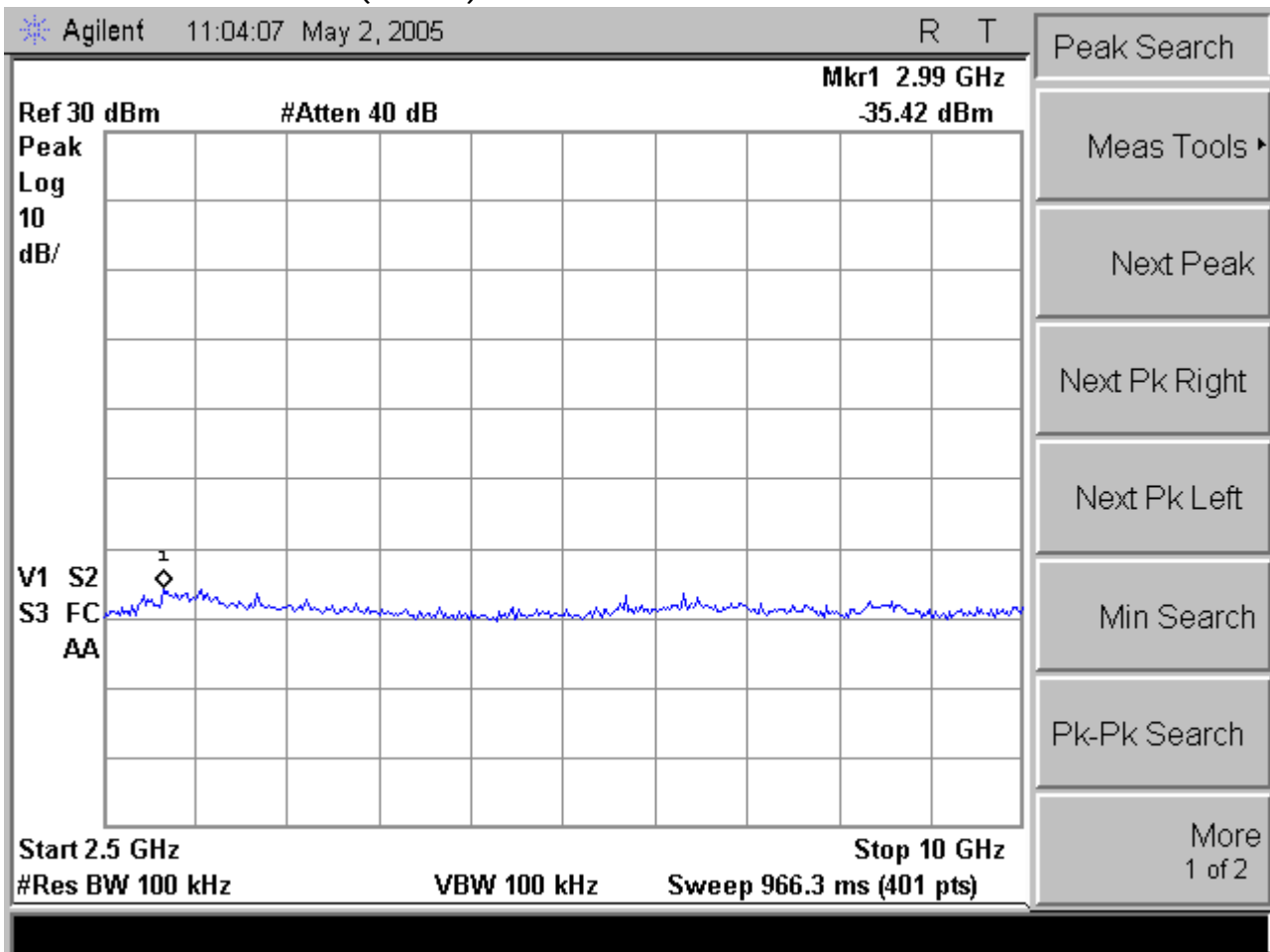



MAX LIGHT

MEASUREMENT REPORT

iWavePort WLM54G 1B
802.11b Channel 11 (5 of 5)

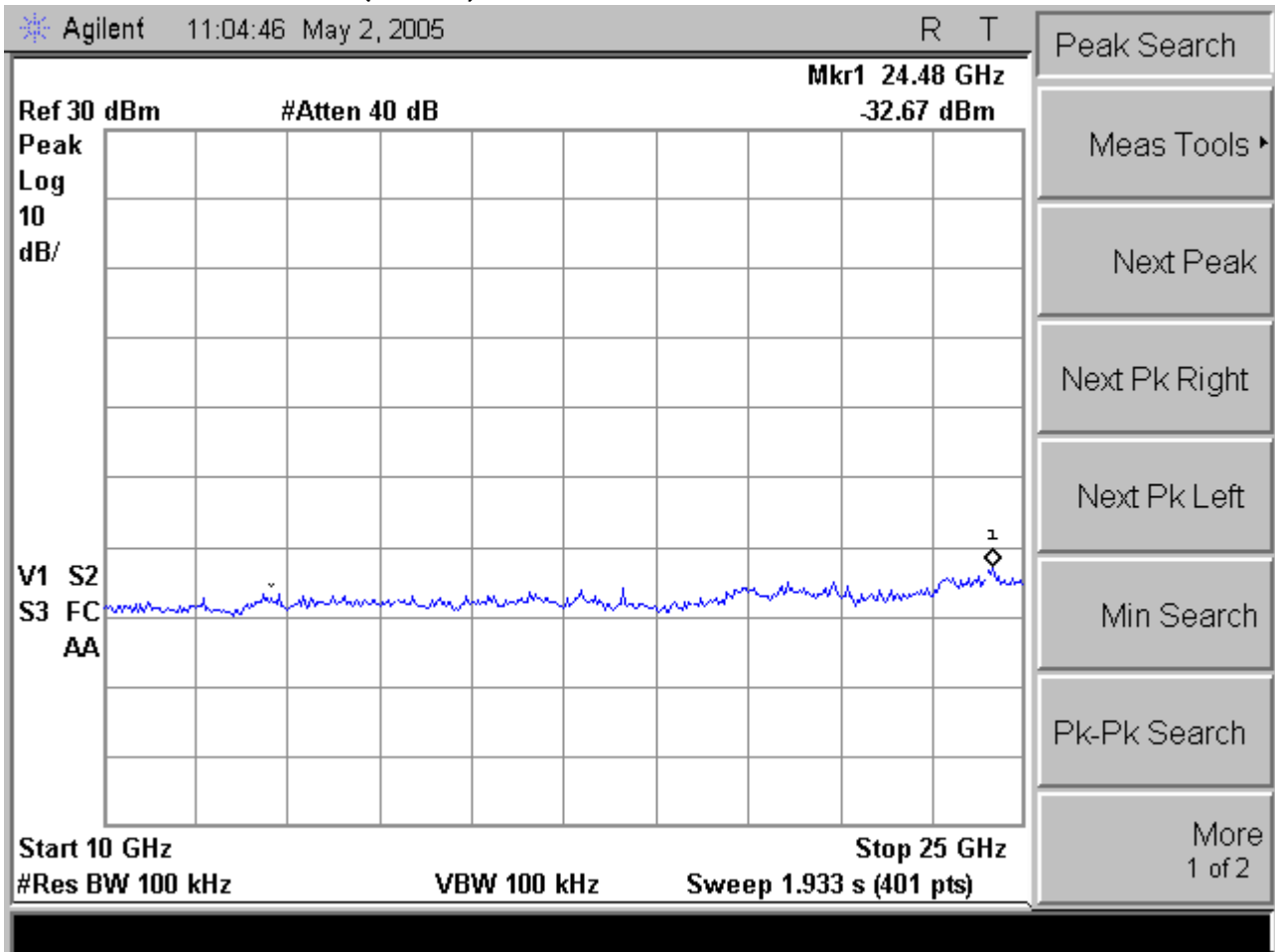



MAX LIGHT

MEASUREMENT REPORT

iWavePort WLM54G 1B
802.11g Channel 01 (1 of 5)

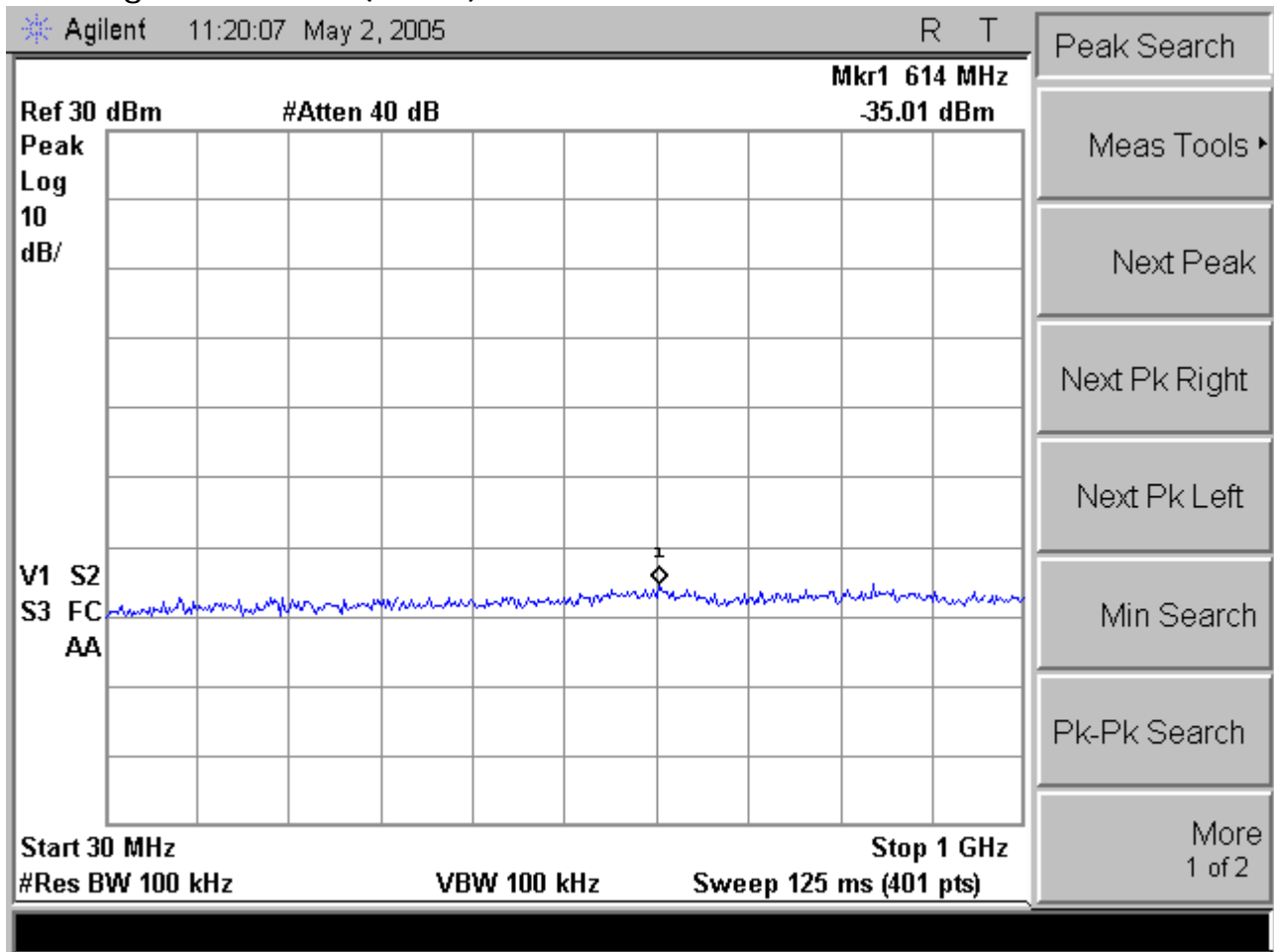



MAX LIGHT

MEASUREMENT REPORT

iWavePort WLM54G 1B
802.11g Channel 01 (2 of 5)

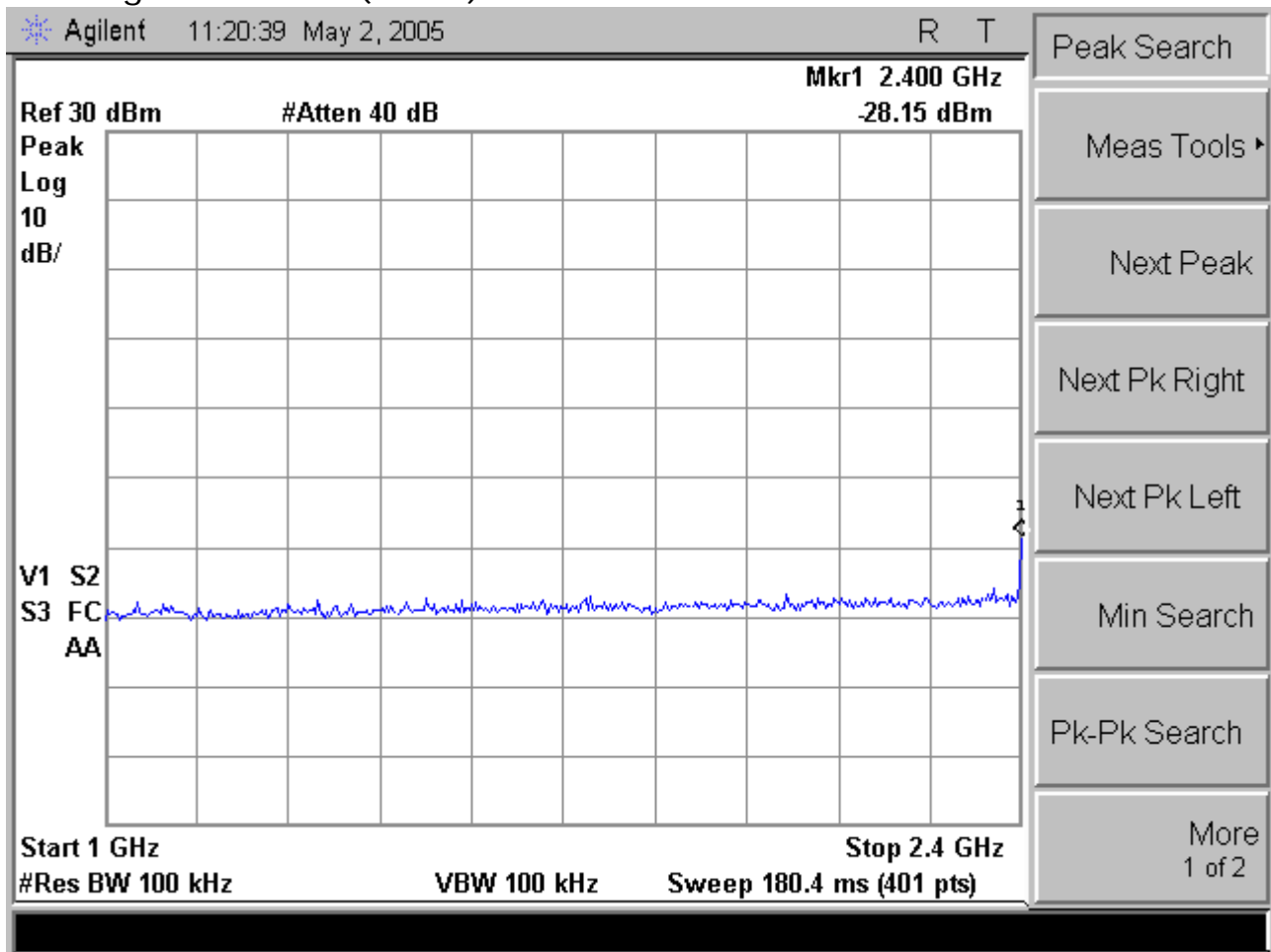

iWavePort WLM54G 1B
 802.11g Channel 01 (3 of 5)

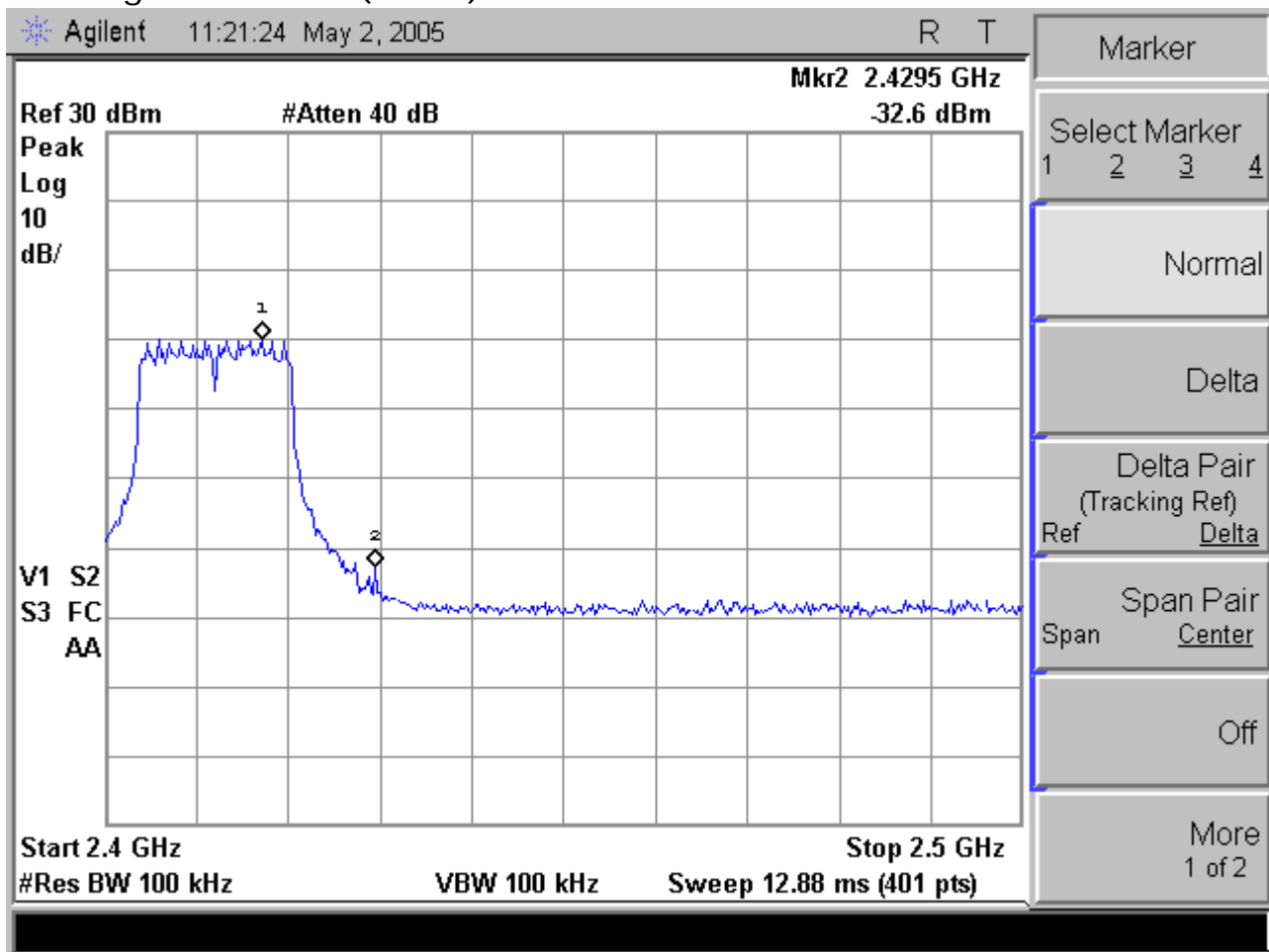



MAX LIGHT

MEASUREMENT REPORT

iWavePort WLM54G 1B
802.11g Channel 01 (4 of 5)

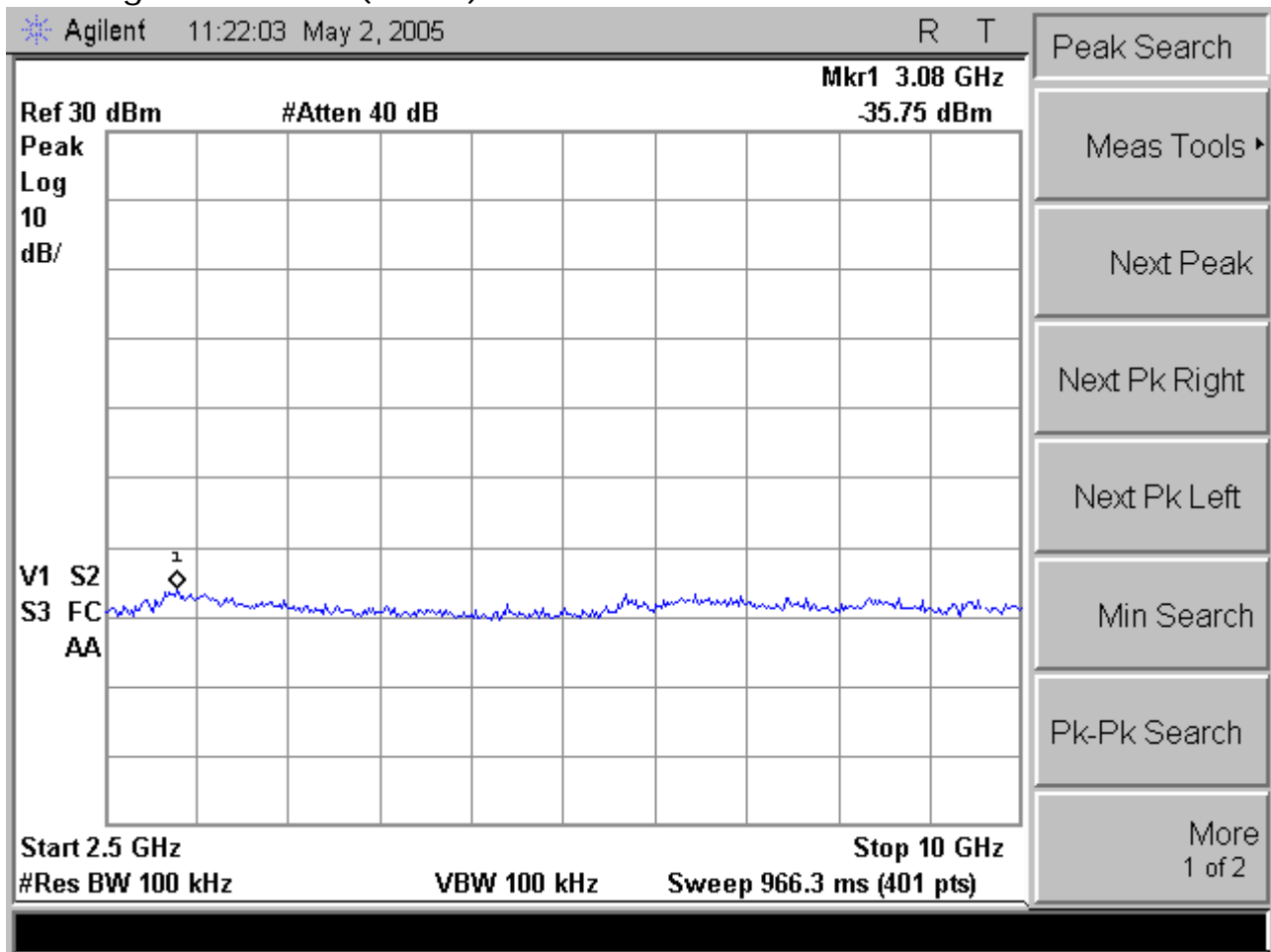



MAX LIGHT

MEASUREMENT REPORT

iWavePort WLM54G 1B
802.11g Channel 01 (5 of 5)

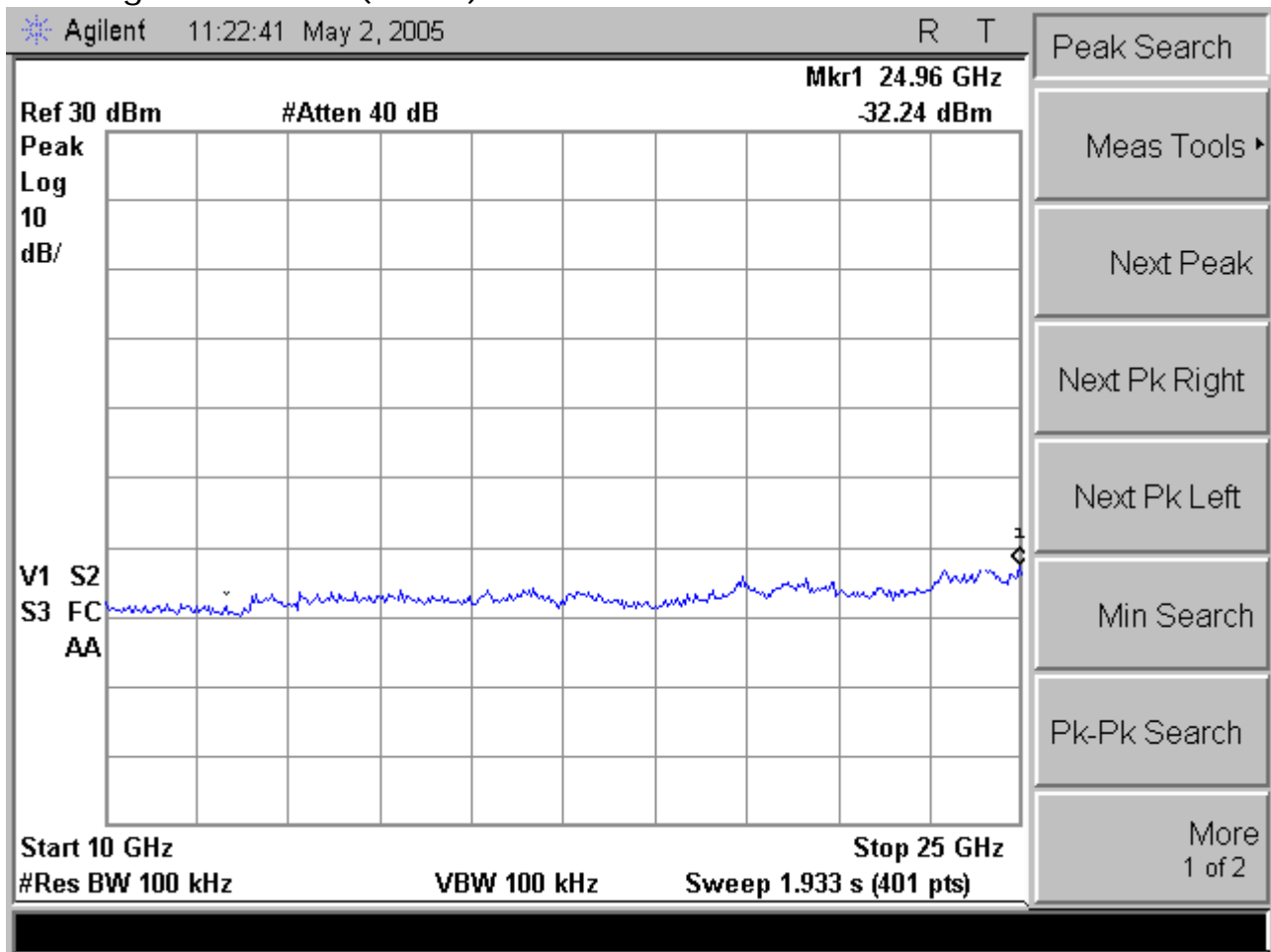



MAX LIGHT

MEASUREMENT REPORT

iWavePort WLM54G 1B
802.11g Channel 06 (1 of 5)

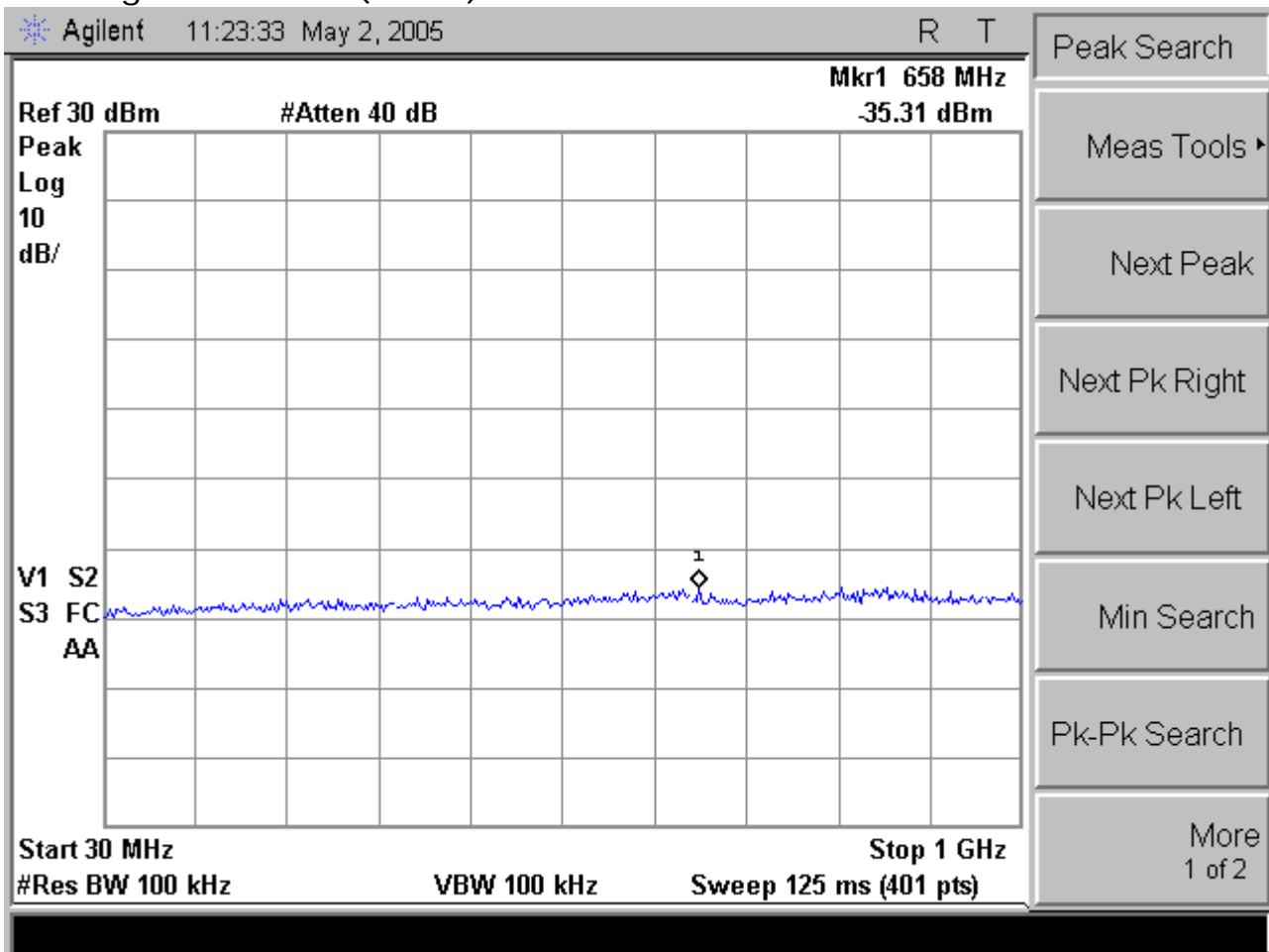



MAX LIGHT

MEASUREMENT REPORT

iWavePort WLM54G 1B
802.11g Channel 06 (2 of 5)

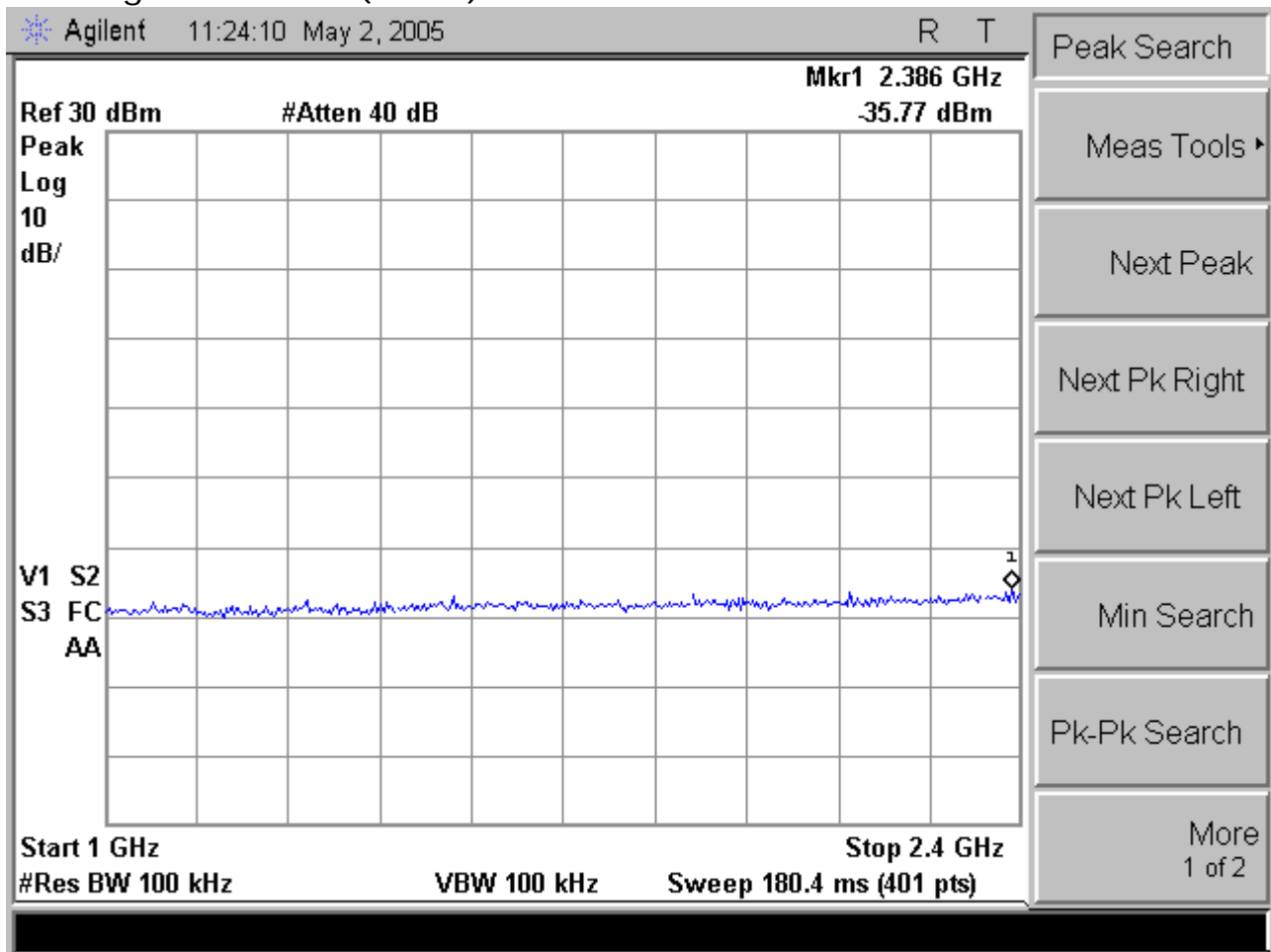

iWavePort WLM54G 1B
 802.11g Channel 06 (3 of 5)

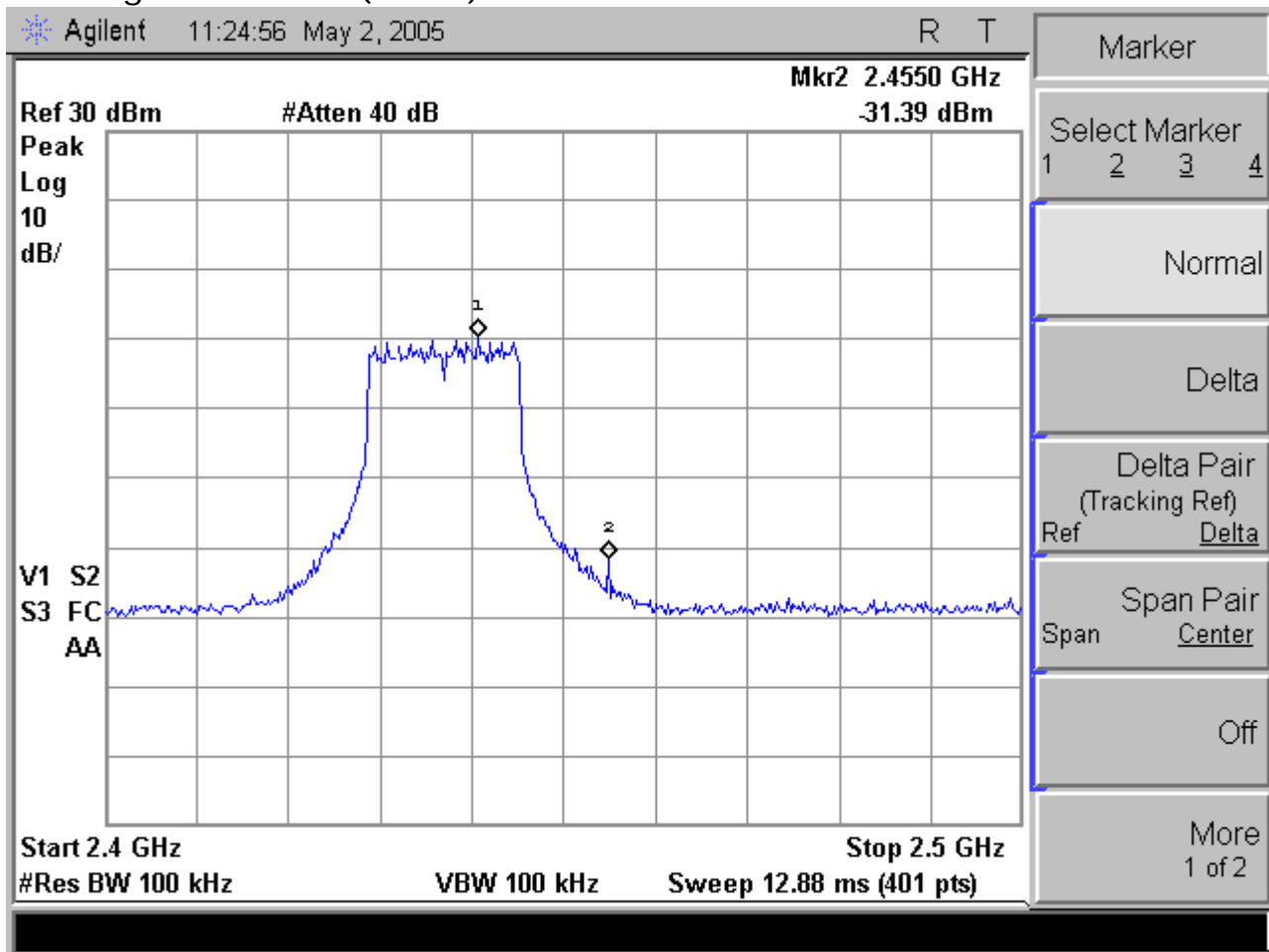



MAX LIGHT

MEASUREMENT REPORT

iWavePort WLM54G 1B
802.11g Channel 06 (4 of 5)

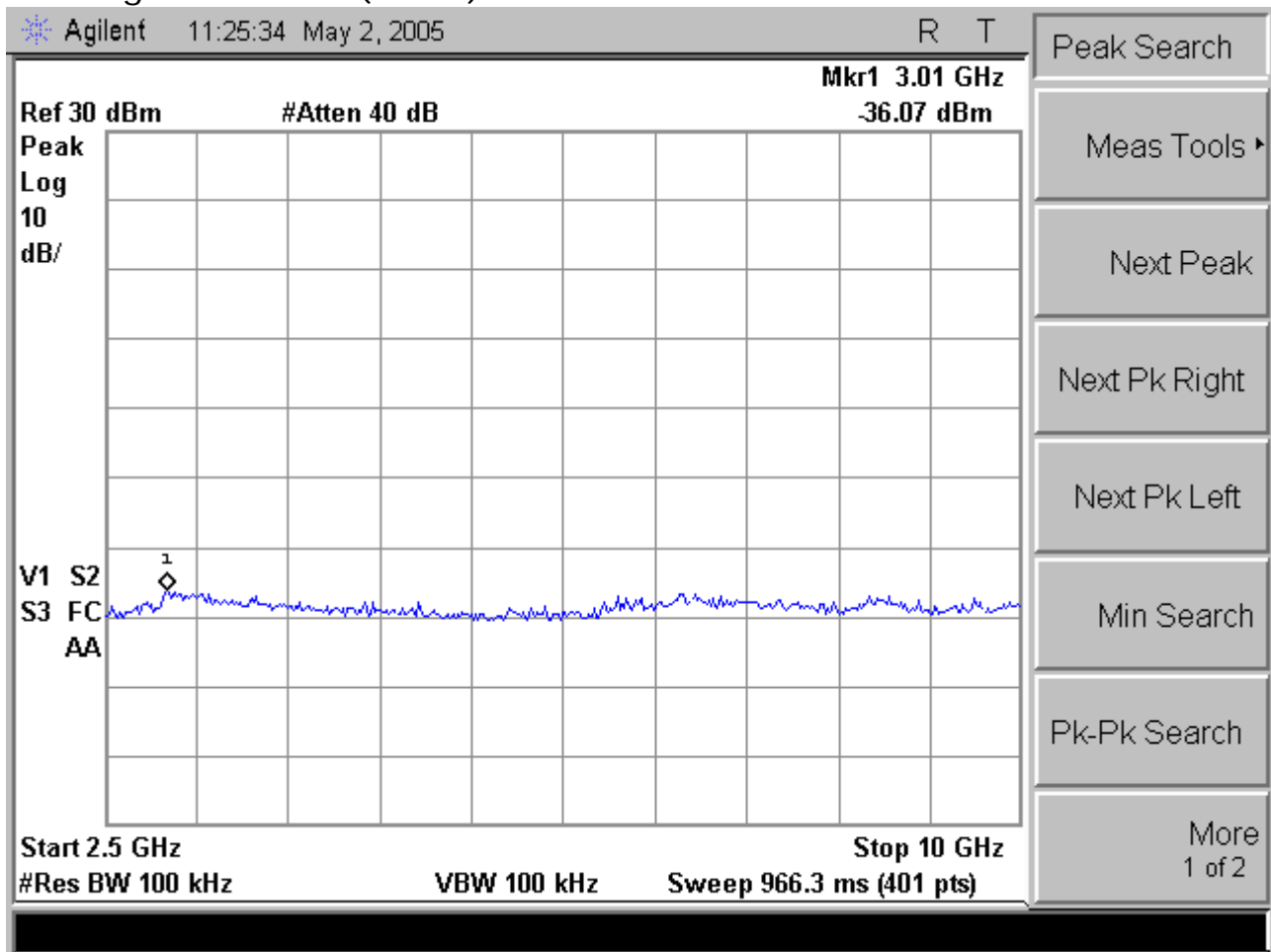



MAX LIGHT

MEASUREMENT REPORT

iWavePort WLM54G 1B
802.11g Channel 06 (5 of 5)

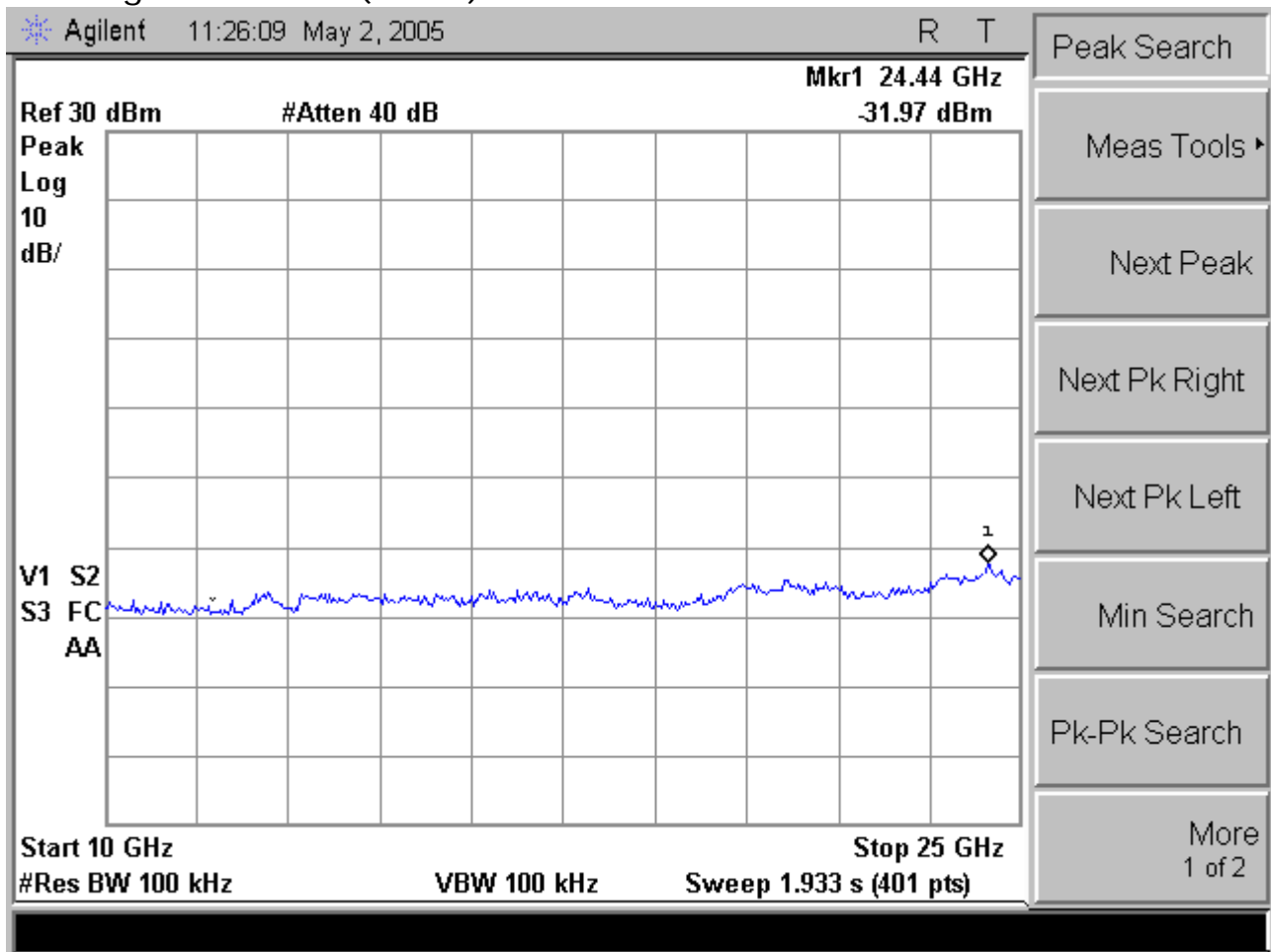



MAX LIGHT

MEASUREMENT REPORT

iWavePort WLM54G 1B
802.11g Channel 11 (1 of 5)

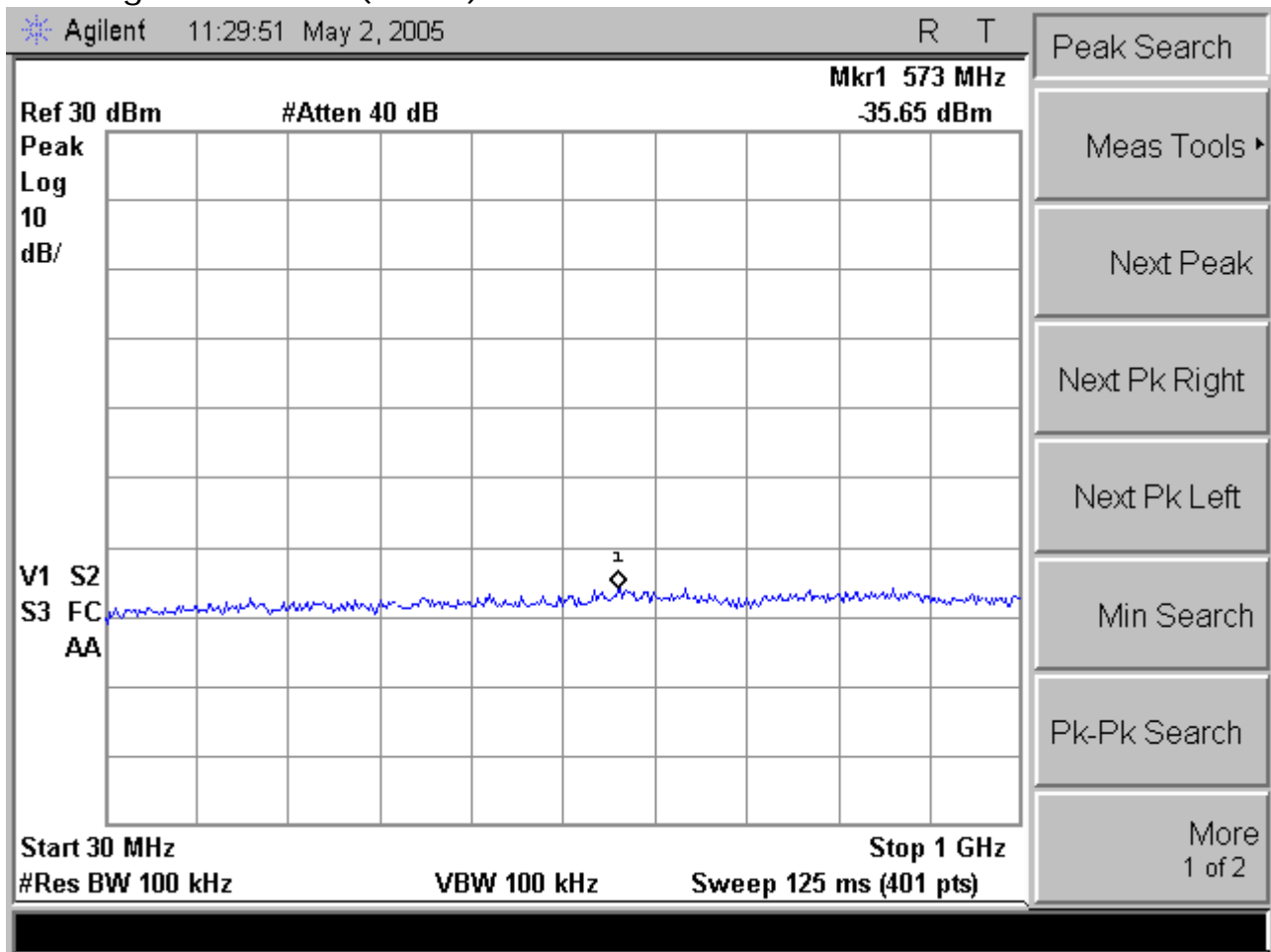



MAX LIGHT

MEASUREMENT REPORT

iWavePort WLM54G 1B
802.11g Channel 11 (2 of 5)

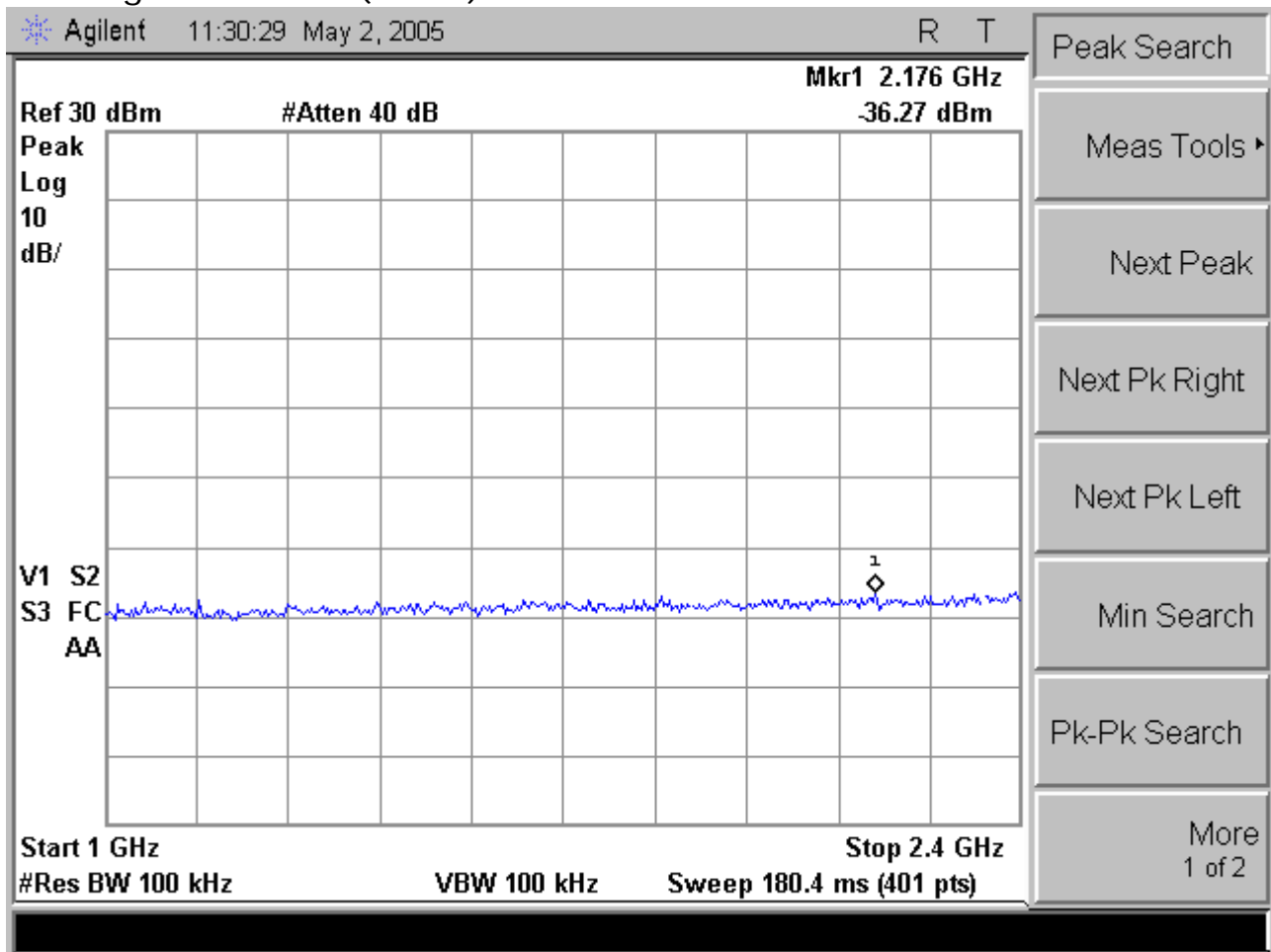

iWavePort WLM54G 1B
802.11g Channel 11 (3 of 5)

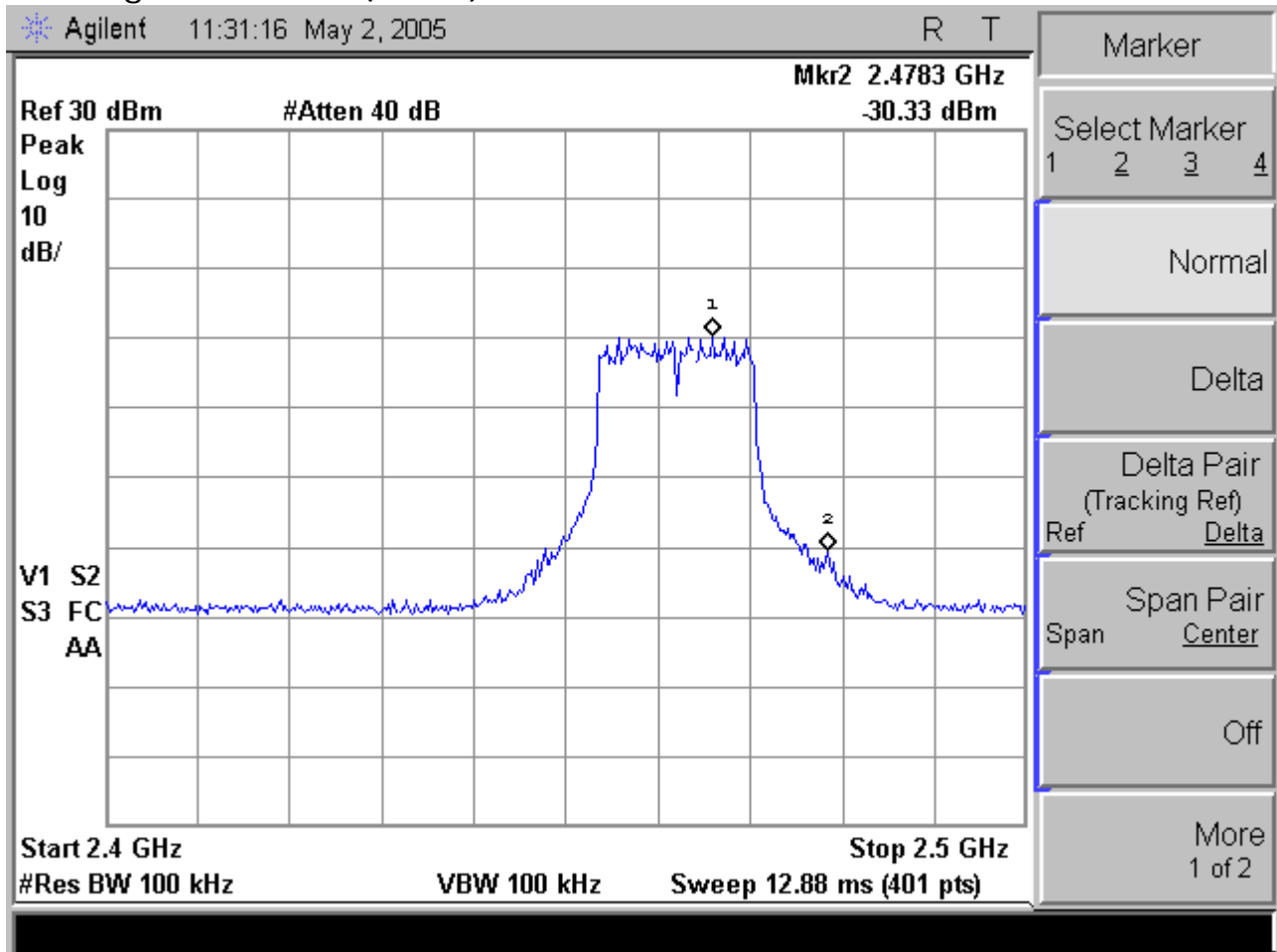



MAX LIGHT

MEASUREMENT REPORT

iWavePort WLM54G 1B
802.11g Channel 11 (4 of 5)

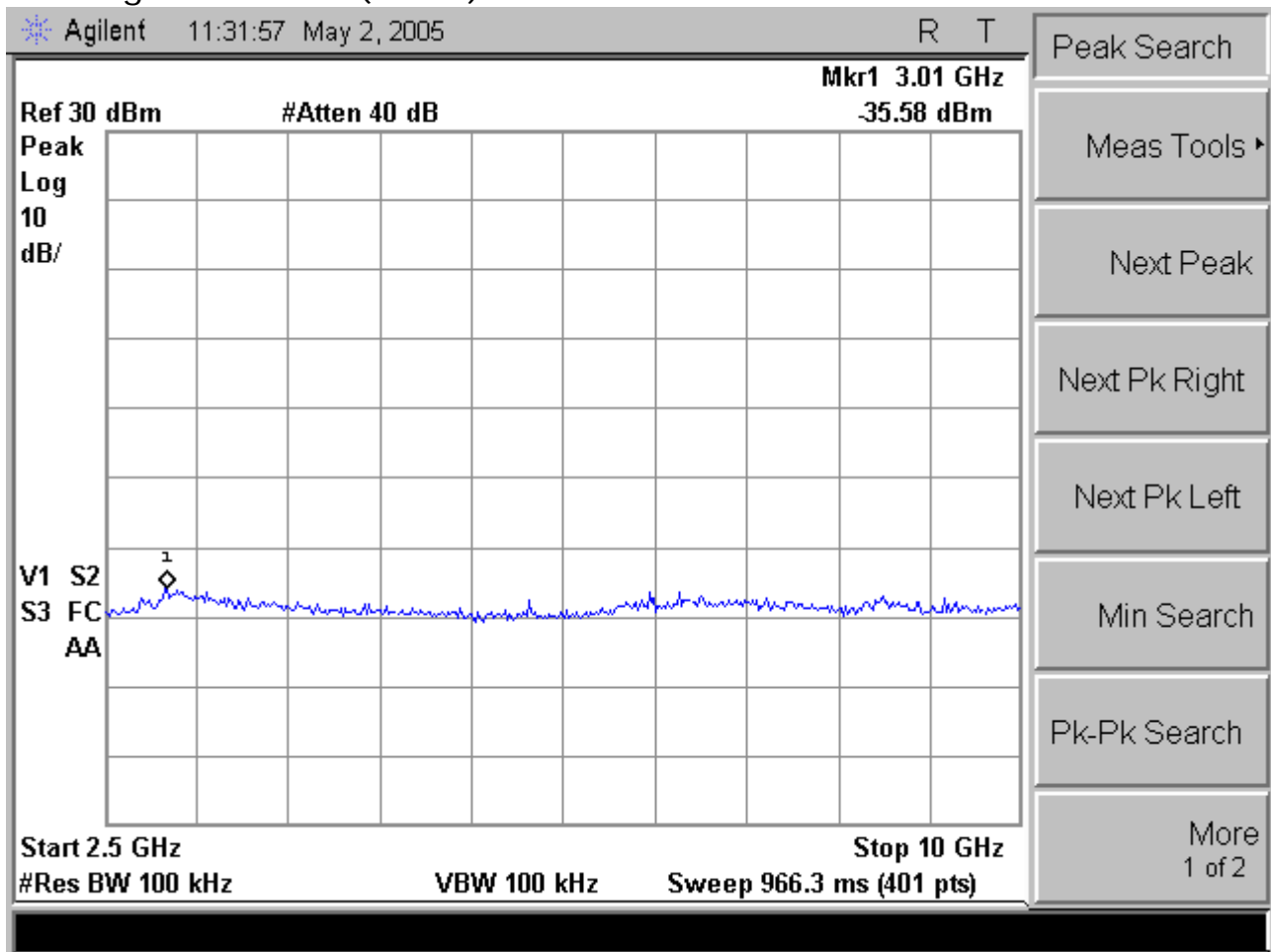



MAX LIGHT

MEASUREMENT REPORT

iWavePort WLM54G 1B
802.11g Channel 11 (5 of 5)

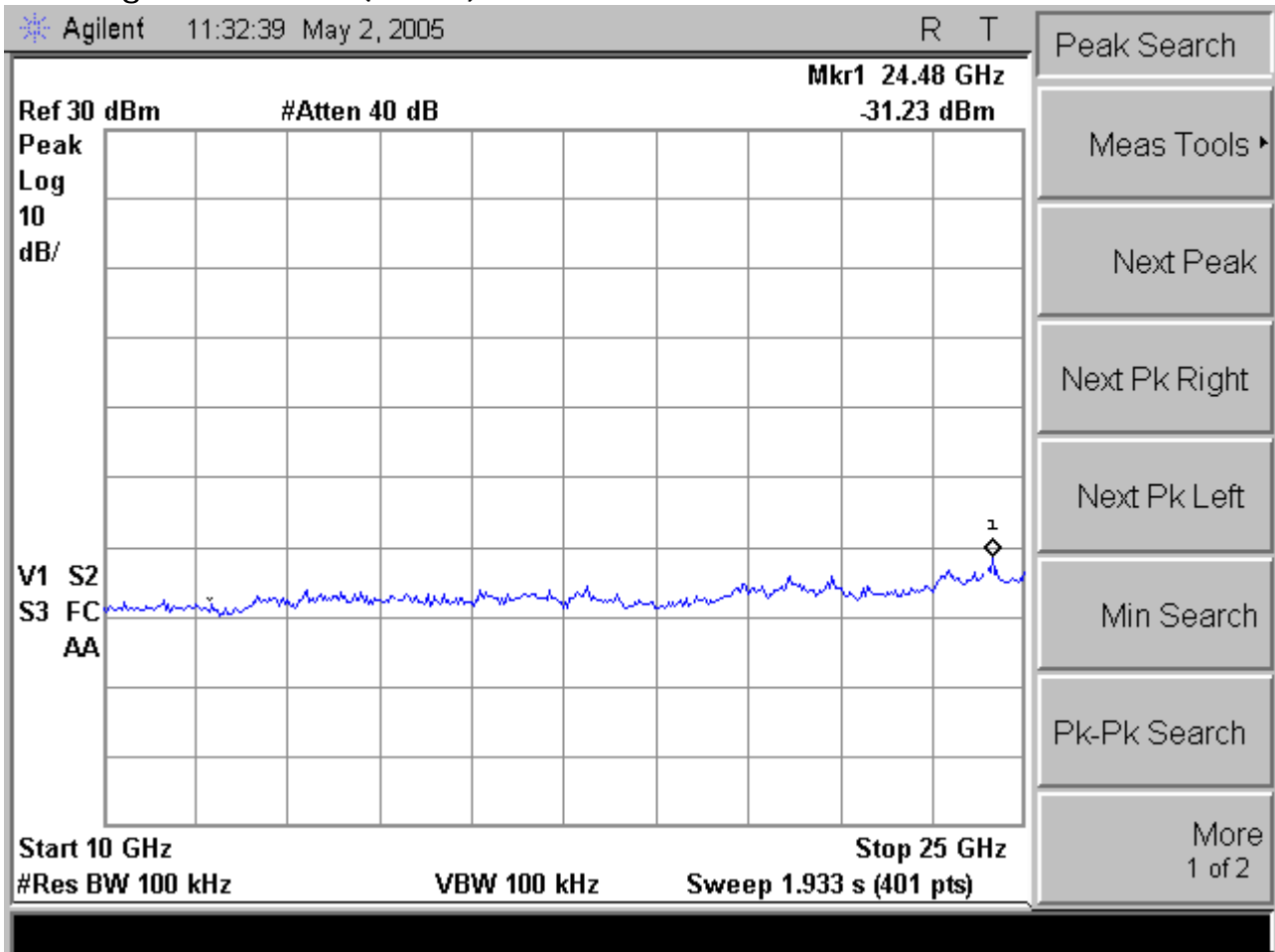



MAX LIGHT

MEASUREMENT REPORT

iWavePort WLM54G 1B
802.11 Super G Channel 06 (1 of 5)

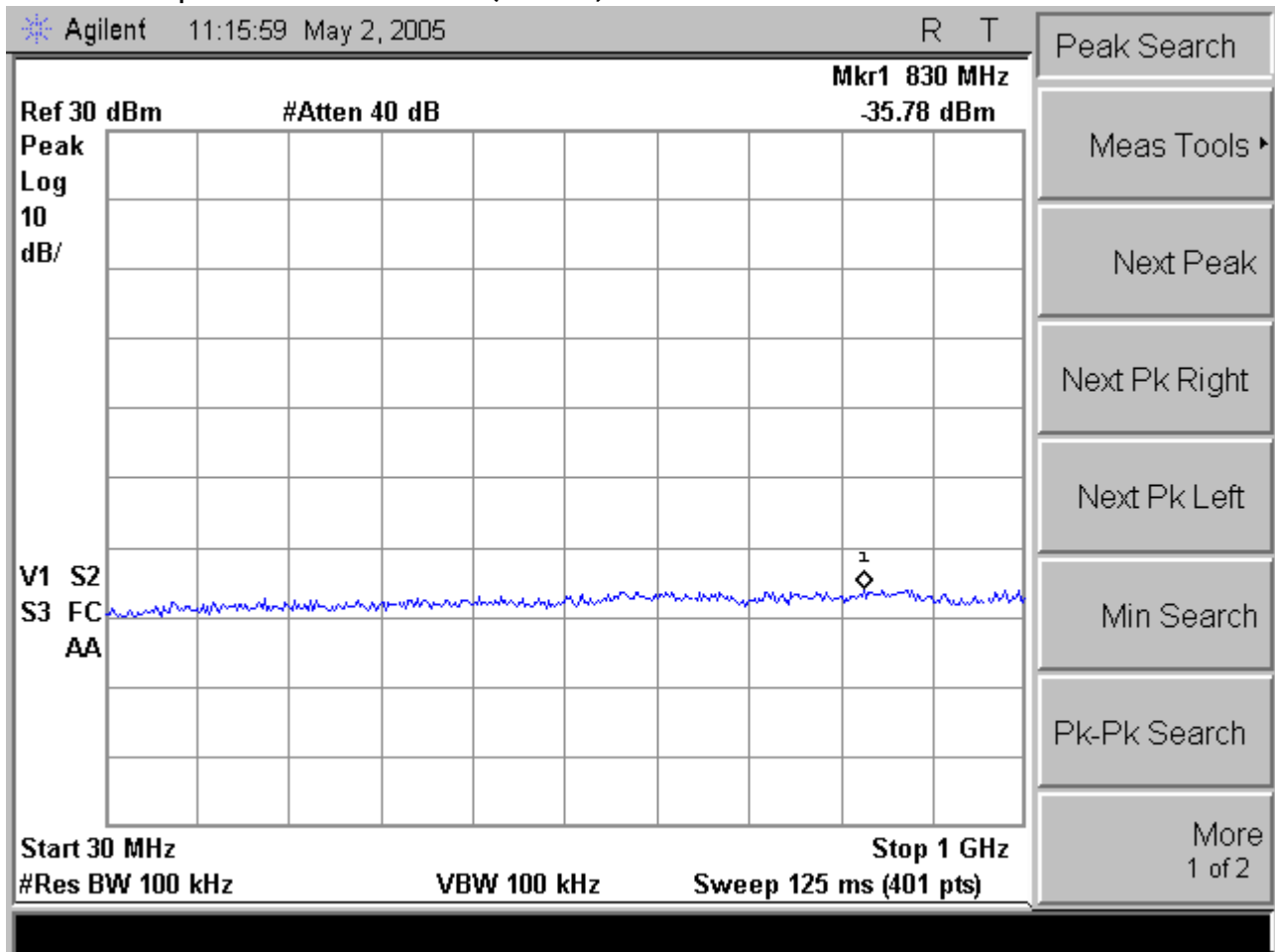



MAX LIGHT

MEASUREMENT REPORT

iWavePort WLM54G 1B
802.11 Super G Channel 06 (2 of 5)

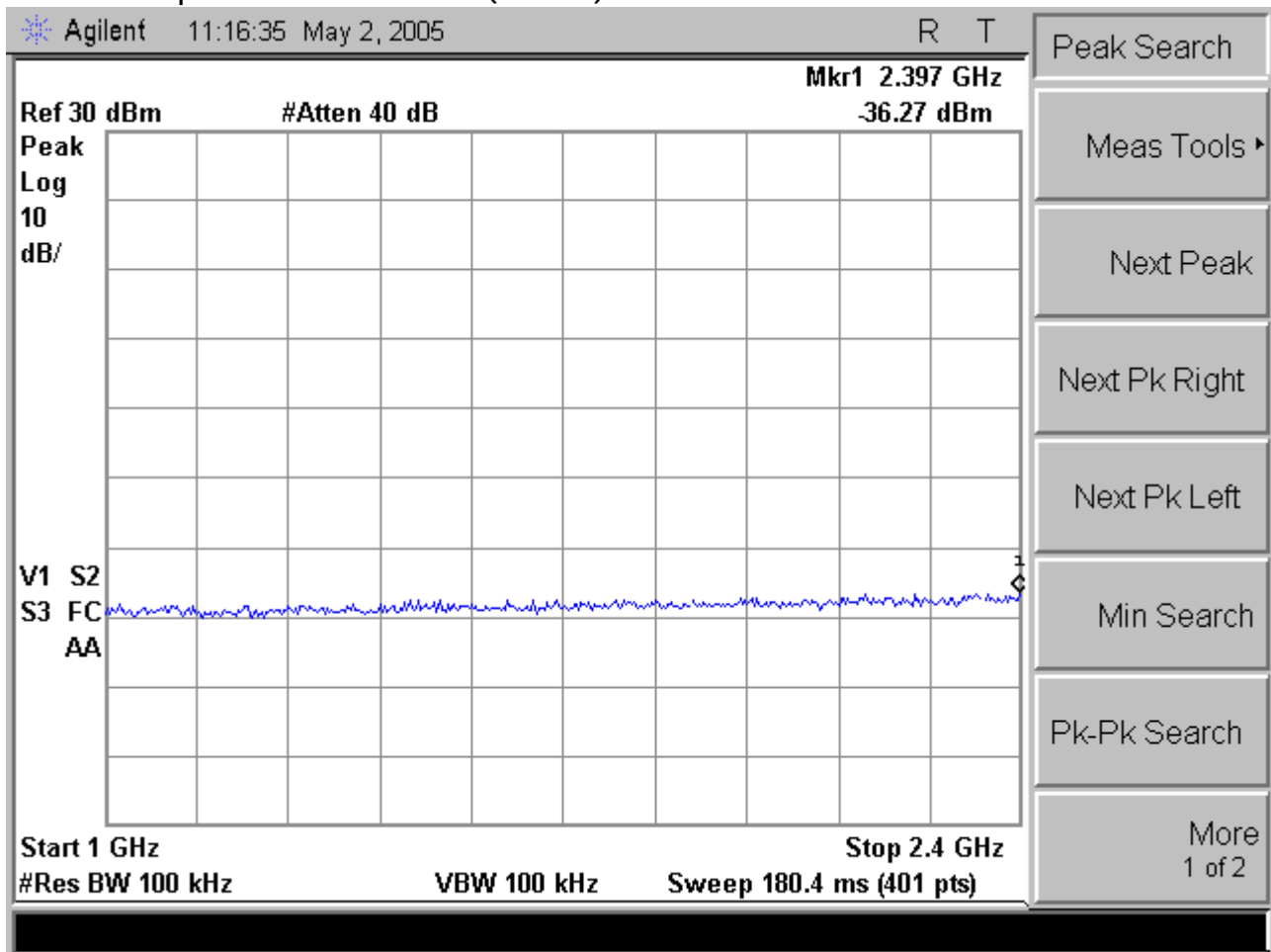

iWavePort WLM54G 1B
 802.11 Super G Channel 06 (3 of 5)

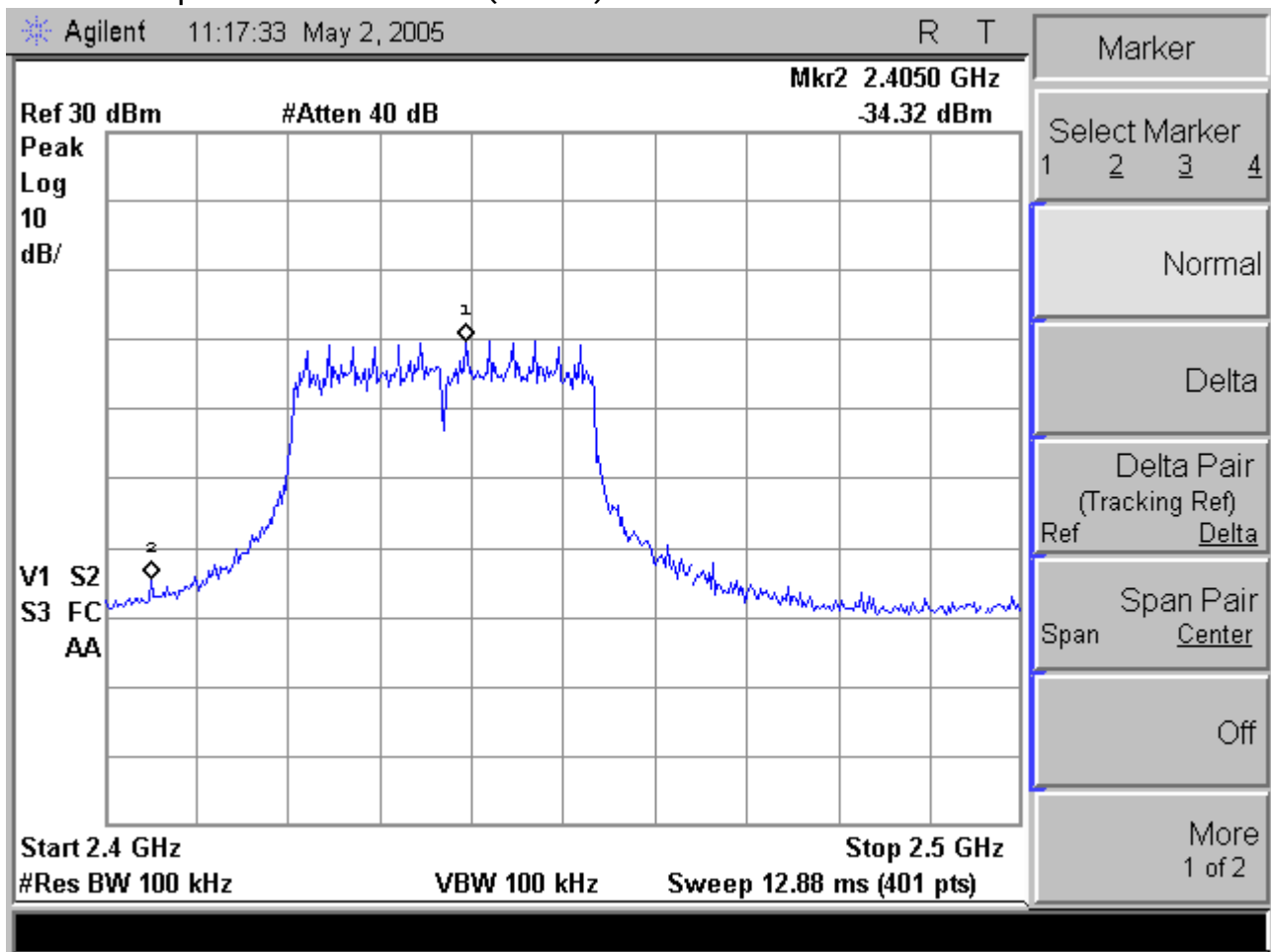



MAX LIGHT

MEASUREMENT REPORT

iWavePort WLM54G 1B
802.11 Super G Channel 06 (4 of 5)

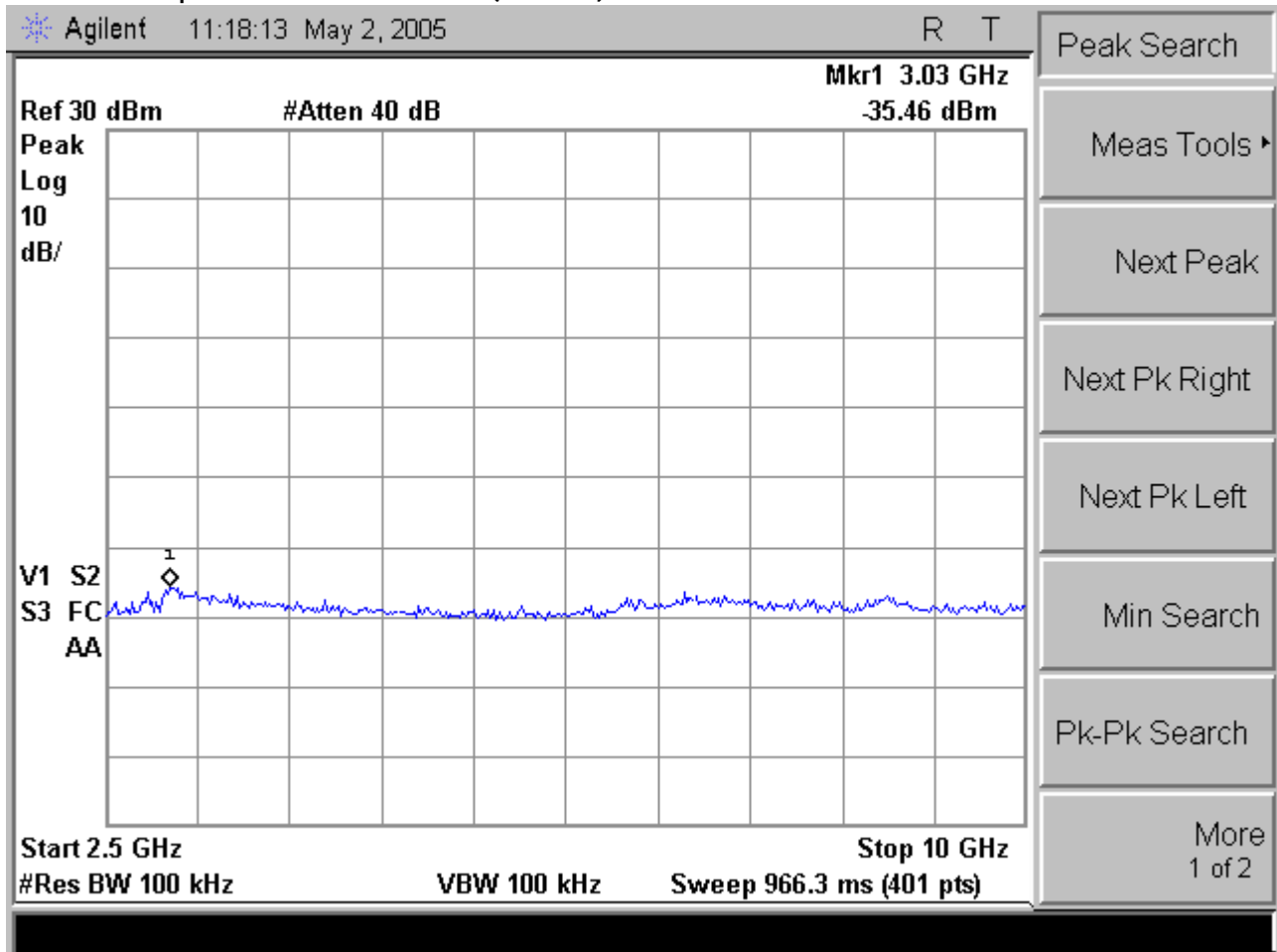



MAX LIGHT

MEASUREMENT REPORT

iWavePort WLM54G 1B
802.11 Super G Channel 06 (5 of 5)

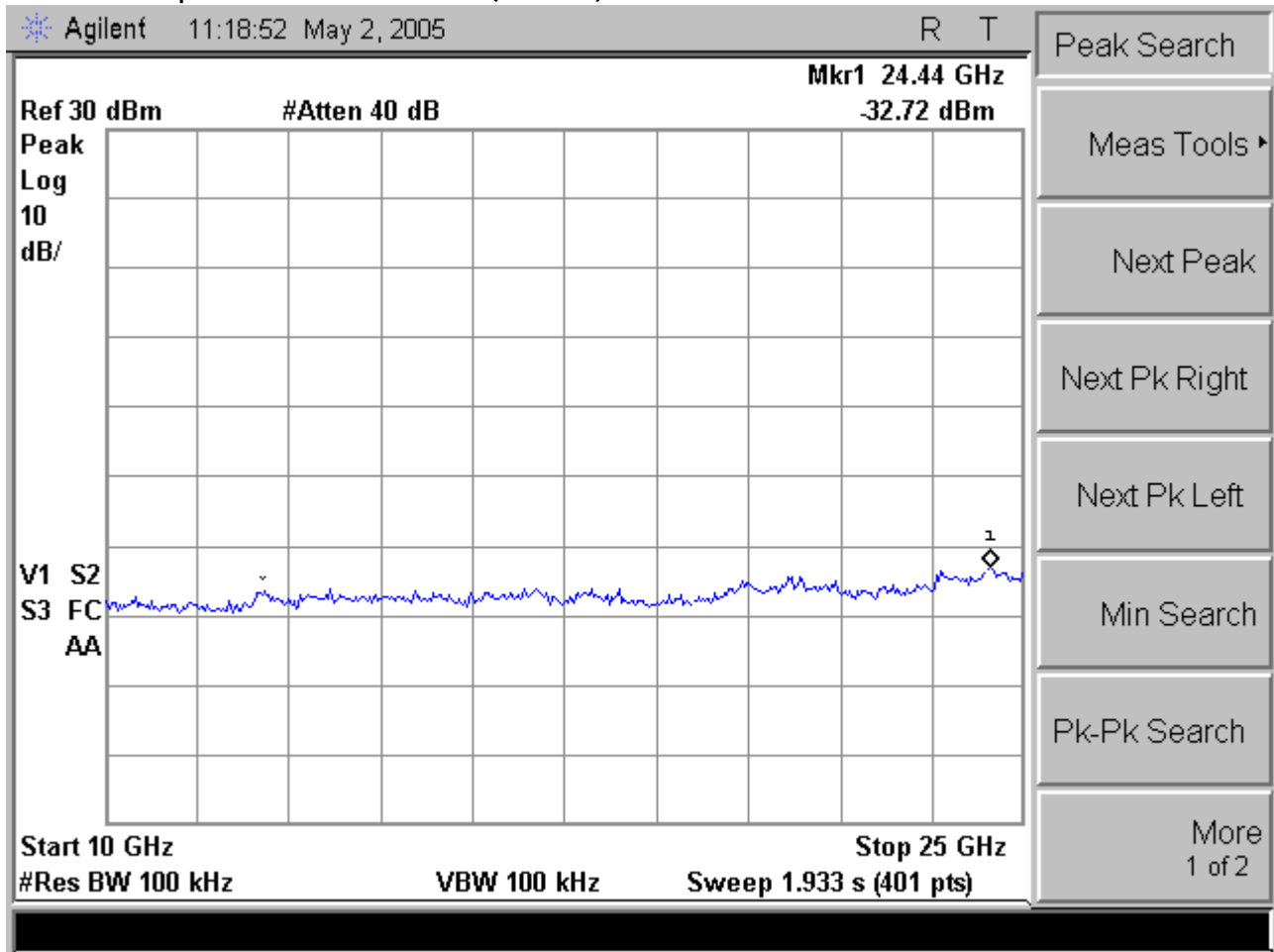

VIII. Band Edges Requirements

8.1 Test Condition & Setup :

The emissions on the harmonics frequencies, the limits, and the margin of compliance are presented. These tests were made when the transmitter was in full radiated power. The additional test was performed to show compliance with the requirement at the band-edge frequency 2483.5 MHz and up to 2500 MHz and at 2390.0 MHz.

The transmitter was configured with the worst case antenna and setup to transmit at the highest channel. Then the field strength was measured at 2483.5 MHz.

The transmitter was then configured with the worst case antenna and setup to transmit at the lowest channel. Then the field strength was measured at 2390.0 MHz. These tests were performed at 4 different bit rates.

8.2 Test Instruments Configuration:

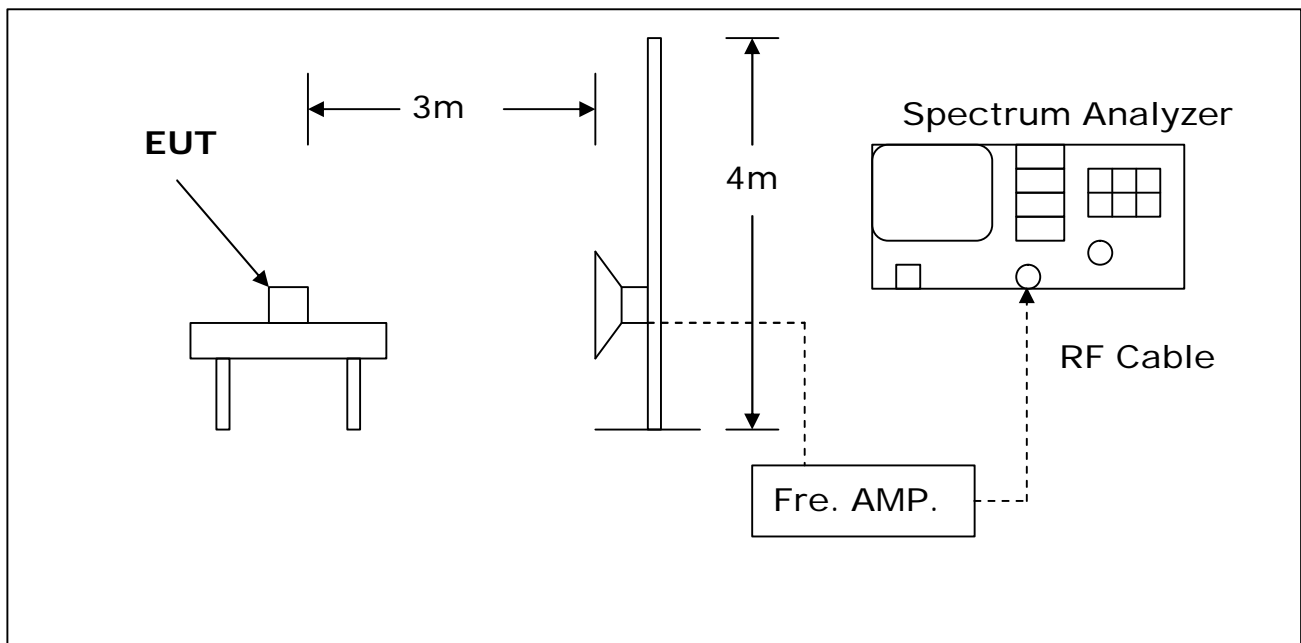

8.3 Test Equipment List:

- A. Agilent E4407B 9KHz-26.5GHz Spectrum Analyzer (S/N:A872JS02291)
- B. HP 8449B 1GHz-26.5GHz Pre Amplifier (S/N:1982901A91)
- C. SCHWARZBECK BBHA 9120D Biconilog Antenna (S/N:141S3)

8.4 Test Result: iWavePort WLM54G 1A (802.11b)

| Radiated Emissions (HORIZONTAL) CH1 | | | | | | | | |
|-------------------------------------|--------------------|----------|----------------|-----------|-----------|---------------------|----------------|-------------|
| Frequency (MHz) | Amplitude (dBuV/m) | Ant. (m) | Table (Degree) | Duty (dB) | Dist (dB) | Actual Amp (dBuV/m) | Limit (dBuV/m) | Margin (dB) |
| 2389.97 | 53.87(PK) | 1 | 320 | 0 | 9.54 | 44.33 | 74.00 | -29.67 |
| 2389.97 | 49.24(AV) | 1 | 320 | 0 | 9.54 | 39.70 | 54.00 | -14.30 |
| Radiated Emissions (VERTICAL) CH1 | | | | | | | | |
| Frequency (MHz) | Amplitude (dBuV/m) | Ant. (m) | Table (Degree) | Duty (dB) | Dist (dB) | Actual Amp (dBuV/m) | Limit (dBuV/m) | Margin (dB) |
| 2389.94 | 54.52(PK) | 1 | 280 | 0 | 9.54 | 44.98 | 74.00 | -29.02 |
| 2389.94 | 50.62(AV) | 1 | 280 | 0 | 9.54 | 41.08 | 54.00 | -12.92 |

| Radiated Emissions (HORIZONTAL) CH11 | | | | | | | | |
|--------------------------------------|--------------------|----------|----------------|-----------|-----------|---------------------|----------------|-------------|
| Frequency (MHz) | Amplitude (dBuV/m) | Ant. (m) | Table (Degree) | Duty (dB) | Dist (dB) | Actual Amp (dBuV/m) | Limit (dBuV/m) | Margin (dB) |
| 2483.50 | 55.24(PK) | 1 | 300 | 0 | 9.54 | 45.70 | 74.00 | -28.30 |
| 2483.50 | 50.87(AV) | 1 | 300 | 0 | 9.54 | 41.33 | 54.00 | -12.67 |
| Radiated Emissions (VERTICAL) CH11 | | | | | | | | |
| Frequency (MHz) | Amplitude (dBuV/m) | Ant. (m) | Table (Degree) | Duty (dB) | Dist (dB) | Actual Amp (dBuV/m) | Limit (dBuV/m) | Margin (dB) |
| 2483.52 | 54.78(PK) | 1 | 250 | 0 | 9.54 | 45.24 | 74.00 | -28.76 |
| 2483.52 | 48.99(AV) | 1 | 250 | 0 | 9.54 | 39.45 | 54.00 | -14.55 |

- Notes :
- 1.Margin= Amplitude - Limits
 - 2.Height of table for EUT placed: 0.8 Meter.
 - 3.ANT= Antenna height.
 - 4.Duty= Duty cycle correction factor.
 - 5.Dis= Distance extrapolation factor.
 - 6.Amplitude= Reading Amplitude - Amplifier gain+Cable loss



MAX LIGHT

MEASUREMENT REPORT

+Antenna factor (Auto calculate in spectrum analyzer)

7.Actual Amp= Amplitude - Duty - Dis.

8.5 Test Result: iWavePort WLM54G 1A (802.11G)

| Radiated Emissions (HORIZONTAL) CH1 | | | | | | | | |
|-------------------------------------|--------------------|----------|----------------|-----------|-----------|---------------------|----------------|-------------|
| Frequency (MHz) | Amplitude (dBuV/m) | Ant. (m) | Table (Degree) | Duty (dB) | Dist (dB) | Actual Amp (dBuV/m) | Limit (dBuV/m) | Margin (dB) |
| 2389.85 | 56.25(PK) | 1 | 360 | 0 | 9.54 | 46.71 | 74.00 | -27.29 |
| 2389.85 | 51.43(AV) | 1 | 360 | 0 | 9.54 | 41.89 | 54.00 | -12.11 |
| Radiated Emissions (VERTICAL) CH1 | | | | | | | | |
| Frequency (MHz) | Amplitude (dBuV/m) | Ant. (m) | Table (Degree) | Duty (dB) | Dist (dB) | Actual Amp (dBuV/m) | Limit (dBuV/m) | Margin (dB) |
| 2389.89 | 57.41(PK) | 1 | 220 | 0 | 9.54 | 47.87 | 74.00 | -26.13 |
| 2389.89 | 50.55(AV) | 1 | 220 | 0 | 9.54 | 41.01 | 54.00 | -12.99 |

| Radiated Emissions (HORIZONTAL) CH11 | | | | | | | | |
|--------------------------------------|--------------------|----------|----------------|-----------|-----------|---------------------|----------------|-------------|
| Frequency (MHz) | Amplitude (dBuV/m) | Ant. (m) | Table (Degree) | Duty (dB) | Dist (dB) | Actual Amp (dBuV/m) | Limit (dBuV/m) | Margin (dB) |
| 2483.53 | 57.44(PK) | 1 | 290 | 0 | 9.54 | 47.90 | 74.00 | -26.10 |
| 2483.53 | 51.23(AV) | 1 | 290 | 0 | 9.54 | 41.69 | 54.00 | -12.31 |
| Radiated Emissions (VERTICAL) CH11 | | | | | | | | |
| Frequency (MHz) | Amplitude (dBuV/m) | Ant. (m) | Table (Degree) | Duty (dB) | Dist (dB) | Actual Amp (dBuV/m) | Limit (dBuV/m) | Margin (dB) |
| 2483.56 | 56.78(PK) | 1 | 250 | 0 | 9.54 | 47.24 | 74.00 | -26.76 |
| 2483.56 | 50.33(AV) | 1 | 250 | 0 | 9.54 | 40.79 | 54.00 | -13.21 |

- Notes :
- 1.Margin= Amplitude - Limits
 - 2.Height of table for EUT placed: 0.8 Meter.
 - 3.ANT= Antenna height.
 - 4.Duty= Duty cycle correction factor.
 - 5.Dis= Distance extrapolation factor.
 - 6.Amplitude= Reading Amplitude - Amplifier gain+Cable loss
+Antenna factor (Auto calculate in spectrum analyzer)
 - 7.Actual Amp= Amplitude - Duty - Dis.

8.6 Test Result: iWavePort WLM54G 1B (802.11b)

| Radiated Emissions (HORIZONTAL) CH1 | | | | | | | | |
|-------------------------------------|--------------------|----------|----------------|-----------|-----------|---------------------|----------------|-------------|
| Frequency (MHz) | Amplitude (dBuV/m) | Ant. (m) | Table (Degree) | Duty (dB) | Dist (dB) | Actual Amp (dBuV/m) | Limit (dBuV/m) | Margin (dB) |
| 2389.96 | 58.33(PK) | 1 | 340 | 0 | 9.54 | 48.79 | 74.00 | -25.21 |
| 2389.96 | 52.76(AV) | 1 | 340 | 0 | 9.54 | 43.22 | 54.00 | -10.78 |
| Radiated Emissions (VERTICAL) CH1 | | | | | | | | |
| Frequency (MHz) | Amplitude (dBuV/m) | Ant. (m) | Table (Degree) | Duty (dB) | Dist (dB) | Actual Amp (dBuV/m) | Limit (dBuV/m) | Margin (dB) |
| 2389.89 | 55.25(PK) | 1 | 270 | 0 | 9.54 | 45.71 | 74.00 | -28.29 |
| 2389.89 | 49.38(AV) | 1 | 270 | 0 | 9.54 | 39.84 | 54.00 | -14.16 |

| Radiated Emissions (HORIZONTAL) CH11 | | | | | | | | |
|--------------------------------------|--------------------|----------|----------------|-----------|-----------|---------------------|----------------|-------------|
| Frequency (MHz) | Amplitude (dBuV/m) | Ant. (m) | Table (Degree) | Duty (dB) | Dist (dB) | Actual Amp (dBuV/m) | Limit (dBuV/m) | Margin (dB) |
| 2483.58 | 56.44(PK) | 1 | 240 | 0 | 9.54 | 46.90 | 74.00 | -27.10 |
| 2483.58 | 50.71(AV) | 1 | 240 | 0 | 9.54 | 41.17 | 54.00 | -12.83 |
| Radiated Emissions (VERTICAL) CH11 | | | | | | | | |
| Frequency (MHz) | Amplitude (dBuV/m) | Ant. (m) | Table (Degree) | Duty (dB) | Dist (dB) | Actual Amp (dBuV/m) | Limit (dBuV/m) | Margin (dB) |
| 2483.64 | 57.09(PK) | 1 | 320 | 0 | 9.54 | 47.55 | 74.00 | -26.45 |
| 2483.64 | 51.52(AV) | 1 | 320 | 0 | 9.54 | 41.98 | 54.00 | -12.02 |

- Notes :
- 1.Margin= Amplitude - Limits
 - 2.Height of table for EUT placed: 0.8 Meter.
 - 3.ANT= Antenna height.
 - 4.Duty= Duty cycle correction factor.
 - 5.Dis= Distance extrapolation factor.
 - 6.Amplitude= Reading Amplitude - Amplifier gain+Cable loss
+Antenna factor (Auto calculate in spectrum analyzer)
 - 7.Actual Amp= Amplitude - Duty - Dis.

8.7 Test Result: iWavePort WLM54G 1B (802.11g)

| Radiated Emissions (HORIZONTAL) CH1 | | | | | | | | |
|-------------------------------------|--------------------|----------|----------------|-----------|-----------|---------------------|----------------|-------------|
| Frequency (MHz) | Amplitude (dBuV/m) | Ant. (m) | Table (Degree) | Duty (dB) | Dist (dB) | Actual Amp (dBuV/m) | Limit (dBuV/m) | Margin (dB) |
| 2389.88 | 58.44(PK) | 1 | 360 | 0 | 9.54 | 48.90 | 74.00 | -25.10 |
| 2389.88 | 51.56(AV) | 1 | 360 | 0 | 9.54 | 42.02 | 54.00 | -11.98 |
| Radiated Emissions (VERTICAL) CH1 | | | | | | | | |
| Frequency (MHz) | Amplitude (dBuV/m) | Ant. (m) | Table (Degree) | Duty (dB) | Dist (dB) | Actual Amp (dBuV/m) | Limit (dBuV/m) | Margin (dB) |
| 2389.97 | 57.84(PK) | 1 | 240 | 0 | 9.54 | 48.30 | 74.00 | -25.70 |
| 2389.97 | 50.39(AV) | 1 | 240 | 0 | 9.54 | 40.85 | 54.00 | -13.15 |

| Radiated Emissions (HORIZONTAL) CH11 | | | | | | | | |
|--------------------------------------|--------------------|----------|----------------|-----------|-----------|---------------------|----------------|-------------|
| Frequency (MHz) | Amplitude (dBuV/m) | Ant. (m) | Table (Degree) | Duty (dB) | Dist (dB) | Actual Amp (dBuV/m) | Limit (dBuV/m) | Margin (dB) |
| 2483.57 | 57.58(PK) | 1 | 230 | 0 | 9.54 | 48.04 | 74.00 | -25.96 |
| 2483.57 | 51.11(AV) | 1 | 230 | 0 | 9.54 | 41.57 | 54.00 | -12.43 |
| Radiated Emissions (VERTICAL) CH11 | | | | | | | | |
| Frequency (MHz) | Amplitude (dBuV/m) | Ant. (m) | Table (Degree) | Duty (dB) | Dist (dB) | Actual Amp (dBuV/m) | Limit (dBuV/m) | Margin (dB) |
| 2483.59 | 56.95(PK) | 1 | 330 | 0 | 9.54 | 47.41 | 74.00 | -26.59 |
| 2483.59 | 52.45(AV) | 1 | 330 | 0 | 9.54 | 42.91 | 54.00 | -11.09 |

- Notes :
- 1.Margin= Amplitude - Limits
 - 2.Height of table for EUT placed: 0.8 Meter.
 - 3.ANT= Antenna height.
 - 4.Duty= Duty cycle correction factor.
 - 5.Dis= Distance extrapolation factor.
 - 6.Amplitude= Reading Amplitude - Amplifier gain+Cable loss
+Antenna factor (Auto calculate in spectrum analyzer)
 - 7.Actual Amp= Amplitude - Duty - Dis.

8.8 Test Result: iWavePort WLM54G 1B (802.11 Super g)

| Radiated Emissions (HORIZONTAL) CH06 | | | | | | | | |
|--------------------------------------|--------------------|----------|----------------|-----------|-----------|---------------------|----------------|-------------|
| Frequency (MHz) | Amplitude (dBuV/m) | Ant. (m) | Table (Degree) | Duty (dB) | Dist (dB) | Actual Amp (dBuV/m) | Limit (dBuV/m) | Margin (dB) |
| 2389.97 | 51.01(PK) | 1 | 320 | 0 | 9.54 | 41.47 | 74.00 | -32.53 |
| - | - | - | - | - | - | - | - | - |
| Radiated Emissions (VERTICAL) CH06 | | | | | | | | |
| Frequency (MHz) | Amplitude (dBuV/m) | Ant. (m) | Table (Degree) | Duty (dB) | Dist (dB) | Actual Amp (dBuV/m) | Limit (dBuV/m) | Margin (dB) |
| 2389.88 | 52.74(PK) | 1 | 189 | 0 | 9.54 | 43.20 | 74.00 | -30.80 |
| - | - | - | - | - | - | - | - | - |

| Radiated Emissions (HORIZONTAL) CH06 | | | | | | | | |
|--------------------------------------|--------------------|----------|----------------|-----------|-----------|---------------------|----------------|-------------|
| Frequency (MHz) | Amplitude (dBuV/m) | Ant. (m) | Table (Degree) | Duty (dB) | Dist (dB) | Actual Amp (dBuV/m) | Limit (dBuV/m) | Margin (dB) |
| 2483.63 | 50.13(PK) | 1 | 270 | 0 | 9.54 | 40.59 | 74.00 | -33.41 |
| - | - | - | - | - | - | - | - | - |
| Radiated Emissions (VERTICAL) CH06 | | | | | | | | |
| Frequency (MHz) | Amplitude (dBuV/m) | Ant. (m) | Table (Degree) | Duty (dB) | Dist (dB) | Actual Amp (dBuV/m) | Limit (dBuV/m) | Margin (dB) |
| 2483.65 | 51.84(PK) | 1 | 310 | 0 | 9.54 | 42.30 | 74.00 | -31.70 |
| - | - | - | - | - | - | - | - | - |

- Notes :
- 1.Margin= Amplitude - Limits
 - 2.Height of table for EUT placed: 0.8 Meter.
 - 3.ANT= Antenna height.
 - 4.Duty= Duty cycle correction factor.
 - 5.Dis= Distance extrapolation factor.
 - 6.Amplitude= Reading Amplitude - Amplifier gain+Cable loss +Antenna factor
(Auto calculate in spectrum analyzer)
 - 7.Actual Amp= Amplitude - Duty - Dis.



IX. Antenna Requirements

9.1 Standard Applicable :

For intentional device, according to 15.203, an intentional radiator shall be designed to ensure that no antenna other than that furnished by the responsible party shall be used with the device.

And According to 15.247 (b), if transmitting antennas of directional gain greater than 6 dBi are used, the power shall be reduced by the amount in dB that the directional gain of the antenna exceeds 6dBi.

9.2 Antenna Connector Construction

The antenna used in this product is 1/4 DIOPLE antenna with UFL connector. And the maximum Gain of this antenna is only 2.0dBi.

Appendix I- EUT Test SETUP

MEASUREMENT OF POWER LINE CONDUCTED RFI VOLTAGE

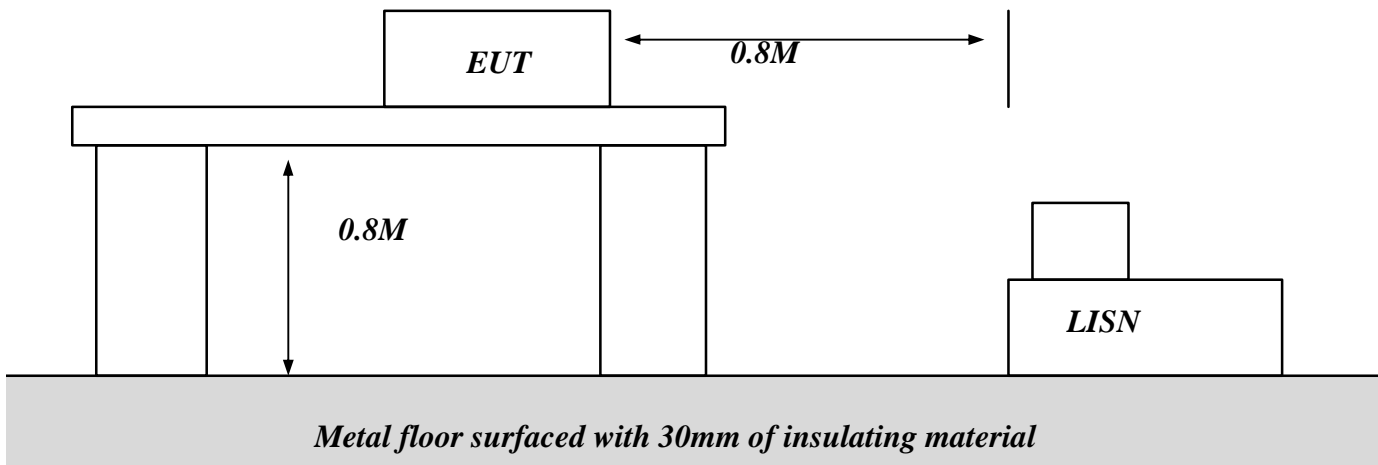

Appendix I- EUT Test SETUP

MEASUREMENT OF RADIATED EMISSION

