



**TEST REPORT  
FROM  
RFI GLOBAL SERVICES LTD**

Test of: Enfora Inc.  
GSM3408

To: OET Bulletin 65 Supplement C: (2001-01)

**Test Report Serial No:**  
RFI/SARE1/RP73579JD01A

<b>This Test Report Is Issued Under The Authority Of Steve Flocks, Radio Performance Group Service Leader:</b>	 pp Brian Watson
<b>Checked By:</b> Brian Watson	 <b>Report Copy No: PDF01</b>
<b>Issue Date: 26 June 2008</b>	<b>Test Dates: 06 February 2008</b>

This report is issued in Adobe Acrobat portable document format (PDF). It is only a valid copy of the report if it is being viewed in PDF format with the following security options not allowed: Changing the document, Selecting text and graphics, Adding or changing notes and form fields.

This report may be copied in full. The results in this report apply only to the sample(s) tested.

**Test of: Enfora Inc.  
GSM3408**

**To: OET Bulletin 65 Supplement C: (2001-01)**

---

This page has been left intentionally blank.

---

Test of: Enfora Inc.  
GSM3408

To: OET Bulletin 65 Supplement C: (2001-01)

---

**Table of Contents**

1. Customer Information .....	4
2. Equipment Under Test (EUT) .....	5
3. Test Specification, Methods and Procedures .....	7
4. Deviations from the Test Specification .....	7
5. Operation and Configuration of the EUT during Testing .....	8
6. Summary of Test Results.....	9
7. Measurements, Examinations and Derived Results.....	10
8. Measurement Uncertainty .....	16
Appendix 1. Test Equipment Used.....	19
Appendix 2. Measurement Methods .....	22
Appendix 3. SAR Distribution Scans .....	24
Appendix 4. Photographs .....	33
Appendix 5. Validation of System .....	44
Appendix 6. Simulated Tissues.....	45
Appendix 7. DASY4 System Details.....	46

---

Test of: Enfora Inc.  
GSM3408

To: OET Bulletin 65 Supplement C: (2001-01)

---

## 1. Customer Information

<b>Company Name:</b>	Enfora Inc.
<b>Address:</b>	251 Renner Parkway Richardson TEXAS 75080 USA
<b>Contact Name:</b>	Mr R Holden

---

Test of: Enfora Inc.  
GSM3408

To: OET Bulletin 65 Supplement C: (2001-01)

## **2. Equipment Under Test (EUT)**

The following information (with the exception of the date of receipt) has been supplied by the customer:

### **2.1. Description of EUT**

The equipment under test is a GSM3408 Quad-band wireless sled for a family of Palms PDAs that is capable of operating in GSM and GPRS technologies bands.

### **2.2. Identification of Equipment Under Test (EUT)**

<b>Description:</b>	Handheld Cradle for palm Tx and E2
<b>Brand Name:</b>	Enfora
<b>Model Name or Number:</b>	GSM3408
<b>Serial Number:</b>	3 408470700294
<b>IMEI Number:</b>	0 11069000179541
<b>Hardware Version Number:</b>	None Stated
<b>Software Version Number:</b>	None Stated
<b>Hardware Revision of GSM Module:</b>	None Stated
<b>Software Revision of GSM Module:</b>	None Stated
<b>FCC ID Number:</b>	MIVGSM3408
<b>Country of Manufacture:</b>	USA
<b>Date of Receipt:</b>	04 February 2008

### **2.3. Modifications Incorporated in the EUT**

During the course of testing the EUT was not modified.

### **2.4. Accessories**

The following accessories were supplied with the EUT during testing:

<b>Description:</b>	PalmOne
<b>Brand Name:</b>	Tungsten
<b>Model Name or Number:</b>	LogPad E2
<b>Serial Number:</b>	PN20UCP5V141
<b>Cable Length and Type:</b>	Not Applicable
<b>Country of Manufacture:</b>	China
<b>Connected to Port</b>	Data Port Unique to Manufacturer

Test of: Enfora Inc.  
GSM3408

To: OET Bulletin 65 Supplement C: (2001-01)

## 2.5. Support Equipment

The following support equipment was used to exercise the EUT during testing:

<b>Description:</b>	Radio Communication Analyser
<b>Brand Name:</b>	Anritsu
<b>Model Name or Number:</b>	MT8820A
<b>Serial Number:</b>	6K000000647
<b>Cable Length and Type:</b>	1.5m Utiflex Cable
<b>Connected to Port:</b>	RF (Input/Output) Air Link

## 2.6. Additional Information Related to Testing

<b>Equipment Category</b>	GSM(850/1900) and GPRS(850/1900)		
<b>Type of Unit</b>	Portable (Standalone battery powered device)		
<b>Intended Operating Environment:</b>	Within GSM/GPRS Coverage		
<b>Transmitter Maximum Output Power Characteristics:</b>	GSM850	33 dBm	
	PCS1900	30 dBm	
<b>Transmitter Frequency Range:</b>	GSM850	( 824 to 849 ) MHz	
	PCS1900	( 1850 to 1910 ) MHz	
<b>Transmitter Frequency Allocation of EUT When Under Test:</b>	<b>Channel Number</b>	<b>Channel Description</b>	<b>Frequency (MHz)</b>
	128	Low	824.2
	189	Middle	836.4
	251	High	848.8
	512	Low	1850.2
	660	Middle	1879.8
	810	High	1909.8
<b>Modulation(s):</b>	217 Hz		
<b>Modulation Scheme (Crest Factor):</b>	GSM: 8.3 GPRS: 4		
<b>Antenna Type:</b>	Patch Antenna		
<b>Antenna Length:</b>	Unknown		
<b>Number of Antenna Positions:</b>	1 Fixed Internal		
<b>Power Supply Requirement:</b>	3.7V / 870 mAh		
<b>Battery Type(s):</b>	Lithium-Ion		

Test of: Enfora Inc.  
GSM3408

To: OET Bulletin 65 Supplement C: (2001-01)

---

### **3. Test Specification, Methods and Procedures**

#### **3.1. Test Specification**

<b>Reference:</b>	OET Bulletin 65 Supplement C: (2001-01)
<b>Title:</b>	Evaluating Compliance with FCC Guidelines for Human Exposure to Radio Frequency Electromagnetic Fields.
<b>Purpose of Test:</b>	To determine whether the equipment met the basic restrictions as defined in OET Bulletin 65 Supplement C: (2001-01) using the SAR averaging method as described in the test specification above.

#### **3.2. Methods and Procedures Reference Documentation**

The methods and procedures used were as detailed in:

Federal Communications Commission, "Evaluating compliance with FCC Guidelines for human exposure to radio frequency electromagnetic fields", OET Bulletin 65 Supplement C, FCC, Washington, D.C, 20554, 2001.

Thomas Schmid, Oliver Egger and Neils Kuster, "Automated E-field scanning system for dosimetric assessments", IEEE Transaction on microwave theory and techniques, Vol. 44, pp. 105-113, January 1996.

Neils Kuster, Ralph Kastle and Thomas Schmid, "Dosimetric evaluation of mobile communications equipment with know precision", IEICE Transactions of communications, Vol. E80-B, No.5, pp. 645-652, May 1997.

#### **3.3. Definition of Measurement Equipment**

The measurement equipment used complied with the requirements of the standards referenced in the methods & procedures section above. Appendix 1 contains a list of the test equipment used.

### **4. Deviations from the Test Specification**

At the clients request the EUT was tested as follows:

- GSM850 and PCS1900 in the Body-worn configuration only
  - GPRS850 and GPRS1900 in the Body worn configuration only
-

Test of: Enfora Inc.  
GSM3408

To: OET Bulletin 65 Supplement C: (2001-01)

---

## **5. Operation and Configuration of the EUT during Testing**

### **5.1. Operating Modes**

The EUT was tested in the following operating mode(s) unless otherwise stated:

- GPRS1900 data allocated mode
- PCS1900 call allocated mode
- GPRS850 data allocated mode
- GSM850 call allocated mode

The reason for choosing these modes was that they were defined by the customer as being typical of normal use and likely represents a "worst case" from a SAR perspective.

### **5.2. Configuration and Peripherals**

The EUT was tested in the following configuration(s) unless otherwise stated:

- GPRS configuration with Coding Scheme set to 4 (CS4) and Multi-slot configuration set to 1-uplink timeslot and 3-downlink timeslot (1UL, 3DL) as device did not support '2UL, 2DL' configuration.
- Stand-alone portable device in a Body-worn configuration at a separation distance of 15mm from the 'SAM' phantom flat section.

#### **Body Configuration**

- a) The EUT was placed in a normal operating position where the centre of EUT was aligned with the centre reference point on the flat section of the 'SAM' phantom.
  - b) With the EUT touching the phantom at an imaginary centre line. The EUT was aligned with a marked plane (X and Y axis) consisting of two lines.
  - c) For the touch-safe position the handset was gradually moved towards the flat section of the 'SAM' phantom until any point of the EUT touched the phantom.
  - d) For position(s) greater than 0mm separation the EUT was positioned as per the touch-safe position, and then the vertical height was decreased/adjusted as required.
  - e) SAR measurements were evaluated at maximum power and the unit was operated for an appropriate period prior to the evaluation in order to minimise the drift.
  - f) The device was keyed to operate continuously in the transmit mode for the duration of the test.
  - g) The location of the maximum spatial SAR distribution (hot spot) was determined relative to the handset and its antenna.
  - h) The EUT was transmitting at full power throughout the duration of the test powered by a fully charged battery.
-



Test of: Enfora Inc.  
GSM3408

To: OET Bulletin 65 Supplement C: (2001-01)

---

## **6. Summary of Test Results**

<b>Test Name</b>	<b>Specification Reference</b>	<b>Compliance Status</b>
Specific Absorption Rate-EGPRS850 Body Configuration 1g	OET Bulletin 65 Supplement C: 2001	Complied
Specific Absorption Rate-GSM850 Body Configuration 1g	OET Bulletin 65 Supplement C: 2001	Complied
Specific Absorption Rate-EGPRS1900 Body Configuration 1g	OET Bulletin 65 Supplement C: 2001	Complied
Specific Absorption Rate-PCS1900 Body Configuration 1g	OET Bulletin 65 Supplement C: 2001	Complied

### **6.1. Location of Tests**

All the measurements described in this report were performed at the premises of RFI Global Services Ltd, Ewhurst Park, Ramsdell, Basingstoke, Hampshire, RG26 5RQ.

---

Test of: Enfora Inc.  
GSM3408

To: OET Bulletin 65 Supplement C: (2001-01)

---

## **7. Measurements, Examinations and Derived Results**

### **7.1. General Comments**

This section contains test results only.

Measurement uncertainties are evaluated in accordance with current best practice. Our reported expanded uncertainties are based on standard uncertainties, which are multiplied by an appropriate coverage factor to provide a statistical confidence level of approximately 95%. Please refer to section 8 for details of measurement uncertainties.

---

Test of: Enfora Inc.  
GSM3408

To: OET Bulletin 65 Supplement C: (2001-01)

## 7.2. Test Results

### 7.2.1. Specific Absorption Rate - EGPRS850 Body Configuration 1g

#### Test Summary:

Tissue Volume:	1g
Maximum Level (W/kg):	0.206

#### Environmental Conditions:

Temperature Variation in Lab (°C):	23.0 to 23.0
Temperature Variation in Liquid (°C):	23.0 to 23.0

#### Results:

EUT Position	Phantom Configuration	Channel Number	Level (W/kg)	Limit (W/kg)	Margin (W/kg)	Note(s)	Result
Front of EUT Facing Phantom	Flat (SAM)	189	0.206	1.600	1.394	1	Complied

#### Note(s):

1. SAR measurements were performed with the EUT at a separation distance of 15mm from the 'SAM' phantom flat section.

Test of: Enfora Inc.  
GSM3408

To: OET Bulletin 65 Supplement C: (2001-01)

### 7.2.2. Specific Absorption Rate - GSM850 Body Configuration 1g

#### Test Summary:

Tissue Volume:	1g
Maximum Level (W/kg):	0.218

#### Environmental Conditions:

Temperature Variation in Lab (°C):	23.0 to 23.0
Temperature Variation in Liquid (°C):	23.0 to 23.0

#### Results:

EUT Position	Phantom Configuration	Channel Number	Level (W/kg)	Limit (W/kg)	Margin (W/kg)	Note(s)	Result
Rear of EUT Facing Phantom	Flat (SAM)	189	0.218	1.600	1.382	1	Complied
Front of EUT Facing Phantom	Flat (SAM)	189	0.143	1.600	1.457	1	Complied

#### Note(s):

1. SAR measurements were performed with the EUT at a separation distance of 15mm from the 'SAM' phantom flat section.

Test of: Enfora Inc.  
GSM3408

To: OET Bulletin 65 Supplement C: (2001-01)

### 7.2.3. Specific Absorption Rate - EGPRS1900 Body Configuration 1g

#### Test Summary:

Tissue Volume:	1g
Maximum Level (W/kg):	0.082

#### Environmental Conditions:

Temperature Variation in Lab (°C):	23.0 to 23.0
Temperature Variation in Liquid (°C):	23.0 to 23.0

#### Results:

EUT Position	Phantom Configuration	Channel Number	Level (W/kg)	Limit (W/kg)	Margin (W/kg)	Note(s)	Result
Rear of EUT Facing Phantom	Flat (SAM)	660	0.082	1.600	1.518	1	Complied

#### Note(s):

1. SAR measurements were performed with the EUT at a separation distance of 15mm from the 'SAM' phantom flat section.

Test of: Enfora Inc.  
GSM3408

To: OET Bulletin 65 Supplement C: (2001-01)

#### 7.2.4. Specific Absorption Rate - PCS1900 Body Configuration 1g

##### Test Summary:

Tissue Volume:	1g
Maximum Level (W/kg):	0.083

##### Environmental Conditions:

Temperature Variation in Lab (°C):	23.0 to 23.0
Temperature Variation in Liquid (°C):	23.0 to 23.0

##### Results:

EUT Position	Phantom Configuration	Channel Number	Level (W/kg)	Limit (W/kg)	Margin (W/kg)	Note(s)	Result
Rear of EUT Facing Phantom	Flat (SAM)	660	0.083	1.600	1.517	1	Complied
Front of EUT Facing Phantom	Flat (SAM)	660	0.023	1.600	1.577	1	Complied

##### Note(s):

1. SAR measurements were performed with the EUT at a separation distance of 15mm from the 'SAM' phantom flat section.

Test of: Enfora Inc.  
GSM3408

To: OET Bulletin 65 Supplement C: (2001-01)

---

#### 7.2.5. EIRP/ERP Measurement

Channel Number	Frequency (MHZ)	TX Power before Test (dBm)	Note
128	824.2	26.2	ERP
189	836.4	27.5	ERP
251	848.8	26.4	ERP
512	1850.2	27.3	EIRP
660	1879.8	25.7	EIRP
810	1909.8	23.9	EIRP

---

Test of: Enfora Inc.  
GSM3408

To: OET Bulletin 65 Supplement C: (2001-01)

---

## **8. Measurement Uncertainty**

No measurement or test can ever be perfect and the imperfections give rise to error of measurement in the results. Consequently, the result of a measurement is only an approximation to the value of the measurand (the specific quantity subject to measurement) and is only complete when accompanied by a statement of the uncertainty of the approximation.

The expression of uncertainty of a measurement result allows realistic comparison of results with reference values and limits given in specifications and standards.

The uncertainty of the result may need to be taken into account when interpreting the measurement results.

The reported expanded uncertainties below are based on a standard uncertainty multiplied by an appropriate coverage factor, such that a confidence level of approximately 95% is maintained. For the purposes of this document "approximately" is interpreted as meaning "effectively" or "for most practical purposes".

<b>Test Name</b>	<b>Confidence Level</b>	<b>Calculated Uncertainty</b>
Specific Absorption Rate-GSM850 Body Configuration 1g	95%	18.03%
Specific Absorption Rate-PCS1900 Body Configuration 1g	95%	18.30%

The methods used to calculate the above uncertainties are in line with those recommended within the various measurement specifications. Where measurement specifications do not include guidelines for the evaluation of measurement uncertainty, the published guidance of the appropriate accreditation body is followed.

---



Test of: Enfora Inc.  
GSM3408

To: OET Bulletin 65 Supplement C: (2001-01)

### Measurement Uncertainty (Continued)

#### 8.1. Specific Absorption Rate Uncertainty at 850 MHz Body 1g, GSM Modulation Scheme calculated in accordance with IEC 62209-1 & IEEE 1528

Type	Source of uncertainty	+ Value	- Value	Probability Distribution	Divisor	C <sub>i</sub> (10g)	Standard Uncertainty		v <sub>i</sub> or v <sub>eff</sub>
							+ u (%)	- u (%)	
B	Probe calibration	11.000	11.000	normal (k=2)	2.0000	1.0000	5.500	5.500	∞
B	Axial Isotropy	0.500	0.500	normal (k=2)	2.0000	1.0000	0.250	0.250	∞
B	Hemispherical Isotropy	2.600	2.600	normal (k=2)	2.0000	1.0000	1.300	1.300	∞
B	Spatial Resolution	0.500	0.500	Rectangular	1.7321	1.0000	0.289	0.289	∞
B	Boundary Effect	0.769	0.769	Rectangular	1.7321	1.0000	0.444	0.444	∞
B	Linearity	0.600	0.600	Rectangular	1.7321	1.0000	0.346	0.346	∞
B	Detection Limits	0.200	0.200	Rectangular	1.7321	1.0000	0.115	0.115	∞
B	Readout Electronics	0.560	0.560	normal (k=2)	2.0000	1.0000	0.280	0.280	∞
B	Response Time	0.000	0.000	Rectangular	1.7321	1.0000	0.000	0.000	∞
B	Integration Time	1.730	1.730	Rectangular	1.7321	1.0000	0.999	0.999	∞
B	RF Ambient conditions	3.000	3.000	Rectangular	1.7321	1.0000	1.732	1.732	∞
B	Probe Positioner Mechanical Restrictions	4.000	4.000	Rectangular	1.7321	1.0000	2.309	2.309	∞
B	Probe Positioning with regard to Phantom Shell	2.850	2.850	Rectangular	1.7321	1.0000	1.645	1.645	∞
B	Extrapolation and integration/ Maximum SAR evaluation	5.080	5.080	Rectangular	1.7321	1.0000	2.933	2.933	∞
A	Test Sample Positioning	0.584	0.584	normal (k=1)	1.0000	1.0000	0.584	0.584	10
A	Device Holder uncertainty	0.154	0.154	normal (k=1)	1.0000	1.0000	0.154	0.154	10
B	Phantom Uncertainty	4.000	4.000	Rectangular	1.7321	1.0000	2.309	2.309	∞
B	Drift of output power	5.000	5.000	Rectangular	1.7321	1.0000	2.887	2.887	∞
B	Liquid Conductivity (target value)	5.000	5.000	Rectangular	1.7321	0.6400	1.848	1.848	∞
A	Liquid Conductivity (measured value)	3.600	3.600	normal (k=1)	1.0000	0.6400	2.304	2.304	5
B	Liquid Permittivity (target value)	5.000	5.000	Rectangular	1.7321	0.6000	1.732	1.732	∞
A	Liquid Permittivity (measured value)	4.000	4.000	normal (k=1)	1.0000	0.6000	2.400	2.400	5
	Combined standard uncertainty			t-distribution			9.20	9.20	>500
	Expanded uncertainty			k = 1.96			18.03	18.03	>500

Test of: Enfora Inc.  
GSM3408

To: OET Bulletin 65 Supplement C: (2001-01)

### Measurement Uncertainty (Continued)

#### 8.2. Specific Absorption Rate Uncertainty at 1900 MHz Body 1g, PCS Modulation Scheme calculated in accordance with IEC 62209-1 & IEEE 1528

Type	Source of uncertainty	+ Value	- Value	Probability Distribution	Divisor	C <sub>i</sub> (10g)	Standard Uncertainty		v <sub>i</sub> or v <sub>eff</sub>
							+ u (%)	- u (%)	
B	Probe calibration	11.000	11.000	normal (k=2)	2.0000	1.0000	5.500	5.500	∞
B	Axial Isotropy	0.500	0.500	normal (k=2)	2.0000	1.0000	0.250	0.250	∞
B	Hemispherical Isotropy	2.600	2.600	normal (k=2)	2.0000	1.0000	1.300	1.300	∞
B	Spatial Resolution	0.500	0.500	Rectangular	1.7321	1.0000	0.289	0.289	∞
B	Boundary Effect	0.769	0.769	Rectangular	1.7321	1.0000	0.444	0.444	∞
B	Linearity	0.600	0.600	Rectangular	1.7321	1.0000	0.346	0.346	∞
B	Detection Limits	0.200	0.200	Rectangular	1.7321	1.0000	0.115	0.115	∞
B	Readout Electronics	0.560	0.560	normal (k=2)	2.0000	1.0000	0.280	0.280	∞
B	Response Time	0.000	0.000	Rectangular	1.7321	1.0000	0.000	0.000	∞
B	Integration Time	1.730	1.730	Rectangular	1.7321	1.0000	0.999	0.999	∞
B	RF Ambient conditions	3.000	3.000	Rectangular	1.7321	1.0000	1.732	1.732	∞
B	Probe Positioner Mechanical Restrictions	4.000	4.000	Rectangular	1.7321	1.0000	2.309	2.309	∞
B	Probe Positioning with regard to Phantom Shell	2.850	2.850	Rectangular	1.7321	1.0000	1.645	1.645	∞
B	Extrapolation and integration/ Maximum SAR evaluation	5.080	5.080	Rectangular	1.7321	1.0000	2.933	2.933	∞
A	Test Sample Positioning	0.584	0.584	normal (k=1)	1.0000	1.0000	0.584	0.584	10
A	Device Holder uncertainty	0.154	0.154	normal (k=1)	1.0000	1.0000	0.154	0.154	10
B	Phantom Uncertainty	4.000	4.000	Rectangular	1.7321	1.0000	2.309	2.309	∞
B	Drift of output power	5.000	5.000	Rectangular	1.7321	1.0000	2.887	2.887	∞
B	Liquid Conductivity (target value)	5.000	5.000	Rectangular	1.7321	0.6400	1.848	1.848	∞
A	Liquid Conductivity (measured value)	4.170	4.170	normal (k=1)	1.0000	0.6400	2.669	2.669	5
B	Liquid Permittivity (target value)	5.000	5.000	Rectangular	1.7321	0.6000	1.732	1.732	∞
A	Liquid Permittivity (measured value)	4.230	4.230	normal (k=1)	1.0000	0.6000	2.538	2.538	5
	Combined standard uncertainty			t-distribution			9.34	9.34	>400
	Expanded uncertainty			k = 1.96			18.30	18.30	>400

Test of: Enfora Inc.  
GSM3408

To: OET Bulletin 65 Supplement C: (2001-01)

### Appendix 1. Test Equipment Used

RFI No.	Instrument	Manufacturer	Type No.	Serial No.	Date Last Calibrated	Cal. Interval (Months)
A034	Narda 20W Termination	Narda	374BNM	8706	Calibrated as part of system	-
A1094	Digital Camera	Sony	MVC - FD81	125805	-	-
A1097	SMA Directional Coupler	MiDISCO	MDC6223-30	None	Calibrated as part of system	-
A1137	3dB Attenuator	Narda	779	04690	Calibrated as part of system	-
A1174	Dielectric Probe Kit	Agilent Technologies	85070C	Us99360072	Calibrated before use	-
A1328	Handset Positioner	Schmid & Partners	Modification	SD 000 H01 DA	-	-
A1182	Handset Positioner	Schmid & Partners	V3.0	None	-	-
A1184	Data Acquisition Electronics	Schmid & Partner	DAE3	394	24 May 2007	12
A1185	Probe	Schmid & Partner	ET3 DV6	1528	06 July 2007	12
A1238	SAM Phantom	Schmid & Partners	SAM b	001	Calibrated before use	-
A1566	SAM Phantom	Schmid & Partners	SAM a	002	Calibrated before use	-
A1237	1900 MHz Dipole Kit	Schmid & Partner Engineering AG	D1900V2	540	11 June 2007	24
A1329	900 MHz Dipole Kit	Schmid & Partner Engineering AG	D900V2	185	18 May 2007	24
A1497	Amplifier	Mini-Circuits	zhl-42w (sma)	e020105	Calibrated as part of system	-
A215	20 dB Attenuator	Narda	766-20	9402	Calibrated as part of system	-
C1144	Cable	Rosenberger MICRO-COAX	FA147AF00 1503030	41842-1	Calibrated as part of system	-
C1145	Cable	Rosenberger MICRO-COAX	FA147AF00 3003030	41843-1	Calibrated as part of system	-
C1146	Cable	Rosenberger MICRO-COAX	FA147AF03 0003030	41752-1	Calibrated as part of system	-

Test of: Enfora Inc.  
GSM3408

To: OET Bulletin 65 Supplement C: (2001-01)

**Test Equipment Used (Continued)**

RFI No.	Instrument	Manufacturer	Type No.	Serial No.	Date Last Calibrated	Cal. Interval (Months)
G051	Signal Generator	Gigatronics	7100/.01-20	749472	Calibrated before use	-
G0528	Robot Power Supply	Schmid & Partner	DASY	None	Calibrated before use	-
G087	PSU	Thurlby Thandar	CPX200	100701	Calibrated before use	-
M010	NRV Power Meter	Rohde & Schwarz	NRV	882 317/065	06 July 2007	12
M1015	Network Analyser	Agilent Technologies	8753ES	US39172406	24 September 2007	12
M1047	Robot Arm	Staubli	RX908 L	F00/SD89A1/A/01	Calibrated before use	-
M1069	Diode Power Sensor	Rohde & Schwarz	NRV-Z2	838824/010	19 April 2007	12
M1129	Power Sensor	Rohde & Schwarz	URY-Z2	890242/16	12 June 2007	12
M1150	Compact Data Logger with Interface and Probe	Testo	175-T2	37503417 / 301	-	-
M136	Temperature/Humidity /Pressure Meter	RS Components	None	None	Internal Calibration	-
M509	Thermometer	Testo	110	40378800433	20 April 2007	12
S256	Site 56	RFI	N/A	N/A	Calibrated before use	-
A512	Double ridged Horn	EMCO	3115	3993	Used for Monitoring only	-
M1270	Temperature/Humidity /Pressure Meter	RS Components	None	None	Internal Calibration	-
M1093	Communications Test Set	Will tek	4202S	0513018	-	-
C1092	Cable	RS Components	293-334	1087200-3 3402	Internal Calibration	-
A1531	Antenna	AARONIA AG	7025	02458	-	-
A1508	Probe Extension Kit	Schmid & Partner	PE 150	1001	Calibrated before use	-

**NB** In accordance with UKAS requirements, all the measurement equipment is on a calibration schedule.

Test of: Enfora Inc.  
GSM3408

To: OET Bulletin 65 Supplement C: (2001-01)

---

### **A.1.1. Calibration Certificates**

This section contains the calibration certificates and data for the Probe(s) and Dipole(s) used, which are not included in the total number of pages for this report.

---

A1185  
12/07/07  
NM

**Calibration Laboratory of  
Schmid & Partner  
Engineering AG**  
Zeughausstrasse 43, 8004 Zurich, Switzerland



**S** Schweizerischer Kalibrierdienst  
**C** Service suisse d'étalonnage  
**S** Servizio svizzero di taratura  
**S** Swiss Calibration Service

Accredited by the Swiss Federal Office of Metrology and Accreditation  
The Swiss Accreditation Service is one of the signatories to the EA  
Multilateral Agreement for the recognition of calibration certificates

Accreditation No.: **SCS 108**

Client **RFI**

Certificate No. **ET3-1528 Jul07**

**CALIBRATION CERTIFICATE**

Object **ET3DV6 - SN:1528**

Calibration procedure(s) **QA CAL-01.v6  
Calibration procedure for dosimetric E-field probes**

Calibration date: **July 6, 2007**

Condition of the calibrated item **In Tolerance**

This calibration certificate documents the traceability to national standards, which realize the physical units of measurements (SI).  
The measurements and the uncertainties with confidence probability are given on the following pages and are part of the certificate.

All calibrations have been conducted in the closed laboratory facility: environment temperature (22 ± 3)°C and humidity < 70%.

Calibration Equipment used (M&TE critical for calibration)

Primary Standards	ID #	Cal Date (Calibrated by, Certificate No.)	Scheduled Calibration
Power meter E4419B	GB41293874	29-Mar-07 (METAS, No. 217-00670)	Mar-08
Power sensor E4412A	MY41495277	29-Mar-07 (METAS, No. 217-00670)	Mar-08
Power sensor E4412A	MY41498087	29-Mar-07 (METAS, No. 217-00670)	Mar-08
Reference 3 dB Attenuator	SN: S5054 (3c)	10-Aug-06 (METAS, No. 217-00592)	Aug-07
Reference 20 dB Attenuator	SN: S5086 (20b)	29-Mar-07 (METAS, No. 217-00671)	Mar-08
Reference 30 dB Attenuator	SN: S5129 (30b)	10-Aug-06 (METAS, No. 217-00593)	Aug-07
Reference Probe ES3DV2	SN: 3013	4-Jan-07 (SPEAG, No. ES3-3013_Jan07)	Jan-08
DAE4	SN: 654	20-Apr-07 (SPEAG, No. DAE4-654_Apr07)	Apr-08
Secondary Standards	ID #	Check Date (in house)	Scheduled Check
RF generator HP 8648C	US3642U01700	4-Aug-99 (SPEAG, in house check Nov-05)	In house check: Nov-07
Network Analyzer HP 8753E	US37390585	18-Oct-01 (SPEAG, in house check Oct-06)	In house check: Oct-07

	Name	Function	Signature
Calibrated by:	Katja Pokovic	Technical Manager	
Approved by:	Niels Kuster	Quality Manager	

Issued: July 6, 2007

This calibration certificate shall not be reproduced except in full without written approval of the laboratory.



### Glossary:

TSL	tissue simulating liquid
NORM <sub>x,y,z</sub>	sensitivity in free space
ConF	sensitivity in TSL / NORM <sub>x,y,z</sub>
DCP	diode compression point
Polarization $\phi$	$\phi$ rotation around probe axis
Polarization $\vartheta$	$\vartheta$ rotation around an axis that is in the plane normal to probe axis (at measurement center), i.e., $\vartheta = 0$ is normal to probe axis

### Calibration is Performed According to the Following Standards:

- IEEE Std 1528-2003, "IEEE Recommended Practice for Determining the Peak Spatial-Averaged Specific Absorption Rate (SAR) in the Human Head from Wireless Communications Devices: Measurement Techniques", December 2003
- IEC 62209-1, "Procedure to measure the Specific Absorption Rate (SAR) for hand-held devices used in close proximity to the ear (frequency range of 300 MHz to 3 GHz)", February 2005

### Methods Applied and Interpretation of Parameters:

- NORM<sub>x,y,z</sub>**: Assessed for E-field polarization  $\vartheta = 0$  ( $f \leq 900$  MHz in TEM-cell;  $f > 1800$  MHz: R22 waveguide). NORM<sub>x,y,z</sub> are only intermediate values, i.e., the uncertainties of NORM<sub>x,y,z</sub> does not effect the E<sup>2</sup>-field uncertainty inside TSL (see below *ConvF*).
- NORM(f)<sub>x,y,z</sub> = NORM<sub>x,y,z</sub> \* frequency\_response** (see Frequency Response Chart). This linearization is implemented in DASY4 software versions later than 4.2. The uncertainty of the frequency response is included in the stated uncertainty of *ConvF*.
- DCP<sub>x,y,z</sub>**: DCP are numerical linearization parameters assessed based on the data of power sweep (no uncertainty required). DCP does not depend on frequency nor media.
- ConvF and Boundary Effect Parameters**: Assessed in flat phantom using E-field (or Temperature Transfer Standard for  $f \leq 800$  MHz) and inside waveguide using analytical field distributions based on power measurements for  $f > 800$  MHz. The same setups are used for assessment of the parameters applied for boundary compensation (alpha, depth) of which typical uncertainty values are given. These parameters are used in DASY4 software to improve probe accuracy close to the boundary. The sensitivity in TSL corresponds to NORM<sub>x,y,z</sub> \* *ConvF* whereby the uncertainty corresponds to that given for *ConvF*. A frequency dependent *ConvF* is used in DASY version 4.4 and higher which allows extending the validity from  $\pm 50$  MHz to  $\pm 100$  MHz.
- Spherical isotropy (3D deviation from isotropy)**: in a field of low gradients realized using a flat phantom exposed by a patch antenna.
- Sensor Offset**: The sensor offset corresponds to the offset of virtual measurement center from the probe tip (on probe axis). No tolerance required.

# Probe ET3DV6

## SN:1528

Manufactured:	March 21, 2000
Last calibrated:	July 12, 2006
Recalibrated:	July 6, 2007

Calibrated for DASY Systems

(Note: non-compatible with DASY2 system!)



**DASY - Parameters of Probe: ET3DV6 SN:1528**

Sensitivity in Free Space <sup>A</sup>			Diode Compression <sup>B</sup>	
NormX	1.52 ± 10.1%	$\mu\text{V}/(\text{V}/\text{m})^2$	DCP X	96 mV
NormY	1.83 ± 10.1%	$\mu\text{V}/(\text{V}/\text{m})^2$	DCP Y	94 mV
NormZ	1.57 ± 10.1%	$\mu\text{V}/(\text{V}/\text{m})^2$	DCP Z	96 mV

**Sensitivity in Tissue Simulating Liquid (Conversion Factors)**

Please see Page 8.

**Boundary Effect**

TSL                      900 MHz      Typical SAR gradient: 5 % per mm

Sensor Center to Phantom Surface Distance		3.7 mm	4.7 mm
SAR <sub>be</sub> [%]	Without Correction Algorithm	8.9	4.7
SAR <sub>be</sub> [%]	With Correction Algorithm	0.1	0.2

TSL                      1750 MHz      Typical SAR gradient: 10 % per mm

Sensor Center to Phantom Surface Distance		3.7 mm	4.7 mm
SAR <sub>be</sub> [%]	Without Correction Algorithm	10.1	5.9
SAR <sub>be</sub> [%]	With Correction Algorithm	0.3	0.6

**Sensor Offset**Probe Tip to Sensor Center                      **2.7 mm**

**The reported uncertainty of measurement is stated as the standard uncertainty of measurement multiplied by the coverage factor k=2, which for a normal distribution corresponds to a coverage probability of approximately 95%.**

<sup>A</sup> The uncertainties of NormX,Y,Z do not affect the E<sup>2</sup>-field uncertainty inside TSL (see Page 8).

<sup>B</sup> Numerical linearization parameter: uncertainty not required.

# Frequency Response of E-Field

(TEM-Cell:ifi110 EXX, Waveguide: R22)

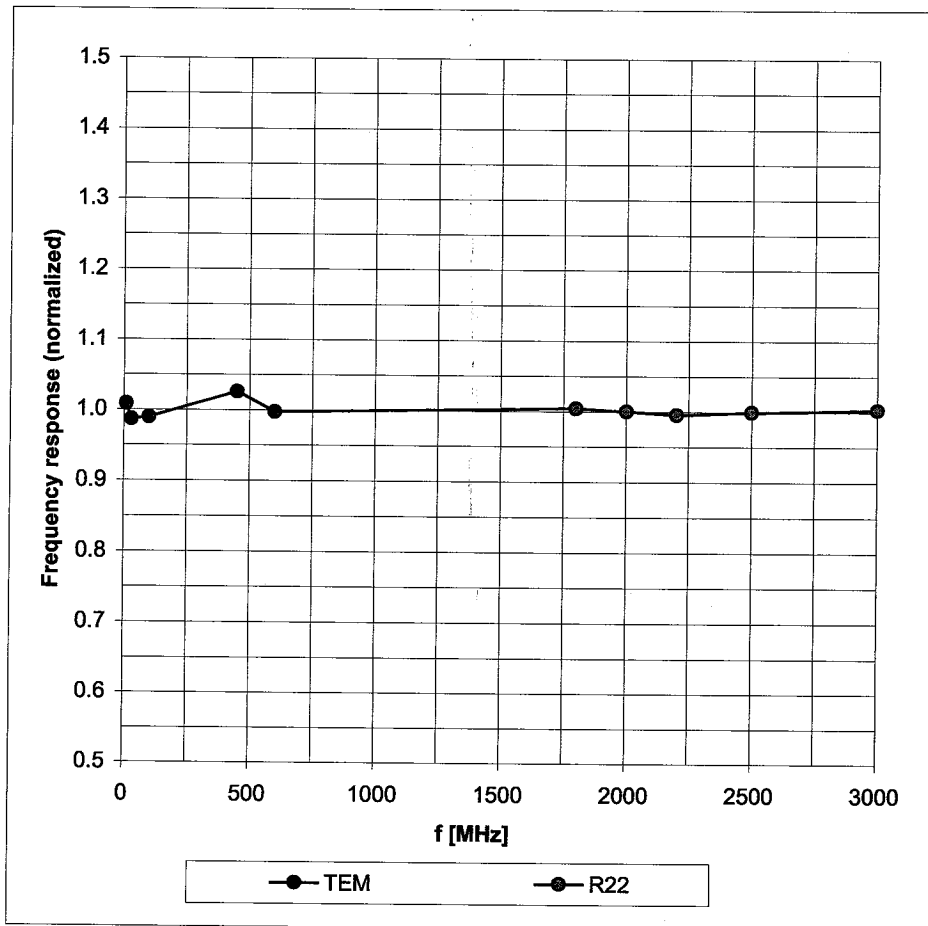

Uncertainty of Frequency Response of E-field:  $\pm 6.3\%$  (k=2)

### Receiving Pattern ( $\phi$ ), $\vartheta = 0^\circ$

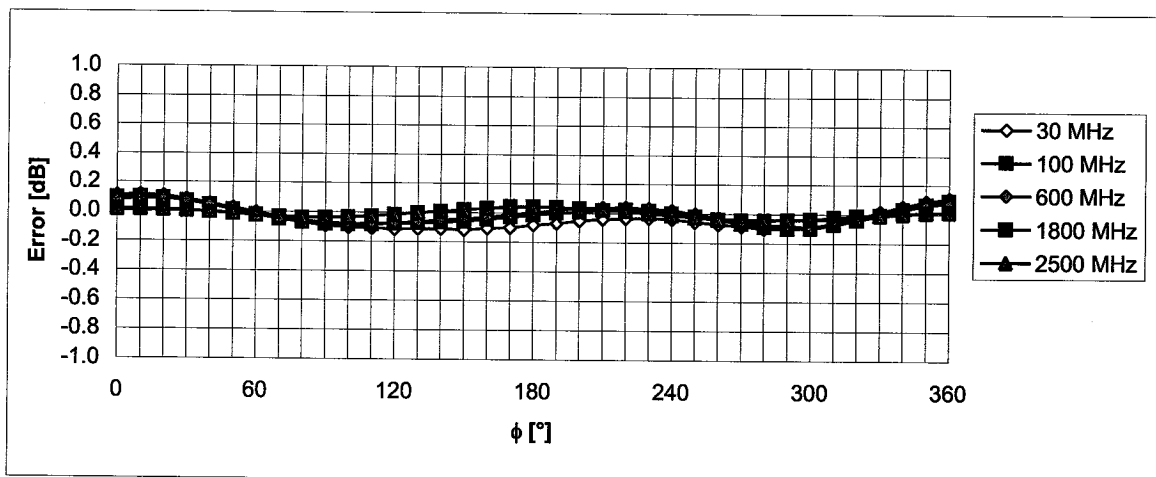
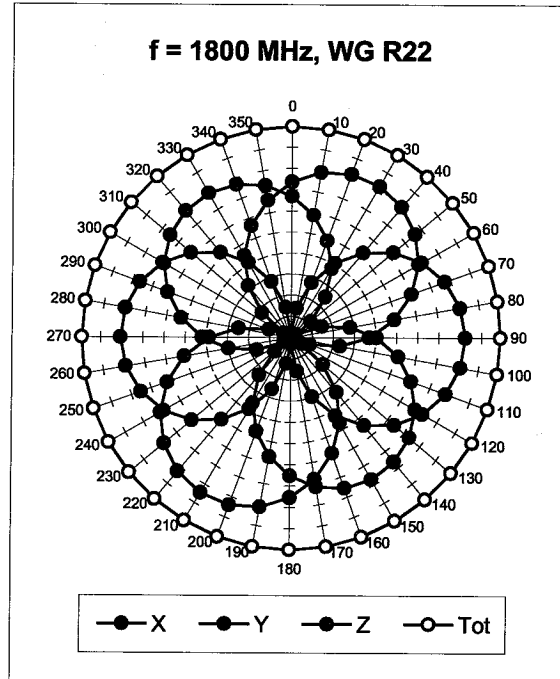
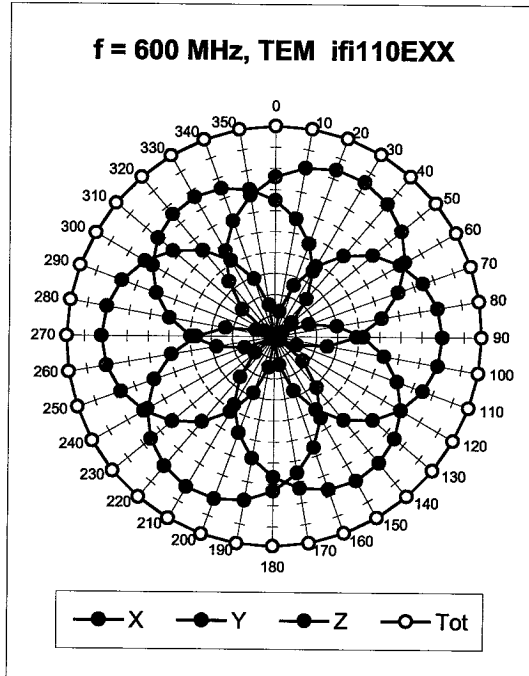

Uncertainty of Axial Isotropy Assessment:  $\pm 0.5\%$  ( $k=2$ )

## Dynamic Range $f(\text{SAR}_{\text{head}})$ (Waveguide R22, $f = 1800 \text{ MHz}$ )

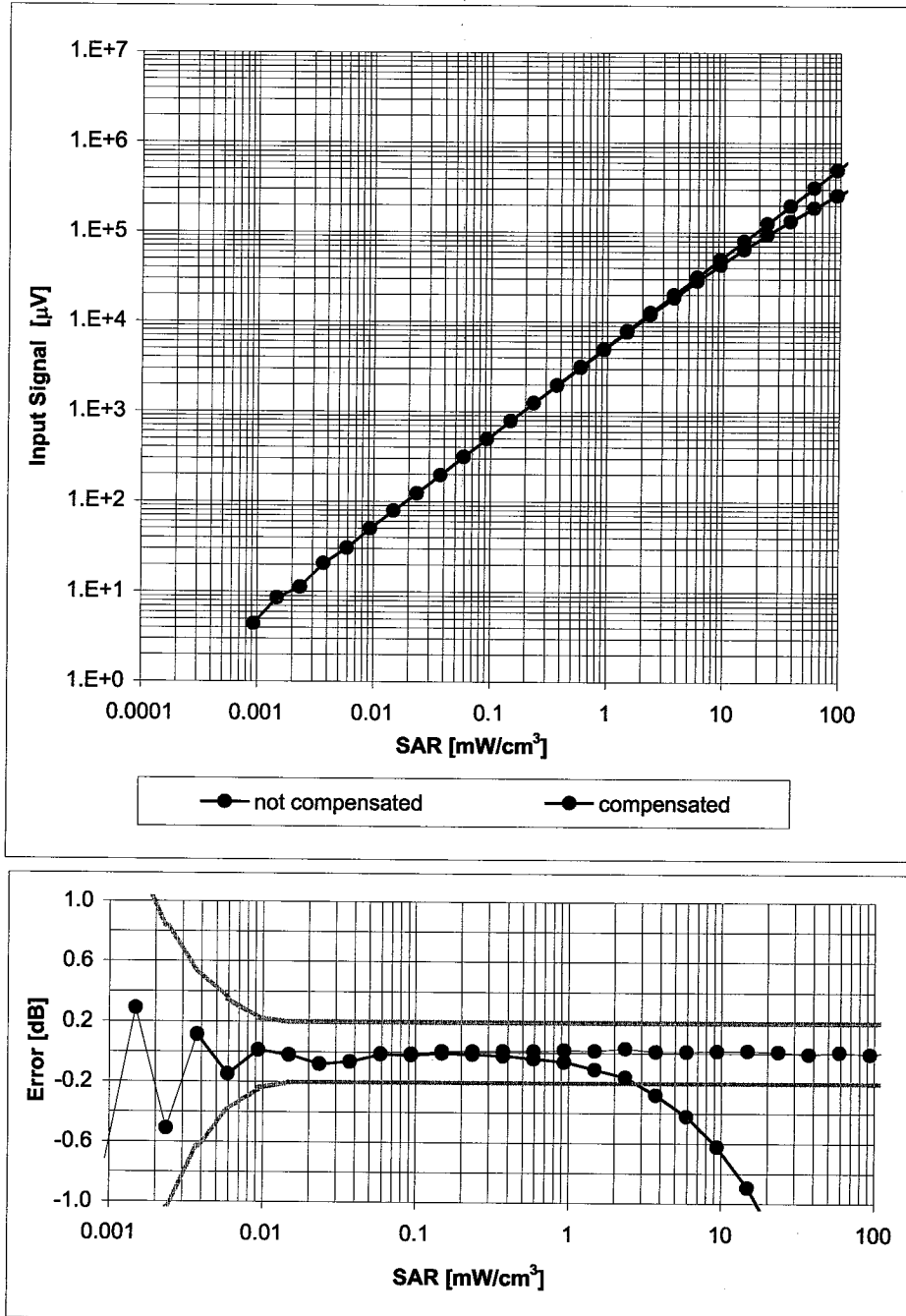

Uncertainty of Linearity Assessment:  $\pm 0.6\%$  ( $k=2$ )

## Conversion Factor Assessment

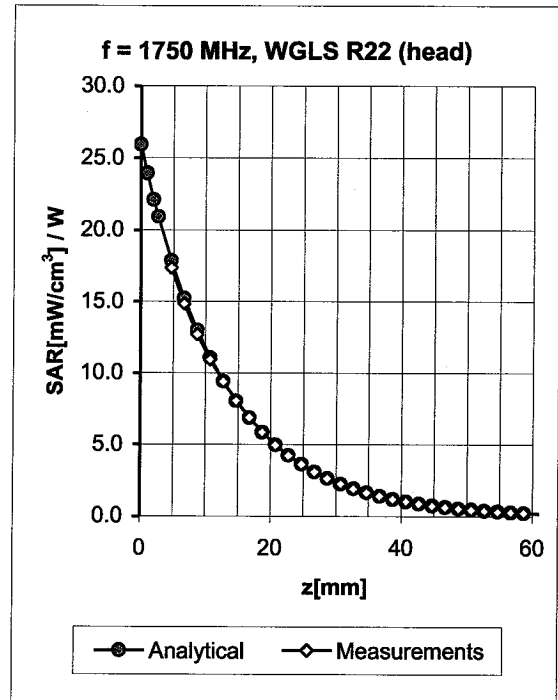
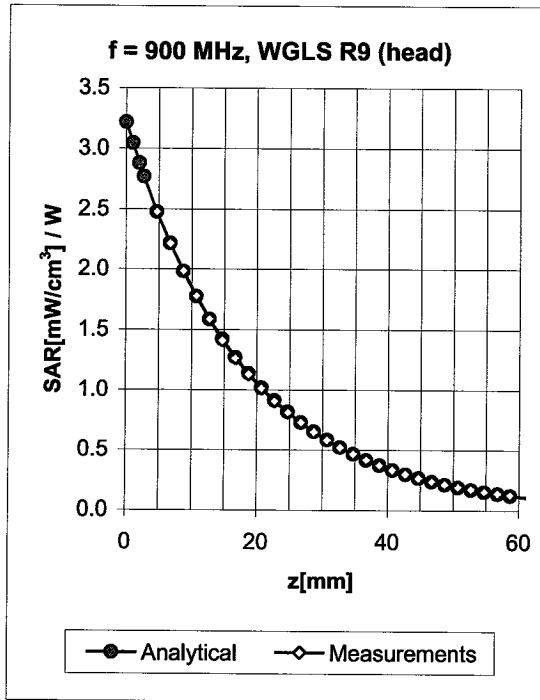

f [MHz]	Validity [MHz] <sup>c</sup>	TSL	Permittivity	Conductivity	Alpha	Depth	ConvF Uncertainty
835	± 50 / ± 99	Head	41.5 ± 5%	0.90 ± 5%	0.32	2.62	6.39 ± 11.0% (k=2)
900	± 50 / ± 100	Head	41.5 ± 5%	0.97 ± 5%	0.37	2.41	6.30 ± 11.0% (k=2)
1750	± 50 / ± 100	Head	40.1 ± 5%	1.37 ± 5%	0.51	2.72	5.12 ± 11.0% (k=2)
1900	± 50 / ± 100	Head	40.0 ± 5%	1.40 ± 5%	0.58	2.53	4.98 ± 11.0% (k=2)
835	± 50 / ± 100	Body	55.2 ± 5%	0.97 ± 5%	0.31	2.80	6.19 ± 11.0% (k=2)
900	± 50 / ± 100	Body	55.0 ± 5%	1.05 ± 5%	0.32	2.89	5.90 ± 11.0% (k=2)
1750	± 50 / ± 100	Body	53.4 ± 5%	1.49 ± 5%	0.67	2.32	4.78 ± 11.0% (k=2)
1900	± 50 / ± 100	Body	53.3 ± 5%	1.52 ± 5%	0.75	2.22	4.57 ± 11.0% (k=2)

<sup>c</sup> The validity of ± 100 MHz only applies for DASY v4.4 and higher (see Page 2). The uncertainty is the RSS of the ConvF uncertainty at calibration frequency and the uncertainty for the indicated frequency band.

### Deviation from Isotropy in HSL

Error ( $\phi, \vartheta$ ),  $f = 900$  MHz

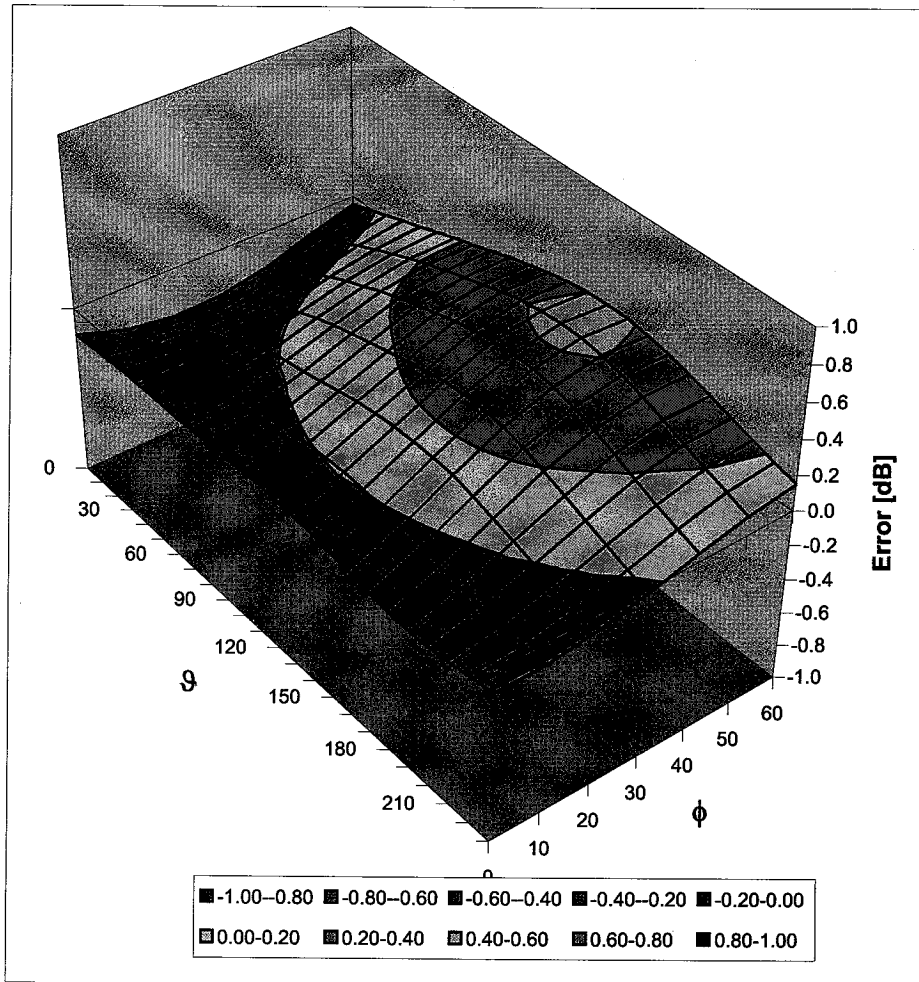

Uncertainty of Spherical Isotropy Assessment:  $\pm 2.6\%$  ( $k=2$ )



A1237  
20/06/07 NM

**S** Schweizerischer Kalibrierdienst  
**C** Service suisse d'étalonnage  
**S** Servizio svizzero di taratura  
**S** Swiss Calibration Service

Accredited by the Swiss Federal Office of Metrology and Accreditation  
The Swiss Accreditation Service is one of the signatories to the EA  
Multilateral Agreement for the recognition of calibration certificates

Accreditation No.: **SCS 108**

Client **RFI**

Certificate No: **D1900V2-540\_Jun07**

**CALIBRATION CERTIFICATE**

Object **D1900V2 - SN: 540**

Calibration procedure(s) **QA CAL-05.v7  
Calibration procedure for dipole validation kits**

Calibration date: **June 11, 2007**

Condition of the calibrated item **In Tolerance**

This calibration certificate documents the traceability to national standards, which realize the physical units of measurements (SI).  
The measurements and the uncertainties with confidence probability are given on the following pages and are part of the certificate.

All calibrations have been conducted in the closed laboratory facility: environment temperature (22 ± 3)°C and humidity < 70%.

Calibration Equipment used (M&TE critical for calibration)

Primary Standards	ID #	Cal Date (Calibrated by, Certificate No.)	Scheduled Calibration
Power meter EPM-442A	GB37480704	03-Oct-06 (METAS, No. 217-00608)	Oct-07
Power sensor HP 8481A	US37292783	03-Oct-06 (METAS, No. 217-00608)	Oct-07
Reference 20 dB Attenuator	SN: 5086 (20g)	10-Aug-06 (METAS, No 217-00591)	Aug-07
Reference 10 dB Attenuator	SN: 5047.2 (10r)	10-Aug-06 (METAS, No 217-00591)	Aug-07
Reference Probe ET3DV6	SN: 1507	19-Oct-06 (SPEAG, No. ET3-1507_Oct06)	Oct-07
Reference Probe ES3DV3	SN: 3025	19-Oct-06 (SPEAG, No. ES3-3025_Oct06)	Oct-07
DAE4	SN 601	30-Jan-07 (SPEAG, No. DAE4-601_Jan07)	Jan-08
Secondary Standards	ID #	Check Date (in house)	Scheduled Check
Power sensor HP 8481A	MY41092317	18-Oct-02 (SPEAG, in house check Oct-05)	In house check: Oct-07
RF generator Agilent E4421B	MY41000675	11-May-05 (SPEAG, in house check Nov-05)	In house check: Nov-07
Network Analyzer HP 8753E	US37390585 S4206	18-Oct-01 (SPEAG, in house check Oct-06)	In house check: Oct-07

Calibrated by: **Claudio Leubler**      **Laboratory Technician**      *[Signature]*

Approved by: **Katja Pokovic**      **Technical Manager**      *[Signature]*

Issued: June 14, 2007

This calibration certificate shall not be reproduced except in full without written approval of the laboratory.



Accredited by the Swiss Federal Office of Metrology and Accreditation  
The Swiss Accreditation Service is one of the signatories to the EA  
Multilateral Agreement for the recognition of calibration certificates

Accreditation No.: **SCS 108**

**Glossary:**

TSL	tissue simulating liquid
ConvF	sensitivity in TSL / NORM x,y,z
N/A	not applicable or not measured

**Calibration is Performed According to the Following Standards:**

- a) IEEE Std 1528-2003, "IEEE Recommended Practice for Determining the Peak Spatial-Averaged Specific Absorption Rate (SAR) in the Human Head from Wireless Communications Devices: Measurement Techniques", December 2003
- b) IEC 62209-1, "Procedure to measure the Specific Absorption Rate (SAR) for hand-held devices used in close proximity to the ear (frequency range of 300 MHz to 3 GHz)", February 2005
- c) Federal Communications Commission Office of Engineering & Technology (FCC OET), "Evaluating Compliance with FCC Guidelines for Human Exposure to Radiofrequency Electromagnetic Fields; Additional Information for Evaluating Compliance of Mobile and Portable Devices with FCC Limits for Human Exposure to Radiofrequency Emissions", Supplement C (Edition 01-01) to Bulletin 65

**Additional Documentation:**

- d) DASY4 System Handbook

**Methods Applied and Interpretation of Parameters:**

- *Measurement Conditions:* Further details are available from the Validation Report at the end of the certificate. All figures stated in the certificate are valid at the frequency indicated.
- *Antenna Parameters with TSL:* The dipole is mounted with the spacer to position its feed point exactly below the center marking of the flat phantom section, with the arms oriented parallel to the body axis.
- *Feed Point Impedance and Return Loss:* These parameters are measured with the dipole positioned under the liquid filled phantom. The impedance stated is transformed from the measurement at the SMA connector to the feed point. The Return Loss ensures low reflected power. No uncertainty required.
- *Electrical Delay:* One-way delay between the SMA connector and the antenna feed point. No uncertainty required.
- *SAR measured:* SAR measured at the stated antenna input power.
- *SAR normalized:* SAR as measured, normalized to an input power of 1 W at the antenna connector.
- *SAR for nominal TSL parameters:* The measured TSL parameters are used to calculate the nominal SAR result.



## Measurement Conditions

DASY system configuration, as far as not given on page 1.

<b>DASY Version</b>	DASY4	V4.7
<b>Extrapolation</b>	Advanced Extrapolation	
<b>Phantom</b>	Modular Flat Phantom V5.0	
<b>Distance Dipole Center - TSL</b>	10 mm	with Spacer
<b>Zoom Scan Resolution</b>	dx, dy, dz = 5 mm	
<b>Frequency</b>	1900 MHz $\pm$ 1 MHz	

## Head TSL parameters

The following parameters and calculations were applied.

	Temperature	Permittivity	Conductivity
<b>Nominal Head TSL parameters</b>	22.0 °C	40.0	1.40 mho/m
<b>Measured Head TSL parameters</b>	(22.0 $\pm$ 0.2) °C	39.7 $\pm$ 6 %	1.46 mho/m $\pm$ 6 %
<b>Head TSL temperature during test</b>	(21.5 $\pm$ 0.2) °C	---	---

## SAR result with Head TSL

<b>SAR averaged over 1 cm<sup>3</sup> (1 g) of Head TSL</b>	condition	
SAR measured	250 mW input power	9.25 mW / g
SAR normalized	normalized to 1W	37.0 mW / g
SAR for nominal Head TSL parameters <sup>1</sup>	normalized to 1W	<b>36.1 mW / g <math>\pm</math> 17.0 % (k=2)</b>

<b>SAR averaged over 10 cm<sup>3</sup> (10 g) of Head TSL</b>	Condition	
SAR measured	250 mW input power	4.89 mW / g
SAR normalized	normalized to 1W	19.6 mW / g
SAR for nominal Head TSL parameters <sup>1</sup>	normalized to 1W	<b>19.3 mW / g <math>\pm</math> 16.5 % (k=2)</b>

<sup>1</sup> Correction to nominal TSL parameters according to d), chapter "SAR Sensitivities"

## Body TSL parameters

The following parameters and calculations were applied.

	Temperature	Permittivity	Conductivity
<b>Nominal Body TSL parameters</b>	22.0 °C	53.3	1.52 mho/m
<b>Measured Body TSL parameters</b>	(22.0 ± 0.2) °C	51.8 ± 6 %	1.58 mho/m ± 6 %
<b>Body TSL temperature during test</b>	(21.2 ± 0.2) °C	---	---

## SAR result with Body TSL

<b>SAR averaged over 1 cm<sup>3</sup> (1 g) of Body TSL</b>	Condition	
SAR measured	250 mW input power	9.52 mW / g
SAR normalized	normalized to 1W	38.1 mW / g
SAR for nominal Body TSL parameters <sup>2</sup>	normalized to 1W	<b>38.0 mW / g ± 17.0 % (k=2)</b>

<b>SAR averaged over 10 cm<sup>3</sup> (10 g) of Body TSL</b>	condition	
SAR measured	250 mW input power	5.14 mW / g
SAR normalized	normalized to 1W	20.6 mW / g
SAR for nominal Body TSL parameters <sup>2</sup>	normalized to 1W	<b>20.7 mW / g ± 16.5 % (k=2)</b>

<sup>2</sup> Correction to nominal TSL parameters according to d), chapter "SAR Sensitivities"

## Appendix

### Antenna Parameters with Head TSL

Impedance, transformed to feed point	$51.9 \Omega + 5.1 j\Omega$
Return Loss	- 25.4 dB

### Antenna Parameters with Body TSL

Impedance, transformed to feed point	$47.7 \Omega + 4.8 j\Omega$
Return Loss	- 25.3 dB

### General Antenna Parameters and Design

Electrical Delay (one direction)	1.197 ns
----------------------------------	----------

After long term use with 100W radiated power, only a slight warming of the dipole near the feedpoint can be measured.

The dipole is made of standard semirigid coaxial cable. The center conductor of the feeding line is directly connected to the second arm of the dipole. The antenna is therefore short-circuited for DC-signals.

No excessive force must be applied to the dipole arms, because they might bend or the soldered connections near the feedpoint may be damaged.

### Additional EUT Data

Manufactured by	SPEAG
Manufactured on	July 26, 2001

## DASY4 Validation Report for Head TSL

Date/Time: 11.06.2007 10:40:22

Test Laboratory: SPEAG, Zurich, Switzerland

**DUT: Dipole 1900 MHz; Type: D1900V2; Serial: D1900V2 - SN:540**

Communication System: CW; Frequency: 1900 MHz; Duty Cycle: 1:1

Medium: HSL U10 BB;

Medium parameters used:  $f = 1900$  MHz;  $\sigma = 1.46$  mho/m;  $\epsilon_r = 39.7$ ;  $\rho = 1000$  kg/m<sup>3</sup>

Phantom section: Flat Section

Measurement Standard: DASY4 (High Precision Assessment)

### DASY4 Configuration:

- Probe: ET3DV6 - SN1507 (HF); ConvF(4.97, 4.97, 4.97); Calibrated: 19.10.2006
- Sensor-Surface: 4mm (Mechanical Surface Detection)
- Electronics: DAE4 Sn601; Calibrated: 30.01.2007
- Phantom: Flat Phantom 5.0 (front); Type: QD000P50AA; ;
- Measurement SW: DASY4, V4.7 Build 53; Postprocessing SW: SEMCAD, V1.8 Build 172

**Pin = 250 mW; d = 10 mm/Zoom Scan (7x7x7)/Cube 0:**

Measurement grid: dx=5mm, dy=5mm, dz=5mm

Reference Value = 87.9 V/m; Power Drift = 0.054 dB

Peak SAR (extrapolated) = 15.7 W/kg

**SAR(1 g) = 9.25 mW/g; SAR(10 g) = 4.89 mW/g**

Maximum value of SAR (measured) = 10.2 mW/g

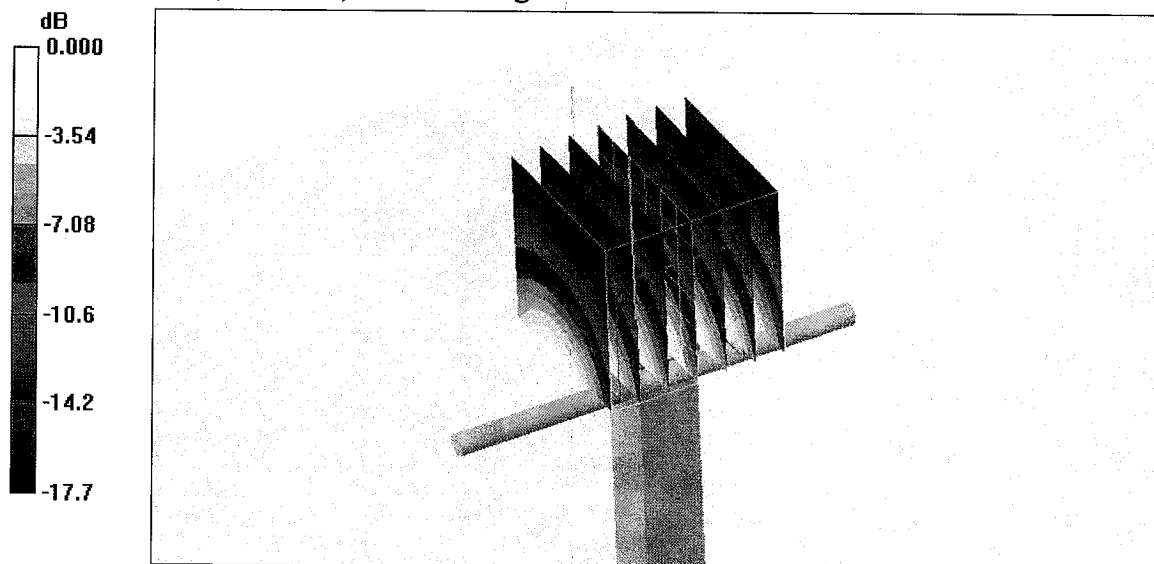

0 dB = 10.2mW/g

# Impedance Measurement Plot for Head TSL

11 Jun 2007 08:42:20

CH1 S11 1 U FS 3: 51.887  $\Omega$  5.1152  $\Omega$  428.48  $\mu\text{H}$  1 900.000 000 MHz

\*  
Del  
Cor  
Avg  
15  
↑

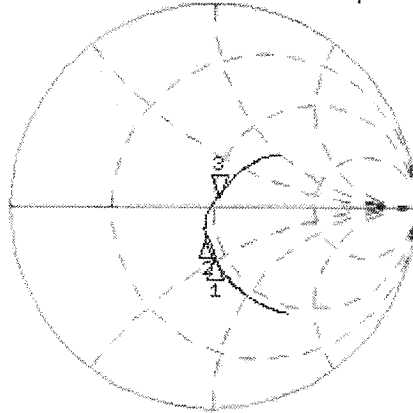

CH1 Markers  
1: 44.473  $\Omega$   
-24.576  $\Omega$   
1.75000 GHz  
2: 44.383  $\Omega$   
-13.623  $\Omega$   
1.80000 GHz

CH2 S11 LOG 5 dB/REF -20 dB 3: -25.442 dB 1 900.000 000 MHz

Cor  
Avg  
15  
↑

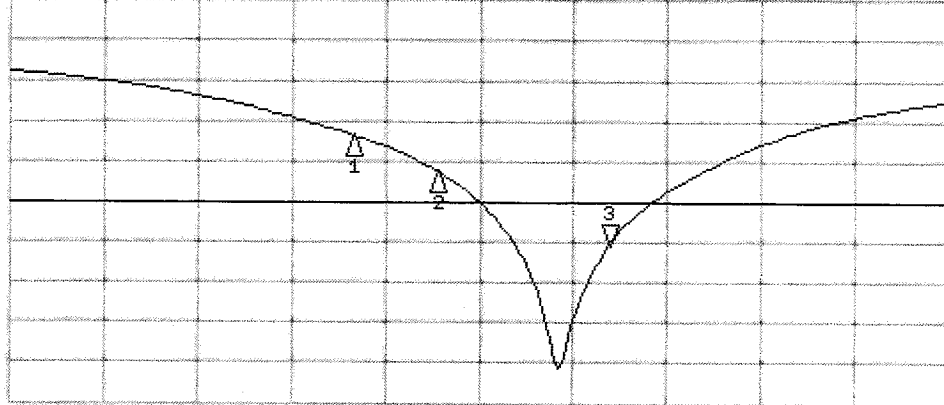

CH2 Markers  
1: -11.765 dB  
1.75000 GHz  
2: -16.222 dB  
1.80000 GHz

START 1 1550.000 000 MHz

STOP 2 1600.000 000 MHz

## DASY4 Validation Report for Body TSL

Date/Time: 11.06.2007 11:24:00

Test Laboratory: SPEAG, Zurich, Switzerland

**DUT: Dipole 1900 MHz; Type: D1900V2; Serial: D1900V2 - SN:540**

Communication System: CW; Frequency: 1900 MHz; Duty Cycle: 1:1

Medium: MSL U10 BB;

Medium parameters used:  $f = 1900$  MHz;  $\sigma = 1.59$  mho/m;  $\epsilon_r = 55.8$ ;  $\rho = 1000$  kg/m<sup>3</sup>

Phantom section: Flat Section

Measurement Standard: DASY4 (High Precision Assessment)

### DASY4 Configuration:

- Probe: ET3DV6 - SN1507 (HF); ConvF(4.43, 4.43, 4.43); Calibrated: 19.10.2006
- Sensor-Surface: 4mm (Mechanical Surface Detection)
- Electronics: DAE4 Sn601; Calibrated: 30.01.2007
- Phantom: Flat Phantom 5.0 (back); Type: QD000P50AA; ;
- Measurement SW: DASY4, V4.7 Build 53; Postprocessing SW: SEMCAD, V1.8 Build 172

### **Pin = 250 mW; d = 10 mm/Zoom Scan (7x7x7)/Cube 0:**

Measurement grid: dx=5mm, dy=5mm, dz=5mm

Reference Value = 87.9 V/m; Power Drift = 0.027 dB

Peak SAR (extrapolated) = 15.8 W/kg

**SAR(1 g) = 9.52 mW/g; SAR(10 g) = 5.14 mW/g**

Maximum value of SAR (measured) = 10.6 mW/g

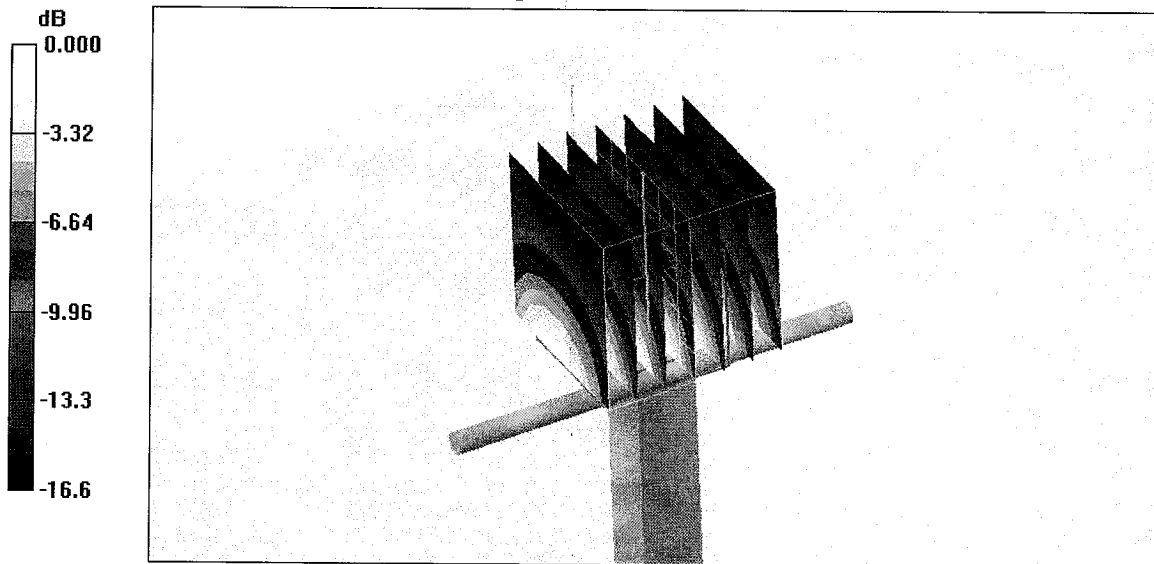

0 dB = 10.6mW/g

# Impedance Measurement Plot for Body TSL

11 Jun 2007 08:43:19

CH1 S11 1 U FS 3: 47.736  $\Omega$  4.8184  $\Omega$  403.61 pF 1 900.000 000 MHz

\*  
Del  
Cor  
Avg  
16  
↑

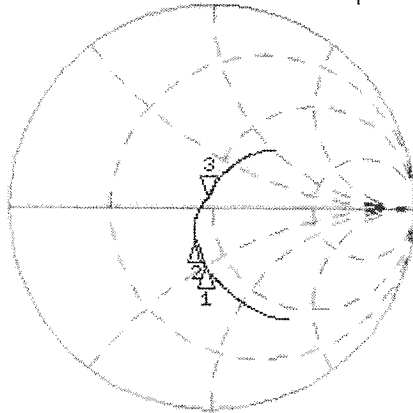

CH1 Markers  
1: 39.707  $\Omega$   
-25.889  $\Omega$   
1.75000 GHz  
2: 40.176  $\Omega$   
-14.076  $\Omega$   
1.80000 GHz

CH2 S11 LOG 5 dB/REF -20 dB 3: -25.286 dB 1 900.000 000 MHz

Cor  
Avg  
16  
↑

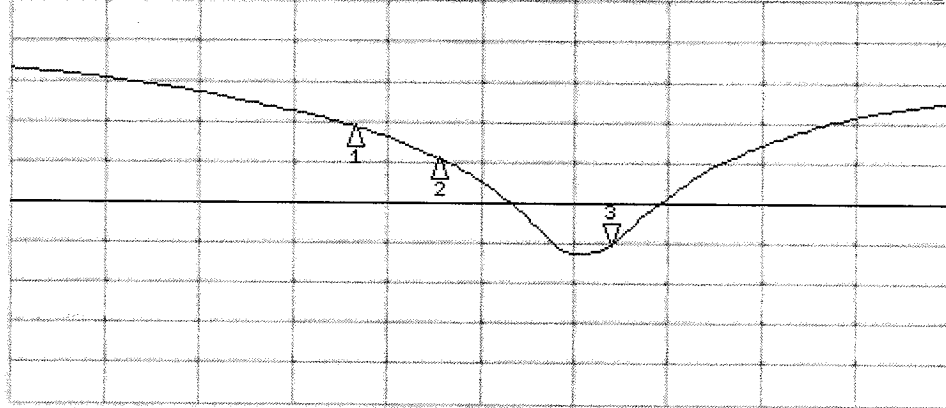

CH2 Markers  
1: -10.505 dB  
1.75000 GHz  
2: -14.514 dB  
1.80000 GHz

START 1 550.000 000 MHz

STOP 2 100.000 000 MHz

A1329  
30/05/07 NM

**Calibration Laboratory of  
Schmid & Partner  
Engineering AG**  
Zeughausstrasse 43, 8004 Zurich, Switzerland



**S** Schweizerischer Kalibrierdienst  
**C** Service suisse d'étalonnage  
**S** Servizio svizzero di taratura  
**S** Swiss Calibration Service

Accredited by the Swiss Federal Office of Metrology and Accreditation  
The Swiss Accreditation Service is one of the signatories to the EA  
Multilateral Agreement for the recognition of calibration certificates

Accreditation No.: **SCS 108**

Client **RFI**

Certificate No. **D900V2-185\_May07**

**CALIBRATION CERTIFICATE**

Object **D900V2 - SN: 185**

Calibration procedure(s) **QA CAL-05.v6  
Calibration procedure for dipole validation kits**

Calibration date: **May 18, 2007**

Condition of the calibrated item **In Tolerance**

This calibration certificate documents the traceability to national standards, which realize the physical units of measurements (SI).  
The measurements and the uncertainties with confidence probability are given on the following pages and are part of the certificate.

All calibrations have been conducted in the closed laboratory facility: environment temperature (22 ± 3)°C and humidity < 70%.

Calibration Equipment used (M&TE critical for calibration)

Primary Standards	ID #	Cal Date (Calibrated by, Certificate No.)	Scheduled Calibration
Power meter EPM-442A	GB37480704	03-Oct-06 (METAS, No. 217-00608)	Oct-07
Power sensor HP 8481A	US37292783	03-Oct-06 (METAS, No. 217-00608)	Oct-07
Reference 20 dB Attenuator	SN: 5086 (20g)	10-Aug-06 (METAS, No 217-00591)	Aug-07
Reference 10 dB Attenuator	SN: 5047.2 (10r)	10-Aug-06 (METAS, No 217-00591)	Aug-07
Reference Probe ET3DV6 (HF)	SN 1507	19-Oct-06 (SPEAG, No. ET3-1507_Oct06)	Oct-07
DAE4	SN 601	30-Jan-07 (SPEAG, No. DAE4-601_Jan07)	Jan-08
Secondary Standards	ID #	Check Date (in house)	Scheduled Check
Power sensor HP 8481A	MY41092317	18-Oct-02 (SPEAG, in house check Oct-05)	In house check: Oct-07
RF generator Agilent E4421B	MY41000675	11-May-05 (SPEAG, in house check Nov-05)	In house check: Nov-07
Network Analyzer HP 8753E	US37390585 S4206	18-Oct-01 (SPEAG, in house check Oct-06)	In house check: Oct-07

Calibrated by: **Claudio Leubler** Laboratory Technician *[Signature]*

Approved by: **Katja Pokovic** Technical Manager *[Signature]*

Issued: May 21, 2007

This calibration certificate shall not be reproduced except in full without written approval of the laboratory.





Accredited by the Swiss Federal Office of Metrology and Accreditation  
The Swiss Accreditation Service is one of the signatories to the EA  
Multilateral Agreement for the recognition of calibration certificates

Accreditation No.: **SCS 108**

**Glossary:**

TSL	tissue simulating liquid
ConvF	sensitivity in TSL / NORM x,y,z
N/A	not applicable or not measured

**Calibration is Performed According to the Following Standards:**

- a) IEEE Std 1528-2003, "IEEE Recommended Practice for Determining the Peak Spatial-Averaged Specific Absorption Rate (SAR) in the Human Head from Wireless Communications Devices: Measurement Techniques", December 2003
- b) IEC 62209-1, "Procedure to measure the Specific Absorption Rate (SAR) for hand-held devices used in close proximity to the ear (frequency range of 300 MHz to 3 GHz)", February 2005
- c) Federal Communications Commission Office of Engineering & Technology (FCC OET), "Evaluating Compliance with FCC Guidelines for Human Exposure to Radiofrequency Electromagnetic Fields; Additional Information for Evaluating Compliance of Mobile and Portable Devices with FCC Limits for Human Exposure to Radiofrequency Emissions", Supplement C (Edition 01-01) to Bulletin 65

**Additional Documentation:**

- d) DASY4 System Handbook

**Methods Applied and Interpretation of Parameters:**

- *Measurement Conditions:* Further details are available from the Validation Report at the end of the certificate. All figures stated in the certificate are valid at the frequency indicated.
- *Antenna Parameters with TSL:* The dipole is mounted with the spacer to position its feed point exactly below the center marking of the flat phantom section, with the arms oriented parallel to the body axis.
- *Feed Point Impedance and Return Loss:* These parameters are measured with the dipole positioned under the liquid filled phantom. The impedance stated is transformed from the measurement at the SMA connector to the feed point. The Return Loss ensures low reflected power. No uncertainty required.
- *Electrical Delay:* One-way delay between the SMA connector and the antenna feed point. No uncertainty required.
- *SAR measured:* SAR measured at the stated antenna input power.
- *SAR normalized:* SAR as measured, normalized to an input power of 1 W at the antenna connector.
- *SAR for nominal TSL parameters:* The measured TSL parameters are used to calculate the nominal SAR result.

## Measurement Conditions

DASY system configuration, as far as not given on page 1.

<b>DASY Version</b>	DASY4	V4.7
<b>Extrapolation</b>	Advanced Extrapolation	
<b>Phantom</b>	Modular Flat Phantom V4.9	
<b>Distance Dipole Center - TSL</b>	15 mm	with Spacer
<b>Zoom Scan Resolution</b>	dx, dy, dz = 5 mm	
<b>Frequency</b>	900 MHz $\pm$ 1 MHz	

## Head TSL parameters

The following parameters and calculations were applied.

	Temperature	Permittivity	Conductivity
<b>Nominal Head TSL parameters</b>	22.0 °C	41.5	0.97 mho/m
<b>Measured Head TSL parameters</b>	(22.0 $\pm$ 0.2) °C	40.9 $\pm$ 6 %	0.95 mho/m $\pm$ 6 %
<b>Head TSL temperature during test</b>	(21.5 $\pm$ 0.2) °C	---	---

## SAR result with Head TSL

<b>SAR averaged over 1 cm<sup>3</sup> (1 g) of Head TSL</b>	Condition	
SAR measured	250 mW input power	2.65 mW / g
SAR normalized	normalized to 1W	10.6 mW / g
SAR for nominal Head TSL parameters <sup>1</sup>	normalized to 1W	<b>10.6 mW / g <math>\pm</math> 17.0 % (k=2)</b>

<b>SAR averaged over 10 cm<sup>3</sup> (10 g) of Head TSL</b>	condition	
SAR measured	250 mW input power	1.71 mW / g
SAR normalized	normalized to 1W	6.84 mW / g
SAR for nominal Head TSL parameters <sup>1</sup>	normalized to 1W	<b>6.84 mW / g <math>\pm</math> 16.5 % (k=2)</b>

<sup>1</sup> Correction to nominal TSL parameters according to d), chapter "SAR Sensitivities"

## Body TSL parameters

The following parameters and calculations were applied.

	Temperature	Permittivity	Conductivity
Nominal Body TSL parameters	22.0 °C	55.0	1.05 mho/m
Measured Body TSL parameters	(22.0 ± 0.2) °C	52.3 ± 6 %	1.04 mho/m ± 6 %
Body TSL temperature during test	(22.5 ± 0.2) °C	---	---

## SAR result with Body TSL

SAR averaged over 1 cm <sup>3</sup> (1 g) of Body TSL	condition	
SAR measured	250 mW input power	2.70 mW / g
SAR normalized	normalized to 1W	10.8 mW / g
SAR for nominal Body TSL parameters <sup>2</sup>	normalized to 1W	<b>10.5 mW / g ± 17.0 % (k=2)</b>

SAR averaged over 10 cm <sup>3</sup> (10 g) of Body TSL	condition	
SAR measured	250 mW input power	1.76 mW / g
SAR normalized	normalized to 1W	7.04 mW / g
SAR for nominal Body TSL parameters <sup>2</sup>	normalized to 1W	<b>6.88 mW / g ± 16.5 % (k=2)</b>

<sup>2</sup> Correction to nominal TSL parameters according to d), chapter "SAR Sensitivities"

## Appendix

### Antenna Parameters with Head TSL

Impedance, transformed to feed point	49.9 $\Omega$ - 8.2 j $\Omega$
Return Loss	- 21.8 dB

### Antenna Parameters with Body TSL

Impedance, transformed to feed point	46.5 $\Omega$ - 9.2 j $\Omega$
Return Loss	- 20.0 dB

### General Antenna Parameters and Design

Electrical Delay (one direction)	1.405 ns
----------------------------------	----------

After long term use with 100W radiated power, only a slight warming of the dipole near the feedpoint can be measured.

The dipole is made of standard semirigid coaxial cable. The center conductor of the feeding line is directly connected to the second arm of the dipole. The antenna is therefore short-circuited for DC-signals.

No excessive force must be applied to the dipole arms, because they might bend or the soldered connections near the feedpoint may be damaged.

### Additional EUT Data

Manufactured by	SPEAG
Manufactured on	May 27, 2003

## DASY4 Validation Report for Head TSL

Date/Time: 14.05.2007 14:01:26

Test Laboratory: SPEAG, Zurich, Switzerland

**DUT: Dipole 900 MHz; Type: D900V2; Serial: D900V2 - SN:185**

Communication System: CW; Frequency: 900 MHz; Duty Cycle: 1:1

Medium: HSL 900 MHz;

Medium parameters used:  $f = 900$  MHz;  $\sigma = 0.95$  mho/m;  $\epsilon_r = 40.8$ ;  $\rho = 1000$  kg/m<sup>3</sup>

Phantom section: Flat Section

Measurement Standard: DASY4 (High Precision Assessment)

### DASY4 Configuration:

- Probe: ET3DV6 - SN1507 (HF); ConvF(6.01, 6.01, 6.01); Calibrated: 19.10.2006
- Sensor-Surface: 4mm (Mechanical Surface Detection)
- Electronics: DAE4 Sn601; Calibrated: 30.01.2007
- Phantom: Flat Phantom 4.9L; Type: QD000P49AA; ;
- Measurement SW: DASY4, V4.7 Build 53; Postprocessing SW: SEMCAD, V1.8 Build 172

**Pin = 250 mW; d = 15 mm/Zoom Scan (7x7x7)/Cube 0:**

Measurement grid: dx=5mm, dy=5mm, dz=5mm

Reference Value = 57.5 V/m; Power Drift = -0.044 dB

Peak SAR (extrapolated) = 3.92 W/kg

**SAR(1 g) = 2.65 mW/g; SAR(10 g) = 1.71 mW/g**

Maximum value of SAR (measured) = 2.89 mW/g

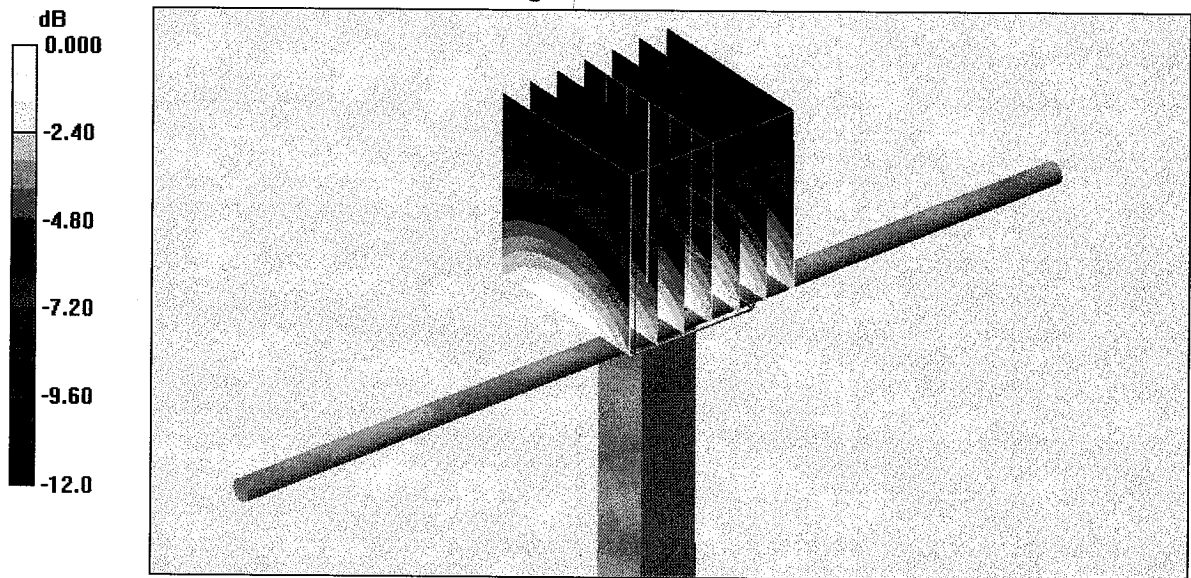

0 dB = 2.89mW/g

# Impedance Measurement Plot for Head TSL

14 May 2007 11:17:55

CH1 S11 1 U FS

1: 49.914  $\Omega$  -8.1777  $\Omega$  21.624 pF

900.000 000 MHz

\*  
Del  
Cor

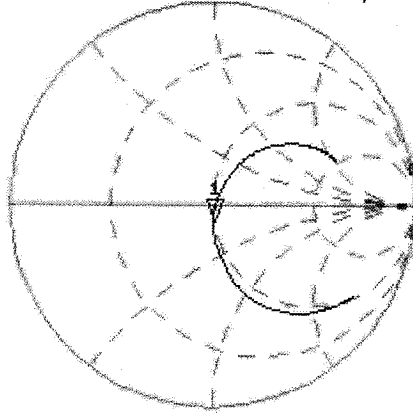

Avg  
16

CH2 S11 LOG 5 dB/REF -20 dB 1:-21.764 dB 900.000 000 MHz

Cor

Avg  
16

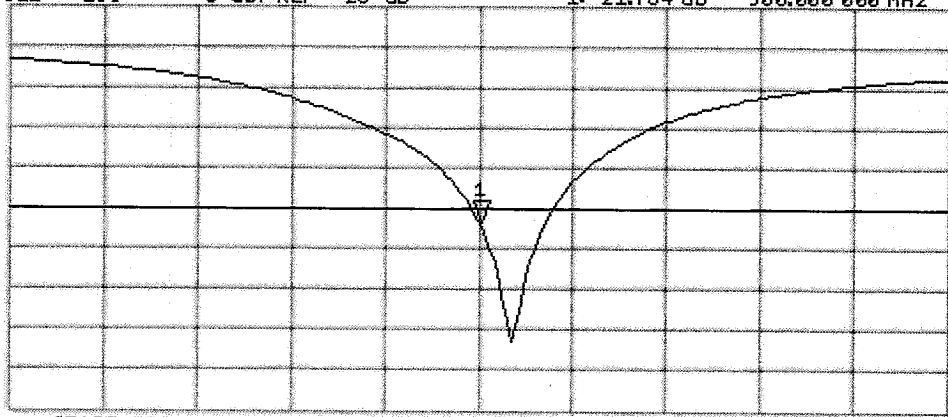

## DASY4 Validation Report for Body TSL

Date/Time: 18.05.2007 15:00:08

Test Laboratory: SPEAG, Zurich, Switzerland

**DUT: Dipole 900 MHz; Type: D900V2; Serial: D900V2 - SN:185**

Communication System: CW; Frequency: 900 MHz; Duty Cycle: 1:1

Medium: MSL900;

Medium parameters used:  $f = 900$  MHz;  $\sigma = 1.04$  mho/m;  $\epsilon_r = 52.3$ ;  $\rho = 1000$  kg/m<sup>3</sup>

Phantom section: Flat Section

Measurement Standard: DASY4 (High Precision Assessment)

### DASY4 Configuration:

- Probe: ET3DV6 - SN1507 (HF); ConvF(5.8, 5.8, 5.8); Calibrated: 19.10.2006
- Sensor-Surface: 4mm (Mechanical Surface Detection)
- Electronics: DAE4 Sn601; Calibrated: 30.01.2007
- Phantom: Flat Phantom 4.9L; Type: QD000P49AA; ;
- Measurement SW: DASY4, V4.7 Build 53; Postprocessing SW: SEMCAD, V1.8 Build 172

### Pin=250mW/Zoom Scan (7x7x7)/Cube 0:

Measurement grid: dx=5mm, dy=5mm, dz=5mm

Reference Value = 55.8 V/m; Power Drift = -0.012 dB

Peak SAR (extrapolated) = 3.82 W/kg

**SAR(1 g) = 2.7 mW/g; SAR(10 g) = 1.76 mW/g**

Maximum value of SAR (measured) = 2.94 mW/g

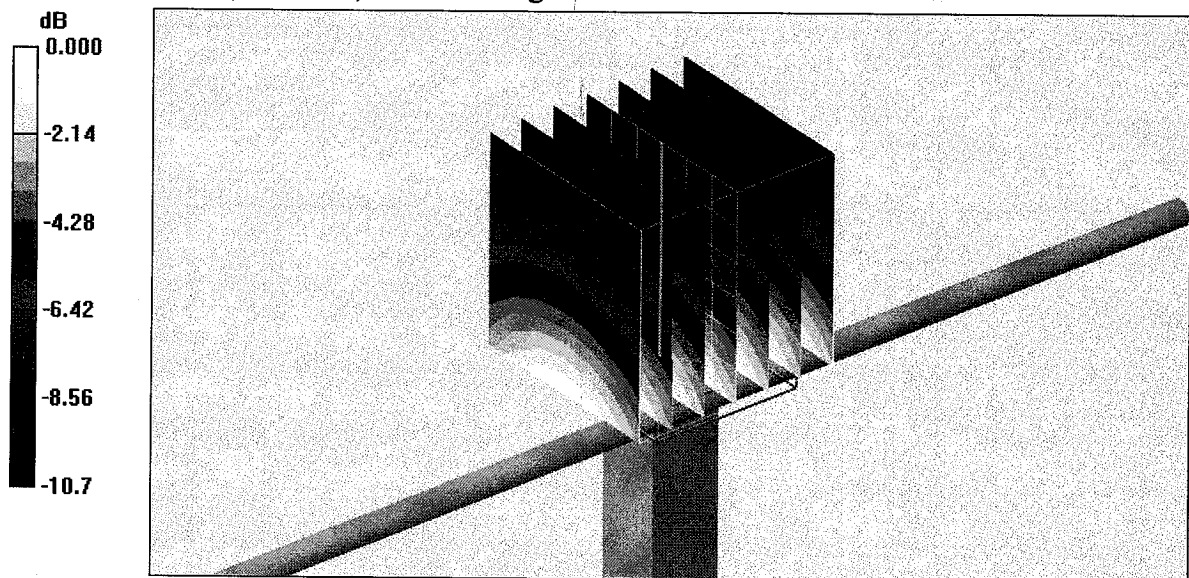

# Impedance Measurement Plot for Body TSL

18 May 2007 12:22:56

CH1 S11 1 U FS

1: 46.508  $\Omega$  -9.2461  $\Omega$  19.126 pF

900.000 000 MHz

\*  
Del  
Cor

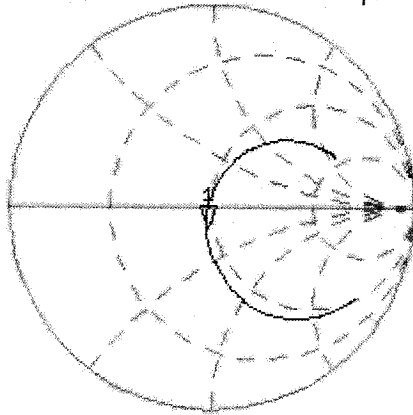

Avg  
16

CH2 S11 LOG 5 dB/REF -20 dB 1:-19.834 dB 900.000 000 MHz

Cor

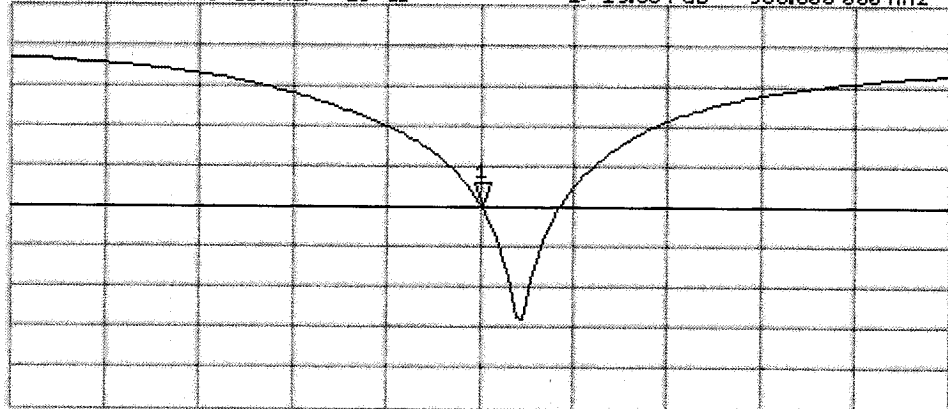

Avg  
16

CENTER 900.000 000 MHz

SPAN 400.000 000 MHz



Test of: Enfora Inc.  
GSM3408

To: OET Bulletin 65 Supplement C: (2001-01)

---

## **Appendix 2. Measurement Methods**

### **A.2.1. Evaluation Procedure**

The Specific Absorption Rate (SAR) evaluation was performed in the following manner:

- a) (i) The evaluation was performed in an applicable area of the phantom depending on the type of device being tested. For devices worn about the ear during normal operation, both the left and right ear positions were evaluated at the centre frequency of the band at maximum power. The side, which produced the greatest SAR, determined which side of the phantom would be used for the entire evaluation. The positioning of the head worn device relative to the phantom was dictated by the test specification identified in section 3.1 of this report.  
  
(ii) For body worn devices or devices which can be operated within 20 cm of the body, the flat section of the SAM phantom was used were the size of the device(s) is normal. for bigger devices and base station the 2mm Oval phantom is used for evaluation. The type of device being evaluated dictated the distance of the EUT to the outer surface of the phantom flat section.
  - b) The SAR was determined by a pre-defined procedure within the DASY4 software. The exposed region of the phantom was scanned near the inner surface with a grid spacing of 20mm x 20mm or appropriate resolution.
  - c) A 7x7x7 matrix was performed around the greatest spatial SAR distribution found during the area scan of the applicable exposed region. SAR values were then calculated using a 3-D spline interpolation algorithm and averaged over spatial volumes of 1 and 10 grams.
  - d) If the EUT had any appreciable drift over the course of the evaluation, then the EUT was re-evaluated. Any unusual anomalies over the course of the test also warranted a re-evaluation.
-

Test of: Enfora Inc.  
GSM3408

To: OET Bulletin 65 Supplement C: (2001-01)

---

### **A.2.2. Specific Absorption Rate (SAR) Measurements to OET Bulletin 65 Supplement C: (2001-01)**

Evaluating Compliance with FCC Guidelines for Human Exposure to Radio Frequency Electromagnetic Fields

SAR measurements were performed in accordance with Appendix D of the standard FCC OET Bulletin 65 Supplement C: 2001, against appropriate limits for each measurement position in accordance with the standard.

The test was performed in a shielded enclosure with the temperature controlled to remain between +18.0°C and +25.0°C. The tissue equivalent material fluid temperature was controlled to give a maximum variation of  $\pm 2.0^\circ\text{C}$

Prior to any SAR measurements on the EUT, system validation and material dielectric property measurements were conducted. In the absence of a detailed procedure within the specification, system validation and material dielectric property measurements were performed in accordance with Appendix C and Appendix D of FCC OET Bulletin 65 Supplement C: 2001.

Following the successful system validation and material dielectric property measurements, a SAR versus time sweep shall be performed within 10 mm of the phantom inner surface. If the EUT power output is stable after three minutes then the measurement probe will perform a coarse surface level scan at each test position in order to ascertain the location of the maximum local SAR level. Once this area had been established, a 7x7x7 cube of 343 points (5 mm spacing in each axis  $\approx 27\text{g}$ ) will be centred at the area of concern. Extrapolation and interpolation will then be carried out on the 27g of tissue and the highest averaged SAR over a 10g cube determined.

Once the maximum interpolated SAR measurement is complete; the coarse scan is visually assessed to check for secondary peaks within 50% of the maximum SAR level. If there are any further SAR measurements required, extra 7x7x7 cubes shall be centred on each of these extra local SAR maxima.

At the end of each position test case a second time sweep shall be performed to check whether the EUT has remained stable throughout the test.

---

Test of: Enfora Inc.  
GSM3408

To: OET Bulletin 65 Supplement C: (2001-01)

---

### **Appendix 3. SAR Distribution Scans**

This appendix contains SAR distribution scans which are not included in the total number of pages for this report.

<b>Scan Reference Number</b>	<b>Title</b>
SCN/45639JD18/001	Rear of EUT Facing Phantom CH660 15mm GPRS
SCN/45639JD18/002	Rear of EUT Facing Phantom CH660 15mm PCS
SCN/45639JD18/003	Front of EUT Facing Phantom CH660 15mm PCS
SCN/45639JD18/004	Rear of EUT Facing Phantom CH189 15mm GSM
SCN/45639JD18/005	Rear of EUT Facing Phantom CH189 15mm GPRS
SCN/45639JD18/006	Front of EUT Facing Phantom CH189 15mm GSM
SCN/45639JD18/007	System Performance Check 1900MHz Body 06 02 08
SCN/45639JD18/008	System Performance Check 900MHz Body 06 02 08

---

Test of: Enfora Inc.  
GSM3408

To: OET Bulletin 65 Supplement C: (2001-01)

SCN/45639JD18/001: Rear of EUT Facing Phantom CH660 15mm GPRS

Date: 06/02/2008

DUT: ENFORA L.P; Type: GSM3408; Serial: 340870700297

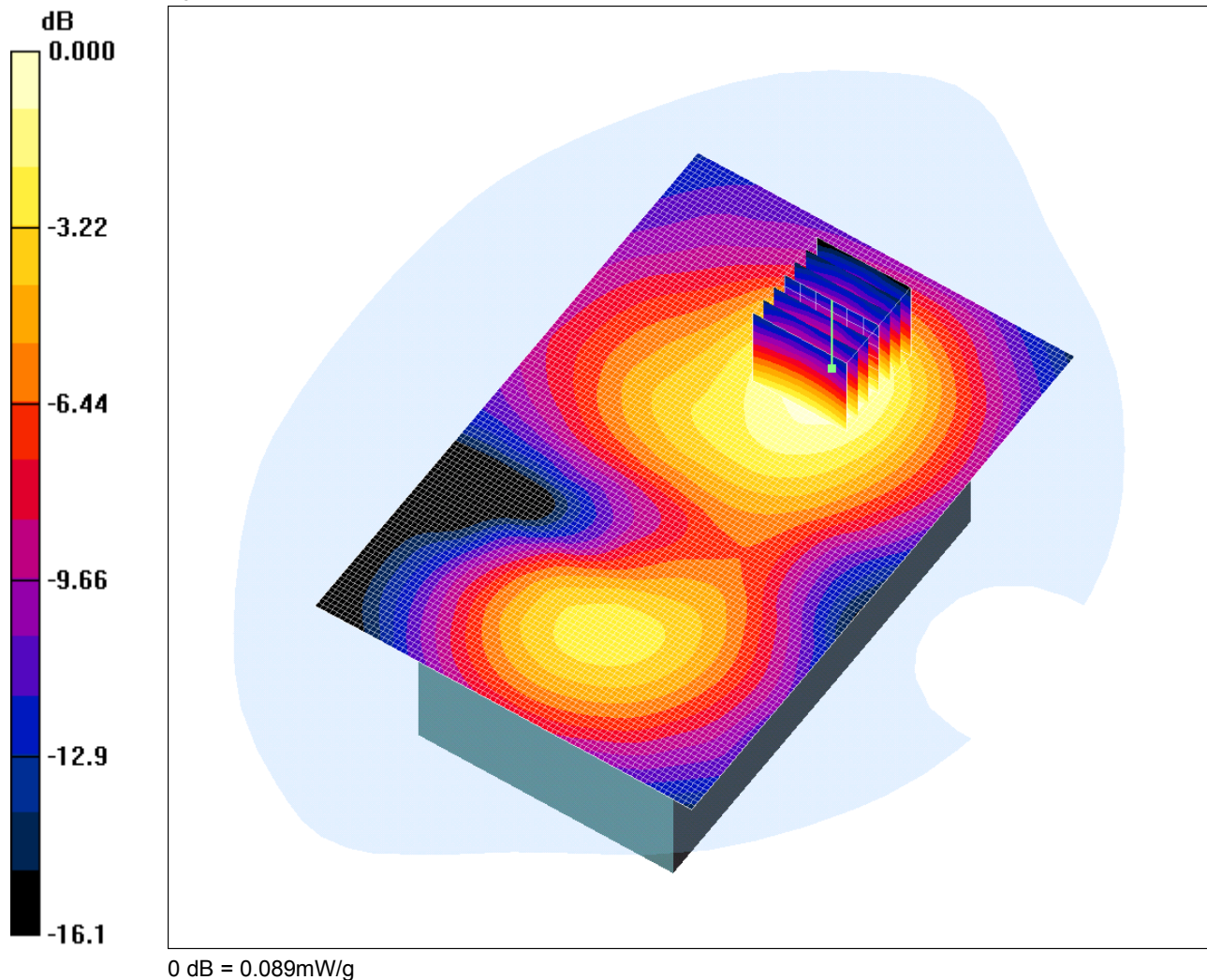

Communication System: GPRS 1900; Frequency: 1879.8 MHz; Duty Cycle: 1:4

Medium: 1900 MHz MSL Medium parameters used (interpolated):  $f = 1879.8$  MHz;  $\sigma = 1.5$  mho/m;  $\epsilon_r = 54.9$ ;  $\rho = 1000$  kg/m<sup>3</sup>

Phantom section: Flat Section

DASY4 Configuration:

- Probe: ET3DV6 - SN1528; ConvF(4.57, 4.57, 4.57); Calibrated: 06/07/2007

- Sensor-Surface: 4mm (Mechanical Surface Detection)

- Electronics: DAE3 Sn394; Calibrated: 24/05/2007

- Phantom: SAM 12a; Type: SAM 4.0; Serial: TP:1193

- Measurement SW: DASY4, V4.7 Build 55; Postprocessing SW: SEMCAD, V1.8 Build 176

**Rear of EUT Facing Phantom at 15 mm - Middle/Area Scan (81x121x1):** Measurement grid: dx=15mm, dy=15mm

Maximum value of SAR (interpolated) = 0.091 mW/g

**Rear of EUT Facing Phantom at 15 mm - Middle/Zoom Scan (7x7x7) (7x7x7)/Cube 0:** Measurement grid: dx=5mm, dy=5mm, dz=5mm

Reference Value = 4.53 V/m; Power Drift = -0.185 dB

Peak SAR (extrapolated) = 0.138 W/kg

**SAR(1 g) = 0.082 mW/g; SAR(10 g) = 0.050 mW/g**

Maximum value of SAR (measured) = 0.089 mW/g

Test of: Enfora Inc.  
GSM3408

To: OET Bulletin 65 Supplement C: (2001-01)

SCN/45639JD18/002: Rear of EUT Facing Phantom CH660 15mm PCS

Date: 06/02/2008

DUT: ENFORA L.P; Type: GSM3408; Serial: 340870700297

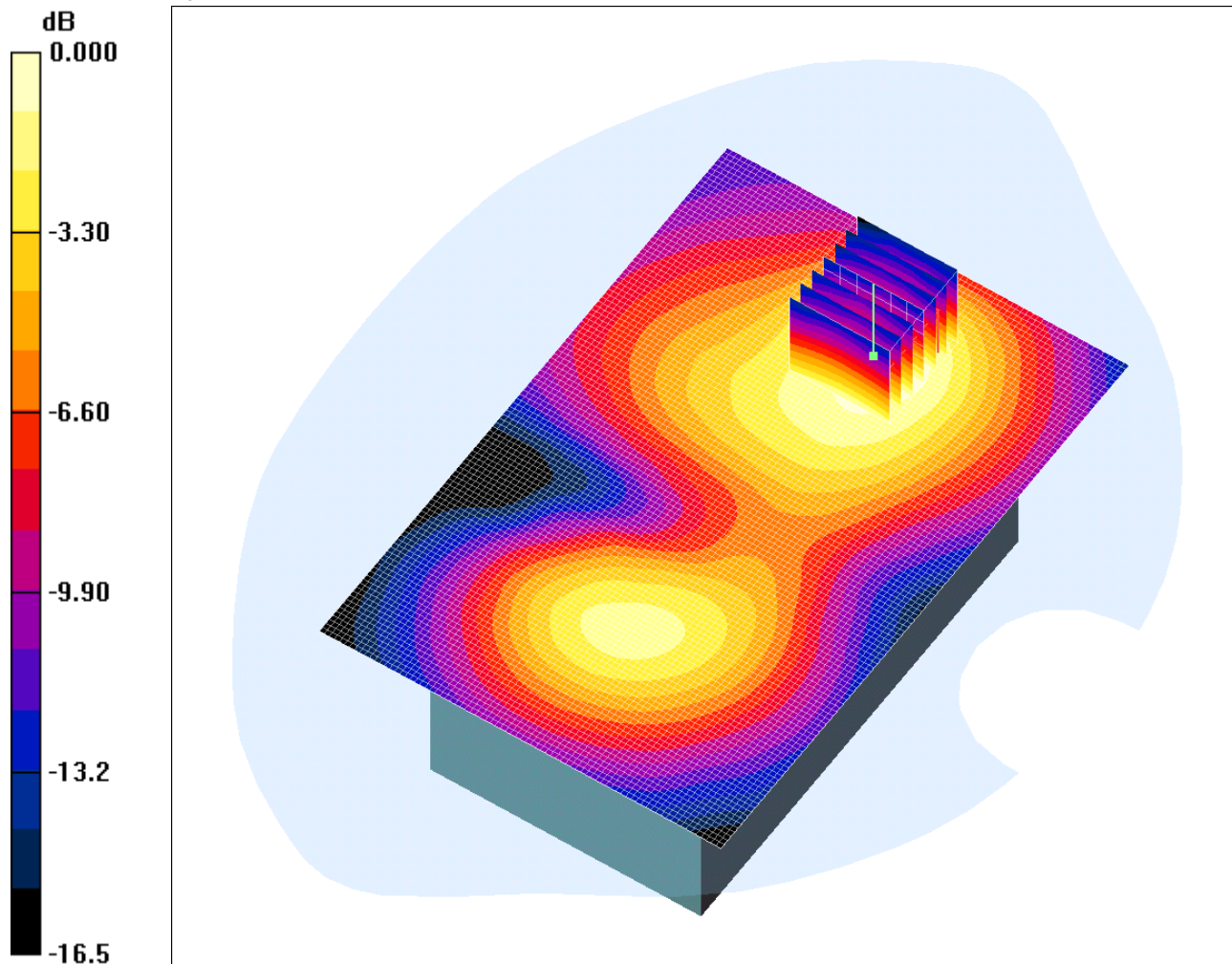

0 dB = 0.089mW/g

Communication System: PCS 1900; Frequency: 1879.8 MHz; Duty Cycle: 1:8.3

Medium: 1900 MHz MSL Medium parameters used (interpolated):  $f = 1879.8$  MHz;  $\sigma = 1.5$  mho/m;  $\epsilon_r = 54.9$ ;  $\rho = 1000$  kg/m<sup>3</sup>

Phantom section: Flat Section

DASY4 Configuration:

- Probe: ET3DV6 - SN1528; ConvF(4.57, 4.57, 4.57); Calibrated: 06/07/2007

- Sensor-Surface: 4mm (Mechanical Surface Detection)

- Electronics: DAE3 Sn394; Calibrated: 24/05/2007

- Phantom: SAM 12a; Type: SAM 4.0; Serial: TP:1193

- Measurement SW: DASY4, V4.7 Build 55; Postprocessing SW: SEMCAD, V1.8 Build 176

**Rear of EUT Facing Phantom at 15 mm - Middle/Area Scan (81x121x1):** Measurement grid: dx=15mm, dy=15mm

Maximum value of SAR (interpolated) = 0.092 mW/g

**Rear of EUT Facing Phantom at 15 mm - Middle/Zoom Scan (7x7x7) (7x7x7)/Cube 0:** Measurement grid: dx=5mm, dy=5mm, dz=5mm

Reference Value = 3.73 V/m; Power Drift = 0.058 dB

Peak SAR (extrapolated) = 0.137 W/kg

**SAR(1 g) = 0.083 mW/g; SAR(10 g) = 0.050 mW/g**

Maximum value of SAR (measured) = 0.089 mW/g

Test of: Enfora Inc.  
GSM3408

To: OET Bulletin 65 Supplement C: (2001-01)

SCN/45639JD18/003: Front of EUT Facing Phantom CH660 15mm PCS

Date: 06/02/2008

DUT: ENFORA L.P; Type: GSM3408; Serial: 340870700297

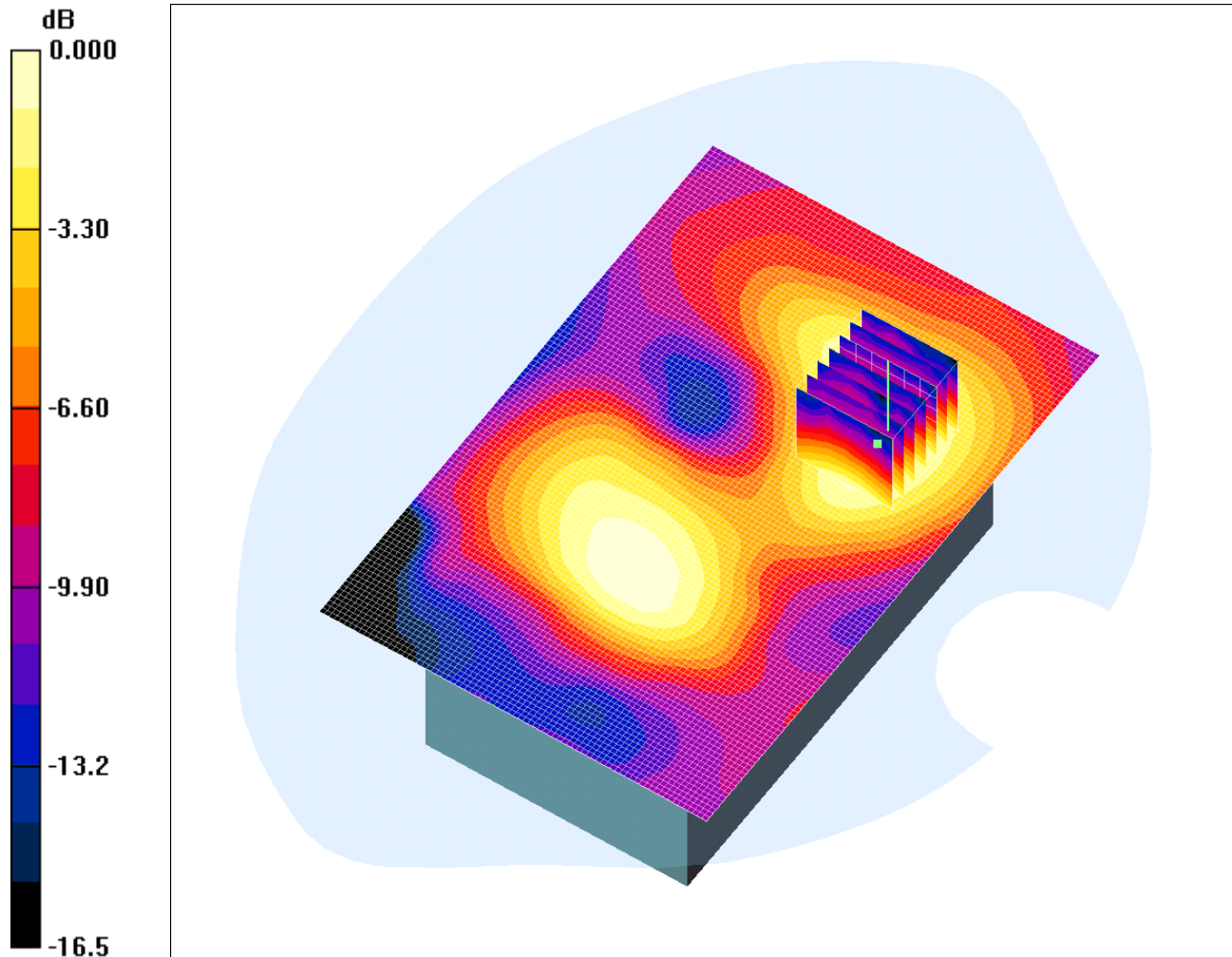

0 dB = 0.024mW/g

Communication System: PCS 1900; Frequency: 1879.8 MHz; Duty Cycle: 1:8.3

Medium: 1900 MHz MSL Medium parameters used (interpolated):  $f = 1879.8$  MHz;  $\sigma = 1.5$  mho/m;  $\epsilon_r = 54.9$ ;  $\rho = 1000$  kg/m<sup>3</sup>

Phantom section: Flat Section

DASY4 Configuration:

- Probe: ET3DV6 - SN1528; ConvF(4.57, 4.57, 4.57); Calibrated: 06/07/2007

- Sensor-Surface: 4mm (Mechanical Surface Detection)

- Electronics: DAE3 Sn394; Calibrated: 24/05/2007

- Phantom: SAM 12a; Type: SAM 4.0; Serial: TP:1193

- Measurement SW: DASY4, V4.7 Build 55; Postprocessing SW: SEMCAD, V1.8 Build 176

**Front of EUT Facing Phantom at 15 mm - Middle/Area Scan (81x121x1):** Measurement grid: dx=15mm, dy=15mm

Maximum value of SAR (interpolated) = 0.026 mW/g

**Front of EUT Facing Phantom at 15 mm - Middle/Zoom Scan (7x7x7) (7x7x7)/Cube 0:** Measurement grid: dx=5mm, dy=5mm, dz=5mm

Reference Value = 2.24 V/m; Power Drift = -0.114 dB

Peak SAR (extrapolated) = 0.036 W/kg

**SAR(1 g) = 0.023 mW/g; SAR(10 g) = 0.014 mW/g**

Maximum value of SAR (measured) = 0.024 mW/g

Test of: Enfora Inc.  
GSM3408

To: OET Bulletin 65 Supplement C: (2001-01)

SCN/45639JD18/004: Rear of EUT Facing Phantom CH189 15mm GSM

Date: 06/02/2008

DUT: ENFORA L.P; Type: GSM3408; Serial: 3408470700294

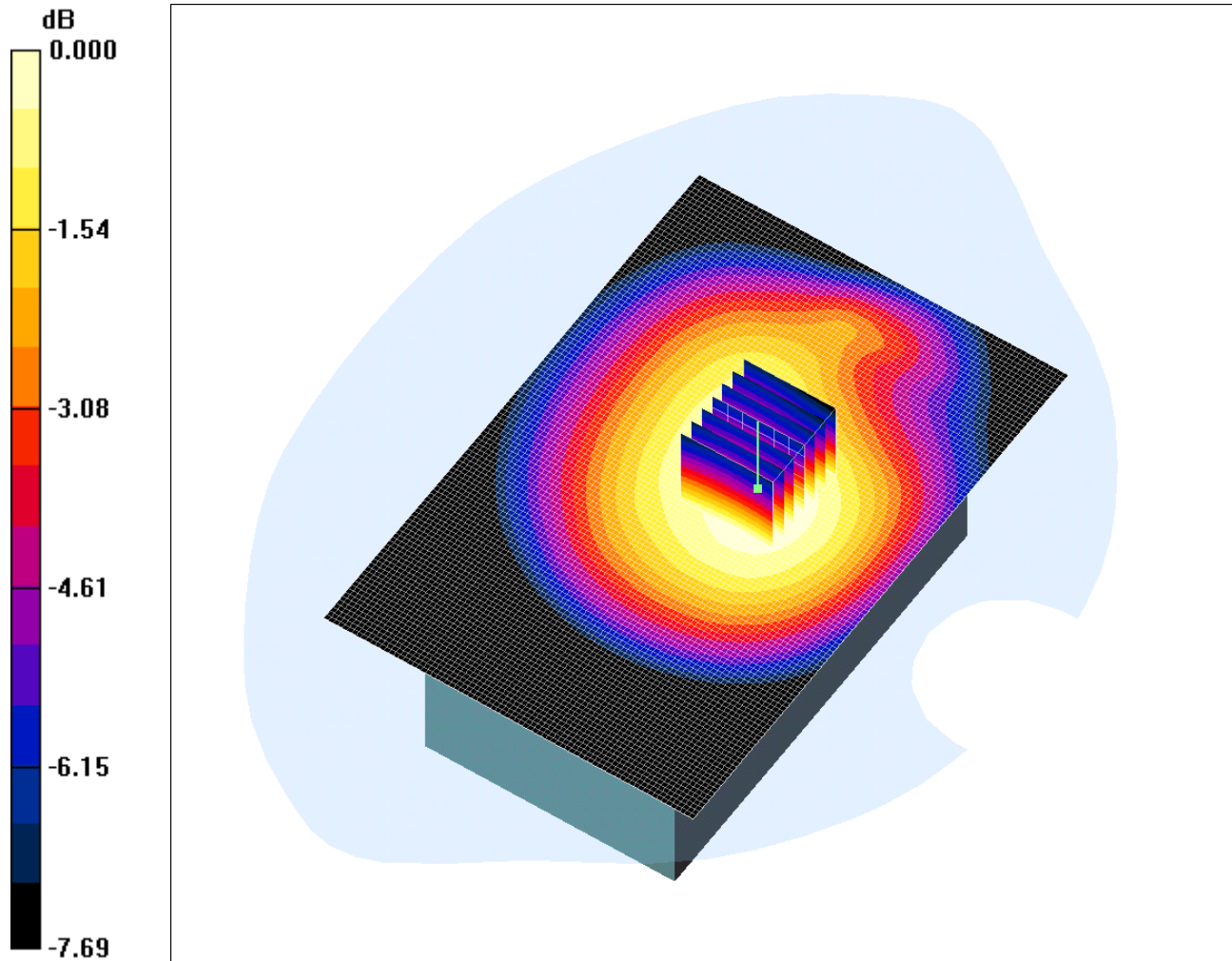

Communication System: 850 MHz; Frequency: 836.4 MHz; Duty Cycle: 1:8.3

Medium: 900 MHz MSL Medium parameters used (interpolated):  $f = 836.4$  MHz;  $\sigma = 0.974$  mho/m;  $\epsilon_r = 53.5$ ;  $\rho = 1000$  kg/m<sup>3</sup>

Phantom section: Flat Section

DASY4 Configuration:

- Probe: ET3DV6 - SN1528; ConvF(6.19, 6.19, 6.19); Calibrated: 06/07/2007

- Sensor-Surface: 4mm (Mechanical Surface Detection)

- Electronics: DAE3 Sn394; Calibrated: 24/05/2007

- Phantom: SAM 12b; Type: SAM 4.0; Serial: TP:1197

- Measurement SW: DASY4, V4.7 Build 55; Postprocessing SW: SEMCAD, V1.8 Build 176

**Rear of EUT Facing Phantom at 15mm - Middle/Area Scan (81x121x1):** Measurement grid: dx=15mm, dy=15mm

Maximum value of SAR (interpolated) = 0.226 mW/g

**Rear of EUT Facing Phantom at 15mm - Middle/Zoom Scan (7x7x7) (7x7x7)/Cube 0:** Measurement grid: dx=5mm, dy=5mm, dz=5mm

Reference Value = 14.9 V/m; Power Drift = 0.134 dB

Peak SAR (extrapolated) = 0.270 W/kg

**SAR(1 g) = 0.218 mW/g; SAR(10 g) = 0.167 mW/g**

Maximum value of SAR (measured) = 0.230 mW/g

Test of: Enfora Inc.  
GSM3408

To: OET Bulletin 65 Supplement C: (2001-01)

SCN/45639JD18/005: Rear of EUT Facing Phantom CH189 15mm GPRS

Date: 06/02/2008

DUT: ENFORA L.P; Type: GSM3408; Serial: 3408470700294

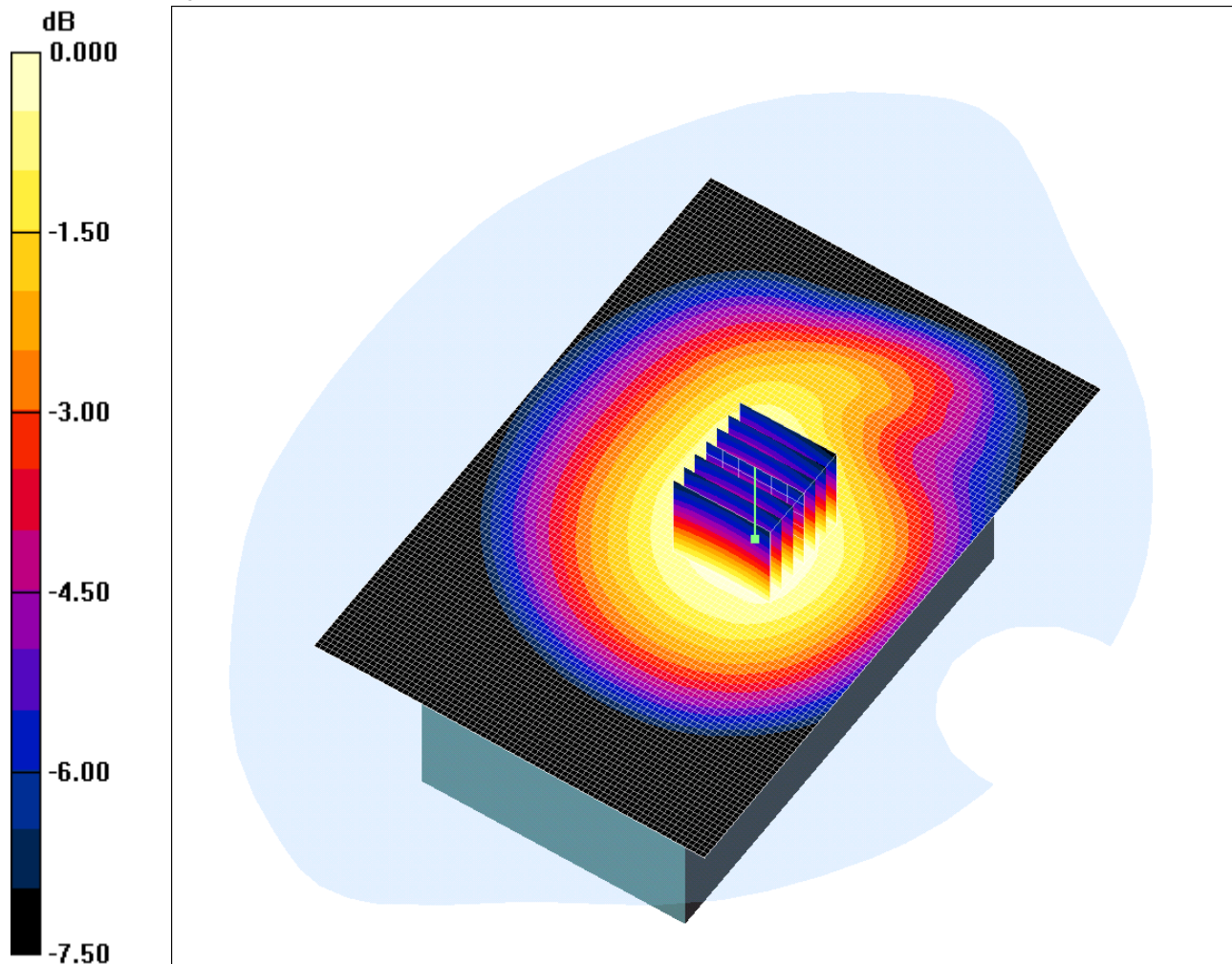

0 dB = 0.217mW/g

Communication System: GPRS 850 MHz; Frequency: 836.4 MHz; Duty Cycle: 1:4

Medium: 900 MHz MSL Medium parameters used (interpolated):  $f = 836.4$  MHz;  $\sigma = 0.974$  mho/m;  $\epsilon_r = 53.5$ ;  $\rho = 1000$  kg/m<sup>3</sup>

Phantom section: Flat Section

DASY4 Configuration:

- Probe: ET3DV6 - SN1528; ConvF(6.19, 6.19, 6.19); Calibrated: 06/07/2007

- Sensor-Surface: 4mm (Mechanical Surface Detection)

- Electronics: DAE3 Sn394; Calibrated: 24/05/2007

- Phantom: SAM 12b; Type: SAM 4.0; Serial: TP:1197

- Measurement SW: DASY4, V4.7 Build 55; Postprocessing SW: SEMCAD, V1.8 Build 176

**Rear of EUT Facing Phantom at 15mm - Middle/Area Scan (81x121x1):** Measurement grid: dx=15mm, dy=15mm

Maximum value of SAR (interpolated) = 0.215 mW/g

**Rear of EUT Facing Phantom at 15mm - Middle/Zoom Scan (7x7x7) (7x7x7)/Cube 0:** Measurement grid: dx=5mm, dy=5mm, dz=5mm

Reference Value = 15.0 V/m; Power Drift = -0.043 dB

Peak SAR (extrapolated) = 0.257 W/kg

**SAR(1 g) = 0.206 mW/g; SAR(10 g) = 0.158 mW/g**

Maximum value of SAR (measured) = 0.217 mW/g



Test of: Enfora Inc.  
GSM3408

To: OET Bulletin 65 Supplement C: (2001-01)

SCN/45639JD18/006: Front of EUT Facing Phantom CH189 15mm GSM

Date: 06/02/2008

DUT: ENFORA L.P; Type: GSM3408; Serial: 3408470700294

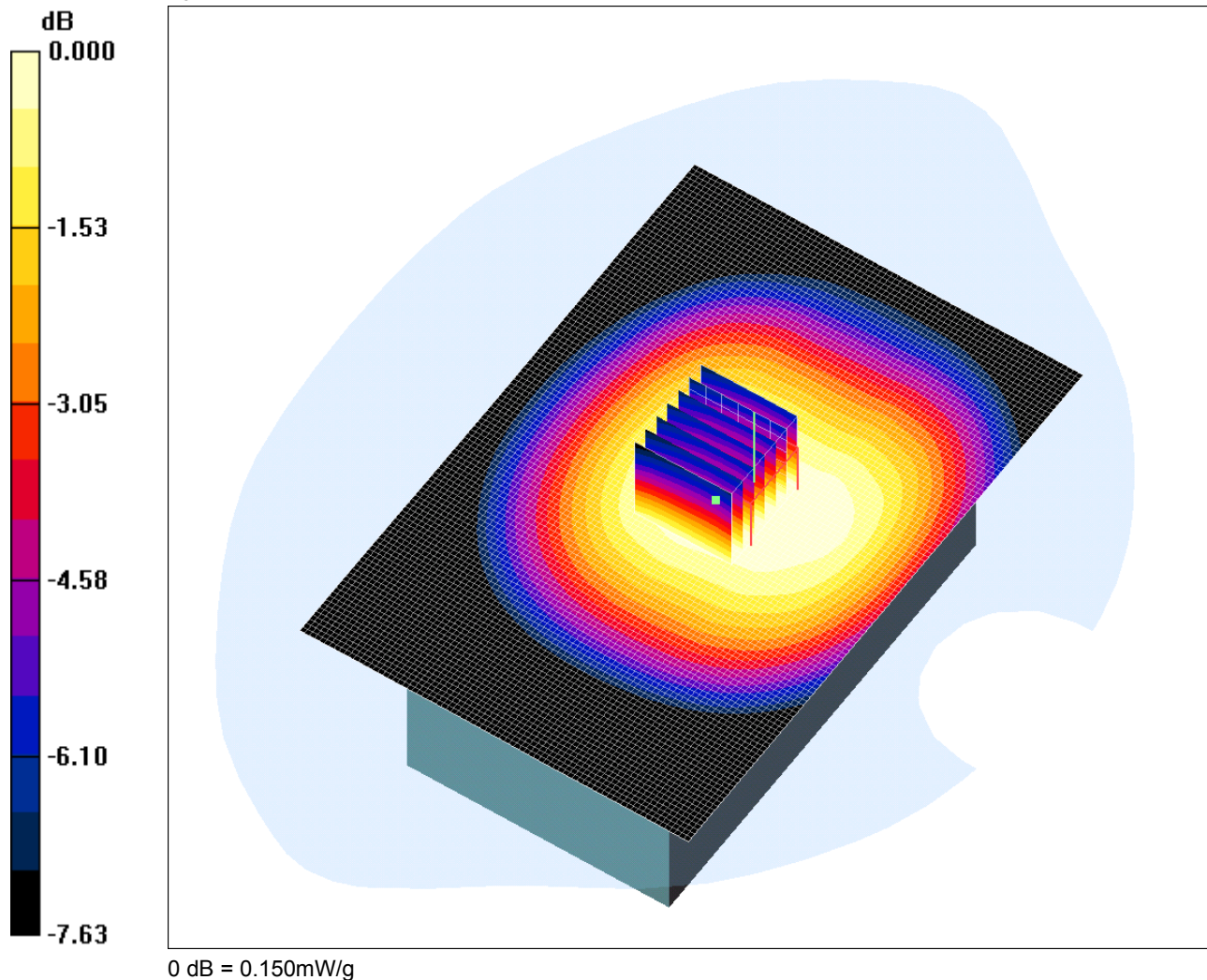

Communication System: GPRS 850 MHz; Frequency: 836.4 MHz; Duty Cycle: 1:4

Medium: 900 MHz MSL Medium parameters used (interpolated):  $f = 836.4$  MHz;  $\sigma = 0.974$  mho/m;  $\epsilon_r = 53.5$ ;  $\rho = 1000$  kg/m<sup>3</sup>

Phantom section: Flat Section

DASY4 Configuration:

- Probe: ET3DV6 - SN1528; ConvF(6.19, 6.19, 6.19); Calibrated: 06/07/2007

- Sensor-Surface: 4mm (Mechanical Surface Detection)

- Electronics: DAE3 Sn394; Calibrated: 24/05/2007

- Phantom: SAM 12b; Type: SAM 4.0; Serial: TP:1197

- Measurement SW: DASY4, V4.7 Build 55; Postprocessing SW: SEMCAD, V1.8 Build 176

**Rear of EUT Facing Phantom at 15mm - Middle/Area Scan (81x121x1):** Measurement grid: dx=15mm, dy=15mm

Maximum value of SAR (interpolated) = 0.150 mW/g

**Rear of EUT Facing Phantom at 15mm - Middle/Zoom Scan (7x7x7) (7x7x7)/Cube 0:** Measurement grid: dx=5mm, dy=5mm, dz=5mm

Reference Value = 12.8 V/m; Power Drift = -0.063 dB

Peak SAR (extrapolated) = 0.178 W/kg

**SAR(1 g) = 0.143 mW/g; SAR(10 g) = 0.112 mW/g**

Maximum value of SAR (measured) = 0.150 mW/g

Test of: Enfora Inc.  
GSM3408

To: OET Bulletin 65 Supplement C: (2001-01)

SCN/45639JD18/007: System Performance Check 1900MHz Body 06 02 08

Date: 06/02/2008

DUT: Dipole 1900 MHz; Type: D1900V2; Serial: SN540

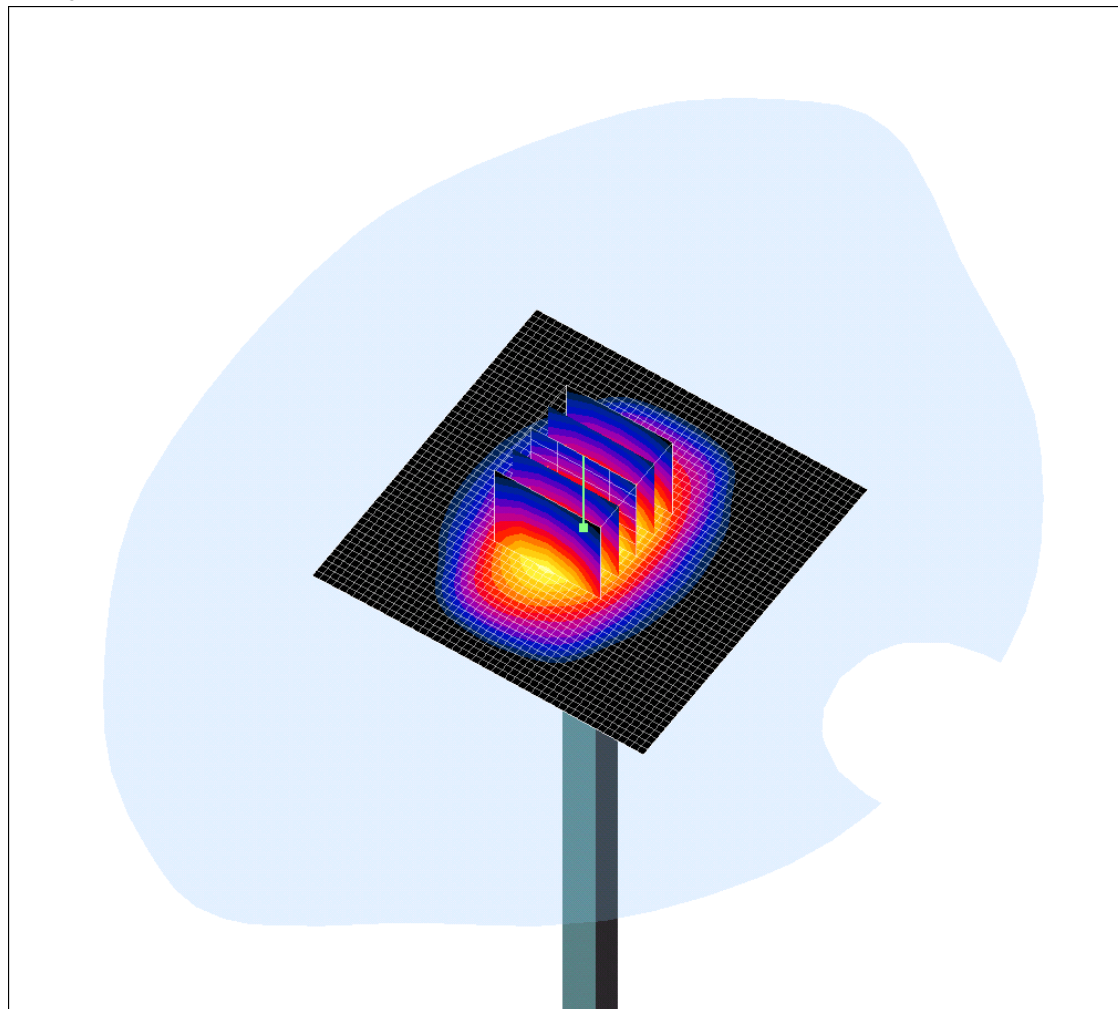

0 dB = 11.0mW/g

Communication System: CW; Frequency: 1900 MHz; Duty Cycle: 1:1

Medium: 1900 MHz MSL Medium parameters used:  $f = 1900$  MHz;  $\sigma = 1.52$  mho/m;  $\epsilon_r = 54.8$ ;  $\rho = 1000$  kg/m<sup>3</sup>

Phantom section: Flat Section

DASY4 Configuration:

- Probe: ET3DV6 - SN1528; ConvF(4.57, 4.57, 4.57); Calibrated: 06/07/2007

- Sensor-Surface: 4mm (Mechanical Surface Detection)

- Electronics: DAE3 Sn394; Calibrated: 24/05/2007

- Phantom: SAM 12a; Type: SAM 4.0; Serial: TP:1193

- Measurement SW: DASY4, V4.7 Build 55; Postprocessing SW: SEMCAD, V1.8 Build 176

**d=15mm, Pin=250mW/Area Scan (51x51x1):** Measurement grid: dx=20mm, dy=20mm

Maximum value of SAR (interpolated) = 14.0 mW/g

**d=15mm, Pin=250mW/Zoom Scan (5x5x7) (5x5x7)/Cube 0:** Measurement grid: dx=8mm, dy=8mm, dz=5mm

Reference Value = 89.2 V/m; Power Drift = -0.001 dB

Peak SAR (extrapolated) = 17.9 W/kg

**SAR(1 g) = 9.73 mW/g; SAR(10 g) = 4.95 mW/g**

Maximum value of SAR (measured) = 11.0 mW/g

Test of: Enfora Inc.  
GSM3408

To: OET Bulletin 65 Supplement C: (2001-01)

SCN/45639JD18/008: System Performance Check 900MHz Body 06 02 08

Date: 06/02/2008

DUT: Dipole 900 MHz - SPARE; Type: D900V2; Serial: SN185

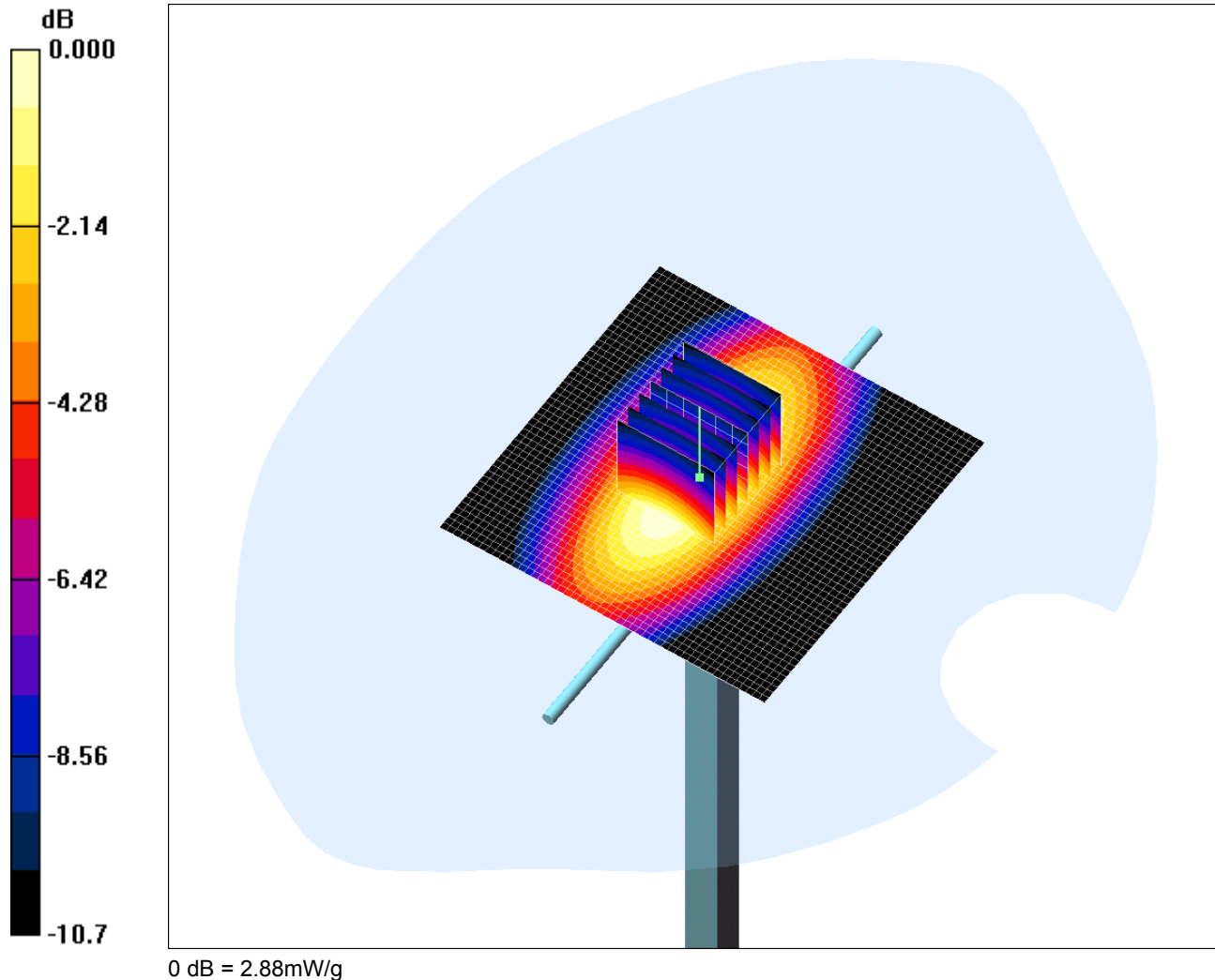

Communication System: CW; Frequency: 900 MHz; Duty Cycle: 1:1

Medium: 900 MHz MSL Medium parameters used:  $f = 900$  MHz;  $\sigma = 1.04$  mho/m;  $\epsilon_r = 52.8$ ;  $\rho = 1000$  kg/m<sup>3</sup>

Phantom section: Flat Section

DASY4 Configuration:

- Probe: ET3DV6 - SN1528; ConvF(5.9, 5.9, 5.9); Calibrated: 06/07/2007

- Sensor-Surface: 4mm (Mechanical Surface Detection)

- Electronics: DAE3 Sn394; Calibrated: 24/05/2007

- Phantom: SAM 12a; Type: SAM 4.0; Serial: TP:1193

- Measurement SW: DASY4, V4.7 Build 55; Postprocessing SW: SEMCAD, V1.8 Build 176

**d=15mm, Pin=250mW/Area Scan (51x51x1):** Measurement grid: dx=20mm, dy=20mm

Maximum value of SAR (interpolated) = 3.00 mW/g

**d=15mm, Pin=250mW/Zoom Scan (7x7x7) (7x7x7)/Cube 0:** Measurement grid: dx=5mm, dy=5mm, dz=5mm

Reference Value = 53.5 V/m; Power Drift = 0.006 dB

Peak SAR (extrapolated) = 3.87 W/kg

**SAR(1 g) = 2.65 mW/g; SAR(10 g) = 1.72 mW/g**

Maximum value of SAR (measured) = 2.88 mW/g

Test of: Enfora Inc.  
GSM3408

To: OET Bulletin 65 Supplement C: (2001-01)

---

#### **Appendix 4. Photographs**

This appendix contains the following photographs:

<b>Photo Reference Number</b>	<b>Title</b>
PHT/45639JD18/001	Test configuration for the measurement of Specific Absorption Rate (SAR)
PHT/45639JD18/002	Front of EUT Facing Phantom
PHT/45639JD18/003	Rear of EUT Facing Phantom
PHT/45639JD18/004	Rear View of EUT
PHT/45639JD18/005	Front View of EUT
PHT/45639JD18/006	Front View of PDA
PHT/45639JD18/007	Rear View of PDA
PHT/45639JD18/008	Close Up View of EUT
PHT/45639JD18/009	EUT Battery 1
PHT/45639JD18/010	EUT Battery 2

---

Test of: Enfora Inc.  
GSM3408

To: OET Bulletin 65 Supplement C: (2001-01)

---

PHT/45639JD18/001: Test configuration for the measurement of Specific Absorption Rate (SAR)



Test of: Enfora Inc.  
GSM3408

To: OET Bulletin 65 Supplement C: (2001-01)

---

PHT/45639JD18/002: Front of EUT Facing Phantom



Test of: Enfora Inc.  
GSM3408

To: OET Bulletin 65 Supplement C: (2001-01)

---

PHT/45639JD18/003: Rear of EUT Facing Phantom



Test of: Enfora Inc.  
GSM3408

To: OET Bulletin 65 Supplement C: (2001-01)

---

PHT/45639JD18/004: Rear View of EUT





Test of: Enfora Inc.  
GSM3408

To: OET Bulletin 65 Supplement C: (2001-01)

PHT/45639JD18/005: Front View of EUT



Test of: Enfora Inc.  
GSM3408

To: OET Bulletin 65 Supplement C: (2001-01)

PHT/45639JD18/006: Front View of PDA



Test of: Enfora Inc.  
GSM3408

To: OET Bulletin 65 Supplement C: (2001-01)

PHT/45639JD18/007: Rear View of PDA



Test of: Enfora Inc.  
GSM3408

To: OET Bulletin 65 Supplement C: (2001-01)

PHT/45639JD18/008: Close Up View of EUT



Test of: Enfora Inc.  
GSM3408

To: OET Bulletin 65 Supplement C: (2001-01)

---

PHT/45639JD18/009: EUT Battery 1



Test of: Enfora Inc.  
GSM3408

To: OET Bulletin 65 Supplement C: (2001-01)

PHT/45639JD18/010: EUT Battery 2



Test of: Enfora Inc.  
GSM3408

To: OET Bulletin 65 Supplement C: (2001-01)

## Appendix 5. Validation of System

Prior to the assessment, the system was verified in the flat region of the phantom. A 900 MHz and 1900 MHz dipole was used. A forward power of 250 mW was applied to the dipole and the system was verified to a tolerance of  $\pm 5\%$  for the 900MHz and 1900 MHz dipole. The applicable verification (normalised to 1 Watt).

Date: 06/02/2008

Validation Dipole and Serial Number: D900V2 SN:185

Simulant	Frequency (MHz)	Room Temperature	Liquid Temperature	Parameters	Target Value	Measured Value	Deviation (%)	Limit (%)
Body	900	24.0 °C	24.0 °C	$\epsilon_r$	55.00	52.85	-0.04	5.00
				$\sigma$	1.05	1.03	-0.02	5.00
				1g SAR	10.50	10.60	0.95	5.00
				10g SAR	6.88	6.88	0.00	5.00

Date: 06/02/2008

Validation Dipole and Serial Number: D1900V2:SN:540

Simulant	Frequency (MHz)	Room Temperature	Liquid Temperature	Parameters	Target Value	Measured Value	Deviation (%)	Limit (%)
Body	1900	23.0 °C	23.0 °C	$\epsilon_r$	53.30	54.82	2.85	5.00
				$\sigma$	1.52	1.52	0.17	5.00
				1g SAR	38.00	38.92	2.42	5.00
				10g SAR	20.70	19.80	-4.35	5.00

Test of: Enfora Inc.  
GSM3408

To: OET Bulletin 65 Supplement C: (2001-01)

## **Appendix 6. Simulated Tissues**

The body mixture consists of water and glycol. Visual inspection is made to ensure air bubbles are not trapped during the mixing process. The mixture is calibrated to obtain proper dielectric constant (permittivity) and conductivity of the tissue.

Ingredient	Frequency
	1800/1900 MHz Body
De-Ionised Water	69.79%
Diglycol Butyl Ether (DGBE)	30.00%
Salt	0.20%

Ingredient	Frequency
	835/850/900 MHz Body
De-Ionised Water	50.75%
Sugar	48.21%
Salt	0.94%
Kathon	0.10%



Test of: Enfora Inc.  
GSM3408

To: OET Bulletin 65 Supplement C: (2001-01)

---

## **Appendix 7. DASY4 System Details**

### **A.7.1. DASY4 SAR Measurement System**

RFI Global Services Ltd, SAR measurement facility utilises the Dosimetric Assessment System (DASY™) manufactured by Schmid & Partner Engineering AG (SPEAG™) of Zurich, Switzerland. The DASY4 system is comprised of the robot controller, computer, near-field probe, probe alignment sensor, and the SAM phantom containing brain or muscle equivalent material. The robot is a six-axis industrial robot performing precise movements to position the probe to the location (points) of maximum electromagnetic field (EMF). A cell controller system contains the power supply, robot controller; teach pendant (Joystick), and remote control. This is used to drive the robot motors. The Staubli robot is connected to the cell controller to allow software manipulation of the robot. The data acquisition electronics (DAE) performs signal amplification, signal multiplexing, AD-conversion, offset measurements, mechanical surface detection, collision detection etc. The DAE is connected to the Electro-optical coupler (EOC). The EOC performs the conversion from the optical into digital electric signal of the DAE and transfers data to the PC plug-in card. The DAE3 utilises a highly sensitive electrometer-grade preamplifier with auto-zeroing, a channel and gain-switching multiplexer, a fast 16-bit AD-converter and a command decoder and control logic unit. Transmission to the PC-card is accomplished through an optical downlink for data and status information and an optical uplink for commands and clock lines. The mechanical probe-mounting device includes two different sensor systems for frontal and sidewise probe contacts. They are also used for mechanical surface detection and probe collision detection. The robot uses its own controller with a built in VME-bus computer.

---

Test of: Enfora Inc.  
GSM3408

To: OET Bulletin 65 Supplement C: (2001-01)

### A.7.2. DASY4 SAR System Specifications

#### Robot System

Positioner:	Stäubli Unimation Corp. Robot Model: RX90L
Repeatability:	0.025 mm
No. of Axis:	6
Serial Number:	F00/SD89A1/A/01
Reach:	1185 mm
Payload:	3.5 kg
Control Unit:	CS7
Programming Language:	V+

#### Data Acquisition Electronic (DAE) System

Serial Number:	DAE3 SN:394
----------------	-------------

#### Cell Controller

PC:	Dell Precision 340
Operating System:	Windows 2000
Data Card:	DASY4 Measurement Server
Serial Number:	1080

#### Data Converter

Features:	Signal Amplifier, multiplexer, A/D converted and control logic.
Software:	DASY4 Software
Connecting Lines:	Optical downlink for data and status info. Optical uplink for commands and clock.

#### PC Interface Card

Function:	24 bit (64 MHz) DSP for real time processing Link to DAE3 16 nit A/D converter for surface detection system serial link to robot direct emergency stop output for robot.
-----------	--

Test of: Enfora Inc.  
GSM3408

To: OET Bulletin 65 Supplement C: (2001-01)

---

### DASY4 SAR System Specifications (Continued)

#### E-Field Probe

Model:	ET3DV6
Serial No:	1528
Construction:	Triangular core fibre optic detection system
Frequency:	10 MHz to 3 GHz
Linearity:	$\pm 0.2$ dB (30 MHz to 3 GHz)
Probe Length (mm):	337
Probe Diameter (mm):	12
Tip Length (mm):	10
Tip Diameter (mm):	6.8
Sensor X Offset (mm):	2.7
Sensor Y Offset (mm):	2.7
Sensor Z Offset (mm):	2.7

#### Phantom

Phantom:	SAM Phantom
Shell Material:	Fibreglass
Thickness:	2.0 $\pm$ 0.1 mm

---