

**Nemko Test Report:** 3L0345RUS1

**Applicant:** Enfora Inc.  
661 E/ 18<sup>th</sup> Street  
Plano, Texas 75074

**Equipment Under Test:  
(E.U.T.)** Aspen – GSM/GPRS Wireless Modem  
GSM0107

**In Accordance With:** **FCC Parts 24, Subpart E**  
Broadband PCS Subscriber Station

**Tested By:** Nemko Dallas Inc.  
802 N. Kealy  
Lewisville, TX



**Authorized By:**  
  
Tom Tidwell, Frontline Manager

**Date:** 25Aug03

**Total Number of Pages:** 39

EQUIPMENT: GSM0107

---

Table of Contents

Section 1. Summary of Test Results.....3

Section 2. General Equipment Specification .....5

Section 3. RF Power Output.....7

Section 4. Occupied Bandwidth .....9

Section 5. Spurious Emissions at Antenna Terminals.....11

Section 6. Field Strength of Spurious .....25

Section 7. Frequency Stability.....28

Section 8. Test Equipment List .....30

ANNEX A - TEST METHODOLOGIES .....31

ANNEX B - TEST DIAGRAMS .....37

**EQUIPMENT: GSM0107**

**Section 1. Summary of Test Results**

Manufacturer: Enfora Inc.

Model No.: GSM0107

Serial No.: 28

General: **All measurements are traceable to national standards.**

These tests were conducted on a sample of the equipment for the purpose of demonstrating compliance with FCC Part 24, Subpart E.

- New Submission
- Production Unit
- Class II Permissive Change
- Pre-Production Unit

THIS TEST REPORT RELATES ONLY TO THE ITEM(S) TESTED.

THE FOLLOWING DEVIATIONS FROM, ADDITIONS TO, OR EXCLUSIONS FROM THE TEST SPECIFICATIONS HAVE BEEN MADE.  
See " Summary of Test Data".

TESTED BY:     Eldon Berry                          DATE:   26 Aug., 2003  

Nemko Dallas Inc. authorizes the above named company to reproduce this report provided it is reproduced in its entirety and for use by the company's employees only.

Any use which a third party makes of this report, or any reliance on or decisions to be made based on it, are the responsibility of such third parties. Nemko Dallas Inc. accepts no responsibility for damages, if any, suffered by any third party as a result of decisions made or actions based on this report.

This report applies only to the items tested.

---

**EQUIPMENT: GSM0107****Summary Of Test Data**

<b>NAME OF TEST</b>	<b>PARA. NO.</b>	<b>SPEC.</b>	<b>RESULT</b>
RF Power Output	24.232	2W eirp	Complies
Occupied Bandwidth (TDMA)	24.238	Not Specified	Complies
Spurious Emissions at Antenna Terminals	24.238(a)	-13 dBm	Complies
Field Strength of Spurious Emissions	24.238(a)	-13 dBm E.I.R.P.	Complies
Frequency Stability	24.235	+/- 0.05 ppm	Complies

**Footnotes:**

EQUIPMENT: GSM0107

**Section 2. General Equipment Specification**

<b>Supply Voltage Input:</b>	3.3 - 5 Vdc
<b>Frequency Bands:</b>	<input checked="" type="checkbox"/> Block A 1850 – 1865 MHz <input checked="" type="checkbox"/> Block D 1865 – 1870 MHz <input checked="" type="checkbox"/> Block B 1870 – 1885 MHz <input checked="" type="checkbox"/> Block E 1885 – 1890 MHz <input checked="" type="checkbox"/> Block F : 1890 – 1895 MHz <input checked="" type="checkbox"/> Block C 1895 – 1910 MHz
<b>Type of Modulation and Designator:</b>	GPRS 200K0G7W <input checked="" type="checkbox"/>
<b>Output Impedance:</b>	50 ohms
<b>RF Output (Rated):</b>	1 Watt

EQUIPMENT: GSM0107

---

### System Description

This device is a wireless GSM/GPRS wireless modem that operates in the PCS band.

### System Diagram

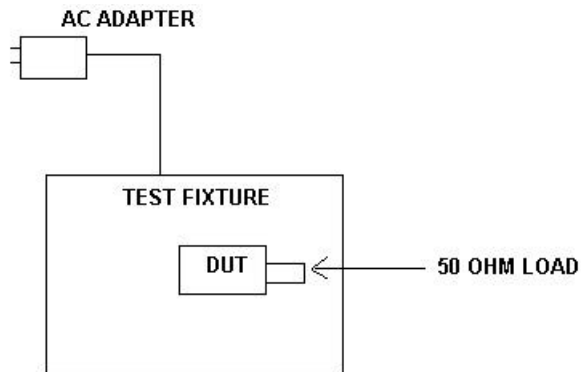

EQUIPMENT: GSM0107

**Section 3. RF Power Output**

NAME OF TEST: RF Power Output	PARA. NO.: 24.232(b)
TESTED BY: Eldon Berry	DATE: 22Aug03

**Test Results:** Complies.

**Measurement Data:**

RF Power Output (Conducted)

Job No.: 3L0345R Date: 8/22/2003  
 Specification: CFR 47, Part 24 Temperature(°C): 21  
 Tested By: Eldon Berry Humidity(%): 50  
 E.U.T.: GSM0107  
 Configuration: EUT on test fixture.  
 Detector: Average

Test Equipment Used:

Power Meter: E4418B Directional Coupler: \_\_\_\_\_  
 Power Sensor: E9304A Cable #1: 1083  
 Load: \_\_\_\_\_ Cable #2: \_\_\_\_\_  
 Spectrum Analyzer: NA Cable #3: \_\_\_\_\_  
 Attenuator #1: 1604 Cable #4: \_\_\_\_\_  
 Attenuator #2: \_\_\_\_\_ Cable #5: \_\_\_\_\_  
 Attenuator #3: \_\_\_\_\_ Cable #6: \_\_\_\_\_  
 Attenuator #4: \_\_\_\_\_ Power Splitter: \_\_\_\_\_

Measurement Uncertainty: +/- .7 dB

Frequency MHz	Channel	Modulation Type	Output Power (dBm)	Output Power (mW)
1850.2	512	GPRS	29.8	954.99
1880.2	662	GPRS	29.7	933.25
1909.8	810	GPRS	28.8	758.58

Power meter set for 12.5 % duty cycle.  
 Cable and attenuator verified with generator # 1053

Nemko Dallas

FCC PARTS 2 and 24  
GSM/GPRS Wireless Modem  
Report No.: 3L0345RUS1

**EQUIPMENT: GSM0107**

---



**EQUIPMENT:** GSM0107

---

**Section 4. Occupied Bandwidth**

NAME OF TEST: Occupied Bandwidth	PARA. NO.: 24.238
TESTED BY: Eldon Berry	DATE: 22Aug03

**Test Results:** Complies.

**Test Data:** See attached plots.

EQUIPMENT: GSM0107

Test Plot – Occupied Bandwidth

Data Plot		Occupied Bandwidth																	
Page 1 of 1		Complete <u>X</u>																	
Job No.: 3L0345R	Date: <u>8/22/2003</u>	Preliminary: _____																	
Specification:	Temperature(°C): <u>22</u>																		
Tested By: <u>Eldon Berry</u>	Relative Humidity(%): <u>50</u>																		
E.U.T.: <u>GSM0107</u>																			
Configuration: <u>EUT on test fixture.</u>																			
Sample Number: <u>1</u>																			
Location: <u>Lab 1</u>	RBW: <u>Refer to plots</u>	Measurement																	
Detector Type: <u>Peak</u>	VBW: <u>Refer to plots</u>	Distance: <u>N/A</u> m																	
<b>Test Equipment Used</b>																			
Antenna: _____	Directional Coupler: _____																		
Pre-Amp: _____	Cable #1: <u>1083</u>																		
Filter: _____	Cable #2: _____																		
Receiver: <u>1036</u>	Cable #3: _____																		
Attenuator #1: <u>1604</u>	Cable #4: _____																		
Attenuator #2: _____	Mixer: _____																		
Additional equipment used: _____																			
Measurement Uncertainty: <u>+/-1.7 dB</u>																			
<table border="1"> <thead> <tr> <th>Ref</th> <th>Lvl</th> <th>Unit</th> <th>RBW</th> <th>VBW</th> <th>SWT</th> <th>RF Att</th> <th>Unit</th> </tr> </thead> <tbody> <tr> <td>1</td> <td>29.7</td> <td>dBm</td> <td>20 KHz</td> <td>20 KHz</td> <td>7.5 ms</td> <td>30</td> <td>dB</td> </tr> </tbody> </table>				Ref	Lvl	Unit	RBW	VBW	SWT	RF Att	Unit	1	29.7	dBm	20 KHz	20 KHz	7.5 ms	30	dB
Ref	Lvl	Unit	RBW	VBW	SWT	RF Att	Unit												
1	29.7	dBm	20 KHz	20 KHz	7.5 ms	30	dB												
Center <u>1.8802 GHz</u> <u>100 KHz</u> Span <u>1 MHz</u> Date: <u>22.AUG.2003 10:22:24</u>																			
Notes: <u>Channel 662</u> _____ _____ _____																			

**EQUIPMENT:** GSM0107

---

**Section 5. Spurious Emissions at Antenna Terminals**

NAME OF TEST: Spurious Emissions @ Antenna Terminals	PARA. NO.: 24.238
TESTED BY: Eldon Berry	DATE: 22Aug03

**Test Results:** Complies.

**Test Data:** See attached plots.

EQUIPMENT: GSM0107

Test Plots – Spurious Emissions at Antenna Terminals

**Data Plot** **Spurious Emissions at Antenna Terminals**

Page 1 of 3 Complete   x  

Job No.: 3L0345R Date: 8/22/2003  
 Specification: CFR 47, Part 2 and 24 Temperature(°C): 22  
 Tested By: Eldon Berry Relative Humidity(%): 50  
 E.U.T.: GSM0107  
 Configuration: EUN on test fixture.  
 Sample Number: S01  
 Location: Lab 1 RBW: Refer to plots Measurement  
 Detector Type: Peak VBW: Refer to plots Distance: na m

**Test Equipment Used**

Antenna: \_\_\_\_\_ Directional Coupler: \_\_\_\_\_  
 Pre-Amp: \_\_\_\_\_ Cable #1: 1083  
 Filter: \_\_\_\_\_ Cable #2: \_\_\_\_\_  
 Receiver: 1036 Cable #3: \_\_\_\_\_  
 Attenuator #1: 1604 Cable #4: \_\_\_\_\_  
 Attenuator #2: \_\_\_\_\_ Mixer: \_\_\_\_\_  
 Additional equipment used: \_\_\_\_\_  
 Measurement Uncertainty: +/-1.7 dB

<b>Ref Lvl</b>	30 dBm	<b>RBW</b>	2 KHz	<b>RF Att</b>	30 dB
		<b>VBW</b>	2 KHz	<b>Unit</b>	dBm
		<b>SWT</b>	1.25 s		

**Notes:** Channel 512, Lower band edge.

EQUIPMENT: GSM0107

Test Plots – Spurious Emissions at Antenna Terminals

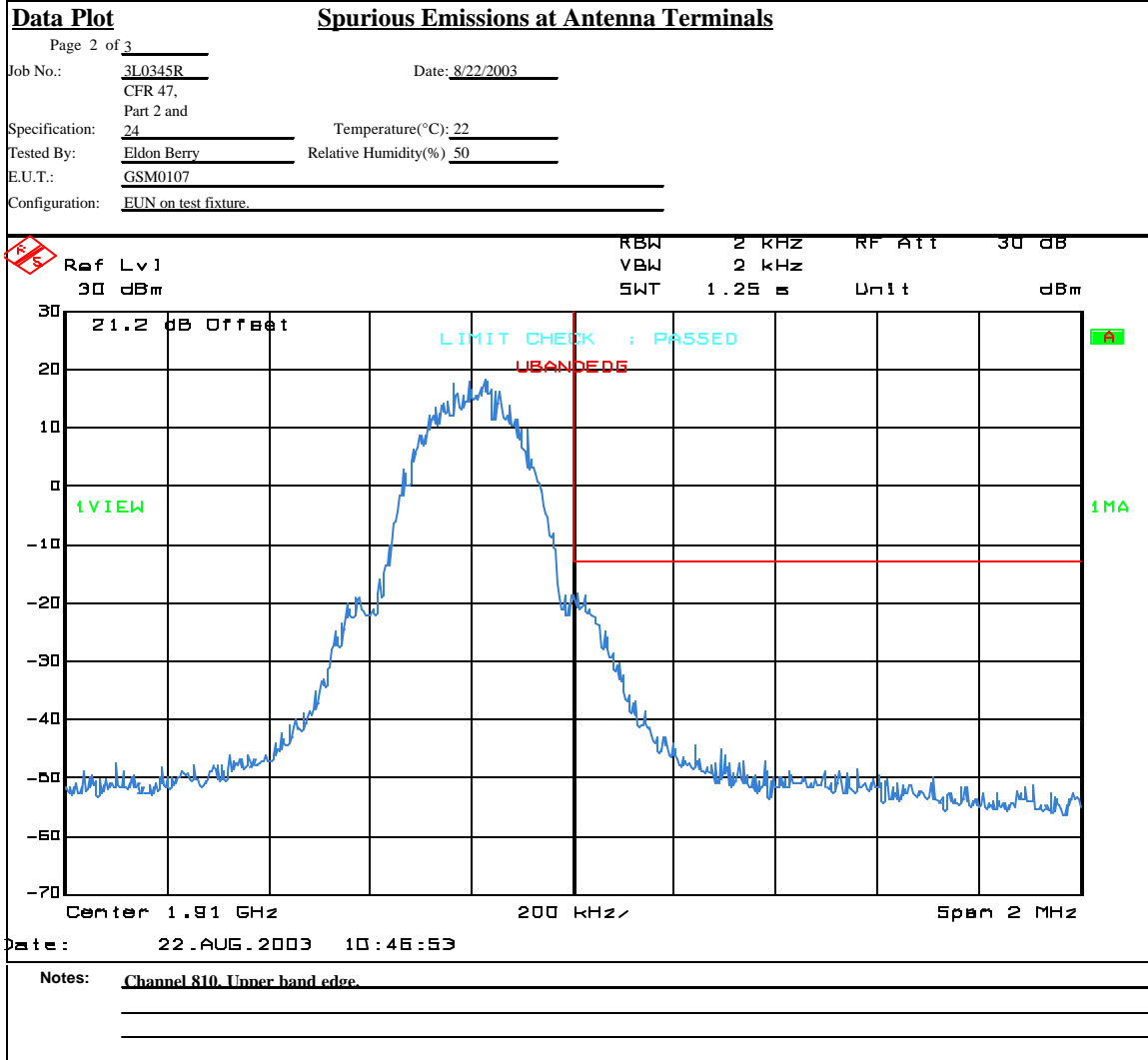

EQUIPMENT: GSM0107

Test Plots – Spurious Emissions at Antenna Terminals

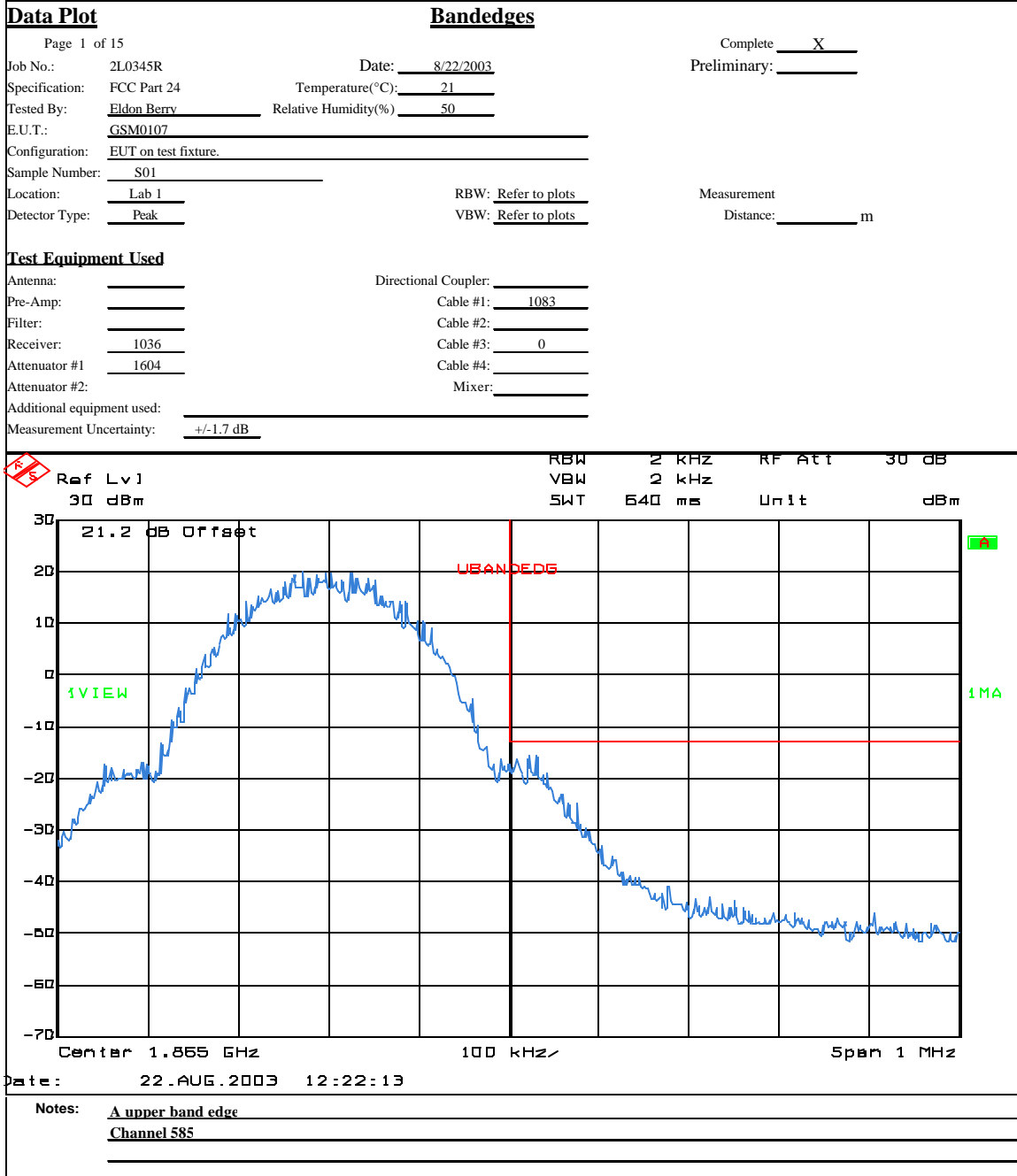

EQUIPMENT: GSM0107

Test Plots – Spurious Emissions at Antenna Terminals

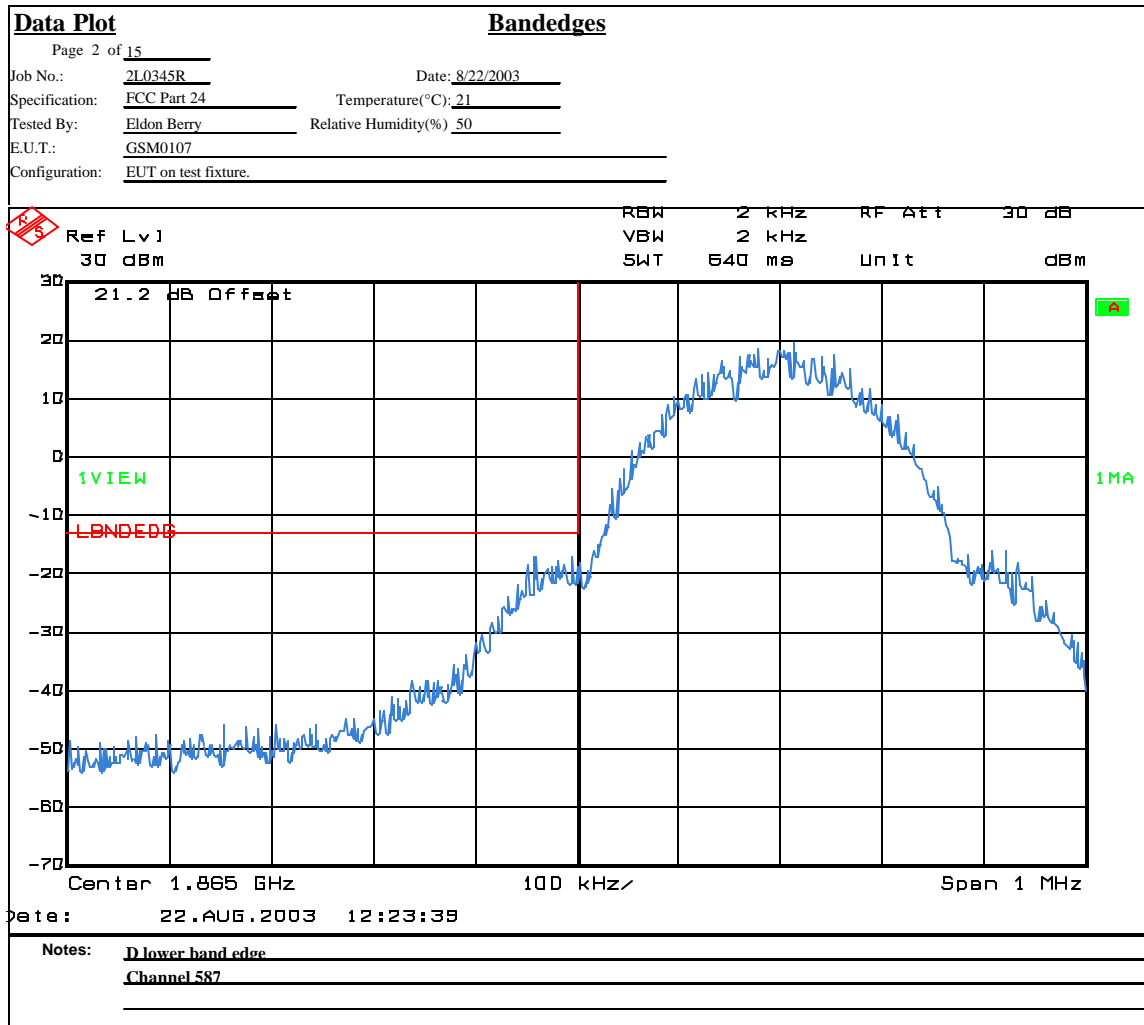

EQUIPMENT: GSM0107

Test Plots – Spurious Emissions at Antenna Terminals

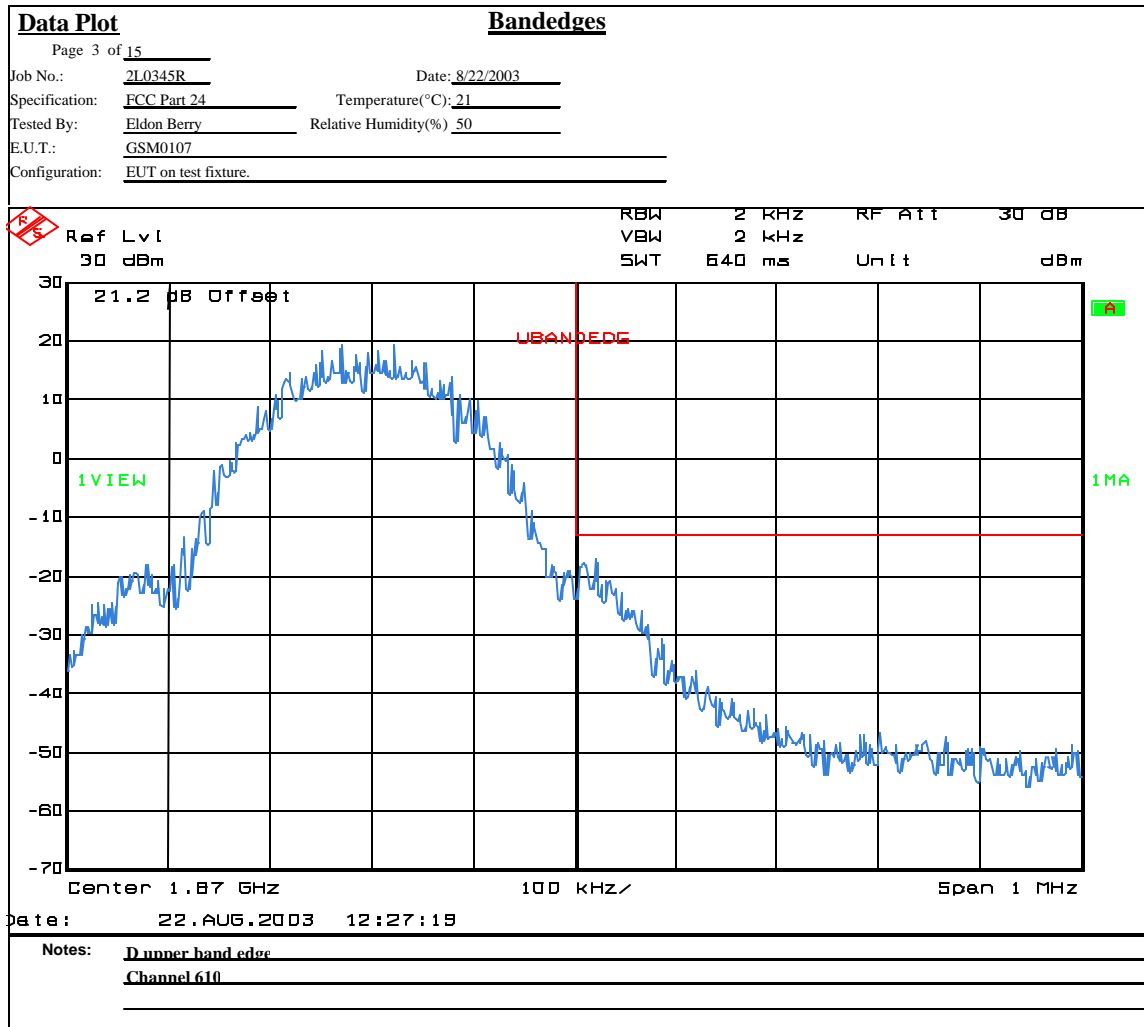



EQUIPMENT: GSM0107

Test Plots – Spurious Emissions at Antenna Terminals

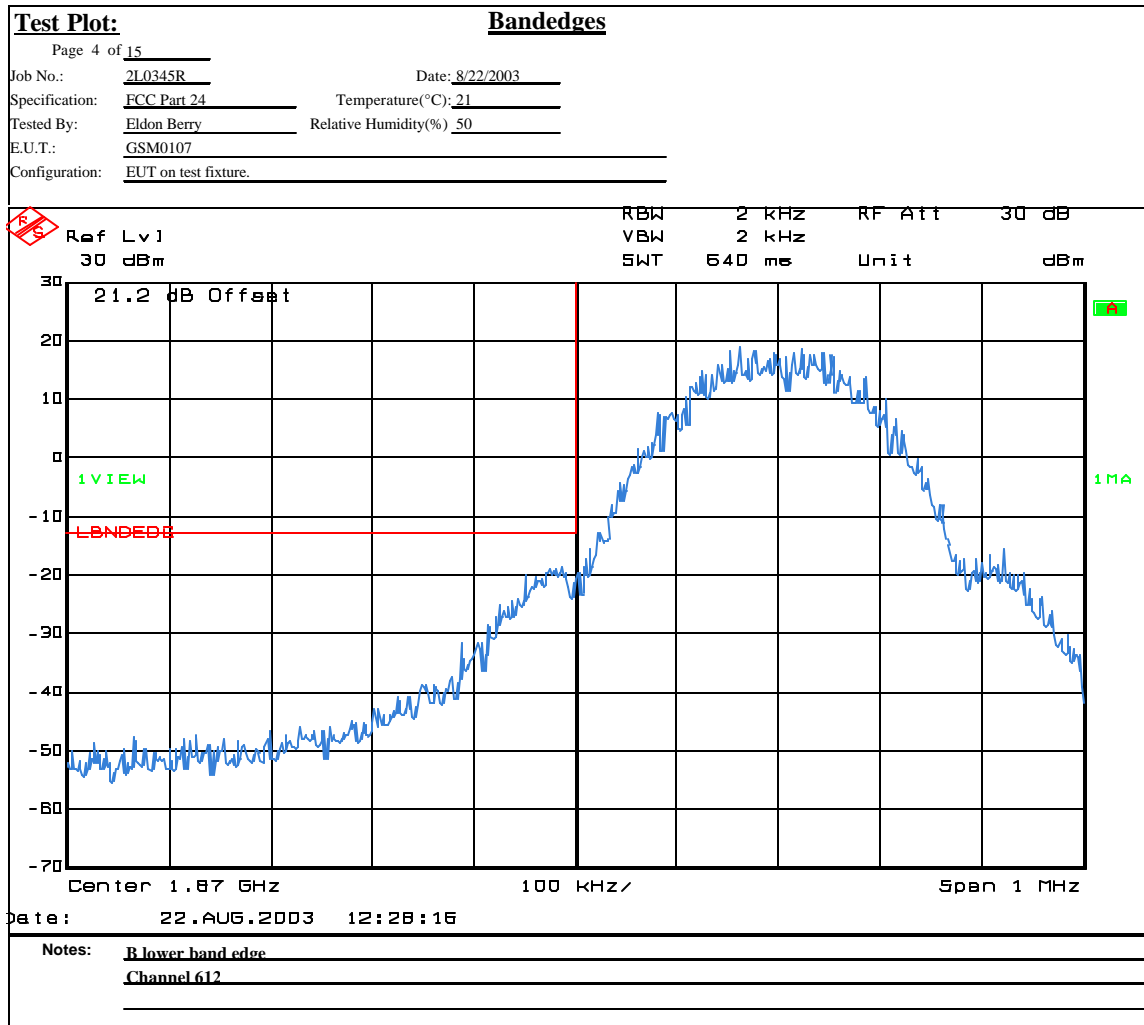

EQUIPMENT: GSM0107

Test Plots – Spurious Emissions at Antenna Terminals

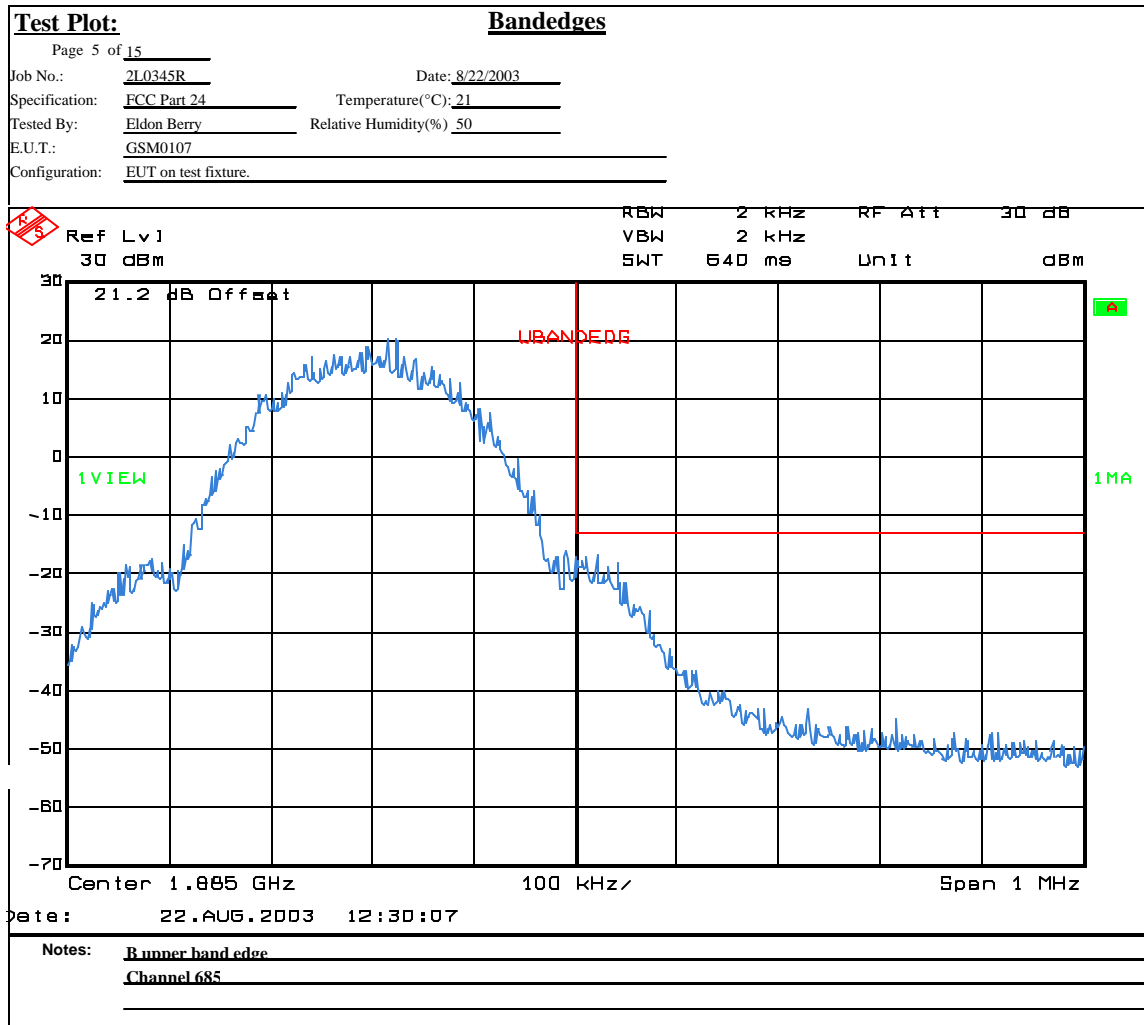

EQUIPMENT: GSM0107

Test Plots – Spurious Emissions at Antenna Terminals

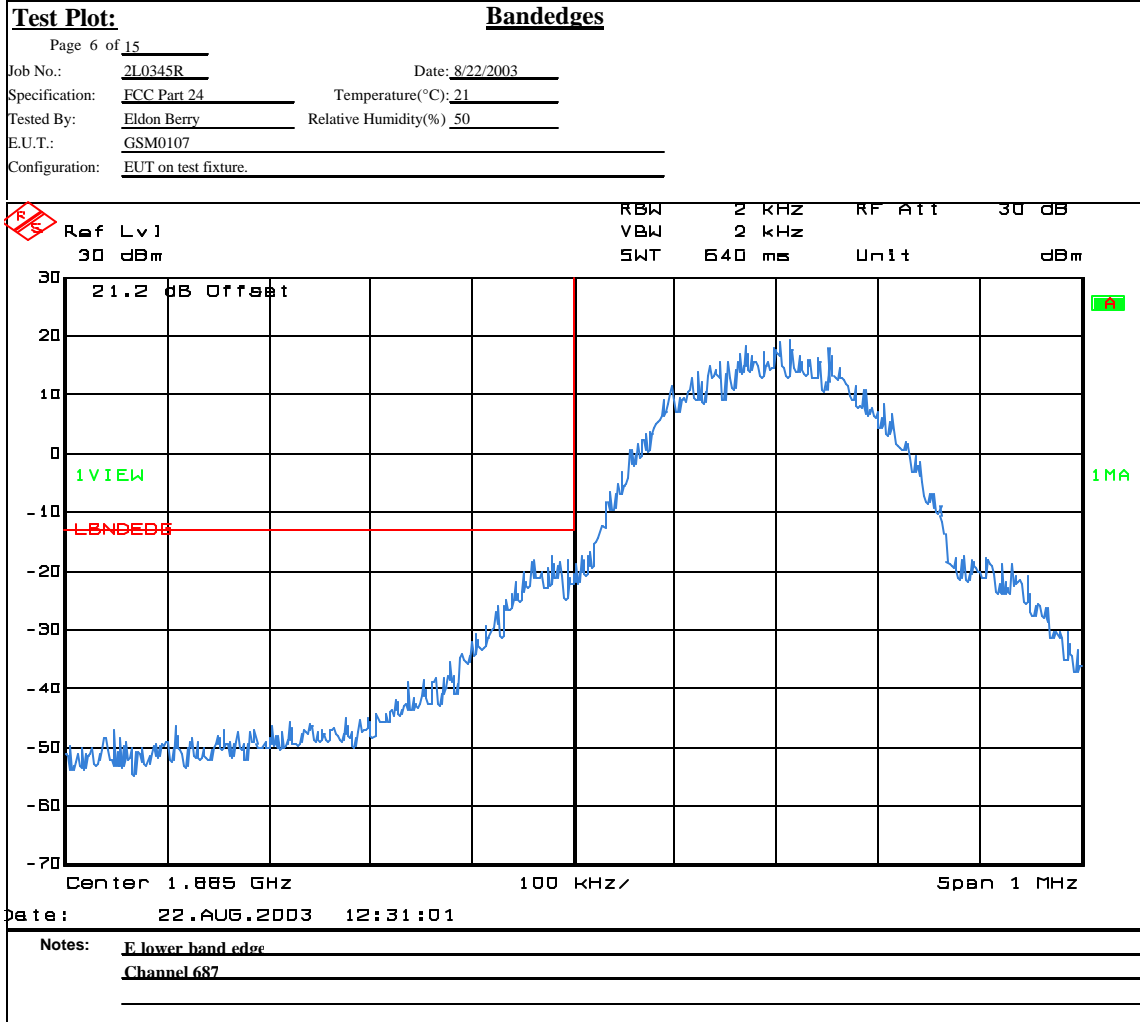

EQUIPMENT: GSM0107

Test Plots – Spurious Emissions at Antenna Terminals

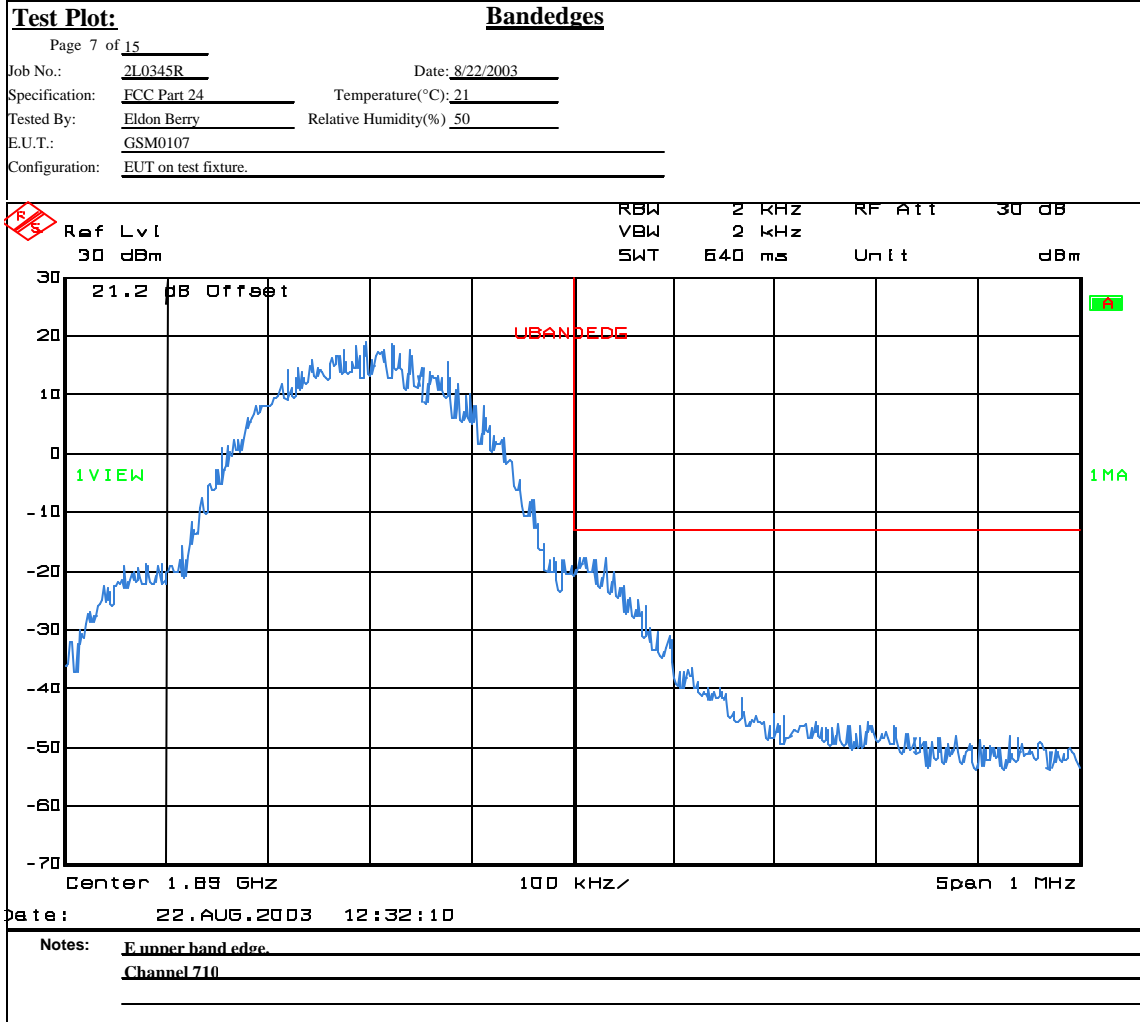

EQUIPMENT: GSM0107

Test Plots – Spurious Emissions at Antenna Terminals

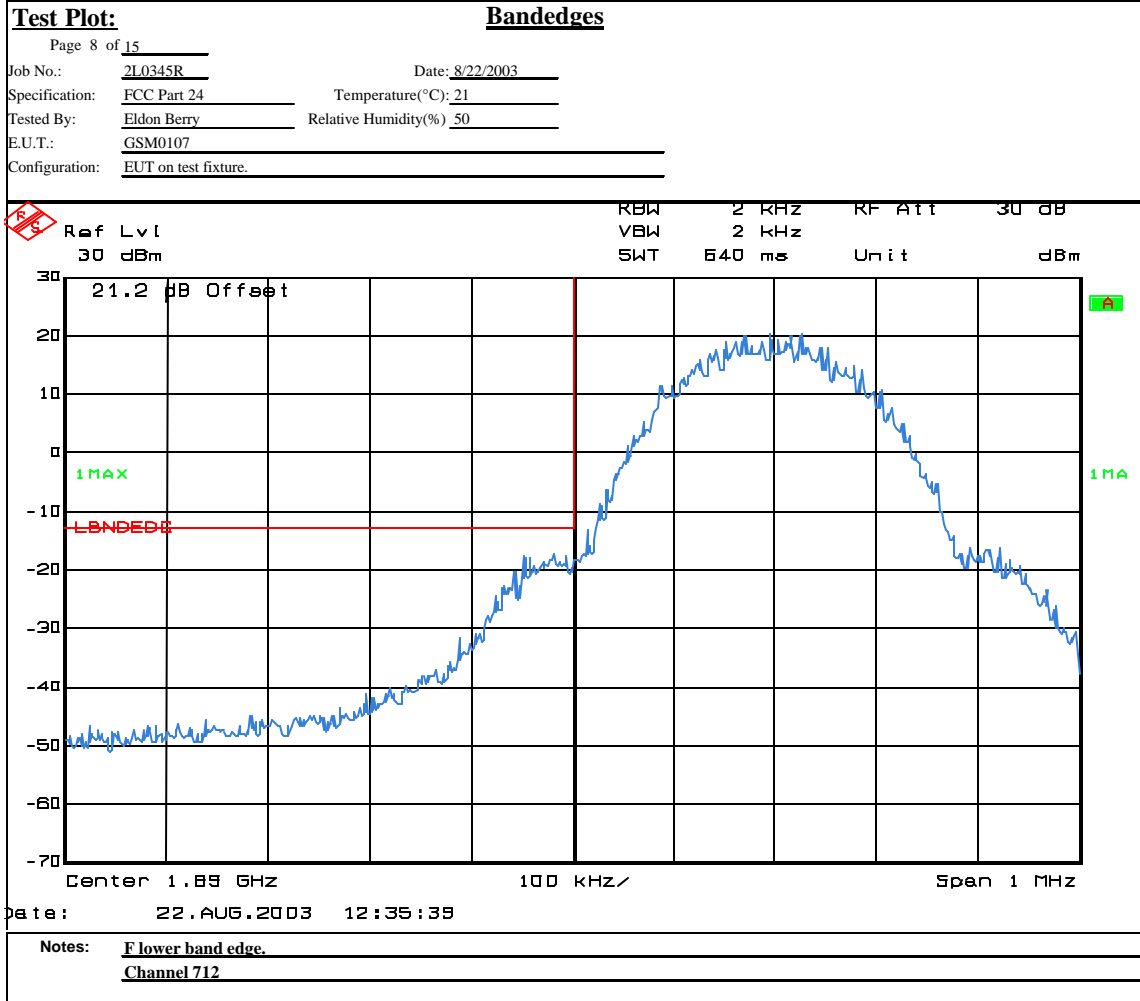

EQUIPMENT: GSM0107

Test Plots – Spurious Emissions at Antenna Terminals

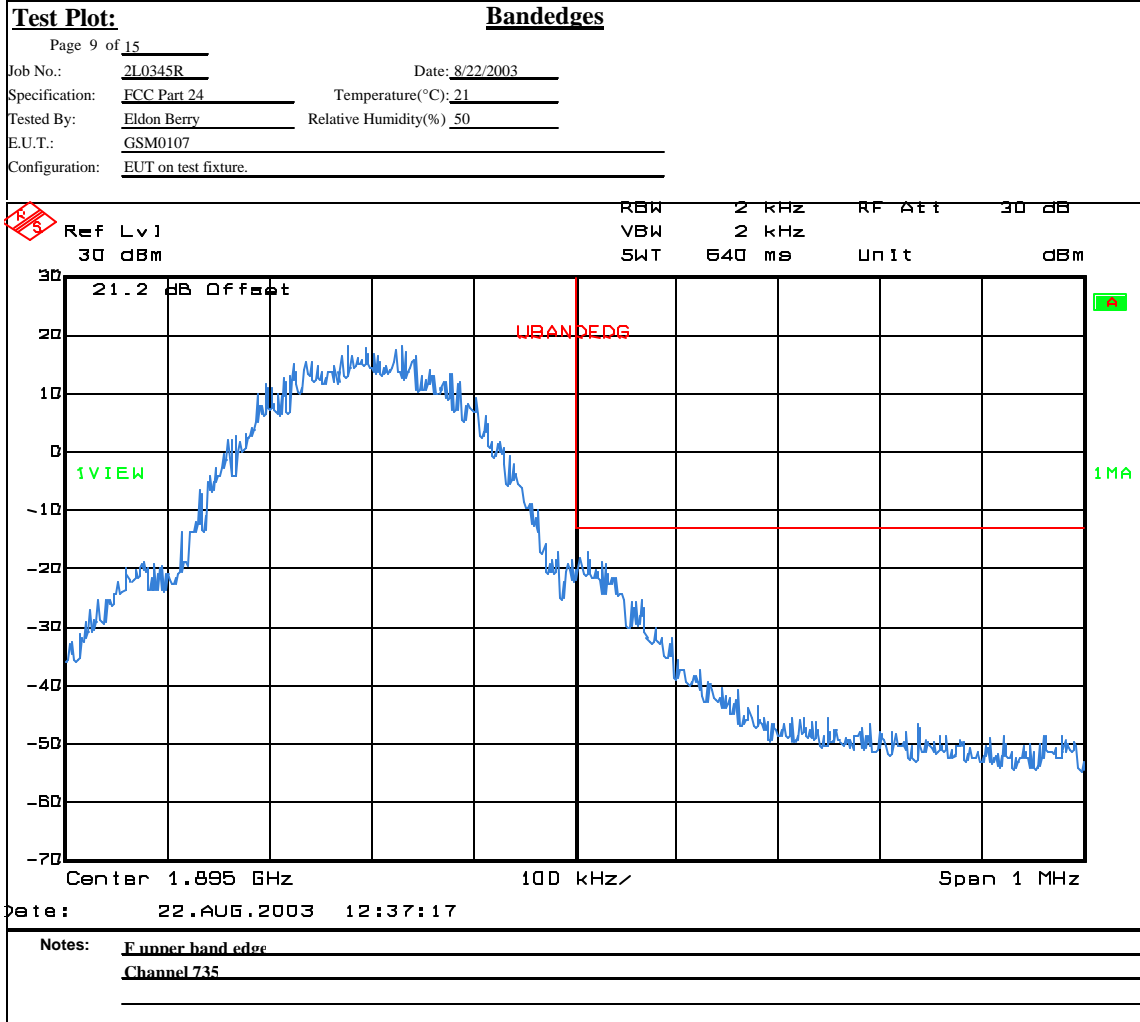

EQUIPMENT: GSM0107

Test Plots – Spurious Emissions at Antenna Terminals

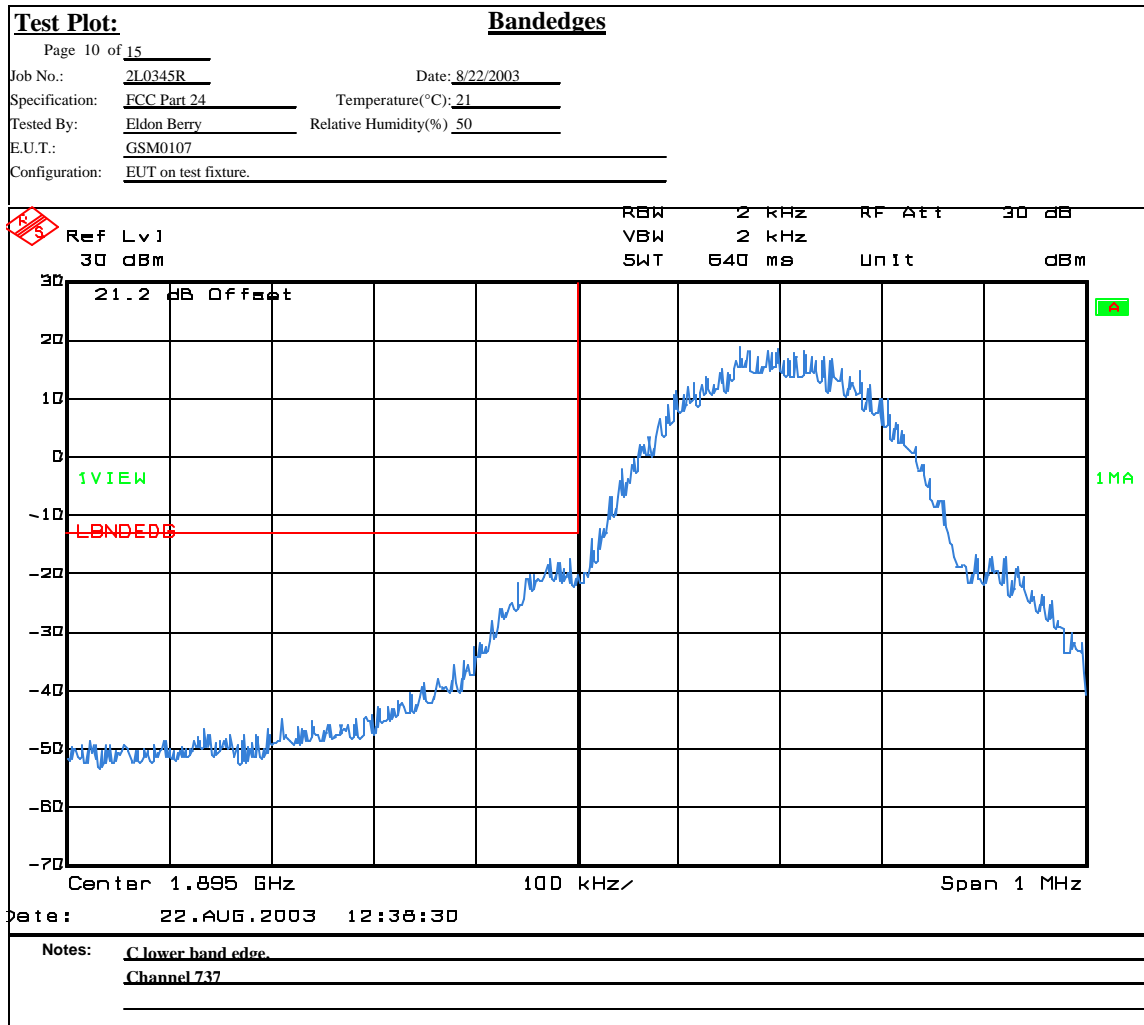

EQUIPMENT: GSM0107

Test Plots – Spurious Emissions at Antenna Terminals

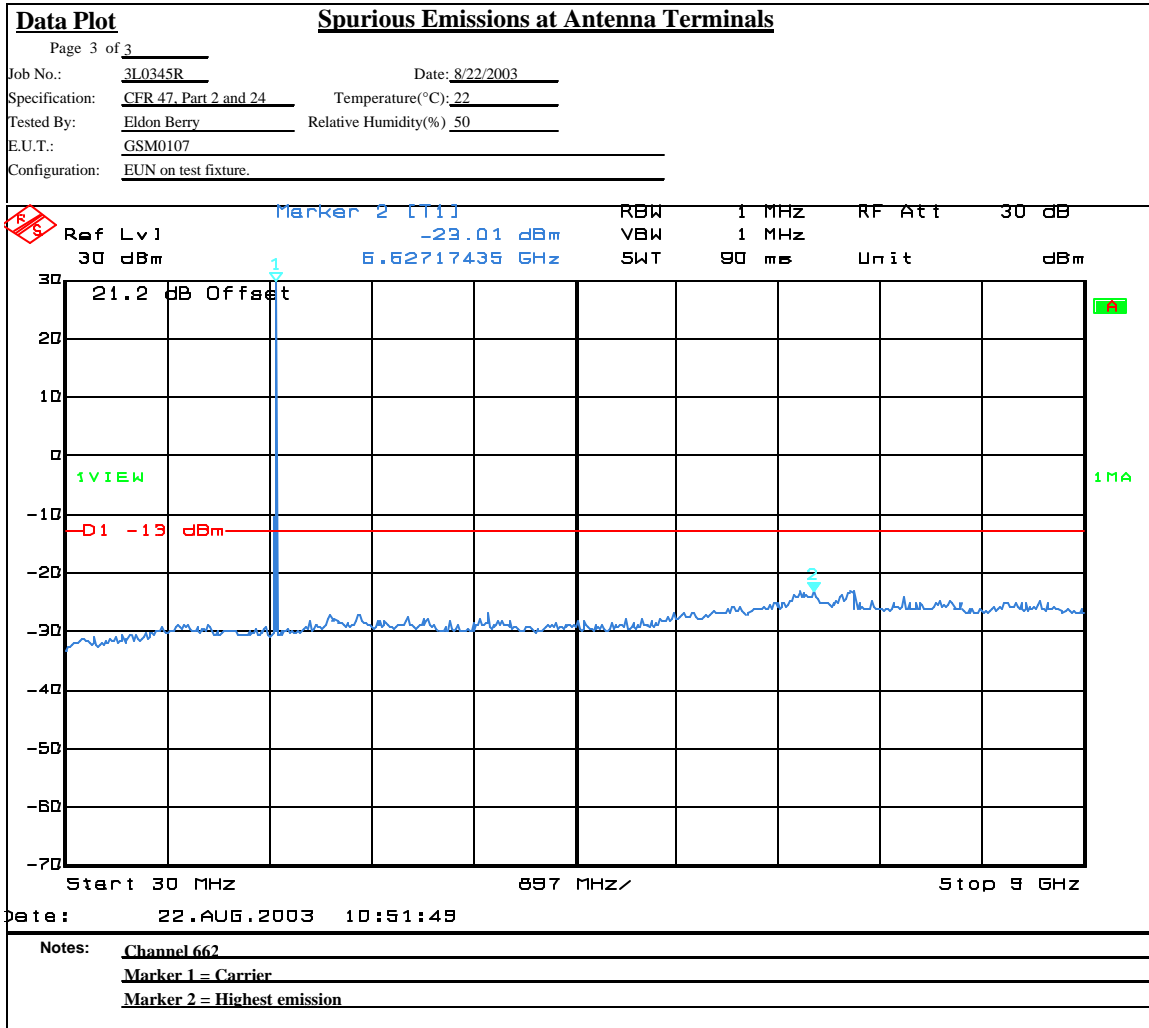



**EQUIPMENT:** GSM0107

---

**Section 6. Field Strength of Spurious**

NAME OF TEST: Field Strength of Spurious	PARA. NO.: 24.238
TESTED BY: Eldon Berry	DATE: 22Aug03

**Test Results:** Complies.

**Test Data:** See attached table.

EQUIPMENT: GSM0107

Test Data - Radiated Emissions

**EIRP Substitution Method**

Page 1 of 1

Job No.: 3L0345R Date: 8/22/03 Complete  X   
 Specification: PT 24 Temperature(°C): 22 Preliminary \_\_\_\_\_  
 Tested By: Eldon Berry Relative Humidity(%) 50  
 E.U.T.: GSM0107  
 Configuration: EUT on test fixture.  
 Sample No: 1  
 Location: AC 3 RBW: 1 MHz Measurement  
 Detector Type: Peak VBW: 1 MHz Distance: 3 m

**Test Equipment Used**

Antenna: 1304 Directional Coupler: \_\_\_\_\_  
 Pre-Amp: 1016 Cable #1: 1484  
 Filter: 1482 Cable #2: 1485  
 Receiver: 1464 Cable #3: \_\_\_\_\_  
 Attenuator #1: \_\_\_\_\_ Cable #4: \_\_\_\_\_  
 Attenuator #2: \_\_\_\_\_ Mixer: \_\_\_\_\_  
 Additional equipment used: \_\_\_\_\_  
 Measurement Uncertainty: +/-1.7 dB

Frequency (MHz)	Meter Reading (dBm)	Correction Factor (dB)	Pre-Amp Gain (dB)	Substitution Antenna Gain (dBi)	EIRP (dBm)	EIRP (mW)	Polarity	Comments
3760.4	-71.3	43.3	0	10.7	-17.3	0.0188	V	Channel 662
5640.6	-61.0	39.8	28.5	11.4	-38.3	0.0001	V	
7520.8	-62.5	41.8	34.1	11.3	-43.5	0.0000	V	
9401	-54.5	41.3	33.4	11.7	-34.9	0.0003	V	
11281.2	-43.2	43.7	34.6	12.5	-21.6	0.0069	V	
13161.4	-60.0	45.8	34.5	11.9	-36.8	0.0002	V	
15041.6	-63.0	45.2	32	12.8	-37.0	0.0002	V	
16921.8	-63.0	46.0	33.3	14.5	-35.8	0.0003	V	
3760.4	-75.0	35.5	0	10.7	-28.8	0.0013	H	
5640.6	-63.8	37.8	28.5	11.4	-43.1	0.0000	H	
7520.8	-62.7	41.5	34.1	11.3	-44.0	0.0000	H	
9401	-57.7	42.3	33.4	11.7	-37.1	0.0002	H	
13161.4	-63.0	47.8	30.3	11.9	-33.6	0.0004	H	

Notes: Searched spectrum to the 10th harmonic of carrier

NOTE: The correction factor in the above table references the pre-calibrated path loss at that frequency and is the difference between the received signal level and the input to the substitution antenna. The same antennas, cables and test range are used for calibration and for measurement.

**EQUIPMENT:** GSM0107

**Photographs of Test Setup**

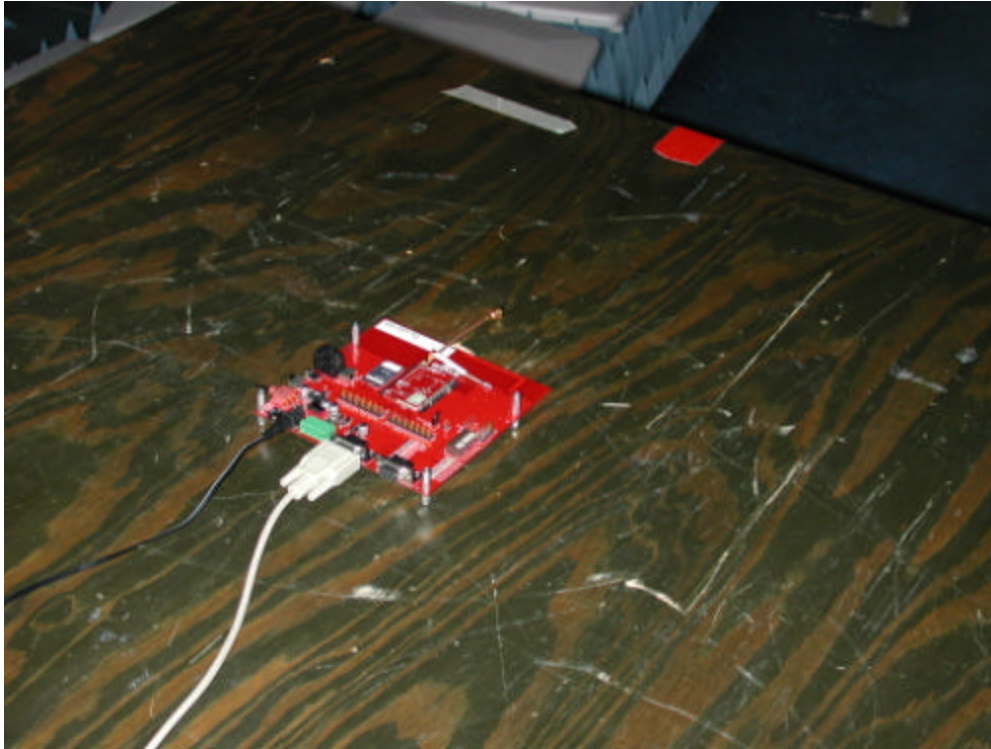

EQUIPMENT: GSM0107

**Section 7. Frequency Stability**

NAME OF TEST: Frequency Stability	PARA. NO.: 24.235
TESTED BY: David Light	DATE: 24Aug03

**Test Results:** Complies.

**Equipment Used:** Wavetek 3600D, Voltmeter # 1558, Thermometer # 619  
 Environmental Chamber # 283

**Temperature:** 23 °C

**Relative Humidity:** 36 %

**Measurement Data:**

Band of Operation PCS  
 Mode GPRS  
 Channel 662  
 Standard Test Frequency: 1880.264638 MHz  
 Standard Test Voltage: 3.8 Vdc

Test Equipment: 283-1464-425-1031

Temperature	Voltage (Vdc)	Frequency (MHz)	Change (Hz)	Change (PPM)
50	3.8	1880.259830	59830	-0.000003
40	3.8	1880.262604	62604	-0.000001
30	3.8	1880.267339	67339	0.000001
20	3.8	1880.264638		0.000000
10	3.8	1880.277320	77320	0.000007
0	3.8	1880.280628	80628	0.000009
-10	3.8	1880.281898	81898	0.000009
-20	3.8	1880.280100	80100	0.000008
-30	3.8	1880.275143	75143	0.000006
20	4.8	1880.264630	64630	0.000000
20	3.3	1880.264748	64748	0.000000

Nemko Dallas

FCC PARTS 2 and 24  
GSM/GPRS Wireless Modem  
Report No.: 3L0345RUS1

**EQUIPMENT: GSM0107**

---

EQUIPMENT: GSM0107

## Section 8. Test Equipment List

Nemko	Description	Manufacturer Model	Serial	Calibration Date	Calibration Due
1083	Cable 2m	Astrolab 32027-2-29094-72TC	N/A	CBU	N/A
	Power meter	E4418B	GB39401848	12/11/02	12/11/04
	Power sensor	E9304A	MY41494308	9/9/02	9/9/03
1604	ATTENUATOR	NARDA 776B-20	NONE	N/A	N/A
1036	SPECTRUM ANALYZER	ROHDE & FSEK30	830844/006	12/18/01	12/19/03
1304	HORN ANTENNA	ELECTRO METRICS RGA-60	6151	07/30/01	07/31/03
1016	Pre-Amp	HEWLETT PACKARD 8449A	2749A00159	07/24/03	07/24/04
1482	Band Pass	K & L 11SH10-4000/T12000-0/0	2	Cal B4	N/A
1464	Spectrum	Hewlett 8563E	3551A04428	02/11/03	02/11/05
1484	Cable 2.0-18.0 Ghz	Storm PR90-010-072	N/A	07/24/03	07/23/04
1485	Cable 2.0-18.0 Ghz	Storm PR90-010-216	N/A	07/24/03	07/23/04
283	Environmental Chamber with controller #	ENVIROTRONIC SH27 & 2030-22844	129010083	04/22/03	04/21/04
425	DIGITAL MULTIMETER	FLUKE 45-01	5930073	10/03/02	10/03/03
1031	D C power	Hewlett 6002A	2930A-12218	Not	N/A

## **ANNEX A - TEST METHODOLOGIES**

**EQUIPMENT:** GSM0107**NAME OF TEST:** RF Power Output**PARA. NO.:** 2.1046

**Minimum Standard:** Para. No.24.232. Mobile/portable stations are limited to 2 watts e.i.r.p. peak power and the equipment must employ means to limit the power to the minimum necessary for successful communications.

**Method Of Measurement:** CDMA Per ANSI/J-STD-008  
TDMA Per ANSI/J-STD-010  
PCS 1900 Per ANSI/J-STD-007

Detachable Antenna:

The peak power at antenna terminals is measured using an in-line peak power meter or a spectrum analyzer.

Integral Antenna:

**Test Method:** TIA/EIA-603-1992, Section 2.2.12

The antenna substitution method was used to determine the equivalent radiated power at spurious frequencies. The spurious emissions were measured at a distance of 3 meters. The EUT was then replaced with a reference substitution antenna with a known gain referenced to a dipole. This antenna was fed with a signal at the spurious frequency. The level of the signal was adjusted to repeat the previously measured level. The resulting erp is the signal level fed to the reference antenna corrected for gain referenced to a dipole.



EQUIPMENT: GSM0107

NAME OF TEST: Occupied Bandwidth

PARA. NO.: 2.1049

**Minimum Standard:** Para. No. 24.238(b). The emission bandwidth is defined as the width of the signal between two points, one below the carrier center frequency and one above the carrier center frequency, outside of which all emissions are attenuated at least 26 dB.

**Method Of Measurement:**

CDMA Per ANSI/J-STD-008

Spectrum analyzer settings:

RBW: 30 kHz

VBW: ? RBW

Span: 5 MHz

Sweep: Auto

GSM Per ANSI/J-STD-007

RBW: 3 kHz

VBW: ? RBW

Span: 2 MHz

Sweep: Auto

NADC Per IS-136

RBW: 1 kHz

VBW: ? RBW

Span: 1 MHz

Sweep: Auto

EQUIPMENT: GSM0107

NAME OF TEST: Spurious Emission at Antenna  
Terminals

PARA. NO.: 2.1053

**Minimum Standard:**

Para. No.24.238(a). On any frequency outside a licensee's frequency block, the power of any emission shall be attenuated below the transmitter power by at least  $43 + 10 \log (P)$  dB.

**Method Of Measurement:**

Spectrum analyzer settings:

CDMA Per ANSI/J-STD-008

RBW: 1 MHz (> 1 MHz from Band Edge)  
RBW: 20 kHz (< 1MHz from Band Edge)  
VBW: ? RBW  
Sweep: Auto  
Video Avg: 6 Sweeps

GSM Per ANSI/J-STD-007

RBW: 1 MHz (> 1 MHz from Band Edge)  
RBW: 3 kHz (< 1 MHz from Band Edge)  
VBW: ? RBW  
Sweep: Auto  
Video Avg: Disabled

NADC Per IS-136

RBW: 1 MHz (> 1 MHz from Band Edge)  
RBW: 1 kHz (< 1 MHz from Band Edge)  
VBW: ? RBW  
Sweep: Auto  
Video Avg: Disabled

To demonstrate compliance at band edges the frequency of the input signal is set to the lowest and highest assigned channel and the center frequency of the spectrum analyzer is set to the upper and lower edges of the appropriate frequency block.

---

**EQUIPMENT: GSM0107**

<b>NAME OF TEST: Field Strength of Spurious Radiation</b>	<b>PARA. NO.: 2.1053</b>
---	--------------------------

**Minimum Standard:** Para. No.24.238(a). On any frequency outside a licensee's frequency block, the power of any emission shall be attenuated below the transmitter power by at least  $43 + 10 \log (P)$  dB.

### **Calculation Of Field Strength Limit**

**Test Method:** TIA/EIA-603-1992, Section 2.2.12

The antenna substitution method was used to determine the equivalent radiated power at spurious frequencies. The spurious emissions were measured at a distance of 3 meters. The EUT was then replaced with a reference substitution antenna with a known gain referenced to a dipole. This antenna was fed with a signal at the spurious frequency. The level of the signal was adjusted to repeat the previously measured level. The resulting erp is the signal level fed to the reference antenna corrected for gain referenced to a dipole.

**EQUIPMENT:** GSM0107**NAME OF TEST:** Frequency Stability**PARA. NO.:** 2.1055

**Minimum Standard:** Para. No. 24.235. The frequency stability shall be sufficient to ensure that the fundamental emission stays within the authorized frequency block.

**Method Of Measurement:** CDMA Per ANSI/J-STD-008  
TDMA Per ANSI/J-STD-007  
NADC Per IS-136

#### Frequency Stability With Voltage Variation

The E.U.T. is placed in an environmental chamber and allowed to stabilize at +20 degrees Celsius for at least 15 minutes. With the voltage input to the E.U.T. set to 85% S.T.V., the frequency is measured in 30 second intervals for a period of 5 minutes. This procedure is repeated at 100% S.T.V. and 115% S.T.V.

#### Frequency Stability With Temperature Variation

The input voltage to the E.U.T. is set to S.T.V. and the temperature of the environmental chamber is varied in 10 degree steps from -30 degrees C to +50 degrees C. The E.U.T. is allowed to stabilize at each temperature and the frequency is measured in 30 second intervals for a period of 5 minutes.

## **ANNEX B - TEST DIAGRAMS**

EQUIPMENT: GSM0107

Para. No. 2.1046 - R.F. Power Output

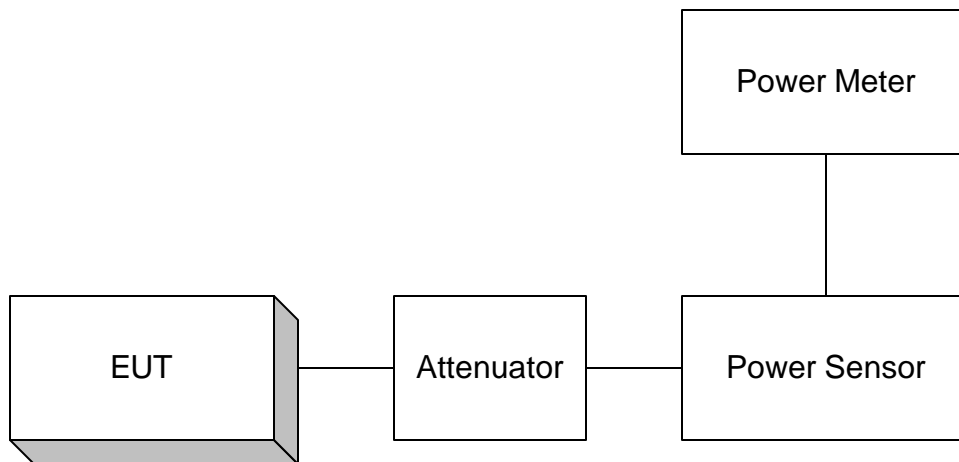

Para. No. 2.1049 - Occupied Bandwidth



EQUIPMENT: GSM0107

Para. No. 2.1053 Spurious Emissions at Antenna Terminals

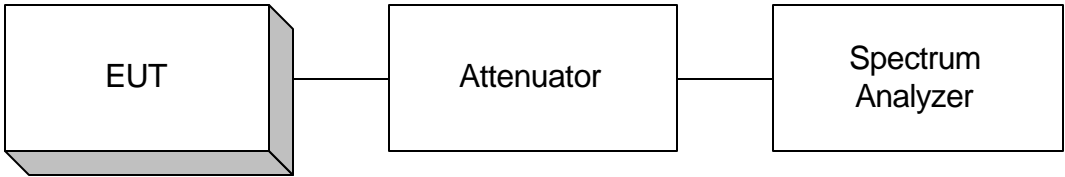

Para. No. 2.1053- Field Strength of Spurious Radiation

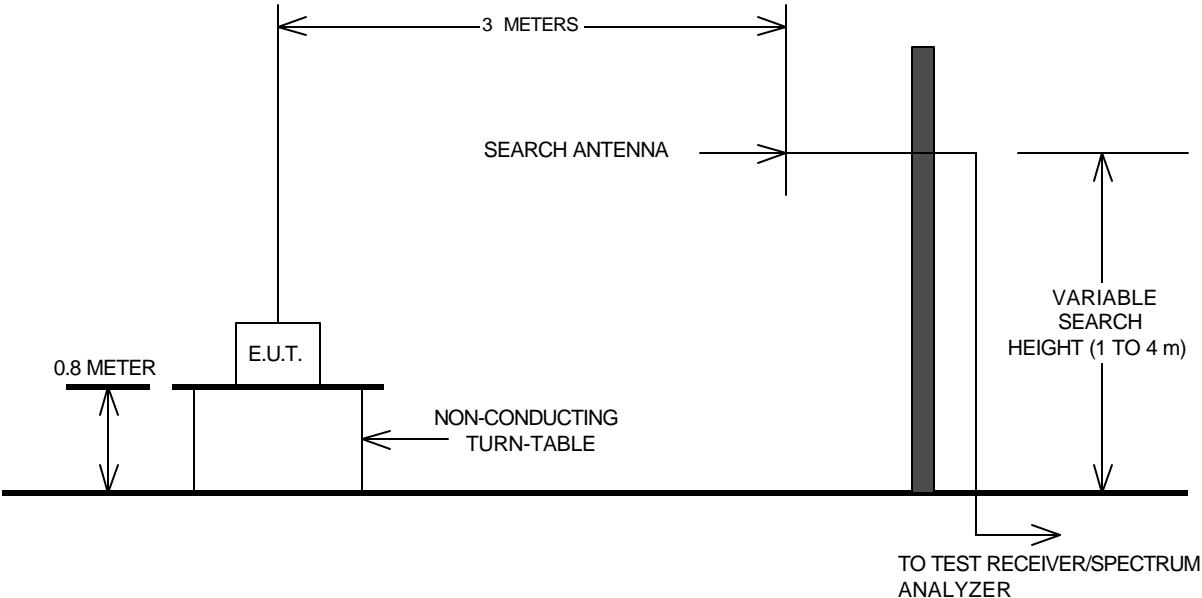

EQUIPMENT: GSM0107

Para. No. 2.1055 - Frequency Stability

