

# RADIO TEST REPORT

## FCC 47 CFR PART 15 SUBPART C

<b>Test Standard</b>	<b>FCC Part 15.247</b>
<b>Product name</b>	<b>Voice Remote Control</b>
<b>Brand Name</b>	<b>Sony</b>
<b>Model No.</b>	<b>RMF-TX621U, RMF-TX621B</b>
<b>Test Result</b>	<b>Pass</b>
<b>Statements of Conformity</b>	<b>Determination of compliance is based on the results of the compliance measurement, not taking into account measurement instrumentation uncertainty.</b>

The test Result was tested by Compliance Certification Services Inc. The test data, data evaluation, test procedures, and equipment configurations shown in this report were given in ANSI C63.10: 2013 and compliance standards.

The test results of this report relate only to the tested sample (EUT) identified in this report.

The test Report of full or partial shall not copy. Without written approval of Compliance Certification Services Inc.(Wugu Laboratory)

Approved by:



---

Kevin Tsai  
 Deputy Manager

Unless otherwise stated the results shown in this test report refer only to the sample(s) tested and such sample(s) are retained for 90 days only.  
 除非另有說明，此報告結果僅對測試之樣品負責，同時此樣品僅保留90天。本報告未經本公司書面許可，不可部份複製。

This document is issued by the Company subject to its General Conditions of Service printed overleaf, available on request or accessible at <http://www.sgs.com.tw/Terms-and-Conditions> and, for electronic format documents, subject to Terms and Conditions for Electronic Documents at <http://www.sgs.com.tw/Terms-and-Conditions>. Attention is drawn to the limitation of liability, indemnification and jurisdiction issues defined therein. Any holder of this document is advised that information contained hereon reflects the Company's findings at the time of its intervention only and within the limits of client's instruction, if any. The Company's sole responsibility is to its Client and this document does not exonerate parties to a transaction from exercising all their rights and obligations under the transaction documents. This document cannot be reproduced, except in full, without prior written approval of the Company. Any unauthorized alteration, forgery or falsification of the content or appearance of this document is unlawful and offenders may be prosecuted to the fullest extent of the law.

### Revision History

Rev.	Issue Date	Revisions	Effect Page	Revised By
00	October 20, 2020	Initial Issue	ALL	Allison Chen
01	October 27, 2020	See the following note Rev.(01)	P.A-1	Allison Chen

**Rev.(01)**

1. Modify test setup photo above 1GHz.

## Table of contents

1.	GENERAL INFORMATION .....	4
1.1	EUT INFORMATION .....	4
1.2	EUT CHANNEL INFORMATION .....	5
1.3	ANTENNA INFORMATION .....	5
1.4	MEASUREMENT UNCERTAINTY.....	6
1.5	FACILITIES AND TEST LOCATION .....	7
1.6	INSTRUMENT CALIBRATION .....	7
1.7	SUPPORT AND EUT ACCESSORIES EQUIPMENT .....	8
1.9	TABLE OF ACCREDITATIONS AND LISTINGS .....	8
2.	TEST SUMMERY .....	9
3.	DESCRIPTION OF TEST MODES.....	10
3.1	THE WORST MODE OF OPERATING CONDITION .....	10
3.2	THE WORST MODE OF MEASUREMENT .....	11
3.3	EUT DUTY CYCLE.....	12
4.	TEST RESULT .....	13
4.1	AC POWER LINE CONDUCTED EMISSION .....	13
4.2	6dB BANDWIDTH AND OCCUPIED BANDWIDTH(99%).....	14
4.3	OUTPUT POWER MEASUREMENT .....	18
4.4	POWER SPECTRAL DENSITY.....	20
4.5	CONDUCTED BANDEDGE AND SPURIOUS EMISSION.....	23
4.6	RADIATION BANDEDGE AND SPURIOUS EMISSION .....	27
APPENDIX 1 - PHOTOGRAPHS OF EUT		

Report No.: T200909W02-RP2

## 1. GENERAL INFORMATION

### 1.1 EUT INFORMATION

<b>Applicant</b>	Universal Electronics Inc. 201 East Sandpointe Ave 7th Floor Santa Ana CA 92707 USA														
<b>Manufacturer</b>	Gemstar Technology (Qinzhou) Co., Ltd Hedong Industrial District, Qinzhou, Guangxi Zhuang Autonomous Region, P.R. China														
<b>Equipment</b>	Voice Remote Control														
<b>Model No.</b>	RMF-TX621U, RMF-TX621B														
<b>Model Discrepancy</b>	<p>1. Client consigns only one sample to test (model RMF-TX621U). Therefore, the testing Lab. just guarantees the unit, which has been tested.</p> <p>2. Difference of the model numbers (list on this report) is just for marketing only, difference between BLE and zigbee function (one or two key label differences depending on country) as below:</p> <table border="1" data-bbox="568 1043 1436 1162"> <thead> <tr> <th>Model</th> <th colspan="3">RF Function</th> </tr> </thead> <tbody> <tr> <td>RMF-TX621U</td> <td>Zigbee</td> <td>BLE</td> <td>Main</td> </tr> <tr> <td>RMF-TX621B</td> <td>X</td> <td>BLE</td> <td>Serial</td> </tr> </tbody> </table>			Model	RF Function			RMF-TX621U	Zigbee	BLE	Main	RMF-TX621B	X	BLE	Serial
Model	RF Function														
RMF-TX621U	Zigbee	BLE	Main												
RMF-TX621B	X	BLE	Serial												
<b>Trade Name</b>	Sony														
<b>Received Date</b>	September 9, 2020														
<b>Date of Test</b>	September 21 ~ 25, 2020														
<b>Power Supply</b>	Power from Battery.														
<b>S.W Version</b>	V21.01.01.005														
<b>H.W: Version</b>	A01														
<b>EUT Serial #</b>	50:61:F6:BC:3C:E7														

Report No.: T200909W02-RP2

## 1.2 EUT CHANNEL INFORMATION

Frequency Range	2425 ~ 2475MHz						
Modulation Type	Zigbee: OQPSK (Offset Quadrature Phase Shift Keyed)						
Number of channels	Zigbee: 3 Channels						
Channels list	CH.	Freq.	CH.	Freq.	CH.	Freq.	
	15	2425	20	2450	25	2475	

### Remark:

Refer as ANSI C63.10: 2013 clause 5.6.1 Table 4 and RSS-GEN Table 1 for test channels

Number of frequencies to be tested		
Frequency range in which device operates	Number of frequencies	Location in frequency range of operation
<input type="checkbox"/> 1 MHz or less	1	Middle
<input type="checkbox"/> 1 MHz to 10 MHz	2	1 near top and 1 near bottom
<input checked="" type="checkbox"/> More than 10 MHz	3	1 near top, 1 near middle, and 1 near bottom

## 1.3 ANTENNA INFORMATION

Antenna Type	<input type="checkbox"/> PIFA <input type="checkbox"/> PCB <input type="checkbox"/> Dipole <input checked="" type="checkbox"/> Chip
Antenna Gain	-0.55 dBi
Antenna Connector	N/A

## 1.4 MEASUREMENT UNCERTAINTY

PARAMETER	UNCERTAINTY
AC Powerline Conducted Emission	+/- 1.2575
Emission bandwidth, 20dB bandwidth	+/- 0.0014
RF output power, conducted	+/- 1.14
Power density, conducted	+/- 1.40
3M Semi Anechoic Chamber / 30M~200M	+/- 4.12
3M Semi Anechoic Chamber / 200M~1000M	+/- 4.68
3M Semi Anechoic Chamber / 1G~8G	+/- 5.18
3M Semi Anechoic Chamber / 8G~18G	+/- 5.47
3M Semi Anechoic Chamber / 18G~26G	+/- 3.81
3M Semi Anechoic Chamber / 26G~40G	+/- 3.87

**Remark:**

- 1.This uncertainty represents an expanded uncertainty expressed at approximately the 95% confidence level using a coverage factor of k=2
2. ISO/IEC 17025 requires that an estimate of the measurement uncertainties associated with the emissions test results be included in the report.

Report No.: T200909W02-RP2

## 1.5 FACILITIES AND TEST LOCATION

All measurement facilities used to collect the measurement data are located at No.11, Wugong 6th Rd., Wugu Dist., New Taipei City, Taiwan. (R.O.C.)

Test site	Test Engineer	Remark
AC Conduction Room	-	Not applicable, because EUT doesn't connect to AC Main Source direct.
Radiation	Jerry Chang	-
RF Conducted	Jane Wang	-

**Remark:** The sites are constructed in conformance with the requirements of ANSI C63.7, ANSI C63.4 and CISPR Publication 22.

## 1.6 INSTRUMENT CALIBRATION

RF Conducted Test Site					
Equipment	Manufacturer	Model	Serial Number	Cal Date	Cal Due
Coaxial Cable	Woken	WC12	CC003	06/29/2020	06/28/2021
EXA Signal Analyzer	KEYSIGHT	N9010B	MY55460167	09/07/2020	09/06/2021
Power Meter	Anritsu	ML2487A	6K00003260	05/21/2020	05/20/2021
Power Sensor	Anritsu	MA2490A	032910	05/21/2020	05/20/2021
Software	N/A				

3M 966 Chamber Test Site					
Equipment	Manufacturer	Model	Serial Number	Cal Date	Cal Due
Band Reject Filters	MICRO TRONICS	BRM 50702	120	02/25/2020	02/24/2021
Bilog Antenna	Sunol Sciences	JB3	A030105	07/24/2020	07/23/2021
Coaxial Cable	HUBER SUHNER	SUCOFLEX 104PEA	20995	02/25/2020	02/24/2021
Coaxial Cable	EMCI	EMC105	190914+25111	09/19/2020	09/19/2021
Digital Thermo-Hygro Meter	WISEWIND	1206	D07	01/15/2020	01/14/2021
double Ridged Guide Horn Antenna	ETC	MCTD 1209	DRH13M02003	10/04/2019	10/03/2020
Loop Ant	COM-POWER	AL-130	121051	03/27/2020	03/26/2021
Pre-Amplifier	EMEC	EM330	060609	02/25/2020	02/24/2021
Pre-Amplifier	HP	8449B	3008A00965	02/25/2020	02/24/2021
PSA Series Spectrum Analyzer	Agilent	E4446A	MY46180323	07/24/2020	07/23/2021
Antenna Tower	CCS	CC-A-1F	N/A	N.C.R	N.C.R
Controller	CCS	CC-C-1F	N/A	N.C.R	N.C.R
Turn Table	CCS	CC-T-1F	N/A	N.C.R	N.C.R
Software	e3 6.11-20180413				

**Note:** 1. The calibration interval of the above test instruments is 12 months and the calibrations are traceable to NML/ROC and NIST/USA.  
2. N.C.R. = No Calibration Required.

## 1.7 SUPPORT AND EUT ACCESSORIES EQUIPMENT

EUT Accessories Equipment					
No.	Equipment	Brand	Model	Series No.	FCC ID
	N/A				

Support Equipment					
No.	Equipment	Brand	Model	Series No.	FCC ID
1	NB(J)	TOSHIBA	PT345T-00L002	N/A	PD97260H

## 1.8 TEST METHODOLOGY AND APPLIED STANDARDS

The test methodology, setups and results comply with all requirements in accordance with ANSI C63.10:2013, RSS-247 Issue 2 and RSS-GEN Issue 5



## 2. TEST SUMMARY

IC Standard Section	Chapter	Test Item	Result
-	1.3	Antenna Requirement	Pass
RSS-GEN 8.8	4.1	AC Conducted Emission	N/A
RSS-247(5.2)(a)	4.2	6 dB Bandwidth	Pass
RSS-GEN 6.7	4.2	Occupied Bandwidth (99%)	Pass
RSS-247(5.4)(d)	4.3	Output Power Measurement	Pass
RSS-247(5.2)(b)	4.4	Power Spectral Density	Pass
RSS-247(5.5)	4.5	Conducted Band Edge	Pass
RSS-247(5.5)	4.5	Conducted Emission	Pass
RSS-247(5.5)	4.6	Radiation Band Edge	Pass
RSS-247(5.5)	4.6	Radiation Spurious Emission	Pass

### 3. DESCRIPTION OF TEST MODES

#### 3.1 THE WORST MODE OF OPERATING CONDITION

Operation mode	Zigbee
Test Channel Frequencies	<b>Zigbee:</b> 1. Lowest Channel : 2425MHz 2. Middle Channel : 2450MHz 3. Highest Channel : 2475MHz

**Remark:**

1. EUT pre-scanned data rate of output power for each mode, the worst data rate were recorded in this report.

### 3.2 THE WORST MODE OF MEASUREMENT

Radiated Emission Measurement Above 1G	
Test Condition	Radiated Emission Above 1G
Power supply Mode	Mode 1: EUT power by Battery
Worst Mode	<input checked="" type="checkbox"/> Mode 1 <input type="checkbox"/> Mode 2 <input type="checkbox"/> Mode 3 <input type="checkbox"/> Mode 4
Worst Position	<input checked="" type="checkbox"/> Placed in fixed position at X-Plane (E2-Plane)

Radiated Emission Measurement Below 1G	
Test Condition	Radiated Emission Below 1G
Power supply Mode	Mode 1: EUT power by Battery
Worst Mode	<input checked="" type="checkbox"/> Mode 1 <input type="checkbox"/> Mode 2 <input type="checkbox"/> Mode 3 <input type="checkbox"/> Mode 4

Remark:

1. The worst mode was record in this test report.
2. EUT pre-scanned in axis ,X and two polarity, for radiated measurement. The worst case(X-Plane) were recorded in this report

Report No.: T200909W02-RP2

### 3.3 EUT DUTY CYCLE

Temperature: 25°C

Humidity: 50% RH

Tested by: Jane Wang

Duty Cycle				
Configuration	Duty Cycle (%)	Duty Factor (dB) =10*log (1/Duty Cycle)	1/T (kHz)	VBW setting (kHz)
Zigbee	100.00%	0.00	1.00	N/A

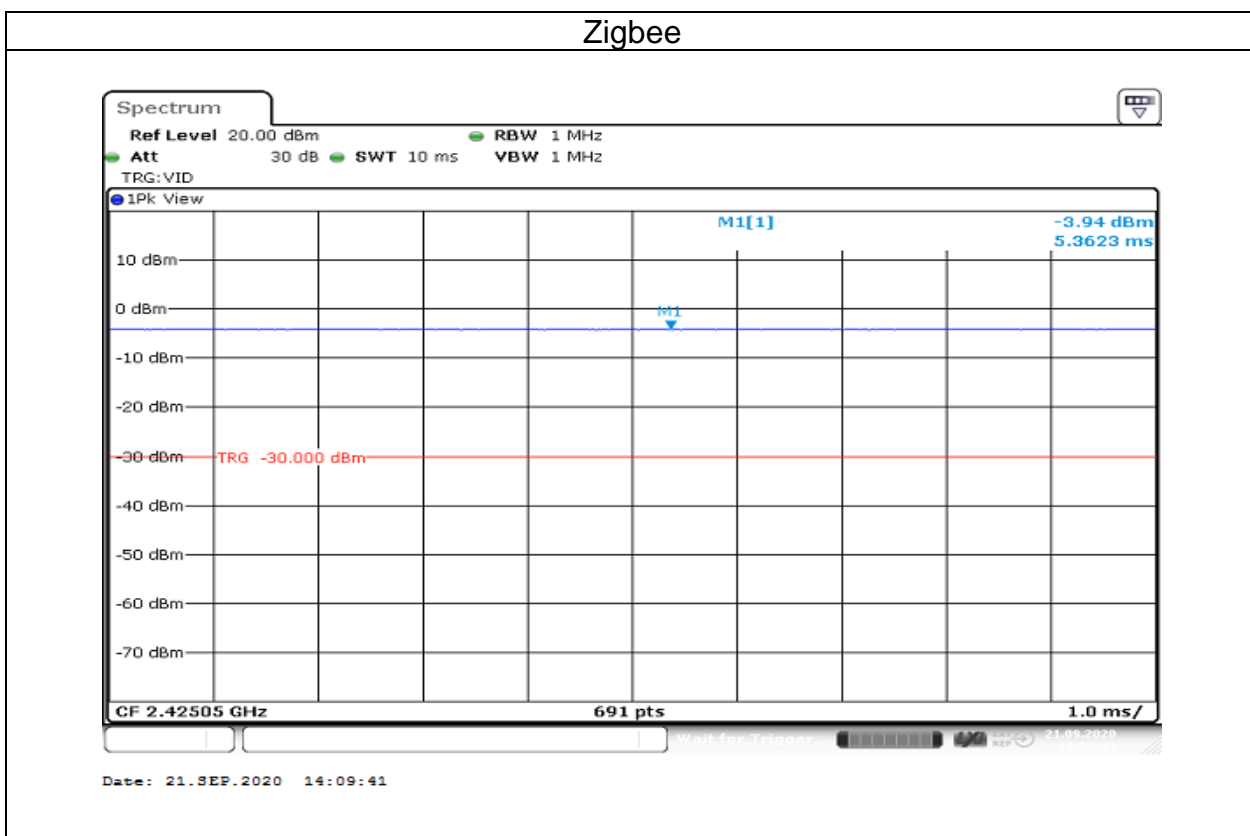

Report No.: T200909W02-RP2

## 4. TEST RESULT

### 4.1 AC POWER LINE CONDUCTED EMISSION

#### 4.1.1 Test Limit

According to §15.207(a)(2),

Frequency Range (MHz)	Limits(dBμV)	
	Quasi-peak	Average
0.15 to 0.50	66 to 56*	56 to 46*
0.50 to 5	56	46
5 to 30	60	50

\* Decreases with the logarithm of the frequency.

#### 4.1.2 Test Procedure

Test method Refer as ANSI C63.10: 2013 clause 6.2,

1. The EUT was placed on a non-conducted table, which is 0.8m above horizontal ground plane and 0.4m above vertical ground plane.
2. EUT connected to the line impedance stabilization network (LISN)
3. Receiver set RBW of 9kHz and Detector Peak, and note as quasi-peak and average.
4. Maximum procedure was performed on the six highest emissions to ensure EUT compliance.
5. Recorded Line for Neutral and Line.

#### 4.1.3 Test Setup

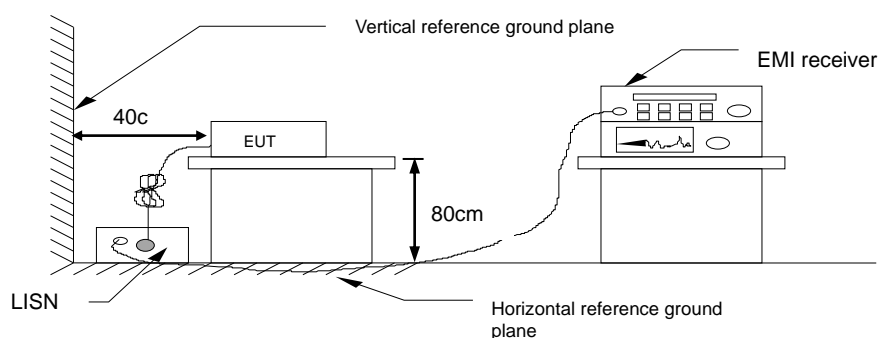

#### 4.1.4 Test Result

**Not applicable, because EUT doesn't connect to AC Main Source direct.**

Report No.: T200909W02-RP2

## 4.2 6dB BANDWIDTH AND OCCUPIED BANDWIDTH (99%)

### 4.2.1 Test Limit

According to §15.247(a)(2)

**6 dB Bandwidth** :

Limit	Shall be at least 500kHz
-------	--------------------------

**Occupied Bandwidth(99%)** : For reporting purposes only.

### 4.2.2 Test Procedure

Test method Refer as KDB 558074 D01 and ANSI C63.10: 2013 clause 6.9.2

1. The EUT RF output connected to the spectrum analyzer by RF cable.
2. Setting maximum power transmit of EUT
3. SA set RBW = 100kHz, VBW = 300kHz and Detector = Peak, to measurement 6 dB Bandwidth.
4. SA set RBW = 1% ~ 5% OBW, VBW = three times the RBW and Detector = Peak, to measurement 99% Bandwidth
5. Measure and record the result of 6 dB Bandwidth and 99% Bandwidth in the test report.

### 4.2.3 Test Setup

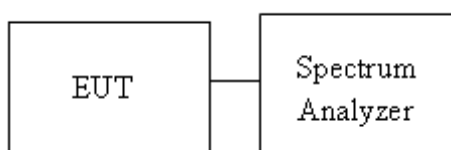

#### 4.2.4 Test Result

Temperature: 25°C                      Humidity: 50% RH  
Tested by: Jane Wang

Test mode: Zigbee / 2425-2475 MHz				
Channel	Frequency (MHz)	OBW (99%) (MHz)	6dB BW (MHz)	6dB limit (kHz)
Low	2405	2.3878	1.5507	≥500
Mid	2440	2.3878	1.5797	
High	2480	2.4023	1.5362	

Report No.: T200909W02-RP2

## Test Data 6dB BANDWIDTH

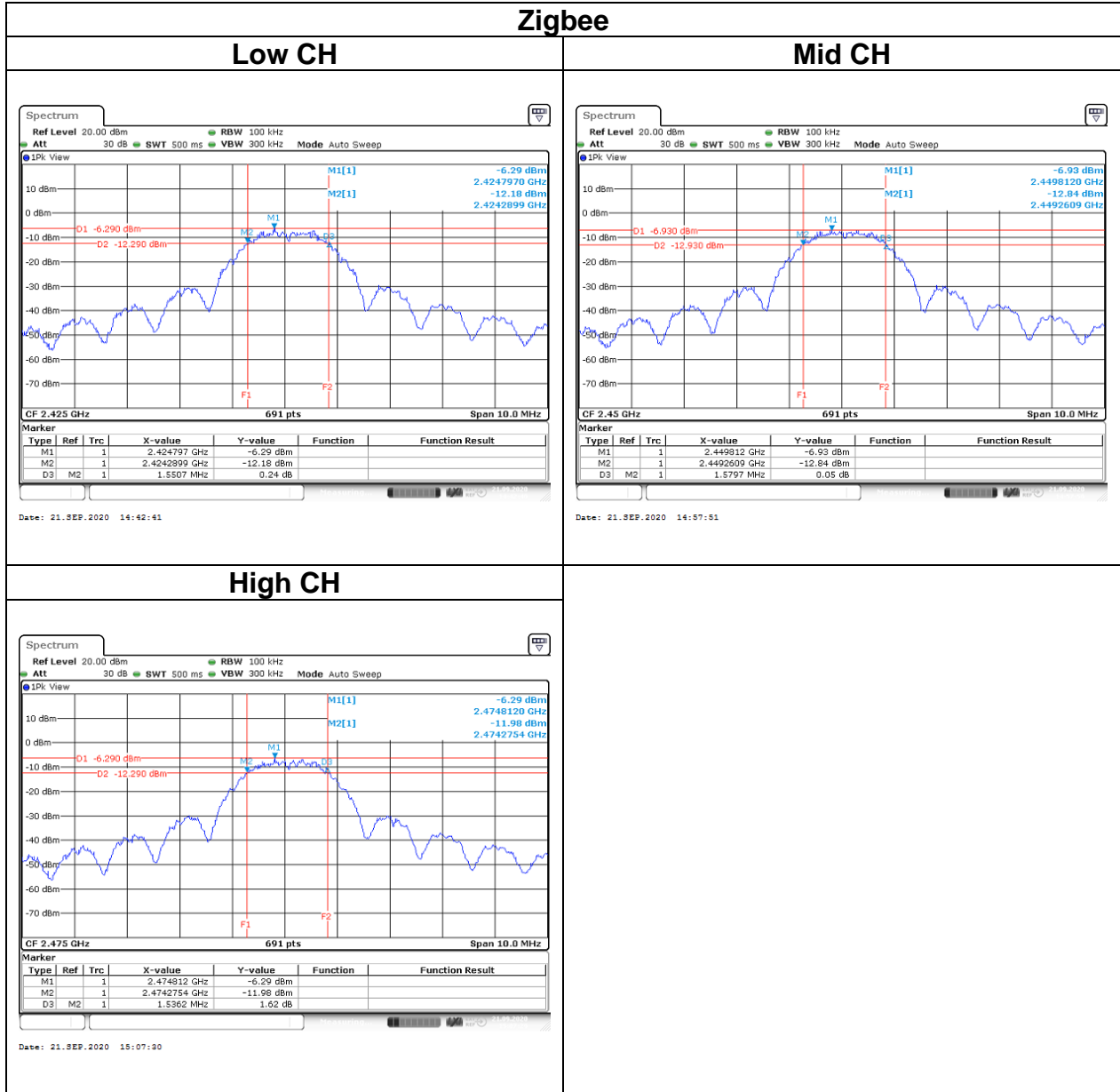



Report No.: T200909W02-RP2

## Test Data BANDWIDTH (99%)

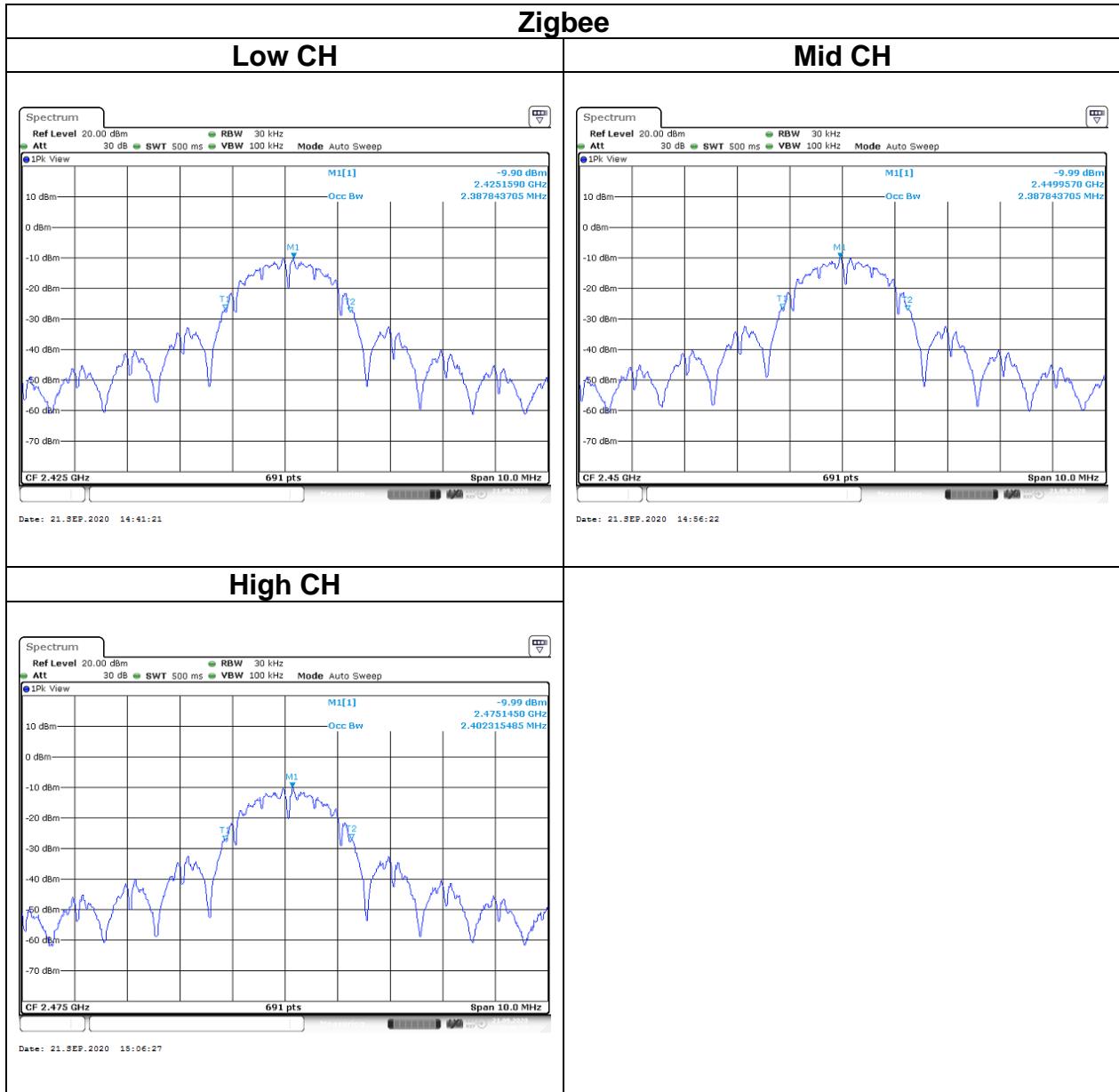

Report No.: T200909W02-RP2

## 4.3 OUTPUT POWER MEASUREMENT

### 4.3.1 Test Limit

According to §15.247(b),

#### Peak output power :

For systems using digital modulation in the 2400-2483.5 MHz, and 5725-5850 MHz bands: 1 Watt(30 dBm), base on the use of antennas with directional gain not exceed 6 dBi If transmitting antennas of directional gain greater than 6dBi are used the peak output power the conducted output power from the intentional radiator shall be reduced by the amount in dB that the directional gain of the antenna exceeds 6 dBi. In case of point-to-point operation, the limit has to be reduced by 1dB for every 3 dB that the directional gain of the antenna exceeds 6 dBi.

Limit	<input checked="" type="checkbox"/> Antenna not exceed 6 dBi : 30dBm <input type="checkbox"/> Antenna with DG greater than 6 dBi : [Limit = 30 – (DG – 6)] <input type="checkbox"/> Point-to-point operation :
-------	---

Average output power : For reporting purposes only.

### 4.3.2 Test Procedure

Test method Refer as KDB 558074 D01.

1. The EUT RF output connected to the power meter by RF cable.
2. Setting maximum power transmit of EUT.
3. The path loss was compensated to the results for each measurement.
4. Measure and record the result of Peak output power and Average output power in the test report.

### 4.3.3 Test Setup

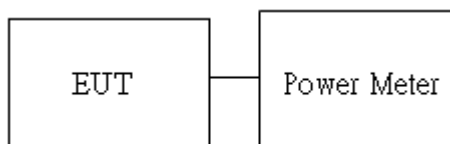

Report No.: T200909W02-RP2

### 4.3.4 Test Result

Temperature: 25°C

Humidity: 50% RH

Tested by: Jane Wang

Test date: September 21, 2020

#### Peak output power :

Zigbee						
Config.	Freq. (MHz)	Power Setting	PK Power (dBm)	PK Power (W)	Ant. Gain (dBi)	Limit (dBm)
Zigbee	2425	7	7.83	0.0061	-0.61	30
	2450	7	<b>7.87</b>	0.0061		
	2475	7	7.82	0.0061		

#### Average output power :

Zigbee		
Config.	Freq. (MHz)	AV Power (dBm)
Zigbee	2425	7.48
	2450	7.50
	2475	7.49

Report No.: T200909W02-RP2

## 4.4 POWER SPECTRAL DENSITY

### 4.4.1 Test Limit

According to RSS-247 section 5.2(b),

For digitally modulated systems, the power spectral density conducted from the intentional radiator to the antenna shall not be greater than 8 dBm in any 3 kHz band during any time interval of continuous transmission.

Limit	<input checked="" type="checkbox"/> Antenna not exceed 6 dBi : 8dBm <input type="checkbox"/> Antenna with DG greater than 6 dBi [ Limit = 8 – (DG – 6)] <input type="checkbox"/> Point-to-point operation :
-------	--

### 4.4.2 Test Procedure

Test method Refer as KDB 558074 D01.

1. The EUT RF output connected to the spectrum analyzer by RF cable.
2. Setting maximum power transmit of EUT
3. SA set RBW = 3kHz, VBW = 30kHz, Span = 1.5 times DTS Bandwidth (6 dB BW), Detector = Peak, Sweep Time = Auto and Trace = Max hold.
4. The path loss and Duty Factor were compensated to the results for each measurement by SA.
5. Mark the maximum level.
6. Measure and record the result of power spectral density. in the test report.

### 4.4.3 Test Setup

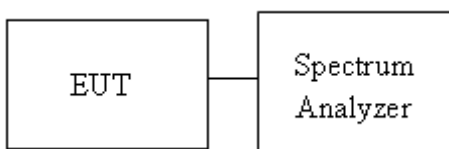

Report No.: T200909W02-RP2

**4.4.4 Test Result**

Temperature: 25°C                      Humidity: 50% RH  
Tested by: Jane Wang

Test mode: Zigbee / 2425 - 2475 MHz			
Channel	Frequency (MHz)	PPSD (dBm)	Limit (dBm)
Low	2425	-5.99	8
Mid	2450	-5.84	
High	2475	-5.49	

Report No.: T200909W02-RP2

## Test Data

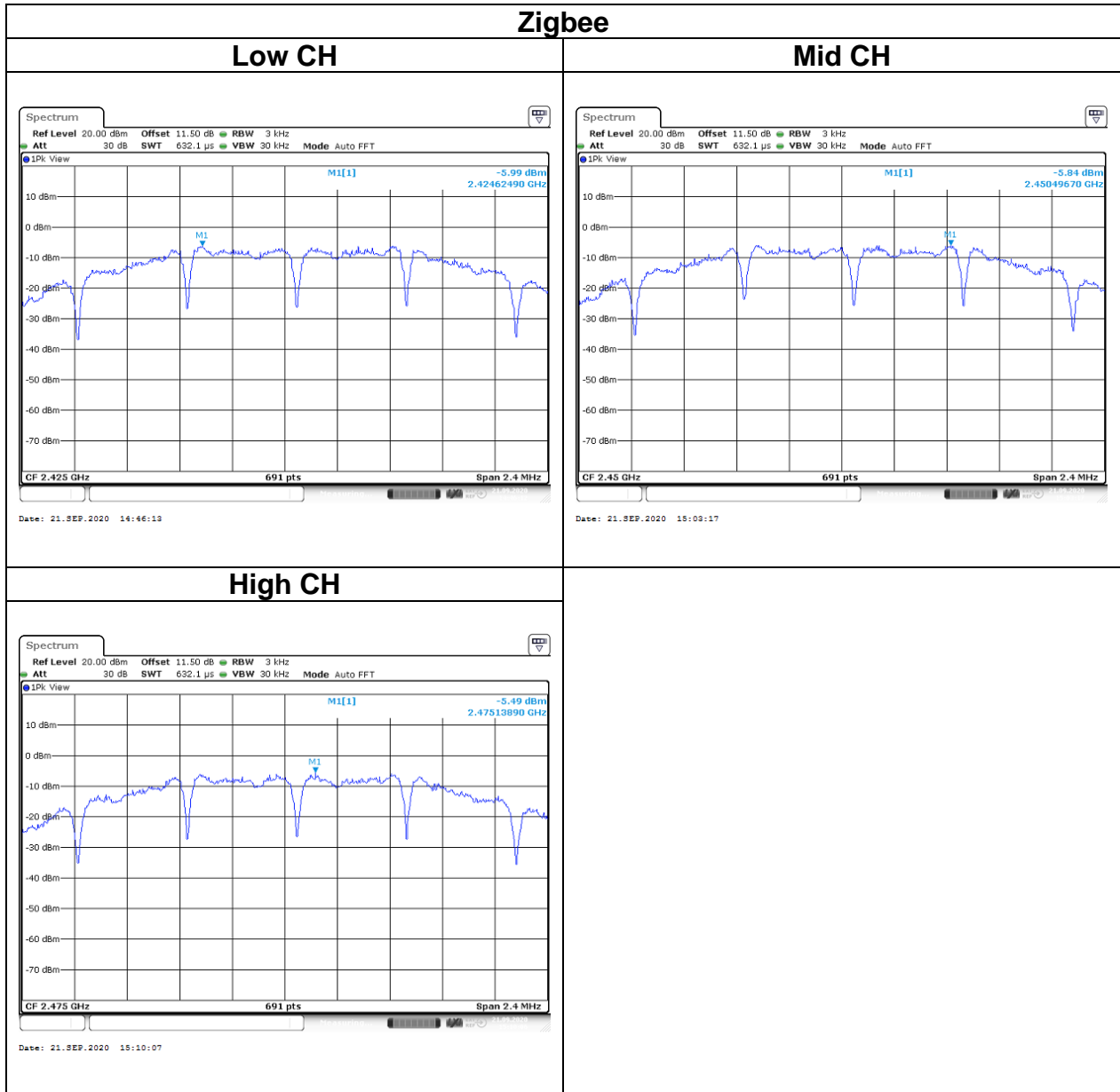

Report No.: T200909W02-RP2

## 4.5 CONDUCTED BANDEDGE AND SPURIOUS EMISSION

### 4.5.1 Test Limit

According to §15.247(d),

In any 100 kHz bandwidth outside the authorized frequency band,

Non-restricted bands shall be attenuated at least 20 dB/30 dB relative to the maximum PSD level in 100 kHz by RF conducted or a radiated measurement which fall in the restricted bands, as defined in §15.205(a), must also comply with the radiated emission limits specified in §15.209(a).

### 4.5.2 Test Procedure

Test method Refer as KDB 558074 D01,

1. EUT RF output port connected to the SA by RF cable, and the path loss was compensated to result.
2. SA setting, RBW=100kHz, VBW=300kHz, Detector=Peak, Trace mode = max hold, SWT = Auto.
3. In any 100 kHz bandwidth outside the authorized frequency band, shall be attenuated at least 20 dB relative to the maximum in-band peak PSD level in 100 kHz when conducted power procedure is used. If the transmitter complies with the conducted power limits based on the use of RMS averaging over a time interval, the attenuation required under this paragraph shall be 30 dB instead of 20 dB.

### 4.5.3 Test Setup



Report No.: T200909W02-RP2

## 4.5.4 Test Result

Temperature: 25°C

Humidity: 50% RH

Tested by: Jane Wang

### Test Data

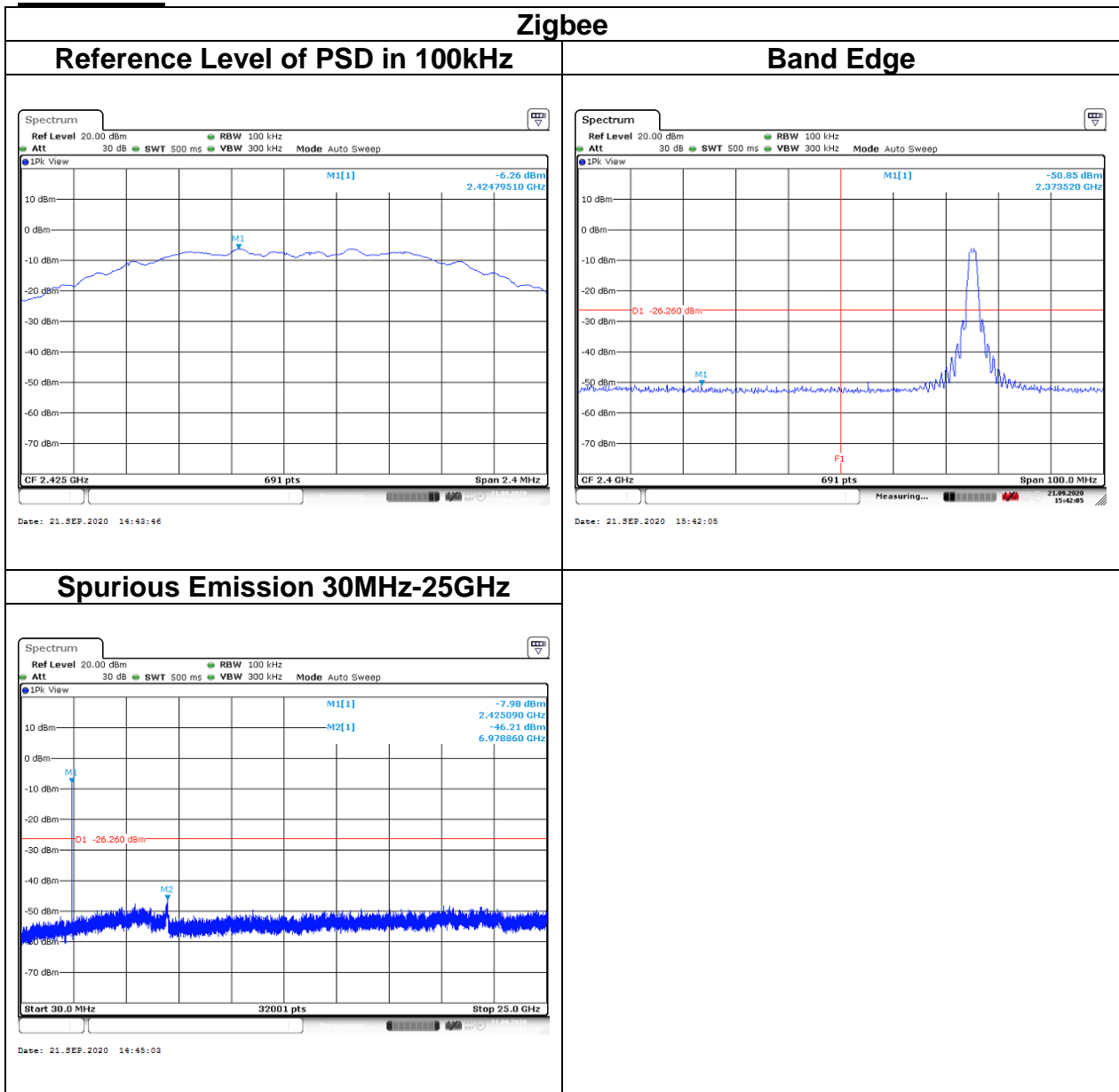



Report No.: T200909W02-RP2

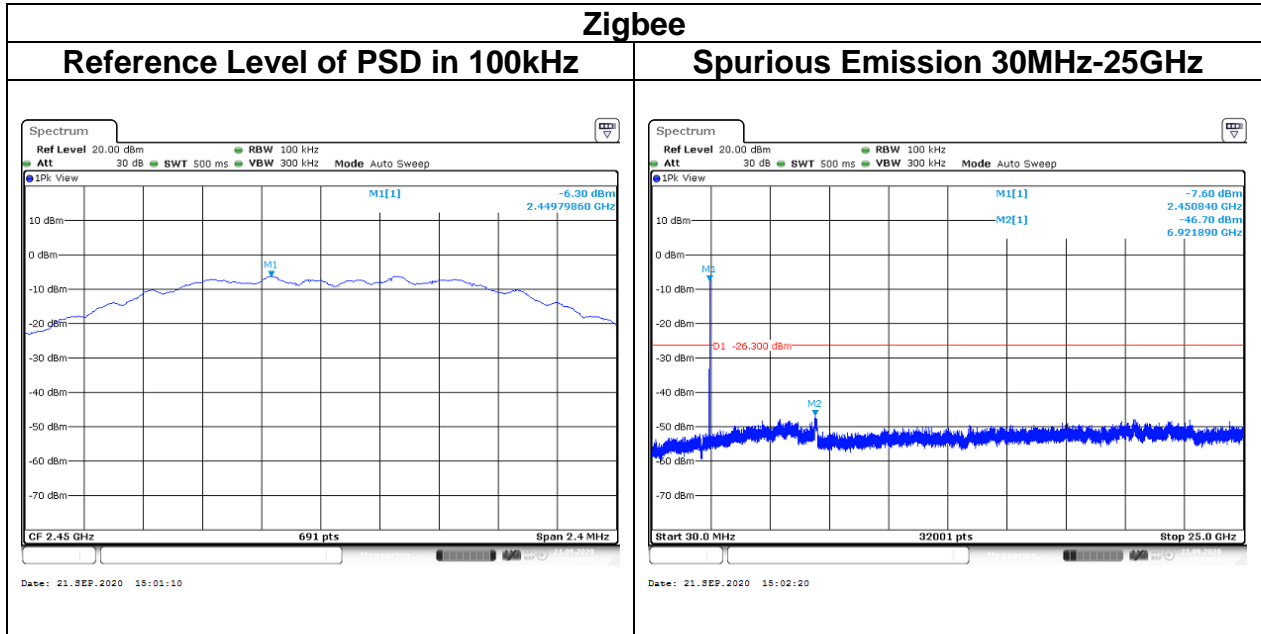

Report No.: T200909W02-RP2

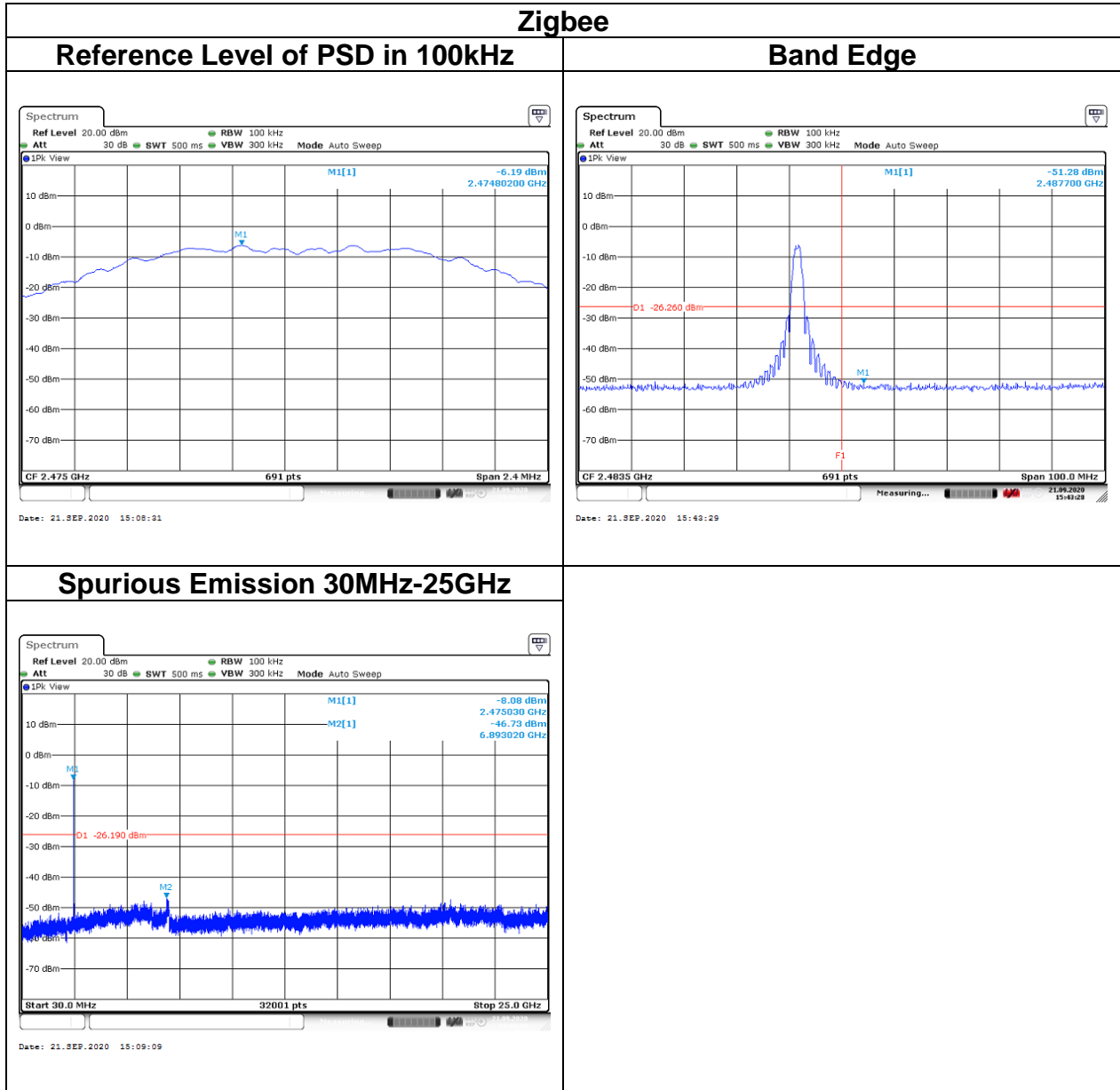

Report No.: T200909W02-RP2

## 4.6 RADIATION BANDEGE AND SPURIOUS EMISSION

### 4.6.1 Test Limit

FCC according to §15.247(d), §15.209 and §15.205,

In any 100 kHz bandwidth outside the authorized frequency band, all harmonic and spurious must be least 20 dB below the highest emission level with the authorized frequency band. Radiation emission which fall in the restricted bands must also follow the FCC section 15.209 as below limit in table.

#### Below 30 MHz

Frequency	Field Strength (microvolts/m)	Magnetic H-Field (microamperes/m)	Measurement Distance (metres)
9-490 kHz	2,400/F (F in kHz)	2,400/F (F in kHz)	300
490-1,705 kHz	24,000/F (F in kHz)	24,000/F (F in kHz)	30
1.705-30 MHz	30	N/A	30

#### Above 30 MHz

Frequency (MHz)	Field Strength microvolts/m at 3 metres (watts, e.i.r.p.)	
	Transmitters	Receivers
30-88	100 (3 nW)	100 (3 nW)
88-216	150 (6.8 nW)	150 (6.8 nW)
216-960	200 (12 nW)	200 (12 nW)
Above 960	500 (75 nW)	500 (75 nW)

Remark:

Although these tests were performed other than open area test site, adequate comparison measurements were confirmed against 30 m open are test site. Therefore sufficient tests were made to demonstrate that the alternative site produces results that correlate with the ones of tests made in an open field based on KDB 414788.

Report No.: T200909W02-RP2

#### 4.6.2 Test Procedure

1. The EUT is placed on a turntable, Above 1 GHz is 1.5m and below 1 GHz is 0.8m above ground plane. The EUT Configured un accordance with ANSI C63.10: 2013, and the EUT set in a continuous mode.

2. The turntable shall be rotated for 360 degrees to determine the position of maximum emission level. And EUT is set 3m away from the receiving antenna, which is scanned from 1m to 4m above the ground plane to find out the highest emissions. Measurement are made polarized in both the vertical and the horizontal positions with antenna.

3. Span shall wide enough to full capture the emission measured. The SA from 30MHz to 26.5GHz set to the low, Mid and High channels with the EUT transmit.

Remark:

1. Although these tests were performed other than open area test site, adequate comparison measurements were confirmed against 30 m open are test site. Therefore sufficient tests were made to demonstrate that the alternative site produces results that correlate with the ones of tests made in an open field based on KDB 414788.

2. No emission found between lowest internal used/generated frequency to 30MHz (9kHz~30MHz).

4. The SA setting following :

(1) Below 1G : RBW = 100kHz, VBW  $\geq$  3 RBW, Sweep = Auto, Detector = Peak, Trace = Max hold.

(2) Above 1G :

(2.1) For Peak measurement : RBW = 1MHz, VBW  $\geq$  3 RBW, Sweep = Auto, Detector = Peak, Trace = Max hold.

(2.2) For Average measurement : RBW = 1MHz, VBW

·If Duty Cycle  $\geq$  98%, VBW=10Hz.

·If Duty Cycle < 98%, VBW $\geq$ 1/T.

Report No.: T200909W02-RP2

## 4.6.3 Test Setup

### 9kHz ~ 30MHz

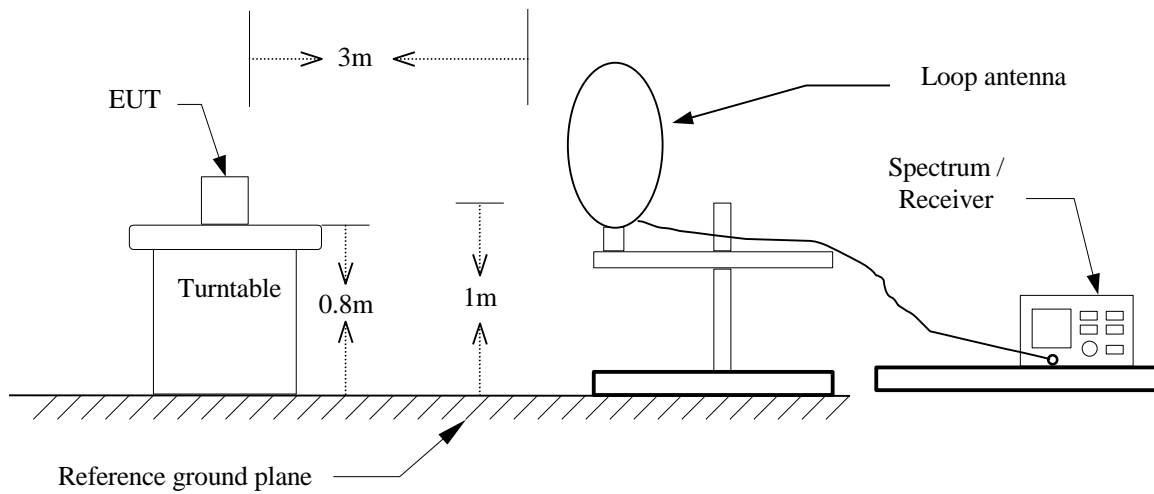

### 30MHz ~ 1GHz

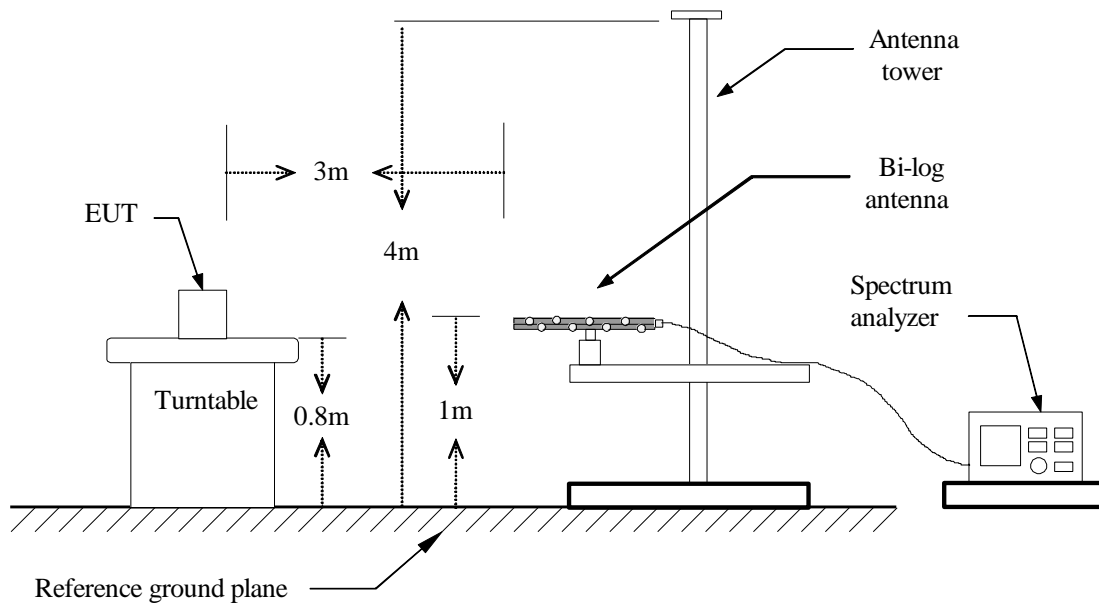

## Above 1 GHz

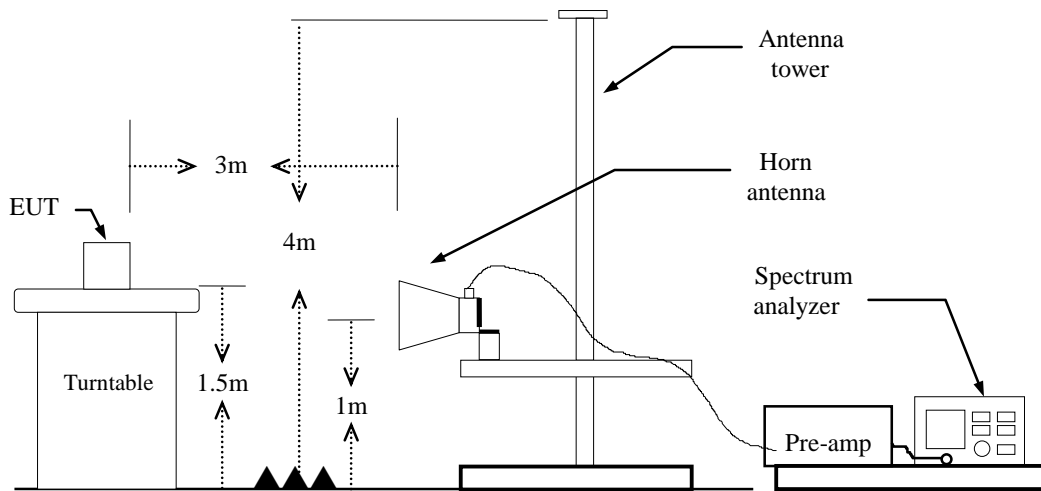

Report No.: T200909W02-RP2

### 4.6.4 Test Result

#### Band Edge Test Data

Test Mode	Zigbee Low CH	Temp/Hum	24.5(°C)/ 40%RH
Test Item	Band Edge	Test Date	September 25, 2020
Polarize	Horizontal	Test Engineer	Jerry Chang
Detector	Peak / Average		

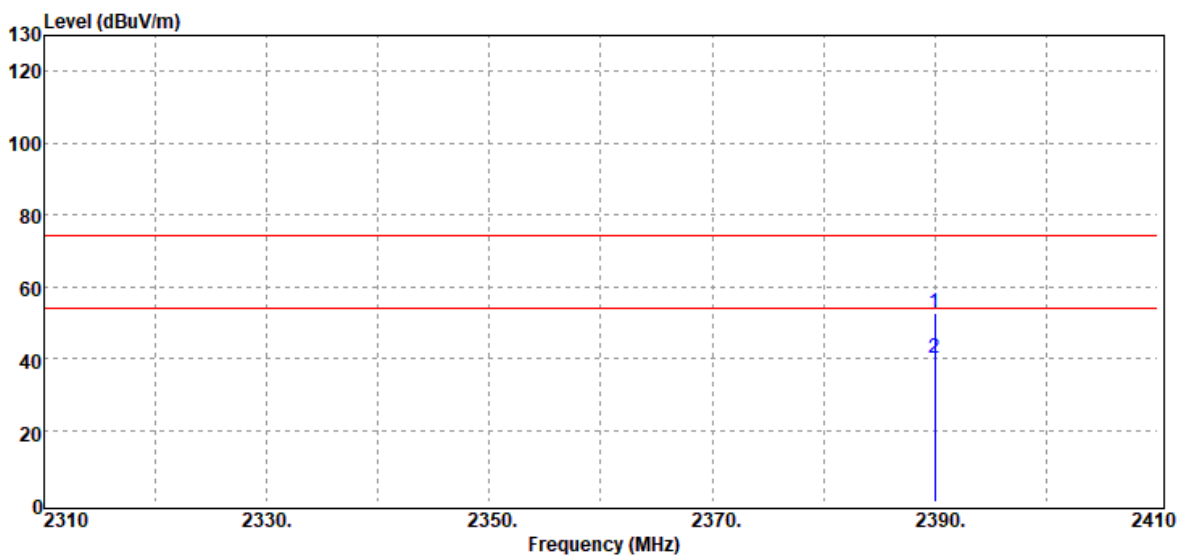

Frequency (MHz)	Detector Mode PK/QP/AV	Spectrum Reading Level dB $\mu$ V	Factor dB	Actual FS dB $\mu$ V/m	Limit @3m dB $\mu$ V/m	Margin dB
2390.00	Peak	51.37	1.25	52.62	74.00	-21.38
2390.00	Average	38.65	1.25	39.90	54.00	-14.10

Test Mode	Zigbee Low CH	Temperature:	24.5(°C)/ 40%RH
Test Item	Band Edge	Test Date	September 25, 2020
Polarize	Horizontal	Test Engineer	Jerry Chang
Detector	Peak / Average		

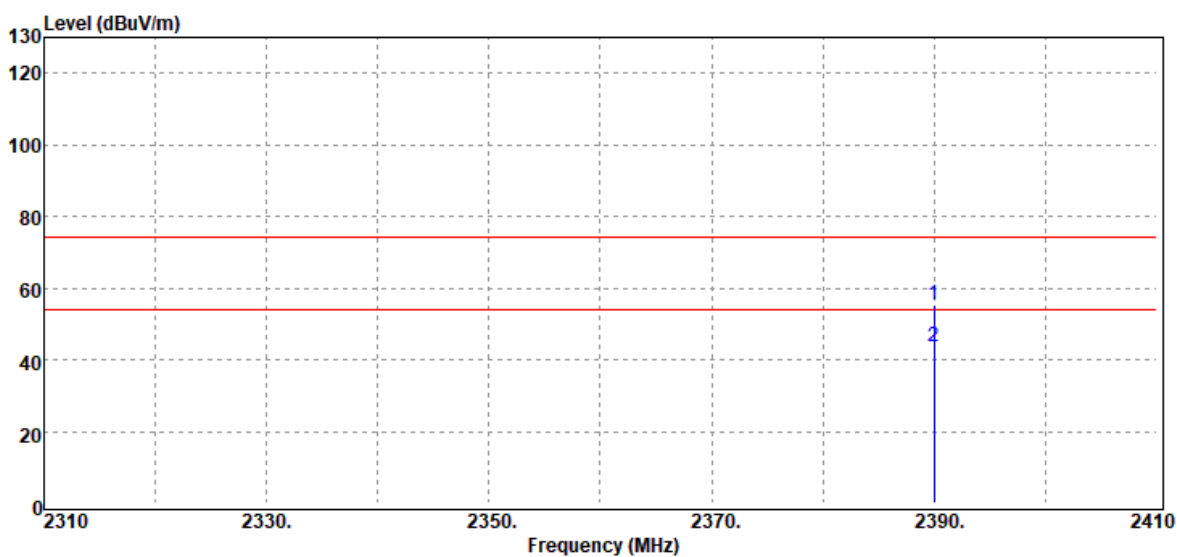

Frequency (MHz)	Detector Mode PK/QP/AV	Spectrum Reading Level dB $\mu$ V	Factor dB	Actual FS dB $\mu$ V/m	Limit @3m dB $\mu$ V/m	Margin dB
2390.00	Peak	54.20	1.25	55.45	74.00	-18.55
2390.00	Average	42.17	1.25	43.42	54.00	-10.58



Report No.: T200909W02-RP2

Test Mode	Zigbee High CH	Temp/Hum	24.5(°C)/ 40%RH
Test Item	Band Edge	Test Date	September 25, 2020
Polarize	Horizontal	Test Engineer	Jerry Chang
Detector	Peak / Average		

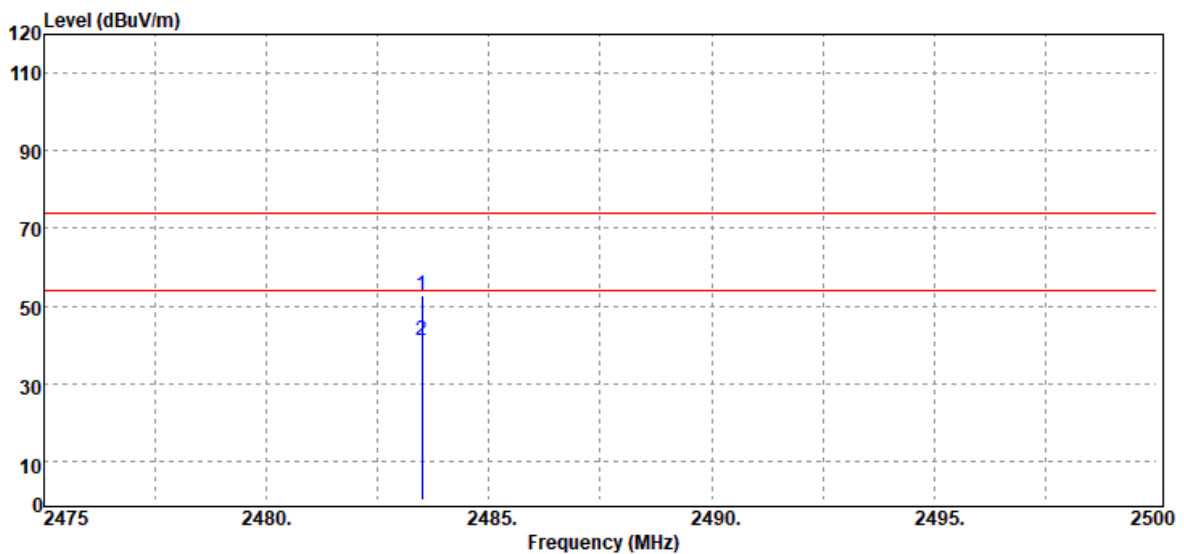

Frequency (MHz)	Detector Mode PK/QP/AV	Spectrum Reading Level dB $\mu$ V	Factor dB	Actual FS dB $\mu$ V/m	Limit @3m dB $\mu$ V/m	Margin dB
2483.50	Peak	51.31	1.62	52.93	74.00	-21.07
2483.50	Average	39.64	1.62	41.26	54.00	-12.74

Report No.: T200909W02-RP2

Test Mode	Zigbee High CH	Temperature:	24.5(°C)/ 40%RH
Test Item	Band Edge	Test Date	September 25, 2020
Polarize	Horizontal	Test Engineer	Jerry Chang
Detector	Peak / Average		

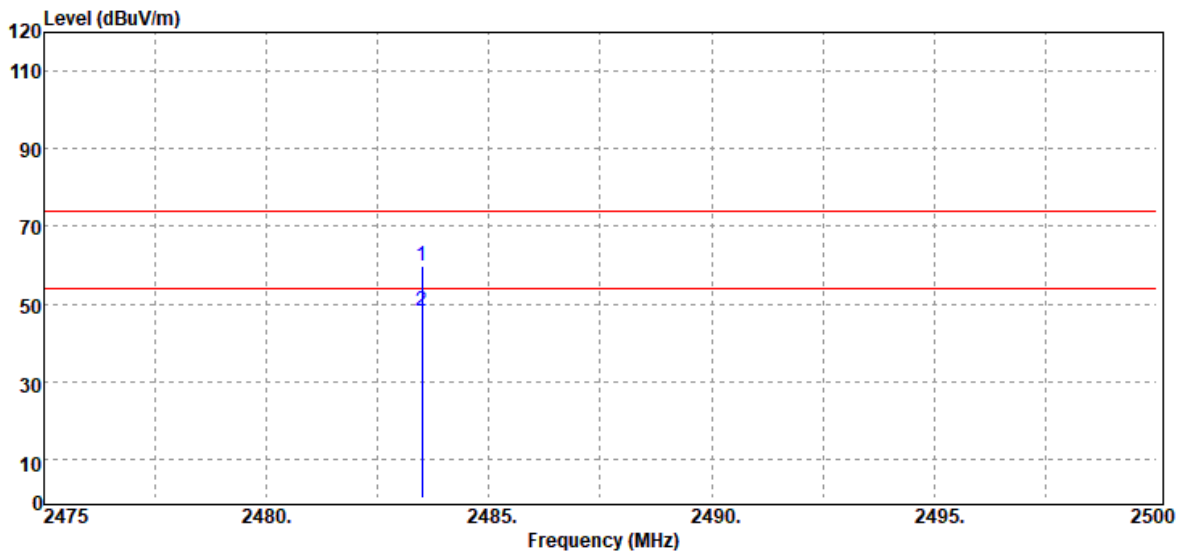

Frequency (MHz)	Detector Mode PK/QP/AV	Spectrum Reading Level dB $\mu$ V	Factor dB	Actual FS dB $\mu$ V/m	Limit @3m dB $\mu$ V/m	Margin dB
2483.50	Peak	58.19	1.62	59.81	74.00	-14.19
2483.50	Average	46.69	1.62	48.31	54.00	-5.69

Report No.: T200909W02-RP2

## Below 1GHz

Test Mode	Mode 1	Temp/Hum	24.5(°C)/ 40%RH
Test Item	30MHz-1GHz	Test Date	September 25, 2020
Polarize	Vertical	Test Engineer	Jerry Chang
Detector	Peak		

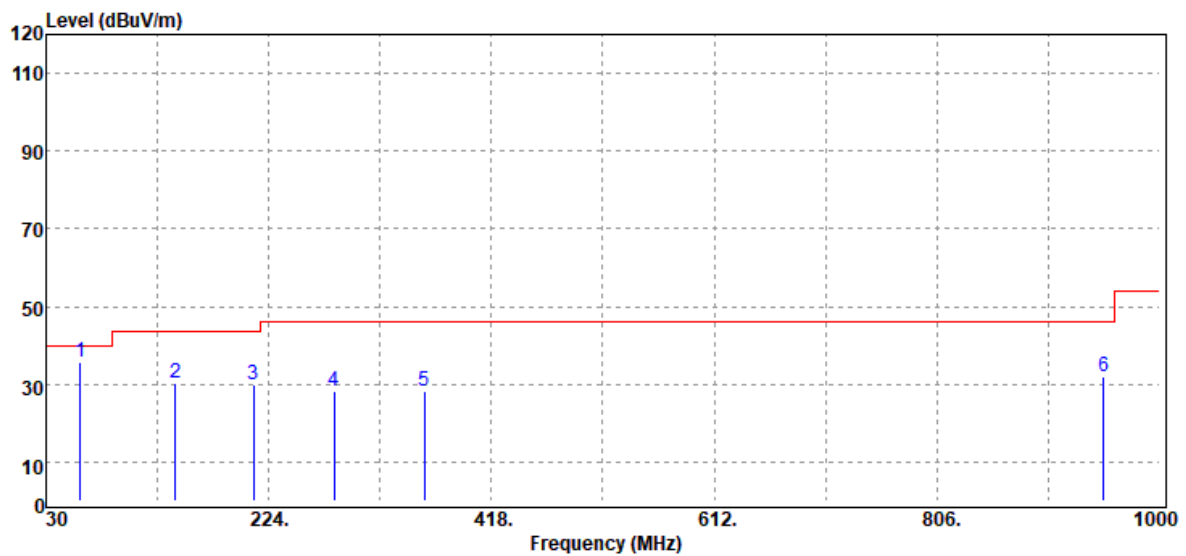

Freq. MHz	Detector Mode PK/QP/AV	Spectrum Reading Level dB $\mu$ V	Factor dB	Actual FS dB $\mu$ V/m	Limit @3m dB $\mu$ V/m	Margin dB
60.07	Peak	51.71	-15.96	35.75	40.00	-4.25
142.52	Peak	40.40	-10.01	30.39	43.50	-13.11
210.42	Peak	41.78	-11.92	29.86	43.50	-13.64
281.23	Peak	37.10	-8.68	28.42	46.00	-17.58
359.80	Peak	35.19	-6.78	28.41	46.00	-17.59
951.50	Peak	27.67	4.30	31.97	46.00	-14.03

Note: No emission found between lowest internal used/generated frequency to 30MHz(9KHz~30MHz)

Report No.: T200909W02-RP2

Test Mode	Mode 1	Temp/Hum	24.5(°C)/ 40%RH
Test Item	30MHz-1GHz	Test Date	September 25, 2020
Polarize	Horizontal	Test Engineer	Jerry Chang
Detector	Peak		

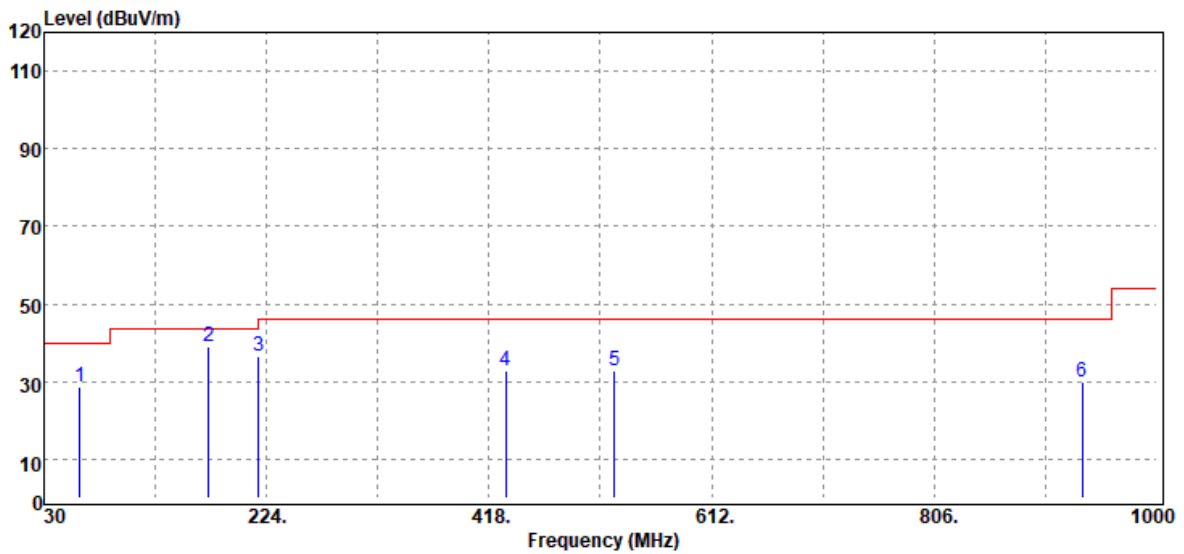

Freq. MHz	Detector Mode PK/QP/AV	Spectrum Reading Level dB $\mu$ V	Factor dB	Actual FS dB $\mu$ V/m	Limit @3m dB $\mu$ V/m	Margin dB
61.04	Peak	44.65	-15.87	28.78	40.00	-11.22
173.56	Peak	50.21	-11.10	39.11	43.50	-4.39
217.21	Peak	48.59	-11.84	36.75	46.00	-9.25
432.55	Peak	37.33	-4.70	32.63	46.00	-13.37
527.61	Peak	35.62	-2.90	32.72	46.00	-13.28
935.01	Peak	26.15	3.62	29.77	46.00	-16.23

Note: No emission found between lowest internal used/generated frequency to 30MHz(9KHz~30MHz)

Report No.: T200909W02-RP2

**Above 1 GHz**

Test Mode	Zigbee Low CH	Temp/Hum	24.5(°C)/ 40%RH
Test Item	Harmonic	Test Date	September 25, 2020
Polarize	Vertical	Test Engineer	Jerry Chang
Detector	Peak		

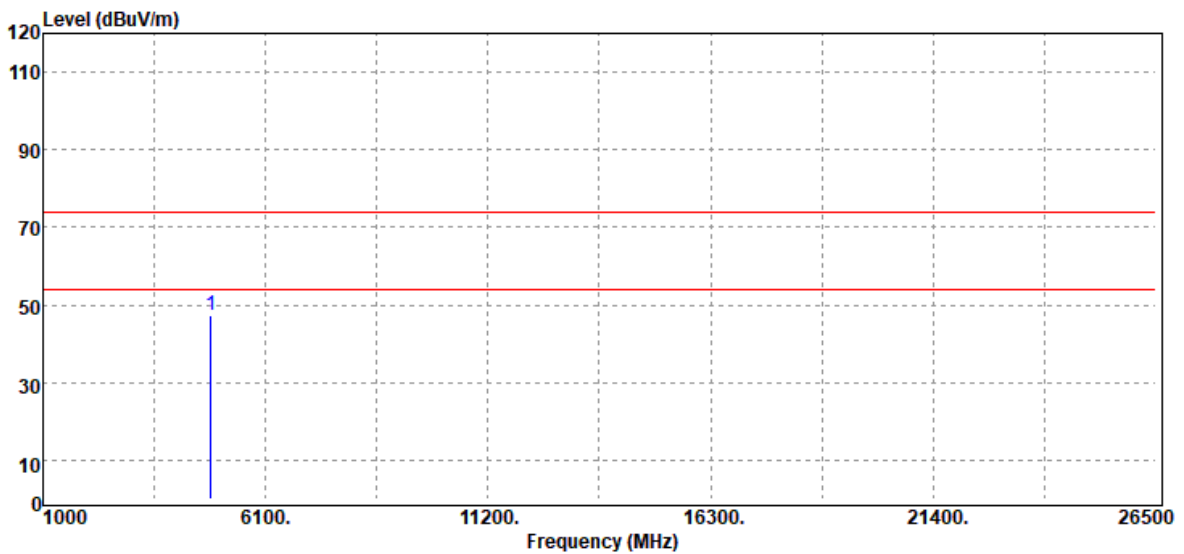

Freq. MHz	Detector Mode PK/QP/AV	Spectrum Reading Level dB $\mu$ V	Factor dB	Actual FS dB $\mu$ V/m	Limit @3m dB $\mu$ V/m	Margin dB
4850.00	Peak	40.92	6.43	47.35	74.00	-26.65
N/A						

**Remark:**

1. Measuring frequencies from 1 GHz to the 10th harmonic of highest fundamental frequency.
2. For above 1GHz, the EUT peak value was under average limit, therefore the Average value compliance with the average limit

Report No.: T200909W02-RP2

Test Mode	Zigbee Low CH	Temp/Hum	24.5(°C)/ 40%RH
Test Item	Harmonic	Test Date	September 25, 2020
Polarize	Horizontal	Test Engineer	Jerry Chang
Detector	Peak		

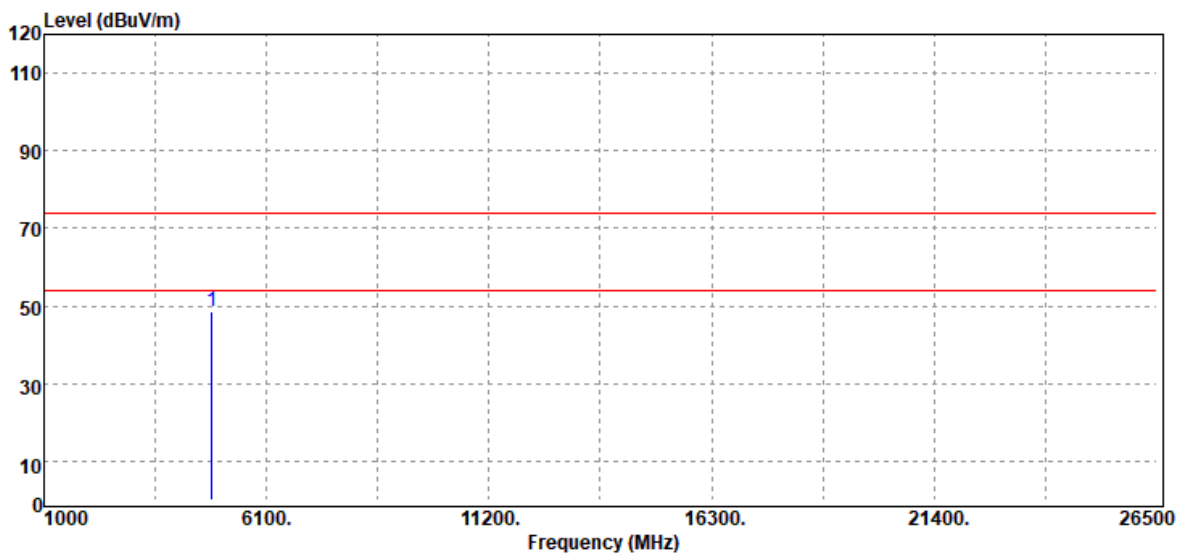

Freq. MHz	Detector Mode PK/QP/AV	Spectrum Reading Level dB $\mu$ V	Factor dB	Actual FS dB $\mu$ V/m	Limit @3m dB $\mu$ V/m	Margin dB
4850.00	Peak	42.21	6.43	48.64	74.00	-25.36
N/A						

**Remark:**

1. Measuring frequencies from 1 GHz to the 10th harmonic of highest fundamental frequency.
2. For above 1GHz, the EUT peak value was under average limit, therefore the Average value compliance with the average limit

Report No.: T200909W02-RP2

Test Mode	Zigbee Mid CH	Temp/Hum	24.5(°C)/ 40%RH
Test Item	Harmonic	Test Date	September 25, 2020
Polarize	Vertical	Test Engineer	Jerry Chang
Detector	Peak		

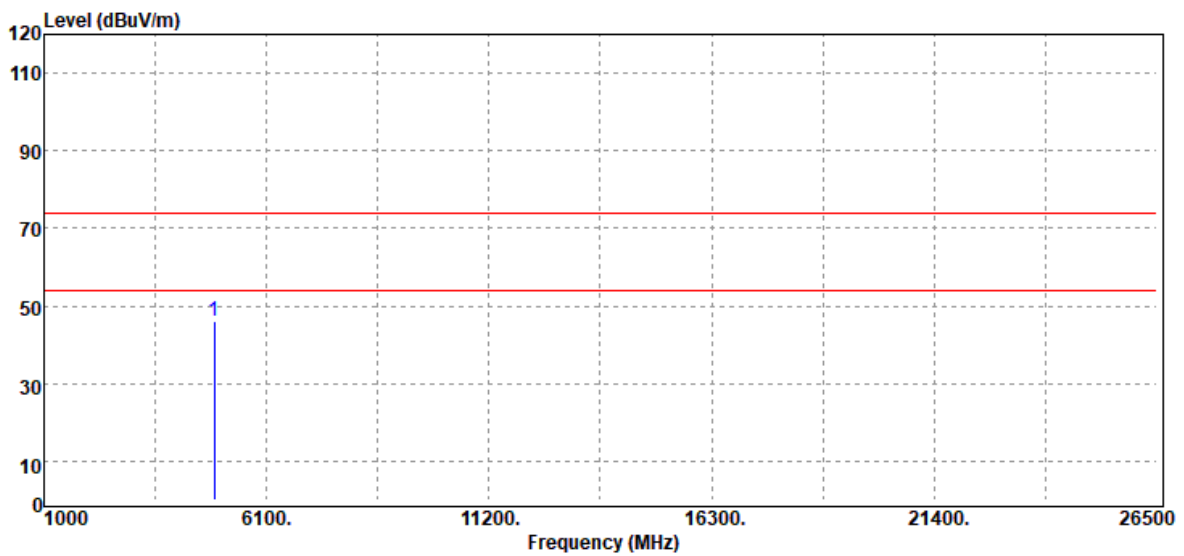

Freq. MHz	Detector Mode PK/QP/AV	Spectrum Reading Level dB $\mu$ V	Factor dB	Actual FS dB $\mu$ V/m	Limit @3m dB $\mu$ V/m	Margin dB
4900.00	Peak	39.71	6.39	46.10	74.00	-27.90
N/A						

**Remark:**

1. Measuring frequencies from 1 GHz to the 10th harmonic of highest fundamental frequency.
2. For above 1GHz, the EUT peak value was under average limit, therefore the Average value compliance with the average limit

Report No.: T200909W02-RP2

Test Mode	Zigbee Mid CH	Temp/Hum	24.5(°C)/ 40%RH
Test Item	Harmonic	Test Date	September 25, 2020
Polarize	Horizontal	Test Engineer	Jerry Chang
Detector	Peak		

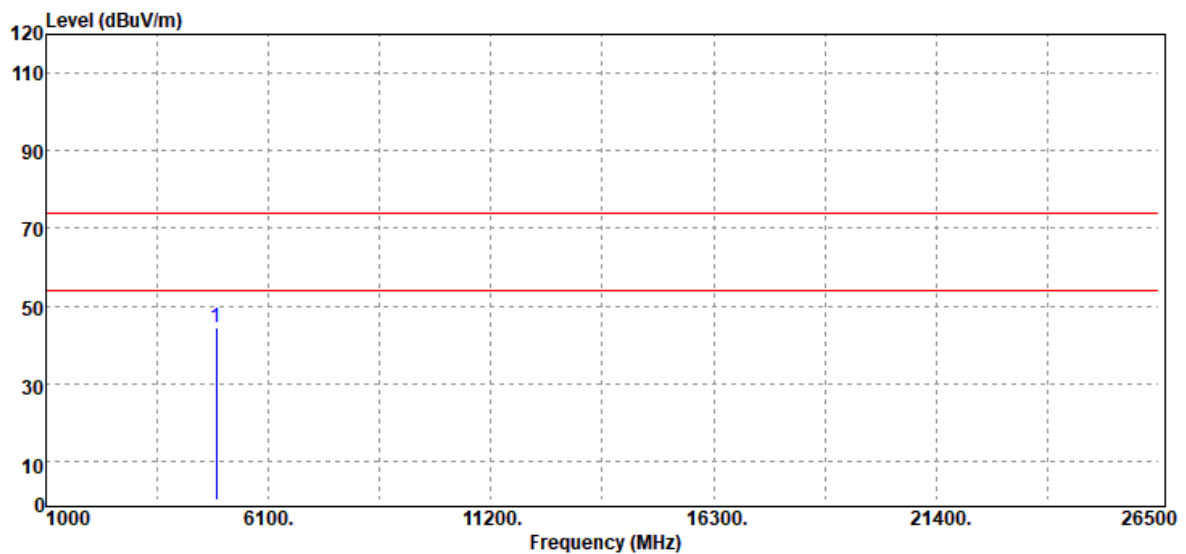

Freq. MHz	Detector Mode PK/QP/AV	Spectrum Reading Level dB $\mu$ V	Factor dB	Actual FS dB $\mu$ V/m	Limit @3m dB $\mu$ V/m	Margin dB
4900.00	Peak	37.97	6.39	44.36	74.00	-29.64
N/A						

**Remark:**

1. Measuring frequencies from 1 GHz to the 10th harmonic of highest fundamental frequency.
2. For above 1GHz, the EUT peak value was under average limit, therefore the Average value compliance with the average limit



Report No.: T200909W02-RP2

Test Mode	Zigbee High CH	Temp/Hum	24.5(°C)/ 40%RH
Test Item	Harmonic	Test Date	September 25, 2020
Polarize	Vertical	Test Engineer	Jerry Chang
Detector	Peak		

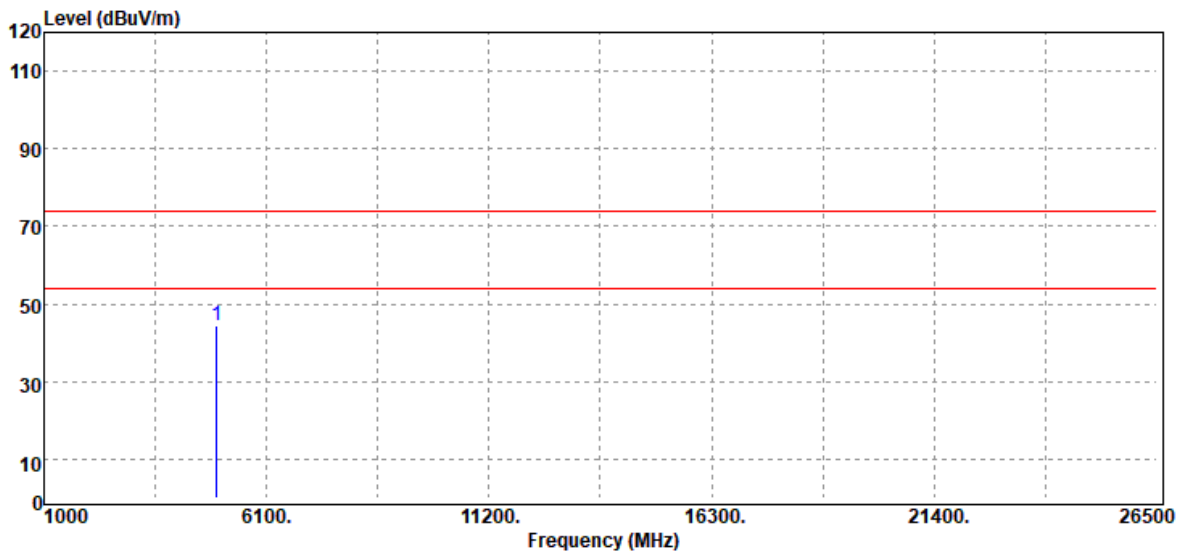

Freq. MHz	Detector Mode PK/QP/AV	Spectrum Reading Level dB $\mu$ V	Factor dB	Actual FS dB $\mu$ V/m	Limit @3m dB $\mu$ V/m	Margin dB
4950.00	Peak	37.48	6.80	44.28	74.00	-29.72
N/A						

**Remark:**

1. Measuring frequencies from 1 GHz to the 10th harmonic of highest fundamental frequency.
2. For above 1GHz, the EUT peak value was under average limit, therefore the Average value compliance with the average limit

Test Mode	Zigbee High CH	Temp/Hum	24.5(°C)/ 40%RH
Test Item	Harmonic	Test Date	September 25, 2020
Polarize	Horizontal	Test Engineer	Jerry Chang
Detector	Peak		

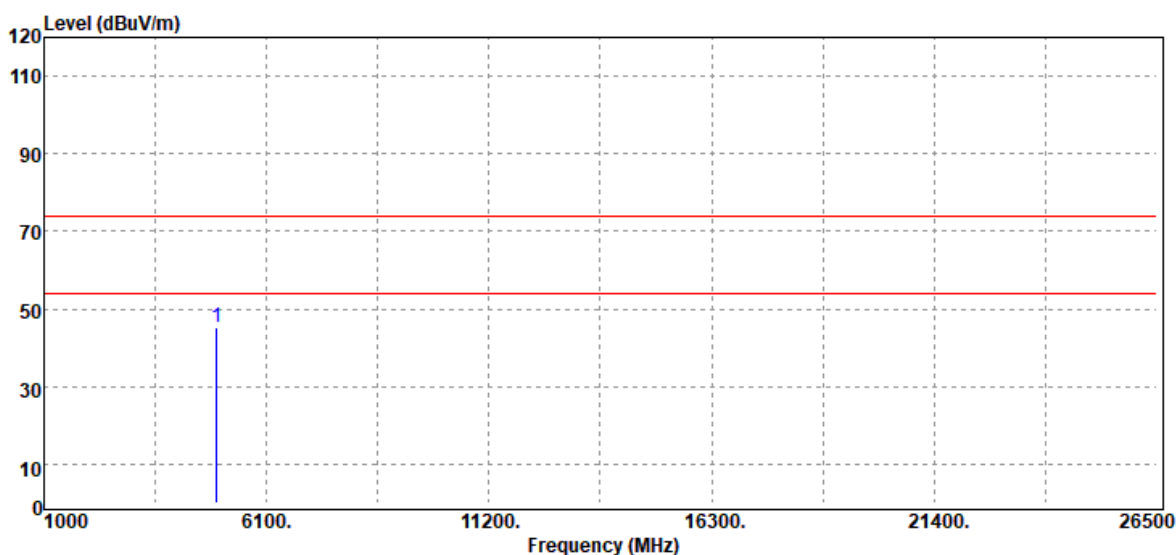

Freq. MHz	Detector Mode PK/QP/AV	Spectrum Reading Level dB $\mu$ V	Factor dB	Actual FS dB $\mu$ V/m	Limit @3m dB $\mu$ V/m	Margin dB
4950.00	Peak	38.51	6.80	45.31	74.00	-28.69
N/A						

**Remark:**

1. Measuring frequencies from 1 GHz to the 10th harmonic of highest fundamental frequency.
2. For above 1GHz, the EUT peak value was under average limit, therefore the Average value compliance with the average limit

--End of Report --