

RADIO TEST REPORT

FCC 47 CFR PART 15 SUBPART C

| | |
|---------------------------------|--|
| Test Standard | FCC Part 15.247 |
| Product name | Voice Remote Control |
| Brand Name | Sony |
| Model No. | RMF-TX621U, RMF-TX621B |
| Test Result | Pass |
| Statements of Conformity | Determination of compliance is based on the results of the compliance measurement, not taking into account measurement instrumentation uncertainty. |

The test Result was tested by Compliance Certification Services Inc. The test data, data evaluation, test procedures, and equipment configurations shown in this report were given in ANSI C63.10: 2013 and compliance standards.

The test results of this report relate only to the tested sample (EUT) identified in this report.

The test Report of full or partial shall not copy. Without written approval of Compliance Certification Services Inc. (Wugu Laboratory)

Approved by:



Kevin Tsai
Deputy Manager

Unless otherwise stated the results shown in this test report refer only to the sample(s) tested and such sample(s) are retained for 90 days only.
除非另有說明，此報告結果僅對測試之樣品負責，同時此樣品僅保留90天。本報告未經本公司書面許可，不可部份複製。

This document is issued by the Company subject to its General Conditions of Service printed overleaf, available on request or accessible at <http://www.sgs.com.tw/Terms-and-Conditions> and, for electronic format documents, subject to Terms and Conditions for Electronic Documents at <http://www.sgs.com.tw/Terms-and-Conditions>. Attention is drawn to the limitation of liability, indemnification and jurisdiction issues defined therein. Any holder of this document is advised that information contained hereon reflects the Company's findings at the time of its intervention only and within the limits of client's instruction, if any. The Company's sole responsibility is to its Client and this document does not exonerate parties to a transaction from exercising all their rights and obligations under the transaction documents. This document cannot be reproduced, except in full, without prior written approval of the Company. Any unauthorized alteration, forgery or falsification of the content or appearance of this document is unlawful and offenders may be prosecuted to the fullest extent of the law.

Revision History

| Rev. | Issue Date | Revisions | Effect Page | Revised By |
|------|------------------|---------------------------------|-------------|--------------|
| 00 | October 20, 2020 | Initial Issue | ALL | Allison Chen |
| 01 | October 27, 2020 | See the following note Rev.(01) | P.A-1 | Allison Chen |

Rev.(01)

1. Modify test setup photo above 1GHz.

Table of contents

| | | |
|---------------------------------|--|----|
| 1. | GENERAL INFORMATION | 4 |
| 1.1 | EUT INFORMATION | 4 |
| 1.2 | EUT CHANNEL INFORMATION | 5 |
| 1.3 | ANTENNA INFORMATION | 5 |
| 1.4 | MEASUREMENT UNCERTAINTY..... | 6 |
| 1.5 | FACILITIES AND TEST LOCATION | 7 |
| 1.6 | INSTRUMENT CALIBRATION | 7 |
| 1.7 | SUPPORT AND EUT ACCESSORIES EQUIPMENT | 8 |
| 1.8 | TEST METHODOLOGY AND APPLIED STANDARDS | 8 |
| 2. | TEST SUMMARY | 9 |
| 3. | DESCRIPTION OF TEST MODES..... | 10 |
| 3.1 | THE WORST MODE OF OPERATING CONDITION | 10 |
| 3.2 | THE WORST MODE OF MEASUREMENT | 11 |
| 3.3 | EUT DUTY CYCLE..... | 12 |
| 4. | TEST RESULT | 13 |
| 4.1 | AC POWER LINE CONDUCTED EMISSION | 13 |
| 4.2 | 6DB BANDWIDTH AND OCCUPIED BANDWIDTH (99%) | 14 |
| 4.3 | OUTPUT POWER MEASUREMENT | 18 |
| 4.4 | POWER SPECTRAL DENSITY..... | 20 |
| 4.5 | CONDUCTED BAND EDGE AND SPURIOUS EMISSION | 23 |
| 4.6 | RADIATION BANDEDGE AND SPURIOUS EMISSION | 27 |
| APPENDIX 1 - PHOTOGRAPHS OF EUT | | |

1. GENERAL INFORMATION

1.1 EUT INFORMATION

| Applicant | Universal Electronics Inc. 201 East Sandpointe Ave 7th Floor Santa Ana CA 92707 USA | | | | | | | | | | | | | | |
|--------------------------|---|-----|--------|-------|-------------|--|--|------------|--------|-----|------|------------|---|-----|--------|
| Manufacturer | Gemstar Technology (Qinzhou) Co., Ltd Hedong Industrial District, Qinzhou, Guangxi Zhuang Autonomous Region, P.R. China | | | | | | | | | | | | | | |
| Equipment | Voice Remote Control | | | | | | | | | | | | | | |
| Model No. | RMF-TX621U, RMF-TX621B | | | | | | | | | | | | | | |
| Model Discrepancy | <p>1. Client consigns only one sample to test (model RMF-TX621U). Therefore, the testing Lab. just guarantees the unit, which has been tested.</p> <p>2. Difference of the model numbers (list on this report) is just for marketing only, difference between BLE and zigbee function (one or two key label differences depending on country) as below:</p> <table border="1"> <thead> <tr> <th>Model</th> <th colspan="2">RF Function</th> <th></th> </tr> </thead> <tbody> <tr> <td>RMF-TX621U</td> <td>Zigbee</td> <td>BLE</td> <td>Main</td> </tr> <tr> <td>RMF-TX621B</td> <td>X</td> <td>BLE</td> <td>Serial</td> </tr> </tbody> </table> | | | Model | RF Function | | | RMF-TX621U | Zigbee | BLE | Main | RMF-TX621B | X | BLE | Serial |
| Model | RF Function | | | | | | | | | | | | | | |
| RMF-TX621U | Zigbee | BLE | Main | | | | | | | | | | | | |
| RMF-TX621B | X | BLE | Serial | | | | | | | | | | | | |
| Trade Name | Sony | | | | | | | | | | | | | | |
| Received Date | September 9, 2020 | | | | | | | | | | | | | | |
| Date of Test | September 21 ~ 25, 2020 | | | | | | | | | | | | | | |
| Power Supply | Power from Battery. | | | | | | | | | | | | | | |
| S.W Version | V21.01.01.005 | | | | | | | | | | | | | | |
| H.W: Version | A01 | | | | | | | | | | | | | | |
| EUT Serial # | 50:61:F6:BC:3C:E7 | | | | | | | | | | | | | | |

Report No.: T200909W02-RP1

1.2 EUT CHANNEL INFORMATION

| | |
|--------------------|---------------------|
| Frequency Range | 2402MHz-2480MHz |
| Modulation Type | GFSK for BLE 1 Mbps |
| Number of channels | 40 Channels |

Remark:

Refer as ANSI C63.10: 2013 clause 5.6.1 Table 4 for test channels

| Number of frequencies to be tested | | |
|--|-----------------------|--|
| Frequency range in which device operates | Number of frequencies | Location in frequency range of operation |
| <input type="checkbox"/> 1 MHz or less | 1 | Middle |
| <input type="checkbox"/> 1 MHz to 10 MHz | 2 | 1 near top and 1 near bottom |
| <input checked="" type="checkbox"/> More than 10 MHz | 3 | 1 near top, 1 near middle, and 1 near bottom |

1.3 ANTENNA INFORMATION

| | |
|-------------------|---|
| Antenna Type | <input type="checkbox"/> PIFA <input type="checkbox"/> PCB <input type="checkbox"/> Dipole <input checked="" type="checkbox"/> Chip |
| Antenna Gain | -0.55 dBi |
| Antenna Connector | N/A |

1.4 MEASUREMENT UNCERTAINTY

| PARAMETER | UNCERTAINTY |
|---------------------------------------|-------------|
| AC Powerline Conducted Emission | +/- 1.2575 |
| Emission bandwidth, 20dB bandwidth | +/- 0.0014 |
| RF output power, conducted | +/- 1.14 |
| Power density, conducted | +/- 1.40 |
| 3M Semi Anechoic Chamber / 30M~200M | +/- 4.12 |
| 3M Semi Anechoic Chamber / 200M~1000M | +/- 4.68 |
| 3M Semi Anechoic Chamber / 1G~8G | +/- 5.18 |
| 3M Semi Anechoic Chamber / 8G~18G | +/- 5.47 |
| 3M Semi Anechoic Chamber / 18G~26G | +/- 3.81 |
| 3M Semi Anechoic Chamber / 26G~40G | +/- 3.87 |

Remark:

1. This uncertainty represents an expanded uncertainty expressed at approximately the 95% confidence level using a coverage factor of k=2
2. ISO/IEC 17025 requires that an estimate of the measurement uncertainties associated with the emissions test results be included in the report.

1.5 FACILITIES AND TEST LOCATION

All measurement facilities used to collect the measurement data are located at No.11, Wugong 6th Rd., Wugu Dist., New Taipei City, Taiwan. (R.O.C.)

| Test site | Test Engineer | Remark |
|--------------------|---------------|---|
| AC Conduction Room | - | Not applicable, because EUT doesn't connect to AC Main Source direct. |
| Radiation | Jerry Chang | - |
| RF Conducted | Jane Wang | - |

Remark: The sites are constructed in conformance with the requirements of ANSI C63.7, ANSI C63.4 and CISPR Publication 22.

1.6 INSTRUMENT CALIBRATION

| RF Conducted Test Site | | | | | |
|------------------------|--------------|---------|---------------|------------|------------|
| Equipment | Manufacturer | Model | Serial Number | Cal Date | Cal Due |
| Coaxial Cable | Woken | WC12 | CC003 | 06/29/2020 | 06/28/2021 |
| EXA Signal Analyzer | KEYSIGHT | N9010B | MY55460167 | 09/07/2020 | 09/06/2021 |
| Power Meter | Anritsu | ML2487A | 6K00003260 | 05/21/2020 | 05/20/2021 |
| Power Seneor | Anritsu | MA2490A | 032910 | 05/21/2020 | 05/20/2021 |
| Software | N/A | | | | |

| 3M 966 Chamber Test Site | | | | | |
|----------------------------------|------------------|-----------------|---------------|------------|------------|
| Equipment | Manufacturer | Model | Serial Number | Cal Date | Cal Due |
| Band Reject Filters | MICRO TRONICS | BRM 50702 | 120 | 02/25/2020 | 02/24/2021 |
| Bilog Antenna | Sunol Sciences | JB3 | A030105 | 07/24/2020 | 07/23/2021 |
| Coaxial Cable | HUBER SUHNER | SUCOFLEX 104PEA | 20995 | 02/25/2020 | 02/24/2021 |
| Coaxial Cable | EMCI | EMC105 | 190914+25111 | 09/19/2020 | 09/19/2021 |
| Digital Thermo-Hygro Meter | WISEWIND | 1206 | D07 | 01/15/2020 | 01/14/2021 |
| double Ridged Guide Horn Antenna | ETC | MCTD 1209 | DRH13M02003 | 10/04/2019 | 10/03/2020 |
| Loop Ant | COM-POWER | AL-130 | 121051 | 03/27/2020 | 03/26/2021 |
| Pre-Amplifier | EMEC | EM330 | 060609 | 02/25/2020 | 02/24/2021 |
| Pre-Amplifier | HP | 8449B | 3008A00965 | 02/25/2020 | 02/24/2021 |
| PSA Series Spectrum Analyzer | Agilent | E4446A | MY46180323 | 07/24/2020 | 07/23/2021 |
| Antenna Tower | CCS | CC-A-1F | N/A | N.C.R | N.C.R |
| Controller | CCS | CC-C-1F | N/A | N.C.R | N.C.R |
| Turn Table | CCS | CC-T-1F | N/A | N.C.R | N.C.R |
| Software | e3 6.11-20180413 | | | | |

Note: 1. The calibration interval of the above test instruments is 12 months and the calibrations are traceable to NML/ROC and NIST/USA.

2. N.C.R. = No Calibration Required.

1.7 SUPPORT AND EUT ACCESSORIES EQUIPMENT

| EUT Accessories Equipment | | | | | |
|---------------------------|-----------|-------|-------|------------|--------|
| No. | Equipment | Brand | Model | Series No. | FCC ID |
| | N/A | | | | |

| Support Equipment | | | | | |
|-------------------|-----------|---------|---------------|------------|----------|
| No. | Equipment | Brand | Model | Series No. | FCC ID |
| 1 | NB(J) | TOSHIBA | PT345T-00L002 | N/A | PD97260H |

1.8 TEST METHODOLOGY AND APPLIED STANDARDS

The test methodology, setups and results comply with all requirements in accordance with ANSI C63.10:2013, FCC Part 2, FCC Part 15.247, KDB 558074 D01.

2. TEST SUMMARY

| FCC Standard Section | Report Section | Test Item | Result |
|----------------------|----------------|-----------------------------|--------|
| 15.203 | 1.3 | Antenna Requirement | Pass |
| 15.207(a) | 4.1 | AC Conducted Emission | N/A |
| 15.247(a)(2) | 4.2 | 6 dB Bandwidth | Pass |
| - | 4.2 | Occupied Bandwidth (99%) | Pass |
| 15.247(b)(3) | 4.3 | Output Power Measurement | Pass |
| 15.247(e) | 4.4 | Power Spectral Density | Pass |
| 15.247(d) | 4.5 | Conducted Band Edge | Pass |
| 15.247(d) | 4.5 | Conducted Spurious Emission | Pass |
| 15.247(d) | 4.6 | Radiation Band Edge | Pass |
| 15.247(d) | 4.6 | Radiation Spurious Emission | Pass |

3. DESCRIPTION OF TEST MODES

3.1 THE WORST MODE OF OPERATING CONDITION

| | |
|--------------------------|---|
| Operation mode | BLE Mode (1Mbps) |
| Test Channel Frequencies | 1.Lowest Channel : 2402MHz 2.Middle Channel : 2442MHz 3.Highest Channel : 2480MHz |

Remark:

1. EUT pre-scanned data rate of output power for each mode, the worst data rate were recorded in this report.

Report No.: T200909W02-RP1

3.2 THE WORST MODE OF MEASUREMENT

| Radiated Emission Measurement Above 1G | |
|--|--|
| Test Condition | Radiated Emission Above 1G |
| Power supply Mode | Mode 1: EUT power by Battery |
| Worst Mode | <input checked="" type="checkbox"/> Mode 1 <input type="checkbox"/> Mode 2 <input type="checkbox"/> Mode 3 <input type="checkbox"/> Mode 4 |
| Worst Position | <input checked="" type="checkbox"/> Placed in fixed position at X-Plane (E2-Plane) |

| Radiated Emission Measurement Below 1G | |
|--|--|
| Test Condition | Radiated Emission Below 1G |
| Power supply Mode | Mode 1: EUT power by Battery |
| Worst Mode | <input checked="" type="checkbox"/> Mode 1 <input type="checkbox"/> Mode 2 <input type="checkbox"/> Mode 3 <input type="checkbox"/> Mode 4 |

Remark:

1. The worst mode was record in this test report.
2. EUT pre-scanned in axis ,X and two polarity, for radiated measurement. The worst case(X-Plane) were recorded in this report

Report No.: T200909W02-RP1

3.3 EUT DUTY CYCLE

Temperature: 25°C

Humidity: 50% RH

Tested by: Jane Wang

| Duty Cycle | | | | |
|---------------|----------------|------------------|-----------|-------------------|
| Configuration | Duty Cycle (%) | Duty Factor (dB) | 1/T (kHz) | VBW Setting (kHz) |
| BLE-1Mbps | 100.00% | 0.00 | 1.00 | N/A |

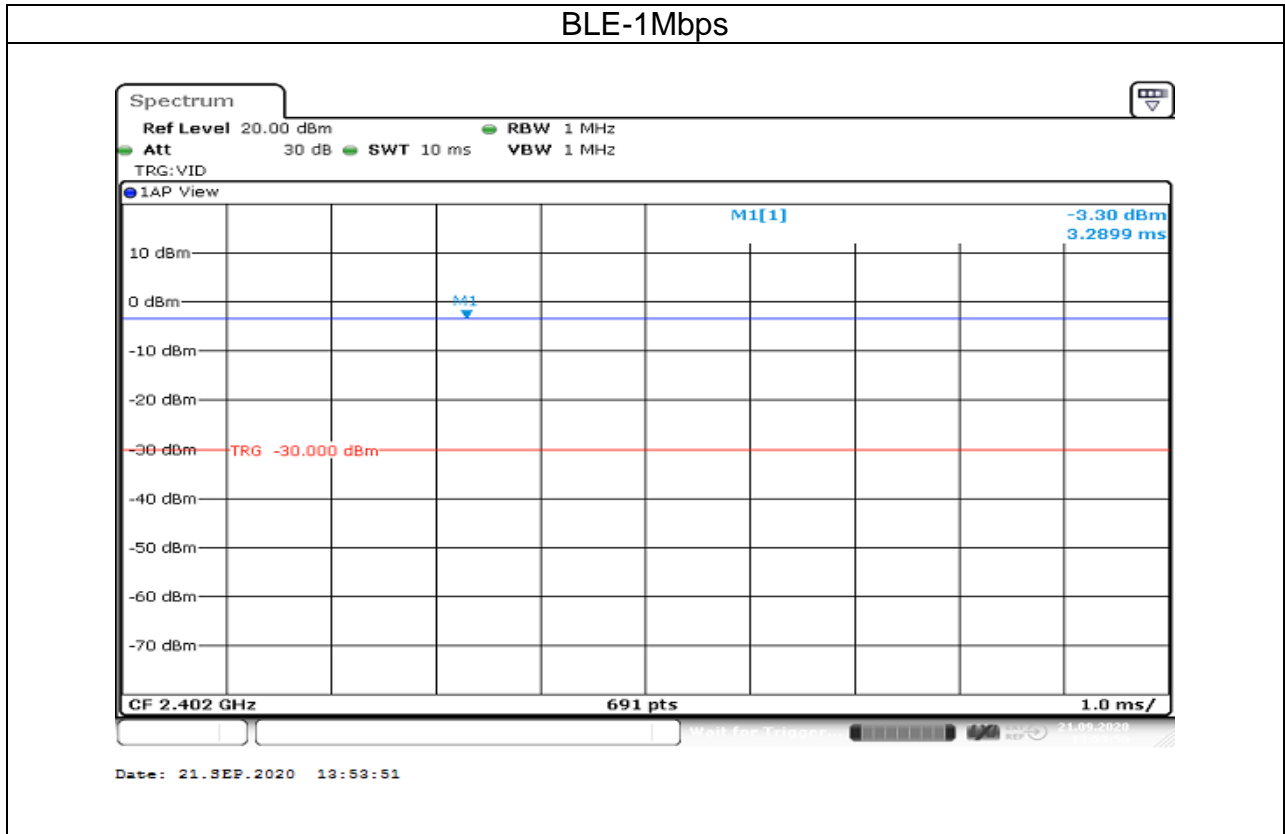

Report No.: T200909W02-RP1

4. TEST RESULT

4.1 AC POWER LINE CONDUCTED EMISSION

4.1.1 Test Limit

According to §15.207(a),

| Frequency Range (MHz) | Limits(dB μ V) | |
|-----------------------|--------------------|-----------|
| | Quasi-peak | Average |
| 0.15 to 0.50 | 66 to 56* | 56 to 46* |
| 0.50 to 5 | 56 | 46 |
| 5 to 30 | 60 | 50 |

* Decreases with the logarithm of the frequency.

4.1.2 Test Procedure

Test method Refer as ANSI C63.10: 2013 clause 6.2,

1. The EUT was placed above horizontal ground plane and 0.4m above vertical ground plane
2. EUT connected to the line impedance stabilization network (LISN)
3. Receiver set RBW of 9kHz and Detector Peak, and note as quasi-peak and average.
4. Maximum procedure was performed on the six highest emissions to ensure EUT compliance.
5. Recorded Line for Neutral and Line.

4.1.3 Test Setup

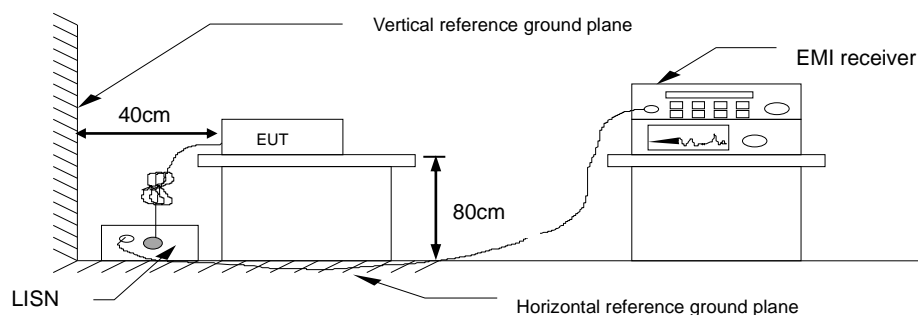

4.1.4 Test Result

Not applicable, because EUT doesn't connect to AC Main Source direct.

Report No.: T200909W02-RP1

4.2 6dB BANDWIDTH AND OCCUPIED BANDWIDTH (99%)

4.2.1 Test Limit

According to §15.247(a)(2)

6 dB Bandwidth :

| | |
|-------|--------------------------|
| Limit | Shall be at least 500kHz |
|-------|--------------------------|

Occupied Bandwidth(99%) : For reporting purposes only.

4.2.2 Test Procedure

Test method Refer as KDB 558074 D01 and ANSI C63.10: 2013 clause 6.9.2,

1. The EUT RF output connected to the spectrum analyzer by RF cable.
2. Setting maximum power transmit of EUT.
3. SA set RBW =100KHz, VBW = 300KHz and Detector = Peak, to measurement 6dB Bandwidth.
4. SA set RBW = 1% ~ 5% OBW, VBW = three times the RBW and Detector = Peak, to measurement 99% Bandwidth.
5. Measure and record the result of 6 dB Bandwidth and 99% Bandwidth. in the test report.

4.2.3 Test Setup

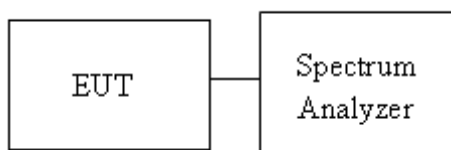

4.2.4 Test Result

Temperature: 25°C

Humidity: 50% RH

Tested by: Jane Wang

| Test mode: BLE-1Mbps mode / 2402-2480 MHz | | | | |
|---|-----------------|-----------------|--------------|-----------------|
| Channel | Frequency (MHz) | OBW (99%) (MHz) | 6dB BW (MHz) | 6dB limit (kHz) |
| Low | 2402 | 1.0549 | 0.7000 | >500 |
| Mid | 2442 | 1.0593 | 0.7000 | |
| High | 2480 | 1.0593 | 0.7043 | |

Report No.: T200909W02-RP1

Test Data

6dB BANDWIDTH

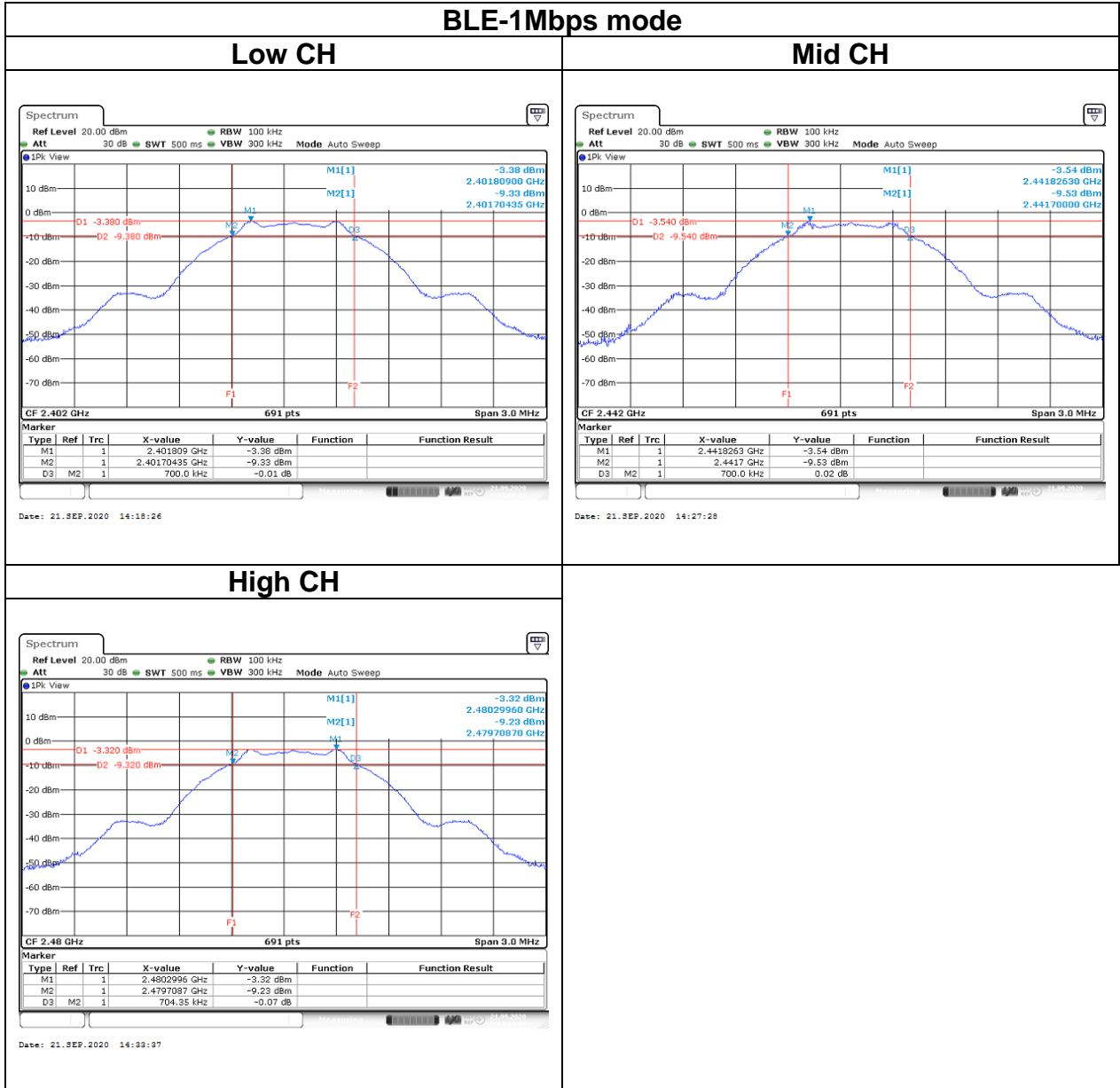

Test Data

BANDWIDTH (99%)

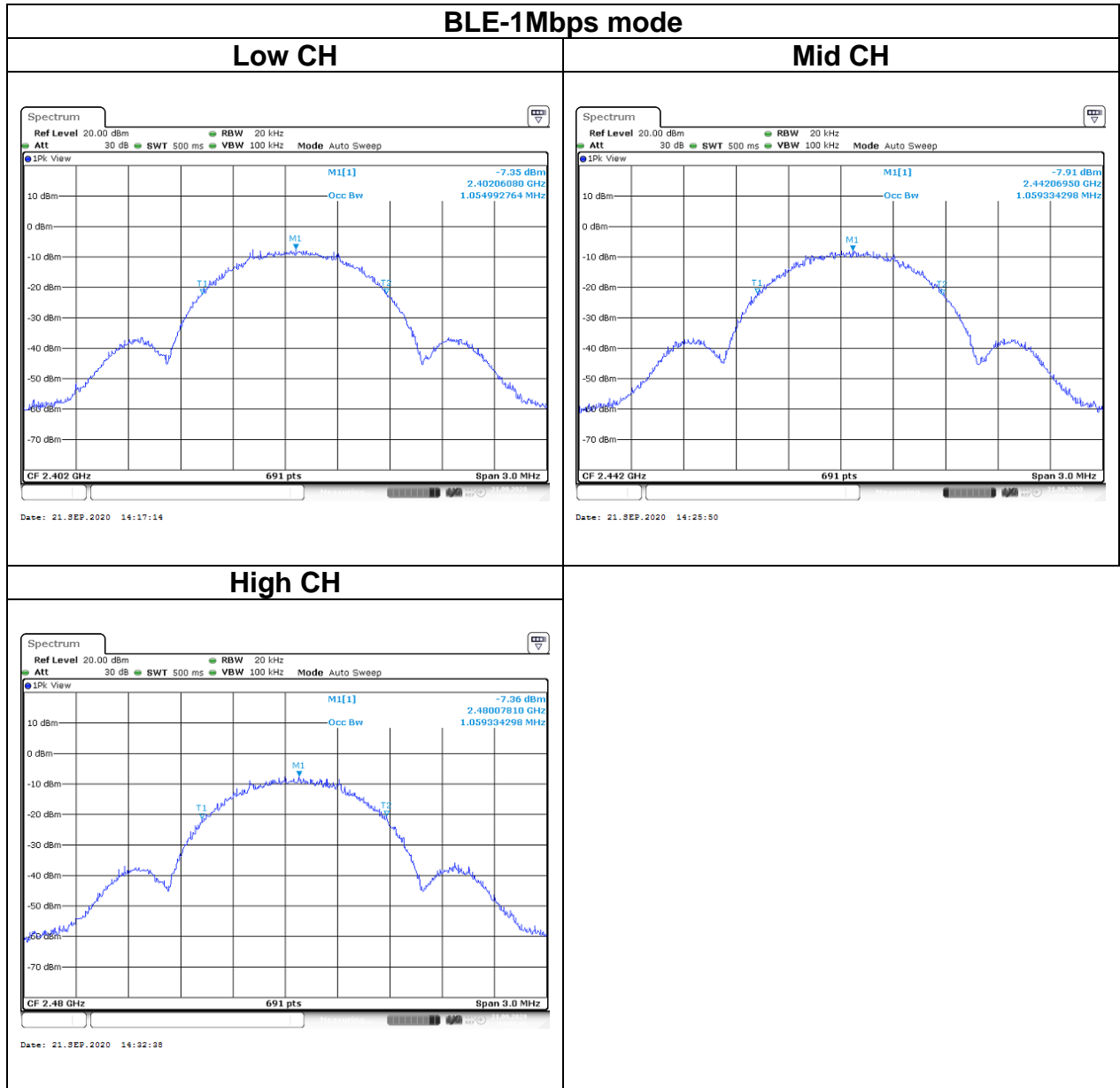

Report No.: T200909W02-RP1

4.3 OUTPUT POWER MEASUREMENT

4.3.1 Test Limit

According to §15.247(b)(3)

Peak output power :

FCC

Alternatively, frequency hopping systems operating in the 2400-2483.5 MHz band may have hopping channel carrier frequencies that are separated by 25 kHz or two-thirds of the 20 dB bandwidth of the hopping channel, whichever is greater, provided the systems operate with an output power no greater than 125 mW.

| | |
|-------|---|
| Limit | <input checked="" type="checkbox"/> Antenna not exceed 6 dBi : 30dBm <input type="checkbox"/> Antenna with DG greater than 6 dBi [Limit = 30 – (DG – 6)] <input type="checkbox"/> Point-to-point operation |
|-------|---|

Average output power : For reporting purposes only.

4.3.2 Test Procedure

Test method Refer as KDB 558074 D01.

1. The EUT RF output connected to the power meter by RF cable.
2. Setting maximum power transmit of EUT.
3. The path loss was compensated to the results for each measurement.
4. Measure and record the result of Peak output power and Average output power. in the test report.

4.3.3 Test Setup

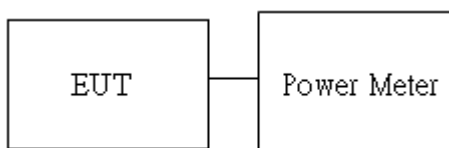

Report No.: T200909W02-RP1

4.3.4 Test Result

Temperature: 25°C

Humidity: 50% RH

Tested by: Jane Wang

Test Date: September 21, 2020

Peak output power :

| BLE Mode | | | | | | |
|----------------------------|----|-------------|---------------|----------------|--------------|-----------------|
| Config. | CH | Freq. (MHz) | Power Setting | PK Power (dBm) | PK Power (W) | FCC Limit (dBm) |
| BLE Data rate: 1Mbps | 0 | 2402 | 7 | 7.92 | 0.0062 | 30 |
| | 20 | 2442 | 7 | 7.82 | 0.0061 | |
| | 39 | 2480 | 7 | 7.85 | 0.0061 | |

Average output power :

| BLE Mode | | | |
|----------------------------|----|-------------|----------------|
| Config. | CH | Freq. (MHz) | AV Power (dBm) |
| BLE Data rate: 1Mbps | 0 | 2402 | 7.49 |
| | 20 | 2442 | 7.50 |
| | 39 | 2480 | 7.48 |

Report No.: T200909W02-RP1

4.4 POWER SPECTRAL DENSITY

4.4.1 Test Limit

According to §15.247(e)

For digitally modulated systems, the power spectral density conducted from the intentional radiator to the antenna shall not be greater than 8 dBm in any 3 kHz band during any time interval of continuous transmission.

| | |
|-------|---|
| Limit | <input checked="" type="checkbox"/> Antenna not exceed 6 dBi : 8dBm <input type="checkbox"/> Antenna with DG greater than 6 dBi [Limit = 8 – (DG – 6)] <input type="checkbox"/> Point-to-point operation : |
|-------|---|

4.4.2 Test Procedure

Test method Refer as KDB 558074 D01.

1. The EUT RF output connected to the spectrum analyzer by RF cable.
2. Setting maximum power transmit of EUT
3. SA set RBW = 3kHz, VBW = 10kHz, Span = 1.5 times DTS Bandwidth (6 dB BW), Detector = Peak, Sweep Time = Auto and Trace = Max hold.
4. The path loss and Duty Factor were compensated to the results for each measurement by SA.
5. Mark the maximum level.
6. Measure and record the result of power spectral density. in the test report.

4.4.3 Test Setup

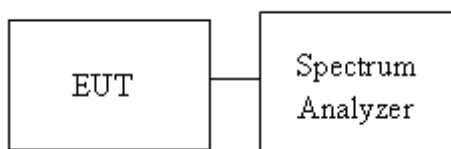

Report No.: T200909W02-RP1

4.4.4 Test Result

Temperature: 25°C

Humidity: 50% RH

Tested by: Jane Wang

| Test mode: BLE-1Mbps mode / 2402-2480 MHz | | | |
|---|-----------------|-----------|-------------|
| Channel | Frequency (MHz) | PSD (dBm) | limit (dBm) |
| Low | 2402 | -2.89 | 8 |
| Mid | 2442 | -3.00 | |
| High | 2480 | -2.92 | |

Report No.: T200909W02-RP1

Test Data

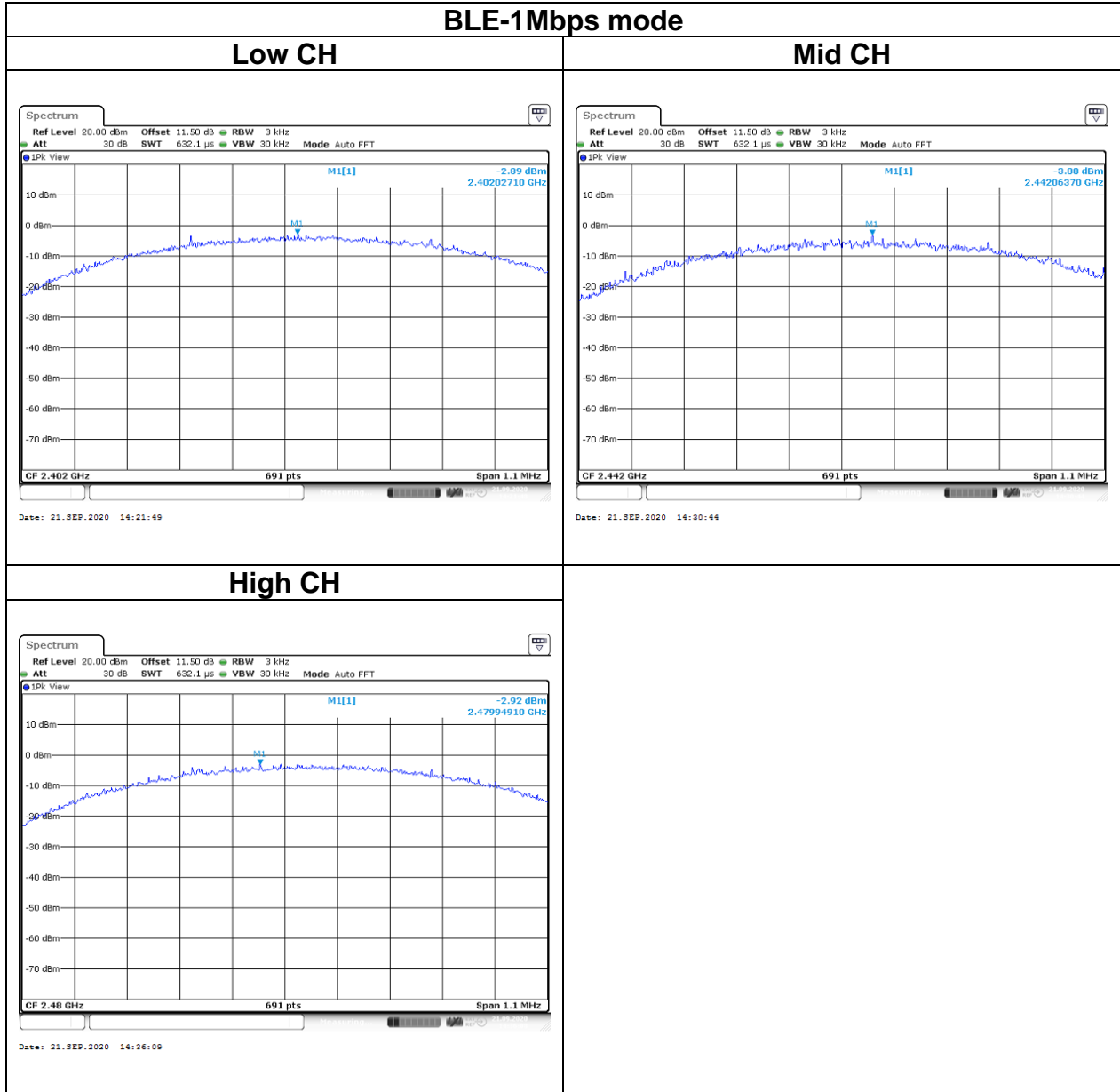

Report No.: T200909W02-RP1

4.5 CONDUCTED BAND EDGE AND SPURIOUS EMISSION

4.5.1 Test Limit

According to §15.247(d)

FCC: In any 100 kHz bandwidth outside the authorized frequency band,

Non-restricted bands shall be attenuated at least 20 dB/30 dB relative to the maximum PSD level in 100 kHz by RF conducted or a radiated measurement which fall in the restricted bands, as defined in §15.205(a), must also comply with the radiated emission limits specified in §15.209(a).

4.5.2 Test Procedure

Test method Refer as KDB 558074 D01.

1. EUT RF output port connected to the SA by RF cable, and the path loss was compensated to result.
2. SA setting, RBW=100kHz, VBW=300kHz, Detector=Peak, Trace mode = max hold, SWT = Auto.
3. In any 100 kHz bandwidth outside the authorized frequency band, shall be attenuated at least 20 dB relative to the maximum in-band peak PSD level in 100 kHz when conducted power procedure is used. If the transmitter complies with the conducted power limits based on the use of RMS averaging over a time interval, the attenuation required under this paragraph shall be 30 dB instead of 20 dB.

4.5.3 Test Setup

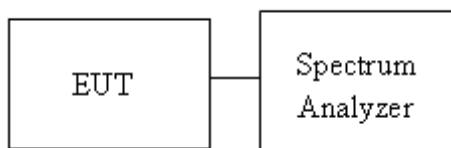

Report No.: T200909W02-RP1

4.5.4 Test Result

Test Data

Temperature: 25°C

Humidity: 50% RH

Tested by: Jane Wang

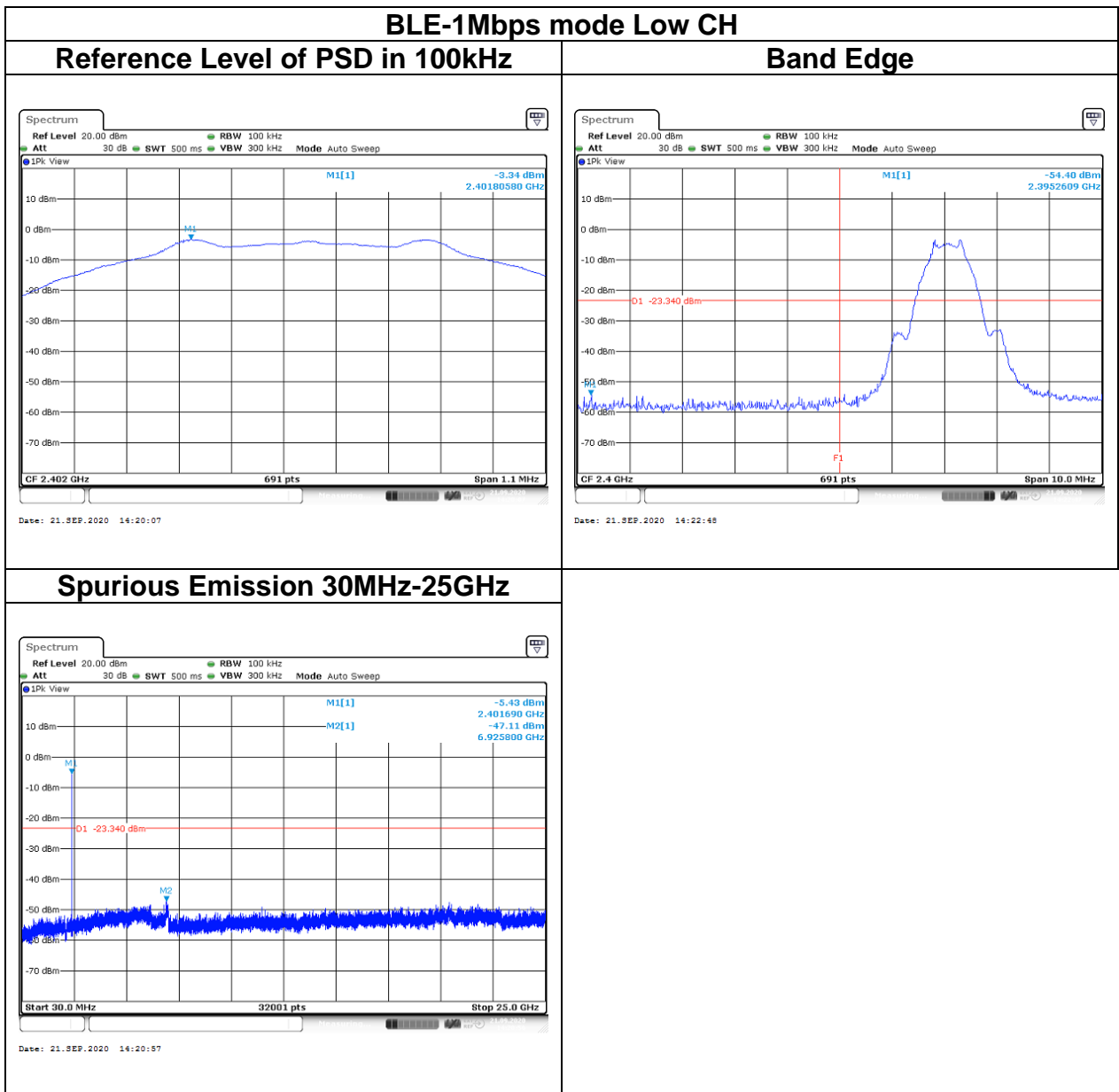

Report No.: T200909W02-RP1

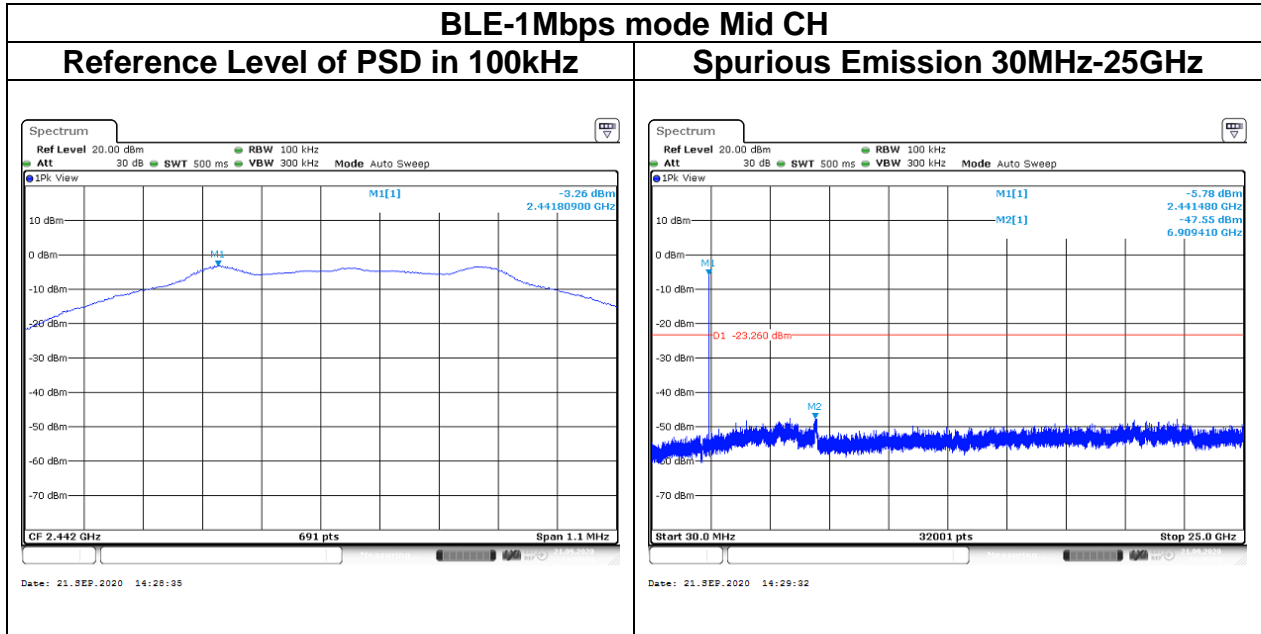

Report No.: T200909W02-RP1

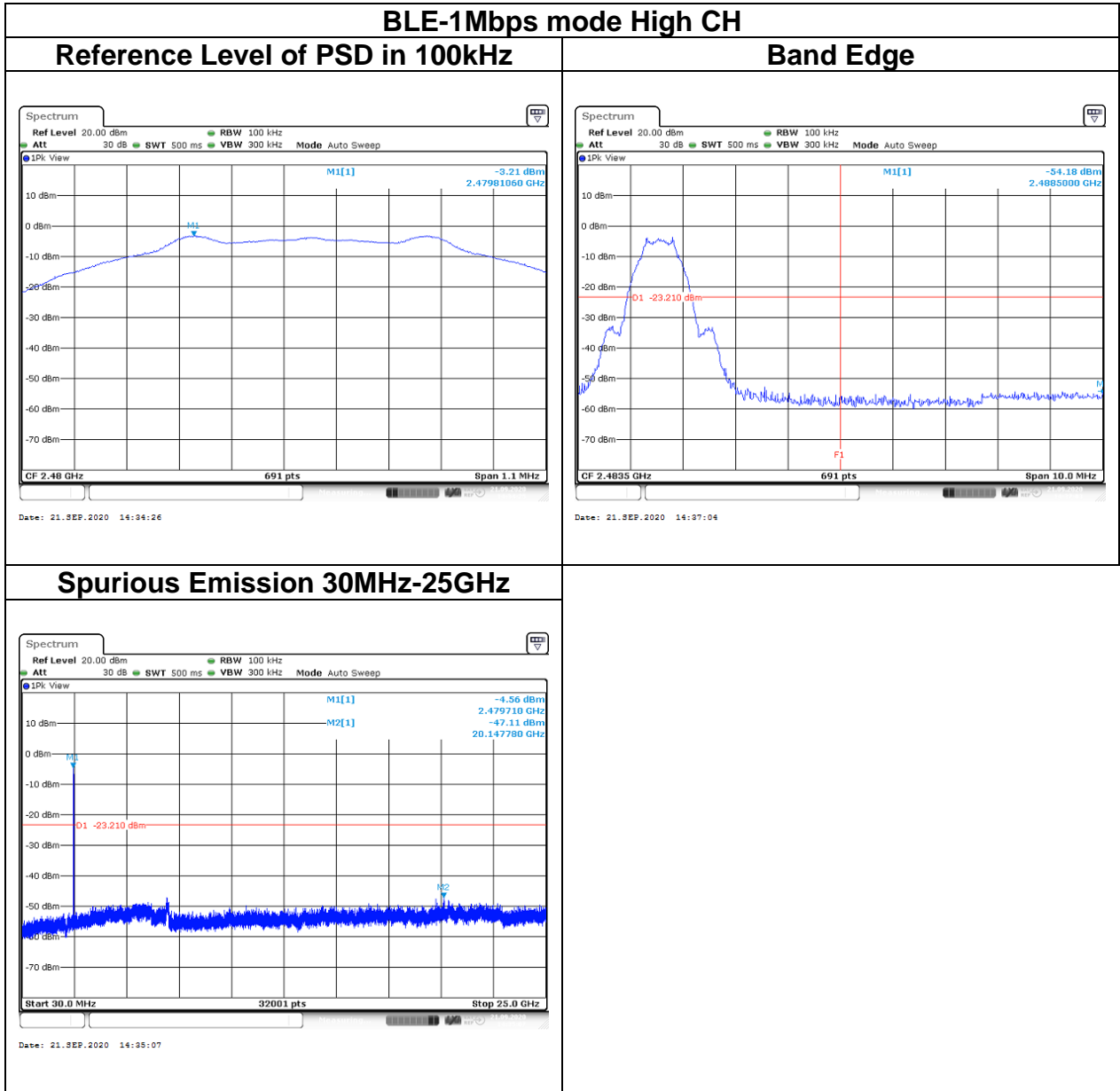

Report No.: T200909W02-RP1

4.6 RADIATION BANDEDGE AND SPURIOUS EMISSION

4.6.1 Test Limit

FCC according to §15.247(d), §15.209 and §15.205,

In any 100 kHz bandwidth outside the authorized frequency band, all harmonic and spurious must be least 20 dB below the highest emission level with the authorized frequency band. Radiation emission which fall in the restricted bands must also follow the FCC section 15.209 as below limit in table.

Below 30 MHz

| Frequency | Field Strength (microvolts/m) | Magnetic H-Field (microamperes/m) | Measurement Distance (metres) |
|---------------|-------------------------------|-----------------------------------|-------------------------------|
| 9-490 kHz | 2,400/F (F in kHz) | 2,400/F (F in kHz) | 300 |
| 490-1,705 kHz | 24,000/F (F in kHz) | 24,000/F (F in kHz) | 30 |
| 1.705-30 MHz | 30 | N/A | 30 |

Above 30 MHz

| Frequency (MHz) | Field Strength microvolts/m at 3 metres (watts, e.i.r.p.) | |
|-----------------|---|--------------|
| | Transmitters | Receivers |
| 30-88 | 100 (3 nW) | 100 (3 nW) |
| 88-216 | 150 (6.8 nW) | 150 (6.8 nW) |
| 216-960 | 200 (12 nW) | 200 (12 nW) |
| Above 960 | 500 (75 nW) | 500 (75 nW) |

Remark:

Although these tests were performed other than open area test site, adequate comparison measurements were confirmed against 30 m open area test site. Therefore sufficient tests were made to demonstrate that the alternative site produces results that correlate with the ones of tests made in an open field based on KDB 414788.

Report No.: T200909W02-RP1

4.6.2 Test Procedure

Test method Refer as KDB 558074 D01.

1. The EUT is placed on a turntable, Above 1 GHz is 1.5m and below 1 GHz is 0.8m above ground plane. The EUT Configured un accordance with ANSI C63.10: 2013, and the EUT set in a continuous mode.
2. The turntable shall be rotated for 360 degrees to determine the position of maximum emission level. And EUT is set 3m away from the receiving antenna, which is scanned from 1m to 4m above the ground plane to find out the highest emissions. Measurement are made polarized in both the vertical and the horizontal positions with antenna.
3. Span shall wide enough to full capture the emission measured. The SA from 9KHz to 26.5GHz set to the low, Mid and High channels with the EUT transmit.

Remark:

1. Although these tests were performed other than open area test site, adequate comparison measurements were confirmed against 30 m open are test site. Therefore sufficient tests were made to demonstrate that the alternative site produces results that correlate with the ones of tests made in an open field based on KDB 414788.
 2. No emission found between lowest internal used/generated frequency to 30MHz (9kHz~30MHz).
4. The SA setting following :
- (1) Below 1G : RBW = 100kHz, VBW \geq 3 RBW, Sweep = Auto, Detector = Peak, Trace = Max hold.
 - (2) Above 1G :
 - (2.1) For Peak measurement : RBW = 1MHz, VBW \geq 3 RBW, Sweep = Auto, Detector = Peak, Trace = Max hold.
 - (2.2) For Average measurement : RBW = 1MHz, VBW
 - 'If Duty Cycle \geq 98%, VBW=10Hz.
 - 'If Duty Cycle < 98%, VBW=1/T.

4.6.3 Test Setup

9kHz ~ 30MHz

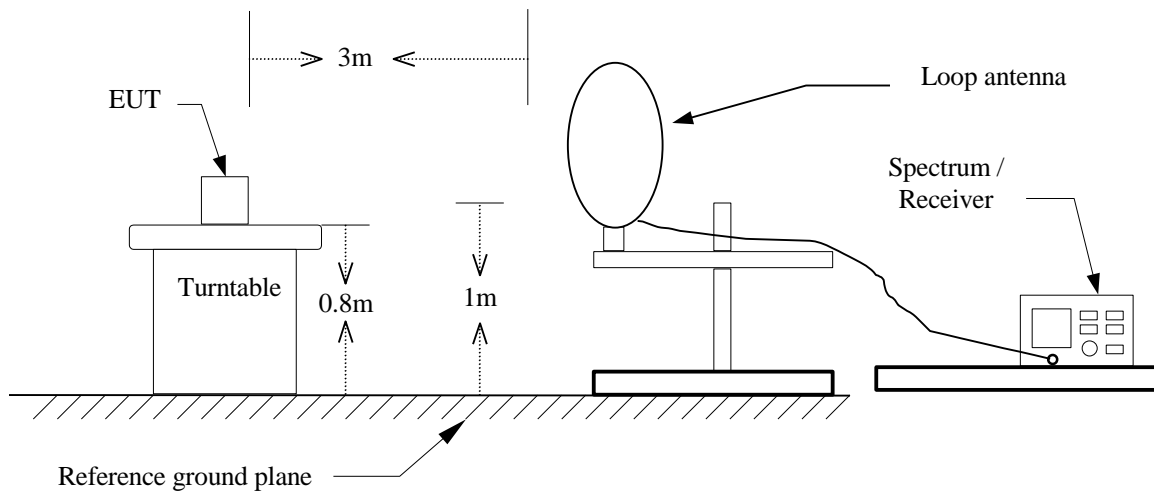

30MHz ~ 1GHz

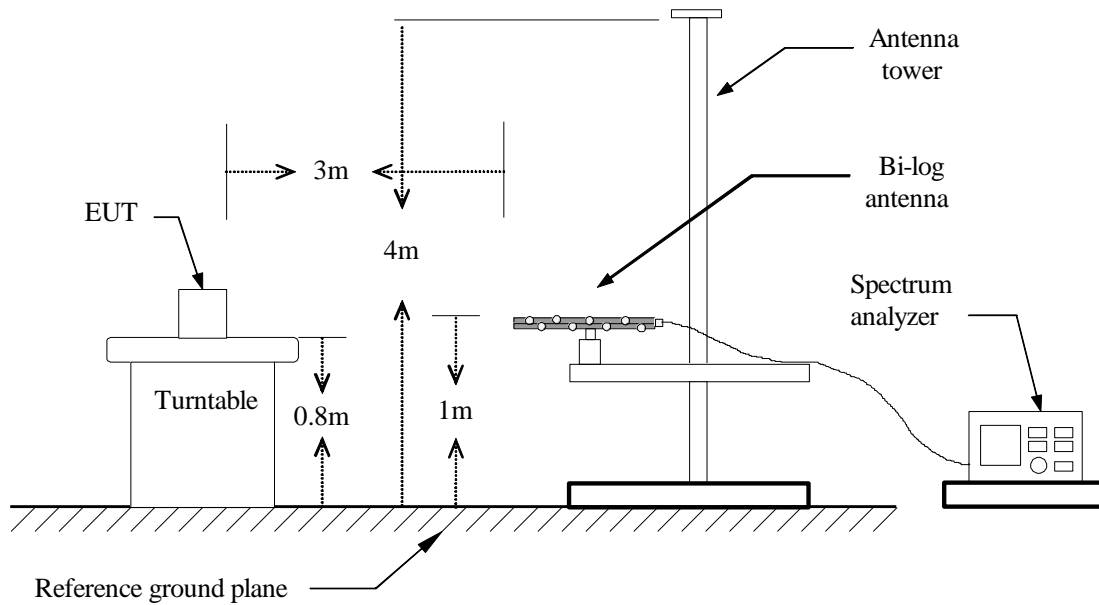

Above 1 GHz

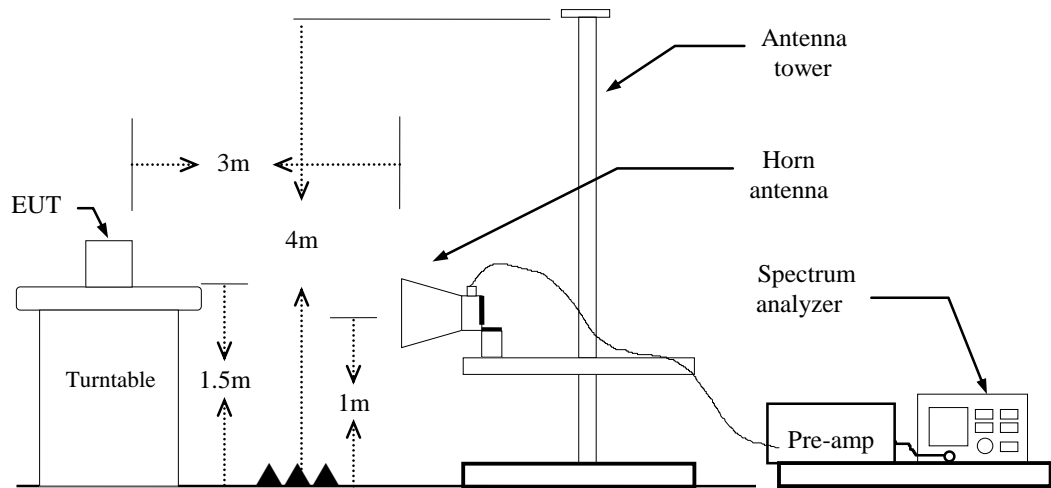

Report No.: T200909W02-RP1

4.6.4 Test Result

Band Edge Test Data

| | | | |
|------------|------------------|---------------|--------------------|
| Test Mode: | BLE-1Mbps Low CH | Temp/Hum | 24.5(°C)/ 40%RH |
| Test Item | Band Edge | Test Date | September 25, 2020 |
| Polarize | Vertical | Test Engineer | Jerry Chang |
| Detector | Peak / Average | | |

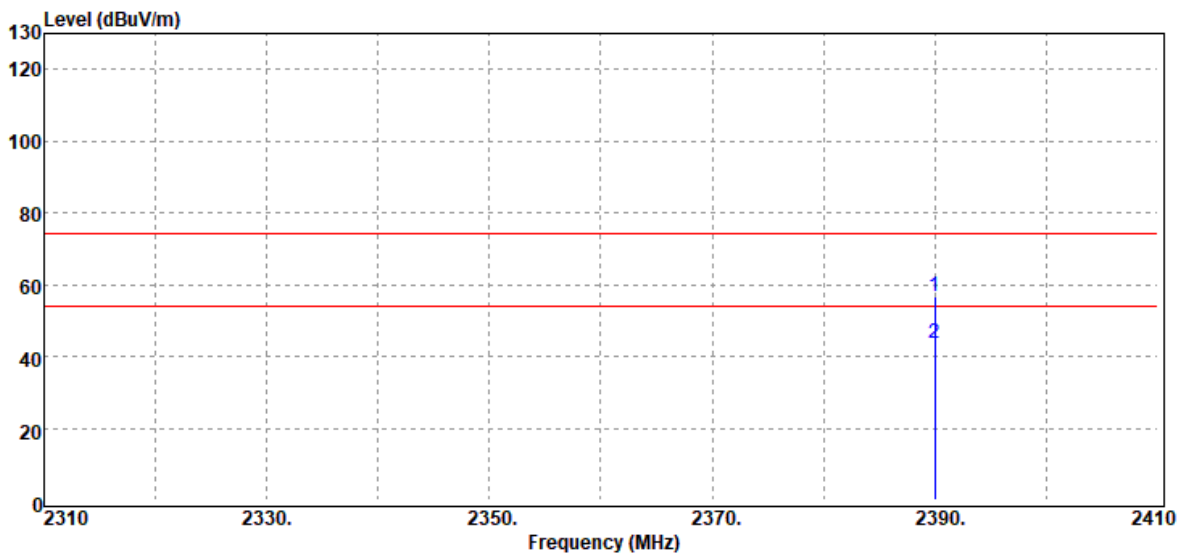

| Freq. MHz | Detector Mode PK/QP/AV | Spectrum Reading Level dB μ V | Factor dB | Actual FS dB μ V/m | Limit @3m dB μ V/m | Margin dB |
|--------------|------------------------------|---|--------------|------------------------------|------------------------------|--------------|
| 2390.00 | Peak | 55.22 | 1.25 | 56.47 | 74.00 | -17.53 |
| 2390.00 | Average | 42.52 | 1.25 | 43.77 | 54.00 | -10.23 |

| | | | |
|------------|------------------|---------------|--------------------|
| Test Mode: | BLE-1Mbps Low CH | Temp/Hum | 24.5(°C)/ 40%RH |
| Test Item | Band Edge | Test Date | September 25, 2020 |
| Polarize | Horizontal | Test Engineer | Jerry Chang |
| Detector | Peak / Average | | |

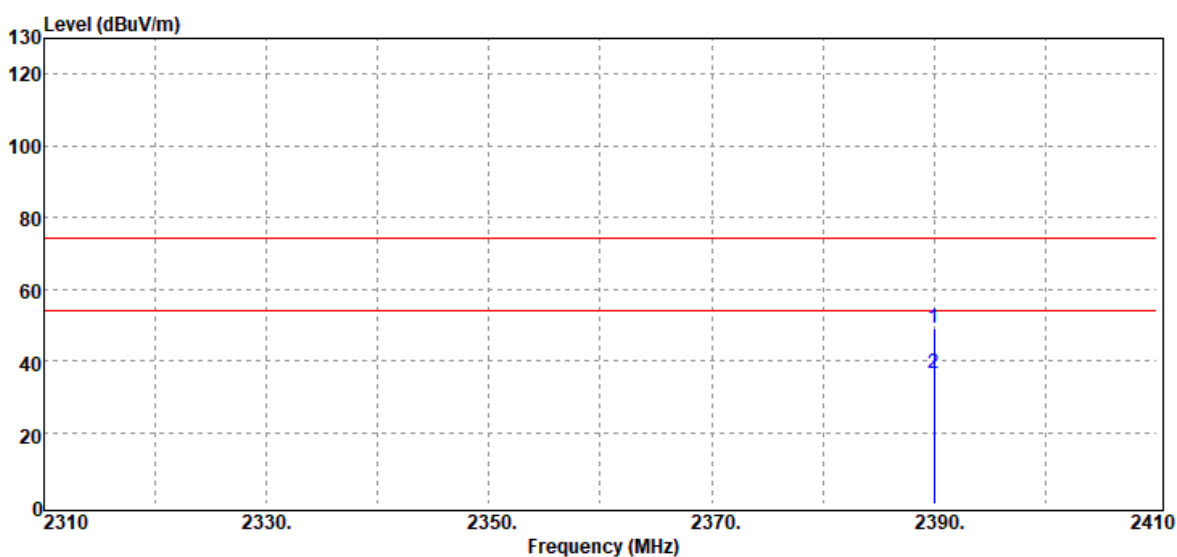

| Freq. MHz | Detector Mode PK/QP/AV | Spectrum Reading Level dB μ V | Factor dB | Actual FS dB μ V/m | Limit @3m dB μ V/m | Margin dB |
|--------------|------------------------------|---|--------------|------------------------------|------------------------------|--------------|
| 2390.00 | Peak | 55.01 | 1.25 | 56.26 | 74.00 | -17.74 |
| 2390.00 | Average | 44.53 | 1.25 | 45.78 | 54.00 | -8.22 |

Report No.: T200909W02-RP1

| | | | |
|------------|-------------------|---------------|--------------------|
| Test Mode: | BLE-1Mbps High CH | Temp/Hum | 24.5(°C)/ 40%RH |
| Test Item | Band Edge | Test Date | September 25, 2020 |
| Polarize | Vertical | Test Engineer | Jerry Chang |
| Detector | Peak / Average | | |

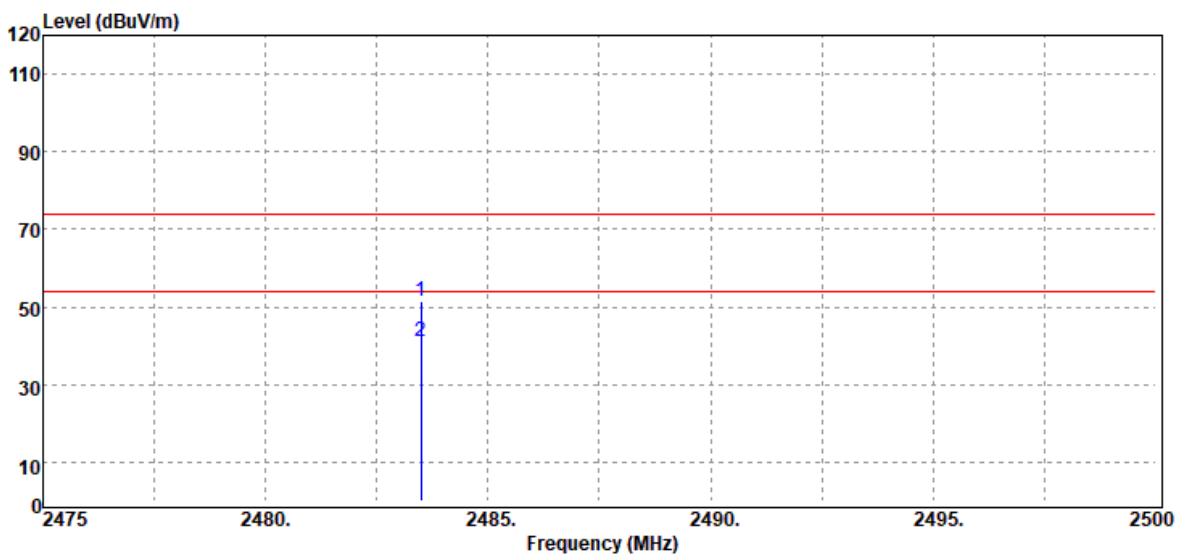

| Freq. MHz | Detector Mode PK/QP/AV | Spectrum Reading Level dB μ V | Factor dB | Actual FS dB μ V/m | Limit @3m dB μ V/m | Margin dB |
|--------------|------------------------------|---|--------------|------------------------------|------------------------------|--------------|
| 2483.50 | Peak | 49.82 | 1.62 | 51.44 | 74.00 | -22.56 |
| 2483.50 | Average | 39.50 | 1.62 | 41.12 | 54.00 | -12.88 |

Report No.: T200909W02-RP1

| | | | |
|------------|-------------------|---------------|--------------------|
| Test Mode: | BLE-1Mbps High CH | Temp/Hum | 24.5(°C)/ 40%RH |
| Test Item | Band Edge | Test Date | September 25, 2020 |
| Polarize | Horizontal | Test Engineer | Jerry Chang |
| Detector | Peak / Average | | |

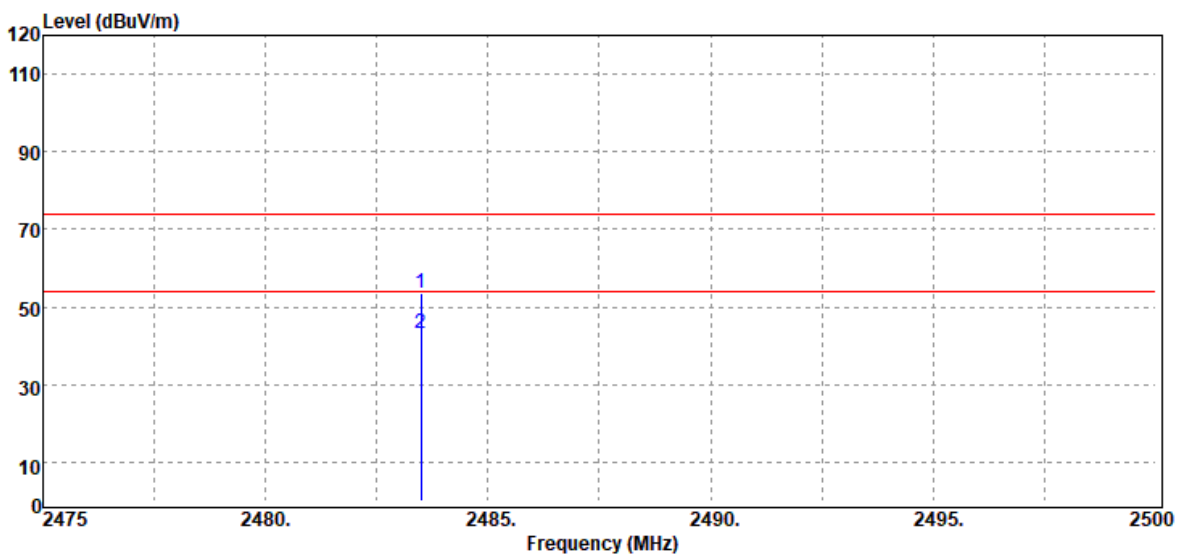

| Freq. MHz | Detector Mode PK/QP/AV | Spectrum Reading Level dB μ V | Factor dB | Actual FS dB μ V/m | Limit @3m dB μ V/m | Margin dB |
|--------------|------------------------------|---|--------------|------------------------------|------------------------------|--------------|
| 2483.50 | Peak | 51.87 | 1.62 | 53.49 | 74.00 | -20.51 |
| 2483.50 | Average | 41.52 | 1.62 | 43.14 | 54.00 | -10.86 |

Below 1G Test Data

| | | | |
|------------|----------------|---------------|--------------------|
| Test Mode: | BLE-1Mbps Mode | Temp/Hum | 24.5(°C)/ 40%RH |
| Test Item | 30MHz-1GHz | Test Date | September 25, 2020 |
| Polarize | Vertical | Test Engineer | Jerry Chang |
| Detector | Peak | | |

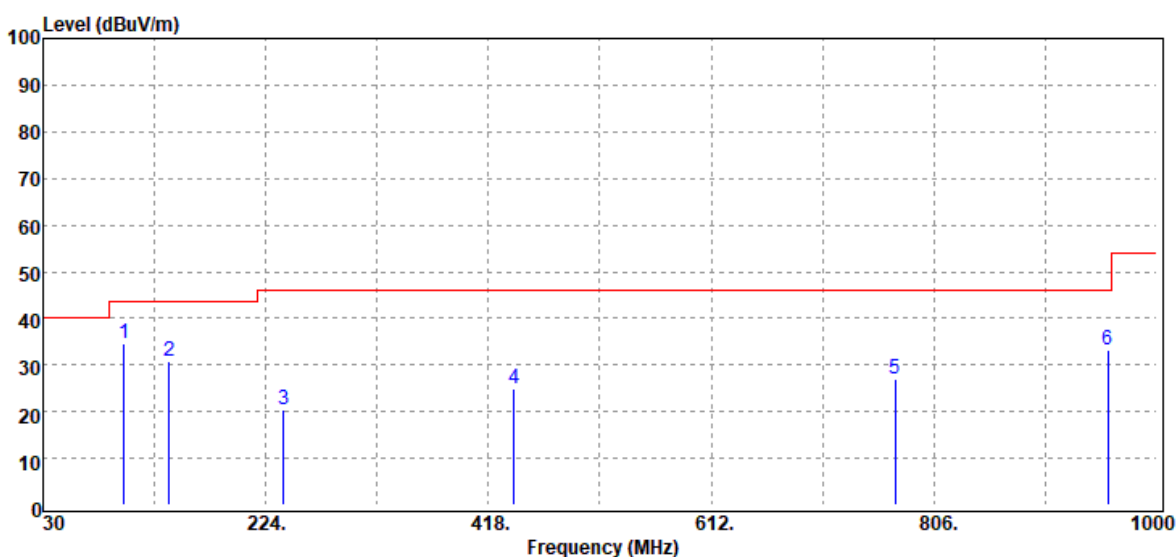

| Freq. MHz | Detector Mode PK/QP/AV | Spectrum Reading Level dBμV | Factor dB | Actual FS dBμV/m | Limit @3m dBμV/m | Margin dB |
|-----------|------------------------|-----------------------------|-----------|------------------|------------------|-----------|
| 100.81 | Peak | 47.20 | -12.66 | 34.54 | 43.50 | -8.96 |
| 139.61 | Peak | 40.70 | -9.78 | 30.92 | 43.50 | -12.58 |
| 239.52 | Peak | 31.12 | -10.77 | 20.35 | 46.00 | -25.65 |
| 440.31 | Peak | 29.30 | -4.54 | 24.76 | 46.00 | -21.24 |
| 772.05 | Peak | 25.92 | 1.24 | 27.16 | 46.00 | -18.84 |
| 957.32 | Peak | 29.44 | 3.82 | 33.26 | 46.00 | -12.74 |

Note: No emission found between lowest internal used/generated frequency to 30MHz (9kHz~30MHz).

| | | | |
|------------|----------------|---------------|--------------------|
| Test Mode: | BLE-1Mbps Mode | Temp/Hum | 24.5(°C)/ 40%RH |
| Test Item | 30MHz-1GHz | Test Date | September 25, 2020 |
| Polarize | Horizontal | Test Engineer | Jerry Chang |
| Detector | Peak | | |

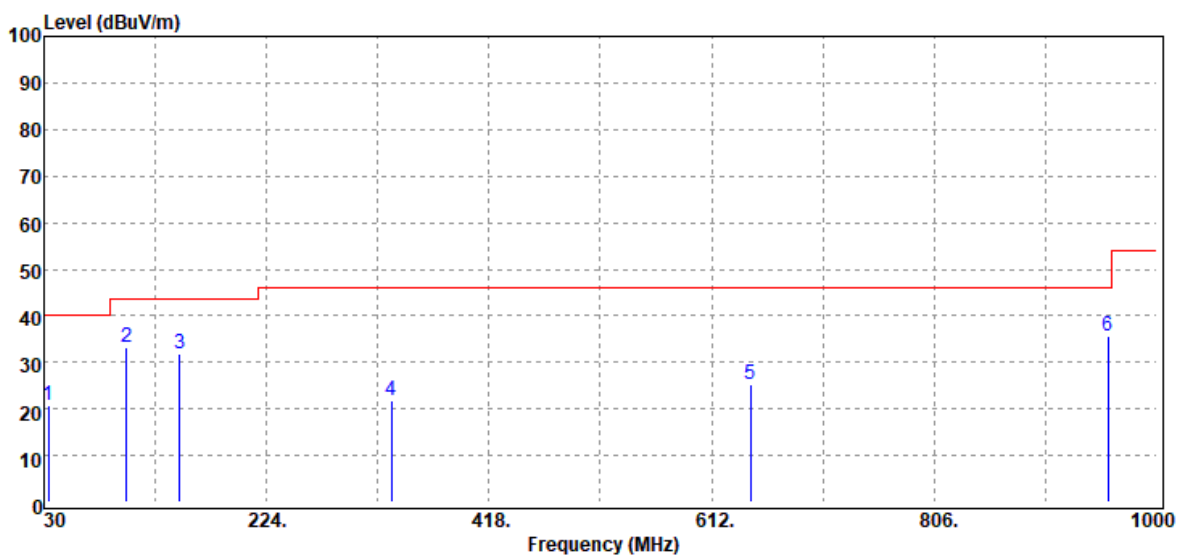

| Freq. MHz | Detector Mode PK/QP/AV | Spectrum Reading Level dB μ V | Factor dB | Actual FS dB μ V/m | Limit @3m dB μ V/m | Margin dB |
|--------------|------------------------------|---|--------------|------------------------------|------------------------------|--------------|
| 33.88 | Peak | 26.00 | -5.08 | 20.92 | 40.00 | -19.08 |
| 101.78 | Peak | 45.47 | -12.28 | 33.19 | 43.50 | -10.31 |
| 148.34 | Peak | 42.06 | -10.33 | 31.73 | 43.50 | -11.77 |
| 332.64 | Peak | 29.50 | -7.80 | 21.70 | 46.00 | -24.30 |
| 645.95 | Peak | 25.97 | -0.57 | 25.40 | 46.00 | -20.60 |
| 957.32 | Peak | 31.67 | 3.82 | 35.49 | 46.00 | -10.51 |

Note: No emission found between lowest internal used/generated frequency to 30MHz (9kHz~30MHz).

Report No.: T200909W02-RP1

Above 1G Test Data

| | | | |
|------------|------------------|---------------|--------------------|
| Test Mode: | BLE-1Mbps Low CH | Temp/Hum | 24.5(°C)/ 40%RH |
| Test Item | Harmonic | Test Date | September 25, 2020 |
| Polarize | Vertical | Test Engineer | Jerry Chang |
| Detector | Peak | | |

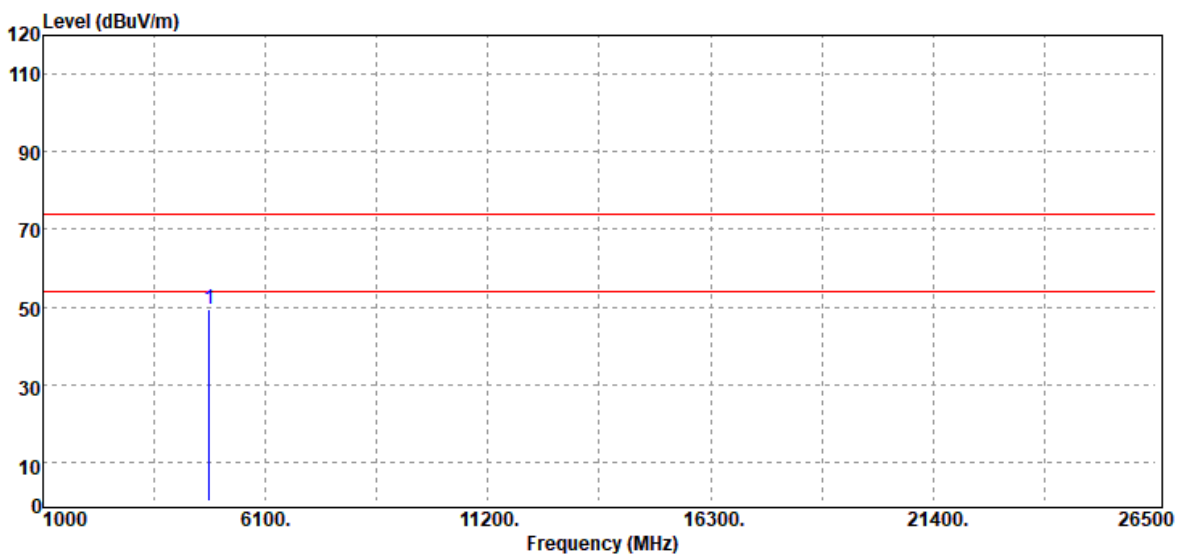

| Freq. MHz | Detector Mode PK/QP/AV | Spectrum Reading Level dBµV | Factor dB | Actual FS dBµV/m | Limit @3m dBµV/m | Margin dB |
|--------------|------------------------------|-----------------------------------|--------------|------------------------|------------------------|--------------|
| 4804.00 | Peak | 43.21 | 6.33 | 49.54 | 74.00 | -24.46 |
| N/A | | | | | | |
| | | | | | | |
| | | | | | | |
| | | | | | | |

Remark:

1. Measuring frequencies from 1 GHz to the 10th harmonic of highest fundamental frequency.
2. For above 1GHz, the EUT peak value was under average limit, therefore the Average value compliance with the average limit

Report No.: T200909W02-RP1

| | | | |
|------------|------------------|---------------|--------------------|
| Test Mode: | BLE-1Mbps Low CH | Temp/Hum | 24.5(°C)/ 40%RH |
| Test Item | Harmonic | Test Date | September 25, 2020 |
| Polarize | Horizontal | Test Engineer | Jerry Chang |
| Detector | Peak | | |

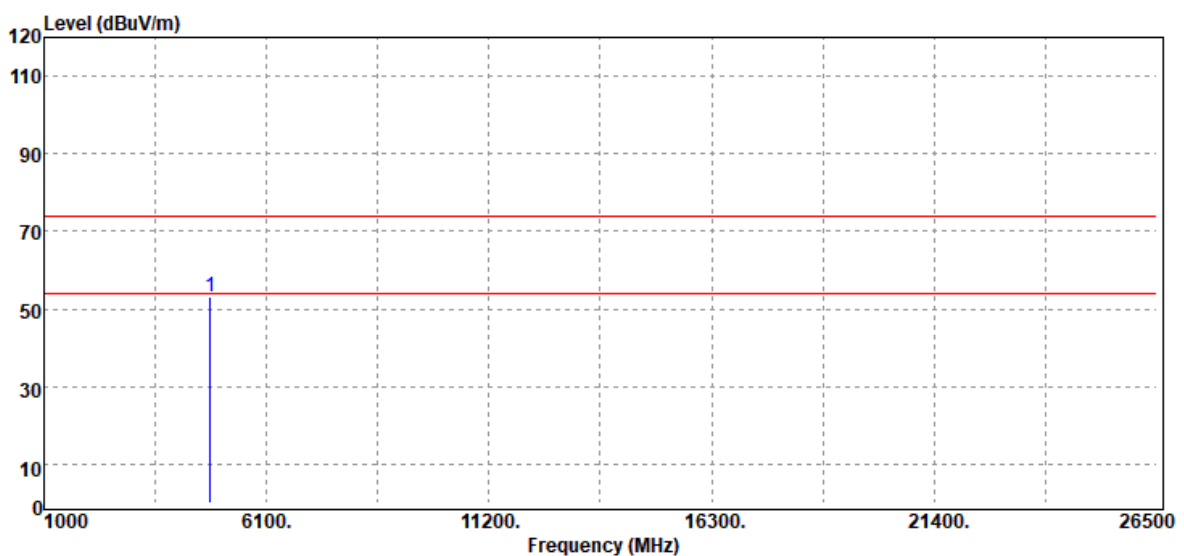

| Freq. MHz | Detector Mode PK/QP/AV | Spectrum Reading Level dB μ V | Factor dB | Actual FS dB μ V/m | Limit @3m dB μ V/m | Margin dB |
|--------------|------------------------------|---|--------------|------------------------------|------------------------------|--------------|
| 4804.00 | Peak | 46.81 | 6.33 | 53.14 | 74.00 | -20.86 |
| N/A | | | | | | |
| | | | | | | |
| | | | | | | |
| | | | | | | |

Remark:

1. Measuring frequencies from 1 GHz to the 10th harmonic of highest fundamental frequency.
2. For above 1GHz, the EUT peak value was under average limit, therefore the Average value compliance with the average limit

Report No.: T200909W02-RP1

| | | | |
|------------|------------------|---------------|--------------------|
| Test Mode: | BLE-1Mbps Mid CH | Temp/Hum | 24.5(°C)/ 40%RH |
| Test Item | Harmonic | Test Date | September 25, 2020 |
| Polarize | Vertical | Test Engineer | Jerry Chang |
| Detector | Peak | | |

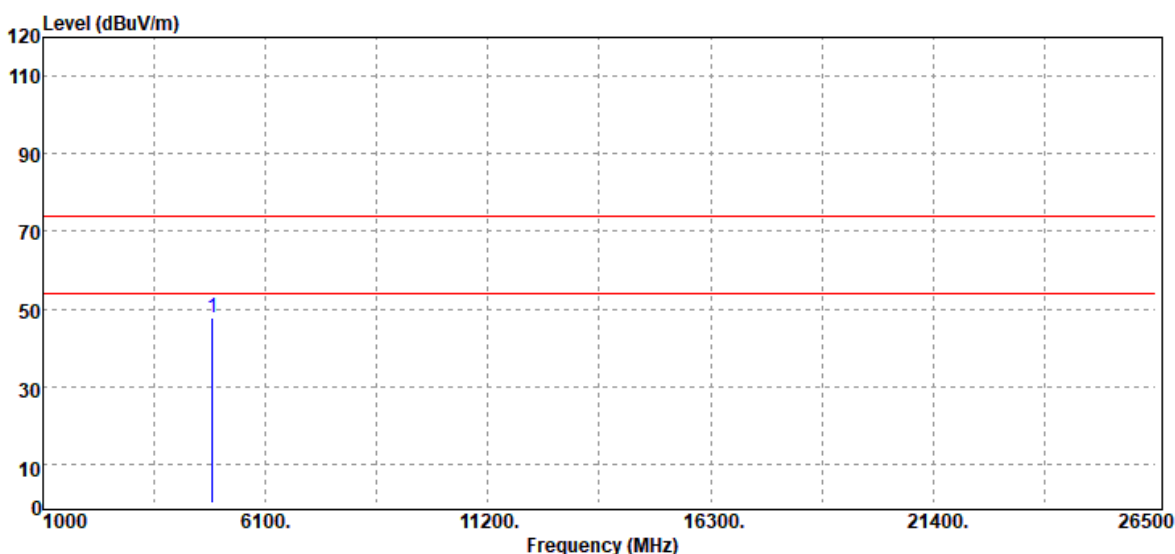

| Freq. MHz | Detector Mode PK/QP/AV | Spectrum Reading Level dB μ V | Factor dB | Actual FS dB μ V/m | Limit @3m dB μ V/m | Margin dB |
|--------------|------------------------------|---|--------------|------------------------------|------------------------------|--------------|
| 4884.00 | Peak | 41.17 | 6.40 | 47.57 | 74.00 | -26.43 |
| N/A | | | | | | |
| | | | | | | |
| | | | | | | |
| | | | | | | |

Remark:

1. Measuring frequencies from 1 GHz to the 10th harmonic of highest fundamental frequency.
2. For above 1GHz, the EUT peak value was under average limit, therefore the Average value compliance with the average limit

Report No.: T200909W02-RP1

| | | | |
|------------|------------------|---------------|--------------------|
| Test Mode: | BLE-1Mbps Mid CH | Temp/Hum | 24.5(°C)/ 40%RH |
| Test Item | Harmonic | Test Date | September 25, 2020 |
| Polarize | Horizontal | Test Engineer | Jerry Chang |
| Detector | Peak | | |

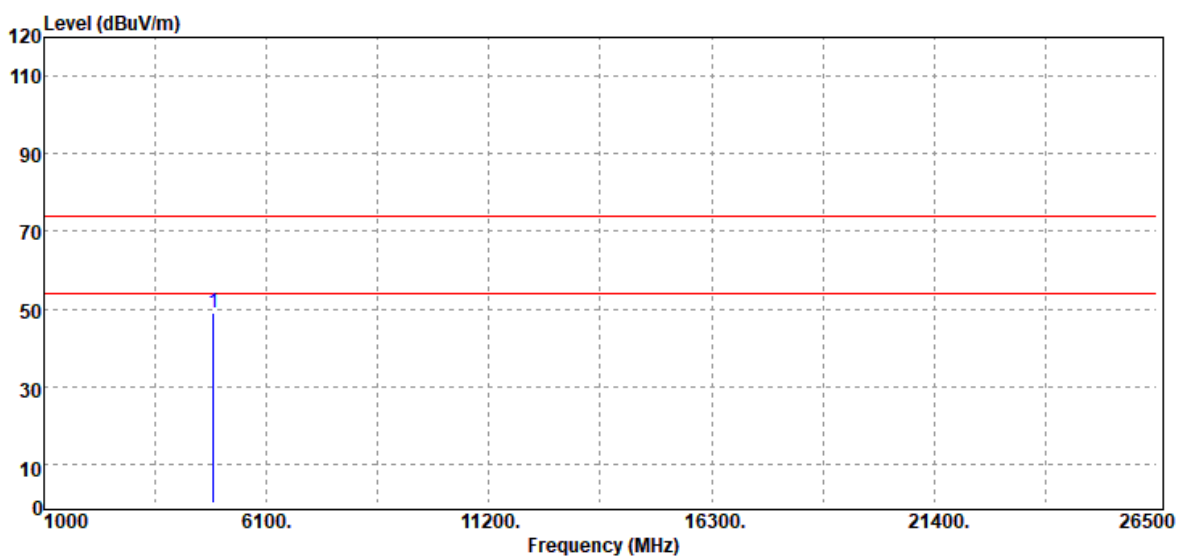

| Freq. MHz | Detector Mode PK/QP/AV | Spectrum Reading Level dBμV | Factor dB | Actual FS dBμV/m | Limit @3m dBμV/m | Margin dB |
|--------------|------------------------------|-----------------------------------|--------------|------------------------|------------------------|--------------|
| 4884.00 | Peak | 42.77 | 6.40 | 49.17 | 74.00 | -24.83 |
| N/A | | | | | | |
| | | | | | | |
| | | | | | | |
| | | | | | | |

Remark:

1. Measuring frequencies from 1 GHz to the 10th harmonic of highest fundamental frequency.
2. For above 1GHz, the EUT peak value was under average limit, therefore the Average value compliance with the average limit

Report No.: T200909W02-RP1

| | | | |
|------------|-------------------|---------------|--------------------|
| Test Mode: | BLE-1Mbps High CH | Temp/Hum | 24.5(°C)/ 40%RH |
| Test Item | Harmonic | Test Date | September 25, 2020 |
| Polarize | Vertical | Test Engineer | Jerry Chang |
| Detector | Peak | | |

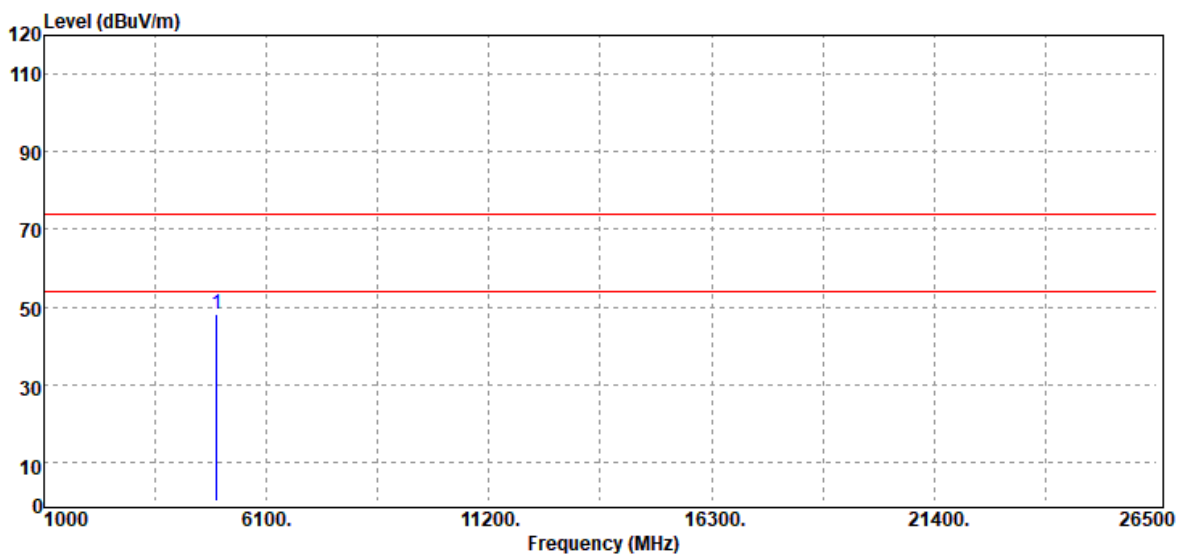

| Freq. MHz | Detector Mode PK/QP/AV | Spectrum Reading Level dB μ V | Factor dB | Actual FS dB μ V/m | Limit @3m dB μ V/m | Margin dB |
|--------------|------------------------------|---|--------------|------------------------------|------------------------------|--------------|
| 4960.00 | Peak | 41.25 | 6.80 | 48.05 | 74.00 | -25.95 |
| N/A | | | | | | |
| | | | | | | |
| | | | | | | |
| | | | | | | |

Remark:

1. Measuring frequencies from 1 GHz to the 10th harmonic of highest fundamental frequency.
2. For above 1GHz, the EUT peak value was under average limit, therefore the Average value compliance with the average limit

Report No.: T200909W02-RP1

| | | | |
|------------|-------------------|---------------|--------------------|
| Test Mode: | BLE-1Mbps High CH | Temp/Hum | 24.5(°C)/ 40%RH |
| Test Item | Harmonic | Test Date | September 25, 2020 |
| Polarize | Horizontal | Test Engineer | Jerry Chang |
| Detector | Peak | | |

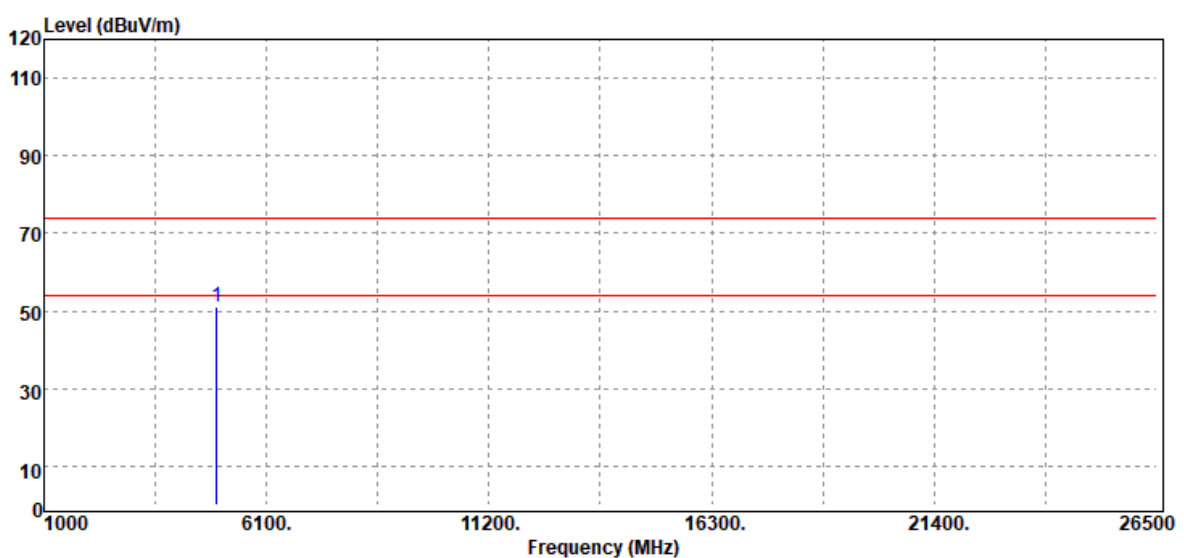

| Freq. MHz | Detector Mode PK/QP/AV | Spectrum Reading Level dB μ V | Factor dB | Actual FS dB μ V/m | Limit @3m dB μ V/m | Margin dB |
|--------------|------------------------------|---|--------------|------------------------------|------------------------------|--------------|
| 4960.00 | Peak | 44.46 | 6.80 | 51.26 | 74.00 | -22.74 |
| N/A | | | | | | |
| | | | | | | |
| | | | | | | |
| | | | | | | |

Remark:

1. Measuring frequencies from 1 GHz to the 10th harmonic of highest fundamental frequency.
2. For above 1GHz, the EUT peak value was under average limit, therefore the Average value compliance with the average limit

--End of Test Report--