

**FCC PART 15, SUBPART B and C; FCC 15.247; RSS-247 and RSS-GEN
TEST REPORT***for***CARRIER ENTRY LEVEL AND ICP THERMOSTAT 2024****MODEL: TSTATCCEWF-01**

Prepared for

UNIVERSAL ELECTRONICS, INC.
201 EAST SANDPOINTE AVE
SANTA ANA, CALIFORNIA 92707Prepared by: 

JAMES ROSS

Approved by: 

KYLE FUJIMOTO

COMPATIBLE ELECTRONICS INC.
114 OLINDA DRIVE
BREA, CALIFORNIA 92823
(714) 579-0500

DATE: FEBRUARY 1, 2023

	REPORT BODY	APPENDICES					TOTAL
		A	B	C	D	E	
PAGES	27	2	2	2	16	263	312

This report shall not be reproduced except in full, without the written approval of Compatible Electronics.



TABLE OF CONTENTS

Section / Title	PAGE
GENERAL REPORT SUMMARY	4
SUMMARY OF TEST RESULTS	5
1. PURPOSE	6
1.1 Decision Rule & Risk	7
2. ADMINISTRATIVE DATA	8
2.1 Location of Testing	8
2.2 Traceability Statement	8
2.3 Cognizant Personnel	8
2.4 Date Test Sample was Received	8
2.5 Disposition of the Test Sample	8
2.6 Abbreviations and Acronyms	8
3. APPLICABLE DOCUMENTS	9
4. DESCRIPTION OF TEST CONFIGURATION	10
4.1.1 Cable Construction and Termination	11
5. LISTS OF EUT, ACCESSORIES AND TEST EQUIPMENT	12
5.1 EUT and Accessory List	12
5.2 Emissions Test Equipment	13
6. TEST SITE DESCRIPTION	14
6.1 Test Facility Description	14
6.2 EUT Mounting, Bonding and Grounding	14
6.3 Measurement Uncertainty	14
7. CHARACTERISTICS OF THE TRANSMITTER	15
7.1 Channel Description and Frequencies	15
7.2 Antenna Gain	15
8. TEST PROCEDURES	16
8.1 RF Emissions	16
8.1.1 Conducted Emissions Test	16
8.1.2 Radiated Emissions Test	17
8.1.3 RF Emissions Test Results	19
8.1.4 Sample Calculations	20
8.2 DTS Bandwidth	22
8.3 Maximum Peak Conducted Output Power – BLE Mode	22
8.4 Maximum Peak Conducted Output Power – WiFi Mode	23
8.5 Emissions in Non-Restricted Bands	23
8.6 RF Band Edges	24
8.7 Spectral Density Test	25
8.8 99 % Bandwidth	25
8.9 Variation of the Input Power	26
9. CONCLUSIONS	27

LIST OF APPENDICES

APPENDIX	TITLE
A	Laboratory Accreditations and Recognitions
B	Modifications to the EUT
C	Additional Models Covered Under This Report
D	Diagrams and Charts <ul style="list-style-type: none">• Test Setup Diagrams• Antenna and Effective Gain Factors
E	Data Sheets

LIST OF FIGURES

FIGURE	TITLE
1	Conducted Emissions Test Setup
2	Layout of the Semi-Anechoic Test Chamber

LIST OF TABLES

TABLE	TITLE
1	Conducted Emissions Test Results
2	Radiated Emissions Test Results

GENERAL REPORT SUMMARY

This electromagnetic emission test report is generated by Compatible Electronics Inc., which is an independent testing and consulting firm. The test report is based on testing performed by Compatible Electronics personnel according to the measurement procedures described in the test specifications given below and in the "Test Procedures" section of this report.

The measurement data and conclusions appearing herein relate only to the sample tested and this report may not be reproduced without the written permission of Compatible Electronics, unless done so in full.

This report must not be used to claim product certification, approval or endorsement by NVLAP, NIST or any agency of the federal government.

Device Tested: Carrier Entry Level and ICP Thermostat 2024
Model: TSTATCCEWF-01
S/N: Unit 4

Product Description: The EUT is a smart thermostat that is a custom basic thermostat.
The clock oscillator is 40 MHz.
Dimensions: 2.1 cm (L) x 8.8cm (W) x 12.9 cm (H).

Modifications: The EUT was not modified to meet the specifications.

Customer: Universal Electronics, Inc.
15147 North Scottsdale Road, Suite H300
Scottsdale, Arizona 85254

Test Dates: December 11, 12, 13, 20, 21, and 22, 2023

Test Specifications covered by accreditation:

Test Specifications: Emissions requirements
CFR Title 47, Part 15, Subpart B;
CFR Title 47, Part 15, Subpart C, sections 15.205, 15.207, 15.209, and 15.247;
RSS-247 and RSS-Gen



Test Procedures: ANSI C63.4 and ANSI C63.10

Test Deviations: The test procedure was not deviated from during the testing.

SUMMARY OF TEST RESULTS

TEST	DESCRIPTION	RESULTS
1	Conducted RF Emissions, 150 kHz – 30 MHz	Complies with the Class B limits of CFR Title 47, Part 15, Subpart B; the limits of CFR Title 47, Part 15, Subpart C section 15.207; and the limits of RSS-Gen for conducted emissions. Highest reading in relation to spec limit 40.54 dBuV (Avg) @ 0.314 MHz (*U = 2.72 dB).
2	Spurious Radiated RF Emissions, 30 MHz – 9200 MHz	The EUT complies with the Class B limits of CFR Title 47, Part 15 Subpart B; the limits of CFR Title 47, Part 15, Subpart C, section 15.209; RSS-247 and RSS-GEN Highest reading in relation to spec limit 49.69 dBuV/m (AVG) @ 3648 MHz (*U = 4.06 dB)
3	Fundamental and Emissions produced by the intentional radiator in non-restricted bands, 9 kHz – 9.3 GHz	Complies with the relevant requirements of CFR Title 47, Part 15, Subpart C, section 15.247(d); RSS-247 and RSS-GEN
4	Emissions produced by the intentional radiator in restricted bands, 9 kHz – 9.3 GHz	Complies with the relevant requirements of CFR Title 47, Part 15, Subpart C, section 15.205, 15.209, section 15.247 (d); RSS-247 and RSS-GEN
5	DTS Bandwidth	Complies with the relevant requirements of FCC Title 47, Part 15, Subpart C, section 15.247 (a)(2); RSS-247
6	Maximum Conducted Output Power	Complies with the relevant requirements of FCC Title 47, Part 15, Subpart C, section 15.247 (b)(3); RSS-247
7	RF Conducted Antenna Test	Complies with the relevant requirements of CFR Title 47, Part 15, Subpart C, section 15.247 (d); RSS-247
8	Power Spectral Density from the Intentional Radiator to the Antenna	Complies with the relevant requirements of CFR Title 47, Part 15, Subpart C, section 15.247 (e); RSS-247
9	Variation of the Input Power	The EUT complies with the relevant requirements of FCC Title 47, Part 15, Subpart A section 15.31 (e); and RSS-Gen
10	99% Bandwidth	This test was performed to obtain the emission designator required by Innovation, Science and Economic Development Canada.

1. PURPOSE

This document is a qualification test report based on the emissions tests performed on the Carrier Entry Level and ICP Thermostat 2024, Model: TSTATCCEWF-01. The emissions measurements were performed according to the measurement procedure described in ANSI C63.4 and ANSI C63.10. The tests were performed in order to determine whether the electromagnetic emissions from the equipment under test, referred to as EUT hereafter, are within the Class B specification limits defined by CFR Title 47, Part 15, Subpart B, section 15.109; and Subpart C, sections 15.205, 15.207, 15.209 and 15.247; and the specifications limits defined by RSS-247 and RSS-Gen.



1.1 Decision Rule & Risk

If a measured value exceeds a specification limit it implies non-compliance. If the value is below a specification limit it implies compliance. Measurement uncertainty of the laboratory is reported with all measurement results but generally not taken into consideration unless a standard, rule or law requires it to be considered.

Qualification test reports are only produced for products that are in compliance with the test requirements, therefore results are always in conformity. Otherwise, an engineering report or just the data is provided to the customer.

When performing a measurement and making a statement of conformity, in or out-of-specification to manufacturer's specifications or Pass/Fail against a requirement, there are two possible outcomes:

- The result is reported as conforming with the specification
- The result is reported as not conforming with the specification

The decision rule is defined below.

When the test result is found to be below the limit but within our measurement uncertainty of the limit, it is our policy that the final acceptance decision is left to the customer, after discussing the implications and potential risks of the decision.

When the test result is found to be exactly on the specification, it is our policy, in the case of unwanted emissions measurements to consider the result non-compliant, however, the final decision is left to the customer, after discussing the implications and potential risks of the decision.

When the test result is found to be over the specification limit under any condition, it is our policy to consider the result non-compliant.

In terms of uncertainty of measurement, the laboratory is a calibrated and tightly controlled environment and generally exceptionally stable, the measurement uncertainties are evaluated without the considering of the test sample. When it comes to the test sample however, as most testing is performed on a single sample rather than a sample population, and that sample is often a pre-production representation of the final product, that test sample represents a significantly higher source of measurement uncertainty. We advise our customers of this and that when in doubt (small test to limit margins), they may wish to perform statistical sampling on a population to gain a higher confidence in the results. All lab reported results are that of a single sample in any event.

2. ADMINISTRATIVE DATA

2.1 Location of Testing

The emissions tests described herein were performed at the test facility of Compatible Electronics, 114 Olinda Drive, Brea, California 92823.

2.2 Traceability Statement

The calibration certificates of all test equipment used during the test are on file at the location of the test. The calibration is traceable to the National Institute of Standards and Technology (NIST).

2.3 Cognizant Personnel

Universal Electronics, Inc.

Jesse Mendez Staff Engineer, Electrical

Compatible Electronics Inc.

Kyle Fujimoto Sr. Test Engineer

James Ross Sr. Test Engineer

2.4 Date Test Sample was Received

The test sample was received on prior to the initial test date.

2.5 Disposition of the Test Sample

The test sample has not been returned to Universal Electronics, Inc. as of the date of this test report.

2.6 Abbreviations and Acronyms

The following abbreviations and acronyms may be used in this document.

EMI	Electromagnetic Interference
EUT	Equipment Under Test
P/N	Part Number
S/N	Serial Number
FCC	Federal Communications Commission
DoC	Declaration of Conformity
N/A	Not Applicable
Tx	Transmit
Rx	Receive
Inc.	Incorporated
RF	Radio Frequency
BLE	Bluetooth Low Energy
CFR	Code of Federal Regulations
Sr.	Senior
DC	Direct Current
RSS	Radio Standards Specification

3. APPLICABLE DOCUMENTS

The following documents are referenced or used in the preparation of this emissions Test Report.

SPEC	TITLE
FCC Title 47, Part 15 Subpart C	FCC Rules – Radio frequency devices (including digital devices) – Intentional Radiators
FCC Title 47, Part 15 Subpart B	FCC Rules – Radio frequency devices (including digital devices) – Unintentional Radiators
558074 D01 DTS Meas Guidance v05 r02	Guidance for Performing Compliance Measurements on Digital Transmissions Systems (DTS) Operating Under Section 15.247
EN 50147-2: 1997	Anechoic chambers. Alternative test site suitability with respect to site attenuation
ANSI C63.4 2014	American National Standard for Methods of Measurement of Radio-Noise Emissions from Low-Voltage Electrical and Electronic Equipment in the Range of 9 kHz to 40 GHz
ANSI C63.10 2013	American National Standard for Testing Unlicensed Wireless Devices
RSS-Gen Issue 5: 2018 + Amendment 1: 2019 + Amendment 2: 2021	General Requirements for Compliance of Radio Apparatus
RSS-247 Issue 2 February 2017	Digital Transmissions Systems (DTSs), Frequency Hopping Systems (FHSs) and Licence-Exempt Local Area Network (LE-LAN) Devices

4. DESCRIPTION OF TEST CONFIGURATION

The Carrier Entry Level and ICP Thermostat 2024, Model: TSTATCCEWF-01 (EUT) was mounted on a stand with seven buttons and a Class 2 transformer. The EUT was continuous transmitting BLE, 802.11b, 802.11g, 802.11n (20 MHz), or 802.11n (40 MHz) on a continuous basis.

The EUT also displayed the temperature when in normal operation.

The cables were moved to maximize the emissions. The final conducted and radiated data was taken in the modes described above. All initial investigations were performed with the EMI Receiver in manual mode scanning the frequency range continuously. The cables were bundled and routed as shown in the photographs in Appendix D.

The firmware was stored on the company's servers.

4.1.1 Cable Construction and Termination

Cable 1

This is a 1-meter unshielded cable connecting the “G” button to J1, pin 3 of the EUT. The cable is hard wired at each end.

Cable 2

This is a 1-meter unshielded cable connecting the “ACC1” button to J2, pin 2 on the EUT. The cable is hard wired at each end.

Cable 3

This is a 1-meter unshielded cable connecting the “ACC2” button to J2, pin 1 on the EUT. The cable is hard wired at each end.

Cable 4

This is a 1-meter unshielded cable connecting the “W2” button to J2, pin 3 on the EUT. The cable is hard wired at each end.

Cable 5

This is a 1-meter unshielded cable connecting the “W1” button to J2, pin 4 on the EUT. The cable is hard wired at each end.

Cable 6

This is a 1-meter unshielded cable connecting the “Y2” button to J1, pin 1 on the EUT. The cable is hard wired at each end.

Cable 7

This is a 1-meter unshielded cable connecting the “Y1” button to J1, pin 2 on the EUT. The cable is hard wired at each end.

Cable 8

This is a 1-meter unshielded cable connecting J2, pin 5 of the EUT to GND. The cable is hard wired at each end.

Cable 9

This is a 1-meter unshielded cable connecting the class 2 transformer to J1, pin 4 of the EUT and GND. The cable is hard wired at each end.

Cables 10-16

These are 10-centimeter unshielded cables connecting the “G”, “ACC1”, “ACC2”, “W2”, “W1”, “Y2”, and “Y1” buttons to GND. The cables are hard wired at each end. Each button has a separate cable.

5. LISTS OF EUT, ACCESSORIES AND TEST EQUIPMENT

5.1 EUT and Accessory List

EQUIPMENT	MANUFACTURER	MODEL NUMBER	SERIAL NUMBER
CARRIER ENTRY LEVEL AND ICP THERMOSTAT 2024	UNIVERSAL ELECTRONICS, INC.	TSTATCCEWF-01	UNIT 4
LAPTOP*	UNIVERSAL ELECTRONICS, INC.	LATTITUDE E6440	CCHDVY1
WIFI FIRMWARE	AMEBA D	UI_mptool_2V2	N/A
BLUETOOTH FIRMWARE	REALTEK	VERSION 5.3.1.4	N/A
CLASS 2 TRANSFORMER**	MG ELECTRONICS	MGT2420	N/A

*The laptop was used to program the EUT only and was removed from the test setup after the EUT was programmed.

**The Class 2 Transformer is used to power the EUT with 24 VAC. It will not be sold with the EUT. The EUT would normally get its power from the 24 VAC from the HVAC system.

5.2 Emissions Test Equipment

EQUIPMENT TYPE	MANU-FACTURER	MODEL NUMBER	SERIAL NUMBER	CAL. DATE	CAL. DUE DATE
TDK TestLab	TDK RF Solutions, Inc.	9.22	700145	N/A	N/A
EMI Receiver, 3 Hz – 44 GHz	Keysight Technologies, Inc.	N9038A	MY59050117	July 14, 2023	July 14, 2024
System Controller	Sunol Sciences Corporation	SC110V	112213-1	N/A	N/A
Turntable	Sunol Sciences Corporation	2011VS	N/A	N/A	N/A
Antenna-Mast	Sunol Sciences Corporation	TWR95-4	112213-3	N/A	N/A
Loop Antenna	Com-Power	AL-130R	121090	February 10, 2022	February 10, 2025
CombiLog Antenna	Com-Power	AC-220	10030004	November 22, 2023	November 22, 2025
Horn Antenna	Com-Power	AH-118	10050192	November 30, 2023	November 30, 2025
Preamplifier	Com-Power	PA-118	181653	March 7, 2022	March 7, 2024
Horn Antenna	Com-Power	AH826	0071957	NCR	NCR
High Pass Filter	Microwave Circuits	H3G020G4	481459	February 16, 2022	February 16, 2024
Preamplifier	Com-Power	PA-840	711013	April 8, 2022	April 8, 2024
Multimeter	Fluke	115	36601149WS	November 21, 2021	November 21, 2024
Variable Autotransformer	Staco Energy Products	3PN2210	003	N/A	N/A
Below 1 GHz Radiated Cable	N/A	N/A	Asset #: 0006	October 27, 2023	October 27, 2025
Power Sensor	ETS-Lindgren	7002-006	00151018	June 2, 2022	June 2, 2024
Above 1 GHz Cable	Suhner	Sucoflex 102EA	2291	August 22, 2023	August 22, 2024
Above 1 GHz Cable	Suhner	Sucoflex 102EA	501393	August 22, 2023	August 22, 2024
Above 1 GHz Cable	Suhner	Sucoflex 102EA	501394	August 22, 2023	August 22, 2024
LISN (EUT)	Com-Power	LI-220C	20070069	July 24, 2023	July 24, 2024
Attenuator 10 dB	SureCall	SC-ATT-10	17100174	December 2, 2022	December 2, 2024
Computer	Hewlett Packard	p6716f	MXX1030PX0	N/A	N/A

6. TEST SITE DESCRIPTION

6.1 Test Facility Description

Please refer to section 2.1 of this report for emissions test location.

6.2 EUT Mounting, Bonding and Grounding

For frequencies 1 GHz and below: The EUT was mounted on a 0.6 by 1.2 meter non-conductive table 0.8 meters above the ground plane.

For frequencies above 1 GHz: The EUT was mounted on a 0.6 by 1.2 meter non-conductive table 1.5 meters above the ground plane.

The EUT was not grounded.

6.3 Measurement Uncertainty

Compatible Electronics' U_{lab} value is less than U_{cispr} , thus based on this – compliance is deemed to occur if no measured disturbance exceeds the disturbance limit

$$u_c(y) = \sqrt{\sum_i c_i^2 u^2(x_i)}$$

Measurement		U_{cispr}	$U_{lab} = 2 u_c(y)$
Conducted disturbance (mains port)	(150 kHz – 30 MHz)	3.4 dB	2.72 dB
Radiated disturbance (electric field strength on an open area test site or alternative test site)	(30 MHz – 1 000 MHz)	6.3 dB	3.32 dB (Vertical) 3.30 dB (Horizontal)
Radiated disturbance (electric field strength on an open area test site or alternative test site)	(1 GHz - 6 GHz)	5.2 dB	4.06 dB
Radiated disturbance (electric field strength on an open area test site or alternative test site)	(6 GHz – 18 GHz)	5.5 dB	4.06 dB
Radiated disturbance (electric field strength on an open area test site or alternative test site)	(18 GHz – 26.5 GHz)	N/A	4.43 dB
Radiated disturbance (electric field strength on an open area test site or alternative test site)	(26.5 GHz – 40 GHz)	N/A	4.57 dB

7. CHARACTERISTICS OF THE TRANSMITTER

7.1 Channel Description and Frequencies

BLE Mode: The EUT operates on 40 channels. The low channel is 2402 MHz and the high channel is 2480 MHz.

802.11b Mode: The EUT operates on 11 channels. The low channel is 2412 MHz and the high channel is 2462 MHz.

802.11g Mode: The EUT operates on 11 channels. The low channel is 2412 MHz and the high channel is 2462 MHz.

802.11n Mode (20 MHz): The EUT operates on 11 channels. The low channel is 2412 MHz and the high channel is 2462 MHz.

802.11 n Mode (40 MHz): The EUT operates on 9 channels. The low channel is 2422 MHz and the high channel is 2462 MHz.

7.2 Antenna Gain

The EUT utilizes is a PCB trace antenna with 1.9 dBi gain.

8. TEST PROCEDURES

The following sections describe the test methods and the specifications for the tests. Test results are also included in this section.

8.1 RF Emissions

8.1.1 Conducted Emissions Test

The EMI Receiver was used as a measuring meter. A quasi-peak and/or average reading was taken only where indicated in the data sheets. A 10 dB attenuator was used for the protection of the EMI Receiver input stage, and the offset was adjusted accordingly to read the actual data measured. The LISN output was measured using the EMI Receiver. The output of the second LISN was terminated by a 50-ohm termination. The effective measurement bandwidth used for this test was 9 kHz.

Please see section 6.2 of this report for mounting, bonding, and grounding of the EUT. The EUT was powered through the LISN, which was bonded to the ground plane. The LISN power was filtered and the filter was bonded to the ground plane. The EUT was set up with the minimum distances from any conductive surfaces as specified in ANSI 63:4. The excess power cord was wrapped in a figure eight pattern to form a bundle not exceeding 0.4 meters in length.

The conducted emissions from the EUT were maximized for operating mode as well as cable placement. The final data was collected under program control by computer software. The final qualification data is located in Appendix E.

The six highest emissions are listed in Table 1.

Test Results:

The EUT complies with the **Class B** limits of CFR Title 47, Part 15, Subpart B; the limits of CFR Title 47, Part 15, Subpart C section 15.207; and the limits of RSS-Gen for conducted emissions.

8.1.2 Radiated Emissions Test

The EMI Receiver was used as the measuring meter. An internal preamplifier was used to increase the sensitivity of the instrument during emissions tests up to 1000 MHz, and an external preamplifier was used to increase the sensitivity of the instrument during emissions tests above 1 GHz. The EMI Receiver was initially used with the Analyzer mode feature activated. In this mode, the EMI receiver can then record the actual frequency to be measured. This final reading is then taken accurately in the EMI Receiver mode, which considers the cable loss, amplifier gain and antenna factors, so that a true reading is compared to the true limit. The effective measurement bandwidth used for the radiated emissions test was according to the frequency measured.

The frequencies below 1 GHz were quasi-peaked using the quasi-peak detector of the EMI Receiver.

The frequencies above 1 GHz were averaged using the RMS detector of the EMI Receiver.

The EMI test chamber of Compatible Electronics, Inc. was used for radiated emissions testing. This test site is in full compliance with ANSI C63.4. Please see section 6.2 of this report for mounting, bonding and grounding of the EUT. The turntable supporting the EUT is remote controlled using a motor. The turntable permits EUT rotation of 360 degrees to maximize emissions. Also, the antenna mast allows height variation of the antenna from 1 meter to 4 meters. Data was collected in the worst case (highest emission) configuration of the EUT. At each reading, the EUT was rotated 360 degrees and the antenna height was varied from 1 to 4 meters (for E field radiated field strength). The gunsight method was used when measuring with the horn antenna to ensure accurate results.

The EUT was tested at a 3-meter test distance. The six highest emissions are listed in Table 2.

Radiated Emissions Test (Continued)

The measurement bandwidths and transducers used for the radiated emissions test were:

FREQUENCY RANGE	EFFECTIVE MEASUREMENT BANDWIDTH	TRANSDUCER
9 kHz to 150 kHz	200 Hz	Loop Antenna
150 kHz to 30 MHz	9 kHz	Loop Antenna
30 MHz to 1 GHz	120 kHz	CombiLog Antenna
1 GHz to 9.2 GHz	1 MHz	Horn Antenna

Test Results:

The EUT complies with the **Class B** limits of CFR Title 47, Part 15, Subpart B; the limits of CFR Title 47, Part 15, Subpart C sections 15.205, 15.209 and 15.247; and the limits of RSS-247 and RSS-Gen for radiated emissions.

8.1.3 RF Emissions Test Results

Table 1 CONDUCTED EMISSION RESULTS
 Carrier Entry Level and ICP Thermostat 2024, Model: TSTATCCEWF-01

Frequency MHz	Average Corrected Reading* dB μ V/m	Average Specification Limit dB μ V/m	Delta (Cor. Reading – Spec. Limit) dB
0.158 (BL) (BLE – 2 Mbit)	33.08	54.88	-21.89
0.158 (BL) (BLE – 1 Mbit)	33.40	55.50	-22.10
0.170 (BL) (802.11g)	32.45	54.55	-22.10
0.178 (BL) (802.11n – 40 MHz)	32.09	54.26	-22.16
0.174 (BL) (802.11n – 20 MHz)	32.39	54.47	-22.08
0.194 (BL) (BLE – 2 Mbit)	31.46	53.65	-22.19

Table 2 RADIATED EMISSION RESULTS
 Carrier Entry Level and ICP Thermostat 2024, Model: TSTATCCEWF-01

Frequency MHz	Corrected Reading* dB μ V/m	Specification Limit dB μ V/m	Delta (Cor. Reading – Spec. Limit) dB
2390.00 (H) (802.11n – 20 MHz)	49.69	53.97	-4.28
2390.00 (V) (802.11n – 20 MHz)	48.13	53.97	-5.84
2483.50 (H) (802.11n – 40 MHz)	47.44	53.97	-6.53
2483.50 (V) (802.11n – 40 MHz)	47.30	53.97	-6.67
2390.00 (V) (802.11n – 40 MHz)	47.06	53.97	-6.91
2483.50 (V) (802.11g)	46.97	53.97	-7.00

Notes:

- * The complete emissions data is given in Appendix E of this report.
- (V) Vertical
- (H) Horizontal
- (BL) Black Lead
- (WL) White Lead
- (AV) Average
- (QP) Quasi-Peak

8.1.4 Sample Calculations

A correction factor for the antenna, cable, and a distance factor (if any) must be applied to the meter reading before a true field strength reading can be obtained. This Corrected Meter Reading is then compared to the specification limit in order to determine compliance with the limits.

Conversion to logarithmic terms: Specification limit ($\mu\text{V}/\text{m}$) $\log \times 20 =$ Specification Limit in $\text{dB}\mu\text{V}/\text{m}$

To correct for distance when measuring at a distance other than the specification

For measurements below 30 MHz: (Specification distance / test distance) $\log \times 40 =$ distance factor

For measurements above 30 MHz: (Specification distance / test distance) $\log \times 20 =$ distance factor

Note: When using an Active Antenna, the Antenna factor shall be subtracted due to the combination of the internal amplification and antenna loss.

Corrected Meter Reading = meter reading + F – A + C

where: F = antenna factor
A = amplifier gain
C = cable loss

The correction factors for the antenna and the amplifier gain are attached in Appendix D of this report. The data sheets are attached in Appendix E.

The distance factor D is 0 when the test is performed at the required specification distance.

When the limit is in terms of magnetic field, the following equation applies:

$$H[\text{dB}(\mu\text{A}/\text{m})] = V[\text{dB}(\mu\text{V})] + L_C [\text{dB}] - G_{PA} [\text{dB}] + AF^H [\text{dB}(\text{S}/\text{m})]$$

where: H is the magnetic field strength (to be compared with the limit),
 V is the voltage level measured by the receiver or spectrum analyzer,
 L_C is the cable loss,
 G_{PA} is the gain of the preamplifier (if used), and
 AF^H is the magnetic antenna factor.

The G_{PA} term is only included in the equation when an external preamplifier is used in the measurement chain, in front of the receiver or spectrum analyzer. An external preamplifier is not usually necessary (or even advisable, due to risk of saturating the input mixer of the receiver) when an active loop antenna is used. In that case, the antenna factor of the loop already includes the gain of its built-in preamplifier.

Sample Calculations (Continued)

If the “electrical” antenna factor is used instead, the above equation becomes:

$$H[\text{dB}(\mu\text{A}/\text{m})] = V[\text{dB}(\mu\text{V})] + L_C[\text{dB}] - G_{\text{PA}}[\text{dB}] + AF^E[\text{dB}(\text{m}^{-1})] - 51.5[\text{dB}\Omega]$$

where: AF^E is the “electric” antenna factor, as provided by the antenna calibration laboratory.

When the limit is in terms of electric field, the following equation applies:

$$E[\text{dB}(\mu\text{V}/\text{m})] = V[\text{dB}(\mu\text{V})] + L_C[\text{dB}] - G_{\text{PA}}[\text{dB}] + AF^E[\text{dB}(\text{m}^{-1})]$$

or, if the magnetic antenna factor is used:

$$E[\text{dB}(\mu\text{V}/\text{m})] = V[\text{dB}(\mu\text{V})] + L_C[\text{dB}] - G_{\text{PA}}[\text{dB}] + AF^H[\text{dB}(\text{S}/\text{m})] + 51.5[\text{dB}\Omega]$$

The display of the receiver (or spectrum analyzer) **shall not** be configured in units of current, e.g. μA or $\text{dB}(\mu\text{A})$. That conversion is calculated inside the receiver (or spectrum analyzer) using its input impedance, which is $50\ \Omega$, while the magnetic field calculation is based on the free-space impedance of $377\ \Omega$.

8.2 DTS Bandwidth

The DTS Bandwidth was measured using the EMI Receiver. The bandwidth was measured using a direct connection from the EUT. The following steps were performed for measuring the DTS Bandwidth.

1. Set RBW = 100 kHz
2. Set the video bandwidth (VBW) to equal or greater than 3 times the RBW
3. Detector = Peak
4. Trace Mode = Max Hold
5. Sweep = Auto Couple
6. Allow the trace to stabilize
7. Measure the maximum width of the emission that is constrained by the frequencies associated with the two outermost amplitude points (upper and lower frequencies) that are attenuated by 6 dB relative to the maximum level measured in the fundamental emission.

Test Results:

The EUT complies with the relevant requirements of FCC Title 47, Part 15, Subpart C section 15.247 (a)(2); and RSS-247.

8.3 Maximum Peak Conducted Output Power – BLE Mode

The maximum peak conducted output power was measured using the EMI Receiver. The following steps were performed for measuring the maximum peak conducted output power.

1. Set the RBW \geq DTS Bandwidth
2. Set the VBW \geq [3 X RBW]
3. Set span \geq [3 X RBW]
4. Sweep time = auto couple
5. Detector = peak
6. Trace mode = max hold
7. Allow trace to fully stabilize
8. Use the peak marker function to determine the peak amplitude level

Test Results:

The EUT complies with the relevant requirements of CFR Title 47, Part 15, Subpart C Section 15.247 (b)(3); and RSS-247.

8.4 Maximum Peak Conducted Output Power – WiFi Mode

The maximum peak conducted output power was measured using the power meter. The output power was measured using the procedure described in section 11.9.1.3 of ANSI C63.10

Test Results:

The EUT complies with the relevant requirements of CFR Title 47, Part 15, Subpart C Section 15.247 (b)(3); and RSS-247.

8.5 Emissions in Non-Restricted Bands

The emissions in the non-restricted frequency bands measurements were performed using the EMI receiver directly connected to the EUT. The reference level was established by setting the instrument center frequency to DTS channel center frequency. The span was set to ≥ 1.5 times the DTS bandwidth. The RBW was set to 100 kHz and the VBW was set to 300 kHz. A peak detector was used with sweep set to auto. A max hold trace was used and allowed to fully stabilize. The peak marker function was used to determine the level and 20 dB below that was the reference level. For emission level measurement, the center frequency and span were set to encompass the frequency range to be measured. The RBW was set to 100 kHz and the VBW was set to 300 kHz. A peak detector was used with a sweep time set to auto. The number of measurement points were greater than the span/RBW. A max hold trace was used and allowed to fully stabilize. The peak marker function was used to determine the maximum amplitude level. The final qualification data sheets are located in Appendix E.

Test Results:

The EUT complies with the relevant requirements of FCC Title 47, Part 15, Subpart C section 15.247 (d); and RSS-247.

8.6 RF Band Edges

The RF band edges were taken at 2390 MHz when the EUT was on the low channel and 2483.5 MHz when the EUT was on the high channel using the EMI Receiver. A preamplifier was used to boost the signal level, with the plots being taken at a 3-meter test distance. The radiated emissions test procedure as described in section 8.1.2 of this test report was used to maximize the emission.

Test Results:

The EUT complies with the relevant requirements of FCC Title 47, Part 15, Subpart C section 15.247 (d). The RF power at the restricted bands closest to the band edges at 2390 MHz and 2483.5 MHz also meet the limits of section 15.209; and RSS-247. Please see the data sheets located in Appendix E.

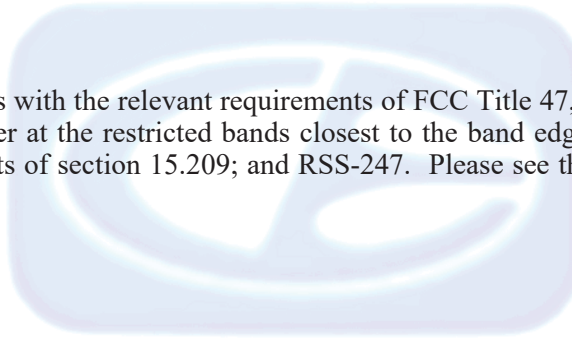

8.7 Spectral Density Test

The spectrum density output was measured using the EMI Receiver. The spectral density output was measured using a direct connection from the RF out on the EUT into the input of the EMI Receiver. The following steps were performed for measuring the spectral density.

1. Set analyzer center frequency to DTS channel center frequency
2. Set the span to 1.5 times the OBW.
3. Set the RBW to $3 \text{ kHz} \leq \text{RBW} \leq 100 \text{ kHz}$
4. Set the VBW $\geq [3 \times \text{RBW}]$
5. Detector = peak
6. Sweep time = auto couple
7. Trace mode = max hold
8. Allow trace to fully stabilize
9. Use the peak marker function to determine the maximum amplitude level within the RBW
10. If measured value exceeds requirement, then reduce RBW (but no less than 3 kHz) and repeat.

Test Results:

The EUT complies with the relevant requirements of FCC Title 47, Part 15, Subpart C section 15.247 (e); and RSS-247.

8.8 99 % Bandwidth

The 99 % bandwidth was measured using an EMI Receiver.

The following steps were performed for measuring the 99 % bandwidth per RSS-GEN, Issue 5, clause 6.7:

1. Set RBW to 1 % to 5 % of the actual occupied bandwidth.
2. Set VBW to greater than 3 times the RBW.
3. Set the EMI Receiver to the occupied bandwidth Function set at 99 %
4. Set the peak detector to max hold.
5. Set the sweep time to auto
6. Allow the trace to stabilize.

Please note that this was only used to determine the emission bandwidth and that there are no limits or pass/fail criteria for this test. Please see the data sheets located in Appendix E.

8.9 Variation of the Input Power

The variation of the input power test was performed using the EMI Receiver. The EUT input power was varied between 85% and 115% of the nominal rated supply voltage. The carrier frequency was monitored for any change in amplitude.

Test Results:

The EUT complies with the relevant requirements of FCC Title 47, Part 15, Subpart C section 15.31 (e); and RSS-247.

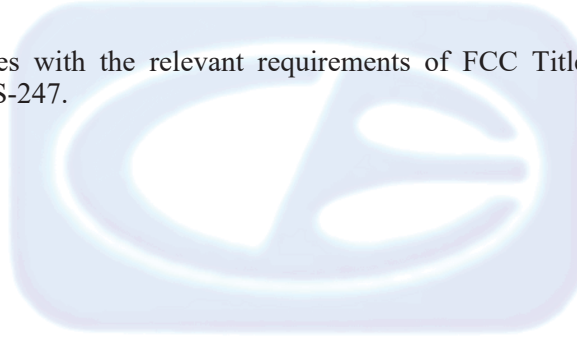

9. CONCLUSIONS

The Carrier Entry Level and ICP Thermostat 2024, Model: TSTATCCEWF-01, as tested, meets all of the specification limits defined in FCC Title 47, Part 15, Subpart B; and Subpart C, sections 15.205, 15.207, 15.209, and 15.247; RSS-GEN and RSS-247.





APPENDIX A

LABORATORY ACCREDITATIONS AND RECOGNITIONS

Brea Division
114 Olinda Drive
Brea, CA 92823
(714) 579-0500

Lake Forest Division
20621 Pascal Way
Lake Forest, CA 92630
(949) 587-0400

Newbury Park Division
1050 Lawrence Drive
Newbury Park, CA 91320
(805) 480-4044

LABORATORY ACCREDITATIONS AND RECOGNITIONS



For US, Canada, Australia/New Zealand, Japan, Taiwan, Korea, and the European Union, Compatible Electronics is currently accredited by NVLAP to ISO/IEC 17025. **For the most up-to-date version of our scopes and certificates please visit <http://celectronics.com/quality/scope/>**

Quote from ISO-ILAC-IAF Communiqué on 17025:

"A laboratory's fulfilment of the requirements of ISO/IEC 17025:2005 means the laboratory meets both the technical competence requirements and management system requirements that are necessary for it to consistently deliver technically valid test results and calibrations. The management system requirements in ISO/IEC 17025:2005 (Section 4) are written in language relevant to laboratory operations and meet the principles of ISO 9001:2008 Quality Management Systems — Requirements."

ISED Test Site Registration Number: 2154A





APPENDIX B

MODIFICATIONS TO THE EUT

MODIFICATIONS TO THE EUT

The modifications listed below were made to the EUT to pass FCC Subpart B and FCC 15.247; RSS-GEN and RSS-247 specifications.

All the rework described below was implemented during the test in a method that could be reproduced in all the units by the manufacturer.

No modifications were made to the EUT during the testing.





APPENDIX C

***MODELS COVERED
UNDER THIS REPORT***

MODELS COVERED UNDER THIS REPORT

USED FOR THE PRIMARY TEST

Carrier Entry Level and ICP Thermostat 2024
Model: TSTATCCEWF-01
S/N: UNIT 4

There are no additional models covered under this report.





APPENDIX D

DIAGRAMS AND CHARTS

FIGURE 1: CONDUCTED EMISSIONS TEST SETUP

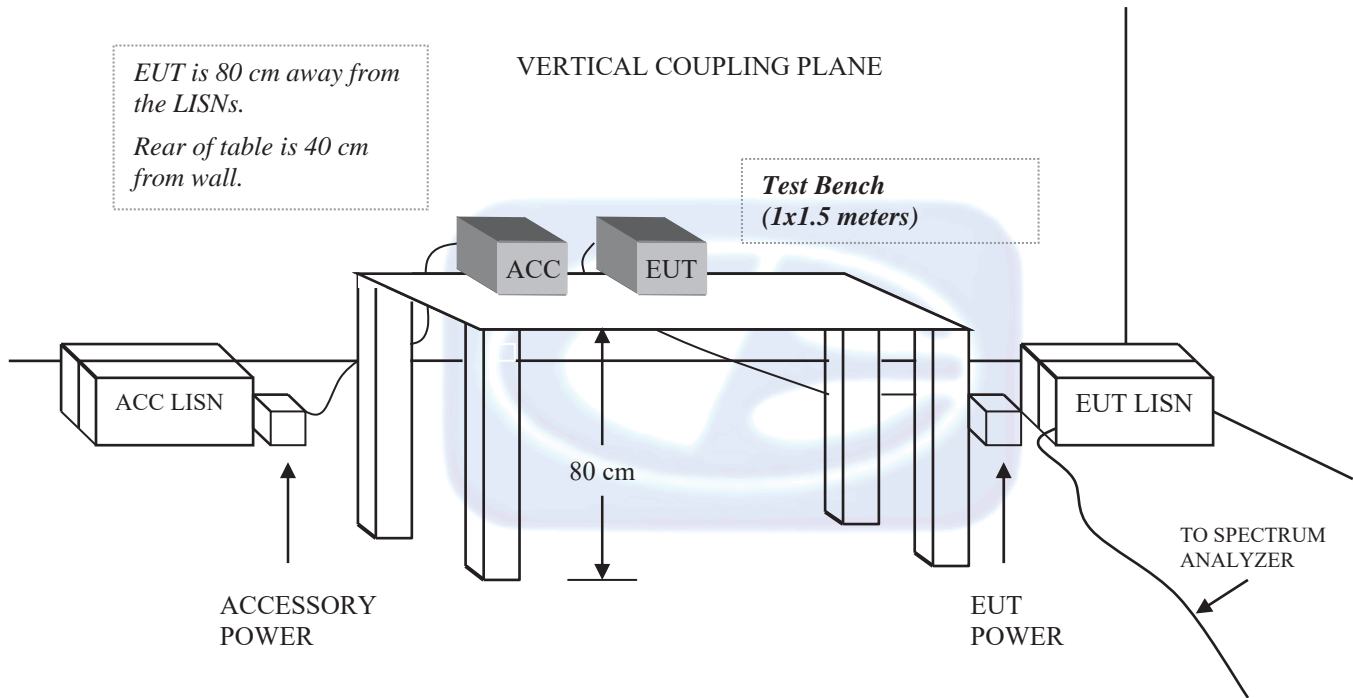
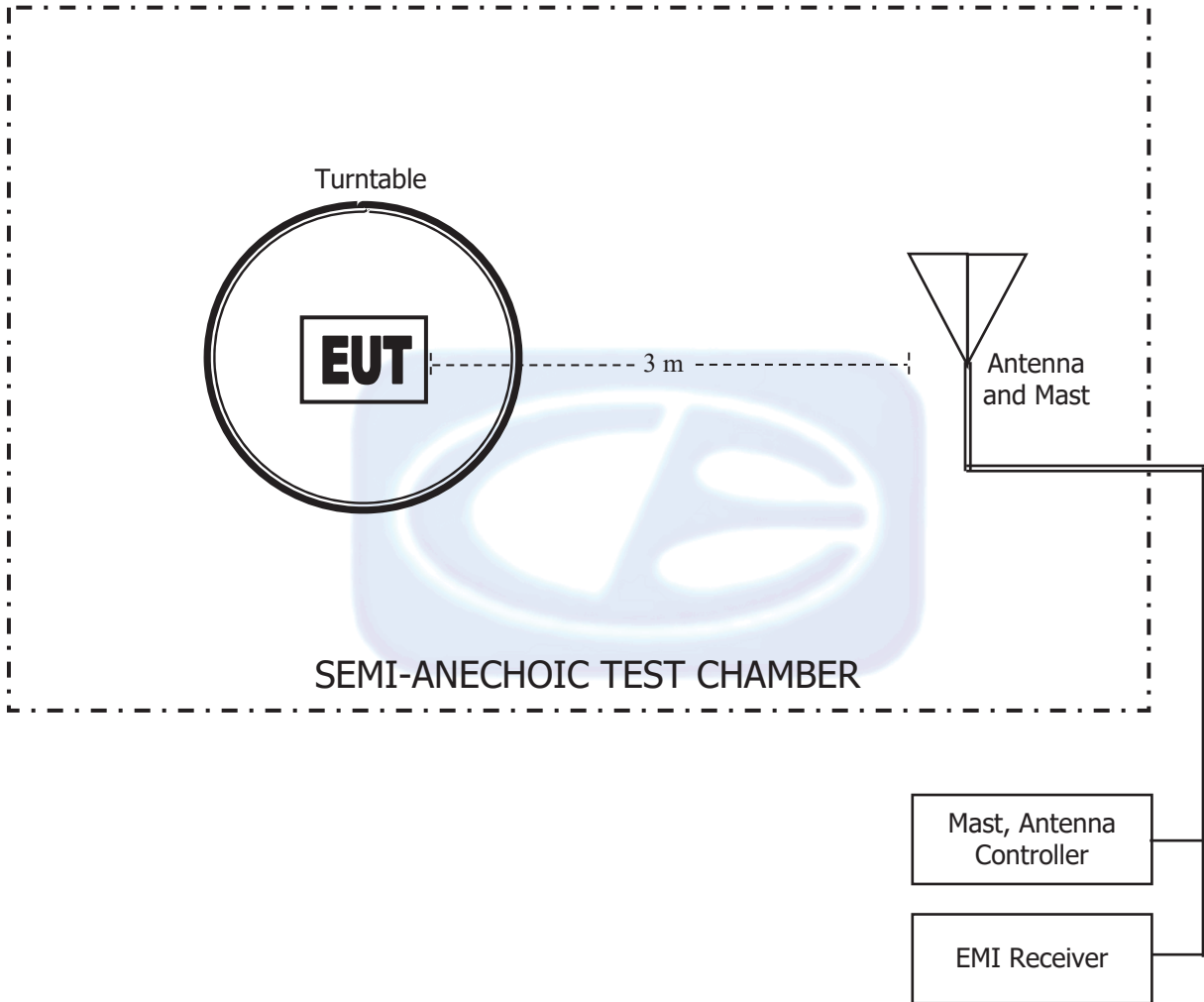

FIGURE 2: LAYOUT OF THE SEMI-ANECHOIC TEST CHAMBER



COM-POWER AL-130R**LOOP ANTENNA**

S/N: 121090

CALIBRATION DATE: FEBRUARY 10, 2022

FREQUENCY (MHz)	MAGNETIC (dB/m)	ELECTRIC (dB/m)
0.009	15.6	-35.8
0.01	15.8	-35.6
0.02	14.8	-36.6
0.03	15.6	-35.9
0.04	15.0	-36.5
0.05	14.4	-37.1
0.06	14.6	-36.9
0.07	14.3	-37.2
0.08	14.3	-37.2
0.09	14.4	-37.0
0.10	14.1	-37.4
0.20	14.1	-37.4
0.30	14.0	-37.5
0.40	13.9	-37.6
0.50	14.1	-37.3
0.60	14.1	-37.3
0.70	14.2	-37.3
0.80	14.2	-37.3
0.90	14.2	-37.2
1.00	14.4	-37.0
2.00	14.6	-36.9
3.00	14.6	-36.8
4.00	14.9	-36.6
5.00	14.9	-36.7
6.00	14.8	-36.7
7.00	14.6	-36.8
8.00	14.5	-37.0
9.00	14.3	-37.2
10.00	14.5	-37.0
11.00	14.6	-36.9
12.00	14.7	-36.7
13.00	14.9	-36.6
14.00	15.0	-36.5
15.00	14.9	-36.6
16.00	14.9	-36.6
17.00	14.6	-36.8
18.00	14.4	-37.1
19.00	14.5	-37.0
20.00	14.5	-37.0
21.00	14.2	-37.3
22.00	13.9	-37.5
23.00	13.9	-37.5
24.00	13.8	-37.7
25.00	13.4	-38.0
26.00	13.2	-38.2
27.00	13.2	-38.3
28.00	12.7	-38.7
29.00	12.7	-38.8
30.00	12.4	-39.0

COM-POWER AC-220**COMBILOG ANTENNA****S/N: 10030004****CALIBRATION DATE: NOVEMBER 22, 2023**

FREQUENCY (MHz)	FACTOR (dB)	FREQUENCY (MHz)	FACTOR (dB)
30	23.10	200	16.10
35	22.00	250	17.90
40	41.30	300	19.10
45	20.50	350	20.30
50	19.30	400	21.60
60	15.40	450	22.20
70	12.40	500	23.20
80	12.40	550	23.70
90	14.10	600	25.10
100	15.50	650	25.30
120	15.90	700	25.10
125	15.90	750	26.70
140	14.80	800	26.60
150	14.60	850	27.20
160	14.80	900	28.00
175	15.90	950	29.10
180	15.50	1000	28.90

COM POWER AH-118**HORN ANTENNA****S/N: 10050192****CALIBRATION DATE: NOVEMBER 30, 2023**

FREQUENCY (GHz)	FACTOR (dB)	FREQUENCY (GHz)	FACTOR (dB)
1.0	24.01	10.0	38.78
1.5	25.25	10.5	39.29
2.0	27.21	11.0	39.30
2.5	27.42	11.5	39.87
3.0	28.89	12.0	39.77
3.5	30.58	12.5	40.21
4.0	31.78	13.0	40.01
4.5	32.48	13.5	40.06
5.0	33.13	14.0	40.63
5.5	34.27	14.5	41.41
6.0	34.92	15.0	41.53
6.5	35.58	15.5	40.59
7.0	36.83	16.0	41.63
7.5	37.02	16.5	40.93
8.0	36.93	17.0	41.27
8.5	37.67	17.5	41.69
9.0	37.53	18.0	44.00
9.5	38.76		

COM-POWER PAM-118**PREAMPLIFIER****S/N: 181653****CALIBRATION DATE: MARCH 7, 2022**

FREQUENCY (GHz)	FACTOR (dB)	FREQUENCY (GHz)	FACTOR (dB)
1.0	40.02	6.0	38.84
1.1	39.72	6.5	39.20
1.2	39.93	7.0	39.46
1.3	39.98	7.5	39.67
1.4	39.99	8.0	39.28
1.5	40.20	8.5	38.63
1.6	40.05	9.0	38.96
1.7	40.15	9.5	39.33
1.8	40.20	10.0	39.58
1.9	40.33	11.0	38.25
2.0	40.33	12.0	40.03
2.5	40.60	13.0	40.55
3.0	40.76	14.0	40.36
3.5	40.87	15.0	39.34
4.0	40.39	16.0	37.34
4.5	39.55	17.0	42.14
5.0	40.34	18.0	42.54
5.5	39.45		

COM-POWER AH-826**HORN ANTENNA**

S/N: 71957

FREQUENCY (GHz)	FACTOR (dB)	FREQUENCY (GHz)	FACTOR (dB)
18.0	33.5	22.5	35.5
18.5	33.5	23.0	35.9
19.0	34.0	23.5	35.7
19.5	34.0	24.0	35.6
20.0	34.3	24.5	36.0
20.5	34.9	25.0	36.2
21.0	34.7	25.5	36.1
21.5	35.0	26.0	36.2
22.0	35.0	26.5	35.7

COM-POWER PA-840**MICROWAVE PREAMPLIFIER**

S/N: 711013

CALIBRATION DATE: APRIL 8, 2022

FREQUENCY (GHz)	FACTOR (dB)	FREQUENCY (GHz)	FACTOR (dB)
18.0	24.85	31.0	25.37
19.0	24.25	31.5	25.44
20.0	22.69	32.0	24.96
21.0	22.17	32.5	26.17
22.0	22.78	33.0	25.83
23.0	23.23	33.5	25.19
24.0	23.72	34.0	26.31
25.0	24.13	34.5	24.70
26.0	24.28	35.0	25.31
26.5	25.06	35.5	24.39
27.0	26.22	36.0	25.09
27.5	24.85	36.5	25.24
28.0	25.30	37.0	27.10
28.5	25.01	37.5	27.45
29.0	25.54	38.0	23.72
29.5	26.23	38.5	23.01
30.0	26.00	39.0	21.29
30.5	25.39	39.5	21.11
		40.0	19.17

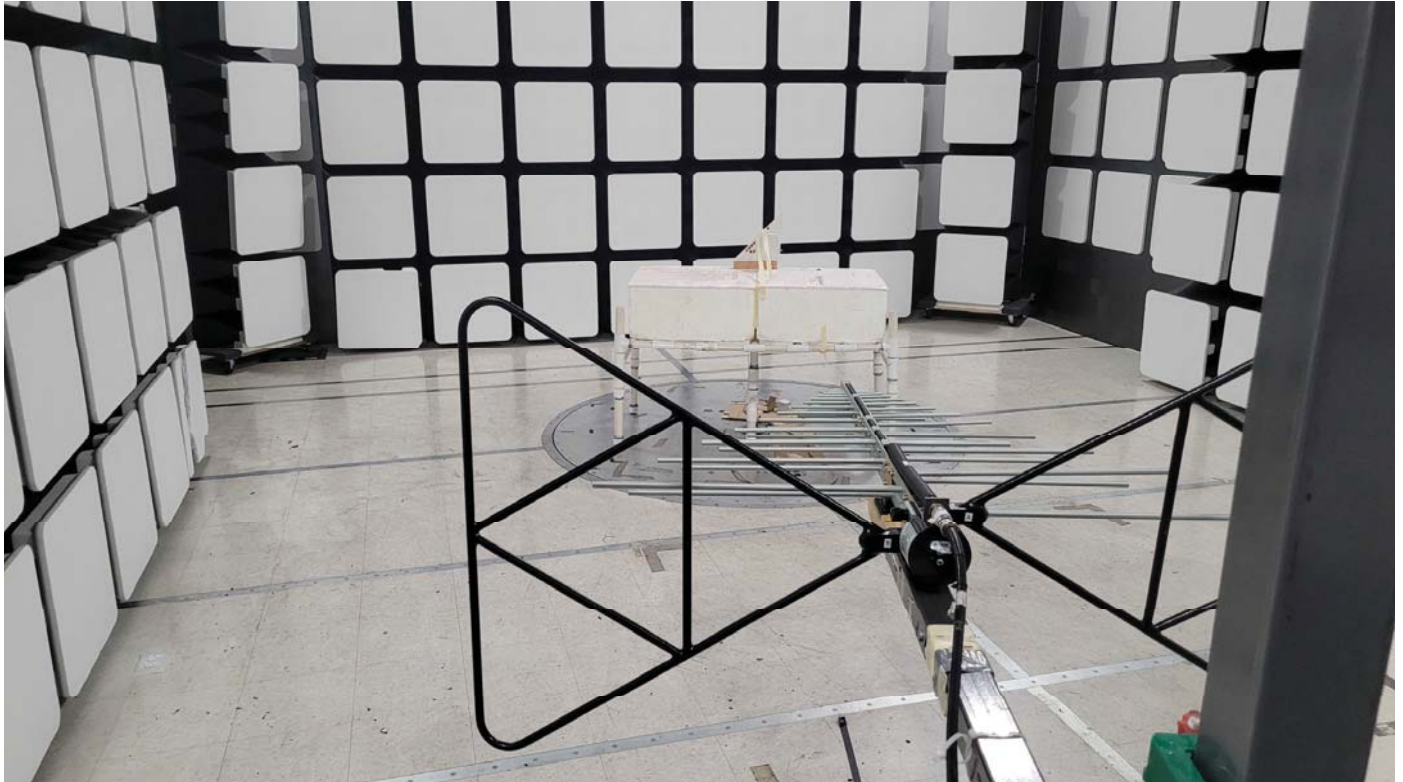

FRONT VIEW

UNIVERSAL ELECTRONICS, INC.
CARRIER ENTRY LEVEL AND ICP THERMOSTAT 2024
MODEL: TSTATCCEWF-01

FCC SUBPART B AND C; RSS-247 AND RSS-GEN – RADIATED EMISSIONS – BELOW 1 GHz

**PHOTOGRAPH SHOWING THE EUT CONFIGURATION
FOR MAXIMUM EMISSIONS**

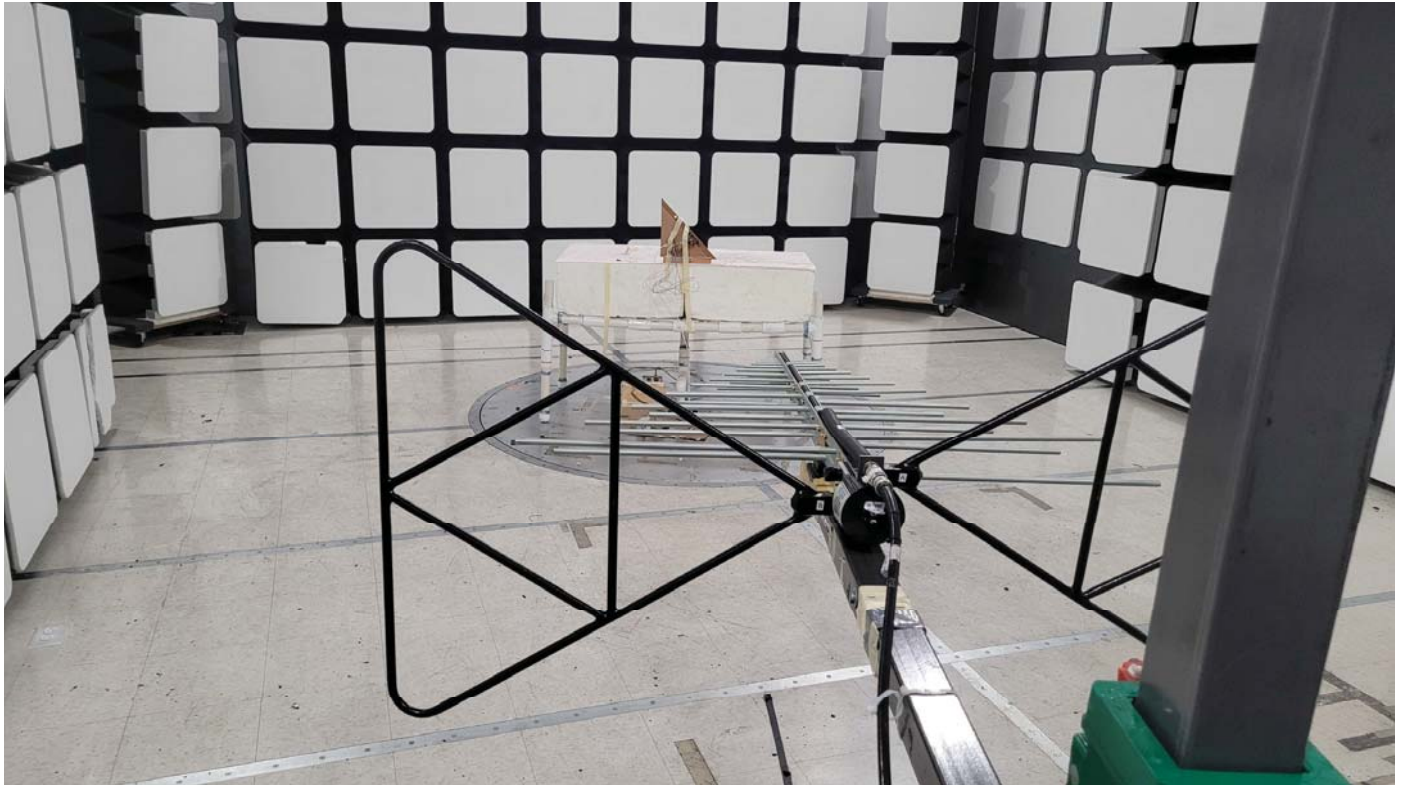

REAR VIEW

UNIVERSAL ELECTRONICS, INC.
CARRIER ENTRY LEVEL AND ICP THERMOSTAT 2024
MODEL: TSTATCCEWF-01

FCC SUBPART B AND C; RSS-247 AND RSS-GEN – RADIATED EMISSIONS – BELOW 1 GHz

**PHOTOGRAPH SHOWING THE EUT CONFIGURATION
FOR MAXIMUM EMISSIONS**

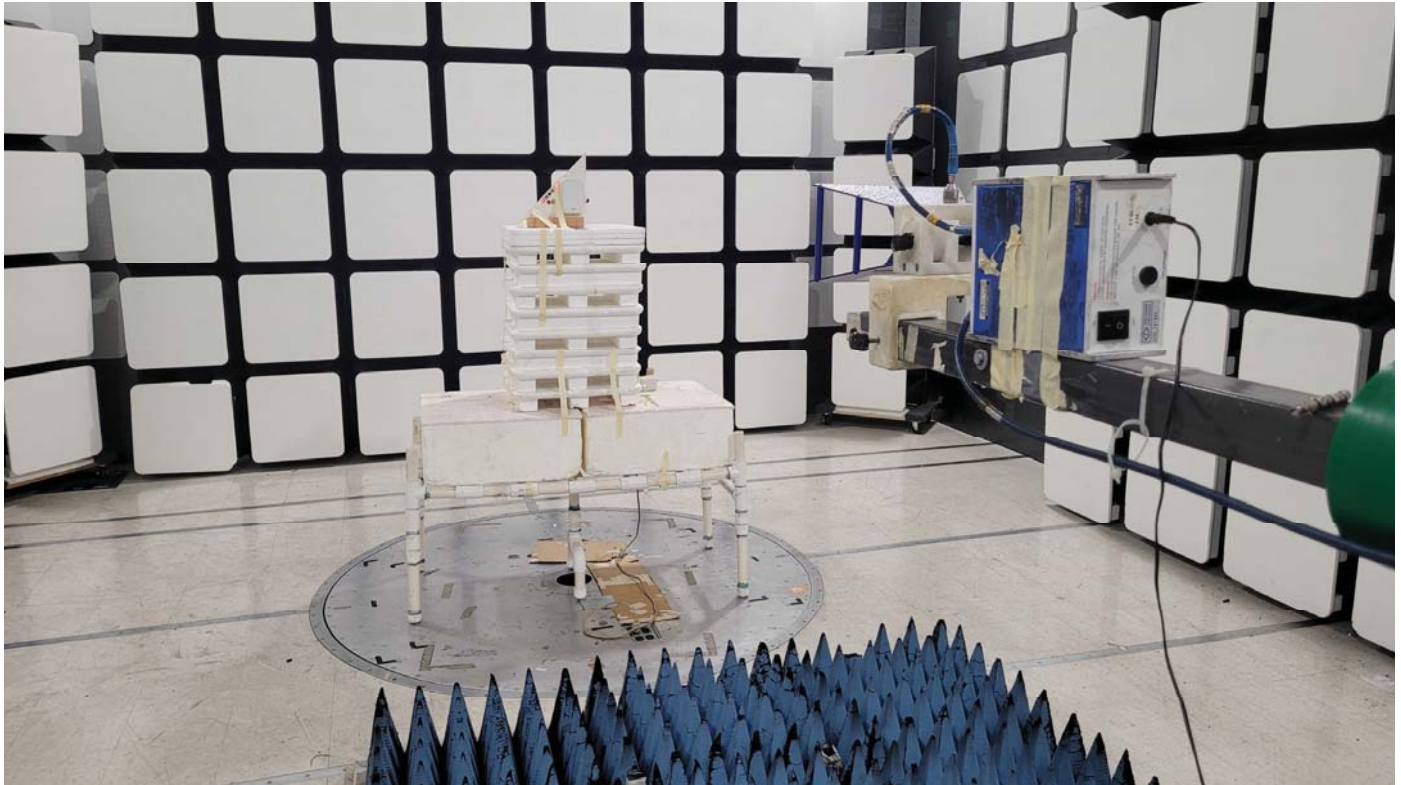

FRONT VIEW

UNIVERSAL ELECTRONICS, INC.
CARRIER ENTRY LEVEL AND ICP THERMOSTAT 2024
MODEL: TSTATCCEWF-01

FCC SUBPART B AND C; RSS-247 AND RSS-GEN – RADIATED EMISSIONS – ABOVE 1 GHz

**PHOTOGRAPH SHOWING THE EUT CONFIGURATION
FOR MAXIMUM EMISSIONS**

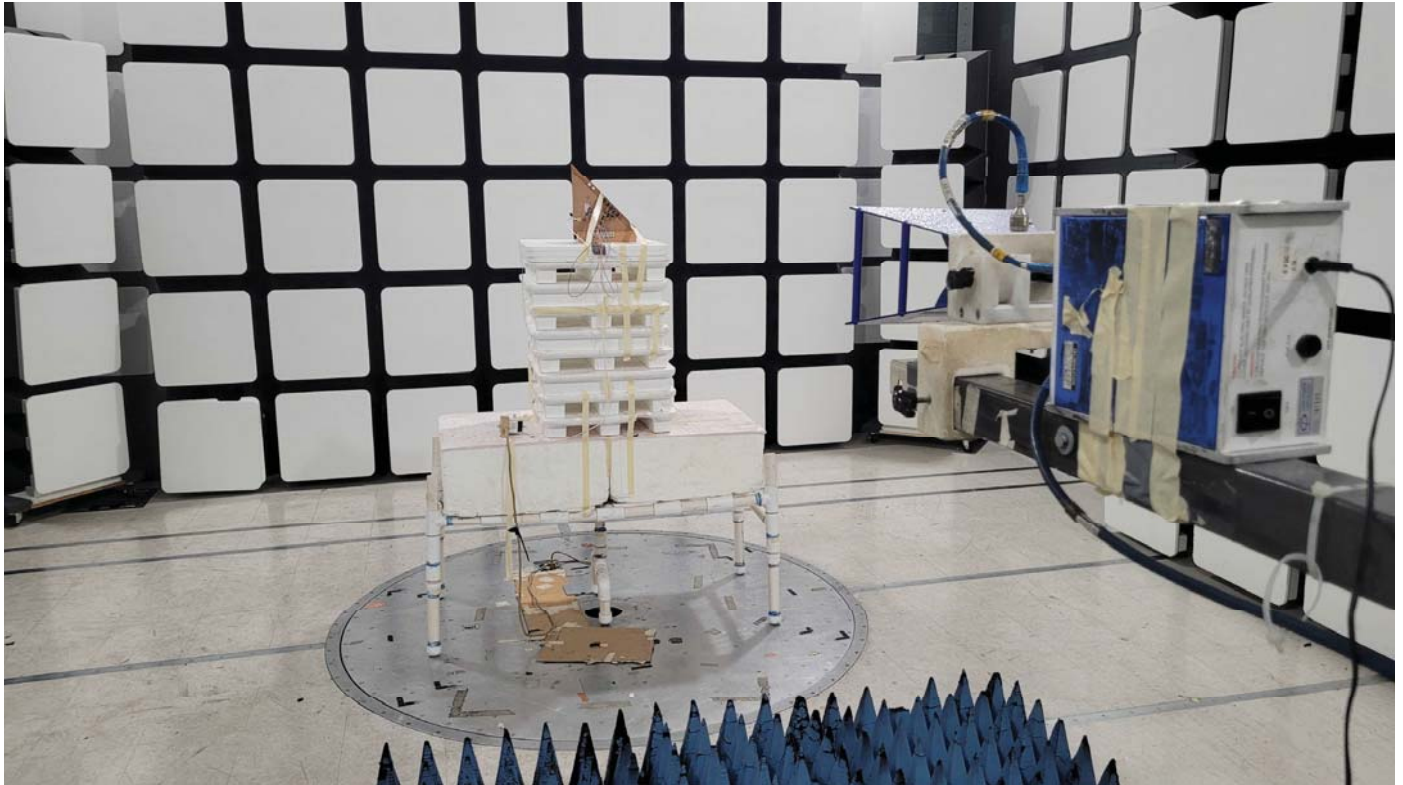

REAR VIEW

UNIVERSAL ELECTRONICS, INC.
CARRIER ENTRY LEVEL AND ICP THERMOSTAT 2024
MODEL: TSTATCCEWF-01

FCC SUBPART B AND C; RSS-247 AND RSS-GEN – RADIATED EMISSIONS – ABOVE 1 GHz

**PHOTOGRAPH SHOWING THE EUT CONFIGURATION
FOR MAXIMUM EMISSIONS**



FRONT VIEW

UNIVERSAL ELECTRONICS, INC.
CARRIER ENTRY LEVEL AND ICP THERMOSTAT 2024
MODEL: TSTATCCEWF-01
FCC SUBPART B AND C; AND RSS-GEN – CONDUCTED EMISSIONS

**PHOTOGRAPH SHOWING THE EUT CONFIGURATION
FOR MAXIMUM EMISSIONS**

**REAR VIEW**

UNIVERSAL ELECTRONICS, INC.
CARRIER ENTRY LEVEL AND ICP THERMOSTAT 2024
MODEL: TSTATCCEWF-01
FCC SUBPART B AND C; AND RSS-GEN – CONDUCTED EMISSIONS

**PHOTOGRAPH SHOWING THE EUT CONFIGURATION
FOR MAXIMUM EMISSIONS**

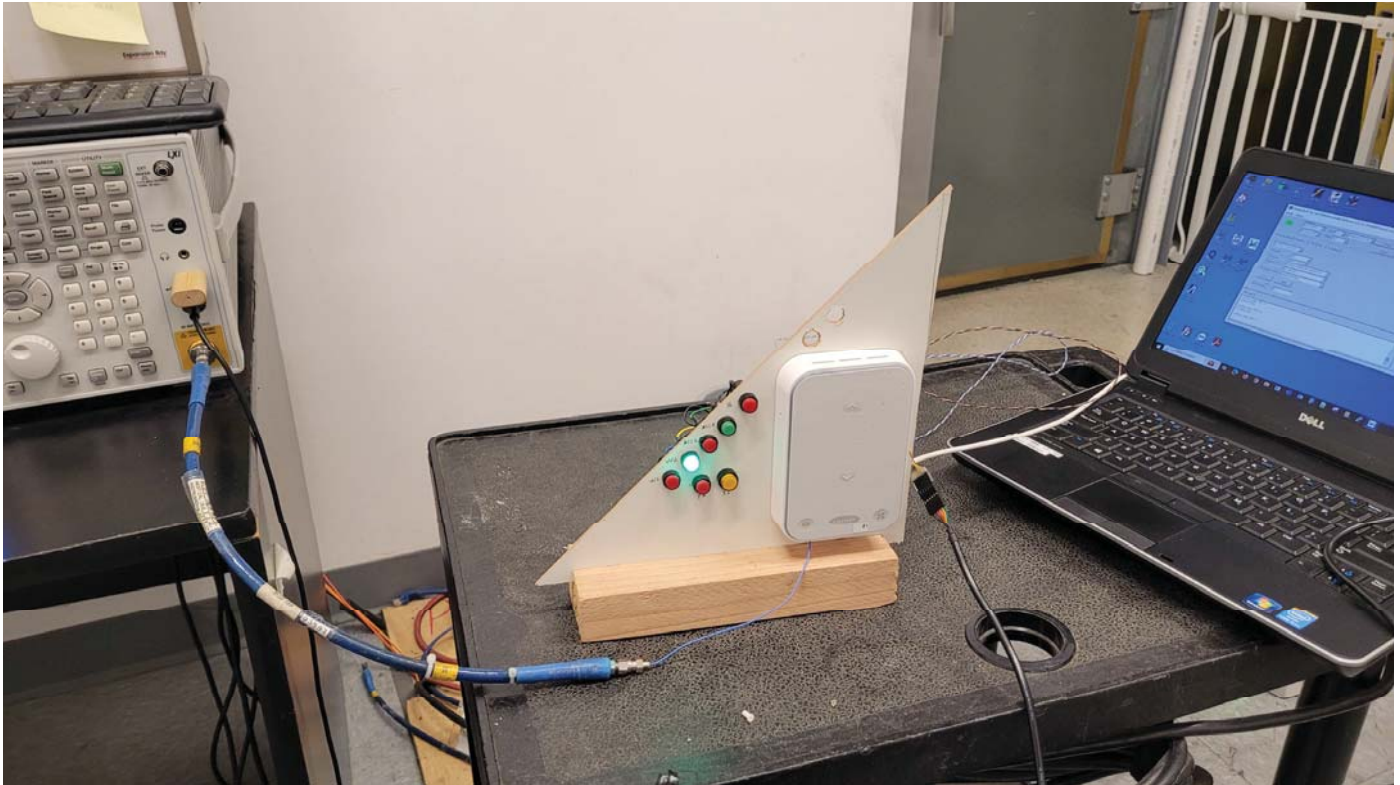

REAR VIEW

UNIVERSAL ELECTRONICS, INC.
CARRIER ENTRY LEVEL AND ICP THERMOSTAT 2024
MODEL: TSTATCCEWF-01
FCC SUBPART B AND C; AND RSS-GEN – DIRECT MEASUREMENTS

**PHOTOGRAPH SHOWING THE EUT CONFIGURATION
FOR MAXIMUM EMISSIONS**



APPENDIX E

DATA SHEETS



***RADIATED EMISSIONS
DATA SHEETS***

Title: Pre-Scan - FCC Class B
File: 1 - Pre-Scan - BLE - 1MBit - Y-Axis - 12-21-2023.set
Operator: Kyle Fujimoto
EUT Type: Carrier Entry Level and ICP Thermostat 2024
EUT Condition: The EUT is continuously transmitting BLE at 2402 MHz at 1 MBit
Company: Universal Electronics, Inc.
Model: TSTATCCEWF-01
S/N: Unit 4
Y-Axis

12/21/2023 11:18:32 AM
Sequence: Preliminary Scan

FCC Class B

Electric Field Strength (dB μ V/m)



Title: Radiated Final - FCC Class B
 File: 1 - Final Scan - BLE - 1MBit - Y-Axis - 12-21-2023.set
 Operator: Kyle Fujimoto
 EUT Type: Carrier Entry Level and ICP Thermostat 2024
 EUT Condition: The EUT is continuously transmitting BLE at 2402 MHz at 1 MBit
 Company: Universal Electronics, Inc.
 Model: TSTATCCEWF-01
 S/N: Unit 4
 Y-Axis

12/21/2023 12:09:46 PM
 Sequence: Final Measurements

FCC Class B

Freq (MHz)	Pol	(PEAK) EMI (dBμV/m)	(QP) EMI (dBμV/m)	(PEAK) Margin (dB)	(QP) Margin (dB)	Limit (dBμV/m)	Transducer (dB)	Cable (dB)	Ttbl Aql (deg)	Twr Ht (cm)
37.50	V	33.09	26.00	-6.91	-14.00	40.00	21.60	0.26	136.75	126.91
120.00	H	26.31	13.71	-17.19	-29.79	43.50	15.90	0.70	236.00	366.31
120.00	V	26.23	23.37	-17.27	-20.13	43.50	15.90	0.70	132.50	302.97
130.70	H	18.46	13.11	-25.04	-30.39	43.50	15.70	0.72	92.25	254.73
132.30	H	18.38	13.46	-25.12	-30.04	43.50	15.59	0.71	167.50	366.49
140.20	V	19.76	14.14	-23.74	-29.36	43.50	14.80	0.71	359.00	111.26



Title: Pre-Scan - FCC Class B
 File: 2 - Pre-Scan - BLE - 2MBit - Y-Axis - 12-21-2023.set
 Operator: Kyle Fujimoto
 EUT Type: Carrier Entry Level and ICP Thermostat 2024
 EUT Condition: The EUT is continuously transmitting BLE at 2402 MHz at 2 MBit
 Company: Universal Electronics, Inc.
 Model: TSTATCCEWF-01
 S/N: Unit 4
 Y-Axis

12/21/2023 11:44:30 AM
 Sequence: Preliminary Scan

FCC Class B



Title: Radiated Final - FCC Class B
 File: 2 - Final Scan - BLE - 2MBit - Y-Axis - 12-21-2023.set
 Operator: Kyle Fujimoto
 EUT Type: Carrier Entry Level and ICP Thermostat 2024
 EUT Condition: The EUT is continuously transmitting BLE at 2402 MHz at 2 MBit
 Company: Universal Electronics, Inc.
 Model: TSTATCCEWF-01
 S/N: Unit 4
 Y-Axis

12/21/2023 11:53:04 AM
 Sequence: Final Measurements

FCC Class B

Freq (MHz)	Pol	(PEAK) EMI (dB μ V/m)	(QP) EMI (dB μ V/m)	(PEAK) Margin (dB)	(QP) Margin (dB)	Limit (dB μ V/m)	Transducer (dB)	Cable (dB)	Ttbl Aql (deg)	Twr Ht (cm)
37.10	V	33.06	26.03	-6.94	-13.97	40.00	21.68	0.26	105.00	111.26
37.60	V	33.03	26.09	-6.97	-13.91	40.00	21.56	0.26	147.50	111.50
37.90	V	31.97	24.94	-8.03	-15.06	40.00	21.50	0.26	21.25	111.44
120.00	H	25.41	20.71	-18.09	-22.79	43.50	15.90	0.70	131.25	366.85
120.00	V	26.26	22.71	-17.24	-20.79	43.50	15.90	0.70	169.25	302.73
125.60	H	18.46	13.33	-25.04	-30.17	43.50	15.90	0.72	262.75	254.67



Title: Pre-Scan - FCC Class B
File: 3 - Pre-Scan - 802.11b - Y-Axis - 12-21-2023.set
Operator: Kyle Fujimoto
EUT Type: Carrier Entry Level and ICP Thermostat 2024
EUT Condition: The EUT is continuously transmitting 802.11b at 2412 MHz
Company: Universal Electronics, Inc.
Model: TSTATCCEWF-01
S/N: Unit 4
Y-Axis

12/21/2023 2:55:53 PM
Sequence: Preliminary Scan

FCC Class B

Electric Field Strength (dBμV/m)

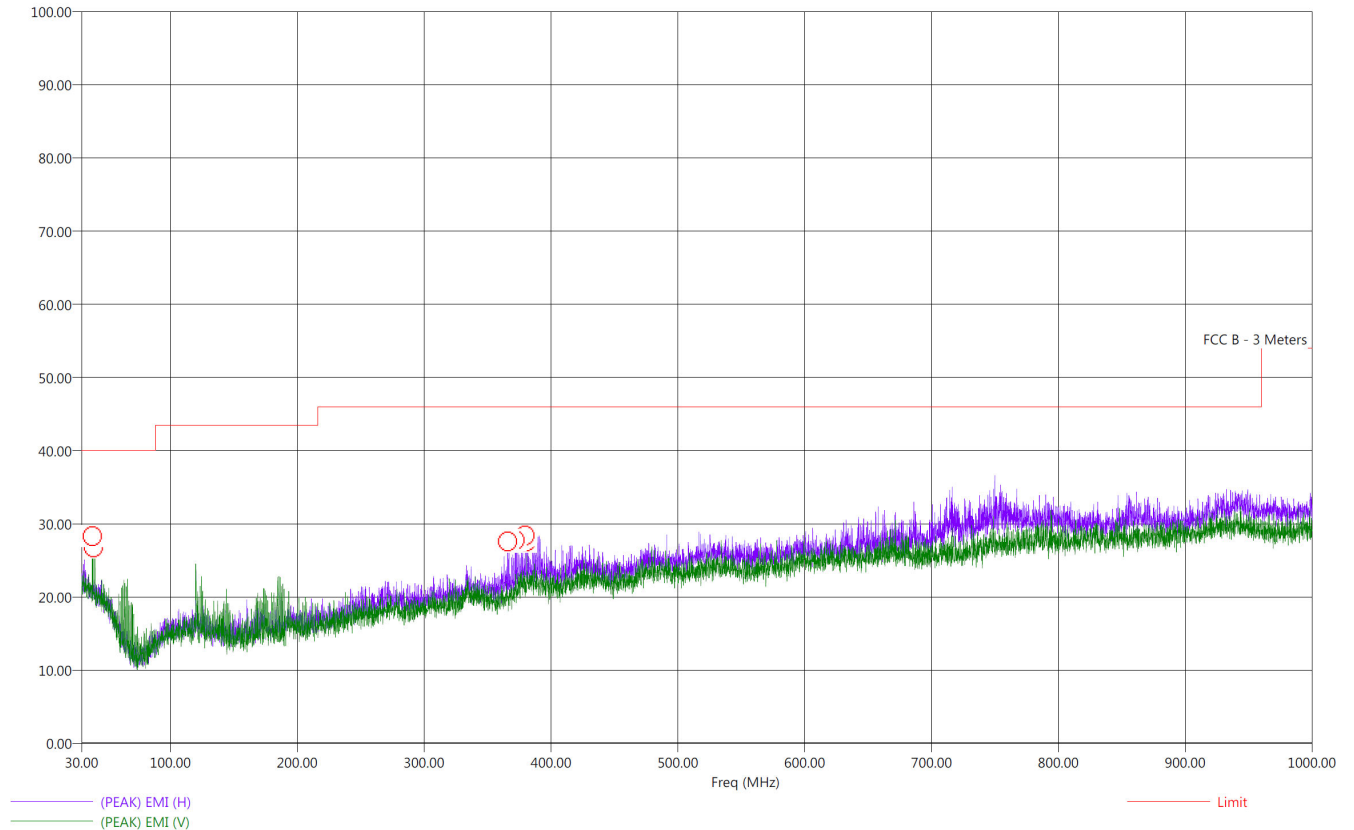

Title: Radiated Final - FCC Class B
 File: 3 - Final Scan - 802.11b - Y-Axis - 12-21-2023.set
 Operator: Kyle Fujimoto
 EUT Type: Carrier Entry Level and ICP Thermostat 2024
 EUT Condition: The EUT is continuously transmitting 802.11b at 2412 MHz
 Company: Universal Electronics, Inc.
 Model: TSTATCCEWF-01
 S/N: Unit 4
 Y-Axis

12/21/2023 3:05:42 PM
 Sequence: Final Measurements

FCC Class B

Freq (MHz)	Pol	(PEAK) EMI (dBμV/m)	(QP) EMI (dBμV/m)	(PEAK) Margin (dB)	(QP) Margin (dB)	Limit (dBμV/m)	Transducer (dB)	Cable (dB)	Ttbl Aql (deg)	Twr Ht (cm)
38.50	V	27.11	23.37	-12.89	-16.63	40.00	21.45	0.26	221.50	270.73
39.40	V	29.63	26.96	-10.37	-13.04	40.00	21.35	0.27	120.50	159.20
365.90	H	28.95	24.46	-17.05	-21.54	46.00	20.59	1.28	281.00	127.32
371.80	H	29.80	25.46	-16.20	-20.54	46.00	21.18	1.31	308.00	111.68
379.60	H	28.50	21.41	-17.50	-24.59	46.00	21.97	1.34	274.75	143.50
380.60	H	26.90	22.28	-19.10	-23.72	46.00	22.08	1.34	284.00	398.73



Title: Pre-Scan - FCC Class B
 File: 4 - Pre-Scan - 802.11g - Y-Axis - 12-21-2023.set
 Operator: Kyle Fujimoto
 EUT Type: Carrier Entry Level and ICP Thermostat 2024
 EUT Condition: The EUT is continuously transmitting 802.11g at 2412 MHz
 Company: Universal Electronics, Inc.
 Model: TSTATCCEWF-01
 S/N: Unit 4
 Y-Axis

12/21/2023 3:23:24 PM
 Sequence: Preliminary Scan

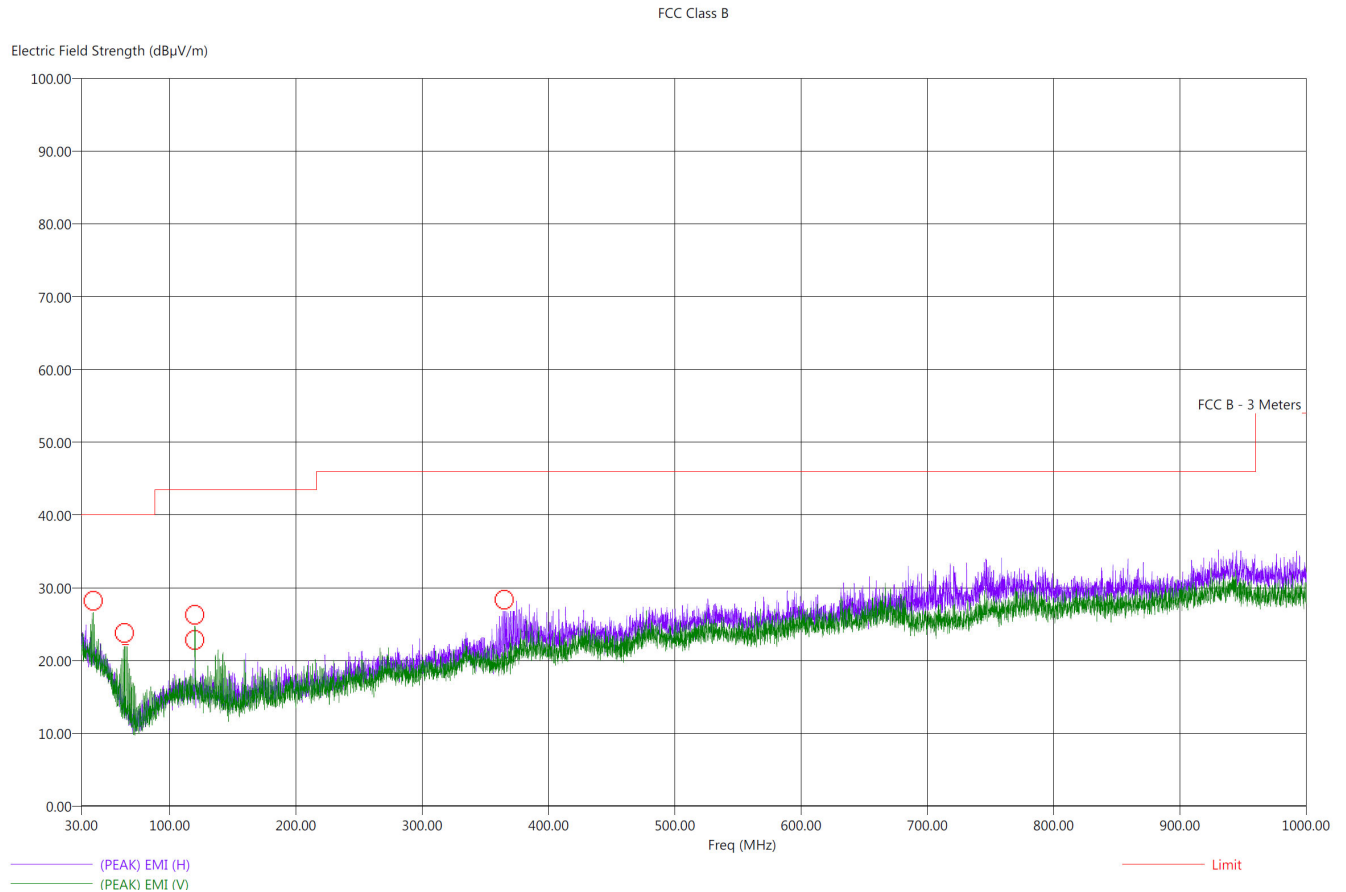

Title: Radiated Final - FCC Class B
 File: 4 - Final Scan - 802.11g - Y-Axis - 12-21-2023.set
 Operator: Kyle Fujimoto
 EUT Type: Carrier Entry Level and ICP Thermostat 2024
 EUT Condition: The EUT is continuously transmitting 802.11g at 2412 MHz
 Company: Universal Electronics, Inc.
 Model: TSTATCCEWF-01
 S/N: Unit 4
 Y-Axis

12/21/2023 3:45:05 PM
 Sequence: Final Measurements

FCC Class B

Freq (MHz)	Pol	(PEAK) EMI (dBµV/m)	(QP) EMI (dBµV/m)	(PEAK) Margin (dB)	(QP) Margin (dB)	Limit (dBµV/m)	Transducer (dB)	Cable (dB)	Ttbl Agl (deg)	Twr Ht (cm)
39.50	V	29.75	24.62	-10.25	-15.38	40.00	21.35	0.27	34.25	127.44
64.20	V	26.66	24.09	-13.34	-15.91	40.00	13.87	0.42	99.25	111.62
65.10	V	25.33	22.68	-14.67	-17.32	40.00	13.56	0.41	93.00	127.68
120.00	H	26.34	14.96	-17.16	-28.54	43.50	15.90	0.70	338.75	382.37
120.00	V	26.81	24.35	-16.69	-19.15	43.50	15.90	0.70	251.50	111.50
365.10	H	29.56	24.61	-16.44	-21.39	46.00	20.49	1.28	298.50	127.08



Title: Pre-Scan - FCC Class B
File: 5 - Pre-Scan - 802.11n - 20 MHz - Y-Axis - 12-21-2023.set
Operator: Kyle Fujimoto
EUT Type: Carrier Entry Level and ICP Thermostat 2024
EUT Condition: The EUT is continuously transmitting 802.11n (20 MHz) at 2412 MHz
Company: Universal Electronics, Inc.
Model: TSTATCCEWF-01
S/N: Unit 4
Y-Axis

12/21/2023 4:05:18 PM
Sequence: Preliminary Scan

FCC Class B

Electric Field Strength (dBμV/m)

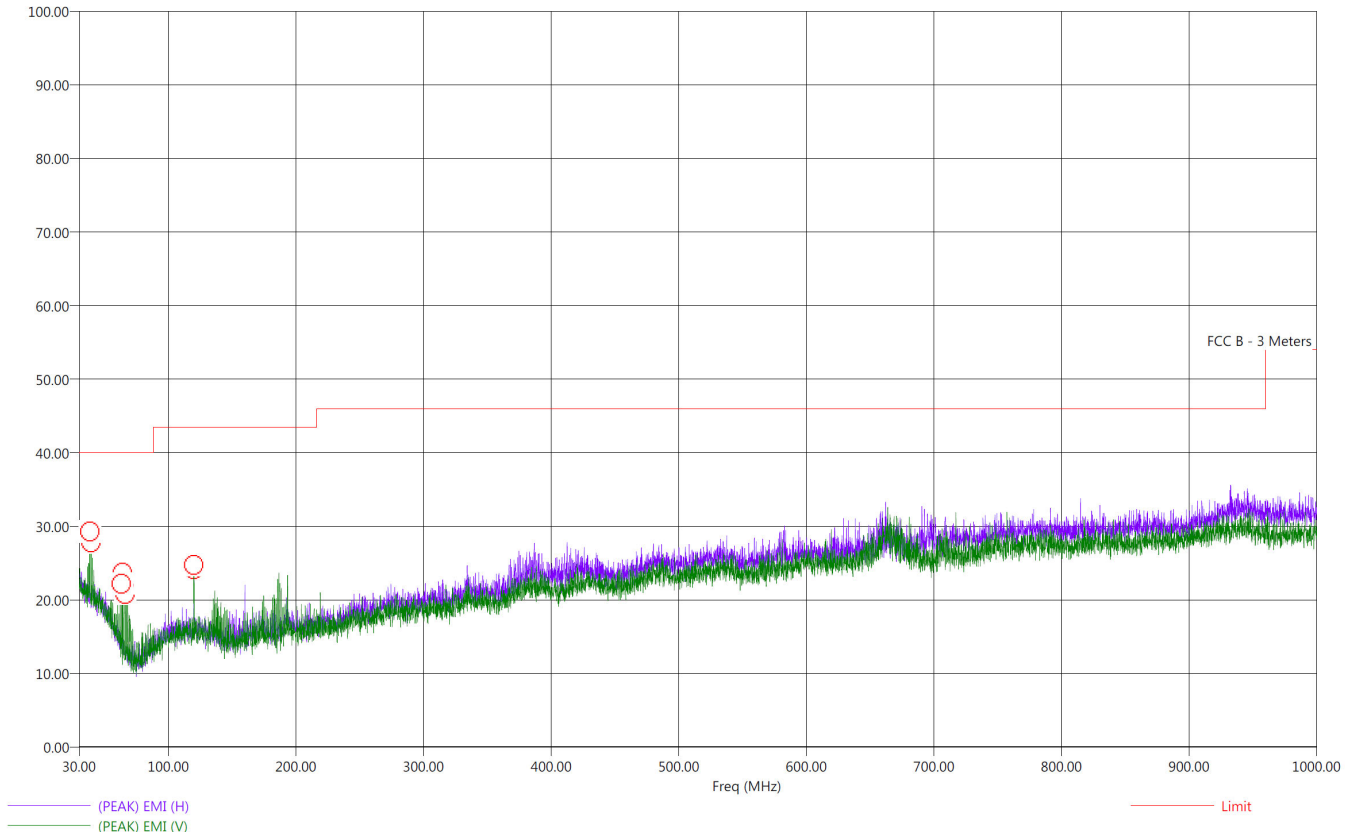

Title: Radiated Final - FCC Class B
 File: 5 - Final Scan - 802.11n - 20 MHz - Y-Axis - 12-21-2023.set
 Operator: Kyle Fujimoto
 EUT Type: Carrier Entry Level and ICP Thermostat 2024
 EUT Condition: The EUT is continuously transmitting 802.11n (20 MHz) at 2412 MHz
 Company: Universal Electronics, Inc.
 Model: TSTATCCEWF-01
 S/N: Unit 4
 Y-Axis

12/21/2023 4:13:47 PM
 Sequence: Final Measurements

FCC Class B

Freq (MHz)	Pol	(PEAK) EMI (dBµV/m)	(QP) EMI (dBµV/m)	(PEAK) Margin (dB)	(QP) Margin (dB)	Limit (dBµV/m)	Transducer (dB)	Cable (dB)	Ttbl Agl (deg)	Twr Ht (cm)
38.50	V	30.98	28.17	-9.02	-11.83	40.00	21.45	0.26	165.25	159.02
39.40	V	29.62	27.24	-10.38	-12.76	40.00	21.35	0.27	37.25	175.14
63.20	V	24.27	20.79	-15.73	-19.21	40.00	14.25	0.43	167.50	222.67
64.10	V	25.26	22.97	-14.74	-17.03	40.00	13.87	0.42	117.75	175.02
65.10	V	24.61	22.43	-15.39	-17.57	40.00	13.56	0.41	116.00	191.20
66.10	V	23.05	21.14	-16.95	-18.86	40.00	13.27	0.40	68.50	158.97
120.00	H	23.88	21.28	-19.62	-22.22	43.50	15.90	0.70	161.75	334.31
120.00	V	25.43	22.99	-18.07	-20.51	43.50	15.90	0.70	125.75	270.85



Title: Pre-Scan - FCC Class B
File: 6 - Pre-Scan - 802.11n - 40 MHz - Y-Axis - 12-21-2023.set
Operator: Kyle Fujimoto
EUT Type: Carrier Entry Level and ICP Thermostat 2024
EUT Condition: The EUT is continuously transmitting 802.11n (40 MHz) at 2422 MHz
Company: Universal Electronics, Inc.
Model: TSTATCCEWF-01
S/N: Unit 4
Y-Axis

12/21/2023 4:38:16 PM
Sequence: Preliminary Scan

FCC Class B

Electric Field Strength (dBμV/m)

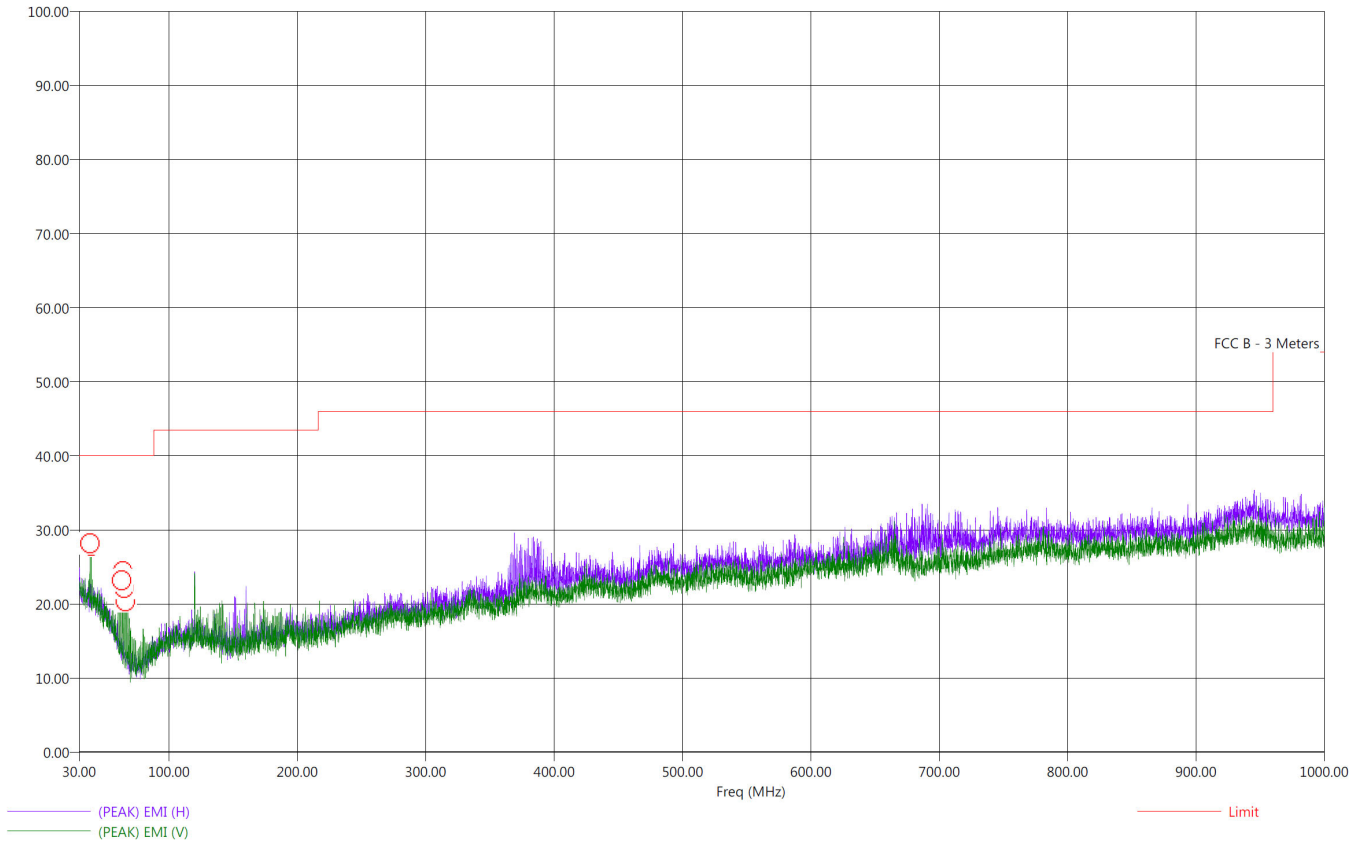

Title: Radiated Final - FCC Class B
 File: 6 - Final Scan - 802.11n - 40 MHz - Y-Axis - 12-21-2023.set
 Operator: Kyle Fujimoto
 EUT Type: Carrier Entry Level and ICP Thermostat 2024
 EUT Condition: The EUT is continuously transmitting 802.11n (40 MHz) at 2422 MHz
 Company: Universal Electronics, Inc.
 Model: TSTATCCEWF-01
 S/N: Unit 4
 Y-Axis

12/21/2023 4:46:56 PM
 Sequence: Final Measurements

FCC Class B

Freq (MHz)	Pol	(PEAK) EMI (dBμV/m)	(QP) EMI (dBμV/m)	(PEAK) Margin (dB)	(QP) Margin (dB)	Limit (dBμV/m)	Transducer (dB)	Cable (dB)	Ttbl Agl (deg)	Twr Ht (cm)
38.50	V	31.29	29.04	-8.71	-10.96	40.00	21.45	0.26	163.75	159.14
39.50	V	30.22	28.02	-9.78	-11.98	40.00	21.35	0.27	107.75	143.50
63.20	V	25.65	22.78	-14.35	-17.22	40.00	14.25	0.43	136.50	127.38
64.10	V	25.36	22.94	-14.64	-17.06	40.00	13.86	0.42	90.50	175.14
65.10	V	23.97	21.57	-16.03	-18.43	40.00	13.56	0.41	79.00	175.08
66.10	V	23.98	21.27	-16.02	-18.73	40.00	13.27	0.40	125.50	175.02

