

**FCC PART 15 SUBPART B and C
TEST REPORT***for***Motorola RF2IR USB Dongle 2012
MODEL: URC-6252BC0-XXXX-R**

Prepared for

UNIVERSAL ELECTRONICS, INC.
201 EAST SANDPOINTE AVENUE, 8TH FLOOR
SANTA ANA, CALIFORNIA 92707

Prepared by: _____



ALEX BENITEZ

Approved by: _____



KYLE FUJIMOTO

COMPATIBLE ELECTRONICS INC.
114 OLINDA DRIVE
BREA, CALIFORNIA 92823
(714) 579-0500

DATE: JANUARY 30, 2013

	REPORT BODY	APPENDICES					TOTAL
		A	B	C	D	E	
PAGES	16	2	2	2	15	32	69

This report shall not be reproduced except in full, without the written approval of Compatible Electronics.

TABLE OF CONTENTS

Section / Title	PAGE
GENERAL REPORT SUMMARY	4
SUMMARY OF TEST RESULTS	4
1. PURPOSE	5
2. ADMINISTRATIVE DATA	6
2.1 Location of Testing	6
2.2 Traceability Statement	6
2.3 Cognizant Personnel	6
2.4 Date Test Sample was Received	6
2.5 Disposition of the Test Sample	6
2.6 Abbreviations and Acronyms	6
3. APPLICABLE DOCUMENTS	7
4. DESCRIPTION OF TEST CONFIGURATION	8
4.1 Description of Test Configuration – Emissions	8
4.1.1 Cable Construction and Termination	8
5. LISTS OF EUT, ACCESSORIES AND TEST EQUIPMENT	9
5.1 EUT and Accessory List	9
5.2 Emissions Test Equipment	10
6. TEST SITE DESCRIPTION	11
6.1 Test Facility Description	11
6.2 EUT Mounting, Bonding and Grounding	11
6.3 Facility Environmental Characteristics	11
7. TEST PROCEDURES	12
7.1 RF Emissions	12
7.1.1 Conducted Emissions Test	12
7.1.2 Radiated Emissions (Spurious and Harmonics) Test	13
7.1.3 RF Emissions Test Results	15
8. CONCLUSIONS	16

LIST OF APPENDICES

APPENDIX	TITLE
A	Laboratory Accreditations and Recognitions
B	Modifications to the EUT
C	Additional Models Covered Under This Report
D	Diagram, Charts, and Photos <ul style="list-style-type: none">• Test Setup Diagram• Antenna and Amplifier Factors• Radiated Emissions Photos
E	Data Sheets

LIST OF FIGURES

FIGURE	TITLE
1	Conducted Emissions Test Setup
2	Plot Map And Layout of Radiated Test Site

GENERAL REPORT SUMMARY

Compatible Electronics Inc. generates this electromagnetic emission test report, which is an independent testing and consulting firm. The test report is based on testing performed by Compatible Electronics personnel according to the measurement procedures described in the test specifications given below and in the "Test Procedures" section of this report.

The measurement data and conclusions appearing herein relate only to the sample tested and this report may not be reproduced without the written permission of Compatible Electronics, unless done so in full.

This report must not be used to claim product endorsement by NVLAP, NIST or any other agency of the U.S. Government.

Device Tested: Motorola RF2IR USB Dongle 2012
Model: URC-6252BC0-XXXX-R
S/N: N/A

Product Description: See Expository Statement

Modifications: The EUT was not modified in order to meet the specifications.

Customer: Universal Electronics, Inc.
201 East Sandpointe Avenue, 8th Floor
Santa Ana, California 92707

Manufacturer: Gemstar Technology Company, Ltd.
Gemstar Industrial Park,
Shi Guang Road Number 45
Zhongcun Town, Panyu
Guangdong Province, China 511495

Test Date(s): December 19, 2012
January 14, 2013

Test Specifications: Emissions requirements
CFR Title 47, Part 15, Subpart B and Subpart C, Sections 15.205, 15.209, and 15.249

Test Procedure: ANSI C63.4

Test Deviations: The test procedure was not deviated from during the testing.

SUMMARY OF TEST RESULTS

TEST	DESCRIPTION	RESULTS
1	Conducted RF Emissions 150 kHz to 30 MHz	Complies with the Class B limits of CFR Title 47, Part 15, Subpart B; and Subpart C, sections 15.205, 15.209, and 15.249..
2	Radiated RF Emissions 10 kHz to 25000 MHz (Transmitter and Digital Portion)	Complies with the Class B limits of CFR Title 47, Part 15, Subpart B; and Subpart C, sections 15.205, 15.209, and 15.249.

1. PURPOSE

This document is a qualification test report based on the emissions tests performed on the Motorola RF2IR USB Dongle 2012, Model: URC-6252BC0-XXXX-R (EUT). The Emissions measurements were performed according to the measurement procedure described in ANSI C63.4. The tests were performed in order to determine whether the electromagnetic emissions from the equipment under test, referred to as EUT hereafter, are within the Class B specification limits defined by CFR Title 47, Part 15, Subpart B for the digital portion; and the limits defined in Subpart C, sections 15.205, 15.209, and 15.249 for the transmitter portion.



2. ADMINISTRATIVE DATA

2.1 Location of Testing

The Emissions tests described herein were performed at the test facility of Compatible Electronics, 114 Olinda Drive, Brea, California.

2.2 Traceability Statement

The calibration certificates of all test equipment used during the test are on file at the location of the test. The calibration is traceable to the National Institute of Standards and Technology (NIST).

2.3 Cognizant Personnel

Universal Electronics, Inc.

Jesse Mendez Senior Electrical Core Engineer

Compatible Electronics Inc.

Alex Benitez Test Technician

Kyle Fujimoto Test Engineer

2.4 Date Test Sample was Received

The test sample was received prior to the initial test date of December 19, 2012.

2.5 Disposition of the Test Sample

The test sample has not been returned to Universal Electronics, Inc. as of the date of the test report.

2.6 Abbreviations and Acronyms

The following abbreviations and acronyms may be used in this document.

FCC	Federal Communications Commission
RF	Radio Frequency
EMI	Electromagnetic Interference
EUT	Equipment Under Test
P/N	Part Number
S/N	Serial Number
ITE	Information Technology Equipment
LISN	Line Impedance Stabilization Network
NVLAP	National Voluntary Laboratory Accreditation Program
CFR	Code of Federal Regulations
N/A	Not Applicable
Ltd.	Limited
Inc.	Incorporated
NCR	No Calibration Required

3. APPLICABLE DOCUMENTS

The following documents are referenced or used in the preparation of this Emissions Test Report.

SPEC	TITLE
CFR Title 47, Part 15	FCC Rules – Radio frequency devices (including digital devices)
ANSI C63.4: 2009	American National Standard for Methods of Measurement of Radio-Noise Emissions from Low-Voltage Electrical and Electronic Equipment in the Range of 9 kHz to 40 GHz

4. DESCRIPTION OF TEST CONFIGURATION

4.1 Description of Test Configuration – Emissions

The Motorola RF2IR USB Dongle 2012, Model: URC-6252BC0-XXXX-R (EUT) was connected to a laptop via its USB cable. The laptop was connected to its power supply via 115 VAC. A modem was used to terminate a serial port on the laptop. During the test, the EUT had a special test program that allowed the low, middle, or high channels, to be tested while continuously transmitting. The EUT was tested in three orthogonal axis.

It was determined that the emissions were at their highest level when the EUT was operating in the above configuration. The final emissions data was taken in this mode of operation and any cables were maximized. All initial investigations were performed with the measurement receiver in manual mode scanning the frequency range continuously. Photographs of the test setup are in Appendix D of this report.

4.1.1 Cable Construction and Termination

Cable 1

This is a 2-meter braid and foil shielded cable connecting the modem to the laptop. The cable contains a D-25 connector at the modem end and contains a D-9 connector at the laptop end. The cable was bundled to a length of 1-meter.

Cable2

This is a 2-meter unshielded cable connecting the laptop to its AC adapter. The cable is hard wired at the AC adapter end and contains a power barrel connector at the laptop end. This cable was bundled to a length of 1-meter.

Cable 3

This is a 75-centimeter foil shielded cable connecting the EUT to the laptop. The cable is hard wired at the EUT end and contains a USB Type A connector at the laptop end.

5. LISTS OF EUT, ACCESSORIES AND TEST EQUIPMENT**5.1 EUT and Accessory List**

EQUIPMENT	MANUFACTURER	MODEL NUMBER	SERIAL NUMBER	FCC ID
MOTOROLA RF2IR USB DONGLE 2012 (EUT)	UNIVERSAL ELECTRONICS, INC.	URC-6252BC0-XXXX-R	N/A	MG3-6252
LAPTOP	LENOVO	T61	7664RWU	DOC
LAPTOP POWER SUPPLY	IBM	P/N: 92P1113	11592P1113Z1A CW58NOJ2	N/A
MODEM	HAYES	07-00038	A0115003041	BFJ9D907- 00038A
MODEM POWER SUPPLY	HAYES	52-00005	N/A	N/A

5.2 Emissions Test Equipment

EQUIPMENT TYPE	MANUFACTURER	MODEL NUMBER	SERIAL NUMBER	CALIBRATION DATE	CALIBRATION DUE DATE
GENERAL TEST EQUIPMENT USED IN LAB B					
Computer	Compaq	CQ5210F	CNX9360CF9	N/A	N/A
Monitor	Hewlett Packard	HPs2031a	3CQ046N3MD	N/A	N/A
EMI Receiver	Rohde & Schwarz	ESIB40	100194	November 19, 2012	2 Years
GENERAL TEST EQUIPMENT USED IN LAB D					
Computer	Hewlett Packard	p6716f	MXX1030PX0	N/A	N/A
Monitor	Hewlett Packard	HPs2031a	3CQ046N3MG	N/A	N/A
Spectrum Analyzer – Main Section	Hewlett Packard	8568B	2517A01563	May 30, 2012	1 Year
Spectrum Analyzer – Display Section	Hewlett Packard	85662A	2648A15285	May 30, 2012	1 Year
Quasi-Peak Adapter	Hewlett Packard	85650A	2430A00424	May 30, 2012	1 Year
RF RADIATED EMISSIONS TEST EQUIPMENT					
Biconical Antenna	Com Power	AB-900	43028	May 24, 2012	1 Year
Log Periodic Antenna	Com Power	AL-100	16252	May 24, 2012	1 Year
Preamplifier	Com-Power	CPPA-102	1017	December 27, 2012	1 Year
Preamplifier	Com-Power	PA-118	181656	December 28, 2011	1 Year
Preamplifier	Com-Power	PA-840	711013	May 17, 2012	1 Year
Loop Antenna	Com-Power	AL-130	17089	January 21, 2011	2 Years
Horn Antenna	Com-Power	AH-118	071175	February 29, 2012	2 Years
Horn Antenna	Com-Power	AH-826	0071957	N/A	N/A
Antenna Mast	Com Power	AM-100	N/A	N/A	N/A
LISN (EUT)	Com Power	LI-215	12078	June 20, 2011	2 Years
LISN (Accessory)	Com Power	LI-215	12076	June 20, 2011	2 Years
Transient Limiter	Seward	252A910	1	November 7, 2012	1 Year

6. TEST SITE DESCRIPTION**6.1 Test Facility Description**

Please refer to section 2.1 and 7.1.2 of this report for Emissions test location.

6.2 EUT Mounting, Bonding and Grounding

The EUT was mounted on a 1.0 by 1.5 meter non-conductive table 0.8 meters above the ground plane.

The EUT was grounded via 3rd pin ground of the Hayes modem with 3-prong AC adapter.

6.3 Facility Environmental Characteristics

When applicable refer to the data sheets in Appendix E for the relative humidity, air temperature, and barometric pressure.

7. TEST PROCEDURES

The following sections describe the test methods and the specifications for the tests. Test results are also included in this section.

7.1 RF Emissions

7.1.1 Conducted Emissions Test

The measurement receiver was used as a measuring meter. The data was collected with the measurement receiver in the peak detect mode with the "Max Hold" feature activated. The quasi-peak was used only where indicated in the data sheets. A transient limiter was used for the protection of the measurement receiver's input stage, and the offset was adjusted accordingly to read the actual data measured. The LISN output was measured using the measurement receiver. The output of the second LISN was terminated by a 50-ohm termination. The effective measurement bandwidth used for this test was 9 kHz.

Please see section 6.2 of this report for mounting, bonding and grounding of the EUT. The EUT was powered through the LISN, which was bonded to the ground plane. The LISN power was filtered and the filter was bonded to the ground plane. The EUT was set up with the minimum distances from any conductive surfaces as specified in ANSI C63.4. The excess power cord was wrapped in a figure eight pattern to form a bundle not exceeding 0.4 meters in length.

The conducted emissions from the EUT were maximized for operating mode as well as cable placement. The final data was collected under program control by the Compatible Electronics conducted emissions software in several overlapping sweeps by running the spectrum analyzer at a minimum scan rate of 10 seconds per octave. The final qualification data is located in Appendix E.

Test Results:

The EUT complies with the **Class B** limits of CFR Title 47, Part 15, Subpart B; and the limits of CFR Title 47, Part 15, Subpart C, Sections 15.209 and 15.249.

7.1.2 Radiated Emissions (Spurious and Harmonics) Test

The spectrum analyzer, along with the quasi-peak adapter, and EMI Receiver were used as a measuring meter. Amplifiers were used to increase the sensitivity of the instrument. The Com-Power Preamplifier Model: PA-102 was used for frequencies from 30 MHz to 1 GHz, the Com-Power Microwave Preamplifier Model: PA-118 was used for frequencies from 1 GHz to 18 GHz, and the Com-Power Microwave Preamplifier Model: PA-840 were used for frequencies above 18 GHz. The spectrum analyzer and EMI Receiver were used in the peak detect mode with the "Max Hold" feature activated. In this mode, the spectrum analyzer and EMI receiver records the highest measured reading over the sweeps.

The quasi-peak function was used only for those readings which are marked accordingly on the data sheets.

The frequencies above 1 GHz were adjusted by a "duty cycle correction factor," derived from $20 \log(\text{dwell time} / 100 \text{ mS})$.

The measurement bandwidths and transducers used for the radiated emissions test were:

FREQUENCY RANGE	EFFECTIVE MEASUREMENT BANDWIDTH	TRANSDUCER
10 kHz to 150 kHz	200 Hz	Active Loop Antenna
150 kHz to 30 MHz	9 kHz	Active Loop Antenna
30 MHz to 300 MHz	120 kHz	Biconical Antenna
300 MHz to 1 GHz	120 kHz	Log Periodic Antenna
1 GHz to 25 GHz	1 MHz	Horn Antennas

The open field test site of Compatible Electronics, Inc. was used for radiated emission testing. This test site is set up according to ANSI C63.4. Please see section 6.2 of this report for mounting, bonding and grounding of the EUT. The turntable supporting the EUT is remote controlled using a motor. The turntable permits EUT rotation of 360 degrees in order to maximize emissions. Also, the antenna mast allows height variation of the antenna from 1 meter to 4 meters. Data was collected in the worst case (highest emission) configuration of the EUT by the Radiated Emission Manual Test software. At each reading, the EUT was rotated 360 degrees and the antenna height was varied from 1 to 4 meters (for E field radiated field strength). The gun sight method was used when measuring with the horn antenna in order to ensure accurate results. The loop antenna was also rotated in the vertical axis in order to ensure accurate results.

Radiated Emissions (Spurious and Harmonics) Test (continued)

The presence of ambient signals was verified by turning the EUT off. In case an ambient signal was detected, the measurement bandwidth was reduced temporarily and verification was made that an additional adjacent peak did not exist. This ensures that the ambient signal does not hide any emissions from the EUT. The EUT was tested at a 3-meter test distance from 30 MHz to 25 GHz and at a 10-meter distance from 10 kHz to 30 MHz to obtain the final test data.

Test Results:

The EUT complies with the **Class B** limits of CFR Title 47, Part 15, Subpart B; and the limits of CFR Title 47, Part 15, Subpart C, Sections 15.209 and 15.249.

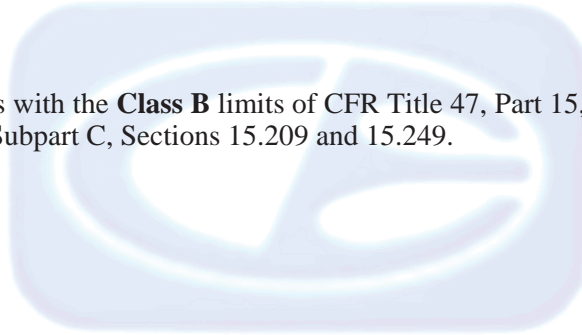

7.1.3 RF Emissions Test Results

Table 1.0 CONDUCTED EMISSION RESULTS
 Motorola RF2IR USB Dongle 2012, Model: URC-6252BC0-XXXX-R

Frequency MHz	Corrected Reading* dBuV	Specification Limit dBuV	Delta (Cor. Reading – Spec. Limit) dB
3.438 (BL)	42.85	46.00	-3.15
3.328 (BL)	42.54	46.00	-3.46
3.644 (BL)	42.35	46.00	-3.65
3.492 (BL)	42.25	46.00	-3.75
2.855 (BL)	41.93	46.00	-4.07
4.456 (WL)	41.77	46.00	-4.23

Table 2.0 RADIATED EMISSION RESULTS
 Motorola RF2IR USB Dongle 2012, Model: URC-6252BC0-XXXX-R

Frequency MHz	Corrected Reading* dBuV	Specification Limit dBuV	Delta (Cor. Reading – Spec. Limit) dB
2425 (Average) (H)	82.97 (Y-Axis)	94	-11.03
2425 (Average) (V)	81.01 (Z-Axis)	94	-12.99
2450 (Average) (H)	80.49 (X-Axis)	94	-13.51
2450 (Average) (H)	79.71 (Y-Axis)	94	-14.29
2425 (Average) (H)	79.66 (X-Axis)	94	-14.34
2425 (Average) (H)	79.64 (Z-Axis)	94	-14.36

Notes:

- * The complete emissions data is given in Appendix E of this report.
- (BL) Black Lead
- (WL) White Lead
- (H) Horizontal
- (V) Vertical

8. CONCLUSIONS

The Motorola RF2IR USB Dongle 2012, Model: URC-6252BC0-XXXX-R (EUT), as tested, meets all of the Class B specification limits defined in CFR Title 47, Part 15, Subpart B for the digital portion; and the limits defined in Subpart C, sections 15.205, 15.209, and 15.249 for the transmitter portion.





APPENDIX A

LABORATORY ACCREDITATIONS AND RECOGNITIONS

Brea Division
114 Olinda Drive
Brea, CA 92823
(714) 579-0500

Agoura Division
2337 Troutdale Drive
Agoura, CA 91301
(818) 597-0600

Silverado Division
19121 El Toro Road
Silverado, CA 92676
(949) 589-0700

Lake Forest Division
20621 Pascal Way
Lake Forest, CA 92630
(949) 587-0400

LABORATORY ACCREDITATIONS AND RECOGNITIONS

NVLAP LAB CODES 200063-0,
200528-0, 200527-0

For US, Canada, Australia/New Zealand, Japan, Taiwan, Korea, and the European Union, Compatible Electronics is currently accredited by NVLAP to ISO/IEC 17025. Please follow the link to the NIST/NVLAP site for each of our facilities' NVLAP certificate and scope of accreditation
NVLAP listing links

[Agoura Division](#) / [Brea Division](#) / [Silverado/Lake Forest Division](#)

.Quote from ISO-ILAC-IAF Communiqué on 17025:

"A laboratory's fulfillment of the requirements of ISO/IEC 17025:2005 means the laboratory meets both the technical competence requirements and management system requirements that are necessary for it to consistently deliver technically valid test results and calibrations. The management system requirements in ISO/IEC 17025:2005 (Section 4) are written in language relevant to laboratory operations and meet the principles of ISO 9001:2008 Quality Management Systems — Requirements."



ANSI listing [CETCB](#)



Compatible Electronics has been nominated as a Conformity Assessment Body (CAB) for EMC under the US/EU Mutual Recognition Agreement (MRA).

US/EU MRA list [NIST MRA site](#)



Compatible Electronics has been nominated as a Conformity Assessment Body (CAB) for Taiwan/BSMI under the US/APEC (Asia-Pacific Economic Cooperation) Mutual Recognition Agreement (MRA).

APEC MRA list [NIST MRA site](#)

We are also listed for IT products by the following country/agency:



VCCI Support member: Please visit http://www.vcci.jp/vcci_e/



FCC Listing, from FCC OET site

[FCC test lab search](https://fjallfoss.fcc.gov/oetcf/eas/reports/TestFirmSearch.cfm) <https://fjallfoss.fcc.gov/oetcf/eas/reports/TestFirmSearch.cfm>



Compatible Electronics IC listing can be found at:

<http://www.ic.gc.ca/eic/site/ic1.nsf/eng/home>



APPENDIX B

MODIFICATIONS TO THE EUT

MODIFICATIONS TO THE EUT

The modifications listed below were made to the EUT to pass FCC 15.249 and/or FCC **Class B** specifications.

All the rework described below was implemented during the test in a method that could be reproduced in all the units by the manufacturer.

No modifications were made to the EUT during the testing.





APPENDIX C

***ADDITIONAL MODELS COVERED
UNDER THIS REPORT***

ADDITIONAL MODELS COVERED UNDER THIS REPORT

USED FOR THE PRIMARY TEST

Motorola RF2IR USB Dongle 2012
Model: URC-6252BC0-XXXX-R
S/N: N/A

ALSO APPROVED UNDER THIS REPORT:

There were no additional models covered under this report.



APPENDIX D

DIAGRAMS, CHARTS, AND PHOTOS

FIGURE 1: CONDUCTED EMISSIONS TEST SETUP

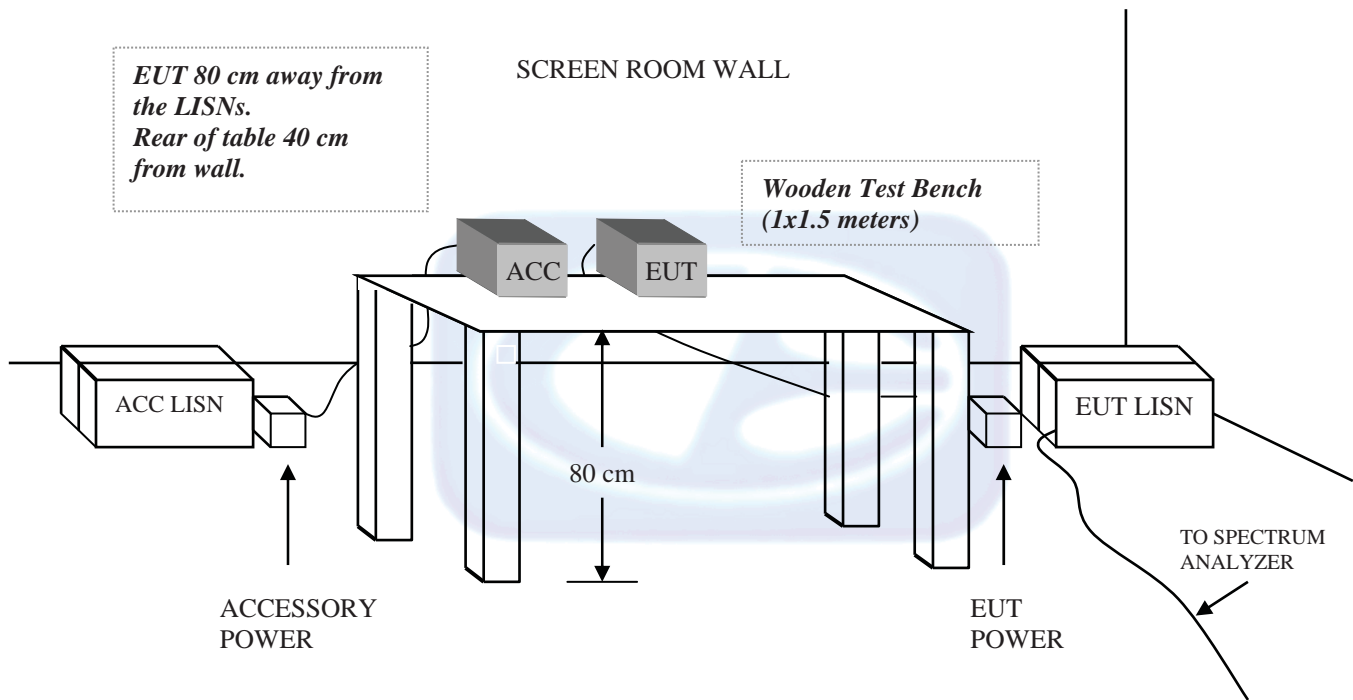
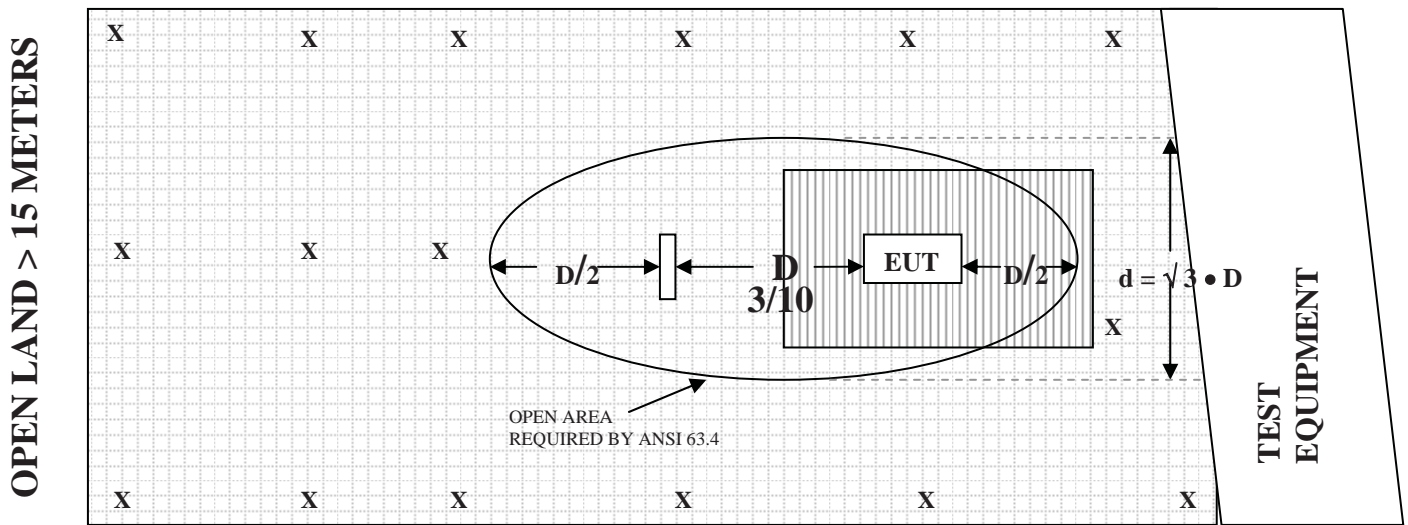

FIGURE 2: PLOT MAP AND LAYOUT OF THE RADIATED TEST SITE

OPEN LAND > 15 METERS



OPEN LAND > 15 METERS

- | | | | |
|----------|--------------------------|--|-----------------|
| X | = GROUND RODS | | = GROUND SCREEN |
| D | = TEST DISTANCE (meters) | | = WOOD COVER |

COM-POWER AL-130**LOOP ANTENNA**

S/N: 17089

CALIBRATION DATE: JANUARY 21, 2011

FREQUENCY (MHz)	MAGNETIC (dB/m)	ELECTRIC (dB/m)
0.009	-41.9	9.60
0.01	-41.79	9.71
0.02	-41.43	10.07
0.03	-40.61	10.89
0.04	-40.87	10.63
0.05	-41.53	9.97
0.06	-41.35	10.15
0.07	-41.47	10.03
0.08	-41.38	10.12
0.09	-41.50	10.00
0.1	-41.44	10.06
0.2	-41.61	9.89
0.3	-41.62	9.88
0.4	-41.59	9.91
0.5	-41.66	9.84
0.6	-41.60	9.90
0.7	-41.48	10.02
0.8	-41.25	10.25
0.9	-41.14	10.36
1	-41.13	10.37
2	-40.89	10.61
3	-41.00	10.50
4	-41.14	10.36
5	-41.02	10.48
6	-40.24	11.26
7	-40.92	10.58
8	-40.65	10.85
9	-40.63	10.87
10	-40.69	10.81
15	-40.41	11.09
20	-41.07	10.43
25	-42.10	9.40
30	-41.15	10.35

COM-POWER AB-900**BICONICAL ANTENNA**

S/N: 43028

CALIBRATION DATE: MAY 24, 2012

FREQUENCY (MHz)	FACTOR (dB)	FREQUENCY (MHz)	FACTOR (dB)
30	11.80	120	13.20
35	11.20	125	13.30
40	11.90	140	11.60
45	10.70	150	11.80
50	11.40	160	12.70
60	10.30	175	14.80
70	7.60	180	15.70
80	5.70	200	15.80
90	7.90	250	14.80
100	10.70	300	19.80

COM-POWER AL-100**LOG PERIODIC ANTENNA**

S/N: 16252

CALIBRATION DATE: MAY 24, 2012

FREQUENCY (MHz)	FACTOR (dB)	FREQUENCY (MHz)	FACTOR (dB)
300	13.00	700	20.30
350	13.20	750	20.80
400	14.50	800	21.00
450	15.40	850	23.30
500	15.80	900	21.70
550	16.60	950	24.20
600	18.90	1000	24.30
650	19.10		

COM POWER AH-118**HORN ANTENNA**

S/N: 071175

CALIBRATION DATE: FEBRUARY 29, 2012

FREQUENCY (GHz)	FACTOR (dB)	FREQUENCY (GHz)	FACTOR (dB)
1.0	23.6	10.0	37.7
1.5	22.0	10.5	38.4
2.0	28.7	11.0	38.0
2.5	29.3	11.5	38.2
3.0	30.6	12.0	39.0
3.5	30.4	12.5	42.4
4.0	31.1	13.0	40.8
4.5	33.4	13.5	40.0
5.0	35.3	14.0	39.7
5.5	35.1	14.5	43.5
6.0	36.9	15.0	42.7
6.5	37.4	15.5	39.7
7.0	37.6	16.0	39.2
7.5	36.2	16.5	39.7
8.0	38.4	17.0	42.2
8.5	39.3	17.5	47.6
9.0	37.4	18.0	51.2
9.5	38.0		

COM-POWER AH-826**HORN ANTENNA**

S/N: 0071957

FREQUENCY (GHz)	FACTOR (dB)	FREQUENCY (GHz)	FACTOR (dB)
18.0	33.5	22.5	35.5
18.5	33.5	23.0	35.9
19.0	34.0	23.5	35.7
19.5	34.0	24.0	35.6
20.0	34.3	24.5	36.0
20.5	34.9	25.0	36.2
21.0	34.7	25.5	36.1
21.5	35.0	26.0	36.2
22.0	35.0	26.5	35.7

COM-POWER CPPA-102**PREAMPLIFIER**

S/N: 1017

CALIBRATION DATE: DECEMEBER 27, 2012

FREQUENCY (MHz)	FACTOR (dB)	FREQUENCY (MHz)	FACTOR (dB)
1	36.9	225	38.14
3	38.1	250	38.15
5	38.1	275	38.14
8	38.2	300	38.18
10	38.3	350	38.22
20	38.2	400	38.26
30	38.3	450	37.53
40	38.2	500	38.24
50	38.5	550	38.53
60	38.5	600	38.69
70	38.4	650	38.66
80	38.4	700	38.58
90	38.5	750	38.37
100	38.4	800	38.23
125	38.6	850	37.68
150	38.4	900	37.38
175	38.5	950	36.82
200	38.5	1000	36.14

COM-POWER PA-118**PREAMPLIFIER**

S/N: 181656

CALIBRATION DATE: DECEMBER 28, 2011

FREQUENCY (GHz)	FACTOR (dB)	FREQUENCY (GHz)	FACTOR (dB)
1.0	23.22	10.0	24.66
1.5	26.31	10.5	25.22
2.0	27.40	11.0	25.17
2.5	26.52	11.5	24.47
3.0	27.35	12.0	25.29
3.5	29.02	12.5	26.03
4.0	28.51	13.0	24.11
4.5	26.62	13.5	24.28
5.0	27.13	14.0	25.81
5.5	27.29	14.5	25.45
6.0	26.72	15.0	25.36
6.5	25.62	15.5	26.76
7.0	25.25	16.0	28.09
7.5	24.23	16.5	23.23
8.0	23.72	17.0	26.58
8.5	24.91	17.5	27.45
9.0	25.73	18.0	27.53
9.5	24.79		

COM-POWER PA-840**MICROWAVE PREAMPLIFIER**

S/N: 711013

CALIBRATION DATE: MAY 17, 2012

FREQUENCY (GHz)	FACTOR (dB)	FREQUENCY (GHz)	FACTOR (dB)
18.0	25.81	31.0	25.77
19.0	24.57	31.5	25.36
20.0	23.46	32.0	25.15
21.0	22.51	32.5	25.13
22.0	23.85	33.0	25.52
23.0	23.31	33.5	25.24
24.0	24.44	34.0	25.08
25.0	25.42	34.5	25.27
26.0	25.71	35.0	23.99
26.5	25.66	35.5	24.67
27.0	25.84	36.5	24.80
27.5	25.29	37.0	26.27
28.0	25.46	37.5	24.86
28.5	25.58	38.0	24.64
29.0	26.16	38.5	23.46
29.5	26.14	39.0	21.29
30.0	26.01	39.5	20.83
30.5	25.67	40.0	19.96

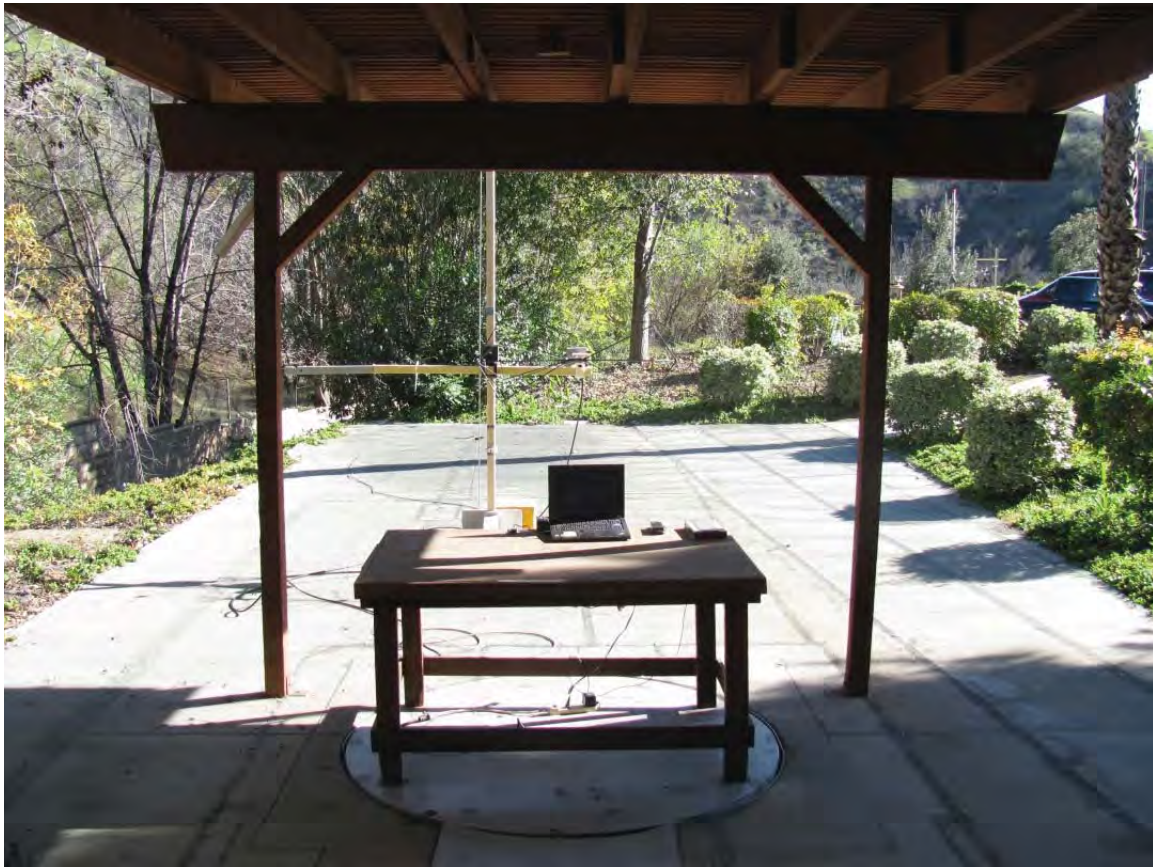

FRONT VIEW

UNIVERSAL ELECTRONICS, INC.
MOTOROLA RF2IR USB DONGLE 2012
MODEL: URC-6252BC0-XXXX-R
FCC SUBPART B AND C – RADIATED EMISSIONS

**PHOTOGRAPH SHOWING THE EUT CONFIGURATION
FOR MAXIMUM EMISSIONS**



REAR VIEW

UNIVERSAL ELECTRONICS, INC.
MOTOROLA RF2IR USB DONGLE 2012
MODEL: URC-6252BC0-XXXX-R
FCC SUBPART B AND C – RADIATED EMISSIONS

**PHOTOGRAPH SHOWING THE EUT CONFIGURATION
FOR MAXIMUM EMISSIONS**



FRONT VIEW

UNIVERSAL ELECTRONICS, INC.
MOTOROLA RF2IR USB DONGLE 2012
MODEL: URC-6252BC0-XXXX-R
FCC SUBPART B AND C – CONDUCTED EMISSIONS

**PHOTOGRAPH SHOWING THE EUT CONFIGURATION
FOR MAXIMUM EMISSIONS**

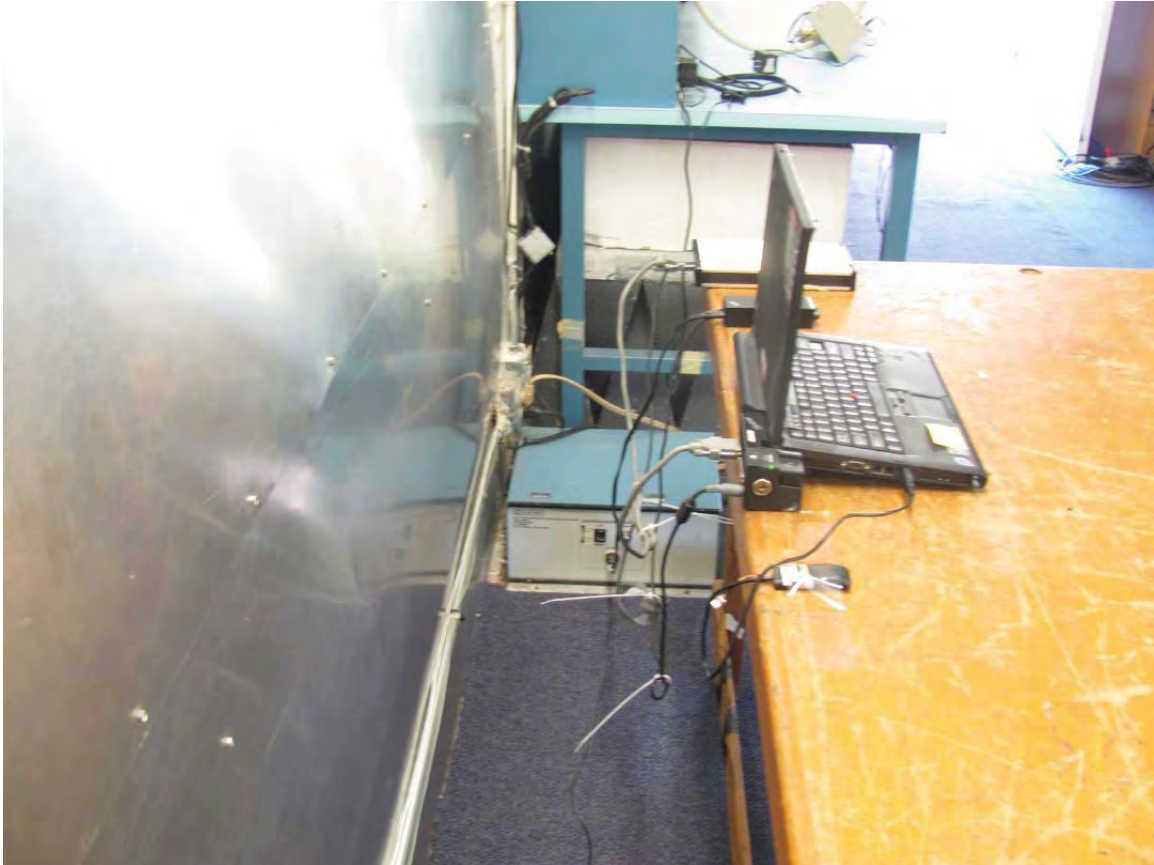

REAR VIEW

UNIVERSAL ELECTRONICS, INC.
MOTOROLA RF2IR USB DONGLE 2012
MODEL: URC-6252BC0-XXXX-R
FCC SUBPART B AND C – CONDUCTED EMISSIONS

**PHOTOGRAPH SHOWING THE EUT CONFIGURATION
FOR MAXIMUM EMISSIONS**

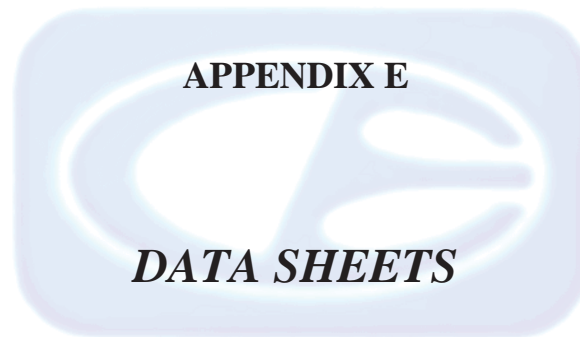

RADIATED EMISSIONS

DATA SHEETS

FCC 15.249

Universal Electronics, Inc.
 Motorola RF2IR USB Dongle 2012
 Model: URC-6252BC0-XXXX-R

Date: 12/19/2012
 Lab: B
 Tested By: Alex Benitez

Middle Channel

Freq. (MHz)	Level (dBuV)	Pol (v/h)	Limit	Margin	Peak / QP / Avg	Ant. Height (m)	Table Angle (deg)	Comments
2450	95.8	V	114	-18.2	Peak	1.25	140	X-Axis
2450	75.8	V	94	-18.2	Avg	1.25	140	Vertical Polarization
2450	100.49	H	114	-13.51	Peak	1.25	170	X-Axis
2450	80.49	H	94	-13.51	Avg	1.25	170	Horizontal Polarization
2450	98.88	V	114	-15.12	Peak	1.75	170	Y-Axis
2450	78.88	V	94	-15.12	Avg	1.75	170	Vertical Polarization
2450	99.71	H	114	-14.29	Peak	1	190	Y-Axis
2450	79.71	H	94	-14.29	Avg	1	190	Horizontal Polarization
2450	98.33	V	114	-15.67	Peak	1.75	140	Z-Axis
2450	78.33	V	94	-15.67	Avg	1.75	140	Vertical Polarization
2450	99.05	H	114	-14.95	Peak	2	220	Z-Axis
2450	79.05	H	94	-14.95	Avg	2	220	Horizontal Polarization

FCC 15.249

Universal Electronics, Inc.
 Motorola RF2IR USB Dongle 2012
 Model: URC-6252BC0-XXXX-R

Date: 12/19/2012
 Lab: B
 Tested By: Alex Benitez

High Channel

Freq. (MHz)	Level (dBuV)	Pol (v/h)	Limit	Margin	Peak / QP / Avg	Ant. Height (m)	Table Angle (deg)	Comments
2475	91.08	V	114	-22.92	Peak	2.25	330	X-Axis
2475	71.08	V	94	-22.92	Avg	2.25	330	Vertical Polarization
2475	95.47	H	114	-18.53	Peak	1.5	180	X-Axis
2475	75.47	H	94	-18.53	Avg	1.5	180	Horizontal Polarization
2475	98.7	V	114	-15.3	Peak	1.5	110	Y-Axis
2475	78.7	V	94	-15.3	Avg	1.5	110	Vertical Polarization
2475	97.85	H	114	-16.15	Peak	1.25	40	Y-Axis
2475	77.85	H	94	-16.15	Avg	1.25	40	Horizontal Polarization
2475	97.25	V	114	-16.75	Peak	1.25	180	Z-Axis
2475	77.25	V	94	-16.75	Avg	1.25	180	Vertical Polarization
2475	99.19	H	114	-14.81	Peak	1.5	240	Z-Axis
2475	79.19	H	94	-14.81	Avg	1.5	240	Horizontal Polarization

FCC 15.249

Universal Electronics, Inc.
 Motorola RF2IR USB Dongle 2012
 Model: URC-6252BC0-XXXX-R

Date: 12/19/2012
 Lab: B
 Tested By: Alex Benitez

**Low Channel
 Transmit Mode - X-Axis**

Freq. (MHz)	Level (dBuV)	Pol (v/h)	Limit	Margin	Peak / QP / Avg	Ant. Height (m)	Table Angle (deg)	Comments
4850	53.6	V	74	-20.4	Peak	2	220	
4850	33.6	V	54	-20.4	Avg	2	220	
7275	56.83	V	74	-17.17	Peak	2.5	270	
7275	36.83	V	54	-17.17	Avg	2.5	270	
9700								No Emissions Detected
9700								
12125								No Emissions Detected
12125								
14550								No Emissions Detected
14550								
16975								No Emissions Detected
16975								
19400								No Emissions Detected
19400								
21825								No Emissions Detected
21825								
24250								No Emissions Detected
24250								

FCC 15.249

Universal Electronics, Inc.
 Motorola RF2IR USB Dongle 2012
 Model: URC-6252BC0-XXXX-R

Date: 12/19/2012
 Lab: B
 Tested By: Alex Benitez

**Low Channel
 Transmit Mode - Y-Axis**

Freq. (MHz)	Level (dBuV)	Pol (v/h)	Limit	Margin	Peak / QP / Avg	Ant. Height (m)	Table Angle (deg)	Comments
4850	52.77	V	74	-21.23	Peak	1.5	220	
4850	32.77	V	54	-21.23	Avg	1.5	220	
7275	57.98	V	74	-16.02	Peak	1.75	120	
7275	37.98	V	54	-16.02	Avg	1.75	120	
9700								No Emissions Detected
9700								
12125								No Emissions Detected
12125								
14550								No Emissions Detected
14550								
16975								No Emissions Detected
16975								
19400								No Emissions Detected
19400								
21825								No Emissions Detected
21825								
24250								No Emissions Detected
24250								

FCC 15.249

Universal Electronics, Inc.
 Motorola RF2IR USB Dongle 2012
 Model: URC-6252BC0-XXXX-R

Date: 12/19/2012
 Lab: B
 Tested By: Alex Benitez

**Low Channel
 Transmit Mode - Z-Axis**

Freq. (MHz)	Level (dBuV)	Pol (v/h)	Limit	Margin	Peak / QP / Avg	Ant. Height (m)	Table Angle (deg)	Comments
4850	54.8	V	74	-19.2	Peak	1.25	180	
4850	34.8	V	54	-19.2	Avg	1.25	180	
7275	57.74	V	74	-16.26	Peak	1.25	190	
7275	37.74	V	54	-16.26	Avg	1.25	190	
9700								No Emissions Detected
9700								
12125								No Emissions Detected
12125								
14550								No Emissions Detected
14550								
16975								No Emissions Detected
16975								
19400								No Emissions Detected
19400								
21825								No Emissions Detected
21825								
24250								No Emissions Detected
24250								

FCC 15.249

Universal Electronics, Inc.
 Motorola RF2IR USB Dongle 2012
 Model: URC-6252BC0-XXXX-R

Date: 12/19/2012
 Lab: B
 Tested By: Alex Benitez

**Low Channel
 Transmit Mode - X-Axis**

Freq. (MHz)	Level (dBuV)	Pol (v/h)	Limit	Margin	Peak / QP / Avg	Ant. Height (m)	Table Angle (deg)	Comments
4850	55.02	H	74	-18.98	Peak	1.5	300	
4850	35.02	H	54	-18.98	Avg	1.5	300	
7275	57.37	H	74	-16.63	Peak	1.75	60	
7275	37.37	H	54	-16.63	Avg	1.75	60	
9700								No Emissions Detected
9700								
12125								No Emissions Detected
12125								
14550								No Emissions Detected
14550								
16975								No Emissions Detected
16975								
19400								No Emissions Detected
19400								
21825								No Emissions Detected
21825								
24250								No Emissions Detected
24250								

FCC 15.249

Universal Electronics, Inc.
 Motorola RF2IR USB Dongle 2012
 Model: URC-6252BC0-XXXX-R

Date: 12/19/2012
 Lab: B
 Tested By: Alex Benitez

**Low Channel
 Transmit Mode - Y-Axis**

Freq. (MHz)	Level (dBuV)	Pol (v/h)	Limit	Margin	Peak / QP / Avg	Ant. Height (m)	Table Angle (deg)	Comments
4850	56.01	H	74	-17.99	Peak	1.5	220	
4850	36.01	H	54	-17.99	Avg	1.5	220	
7275	56.51	H	74	-17.49	Peak	1.5	60	
7275	36.51	H	54	-17.49	Avg	1.5	60	
9700								No Emissions Detected
9700								
12125								No Emissions Detected
12125								
14550								No Emissions Detected
14550								
16975								No Emissions Detected
16975								
19400								No Emissions Detected
19400								
21825								No Emissions Detected
21825								
24250								No Emissions Detected
24250								

FCC 15.249

Universal Electronics, Inc.
 Motorola RF2IR USB Dongle 2012
 Model: URC-6252BC0-XXXX-R

Date: 12/19/2012
 Lab: B
 Tested By: Alex Benitez

**Low Channel
 Transmit Mode - Z-Axis**

Freq. (MHz)	Level (dBuV)	Pol (v/h)	Limit	Margin	Peak / QP / Avg	Ant. Height (m)	Table Angle (deg)	Comments
4850	52.87	H	74	-21.13	Peak	1.75	50	
4850	32.87	H	54	-21.13	Avg	1.75	50	
7275	57.08	H	74	-16.92	Peak	2.25	140	
7275	37.08	H	54	-16.92	Avg	2.25	140	
9700								No Emissions Detected
9700								
12125								No Emissions Detected
12125								
14550								No Emissions Detected
14550								
16975								No Emissions Detected
16975								
19400								No Emissions Detected
19400								
21825								No Emissions Detected
21825								
24250								No Emissions Detected
24250								

FCC 15.249

Universal Electronics, Inc.
 Motorola RF2IR USB Dongle 2012
 Model: URC-6252BC0-XXXX-R

Date: 12/19/2012
 Lab: B
 Tested By: Alex Benitez

**Middle Channel
 Transmit Mode - X-Axis**

Freq. (MHz)	Level (dBuV)	Pol (v/h)	Limit	Margin	Peak / QP / Avg	Ant. Height (m)	Table Angle (deg)	Comments
4900	53.69	V	74	-20.31	Peak	2	200	
4900	33.69	V	54	-20.31	Avg	2	200	
7350	55.97	V	74	-18.03	Peak	2	280	
7350	35.97	V	54	-18.03	Avg	2	280	
9800								No Emissions Detected
9800								
12250								No Emissions Detected
12250								
14700								No Emissions Detected
14700								
17150								No Emissions Detected
17150								
19600								No Emissions Detected
19600								
22050								No Emissions Detected
22050								
24500								No Emissions Detected
24500								

FCC 15.249

Universal Electronics, Inc.
 Motorola RF2IR USB Dongle 2012
 Model: URC-6252BC0-XXXX-R

Date: 12/19/2012
 Lab: B
 Tested By: Alex Benitez

**Middle Channel
 Transmit Mode - Y-Axis**

Freq. (MHz)	Level (dBuV)	Pol (v/h)	Limit	Margin	Peak / QP / Avg	Ant. Height (m)	Table Angle (deg)	Comments
4900	54.04	V	74	-19.96	Peak	1.5	190	
4900	34.04	V	54	-19.96	Avg	1.5	190	
7350	57.22	V	74	-16.78	Peak	1.5	140	
7350	37.22	V	54	-16.78	Avg	1.5	140	
9800								No Emissions Detected
9800								
12250								No Emissions Detected
12250								
14700								No Emissions Detected
14700								
17150								No Emissions Detected
17150								
19600								No Emissions Detected
19600								
22050								No Emissions Detected
22050								
24500								No Emissions Detected
24500								

FCC 15.249

Universal Electronics, Inc.
 Motorola RF2IR USB Dongle 2012
 Model: URC-6252BC0-XXXX-R

Date: 12/19/2012
 Lab: B
 Tested By: Alex Benitez

**Middle Channel
 Transmit Mode - Z-Axis**

Freq. (MHz)	Level (dBuV)	Pol (v/h)	Limit	Margin	Peak / QP / Avg	Ant. Height (m)	Table Angle (deg)	Comments
4900	53.46	V	74	-20.54	Peak	1.75	120	
4900	33.46	V	54	-20.54	Avg	1.75	120	
7350	57.6	V	74	-16.4	Peak	2.25	120	
7350	37.6	V	54	-16.4	Avg	2.25	120	
9800								No Emissions Detected
9800								
12250								No Emissions Detected
12250								
14700								No Emissions Detected
14700								
17150								No Emissions Detected
17150								
19600								No Emissions Detected
19600								
22050								No Emissions Detected
22050								
24500								No Emissions Detected
24500								

FCC 15.249

Universal Electronics, Inc.
 Motorola RF2IR USB Dongle 2012
 Model: URC-6252BC0-XXXX-R

Date: 12/19/2012
 Lab: B
 Tested By: Alex Benitez

**Middle Channel
 Transmit Mode - X-Axis**

Freq. (MHz)	Level (dBuV)	Pol (v/h)	Limit	Margin	Peak / QP / Avg	Ant. Height (m)	Table Angle (deg)	Comments
4900	55.32	H	74	-18.68	Peak	2	210	
4900	35.32	H	54	-18.68	Avg	2	210	
7350	57.79	H	74	-16.21	Peak	1.75	50	
7350	37.79	H	54	-16.21	Avg	1.75	50	
9800								No Emissions Detected
9800								
12250								No Emissions Detected
12250								
14700								No Emissions Detected
14700								
17150								No Emissions Detected
17150								
19600								No Emissions Detected
19600								
22050								No Emissions Detected
22050								
24500								No Emissions Detected
24500								

FCC 15.249

Universal Electronics, Inc.
 Motorola RF2IR USB Dongle 2012
 Model: URC-6252BC0-XXXX-R

Date: 12/19/2012
 Lab: B
 Tested By: Alex Benitez

**Middle Channel
 Transmit Mode - Y-Axis**

Freq. (MHz)	Level (dBuV)	Pol (v/h)	Limit	Margin	Peak / QP / Avg	Ant. Height (m)	Table Angle (deg)	Comments
4900	54.23	H	74	-19.77	Peak	1	170	
4900	34.23	H	54	-19.77	Avg	1	170	
7350	56.88	H	74	-17.12	Peak	1	170	
7350	36.88	H	54	-17.12	Avg	1	170	
9800								No Emissions Detected
9800								
12250								No Emissions Detected
12250								
14700								No Emissions Detected
14700								
17150								No Emissions Detected
17150								
19600								No Emissions Detected
19600								
22050								No Emissions Detected
22050								
24500								No Emissions Detected
24500								

FCC 15.249

Universal Electronics, Inc.
 Motorola RF2IR USB Dongle 2012
 Model: URC-6252BC0-XXXX-R

Date: 12/19/2012
 Lab: B
 Tested By: Alex Benitez

**Middle Channel
 Transmit Mode - Z-Axis**

Freq. (MHz)	Level (dBuV)	Pol (v/h)	Limit	Margin	Peak / QP / Avg	Ant. Height (m)	Table Angle (deg)	Comments
4900	53.01	H	74	-20.99	Peak	2	300	
4900	33.01	H	54	-20.99	Avg	2	300	
7350	58.46	H	74	-15.54	Peak	2	40	
7350	38.46	H	54	-15.54	Avg	2	40	
9800								No Emissions Detected
9800								
12250								No Emissions Detected
12250								
14700								No Emissions Detected
14700								
17150								No Emissions Detected
17150								
19600								No Emissions Detected
19600								
22050								No Emissions Detected
22050								
24500								No Emissions Detected
24500								

FCC 15.249

Universal Electronics, Inc.
 Motorola RF2IR USB Dongle 2012
 Model: URC-6252BC0-XXXX-R

Date: 12/19/2012
 Lab: B
 Tested By: Alex Benitez

**High Channel
 Transmit Mode - X-Axis**

Freq. (MHz)	Level (dBuV)	Pol (v/h)	Limit	Margin	Peak / QP / Avg	Ant. Height (m)	Table Angle (deg)	Comments
4950	52.32	V	74	-21.68	Peak	2.25	40	
4950	32.32	V	54	-21.68	Avg	2.25	40	
7425								No Emissions Detected
7425								
9900								No Emissions Detected
9900								
12375								No Emissions Detected
12375								
14850								No Emissions Detected
14850								
17325								No Emissions Detected
17325								
19800								No Emissions Detected
19800								
22275								No Emissions Detected
22275								
24750								No Emissions Detected
24750								

FCC 15.249

Universal Electronics, Inc.
 Motorola RF2IR USB Dongle 2012
 Model: URC-6252BC0-XXXX-R

Date: 12/19/2012
 Lab: B
 Tested By: Alex Benitez

**High Channel
 Transmit Mode - Y-Axis**

Freq. (MHz)	Level (dBuV)	Pol (v/h)	Limit	Margin	Peak / QP / Avg	Ant. Height (m)	Table Angle (deg)	Comments
4950	54.85	V	74	-19.15	Peak	1.5	240	
4950	34.85	V	54	-19.15	Avg	1.5	240	
7425	58.43	V	74	-15.57	Peak	1.5	130	
7425	38.43	V	54	-15.57	Avg	1.5	130	
9900								No Emissions Detected
12375								No Emissions Detected
14850								No Emissions Detected
17325								No Emissions Detected
19800								No Emissions Detected
22275								No Emissions Detected
24750								No Emissions Detected

FCC 15.249

Universal Electronics, Inc.
 Motorola RF2IR USB Dongle 2012
 Model: URC-6252BC0-XXXX-R

Date: 12/19/2012
 Lab: B
 Tested By: Alex Benitez

**High Channel
 Transmit Mode - Z-Axis**

Freq. (MHz)	Level (dBuV)	Pol (v/h)	Limit	Margin	Peak / QP / Avg	Ant. Height (m)	Table Angle (deg)	Comments
4950	53.62	V	74	-20.38	Peak	1.25	160	
4950	33.62	V	54	-20.38	Avg	1.25	160	
7425	58.42	V	74	-15.58	Peak	1	190	
7425	38.42	V	54	-15.58	Avg	1	190	
9900								No Emissions Detected
9900								
12375								No Emissions Detected
12375								
14850								No Emissions Detected
14850								
17325								No Emissions Detected
17325								
19800								No Emissions Detected
19800								
22275								No Emissions Detected
22275								
24750								No Emissions Detected
24750								

FCC 15.249

Universal Electronics, Inc.
 Motorola RF2IR USB Dongle 2012
 Model: URC-6252BC0-XXXX-R

Date: 12/19/2012
 Lab: B
 Tested By: Alex Benitez

**High Channel
 Transmit Mode - X-Axis**

Freq. (MHz)	Level (dBuV)	Pol (v/h)	Limit	Margin	Peak / QP / Avg	Ant. Height (m)	Table Angle (deg)	Comments
4950	54.35	H	74	-19.65	Peak	2	300	
4950	34.35	H	54	-19.65	Avg	2	300	
7425	49.3	H	74	-24.7	Peak	2	60	
7425	29.3	H	54	-24.7	Avg	2	60	
9900								No Emissions Detected
12375								No Emissions Detected
14850								No Emissions Detected
17325								No Emissions Detected
19800								No Emissions Detected
22275								No Emissions Detected
24750								No Emissions Detected

FCC 15.249

Universal Electronics, Inc.
 Motorola RF2IR USB Dongle 2012
 Model: URC-6252BC0-XXXX-R

Date: 12/19/2012
 Lab: B
 Tested By: Alex Benitez

**High Channel
 Transmit Mode - Y-Axis**

Freq. (MHz)	Level (dBuV)	Pol (v/h)	Limit	Margin	Peak / QP / Avg	Ant. Height (m)	Table Angle (deg)	Comments
4950	55.91	H	74	-18.09	Peak	1.75	0	
4950	35.91	H	54	-18.09	Avg	1.75	0	
7425	57.47	H	74	-16.53	Peak	2	210	
7425	37.47	H	54	-16.53	Avg	2	210	
9900								No Emissions Detected
9900								
12375								No Emissions Detected
12375								
14850								No Emissions Detected
14850								
17325								No Emissions Detected
17325								
19800								No Emissions Detected
19800								
22275								No Emissions Detected
22275								
24750								No Emissions Detected
24750								

FCC 15.249

Universal Electronics, Inc.
 Motorola RF2IR USB Dongle 2012
 Model: URC-6252BC0-XXXX-R

Date: 12/19/2012
 Lab: B
 Tested By: Alex Benitez

**High Channel
 Transmit Mode - Z-Axis**

Freq. (MHz)	Level (dBuV)	Pol (v/h)	Limit	Margin	Peak / QP / Avg	Ant. Height (m)	Table Angle (deg)	Comments
4950	53.6	H	74	-20.4	Peak	1.5	240	
4950	33.6	H	54	-20.4	Avg	1.5	240	
7425	57.9	H	74	-16.1	Peak	2.25	160	
7425	37.9	H	54	-16.1	Avg	2.25	160	
9900								No Emissions Detected
9900								
12375								No Emissions Detected
12375								
14850								No Emissions Detected
14850								
17325								No Emissions Detected
17325								
19800								No Emissions Detected
19800								
22275								No Emissions Detected
22275								
24750								No Emissions Detected
24750								

FCC Class B and FCC 15.249

Universal Electronics, Inc.
 Motorola RF2IR USB Dongle 2012
 Model: URC-6252BC0-XXXX-R

Date: 1/14/2013
 Lab: D
 Tested By: Kyle Fujimoto

Non Harmonic Emissions from the Tx and Digital Portion -- 10 kHz to 1 GHz

Freq. (MHz)	Level (dBuV)	Pol (v/h)	Limit	Margin	Peak / QP / Avg	Ant. Height (m)	Table Angle (deg)	Comments
								No Emissions Found for the Digital Portion from 10 kHz to 1 GHz for both Vertical and Horizontal Polarizations
								No Non Harmonic Emissions Found for the Tx Mode from 10 kHz to 1 GHz for both Vertical and Horizontal Polarizations
								Investigated in the X-Axis, Y-Axis, and Z-Axis

CONDUCTED EMISSIONS

DATA SHEETS

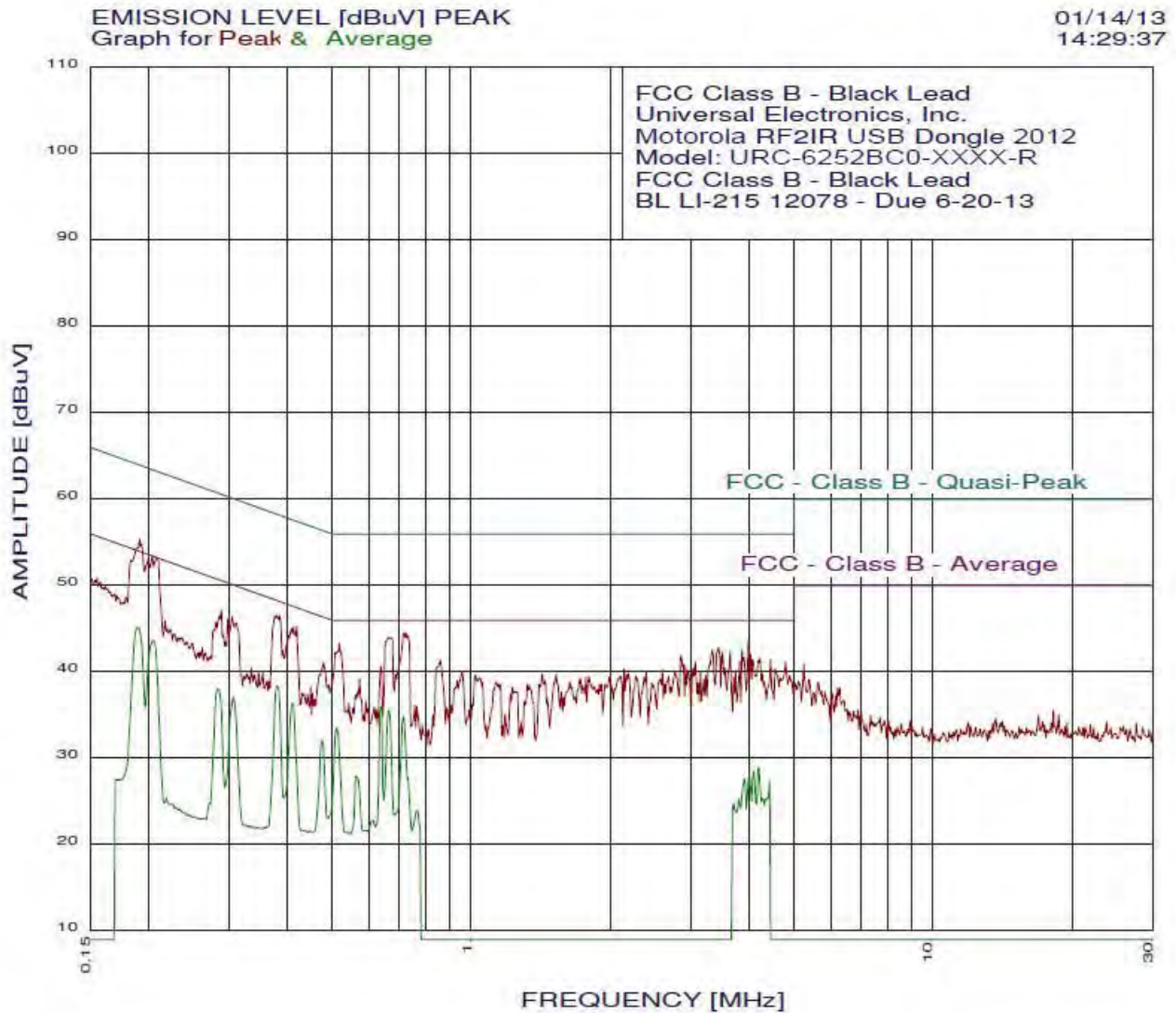

01/14/13 14:29:37

FCC Class B - Black Lead
 Universal Electronics, Inc.
 Motorola RF2IR USB Dongle 2012
 Model: URC-6252BC0-XXXX-R
 FCC Class B - Black Lead
 BL LI-215 12078 - Due 6-20-13
 Test Engineer : Kyle Fujimoto

 41 highest peaks above -50.00 dB of FCC - Class B - Average limit line
 Peak criteria : 1.00 dB, Curve : Peak

Peak#	Freq(MHz)	Amp(dBuV)	Limit(dB)	Delta(dB)
1	0.192	55.40	53.97	1.43**
2	0.204	53.50	53.44	0.06**
3	0.716	44.56	46.00	-1.44**
4	0.385	46.51	48.16	-1.65**
5	0.662	43.97	46.00	-2.03**
6	0.419	45.22	47.46	-2.24**
7	0.413	45.22	47.59	-2.37**
8	3.987	43.57	46.00	-2.43**
9	0.518	43.31	46.00	-2.69**
10	3.438	42.85	46.00	-3.15
11	3.862	42.66	46.00	-3.34**
12	0.288	47.20	50.58	-3.38**
13	3.328	42.54	46.00	-3.46
14	3.644	42.35	46.00	-3.65
15	3.492	42.25	46.00	-3.75
16	0.304	46.30	50.14	-3.84**
17	4.029	42.07	46.00	-3.93**
18	2.855	41.93	46.00	-4.07
19	0.297	46.10	50.32	-4.22**
20	4.227	41.57	46.00	-4.43**
21	4.456	41.48	46.00	-4.52
22	4.071	41.47	46.00	-4.53**
23	0.858	41.43	46.00	-4.57
24	3.820	41.26	46.00	-4.74**
25	3.059	41.24	46.00	-4.76
26	4.799	41.19	46.00	-4.81
27	2.916	40.73	46.00	-5.27
28	0.637	40.68	46.00	-5.32**
29	0.479	41.01	46.36	-5.35**
30	4.552	40.39	46.00	-5.61
31	2.596	40.32	46.00	-5.68
32	2.145	40.30	46.00	-5.70
33	2.948	40.23	46.00	-5.77
34	3.741	40.16	46.00	-5.84**
35	2.766	40.13	46.00	-5.87
36	3.141	40.04	46.00	-5.96
37	2.397	40.01	46.00	-5.99
38	0.953	40.01	46.00	-5.99
39	2.190	39.81	46.00	-6.19
40	1.528	39.75	46.00	-6.25
41	1.426	39.74	46.00	-6.26

 ** Please See the Average Readings on the Next Page and on the Plot

01/14/13 14:29:37

FCC Class B - Black Lead
Universal Electronics, Inc.
Motorola RF2IR USB Dongle 2012
Model: URC-6252BC0-XXXX-R
FCC Class B - Black Lead
BL LI-215 12078 - Due 6-20-13
Test Engineer : Kyle Fujimoto

41 highest peaks above -50.00 dB of FCC - Class B - Average limit line
Peak criteria : 0.00 dB, Curve : Average

Peak#	Freq(MHz)	Amp(dBuV)	Limit(dB)	Delta(dB)
1	0.190	45.15	54.01	-8.86
2	0.204	43.62	53.44	-9.82
3	0.379	38.41	48.29	-9.88
4	0.637	36.05	46.00	-9.95
5	0.665	35.53	46.00	-10.47
6	0.713	34.81	46.00	-11.19
7	0.411	36.41	47.63	-11.23
8	0.513	33.50	46.00	-12.50
9	0.283	38.03	50.72	-12.69
10	0.305	37.05	50.10	-13.05
11	0.476	32.08	46.40	-14.32
12	4.204	28.95	46.00	-17.05
13	4.092	28.49	46.00	-17.51
14	4.008	28.12	46.00	-17.88
15	0.564	27.97	46.00	-18.03
16	0.731	27.75	46.00	-18.25
17	3.903	27.64	46.00	-18.36
18	4.432	27.44	46.00	-18.56
19	4.272	25.37	46.00	-20.63
20	3.800	25.23	46.00	-20.77
21	3.702	24.82	46.00	-21.18
22	0.763	23.95	46.00	-22.05
23	0.611	22.78	46.00	-23.22
24	0.592	21.64	46.00	-24.36
25	0.547	21.39	46.00	-24.61
26	0.447	21.58	46.93	-25.36
27	0.433	21.67	47.19	-25.53
28	0.272	24.82	51.07	-26.25
29	0.358	21.99	48.78	-26.79
30	0.352	21.91	48.91	-27.00
31	0.175	27.63	54.72	-27.09
32	0.345	21.99	49.09	-27.10
33	0.338	22.07	49.26	-27.19
34	0.332	22.16	49.39	-27.23
35	0.325	22.24	49.57	-27.33
36	0.170	27.54	54.98	-27.44
37	0.219	25.40	52.87	-27.47
38	0.224	24.70	52.65	-27.95
39	0.229	24.32	52.48	-28.16
40	0.265	23.09	51.29	-28.20
41	0.234	24.06	52.30	-28.24

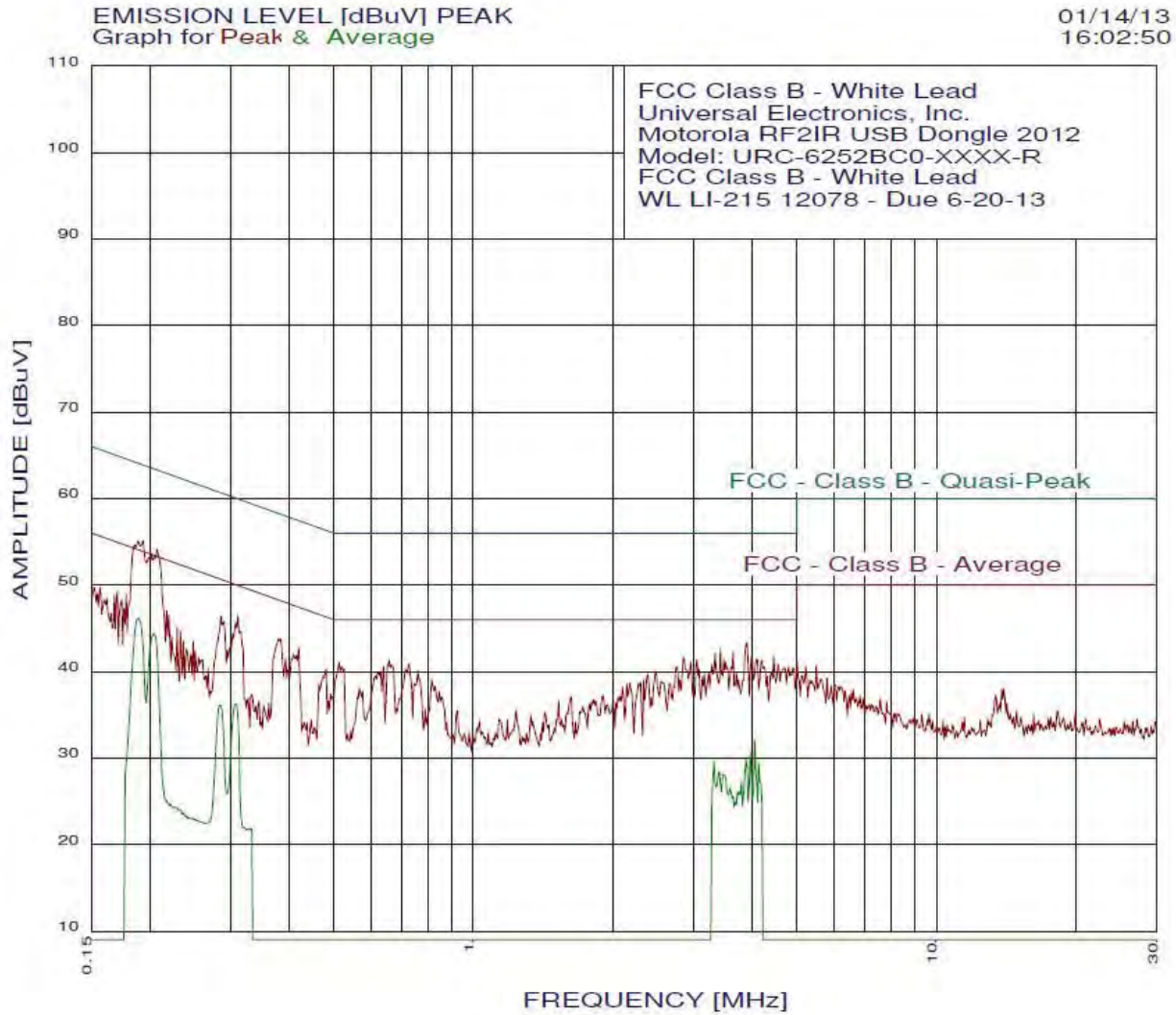

01/14/13 16:02:50

FCC Class B - White Lead
 Universal Electronics, Inc.
 Motorola RF2IR USB Dongle 2012
 Model: URC-6252BC0-XXXX-R
 FCC Class B - White Lead
 WL LI-215 12078 - Due 6-20-13
 Test Engineer : Kyle Fujimoto

 41 highest peaks above -50.00 dB of FCC - Class B - Average limit line
 Peak criteria : 1.00 dB, Curve : Peak

Peak#	Freq(MHz)	Amp(dBuV)	Limit(dB)	Delta(dB)
1	0.194	55.13	53.88	1.25**
2	0.207	54.13	53.31	0.82**
3	3.903	43.34	46.00	-2.66**
4	3.419	42.66	46.00	-3.34**
5	0.310	46.45	49.97	-3.51**
6	3.644	42.30	46.00	-3.70**
7	3.328	42.15	46.00	-3.85**
8	4.456	41.77	46.00	-4.23
9	0.285	46.38	50.67	-4.29**
10	3.987	41.65	46.00	-4.35**
11	2.840	41.59	46.00	-4.41
12	0.379	43.75	48.29	-4.54
13	4.092	41.46	46.00	-4.54**
14	3.043	41.40	46.00	-4.60
15	3.474	41.37	46.00	-4.63**
16	0.658	41.34	46.00	-4.66
17	0.419	42.76	47.46	-4.70
18	4.204	41.26	46.00	-4.74**
19	0.513	41.11	46.00	-4.89
20	2.948	41.09	46.00	-4.91
21	4.552	40.88	46.00	-5.12
22	0.728	40.82	46.00	-5.18
23	4.799	40.58	46.00	-5.42
24	0.641	40.54	46.00	-5.46
25	2.751	40.49	46.00	-5.51
26	4.696	40.38	46.00	-5.62
27	0.178	48.94	54.59	-5.65**
28	0.170	49.24	54.94	-5.70
29	0.217	47.04	52.91	-5.87**
30	0.759	40.11	46.00	-5.89
31	2.475	40.09	46.00	-5.91
32	0.157	49.71	55.64	-5.94
33	0.481	40.29	46.32	-6.03
34	0.624	39.95	46.00	-6.05
35	3.226	39.93	46.00	-6.07
36	0.152	49.79	55.91	-6.12
37	3.702	39.81	46.00	-6.19**
38	0.168	48.83	55.07	-6.24
39	3.158	39.72	46.00	-6.28
40	0.220	46.54	52.83	-6.28**
41	2.384	39.68	46.00	-6.32

 ** Please See the Average Readings on the Next Page and on the Plot

01/14/13 16:02:50

FCC Class B - White Lead
Universal Electronics, Inc.
Motorola RF2IR USB Dongle 2012
Model: URC-6252BC0-XXXX-R
FCC Class B - White Lead
WL LI-215 12078 - Due 6-20-13
Test Engineer : Kyle Fujimoto

33 highest peaks above -50.00 dB of FCC - Class B - Average limit line

Peak criteria : 0.00 dB, Curve : Average

Peak#	Freq(MHz)	Amp(dBuV)	Limit(dB)	Delta(dB)
1	0.189	46.14	54.06	-7.92
2	0.204	44.38	53.44	-9.06
3	0.307	36.25	50.05	-13.80
4	4.050	32.14	46.00	-13.86
5	0.283	36.13	50.72	-14.59
6	3.966	30.56	46.00	-15.44
7	3.882	29.88	46.00	-16.12
8	3.311	29.60	46.00	-16.40
9	4.137	29.39	46.00	-16.61
10	3.401	28.48	46.00	-17.52
11	3.456	28.11	46.00	-17.89
12	3.800	27.36	46.00	-18.64
13	3.585	26.55	46.00	-19.45
14	3.761	26.11	46.00	-19.89
15	3.722	26.10	46.00	-19.90
16	3.644	25.64	46.00	-20.36
17	3.683	24.87	46.00	-21.13
18	0.332	21.80	49.39	-27.60
19	0.320	21.96	49.71	-27.74
20	0.217	25.14	52.91	-27.77
21	0.325	21.80	49.57	-27.78
22	0.222	24.65	52.74	-28.09
23	0.220	24.71	52.83	-28.11
24	0.228	24.34	52.52	-28.19
25	0.226	24.34	52.61	-28.27
26	0.233	24.01	52.34	-28.33
27	0.237	23.60	52.21	-28.61
28	0.265	22.53	51.29	-28.76
29	0.251	22.95	51.73	-28.78
30	0.248	23.02	51.82	-28.80
31	0.240	23.24	52.08	-28.84
32	0.246	23.02	51.90	-28.89
33	0.243	23.10	52.00	-28.90
