

# Remote Control

Model 54.0

Quick Start Guide



# Turn On Your Remote

- 1 Remove the back cover by pushing the latch upward, and remove the *PULL* tab

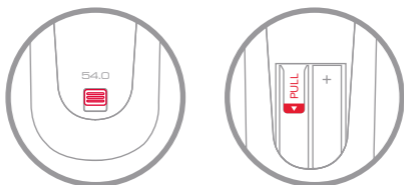

- 2 Replace the back cover
- 3 Open the front panel of your DISH receiver, and press the *SYS INFO* button

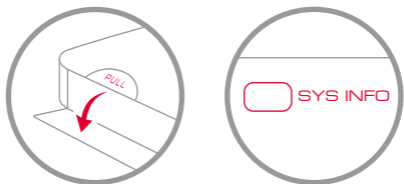

- 4 Press the *SAT* button on the side of the remote control

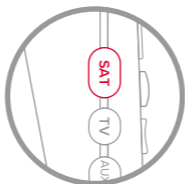

You will hear three beeps from the remote control, indicating it has paired with your DISH receiver

# Pair Your Remote

- 1 Press the home button twice



- 2 Select *Settings* and then *Remote Control*



- 3 Select *TV* and then *TV Pairing Wizard*



- 4 Follow the prompts

- 5 You can also pair your remote with an *Auxiliary Device* such as a Blu-ray™ player or stereo



# Activate Backlighting

To activate the backlighting on your remote control, simply pick it up, move it, or shake it gently in a dark room

You asked. We listened.

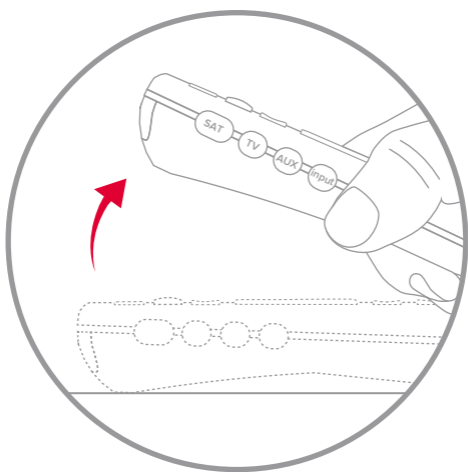

To conserve your remote control's battery life, its light sensor detects the amount of light in the room

If the room is sufficiently dark when you move your remote, its buttons will light up automatically!

# Explore Your Remote

## Device Buttons

Use your remote as a universal remote control by pairing it with your TV and an auxiliary device such as a Blu-ray™ player or stereo

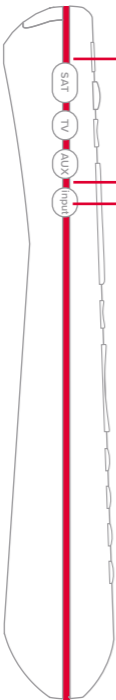

## Input

Change inputs on your TV when in TV mode

When in SAT mode, use this button to swap picture-in-picture or multi-view windows

# Explore Your Remote

## Home

Easily find shows, movies, and sports that are live, on your DVR, or on demand—all in one place

## Options

Access additional options and features in the current menu

## Back/Live TV

Press to go back one menu

Press and hold to go to live TV

## Skip Backward

Press to skip back 10 seconds

Press and hold to rewind (⏮)

## Recall

While watching TV, press to tune to channels you have watched recently

## Power

Turn your TV, DISH receiver, and other selected devices on and off



## Diamond Button

Customize this button to turn closed captioning on and off, launch Netflix®, turn on picture in picture, and more

See *Personalize Your Remote* in this guide

## Microphone

Listens to you when you are using voice control

## Light Sensor

Extends battery life by determining whether backlighting should be activated when you pick up the remote

## Voice Control

Find what you're looking for by pressing and holding this button, speaking into the microphone, and releasing it

## Info/Help

Press to get more information about a program

Press and hold to get quick tips and tricks in most menus

## Skip Forward

Press to skip forward 30 seconds

Press and hold to fast-forward (⏩)

## Channel Up & Down

In addition to changing channels, use these buttons to page through menus such as the *Guide*

## Double-Diamond Button

You can personalize this button too!



# Take Control with Your Voice

- 1 Press and hold the voice button



- 2 Say the name of a movie, TV show, sport, sports team, actor, collection, or feature



- 3 Release the voice button
- 4 Try other examples such as

“Watch ESPN”

“Big Bang Theory”

“Batman movies”

“Action movies with Matt Damon”

“Launch Game Finder”

“Denver Broncos”

“Closed captioning on”

“Text to speech on”



# Personalize Your Remote

- 1 Press and hold the diamond or double-diamond button

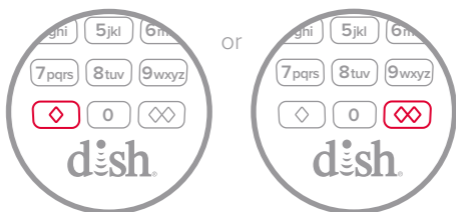

- 2 Select from the menu what you want the button to do

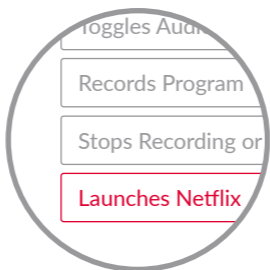

You can turn closed captioning on and off, launch Netflix®, turn on picture in picture (PiP), record a program with one click, and more

- 3 Select *OK*

That's it!

# Locate Your Remote Anytime

- 1 Open the front panel of your DISH receiver

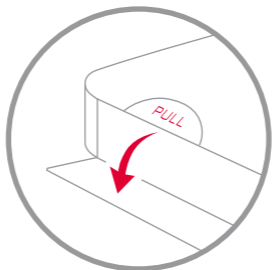

- 2 Press the *LOCATE REMOTE* button



You will hear a series of beeps from your remote, allowing you to find it.

It's that simple!

# Regulatory Information

This device complies with Part 15 of FCC Rules. Operation is subject to the following two conditions:

1. This device may not cause harmful interference,  
and
2. This device must accept any interference received, including interference that may cause undesired operation.

This equipment has been tested and found to comply with the limits for a Class B digital device, pursuant to Part 15 of the FCC Rules. These limits are designed to provide protection against harmful interference in a residential installation. This equipment generates, uses, and can radiate radio frequency energy and, if not installed and used in accordance with the instructions, may cause harmful interference to radio communications. However, there is no guarantee that interference will not occur in a particular installation. If this equipment does cause harmful interference to radio or television reception, which can be determined by turning the equipment off and on, the user is encouraged to try to correct the interference by following one or more of the following measures:

- Reorient or relocate the receiving antenna.
- Increase the separation between the equipment and receiver.
- Connect the equipment into an outlet on a circuit different from that to which the receiver is connected.
- Consult the dealer or an experienced radio/TV technician for help.

Changes or modifications to this device may void your authority to operate this equipment.

## Safety Instructions

You must keep safety in mind while using this device. Keep these and any other instructions for future reference.

**Observe Warnings:** Carefully follow all warnings on the device and in the operating instructions.

**Heat:** Do NOT place the device near heat sources such as radiators, stoves, heat registers, or other appliances that produce heat.

## Case and Use

**Cleaning:** Do NOT use liquid, abrasive, solvent, or aerosol cleaners. Use a damp cloth for cleaning.

**When Not in Use:** Remove the batteries if this device is to be left unattended or unused for a long period of time.



Refer servicing to qualified personnel when a solid object or liquid has fallen onto or into the device.



Do NOT attempt to service this device. Refer all servicing to qualified personnel. Opening covers other than the battery cover will void the warranty.

# Need Help?



Press and hold *Info/Help*



Channel 103



The Hopper Features Guide



[mydish.com/support/remotes](http://mydish.com/support/remotes)



TUNED IN TO YOU™