

Prüfbericht-Nr.: <i>Test report no.:</i>	CN21KHZP (P15C-BLE) 001	Auftrags-Nr.: <i>Order no.:</i>	238511047	Seite 1 von 25 Page 1 of 25
Kunden-Referenz-Nr.: <i>Client reference no.:</i>	N/A	Auftragsdatum: <i>Order date:</i>	2021-01-14	
Auftraggeber: <i>Client:</i>	THALES DIS FRANCE 6 rue de la Verrerie Meudon, 92190 FRANCE			
Prüfgegenstand: <i>Test item:</i>	BLUETOOTH THALES CARD			
Bezeichnung / Typ-Nr.: <i>Identification / Type no.:</i>	BLUETOOTH THALES CARD			
Auftrags-Inhalt: <i>Order content:</i>	FCC Part 15C Test report (BLE)			
Prüfgrundlage: <i>Test specification:</i>	FCC 47CFR Part 15: Subpart C Section 15.247			
Wareneingangsdatum: <i>Date of sample receipt:</i>	2021-02-05			
Prüfmuster-Nr.: <i>Test sample no.:</i>	A002999984-006 A002999984-007			
Prüfzeitraum: <i>Testing period:</i>	2021-04-28 - 2021-04-29			
Ort der Prüfung: <i>Place of testing:</i>	EMC/RF Taipei Testing Site			
Prüflaboratorium: <i>Testing laboratory:</i>	Taipei Testing Laboratories			
Prüfergebnis*: <i>Test result*:</i>	Pass			
überprüft von: <i>reviewed by:</i>	genehmigt von: <i>authorized by:</i>			
Datum: <i>Date:</i> 2021-11-01	 Ethan Shao		 Ryan Chen	
Stellung / Position:	Assistant Project Engineer		Senior Project Manager	
Sonstiges / Other:				
Zustand des Prüfgegenstandes bei Anlieferung: <i>Condition of the test item at delivery:</i>		Prüfmuster vollständig und unbeschädigt <i>Test item complete and undamaged</i>		
* Legende:	1 = sehr gut P(ass) = entspricht o.g. Prüfgrundlage(n)	2 = gut F(ail) = entspricht nicht o.g. Prüfgrundlage(n)	3 = befriedigend N/A = nicht anwendbar	4 = ausreichend N/T = nicht getestet
* Legend:	1 = very good P(ass) = passed a.m. test specification(s)	2 = good F(ail) = failed a.m. test specification(s)	3 = satisfactory N/A = not applicable	4 = sufficient N/T = not tested
Dieser Prüfbericht bezieht sich nur auf das o.g. Prüfmuster und darf ohne Genehmigung der Prüfstelle nicht auszugsweise vervielfältigt werden. Dieser Bericht berechtigt nicht zur Verwendung eines Prüfzeichens. <i>This test report only relates to the a. m. test sample. Without permission of the test center this test report is not permitted to be duplicated in extracts. This test report does not entitle to carry any test mark.</i>				

TEST SUMMARY

Report Section	FCC Clause	Test Item	Result
5.1.1	15.247(b) & 15.203	Antenna Requirement	Pass
5.1.2	15.247(b)(3)	Peak Output Power	Pass
5.1.3	15.247(a)(2)	6 dB Bandwidth	Pass
5.1.3	2.1049	99% Occupied Bandwidth	Pass
5.1.4	15.247(e)	Power Spectral Density	Pass
5.1.5	15.247(d)	Conducted Spurious Emissions and Band Edges	Pass
5.1.6	15.247(d) & 15.205 & 15.209	Radiated Spurious Emissions and Band Edges	Pass
-	15.207	Mains Conducted Emission	N/A

Note: Determining compliance based on the results of the compliance measurement, not taking into account measurement instrumentation uncertainty.

Contents

HISTORY OF THIS TEST REPORT	5
1. GENERAL REMARKS	6
1.1 COMPLEMENTARY MATERIALS.....	6
1.2 DECISION RULE OF CONFORMITY	6
2. TEST SITES	7
2.1 TEST LABORATORY	7
2.2 TEST FACILITY.....	7
2.3 TRACEABILITY	8
2.4 CALIBRATION	8
2.5 MEASUREMENT UNCERTAINTY	8
3. GENERAL PRODUCT INFORMATION.....	9
3.1 PRODUCT FUNCTION AND INTENDED USE	9
3.2 SYSTEM DETAILS AND RATINGS.....	9
3.3 NOISE GENERATING AND NOISE SUPPRESSING PARTS	10
3.4 SUBMITTED DOCUMENTS.....	10
4. TEST SET-UP AND OPERATION MODES.....	11
4.1 PRINCIPLE OF CONFIGURATION SELECTION	11
4.2 CARRIER FREQUENCY AND CHANNEL.....	11
4.3 TEST OPERATION AND TEST SOFTWARE.....	12
4.4 SPECIAL ACCESSORIES AND AUXILIARY EQUIPMENT	13
4.5 TEST SETUP DIAGRAM	14
5. TEST RESULTS	15
5.1 TRANSMITTER REQUIREMENT & TEST SUITES	15
5.1.1 <i>Antenna Requirement</i>	<i>15</i>
5.1.2 <i>Peak Output Power</i>	<i>16</i>
5.1.3 <i>6 dB Bandwidth and 99% Occupied Bandwidth.....</i>	<i>18</i>
5.1.4 <i>Power Spectral Density.....</i>	<i>19</i>
5.1.5 <i>Conducted Spurious Emissions and Frequency Band Edges Measured in 100kHz Bandwidth.....</i>	<i>20</i>
5.1.6 <i>Radiated Spurious Emissions and Band Edges</i>	<i>21</i>

Prüfbericht - Nr.: CN21KHZP (P15C-BLE) 001
Test Report No.

Seite 4 von 25
Page 4 of 25

APPENDIX A - TEST RESULT OF CONDUCTED

APPENDIX B - TEST RESULT OF RADIATED EMISSIONS

APPENDIX SP - PHOTOGRAPHS OF TEST SETUP

APPENDIX EP - PHOTOGRAPHS OF EUT

HISTORY OF THIS TEST REPORT

Report No.	Description	Date Issued
CN21KHZP (P15C-BLE) 001	Original Release	2021-11-01

1. General Remarks

1.1 Complementary Materials

All attachments are integral parts of this test report. This applies especially to the following appendix:

Appendix A - Test Result of Conducted

Appendix B - Test Result of Radiated Emissions

Appendix SP - Photographs of Test Setup

Appendix EP - Photographs of EUT

Applied Standard and Test Levels

Radio
FCC 47CFR Part 15: Subpart C Section 15.247
FCC 47CFR Part 2: Subpart J Section 2.1049
ANSI C63.10:2013
KDB 558074 D01 15.247 Meas Guidance v05r02

1.2 Decision Rule of Conformity

The decision rule of conformity of this test report is following the requirements of the requested standard in the quotation, and agreed among testing laboratory and manufacturer (applicant) to exclude the consideration of Measurement Uncertainty, unless it is required by the specific standard.

2. Test Sites

2.1 Test Laboratory

Taipei Testing Laboratories

11F. No.758, Sec. 4, Bade Rd., Songshan Dist.
Taipei City 105
Taiwan (R.O.C.)

2.2 Test Facility

Taipei Testing Laboratories

No.458-18, Sec. 2, Fenliao Rd., Linkou Dist.,
New Taipei City 244
Taiwan (R.O.C.)
FCC Registration No.: 226631
ISED Registration No.: 25563

2.3 Traceability

All measurement equipment calibrations are traceable to NML(Taiwan)/NIST(USA) or where calibration is performed outside Taiwan, to equivalent nationally recognized standards organizations.

2.4 Calibration

Equipment requiring calibration is calibrated periodically in a suitably accredited Calibration Lab. Additionally all equipment is verified for proper performance on a regular basis using in house standards or comparisons.

2.5 Measurement Uncertainty

All measurement uncertainty values are shown with a coverage factor of $k=2$ to indicate a 95% level of confidence.

Emission Measurement Uncertainty

Parameter	Uncertainty
Radiated Emission (9 kHz ~ 30 MHz)	± 1.15 dB
Radiated Emission (30 MHz ~ 200 MHz)	± 1.30 dB
Radiated Emission (200 MHz ~ 1 GHz)	± 1.30 dB
Radiated Emission (1 GHz ~ 18 GHz)	± 1.54 dB
Radiated Emission (18 GHz ~ 40 GHz)	± 2.52 dB
Mains Conducted Emission	± 1.65 dB

3. General Product Information

3.1 Product Function and Intended Use

The EUT is a BLUETOOTH THALES CARD. It contains a Bluetooth compatible chip enabling the user to communicate data through a Wireless interface.

For details refer to the User Guide, Data Sheet and Circuit Diagram.

3.2 System Details and Ratings

Basic Information of EUT

Item	EUT information
Kind of Equipment/Test Item	BLUETOOTH THALES CARD
Type Identification	BLUETOOTH THALES CARD
FCC ID	MESVOICECARD

Technical Specification of EUT

Item	EUT information
Operating Frequency	2402 MHz ~ 2480 MHz
Channel Number	40
Data Rate	1Mbps
Operation Voltage	5 Vdc
Modulation	GFSK
Maximum Output Power (mW) *	0.07
Antenna Information	Refer to 5.1.1
Accessory Device	Refer to 4.4

* RF Exemption, in accordance with 447498 D04, Appendix A - General Process to Determine RF Exposure Compliance. Because the max output power is less than 1mW, hence "Blanket exemption" is applied, no evaluation required.

3.3 Noise Generating and Noise Suppressing Parts

Refer to the Circuit Diagram.

3.4 Submitted Documents

- Circuit Diagram
- Instruction Manual
- Rating Label
- Technical Description

4. Test Set-up and Operation Modes

4.1 Principle of Configuration Selection

The test modes were adapted accordingly in reference to the instructions for use.

During testing, Channel and Power Controlling Software provided by the customer was used to control the operating channel as well as the output power level. The RF output power selection is for the setting of RF output expected by the customer and is going to be fixed on the firmware of the final end product.

Table for Parameters of Test Software Setting

Frequency (MHz)	Power Setting
2402	Default
2440	Default
2480	Default

4.2 Carrier Frequency and Channel

Channel	Freq. (MHz)	Channel	Freq. (MHz)	Channel	Freq. (MHz)	Channel	Freq. (MHz)
0	2402	10	2422	20	2442	30	2462
1	2404	11	2424	21	2444	31	2464
2	2406	12	2426	22	2446	32	2466
3	2408	13	2428	23	2448	33	2468
4	2410	14	2430	24	2450	34	2470
5	2412	15	2432	25	2452	35	2472
6	2414	16	2434	26	2454	36	2474
7	2416	17	2436	27	2456	37	2476
8	2418	18	2438	28	2458	38	2478
9	2420	19	2440	29	2460	39	2480

4.3 Test Operation and Test Software

Setup for testing: Test samples are provided with a USB interface which makes it possible to control them through a test software installed on a notebook computer.

This software was running on the laptop computer connected to the EUT, and then the EUT can be controlled by CMW500. It was used to enable the operation modes listed as below.

Test Software	Thales_BLE_Certification_Tool
---------------	-------------------------------

The samples were used as follows:

A002999984-006

A002999984-007

Full test was applied on all test modes, but only worst case was shown.

EUT Configure Mode	Applicable To			Mains Conducted Emission	Description
	Antenna Port Conducted Measurement	Radiated Spurious Emissions above 1 GHz	Radiated Spurious Emissions below 1 GHz		
-	√	√	√	-	-

Note:

1. The EUT had been pre-tested on the positioned of each 3 axis. The worst case was found when position on **Z-plane**.
2. "-" means no effect.

Antenna Port Conducted Measurement

Pre-Scan full test was applied on all test modes, but only worst case was shown.

Following channel(s) was (were) selected for the final test as listed below.

EUT Configure Mode	Available Frequency (MHz)	Tested Frequency (MHz)	Date Rate (Mbps)
-	2402 to 2480	2402, 2440, 2480	1

Radiated Spurious Emissions (Above 1 GHz)

Pre-Scan full test was applied on all test modes, but only worst case was shown.

Following channel(s) was (were) selected for the final test as listed below.

EUT Configure Mode	Available Frequency (MHz)	Tested Frequency (MHz)	Date Rate (Mbps)
-	2402 to 2480	2402, 2440, 2480	1

Radiated Spurious Emissions (Below 1 GHz)

Pre-Scan full test was applied on all test modes, but only worst case was shown.

Following channel(s) was (were) selected for the final test as listed below.

EUT Configure Mode	Available Frequency (MHz)	Tested Frequency (MHz)	Date Rate (Mbps)
-	2402 to 2480	2440	1

Test Condition

Test Item	Ambient Temperature	Relative Humidity	Tested by
Conducted Measurement	23.7 °C	68.3 %	Stanislas Charles
Radiated Spurious Emissions above 1 GHz	18-22 °C	53.3-60.5 %	Eagle Tsai
Radiated Spurious Emissions below 1 GHz	18-22 °C	53.3-60.5 %	Eagle Tsai

4.4 Special Accessories and Auxiliary Equipment

The product has been tested together with the following additional accessories:

Accessory of EUT

None

Support Unit

Support Unit					
No.	Description	Brand	Model	S/N	Remark
1	Wireless Tester	R&S	CMW500	166978	--
2	NoteBook	HP	15-da1046TX	CND9111RHH	--
A	Fixtrue	Thales DIS	DIS-063	N/A	--
B	Signal Cable	Thales DIS	DID-080	N/A	--

Interface Cable					
No.	Description	Shielded Type	Ferrite Core (Qty)	Length (cm)	Remark
A	Fixtrue Cable	YES	NO	150	--
B	Signal Cable	NO	NO	180	--

4.5 Test Setup Diagram

<Radiated Spurious Emissions mode>

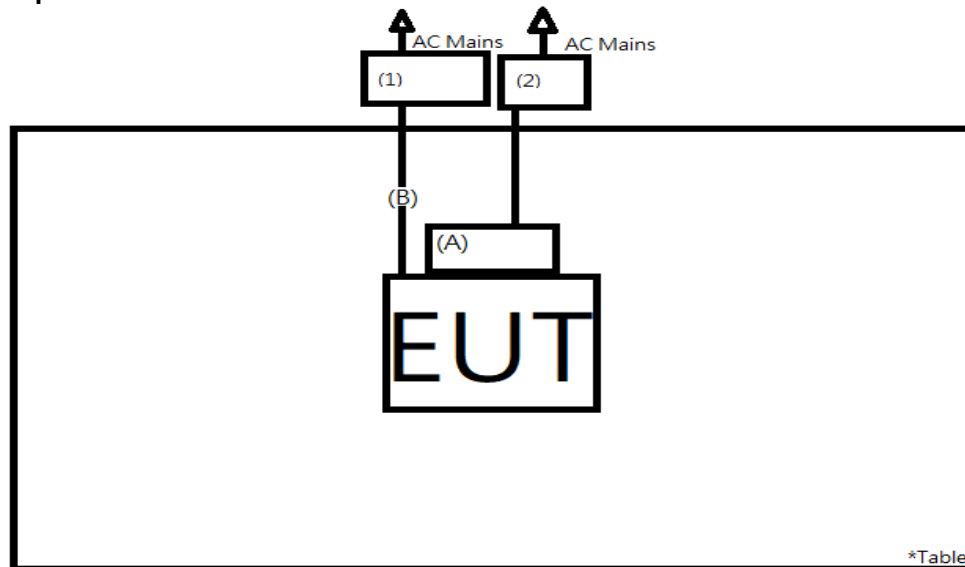

5. Test Results

5.1 Transmitter Requirement & Test Suites

5.1.1 Antenna Requirement

Requirement Use of approved antennas only

According to the manufacturer declaration, the EUT has an antenna with a directional gain of -2 dBi. The antenna is a PCB antenna with no possibility of replacement with a non-approved antenna by the end-user. Therefore, the EUT is considered to comply with this provision. Refer to EUT photo for details.

5.1.2 Peak Output Power

Limit 1 watt (30 dBm)

Kind of Test Site Shielded room

Test Setup



Test Instruments

Kind of Equipment	Manufacturer	Type	S/N	Calibration Date	Calibration Due Date	Test Date	
						From	Until
Power Meter	Anritsu	ML2495A	1901008	2021/3/24	2022/3/23	2021/4/28	2021/4/28
Power Sensor	Anritsu	MA2411B	1725269	2021/3/24	2022/3/23	2021/4/28	2021/4/28

Test Procedures

A peak power sensor was used on the output port of the EUT. A power meter was used to read the response of the peak power sensor. Record the power level.

Average power sensor was used to perform output power measurement, trigger and gating function of wide band power meter is enabled to measure max output power of TX on burst. Duty factor is not added to measured value.

Test Result**Peak Output Power**

<1Mbps>

Channel	Channel Frequency	Peak Output Power		Limit (dBm)
	(MHz)	(dBm)	(mW)	
Low Channel	2402	-11.40	0.07	30
Middle Channel	2440	-12.09	0.06	30
High Channel	2480	-12.75	0.05	30

Average Power

<1Mbps>

Channel	Channel Frequency	Average Power	
	(MHz)	(dBm)	(mW)
Low Channel	2402	-11.60	0.07
Middle Channel	2440	-12.33	0.06
High Channel	2480	-13.05	0.05

5.1.3 6 dB Bandwidth and 99% Occupied Bandwidth

Limit The minimum 6 dB bandwidth shall be at least 500 kHz.

Kind of Test Site Shielded room

Test Setup

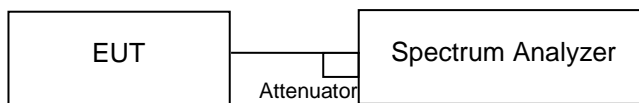

Test Instruments

Kind of Equipment	Manufacturer	Type	S/N	Calibration Date	Calibration Due Date	Test Date	
						From	Until
Spectrum Analyzer	R&S	FSV40	101512	2021/1/29	2022/1/28	2021/4/28	2021/4/28

Test Procedure

- a. Set resolution bandwidth (RBW) = 100 kHz
- b. Set the video bandwidth (VBW) $\geq 3 \times$ RBW, Detector = Peak.
- c. Trace mode = max hold.
- d. Sweep = auto couple.
- e. Measure the maximum width of the emission that is constrained by the frequencies associated with the two amplitude points (upper and lower) that are attenuated by 6 dB relative to the maximum level measured in the fundamental emission.
- f. For 99% occupied bandwidth measurement, the transmitter output was connected to the spectrum analyzer through an attenuator. The bandwidth of the fundamental frequency was measured by spectrum analyzer with resolution bandwidth in the range of 1% to 5% of the anticipated emission bandwidth, and a video bandwidth at least 3x the resolution bandwidth and set the detector to PEAK. The width of a frequency band such that, below the lower and above the upper frequency limits, the mean powers emitted are each equal to a specified percentage 0.5% of the total mean power of a given emission.

Test Results

Please refer to Appendix A.

5.1.4 Power Spectral Density

Limit

The power spectral density shall not be greater than 8 dBm in any 3 kHz band.

Kind of Test Site Shielded room

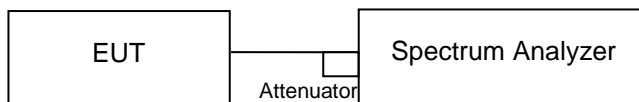
Test Setup

Test Instruments

Kind of Equipment	Manufacturer	Type	S/N	Calibration Date	Calibration Due Date	Test Date	
						From	Until
Spectrum Analyzer	R&S	FSV40	101512	2021/1/29	2022/1/28	2021/4/28	2021/4/28

Test Procedure

- a. Set analyzer center frequency to DTS channel center frequency.
- b. Set the span to 1.5 times the DTS bandwidth.
- c. Set the RBW to: $3 \text{ kHz} \leq \text{RBW} \leq 100 \text{ kHz}$.
- d. Set the VBW $\geq 3 \times \text{RBW}$.
- e. Detector = peak.
- f. Sweep time = auto couple.
- g. Trace mode = max hold.
- h. Allow trace to fully stabilize.
- i. Use the peak marker function to determine the maximum amplitude level within the RBW.

Test Results

Please refer to Appendix A.

5.1.5 Conducted Spurious Emissions and Frequency Band Edges Measured in 100kHz Bandwidth

Limit

20dB (below that in the 100 kHz bandwidth within the band that contains the highest level of the desired power.)

Kind of Test Site Shielded room

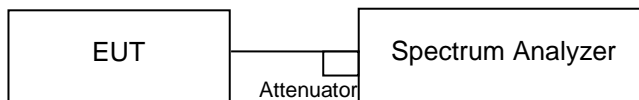
Test Setup

Test Instruments

Kind of Equipment	Manufacturer	Type	S/N	Calibration Date	Calibration Due Date	Test Date	
						From	Until
Spectrum Analyzer	R&S	FSV40	101512	2021/1/29	2022/1/28	2021/4/28	2021/4/28

Test Procedure

Measurement procedure REF

1. Set the RBW = 100 kHz.
2. Set the VBW \geq 300 kHz.
3. Detector = peak.
4. Sweep time = auto couple.
5. Trace mode = max hold.
6. Allow trace to fully stabilize.
7. Use the peak marker function to determine the maximum power level in any 100 kHz band segment within the fundamental EBW.

Measurement procedure OOBE

1. Set RBW = 100 kHz.
2. Set VBW \geq 300 kHz.
3. Detector = peak.
4. Sweep = auto couple.
5. Trace Mode = max hold.
6. Allow trace to fully stabilize.
7. Use the peak marker function to determine the maximum amplitude level.

Test Results

Please refer to Appendix A.

5.1.6 Radiated Spurious Emissions and Band Edges

Limit

Radiated emissions which fall in the restricted bands, as defined in §15.205(a), must comply with the radiated emission limits specified in §15.209(a).

Emissions radiated outside the restricted and authorized frequency bands must either comply with the radiated emission limits specified for the restricted bands or in §15.247(d).

Kind of Test Site 3m Semi-Anechoic Chamber

Test Setup

<Radiated Emissions below 30 MHz>

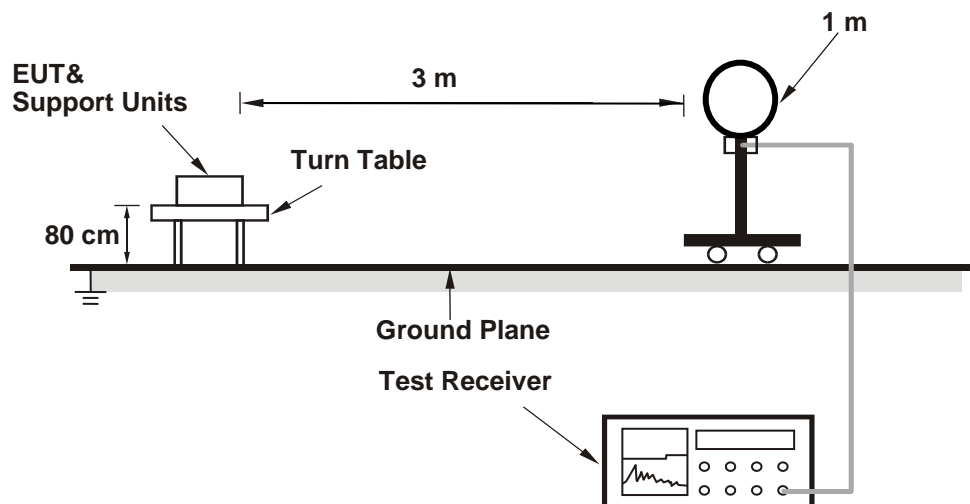

<Radiated Emissions 30 MHz to 1 GHz>

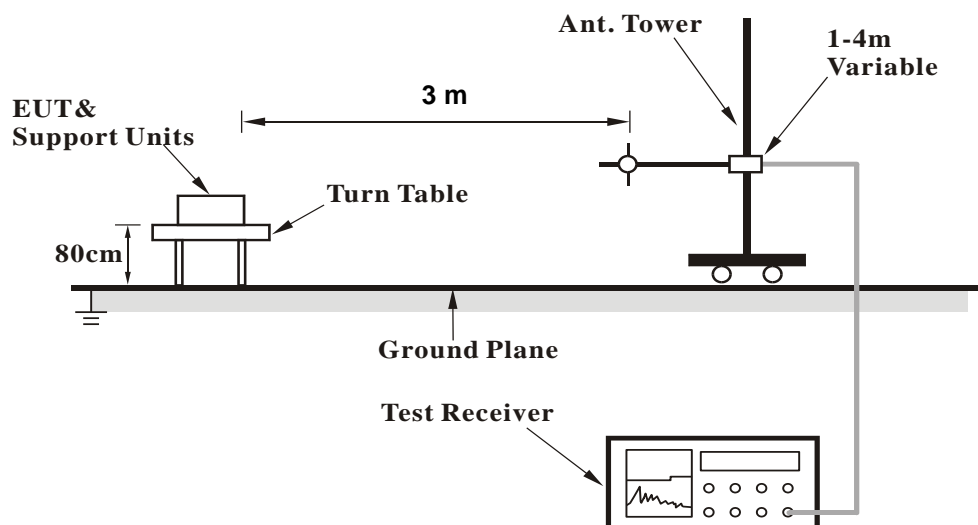

<Radiated Emissions above 1 GHz>

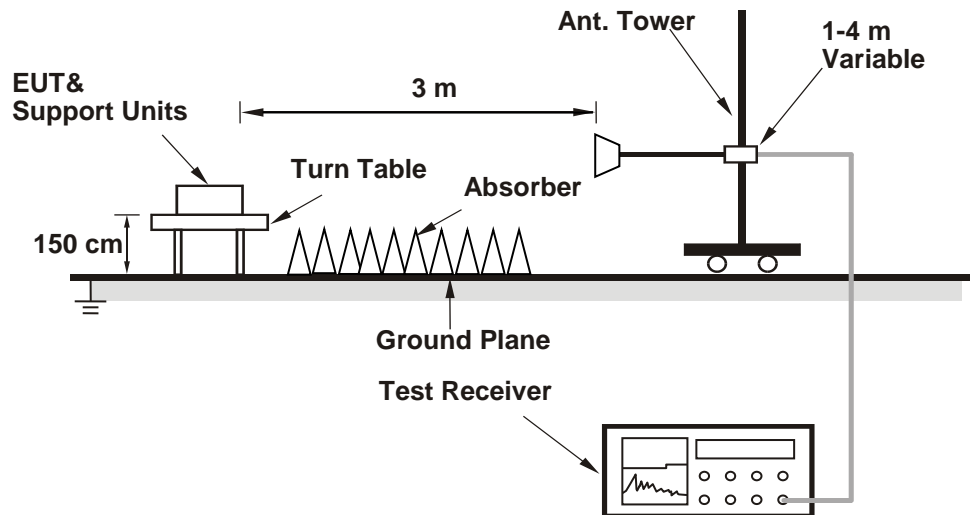

For the actual test configuration, please refer to the attached file (Test Setup Photo).

Test Instruments

Kind of Equipment	Manufacturer	Type	S/N	Calibration Date	Calibration Due Date
Signal Analyzer	R&S	FSV40	101508	2021/3/16	2022/3/15
Receiver	R&S	ESR7	102109	2021/3/16	2022/3/15
Bilog Antenna	SCHWARZBECK	VULB-9168	00951	2021/2/18	2022/2/17
Horn Antenna	ETS-Lindgren	3117	00218930	2020/12/1	2021/11/30
LF-AMP	Agilent	8447D	2944A10772	2021/2/18	2022/2/17
HF-AMP + AC source	EMCI	EMC051845SE	980633	2021/2/9	2022/2/8
HF-AMP + AC source	EMCI	EMC184045SE	980657	2021/2/1	2022/1/31
Horn Antenna	SCHWARZBECK	BBHA 9170	00887	2021/4/8	2022/4/7
Microwave Cable	HUBER+SUHNER	SUCOFLEX 104EA	800056/4EA	2021/3/17	2022/3/16
Microwave Cable	HUBER+SUHNER	SUCOFLEX 104	804680/4	2021/3/17	2022/3/16
Microwave Cable	HUBER+SUHNER	SUCOFLEX 104	MY37202/4	2021/3/17	2022/3/16
Microwave Cable	HUBER+SUHNER	SUCOFLEX 102EA	800898/2EA	2021/4/16	2022/4/15
Microwave Cable	HUBER+SUHNER	SUCOFLEX 102EA	800901/2EA	2021/4/16	2022/4/15
Microwave Cable	HUBER+SUHNER	SUCOFLEX 102EA	801027/2EA	2021/4/16	2022/4/15
Loop Antenna	Chance Most	EMCILPA600 +calibration	287	2020/6/17	2021/6/16

Test Procedures**For Radiated Emissions below 30 MHz**

- a. The EUT was placed on the top of a rotating table 0.8 meters above the ground at a 3 meter chamber room. The table was rotated 360 degrees to determine the position of the highest radiation.
- b. The EUT was set 3 meters away from the interference-receiving antenna, which was mounted on the top of a variable-height antenna tower.
- c. Parallel (OPEN), perpendicular (CLOSE), and ground-parallel (GROUND) orientations of the antenna are set to make the measurement.
- d. For each suspected emission, the EUT was arranged to its worst case and the rotatable table was turned from 0 degrees to 360 degrees to find the maximum reading.
- e. The test-receiver system was set to Quasi-Peak Detect Function and Specified Bandwidth with Maximum Hold Mode.

Note:

1. The resolution bandwidth and video bandwidth of test receiver/spectrum analyzer is 9 kHz at frequency below 30 MHz.
2. All modes of operation were investigated and the worst-case emissions are reported.

For Radiated Emissions above 30 MHz

- a. The EUT was placed on the top of a rotating table 0.8 meters (for 30 MHz ~ 1 GHz) / 1.5 meters (for above 1 GHz) above the ground at 3 meter chamber room for test. The table was rotated 360 degrees to determine the position of the highest radiation.
- b. The EUT was set 3 meters away from the interference-receiving antenna, which was mounted on the top of a variable-height antenna tower.
- c. The height of antenna is varied from one meter to four meters above the ground to determine the maximum value of the field strength. Both horizontal and vertical polarizations of the antenna are set to make the measurement.
- d. For each suspected emission, the EUT was arranged to its worst case and then the antenna was tuned to heights from 1 meter to 4 meters and the rotatable table was turned from 0 degrees to 360 degrees to find the maximum reading.
- e. The test-receiver system was set to quasi-peak detect function and specified bandwidth with maximum hold mode when the test frequency is below 1 GHz.
- f. The test-receiver system was set to peak and average detected function and specified bandwidth with maximum hold mode when the test frequency is above 1 GHz. If the peak reading value also meets average limit, measurement with the average detector is unnecessary.

Note:

1. The resolution bandwidth and video bandwidth of test receiver/spectrum analyzer is 120 kHz for Quasi-peak detection (QP) or Peak detection (PK) at frequency below 1 GHz.
2. The resolution bandwidth of test receiver/spectrum analyzer is 1 MHz and the video bandwidth is 3 MHz for Peak detection (PK) at frequency above 1 GHz.
3. The resolution bandwidth of test receiver/spectrum analyzer is 1 MHz and the video bandwidth is $\geq 1/T$ (Duty cycle < 98 %) or 10 Hz (Duty cycle ≥ 98 %) for Average detection (AV) at frequency above 1 GHz.
4. All modes of operation were investigated and the worst-case emissions are reported.
5. The Radiated Emissions testing was performed in the X(E1), Y(H) and Z(E2) axis orientation. The worst-case Axis orientation is recorded in this test report.

Prüfbericht - Nr.: CN21KHZP (P15C-BLE) 001
Test Report No.

Seite 25 von 25
Page 25 of 25

Test Results

Factor (dB/m) = Antenna Factor (dB/m) + Cable Loss (dB)
Level (dBuV/m) = Reading (dBuV) + Factor (dB/m)

Please refer to Appendix B.

Appendix A: Test Results of Conducted Test

Test Result of 6 dB Bandwidth

BLE_1M

Channel	Channel Frequency (MHz)	6 dB Bandwidth (kHz)	Limit (kHz)	Result
Low Channel	2402	689.31	> 500	Pass
Middle Channel	2440	716.28	> 500	Pass
High Channel	2480	740.26	> 500	Pass

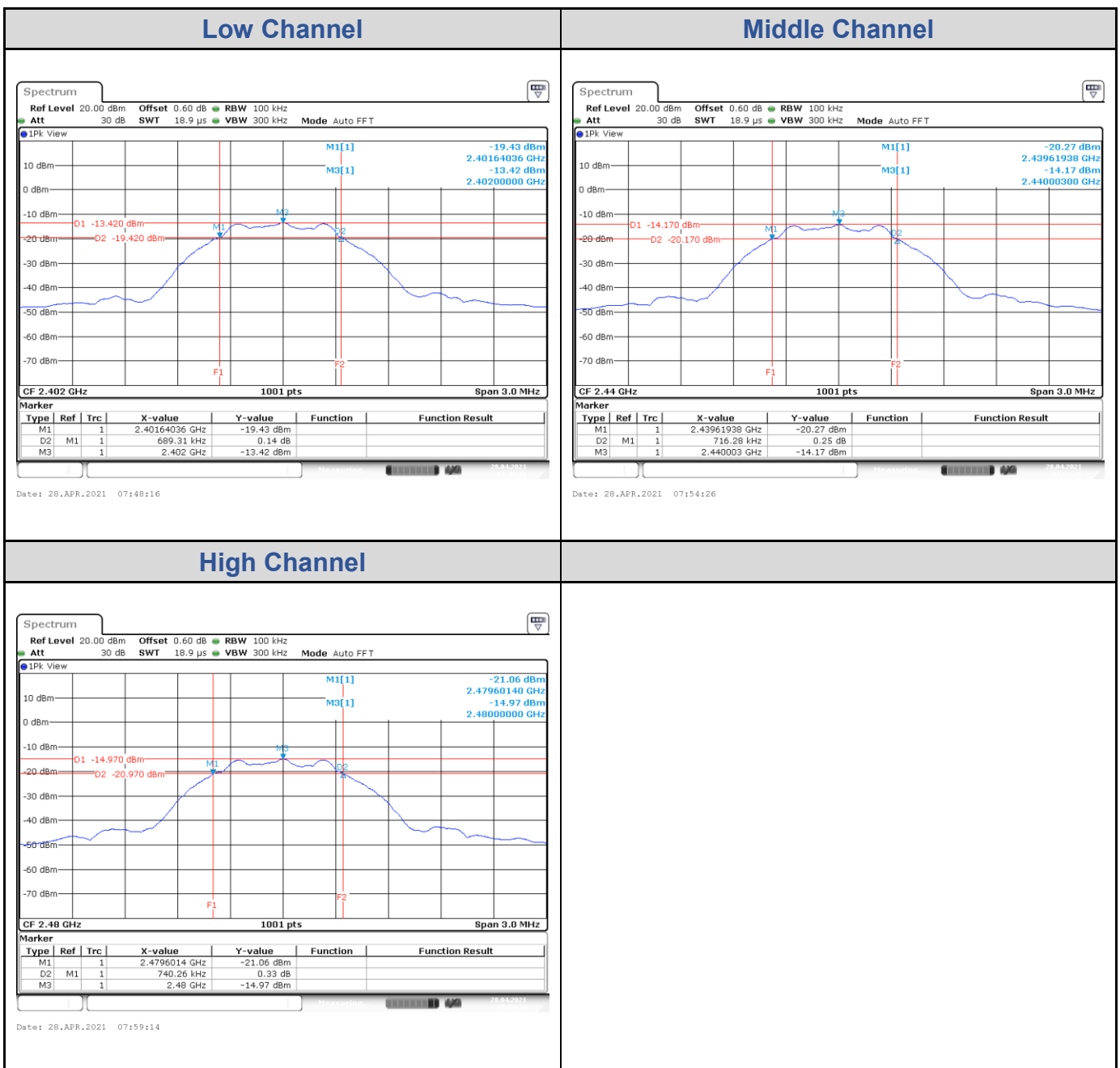

Test Result of 99% Occupied Bandwidth
BLE_1M

Channel	Channel Frequency (MHz)	99% Bandwidth (MHz)
Low Channel	2402	1.037
Middle Channel	2440	1.055
High Channel	2480	1.079

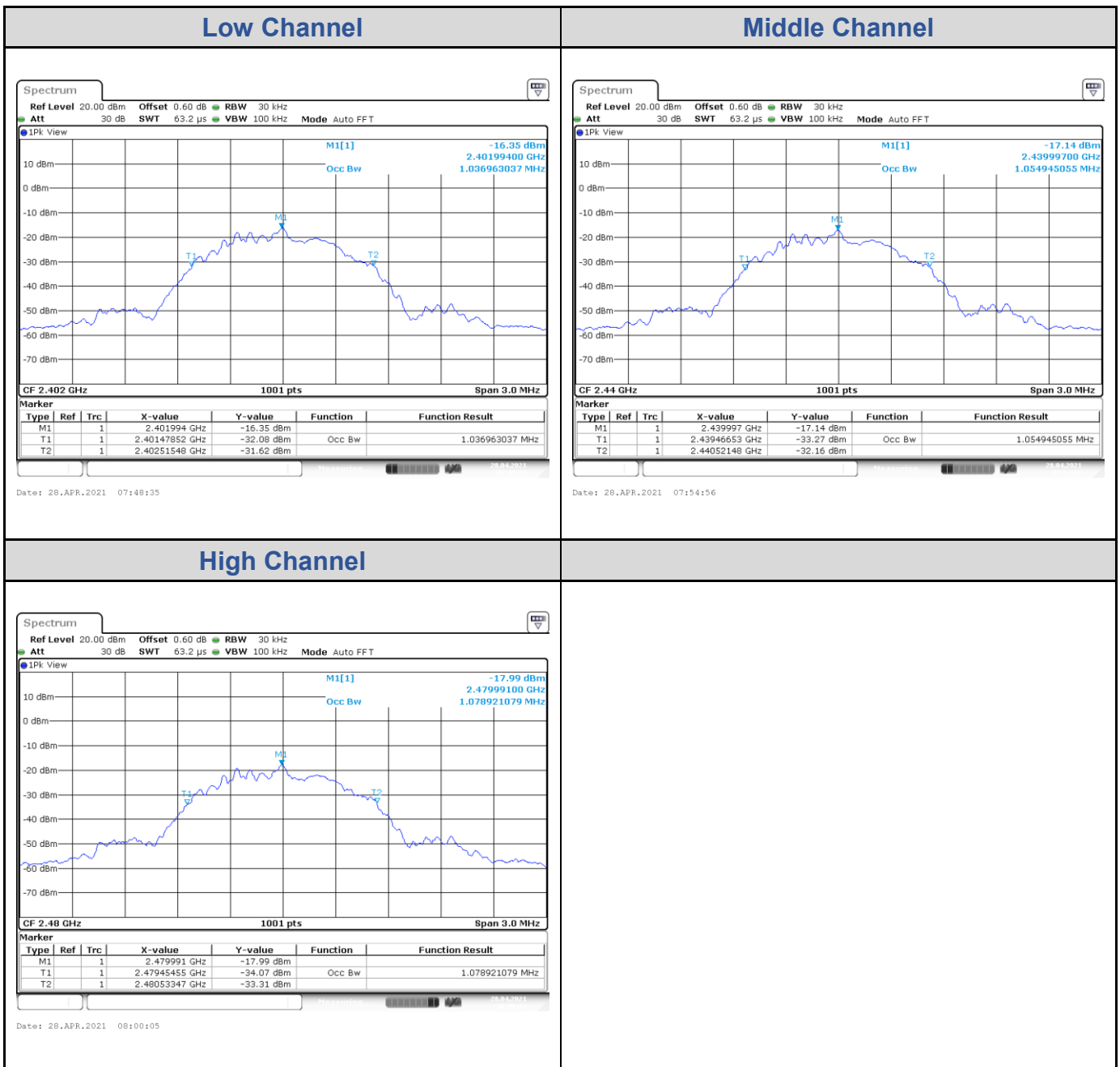

Test Result of Power Spectral Density

BLE_1M

Channel	Channel Frequency (MHz)	Power Density (dBm/3kHz)	Limit (dBm/3kHz)	Result
Low Channel	2402	-28.96	8	Pass
Middle Channel	2440	-29.69	8	Pass
High Channel	2480	-30.44	8	Pass

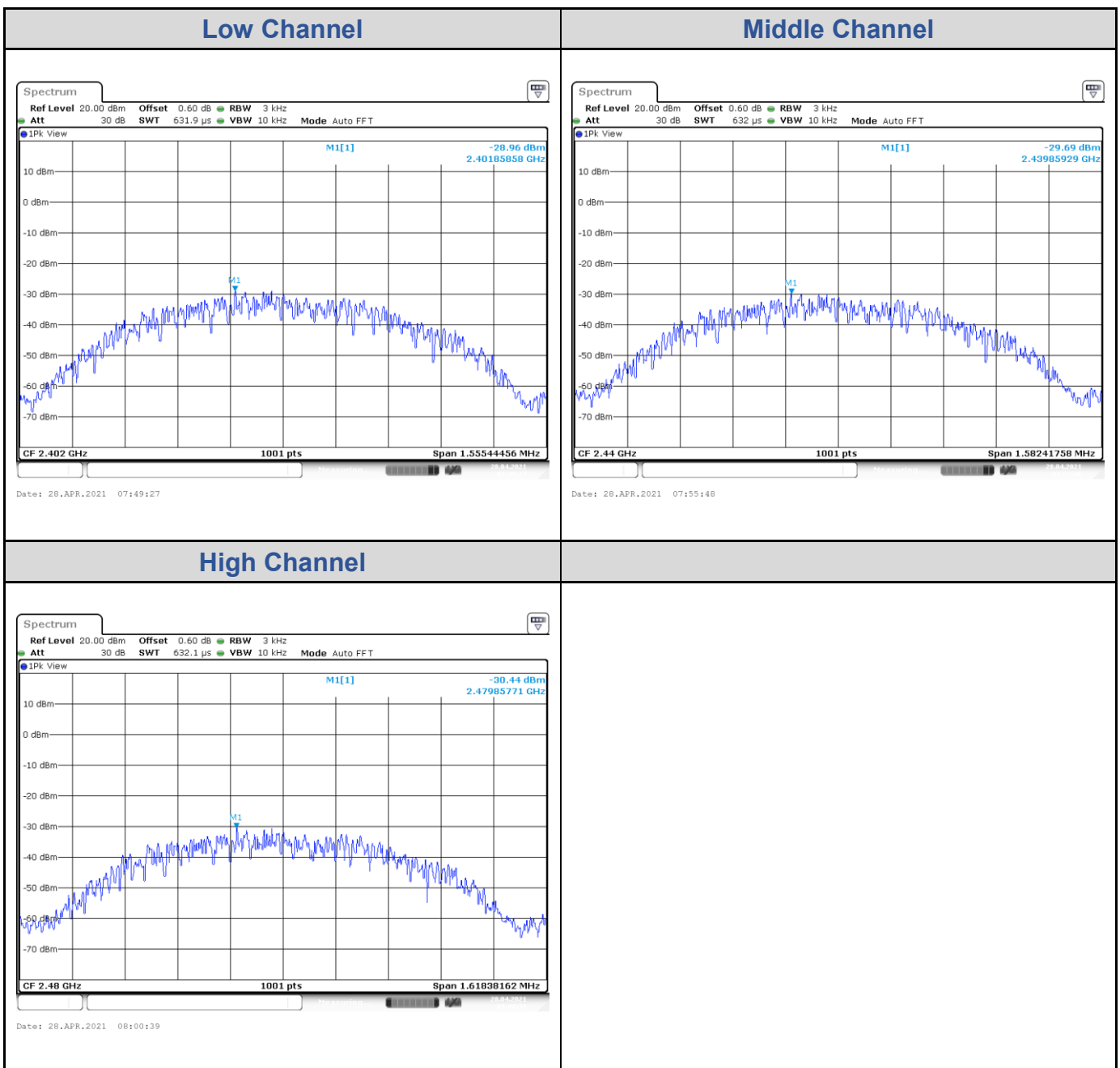

Test Result of Conducted Spurious Emissions, Tx Mode

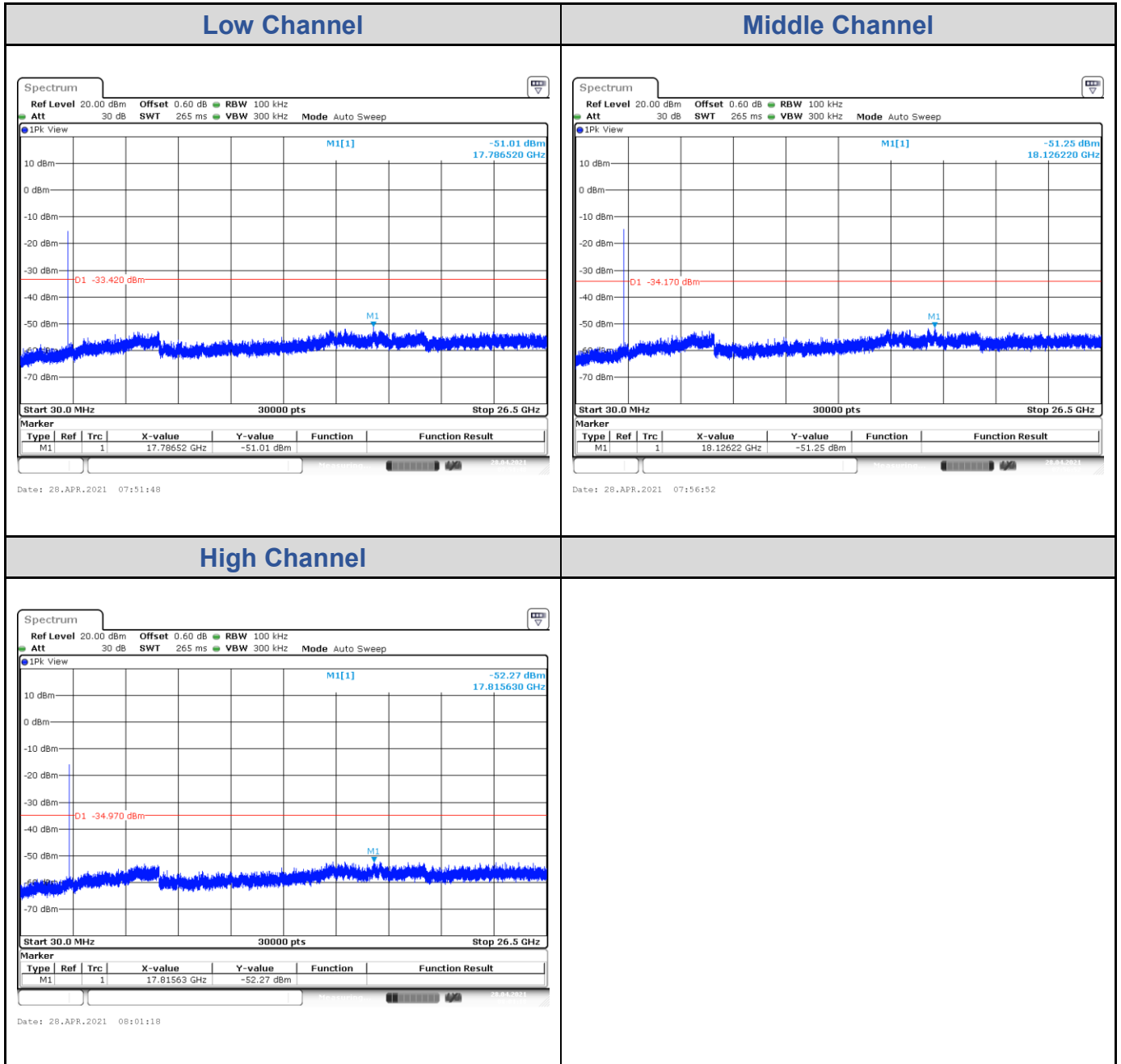
BLE_1M

Test Result of Conducted Band Edge, Tx Mode

BLE_1M

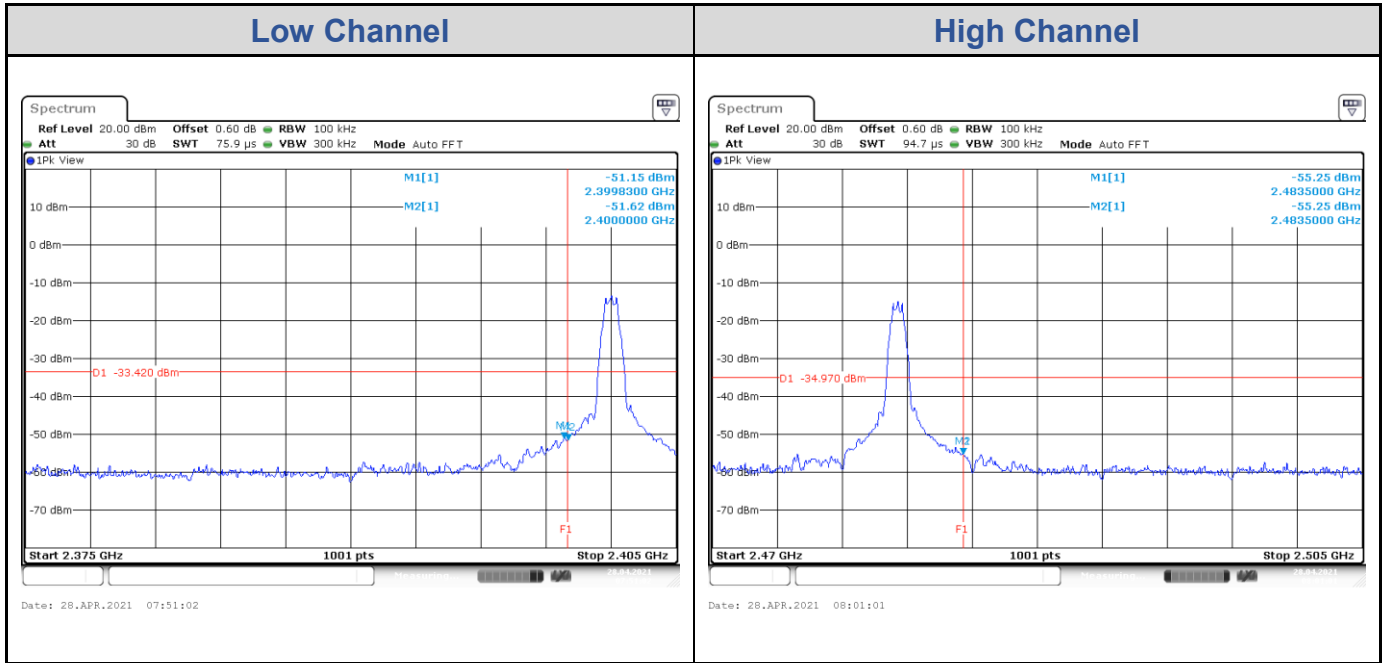

Appendix B: Test Results of Radiated Emissions

Band Edges, 2.31GHz ~ 2.9GHz

BLE_1M

Low Channel (Horizontal) Peak

Low Channel (Vertical) Peak



TUV Rheinland Taiwan Ltd.
No. 438-18, Sec. 2, Fenhiao, Linkou Dist., New Taipei City 244, Taiwan(R.O.C.)
Tel: +886-2172-1000 Fax: +886-2172-1322

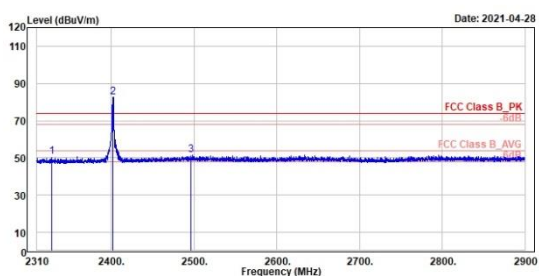

Freq	Level	Read	Limit	Over	APos	TPos	Remark	Pol/Phase	Note
MHz	dBuV/m	dBuV	dB/m	dBuV/m	dB	cm	deg		
1	2327.58	50.50	16.82	33.68	74.00	-23.50	100	124 Peak	Horizontal
2 *	2482.00	82.74	48.68	34.06	74.00	8.74	100	124 Peak	Horizontal
3	2496.20	51.66	17.09	34.57	74.00	-22.34	100	124 Peak	Horizontal



TUV Rheinland Taiwan Ltd.
No. 438-18, Sec. 2, Fenhiao, Linkou Dist., New Taipei City 244, Taiwan(R.O.C.)
Tel: +886-2172-1000 Fax: +886-2172-1322

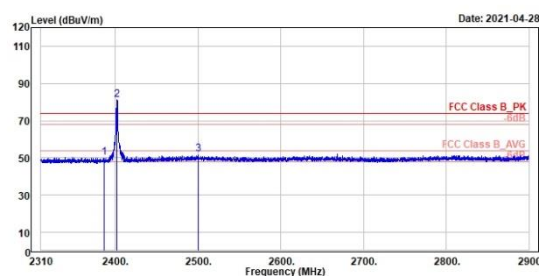

Freq	Level	Read	Limit	Over	APos	TPos	Remark	Pol/Phase	Note
MHz	dBuV/m	dBuV	dB/m	dBuV/m	dB	cm	deg		
1	2306.46	50.34	16.38	33.96	74.00	-23.66	349	176 Peak	Vertical
2 *	2482.00	81.00	46.94	34.06	74.00	7.00	349	176 Peak	Vertical
3	2499.98	51.82	17.23	34.59	74.00	-22.18	349	176 Peak	Vertical

BLE_1M

Low Channel (Horizontal) Average

Low Channel (Vertical) Average

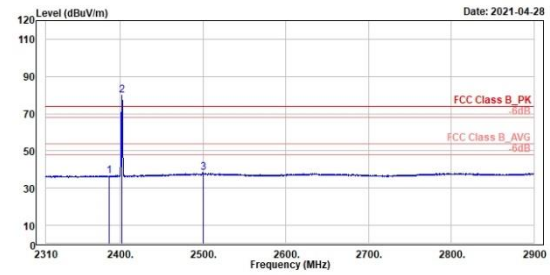
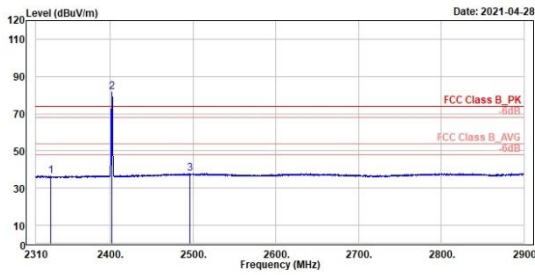

Freq	Level	Read Level	Factor	Limit Line	Over Limit	APos	TPos	Remark	Pol/Phase	Note
MHz	dBuV/m	dBuV	dB/m	dBuV/m	dB	cm	deg			
1	2327.58	36.59	2.91	33.68	54.00	-17.41	100	124 Average	Horizontal	
2 *	2482.00	81.71	47.65	34.06	54.00	27.71	100	124 Average	Horizontal	
3	2496.20	37.98	3.41	34.57	54.00	-16.02	100	124 Average	Horizontal	

Freq	Level	Read Level	Factor	Limit Line	Over Limit	APos	TPos	Remark	Pol/Phase	Note
MHz	dBuV/m	dBuV	dB/m	dBuV/m	dB	cm	deg			
1	2386.46	36.64	2.68	33.96	54.00	-17.36	349	176 Average	Vertical	
2 *	2482.00	79.91	45.85	34.06	54.00	25.91	349	176 Average	Vertical	
3	2499.98	38.32	3.73	34.59	54.00	-15.68	349	176 Average	Vertical	

BLE_1M

High Channel (Horizontal) Peak

High Channel (Vertical) Peak

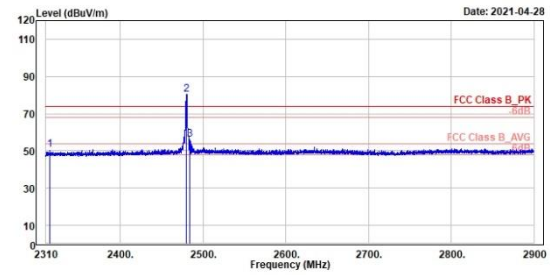
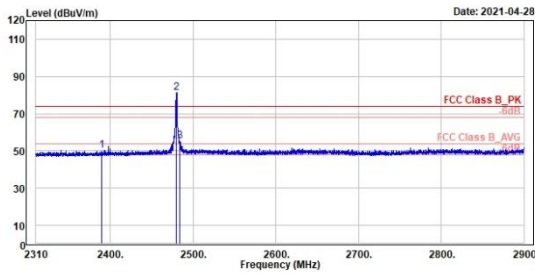

Peak	Freq	Level	Read	Level	Factor	Limit	Over	APos	TPos	Remark	Pol/Phase	Note
	MHz	dBuV/m	dBuV	dB/m	dBuV/m	dB	dB	cm	deg			
1	2390.00	50.05	16.06	33.99	74.00	-23.95	240	128	Peak	Horizontal		
2 *	2480.00	81.23	46.73	34.50	74.00	7.23	240	128	Peak	Horizontal		
3	2483.50	55.34	20.83	34.51	74.00	-18.66	240	128	Peak	Horizontal		

Peak	Freq	Level	Read	Level	Factor	Limit	Over	APos	TPos	Remark	Pol/Phase	Note
	MHz	dBuV/m	dBuV	dB/m	dBuV/m	dB	dB	cm	deg			
1	2315.07	50.64	16.99	33.65	74.00	-23.36	100	175	Peak	Vertical		
2 *	2480.00	80.45	45.95	34.50	74.00	6.45	100	175	Peak	Vertical		
3	2483.50	56.01	21.50	34.51	74.00	-17.99	100	175	Peak	Vertical		

BLE_1M

High Channel (Horizontal) Average

High Channel (Vertical) Average



TUV Rheinland Taiwan Ltd.
No. 458-18, Sec. 2, Fenhiao, Linkou Dist., New Taipei City 244, Taiwan(R.O.C.)
Tel: +886-2172-1000 Fax: +886-2172-1322

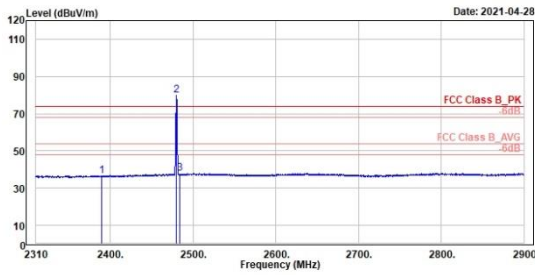

Freq	Level	Read Level	Factor	Limit Line	Over Limit	APos	TPos	Remark	Pol/Phase	Note
MHz	dBuV/m	dBuV	dB/m	dBuV/m	dB	cm	deg			
1	2390.00	36.64	2.65	33.99	54.00	-17.36	240	128 Average	Horizontal	
2 *	2480.00	89.01	45.51	34.50	54.00	26.01	240	128 Average	Horizontal	
3	2483.50	37.93	3.42	34.51	54.00	-16.07	240	128 Average	Horizontal	



TUV Rheinland Taiwan Ltd.
No. 458-18, Sec. 2, Fenhiao, Linkou Dist., New Taipei City 244, Taiwan(R.O.C.)
Tel: +886-2172-1000 Fax: +886-2172-1322

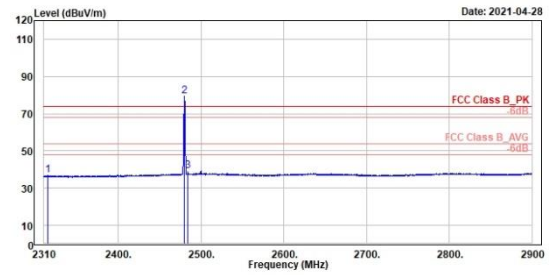

Freq	Level	Read Level	Factor	Limit Line	Over Limit	APos	TPos	Remark	Pol/Phase	Note
MHz	dBuV/m	dBuV	dB/m	dBuV/m	dB	cm	deg			
1	2315.07	36.85	3.20	33.65	54.00	-17.15	100	175 Average	Vertical	
2 *	2480.00	79.29	44.79	34.50	54.00	25.29	100	175 Average	Vertical	
3	2483.50	39.13	4.62	34.51	54.00	-14.87	100	175 Average	Vertical	

Spurious Emissions, Tx Mode, 9kHz ~ 30MHz
BLE_1M
Middle Channel (Open) 9kHz~150kHz
Middle Channel (Open) 150kHz~30MHz

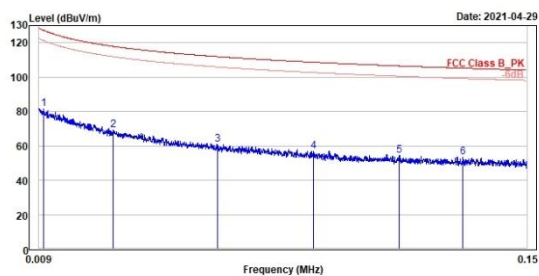
 TÜV Rheinland Taiwan Ltd.
 No. 458-18, Sec. 2, Fenhiao, Linkou Dist., New Taipei City 244, Taiwan(R.O.C.)
 Tel: +886-2172-1000 Fax: +886-2172-1322

1	2	3	4	5	6
0.01	0.03	0.06	0.09	0.11	0.13
81.50	69.26	60.84	57.08	54.40	53.25
4.92	0.64	-1.62	-1.73	-2.29	-2.65
76.58	68.62	62.46	58.81	56.69	55.90
127.24	117.90	111.96	108.68	106.52	105.22
-45.74	-48.64	-51.12	-51.60	-52.12	-51.97
100	100	100	100	100	100
320	203	217	303	120	80
QP	QP	QP	QP	QP	QP
Open	Open	Open	Open	Open	Open

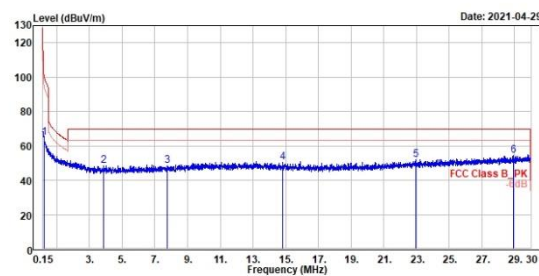
 TÜV Rheinland Taiwan Ltd.
 No. 458-18, Sec. 2, Fenhiao, Linkou Dist., New Taipei City 244, Taiwan(R.O.C.)
 Tel: +886-2172-1000 Fax: +886-2172-1322

1	2	3	4	5	6
0.23	3.06	7.75	14.80	22.95	28.96
64.64	48.22	48.60	50.35	52.14	54.23
12.86	11.54	11.24	12.52	13.31	12.59
51.78	36.68	37.36	37.83	38.83	41.64
100.46	21.28	20.90	19.15	17.36	15.27
-35.82	-21.28	-20.90	-19.15	-17.36	-15.27
100	100	100	100	100	100
168	121	51	172	341	183
QP	QP	QP	QP	QP	QP
Open	Open	Open	Open	Open	Open

BLE_1M

Middle Channel (Close) 9kHz~150kHz

Middle Channel (Close) 150kHz~30MHz



TUV Rheinland Taiwan Ltd.
No. 458-18, Sec. 2, Fenhiao, Linkou Dist., New Taipei City 244, Taiwan(R.O.C.)
Tel: +886-2172-1000 Fax: +886-2172-1322

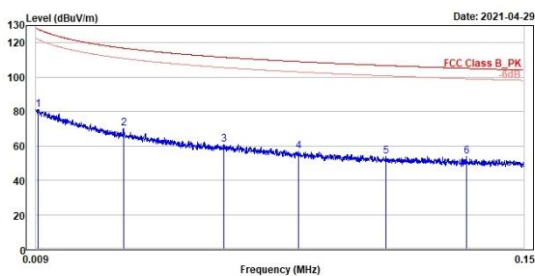

Freq	Level	Read	Limit	Over	APos	TPos	Remark	Pol/Phase	Note
MHz	dBuV/m	dBuV	dB/m	dBuV/m	dB	cm	deg		
1	81.31	4.12	77.19	127.95	-46.64	100	32 QP	Close	
2	78.09	2.39	67.70	116.89	-46.80	100	342 QP	Close	
3	60.83	-1.27	62.10	111.58	-50.75	100	41 QP	Close	
4	56.88	-2.37	59.25	109.01	-52.13	100	214 QP	Close	
5	54.01	-2.81	56.82	106.76	-52.75	100	278 QP	Close	
6	53.76	-2.06	55.82	105.09	-51.33	100	86 QP	Close	



TUV Rheinland Taiwan Ltd.
No. 458-18, Sec. 2, Fenhiao, Linkou Dist., New Taipei City 244, Taiwan(R.O.C.)
Tel: +886-2172-1000 Fax: +886-2172-1322

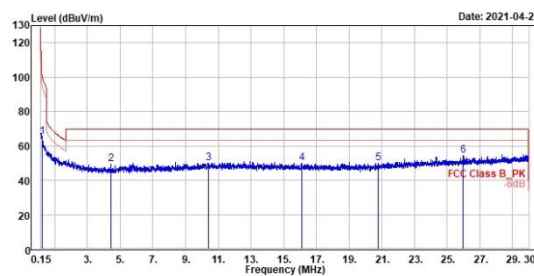

Freq	Level	Read	Limit	Over	APos	TPos	Remark	Pol/Phase	Note
MHz	dBuV/m	dBuV	dB/m	dBuV/m	dB	cm	deg		
1	65.33	13.80	51.53	100.23	-34.90	100	308 QP	Close	
2	49.53	13.02	36.51	69.50	-19.97	100	102 QP	Close	
3	49.92	11.77	38.15	69.50	-19.58	100	309 QP	Close	
4	49.72	11.99	37.73	69.50	-19.78	100	3 QP	Close	
5	49.80	11.98	37.82	69.50	-19.70	100	43 QP	Close	
6	54.19	13.93	40.26	69.50	-15.31	100	317 QP	Close	

Spurious Emissions, Tx Mode, 30MHz ~ 1GHz
BLE_1M
Middle Channel (Horizontal)
Middle Channel (Vertical)

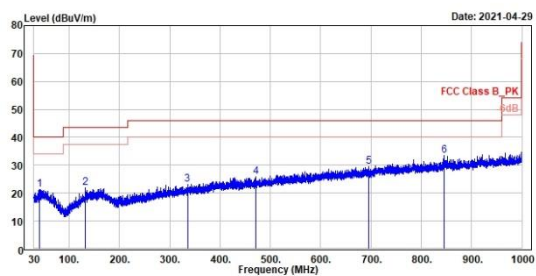
 TÜV Rheinland Taiwan Ltd.
 No. 458-18, Sec. 2, Fenliao, Linkou Dist., New Taipei City 244, Taiwan(R.O.C.)
 Tel: +886-2172-1000 Fax: +886-2172-1322

Freq	Level	Read	Limit	Over	APos	TPos	Remark	Pol/Phase	Note	
MHz	dBuV/m	dBuV	dB/m	dBuV/m	dB	cm	deg			
1	48.67	21.41	29.65	-8.24	48.00	-18.59	114	360	QP	Horizontal
2	132.53	21.82	38.12	-8.30	43.50	-21.68	200	275	QP	Horizontal
3	335.36	22.99	28.61	-5.62	46.00	-23.01	400	217	QP	Horizontal
4	478.67	25.86	29.35	-3.49	46.00	-20.14	200	136	QP	Horizontal
5	695.61	29.41	29.17	0.24	46.00	-16.59	200	213	QP	Horizontal
6	845.29	33.56	31.01	2.55	46.00	-12.44	200	202	QP	Horizontal

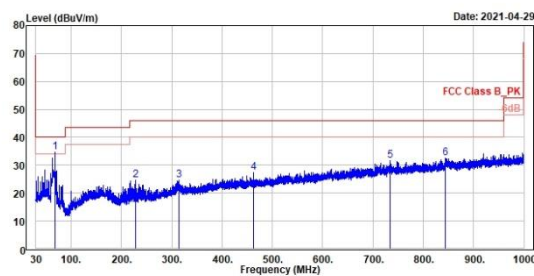
 TÜV Rheinland Taiwan Ltd.
 No. 458-18, Sec. 2, Fenliao, Linkou Dist., New Taipei City 244, Taiwan(R.O.C.)
 Tel: +886-2172-1000 Fax: +886-2172-1322

Freq	Level	Read	Limit	Over	APos	TPos	Remark	Pol/Phase	Note	
MHz	dBuV/m	dBuV	dB/m	dBuV/m	dB	cm	deg			
1	67.54	34.66	44.41	-9.75	48.00	-5.34	100	23	QP	Vertical
2	227.78	24.69	33.62	-8.93	46.00	-21.31	300	37	QP	Vertical
3	314.02	24.70	30.83	-6.13	46.00	-21.30	100	169	QP	Vertical
4	462.52	27.43	31.04	-3.61	46.00	-18.57	100	21	QP	Vertical
5	733.74	31.68	30.80	0.88	46.00	-14.32	200	108	QP	Vertical
6	844.80	32.47	29.92	2.55	46.00	-13.53	200	15	QP	Vertical

Spurious Emissions, Tx Mode, 1GHz ~ 26.5GHz

BLE_1M

Low Channel (Horizontal)

Low Channel (Vertical)



TUV Rheinland Taiwan Ltd.
No. 458-18, Sec. 2, Fenhiao, Linkou Dist., New Taipei City 244, Taiwan(R.O.C.)
Tel: +886-2172-1000 Fax: +886-2172-1322

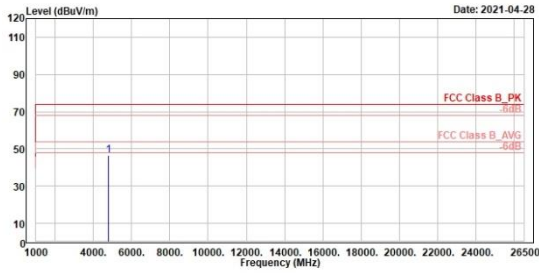

Freq	Level	Read	Limit	Over	APos	TPos	Remark	Pol/Phase	Note
MHz	dBuV/m	dBuV	dB/m	dBuV/m	dB	cm	deg		
1	4884.00	46.66	56.46	-9.80	74.00	-27.34	269	0 Peak	Horizontal



TUV Rheinland Taiwan Ltd.
No. 458-18, Sec. 2, Fenhiao, Linkou Dist., New Taipei City 244, Taiwan(R.O.C.)
Tel: +886-2172-1000 Fax: +886-2172-1322

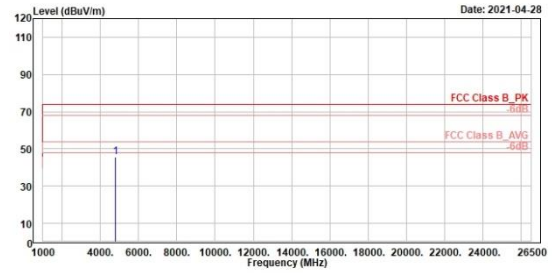

Freq	Level	Read	Limit	Over	APos	TPos	Remark	Pol/Phase	Note
MHz	dBuV/m	dBuV	dB/m	dBuV/m	dB	cm	deg		
1	4884.00	45.74	55.54	-9.80	74.00	-28.26	341	360 Peak	Vertical

BLE_1M

Middle Channel (Horizontal)

Middle Channel (Vertical)



TUV Rheinland Taiwan Ltd.
No. 458-18, Sec. 2, Fenhiao, Linkou Dist., New Taipei City 244, Taiwan(R.O.C.)
Tel: +886-2172-1000 Fax: +886-2172-1322

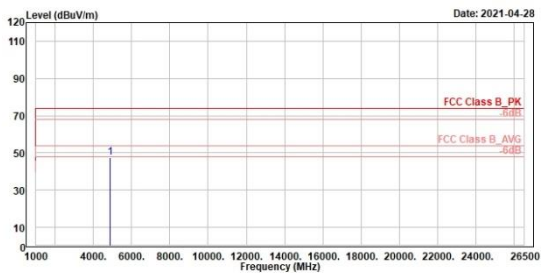

1	4880.00	47.35	57.04	-9.69	74.00	-26.65	300	254	Peak	Horizontal
---	---------	-------	-------	-------	-------	--------	-----	-----	------	------------



TUV Rheinland Taiwan Ltd.
No. 458-18, Sec. 2, Fenhiao, Linkou Dist., New Taipei City 244, Taiwan(R.O.C.)
Tel: +886-2172-1000 Fax: +886-2172-1322

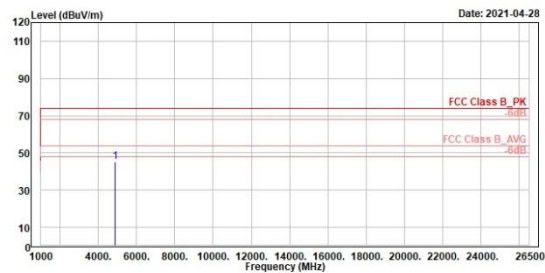

1	4880.00	44.99	54.68	-9.69	74.00	-29.01	300	268	Peak	Vertical
---	---------	-------	-------	-------	-------	--------	-----	-----	------	----------

BLE_1M

High Channel (Horizontal)

High Channel (Vertical)



TUV Rheinland Taiwan Ltd.
No. 458-18, Sec. 2, Fenhiao, Linkou Dist., New Taipei City 244, Taiwan(R.O.C.)
Tel: +886-2172-1000 Fax: +886-2172-1322

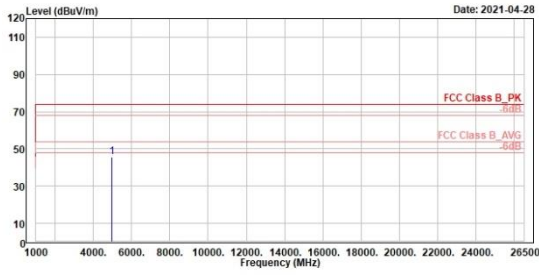

1	4960.00	45.82	55.31	-9.49	74.00	-28.18	283	0	Peak	Horizontal
---	---------	-------	-------	-------	-------	--------	-----	---	------	------------



TUV Rheinland Taiwan Ltd.
No. 458-18, Sec. 2, Fenhiao, Linkou Dist., New Taipei City 244, Taiwan(R.O.C.)
Tel: +886-2172-1000 Fax: +886-2172-1322

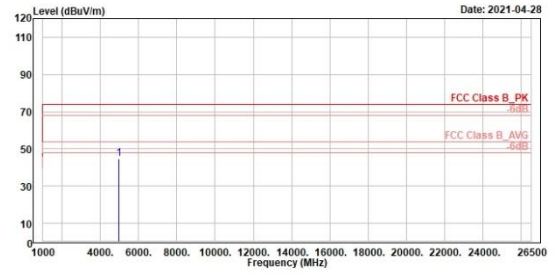

1	4960.00	44.68	54.17	-9.49	74.00	-29.32	480	171	Peak	Vertical
---	---------	-------	-------	-------	-------	--------	-----	-----	------	----------