

6. PHOTOGRAPHS

6.1. Photos of Radiated Measurement at Semi-Anechoic Chamber

6.1.1. Frequency Range 30MHz~1GHz (With Host: VIZIO XVT553SV)



FRONT VIEW OF RADIATED MEASUREMENT



BACK VIEW OF RADIATED MEASUREMENT

6.1.2. Frequency Range: Above 1GHz (With Host: VIZIO XVT553SV)



FRONT VIEW OF RADIATED MEASUREMENT



BACK VIEW OF RADIATED MEASUREMENT

APPENDIX

Schematic (J1 pine define different)

VIA schematic

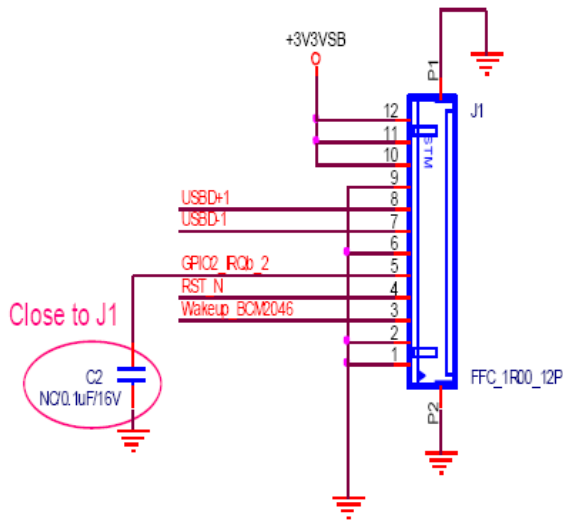

Connector is FFC type

VIA2 schematic

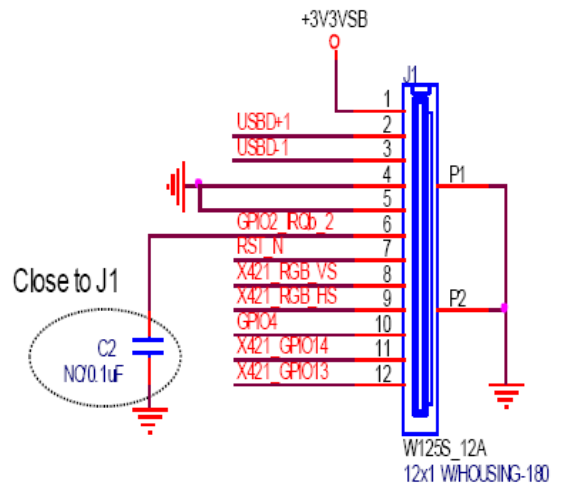

Connector is Normal type

AmTRAN