

### 13. SETUP PHOTOS

#### RADIATED AND POWERLINE CONDUCTED EMISSIONS MEASUREMENT SETUP

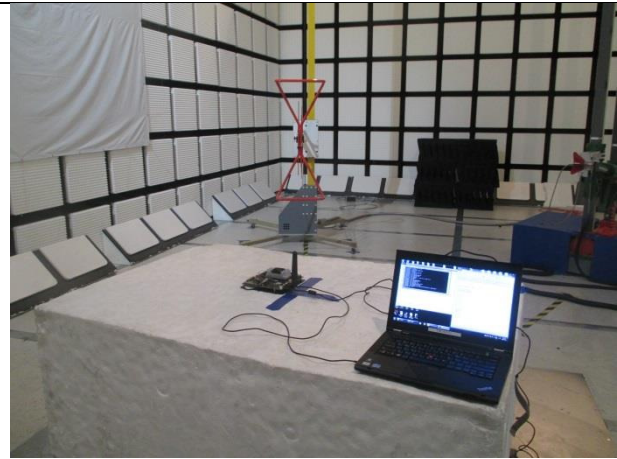

RADIATED FRONT PHOTO (BELOW 1 GHz)



RADIATED BACK PHOTO (BELOW 1 GHz)

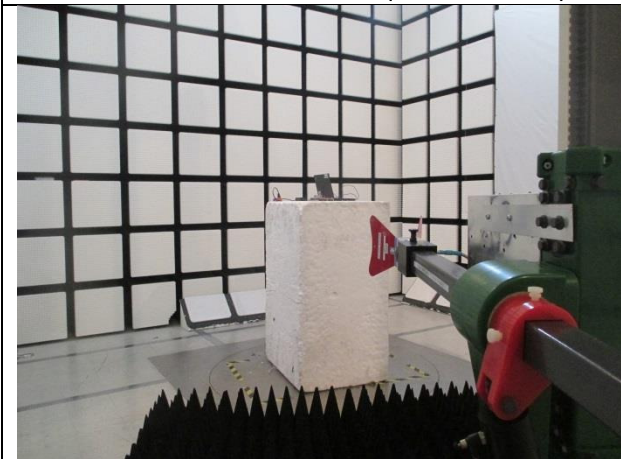

RADIATED FRONT PHOTO (ABOVE 1 GHz)

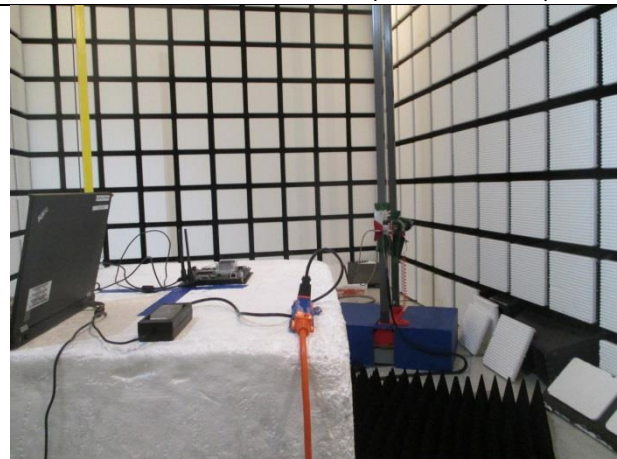

RADIATED BACK PHOTO (ABOVE 1 GHz)

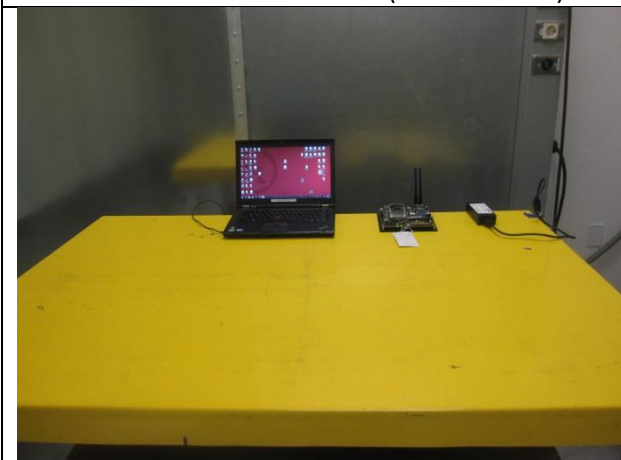

LINE CONDUCTED FRONT PHOTO

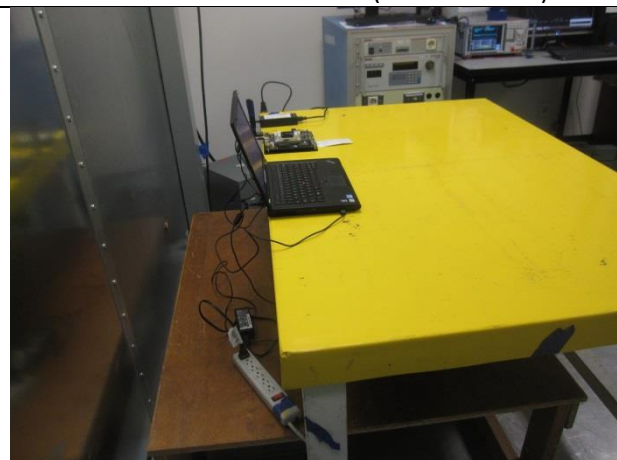

LINE CONDUCTED SIDE VIEW PHOTO

**ANTENNA PORT CONDUCTED RF MEASUREMENT SETUP AND  
RADIATED RF MEASUREMENT SETUP FOR PORTABLE CONFIGURATION**

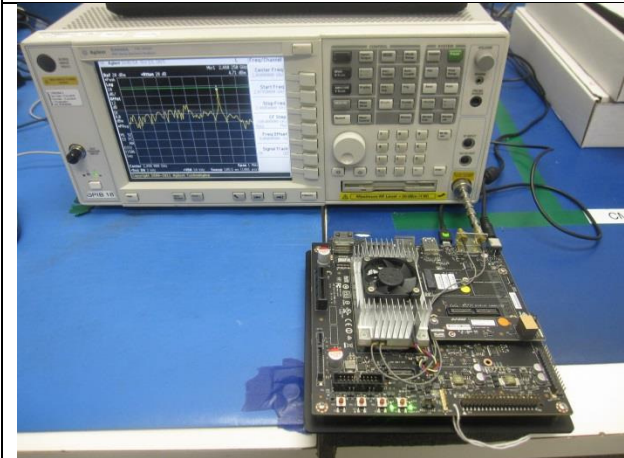

ANTENNA PORT CONDUCTED PHOTO

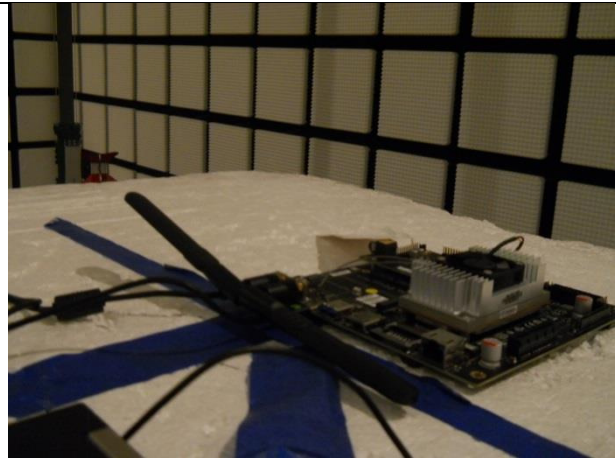

0 Degrees PHOTO

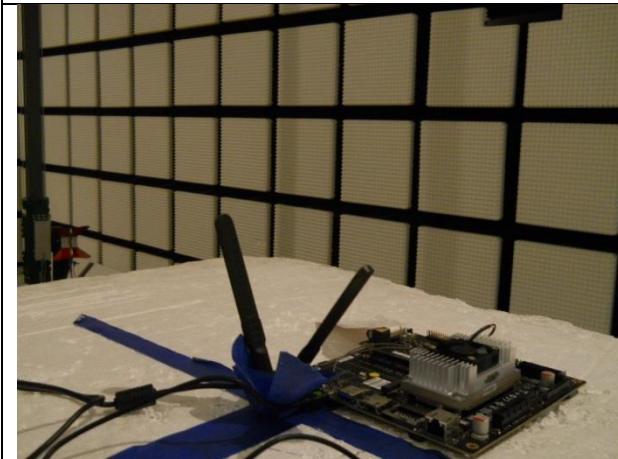

45 Degrees PHOTO

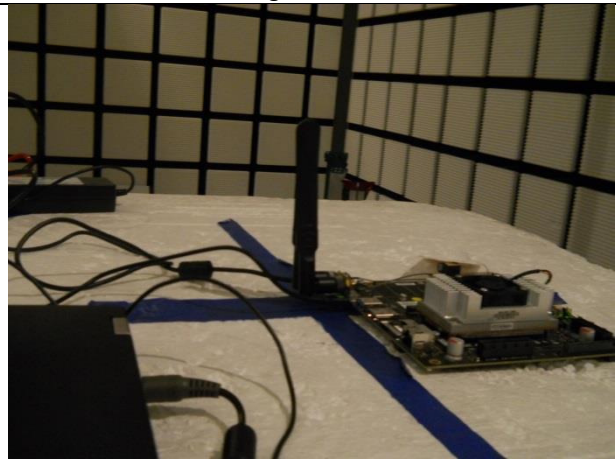

90 Degrees PHOTO

**END OF REPORT**

## 14. EUT PHOTOS

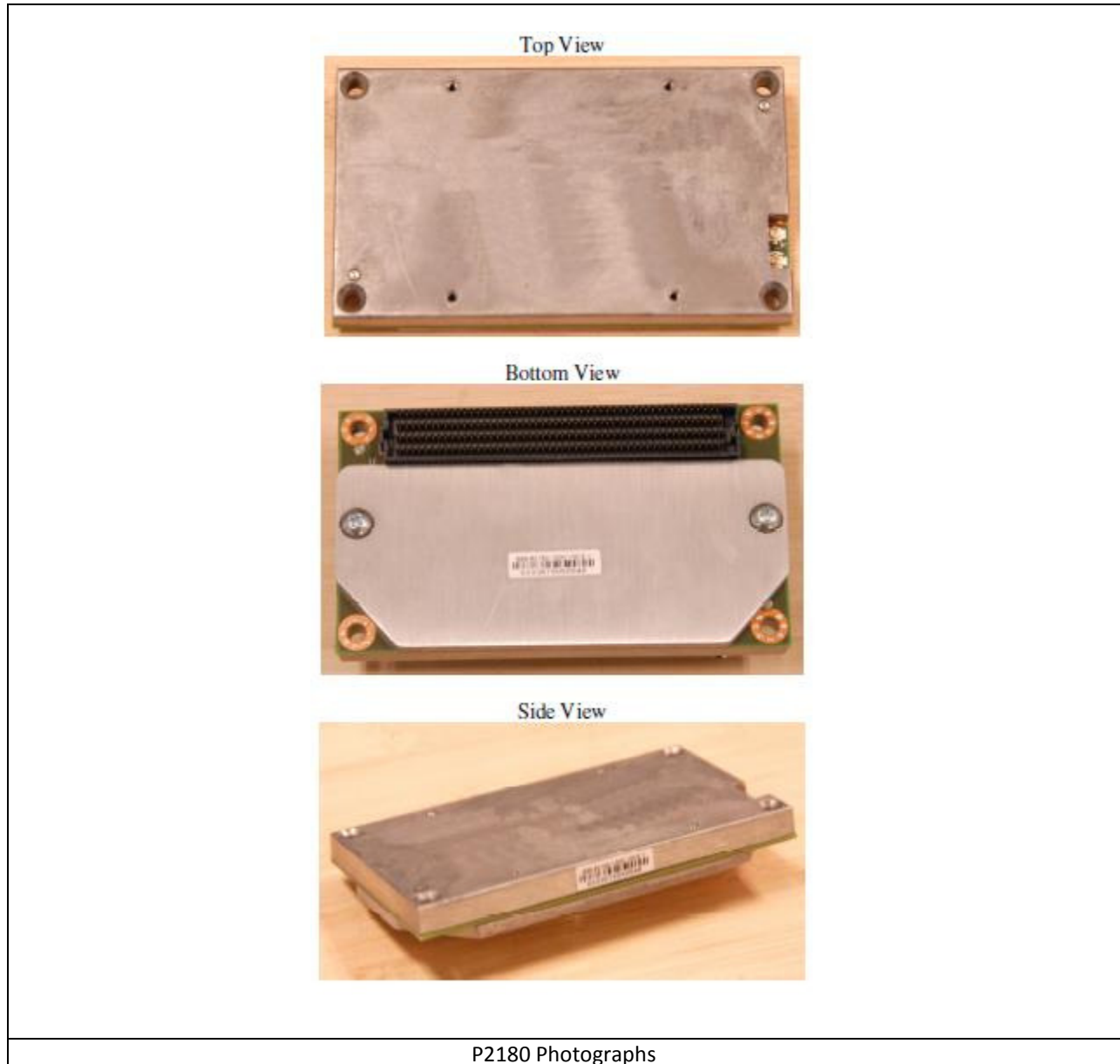



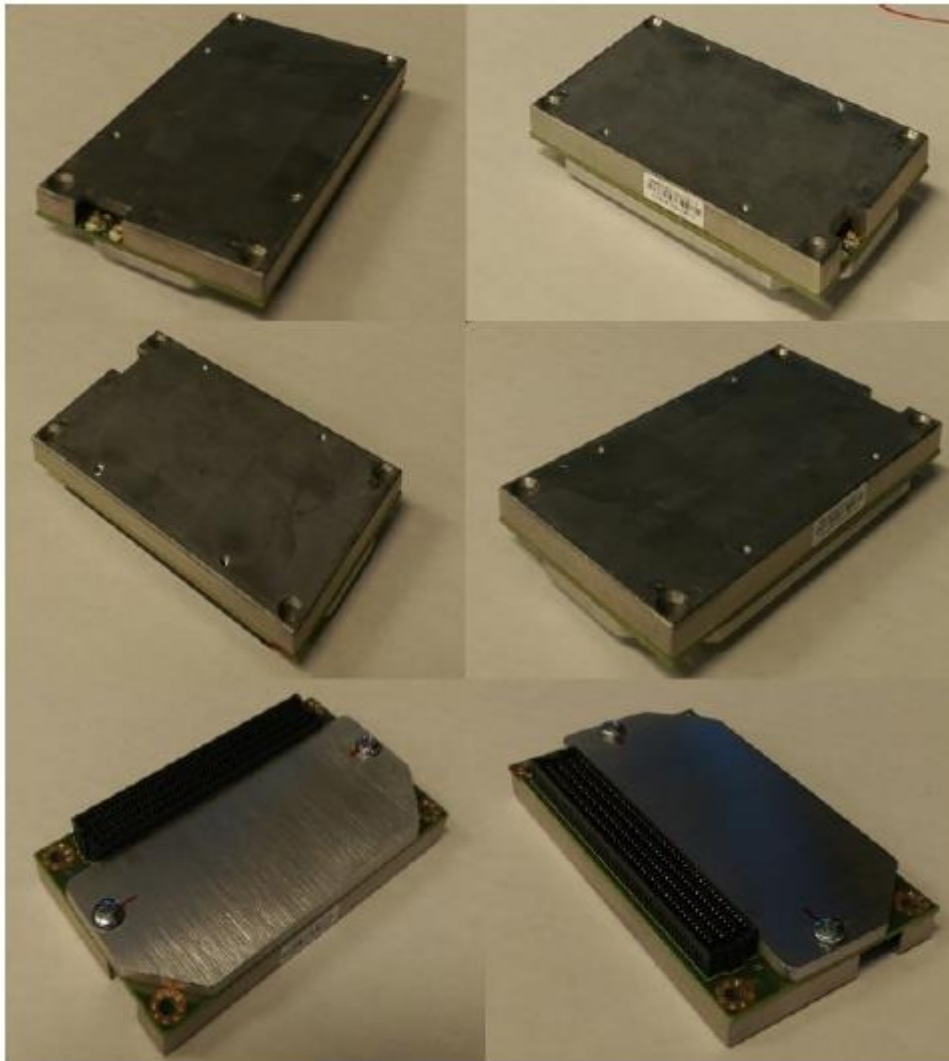

Side View (continued)

PCB View

Top View



Bottom View



PCB View

Heat Sink Internal View



Heat Sink Internal View

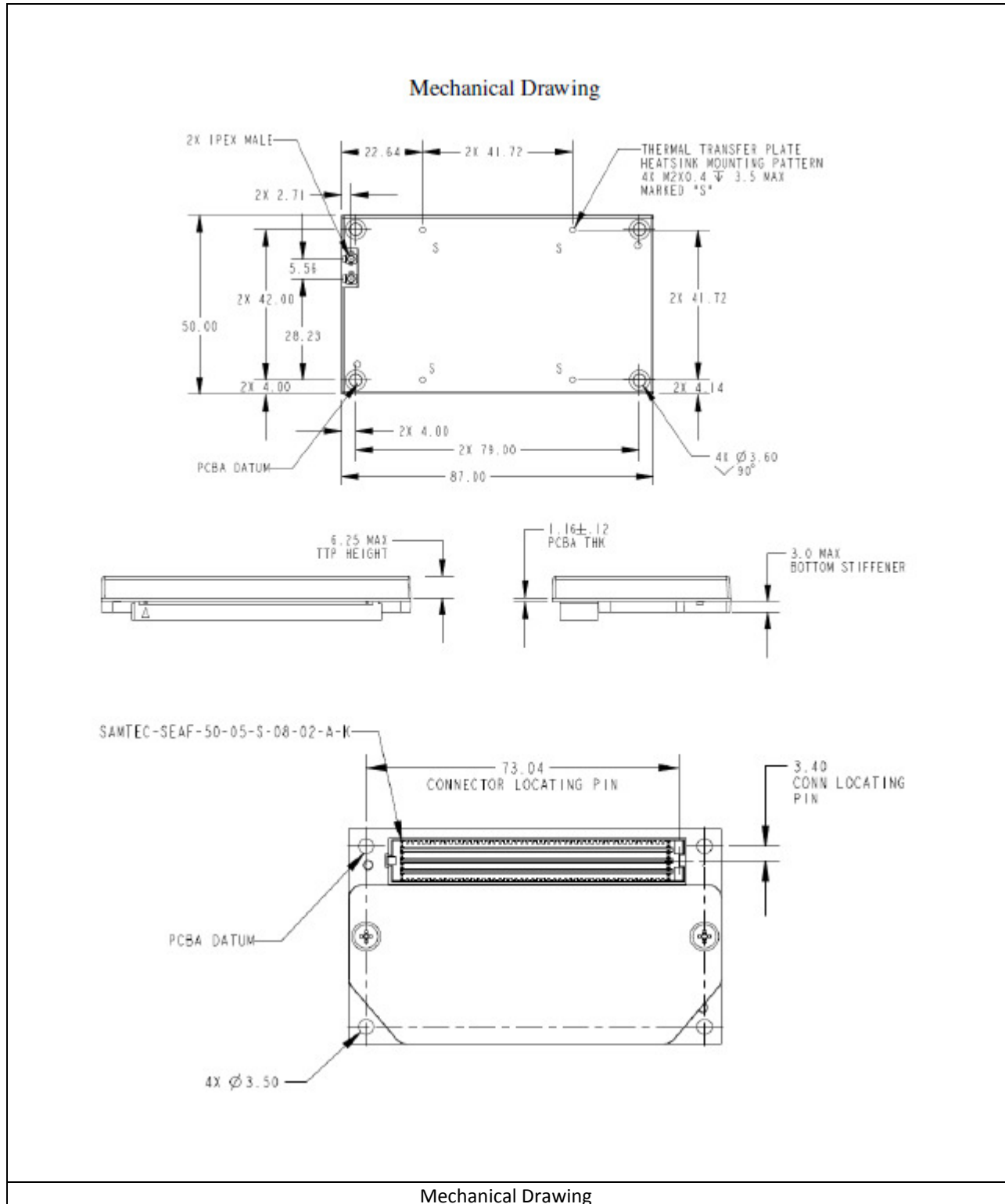

**END OF REPORT**