



LG

Life's Good

OWNER'S MANUAL

LED TV

Please read this manual carefully before operating your set and retain it for future reference.

LED TV MODELS

32LV2400-UA

42LV4400-UA

47LV4400-UA

55LV4400-UA

WARNING / CAUTION



WARNING / CAUTION

RISK OF ELECTRIC SHOCK
DO NOT OPEN



TO REDUCE THE RISK OF ELECTRIC SHOCK DO NOT REMOVE COVER (OR BACK). NO USER SERVICEABLE PARTS INSIDE. REFER TO QUALIFIED SERVICE PERSONNEL.



The lightning flash with arrowhead symbol, within an equilateral triangle, is intended to alert the user to the presence of uninsulated "dangerous voltage" within the product's enclosure that may be of sufficient magnitude to constitute a risk of electric shock to persons.



The exclamation point within an equilateral triangle is intended to alert the user to the presence of important operating and maintenance (servicing) instructions in the literature accompanying the appliance.

WARNING/CAUTION

TO REDUCE THE RISK OF FIRE AND ELECTRIC SHOCK, DO NOT EXPOSE THIS PRODUCT TO RAIN OR MOISTURE.

NOTE TO CABLE/TV INSTALLER

This reminder is provided to call the CATV system installer's attention to Article 820-40 of the National Electric Code (U.S.A.). The code provides guidelines for proper grounding and, in particular, specifies that the cable ground shall be connected to the grounding system of the building, as close to the point of the cable entry as practical.

WARNING / CAUTION

To prevent fire or shock hazards, do not expose this product to rain or moisture.

FCC Notice

Class B digital device

This equipment has been tested and found to comply with the limits for a Class B digital device, pursuant to Part 15 of the FCC Rules. These limits are designed to provide reasonable protection against harmful interference in a residential installation. This equipment generates, uses and can radiate radio frequency energy and, if not installed and used in accordance with the instructions, may cause harmful interference to radio communications. However, there is no guarantee that interference will not occur in a particular installation. If this equipment does cause harmful interference to radio or television reception, which can be determined by turning the equipment off and on, the user is encouraged to try to correct the interference by one or more of the following measures:

- Reorient or relocate the receiving antenna.
- Increase the separation between the equipment and receiver.
- Connect the equipment to an outlet on a circuit different from that to which the receiver is connected.
- Consult the dealer or an experienced radio/TV technician for help.

This device complies with part 15 of the FCC Rules. Operation is subject to the following two conditions: (1) This device may not cause (harmful) interference, and (2) this device must accept any interference received, including interference that may cause undesired operation (of the device).

Any changes or modifications in construction of this device which are not expressly approved by the party responsible for compliance could void the user's authority to operate the equipment.

CAUTION

Do not attempt to modify this product in any way without written authorization from LG Electronics. Unauthorized modification could void the user's authority to operate this product.

SAFETY INSTRUCTIONS

Important Safety Instructions

Read these instructions.

Keep these instructions.

Heed all warnings.

Follow all instructions.



- 1** Do not use this apparatus near water.



- 2** Clean only with dry cloth.



- 3** Do not block any ventilation openings. Install in accordance with the manufacturer's instructions.

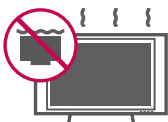

- 4** Do not install near any heat sources such as radiators, heat registers, stoves, or other apparatus (including amplifiers) that produce heat.



- 5** Do not defeat the safety purpose of the polarized or grounding-type plug. A polarized plug has two blades with one wider than the other. A grounding type plug has two blades and a third grounding prong. The wide blade or the third prong are provided for your safety. If the provided plug does not fit into your outlet, consult an electrician for replacement of the obsolete outlet.



- 6** Protect the power cord from being walked on or pinched particularly at plugs, convenience receptacles, and the point where they exit from the apparatus.



- 7** Only use attachments/accessories specified by the manufacturer.



- 8** Use only with the cart, stand, tripod, bracket, or table specified by the manufacturer, or sold with the apparatus. When a cart is used, use caution when moving the cart/apparatus combination to avoid injury from tip-over.



S3125A

- 9** Unplug this apparatus during lightning storms or when unused for long periods of time.

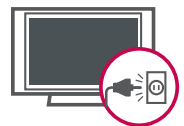

- 10** Refer all servicing to qualified service personnel. Servicing is required when the apparatus has been damaged in any way, such as power-supply cord or plug is damaged, liquid has been spilled or objects have fallen into the apparatus, the apparatus has been exposed to rain or moisture, does not operate normally, or has been dropped.

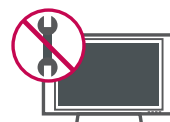

SAFETY INSTRUCTIONS

11 Never touch this apparatus or antenna during a thunder or lightning storm.

12 Do not allow an impact shock or any objects to fall into the product, and do not drop onto the screen with something.

13 CAUTION concerning the Power Cord:

It is recommend that appliances be placed upon a dedicated circuit; that is, a single outlet circuit which powers only that appliance and has no additional outlets or branch circuits. Check the specification page of this owner's manual to be certain.

Do not connect too many appliances to the same AC power outlet as this could result in fire or electric shock.

Do not overload wall outlets. Overloaded wall outlets, loose or damaged wall outlets, extension cords, frayed power cords, or damaged or cracked wire insulation are dangerous. Any of these conditions could result in electric shock or fire. Periodically examine the cord of your appliance, and if its appearance indicates damage or deterioration, unplug it, discontinue use of the appliance, and have the cord replaced with an exact replacement part by an authorized servicer. Protect the power cord from physical or mechanical abuse, such as being twisted, kinked, pinched, closed in a door, or walked upon. Pay particular attention to plugs, wall outlets, and the point where the cord exits the appliance.

Do not make the TV with the power cord plugged in. Do not use a damaged or loose power cord. Be sure do grasp the plug when unplugging the power cord. Do not pull on the power cord to unplug the TV.



14 WARNING - To reduce the risk of fire or electrical shock, do not expose this product to rain, moisture or other liquids. Do not touch the TV with wet hands. Do not install this product near flammable objects such as gasoline or candles or expose the TV to direct air conditioning.



15 Do not expose to dripping or splashing and do not place objects filled with liquids, such as vases, cups, etc. on or over the apparatus (e.g. on shelves above the unit).



16 GROUNDING

Ensure that you connect the earth ground wire to prevent possible electric shock (i.e. a TV with a three-prong grounded AC plug must be connected to a three-prong grounded AC outlet). If grounding methods are not possible, have a qualified electrician install a separate circuit breaker.

Do not try to ground the unit by connecting it to telephone wires, lightning rods, or gas pipes.

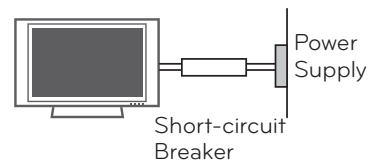

17 DISCONNECTING DEVICE FROM MAINS

Mains plug is the disconnecting device. The plug must remain readily operable.

18 As long as this unit is connected to the AC wall outlet, it is not disconnected from the AC power source even if you turn off this unit by SWITCH.

19 Cleaning

When cleaning, unplug the power cord and rub gently with a soft cloth to prevent scratching. Do not spray water or other liquids directly on the TV as electric shock may occur. Do not clean with chemicals such as alcohol, thinners or benzene.

20 Moving

Make sure the product is turned off, unplugged and all cables have been removed. It may take 2 or more people to carry larger TVs. Do not press against or put stress on the front panel of the TV.

21 ANTENNAS

Outdoor antenna grounding

If an outdoor antenna is installed, follow the precautions below. An outdoor antenna system should not be located in the vicinity of overhead power lines or other electric light or power circuits, or where it can come in contact with such power lines or circuits as death or serious injury can occur.

Be sure the antenna system is grounded so as to provide some protection against voltage surges and built-up static charges.

Section 810 of the National Electrical Code (NEC) in the U.S.A. provides information with respect to proper grounding of the mast and supporting structure, grounding of the lead-in wire to an antenna discharge unit, size of grounding conductors, location of antenna discharge unit, connection to grounding electrodes and requirements for the grounding electrode.

Antenna grounding according to the National Electrical Code, ANSI/NFPA 70

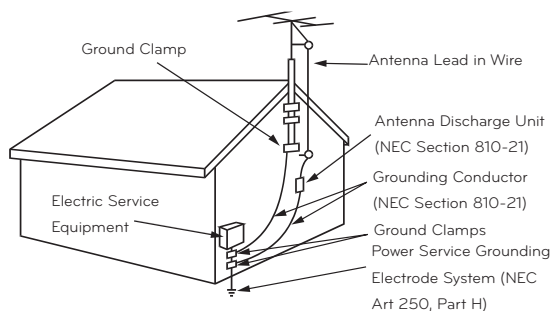

NEC: National Electrical Code

22 Ventilation

Install your TV where there is proper ventilation. Do not install in a confined space such as a bookcase. Do not cover the product with cloth or other materials (e.g.) plastic while plugged in. Do not install in excessively dusty places.

23 Take care not to touch the ventilation openings. When watching the TV for a long period, the ventilation openings may become hot.

24 If you smell smoke or other odors coming from the TV or hear strange sounds, unplug the power cord contact an authorized service center.

25 Do not press strongly upon the panel with hand or sharp object such as nail, pencil or pen, or make a scratch on it.

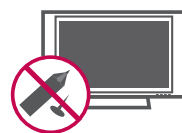

26 Keep the product away from direct sunlight.

27 Dot Effect

The Plasma or LCD panel is a high technology product with resolution of two million to six million pixels. In a very few cases, you could see fine dots on the screen while you're viewing the TV. Those dots are deactivated pixels and do not affect the performance and reliability of the TV.

28 Generated Sound

"Cracking" noise: A cracking noise that occurs when watching or turning off the TV is generated by plastic thermal contraction due to temperature and humidity. This noise is common for products where thermal deformation is required.

Electrical circuit humming/ panel buzzing: A low level noise is generated from a high-speed switching circuit, which supplies a large amount of current to operate a product. It varies depending on the product.

This generated sound does not affect the performance and reliability of the product.

ON DISPOSAL

The fluorescent lamp used in this product contains a small amount of mercury. Do not dispose of this product with general household waste. Disposal of this product must be carried out in accordance to the regulations of your local authority.

Contents

WARNING / CAUTION.....2

SAFETY INSTRUCTIONS3

Important Safety Instructions3

FEATURE OF THIS TV..... 7

PREPARATION

Accessories8

Front Panel Information9

Back Panel Information.....10

Stand Instructions12

Desktop Pedestal Installation13

Swivel Stand.....13

Securing the TV to the Wall to Prevent
Falling When the TV is Used on a
Stand14

Antenna or Cable Connection15

EXTERNAL EQUIPMENT SETUP

HD Receiver Setup.....16

DVD Setup.....18

VCR Setup.....20

Other A/V Source Setup.....21

USB Connection.....21

Audio Out Connection.....22

PC Setup23

WATCHING TV/ CHANNEL CONTROL

Remote Control Functions25

Turning on the TV.....27

Channel Selection27

Volume Adjustment.....27

Initial Setting.....28

MENU ADJUSTMENTS

On-Screen Menus Selection30

Quick Menu.....31

Channel Menu.....32

Picture Menu33

Audio Menu34

Time Menu.....35

Option Menu.....36

Parental Control / Ratings37

Input Menu.....39

My Media Menu40

APPENDIX

Troubleshooting42

Maintenance44

Product Specifications.....45

Open Source License.....46

FEATURE OF THIS TV

⇒ Some of these features are not available on all models.

HDTV High-definition television. High-resolution digital television broadcast and playback system composed of roughly a million or more pixels, 16:9 aspect-ratio screens, and AC3 digital audio. A subset of digital television, HDTV formats include 1080i and 720p resolutions.

FULL HD
1080P Displays HDTV programs in full 1920 x 1080p resolution for a more detailed picture.

USB
2.0 View videos and photos and listen to music on your TV through USB 2.0 ('videos' dependent on model).

DOLBY DIGITAL Manufactured under license from Dolby Laboratories. Dolby and the double-D symbol are trademarks of Dolby Laboratories.

HDMI
HIGH DEFINITION MULTIMEDIA INTERFACE **HDMI Trademark Notice**
"HDMI, the HDMI Logo and High-Definition Multimedia Interface are trademarks or registered trademarks of HDMI Licensing LLC. in the United States and other countries."



IMPORTANT INFORMATION TO PREVENT "IMAGE BURN / BURN-IN" ON YOUR TV SCREEN

- ⇒ When a fixed image (e.g. logos, screen menus, video game, and computer display) is displayed on the TV for an extended period, it can become permanently imprinted on the screen. This phenomenon is known as "image burn" or "burn-in." Image burn is not covered under the manufacturer's warranty.
- ⇒ In order to prevent image burn, avoid displaying a fixed image on your TV screen for a prolonged period (2 or more hours for LCD).
- ⇒ Image burn can also occur on the letter-boxed areas of your TV if you use the 4:3 aspect ratio setting for an extended period.

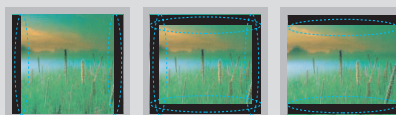

PREPARATION

Accessories

Ensure that the following accessories are included with your TV. If an accessory is missing, please contact the dealer where you purchased the TV.

The accessories included may differ from the images below.

PREPARATION

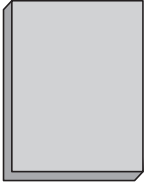

Owner's Manual



CD Manual

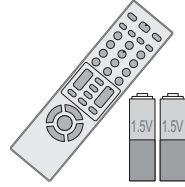

Remote Control, Batteries (AAA)

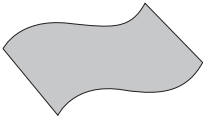

Polishing Cloth

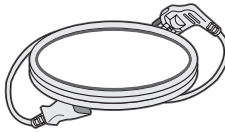

Power cable

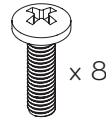

(M4 x 12mm)
Stand screws

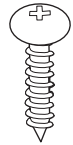

(T4 x 20mm)
Safety screw

Option Extras

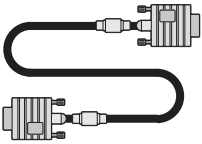

When using the VGA (D-sub 15 pin cable) PC connection, the user must use shielded signal interface cables with ferrite cores to maintain standards compliance.

D-sub 15 pin cable

Front Panel Information

❑ Image shown may differ from your TV.

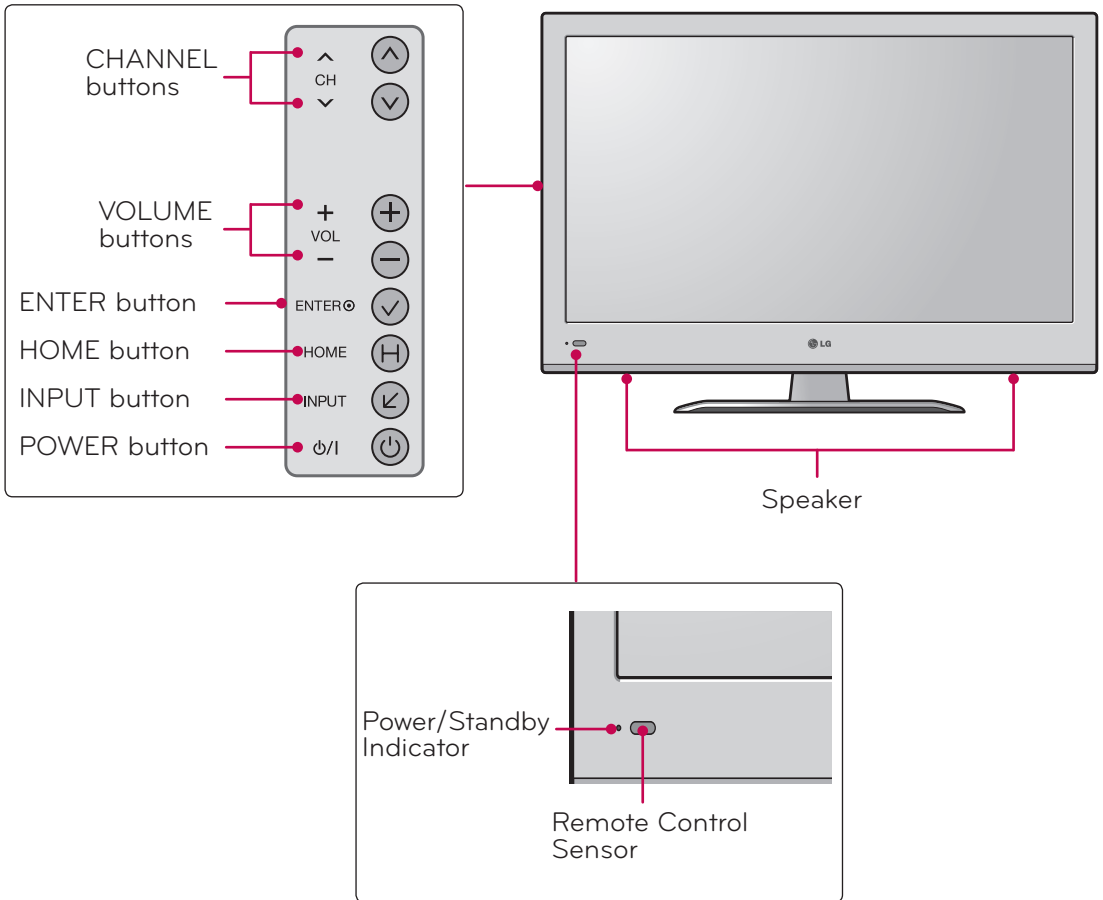

! NOTE

- ⇒ Do not step on the glass stand or subject it to any impact. It may break, causing possible injury from fragments of glass, or the TV may fall.
- ⇒ Do not drag the TV. The floor or the product may be damaged.

Back Panel Information

Image shown may differ from your TV.

PREPARATION

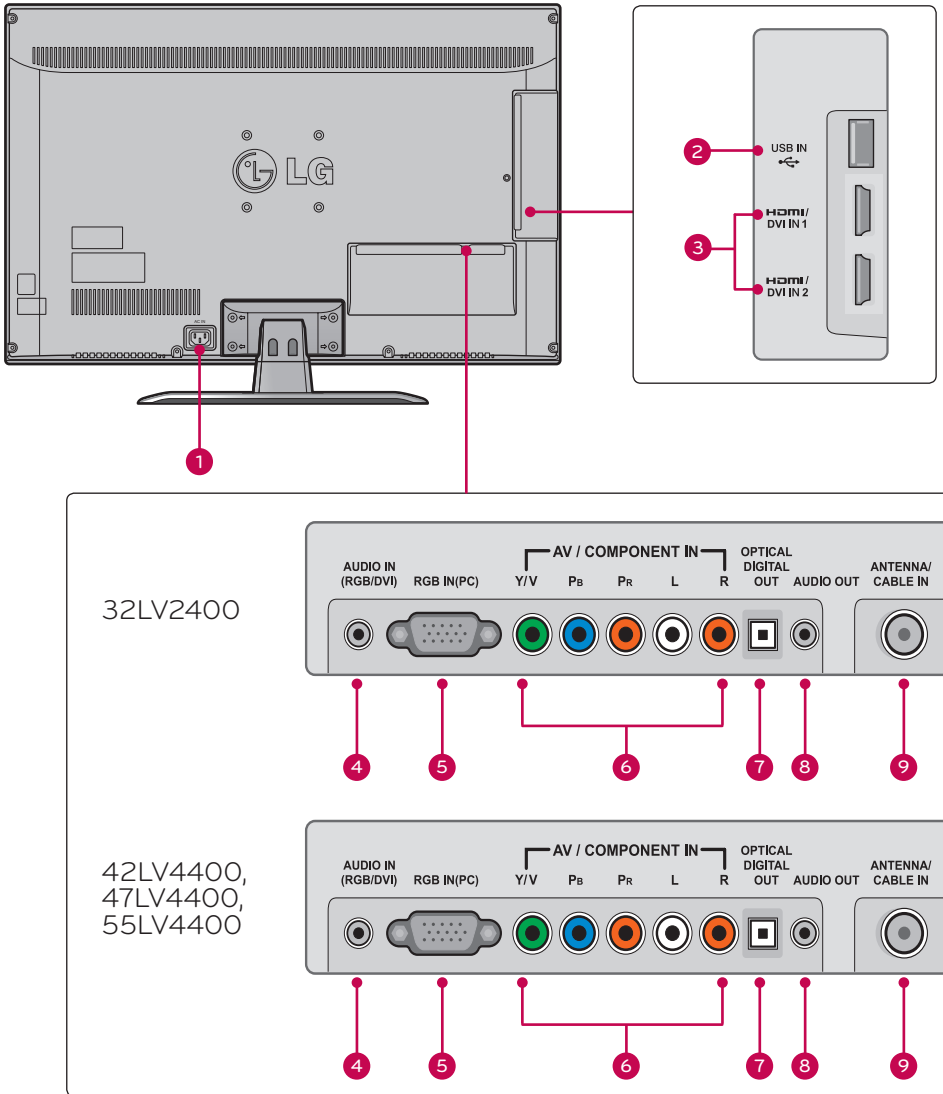

1 Power Cord Socket
For operation with AC power.
Caution: Never attempt to operate the TV on DC power.

2 USB INPUT
Used for viewing photos.

3 HDMI/DVI IN, HDMI IN
Digital Connection.
Supports HD video and Digital audio. Doesn't support 480i.
Accepts DVI video using an adapter or HDMI to DVI cable (not included).

4 DVI/RGB AUDIO IN
Used for audio input.

5 RGB IN (PC)

Analog PC Connection. Uses a D-sub 15 pin cable (VGA cable).

7 OPTICAL DIGITAL AUDIO OUT

Digital optical audio output for use with amps and home theater systems.

Note: In standby mode, this port doesn't work.

9 ANTENNA/CABLE IN

Connect over-the-air or cable signals to this jack.

6 AV/COMPONENT IN

Analog Connection.
Supports HD.

Uses a red, green, and blue cable for video & red and white for audio.

8 AUDIO OUT

For use with external speakers.

10 HDMI IN 3

Digital Connection.

Supports HD video and Digital audio. Doesn't support 480i.

** HDMI 3: For 42LV4400, 47LV4400, 55LV4400*

! CAUTION

For HDMI IN 3 and USB INPUT

⇒ For an optimal connection, HDMI cables and USB devices should have bezels less than 10 mm (0.39 inches) thick.

Precautions when using the USB device

⇒ The recommended capacity is 1 TB or less for a USB external hard disk and 32 GB or less for USB memory.

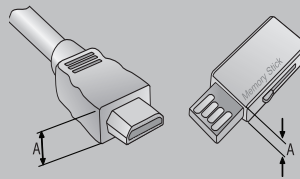

*A is smaller or equals to 10 mm (0.39 inches)

Stand Instructions

❑ Image shown may differ from your TV.

PREPARATION

INSTALLATION

- 1 Carefully place the TV screen side down on a cushioned surface to protect the screen from damage.

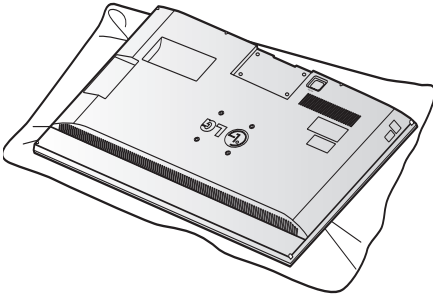

- 2 Connect the base to the stand and install the 8 screws into the holes as shown.

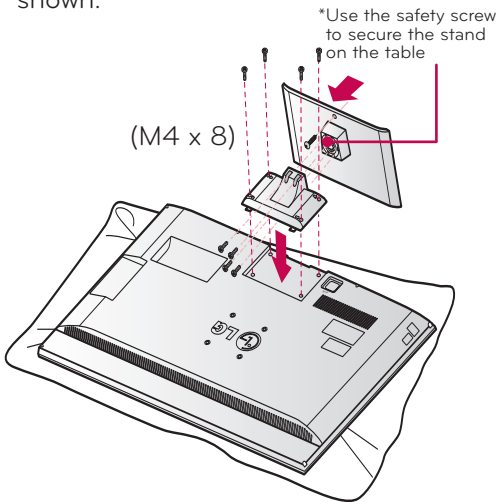

DETACHMENT

- 1 Carefully place the TV screen side down on a cushioned surface to protect the screen from damage and remove the screws.

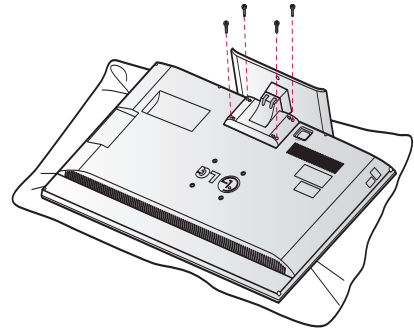

- 2 Detach the stand from the TV.

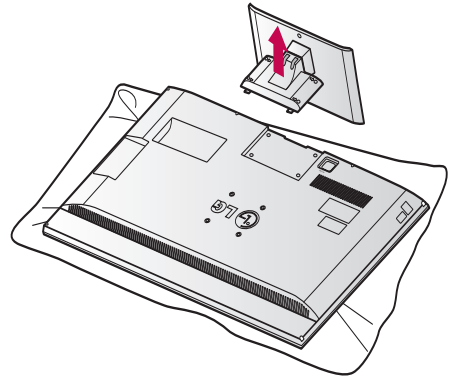

! NOTE

⇒ When assembling the desk type stand, make sure the screws are fully tightened (If not tightened fully, the TV can tilt forward after the product installation). Do not over tighten.

Desktop Pedestal Installation

❑ Image shown may differ from your TV.

For proper ventilation, allow a clearance of 10.1 cm (4 inches) on all four sides from the wall.

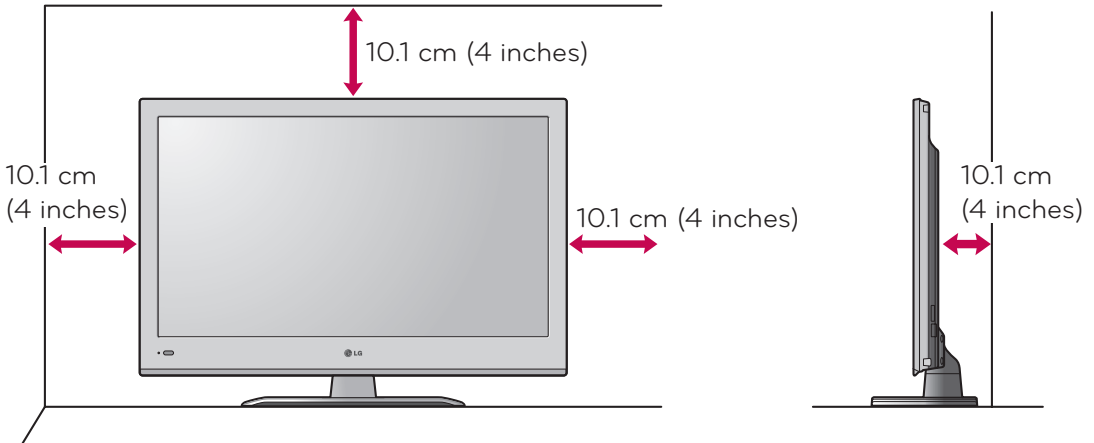

! CAUTION

- ⇒ Ensure adequate ventilation by following the clearance recommendations.
- ⇒ Do not mount near or above any type of heat source.

Swivel Stand

After installing the TV, you can adjust the TV set manually to the left or right direction by 20° to suit your viewing position.

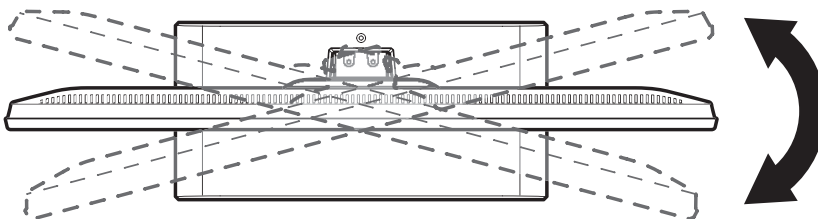

Securing the TV to the Wall to Prevent Falling When the TV is Used on a Stand

- ❑ You should purchase necessary components to prevent the TV from tipping over.
- ❑ Image shown may differ from your TV.

We recommend that you set up the TV close to a wall so it cannot fall over if pushed backwards.

Additionally, we recommend that the TV be attached to a wall so it cannot be pulled in a forward direction, potentially causing injury or damaging the product.

Caution: Please make sure that children don't climb on or hang from the TV.

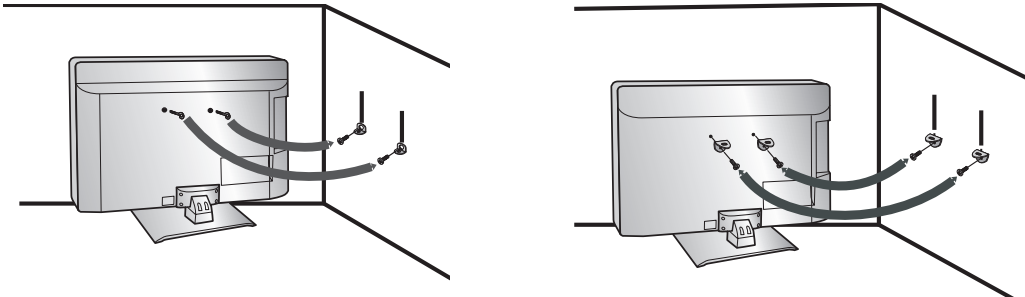

- ❑ Insert the eye-bolts (or TV brackets and bolts) to tighten the product to the wall as shown in the picture.
 - * If your product has the bolts in the eye-bolts position before inserting the eye-bolts, loosen the bolts.
 - * Insert the eye-bolts or TV brackets/bolts and tighten them securely in the upper holes.

Secure the wall brackets with the bolts (sold separately) to the wall. Match the height of the bracket that is mounted on the wall to the holes in the product.

Ensure the eye-bolts or brackets are tightened securely.

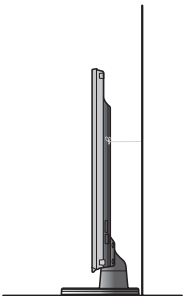

- ❑ Use a sturdy rope (sold separately) to tie the product. It is safer to tie the rope so it becomes horizontal between the wall and the product.

! NOTE

- ⇒ Use a platform or cabinet strong enough and large enough to support the size and weight of the TV.
- ⇒ To use the TV safely make sure that the height of the bracket on the wall and the one on the TV are the same.

Antenna or Cable Connection

1. Antenna (Analog or Digital)

Wall Antenna Socket or Outdoor Antenna without a Cable Box Connections.
 For optimum picture quality, adjust antenna direction if needed.

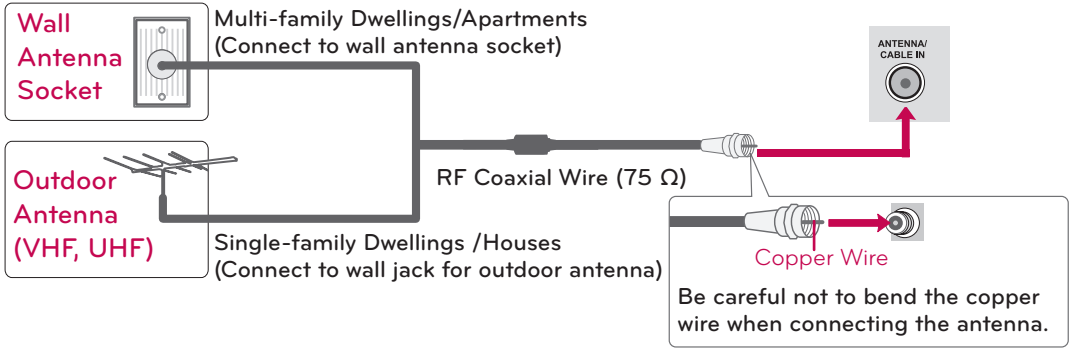

2. Cable

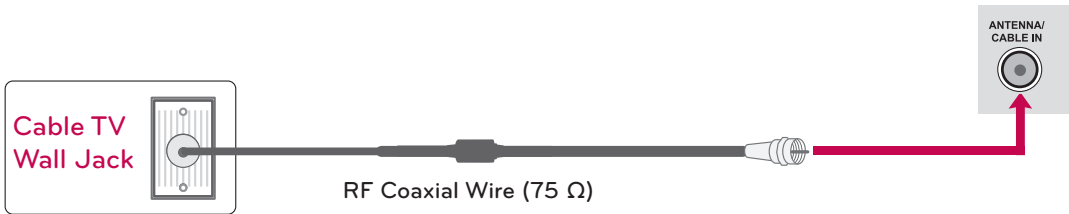

NOTE

- ⇒ If the antenna needs to be split for two TV's, install a 2-Way Signal Splitter.
- ⇒ For much more information about antennas visit our Knowledgebase at <http://lgknowledgebase.com>. Search for antenna.

EXTERNAL EQUIPMENT SETUP

- ❑ To prevent equipment damage, never plug in any power cords until you have finished connecting all equipment.
- ❑ The pictures in this section may be slightly different from your model.

HD Receiver Setup

This TV can receive digital over-the-air/digital cable signals without an external digital set-top box. However, if you do receive digital signals from a digital set-top box or other digital external device.

Component Connection

1. How to connect

- 1 Connect the video outputs (Y, P_B, P_R) of the digital set-top box to the **COMPONENT IN VIDEO** jack on the TV. Match the jack colors (Y = green, P_B = blue, and P_R = red).
- 2 Connect the audio output of the digital set-top box to the **COMPONENT IN AUDIO** jack on the TV.

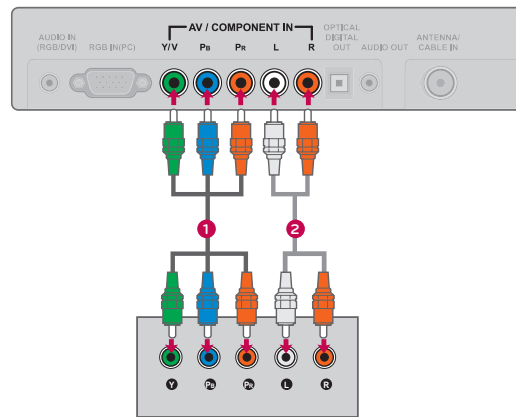

2. How to use

- ❑ Turn on the digital set-top box.
(Refer to the owner's manual for the digital set-top box operation.)
- ❑ Select the **Component** input source on the TV using the **INPUT** button on the remote control.

Y, C_B/P_B, C_R/P_R

Resolution	Horizontal Frequency(kHz)	Vertical Frequency(Hz)
720x480i	15.73	59.94
	15.73	60.00
720x480p	31.47	59.94
	31.50	60.00
1280x720p	44.96	59.94
	45.00	60.00
1920x1080i	33.72	59.94
	33.75	60.00
1920x1080p	26.97	23.976
	27.00	24.00
	33.71	29.97
	33.75	30.00
	67.432	59.94
	67.50	60.00

HDMI Connection

1. How to connect

- 1 Connect the digital set-top box to **HDMI/DVI IN 1, 2, or 3*** jack on the TV.
- 2 No separate audio connection is necessary.
HDMI supports both audio and video.

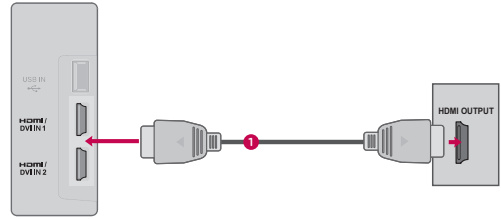

2. How to use

- Turn on the digital set-top box.
(Refer to the owner's manual for the digital set-top box operation.)
- Select the **HDMI 1, HDMI 2, or HDMI 3*** input source on the TV using the **INPUT** button on the remote control.

* **HDMI 3:** For 42LV4400, 47LV4400, 55LV4400

! NOTE

- ⇒ If an HDMI cable doesn't support High Speed HDMI, it can cause flickers or no screen display. In this case use the latest cables that support High Speed HDMI.
- ⇒ HDMI Audio Supported Format: Dolby Digital (32 kHz, 44.1 kHz, 48 kHz), Linear PCM (32 kHz, 44.1 kHz, 48 kHz)

HDMI-DTV

Resolution	Horizontal Frequency(kHz)	Vertical Frequency(Hz)
720x480p	31.47	59.94
	31.50	60.00
1280x720p	44.96	59.94
	45.00	60.00
1920x1080i	33.72	59.94
	33.75	60.00
1920x1080p	26.97	23.976
	27.00	24.00
	33.71	29.97
	33.75	30.00
	67.432	59.94
	67.50	60.00

DVI to HDMI Connection

1. How to connect

- 1 Connect the digital set-top box to **HDMI/DVI IN 1** or **2** jack on the TV.
- 2 Connect the digital set-top box audio output to the **DVI AUDIO** jack on the TV.

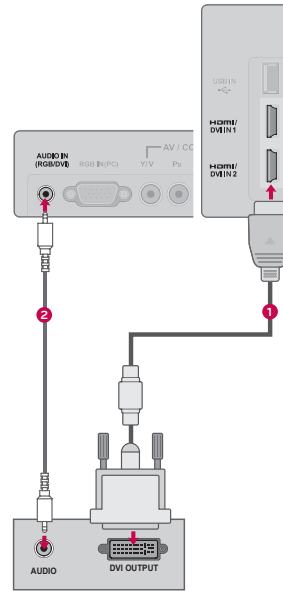

2. How to use

- ❑ Turn on the digital set-top box.
(Refer to the owner's manual for the digital set-top box operation.)
- ❑ Select the **HDMI 1** or **HDMI 2** input source on the TV using the **INPUT** button on the remote control.

! NOTE

- ⇒ A DVI to HDMI cable or adapter is required for this connection.
DVI doesn't support audio, so a separate audio connection is necessary.

DVD Setup

Component Connection

1. How to connect

- 1 Connect the video outputs (Y, P_B, P_R) of the digital set-top box to the **COMPONENT IN VIDEO** jack on the TV. Match the jack colors (Y = green, P_B = blue, and P_R = red).
- 2 Connect the audio output of the digital set-top box to the **COMPONENT IN AUDIO** jack on the TV.

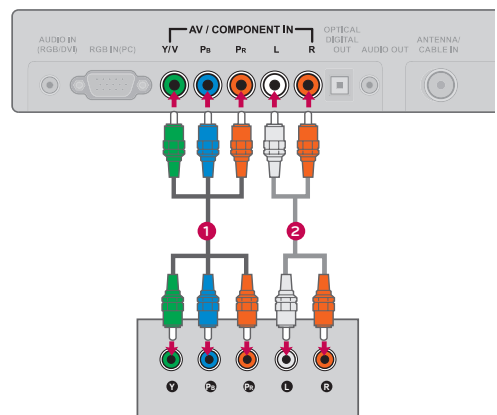

2. How to use

- ❑ Turn on the DVD player, insert a DVD.
- ❑ Select the **Component** input source on the TV using the **INPUT** button on the remote control.
- ❑ Refer to the DVD player's manual for operating instructions.

Composite (RCA) Connection

1. How to connect

- 1 Connect the **AUDIO/VIDEO** jacks between TV and DVD. Match the jack colors (Video = yellow, Audio Left = white, and Audio Right = red)

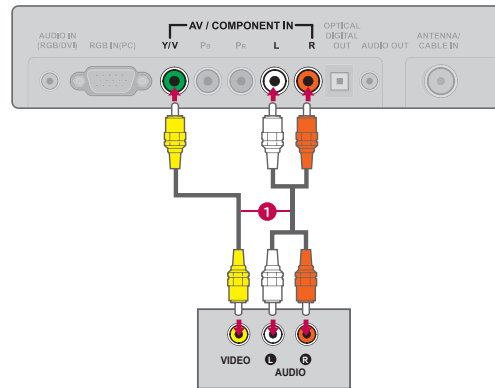

2. How to use

- ❑ Turn on the DVD player, insert a DVD.
- ❑ Select the **AV** input source on the TV using the **INPUT** button on the remote control.
- ❑ Refer to the DVD player's manual for operating instructions.

HDMI Connection

1. How to connect

- 1 Connect the digital set-top box to **HDMI/DVI IN 1, 2, or 3*** jack on the TV.
- 2 No separate audio connection is necessary. HDMI supports both audio and video.

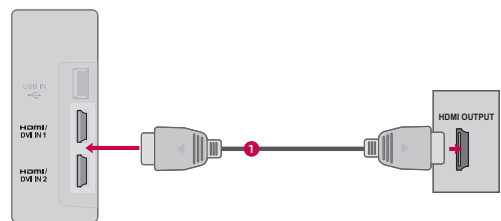

2. How to use

- ❑ Select the **HDMI 1, HDMI 2, or HDMI 3*** input source on the TV using the **INPUT** button on the remote control.
- ❑ Refer to the DVD player's manual for operating instructions.

* **HDMI 3:** For 42LV4400, 47LV4400, 55LV4400

! NOTE

- ⇒ If an HDMI cable doesn't support High Speed HDMI, it can cause flickers or no screen display. In this case use the latest cables that support High Speed HDMI.
- ⇒ HDMI Audio Supported Format: Dolby Digital (32 kHz, 44.1 kHz, 48 kHz), Linear PCM (32 kHz, 44.1 kHz, 48 kHz)

VCR Setup

Antenna Connection

1. How to connect

- 1 Connect the RF antenna out socket of the VCR to the **ANTENNA/CABLE IN** socket on the TV.
- 2 Connect the antenna cable to the RF antenna in socket of the VCR.

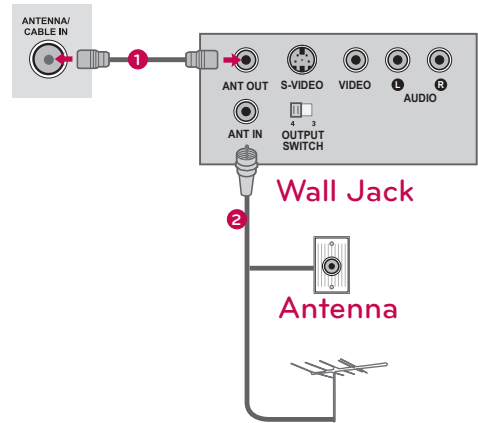

2. How to use

- ❑ Set VCR output switch to 3 or 4 and then tune TV to the same channel number.
- ❑ Insert a video tape into the VCR and press PLAY on the VCR (Refer to the VCR owner's manual).

Composite (RCA) Connection

1. How to connect

- 1 Connect the **AUDIO/VIDEO** jacks between TV and VCR. Match the jack colors (Video = yellow, Audio Left = white, and Audio Right = red)

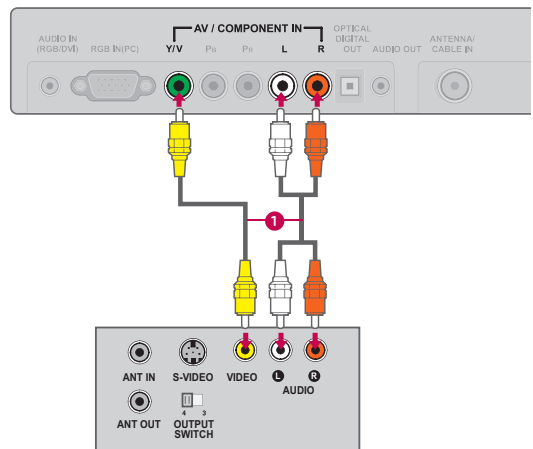

2. How to use

- ❑ Insert a video tape into the VCR and press PLAY on the VCR. (Refer to the VCR owner's manual.)
- ❑ Select the **AV** input source on the TV using the **INPUT** button on the remote control.

! NOTE

⇒ If you have a mono VCR, connect the audio cable from the VCR to the **AUDIO L(MONO)** jack of the TV.

Other A/V Source Setup

1. How to connect

- 1 Connect the **AUDIO/VIDEO** jacks between TV and external equipment. Match the jack colors. (Video = yellow, Audio Left = white, and Audio Right = red)

2. How to use

- ❑ Select the **AV** input source on the TV using the **INPUT** button on the remote control.
- ❑ Operate the corresponding external equipment.

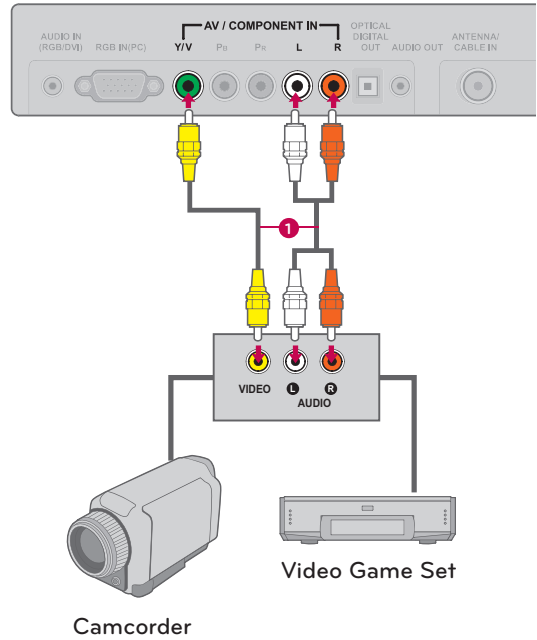

USB Connection

1. How to connect

- 1 Connect the USB device to the **USB IN** jack on the side of TV.

2. How to use

- ❑ After connecting the **USB IN** jack, you use the USB function.

Precautions when using the USB device

- ⇒ The recommended capacity is 1 TB or less for a USB external hard disk and 32 GB or less for USB memory.

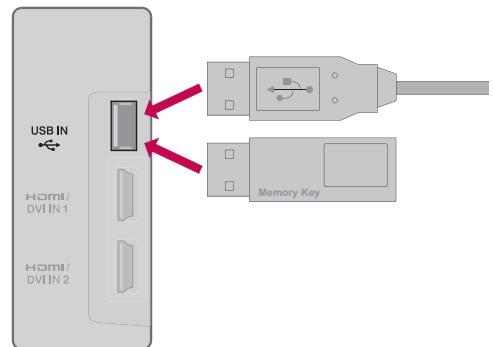

Audio Out Connection

Send the TV's audio to external audio equipment via the Audio Output port.

Digital Connection to a Home Theater Audio System

If you want to enjoy digital broadcasting through 5.1-channel speakers, connect the OPTICAL DIGITAL AUDIO OUT terminal on the back of TV to a Home Theater (or amp).

1. How to connect

- 1 Connect one end of the optical cable to the TV port of **OPTICAL DIGITAL AUDIO OUT**.
- 2 Connect the other end of the optical cable to the digital audio input on the audio equipment.
- 3 Set the "TV Speaker option - Off" in the **AUDIO** menu. See the external audio equipment instruction manual for operation.

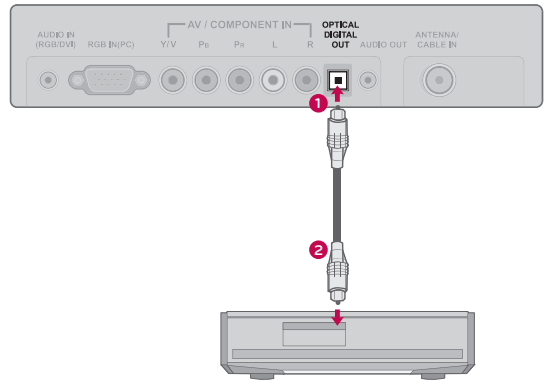

! NOTE

⇒ When connecting with external audio equipment, such as amplifiers or speakers, you can turn the TV speakers off in the menu.

! CAUTION

⇒ Do not look into the optical output port. Looking at the laser beam may damage your vision.

⇒ Audio with ACP (Audio Copy Protection) function may block digital audio output.

Connecting Using Analogue Audio Cable

1. How to connect

- 1 Connect one end of the audio cable to the TV port of **AUDIO OUT**.
- 2 Connect the other end of the audio cable to the audio input on the audio equipment.
- 3 Set the "TV Speaker option - Off" in the **AUDIO** menu. See the external audio equipment instruction manual for operation.

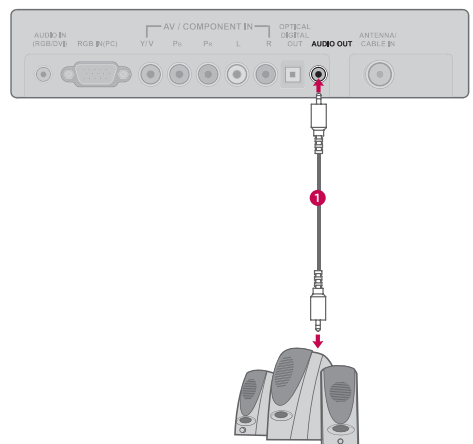

PC Setup

This TV provides Plug and Play capability, meaning that a PC adjusts automatically to the TV's settings.

VGA (D-Sub 15 Pin) Connection

1. How to connect

- 1 Connect the VGA output of the PC to the **RGB IN (PC)** jack on the TV.
- 2 Connect PC audio output to the **RGB IN (AUDIO)** jack on the TV.

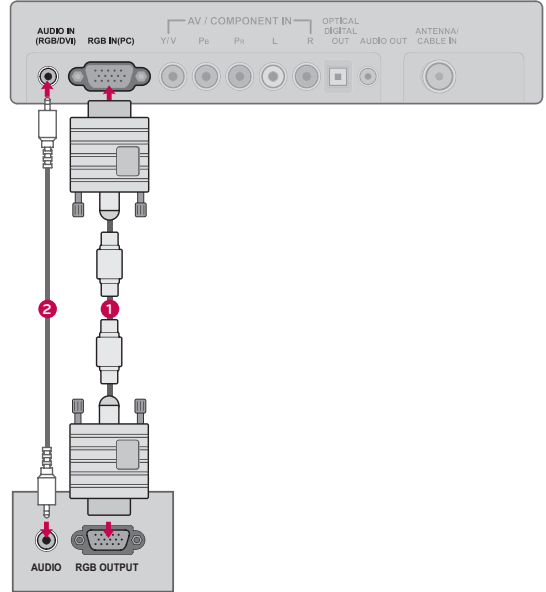

2. How to use

- ❑ Turn on the PC and the TV.
- ❑ Select the **RGB-PC** input source on the TV using the **INPUT** button on the remote control.

DVI to HDMI Connection

1. How to connect

- 1 Connect the DVI output of the PC to the **HDMI/DVIN 1** or **2** jack on the TV.
- 2 Connect the PC audio output to the **DVI AUDIO** jack on the TV.

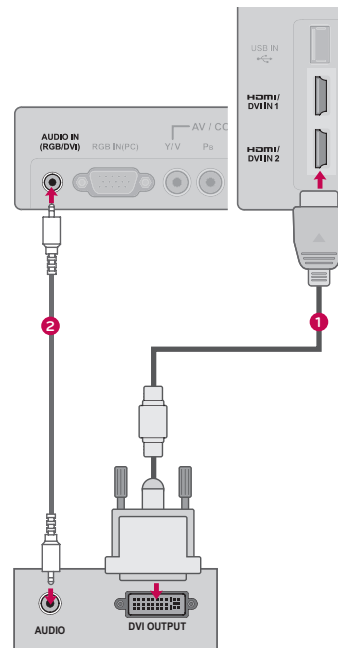

2. How to use

- ❑ Turn on the PC and the TV.
- ❑ Select the **HDMI 1** or **HDMI 2** input source on the TV using the **INPUT** button on the remote control.

! NOTE

- ⇒ To get the the best picture quality, adjust the PC graphics card to 1920 x 1080.
- ⇒ Depending on the graphics card, DOS mode may not work if a HDMI to DVI Cable is in use.
- ⇒ In PC mode, there may be noise associated with the resolution, vertical pattern, contrast or brightness.
- ⇒ If noise is present, change the PC output to another resolution, change the refresh rate to another rate or adjust the brightness and contrast on the PICTURE menu until the picture is clear.
- ⇒ Avoid keeping a fixed image on the screen for a long period of time. The fixed image may become permanently imprinted on the screen.
- ⇒ Depending on the graphics card, some resolution settings may not allow the image to be positioned on the screen properly.

Supported Display Specifications (RGB-PC, HDMI-PC)

Resolution	Horizontal Frequency(kHz)	Vertical Frequency(Hz)
640x350	31.468	70.09
720x400	31.469	70.08
640x480	31.469	59.94
800x600	37.879	60.31
1024x768	48.363	60.00
1280x768	47.776	59.87
1360x768	47.712	60.015
1360x768	63.981	60.02
1600x1200	75.00	60.00
1920x1080 RGB-PC	66.587	59.934
1920x1080 HDMI-PC	66.587	59.934

* 32LV2400 does not support 1600 x 1200, 1920 x 1080 (RGB-PC), and 1920 x 1080 (HDMI-PC) resolutions.

WATCHING TV/ CHANNEL CONTROL

Remote Control Functions

When using the remote control, aim it at the remote control sensor on the TV.

The remote control may differ from the images below.

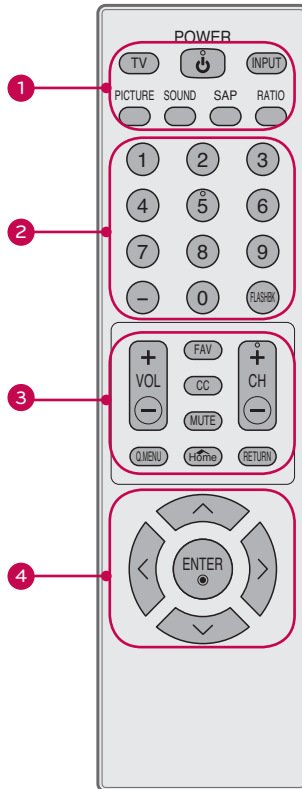

Group No.	Item	Description
1	TV	Returns to the last TV channel.
	POWER	Turns the TV on from standby or off to standby.
	INPUT	Rotates through inputs.
	RATIO	Changes the aspect ratio.
	SAP	Selects MTS sound.
	SOUND	Changes the sound mode.
	PICTURE	Changes the picture mode.
2	NUMBER buttons	Used to enter a program number for multiple program channels such as 2-1, 2-2, etc.
	FLASHBK	Tunes to the last channel viewed.

Group No.	Item	Description
3	CHANNEL (UP/DOWN)	Changes the channel.
	RETURN	Allows the user to move return one step in an interactive application or other user interaction function.
	FAV	Scroll through the programmed Favorite channels.
	CC	Switches the caption on or off.
	MUTE	Switches the sound on or off.
	HOME	Displays the main menu or hides on-screen displays and return to TV viewing.
	VOLUME (UP/DOWN)	Adjusts the volume.
	Q.MENU	Opens the list of Quick Menu options.
4	THUMBSTICK (Up/Down/Left/Right/ENTER)	Navigates the on-screen menus and adjusts the system settings to your preference.

Installing Batteries

- Open the battery compartment cover on the back side and install the batteries matching correct polarity.
- Install two 1.5V AAA batteries. Don't mix old or used batteries with new ones.
- Close cover.

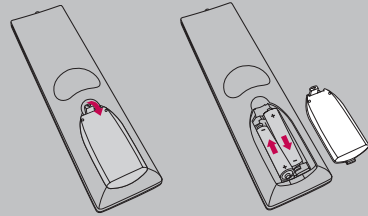

Turning on the TV

- 1** First, connect power cord correctly.
At this moment, the TV switches to standby mode.
⇒ In standby mode to turn TV on, press the **POWER** button.
 - 2** Select the viewing source by using the **INPUT** button on the remote control.
 - 3** When finished using the TV, press the **POWER** button on the remote control. The TV reverts to standby mode.
-

NOTE

⇒ If you intend to be away on vacation, disconnect the power plug from the wall power outlet.

Channel Selection

- 1** Press the **CHANNEL** or **NUMBER** buttons to select a channel number.
-

Volume Adjustment

- 1** Press the **VOLUME** button to adjust the volume.
 - 2** If you want to switch the sound off, press the **MUTE** button.
 - 3** You can cancel the Mute function by pressing the **MUTE** or **VOLUME** button.
-



Initial Setting

This Function guides the user to easily set the essential items for viewing the TV for the first time when purchasing the TV. It will be displayed on the screen when turning the TV on for the first time. It can also be activated from the user menus.

- Default selection is "Home". We recommend setting the TV to "Home" mode for the best picture in your home environment.
- "In Store" Mode is only intended for use in retail environments. Customers can adjust the "Picture menu - Picture mode" manually while inspecting the TV, but the TV will automatically return to preset in-store mode after 5 minutes.
- "In Store" Mode is an optimal setting for displaying at stores. "In Store" mode initializes the TV to set the image quality.

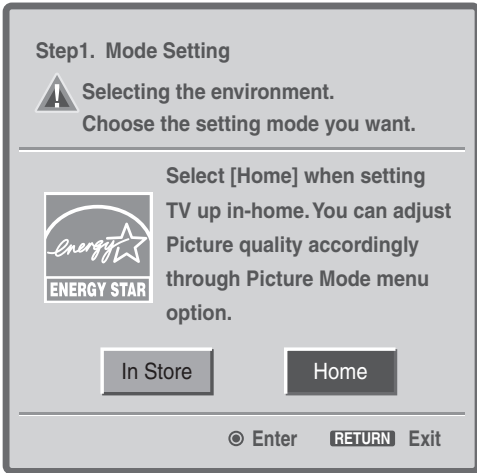



1. Mode Setting

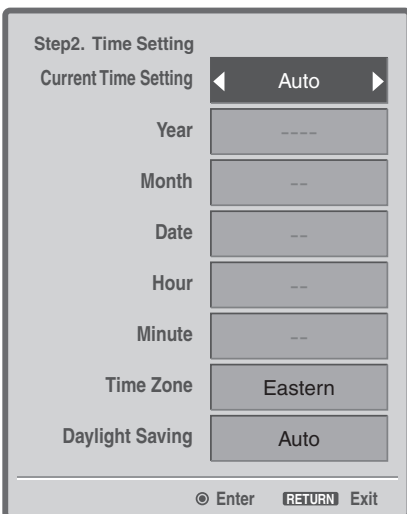

- 1  Select **Setting Mode** option.
- 2  Press the **ENTER** button.

2. Time Setting



- 1  Select **Current Time Setting** option.
 If you select "Manual", enter the data for **Year, Month, Date, Hour, Minute**.
- 2  Select **Time Zone** option.
- 3  Select **Daylight Saving** option.
- 4  After all settings are completed, press the **ENTER** button.

3. Option Setting

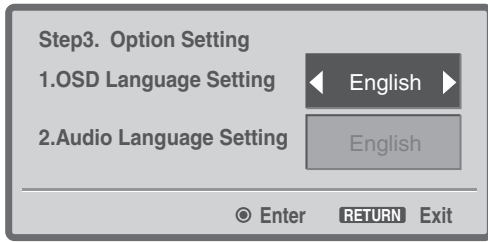

1  Select **OSD Language Setting** option.

2  Select **Audio Language Setting** option.

3  Press the **ENTER** button.

4. Auto Tuning

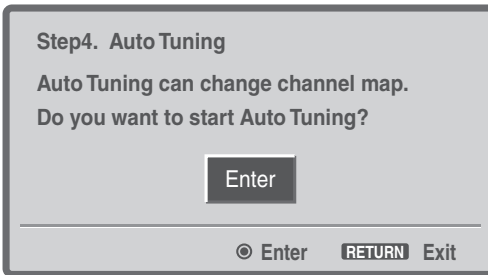

1  Check your antenna connection and press the **ENTER** button to start **Auto Tuning**.

2  Select **Yes** to begin auto tuning.

3  Press the **ENTER** button.

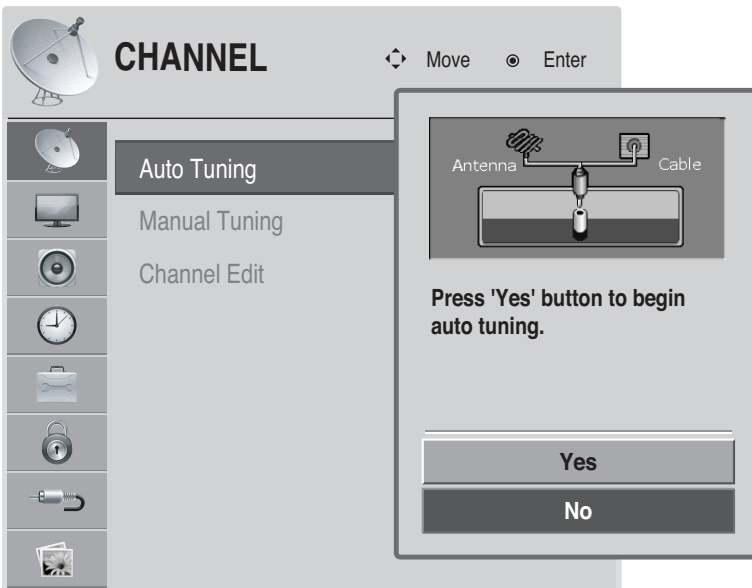

MENU ADJUSTMENTS

On-Screen Menu Selection

Your TV's OSD (On Screen Display) may differ slightly from that shown in this manual.

1   Display each menu.

2   Select a menu item.

3  Accept the current selection.

4  Return to TV viewing.

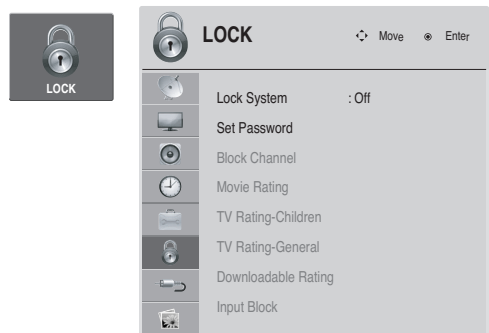
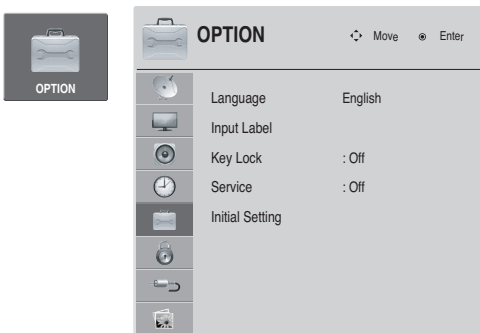
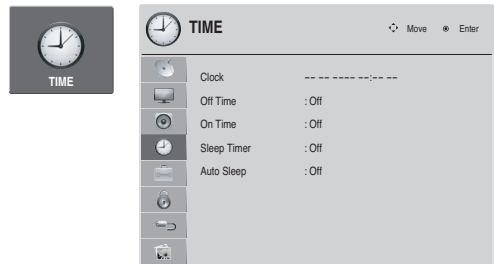
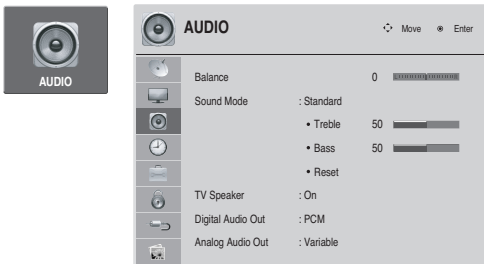
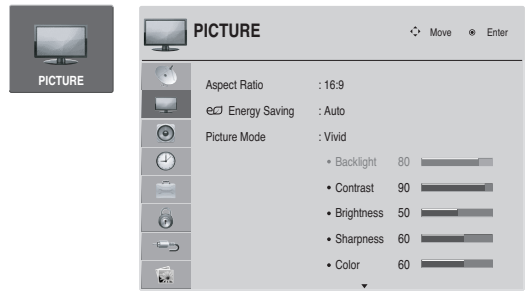
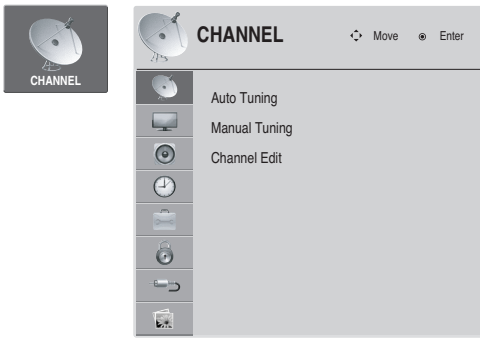

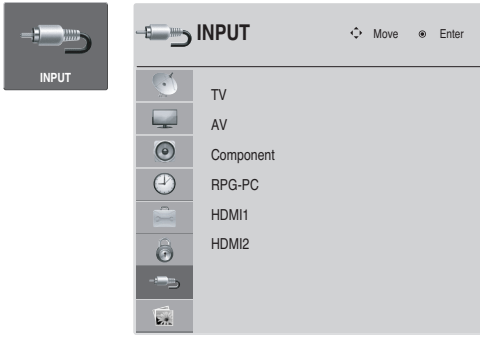

* HDMI 3: For 42LV4400, 47LV4400, 55LV4400

Quick Menu

Your TV's OSD (On Screen Display) may differ slightly from what is shown in this manual. Q.Menu (Quick Menu) is a menu of features which users might use frequently.

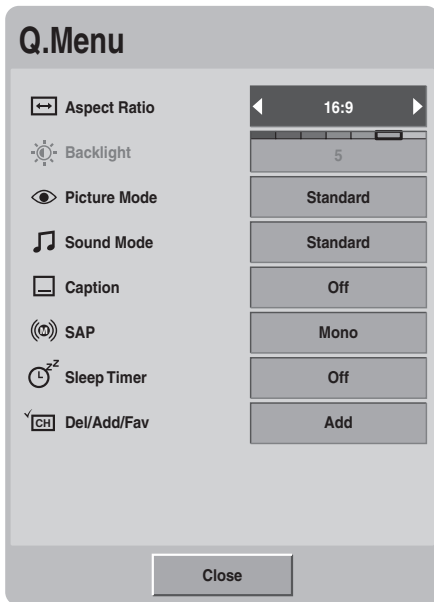

- 1 Display Quick menu.
- 2 Select a menu item.
- 3 Choose the setting.
- 4 Accept the current selection and return to TV viewing.

- ⇒ **Aspect Ratio:** Selects your desired picture format.
- ⇒ **Backlight:** Selects your desired brightness level of the backlight behind the LCD screen.
- ⇒ **Picture Mode:** Selects the desired preset picture setting.
- ⇒ **Sound Mode:** Selects the desired preset sound setting.
- ⇒ **Caption:** Sets the caption mode to on or off.
- ⇒ **SAP:** Selects MTS sound.
 - Analog TV: Mono / Stereo / SAP
 - Digital TV: English / French / Spanish / Korean / Japanese / Chinese / German / Italian / Russian
- ⇒ **Sleep Timer:** Turns the TV off at the preset time.
- ⇒ **Del/Add/Fav:** Selects channel you want to add, delete, or add to the Favorite list.

Channel Menu

The Channel menu offers options to setup of your television to receive TV channels.

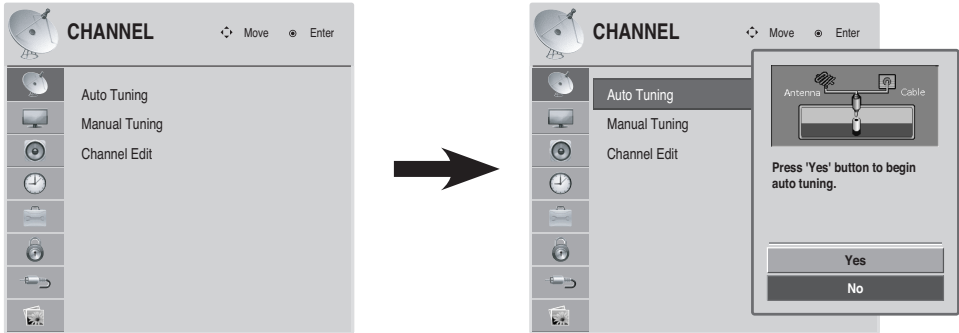

1   Display **CHANNEL** menu.

2   Select a menu item.

3   Set the setting.

4  Return to TV viewing.

⇒ Auto Tuning

- Automatically finds all channels available through antenna or cable inputs, and stores them in memory on the channel list.
- Run this function if you change your residence or move the TV.
- Auto Tuning memorizes only the channels available at the time.
- Found channels are grouped in the order of DTV, TV, Cable DTV (CADTV) and Cable TV (CATV).

⇒ Manual Tuning

- When selecting DTV or Cable DTV input signal in Manual Tuning, you can view the on-screen signal strength monitor to see the quality of the signal being received.
- Select the channel type and RF-channel number. Then select **Add** or **Delete**.

⇒ Channel Edit

- The channels in the Channel Edit List are displayed in black and the channels deleted from the Channel Edit List are displayed in gray. Press the **Q.MENU** button to delete or add the selected channel.
- When a channel number is deleted, it means that you will be unable to select it using **CHANNEL** button during TV viewing. If you wish to select the deleted channel, directly enter the channel number with the **NUMBER** buttons or select it in the **Channel Edit** menu.

Picture Menu

The Picture menu offers options to enhance and refine the picture displayed on your TV based on ambient room light and personal preferences.

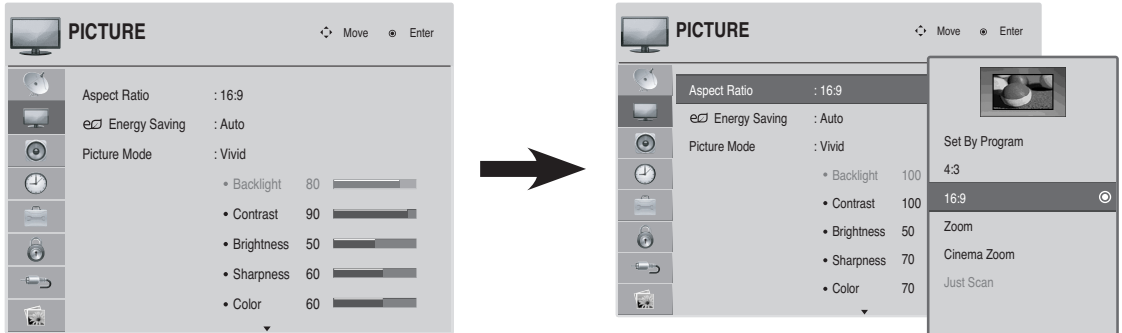

- 1** Display PICTURE menu.
- 2** Select a menu item.
- 3** Set the setting.
- 4** Return to TV viewing.

⇒ Aspect Ratio

- This feature lets you choose the way an analog picture with a 4:3 aspect ratio is displayed on your TV. You can select a different aspect ratio depending on input source (analog broadcasting, digital broadcasting, aux).

⇒ Energy Saving

- It reduces the TV's power consumption by lowering the backlight level.
- You can increase the brightness of your screen by adjusting the Energy Saving level.
- When selecting **Screen off**, the screen will turn off after 3 seconds. Pressing any button of the remote control will turn on the screen again.
- When selecting **Auto**, **Backlight** is automatically adjusted through **Intelligent Sensor** according to the surrounding conditions.

⇒ Picture Mode

- Vivid**, **Standard(User)**, **Cinema**, **Sport**, and **Game** settings are preset for the optimum picture quality at the factory.
- You can use a preset, change each setting manually.
 - ⇒ **Backlight**: This function adjusts the brightness of the backlight behind the LCD screen. Adjusting the backlight is recommended when setting the brightness of the TV. When decreasing the backlight, the brightness of the black becomes darker without any loss in video signal and the power consumption is reduced.
 - ⇒ **Contrast**: Increases or decreases the gradient of the video signal. You may use Contrast when the bright part of the picture is saturated.

- ⇒ **Brightness:** Adjusts the base level of the signal in the picture. You may use Brightness when the dark part of the picture is saturated.
- ⇒ **Sharpness:** Adjusts the level of crispness in the edges between the light and dark areas of the picture. The lower the level, the softer the image.
- ⇒ **Color:** Adjusts intensity of all colors.
- ⇒ **Tint:** Adjusts the balance between red and green levels.
- ⇒ **Advanced Control:** Allows you to adjust some of the advanced features of your LG display such as **Color Temperature, Fresh Contrast, Fresh Color, Noise Reduction, Gamma, Black Level, Eye Care,** and **Real Cinema** settings.
- ⇒ **Reset:** Returns to factory default settings.

Audio Menu

The Audio menu offers options to enhance and refine the sound setting on your TV based on personal preferences.

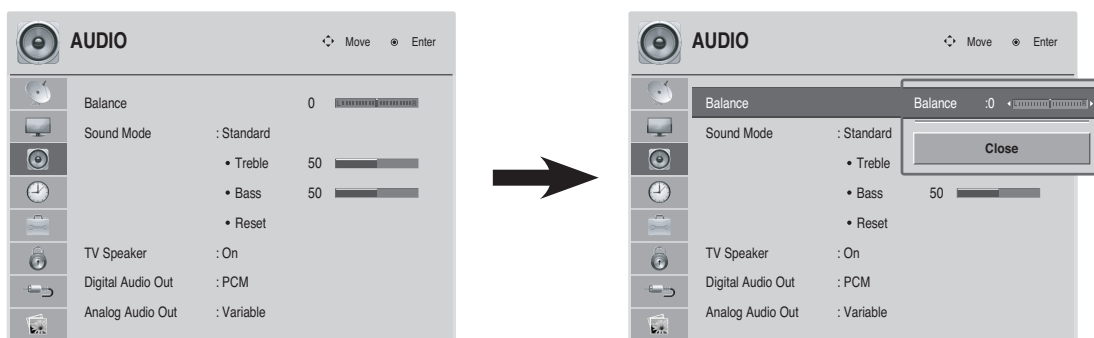

- 1 Display **AUDIO** menu.
- 2 Select a menu item.
- 3 Set the setting.
- 4 Return to TV viewing.

⇒ **Balance**

- Adjusts the left/right sound of speaker to suit your taste and room situations.

⇒ **Sound Mode**

- Standard, Music, Cinema, Sport,** and **Game** are preset for optimum sound quality at the factory.
 - ⇒ **Treble:** Adjusts the high frequency intensity setting.
 - ⇒ **Bass:** Adjusts the low frequency intensity setting.
 - ⇒ **Reset:** Returns to factory default settings.

⇒ TV Speaker

- ❑ If you wish to use an external Hi-Fi system, turn off the TV's internal speakers.

⇒ Digital Audio Out

- ❑ Sets the digital audio out setting.

⇒ Analog Audio Out

- ❑ Sets the analog audio out setting.

Time Menu

The Time menu offers options to adjust the time setting, set the TV turn/off time, sleep timer, and auto sleep.

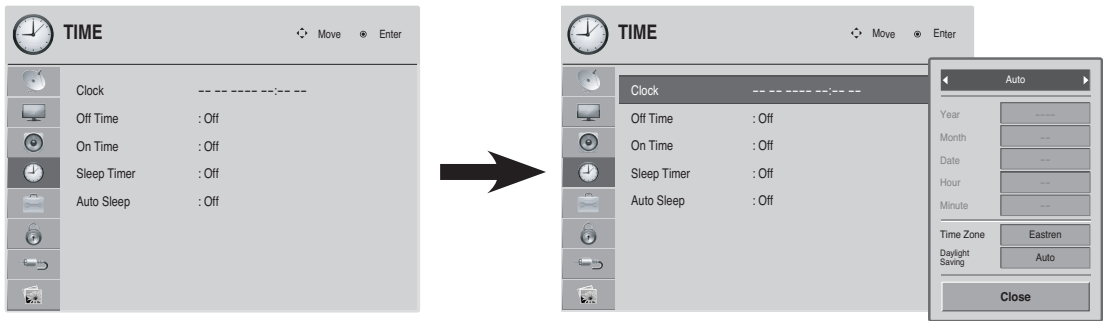

1 Display **TIME** menu.

2 Select a menu item.

3 Set the setting.

4 Return to TV viewing.

⇒ Clock

- ❑ Adjusts the time settings on your TV.
- ❑ With **Auto** setting, the time is set automatically from a digital channel signal.
- ❑ If the current time setting is wrong, reset the clock manually.

⇒ Off Time

- ❑ Sets the time the TV will automatically be turned off.
- ❑ This function operates only if the current time has been set.

⇒ On Time

- ❑ Sets the time the TV will automatically be turned on.
- ❑ This function operates only if the current time has been set.
- ❑ The TV must be in standby mode for the **On Time** to work.
- ❑ If you do not press any button within 2 hours after the TV turns on with the **On Time** function, the TV will automatically revert to standby mode.

⇒ Sleep Timer

- ❑ Turns the TV off at the preset time.

⇒ Auto Sleep

- ❑ If sets "Auto Sleep" to "On", the TV will automatically turn off in case of no signal for 10 minutes.

Option Menu

The Option menu offers options to set the TV operating environment.

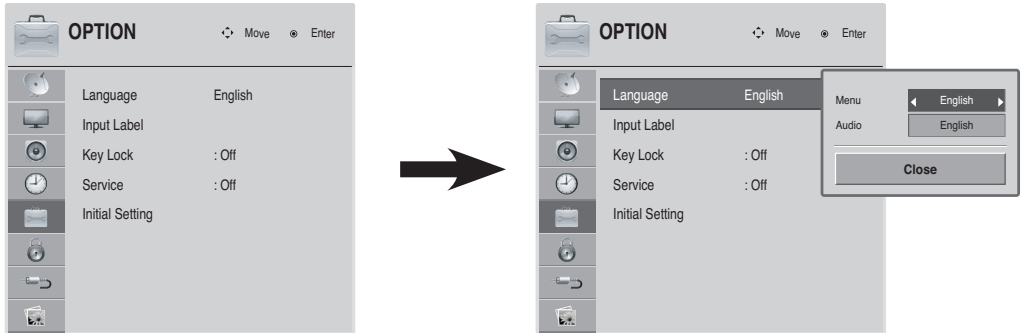

- 1** Display **OPTION** menu.
- 2** Select a menu item.
- 3** Set the setting.
- 4** Return to TV viewing.

⇒ Language

- ❑ Sets the on-screen menus and audio languages.

⇒ Input Label

- ❑ Sets the label for each input source.
 - ⇒ **AV**: Input source from a VCR or other external equipment.
 - ⇒ **Component**: Input source from DVD or a Digital set-top box.
 - ⇒ **RGB-PC**: Input source from a computer.
 - ⇒ **HDMI1/HDMI2/HDMI3***: Input source from high definition (HD) devices.
* *HDMI 3: For 42LV4400, 47LV4400, 55LV4400*

⇒ Key Lock

- ❑ Sets the key lock on or off.

⇒ **Caption**

- ❑ Captions are provided to help the hearing impaired watch TV. Select a caption mode for displaying captioning information if provided on a program. Analog caption displays information at any position on the screen and is usually the program's dialog. Caption/Text, if provided by the broadcaster, would be available for both digital and analog channels on the Antenna/Cable. This TV is programmed to memorize the caption/text mode which was last set when you turned the power off.
- ❑ This function is only available when **Caption Mode** is set **On**.
 - ⇒ **Caption (CC1-4)**: The term for the words that scroll across the bottom of the TV screen; usually the audio portion of the program provided for the hearing impaired.
 - ⇒ **Text (Text1-4)**: The term for the words that appear in a large black frame and almost cover the entire screen; usually messages provided by the broadcaster.
 - ⇒ **Service (Service1-6)**: This function is only available for digital broadcasting system captions (digital input source from DTV/Cable DTV).

⇒ **Initial Setting**

- ❑ See "Initial Setting" (page 29).

Parental Control / Ratings

The Lock menu offers options to set up blocking schemes to block specific channels, ratings, and external viewing sources. A password is required to gain access to this menu.

⇒ The TV is set up with the initial password "0-0-0-0".

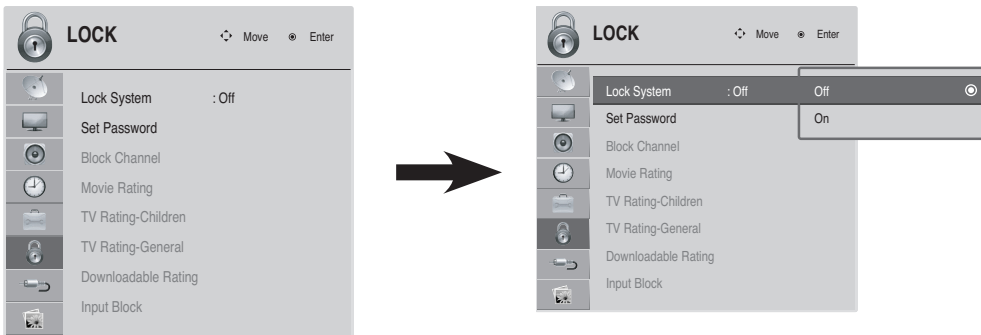

- 1 Display **LOCK** menu.
- 2 Input the password.
- 3 Select a menu item.

- 4 Set the setting.
- 5 Return to TV viewing.

⇒ **Lock System**

- Enables or disables the blocking scheme you set up previously.

⇒ **Set Password**

- Change the password by inputting a new password twice.
 - ⇒ The TV is set up with the initial password "0-0-0-0".

⇒ **Block Channel**

- Blocks any channels that you do not want to watch or that you do not want your children to watch. Press the **Q.MENU** button to delete or add the selected channel.

⇒ **Movie Rating**

- Blocks movies according to the movie ratings limits specified, so children cannot view certain movies. You can set the ratings limit by blocking out all the movies with the ratings above a specified level. Keep in mind that the movie ratings limit only applies to movies shown on TV, not TV programs, such as soap operas.
- Movie Rating** block options:
 - ⇒ **G** (General audience)
 - ⇒ **PG** (Parental guidance suggested)
 - ⇒ **PG-13** (Parents strongly cautioned)
 - ⇒ **R** (Restricted)
 - ⇒ **NC-17** (No one 17 and under admitted)
 - ⇒ **X** (Adult only)
 - ⇒ **Blocking Off** (Permits all programs)
 - ⇒ If you set **PG-13**: **G** and **PG** movies will be available, **PG-13**, **R**, **NC-17** and **X** will be blocked.

⇒ **TV Rating-Children**

- Prevents children from watching certain children's TV programs, according to the ratings limit set. The children rating does not apply to other TV programs. Unless you block certain TV programs intended for mature audiences in the TV Rating - sub menu, your children can view those programs.
- TV Rating-Children** block options:
 - ⇒ **Age** (applies to TV-Y, TV-Y7)
 - ⇒ **Fantasy Violence** (applies to TV-Y7)

⇒ **TV Rating-General**

- Based on the ratings, blocks certain TV programs that you and your family do not want to view.
- TV Rating-General** block options:
 - ⇒ **Age** (applies to TV-G, TV-PG, TV-14, TV-MA).
 - ⇒ **Dialogue**-sexual dialogue (applies to TV-PG, TV-14).
 - ⇒ **Language**-adult language (applies to TV-PG, TV-14, TV-MA).

⇒ **Sex**-sexual situations (applies to TV-PG, TV-14, TV-MA).

⇒ **Violence** (applies to TV-PG, TV-14, TV-MA).

⇒ Downloadable Rating

- ❑ This function is available only for digital channels.
- ❑ This function operates only when TV has received Region5 Rating data.



⇒ Input Block

- ❑ Enables you to block an input.

Input Menu

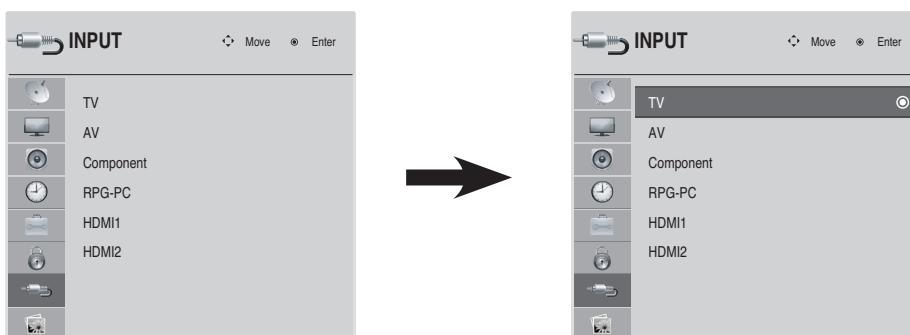
The Input menu offers options to select the desired input source.



1    Display **INPUT** menu.

2   Select the desired input source.

3  Return to TV viewing.

⇒ **TV**: Select it to watch over-the-air, cable and digital cable broadcasts.

⇒ **AV**: Select them to watch a VCR or other external equipment.

⇒ **Component**: Select them to watch DVD or a Digital set-top box.

⇒ **RGB-PC**: Select it to view PC input.





⇒ **HDMI1/HDMI2/HDMI3***: Select them to watch high definition devices.

* *HDMI 3: For 42LV4400, 47LV4400, 55LV4400*

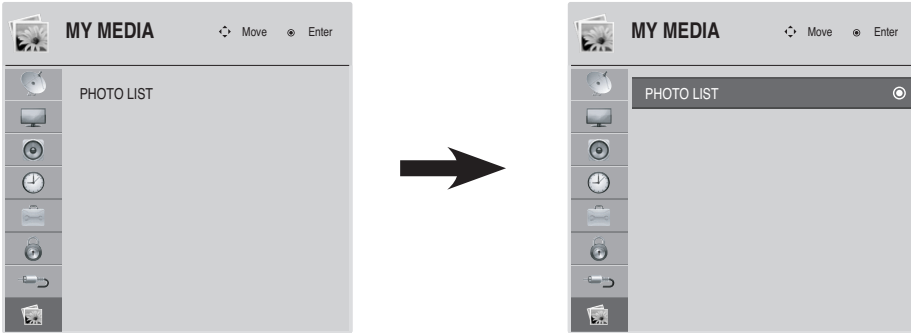
My Media Menu

The My Media menu will open automatically when you insert a USB drive. USB can also be accessed by choosing MY MEDIA in the user menu.



- 1 Connect the USB device to the USB IN jack on the side of TV.
- 2    Display MY MEDIA menu.
- 3  Select PHOTO LIST.
- 4  Return to TV viewing.

⇒ PHOTO LIST

Supported photo file: *.JPG

- Baseline: 64 pixel (width) x 64 pixel (height) to 15360 pixel (width) x 8640 pixel (height)
- Progressive: 64 pixel (width) x 64 pixel (height) to 1920 pixel (width) x 1440 pixel (height)
- You can play JPEG files only.
- Non-supported files are displayed in the form of predefined icon.



- To display the image on the screen in full size, select the desired image file and press the **ENTER** button.

☐ Press the **HOME** button to more options:

- ⇒ **Slideshow Mode:** Selects the slideshow mode.
- ⇒ **Repeat:** Sets the repeat mode to on or off.
- ⇒ **Sort By:** Selects the file sorting type.
- ⇒ **Duration:** Sets the time interval of the slide show.
- ⇒ **Slideshow Effect:** Selects the slideshow transition effect.
- ⇒ **Thumbnail Size:** Selects the thumbnail size.
- ⇒ **Information:** Sets the information to on or off.



APPENDIX

Troubleshooting

Abnormal Operation	
The remote control doesn't work	<ul style="list-style-type: none"><input type="checkbox"/> Check to see if there is any object between the product and the remote control causing obstruction. Ensure you are pointing the remote control directly at the TV.<input type="checkbox"/> Ensure that the batteries are installed with correct polarity (+ to +, - to -).<input type="checkbox"/> Ensure that the correct remote operating mode is set: TV, VCR etc.<input type="checkbox"/> Install new batteries.
TV turns off suddenly	<ul style="list-style-type: none"><input type="checkbox"/> Is the sleep timer set?<input type="checkbox"/> Check the power control settings. Power interrupted.<input type="checkbox"/> If there is no signal, the TV turns off automatically in 10 minutes.

Video Problems	
No picture & No sound	<ul style="list-style-type: none"><input type="checkbox"/> Check whether the product is turned on.<input type="checkbox"/> Try another channel. The problem may be with the broadcast.<input type="checkbox"/> Is the power cord inserted into wall power outlet?<input type="checkbox"/> Check your antenna direction and/or location.<input type="checkbox"/> Test the wall power outlet, plug another product's power cord into the outlet where the product's power cord was plugged in.
Picture appears slowly after switching on	<ul style="list-style-type: none"><input type="checkbox"/> This is normal, the image is muted during the product startup process. Please contact your service center, if the picture has not appeared after five minutes.
No or poor color or poor picture	<ul style="list-style-type: none"><input type="checkbox"/> Adjust Color in menu option.<input type="checkbox"/> Keep a sufficient distance between the product and the VCR.<input type="checkbox"/> Try another channel. The problem may be with the broadcast.<input type="checkbox"/> Are the video cables installed properly?<input type="checkbox"/> Activate any function to restore the brightness of the picture.
Horizontal/vertical bars or picture shaking	<ul style="list-style-type: none"><input type="checkbox"/> Check for local interference such as an electrical appliance or power tool.
Poor reception on some channels	<ul style="list-style-type: none"><input type="checkbox"/> Station or cable product experiencing problems, tune to another station.<input type="checkbox"/> Station signal is weak, reorient antenna to receive weaker station.<input type="checkbox"/> Check for sources of possible interference.

Video Problems	
Lines or streaks in pictures	<input type="checkbox"/> Check antenna (Change the direction of the antenna).
No picture when connecting HDMI	<input type="checkbox"/> If an HDMI cable doesn't support High Speed HDMI, it can cause flickers or no screen display. In this case use the latest cables that support High Speed HDMI.

Audio Problems	
No output from one of the speakers	<input type="checkbox"/> Adjust Balance in menu option.
Unusual sound from inside the product	<input type="checkbox"/> A change in ambient humidity or temperature may result in an unusual noise when the product is turned on or off and does not indicate a fault with the product.
No sound when connecting HDMI	<input type="checkbox"/> Check High Speed HDMI cable.

PC Mode Problems	
The signal is out of range	<input type="checkbox"/> Adjust resolution, horizontal frequency, or vertical frequency on the PC. <input type="checkbox"/> Check the input source.
Screen color is unstable or single color	<input type="checkbox"/> Check the signal cable. <input type="checkbox"/> Reinstall the PC video card.
When connecting the HDMI cable to the PC, there is no audio.	<input type="checkbox"/> Check the manual for the video card in the PC to see if it supports HDMI audio and how to set it up properly.

Maintenance

Early malfunctions can be prevented. Careful and regular cleaning can extend the amount of time you can enjoy your new TV.

Caution: Be sure to turn the power off and unplug the power cord before you begin any cleaning.

Cleaning the Screen

- 1 Here's a great way to keep the dust off your screen for a while. Wet a soft cloth in a mixture of lukewarm water and a little fabric softener or dish washing detergent. Wring the cloth until it's almost dry, and then use it to wipe the screen.
- 2 Make sure the excess water is off the screen, and then let it air-dry before you turn on your TV.

Cleaning the Cabinet

- To remove dirt or dust, wipe the cabinet with a soft, dry, lint-free cloth.
- Please be sure not to use a wet cloth.

Extended Absence

CAUTION

- ⇒ If you expect to leave your TV dormant for a long time (such as a vacation), it's a good idea to unplug the power cord to protect against possible damage from lightning or power surges.

Product Specifications

Models		32LV2400	42LV4400	47LV4400	55LV4400
Dimensions (Width x Height x Depth)	With stand	770.2 x 554.7 x 190mm (30.323" x 21.838" x 7.48")	999.0 x 687.7 x 220mm (39.3" x 27" x 8.7")	1108.1 x 751.4 x 250mm (43.6" x 29.5" x 9.84")	1287.9 x 850 x 276mm (50.7" x 33.5" x 9")
	Without stand	770.2 x 500 x 44.5mm (30.323" x 19.68" x 1.75")	999 x 631.7 x 45.4mm (39.3" x 24.9" x 1.8")	1108.1 x 693.5 x 45.4mm (43.6" x 27.2" x 1.8")	1287.9 x 796.4 x 49.9mm (50.7" x 31.3" x 1.94")
Weight	With stand	6.55 kg (14.4 lb)	11.5 kg (25.3 lb)	17.7 kg (38.9 lb)	23.5 kg (51.8 lb)
	Without stand	5.95 kg (13.1 lb)	10 kg (22 lb)	16.2 kg (35.6 lb)	22 kg (48.5 lb)

Power requirement	AC 100-240 V ~50/60 Hz	
Television System	NTSC-M, ATSC, 64 & 256 QAM	
Program Coverage	VHF 2-13, UHF 14-69, CATV 1-135, DTV 2-69, CADTV 1-135	
External Antenna Impedance	75 Ω	
Environment condition	Operating Temperature	0°C to 35°C (32°F to 95°F)
	Operating Humidity	10%~90% (No-condensation)
	Storage Temperature	-20°C to 60°C (-4°F to 140°F)
	Storage Humidity	10%~70% (No-condensation)

* The specifications shown above may be changed without prior notice for quality improvement.

Open Source License

GNU GENERAL PUBLIC LICENSE

Version 2, June 1991

Copyright (C) 1989, 1991 Free Software Foundation, Inc., 51 Franklin Street, Fifth Floor, Boston, MA 02110-1301 USA

Everyone is permitted to copy and distribute verbatim copies of this license document, but changing it is not allowed.

Preamble

The licenses for most software are designed to take away your freedom to share and change it. By contrast, the GNU General Public License is intended to guarantee your freedom to share and change free software - to make sure the software is free for all its users. This General Public License applies to most of the Free Software Foundation's software and to any other program whose authors commit to using it. (Some other free software foundation software is covered by the GNU Lesser General Public License instead.) You can apply it to your programs, too.

When we speak of free software, we are referring to freedom, not price. Our General Public Licenses are designed to make sure that you have the freedom to distribute copies of free software (and charge for this service if you wish), that you receive source code or can get it if you want it, that you can change the software or use pieces of it in new free programs; and that you know you can do these things.

To protect your rights, we need to make restrictions that forbid anyone to deny you these rights or to ask you to surrender the rights. These restrictions translate to certain responsibilities for you if you distribute copies of the software, or if you modify it.

For example, if you distribute copies of such a program, whether gratis or for a fee, you must give the recipients all the rights that you have. You must make sure that they, too, receive or can get the source code. And you must show them these terms so they know their rights.

We protect your rights with two steps: (1) copyright the software, and (2) offer you this license which gives you legal permission to copy, distribute and/or modify the software.

Also, for each author's protection and ours, we want to make certain that everyone understands that there is no warranty for this free software. If the software is modified by someone else and passed on, we want its recipients to know that what they have is not the original, so that any problems introduced by others will not reflect on the original authors' reputations.

Finally, any free program is threatened constantly by software patents. We wish to avoid the danger that redistributors of a free program will individually obtain patent licenses, in effect making the program proprietary. To prevent this, we have made it clear that any patent must be licensed for everyone's free use or not licensed at all.

The precise terms and conditions for copying, distribution and modification follow.

GNU GENERAL PUBLIC LICENSE TERMS AND CONDITIONS FOR COPYING, DISTRIBUTION AND MODIFICATION

0. This license applies to any program or other work which contains a notice placed by the copyright holder saying it may be distributed under the terms of this General Public License. The "Program", below, refers to any such program or work, and a "work based on the Program" means either the Program or any derivative work under copyright law: that is to say, a work containing the Program or a portion of it, either verbatim or with modifications and/or translated into another language. (Hereinafter, translation is included without limitation in the term "modification".) Each licensee is addressed as "you".

Activities other than copying, distribution and modification are not covered by this license; they are outside its scope. The act of running the Program is not restricted, and the output from the program is covered only if its contents constitute a work based on the program (independent of having been made by running the program). Whether that is true depends on what the program does.

1. You may copy and distribute verbatim copies of the program's source code as you receive it, in any medium, provided that you conspicuously and appropriately publish on each copy an appropriate copyright notice and disclaimer of warranty; keep intact all the notices that refer to this license and to the absence of any warranty; and give any other recipients of the program a copy of this license along with the Program.

You may charge a fee for the physical act of transferring a copy, and you may at your option offer warranty protection in exchange for a fee.

2. You may modify your copy or copies of the program or any portion of it, thus forming a work based on the Program, and copy and distribute such modifications or work under the terms of section 1 above, provided that you also meet all of these conditions:
 - a) You must cause the modified files to carry prominent notices stating that you changed the files and the date of any change.
 - b) You must cause any work that you distribute or publish, that in whole or in part contains or is derived from the Program or any part thereof, to be licensed as a whole at no charge to all third parties under the terms of this license.
 - c) If the modified program normally reads commands interactively when run, you must cause it, when started running for such interactive use in the most ordinary way, to print or display an announcement including an appropriate copyright notice and a notice that there is no warranty (or else, saying that you provide a warranty) and that users may redistribute the program under these conditions, and telling the user how to view a copy of this license. (Exception: if the Program itself is interactive but does not normally print such an announcement, your work based on the Program is not required to print an announcement.)

These requirements apply to the modified work as a whole. If identifiable sections of that work are not derived from the Program, and can be reasonably considered independent and separate works in themselves, then this license, and its terms, do not apply to those sections when you distribute them as separate works. But when you

distribute the same sections as part of a whole which is a work based on the Program, the distribution of the whole must be on the terms of this license, whose permissions for other licensees extend to the entire whole, and thus to each and every part regardless of who wrote it.

Thus, it is not the intent of this section to claim rights or contest your rights to work written entirely by you; rather, the intent is to exercise the right to control the distribution of derivative or collective works based on the program.

In addition, mere aggregation of another work not based on the program with the Program (or with a work based on the program) on a volume of a storage or distribution medium does not bring the other work under the scope of this license.

3. You may copy and distribute the program (or a work based on it, under section 2) in object code or executable form under the terms of sections 1 and 2 above provided that you also do one of the following:
 - a) Accompany it with the complete corresponding machine-readable source code, which must be distributed under the terms of sections 1 and 2 above on a medium customarily used for software interchange; or,
 - b) Accompany it with a written offer, valid for at least three years, to give any third party, for a charge no more than your cost of physically performing source distribution, a complete machine-readable copy of the corresponding source code, to be distributed under the terms of sections 1 and 2 above on a medium customarily used for software interchange; or,
 - c) Accompany it with the information you received as to the offer to distribute corresponding source code. (This alternative is allowed only for noncommercial distribution and only if you received the program in object code or executable form with such an offer, in accord with Subsection b above.)

The source code for a work means the preferred form of the work for making modifications to it. For an executable work, complete source code means all the source code for all modules it contains, plus any associated interface definition files, plus the scripts used

to control compilation and installation of the executable. However, as a special exception, the source code distributed need not include anything that is normally distributed (in either source or binary form) with the major components (compiler, kernel, and so on) of the operating system on which the executable runs, unless that component itself accompanies the executable.

If distribution of executable or object code is made by offering access to copy from a designated place, then offering equivalent access to copy the source code from the same place counts as distribution of the source code, even though third parties are not compelled to copy the source along with the object code.

4. You may not copy, modify, sublicense, or distribute the Program except as expressly provided under this license. Any attempt otherwise to copy, modify, sublicense or distribute the Program is void, and will automatically terminate your rights under this license. However, parties who have received copies, or rights, from you under this license will not have their licenses terminated so long as such parties remain in full compliance.
5. You are not required to accept this license, since you have not signed it. However, nothing else grants you permission to modify or distribute the Program or its derivative works. These actions are prohibited by law if you do not accept this license. Therefore, by modifying or distributing the program (or any work based on the program), you indicate your acceptance of this license to do so, and all its terms and conditions for copying, distributing or modifying the program or works based on it.
6. Each time you redistribute the program (or any work based on the Program), the recipient automatically receives a license from the original licensor to copy, distribute or modify the Program subject to these terms and conditions. You may not impose any further restrictions on the recipients' exercise of the rights granted herein. You are not responsible for enforcing compliance by third parties to this license.
7. If, as a consequence of a court judgment or allegation of patent

infringement or for any other reason (not limited to patent issues), conditions are imposed on you (whether by court order, agreement or otherwise) that contradict the conditions of this license, they do not excuse you from the conditions of this license. If you cannot distribute so as to satisfy simultaneously your obligations under this license and any other pertinent obligations, then as a consequence you may not distribute the program at all. For example, if a patent license would not permit royalty-free redistribution of the program by all those who receive copies directly or indirectly through you, then the only way you could satisfy both it and this license would be to refrain entirely from distribution of the program.

If any portion of this section is held invalid or unenforceable under any particular circumstance, the balance of the section is intended to apply and the section as a whole is intended to apply in other circumstances.

It is not the purpose of this section to induce you to infringe any patents or other property right claims or to contest validity of any such claims; this section has the sole purpose of protecting the integrity of the free software distribution system, which is implemented by public license practices. Many people have made generous contributions to the wide range of software distributed through that system in reliance on consistent application of that system; it is up to the author/donor to decide if he or she is willing to distribute software through any other system and a licensee cannot impose that choice.

This section is intended to make thoroughly clear what is believed to be a consequence of the rest of this license.

8. If the distribution and/or use of the program is restricted in certain countries either by patents or by copyrighted interfaces, the original copyright holder who places the program under this license may add an explicit geographical distribution limitation excluding those countries, so that distribution is permitted only in or among countries not thus excluded. In such case, this license incorporates the limitation as if written in the body of this license.
9. The Free Software Foundation may publish revised and/or new versions of the General Public License from time to time. Such new versions will be

similar in spirit to the present version, but may differ in detail to address new problems or concerns.

Each version is given a distinguishing version number. If the program specifies a version number of this license which applies to it and "any later version", you have the option of following the terms and conditions either of that version or of any later version published by the Free Software Foundation. If the program does not specify a version number of this license, you may choose any version ever published by the Free Software Foundation.

10. If you wish to incorporate parts of the program into other free programs whose distribution conditions are different, write to the author to ask for permission. For software which is copyrighted by the Free Software Foundation, write to the Free Software Foundation; we sometimes make exceptions for this. Our decision will be guided by the two goals of preserving the free status of all derivatives of our free software and of promoting the sharing and reuse of software generally.

NO WARRANTY

11. BECAUSE THE PROGRAM IS LICENSED FREE OF CHARGE, THERE IS NO WARRANTY FOR THE PROGRAM, TO THE EXTENT PERMITTED BY APPLICABLE LAW. EXCEPT WHEN OTHERWISE STATED IN WRITING THE COPYRIGHT HOLDERS AND/OR OTHER PARTIES PROVIDE THE PROGRAM "AS IS" WITHOUT WARRANTY OF ANY KIND, EITHER EXPRESSED OR IMPLIED, INCLUDING, BUT NOT LIMITED TO, THE IMPLIED WARRANTIES OF MERCHANTABILITY AND FITNESS FOR A PARTICULAR PURPOSE. THE ENTIRE RISK AS TO THE QUALITY AND PERFORMANCE OF THE PROGRAM IS WITH YOU. SHOULD THE PROGRAM PROVE DEFECTIVE, YOU ASSUME THE COST OF ALL NECESSARY SERVICING, REPAIR OR CORRECTION.
12. IN NO EVENT UNLESS REQUIRED BY APPLICABLE LAW OR AGREED TO IN WRITING WILL ANY COPYRIGHT HOLDER, OR ANY OTHER PARTY WHO MAY MODIFY AND/OR REDISTRIBUTE THE PROGRAM AS

PERMITTED ABOVE, BE LIABLE TO YOU FOR DAMAGES, INCLUDING ANY GENERAL, SPECIAL, INCIDENTAL OR CONSEQUENTIAL DAMAGES ARISING OUT OF THE USE OR INABILITY TO USE THE PROGRAM (INCLUDING BUT NOT LIMITED TO LOSS OF DATA OR DATA BEING RENDERED INACCURATE OR LOSSES SUSTAINED BY YOU OR THIRD PARTIES OR A FAILURE OF THE PROGRAM TO OPERATE WITH ANY OTHER PROGRAMS), EVEN IF SUCH HOLDER OR OTHER PARTY HAS BEEN ADVISED OF THE POSSIBILITY OF SUCH DAMAGES.

END OF TERMS AND CONDITIONS

How to apply these terms to your new programs

If you develop a new program, and you want it to be of the greatest possible use to the public, the best way to achieve this is to make it free software which everyone can redistribute and change under these terms.

To do so, attach the following notices to the program. It is safest to attach them to the start of each source file to most effectively convey the exclusion of warranty; and each file should have at least the "copyright" line and a pointer to where the full notice is found.

one line to give the program's name and a brief idea of what it does.

Copyright (C) <year> <name of author>

This program is free software; you can redistribute it and/or modify it under the terms of the GNU General Public License as published by the Free Software Foundation; either version 2 of the license, or (at your option) any later version.

This program is distributed in the hope that it will be useful, but WITHOUT ANY WARRANTY; without even the implied warranty of MERCHANTABILITY or FITNESS FOR A PARTICULAR PURPOSE. See the GNU General Public License for more details.

You should have received a copy of the GNU General Public License along with this program; if not, write to the Free Software Foundation, Inc., 51 Franklin Street, Fifth Floor, Boston, MA 02110-1301 USA.

Also add information on how to contact you by electronic and paper mail.

If the program is interactive, make it output a short notice like this when it starts in an interactive mode:

Gnomovision version 69, Copyright (C) year name of author Gnomovision comes with ABSOLUTELY NO WARRANTY; for details type 'show w'. This is free software, and you are welcome to redistribute it under certain conditions; type 'show c' for details.

The hypothetical commands 'show w' and 'show c' should show the appropriate parts of the General Public License. Of course, the commands you use may be called something other than 'show w' and 'show c'; they could even be mouse-clicks or menu items-whatever suits your program.

You should also get your employer (if you work as a programmer) or your school, if any, to sign a "copyright disclaimer" for the program, if necessary.

Here is a sample; alter the names:

Yoyodyne, Inc., hereby disclaims all copyright interest in the program 'Gnomovision' (which makes passes at compilers) written by James Hacker.

signature of Ty Coon, 1 April 1989
Ty Coon, President of Vice

This General Public License does not permit incorporating your program into proprietary programs. If your program is a subroutine library, you may consider it more useful to permit linking proprietary applications with the library. If this is what you want to do, use the GNU Lesser General Public License instead of this license

GNU LESSER GENERAL PUBLIC LICENSE

Version 2.1, February 1999

Copyright (C) 1991, 1999 Free Software Foundation, Inc. 51 Franklin Street, Fifth Floor, Boston, MA 02110-1301 USA
Everyone is permitted to copy and distribute verbatim copies of this license document, but changing it is not allowed.

[This is the first released version of the Lesser GPL. It also counts as the successor of the GNU Library Public License, version 2, hence the version number 2.1.]

Preamble

The licenses for most software are designed to take away your freedom to share and change it. By contrast, the GNU General Public Licenses are intended to guarantee your freedom to share and change free software - to make sure the software is free for all its users.

This license, the Lesser General Public License, applies to some specially designated software packages - typically libraries - of the Free Software Foundation and other authors who decide to use it. You can use it too, but we suggest you first think carefully about whether this license or the ordinary General Public License is the better strategy to use in any particular case, based on the explanations below.

When we speak of free software, we are referring to freedom of use, not price. Our

General Public Licenses are designed to make sure that you have the freedom to distribute copies of free software (and charge for this service if you wish); that you receive source code or can get it if you want it; that you can change the software and use pieces of it in new free programs; and that you are informed that you can do these things.

To protect your rights, we need to make restrictions that forbid distributors to deny you these rights or to ask you to surrender these rights. These restrictions translate to certain responsibilities for you if you distribute copies of the library or if you modify it.

For example, if you distribute copies of the library, whether gratis or for a fee, you must give the recipients all the rights that we gave you. You must make sure that they, too, receive or can get the source code. If you link other code with the library, you must provide complete object files to the recipients, so that they can relink them with the library after making changes to the library and recompiling it. And you must show them these terms so they know their rights.

We protect your rights with a two-step method: (1) we copyright the library, and (2) we offer you this license, which gives you legal permission to copy, distribute and/or modify the library.

To protect each distributor, we want to make it very clear that there is no warranty for the free library. Also, if the library is modified by someone else and passed on, the recipients should know that what they have is not the original version, so that the original author's reputation will not be affected by problems that might be introduced by others.

Finally, software patents pose a constant threat to the existence of any free program. We wish to make sure that a company cannot effectively restrict the users of a free program by obtaining a restrictive license from a patent holder. Therefore, we insist that any patent license obtained for a version of the library must be consistent with the full freedom of use specified in this license.

Most GNU software, including some libraries, is covered by the ordinary GNU General Public License. This license, the GNU Lesser General Public License, applies to certain designated libraries, and is quite different from the ordinary General Public License. We use this license for certain libraries in order to permit linking those libraries into non-free programs.

When a program is linked with a library, whether statically or using a shared library, the combination of the two is legally speaking a combined work, a derivative of the original library. The ordinary General Public License therefore permits such linking only if the entire combination fits its criteria of freedom. The Lesser General Public License permits more lax criteria for linking other code with the library.

We call this license the "Lesser" General Public License because it does Less to protect the user's freedom than the ordinary General Public License. It also provides other free software developers Less of an advantage over competing non-free programs. These disadvantages are the reason we use the ordinary General Public License for many libraries. However, the Lesser license provides advantages in certain special circumstances.

For example, on rare occasions, there may be a special need to encourage the widest possible use of a certain library, so that it becomes a de-facto standard. To achieve this, non-free programs must be allowed to use the library. A more frequent case is that a free library does

the same job as widely used non-free libraries. In this case, there is little to gain by limiting the free library to free software only, so we use the Lesser General Public License.

In other cases, permission to use a particular library in non-free programs enables a greater number of people to use a large body of free software. For example, permission to use the GNU C Library in non-free programs enables many more people to use the whole GNU operating system, as well as its variant, the GNU/Linux operating system.

Although the Lesser General Public License is Less protective of the users' freedom, it does ensure that the user of a program that is linked with the Library has the freedom and the wherewithal to run that program using a modified version of the Library.

The precise terms and conditions for copying, distribution and modification follow. Pay close attention to the difference between a "work based on the library" and a "work that uses the library". The former contains code derived from the library, whereas the latter must be combined with the library in order to run.

GNU LESSER GENERAL PUBLIC LICENSE

TERMS AND CONDITIONS FOR COPYING, DISTRIBUTION AND MODIFICATION

0. This license agreement applies to any software library or other program which contains a notice placed by the copyright holder or other authorized party saying it may be distributed under the terms of this Lesser General Public License (also called "this license"). Each license is addressed as "you".

A "library" means a collection of software functions and/or data prepared so as to be conveniently linked with application programs (which use some of those functions and data) to form executables.

The "Library", below, refers to any such software library or work which has been distributed under these terms. A "work based on the Library" means either the Library or any derivative work under copyright law: that is to say, a work containing the library or a portion of it,

either verbatim or with modifications and/or translated straightforwardly into another language. (Hereinafter, translation is included without limitation in the term "modification".)

"Source code" for a work means the preferred form of the work for making modifications to it. For a library, complete source code means all the source code for all modules it contains, plus any associated interface definition files, plus the scripts used to control compilation and installation of the library.

Activities other than copying, distribution and modification are not covered by this license; they are outside its scope. The act of running a program using the Library is not restricted, and output from such a program is covered only if its contents constitute a work based on the library (independent of the use of the Library in a tool for writing it). Whether that is true depends on what the library does and what the program that uses the library does.

1. You may copy and distribute verbatim copies of the library's complete source code as you receive it, in any medium, provided that you conspicuously and appropriately publish on each copy an appropriate copyright notice and disclaimer of warranty; keep intact all the notices that refer to this license and to the absence of any warranty; and distribute a copy of this license along with the Library.

You may charge a fee for the physical act of transferring a copy, and you may at your option offer warranty protection in exchange for a fee.

2. You may modify your copy or copies of the Library or any portion of it, thus forming a work based on the Library, and copy and distribute such modifications or work under the terms of section 1 above, provided that you also meet all of these conditions:
 - a) The modified work must itself be a software library.
 - b) You must cause the files modified to carry prominent notices stating that you changed the files and the date of any change.
 - c) You must cause the whole of the

work to be licensed at no charge to all third parties under the terms of this license.

- d) If a facility in the modified Library refers to a function or a table of data to be supplied by an application program that uses the facility, other than as an argument passed when the facility is invoked, then you must make a good faith effort to ensure that, in the event an application does not supply such function or table, the facility still operates, and performs whatever part of its purpose remains meaningful.

(For example, a function in a library to compute square roots has a purpose that is entirely well-defined independent of the application. Therefore, Subsection 2d requires that any application-supplied function or table used by this function must be optional: if the application does not supply it, the square root function must still compute square roots.)

These requirements apply to the modified work as a whole. If identifiable sections of that work are not derived from the library, and can be reasonably considered independent and separate works in themselves, then this license, and its terms, do not apply to those sections when you distribute them as separate works. But when you distribute the same sections as part of a whole which is a work based on the library, the distribution of the whole must be on the terms of this license, whose permissions for other licenses extend to the entire whole, and thus to each and every part regardless of who wrote it.

Thus, it is not the intent of this section to claim rights or contest your rights to work written entirely by you; rather, the intent is to exercise the right to control the distribution of derivative or collective works based on the library.

In addition, mere aggregation of another work not based on the library with the library (or with a work based on the library) on a volume of a storage or distribution medium does not bring the other work under the scope of this license.

3. You may opt to apply the terms of the

ordinary GNU General Public License instead of this License to a given copy of the Library. To do this, you must alter all the notices that refer to this License, so that they refer to the ordinary GNU General Public License, version 2, instead of to this License. (If a newer version than version 2 of the ordinary GNU General Public License has appeared, then you can specify that version instead if you wish.) Do not make any other change in these notices.

Once this change is made in a given copy, it is irreversible for that copy, so the ordinary GNU General Public License applies to all subsequent copies and derivative works made from that copy.

This option is useful when you wish to copy part of the code of the library into a program that is not a library.

4. You may copy and distribute the library (or a portion or derivative of it, under Section 2) in object code or executable form under the terms of Sections 1 and 2 above provided that you accompany it with the complete corresponding machine-readable source code, which must be distributed under the terms of sections 1 and 2 above on a medium customarily used for software interchange.

If distribution of object code is made by offering access to copy from a designated place, then offering equivalent access to copy the source code from the same place satisfies the requirement to distribute the source code, even though third parties are not compelled to copy the source along with the object code.

5. A program that contains no derivative of any portion of the Library, but is designed to work with the Library by being compiled or linked with it, is called a "work that uses the Library". Such a work, in isolation, is not a derivative work of the Library, and therefore falls outside the scope of this license.

However, linking a "work that uses the library" with the Library creates an executable that is a derivative of the Library (because it contains portions of the library), rather than a "work that uses the library". The executable is therefore covered by this license. Section 6 states terms for distribution

of such executable.

When a "work that uses the library" uses material from a header file that is part of the library, the object code for the work may be a derivative work of the library even though the source code is not.

Whether this is true is especially significant if the work can be linked without the library, or if the work is itself a library. The threshold for this to be true is not precisely defined by law.

If such an object file uses only numerical parameters, data structure layouts and accessories, and small macros and small inline functions (ten lines or less in length), then the use of the object file is unrestricted, regardless of whether it is legally a derivative work. (Executable containing this object code plus portions of the library will still fall under Section 6.)

Otherwise, if the work is a derivative of the library, you may distribute the object code for the work under the terms of Section 6. Any executable containing that work also fall under Section 6, whether or not they are linked directly with the library itself.

6. As an exception to the sections above, you may also combine or link a "work that uses the library" with the library to produce a work containing portions of the library, and distribute that work under terms of your choice, provided that the terms permit modification of the work for the customer's own use and reverse engineering for debugging such modifications.

You must give prominent notice with each copy of the work that the library is used in it and that the Library and its use are covered by this license. You must supply a copy of this license. If the work during execution displays copyright notices, you must include the copyright notice for the library among them, as well as a reference directing the user to the copy of this license. Also, you must do one of these things:

- a) Accompany the work with the complete corresponding machine-readable source code for the library including whatever changes were used in the work (which must be distributed under Sections 1 and 2 above); and, if the work is an executable linked with the Library,

with the complete machine-readable “work that uses the Library”, as object code and/or source code, so that the user can modify the library and then relink to produce a modified executable containing the modified library. (It is understood that the user who changes the contents of definitions files in the library will not necessarily be able to recompile the application to use the modified definitions.)

- b) Use a suitable shared library mechanism for linking with the library. A suitable mechanism is one that (1) uses at run time a copy of the library already present on the user’s computer system, rather than copying library functions into the executable, and (2) will operate properly with a modified version of the library, if the user installs one, as long as the modified version is interface-compatible with the version that the work was made with.
- c) Accompany the work with a written offer, valid for at least three years, to give the same user the materials specified in Subsection 6, above, for a charge no more than the cost of performing this distribution.
- d) If distribution of the work is made by offering access to copy from a designated place, offer equivalent access to copy the above specified materials from the same place.
- e) Verify that the user has already received a copy of these materials or that you have already sent this user a copy.

For an executable, the required form of the “work that uses the library” must include any data and utility programs needed for reproducing the executable from it. However, as a special exception, the materials to be distributed need not include anything that is normally distributed (in either source or binary form) with the major components (compiler, kernel, and so on) of the operating system on which the executable runs, unless that component itself accompanies the executable.

It may happen that this requirement contradicts the license restrictions of other proprietary libraries that do not normally accompany the operating system. Such a contradiction means

you cannot use both them and the library together in an executable that you distribute.

7. You may place library facilities that are a work based on the library side-by-side in a single library together with other library facilities not covered by this license, and distribute such a combined library, provided that the separate distribution of the work based on the Library and of the other library facilities is otherwise permitted, and provided that you do these two things:
 - a) Accompany the combined library with a copy of the same work based on the Library, uncombined with any other library facilities. This must be distributed under the terms of the sections above.
 - b) Give prominent notice with the combined library of the fact that part of it is a work based on the library, and explaining where to find the accompanying uncombined form of the same work.
8. You may not copy, modify, sublicense, link with, or distribute the library except as expressly provided under this license. Any attempt otherwise to copy, modify, sublicense, link with, or distribute the library is void, and will automatically terminate your rights under this license. However, parties who have received copies, or rights, from you under this license will not have their licenses terminated so long as such parties remain in full compliance.
9. You are not required to accept this license, since you have not signed it. However, nothing else grants you permission to modify or distribute the library or its derivative works. These actions are prohibited by law if you do not accept this license. Therefore, by modifying or distributing the library (or any work based on the library), you indicate your acceptance of this license to do so, and all its terms and conditions for copying, distributing or modifying the library or works based on it.
10. Each time you redistribute the library (or any work based on the Library), the recipient automatically receives a license from the original licensor to copy, distribute, link with or modify the library subject to these terms and

conditions. You may not impose any further restrictions on the recipients' exercise of the rights granted herein.

You are not responsible for enforcing compliance by third parties with this license.

11. If, as a consequence of a court judgment or allegation of patent infringement or for any other reason (not limited to patent issues), conditions are imposed on you (whether by court order, agreement or otherwise) that contradict the conditions of this license, they do not excuse you from the conditions of this license. If you cannot distribute so as to satisfy simultaneously your obligations under this license and any other pertinent obligations, then as a consequence you may not distribute the library at all. For example, if a patent license would not permit royalty-free redistribution of the library by all those who receive copies directly or indirectly through you, then the only way you could satisfy both it and this license would be to refrain entirely from distribution of the library.

If any portion of this section is held invalid or unenforceable under any particular circumstance, the balance of the section is intended to apply, and the section as a whole is intended to apply in other circumstances.

It is not the purpose of this section to induce you to infringe any patents or other property right claims or to contest validity of any such claims; this section has the sole purpose of protecting the integrity of the free software distribution system which is implemented by public license practices. Many people have made generous contributions to the wide range of software distributed through that system in reliance on consistent application of that system; it is up to the author/donor to decide if he or she is willing to distribute software through any other system and a license cannot impose that choice.

This section is intended to make thoroughly clear what is believed to be a consequence of the rest of this license.

12. If the distribution and/or use of the library is restricted in certain countries either by patents or by copyrighted interfaces, the original copyright

holder who places the library under this license may add an explicit geographical distribution limitation excluding those countries, so that distribution is permitted only in or among countries not thus excluded. In such case, this license incorporates the limitation as if written in the body of this license.

13. The Free Software Foundation may publish revised and/or new versions of the Lesser General Public License from time to time. Such new versions will be similar in spirit to the present version, but may differ in detail to address new problems or concerns.

Each version is given a distinguishing version number. If the library specifies a version number of this license which applies to it and "any later version", you have the option of following the terms and conditions either of that version or of any later version published by the Free Software Foundation.

If the library does not specify a license version number, you may choose any version ever published by the Free Software Foundation.

14. If you wish to incorporate parts of the library into other free programs whose distribution conditions are incompatible with these, write to the author to ask for permission. For software which is copyrighted by the Free Software Foundation, write to the Free Software Foundation; we sometimes make exceptions for this. Our decision will be guided by the two goals of preserving the free status of all derivatives of our free software and of promoting the sharing and reuse of software generally.

NO WARRANTY

15. BECAUSE THE LIBRARY IS LICENSED FREE OF CHARGE, THERE IS NO WARRANTY FOR THE LIBRARY, TO THE EXTENT PERMITTED BY APPLICABLE LAW. EXCEPT WHEN OTHERWISE STATED IN WRITING THE COPYRIGHT HOLDERS AND/OR OTHER PARTIES PROVIDE THE LIBRARY "AS IS" WITHOUT WARRANTY OF ANY KIND, EITHER EXPRESSED OR IMPLIED, INCLUDING, BUT NOT LIMITED TO, THE IMPLIED WARRANTIES OF MERCHANTABILITY AND FITNESS

FOR A PARTICULAR PURPOSE. THE ENTIRE RISK AS TO THE QUALITY AND PERFORMANCE OF THE LIBRARY IS WITH YOU. SHOULD THE LIBRARY PROVE DEFECTIVE, YOU ASSUME THE COST OF ALL NECESSARY SERVICING, REPAIR OR CORRECTION.

16. IN NO EVENT UNLESS REQUIRED BY APPLICABLE LAW OR AGREED TO IN WRITING WILL ANY COPYRIGHT HOLDER, OR ANY OTHER PARTY WHO MAY MODIFY AND/OR REDISTRIBUTE THE LIBRARY AS PERMITTED ABOVE, BE LIABLE TO YOU FOR DAMAGES, INCLUDING ANY GENERAL, SPECIAL, INCIDENTAL OR CONSEQUENTIAL DAMAGES ARISING OUT OF THE USE OR INABILITY TO USE THE LIBRARY (INCLUDING BUT NOT LIMITED TO LOSS OF DATA OR DATA BEING RENDERED INACCURATE OR LOSSES SUSTAINED BY YOU OR THIRD PARTIES OR A FAILURE OF THE LIBRARY TO OPERATE WITH ANY OTHER SOFTWARE), EVEN IF SUCH HOLDER OR OTHER PARTY HAS BEEN ADVISED OF THE POSSIBILITY OF SUCH DAMAGES.

END OF TERMS AND CONDITIONS

How to apply these terms to your new libraries

If you develop a new library, and you want it to be of the greatest possible use to the public, we recommend making it free software that everyone can redistribute and change. You can do so by permitting redistribution under these terms (or, alternatively, under the terms of the ordinary General Public License).

To apply these terms, attach the following notices to the library. It is safest to attach them to the start of each source file to most effectively convey the exclusion of warranty;

and each file should have at least the "copyright" line and a pointer to where the full notice is found.

one line to give the library's name and a brief idea of what it does.

Copyright (C) <year> <name of author>

This library is free software; you can redistribute it and/or modify it under the terms of the GNU Lesser General Public License as published by the Free Software Foundation; either version 2.1 of the license, or (at your option) any later version.

This library is distributed in the hope that it will be useful, but WITHOUT ANY WARRANTY; without even the implied warranty of MERCHANTABILITY or FITNESS FOR A PARTICULAR PURPOSE. See the GNU Lesser General Public License for more details.

You should have received a copy of the GNU Lesser General Public License along with this library; if not, write to the Free Software Foundation, Inc., 51 Franklin Street, Fifth Floor, Boston, MA 02110-1301 USA

Also add information on how to contact you by electronic and paper mail.

You should also get your employer (if you work as a programmer) or your school, if any, to sign a "copyright disclaimer" for the library, if necessary. Here is a sample; alter the names:

Yoyodyne, Inc., hereby disclaims all copyright interest in the library 'Frob' (a library for tweaking knobs) written by James Random Hacker.

signature of Ty Coon, 1 April 1990
Ty Coon, President of Vice

MOZILLA PUBLIC LICENSE

Version 1.1

1. Definitions.

- 1.0.1. "Commercial use" means distribution or otherwise making the covered code available to a third party.
- 1.1. "Contributor" means each entity that creates or contributes to the creation of modifications.
- 1.2. "Contributor version" means the combination of the original code, prior modifications used by a contributor, and the modifications made by that particular contributor.
- 1.3. "Covered code" means the original code or modifications or the combination of the original code and modifications, in each case including portions thereof.
- 1.4. "Electronic distribution mechanism" means a mechanism generally accepted in the software development community for the electronic transfer of data.
- 1.5. "Executable" means covered code in any form other than source code.
- 1.6. "Initial developer" means the individual or entity identified as the initial Developer in the Source Code notice required by exhibit A.
- 1.7. "Larger work" means a work which combines covered code or portions thereof with code not governed by the terms of this License.
- 1.8. "License" means this document.
- 1.8.1. "Licensable" means having the right to grant, to the maximum extent possible, whether at the time of the initial grant or subsequently acquired, any and all of the rights conveyed herein.
 - A. Any addition to or deletion from the contents of a file containing original code or previous modifications.
 - B. Any new file that contains any part of the original code or previous modifications.
- 1.10. "Original code" means source code of computer software code which is described in the source code notice required by exhibit as original code, and which, at the time of its release under this license is not already covered code governed by this license.
 - 1.10.1. "Patent claims" means any patent claim(s), now owned or hereafter acquired, including without limitation, method, process, and apparatus claims, in any patent licensable by grantor.
 - 1.11. "Source code" means the preferred form of the covered code for making modifications to it, including all modules it contains, plus any associated interface definition files, scripts used to control compilation and installation of an executable, or source code differential comparisons against either the original code or another well known, available covered code of the contributor's choice. The source code can be in a compressed or archival form, provided the appropriate decompression or de-archiving software is widely available for no charge.
 - 1.12. "You" (or "Your") means an individual or a legal entity exercising rights under, and complying with all of the terms of, this license or a future version of this license issued under section 6.1.

For legal entities, "You" includes any entity which controls, is controlled by, or is under common control with You. For purposes of this definition, "control" means (a) the power, direct or indirect, to cause the direction or management of such entity, whether by contract or otherwise, or (b) ownership of more than fifty percent (50%) of the outstanding shares or beneficial ownership of such entity.

2. Source Code License.

2.1. The initial developer grant.

The initial developer hereby grants You a world-wide, royalty-free, non-exclusive license, subject to third party intellectual property claims:

- (a) under intellectual property rights (other than patent or trademark) licensable by initial developer to use, reproduce, modify, display, perform, sublicense and distribute the original code (or portions thereof) with or without modifications, and/or as part of a larger work; and
- (b) under patents claims infringed by the making, using or selling of original code, to make, have made, use, practice, sell, and offer for sale, and/or otherwise dispose of the original code (or portions thereof).
- (c) the licenses granted in this section 2.1(a) and (b) are effective on the date Initial developer first distributes original code under the terms of this license.
- (d) Notwithstanding section 2.1(b) above, no patent license is granted: 1) for code that You delete from the original Code; 2) separate from the original code; or 3) for infringements caused by: i) the modification of the original code or ii) the combination of the original code with other software or devices.

2.2. Contributor Grant.

Subject to third party intellectual property claims, each contributor hereby grants You a world-wide, royalty-free, non-exclusive license

- (a) under intellectual property rights (other than patent or trademark) licensable by contributor, to use, reproduce, modify, display, perform, sublicense and distribute the modifications created by such contributor (or portions thereof) either on an unmodified basis, with other modifications, as covered code and/or as part of a larger work; and
- (b) under patent claims infringed by the making, using, or selling of modifications made by that contributor either alone and/or in combination with its contributor version (or portions of such combination), to make, use,

sell, offer for sale, have made, and/or otherwise dispose of: 1) modifications made by that contributor (or portions thereof); and 2) the combination of modifications made by that contributor with its contributor version (or portions of such combination).

- (c) the licenses granted in sections 2.2(a) and 2.2(b) are effective on the date contributor first makes commercial use of the covered code.
- (d) Notwithstanding section 2.2(b) above, no patent license is granted: 1) for any code that contributor has deleted from the contributor version; 2) separate from the contributor version; 3) for infringements caused by: i) third party modifications of contributor version or ii) the combination of modifications made by that contributor with other software (except as part of the contributor version) or other devices; or 4) under patent claims infringed by covered code in the absence of modifications made by that contributor.

3. Distribution Obligations.

3.1. Application of license.

The modifications which You create or to which you contribute are governed by the terms of this license, including without limitation section 2.2. The source code version of covered code may be distributed only under the terms of this license or a future version of this license released under section 6.1, and you must include a copy of this license with every copy of the source code you distribute. You may not offer or impose any terms on any source code version that alters or restricts the applicable version of this license or the recipients' rights hereunder. However, you may include an additional document offering the additional rights described in section 3.5.

3.2. Availability of source code.

Any modification which you create or to which you contribute must be made available in source code form under the terms of this license either on the same media as an executable version or via an accepted electronic distribution mechanism to anyone to whom you made an executable version available; and if made available via

electronic distribution mechanism, must remain available for at least twelve (12) months after the date it initially became available, or at least six (6) months after a subsequent version of that particular modification has been made available to such recipients. You are responsible for ensuring that the source code version remains available even if the electronic distribution mechanism is maintained by a third party.

3.3. Description of modifications.

You must cause all covered code to which you contribute to contain a file documenting the changes You made to create that covered code and the date of any change. You must include a prominent statement that the modification is derived, directly or indirectly, from original code provided by the initial developer and including the name of the initial developer in (a) the source code, and (b) in any notice in an executable version or related documentation in which you describe the origin or ownership of the covered code.

3.4. Intellectual property matters

(a) Third party claims.

If contributor has knowledge that a license under a third party's intellectual property rights is required to exercise the rights granted by such contributor under sections 2.1 or 2.2, contributor must include a text file with the source code distribution titled "LEGAL" which describes the claim and the party making the claim in sufficient detail that a recipient will know whom to contact. If contributor obtains such knowledge after the modification is made available as described in section 3.2, contributor shall promptly modify the LEGAL file in all copies contributor makes available thereafter and shall take other steps (such as notifying appropriate mailing lists or newsgroups) reasonably calculated to inform those who received the covered code that new knowledge has been obtained.

(b) Contributor APIs.

If contributor's modifications include an application programming interface and contributor has knowledge of patent licenses which are reasonably necessary to implement that API, contributor must also include this information in the LEGAL file.

(c) Representations.

contributor represents that, except as disclosed pursuant to section 3.4(a) above, contributor believes that contributor's modifications are contributor's original creation(s) and/or contributor has sufficient rights to grant the rights conveyed by this license.

3.5. Required notices.

You must duplicate the notice in exhibit A in each file of the source code. If it is not possible to put such notice in a particular source code file due to its structure, then You must include such notice in a location (such as a relevant directory) where a user would be likely to look for such a notice. If You created one or more modification(s), you may add your name as a contributor to the notice described in exhibit A. you must also duplicate this license in any documentation for the source code where You describe recipients' rights or ownership rights relating to covered code. You may choose to offer, and to charge a fee for, warranty, support, indemnity or liability obligations to one or more recipients of covered code. However, you may do so only on your own behalf, and not on behalf of the Initial developer or any contributor.

You must make it absolutely clear than any such warranty, support, indemnity or liability obligation is offered by you alone, and You hereby agree to indemnify the Initial developer and every contributor for any liability incurred by the Initial developer or such contributor as a result of warranty, support, indemnity or liability terms you offer.

3.6. Distribution of executable versions.

You may distribute covered code in executable form only if the requirements of section 3.1-3.5 have been met for that covered code, and if you include a notice stating that the source code version of the covered code is available under the terms of this license, including a description of how and where you have fulfilled the obligations of section 3.2. The notice must be conspicuously included in any notice in an executable version, related documentation or collateral in which you describe recipients' rights relating to the covered code. You may

distribute the executable version of covered code or ownership rights under a license of your choice, which may contain terms different from this license, provided that you are in compliance with the terms of this license and that the license for the executable version does not attempt to limit or alter the recipient's rights in the source code version from the rights set forth in this license. If you distribute the executable version under a different license you must make it absolutely clear that any terms which differ from this license are offered by you alone, not by the Initial developer or any contributor. You hereby agree to indemnify the initial developer and every contributor for any liability incurred by the initial developer or such contributor as a result of any such terms You offer.

3.7. Larger works.

You may create a larger work by combining covered code with other code not governed by the terms of this license and distribute the larger work as a single product. In such a case, you must make sure the requirements of this license are fulfilled for the covered code.

4. Inability to comply due to statute or regulation.

If it is impossible for you to comply with any of the terms of this license with respect to some or all of the covered code due to statute, judicial order, or regulation then you must: (a) comply with the terms of this license to the maximum extent possible; and (b) describe the limitations and the code they affect. Such description must be included in the LEGAL file described in section 3.4 and must be included with all distributions of the source code. Except to the extent prohibited by statute or regulation, such description must be sufficiently detailed for a recipient of ordinary skill to be able to understand it.

5. Application of this license.

This license applies to code to which the initial developer has attached the notice in exhibit A and to related covered code.

6. Versions of the license.

6.1. New versions.

Netscape communications corporation ("Netscape") may publish revised and/or new versions of the license from time to time. Each version will be given a distinguishing version number.

6.2. Effect of new versions.

Once covered code has been published under a particular version of the license, you may always continue to use it under the terms of that version. You may also choose to use such covered code under the terms of any subsequent version of the license published by netscape. No one other than netscape has the right to modify the terms applicable to covered code created under this license.

6.3. Derivative works.

If You create or use a modified version of this license (which you may only do in order to apply it to code which is not already covered code governed by this license), You must (a) rename Your license so that the phrases "Mozilla", "MOZILLAPL", "MOZPL", "Netscape", "MPL", "NPL" or any confusingly similar phrase do not appear in your license (except to note that your license differs from this license) and (b) otherwise make it clear that Your version of the license contains terms which differ from the Mozilla Public license and netscape Public License. (Filling in the name of the initial developer, original code or contributor in the notice described in exhibit A shall not of themselves be deemed to be modifications of this license.)

7. DISCLAIMER OF WARRANTY.

COVERED CODE IS PROVIDED UNDER THIS LICENSE ON AN "AS IS" BASIS, WITHOUT WARRANTY OF ANY KIND, EITHER EXPRESSED OR IMPLIED, INCLUDING, WITHOUT LIMITATION, WARRANTIES THAT THE COVERED CODE IS FREE OF DEFECTS, MERCHANTABILITY, FIT FOR A PARTICULAR PURPOSE OR NON-INFRINGEMENT. THE ENTIRE RISK AS TO THE QUALITY AND PERFORMANCE OF THE COVERED CODE IS WITH YOU. SHOULD ANY COVERED CODE PROVE DEFECTIVE IN ANY RESPECT, YOU (NOT THE INITIAL DEVELOPER OR ANY OTHER CONTRIBUTOR) ASSUME THE COST OF ANY

NECESSARY SERVICING, REPAIR OR CORRECTION. THIS DISCLAIMER OF WARRANTY CONSTITUTES AN ESSENTIAL PART OF THIS LICENSE. NO USE OF ANY COVERED CODE IS AUTHORIZED HEREUNDER EXCEPT UNDER THIS DISCLAIMER.

8. TERMINATION.

8.1. This license and the rights granted hereunder will terminate automatically if you fail to comply with terms herein and fail to cure such breach within 30 days of becoming aware of the breach. All sublicenses to the covered code which are properly granted shall survive any termination of this license. Provisions which, by their nature, must remain in effect beyond the termination of this license shall survive.

8.2. If you initiate litigation by asserting a patent infringement

claim (excluding declaratory judgment actions) against initial developer or a contributor (the initial developer or contributor against whom you file such action is referred to as "Participant") alleging that:

- (a) such participant's contributor version directly or indirectly infringes any patent, then any and all rights granted by such participant to you under sections 2.1 and/or 2.2 of this license shall, upon 60 days notice from Participant terminate prospectively, unless if within 60 days after receipt of notice you either: (i) agree in writing to pay participant a mutually agreeable reasonable royalty for your past and future use of modifications made by such participant, or (ii) withdraw your litigation claim with respect to the contributor version against such participant. If within 60 days of notice, a reasonable royalty and payment arrangement are not mutually agreed upon in writing by the parties or the litigation claim is not withdrawn, the rights granted by participant to you under sections 2.1 and/or 2.2 automatically terminate at the expiration of the 60 day notice period specified above.
- (b) any software, hardware, or device, other than such participant's contributor Version, directly or indirectly infringes any patent, then any rights granted to You by such participant under sections 2.1(b)

and 2.2(b) are revoked effective as of the date you first made, used, sold, distributed, or had made, modifications made by that participant.

8.3. If you assert a patent infringement claim against participant alleging that such participant's contributor version directly or indirectly infringes any patent where such claim is resolved (such as by license or settlement) prior to the initiation of patent infringement litigation, then the reasonable value of the licenses granted by such participant under sections 2.1 or 2.2 shall be taken into account in determining the amount or value of any payment or license.

8.4. In the event of termination under sections 8.1 or 8.2 above, all end user license agreements (excluding distributors and resellers) which have been validly granted by you or any distributor hereunder prior to termination shall survive termination.

9. LIMITATION OF LIABILITY.

UNDER NO CIRCUMSTANCES AND UNDER NO LEGAL THEORY, WHETHER TORT (INCLUDING NEGLIGENCE), CONTRACT, OR OTHERWISE, SHALL YOU, THE INITIAL DEVELOPER, ANY OTHER CONTRIBUTOR, OR ANY DISTRIBUTOR OF COVERED CODE, OR ANY SUPPLIER OF ANY OF SUCH PARTIES, BE LIABLE TO ANY PERSON FOR ANY INDIRECT, SPECIAL, INCIDENTAL, OR CONSEQUENTIAL DAMAGES OF ANY CHARACTER INCLUDING, WITHOUT LIMITATION, DAMAGES FOR LOSS OF GOODWILL, WORK STOPPAGE, COMPUTER FAILURE OR MALFUNCTION, OR ANY AND ALL OTHER COMMERCIAL DAMAGES OR LOSSES, EVEN IF SUCH PARTY SHALL HAVE BEEN INFORMED OF THE POSSIBILITY OF SUCH DAMAGES. THIS LIMITATION OF LIABILITY SHALL NOT APPLY TO LIABILITY FOR DEATH OR PERSONAL INJURY RESULTING FROM SUCH PARTY'S NEGLIGENCE TO THE EXTENT APPLICABLE LAW PROHIBITS SUCH LIMITATION. SOME JURISDICTIONS DO NOT ALLOW THE EXCLUSION OR LIMITATION OF INCIDENTAL OR CONSEQUENTIAL DAMAGES, SO THIS EXCLUSION AND LIMITATION MAY NOT APPLY TO YOU.

10. U.S. GOVERNMENT END USERS.

The covered code is a "commercial item," as that term is defined in 48 C.F.R. 2.101 (Oct. 1995), consisting of "commercial computer software" and "commercial computer software documentation," as such terms are used in 48 C.F.R. 12.212 (Sept. 1995). Consistent with 48 C.F.R. 12.212 and 48 C.F.R. 227.7202-1 through 227.7202-4 (June 1995), all U.S. Government end users acquire covered code with only those rights set forth herein.

11. MISCELLANEOUS.

This license represents the complete agreement concerning subject matter hereof. If any provision of this license is held to be unenforceable, such provision shall be reformed only to the extent necessary to make it enforceable. This License shall be governed by California law provisions (except to the extent applicable law, if any, provides otherwise), excluding its conflict-of-law provisions. With respect to disputes in which at least one party is a citizen of, or an entity chartered or registered to do business in the united states of america, any litigation relating to this License shall be subject to the jurisdiction of the federal courts of the northern district of california, with venue lying in santa clara county, california, with the losing party responsible for costs, including without limitation, court costs and reasonable attorneys' fees and expenses. The application of the united nations convention on contracts for the International sale of goods is expressly excluded. Any law or regulation which provides that the language of a contract shall be construed against the drafter shall not apply to this license.

12. RESPONSIBILITY FOR CLAIMS.

As between initial developer and the contributors, each party is responsible for claims and damages arising, directly or indirectly, out of its utilization of rights under this license and you agree to work with initial developer and contributors to distribute such responsibility on an equitable basis. Nothing herein is intended or shall be deemed to constitute any admission of liability.

13. MULTIPLE-LICENSED CODE.

Initial developer may designate portions of the covered code as "Multiple-Licensed". "Multiple-Licensed" means that the initial developer permits you to utilize portions of the covered code under your choice of the NPL or the alternative licenses, if any, specified by the initial developer in the file described in exhibit A.

EXHIBIT A -Mozilla Public License.

The contents of this file are subject to the Mozilla Public License Version 1.1 (the "license"); you may not use this file except in compliance with the License. You may obtain a copy of the license at <http://www.mozilla.org/MPL/>

Software distributed under the license is distributed on an "AS IS" basis, WITHOUT WARRANTY OF ANY KIND, either express or implied. See the license for the specific language governing rights and limitations under the License.

The Original Code is _____.

The Initial Developer of the Original Code is _____.

Portions created by _____ are Copyright (C) _____. All Rights Reserved.

Contributor(s): _____.

Alternatively, the contents of this file may be used under the terms of the _____ license (the "[] License"), in which case the provisions of [] license are applicable instead of those above. If you wish to allow use of your version of this file only under the terms of the [] license and not to allow others to use your version of this file under the MPL, indicate your decision by deleting the provisions above and replace them with the notice and other provisions required by the [] license. If you do not delete the provisions above, a recipient may use your version of this file under either the MPL or the [] license."

NOTE: The text of this exhibit A may differ slightly from the text of the notices in the source code files of the original code. You should use the text of this exhibit A rather than the text found in the original code/source code for Your modifications.



The model and serial number of the TV is located on the back and one side of the TV. Record it below should you ever need service.

MODEL _____

SERIAL _____