

ENGINEERING TEST REPORT

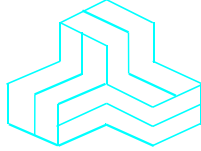

XStick 802.15.4
Model No.: XSTICK1

FCC ID: MCQ-XSTICK1

Applicant:

Digi International Inc.
11001 Bren Road East
Minnetonka, MN 55343

In Accordance With

Federal Communications Commission (FCC)
Part 15, Subpart C, Section 15.247
Digital Modulation Systems (DTS) Operating in 2400 – 2483.5 MHz Band

UltraTech's File No.: MXS-076F15C247

This Test report is Issued under the Authority
of
Tri M. Luu, Professional Engineer,
Vice President of Engineering
UltraTech Group of Labs



Date: July 24, 2008

Report Prepared by: Dan Huynh

Tested by: Mr. Wayne Wu, EMI/RFI Technician

Issued Date: July 24, 2008

Test Dates: July 11-16, 2008

*The results in this Test Report apply only to the sample(s) tested, and the sample tested is randomly selected.
This report must not be used by the client to claim product endorsement by NVLAP or any agency of the US Government.*

UltraTech

3000 Bristol Circle, Oakville, Ontario, Canada, L6H 6G4
Tel.: (905) 829-1570 Fax.: (905) 829-8050
Website: www.ultratech-labs.com, Email: vic@ultratech-labs.com, Email: tri@ultratech-labs.com



0685



31040/SIT



C-1376



46390-2049



200093-0



SL2-IN-E-1119R

TABLE OF CONTENTS

EXHIBIT 1.	SUBMITTAL CHECK LIST	1
EXHIBIT 2.	INTRODUCTION.....	2
2.1.	SCOPE	2
2.2.	RELATED SUBMITTAL(S)/GRANT(S).....	2
2.3.	NORMATIVE REFERENCES	2
EXHIBIT 3.	PERFORMANCE ASSESSMENT	3
3.1.	CLIENT INFORMATION.....	3
3.2.	EQUIPMENT UNDER TEST (EUT) INFORMATION.....	3
3.3.	EUT'S TECHNICAL SPECIFICATIONS.....	4
3.4.	LIST OF EUT'S PORTS.....	4
3.5.	ANCILLARY EQUIPMENT	5
EXHIBIT 4.	EUT OPERATING CONDITIONS AND CONFIGURATIONS DURING TESTS.....	6
4.1.	CLIMATE TEST CONDITIONS	6
4.2.	OPERATIONAL TEST CONDITIONS & ARRANGEMENT FOR TESTS.....	6
EXHIBIT 5.	SUMMARY OF TEST RESULTS.....	7
5.1.	LOCATION OF TESTS.....	7
5.2.	APPLICABILITY & SUMMARY OF EMC EMISSION TEST RESULTS.....	7
5.3.	MODIFICATIONS INCORPORATED IN THE EUT FOR COMPLIANCE PURPOSES.....	7
EXHIBIT 6.	MEASUREMENTS, EXAMINATIONS & TEST DATA FOR EMC EMISSIONS	8
6.1.	TEST PROCEDURES	8
6.2.	MEASUREMENT UNCERTAINTIES	8
6.3.	MEASUREMENT EQUIPMENT USED	8
6.4.	ESSENTIAL/PRIMARY FUNCTIONS AS DECLARED BY THE MANUFACTURER.....	8
6.5.	POWER LINE CONDUCTED EMISSIONS [§15.207(a)].....	9
6.6.	OCCUPIED BANDWIDTH [§ 15.247(a)(2)].....	12
6.7.	PEAK CONDUCTED OUTPUT POWER - DTS [§ 15.247(b)].....	16
6.8.	TRANSMITTER BAND-EDGE & SPURIOUS CONDUCTED EMISSIONS [§ 15.247(d)].....	20
6.9.	TRANSMITTER SPURIOUS RADIATED EMISSIONS AT 3 METERS [§§ 15.247(d), 15.209 & 15.205].....	29
6.10.	POWER SPECTRAL DENSITY [§ 15.247(e)].....	37
EXHIBIT 7.	MEASUREMENT UNCERTAINTY.....	41
7.1.	LINE CONDUCTED EMISSION MEASUREMENT UNCERTAINTY.....	41
7.2.	RADIATED EMISSION MEASUREMENT UNCERTAINTY.....	42

EXHIBIT 1. SUBMITTAL CHECK LIST

Annex No.	Exhibit Type	Description of Contents	Quality Check (OK)
--	Test Report	<ul style="list-style-type: none"> ▪ Exhibit 1: Submittal check lists ▪ Exhibit 2: Introduction ▪ Exhibit 3: Performance Assessment ▪ Exhibit 4: EUT Operation and Configuration during Tests ▪ Exhibit 5: Summary of test Results ▪ Exhibit 6: Measurement Data ▪ Exhibit 7: Measurement Uncertainty 	OK
1	Test Setup Photos	<ul style="list-style-type: none"> ▪ Power Line Conducted Emissions Setup Photos ▪ Radiated Emissions Setup Photos 	OK
2	External EUT Photos	External EUT Photos	OK
3	Internal EUT Photos	Internal EUT Photos	OK
4	Cover Letters	<ul style="list-style-type: none"> ▪ Letter from Ultratech for Certification Request ▪ Letter from the Applicant to appoint Ultratech to act as an agent ▪ Letter from the Applicant to request for Confidentiality Filing ▪ Manufacturer Declaration of Conformity 	OK
5	Attestation Statements	--	--
6	ID Label/Location Info	ID Label and Location of Label	OK
7	Block Diagrams	Block Diagram	OK
8	Schematic Diagrams	Schematics	OK
9	Parts List/Tune Up Info	Parts List	OK
10	Operational Description	Operation Description	OK
11	RF Exposure Info	--	--
12	Users Manual	XBee™ Adapters, Routers, and Sensors User's Guide	OK

ULTRATECH GROUP OF LABS

3000 Bristol Circle, Oakville, Ontario, Canada L6H 6G4
 Tel. #: 905-829-1570, Fax. #: 905-829-8050, Email: vic@ultratech-labs.com, Website: <http://www.ultratech-labs.com>

File #: MXS-076F15C247
 July 24, 2008

All test results contained in this engineering test report are traceable to National Institute of Standards and Technology (NIST)

EXHIBIT 2. INTRODUCTION

2.1. SCOPE

Reference:	FCC Part 15, Subpart C, Section 15.247
Title:	Code of Federal Regulations (CFR), Title 47 – Telecommunication, Part 15
Purpose of Test:	Equipment Certification for Digital Modulation Systems (DTS) Transmitter Operating in the Frequency Band 2400-2483.5 MHz.
Test Procedures:	Both conducted and radiated emissions measurements were conducted in accordance with American National Standards Institute ANSI C63.4 - American National Standard for Methods of Measurement of Radio-Noise Emissions from Low-Voltage Electrical and Electronic Equipment in the Range of 9 kHz to 40 GHz.
Environmental Classification:	[x] Commercial, industrial or business environment [x] Residential environment

2.2. RELATED SUBMITTAL(S)/GRANT(S)

None.

2.3. NORMATIVE REFERENCES

Publication	Year	Title
47 CFR Parts 0-19	2008	Code of Federal Regulations – Telecommunication
ANSI C63.4	2003	American National Standard for Methods of Measurement of Radio-Noise Emissions from Low-Voltage Electrical and Electronic Equipment in the Range of 9 kHz to 40 GHz
CISPR 22 & EN 55022	2006 2006	Information Technology Equipment - Radio Disturbance Characteristics – Limits and Methods of Measurement
CISPR 16-1-1	2003	Specification for radio disturbance and immunity measuring apparatus and methods. Part 1-1: Measuring Apparatus
CISPR 16-2-1	2003	Specification for radio disturbance and immunity measuring apparatus and methods. Part 2-1: Conducted disturbance measurement
KDB Publication No. 558074	2005	Guidance on Measurements for Digital Transmission Systems (47 CFR 15.247)

ULTRATECH GROUP OF LABS

3000 Bristol Circle, Oakville, Ontario, Canada L6H 6G4
 Tel. #: 905-829-1570, Fax. #: 905-829-8050, Email: vic@ultratech-labs.com, Website: <http://www.ultratech-labs.com>

File #: MXS-076F15C247
 July 24, 2008

All test results contained in this engineering test report are traceable to National Institute of Standards and Technology (NIST)

EXHIBIT 3. PERFORMANCE ASSESSMENT

3.1. CLIENT INFORMATION

APPLICANT	
Name:	Digi International Inc.
Address:	11001 Bren Road East Minnetonka, MN 55343 USA
Contact Person:	Mr. Paul Dahl Phone #: 801-765-9885 Fax #: 801-765-9895 Email Address: Paul.dahl@digi.com

MANUFACTURER	
Name:	Digi International Inc.
Address:	11001 Bren Road East Minnetonka, MN 55343 USA
Contact Person:	Mr. Paul Dahl Phone #: 801-765-9885 Fax #: 801-765-9895 Email Address: Paul.dahl@digi.com

3.2. EQUIPMENT UNDER TEST (EUT) INFORMATION

The following information (with the exception of the Date of Receipt) has been supplied by the applicant.

Brand Name:	Digi International Inc.
Product Name:	XStick 802.15.4
Model Name or Number:	XSTICK1
Serial Number:	Test Sample
Type of Equipment:	Digital Modulation Transmitter
Input Power Supply Type:	5V from USB port of PC
Primary User Functions of EUT:	Provides short-range wireless connectivity to a 802.15.4 network.

ULTRATECH GROUP OF LABS

3000 Bristol Circle, Oakville, Ontario, Canada L6H 6G4
Tel. #: 905-829-1570, Fax. #: 905-829-8050, Email: vic@ultratech-labs.com, Website: <http://www.ultratech-labs.com>

File #: MXS-076F15C247
July 24, 2008

All test results contained in this engineering test report are traceable to National Institute of Standards and Technology (NIST)

3.3. EUT'S TECHNICAL SPECIFICATIONS

TRANSMITTER	
Equipment Type:	Portable
Intended Operating Environment:	Residential Commercial, industrial or business
Power Supply Requirement:	5V from USB port of PC
RF Output Power Rating:	0.96 mW (-0.19 dBm) Peak
Operating Frequency Range:	2405 – 2480 MHz
RF Output Impedance:	N/A
Channel Spacing:	5 MHz
Duty Cycle:	100 %
6 dB bandwidth:	1.587 MHz
Modulation Type:	QPSK
Oscillator Frequencies:	24 MHz, reference oscillator
Antenna Description:	Manufacturer: Fractus Type: chip Model: FR05-S1-N-0-102 Frequency Range: 2400-2500 MHz Gain (dBi): -2.3dBi (typical)
Antenna Connector Type:	Integral

3.4. LIST OF EUT'S PORTS

Port Number	EUT's Port Description	Number of Identical Ports	Connector Type	Cable Type (Shielded/Non-shielded)
1	USB	1	USB	Shielded

3.5. ANCILLARY EQUIPMENT

The EUT was tested while connected to the following representative configuration of ancillary equipment necessary to exercise the ports during tests:

Ancillary Equipment # 1	
Description:	Laptop
Brand name:	Toshiba
Model Name or Number:	PS160U-18886
Serial Number:	1027387CU
Connected to EUT's Port:	USB

Ancillary Equipment # 2	
Description:	AC Adaptor
Brand name:	ACBEL Polytech Inc.
Model Name or Number:	API-7595
Serial Number:	001222
Connected to EUT's Port:	N/A

EXHIBIT 4. EUT OPERATING CONDITIONS AND CONFIGURATIONS DURING TESTS

4.1. CLIMATE TEST CONDITIONS

The climate conditions of the test environment are as follows:

Temperature:	21°C
Humidity:	51%
Pressure:	102 kPa
Power input source:	5V from USB port of PC

4.2. OPERATIONAL TEST CONDITIONS & ARRANGEMENT FOR TESTS

Operating Modes:	Each of lowest, middle and highest channel frequencies transmits continuously for emissions measurements.
Special Test Software:	Special software and hardware by the Applicant to operate the EUT at each channel frequency continuously. For example, the transmitter will be operated at each of the lowest, middle and highest frequencies individually continuously during testing.
Special Hardware Used:	None
Transmitter Test Antenna:	The EUT is tested with the antenna fitted in a manner typical of normal intended use as integral antenna equipment.

Transmitter Test Signals	
Frequency Band(s):	2405 – 2480 MHz
Frequency(ies) Tested: (Near lowest, near middle & near highest frequencies in the frequency range of operation.)	2405 MHz, 2440 MHz and 2480 MHz
RF Power Output: (measured maximum output power at antenna terminals)	0.96 mW (-0.19) Peak
Normal Test Modulation:	QPSK
Modulating Signal Source:	Internal

EXHIBIT 5. SUMMARY OF TEST RESULTS

5.1. LOCATION OF TESTS

All of the measurements described in this report were performed at Ultratech Group of Labs located in the city of Oakville, Province of Ontario, Canada.

- AC Power Line Conducted Emissions were performed in UltraTech's shielded room, 24'(L) by 16'(W) by 8'(H).
- Radiated Emissions were performed at the Ultratech's 3-10 TDK Semi-Anechoic Chamber situated in the Town of Oakville, province of Ontario. This test site been calibrated in accordance with ANSI C63.4, and found to be in compliance with the requirements of Sec. 2.948 of the FCC Rules. The descriptions and site measurement data of the Oakville 3-10 TDK Semi-Anechoic Chamber has been filed with FCC office (FCC File No.: 31040/SIT 1300B3) and Industry Canada office (Industry Canada Site No.: 2049A-3, Expiry Date: May 17, 2009).

5.2. APPLICABILITY & SUMMARY OF EMC EMISSION TEST RESULTS

FCC Section(s)	Test Requirements	Compliance (Yes/No)
15.203	Antenna requirements	Yes
15.207(a)	Power Line Conducted Emissions	Yes
15.247(a)(2)	6 dB Bandwidth	Yes
15.247(b)(3)	Peak Conducted Output Power - DTS	Yes
15.247(d)	Band-Edge and RF Conducted Spurious Emissions at the Transmitter Antenna Terminal	Yes
15.247(d), 15.209 & 15.205	Transmitter Spurious Radiated Emissions	Yes
15.247(e)	Power Spectral Density	Yes
15.247(i) 1.1307, 1.1310, 2.1091 & 2.1093	RF Exposure	Yes*
The digital circuit portion of the EUT has been tested and verified to comply with FCC Part 15, Subpart B, Class B Digital Devices. The engineering test report is available upon request.		

* SAR evaluation is not required, output power is below the low threshold ($60/f(\text{GHz}) \text{ mW} = (60/2.48) \text{ mW} = 24 \text{ mW}$)

5.3. MODIFICATIONS INCORPORATED IN THE EUT FOR COMPLIANCE PURPOSES

None.

ULTRATECH GROUP OF LABS

3000 Bristol Circle, Oakville, Ontario, Canada L6H 6G4
 Tel. #: 905-829-1570, Fax. #: 905-829-8050, Email: vic@ultratech-labs.com, Website: <http://www.ultratech-labs.com>

File #: MXS-076F15C247
 July 24, 2008

All test results contained in this engineering test report are traceable to National Institute of Standards and Technology (NIST)

EXHIBIT 6. MEASUREMENTS, EXAMINATIONS & TEST DATA FOR EMC EMISSIONS

6.1. TEST PROCEDURES

This section contains test results only. Details of test methods and procedures can be found in ANSI C63.4; FCC KDB Publication No. 558074: Guidance on Measurements for Digital Transmission Systems.

6.2. MEASUREMENT UNCERTAINTIES

The measurement uncertainties stated were calculated in accordance with requirements of UKAS Document NIS 81 with a confidence level of 95%. Please refer to Exhibit 7 for Measurement Uncertainties.

6.3. MEASUREMENT EQUIPMENT USED

The measurement equipment used complied with the requirements of the Standards referenced in the Methods & Procedures ANSI C63.4 and CISPR 16-1-1.

6.4. ESSENTIAL/PRIMARY FUNCTIONS AS DECLARED BY THE MANUFACTURER

The XStick 802.15.4 is a USB peripheral module adapter that provides short-range wireless connectivity to a 802.15.4 network.

6.5. POWER LINE CONDUCTED EMISSIONS [§15.207(a)]

6.5.1. Limit(s)

The equipment shall meet the limits of the following table:

Frequency of emission (MHz)	Conducted Limits (dB μ V)		Measuring Bandwidth
	Quasi-peak	Average	
0.15–0.5	66 to 56*	56 to 46*	RBW = 9 kHz
0.5–5	56	46	VBW \geq 9 kHz for QP
5–30	60	50	VBW = 1 Hz for Average

*Decreases linearly with the logarithm of the frequency

6.5.2. Method of Measurements

ANSI C63.4

6.5.3. Test Arrangement

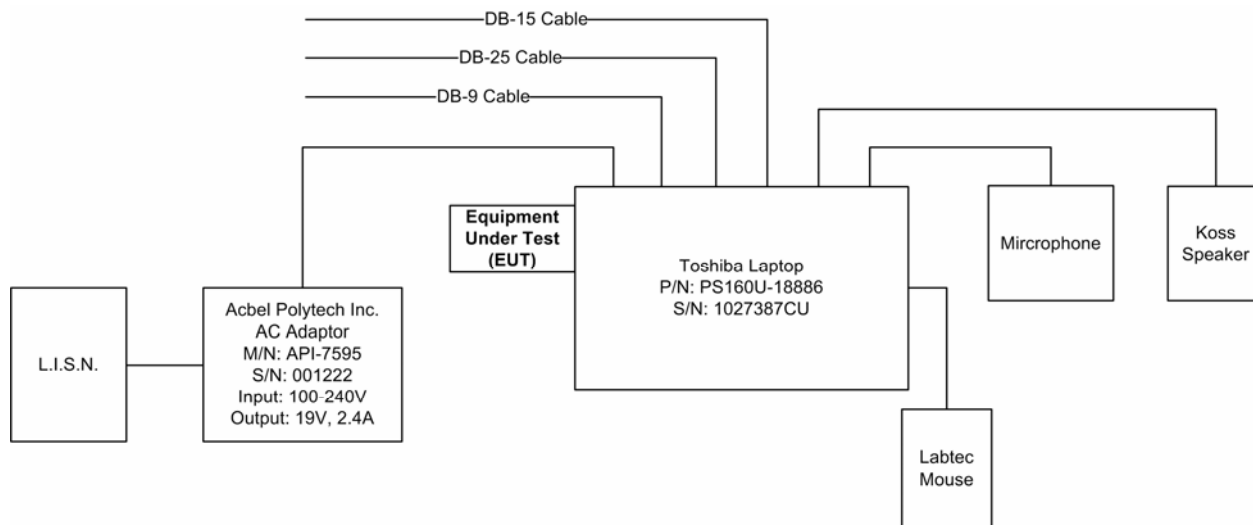

6.5.4. Test Equipment List

Test Instruments	Manufacturer	Model No.	Serial No.	Frequency Range
Spectrum Analyzer/ EMI Receiver	Hewlett Packard	HP 8593EM	3710A00223	9 kHz – 22.0 GHz
Transient Limiter	Hewlett Packard	11947A	310701998	9 kHz – 200 MHz 10 dB attenuation
L.I.S.N.	EMCO	3825/2	89071531	9 kHz – 200 MHz 50 Ohms / 50 μ H
24'(L) x 16'(W) x 8'(H) RF Shielded Chamber	Braden Shielding

6.5.5. Test Data

Plot 6.5.5.1 Power Line Conducted Emissions
 Line Voltage: 120 VAC 60 Hz
 Line Tested: Hot

Current Graph

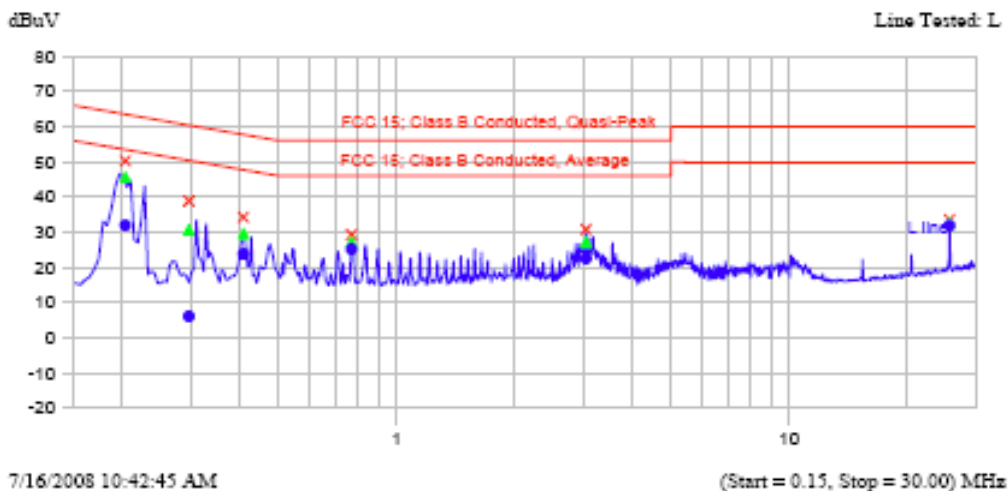

Current List

Frequency MHz	Peak dBuV	QP dBuV	Delta dB	QP-QP Limit	Avg dBuV	Delta dB	Avg-Avg Limit	Trace Name
0.204	50.2	45.6	-18.8		31.9	-22.5		L line
0.296	38.9	30.7	-31.1		6.1	-45.7		L line
0.408	34.2	29.6	-29.0		23.8	-24.8		L line
0.768	29.3	27.1	-28.9		25.2	-20.8		L line
3.040	30.8	27.1	-28.9		22.4	-23.6		L line
25.639	33.6	32.6	-27.4		31.9	-18.1		L line

Plot 6.5.5.2 Power Line Conducted Emissions
 Line Voltage: 120 VAC 60 Hz
 Line Tested: Neutral

Current Graph

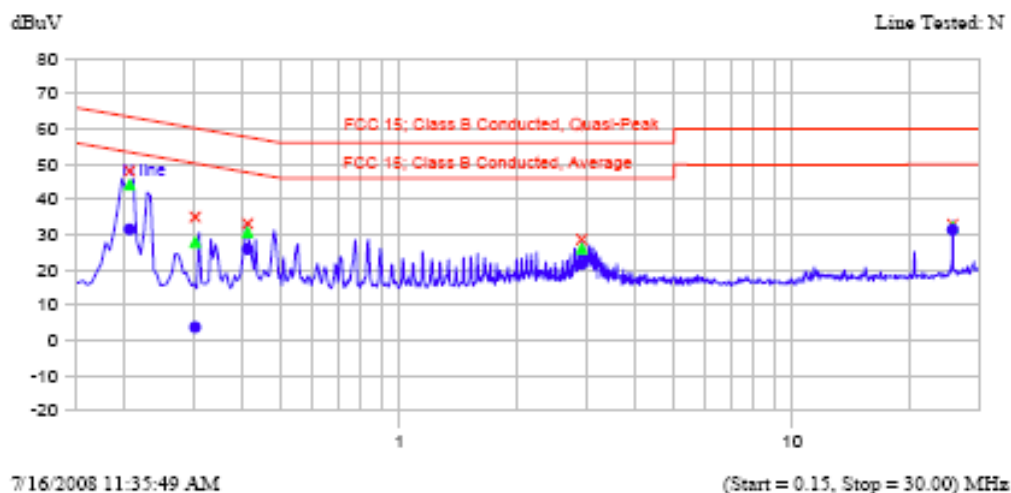

Current List

Frequency MHz	Peak dBuV	QP dBuV	Delta dB	QP-QP Limit dB	Avg dBuV	Delta dB	Avg-Avg Limit dB	Trace Name
0.206	48.0	44.1	-20.2		31.5	-22.9		N line
0.303	35.0	27.9	-33.7		3.7	-47.8		N line
0.411	33.1	30.6	-27.9		25.9	-22.6		N line
2.916	28.6	26.0	-30.0		21.6	-24.4		N line
25.638	32.9	32.0	-28.0		31.4	-18.6		N line

6.6. OCCUPIED BANDWIDTH [§ 15.247(a)(2)]

6.6.1. Limit(s)

For a Digital Modulation System, the minimum 6 dB bandwidth shall be at least 500 kHz.

6.6.2. Method of Measurements

KDB Publication No. 558074: Guidance on Measurements for Digital Transmission Systems (47 CFR 15.247)

6.6.3. Test Arrangement

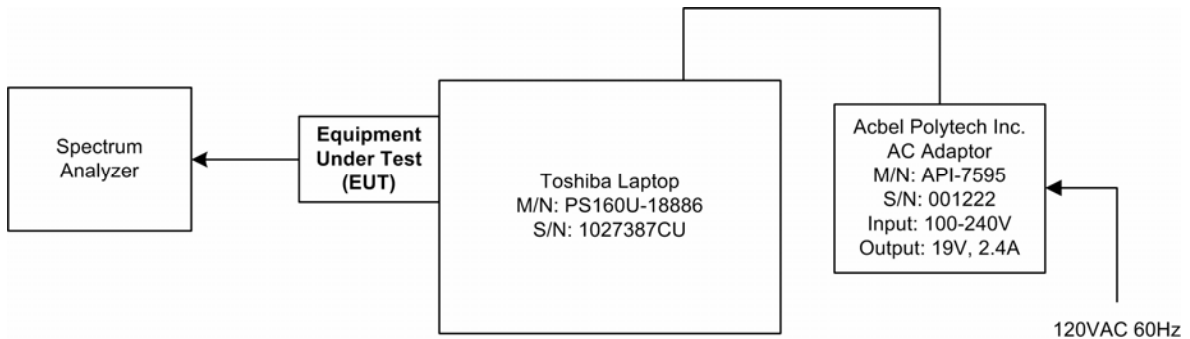

6.6.4. Test Equipment List

Test Instruments	Manufacturer	Model No.	Serial No.	Frequency Range
Spectrum Analyzer	Rhode & Schwarz	FSEK20/B4/B21	834157/005	9 kHz - 40 GHz

6.6.5. Test Data

Frequency (MHz)	6 dB Bandwidth (MHz)
2405	1.571
2440	1.563
2480	1.587

See the following plots for detailed measurements.

Plot 6.6.5.1 6 dB Bandwidth
 Frequency: 2405 MHz

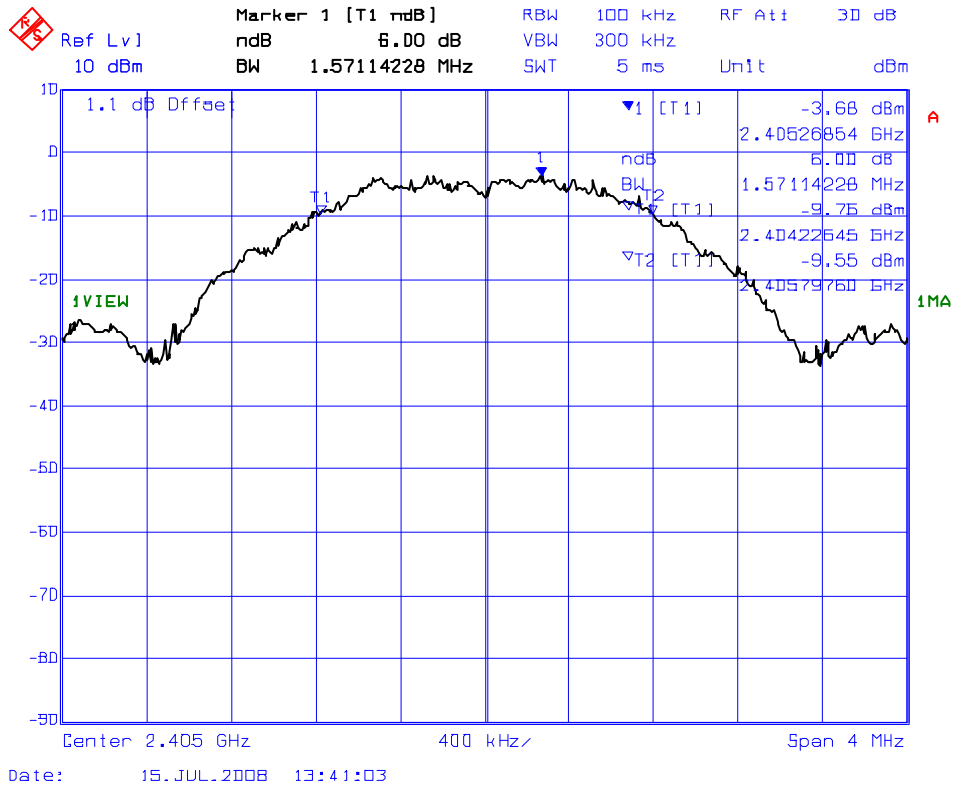

Plot 6.6.5.2 6 dB Bandwidth
 Frequency: 2440 MHz

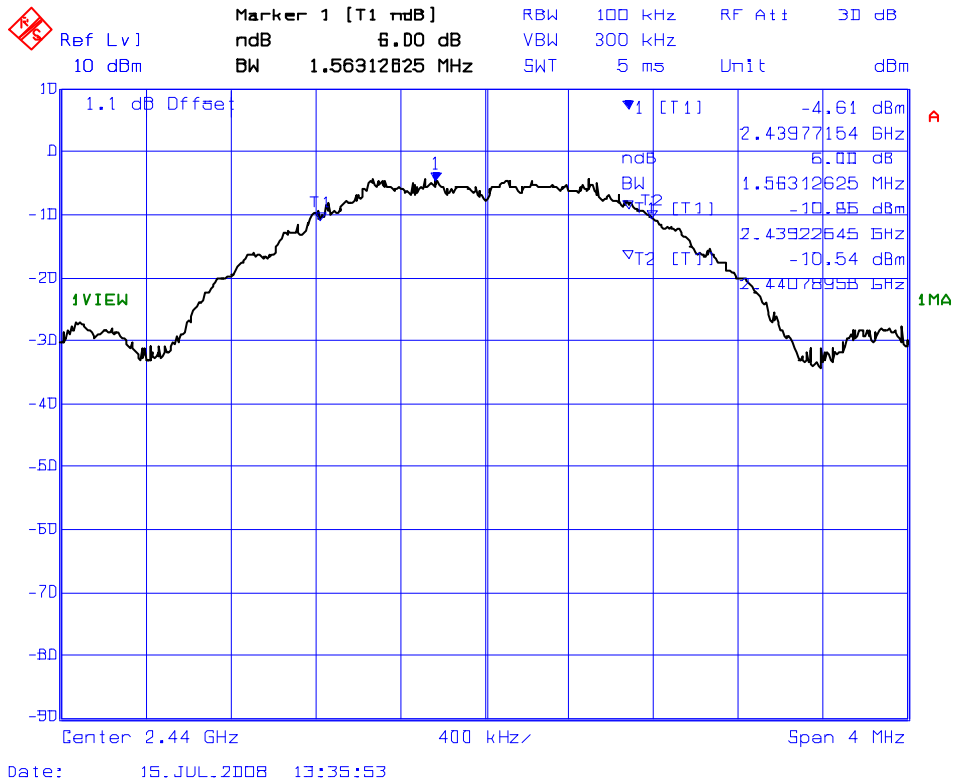

ULTRATECH GROUP OF LABS

3000 Bristol Circle, Oakville, Ontario, Canada L6H 6G4
 Tel. #: 905-829-1570, Fax. #: 905-829-8050, Email: vic@ultratech-labs.com, Website: <http://www.ultratech-labs.com>

File #: MXS-076F15C247
 July 24, 2008

All test results contained in this engineering test report are traceable to National Institute of Standards and Technology (NIST)

Plot 6.6.5.3 6 dB Bandwidth
 Frequency: 2480 MHz

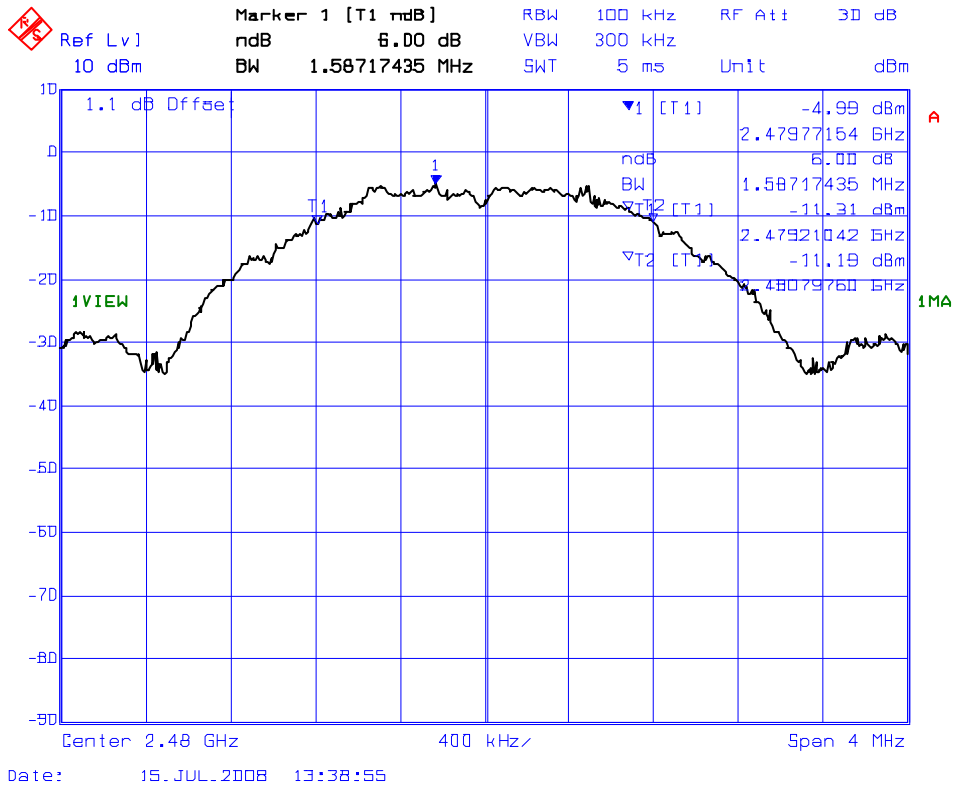

6.7. PEAK CONDUCTED OUTPUT POWER - DTS [§ 15.247(b)]

6.7.1. Limit(s)

§ 15.247(b)(3): For systems using digital modulation in the 902-928 MHz, 2400-2483.5 MHz, and 5725-5850 MHz bands: 1 Watt. As an alternative to a peak power measurement, compliance with the one Watt limit can be based on a measurement of the maximum conducted output power. Maximum Conducted Output Power is defined as the total transmit power delivered to all antennas and antenna elements averaged across all symbols in the signaling alphabet when the transmitter is operating at its maximum power control level. Power must be summed across all antennas and antenna elements. The average must not include any time intervals during which the transmitter is off or is transmitting at a reduced power level. If multiple modes of operation are possible (e.g., alternative modulation methods), the *maximum conducted output power* is the highest total transmit power occurring in any mode.

§15.247(b)(4): The conducted output power limit specified in paragraph (b) of this section is based on the use of antennas with directional gains that do not exceed 6 dBi. Except as shown in paragraph (c) of this section, if transmitting antennas of directional gain greater than 6 dBi are used, the conducted output power from the intentional radiator shall be reduced below the stated values in paragraphs (b)(1), (b)(2), and (b)(3) of this section, as appropriate, by the amount in dB that the directional gain of the antenna exceeds 6 dBi.

6.7.2. Method of Measurements & Test Arrangement

KDB Publication No. 558074: Guidance on Measurements for Digital Transmission Systems (47 CFR 15.247)

6.7.3. Test Arrangement

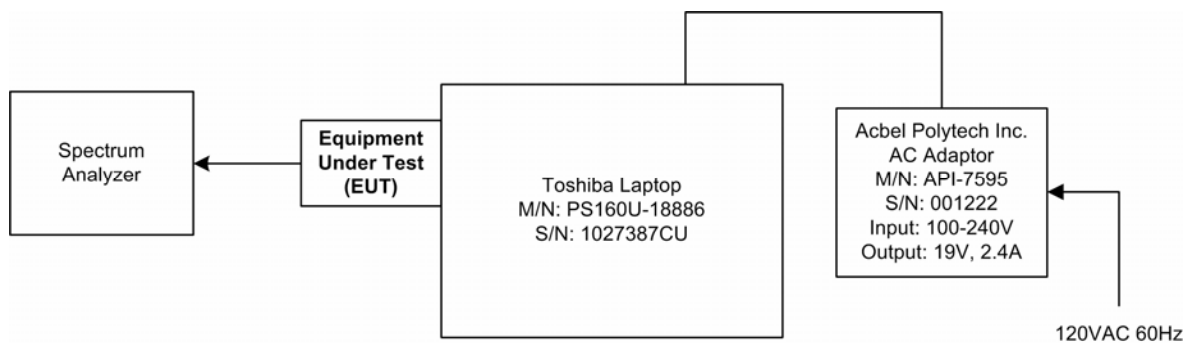

6.7.4. Test Equipment List

Test Instruments	Manufacturer	Model No.	Serial No.	Frequency Range
Spectrum Analyzer	Rhode & Schwarz	FSEK20/B4/B21	834157/005	9 kHz - 40 GHz

6.7.5. Test Data

Frequency (MHz)	Peak Conducted Power (dBm)	Peak EIRP ^(Note 1, 2) (dBm)	Peak Conducted Power Limit (dBm)	EIRP Limit (dBm)
2405	-0.19	-2.49	30	36
2440	-1.01	-3.31	30	36
2480	-1.53	-3.83	30	36

Note 1: The Peak EIRP is calculated as the sum of Peak Conducted Power in dBm and antenna assembly gain of EUT in dBi (antenna gain – cable loss).

Note 2: The maximum antenna gain to be used with the EUT is -2.3 dBi.

Plot 6.7.5.1 Peak Conducted Output Power
 Frequency: 2405 MHz

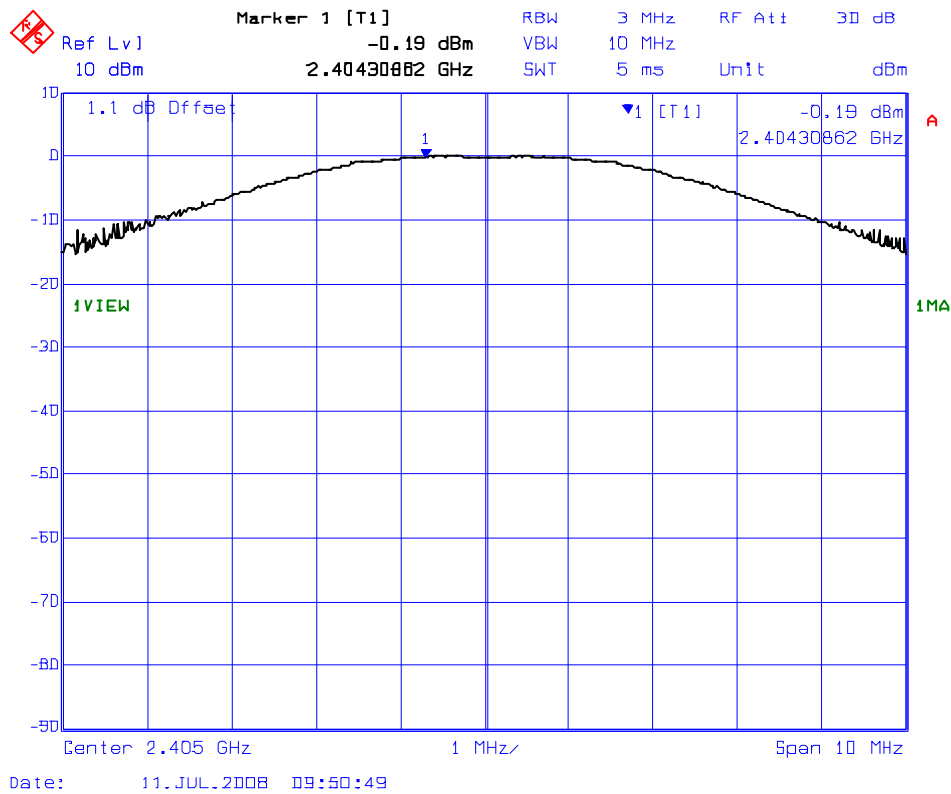

Plot 6.7.5.2 Peak Conducted Output Power
Frequency: 2440 MHz

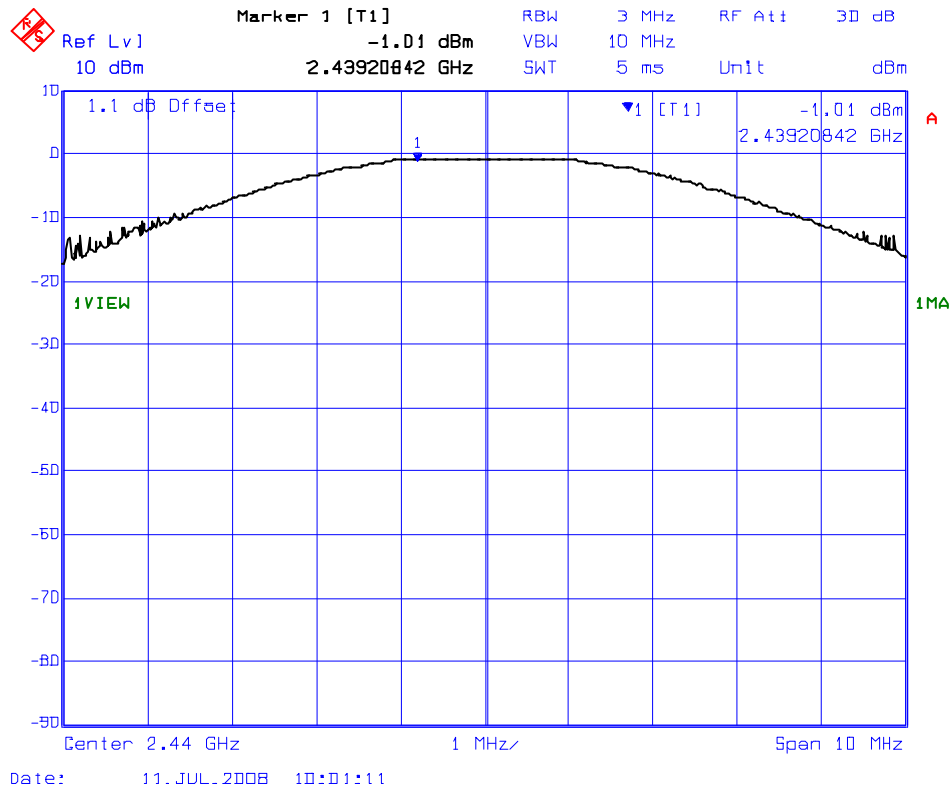

ULTRATECH GROUP OF LABS

3000 Bristol Circle, Oakville, Ontario, Canada L6H 6G4
Tel. #: 905-829-1570, Fax. #: 905-829-8050, Email: vic@ultratech-labs.com, Website: <http://www.ultratech-labs.com>

File #: MXS-076F15C247
July 24, 2008

All test results contained in this engineering test report are traceable to National Institute of Standards and Technology (NIST)

Plot 6.7.5.3 Peak Conducted Output Power
Frequency: 2480 MHz

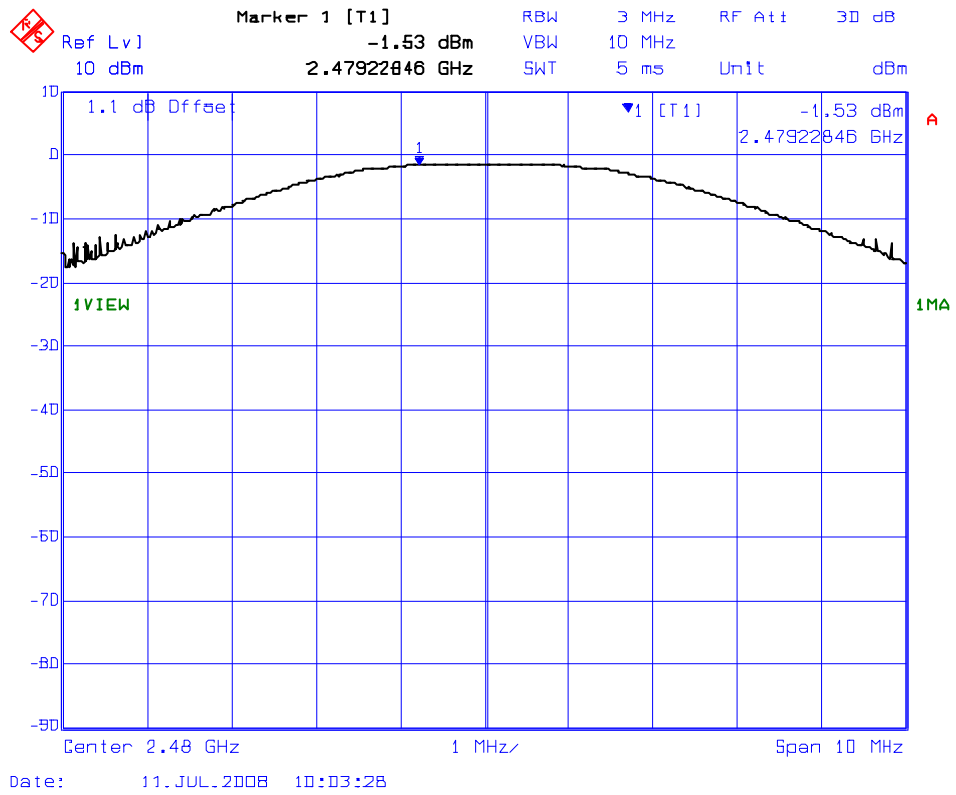

6.8. TRANSMITTER BAND-EDGE & SPURIOUS CONDUCTED EMISSIONS [§ 15.247(d)]

6.8.1. Limit(s)

§ 15.247 (d): In any 100 kHz bandwidth outside the frequency band in which the spread spectrum or digitally modulated intentional radiator is operating, the radio frequency power that is produced by the intentional radiator shall be at least 20 dB below that in the 100 kHz bandwidth within the band that contains the highest level of the desired power, based on either an RF conducted or a radiated measurement, provided the transmitter demonstrates compliance with the peak conducted power limits. If the transmitter complies with the conducted power limits based on the use of RMS averaging over a time interval, as permitted under paragraph (b)(3) of this section, the attenuation required under this paragraph shall be 30 dB instead of 20 dB.

6.8.2. Method of Measurements

KDB Publication No. 558074: Guidance on Measurements for Digital Transmission Systems (47 CFR 15.247)

6.8.3. Test Arrangement

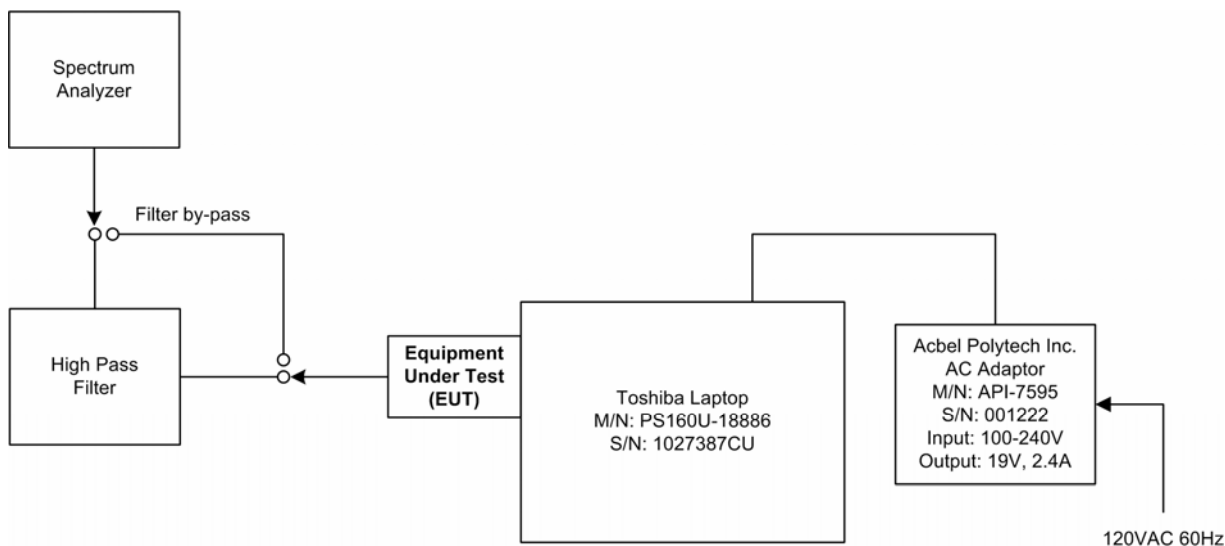

6.8.4. Test Equipment List

Test Instruments	Manufacturer	Model No.	Serial No.	Frequency Range
Spectrum Analyzer	Rhode & Schwarz	FSEK20/B4/B21	834157/005	9 kHz - 40 GHz
High Pass Filter	K & L	11SH10-4000T12000	4	3 dB cutoff at 4 GHz

6.8.5. Test Data

6.8.5.1. Band-Edge RF Conducted Emissions

Plot 6.8.5.1.1 Band-Edge RF Conducted Emissions
Low End of Frequency Band

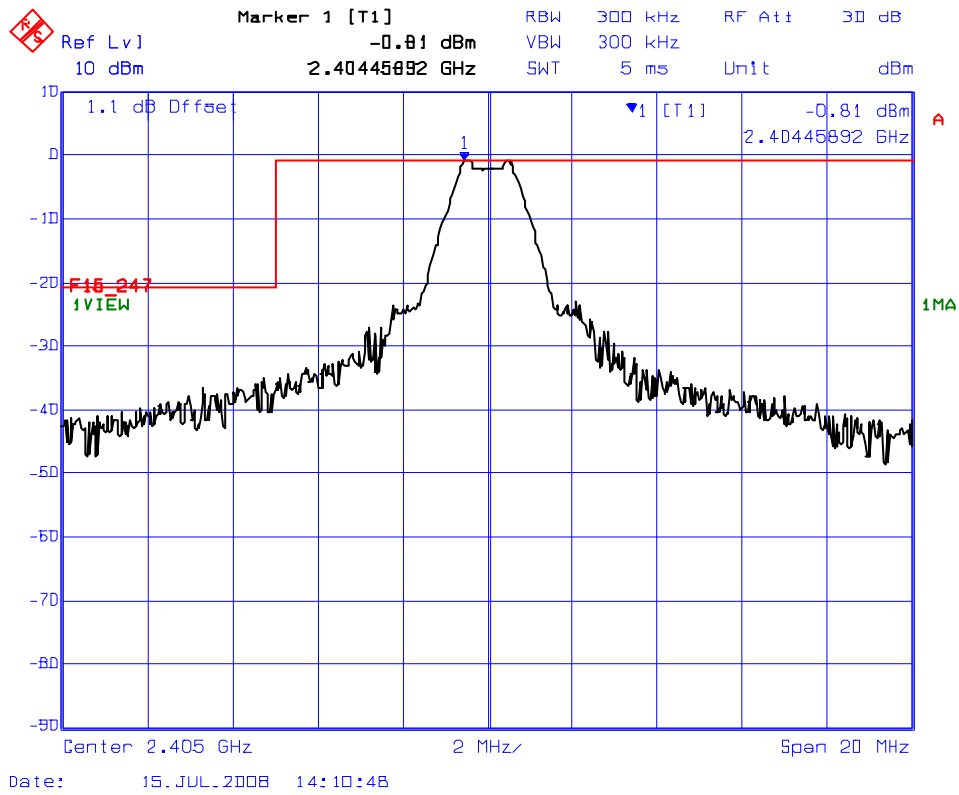

Plot 6.8.5.1.2 Band-Edge RF Conducted Emissions
High End of Frequency Band

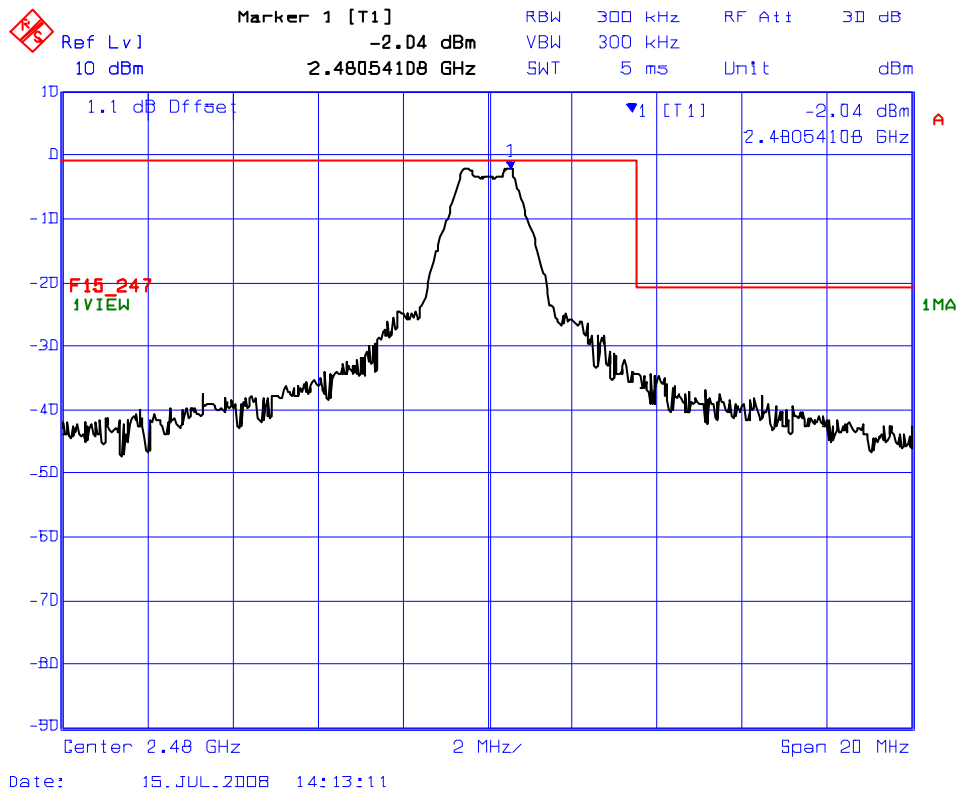

6.8.5.2. Spurious RF Conducted Emissions

Plot 6.8.5.2.1(i) Spurious RF Conducted Emissions
Transmitter Frequency: 2405 MHz

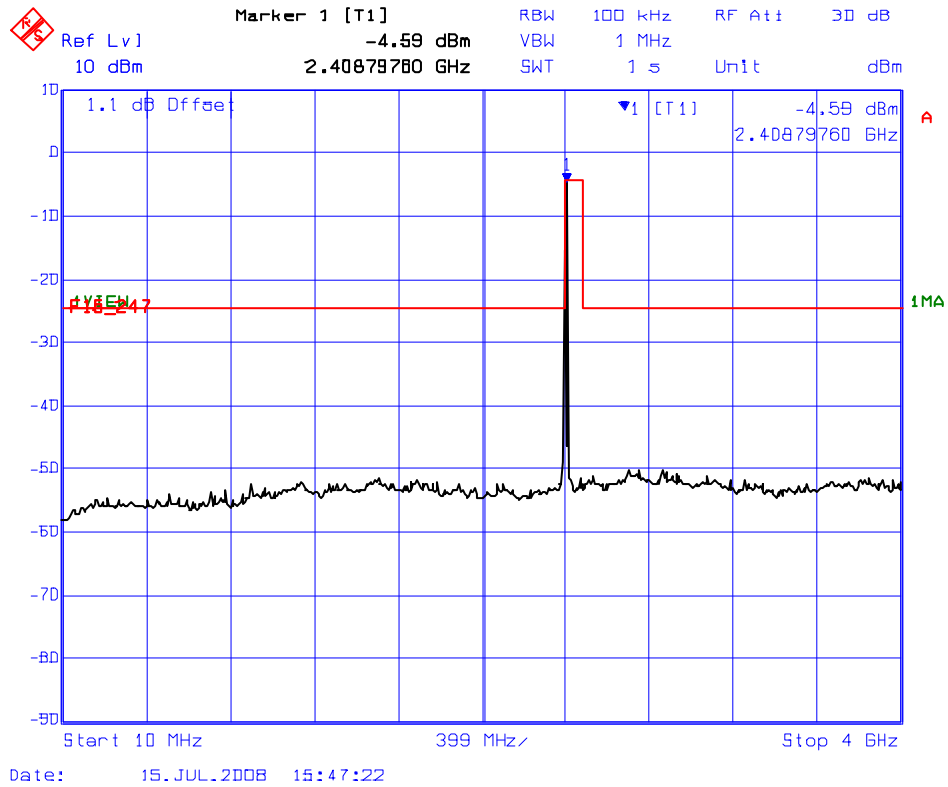

Plot 6.8.5.2.1(ii) Spurious RF Conducted Emissions
Transmitter Frequency: 2405 MHz

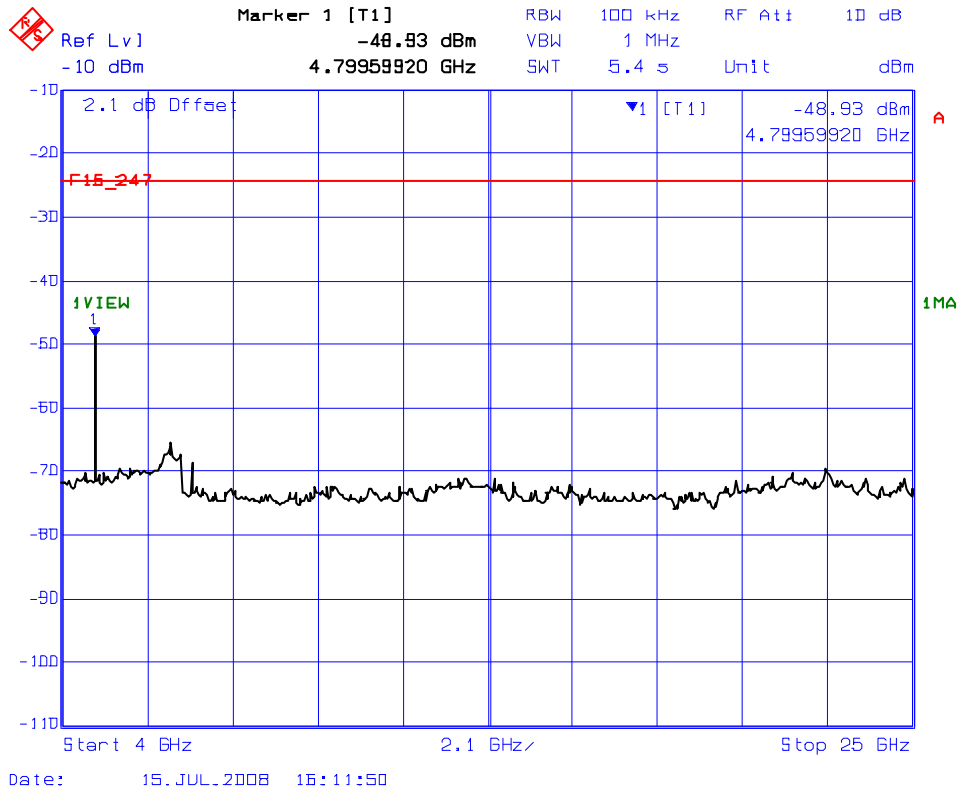

Plot 6.8.5.2.2(i) Spurious RF Conducted Emissions
Transmitter Frequency: 2440 MHz

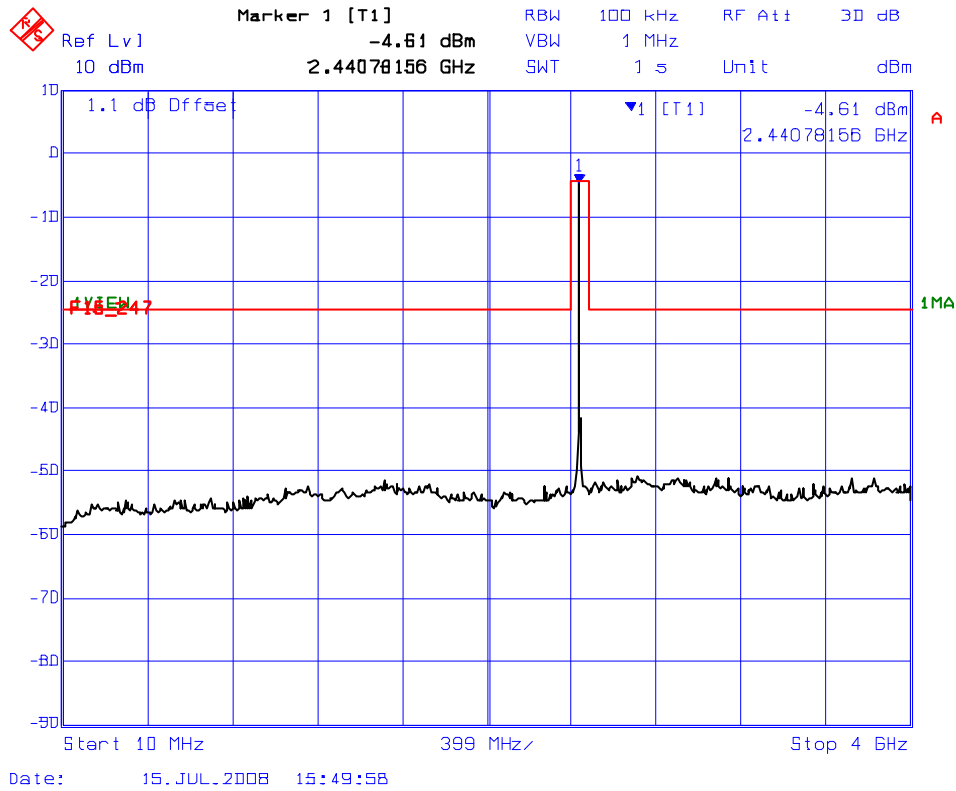

Plot 6.8.5.2.2(ii) Spurious RF Conducted Emissions
Transmitter Frequency: 2440 MHz

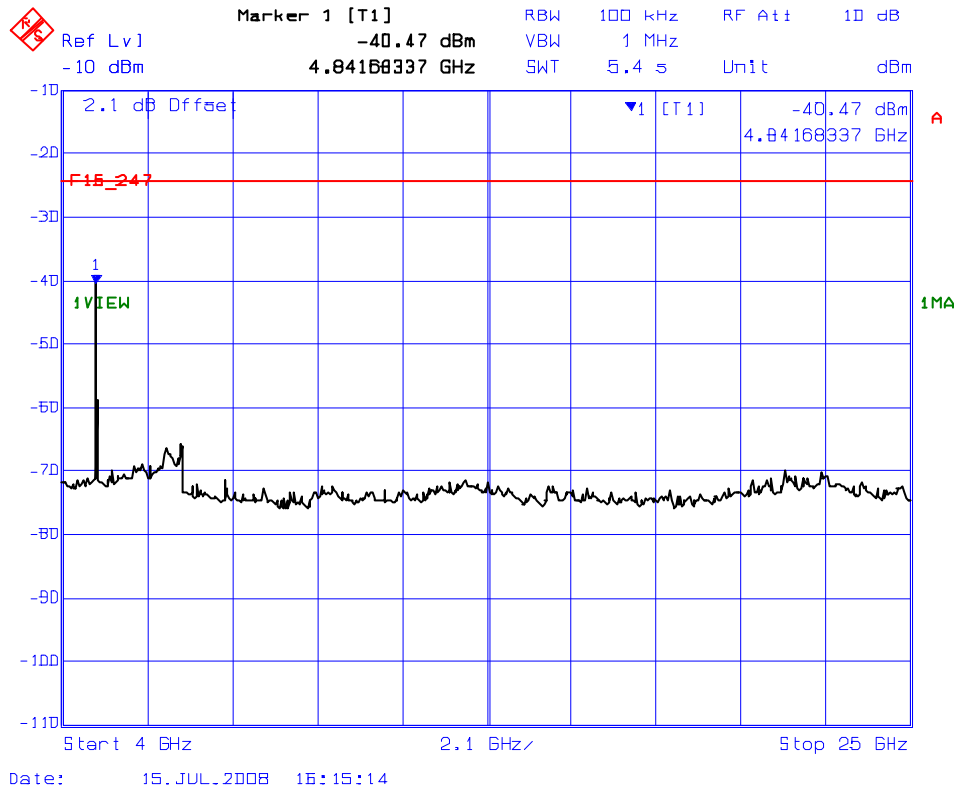

Plot 6.8.5.2.3(i) Spurious RF Conducted Emissions
Transmitter Frequency: 2480 MHz

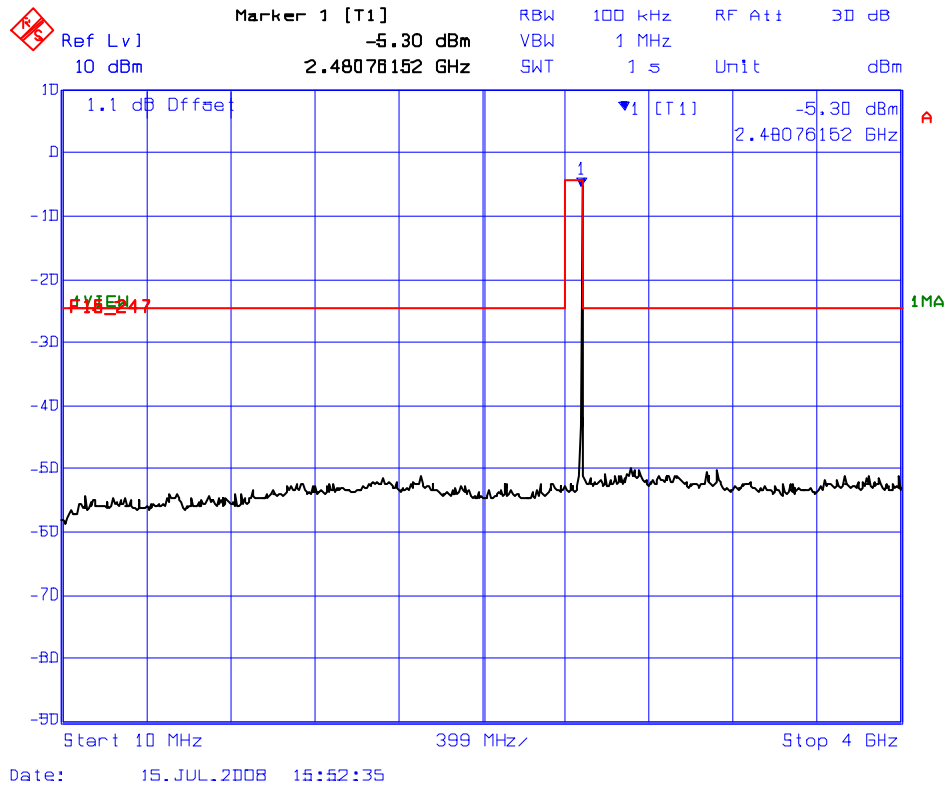

Plot 6.8.5.2.3(ii) Spurious RF Conducted Emissions
Transmitter Frequency: 2480 MHz

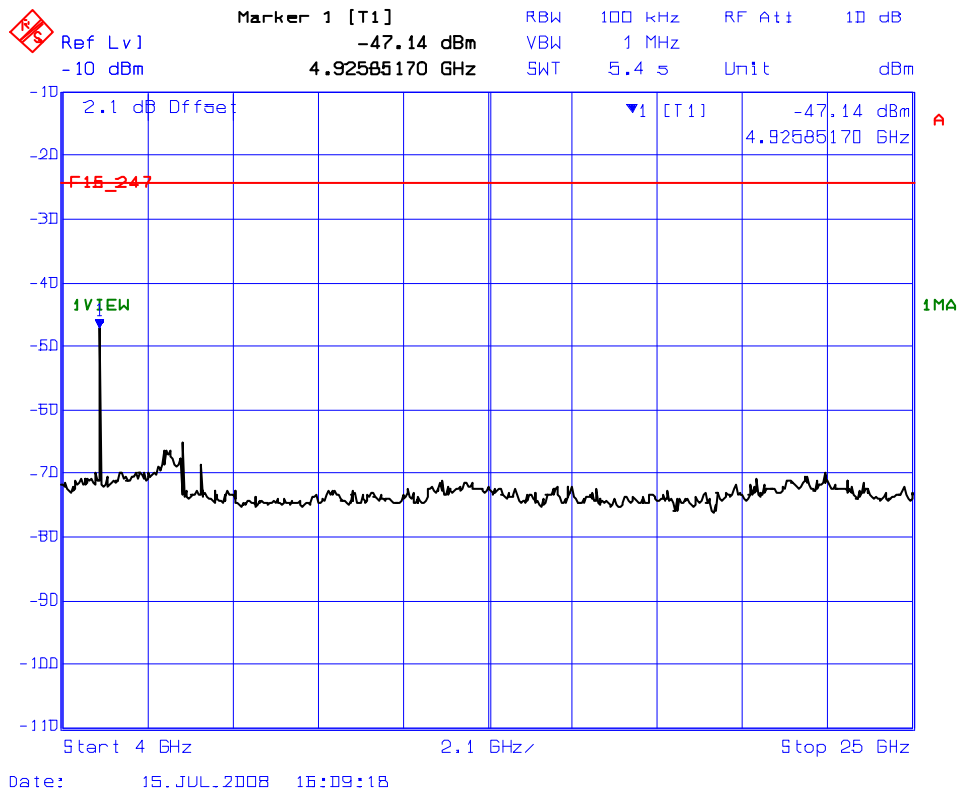

6.9. TRANSMITTER SPURIOUS RADIATED EMISSIONS AT 3 METERS [§§ 15.247(d), 15.209 & 15.205]

6.9.1. Limit(s)

§ 15.247 (d): In any 100 kHz bandwidth outside the frequency band in which the spread spectrum or digitally modulated intentional radiator is operating, the radio frequency power that is produced by the intentional radiator shall be at least 20 dB below that in the 100 kHz bandwidth within the band that contains the highest level of the desired power, based on either an RF conducted or a radiated measurement, provided the transmitter demonstrates compliance with the peak conducted power limits. If the transmitter complies with the conducted power limits based on the use of RMS averaging over a time interval, as permitted under paragraph (b)(3) of this section, the attenuation required under this paragraph shall be 30 dB instead of 20 dB. Attenuation below the general limits specified in Section 15.209(a) is not required. In addition, radiated emissions which fall in the restricted bands, as defined in Section 15.205(a), must also comply with the radiated emission limits specified in Section 15.209(a) (see Section 15.205(c)).

Section 15.205(a) - Restricted Bands of Operation

MHz	MHz	MHz	GHz
0.090–0.110	16.42–16.423	399.9–410	4.5–5.15
¹ 0.495–0.505	16.69475–16.69525	608–614	5.35–5.46
2.1735–2.1905	16.80425–16.80475	960–1240	7.25–7.75
4.125–4.128	25.5–25.67	1300–1427	8.025–8.5
4.17725–4.17775	37.5–38.25	1435–1626.5	9.0–9.2
4.20725–4.20775	73–74.6	1645.5–1646.5	9.3–9.5
6.215–6.218	74.8–75.2	1660–1710	10.6–12.7
6.26775–6.26825	108–121.94	1718.8–1722.2	13.25–13.4
6.31175–6.31225	123–138	2200–2300	14.47–14.5
8.291–8.294	149.9–150.05	2310–2390	15.35–16.2
8.362–8.366	156.52475–156.52525	2483.5–2500	17.7–21.4
8.37625–8.38675	156.7–156.9	2655–2900	22.01–23.12
8.41425–8.41475	162.0125–167.17	3260–3267	23.6–24.0
12.29–12.293	167.72–173.2	3332–3339	31.2–31.8
12.51975–12.52025	240–285	3345.8–3358	36.43–36.5
12.57675–12.57725	322–335.4	3600–4400	(²)
13.36–13.41			

¹ Until February 1, 1999, this restricted band shall be 0.490–0.510 MHz.

² Above 38.6

**Section 15.209(a)
 -- Field Strength Limits within Restricted Frequency Bands --**

Frequency (MHz)	Field Strength (microvolts/meter)	Measurement Distance (meters)
0.009 - 0.490	2,400 / F (kHz)	300
0.490 - 1.705	24,000 / F (kHz)	30
1.705 - 30.0	30	30
30 - 88	100	3
88 - 216	150	3
216 - 960	200	3
Above 960	500	3

6.9.2. Method of Measurements

KDB Publication No. 558074: Guidance on Measurements for Digital Transmission Systems (47 CFR 15.247)

6.9.3. Test Arrangement

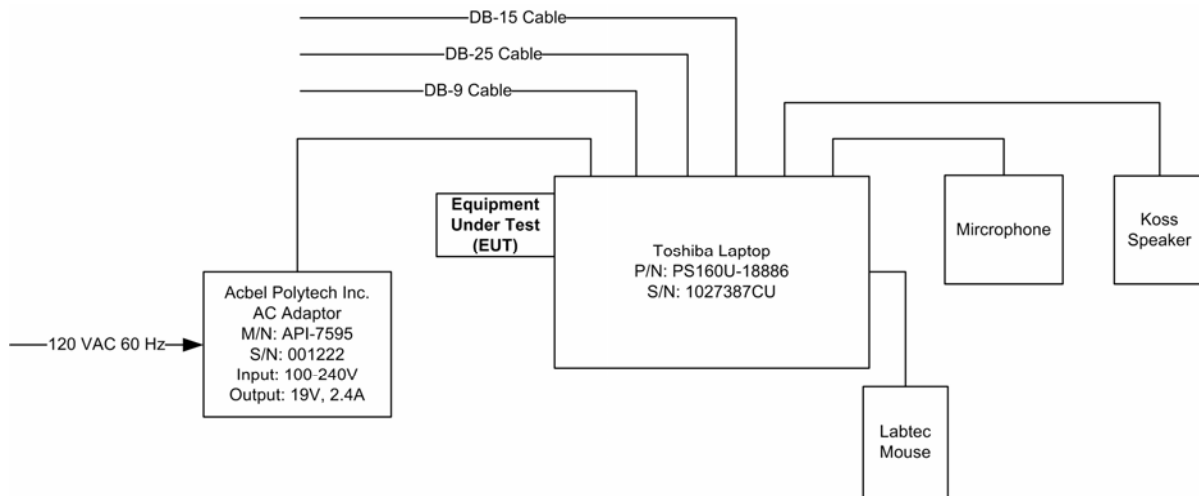

6.9.4. Test Equipment List

Test Instruments	Manufacturer	Model No.	Serial No.	Frequency Range
Spectrum Analyzer	Rhode & Schwarz	FSEK20/B4/B21	834157/005	9 kHz - 40 GHz
Microwave Amplifier	Hewlett Packard	8449B	3008A00769	1 GHz to 26.5 GHz
Biconilog Antenna	EMCO	3143	1029	20 MHz to 2 GHz
Horn Antenna	EMCO	3155	9701-5061	1 GHz – 18 GHz
Horn Antenna	EMCO	3160-09	1007	18 GHz – 26.5 GHz

6.9.5. Test Data

Remarks:

- All spurious emissions that are in excess of 20 dB below the specified limit shall be recorded.
- EUT is tested in three orthogonal positions.
- The following test results are the worst-case measurements.

Fundamental Frequency:		2405 MHz					
Frequency Test Range:		30 MHz – 25 GHz					
Frequency (MHz)	RF Peak Level (dBµV/m)	RF Avg Level (dBµV/m)	Antenna Plane (H/V)	Limit (dBµV/m)		Margin (dB)	Pass/Fail
				§15.209	§15.247		
2405	97.33	--	V	--	--	--	--
2405	99.98	--	H	--	--	--	--
4810	48.39	33.22	V	54.0	80.0	-20.8	Pass*
4810	48.90	33.41	H	54.0	80.0	-20.6	Pass*

*Field strength of emissions appearing within restricted frequency bands shall not exceed the limits shown in § 15.209.

See the following test data plots for band-edge emissions.

Plot 6.9.5.1 Band-Edge RF Radiated Emissions @ 3 m
Low End of Frequency Band
Rx Antenna Orientation: Horizontal

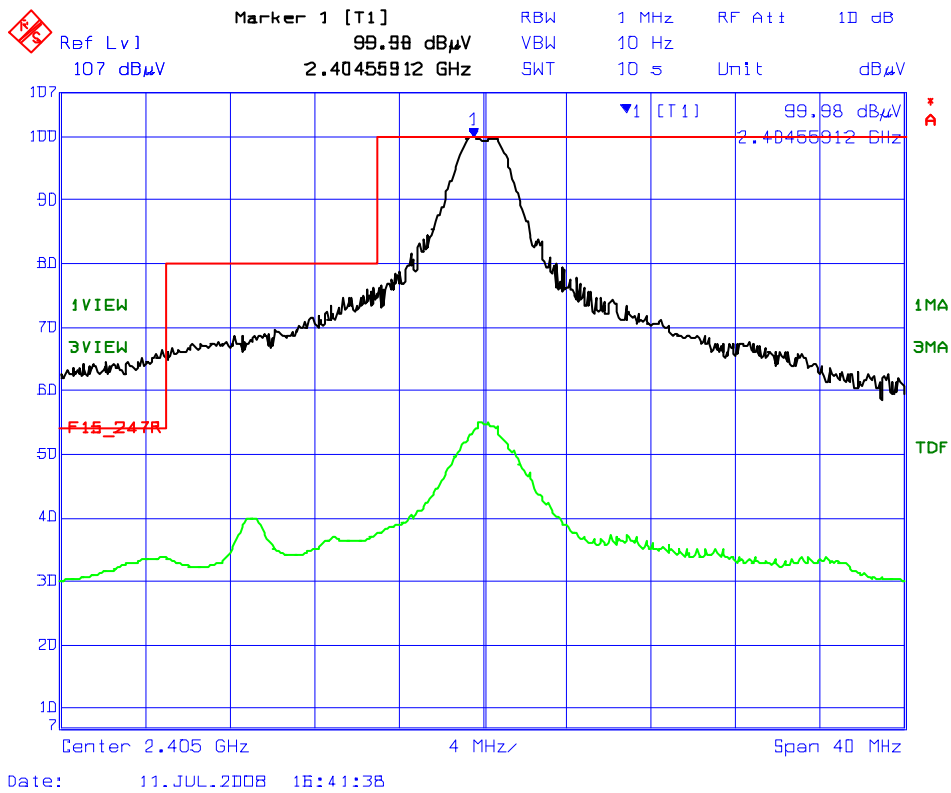

Trace 1: RBW = 1 MHz, VBW = 3 MHz
Trace 3: RBW = 1 MHz, VBW = 10 Hz

Plot 6.9.5.2 Band-Edge RF Radiated Emissions @ 3 m
 Low End of Frequency Band
 Rx Antenna Orientation: Vertical

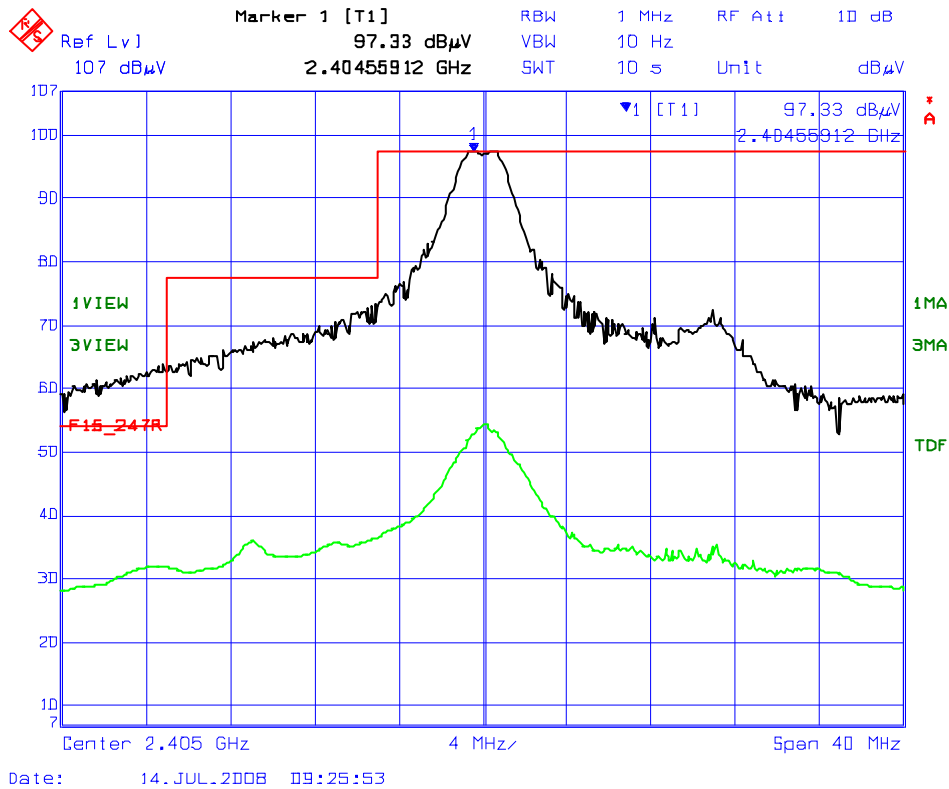

Trace 1: RBW = 1 MHz, VBW = 3 MHz
 Trace 3: RBW = 1 MHz, VBW = 10 Hz

Fundamental Frequency:		2440 MHz					
Frequency Test Range:		30 MHz – 25 GHz					
Frequency (MHz)	RF Peak Level (dBµV/m)	RF Avg Level (dBµV/m)	Antenna Plane (H/V)	Limit (dBµV/m)		Margin (dB)	Pass/Fail
				§15.209	§15.247		
2440	95.21	--	V	--	--	--	--
2440	99.64	--	H	--	--	--	--
4880	47.96	33.17	V	54.00	79.64	-20.83	Pass*
4880	51.04	33.42	H	54.00	79.64	-20.58	Pass*

*Field strength of emissions appearing within restricted frequency bands shall not exceed the limits shown in § 15.209.

Fundamental Frequency:		2480 MHz					
Frequency Test Range:		30 MHz – 25 GHz					
Frequency (MHz)	RF Peak Level (dBµV/m)	RF Avg Level (dBµV/m)	Antenna Plane (H/V)	Limit (dBµV/m)		Margin (dB)	Pass/Fail
				§15.209	§15.247		
2480	94.76	--	V	--	--	--	--
2480	98.00	--	H	--	--	--	--
4960	50.11	34.02	V	54.0	78.0	-20.0	Pass*
4960	51.18	34.19	H	54.0	78.0	-19.8	Pass*

*Field strength of emissions appearing within restricted frequency bands shall not exceed the limits shown in § 15.209.

See the following test data plots for band-edge emissions.

Plot 6.9.5.3(i) Band-Edge RF Radiated Emissions @ 3 m
 High End of Frequency Band
 Rx Antenna Orientation: Horizontal

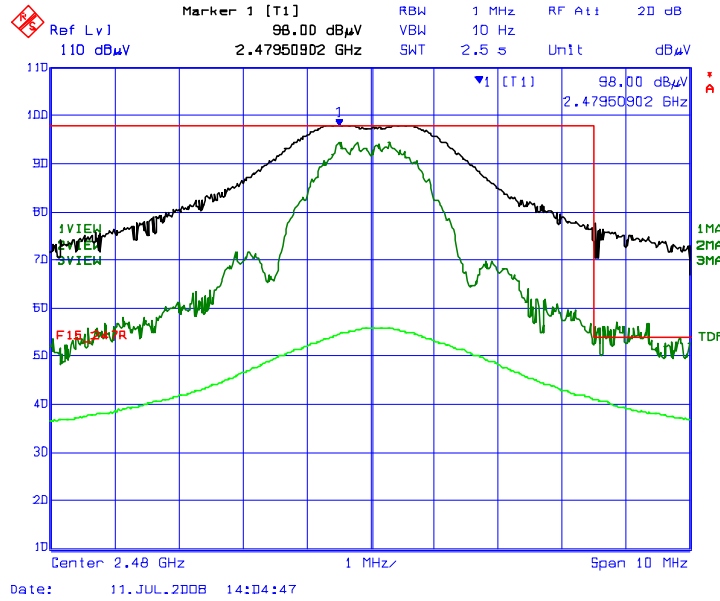

Plot 6.9.5.3(ii) Band-Edge RF Radiated Emissions @ 3 m
 High End of Frequency Band
 Rx Antenna Orientation: Horizontal

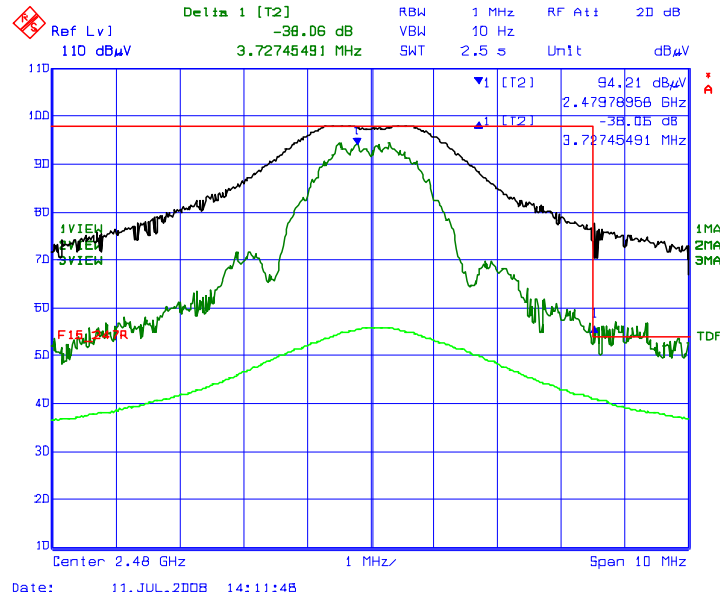

Trace 1: RBW = 1 MHz, VBW = 3 MHz
 Trace 2: RBW = 100 kHz, VBW = 300 kHz, Delta (Peak to Band-Edge): 38.06 dB
 Trace 3: RBW = 1 MHz, VBW = 10 Hz
 Band-Edge Level at 2483.5 MHz: Peak = 98 dBμV/m – 38.06 dB = 59.94 dBμV/m

Plot 6.9.5.4(i) Band-Edge RF Radiated Emissions @ 3 m
 High End of Frequency Band
 Rx Antenna Orientation: Vertical

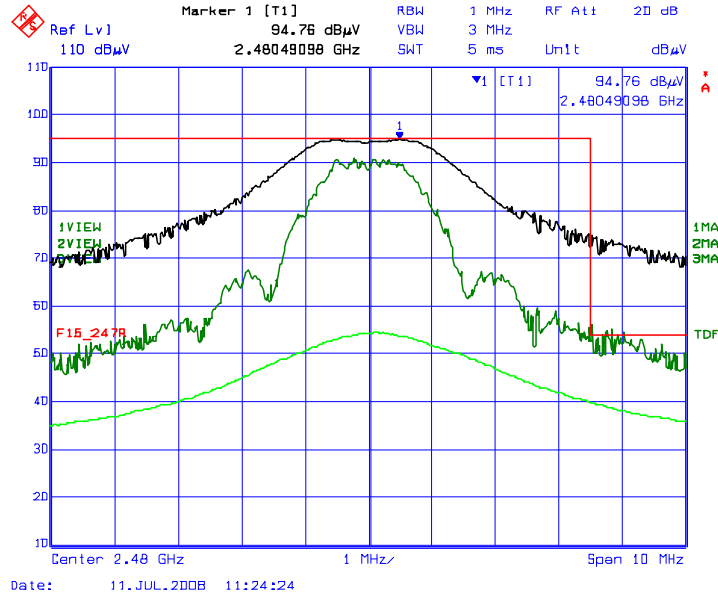

Plot 6.9.5.4(ii) Band-Edge RF Radiated Emissions @ 3 m
 High End of Frequency Band
 Rx Antenna Orientation: Vertical

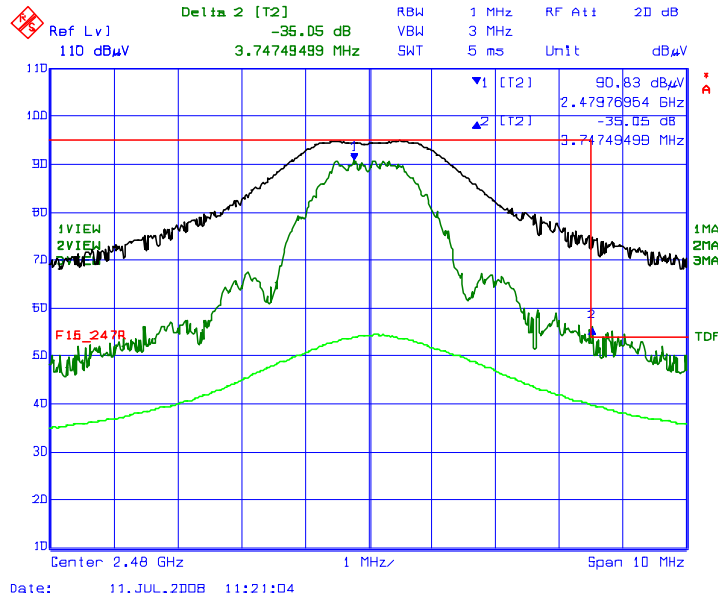

Trace 1: RBW = 1 MHz, VBW = 3 MHz
 Trace 2: RBW = 100 kHz, VBW = 300 kHz, Delta (Peak to Band-Edge): 35.05 dB
 Trace 3: RBW = 1 MHz, VBW = 10 Hz
 Band-Edge Level at 2483.5 MHz: Peak = 94.76 dBμV/m - 35.05dB = 59.71 dBμV/m

6.10. POWER SPECTRAL DENSITY [§ 15.247(e)]

6.10.1. Limit(s)

For digitally modulated systems, the power spectral density conducted from the intentional radiator to the antenna shall not be greater than 8 dBm in any 3 kHz band during any time interval of continuous transmission.

6.10.2. Method of Measurements

KDB Publication No. 558074: Guidance on Measurements for Digital Transmission Systems (47 CFR 15.247), PSD Option 1 method.

6.10.3. Test Arrangement

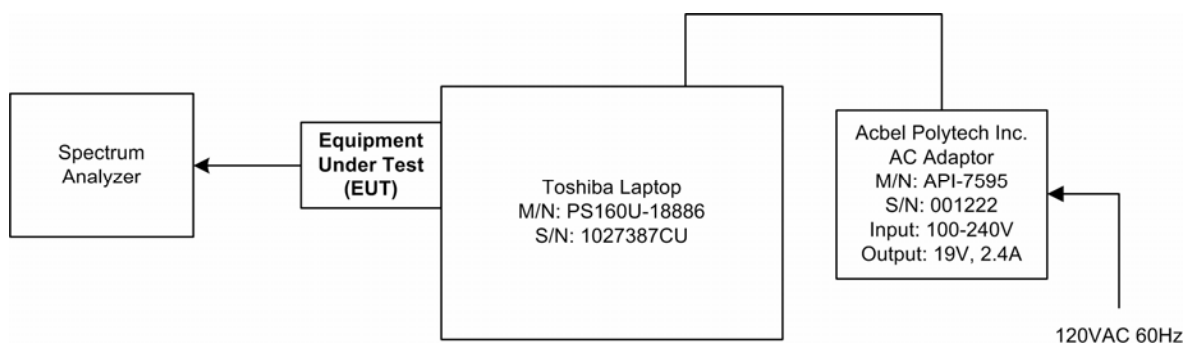

6.10.4. Test Equipment List

Test Instruments	Manufacturer	Model No.	Serial No.	Frequency Range
Spectrum Analyzer	Rhode & Schwarz	FSEK20/B4/B21	834157/005	9 kHz - 40 GHz

6.10.5. Test Data

Remark: Measurement method: Power spectral density (PSD) Option 1.

Frequency (MHz)	*PSD in 3 kHz BW (dBm)	Limit (dBm)	Margin (dB)	Comments (Pass/Fail)
2405	-13.61	8	-21.61	Pass
2440	-14.72	8	-22.72	Pass
2480	-15.10	8	-23.10	Pass

*See the following plots for measurement details.

Plot 6.10.5.1 Power Spectral Density
Frequency: 2405 MHz

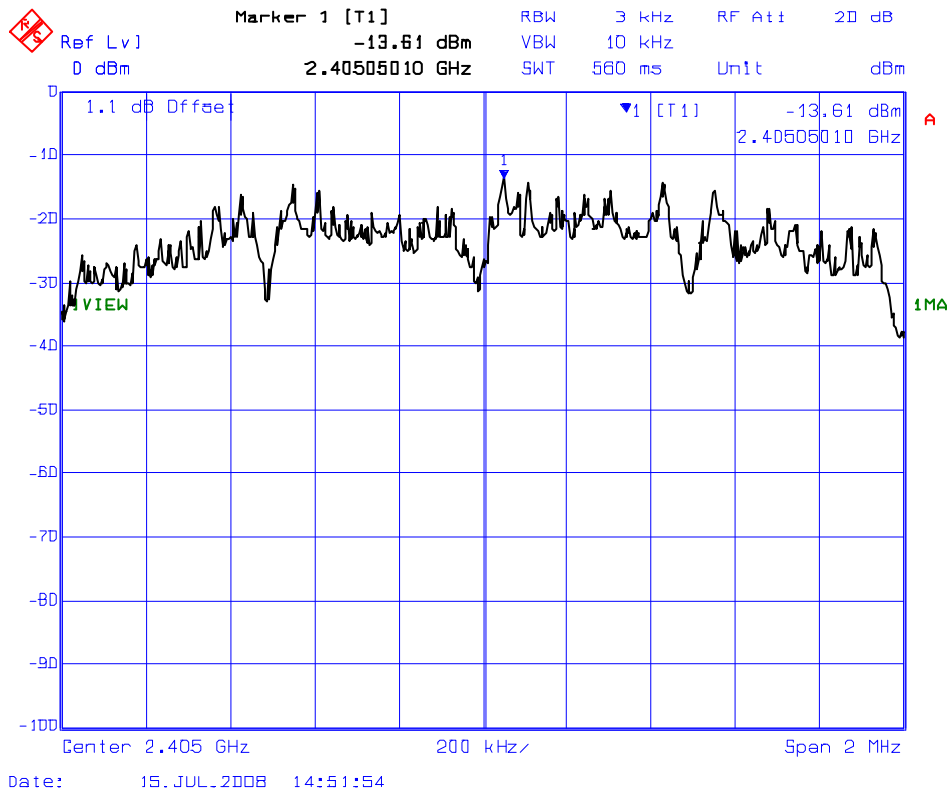

Plot 6.10.5.2 Power Spectral Density
Frequency: 2440 MHz

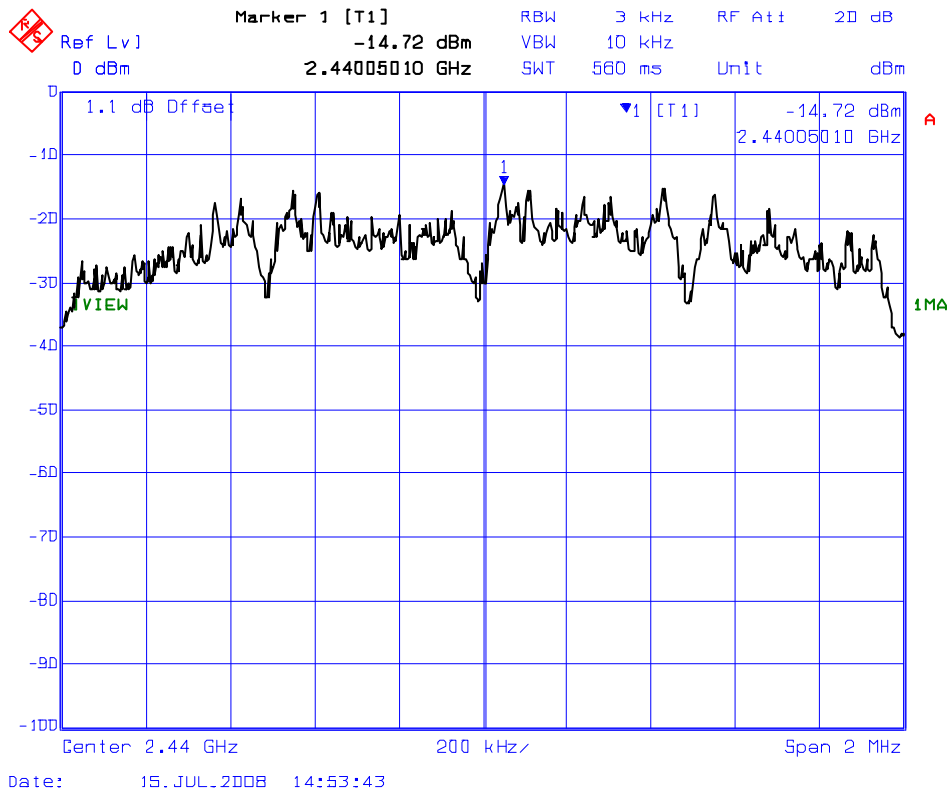

Plot 6.10.5.3 Power Spectral Density
Frequency: 2480 MHz

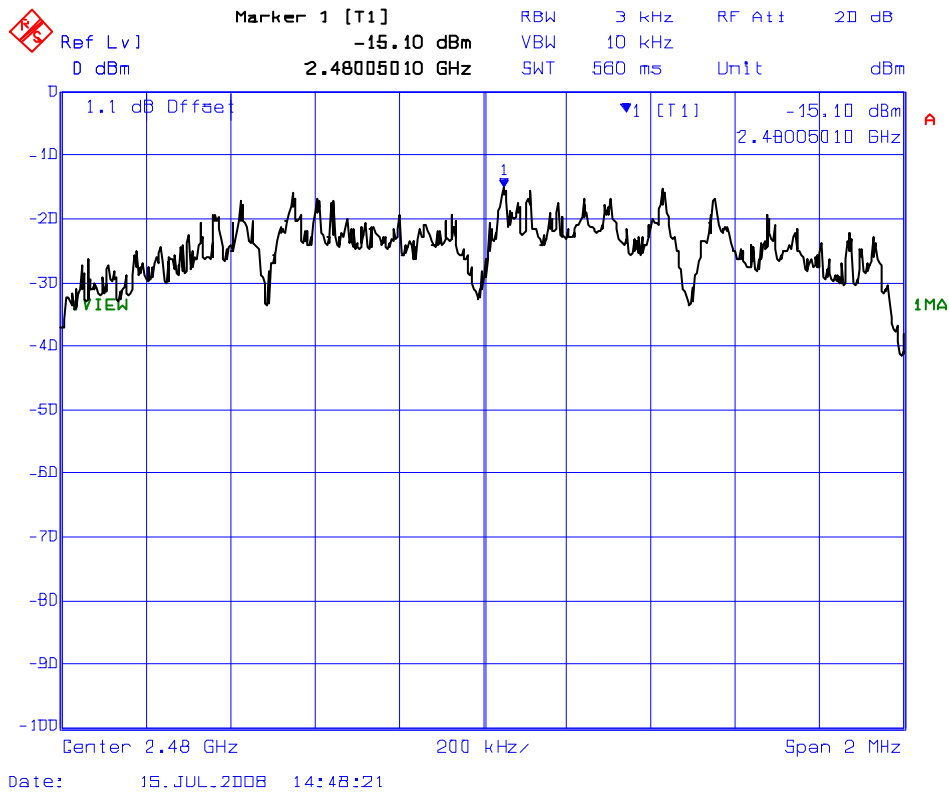

EXHIBIT 7. MEASUREMENT UNCERTAINTY

The measurement uncertainties stated were calculated in accordance with the requirements of NIST Technical Note 1297 and NIS 81 (1994)

7.1. LINE CONDUCTED EMISSION MEASUREMENT UNCERTAINTY

CONTRIBUTION (Line Conducted)	PROBABILITY DISTRIBUTION	UNCERTAINTY (dB)	
		9-150 kHz	0.15-30 MHz
EMI Receiver specification	Rectangular	± 1.5	± 1.5
LISN coupling specification	Rectangular	± 1.5	± 1.5
Cable and Input Transient Limiter calibration	Normal (k=2)	± 0.3	± 0.5
Mismatch: Receiver VRC $\Gamma_1 = 0.03$ LISN VRC $\Gamma_R = 0.8(9 \text{ kHz}) 0.2 (30 \text{ MHz})$ Uncertainty limits $20\text{Log}(1 \pm \Gamma_1 \Gamma_R)$	U-Shaped	± 0.2	± 0.3
System repeatability	Std. deviation	± 0.2	± 0.05
Repeatability of EUT	--	--	--
Combined standard uncertainty	Normal	± 1.25	± 1.30
Expanded uncertainty U	Normal (k=2)	± 2.50	± 2.60

Sample Calculation for Measurement Accuracy in 450 kHz to 30 MHz Band:

$$u_c(y) = \sqrt{\sum_{i=1}^m u_i^2(y)} = \pm \sqrt{(1.5^2 + 1.5^2)/3 + (0.5/2)^2 + (0.05/2)^2 + 0.35^2} = \pm 1.30 \text{ dB}$$

$$U = 2u_c(y) = \pm 2.6 \text{ dB}$$

7.2. RADIATED EMISSION MEASUREMENT UNCERTAINTY

CONTRIBUTION (Radiated Emissions)	PROBABILITY DISTRIBUTION	UNCERTAINTY (\pm dB)	
		3 m	10 m
Antenna Factor Calibration	Normal (k=2)	± 1.0	± 1.0
Cable Loss Calibration	Normal (k=2)	± 0.3	± 0.5
EMI Receiver specification	Rectangular	± 1.5	± 1.5
Antenna Directivity	Rectangular	± 0.5	± 0.5
Antenna factor variation with height	Rectangular	± 2.0	± 0.5
Antenna phase center variation	Rectangular	0.0	± 0.2
Antenna factor frequency interpolation	Rectangular	± 0.25	± 0.25
Measurement distance variation	Rectangular	± 0.6	± 0.4
Site imperfections	Rectangular	± 2.0	± 2.0
Mismatch: Receiver VRC $\Gamma_1 = 0.2$ Antenna VRC $\Gamma_R = 0.67$ (Bi) 0.3 (Lp) Uncertainty limits $20\text{Log}(1 \pm \Gamma_1 \Gamma_R)$	U-Shaped	+1.1 -1.25	± 0.5
System repeatability	Std. Deviation	± 0.5	± 0.5
Repeatability of EUT		-	-
Combined standard uncertainty	Normal	+2.19 / -2.21	+1.74 / -1.72
Expanded uncertainty U	Normal (k=2)	+4.38 / -4.42	+3.48 / -3.44

Calculation for maximum uncertainty when 3m biconical antenna including a factor of k = 2 is used:

$$U = 2u_c(y) = 2x(+2.19) = +4.38 \text{ dB} \quad \text{And} \quad U = 2u_c(y) = 2x(-2.21) = -4.42 \text{ dB}$$