



XBee/XBee-PRO XTC

Radio Frequency (RF) Module

User Guide

Revision history

900001476 A

Revision	Date	Description
A	December, 2015	Baseline release of the document.

Trademarks and copyright

Digi, Digi International, and the Digi logo are trademarks or registered trademarks in the United States and other countries worldwide. All other trademarks mentioned in this document are the property of their respective owners.

© 2015 Digi International Inc. All rights reserved.

Disclaimers

Information in this document is subject to change without notice and does not represent a commitment on the part of Digi International. Digi provides this document “as is,” without warranty of any kind, expressed or implied, including, but not limited to, the implied warranties of fitness or merchantability for a particular purpose. Digi may make improvements and/or changes in this manual or in the product(s) and/or the program(s) described in this manual at any time.

Warranty

To view the product's warranty information, go to the following website:

<http://www.digi.com/howtobuy/terms>

Customer support

Telephone (8:00 am — 5:00 pm U.S. Central Time):

Toll-free US and Canada: 866.912.3444

Worldwide: +1 952.912.3456

Online: www.digi.com/support/eservice

Mail:

Digi International Inc.
11001 Bren Road East
Minnetonka, MN 55434
USA

Contents

Revision history	2
The XBee/XBee-PRO XTend Compatible (XTC) RF module	
About the XTC RF module	9
Applicable firmware	9
Technical specifications	10
Performance specifications	10
Power requirements	11
Networking and security specifications	11
Physical specifications	12
Regulatory approvals	12
Hardware	
Mechanical drawings	14
Pin signals	16
Recommended pin connections	18
XTC RF Module Modes	
Transparent and API operating modes	19
Transparent operating mode	19
API operating mode	19
Additional modes	20
Command mode	20
Binary Command mode	20
Idle mode	20
Receive mode	20

Sleep modes	21
Shutdown mode	21
Transmit mode	21
Enter Command mode	21
Send AT commands	22
Exit Command mode	22
Enter Binary Command mode	23
Exit Binary Command mode	23
Binary Command mode FAQs	23
Sleep modes	25
Pin Sleep (SM = 1)	26
Serial Port Sleep (SM = 2)	27
Cyclic Sleep Mode (SM = 4-8)	27

Operation

Serial interface	29
UART data flow	29
Serial data	29
Flow control	30
Data In (DIN) buffer and flow control	30
Data Out (DO) buffer and flow control	31

Configure the XTC RF Module

Configure the device using XCTU	33
---------------------------------------	----

Program the XTC RF Module

XTC RF Module programming examples	34
Connect the device to a PC	34
Modify a device address	35
Restore device defaults	35
Send binary commands	35
Query binary commands	36

XTC RF Module commands

Command mode options	41
AT (Guard Time After)	41
BT (Guard Time Before)	41

CC (Command Sequence Character)	42
CF (Number Base)	42
CN (Exit Command Mode)	43
CT (Command Mode Timeout)	44
E0 (Echo Off)	44
E1 (Echo On)	45
Diagnostic commands	45
%V (Board Voltage)	45
DB (Received Signal Strength)	46
GD (Receive Good Count)	47
HV (Hardware Version)	48
RC (Ambient Power - Single Channel)	48
RE (Restore Defaults)	49
RM (Ambient Power)	50
RP (RSSI PWM Timer)	51
SH (Serial Number High)	52
SL (Serial Number Low)	52
TP (Board Temperature)	53
TR (Transmit Error Count)	53
VL (Firmware Version - Verbose)	54
VR (Firmware Version - Short)	54
WA (Active Warning Numbers)	55
WN (Warning Data)	56
WS (Sticky Warning Numbers)	58
MAC/PHY commands	58
AM (Auto-set MY)	58
DT (Destination Address)	59
HP (Preamble ID)	60
ID (Network ID)	60
MK (Address Mask)	61
MT (Multi-transmit)	61
MY (Source Address)	62
RN (Delay Slots)	63
RR (Retries)	64
TT (Streaming Limit)	64
RF interfacing commands	65
BR (RF Data Rate)	65
FS (Forced Synch Time)	66
MD (RF Mode)	66
PB (Polling Begin Address)	67

PD (Minimum Polling Delay)	68
PE (Polling End Address)	68
PK (Maximum RF Packet Size)	69
PL (TX Power Level)	71
TX (Transmit Only)	72
Security commands	73
KY (AES Encryption Key)	73
Serial interfacing commands	73
AP (API Enable)	74
BD (Interface Data Rate)	74
CD (GP02 Configuration)	76
CS (GP01 Configuration)	77
FL (Software Flow Control)	78
FT (Flow Control Threshold)	79
NB (Parity)	79
RB (Packetization Threshold)	80
RO (Packetization Timeout)	81
RT (GPI1 Configuration)	82
SB (Stop Bits)	82
Sleep commands	83
FH (Force Wakeup Initializer)	83
HT (Time before Wake-up Initializer)	84
LH (Wakeup Initializer Timer)	84
PW (Pin Wakeup)	85
SM (Sleep Mode)	86
ST (Time before Sleep)	87
XTC RF ModuleSpecial commands	88
WR (Write)	88

XTC RF Module API operation

API mode overview	89
API frame specifications	89
Calculate and verify checksums	91
Escaped characters in API frames	92
XTC RF ModuleAPI frame overview	93
RF Module Status 0x8A	93
Transmit Request: 16-bit address 0x01	94
Transmit Status frame 0x89	96
Receive Packet: 16-bit address 0x81	97

Network configurations

network topologies	100
Point-to-point networks	100
Point-to-multipoint networks	101
Peer to peer networks	102
Addressing	103
Address recognition	103
Basic communications	104
Streaming mode (default)	104
Multi-transmit mode	105
Repeater mode	106
Polling mode (basic)	111
Acknowledged communications: Acknowledged mode	113
Acknowledged mode connection sequence	114
Polling mode (acknowledged)	115

Certifications

FCC (United States)	117
OEM labeling requirements	117
FCC notices	118
FCC antenna certifications	118
XBee-PRO XTC Antenna options	119
XBee XTC antenna options	127
Industry Canada (IC)	135
Labeling requirements	135
Transmitters for detachable antennas	136
Detachables antennas	136
ACMA (Australia)	137
Power requirements	137

PCB design and manufacturing

Recommended footprint and keepout	138
Design notes	140
Host board design	140
Improve antenna performance	141
RF pad version	141
Recommended solder reflow cycle	143
Flux and cleaning	144

Rework 144

The XBee/XBee-PRO XTend Compatible (XTC) RF module

About the XTC RF module

The XBee/XBee-PRO XTend Compatible (XTC) RF module provides a radio frequency (RF) solution for the reliable delivery of critical data between remote devices. It is a 30 dBm (1 Watt) long-range original equipment manufacturer (OEM) device. We also offer a low power version of this module that offers transmit power adjustable up to 13 dBm.

The XTC module uses Frequency Hopping Spread Spectrum (FHSS) agility to avoid interference by hopping to a new frequency on every packet transmission or re-transmission. Its transmit power is software adjustable up to 30 dBm, which is the maximum output power allowable by governments that use 900 MHz as a license-free band. The XTC module is approved for use in the United States, Canada, Australia and other countries.

The XTC transfers a standard asynchronous serial data stream, operates within the ISM 900 MHz frequency band and offers two RF data rates of 10 kb/s and 125 kb/s.

As the name suggests, the XTC is over-the-air compatible with Digi's XTend module. The XTC is not a drop-in replacement for the XTend. If you require form factor compatibility, you must use the XTend vB RF Module.

For new applications, we recommend that you use the XBee/XBee-Pro SX module. It uses the same hardware as the XTC but we optimize the firmware for the best range and interference immunity. However, it is not over-the-air compatible with the XTend.

Applicable firmware

This manual supports the following firmware:

- 0x200X for XTC Hopping

Technical specifications

The following tables provide the device's technical specifications.



When operating at 1 W power output, observe a minimum separation distance of 6 ft (2 m) between devices. Transmitting in close proximity of other devices can damage the device's front end.

Performance specifications

The following table provides the performance specifications for the device. They cover the standard (XBee-PRO) and low-power (XBee) versions of the device.

Specification		XBee XTC	XBee-PRO XTC
Frequency range		ISM 902 to 928 MHz	
RF data rate (software selectable)		10 kb/s to 125 kb/s	
Transmit power (software selectable)		Up to 13 dBm	Up to 30 dBm ¹
Channels		10 hopping sequences share 50 frequencies	
Available channel frequencies		50	
Receiver sensitivity	10 kb/s	-110 dBm	
	125 kb/s	-100 dBm	
Outdoor range (line of sight)	10 kb/s	Up to 5 miles	up to 40 miles ²
	125 kb/s	Up to 1.5 miles	Up to 7 miles
Indoor range	10 kb/s	Up to 360 feet (110 m)	Up to 1,000 feet (300 m)
	125 kb/s	Up to 180 feet (55 m)	Up to 500 feet (150 m)

¹30 dBm guaranteed at 3.3 V and above. Maximum transmit power will reduce at lower voltages. See [PL \(TX Power Level\) on page 71](#) for more information on adjustable power levels.

²Estimated based on a 9 mile range test with dipole antennas.

Power requirements

The following table provides the power requirements for the device.

Specification		XBee XTC	XBee-PRO XTC
Supply voltage		2.4 to 3.6 VDC, 3.3 V typical	2.6 to 3.6 VDC, 3.3 V typical
Receive current	VCC = 3.3 V	40 mA	40 mA
Transmit current	VCC = 3.3 V	55 mA @ 13 dBm	900 mA @ 30 dBm
	VCC = 3.3 V	45 mA @ 10 dBm	640 mA @ 27 dBm
	VCC = 3.3 V	35 mA @ 0 dBm	330 mA @ 20 dBm ¹
Sleep current		2.5 μ A	2.5 μ A

Networking and security specifications

The following table provides the networking and security requirements for the device.

Specification	Value
Frequency	902-928 MHz, 915-928 MHz for the International variant
Spread spectrum	Frequency Hopping Spread Spectrum (FHSS)
Modulation	Frequency Shift Keying (FSK/GFSK)
Supported network topologies	Peer-to-peer (master/slave relationship not required), point-to-point, and point-to-multipoint
Channel capacity	10 hop sequences share 50 frequencies

¹We do not recommend the 20 dBm power level when operating at temperatures below 0°C. Output power may vary significantly when operating below 0°C.

Specification	Value
Encryption	256-bit or 128-bit AES depending on region, not software selectable 256-bit is only available on the North American variant 128-bit is only available on the Australian and international variants The KY command enables and disables encryption. The KY command sets the key

Physical specifications

The following table provides the physical specifications for the device.

Specification	Value
Dimensions	1.33 x 0.87 x 0.12" (3.38 x 2.21 x 1.29 cm)
Weight	3 g
RoHS	Compliant
Manufacturing	ISO 9001:2000 registered standards
Connector	37 castellated SMT pads
Antenna connector options	U.FL or RF pad
Antenna impedance	50 ohms unbalanced
Maximum input RF level at antenna port	6 dBm
Operating temperature	-40°C to 85°C

Regulatory approvals

The following table provides the regulatory approvals for the device.

Country	XBee XTC	XBee-PRO XTC
United States	FCC ID: MCQ-XBSX (pending)	FCC ID: MCQ-XBPSX (pending)
Canada	IC: 1846A-XBSX (pending)	IC: 1846A-XBPSX (pending)
Australia	RCM (pending)	RCM (pending)

Hardware

Mechanical drawings

The following images show the XTC mechanical drawings. The XTC has the same form factor as other Digi surface mount (SMT) XBee devices, except there is an additional copper ground pad on the bottom.

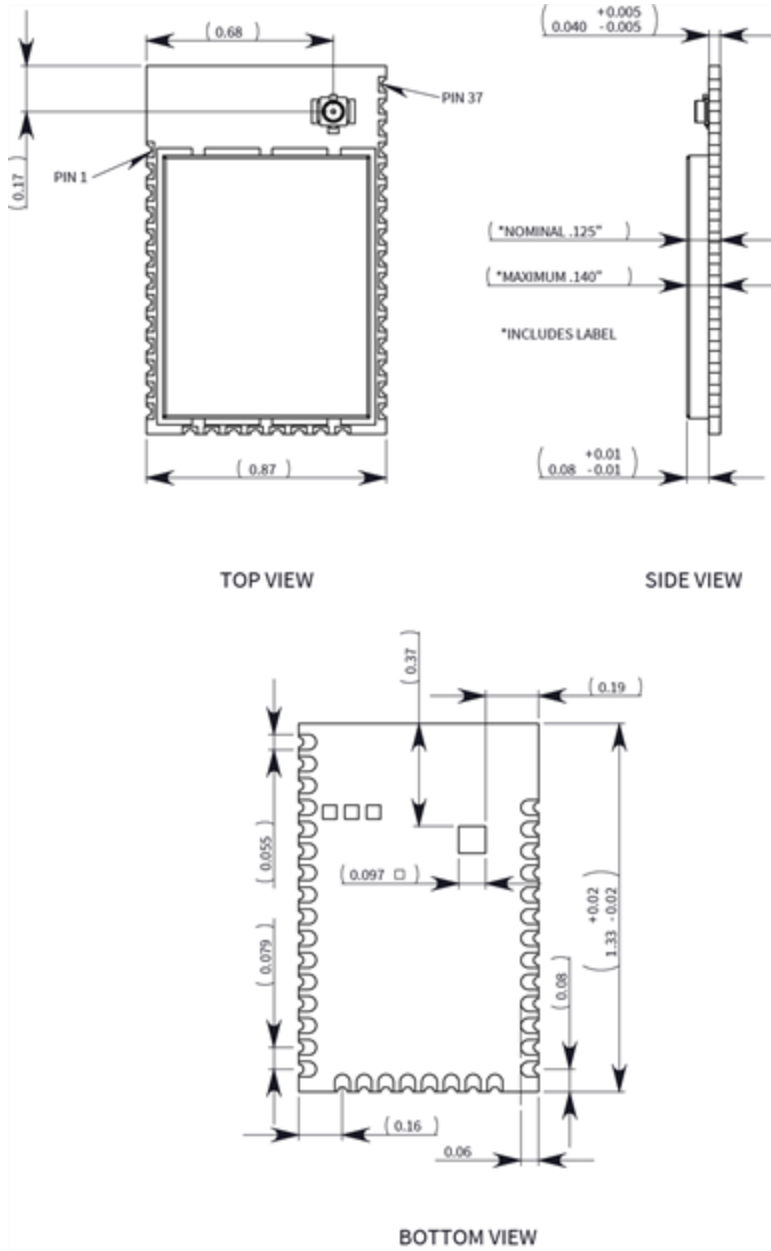

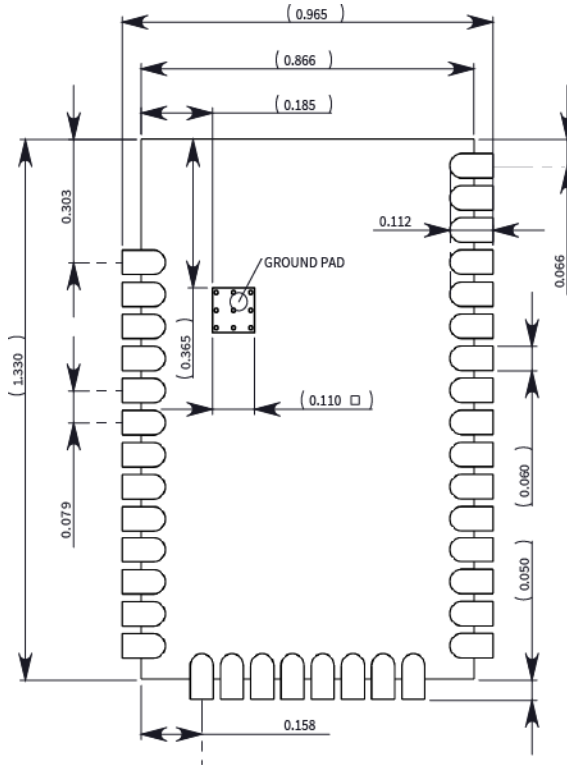

Pin signals

The following table describes the pin signals. Low-asserted signals have a horizontal line over the signal name.

Pin	Designation	I/O	Function
1	GND	-	Ground
2	VCC	I	Power supply
3	DOUT	O	UART Data Out
4	DIN	I	UART Data In
5	GPO2/RX LED	O	General Purpose Output / RX LED
6	<u>RESET</u>	I	Module reset

Pin	Designation	I/O	Function
7	RSSI	O	RX Signal Strength Indicator
8		-	Disabled
9	Reserved	NC	Do not connect
10	SLEEP (DTR)	I	Pin Sleep Control Line
11	GND	-	Ground
12		-	Disabled
13	GND	-	Ground
14		-	Disabled
15		-	Disabled
16		-	Disabled
17		-	Disabled
18	Reserved	NC	Do not connect
19	Reserved	NC	Do not connect
20	Reserved	NC	Do not connect
21	Reserved	NC	Do not connect
22	GND	-	Ground
23	Reserved	NC	Do not connect
24		-	Disabled

Pin	Designation	I/O	Function
25	GPO1/ $\overline{\text{CTS}}$ /RS-485 TX_EN	O	General Purpose Output / Clear-to-Send Flow Control / RS-485 Transmit Enable
26	ON/ $\overline{\text{SLEEP}}$	O	Module sleep status indicator
27	Reserved	NC	Do not connect
28	$\overline{\text{TX_PWR}}$	O	Transmit power
29	$\overline{\text{RTS}}$ /CMD	I	Request-to-Send Flow Control / Binary Command Control
30		-	Disabled
31		-	Disabled
32	$\overline{\text{CONFIG}}$	I	Configuration
33		-	Disabled
34	Reserved	NC	
35	GND	-	Ground
36	RF	I/O	RF IO for RF pad variant
37	NC	NC	
38	GND	-	Ground pad for heat transfer to host PCB

Note If you integrate the XTC with a host PC board, leave all lines you do not use disconnected (floating).

Recommended pin connections

The only required pin connections are VCC, GND, DOUT and DIN. To support serial firmware updates, you should connect VCC, GND, DOUT, DIN, RTS, and SLEEP (DTR).

XTC RF Module Modes

Transparent and API operating modes

The firmware operates in several different modes. Two top-level modes establish how the device communicates with other devices through its serial interface: Transparent operating mode and API operating mode.

Transparent operating mode

Devices operate in this mode by default. We also call this mode “AT operating mode.” The device acts as a serial line replacement when it is in Transparent operating mode. The device queues all UART data it receives through the DIN pin for RF transmission. When a device receives RF data, it sends the data out through the DOUT pin. You can set the configuration parameters using the AT Command interface.

API operating mode

API operating mode is an alternative to Transparent mode. API mode is a frame-based protocol that allows you to direct data on a packet basis. It can be particularly useful in large networks where you need to control the route a data packet takes or when you need to know which node a data packet is from. The device communicates UART data in packets, also known as API frames. This mode allows for structured communications with serial devices. It is helpful in managing larger networks and is more appropriate for performing tasks such as collecting data from multiple locations or controlling multiple devices remotely.

There are two types of API operating modes: one with escaped characters and another without escaped characters.

- Without escaped characters (**AP** = 1). This mode eliminates escaping character sequences. This makes it simpler to create code and libraries, but runs a minor risk of lost frames or errors due to the possibility that payload data can be confused with frame structure. We do not recommend this mode for noisy radio environments and where payload data may include special characters (specifically 0x7E, 0x7D, 0x11, and 0x13).

- With escaped characters (**AP** = 2). API escaped operating mode works similarly to API mode. The only difference is that when working in API escaped mode, the software must escape any payload bytes that match API frame specific data, such as the start-of-frame byte (0x7E).

Additional modes

In addition to the serial communication modes, several modes apply to how to configure devices and how devices communicate with each other.

Command mode

Command mode is a state in which the firmware interprets incoming characters as commands. Command mode allows you to modify the device's firmware using parameters you can set using AT commands. When you want to read or set any setting of the device, you have to send it an AT command. Every AT command starts with the letters "AT" followed by the two characters that identify the command the device issues and then by some optional configuration values. For more details, see [Enter Command mode on the next page](#).

Binary Command mode

Binary Command mode allows you to configure a device at a faster rate than AT commands will allow. Using binary commands to send and receive parameter values is the fastest way to change the operating parameters of the device. Use binary commands to:

- Sample signal strength and/or error counts;
- Change device addresses and channels for polling systems when a quick response is necessary.

For more details, see [Enter Binary Command mode on page 23](#) and [DB \(Received Signal Strength\) on page 46](#).

Idle mode

When not receiving or transmitting data, the device is in Idle mode. During Idle mode, the device listens for valid data on the serial port.

Receive mode

If a destination node receives a valid RF packet, the destination node transfers the data to its serial transmit buffer. For the serial interface to report receive data on the RF network, that data must meet the following criteria:

- ID match
- Channel match
- Address match

Sleep modes

Sleep Modes enable the device to enter states of low-power consumption when not in use. The device support three software sleep modes:

- Pin Sleep: the host controls this
- Serial Port Sleep: wakes when it detects serial port activity
- Cyclic Sleep: wakes when it detects RF activity

For more information, see [Sleep modes on page 25](#).

Shutdown mode

Shutdown mode offers the lowest power mode available to the device. This is helpful for applications that must keep power consumption to a minimum during idle periods.

When you drive the $\overline{\text{SHDN}}$ pin (pin 7) low, it forces the device into Shutdown mode. This halts any communication in progress (transmit or receive) and any buffered data is lost. For any other mode of operation, you must drive or pull SHDN high.

Immediately after the $\overline{\text{SHDN}}$ pin changes states from low to high, the device resets. After reset, the application must observe a delay time of <100 ms.

While SHDN is driven low, the device sets the following pins to high impedance: DCD, TX_PWR, RX LED, DO and CTS. The $\overline{\text{SHDN}}$ line is driven low during shutdown.

The following input pins may continue to be driven by external circuitry when in shutdown mode: $\overline{\text{RTS}}$, DI and $\overline{\text{SHDN}}$.

Because the DO pin is set to high impedance during Shutdown, if the XTC RF Module is connected to a processor, the UART receive pin could be floating. Place a weak pull-up between the device and the microcontroller so that the application does not misinterpret noise as data.

Transmit mode

When the device receives serial data and is ready to packetize it, the device exits Idle mode and attempts to transmit the serial data.

Enter Command mode

There are two ways to enter Command mode:

1. To get a device to switch into this mode, you must issue a unique string of text in a special way: +++ (default). When the device sees a full second of silence in the data stream followed by the string +++ (without Enter or Return) and another full second of silence, it knows to stop sending data through and start accepting commands locally. Do not press Return or Enter after typing +++ because it will interrupt the guard time silence and prevent you from entering Command mode.
2. Assert (low) the CONFIG pin. Turn the power going to the device off and back on.

The device sends the letters **OK** followed by a carriage return out of the UART to indicate that it entered Command mode.

You can customize the guard times and timeout in the device's configuration settings. See [CC \(Command Sequence Character\) on page 42](#), [BT \(Guard Time Before\) on page 41](#) and [AT \(Guard Time After\) on page 41](#).

Send AT commands

Once the device enters Command mode, use the syntax in the following figure to send AT commands.

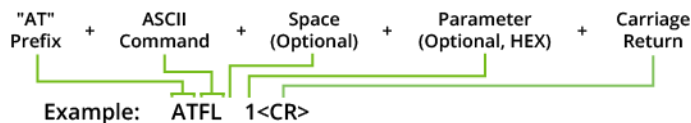

To read a parameter value stored in the device's register, omit the parameter field.

The preceding example would enable software flow control.

To store the new value to non-volatile (long term) memory, send the **WR** (Write) command. This allows parameter values that you modify to persist in the device's registry after a reset. Otherwise, the device restores parameters to the previous values after a reset.

Respond to AT commands

When you send a command to the device, the device parses and runs the command. If the command runs successfully, the device returns an **OK** message. If the command errors, the device returns an **ERROR** message.

Exit Command mode

1. Send the **CN** (Exit Command Mode) command followed by a carriage return.
or:
2. If the device does not receive any valid AT commands within the time specified by **CT** (Command Mode Timeout), it returns to Idle mode. The default Command Mode Timeout is 20 seconds.

Enter Binary Command mode

To enter Binary Command mode, you must first be in Command mode:

1. Set RT to 1; see [RT \(GP11 Configuration\) on page 82](#).
2. Assert CMD by driving pin 1029 high to enter Binary Command mode.
3. Disable hardware flow control.

$\overline{\text{CTS}}$ (pin 25) is high when the firmware executes a command. That is why you must disable hardware flow control, because $\overline{\text{CTS}}$ holds off parameter bytes.

Exit Binary Command mode

To exit Binary Command mode, de-assert CMD by driving pin 2910 low.

Binary Command mode FAQs

Since sending and receiving binary commands takes place through the same serial data path as live data, interference between the two types of data can be a concern. Some common questions about using binary commands are:

- What are the implications of asserting CMD while the device is sending or receiving live data?

You must assert the CMD pin (pin 2910) in order to send binary commands to the device. You can assert the CMD pin to recognize binary commands anytime during the transmission or reception of data.

The device only checks the status of the CMD signal at the end of the stop bit as the byte shifts into the serial port.

The firmware does not allow control over when the device receives data, except by waiting for dead time between bursts of communication.

If the command is sent in the middle of a stream of payload data, the device executes the command in the order it is received. If the device is continuously receiving data, it waits for a break in the data it receives before executing the command.

In the following figure, the host writes a value to a register and then reads it out of the device to verify it. While not in the middle of other received data, the $\overline{\text{CTS}}$ signal outlines the data response out of the device.

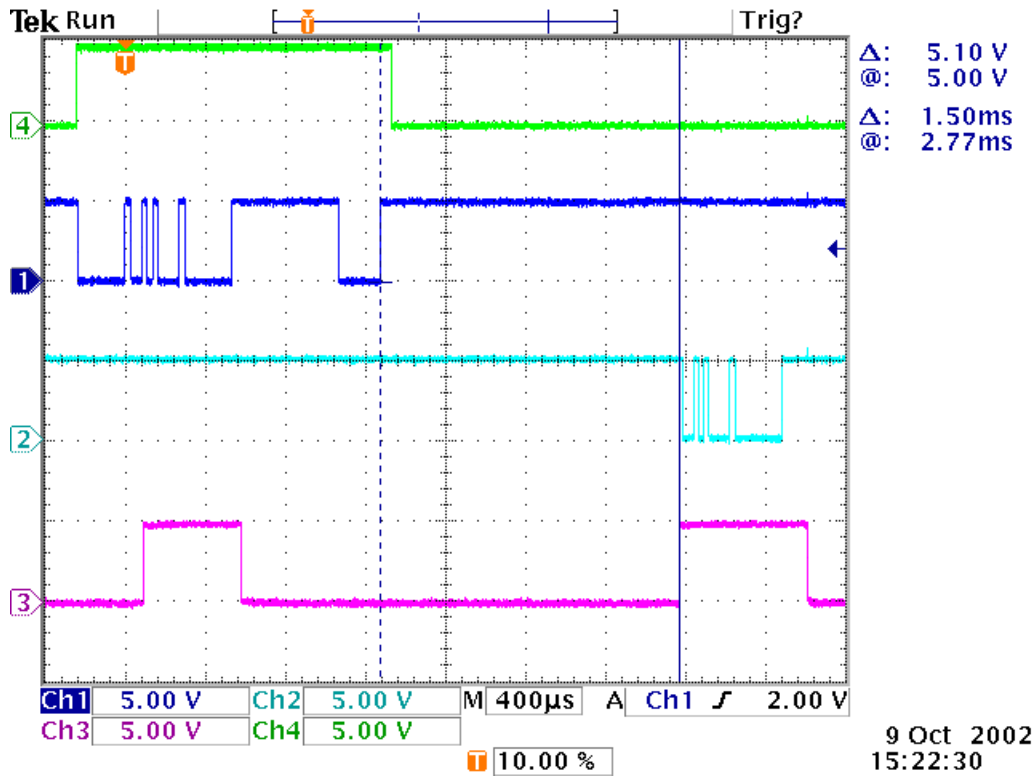

Signal number	Pin name
1	DIN (Pin 4)
2	DOUT (Pin 3)
3	$\overline{\text{CTS}}$ (Pin 259)
4	CMD (Pin 2910)

- After sending serial data, is there a minimum time delay before you can assert CMD?
- Is a time delay required after CMD is de-asserted before payload data can be sent?

The host must observe a minimum time delay of 100 μs after sending the stop bit of the command byte before the host de-asserts the CMD pin. The command executes after the host sends all of its associated parameters. If the device does not receive all of these parameters within 0.5 seconds, the device returns to Idle mode.

Note When a host sends parameters, they are two bytes long with the least significant byte sent first. Binary commands that return one parameter byte must be written with two parameter bytes. Example: to set PL to 3, send the following data: 0x3A 0x03 0x00 (Binary Command, LSB, MSB).

- How does one discern between live data and data received in response to a command?

To query command parameters using Binary Command mode, set the most significant bit of the binary command. This can be accomplished by logically ORing (bit-wise) the binary command with hexadecimal 0x80. The parameter bytes are returned in hexadecimal bytes with the least significant bit first (if multiple bytes are returned).

Example: to query HP in Binary Command mode, instead of setting it, send 0x11 (HP binary command) as 0x91 with no parameter bytes.

The device must be in Binary Command mode in order for the device to recognize a binary command; see [Enter Binary Command mode on page 23](#).

If the device is not in Binary Command mode (the RT parameter value is not 1), the device does not recognize that the CMD pin is asserted and therefore does not recognize the data as binary commands.

For an example of binary programming, see [Send binary commands on page 35](#).

Sleep modes

For the device to enter one of the sleep modes, SM must have a non-zero parameter value, and it must meet one of the following conditions:

1. The device is idle (no data transmission or reception) for the amount of time defined by the ST parameter. ST is only active when SM = 4-5.
2. The host asserts SLEEP (pin 10). This only applies to the Pin Sleep option.

When in Sleep mode, the device does not transmit or receive data until it transitions to Idle mode.

Use the SM command to enable or disable all Sleep modes. The following table shows the transitions into and out of Sleep modes.

Sleep mode (setting)	Transition into Sleep mode	Transition out of Sleep mode (wake)	Related commands	Power consumption
Pin Sleep (SM = 1)	Assert (high) SLEEP pin. A microcontroller can shut down and wake devices via the SLEEP pin. The device completes a transmission or reception before activating Pin Sleep.	De-assert (low) SLEEP pin	SM	< 147 μ A

Sleep mode (setting)	Transition into Sleep mode	Transition out of Sleep mode (wake)	Related commands	Power consumption
Serial Port Sleep (SM = 2)	Automatic transition to Sleep Mode occurs after a user-defined period of inactivity (no transmitting or receiving of data). Period of inactivity is defined by the ST command.	When a serial byte is received on the DI pin	(SM), ST	7.3 mA
Cyclic Sleep (SM = 4 - 8)	The device transitions in and out of Sleep Mode in cycles (you set the sleep interval of time using the SM command). The cyclic sleep interval of time must be shorter than the interval of time that is defined by the LH command. You can for the device into Idle Mode using the SLEEP pin if you issue the PW command.		(SM), ST, HT, LH, PW	See Power requirements

The SM (Sleep Mode) command is central to setting all Sleep Mode configurations. By default, Sleep Modes are disabled (SM = 0) and the device remains in Idle/Receive Mode. When in this state, the device remains constantly ready to respond to serial or RF activity.

Pin Sleep (SM = 1)

- Pin/Host-controlled
- Typical sleep current: 2.5 μ A

When the host asserts the SLEEP pin, the device finishes any transmitting or receiving activity, enters Idle mode, then enters a sleep state. When in Pin Sleep mode, the device does not respond to serial or RF activity.

After enabling Pin Sleep, the SLEEP pin controls whether the device is active or sleeping. When the host de-asserts SLEEP, the device is fully operational. When the host asserts SLEEP, the device transitions to Sleep mode and remains in its lowest power-consuming state until the host de-asserts the pin. This pin is only active if the device is setup to operate in this mode; otherwise the firmware ignores the pin.

Once in Pin Sleep, the device de-asserts (high) $\overline{\text{CTS}}$ (pin 259), indicating that other devices should not send data to the device. The device also de-asserts (low) the $\overline{\text{TX_PWR}}$ line (pin 284) when the device is in Pin Sleep mode.

Note The device completes a transmission or reception before activating Pin Sleep.

Serial Port Sleep (SM = 2)

- Wake on serial port activity
- Typical sleep current: 6.3 mA

Serial Port Sleep is a Sleep mode in which the device runs in a low power state until it detects serial data on the DI pin.

The ST command determines the period of time that the device sleeps. Once it receives a character through the DI pin, the device returns to Idle mode and is fully operational.

Cyclic Sleep Mode (SM = 4-8)

- Typical sleep Current: 2.5 μ A (when asleep)

Cyclic Sleep modes allow device wakes according to the times designated by the cyclic sleep settings. If the device detects a wake-up initializer during the time it is awake, the device synchronizes with the transmitting device and receives data after the wake-up initializer runs its duration. Otherwise, the device returns to Sleep mode and continues to cycle in and out of activity until a wake-up initializer is detected.

While the device is in Cyclic Sleep mode, it de-asserts (high) $\overline{\text{CTS}}$ (pin 259) to indicate not to send data to the device. When the device awakens to listen for data, it asserts $\overline{\text{CTS}}$ and transmits any data received on the DI pin. The device also de-asserts (low) the $\overline{\text{TX_PWR}}$ (pin 284) when it is in Cyclic Sleep mode.

The device remains in Sleep mode for a user-defined period of time ranging from 1 second to 16 seconds (SM parameters 4 through 8). After this interval of time, the device returns to Idle mode and listens for a valid data packet. The listen time depends on the BR parameter setting. The default BR setting of 1 requires at least a 35 ms wake time, while the BR setting of 0 requires a wake time of up to 225 ms. If the device does not detect valid data on any frequency, it returns to Sleep mode. If it detects valid data, it transitions into Receive mode and receives the incoming RF packets. The device then returns to Sleep mode after a period of inactivity determined by the ST parameter.

You can also configure the device to wake from cyclic sleep when the SLEEP pin is de-asserted. To configure a device to operate in this manner, you must issue the PW (Pin Wake-up) command. When you de-assert the SLEEP pin, it forces the device into Idle mode and it can begin transmitting or receiving data. It remains active until it no longer detects data for the time that ST specifies, at which point it resumes its low-power cyclic state.

Cyclic scanning

Each RF transmission consists of an RF initializer and payload. The RF initializer contains initialization information and all receiving devices must wake during the wake-up initializer portion of data transmission in order to synchronize with the transmitting device and receive the data.

The cyclic interval time defined by the SM (Sleep Mode) command must be shorter than the interval time defined by LH (Wake-up Initializer Timer) command.

Correct configuration (LH > SM)

In the following figure, the length of the wake-up initializer exceeds the time interval of Cyclic Sleep. The receiver is guaranteed to detect the wake-up initializer and receive the accompanying payload data.

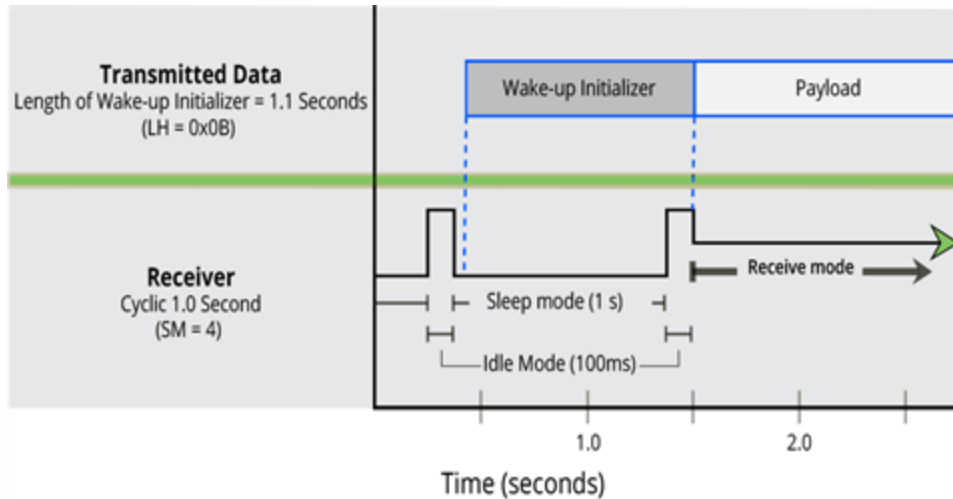

Operation



When operating at 1 W power output, observe a minimum separation distance of 6 ft (2 m) between devices. Transmitting in close proximity of other devices can damage the device's front end.

Serial interface

The XTC RF Module provides a serial interface to an RF link. The XTC RF Module converts serial data to RF data and sends that data to any over-the-air compatible device in an RF network. The device can communicate through its serial port with any logic and voltage compatible universal asynchronous receiver/transmitter (UART), or through a level translator to any serial device.

UART data flow

Devices that have a UART interface can connect directly to the pins of the XTC RF Module as the following figure shows. The figure shows system data flow in a UART-interfaced environment. Low-asserted signals have a horizontal line over the signal name.

Serial data

A device sends data to the device's UART through pin 4 (DIN) as an asynchronous serial signal. When the device is not transmitting data, the signal idles high.

For serial communication to occur, you must configure the UART of both devices with compatible settings for the baud rate, parity, start bits, stop bits, and data bits. Each data byte consists of a start bit (low), 8 data bits (least significant bit first) and a stop bit (high). The following diagram illustrates the serial bit pattern of data passing through the device. It shows UART data packet 0x1F (decimal number 31) as transmitted through the device.

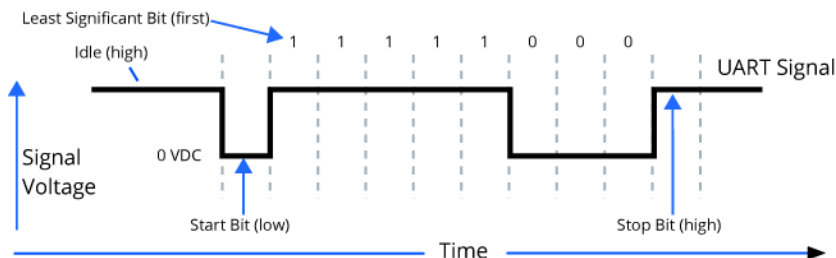

Flow control

The $\overline{\text{RTS}}$ and $\overline{\text{CTS}}$ device pins provide $\overline{\text{RTS}}$ and/or $\overline{\text{CTS}}$ flow control. $\overline{\text{CTS}}$ flow control signals the host to stop sending serial data to the device. $\overline{\text{RTS}}$ flow control lets the host signal the device so it will not send the data in the serial transmit buffer out the UART. The following diagram shows the internal data flow, with the five most common pin signals.

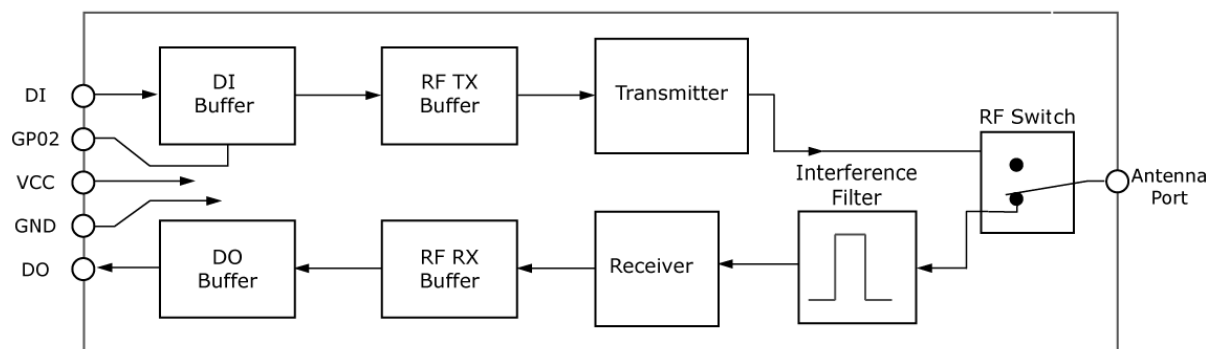

The firmware has Hardware flow control ($\overline{\text{CTS}}$) configured by default. You must configure $\overline{\text{CTS}}$ flow control on the host side for it to work.

You must configure Software flow control (XON) on both the host and device side for it to work.

If you change the **CS** command from 0, then $\overline{\text{CTS}}$ flow control will not work even if you have it configured on the host.

Data In (DIN) buffer and flow control

When serial data enters the device through the DIN pin (pin 4), it stores the data in the DIN buffer until it can process the data.

When the firmware satisfies the **RB** and **RO** parameter thresholds, the device attempts to initialize an RF transmission. If the device is already receiving RF data, it stores the serial data in the device's DIN buffer.

The device creates and transmits data packets when it meets one of the following conditions:

1. The device does not receive any serial characters for the amount of time set with in the **RO** command; see [RO \(Packetization Timeout\) on page 81](#).
2. The device receives the maximum number of characters that fits in an RF packet.
3. The device receives the Command Mode sequence; see [Enter Command mode on page 21](#).

If the DIN buffer becomes full, you must implement hardware or software flow control in order to prevent overflow (loss of data between the host and the device). To eliminate the need for flow control:

1. Send messages that are smaller than the DIN buffer size. The size of the DIN buffer varies according to the packet size (**PK** parameter) and the parity setting (**NB** parameter) you use.
2. Interface at a lower baud rate (**BD** parameter) than the RF data rate (**BR** parameter).

In the following situations, the DIN buffer may become full and overflow:

1. If you set the serial interface data rate higher than the RF data rate of the device, the device receives data from the host faster than it can transmit the data over-the-air.
2. If the device receives a continuous stream of RF data or if the device monitors data on a network, it places any serial data that arrives on the DIN pin (pin 4) in the DIN buffer. It transmits the data in the DIN buffer over-the-air when the device no longer detects RF data in the network.

Hardware flow control (CTS)

The firmware asserts $\overline{\text{CTS}}$ before the DIN buffer is full so it has time to send the signal and the host has time to stop sending data.

When the DIN buffer is full, the firmware de-asserts $\overline{\text{CTS}}$ (high) to signal the host to stop sending data; refer to [FT \(Flow Control Threshold\) on page 79](#) and [CS \(GP01 Configuration\) on page 77](#).

The firmware re-asserts $\overline{\text{CTS}}$ after the DIN buffer has 34 bytes of memory available.

Software flow control (XON/OFF)

Use FL to enable XON/XOFF software flow control. This option only works with ASCII data.

Data Out (DO) buffer and flow control

When a device receives RF data, the data enters the DOUT buffer and the device sends it out the serial port to a host device. Once the DOUT buffer reaches capacity, it loses any additional incoming RF data. The DOUT buffer stores at least 2.1 kB.

In the following situations, the DOUT buffer may become full and overflow:

1. If you set the interface data rate higher than the RF data rate of the device, the receiving device receives data from the transmitting device faster than it can send the data to the

host.

2. If the host does not allow the device to transmit data out from the DOUT buffer because of being held off by hardware or software flow control.

Configure the XTC RF Module

Configure the device using XCTU

XBee Configuration and Test Utility (XCTU) is a multi-platform program that enables developers to interact with Digi radio frequency (RF) devices through a graphical interface. The application includes built-in tools that make it easy to set up, configure, and test Digi RF devices.

For full support of the XTC RF Module, you must use XCTU version 6.3.0 or higher.

For instructions on downloading and using XCTU, go to:

<http://www.digi.com/products/xbee-rf-solutions/xctu-software/xctu>

Program the XTC RF Module

XTC RF Module programming examples

For steps on sending AT commands to a device, refer to:

- [Send AT commands on page 22](#)
- [Exit Command mode on page 22](#)

Refer to the online help for XCTU for more information on the program and how to use it. The help information is available at:

<https://docs.digi.com/display/XCTU/XCTU+Overview>

Connect the device to a PC



The programming examples that follow require the installation of XCTU and a serial connection to a PC. Digi stocks connector boards to facilitate interfacing with a PC.

1. Download XCTU from Digi's website:
<http://www.digi.com/products/xbec-rf-solutions/xctu-software/xctu#resources>
2. After the .exe file downloads to the PC, double-click the file to launch the XCTU Setup Wizard. Follow the steps in the wizard to completely install XCTU.
3. Mount the device to an interface board, then connect the assembly to a PC.
4. Launch XCTU and click the **Add devices** tab on the upper left corner of the screen.
5. Verify that the baud rate and parity settings of the Serial/USB port match those of the device.

Note Failure to enter Command mode is commonly due to baud rate mismatch. Ensure that the **Baud Rate**: setting on the Add radio device window matches the interface data rate of the device. By default, the BD parameter = 9600 b/s.





Modify a device address

The following programming example shows you how to modify the device's destination address.

1. Once you add the device in XCTU, click on it in the **Radio Modules** pane to display the Configuration working mode. This mode shows most of the device's parameters that you can edit.
2. Scroll down in the Radio Configuration pane until you find the parameter you want to edit, in this case the DT (Destination Address) parameter, or use the search box and type DT. XCTU automatically scrolls to the selected parameter.
3. When you locate the parameter, change its value, for example to 1A0D. If you do not save the parameter, the color of the surrounding container is light green.
4. Click the **write** button to save the value to non-volatile memory; it is the pencil icon to the right of the parameter . If you change other parameters but have not saved them, you can use the **Write radio settings** button to save them. It is the white and blue pencil icon on the top of the configuration panel .

Restore device defaults

The following programming example shows you how to restore a device's default parameters.

1. After establishing a connection between the device and a PC click the Configuration working mode tab of XCTU   .
2. Click the **Load default firmware settings** button and agree to restore the default values. The button is the factory icon .
3. The restored parameters have a light green surrounding color, which means that they have been changed but not saved.
4. Click the **Write module settings** button  to save all of the parameters simultaneously.
5. All the parameters surrounding box must change to gray indicating that their values are now saved in the device's non-volatile memory.

Send binary commands

Example: use XCTU's Serial Console tool to change the device's DT (Destination Address) parameter and save the new address to non-volatile memory.

This example requires XCTU and a serial connection to a PC.

To send binary commands:

1. Set the RT command to 1 to enable binary command programming; do this in Command mode or configure it through XCTU.

2. Drive pin 2910 high to assert CMD. To accomplish this, de-assert the $\overline{\text{RTS}}$ line in XCTU. The device enters Binary Command mode.
3. Send hexadecimal bytes (parameter bytes must be 2 bytes long). The next four lines are examples, not required values:
 - 00 (Send binary command DT)
 - 0D (Least significant byte of parameter bytes)
 - 1A (Most significant byte of parameter bytes)
 - 08 (Send binary command WR)
4. Drive pin 2910 low to de-assert CMD. After you send the commands, $\overline{\text{CTS}}$ (pin 259) will de-assert (driven low) temporarily. The device exits Binary Command mode.

The default flow control is NONE, so if you are using XCTU, you should not need to worry about $\overline{\text{CTS}}$. However, you can still observe the behavior of the $\overline{\text{CTS}}$ line by monitoring the $\overline{\text{CTS}}$ indicator in the terminal or console.

Query binary commands

Example: use XCTU's Serial Console tool to query the device's DT (Destination Address) and DB (Received Signal strength) parameters. In order to query a parameter instead of setting it, you must logically OR the binary command byte with 0x80.

1. Set the RT command to 1 to enable binary command programming. To do this, you must either be in Command mode or use XCTU to configure the device.
2. Assert CMD by driving pin 29 high. To do this de-assert the $\overline{\text{RTS}}$ line in XCTU.
3. Send hexadecimal bytes:
 - 80 (Binary command DT (0x00) ORed with 0x80)
 - B6 (Binary command DB (0x36) ORed with 0x80)
4. Read the device's output for the parameter values of the two commands.
5. De-assert CMD by driving pin 29 low. The device exits Binary Command mode.

When querying commands in binary command mode, the output is the least significant byte followed by the most significant byte and is always represented in hexadecimal values.

XTC RF Module commands

The following table lists the AT and binary commands in the XTC RF Module firmware and links to the description of the individual command.

By default, the device expects numerical values in hexadecimal since the default value of the CF (Number Base) Parameter is 1. Hexadecimal values are designated by the 0x prefix and decimal values by the d suffix.

AT command	Binary command
%V (Board Voltage) on page 45	0x3B (59d)
AM (Auto-set MY) on page 58	0x41 (65d)
AP (API Enable) on page 74	--
AT (Guard Time After) on page 41	0x05 (5d)
BD (Interface Data Rate) on page 74	0x15 (21d)
BR (RF Data Rate) on page 65	0x39 (57d)
BT (Guard Time Before) on page 41	0x04 (4d)
CC (Command Sequence Character) on page 42	0x13 (19d)
CD (GP02 Configuration) on page 76	0x28 (40d)

AT command	Binary command
CF (Number Base) on page 42	--
CN (Exit Command Mode) on page 43	0x09 (9d)
CS (GP01 Configuration) on page 77	0x1F (31d)
CT (Command Mode Timeout) on page 44	0x06 (6d)
DB (Received Signal Strength) on page 46	0x36 (54d)
DT (Destination Address) on page 59	0x00 (0d)
E0 (Echo Off) on page 44	0x0A (10d)
E1 (Echo On) on page 45	0x0B (11d)
ER (Receive Count Error)	0x0F (15d)
FH (Force Wakeup Initializer) on page 83	0x0D (13d)
FL (Software Flow Control) on page 78	0x07 (7d)
FS (Forced Synch Time) on page 66	0x3F (63d)
FT (Flow Control Threshold) on page 79	0x24 (36d)
GD (Receive Good Count) on page 47	0x10 (16d)
HP (Preamble ID) on page 60	0x11 (17d)
HT (Time before Wake-up Initializer) on page 84	0x03 (3d)
HV (Hardware Version) on page 48	--
ID (Network ID) on page 60	0x27 (39d)

AT command	Binary command
KY (AES Encryption Key) on page 73	0x43 (67d)
LH (Wakeup Initializer Timer) on page 84	0x0C (12d)
MD (RF Mode) on page 66	0x31 (49d)
MK (Address Mask) on page 61	0x12 (18d)
MT (Multi-transmit) on page 61	0x3E (62d)
MY (Source Address) on page 62	0x2A (42d)
NB (Parity) on page 79	0x23 (35d)
PB (Polling Begin Address) on page 67	0x45 (69d)
PD (Minimum Polling Delay) on page 68	0x47 (71d)
PE (Polling End Address) on page 68	0x46 (70d)
PK (Maximum RF Packet Size) on page 69	0x29 (41d)
PL (TX Power Level) on page 71	0x3A (58d)
PW (Pin Wakeup) on page 85	0x1D (29d)
RB (Packetization Threshold) on page 80	0x20 (32d)
RC (Ambient Power - Single Channel) on page 48	--
RE (Restore Defaults) on page 49	0x0E (14d)
RM (Ambient Power) on page 50	--
RN (Delay Slots) on page 63	0x19 (25d)

AT command	Binary command
RO (Packetization Timeout) on page 81	0x21 (33d)
RP (RSSI PWM Timer) on page 51	0x22 (34d)
RR (Retries) on page 64	0x18 (24d)
RT (GPI1 Configuration) on page 82	0x16 (22d)
SB (Stop Bits) on page 82	0x37 (55d)
SH (Serial Number High) on page 52	0x25 (37d)
SL (Serial Number Low) on page 52	0x26 (38d)
SM (Sleep Mode) on page 86	0x01 (1d)
ST (Time before Sleep) on page 87	0x02 (2d)
TP (Board Temperature) on page 53	0x38 (56d)
TR (Transmit Error Count) on page 53	0x1B (27d)
TT (Streaming Limit) on page 64	0x1A (26d)
TX (Transmit Only) on page 72	0x40 (64d)
VL (Firmware Version - Verbose) on page 54	--
VR (Firmware Version - Short) on page 54	0x14 (20d)
WA (Active Warning Numbers) on page 55	--
WN (Warning Data) on page 56	--
WR (Write) on page 88	0x08 (8d)

AT command	Binary command
WS (Sticky Warning Numbers) on page 58	--

Command mode options

The following AT commands are Command mode option commands.

AT (Guard Time After)

Sets or reads the time-of-silence that follows the CC (Command Sequence Character) of the Command mode sequence (BT + CC + AT). By default, one second must elapse before and after the command sequence character.

The times-of-silence surrounding the Command Sequence Character prevent the device from inadvertently entering Command mode.

Binary command

0x05 (5 decimal)

Command type

Command mode options

Parameter range

2 - (ST-3) up to 0x1770 [x 100 ms]

Default

0xA (1 second)

Bytes returned

2

BT (Guard Time Before)

Sets the DI pin silence time that must precede the Command Sequence Character (CC command) of the Command mode sequence. For more information about the Command mode sequence, see [Enter Command mode on page 21](#).

Binary command

0x04 (4 decimal)

Command type

Command mode options

Parameter range

0 - 0x1770 [x 100ms]

Default

0x0A (1 second)

Bytes returned

2

CC (Command Sequence Character)

The ASCII character value you use to enter Command mode. Use CC to set or read the character used between guard times of the Command mode sequence (BT + CC + AT). This sequence enters the device into Command mode so that device recognizes data entering it from the host as commands instead of payload data.

Binary command

0x13 (19 decimal)

Command type

Command mode options

Parameter range

0x20 - 0x7F

Default

0x2B (ASCII "+")

Bytes returned

1

CF (Number Base)

Sets or reads the command formatting setting.

The firmware always enters and reads the following commands in hex, no matter what the CF setting is:

VR (Firmware Version)

HV (Hardware Version)

KY (AES Encryption Key)

Binary command

N/A

Command type

Command mode options

Parameter range

0 - 2

Parameter	Configuration
0	Commands use the default number base; decimal commands may output units.
1	All commands are forced to unsigned, unit-less hex.
2	Commands use their default number base; no units are output.

Default

1

Bytes returned

1

CN (Exit Command Mode)

Makes the device exit Command mode.

Binary command

0x09 (9 decimal)

Command type

Command mode options

Parameter range

N/A

Default

N/A

Bytes returned

N/A

CT (Command Mode Timeout)

Set or read the Command mode timeout parameter. If a device does not receive any valid commands within this time period, it returns to Idle mode from Command mode.

Use the CN (Exit Command mode) command to exit Command mode manually.

Binary command

0x06 (6 decimal)

Command type

Command mode options

Parameter range

2 - 0x53E2 [x 100 milliseconds]

Default

0xC8 (20 seconds)

Bytes returned

2

E0 (Echo Off)

Turns off the character echo in Command mode.

By default, echo is off.

Binary command

0x0A (10 decimal)

Command type

Command mode options

Parameter range

N/A

Default

N/A

Bytes returned

N/A

E1 (Echo On)

Enables character echo in Command mode. Each character that you type echoes back to the terminal when E1 is active. E0 (Echo Off) is the default.

Binary command

0x0B (11 decimal)

Command type

Command mode options

Parameter range

N/A

Default

N/A

Bytes returned

N/A

Diagnostic commands

The following AT commands are diagnostic commands. Diagnostic commands are typically volatile and will not persist across a power cycle.

%V (Board Voltage)

Reads the supply voltage to the module's VCC (pin 2).

The conversion of the hex value returned by **%V** to Volts is $VAL/65536 = \text{Volts}$.

Example:

2.8 VDC = $2.8 * 65536 = 0x2CCCCD$

3.3 VDC = $3.3 * 65536 = 0x34CCD$

Sample output

3.27 V (when CF = 0)

345E3 (when CF = 1) ¹

3.27 (when CF = 2)

Binary command

0x3B (59 decimal)

Parameter range

(read-only):

0x26666 - 0x39999 (2.40 to 3.60 V)

Default

N/A

Bytes returned

4

DB (Received Signal Strength)

This command reports the received signal strength indicator (RSSI) of the last RF data packet that a device receives. It reports the RSSI in decibels relative to milliwatts. DB is useful in determining range characteristics of the RF devices under various conditions. On XTC, this is accurate from approximately -50 to -100 dBm.

In Transparent operating mode, DB shows the power level in signed decimal format with the units (dBm). If CF = 1, the magnitude of the value is in unsigned hex. If CF = 2, the value is in decimal, but without the units.

¹When CF = 1 (default), the firmware shows a hex integer that is equal to $(\text{voltage} * 65536d)$.

Sample output

-88 dBm (when CF = 0)

58 (when CF = 1)

-88 (when CF = 2)

Note If the firmware reads the DB register before the device receives an RF packet, the device returns a value of 0x8000.

Binary command

0x36 (54 decimal)

Command type

Diagnostics

Parameter range

(read-only): 0x6E - 0x28

(-110 to -40 decimal)

Default

N/A

Bytes returned

2

GD (Receive Good Count)

Sets or reads the number of RF packets with valid MAC headers that the device receives successfully on the RF interface. When the value reaches 0xFFFF, it stays there until you manually change the maximum count value or reset the device.

Its parameter value is reset to 0 after every device reset and is not non-volatile; the parameter value does not persist in the device's memory after a power-up sequence.

Pin, serial port or cyclic sleep modes do not reset the GD parameter.

Binary command

0x10 (16 decimal)

Command type

Diagnostics

Parameter range

0 - 0xFFFF

Default

0

Bytes returned

2

HV (Hardware Version)

Reads the device's hardware version number.

Binary command

N/A

Command type

Diagnostics

Parameter range

(read-only): 0 - 0xFFFF

Default

N/A

Bytes returned

N/A

RC (Ambient Power - Single Channel)

Reads and reports the power level on a given channel.

Sample output-78 dBm (when **CF** = 0)4e (when **CF** = 1)

-78 (when **CF** = 2)

Binary command

N/A

Parameter range

(read-only): 0 - 0x31 [dBm]

Default

N/A

Bytes returned

1

RE (Restore Defaults)

Restore device parameters to factory defaults.

RE does not cause the device to store default values to non-volatile (persistent) memory. You must send the WR command prior to power-down or reset to save the default settings in the device's non-volatile memory.

Binary command

0x0E (14 decimal)

Command type

Diagnostics

Parameter range

N/A

Default

N/A

Bytes returned

N/A

RM (Ambient Power)

Reads and reports power levels on all channels. If you do not provide a parameter, the device scans the channels one time. If you do provide a parameter, the device scans the channels repeatedly for the number of seconds that the parameter calls for. The firmware reports the maximum power level seen for each channel (in other words, peak hold).

To implement a graphical spectrum analyzer, repeatedly send RM with no arguments and read the resulting 50 power levels. This is easiest to do when CF = 1 or 2.

Sample output when CF = 0:	Ch 0: -100 dBm
	Ch 1: -103 dBm
	...
	Ch 49: -99 dBm
Sample output when CF = 1: 64	64
	67
	...
	63
Sample output when CF = 2: 100	100
	-103
	...
	-99

Binary command

N/A

Command type

Diagnostics

Parameter range

no parameter - 0x7D0

Default

N/A

Bytes returned

2

RP (RSSI PWM Timer)

Enables a pulse-width modulated (PWM) output on the RSSI pin (pin 7 of the device). We calibrate the pin to show the difference between received signal strength and the sensitivity level of the device. PWM pulses vary from zero to 95 percent. Zero percent means the RF signal the device receives is at or below the device's sensitivity level.

The following table shows dB levels above sensitivity and PWM values. The total time period of the PWM output is 8.32 ms PWM output consists of 40 steps and therefore the minimum step size is 0.208 ms.

dB above sensitivity	PWM percentage (high period / total period)
10	30%
20	45%
30	60%

A non-zero value defines the time that PWM output is active with the RSSI value of the last RF packet the device receives. After the set time when the device has not received RF packets, it sets the PWM output low (0 percent PWM) until the device receives another RF packet. It also sets PWM output low at power-up. A parameter value of 0xFF permanently enables PWM output and always reflects the value of the last received RF packet.

Binary command

0x22 (34 decimal)

Parameter range

0 - 0xFF [x 100 milliseconds]

Default

0x20 (3.2 seconds)

Bytes returned

1

SH (Serial Number High)

Sets or reads the device's serial number high word.

Binary command

0x25 (37 decimal)

Command type

Diagnostics

Parameter range

0 - 0xFFFF

Default

Varies

Bytes returned

2

SL (Serial Number Low)

Sets or reads the serial number low word of the device.

Binary command

0x26 (38 decimal)

Command type

Diagnostics

Parameter range

(read-only): 0 - 0xFFFF

Default

Varies

Bytes returned

2

TP (Board Temperature)

The current module temperature in degrees Celsius in 8-bit two's complement format. For example 0x1A = 26°C, and 0xF6 = -10°C.

Sample output26 C when **CF** = 01A when **CF** = 126 when **CF** = 2**Binary command**

0x38 (56 decimal)

Parameter range

(read-only) 0 - 0x7F

Default

N/A

Bytes returned

1

TR (Transmit Error Count)

Reads the number of RF packets where retries expire without receiving an ACK (when RR > 0).

This count increments whenever a MAC transmission attempt exhausts all MAC retries without ever receiving a MAC acknowledgment message from the destination node. Once the number reaches 0xFFFF, it does not count further events. To reset the counter to any 16-bit value, append a hexadecimal parameter to the command.

This value is volatile (the value does not persist in the device's memory after a power-up sequence).

Binary command

0x1B (27 decimal)

Parameter range

0 - 0xFFFF

Default

0

Bytes returned

2

VL (Firmware Version - Verbose)

Reads the verbose firmware version of the device.

Binary command

N/A

Parameter range

Returns a string

Default

0

Bytes returned

2

VR (Firmware Version - Short)

Reads the firmware version on a device.

Firmware versions contain four significant digits: A.B.C.D. If B = 2, the device is programmed for operation in Australia only.

Binary command

0x14 (20 decimal)

Command type

Diagnostics

Parameter range

(read-only): 0 - 0xFFFF

Default

N/A

Bytes returned

2

WA (Active Warning Numbers)

Reports the warning numbers of all active warnings, one warning number per line. It does not show further information and does not reset warning counts. For information on what the warning numbers mean, see [WN \(Warning Data\) on the next page](#).

Sample output (indicates warnings 1 and 3 are currently active)

1

3

OK

Binary command

N/A

Command type

Diagnostics

Parameter range

Returns a string: one warning number per line.

Default

N/A

Bytes returned

N/A

WN (Warning Data)

Reports the following data for all active and sticky warnings:

- Warning number and description
- Number of occurrences since the last WN or WS command
- Whether the warning is currently active

WN does not display warnings that are not currently active and have not been active since the last issuance of the WN or WS commands. WN resets all non-zero warning counts except for warnings that are presently active, which are set to 1.

Sample output

Warning 4: Over-temperature

5 occurrences; presently inactive.

Warning #	Description
1	Under-voltage. This is caused if the supply voltage falls below the minimum threshold for the lowest power level (2.8 V). If/when the voltage rises above the threshold, the warning is deactivated. The device does not transmit below this voltage threshold.
2	Deprecated.
3	Under-temperature. This is caused if the temperature sensed by the device is less than -40° C. The device does not artificially limit operation while this warning is active, but device functionality is not guaranteed.
4	Over-temperature. This is caused if the temperature sensed by the device is greater than 105° C. The device does not allow transmission nor reception while this warning is active. The warning is deactivated when the temperature falls below 100° C.
5	Deprecated.
6	Deprecated.

Warning #	Description
7	Default configuration parameters in flash. This is caused if user-modifiable parameters (i.e. those stored by WR) in flash are all the compiled-in default values. This is caused if the user configuration is found to be not present or invalid at power-up and there is no custom configuration, or if no user-modifiable parameters have been modified from the compiled-in defaults. Modification of one or more parameters without the subsequent WR to commit the changes to flash will not deactivate this warning, since it reflects the status of the parameters in flash. This warning does not reflect usage of the custom configuration defaults, only usage of the compiled-in defaults.
8	Default factory configuration parameters in flash. This is caused if the factory parameters in flash are all the default values. This is caused if the factory configuration is found to be not present or invalid at power-up, or if no factory parameters have been modified.
9	Watchdog reset occurred.
10	PK was reduced by BR.
11	RB was reduced by PK.
12	One or more parameters overridden due to conflict.

Binary command

N/A

Command type

Diagnostics

Parameter range

Returns a string

Default

N/A

Bytes returned

N/A

WS (Sticky Warning Numbers)

Reports warning numbers of all warnings active since the last use of WS or WN, including any warnings that are currently active. WS also resets all non-zero warning counts, except for warnings that are presently active, which are set to 1.

Binary command

N/A

Command type

Diagnostics

Parameter range

(read-only): 1 - 8

Default

N/A

Bytes returned

1

MAC/PHY commands

The following AT commands are MAC/PHY commands.

AM (Auto-set MY)

Sets the MY (Source Address) parameter from the factory-set serial number of the device. The address consists of bits 29, 28 and 13-0 of the serial number, in that order.

Sending AM displays the address.

Binary command

0x41 (65 decimal)

Command type

MAC/PHY

Parameter range

N/A

Default

N/A

Bytes returned

N/A

DT (Destination Address)

Sets or reads the networking address of a device. The devices use three filtration layers:

- Vendor ID Number (ATID)
- Channel (ATHP)
- Destination Address (ATDT)

The DT command assigns an address to a device that enables it to communicate with other devices in the network. The simplest use of this command is that when MY=0xFFFF and MK=0xFFFF on all devices in a network, only devices with matching DT's communicate with each other.

If MY is not 0xFFFF, then DT acts as a transmit address and MY acts as a receive address. For example, you can set MY to unique values 1, 2, 3, and so forth on unique devices in the network. Then set DT on the transmitting device to match the MY of the receiving device you intend to communicate with.

Setting DT=0xFFFF broadcasts to all devices in the network. For more information, see [Addressing on page 103](#).

Binary command

0x00 (0 decimal)

Command type

MAC/PHY

Parameter range

0 - 0xFFFF

Default

0

Bytes returned

2

HP (Preamble ID)

Set or read the device's hopping channel number. A channel is one of three layers of filtration available to the device.

In order for devices to communicate with each other, the devices must have the same channel number since each channel uses a different hopping sequence. Devices can use different channels to prevent devices in one network from listening to transmissions of another.

When a device receives a packet it checks **HP** before the network ID, as it is encoded in the preamble and the network ID is encoded in the MAC header.

Binary command

0x11 (17 decimal)

Parameter range

0 - 9

Default

0

Bytes returned

1

ID (Network ID)

Sets or reads the Vendor Identification Number (VID) of the device. Devices must have matching VIDs in order to communicate. If the device uses OEM network IDs, 0xFFFF uses the factory value.

Binary command

0x27 (39 decimal)

Parameter range

0x11 - 0x7FFF (user-settable)

0 - 0x10 and 0x8000 - 0xFFFF (factory-set)

Default

0x3332

Bytes returned

2

MK (Address Mask)

Sets or read the device's Address Mask.

All RF data packets contain the Destination Address of the transmitting (TX) device. When a device receives a packet, the TX device's Destination Address is logically combined bitwise (in other words, joined with AND) with the Address Mask of the receiving (RX) device. The resulting value must match the Destination Address or Address Mask of the RX device for the packet to be received and sent out the RX device's DO (Data Out) pin. If the combined value does not match the Destination Address or Address Mask of the RX device, it discards the packet.

Sniffer mode (when MK = 0): the device ignores ACK requests and sends every RX (receive) frame out the UART, without regard for repeated frames.

The firmware treats all 0 values as irrelevant and ignores them. For more information, see [Addressing on page 103](#).

Binary command

0x12 (18 decimal)

Command type

MAC/PHY

Parameter range

0 - 0xFFFF

Default

0xFFFF

Bytes returned

2

MT (Multi-transmit)

Enables multiple transmissions of RF data packets. When you enable Multi-transmit mode (MT > 0), packets do not request an ACK from the receiving devices. MT takes precedence over RR, so if both MT and RR are non-zero, then a device sends MT+1 packets with no ACK requests.

When a receiving device receives a packet with remaining forced retransmissions, it calculates the length of the packet and inhibits transmission for the amount of time required for all retransmissions. From that time on, the device inserts a random number of delay slots between 0 and RN before allowing transmission from the receiving devices. This prevents all listening devices from transmitting at once upon conclusion of a multiple transmission event (when $RN > 0$).

Note The actual number of forced transmissions is the parameter value plus one. For example, if $MT = 1$, a device sends two transmissions of each packet.

For more information, see [Multi-transmit mode on page 105](#).

Binary command

0x3E (62d)

Command type

MAC/PHY

Parameter range

0 - 0xFF

Default

0 (no forced retransmissions)

Bytes returned

1

MY (Source Address)

Sets or reads the Source Address of a device.

For more information, see [DT \(Destination Address\) on page 59](#) and [Addressing on page 103](#).

Binary command

0x2A (42 decimal)

Command type

MAC/PHY

Parameter range

0 - 0xFFFF

Default

0xFFFF (Disabled - DT (Destination Address) parameter serves as both source and destination address).

Bytes returned

2

RN (Delay Slots)

Sets or reads the time delay that the transmitting device inserts before attempting to resend a packet. If the transmitting device fails to receive an acknowledgment after sending a packet, it inserts a random number of delay slots (ranging from 0 to (RN minus 1)) before attempting to resend the packet. Each delay slot is 5 msec when BR = 1 and 54 msec when BR = 0.

If two devices attempt to transmit at the same time, the random time delay after packet failure only allows one device to transmit the packet successfully, while the other device waits until the channel is available for RF transmission.

RN is only applicable if:

- You enable retries using the RR command, or
- You insert forced delays into a transmission using the TT command

Binary command

0x19 (25 decimal)

Command type

MAC/PHY

Parameter range

0 - 0xFF [38 ms delay slots]

Default

0 (no delay slots inserted)

Bytes returned

1

RR (Retries)

Sets or reads the maximum number of retries sent for a given RF packet. When you enable RR (RR > 0), it enables RF packet retries and ACKs.

Exceptions: If you enable the MT command (MT > 0) or if you use a broadcast destination address (DT = 0xFFFF) it disables RF packet retries and ACKs.

After transmitting a packet, the transmitting device waits to receive an ACK from a receiving device. If it does not receive the ACK in the time that RN specifies, it transmits the original packet again. The transmitting device transmits the RF packet repeatedly until it receives an ACK or until it sends the packet RR times.

Binary command

0x18 (24 decimal)

Command type

MAC/PHY

Parameter range

0 - 0xFF

Default

0x0A (10 decimal)

Bytes returned

1

TT (Streaming Limit)

Sets or reads the limit on the number of bytes that a device can send before issuing a random delay.

If a device is sending a continuous stream of RF data, it inserts a delay that stops its transmission and gives other devices time to transmit once it sends TT bytes of data. The random delay it inserts lasts between 1 and RN + 1 delay slots.

You can use TT to simulate full-duplex behavior.

Binary command

0x1A (26 decimal)

Command type

MAC/PHY

Parameter range

0 - 0xFFFF [bytes]

Default

0

Bytes returned

2

RF interfacing commands

The following AT commands are RF interfacing commands.

BR (RF Data Rate)

Sets and reads the device's RF data rate (the rate that the device transmits RF data over-the-air).

Binary command

0x39 (57 decimal)

Parameter range

0 - 1

Parameter	RF data rate
0	10 kb/s
1	125 kb/s

Default

1

Bytes returned

1

FS (Forced Synch Time)

The FS command only applies to streaming data. Normally, only the first packet of a continuous stream contains the full RF initializer. The RF devices then remain synchronized for subsequent packets of the stream.

You can use this parameter to periodically force an RF initializer during such streaming. Any break in UART character reception that is long enough to drain the DI buffer and cause a pause in RF data transmission also causes the firmware to insert an RF initializer on the next transmission.

Binary command

0x3F (63 decimal)

Command type

RF interfacing

Parameter range

0 - 0xFFFF

[x 10 milliseconds]

Default

0

Bytes returned

2

MD (RF Mode)

Sets or reads the settings that enable the Polling and Repeater modes on the device.

Polling Mode: a Polling Base is responsible for polling remotes. A Polling Remote requires a poll from a Polling Base in order to transmit.

Repeater Mode: a Repeater re-sends RF data unless the transmission is addressed to it or if it has already detected the transmission. A Repeater End Node handles repeated messages, but will not repeat the message over-the-air.

For more information, see [Basic communications on page 104](#).

Binary command

0x31 (49 decimal)

Command type

RF interface

Parameter range

0 - 6

Parameter	Configuration
0	Transparent Operation (Repeater Base)
1	Reserved - not used
2	Reserved - not used
3	Polling Base
4	Polling Remote
5	Repeater
6	Repeater End Node

Default

0

Bytes returned

1

PB (Polling Begin Address)

Sets or reads the device's Polling Begin Address, which is the first address polled when you enable Polling mode.

Binary command

0x45 (69 decimal)

Command type

RF interface

Parameter range

0 - 0xFFFF

Default

0

Bytes returned

2

PD (Minimum Polling Delay)

Sets or reads the Polling Delay (Base, MD = 3) or Polling Timeout (Remote, MD = 4).

Polling Delay (Base) is the time between polling cycles. The Polling Base starts the polling cycle after sending the first poll. After the polling cycle completes, the timer restarts.

Polling Timeout (Remote) is the amount of time the remote device holds data from the serial port before discarding it. The device transmits data entered within the PD time of the poll and does not discard it.

Binary command

0x47 (71 decimal)

Command type

RF interface

Parameter range

0 - 0xFFFF (Base: [x 1ms], Remote: [x 10ms])

Default

0x64

Bytes returned

2

PE (Polling End Address)

Sets or reads the device's Polling End Address; which is the last address polled when you enable Polling mode.

Binary command

0x46 (70 decimal)

Command type

RF interface

Parameter range

0 - 0xFFFF

Default

0

Bytes returned

2

PK (Maximum RF Packet Size)

Sets or reads the maximum size of RF packets that a device in Transparent operating mode (AP = 0) transmits. You can use the maximum packet size along with the RB and RO parameters to implicitly set the channel dwell time.

If you set PK above 256 and subsequently change BR to 0, PK lowers to 256 and issues a warning. For more information, see [BR \(RF Data Rate\) on page 65](#) and [WN \(Warning Data\) on page 56](#).

Changes to the PK parameter may have a secondary effect on the RB (Packetization Threshold) parameter. RB must always be less than or equal to PK. If you change PK to a value that is less than the current value of RB, the RB value lowers to be equal to PK.

Binary command

0x29 (41 decimal)

Command type

RF interfacing

Parameter range

1 - 0x800 [Bytes]

Default

0x100 (BR=0) 0x800 (BR=1)¹

Bytes returned

2

¹When BR = 0 (9600 baud), the maximum PK value is 0x100 (256 bytes). When BR = 1 (115,200 baud), the maximum PK value is 0x800 (2048 bytes).

PL (TX Power Level)

Sets or reads the power level at which the device transmits conducted power.

The PRO XTC device requires the power supply to be above 3.3 V to ensure 30 dBm output power. The following table shows the typical values over supply voltage.

Power supply	Output power
3.3 to 3.6 V	30 dBm typical
3.0 V	29 dBm typical
2.6 V	27 dBm typical

Binary command

0x3A (58 decimal)

Command type

RF interfacing

Parameter range

0 - 4

XB9XT (non-PRO)		XBP9XT (PRO)
Parameter	Configuration	Configuration
PL0	0 dBm	20 dBm ¹
PL1	10 dBm	
PL2	13 dBm	
PL3	13 dBm	27 dBm

¹We do not recommend the 20 dBm power level when operating at temperatures below 0°C. Output power may vary significantly below 0°C.

XB9XT (non-PRO)		XBP9XT (PRO)
Parameter	Configuration	Configuration
PL4	13 dBm	30 dBm (1 Watt)

Default

4

Bytes returned

1

TX (Transmit Only)

Sets or reads the transmit or receive behaviors of the device. Setting a device to TX-only (TX = 1) may reduce latency because the you can not limit the transmitting device to receiving data from other devices.

Binary command

0x40 (64d)

Command type

RF Interfacing

Parameter range

0 - 1

Parameter	Description
0	TX and RX
1	TX only

Default

0

Bytes returned

1

Security commands

The following AT commands are security commands.

KY (AES Encryption Key)

Sets the 256-bit Advanced Encryption Standard (AES) key for encrypting or decrypting data. Once set, you cannot read the key out of the device by any means. The firmware encrypts the entire payload of the packet using the key and computes the CRC across the ciphertext. When you enable encryption, each packet carries an additional 16 bytes to convey the random cipher-block chaining (CBC) Initialization Vector (IV) to the receiver(s). The KY value may be 0 or any 256-bit value (= 64 hex digits = 32 bytes). Any other value, including entering **ATKY** by itself with no parameters, causes an error.

A device with the wrong key (or no key) receives encrypted data, but the data driven out the serial port is meaningless. Likewise, a device with a key receives unencrypted data sent from a device without a key, but the output is meaningless. Because it uses CBC mode, repetitive data appears differently in different transmissions due to the randomly-generated IV.

Note For international (non-U.S.) variants of XTC devices, the encryption key is 128-bit AES. The command operates the same except the key length is 16 bytes rather than 32 bytes. This pertains to part numbers ending with 128, no matter which firmware version is loaded. This also pertains to the Australia version of firmware 22xx.

Binary command

0x43 (67d)

Command type

Security

Parameter range

0 - (64 hex digits all set to 'F')

Default

0 (disabled)

Bytes returned

2

Serial interfacing commands

The following AT commands are serial interfacing commands.

AP (API Enable)

The API mode setting. The device can format the RF packets it receives into API frames and send them out the serial port.

When you enable API, you must format the serial data as API frames because Transparent operating mode is disabled.

Binary command

N/A

Parameter range

0-2

Parameter	Description
0	Transparent Mode. All UART input and output is raw data and the device uses the RO parameter to delineate packets.
1	API Mode Without Escapes. The device packetizes all UART input and output data in API format, without escape sequences.
2	API Mode With Escapes. The device is in API mode and inserts escaped sequences to allow for control characters. The device passes 0x11, 0x13, 0x7d, and 0x7e as data.

Default

0

Bytes returned

1

BD (Interface Data Rate)

Sets and reads the serial interface data rate (baud rate) between the device and the host. The baud rate is the rate that the host sends serial data to the device.

When you make an update to the interface data rate, the change does not take effect until the host issues the CN command and the device returns the OK response.

The BD parameter does not affect the RF data rate. If you set the interface data rate higher than the RF data rate, you may need to implement a flow control configuration.

The range between standard and non-standard baud rates (0x9 - 0x4B0) is invalid. The range between 0x2580 and 0x4AFF is also invalid.

Non-standard interface data rates

The firmware interprets any value within 0x4B0 - 0x2580 and 0x4B00 - 0x1C9468 as an actual baud rate. When the host sends a value above 0x4B0, the firmware stores the closest interface data rate represented by the number in the BD register. For example, to set a rate of 19200 b/s, send the following command line: **ATBD4B00**.

Note When using XCTU, you can only set and read non-standard interface data rates using the XCTU Serial Console tool. You cannot access non-standard rates through the configuration section of XCTU.

Note The device does not support nonstandard baud rates between 9601 and 19199 baud. If you attempt to set baud rates in this range, it will return an error.

When you send the BD command with a non-standard interface data rate, the UART adjusts to accommodate the interface rate you request. In most cases, the clock resolution causes the stored BD parameter to vary from the sent parameter. Sending **ATBD** without an associated parameter value returns the value actually stored in the device's BD register.

The following table provides the parameters sent versus the parameters stored.

BD parameter sent (HEX)	Interface data rate (b/s)	BD parameter stored (HEX)
0	1200	0
4	19,200	4
7	115,200	7
1C200	115,200	1B207

Binary command

0x15 (21 decimal)

Command type

Serial Interfacing

Parameter ranges

0 - 8 (standard rates)

0x4B0 - 0x1C9468 (non-standard rates; ; 0x2581 to 0x4AFF not supported)

Parameter	Configuration (b/s)
0	1200
1	2400
2	4800
3	9600
4	19200
5	38400
6	57600
7	115200
8	230400

Default

3

Bytes returned

4

CD (GP02 Configuration)

Selects or reads the behavior of the GPO2 line (pin 5).

Binary command

0x28 (40 decimal)

Parameter range

0 - 4

Parameter	Configuration
0	RX LED
1	Static high
2	Static low
3	Reserved
4	RX LED (valid address only)

Default

2

Bytes returned

1

CS (GP01 Configuration)

Sets or reads the behavior of the GP01 line (pin 25). This output can provide RS-232 flow control and controls the TX enable signal for RS-485 or RS-422 operations.

By default, GP01 provides RS-232 Clear-to-Send ($\overline{\text{CTS}}$) flow control.

Binary command

0x1F (31 decimal)

Parameter range

0 - 4

Parameter	Configuration
0	RS-232 $\overline{\text{CTS}}$ flow control

Parameter	Configuration
1	RS-485 TX enable low
2	Static high
3	RS-485 TX enable high
4	Static low

Default

0

Bytes returned

1

FL (Software Flow Control)

Configures software flow control. Use the CS and RT commands to implement Hardware Flow Control.

Set FL to 1 to enable Software flow control (XON/XOFF).

Set FL to 0 to disable Software flow control.

The XON character used is 0x11 (17 decimal).

The XOFF character used is 0x13 (19 decimal).

Binary command

0x07 (7 decimal)

Command type

Serial interfacing

Parameter range

0 - 1

Default

0

Bytes returned

1

FT (Flow Control Threshold)

Sets or reads the flow control threshold.

De-assert $\overline{\text{CTS}}$ when the number of bytes specified by the **FT** parameter are in the DIN buffer. Re-assert $\overline{\text{CTS}}$ when less than FT - 16 bytes are in the UART receive buffer.

Binary command

0x24 (36 decimal)

Parameter range

0x11 - 0xC00 [bytes]

Default

0xBBF (DI buffer size minus 0x11)

Bytes returned

2

NB (Parity)

Set or read the parity settings for UART communications.

Binary command

0x23 (35 decimal)

Command type

Serial interfacing

Parameter range

0 - 4

Parameter	Configuration
0	8-bit (no parity) or 7-bit (any parity)

Parameter	Configuration
1	8-bit even
2	8-bit odd
3	8-bit mark
4	8-bit space

Default

0

Bytes returned

1

RB (Packetization Threshold)

Sets or reads the character threshold value.

RF transmission begins after a device receives data in the DIN buffer and meets either of the following criteria:

- The UART receives **RB** characters
- The UART receive lines detect **RO** character times of silence after receiving at least 1 byte of data

If a device lowers **PK** below the value of **RB**, **RB** is automatically lowered to match the PK value.

If **RO** = 0, the device must receive **RB** bytes before beginning transmission.

RB and **RO** criteria only apply to the first packet of a multi-packet transmission. If data remains in the DIN buffer after the first packet, transmissions continue in a streaming manner until there is no data left in the DIN buffer.

Binary command

0x20 (32 decimal)

Parameter range0 - **PK** parameter value

(up to 0x800 bytes)

Default

0x800 (2048 bytes)

Bytes returned

2

RO (Packetization Timeout)

Set or read the number of character times of inter-character silence required before transmission begins. For information on how **RO** works with the **RB** command, see [RB \(Packetization Threshold\) on the previous page](#).

When RO is the transmission-beginning criteria:

The actual time between the reception of the last character from the UART and the beginning of RF transmission is at least 800 μ sec longer than the actual **RO** time to allow for transmission setup. It is also subject to 100-200 μ sec of additional uncertainty, which could be significant for small values of **RO** at high UART bit rates.

The firmware calculates the correct UART character time (10, 11, or 12 bits) based on the following criteria:

- 1 start bit
- 8 data bits
- 0 or 1 parity bit (as determined by the **NB** command)
- 1 or 2 stop bits (as determined by **SB** command)

Binary command

0x21 (33 decimal)

Parameter range

0 - 0x53E2 [x UART character times]

Default

3

Bytes returned

2

RT (GPI1 Configuration)

Sets or reads the behavior of the GPI1 pin (pin 29) of the device. You can configure the pin to enable Binary Command mode or $\overline{\text{RTS}}$ flow control.

Binary command

0x16 (22 decimal)

Parameter range

0 - 2

Parameter	Configuration
0	Disabled
1	Binary Command enable
2	$\overline{\text{RTS}}$ flow control

Default

0 (disabled)

Bytes returned

1

SB (Stop Bits)

Sets or reads the number of stop bits in the data packet.

Binary command

0x37 (55 decimal)

Parameter range

0 - 1

Parameter	Configuration
0	1 stop bit

Parameter	Configuration
1	2 stop bits

Default

0

Bytes returned

1

Sleep commands

The following AT commands are sleep commands.

FH (Force Wakeup Initializer)

Forces the device to send a wake-up initializer on the next transmission.

Only use FH with cyclic sleep modes active on remote devices.

FH will not send a long header if HT = 0xFFFF.

You do not need to issue the WR (Write) command with FH.

Binary command

0x0D (13 decimal)

Command type

Sleep (low power)

Parameter range

N/A

Default

N/A

Bytes returned

N/A

HT (Time before Wake-up Initializer)

Sets or reads the time of inactivity (no serial or RF data is sent or received) before a transmitting (TX) RF device sends a wake-up initializer. The main purpose of this command is to prevent devices from sending the Long Header with every data packet. For more information on long headers, see [LH \(Wakeup Initializer Timer\) below](#).

For RX devices operating in Cyclic Sleep mode (SM = 4-8), set HT to be shorter than the ST command.

The TX device sends a wake-up initializer, which instructs all receiving (RX) devices to remain awake to receive RF data.

From the perspective of the RX device: after HT time elapses and the inactivity timeout (ST command) is met, the RX device goes into cyclic sleep. In cyclic sleep, the RX device wakes once per sleep interval (SM command) to check for a wake-up initializer. When it detects a wake-up initializer, the device stays awake to receive data. The wake-up initializer must be longer than the cyclic sleep interval to ensure that sleeping devices detect incoming data.

When HT time elapses, the TX device knows it needs to send a wake-up initializer for all RX devices to remain awake and receive the next transmission.

Binary command

0x03 (3 decimal)

Command type

Sleep

Parameter range

0 - 0x53E2, 0xFFFF [x 100 ms]

Default

0xFFFF (wake-up initializer will not be sent)

Bytes returned

2

LH (Wakeup Initializer Timer)

Sets or reads the duration of time during which the wake-up initializer is sent. When receiving devices are in Cyclic Sleep Mode, they power-down after a period of inactivity as specified by the ST parameter and will

periodically wake and listen for data transmissions. In order for the receiving devices to remain awake, they must detect ~35 ms of the wake-up initializer.

You must use LH whenever a receiving device is operating in Cyclic Sleep mode. The wake-up initializer time must be longer than the cyclic sleep time, which is set by the SM (Sleep Mode) parameter. If the wake-up initializer time is less than the Cyclic Sleep interval, the connection is at risk of missing the wake-up initializer transmission.

To view a diagram of the correct configuration, see [Cyclic Sleep Mode \(SM = 4-8\) on page 27](#).

Binary command

0x0C (12 decimal)

Command type

Sleep

Parameter range

0 - 0xFF [x100 milliseconds]

Default

1

Bytes returned

1

PW (Pin Wakeup)

Enables or disables the sleep pin.

Under normal operation, a device in Cyclic Sleep mode cycles from an active state to a low-power state at regular intervals until it is ready to receive data. If you set PW to 1, you can use the SLEEP pin (pin 26) to wake the device from Cyclic Sleep. When you de-assert (low) the SLEEP pin, the device is operational and will not go into Cyclic Sleep.

Once you assert the SLEEP pin, the device remains active for the period of time specified by the ST parameter and returns to Cyclic Sleep mode if no data is ready to transmit. PW is only valid if Cyclic Sleep is enabled.

Binary command

0x1D (29 decimal)

Command type

Sleep

Parameter range

0 - 1

Parameter	Configuration
0	Disabled
1	Enabled

Default

0

Bytes returned

1

SM (Sleep Mode)

Sets or reads the device's sleep mode settings, which configure the device to run in states that require minimal power consumption.

Binary command

0x01

Command type

Sleep

Parameter range

0 - 8 (3 is reserved)

Parameter	Description
0	Disabled
1	Pin Sleep

Parameter	Description
2	Serial Port Sleep
3	[reserved]
4	Cyclic 1 second sleep (RF module wakes every 1.0 seconds)
5	Cyclic 2 second sleep
6	Cyclic 4 second sleep
7	Cyclic 8 second sleep
8	Cyclic 16 second sleep

Default

0

Bytes returned

1

ST (Time before Sleep)

Sets or reads the amount of time (in milliseconds) that the device remains inactive before entering Sleep mode. For example, if you set ST to 0x64 (100 decimal), the device enters Sleep mode after 10 seconds of inactivity (no transmitting or receiving).

You can only use this command if you use SM to select Cyclic Sleep or Serial Port Sleep mode settings; see [SM \(Sleep Mode\) on the previous page](#).

Binary command

0x02 (2 decimal)

Command type

Sleep

Parameter range

(AT + 3) - 0x53E2 [x 100 ms]

Default

0x64 (10 seconds)

Bytes returned

2

XTC RF ModuleSpecial commands

The following AT commands are special commands.

WR (Write)

Writes parameter values to non-volatile memory so that parameter modifications persist through subsequent resets.

If you make changes without writing them to non-volatile memory, the device reverts to previously saved parameters the next time it is powered on.

If the non-volatile user configuration is not correct, WR will re-attempt up to three times. If all three attempts fail, the command returns an ERROR alert.

Binary command

0x08

Command type

Special

Parameter range

N/A

Default

N/A

Bytes returned

N/A

XTC RF Module API operation

API mode overview

By default, the XTC RF Module acts as a serial line replacement (Transparent operation), it queues all UART data that it receive through the DI pin for RF transmission. When the device receives an RF packet, it sends the data out the DO pin with no additional information.

The following behaviors are inherent to Transparent operation:

- If device parameter registers are to be set or queried, a special operation is required for transitioning the device into Command Mode; refer to [Enter Command mode on page 21](#).
- In point-to-multipoint systems, the host application must send eXTend vBa if the receiving device(s) need to distinguish between data coming from different remotes.

API operating mode is an alternative to transparent mode. API mode is a frame-based protocol that allows you to direct data on a packet basis. It can be particularly useful in large networks where you need to control the destination of individual data packets or when you need to know which node a data packet was sent from. The device communicates UART data in packets, also known as API frames. This mode allows for structured communications with serial devices. It is helpful in managing larger networks and is more appropriate for performing tasks such as collecting data from multiple locations or controlling multiple devices remotely.

API frame specifications

The firmware supports two API operating modes: with escaped characters and without escaped characters. Use the AP command to enable either mode. To configure a device to one of these modes, set the following AP parameter values:

1. AP = 0: Transparent operating mode, UART serial line replacement with API modes disabled.
2. AP = 1: API operation.
3. AP = 2: API operation with escaped characters.

The API data frame structure differs depending on what mode you choose.

API operation (AP parameter = 1)

When you enable this mode, the following diagram illustrates the data frame structure:

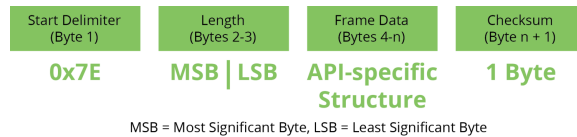

The firmware silently discards any data it receives prior to the start delimiter. If the device does not receive the frame correctly or if the checksum fails, the device discards the frame.

API operation-with escaped characters (AP parameter = 2)

API mode 2 is rarely necessary to use. API mode 1 is fully capable of transmitting all characters including those that can be escaped. If you think you need to use API mode 2, contact Digi Support so we can discuss your application. For details, read the following article:

http://knowledge.digi.com/articles/Knowledge_Base_Article/Escaped-Characters-and-API-Mode-2

When you enable this mode, the following diagram illustrates the data frame structure:

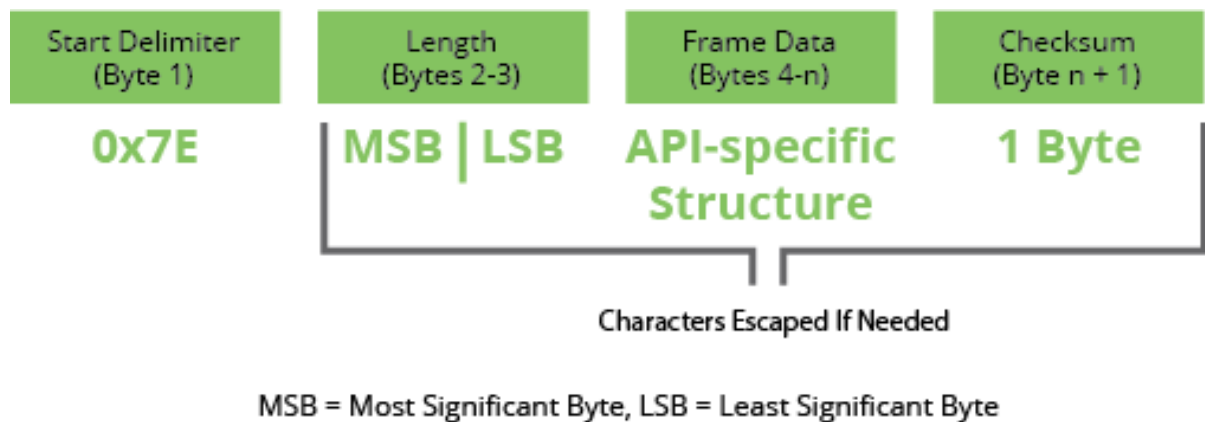

The following paragraphs explain what the fields within the API frame mean.

Start delimiter

The first byte of a frame consists of a special sequence of bits that indicate the beginning of a data frame. Its value is always 0x7E. This allows an application to easily detect a new incoming frame.

Length

The length field specifies the total number of bytes included in the frame's data field. Its two-byte value excludes the start delimiter, the length, and the checksum.

Frame data

This field contains the information that a device receives or will transmit. The structure of frame data depends on the purpose of the API frame:

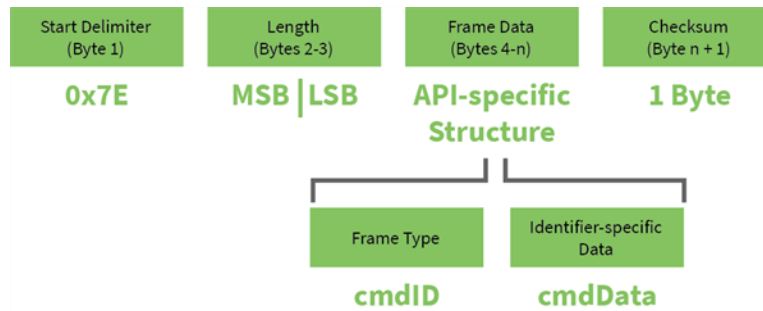

- **Frame type** is the API frame type identifier. It determines the type of API frame and indicates how the Data field organizes the information.
- **Data** contains the data itself. This information and its order depend on the what type of frame that the Frame type field defines.

The Frame Type byte indicates which API messages the data bytes (Identifier-specific data) will contain.

Checksum

The value 0xFF minus the 8-bit sum of bytes from offset 3 to this byte. Checksum is the last byte of the frame and helps test data integrity.

The device does not process frames sent through the serial interface with incorrect checksums, and ignores their data.

Calculate and verify checksums

To calculate the checksum of an API frame:

1. Add all bytes of the packet, excluding the start delimiter 0x7E and the length (the second and third bytes).
2. Keep only the lowest 8 bits from the result.
3. Subtract this quantity from 0xFF.

To verify the checksum of an API frame:

1. Add all bytes including the checksum; do not include the delimiter and length.
2. If the checksum is correct, the last two digits on the far right of the sum will equal 0xFF.

Escaped characters in API frames

If operating in API mode with escaped characters (AP parameter = 2), when you send or receive an API frame, you must escape (flag) specific data values so they do not interfere with data frame sequencing. In API operating mode with escaped characters, you must escape the following data bytes:

- 0x7E: start delimiter
- 0x7D: escape character
- 0x11: XON
- 0x13: XOFF

API operating mode with escaped characters guarantees that all the 0x7E bytes a device receives are start delimiters: this character cannot be part of any of the other frame fields (length, data, or checksum) since you must escape it.

To escape a character:

1. Insert 0x7D, the escape character.
2. Append it with the byte you want to escape, XORed with 0x20.

In API operating mode with escaped characters, the length field does not include any escape characters in the frame and the firmware calculates the checksum with non-escaped data.

Example: escape an API frame

To express the following API non-escaped frame in API operating mode with escaped characters:

Start delimiter	Length		Frame type	Frame Data														Checksum
				Data														
7E	00	0F	17	01	00	13	A2	00	40	AD	14	2E	FF	FE	02	4E	49	6D

You must escape the 0x13 byte:

1. Insert a 0x7D.
2. XOR byte 0x13 with 0x20: $13 \oplus 20 = 33$

The following figure shows the resulting frame. Note that the length and checksum are the same as the non-escaped frame.

Start delimiter	Length		Frame type	Frame Data														Checksum	
				Data															
7E	00	0F	17	01	00	7D	33	A2	00	40	AD	14	2E	FF	FE	02	4E	49	6D

The length field has a two-byte value that specifies the number of bytes in the frame data field. It does not include the checksum field.

XTC RF Module API frame overview

The device sends multi-byte values in big-endian format. The devices support the following API frames:

API frame name	API ID
Transmit Request	0x01
RF Module Status	0x8A
Transmit Status	0x89
Receive Packet	0x81

RF Module Status 0x8A

Description

Devices send the status messages in this frame in response to specific conditions.

Format

The following table provides the contents of the frame. For details on frame structure, see [API frame specifications on page 89](#).

Frame fields	Byte(s)	Description
Frame type	4	0x8A
Status	5	0x00 = Hardware reset 0x01 = Watchdog timer reset

Example

When a device powers up, it returns the following API frame:

Frame fields	Offset	Example
Start Delimiter	0	0x7E
Length	MSB 1	0x00
	LSB 2	0x02
Frame Type	3	0x8A
Status	4	0x00
Checksum	5	0x75

Transmit Request: 16-bit address 0x01**Description**

This frame causes the device to send data as an RF packet to a specific destination.

Format

The following table provides the contents of the frame. For details on frame structure, see [API frame specifications on page 89](#).

Frame fields	Byte(s)	Description
Frame type	4	0x01
Frame ID	5	Identifies the data frame for the host to correlate with a subsequent ACK. Setting Frame ID to 0 disables the response frame.
Destination address	6-7	MSB first, LSB last. Broadcast = 0xFFFF.
Options	8	0 = standard. 1 = disable ACK.
RF data	9-n	Up to 2048 bytes per packet. The payload size is limited by the PK command.

Example

The following example shows how to send a transmission to a device with destination address 0x5642, and payload “TxData0A”.

Frame fields	Offset	Example
Start delimiter	0	0x7E
Length	MSB 1	0x00
	LSB 2	0x0D
Frame type	3	0x01
Frame ID	4	0x01
Destination address	MSB 5	0x56
	LSB 6	0x42
Options	7	0x00

Frame fields	Offset	Example
RF data	8	0x54
	9	0x78
	10	0x44
	11	0x61
	12	0x74
	13	0x61
	14	0x30
	15	0x41
Checksum	16	0xAE

Transmit Status frame 0x89

Description

When a TX Request is completed, the device sends a TX Status message. This message will indicate if the packet was transmitted successfully or if there was a failure.

Format

The following table provides the contents of the frame. For details on frame structure, see [API frame specifications on page 89](#).

Frame fields	Byte (s)	Description
Frame type	4	0x89

Frame fields	Byte (s)	Description
Frame ID	5	Identifies the data frame for the host to correlate with a subsequent ACK. Setting Frame ID to 0 disables the response frame.
Status	6	0 = success. 1 = all retries expired and no ACK received. 3 = a packet is purged due to a Polled Remote not receiving a poll.

Example

In the following example, the destination device reports that a unicast data transmission was successful using a frame ID of 0x47.

Frame fields	Offset	Example
Start Delimiter	0	0x7E
Length	MSB 1	0x00
	LSB 2	0x03
Frame type	3	0x89
Frame ID	4	0x47
Options	5	0x00
Checksum	6	0x2F

Receive Packet: 16-bit address 0x81

Description

When the device receives an RF packet, it is sent out the UART using this message type.

Format

The following table provides the contents of the frame. For details on frame structure, see [API frame specifications on page 89](#).

Frame fields	Byte (s)	Description
Frame type	4	0x81
Source address	5-6	MSB first LSB last
RSSI	7	RSSI = hexadecimal equivalent of -dBm value. For example, if RX signal strength = -40 dBm, it returns 0x28 (40 decimal).
Options	8	Bit 0 = ACK Bit 1 = indicate broadcast bits 2-7 = reserved
RF data	9-n	Up to 2048 bytes per packet.

Example

In the following example, a device with a source address of 0xA35E sent a unicast data transmission to a remote device with a payload of "RxData". The receiving device would send the following frame out its UART:

Frame fields	Offset	Example
Start Delimiter	0	0x7E
Length	MSB 1	0x00
	LSB 2	0x0B
Frame type	3	0x81

Frame fields	Offset	Example
Source address	MSB 4	0xA3
	LSB5	0x5E
RSSI	6	0x5D
Options	7	0x01
RF data	8	0x52
	9	0x78
	10	0x44
	11	0x61
	12	0x74
	13	0x61
Checksum	14	0xDB

Network configurations

network topologies

The XTC RF Module supports three different network topologies: point-to-point, point-to-multipoint and peer-to-peer.

Point-to-point networks

This following section provides the RF communication type and RF mode for XTC RF Module point-to-point networks.

Definition

Point-to-point means an RF data link between two devices.



Sample network profile (Broadcast communications)

Use the default values for all devices.

Sample network profile (Acknowledged communications)

Note Assume the default value for all parameters that are not in this list. These profiles do not reflect addressing implementations.

1. Use XCTU or another terminal program to send the AM command. See [AM \(Auto-set MY\) on page 58](#) for details.
2. Set the destination address to 0xFFFF, send: **ATDT FFFF**

Basic RF modes

Streaming, Multi-Transmit, Repeater.

Acknowledged RF mode

Acknowledged mode.

Point-to-multipoint networks

This following section provides the RF communication type and RF mode for XTC RF Module point-to-multipoint networks.

Definition

Point-to-multipoint means a network with RF data links between one base and multiple remotes.

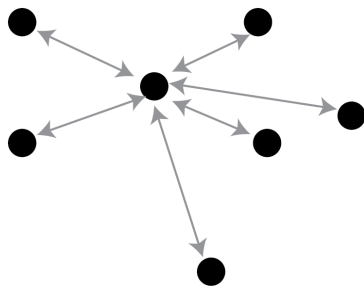
**Sample network profile (Broadcast communications)**

Note Assume the default value for all parameters that are not in this list. These profiles do not reflect addressing implementations.

Base:

1. Send **ATMY 0** to set the source address to 0x00.
2. Send **ATDT FFFF** to set the destination address to 0xFFFF.

Remotes:

1. Use XCTU or another terminal program to send the AM command. See [AM \(Auto-set MY\) on page 58](#) for details.
2. Send **ATDT 0** to set the destination address to 0x00.

Sample network profile (Acknowledged communications)

Note Assume the default value for all parameters that are not in this list. These profiles do not reflect addressing implementations.

Base:

1. Send **ATMY 0** to set the source address to 0x00.
2. Send **ATDT FFFF** to set the destination address to 0xFFFF.

3. Send **ATTR 3** to set the number of retries to 3.

Remotes:

1. Use XCTU or another terminal program to send the AM command.
2. Send **ATDT FFFF** to set the destination address to 0xFFFF.
3. Send **ATTR 3** to set the number of retries to 3.

Basic RF modes

Streaming, Multi-Transmit, Repeater, and Polling.

Acknowledged RF mode

Acknowledged and Polling.

Peer to peer networks

This following section provides the RF communication type and RF mode for XTC RF Module peer-to-peer networks.

Definition

In Peer-to-peer networks, RF devices remain synchronized without the use of master/server dependencies. Each device shares the roles of master and slave. Digi's peer-to-peer architecture features fast synch times (35 ms to synchronize devices) and fast cold start times (50 ms before transmission).

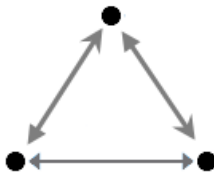

Sample network profile (Broadcast communications)

Note Assume the default value for all parameters that are not in this list. These profiles do not reflect addressing implementations.

Use the default values for all devices.

Sample network profile (Acknowledged communications)

Note Assume the default value for all parameters that are not in this list. These profiles do not reflect addressing implementations.

All devices:

1. Send **ATMY 0** to set the source address to 0x00.
2. Send **ATDT FFFF** to set the destination address to 0xFFFF.
3. Send **ATRR 3** to set the number of retries to 3.

Basic RF modes

Streaming.

Acknowledged RF mode

Acknowledged.

Addressing

Each RF packet contains addressing information that the receiving devices use to filter incoming RF data. Receiving devices inspect the Preamble ID (**HP** parameter), Vendor Identification Number (**ID** parameter) and Destination Address (**DT** parameter) in each RF packet. A receiving device discards all data that does not pass through all three network security layers.

The following image illustrates the addressing layers in the RF packet header.

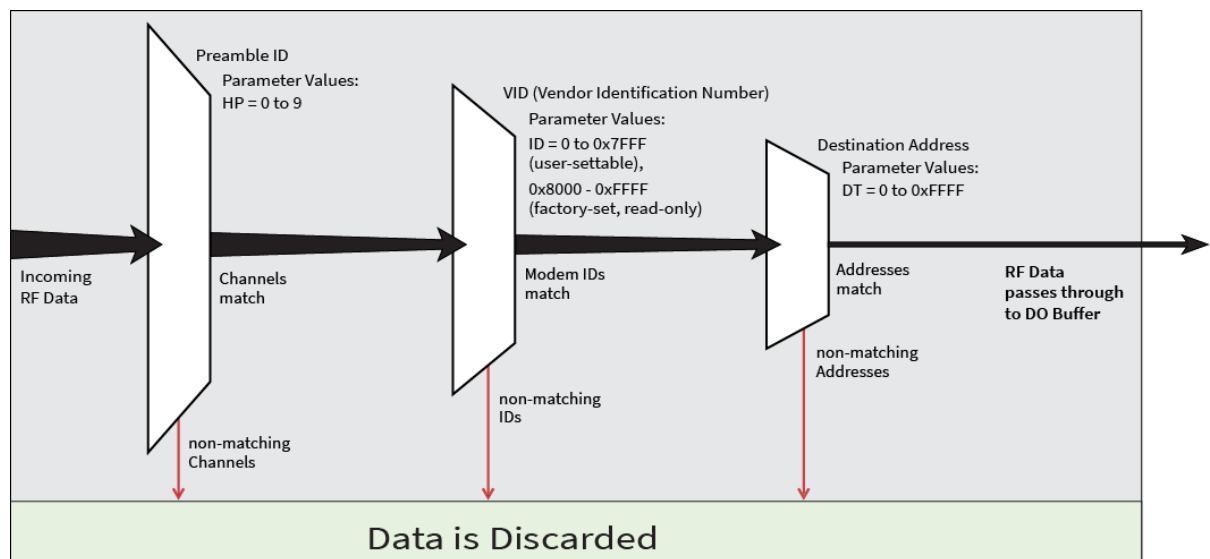

Address recognition

The transmitting device can address transmissions to a specific device or group of devices using the DT and MK commands. A receiving device only accepts a packet if it determines that the packet is addressed to it, either as a global or local packet. The receiving device makes this determination by inspecting the destination address of the packet and comparing it to its own address and address mask.

The transmitting device determines whether the packet is for a specific node (local address) or multiple nodes (global address) by comparing the packet's destination address (DT) and its own address mask (MK). This assumes you program the address masks on the transmitting device and receiving device to the same value for proper operation in each RF communication mode.

For more information, see [DT \(Destination Address\) on page 59](#) and [MK \(Address Mask\) on page 61](#).

Basic communications

Basic communications includes two sub-types:

- **Broadcast.** By default, the XTC RF Module communicates through Broadcast communications and within a peer-to-peer network topology. When any device transmits, all other devices within range receive the data and pass it directly to their host device.
- **Addressed.** If addressing parameters match, the device forwards the RF data it receives to the DOUT buffer; otherwise, it discards the RF data.

When using Basic communications, the integrator handles any functions, such as acknowledgments, at the application layer. The Broadcast modes provide transparent communications, meaning that the RF link replaces a wired link.

Streaming mode (default)

Streaming mode is most appropriate for data systems that are more sensitive to latency and/or jitter than to occasional packet loss; for example: streaming audio or video.

Characteristics	Highest data throughput Lowest latency and jitter Reduced immunity to interference Transmissions never acknowledged (ACK) by receiving device (s)
Required parameter values (TX device)	RR = 0
Related commands	Networking (DT, MK, MY), Serial interfacing (PK, RB, RO, TT)

Streaming mode connection sequence

Events and processes in this mode are common to all of the other RF modes.

When streaming data, the firmware only observes the RB and RO parameters on the first packet.

After transmission begins, the transmission event continues without interruption until the DIN buffer is empty or the device reaches the streaming limit (TT parameter). As with the first packet, the payload of each subsequent packet includes up to the maximum packet size (PK parameter).

The TX (transmitting) device specifies the TT parameter as the maximum number of bytes the TX device can send in one transmission event. After the device reaches the TT parameter threshold, the TX device forces a random delay of 1 to RN delay slots; exactly 1 delay slot if RN = 0.

The TX device sends subsequent packets without an RF initializer since RX (receiving) devices remain synchronized with the TX device for the duration of the transmission (from preceding packet information). However, due to interference, some RX devices may lose data (and synchronization to the TX device), particularly during long transmission events.

Once the TX device has sent all pending data or has reached the TT limit, the transmission event ends. The TX device does not transmit again for exactly RN delay slots if the local (for example the TX device's) RN parameter is set to a nonzero value. The RX device(s) do not transmit for a random number of delay slots between 0 and (RN-1) if the local (for example the RX device's) RN parameter is set to a non-zero value. These delays lessen congestion following long bursts of packets from a single TX device, during which several RX devices may have become ready to transmit.

Multi-transmit mode

Use Multi-transmit mode for applications that require reliable delivery without using retries and acknowledgments.

Characteristics	Reliable delivery through forcing the transmission of every RF packet. Every RF packet is sent exactly MT + 1 times, with no delays between packets. Diminished throughput and increased latency.
Required parameter values (TX device)	MT ≥ 1.
Related commands	Networking (DT, MK, MY, RN, TT), Serial interfacing (BR, PK, RB, RO), RF interfacing (FS).

Multi-transmit mode connection sequence

In Multi-transmit mode, the device re-transmits each packet MT times, for a total of (MT+1) transmissions. There is no delay between retransmissions, and the TX (transmitting) device never receives RF data between retransmissions. Each retransmission includes an RF initializer. A transmission event may include

follow-on packets, each of which retransmit MT times. Devices ignore the Forced Sync (FS) parameter in Multi-Transmit Mode.

The firmware does not apply the RB and RO parameters to follow-on packets, meaning that once transmission has begun, it continues without interruption until the DIN buffer is empty or the device reaches the streaming limit (TT parameter). As with the first packet, the payload of each follow-on packet includes up to the maximum packet size (PK parameter) bytes, and the TX device checks for more pending data near the end of each packet. The device does not send follow-on packets until it finishes all retransmissions of the previous packet.

The TX device specifies the streaming limit (TT) as the maximum number of bytes that the TX device can send in one transmission event, which may consist of many packets. If the device reaches the TT parameter limit, the TX device forces a random delay of 1 to RN delay slots (exactly 1 delay slot if RN is zero). In Multi-transmit mode, the firmware counts each packet only once when tracking the streaming limit (TT), no matter how many times it is retransmitted.

When an RX (receiving) device receives a Multi-transmit packet, it calculates the amount of time remaining in the Multi-transmit event, and inhibits its own transmissions for the duration of the Multi-transmit event, plus a random number of delay slots between 0 and (RN-1). If the local RN parameter is zero, the delay is only for the calculated duration of the event. An RX device only needs to receive one of the transmissions, and it keep the channel off until the TX device is complete. If follow-on packets are coming, the RX devices move to the new frequency and listen for the follow-on packet for a specific period of time.

Repeater mode

Use Repeater mode in networks where you need intermediary devices to relay data to devices beyond the transmission range of the base device.

Characteristics	<p>Low power consumption.</p> <p>Minimizes interference</p> <p>Tags each RF packet with a unique Packet ID (PID).</p> <p>Each repeater only repeats a packet once (the PID tracks the packet).</p> <p>Increases latency and decreases throughput. The number of hops determine latency and throughput, not the number of repeaters. Multiple repeaters within range of a source node count as one hop.</p> <p>All RF packets propagate to every device in the network (filtering rules apply).</p> <p>Packet destination addresses (DT) determine which packets the device sends out the serial port and/or retransmits.</p> <p>Broadcast communications: each packet comes out every node exactly once.</p> <p>Addressed communications: all devices see every packet. Only the devices with a matching address forward it to the DOUT buffer.</p>
Constraints	<p>Requires that each device have a unique MY parameter.</p> <p>System must introduce only one packet at a time to the network for transmission.</p> <p>The PK parameter determines the maximum number of bytes.</p> <p>Each hop (H) decreases network throughput by a factor of $1/(H+1)$. Additional repeaters add network redundancy without decreasing throughput.</p>
Suggestions	<p>Insert a variable delay before repeating packets to avoid collisions (based on RSSI).</p> <p>Buffer any incoming serial data and delay response packet transmissions until the previous packet clears out of the network.</p> <p>For best results, use the RO and RB commands to ensure that the RF packets align with the underlying protocol packets as the network can only accept one RF packet at a time.</p>
Required parameter values (TX device)	<p>MD = 5 or 6.</p> <p>MY = unique value. You can accomplish this by issuing the AM and WR commands to all devices in the network.</p>
Related commands	Networking (MD, DT, MY, AM), Serial interfacing (RN, PK, RO, RB)

Repeater mode theory of operation

You can extend the effective range and reliability of your data system by forwarding traffic through one or more repeaters. Instead of using routing tables and path discovery to establish dynamic paths through a

network, the repeater system uses a sophisticated algorithm to propagate each RF packet through the entire network.

The network supports RF packets up to 2048 bytes when the RF data rate is set at 9600 bps (BR = 0). The repeater network can operate using broadcast or addressed communications for multi-drop networks, and it works well in many systems with no special configuration.

When in Repeater mode, the network repeats each message among all available devices exactly one time. This mechanism eliminates the need for configuring specific routes. The following figure illustrates the Repeater network topology.

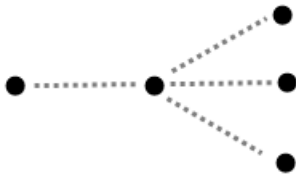

Configure a repeater network

If an RF link is weak, a device is out-of-range or a difficult RF environment is present; you can use repeaters to extend the effective range and reliability of the network.

A network may consist of End Nodes (EN), End/Repeater Nodes (ERN) and a Base Node (BN). The base node initiates all communications. Both Repeater Nodes and End Nodes can source data, allowing connection to host devices. Repeater Nodes however, are able to repeat information in a simple store and forward fashion. As an example, one End Node (which can be a base or remote) must send a message to another End Node. Because the End Node is out of range of the base device, you can use a repeater to forward information from the Base to the End Node.

You can configure a repeater network to operate using Basic Broadcast or Basic Addressed communications. The addressing capabilities of the device allow integrators to send a packet as a global packet (DT = 0xFFFF) and shift out of every device in the network (Basic Broadcast). Alternately, you can send the packet with a specific DT parameter so that only a specific remote node accepts it (Basic Addressed).

Repeater network: configure communications

To configure a Repeater network for Basic broadcast communications:

1. Assign each device a unique MY (source) address. Use the AM command to configure a unique source address based on the device serial number. This is essential because a unique packet ID on each RF packet is based on the originator's MY value.
2. Set DT = 0xFFFF to enable Basic Broadcast communications OR Basic Addressed communications (DT specifies a specific destination).

3. Configure PK, RO and RB to ensure that the RF packet aligns with the protocol packet. For example:
 PK=0x100
 RB=0x100
 RO depends on baud rate
4. Set MD = 5 to configure one or more devices that you do not intend to be repeaters as repeater End Nodes in the system.
5. Set MD = 6 to configure remote nodes as destinations. This ensures that the remote node waits for the repeater traffic to subside before it transmits a response.

To configure a Repeater network for Basic addressed communications, use DT to assign unique addresses to each device in the network.

AT commands to configure Repeater network functions

The following table lists the AT commands you use to configure repeater functions.

AT Command	Binary Command	AT Command Name	Range	# Bytes Returned	Factory Default
AM	0x3A (58d)	Auto-set MY	-	-	-
DT	0x00 (0d)	Destination Address	0 - 0xFFFF	2	0
MD	0x3C (60d)	RF Mode	0 - 6	1	0
MY	0x2A (42d)	Source Address	0 - 0xFFFF	2	0xFFFF
RN	0x19 (25d)	Delay Slots	0 - 0xFF [slots]	1	0
WR	0x08 (8d)	Write	-	-	-

Repeater network algorithm details

The firmware uses an algorithm to propagate each RF packet through the entire repeater network. Within a repeater network, the firmware only defines Repeater Nodes and repeater End Nodes. Repeater Nodes forward messages on to other devices within range; End Nodes do not.

The algorithm maintains a list of messages previously received in a buffer. The firmware discards messages already in the buffer. This eliminates End Nodes receiving multiple copies of a packet from more than one source, and also eliminates multiple repeaters within range of each other from continually passing messages in an infinite loop.

Packet ID (PID) is composed of the TX (transmitting) device MY address and the packet sequence number.

The firmware ignores incoming packets with a PID already in the buffer.

Each device maintains a PID buffer 4-deep of previously received packets (managed as FIFO).

The firmware may shift packets out the serial port and/or repeat them depending on the DT parameter in the RF packet. The following table shows the basis for these decisions.

Address Match	Send out serial port?	Repeat?
Global	Yes	Yes
Local	Yes	No
None	No	Yes

Repeat delay based on RSSI

A transmitted packet may be received by more than one repeater at the same time. In order to reduce the probability that the repeaters will transmit at the same instant, resulting in a collision and possible data loss; the firmware uses an algorithm that allows a variable back-off prior to a repeater retransmitting the packet. The algorithm allows devices that receive the packet with a stronger RF signal (RSSI) to have the first opportunity to retransmit the packet.

Use the RN (Delay Slots) parameter to configure this delay. Set RN = 0 (no delays) for small networks with few repeaters or repeaters that are not within range of each other. Set RN = 1 for systems with two to five repeaters that may be within range of each other.

The actual length of the delay is computed by the formula:

$$\text{Delay (ms)} = L * DS$$

$$DS = (-41 - \text{RSSI}) / 10 * RN + \text{RandomInt}(0, RN)$$

Where L is the length of the transmitted packet in milliseconds, DS is the number of delay slots to wait, RSSI is the received signal strength in dBm, RN is the value of the RN register and RandomInt (A,B) is a function that returns a random integer from A to B-0

Response packet delay

As a packet propagates through the repeater network, if any node receives the data and generates a quick response, the network needs to delay the response so as not to collide with subsequent retransmissions of the original packet. To reduce collisions, both repeater and end node devices in a repeater network delay transmission of data shifted in the serial port to allow any repeaters within range to complete their retransmissions.

The time for this delay is computed by the formula:

$$\text{Maximum Delay (ms)} = L * DS$$

$$DS = ((-41 - (-100)) / 10) * RN + RN + 1$$

Where L is the length of the transmitted packet in milliseconds, DS is the number of delay slots to wait, RSSI is the received signal strength in dBm, and RN is the value of the RN register.

Bandwidth considerations

Using broadcast repeaters in a network reduces the overall network data throughput as each repeater must buffer an entire packet before retransmitting it. For example: if the destination is within range of the transmitter and the packet is 32-bytes long, the transmission takes 12 ms on a device operating at 115,200 baud. If the same packet must propagate through two repeaters, it takes 12 ms to arrive at the first repeater, 12 ms to get to the second and a final 12 ms to reach the destination for a total of 36 ms. Accounting for UART transfer times (~1ms/byte at 9600 baud), the time for a server to send a 32-byte query and receive a 32-byte response is about 200 ms, allowing for 5 polls per second. With the two repeaters in the path, the same query/response sequence would take about 500 ms for two polls per second.

Generally, network throughput decreases by a factor of $1/(R+1)$, with R representing the number of repeaters between the source and destination.

Polling mode (basic)

Polling mode (basic) and Polling mode (acknowledged) operate in the same way. The only difference between the two modes is in their means of achieving reliable delivery of data. Polling mode (basic) uses multiple transmissions to achieve reliable delivery.

Characteristics	<p>Uses a high percentage of available network bandwidth.</p> <p>Eliminates collisions.</p> <p>Works with reliable delivery (RR or MT parameters).</p> <p>Supports binary data transfers.</p> <p>Base device requests packets from remote device by polling a sequential range of addresses.</p> <p>Base device is configured to specify the range of addresses being polled.</p> <p>Uses inter-character delay to create RF packet lengths aligned with protocol packet lengths up to 2048 bytes long.</p>
Constraints	<p>The minimum time interval between polling cycles is configurable. However, if the remote devices cannot all be processed within that time interval, the polling cycle is ineffective (i.e. it will impose no additional delay). In order to ensure a pause between polling cycles, you must set PD to a value that is large enough to accommodate the pause.</p>
Recommended use	<p>Use for point-to-multipoint applications that require Reliable Delivery of data. Use this mode when it is critical that a base device be able to discern data coming from multiple devices.</p>
Required parameter values (Base)	<p>MD (RF Mode) = 3</p> <p>PB (Polling Begin Address)</p> <p>PE (Polling End Address)</p>
Required parameter values (Remote)	<p>MD (RF Mode) = 4</p>
Related commands	<p>Networking: MT, PD, DT, MY, and AM</p>

Polling mode theory of operation

A Polling Base device cycles through a sequential range of addresses. The Polling Base polls each Polling Remote device, waits for a response, then poll the next remote address in the sequence. Each Polling Remote responds by sending the data from its DIN buffer following the RB and RO parameters. When there is no eligible data to send, the Polling Remote does not respond. The Polling Base polls the next address in the polling sequence after a short delay.

Configure a Polling Base

To configure a device as a Polling Base:

1. Set MD = 3.
2. Set MY = 0.
3. Set the sequential range of polling addresses using PB and PE.
4. (Optional) Enable Basic Reliable Delivery ($MT \geq 0$). The firmware also supports Acknowledged Reliable Delivery. For more information, see [Polling mode \(acknowledged\) on page 115](#).
5. (Optional) Use PD to configure a delay between polls to slow down the system, if needed.
6. (Optional) Enable API Mode to address remote devices within polling range on a packet-by-packet basis.

Configure a Polling Remote

To configure a device as a Polling Remote:

1. Set MD = 4.
2. Configure sequential source addresses for all remote devices using MY.
3. Set DT to point to the Polling Base ($DT = 0x0000$).
4. (Optional) Enable Basic Reliable Delivery ($MT \geq 0$). The firmware also supports Acknowledged Reliable Delivery. For more information, see [Polling mode \(acknowledged\) on page 115](#).

Acknowledged communications: Acknowledged mode

Use Acknowledged mode for applications that need reliable delivery. If messages are smaller than 256 bytes, use the RB and RO commands to align RF packets to application packets.

Characteristics	Reliable delivery through positive acknowledgments for each packet. Throughput, latency and jitter vary depending on the quality of the channel and the strength of the signal.
Required parameter values (TX device)	RR (Retries) ≥ 1
Related commands	Networking (DT, MK, RR), Serial Interfacing (PK, RN, RO, RB, TT)

Acknowledged mode connection sequence

After sending a packet while in Acknowledged mode, the TX (transmitting) device listens for an acknowledgment (ACK). If it receives the ACK, it either moves on to sending a subsequent packet if more transmit data is pending or waits for exactly RN random delay slots before allowing another transmission if no more data is pending transmit.

If the TX device does not receive the ACK within the allotted time, it retransmits the packet with a new RF initializer following the ACK slot. There is no delay between the first ACK slot and the first retransmission. Subsequent retransmissions incur a delay of a random number of delay slots, between 0 and RN. If RN is set to 0 on the TX device, there are never any back-off delays between retransmissions. During back-off delays, the TX device goes into Idle Mode and may receive RF data. This can have the effect of increasing the back-off delay, as the device cannot return to Transmit (or retransmit) mode as long as it is receiving RF data.

After receiving and acknowledging a packet, the RX (receiving) device moves to the next frequency and listens for either a retransmission or new data for a specific period of time. Even if the TX device indicates that it has no more pending transmit data, it may not have received the previous ACK, and so may retransmit the packet, possibly with no delay after the ACK slot. In this case, the RX device always detects the immediate retransmission, which holds off the communications channel and reduces collisions. RX devices acknowledge each retransmission they receive, but they only pass the first copy of a packet they receive out the UART.

The device does not apply the RB and RO parameters to subsequent packets, meaning that once transmission begins, it continues uninterrupted until the DIN buffer is empty or it reaches the streaming limit (TT parameter). As with the first packet, the payload of each subsequent packet includes up to the maximum packet size (PK parameter), and the TX device checks for more pending data near the end of each packet.

The TT parameter specifies the maximum number of bytes that the TX device sends in one transmission event, which may consist of many packets and retries. If a device reaches the TT parameter limit, the TX device forces a random delay of 1 to RN delay slots (exactly 1 delay slot if RN is zero). Each packet counts only once toward TT, no matter how many times the packet is retransmitted.

Subsequent packets in Acknowledged mode are similar to those in Streaming mode, with the addition of an ACK between each packet, and the possibility of retransmissions. The device sends subsequent packets without an RF initializer, as the RX devices are already synchronized to the TX device from the preceding packet(s) and they remain synchronized for the duration of the transmission event. Each packet retransmission includes an RF initializer.

Once the TX device sends all pending data or reaches the TT limit, the acknowledged transmission event is complete. The TX device does not transmit again for exactly RN delay slots, if the local RN parameter is set

to a non-zero value. The RX device does not transmit for a random number of delay slots between 0 and (RN-1), if the local RN parameter is set to a non-zero value. The intent of these delays is to lessen congestion following long bursts of packets from a single TX device, during which several RX devices may have themselves become ready to transmit.

Polling mode (acknowledged)

Polling mode (acknowledged) and Polling mode (basic) operate in the same way. The difference between the two modes is in their means of achieving the reliable delivery of data. In Polling mode (acknowledged), the firmware achieves reliable delivery using retries and acknowledgments.

Characteristics	<p>Uses a high percentage of available network bandwidth.</p> <p>Eliminates collisions.</p> <p>Works with reliable delivery (RR or MT parameters).</p> <p>Supports binary data transfers.</p> <p>Base device requests packets from remote device by polling a sequential range of addresses.</p> <p>Base device is configured to specify the range of addresses being polled.</p> <p>Uses inter-character delay to create RF packet lengths aligned with protocol packet lengths up to 2048 bytes long.</p>
Constraints	<p>The minimum time interval between polling cycles is configurable. However, if the remote devices cannot all be processed within that time interval, the polling cycle is ineffective (i.e. it will impose no additional delay). In order to ensure a pause between polling cycles, PD must be set to a value which is large enough to accommodate the pause.</p>
Recommended use	<p>Use for point-to-multipoint applications that require Reliable Delivery of data. Use this mode when it is critical that a base device be able to discern data coming from multiple devices.</p>
Required parameter values (Base)	<p>MD (RF Mode) = 3,</p> <p>PB (Polling Begin Address)</p> <p>PE (Polling End Address)</p>

Required parameter values (Remote)	MD (RF Mode) = 4
Related commands	Networking (RR, PD, DT, MY, AM)

For configuration and theory of operation information, see [Polling mode theory of operation on page 112](#), [Configure a Polling Base on page 113](#) and [Configure a Polling Remote on page 113](#).

Certifications

FCC (United States)

These RF modules comply with Part 15 of the FCC rules and regulations. Compliance with the labeling requirements, FCC notices and antenna usage guidelines is required.

In order to operate under Digi's FCC Certification, integrators must comply with the following regulations:

1. The integrator must ensure that the text provided with this device (in the labeling requirements section that follows) is placed on the outside of the final product and within the final product operation manual.
2. The device may only be used with antennas that have been tested and approved for use with this device; refer to [FCC antenna certifications on the next page](#).

OEM labeling requirements



The Original Equipment Manufacturer (OEM) must ensure that FCC labeling requirements are met. This includes a clearly visible label on the outside of the final product enclosure that displays the text shown in the figure below.

The following text is the required FCC label for OEM products containing the XBee-PRO SX RF Module:

Contains FCC ID: MCQ-XBPSX

The enclosed device complies with Part 15 of the FCC Rules. Operation is subject to the following two conditions: *(i.)* this device may not cause harmful interference and *(ii.)* this device must accept any interference received, including interference that may cause undesired operation.

The following text is the required FCC label for OEM products containing the XBee SX RF Module:

Contains FCC ID: MCQ-XBSX

The enclosed device complies with Part 15 of the FCC Rules. Operation is subject to the following two conditions: (i.) this device may not cause harmful interference and (ii.) this device must accept any interference received, including interference that may cause undesired operation.

FCC notices

IMPORTANT: These RF modules have been certified by the FCC for use with other products without any further certification (as per FCC section 2.1091). Modifications not expressly approved by Digi could void the user's authority to operate the equipment.

IMPORTANT: Integrators must test final product to comply with unintentional radiators (FCC sections 15.107 & 15.109) before declaring compliance of their final product to Part 15 of the FCC rules.

IMPORTANT: These RF modules have been certified for remote and base radio applications. If the module will be used for portable applications, the device must undergo SAR testing.

This equipment has been tested and found to comply with the limits for a Class B digital device, pursuant to Part 15 of the FCC Rules. These limits are designed to provide reasonable protection against harmful interference in a residential installation. This equipment generates, uses and can radiate radio frequency energy and, if not installed and used in accordance with the instructions, may cause harmful interference to radio communications. However, there is no guarantee that interference will not occur in a particular installation.

If this equipment does cause harmful interference to radio or television reception, which can be determined by turning the equipment off and on, the user is encouraged to try to correct the interference by one or more of the following measures: Re-orient or relocate the receiving antenna, Increase the separation between the equipment and receiver, Connect equipment and receiver to outlets on different circuits, or Consult the dealer or an experienced radio/TV technician for help.

FCC antenna certifications



This device has been tested with the antennas listed in the tables of this section. When integrated into products, fixed antennas require installation preventing end users from replacing them with non-approved antennas. Antennas not listed in the tables must be tested to comply with FCC Section 15.203 (unique antenna connectors) and Section 15.247 (emissions).

Fixed base station and mobile applications

Digi devices are pre-FCC approved for use in fixed base station and mobile applications. When the antenna is mounted at least 20cm (8") from nearby persons, the application is considered a mobile application.

Portable applications and SAR testing

When the antenna is mounted closer than 20 cm to nearby persons, then the application is considered "portable" and requires an additional test be performed on the final product. This test is called Specific Absorption Rate (SAR) testing and measures the emissions from the device and how they affect the person.

RF exposure statement

This statement must be included as a CAUTION statement in integrator product manuals.



WARNING: This equipment is approved only for mobile and base station transmitting devices. Antenna(s) used for this transmitter must be installed to provide a separation distance of at least 34 cm from all persons and must not be co-located or operating in conjunction with any other antenna or transmitter.

XBee-PRO XTC Antenna options

The following tables cover the antennas that are approved for use with the XBee-PRO XTC RF modules. If applicable, the tables show the required cable loss between the device and the antenna.

Digi does not carry all of these antenna variants. Contact Digi Sales for available antennas.

Dipole antennas

All antenna part numbers followed by an asterisk (*) are not available from Digi. Consult with an antenna manufacturer for an equivalent option.

Part Number	Type	Connector	Gain	Required Antenna Cable Loss	Application
A09-HSM-7	Straight half-wave	RPSMA	2.1 dBi	0.4 dB	Fixed / Mobile
A09-HASM-675	Articulated half-wave	RPSMA	2.1 dBi	0.4 dB	Fixed / Mobile
A09-HABMM-P51	Swivel half wave with 5" pigtail	MMCX	2.1 dBi	0.4 dB	Fixed / Mobile

Part Number	Type	Connector	Gain	Required Antenna Cable Loss	Application
A09-HBMM-P5I	Straight half-wave with 6" pigtail	MMCX	2.1 dBi	0.4 dB	Fixed / Mobile
A09-HASM-7	Articulated half-wave	RPSMA	2.1 dBi	0.4 dB	Fixed
A09-HRSM*	Right angle half-wave	RPSMA	2.1 dBi	0.4 dB	Fixed
A09-HG*	Glass mounted half-wave	RPSMA	2.1 dBi	0.4 dB	Fixed
A09-HATM*	Articulated half-wave	RPTNC	2.1 dBi	0.4 dB	Fixed
A09-H*	Half-wave dipole	RPSMA	2.1 dBi	0.4 dB	Fixed

Yagi antennas

All antenna part numbers followed by an asterisk (*) are not available from Digi. Consult with an antenna manufacturer for an equivalent option.

Part Number	Type	Gain	Connector	Required Antenna Cable Loss	Application
A09-Y6NF*	2 element Yagi	6.1 dBi	N	2.0 dB	Fixed/Mobile
A09-Y7NF*	3 element Yagi	7.1 dBi	N	3.0 dB	Fixed/Mobile
A09-Y8NF	4 element Yagi	8.1 dBi	N	4.0 dB	Fixed/Mobile

Part Number	Type	Gain	Connector	Required Antenna Cable Loss	Application
A09-Y9NF*	4 element Yagi	9.1 dBi	N	5.0 dB	Fixed/Mobile
A09-Y10NF*	5 element Yagi	10.1 dBi	N	6.0 dB	Fixed/Mobile
A09-Y11NF	6 element Yagi	11.1 dBi	N	7.0 dB	Fixed/Mobile
A09-Y12NF*	7 element Yagi	12.1 dBi	N	8.0 dB	Fixed/Mobile
A09-Y13NF*	9 element Yagi	13.1 dBi	N	9.0 dB	Fixed/Mobile
A09-Y14NF*	14 element Yagi	14.0 dBi	N	9.9 dB	Fixed/Mobile
A09-Y6TM*	2 element Yagi	6.1 dBi	RPTNC	2.0 dB	Fixed/Mobile
A09-Y7TM*	3 element Yagi	7.1 dBi	RPTNC	3.0 dB	Fixed/Mobile
A09-Y8TM*	4 element Yagi	8.1 dBi	RPTNC	4.0 dB	Fixed/Mobile
A09-Y9TM*	4 element Yagi	9.1 dBi	RPTNC	5.0 dB	Fixed/Mobile
A09-Y10TM-P10I	5 element Yagi	10.1 dBi	RPTNC	6.0 dB	Fixed/Mobile

Part Number	Type	Gain	Connector	Required Antenna Cable Loss	Application
A09-Y11TM*	6 element Yagi	11.1 dBi	RPTNC	7.0 dB	Fixed/Mobile
A09-Y12TM*	7 element Yagi	12.1 dBi	RPTNC	8.0 dB	Fixed/Mobile
A09-Y13TM*	9 element Yagi	13.1 dBi	RPTNC	9.0 dB	Fixed/Mobile
A09-Y14TM*	14 element Yagi	14.0 dBi	RPTNC	9.9 dB	Fixed/Mobile

Omni-directional base station antennas

All antenna part numbers followed by an asterisk (*) are not available from Digi. Consult with an antenna manufacturer for an equivalent option.

Part Number	Type	Gain	Connector	Required Antenna Cable Loss	Application
A09-F0NF*	Fiberglass Base Station	0 dBi	N	-	Fixed
A09-F1NF*	Fiberglass Base Station	1.0 dBi	N	-	Fixed
A09-F2NF-M	Fiberglass Base Station	2.1 dBi	N	-	Fixed
A09-F3NF*	Fiberglass Base Station	3.1 dBi	N	-	Fixed
A09-F4NF*	Fiberglass Base Station	4.1 dBi	N	-	Fixed

Part Number	Type	Gain	Connector	Required Antenna Cable Loss	Application
A09-F5NF-M	Fiberglass Base Station	5.1 dBi	N	-	Fixed
A09-F6NF*	Fiberglass Base Station	6.1 dBi	N	0.9 dB	Fixed
A09-F7NF*	Fiberglass Base Station	7.1 dBi	N	1.9 dB	Fixed
A09-F8NF-M	Fiberglass Base Station	8.1 dBi	N	2.9 dB	Fixed
A09-F0SM*	Fiberglass Base Station	0 dBi	RPSMA	-	Fixed
A09-F1SM*	Fiberglass Base Station	1.0 dBi	RPSMA	-	Fixed
A09-F2SM*	Fiberglass Base Station	2.1 dBi	RPSMA	-	Fixed
A09-F3SM*	Fiberglass Base Station	3.1 dBi	RPSMA	-	Fixed
A09-F4SM*	Fiberglass Base Station	4.1 dBi	RPSMA	-	Fixed
A09-F5SM*	Fiberglass Base Station	5.1 dBi	RPSMA	-	Fixed
A09-F6SM*	Fiberglass Base Station	6.1 dBi	RPSMA	0.9 dB	Fixed

Part Number	Type	Gain	Connector	Required Antenna Cable Loss	Application
A09-F7SM*	Fiberglass Base Station	7.1 dBi	RPSMA	1.9 dB	Fixed
A09-F8SM*	Fiberglass Base Station	8.1 dBi	RPSMA	2.9 dB	Fixed
A09-F0TM*	Fiberglass Base Station	0 dBi	RPTNC	-	Fixed
A09-F1TM*	Fiberglass Base Station	1.0 dBi	RPTNC	-	Fixed
A09-F2TM*	Fiberglass Base Station	2.1 dBi	RPTNC	-	Fixed
A09-F3TM*	Fiberglass Base Station	3.1 dBi	RPTNC	-	Fixed
A09-F4TM*	Fiberglass Base Station	4.1 dBi	RPTNC	-	Fixed
A09-F5TM*	Fiberglass Base Station	5.1 dBi	RPTNC	-	Fixed
A09-F6TM*	Fiberglass Base Station	6.1 dBi	RPTNC	0.9 dB	Fixed
A09-F7TM*	Fiberglass Base Station	7.1 dBi	RPTNC	1.9 dB	Fixed
A09-F8TM*	Fiberglass Base Station	8.1 dBi	RPTNC	2.9 dB	Fixed

Part Number	Type	Gain	Connector	Required Antenna Cable Loss	Application
A09-W7*	Wire Base Station	7.1 dBi	RPN	1.9 dB	Fixed
A09-W7SM*	Wire Base Station	7.1 dBi	RPSMA	1.9 dB	Fixed
A09-W7TM*	Wire Base Station	7.1 dBi	RPTNC	1.9 dB	Fixed

Dome antennas

All antenna part numbers followed by an asterisk (*) are not available from Digi. Consult with an antenna manufacturer for an equivalent option.

Part Number	Type	Gain	Connector	Required Antenna Cable Loss	Application
A09-D3PNF*	Omnidirectional permanent mount	3.0 dBi	N	0.4 dB	Fixed/Mobile
A09-D3NF*	Omnidirectional magnetic mount	3.0 dBi	N	0.4 dB	Fixed/Mobile
A09-D3PTM*	Omnidirectional permanent mount	3.0 dBi	RPTNC	0.4 dB	Fixed/Mobile
A09-D3PSM*	Omnidirectional permanent mount	3.0 dBi	RPSMA	0.4 dB	Fixed/Mobile

Monopole antennas

All antenna part numbers followed by an asterisk (*) are not available from Digi. Consult with an antenna manufacturer for an equivalent option.

Part Number	Type	Gain	Connector	Required Antenna Cable Loss	Application
A09-QRAMM	3" Quarter wave wire	2.1 dBi	MMCX	-	Fixed/Mobile
A09-QRSM-2.1*	Quarter wave 2.1" right angle	3.3 dBi	RPSMA	0.4 dB	Fixed/Mobile
A09-QW*	Quarter wave wire	1.9 dBi	Permanent	-	Fixed/Mobile
A09-QSM-3*	Quarter wave straight	1.9 dBi	RPSMA	-	Fixed/Mobile
A09-QSM-3H*	Heavy duty quarter wave straight	1.9 dBi	RPSMA	-	Fixed/Mobile
A09-QBMM-P6I*	Quarter wave w/ 6" pigtail	1.9 dBi	MMCX	-	Fixed/Mobile
A09-QHSM-2*	2" straight	1.9 dBi	RPSMA	-	Fixed/Mobile
A09-QHRSM-2*	2" right angle	1.9 dBi	RPSMA	-	Fixed/Mobile
A09-QHRSM-170*	1.7" right angle	1.9 dBi	RPSMA	-	Fixed/Mobile
A09-QRSM-380*	3.8" right angle	1.9 dBi	RPSMA	-	Fixed/Mobile
A09-QAPM-520*	5.2" articulated screw mount	1.9 dBi	Permanent	-	Fixed/Mobile

Part Number	Type	Gain	Connector	Required Antenna Cable Loss	Application
A09-QSPM-3*	3" straight screw mount	1.9 dBi	Permanent	-	Fixed/Mobile
A09-QAPM-3*	3" articulated screw mount	1.9 dBi	Permanent	-	Fixed/Mobile
A09-QAPM-3H*	3" articulated screw mount	1.9 dBi	Permanent	-	Fixed/Mobile

XBee XTC antenna options

The following tables cover the antennas that are approved for use with the XBee XTC RF modules. If applicable, the tables show the required cable loss between the device and the antenna.

Digi does not carry all of these antenna variants. Contact Digi Sales for available antennas.

Dipole antennas

All antenna part numbers followed by an asterisk (*) are not available from Digi. Consult with an antenna manufacturer for an equivalent option.

Part Number	Type	Connector	Gain	Required Antenna Cable Loss	Application
A09-HSM-7	Straight half-wave	RPSMA	2.1 dBi	0.4 dB	Fixed / Mobile
A09-HASM-675	Articulated half-wave	RPSMA	2.1 dBi	0.4 dB	Fixed / Mobile
A09-HABMM-P5I	Swivel half wave with 5" pigtail	MMCX	2.1 dBi	0.4 dB	Fixed / Mobile
A09-HBMM-P5I	Straight half-wave with 6" pigtail	MMCX	2.1 dBi	0.4 dB	Fixed / Mobile

Part Number	Type	Connector	Gain	Required Antenna Cable Loss	Application
A09-HASM-7	Articulated half-wave	RPSMA	2.1 dBi	0.4 dB	Fixed
A09-HRSM*	Right angle half-wave	RPSMA	2.1 dBi	0.4 dB	Fixed
A09-HG*	Glass mounted half-wave	RPSMA	2.1 dBi	0.4 dB	Fixed
A09-HATM*	Articulated half-wave	RPTNC	2.1 dBi	0.4 dB	Fixed
A09-H*	Half-wave dipole	RPSMA	2.1 dBi	0.4 dB	Fixed

Yagi antennas

All antenna part numbers followed by an asterisk (*) are not available from Digi. Consult with an antenna manufacturer for an equivalent option.

Part Number	Type	Gain	Connector	Required Antenna Cable Loss	Application
A09-Y6NF*	2 element Yagi	6.1 dBi	N	-	Fixed/Mobile
A09-Y7NF*	3 element Yagi	7.1 dBi	N	-	Fixed/Mobile
A09-Y8NF	4 element Yagi	8.1 dBi	N	-	Fixed/Mobile

Part Number	Type	Gain	Connector	Required Antenna Cable Loss	Application
A09-Y9NF*	4 element Yagi	9.1 dBi	N	-	Fixed/Mobile
A09-Y10NF*	5 element Yagi	10.1 dBi	N	-	Fixed/Mobile
A09-Y11NF	6 element Yagi	11.1 dBi	N	-	Fixed/Mobile
A09-Y12NF*	7 element Yagi	12.1 dBi	N	-	Fixed/Mobile
A09-Y13NF*	9 element Yagi	13.1 dBi	N	-	Fixed/Mobile
A09-Y14NF*	10 element Yagi	14.1 dBi	N	-	Fixed/Mobile
A09-Y14NF-ALT*	12 element Yagi	14.1 dBi	N	-	Fixed/Mobile
A09-Y15NF	13 element Yagi	15.1 dBi	N	0.7 dB	Fixed/Mobile
A09-Y15NF-ALT*	15 element Yagi	15.1 dBi	N	0.7 dB	Fixed/Mobile
A09-Y6TM*	2 element Yagi	6.1 dBi	RPTNC	-	Fixed/Mobile
A09-Y7TM*	3 element Yagi	7.1 dBi	RPTNC	-	Fixed/Mobile

Part Number	Type	Gain	Connector	Required Antenna Cable Loss	Application
A09-Y8TM*	4 element Yagi	8.1 dBi	RPTNC	-	Fixed/Mobile
A09-Y9TM*	4 element Yagi	9.1 dBi	RPTNC	-	Fixed/Mobile
A09-Y10TM-P10*	5 element Yagi	10.1 dBi	RPTNC	-	Fixed/Mobile
A09-Y11TM*	6 element Yagi	11.1 dBi	RPTNC	-	Fixed/Mobile
A09-Y12TM*	7 element Yagi	12.1 dBi	RPTNC	-	Fixed/Mobile
A09-Y13TM*	9 element Yagi	13.1 dBi	RPTNC	-	Fixed/Mobile
A09-Y14TM*	10 element Yagi	14.1 dBi	RPTNC	-	Fixed/Mobile
A09-Y14TM-ALT*	12 element Yagi	14.1 dBi	RPTNC	-	Fixed/Mobile
A09-Y15TM*	13 element Yagi	15.1 dBi	RPTNC	0.7 dB	Fixed/Mobile
A09-Y15TM-P10I	15 element Yagi	15.1 dBi	RPTNC	0.7 dB	Fixed/Mobile

Omni-directional base station antennas

All antenna part numbers followed by an asterisk (*) are not available from Digi. Consult with an antenna manufacturer for an equivalent option.

Part Number	Type	Gain	Connector	Required Antenna Cable Loss	Application
A09-F0NF*	Fiberglass Base Station	0 dBi	N	-	Fixed
A09-F1NF*	Fiberglass Base Station	1.0 dBi	N	-	Fixed
A09-F2NF-M	Fiberglass Base Station	2.1 dBi	N	-	Fixed
A09-F3NF*	Fiberglass Base Station	3.1 dBi	N	-	Fixed
A09-F4NF*	Fiberglass Base Station	4.1 dBi	N	-	Fixed
A09-F5NF-M	Fiberglass Base Station	5.1 dBi	N	-	Fixed
A09-F6NF*	Fiberglass Base Station	6.1 dBi	N	-	Fixed
A09-F7NF*	Fiberglass Base Station	7.1 dBi	N	-	Fixed
A09-F8NF-M	Fiberglass Base Station	8.1 dBi	N	0.7 dB	Fixed
A09-F0SM*	Fiberglass Base Station	0 dBi	RPSMA	-	Fixed
A09-F1SM*	Fiberglass Base Station	1.0 dBi	RPSMA	-	Fixed

Part Number	Type	Gain	Connector	Required Antenna Cable Loss	Application
A09-F2SM*	Fiberglass Base Station	2.1 dBi	RPSMA	-	Fixed
A09-F3SM*	Fiberglass Base Station	3.1 dBi	RPSMA	-	Fixed
A09-F4SM*	Fiberglass Base Station	4.1 dBi	RPSMA	-	Fixed
A09-F5SM*	Fiberglass Base Station	5.1 dBi	RPSMA	-	Fixed
A09-F6SM*	Fiberglass Base Station	6.1 dBi	RPSMA	-	Fixed
A09-F7SM*	Fiberglass Base Station	7.1 dBi	RPSMA	-	Fixed
A09-F8SM*	Fiberglass Base Station	8.1 dBi	RPSMA	0.7 dB	Fixed
A09-F0TM*	Fiberglass Base Station	0 dBi	RPTNC	-	Fixed
A09-F1TM*	Fiberglass Base Station	1.0 dBi	RPTNC	-	Fixed
A09-F2TM*	Fiberglass Base Station	2.1 dBi	RPTNC	-	Fixed
A09-F3TM*	Fiberglass Base Station	3.1 dBi	RPTNC	-	Fixed

Part Number	Type	Gain	Connector	Required Antenna Cable Loss	Application
A09-F4TM*	Fiberglass Base Station	4.1 dBi	RPTNC	-	Fixed
A09-F5TM*	Fiberglass Base Station	5.1 dBi	RPTNC	-	Fixed
A09-F6TM*	Fiberglass Base Station	6.1 dBi	RPTNC	-	Fixed
A09-F7TM*	Fiberglass Base Station	7.1 dBi	RPTNC	-	Fixed
A09-F8TM*	Fiberglass Base Station	8.1 dBi	RPTNC	0.7 dB	Fixed
A09-W7*	Wire Base Station	7.1 dBi	RPN	-	Fixed
A09-W7SM*	Wire Base Station	7.1 dBi	RPSMA	-	Fixed
A09-W7TM*	Wire Base Station	7.1 dBi	RPTNC	-	Fixed

Dome antennas

All antenna part numbers followed by an asterisk (*) are not available from Digi. Consult with an antenna manufacturer for an equivalent option.

Part Number	Type	Gain	Connector	Required Antenna Cable Loss	Application
A09-D3PNF*	Omnidirectional permanent mount	3.0 dBi	N	0.4 dB	Fixed/Mobile

Part Number	Type	Gain	Connector	Required Antenna Cable Loss	Application
A09-D3NF*	Omnidirectional magnetic mount	3.0 dBi	N	0.4 dB	Fixed/Mobile
A09-D3PTM*	Omnidirectional permanent mount	3.0 dBi	RPTNC	0.4 dB	Fixed/Mobile
A09-D3PSM*	Omnidirectional permanent mount	3.0 dBi	RPSMA	0.4 dB	Fixed/Mobile

Monopole antennas

All antenna part numbers followed by an asterisk (*) are not available from Digi. Consult with an antenna manufacturer for an equivalent option.

Part Number	Type	Gain	Connector	Required Antenna Cable Loss	Application
A09-QRAMM	3" Quarter wave wire	2.1 dBi	MMCX	-	Fixed/Mobile
A09-QRSM-2.1*	Quarter wave 2.1" right angle	3.3 dBi	RPSMA	0.4 dB	Fixed/Mobile
A09-QW*	Quarter wave wire	1.9 dBi	Permanent	-	Fixed/Mobile
A09-QSM-3*	Quarter wave straight	1.9 dBi	RPSMA	-	Fixed/Mobile
A09-QSM-3H*	Heavy duty quarter wave straight	1.9 dBi	RPSMA	-	Fixed/Mobile
A09-QBMM-P6I*	Quarter wave w/ 6" pigtail	1.9 dBi	MMCX	-	Fixed/Mobile

Part Number	Type	Gain	Connector	Required Antenna Cable Loss	Application
A09-QHSM-2*	2" straight	1.9 dBi	RPSMA	-	Fixed/Mobile
A09-QHRSM-2*	2" right angle	1.9 dBi	RPSMA	-	Fixed/Mobile
A09-QHRSM-170*	1.7" right angle	1.9 dBi	RPSMA	-	Fixed/Mobile
A09-QRSM-380*	3.8" right angle	1.9 dBi	RPSMA	-	Fixed/Mobile
A09-QAPM-520*	5.2" articulated screw mount	1.9 dBi	Permanent	-	Fixed/Mobile
A09-QSPM-3*	3" straight screw mount	1.9 dBi	Permanent	-	Fixed/Mobile
A09-QAPM-3*	3" articulated screw mount	1.9 dBi	Permanent	-	Fixed/Mobile
A09-QAPM-3H*	3" articulated screw mount	1.9 dBi	Permanent	-	Fixed/Mobile

Industry Canada (IC)

This device complies with Industry Canada license-exempt RSS standard(s). Operation is subject to the following two conditions: (1) this device may not cause interference, and (2) this device must accept any interference, including interference that may cause undesired operation of the device.

Le présent appareil est conforme aux CNR d'Industrie Canada applicables aux appareils radio exempts de licence. L'exploitation est autorisée aux deux conditions suivantes : (1) l'appareil ne doit pas produire de brouillage, et (2) l'utilisateur de l'appareil doit accepter tout brouillage radioélectrique subi, même si le brouillage est susceptible d'en compromettre le fonctionnement.

Labeling requirements

XBee XTC

Labeling requirements for Industry Canada are similar to those of the FCC. A clearly visible label on the outside of the final product must display the following text:

Contains Model XBSX Radio, IC: 1846A-XBSX

The integrator is responsible for its product to comply with IC ICES-003 and FCC Part 15, Sub. B - Unintentional Radiators. ICES-003 is the same as FCC Part 15 Sub. B and Industry Canada accepts FCC test report or CISPR 22 test report for compliance with ICES-003.

XBee-PRO XTC

Labeling requirements for Industry Canada are similar to those of the FCC. A clearly visible label on the outside of the final product must display the following text:

Contains Model XBPSX Radio, IC: 1846A-XBPSX

The integrator is responsible for its product to comply with IC ICES-003 and FCC Part 15, Sub. B - Unintentional Radiators. ICES-003 is the same as FCC Part 15 Sub. B and Industry Canada accepts FCC test report or CISPR 22 test report for compliance with ICES-003.

Transmitters for detachable antennas

This radio transmitter has been approved by Industry Canada to operate with the antenna types listed in the tables in [FCC antenna certifications on page 118](#) with the maximum permissible gain and required antenna impedance for each antenna type indicated. Antenna types not included in this list, having a gain greater than the maximum gain indicated for that type, are strictly prohibited for use with this device. The required antenna impedance is 50 ohms.

Le présent émetteur radio a été approuvé par Industrie Canada pour fonctionner avec les types d'antenne énumérés ci-dessous et ayant un gain admissible maximal et l'impédance requise pour chaque type d'antenne. Les types d'antenne non inclus dans cette liste, ou dont le gain est supérieur au gain maximal indiqué, sont strictement interdits pour l'exploitation de l'émetteur.

Detachable antennas

Under Industry Canada regulations, this radio transmitter may only operate using an antenna of a type and maximum (or lesser) gain approved for the transmitter by Industry Canada. To reduce potential radio interference to other users, the antenna type and its gain should be so chosen that the equivalent isotropically radiated power (e.i.r.p.) is not more than that necessary for successful communication.

Conformément à la réglementation d'Industrie Canada, le présent émetteur radio peut fonctionner avec une antenne d'un type et d'un gain maximal (ou inférieur) approuvé pour l'émetteur par Industrie Canada. Dans le but de réduire les risques de brouillage radioélectrique à l'intention des autres utilisateurs, il faut choisir le type d'antenne et son gain de sorte que la puissance isotrope rayonnée équivalente (p.i.r.e.) ne dépasse pas l'intensité nécessaire à l'établissement d'une communication satisfaisante.

ACMA (Australia)

Power requirements

Regulations in Australia stipulate a maximum of 30 dBm EIRP (Effective Isotropic Radiated Power). The EIRP equals the sum (in dBm) of power output, antenna gain and cable loss and cannot not exceed 30 dBm.

The EIRP formula for Australia is:

$$\text{power output} + \text{antenna gain} - \text{cable loss} \leq 30 \text{ dBm}$$

Note The maximum EIRP for the FCC (United States) and IC (Canada) is 36 dBm.

These modules comply with requirements to be used in end products in Australia. All products with EMC and radio communications must have a registered RCM mark. Registration to use the compliance mark will only be accepted from Australian manufacturers or importers, or their agent, in Australia. In order to have a RCM mark on an end product, a company must comply with a or b below:

- a. have a company presence in Australia.
- b. have a company/distributor/agent in Australia that will sponsor the import of the end product.

Contact Digi for questions related to locating a contact in Australia.

PCB design and manufacturing

Recommended footprint and keepout

We designed the XTC RF Module for surface mounting on the OEM printed circuit board (PCB). It has castellated pads around the edges and one ground pad on the bottom. [Mechanical drawings on page 14](#) includes a detailed mechanical drawing.

We recommend that you use the following PCB footprint for surface mounting. Dimensions are in inches.

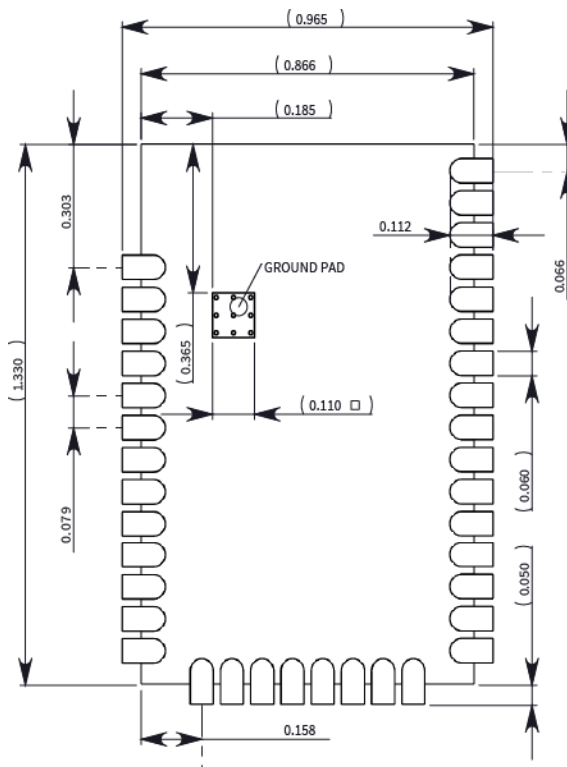

The recommended footprint includes an additional ground pad that you must solder to the corresponding pad on the XTC device. This ground pad transfers heat generated during transmit mode away from the

device's power amplifier. The pad must connect through vias to a ground plane on the host PCB. Connecting to planes on multiple layers will further improve the heat transfer performance and we recommend doing this for applications that will be in transmit mode for sustained periods. We recommend using nine 0.012 inch diameter vias in the pad as shown. Plug vias with epoxy or solder mask them on the opposite side to prevent solder paste from leaking through the holes during reflow. Do not mask over the ground pad.

Note The ground pad is unique to the XBee/XBee-PRO XTC and SX modules. This footprint is not compatible with other SMT XBees.

Although the underside of the device is mostly coated with solder mask, we recommend that you leave the copper layer directly below the device open to avoid unintended contacts. Most importantly, copper or vias must not interfere with the three exposed RF test points on the bottom of the device shown in the following keepout drawing. Observe the copper keepout on all layers of the host PCB, to avoid the possibility of capacitive coupling that could impact RF performance.

Match the solder footprint to the copper pads, but you may need to adjust it depending on the specific needs of assembly and product standards. We recommend a stencil thickness of 0.15 mm (0.005 in). Place the component last and set the placement speed to the slowest setting.

SMT footprint showing required copper keepout (all layers)

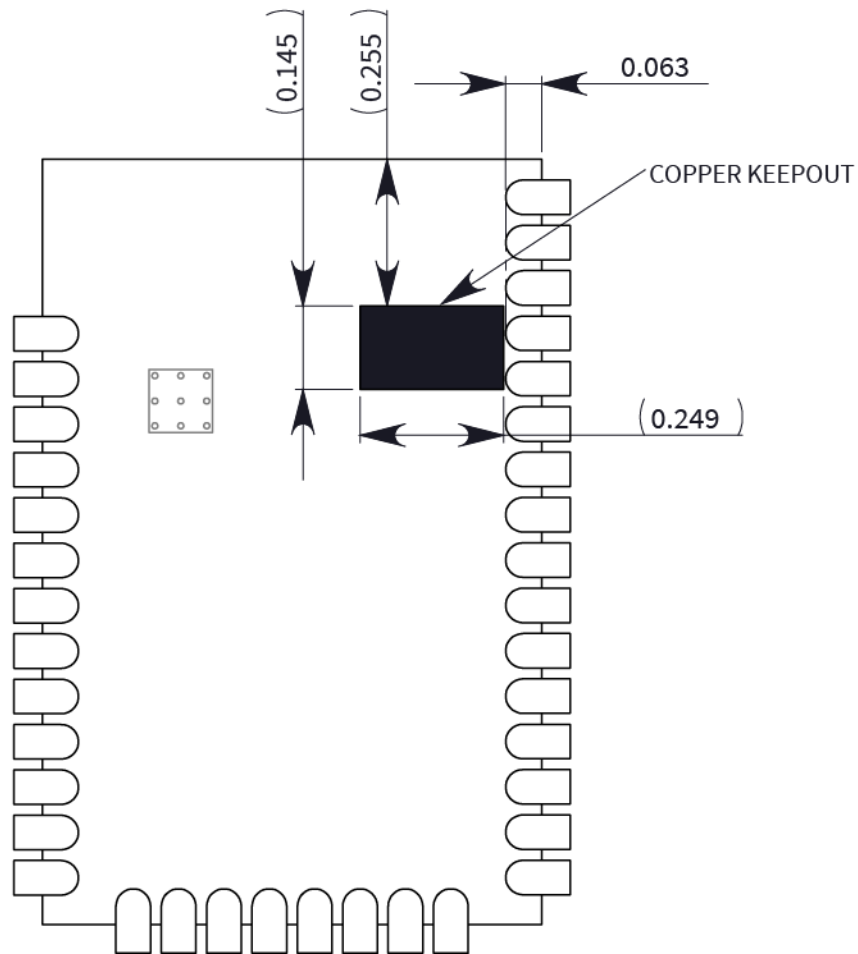

Design notes

The following guidelines help to ensure a robust design.

Host board design

A good power supply design is critical for proper device operation. If the supply voltage is not kept within tolerance, or is excessively noisy, it may degrade device performance and reliability. To help reduce noise, we recommend placing both a 1 μF and 100 pF capacitor as near to VCC (pin 2) as possible. If you use a switching regulator, we recommend switching frequencies above 500 kHz and you should limit power supply ripple to a maximum 50 mV peak to peak.

As with all PCB designs, make power and ground traces thicker than signal traces and make them able to comfortably support the maximum current specifications. Ground planes are preferable.

Improve antenna performance

The choice of antenna and antenna location is important for optimal performance. In general, antenna elements radiate perpendicular to the direction they point. Thus a vertical antenna, such as a dipole, emit across the horizon.

Metal objects near the antenna cause parasitic coupling and detuning, preventing the antenna from radiating efficiently. Metal objects between the transmitter and receiver can also block the radiation path or reduce the transmission distance, so position external antennas away from them as much as possible. Some objects that are often overlooked are:

- Metal poles
- Metal studs or beams in structures
- Concrete (reinforced with metal rods)
- Metal enclosures
- Vehicles
- Elevators
- Ventilation ducts
- Large appliances
- Batteries
- Tall electrolytic capacitors

RF pad version

The RF Pad is a soldered antenna connection. The RF signal travels from pin 36 on the module to the antenna through a single ended RF transmission line on the PCB. This line should have a controlled impedance of 50 Ω .

For the transmission line, we recommend either a microstrip or coplanar waveguide trace on the PCB. We provide a microstrip example below, because it is simpler to design and generally requires less area on the host PCB than coplanar waveguide.

We do not recommend using a stripline RF trace because that requires routing the RF trace to an inner PCB layer, and via transitions can introduce matching and performance problems.

The following figure shows a layout example of a microstrip connecting an RF Pad module to a through hole RPSMA RF connector.

- The top two layers of the PCB have a controlled thickness dielectric material in between. The second layer has a ground plane which runs underneath the entire RF Pad area. This ground plane is a distance d , the thickness of the dielectric, below the top layer.

- The top layer has an RF trace running from pin 36 of the module to the RF pin of the RPSMA connector. The RF trace's width determines the impedance of the transmission line with relation to the ground plane. Many online tools can estimate this value, although you should consult the PCB manufacturer for the exact width. Assuming $d = 0.025$ in, and that the dielectric has a relative permittivity of 4.4, the width in this example will be approximately 0.045 in for a $50\ \Omega$ trace. This trace width is a good fit with the module footprint's 0.060 in pad width.

We do not recommend using a trace wider than the pad width, and using a very narrow trace can cause unwanted RF loss. The length of the trace is minimized by placing the RPSMA jack close to the module. All of the grounds on the jack and the module are connected to the ground planes directly or through closely placed vias. Space any ground fill on the top layer at least twice the distance d (in this case, at least 0.050 in) from the microstrip to minimize their interaction.

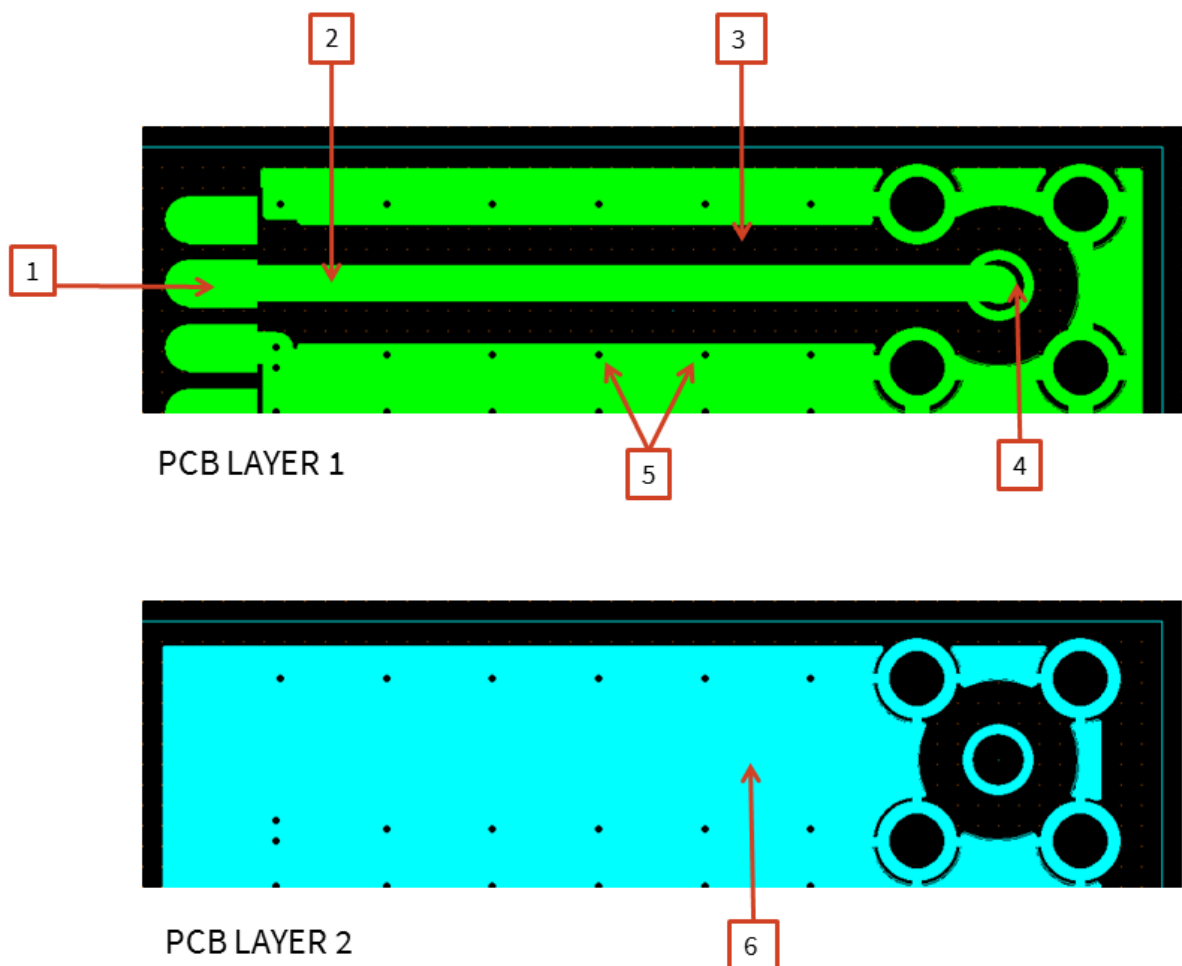

Number	Description
1	XBee pin 36
2	50 Ω microstrip trace
3	Back off ground fill at least twice the distance between layers 1 and 2
4	RF connector
5	Stitch vias near the edges of the ground plane
6	Pour a solid ground plane under the RF trace on the reference layer

Implementing these design suggestion will help ensure that the RF Pad module performs to specifications.

Recommended solder reflow cycle

The following table provides the recommended solder reflow cycle. The table shows the temperature setting and the time to reach the temperature; It does not show the cooling cycle.

Time (seconds)	Temperature (degrees C)
30	65
60	100
90	135
120	160
150	195
180	240
210	260

The maximum temperature should not exceed 260°C.

The XTC device will reflow during this cycle, and therefore must not be reflowed upside down. Take care not to jar the XTC while the solder is molten, as this can remove components under the shield from their required locations.

The device has a Moisture Sensitivity Level (MSL) of 3. When using this product, consider the relative requirements in accordance with standard IPC/JEDEC J-STD-020.

In addition, note the following conditions:

- a. Calculated shelf life in sealed bag: 12 months at < 40°C and < 90% relative humidity (RH).
- b. Environmental condition during the production: 30°C /60% RH according to IPC/JEDEC J-STD-033C, paragraphs 5 through 7.
- c. The time between the opening of the sealed bag and the start of the reflow process cannot exceed 168 hours if condition b) is met.
- d. Baking is required if conditions b) or c) are not met.
- e. Baking is required if the humidity indicator inside the bag indicates a RH of 10% more.
- f. If baking is required, bake modules in trays stacked no more than 10 high for 4-6 hours at 125°C.

Flux and cleaning

We recommend that you use a “no clean” solder paste in assembling these devices. This eliminates the clean step and ensures that you do not leave unwanted residual flux under the device where it is difficult to remove. In addition:

- Cleaning with liquids can result in liquid remaining under the device or in the gap between the device and the host PCB. This can lead to unintended connections between pads.
- The residual moisture and flux residue under the device are not easily seen during an inspection process.

Rework

Once you mount the device, do not perform rework on the XTC device (for example, removing it from the host PCB).



Any modification to the device voids the warranty coverage and certifications.
