

# ENGINEERING TEST REPORT

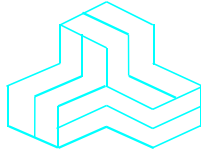

**XBEE SX RF Module**  
**Model: XBSX**  
**FCC ID: MCQ-XBSX**

*Applicant:*

**Digi International Inc.**  
11001 Bren Road East  
Minnetonka, MN  
USA 55343

*In Accordance With*

**Federal Communications Commission (FCC)**  
**Part 15, Subpart C, Section 15.247 Frequency Hopping Spread Spectrum (FHSS)**

**UltraTech's File No.: 15DIGI102\_FCC15C247**

This Test report is Issued under the Authority of  
Tri M. Luu  
Vice President of Engineering  
UltraTech Group of Labs

Date: December 24, 2015

Report Prepared by: Dharmajit Solanki

Tested by: Hung Trinh

Issued Date: December 24, 2015

Test Dates: Nov 05 - Dec 08, 2015

- *The results in this Test Report apply only to the sample(s) tested, and the sample tested is randomly selected.*
- *This report must not be used by the client to claim product endorsement by NVLAP or any agency of the US Government.*

## UltraTech

3000 Bristol Circle, Oakville, Ontario, Canada, L6H 6G4  
Tel.: (905) 829-1570 Fax.: (905) 829-8050  
Website: [www.ultratech-labs.com](http://www.ultratech-labs.com), Email: [vic@ultratech-labs.com](mailto:vic@ultratech-labs.com), Email: [tri@ultratech-labs.com](mailto:tri@ultratech-labs.com)



91038



1309



46390-2049



NVLAP LAB  
CODE 200093-0



AT-1945



SL2-IN-E-  
1119R



Korea  
KCC-RRA

CA2049



TL363\_B



TPTDP  
DA1300

## TABLE OF CONTENTS

<b>EXHIBIT 1.</b>	<b>INTRODUCTION .....</b>	<b>1</b>
1.1.	SCOPE.....	1
1.2.	RELATED SUBMITTAL(S)/GRANT(S).....	1
1.3.	NORMATIVE REFERENCES .....	1
<b>EXHIBIT 2.</b>	<b>PERFORMANCE ASSESSMENT .....</b>	<b>2</b>
2.1.	CLIENT INFORMATION .....	2
2.2.	EQUIPMENT UNDER TEST (EUT) INFORMATION .....	2
2.3.	EUT’S TECHNICAL SPECIFICATIONS .....	3
2.4.	ASSOCIATED ANTENNA DESCRIPTIONS .....	4
2.5.	LIST OF EUT’S PORTS .....	4
2.6.	ANCILLARY EQUIPMENT .....	4
<b>EXHIBIT 3.</b>	<b>EUT OPERATING CONDITIONS AND CONFIGURATIONS DURING TESTS.....</b>	<b>5</b>
3.1.	CLIMATE TEST CONDITIONS .....	5
3.2.	OPERATIONAL TEST CONDITIONS & ARRANGEMENT FOR TESTS .....	5
<b>EXHIBIT 4.</b>	<b>SUMMARY OF TEST RESULTS .....</b>	<b>6</b>
4.1.	LOCATION OF TESTS .....	6
4.2.	APPLICABILITY & SUMMARY OF EMC EMISSION TEST RESULTS .....	6
4.3.	MODIFICATIONS INCORPORATED IN THE EUT FOR COMPLIANCE PURPOSES .....	6
<b>EXHIBIT 5.</b>	<b>MEASUREMENTS, EXAMINATIONS &amp; TEST DATA FOR EMC EMISSIONS.....</b>	<b>7</b>
5.1.	POWER LINE CONDUCTED EMISSIONS [§15.207(A)].....	7
5.2.	COMPLIANCE WITH FCC PART 15 – GENERAL TECHNICAL REQUIREMENTS.....	12
5.3.	PROVISIONS FOR FREQUENCY HOPPING SYSTEMS [§ 15.247(A)(1)].....	14
5.4.	PEAK CONDUCTED OUTPUT POWER [§ 15.247(B)(2)] .....	61
5.5.	TRANSMITTER SPURIOUS RADIATED EMISSIONS AT 3 METERS [§§ 15.247(D), 15.209 & 15.205] .....	69
5.6.	RF EXPOSURE REQUIRMENTS [§§ 15.247(i), 1.1310 & 2.1091] .....	221
<b>EXHIBIT 6.</b>	<b>TEST EQUIPMENT LIST .....</b>	<b>223</b>
<b>EXHIBIT 7.</b>	<b>MEASUREMENT UNCERTAINTY.....</b>	<b>224</b>
7.1.	LINE CONDUCTED EMISSION MEASUREMENT UNCERTAINTY .....	224
7.2.	RADIATED EMISSION MEASUREMENT UNCERTAINTY .....	224

## EXHIBIT 1. INTRODUCTION

### 1.1. SCOPE

<b>Reference:</b>	FCC Part 15, Subpart C, Section 15.247
<b>Title:</b>	Code of Federal Regulations (CFR), Title 47 – Telecommunication, Part 15
<b>Purpose of Test:</b>	Equipment Certification for Frequency Hopping Spread Spectrum (FHSS) Transmitter.
<b>Test Procedures:</b>	<ul style="list-style-type: none"><li>▪ ANSI C63.4</li><li>▪ ANSI C63.10</li><li>▪ FCC Public Notice DA 00-705</li></ul>
<b>Environmental Classification:</b>	<input checked="" type="checkbox"/> Commercial, industrial or business environment <input checked="" type="checkbox"/> Residential environment

### 1.2. RELATED SUBMITTAL(S)/GRANT(S)

None

### 1.3. NORMATIVE REFERENCES

Publication	Year	Title
47 CFR Parts 0-19	2015	Code of Federal Regulations (CFR), Title 47 – Telecommunication
ANSI C63.4	2014	American National Standard for Methods of Measurement of Radio-Noise Emissions from Low-Voltage Electrical and Electronic Equipment in the Range of 9 KHz to 40 GHz
ANSI C63.10	2013	American National Standard for Testing Unlicensed Wireless Devices
CISPR 22 & EN 55022	2008-09, Ed 6 2006	Information Technology Equipment - Radio Disturbance Characteristics - Limits and Methods of Measurement
FCC Public Notice DA 00-705	2000	Filing and Measurement Guidelines for Frequency Hopping Spread Spectrum Systems

## EXHIBIT 2. PERFORMANCE ASSESSMENT

### 2.1. CLIENT INFORMATION

APPLICANT	
<b>Name:</b>	Digi International Inc.
<b>Address:</b>	11001 Bren Road East Minnetonka, MN USA 55343
<b>Contact Person:</b>	Mr. Eric Smith Phone #: 801-701-4250 Fax #: 801-765-9895 Email Address: eric.smith@digi.com

MANUFACTURER	
<b>Name:</b>	Digi International Inc.
<b>Address:</b>	11001 Bren Road East Minnetonka, MN USA 55343
<b>Contact Person:</b>	Mr. Dan Leveille Phone #: 952-912-4794 Fax #: 952-912-4991 Email Address: dan.levaille@digi.com

### 2.2. EQUIPMENT UNDER TEST (EUT) INFORMATION

The following information (with the exception of the Date of Receipt) has been supplied by the applicant.

<b>Brand Name:</b>	Digi International Inc.
<b>Product Name:</b>	XBEE SX RF Module
<b>Model Name or Number:</b>	XBSX
<b>Serial Number:</b>	Test Samples
<b>Type of Equipment:</b>	FHSS Transmitter
<b>Input Power Supply Type:</b>	External Regulated DC Sources
<b>Primary User Functions of EUT:</b>	Wireless Data transmission

**2.3. EUT’S TECHNICAL SPECIFICATIONS**

<b>Transmitter</b>	
<b>Equipment Type:</b>	<ul style="list-style-type: none"> <li>▪ Mobile</li> <li>▪ Base Station (fixed use)</li> </ul>
<b>Intended Operating Environment:</b>	<ul style="list-style-type: none"> <li>▪ Commercial, industrial or business environment</li> <li>▪ Residential environment</li> </ul>
<b>Power Supply Requirement:</b>	2.4 to 3.6VDC, 3.3 VDC Nominal
<b>RF Output Power Rating:</b>	0 to 13 dBm
<b>Operating Frequency Range:</b>	902.5 - 927.5 MHz
<b>Channel Spacing:</b>	235 to 500 kHz; See Data Rate Specifications table below
<b>RF Output Impedance:</b>	50 Ω
<b>Modulation Type:</b>	FSK and GFSK
<b>Antenna Connector Type:</b>	U.FL or Castellated RF pad

<b>Data Rate Specifications</b>					
Sample Number	Modes	Data Rate (kbps)	Center Frequencies (MHz)	Channel Spacing (kHz)	Modulation
A20 (XTC Firmware)	XTC0	10	905/916.6/925	350	FSK
	XTC1	125	905/916.6/925	350	GFSK
A21 & A23 (XTC AUS Firmware)	XTCA0	10	915.75/921.625/927.265	235	FSK
	XTCA1	105	915.75/921.625/927.265	235	GFSK
A22 (XBX Firmware)	XBX0	10	902.5/915/927.5	250	GFSK
	XBX1	110	902.5/915/927.5	250	GFSK
	XBX2	250	902.75/915.25/927.25	500	GFSK

**2.4. ASSOCIATED ANTENNA DESCRIPTIONS**

Antenna Type	Maximum Gain allowed (dBi)	Required Assembly & Cable Loss for Max Gain of antenna (dB)
Omni-directional base station antenna	8.1	0.65
Yagi antenna	15.1	0.65
Dome antenna	3.0	0.44
Dipole antenna	2.1	0.36
Monopole (Integrated Whip) antenna	3.3	0.44

The highest gain antenna from each of the above antenna types were selected for testing to represents the worst-case. Refer to the antennas list in the User Manual for detailed specifications.

**2.5. LIST OF EUT’S PORTS**

Port Number	EUT’s Port Description	Number of Identical Ports	Connector Type	Cable Type (Shielded/Non-shielded)
1	U.FL	1	U.FL	Shielded, No minimum length
2	RF Pad	1	Castellated Pad	Shielded, No minimum length
3	Interface I/O	1	Castellated Pad	Direct connect
4	DC power	1	Castellated Pad	Direct connect

**2.6. ANCILLARY EQUIPMENT**

The EUT was tested while connected to the following representative configuration of ancillary equipment necessary to exercise the ports during tests:

Ancillary Equipment # 1	
Description:	Test Jig
Brand name:	Digi International Inc.
Model Name or Number:	N/A
Connected to EUT’s Port:	I/O Port

Ancillary Equipment # 2	
Description:	AC/DC Adapter
Brand name:	Volgen
Model Name or Number:	KTPS10-03320WA
Connected to EUT’s Port:	Test Jig of the EUT

Ancillary Equipment # 3	
Description:	Laptop
Brand name:	Dell
Model Name or Number:	PPL
Connected to EUT’s Port:	Test Jig of the EUT

### EXHIBIT 3. EUT OPERATING CONDITIONS AND CONFIGURATIONS DURING TESTS

#### 3.1. CLIMATE TEST CONDITIONS

The climate conditions of the test environment are as follows:

<b>Temperature:</b>	21 to 23 °C
<b>Humidity:</b>	41 to 55%
<b>Pressure:</b>	102 kPa
<b>Power Input Source:</b>	3.6 VDC

#### 3.2. OPERATIONAL TEST CONDITIONS & ARRANGEMENT FOR TESTS

<b>Operating Modes:</b>	<ul style="list-style-type: none"> <li>▪ Each of lowest, middle and highest channel frequencies transmits continuously for emissions measurements.</li> <li>▪ The EUT operates in normal Frequency Hopping mode for occupancy duration, and frequency separation.</li> </ul>
<b>Special Test Software &amp; Hardware:</b>	Special software provided by the Applicant is installed to allow the EUT to operate in hopping mode or at each channel frequency continuously. For example, the transmitter will be operated at each of lowest, middle and highest frequencies individually continuously during testing.
<b>Transmitter Test Antenna:</b>	The EUT is tested with the antenna fitted in a manner typical of normal intended use as non-integral antenna equipment as described with the test results.

<b>Transmitter Test Signals</b>	
<b>Frequency Band(s):</b>	905 - 925 MHz 915.75 - 927.265 MHz 902.5 - 927.5 MHz 902.75 - 927.25 MHz
<b>Frequency(ies) Tested:</b> (Near lowest, near middle & near highest frequencies in the frequency range of operation.)	905, 916.6 & 925 MHz 915.75, 921.625, 927.265 MHz 902.5, 915.0, 927.5 MHz 902.75, 915.25, 927.25 MHz
<b>RF Power Output:</b> (measured maximum output power at antenna terminals)	0.0223 Watt (Conducted)
<b>Normal Test Modulation:</b>	FSK or GFSK as per Sec 2.3
<b>Modulating Signal Source:</b>	Internal

## EXHIBIT 4. SUMMARY OF TEST RESULTS

### 4.1. LOCATION OF TESTS

All of the measurements described in this report were performed at Ultratech Group of Labs located in the city of Oakville, Province of Ontario, Canada.

- AC Power Line Conducted Emissions were performed in UltraTech's shielded room, 24'(L) by 16'(W) by 8'(H).
- Radiated Emissions were performed at the Ultratech's 3-10 TDK Semi-Anechoic Chamber situated in the Town of Oakville, province of Ontario. This test site been calibrated in accordance with ANSI C63.4, and found to be in compliance with the requirements of Sec. 2.948 of the FCC Rules. The descriptions and site measurement data of the Oakville 3-10 TDK Semi-Anechoic Chamber has been filed with FCC office (FCC File No.: 91038) and Industry Canada office (Industry Canada File No.: 2049A-3). Expiry Date: 2017-04-02.

### 4.2. APPLICABILITY & SUMMARY OF EMC EMISSION TEST RESULTS

FCC Section(s)	Test Requirements	Compliance (Yes/No)
15.203	Antenna requirements	Yes
15.207(a)	AC Power Line Conducted Emissions	Yes
15.247(a)(1) & (1)(i)	Provisions for Frequency Hopping Systems	Yes*
15.247(b)(2)	Peak Conducted Output Power	Yes
15.247(c)	Operation with directional antenna gains greater than 6 dBi	Yes
15.247(d)	Band-Edge and RF Conducted Spurious Emissions at the Transmitter Antenna Terminal	Yes
15.247(d), 15.209 & 15.205	Transmitter Spurious Radiated Emissions	Yes
15.247 (g) & (h)	Requirements for FHSS	Yes*
15.247(i), 1.1307, 1.1310, 2.1091	RF Exposure	Yes

\* Refer to the Operational Description

### 4.3. MODIFICATIONS INCORPORATED IN THE EUT FOR COMPLIANCE PURPOSES

None



## EXHIBIT 5. MEASUREMENTS, EXAMINATIONS & TEST DATA FOR EMC EMISSIONS

### 5.1. POWER LINE CONDUCTED EMISSIONS [§15.207(a)]

#### 5.1.1. Limit(s)

The equipment shall meet the limits of the following table:

Frequency of emission (MHz)	Conducted Limits (dB $\mu$ V)	
	Quasi-peak	Average
0.15–0.5 .....	66 to 56* .....	56 to 46*
0.5–5 .....	56 .....	46
5–30 .....	60 .....	50

\*Decreases linearly with the logarithm of the frequency

#### 5.1.2. Method of Measurements

ANSI C63.4-2009

#### 5.1.3. Test Arrangement

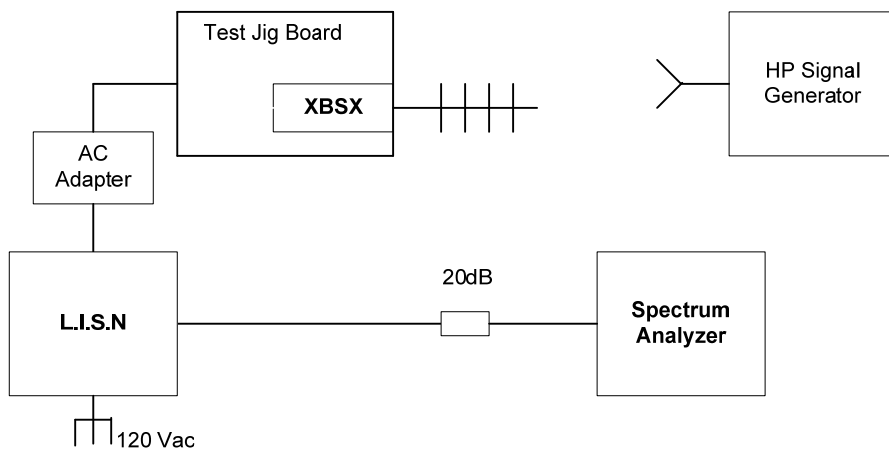

5.1.4. Test Data

Plot 5.1.4.1. Power Line Conducted Emissions (Tx Mode)  
 Line Voltage: 120 VAC; Line Tested: Hot

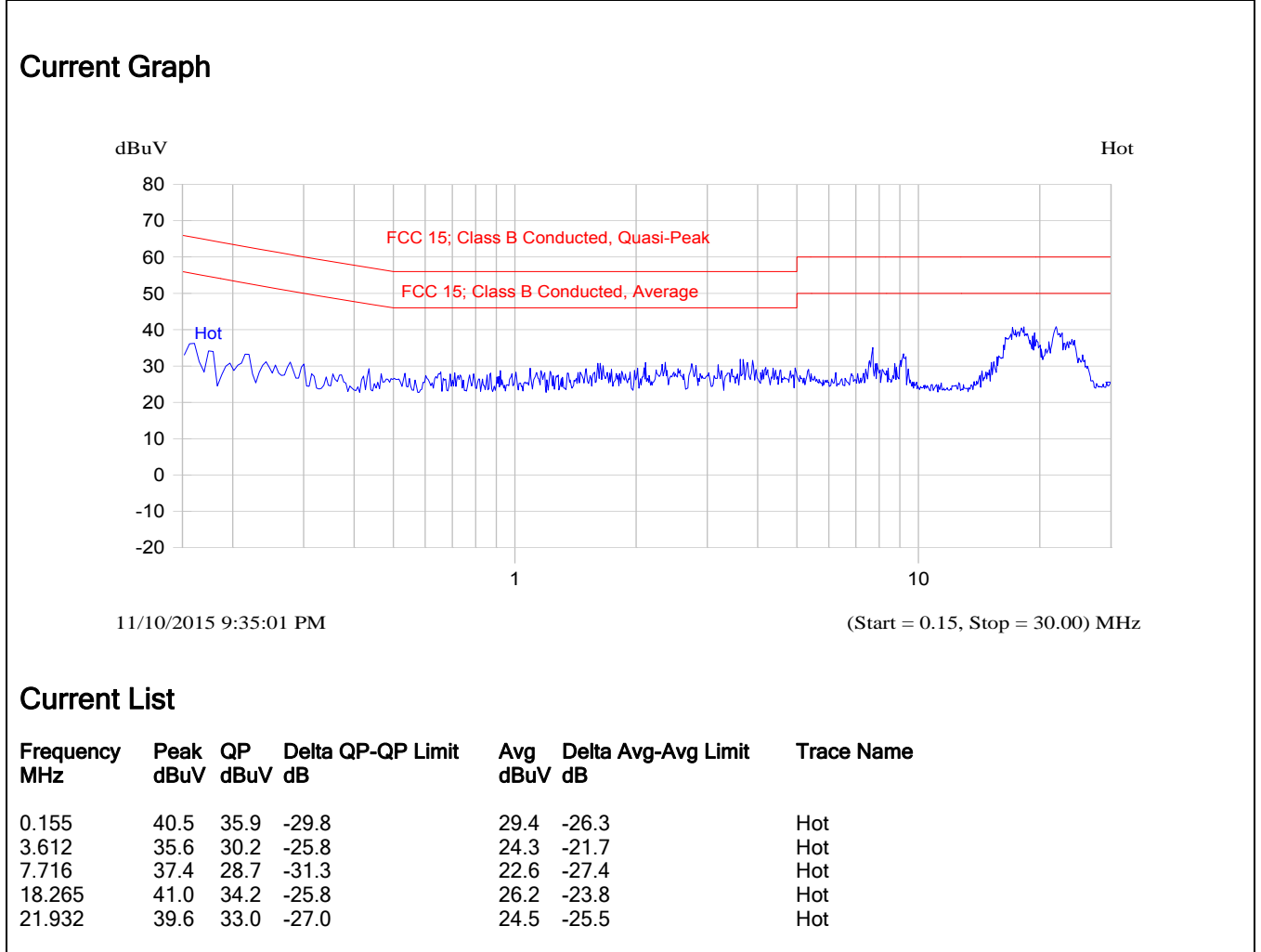

**Plot 5.1.4.2. Power Line Conducted Emissions (Tx Mode)**  
 Line Voltage: 120 VAC; Line Tested: Neutral

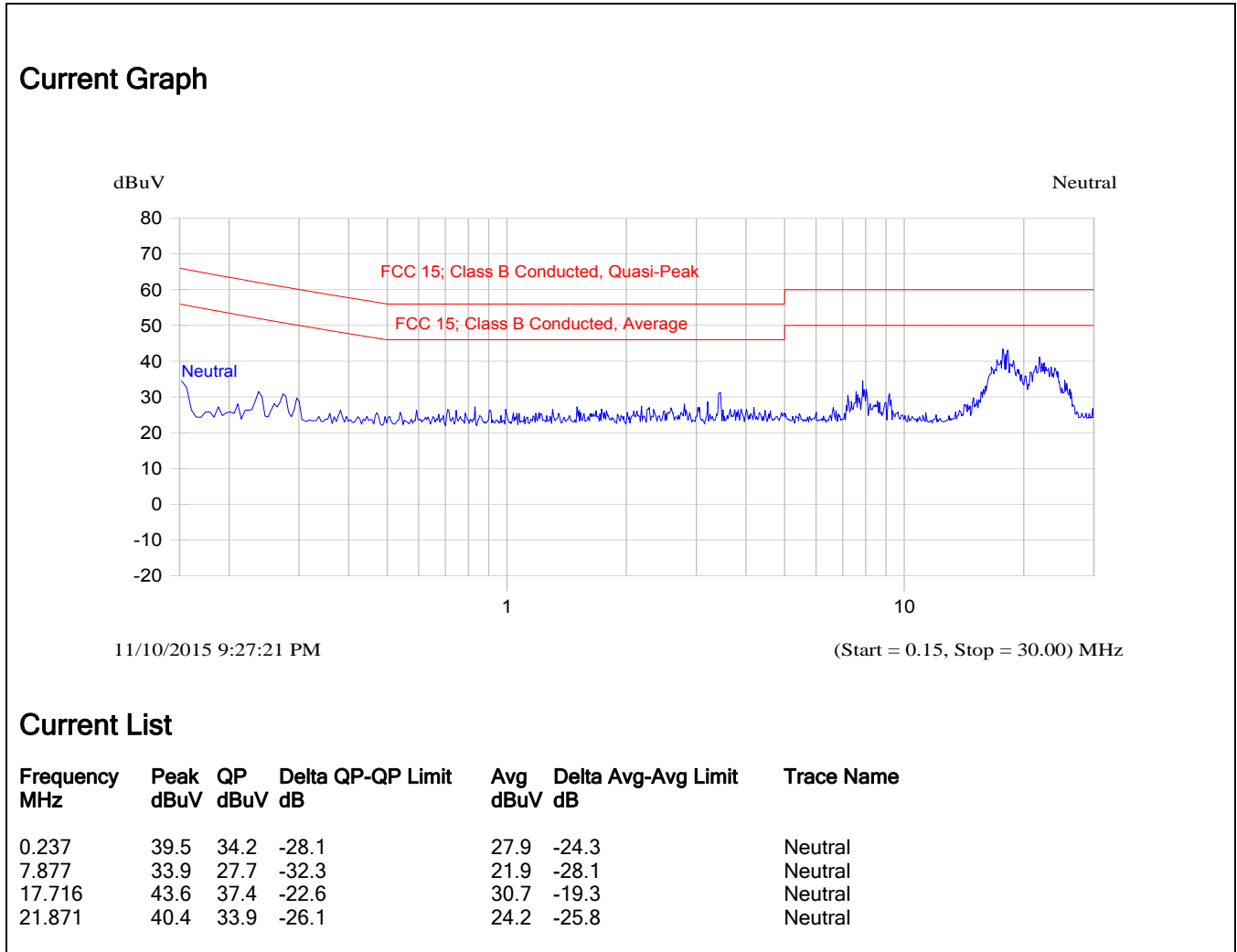

**Plot 5.1.4.3. Power Line Conducted Emissions (Rx Mode)**  
 Line Voltage: 120 VAC; Line Tested: Hot

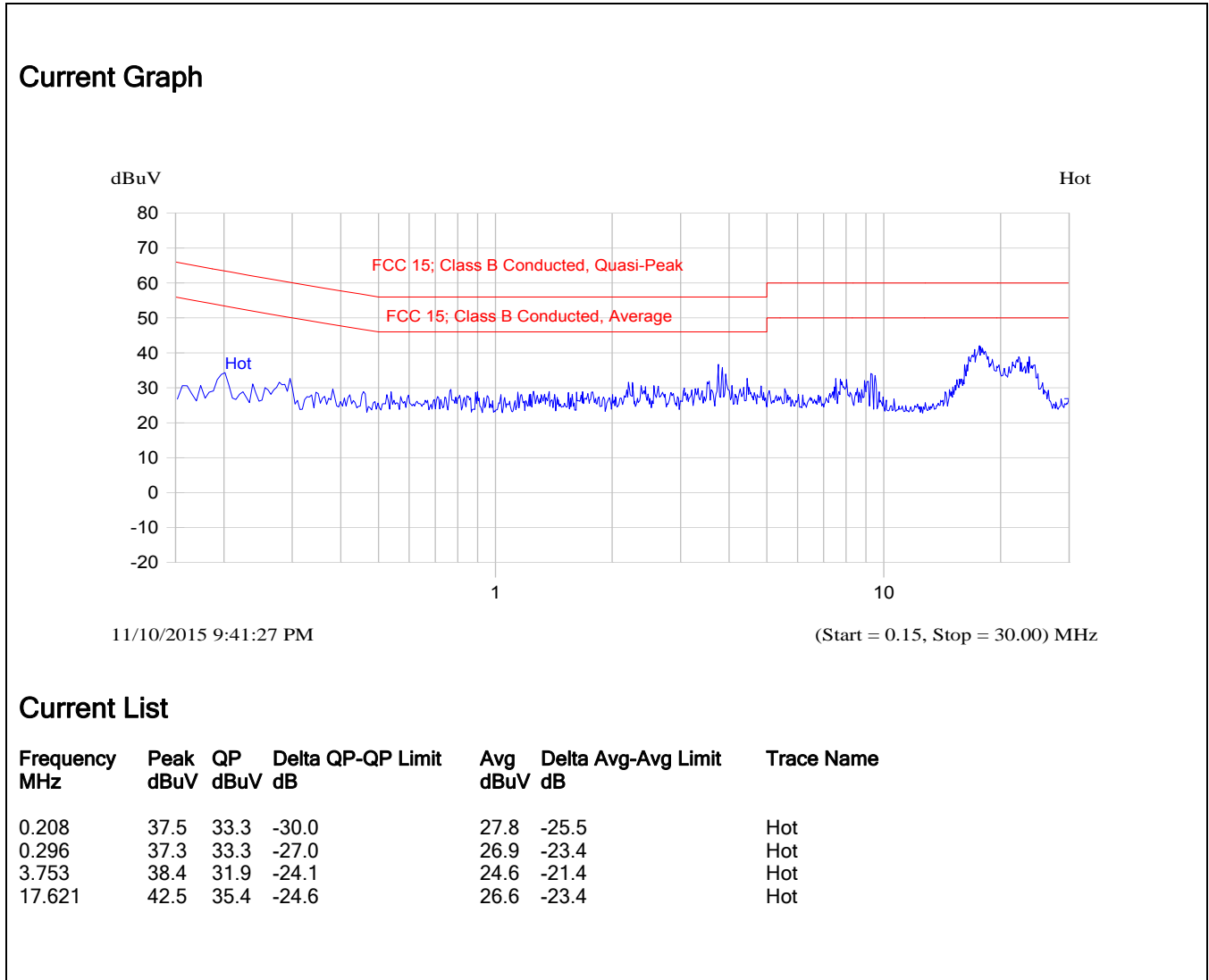

**Plot 5.1.4.4. Power Line Conducted Emissions (Rx Mode)**  
 Line Voltage: 120 VAC; Line Tested: Neutral

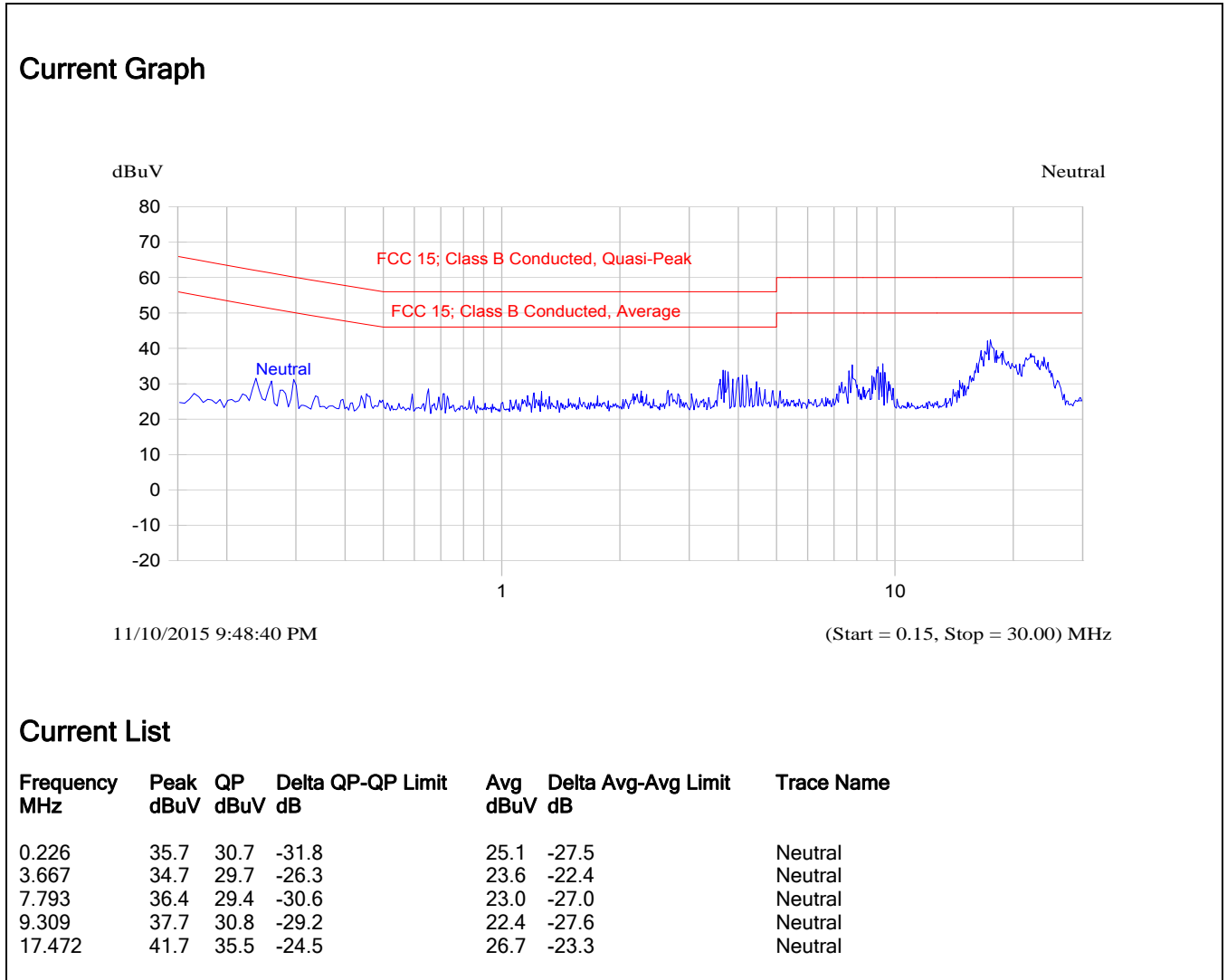

**ULTRATECH GROUP OF LABS**

3000 Bristol Circle, Oakville, Ontario, Canada L6H 6G4  
 Tel. #: 905-829-1570, Fax. #: 905-829-8050, Email: [vic@ultratech-labs.com](mailto:vic@ultratech-labs.com), Website: <http://www.ultratech-labs.com>

File #: 15DIG102\_FCC15C247

December 24, 2015

All test results contained in this engineering test report are traceable to National Institute of Standards and Technology (NIST)

**5.2. COMPLIANCE WITH FCC PART 15 – GENERAL TECHNICAL REQUIREMENTS**

FCC Section	FCC Rules	Manufacturer’s Clarification
15.31	The hopping function must be disabled for tests, which should be performed with the EUT transmitting on the number of frequencies specified in this Section. The measurements made at the upper and lower ends of the band of operation should be made with the EUT tuned to the highest and lowest available channels.	See Operational Description
15.203	<p>Described how the EUT complies with the requirement that either its antenna is permanently attached, or that it employs a unique antenna connector, for every antenna proposed for use with the EUT.</p> <p>The exception is in those cases where EUT must be professionally installed. In order to demonstrate that professional installation is required, the following 3 points must be addressed:</p> <ul style="list-style-type: none"> <li>➤ The application (or intended use) of the EUT</li> <li>➤ The installation requirements of the EUT</li> <li>➤ The method by which the EUT will be marketed</li> </ul>	The antenna employs a unique antenna connector.
15.204	<p>Provided the information for every antenna proposed for use with the EUT:</p> <ul style="list-style-type: none"> <li>➤ type (e.g. Yagi, patch, grid, dish, etc...),</li> <li>➤ manufacturer and model number</li> <li>➤ gain with reference to an isotropic radiator</li> </ul>	See proposed antenna list.
15.247(a)	Description of how the EUT meets the definition of a frequency hopping spread spectrum, found in Section 2.1. Based on the technical description.	See Operational Description
15.247(a)	Pseudo Frequency Hopping Sequence: Describe how the hopping sequence is generated. Provide an example of the hopping sequence channels, in order to demonstrate that the sequence meets the requirements specified in the definition of a frequency hopping spread spectrum system, found in Section 2.1	See Operational Description

FCC Section	FCC Rules	Manufacturer's Clarification
15.247(a)	<u>Equal Hopping Frequency Use:</u> Describe how each individual EUT meets the requirement that each of its hopping channels is used equally on average (e.g. that each new transmission event begins on the next channel in the hopping sequence after final channel used in the previous transmission events).	See Operational Description
15.247(g)	Describe how the EUT complies with the requirement that it be designed to be capable of operating as a true frequency hopping system	See Operational Description
15.247(h)	Describe how the EUT complies with the requirement that it not have the ability to coordinated with other FHSS is an effort to avoid the simultaneous occupancy of individual hopping frequencies by multiple transmitters	See Operational Description
Public Notice DA 00-705	<u>System Receiver Input Bandwidth:</u> Describe how the associated receiver(s) complies with the requirement that its input bandwidth (either RF or IF) matches the bandwidth of the transmitted signal.	See Operational Description
Public Notice DA 00-705	<u>System Receiver Hopping Capability:</u> Describe how the associated receiver(s) has the ability to shift frequencies in synchronization with the transmitted signals	See Operational Description

### 5.3. PROVISIONS FOR FREQUENCY HOPPING SYSTEMS [§ 15.247(a)(1)]

#### 5.3.1. Limits

**§ 15.247(a)(1):** Frequency hopping systems shall have hopping channel carrier frequencies separated by a minimum of 25 kHz or the 20 dB bandwidth of the hopping channel, whichever is greater. Alternatively, frequency hopping systems operating in the 2400–2483.5 MHz band may have hopping channel carrier frequencies that are separated by 25 kHz or two-thirds of the 20 dB bandwidth of the hopping channel, whichever is greater, provided the systems operate with an output power no greater than 125 mW. The system shall hop to channel frequencies that are selected at the system hopping rate from a pseudo randomly ordered list of hopping frequencies. Each frequency must be used equally on the average by each transmitter. The system receivers shall have input bandwidths that match the hopping channel bandwidths of their corresponding transmitters and shall shift frequencies in synchronization with the transmitted signals.

**§ 15.247(a)(1)(i):** For frequency hopping systems operating in the 902-928 MHz band: if the 20 dB bandwidth of the hopping channel is less than 250 kHz, the system shall use at least 50 hopping frequencies and the average time of occupancy on any frequency shall not be greater than 0.4 seconds within a 20 second period; if the 20 dB bandwidth of the hopping channel is 250 kHz or greater, the system shall use at least 25 hopping frequencies and the average time of occupancy on any frequency shall not be greater than 0.4 seconds within a 10 second period. The maximum allowed 20 dB bandwidth of the hopping channel is 500 kHz.

#### 5.3.2. Method of Measurements

FCC Public Notice DA 00-705 and ANSI C63.10

#### 5.3.3. Test Arrangement

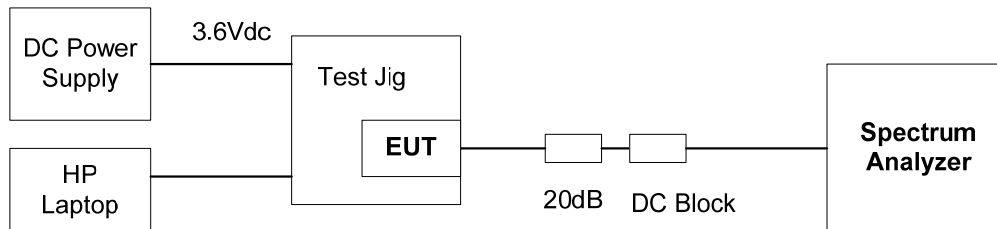



5.3.4. Test Data

Test Description	FCC Specification	Measured Values	Comments
Frequency Hopping Systems Requirements	The system shall hop to channel frequencies that are selected at the system hopping rate from a pseudo randomly ordered list of hopping frequencies. Each frequency must be used equally on the average by each transmitter. The system receivers shall have input bandwidths that match the hopping channel bandwidths of their corresponding transmitters and shall shift frequencies in synchronization with the transmitted signals.	--	See Note 1
20 dB BW of the hopping channel	The maximum allowed 20 dB bandwidth of the hopping channel is 500 kHz	XBX0 10kbps: 79.8 kHz XBX1 110kbps: 224.5 kHz XBX2 250kbps: 396.8 kHz XTC0 10kbps: 301.6 kHz XTC1 125kbps: 265.1 kHz XTCA0 10kbps: 204.4 kHz XTCA1 125kbps: 222.4 kHz	See Note 2
Channel Hopping Frequency Separation	Frequency hopping systems shall have hopping channel carrier frequencies separated by a minimum of 25 kHz or the 20 dB bandwidth of the hopping channel, whichever is greater.	XBX0 10kbps: 249.3 kHz XBX1 110kbps: 249.3 kHz XBX2 250kbps: 497.8 kHz XTC0 10kbps: 349.5 kHz XTC1 125kbps: 349.5 kHz XTCA0 10kbps: 235.7 kHz XTCA1 125kbps: 235.7 kHz	See Note 2
Number hopping frequencies	If the 20 dB bandwidth of the hopping channel is less than 250 kHz, the system shall use at least 50 hopping frequencies.  If the 20 dB bandwidth of the hopping channel is 250 kHz or greater, the system shall use at least 25 hopping frequencies.	50 hopping frequencies for all data rates & modes	See Note 1 and 2
Average Time of Occupancy	If the 20 dB bandwidth of the hopping channel is less than 250 kHz, the average time of occupancy on any frequency shall not be greater than 0.4 seconds within a 20 second period.  If the 20 dB bandwidth of the hopping channel is 250 kHz or greater, the average time of occupancy on any frequency shall not be greater than 0.4 seconds within a 10 second period.	XBX0 10kbps: 0.325 in 20s XBX1 110kbps: 0.183 in 20s XBX2 250kbps: 0.046 in 10s XTC0 10kbps: 0.273 in 10s XTC1 125kbps: 0.183 in 10s XTCA0 10kbps: 0.378 in 20s XTCA1 125kbps: 0.384 in 20s	See Note 2

**Note 1:** See operational description exhibit for details.

**Note 2:** See the following plots for details.

Plot 5.3.4.1. 20 dB Bandwidth, 902.5 MHz, XBX0, Data Rate at 10 kbps

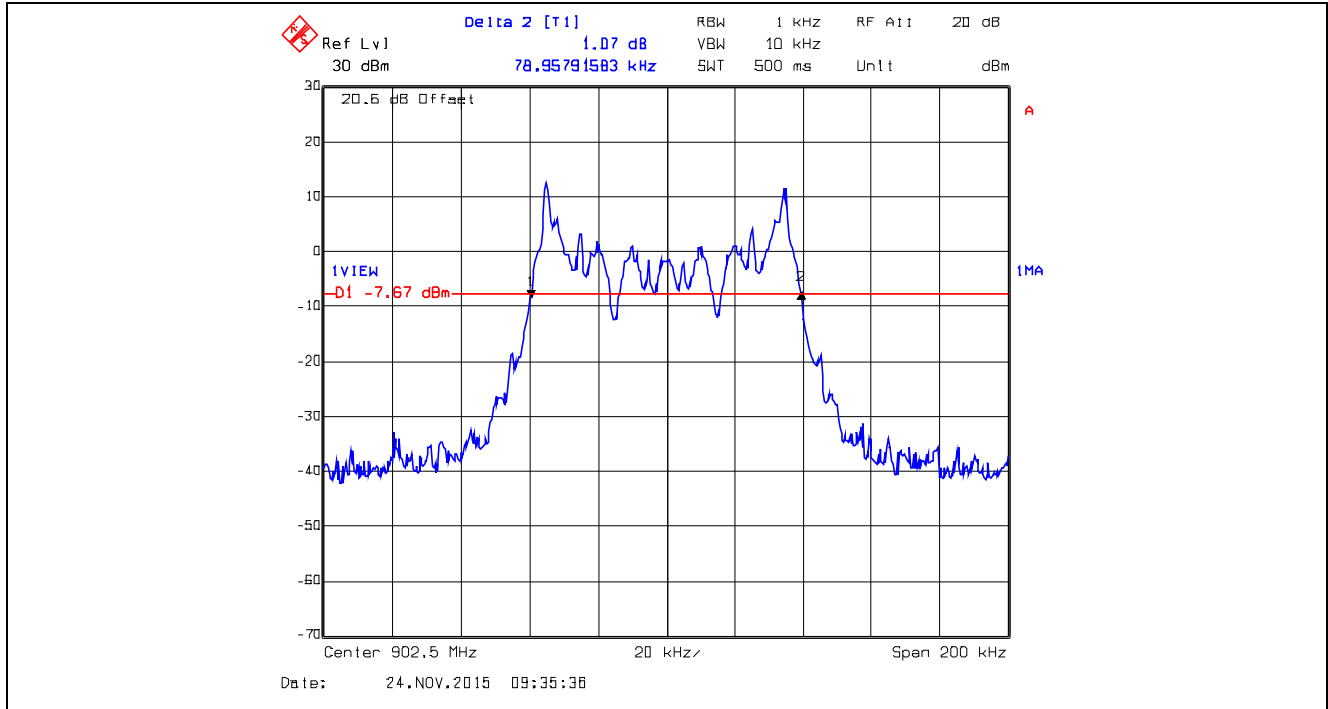

Plot 5.3.4.2. 20 dB Bandwidth, 915 MHz, XBX0, Data Rate at 10 kbps

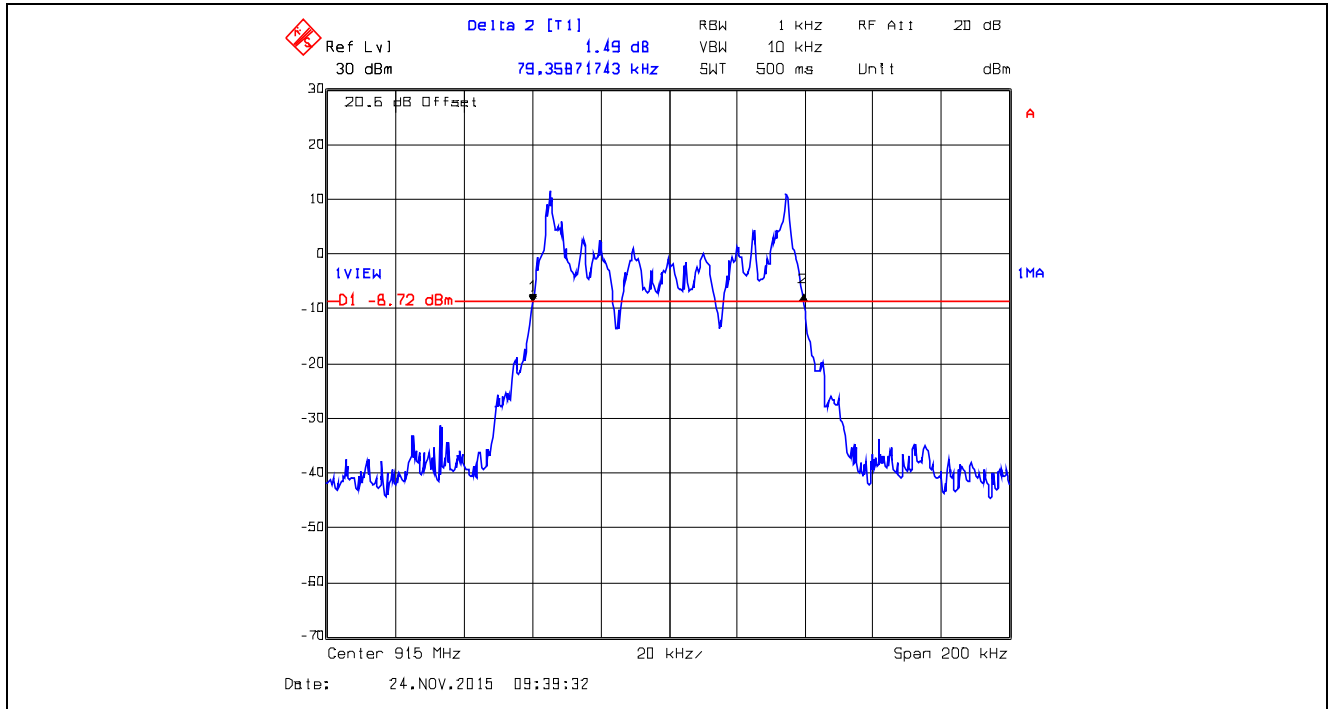

Plot 5.3.4.3. 20 dB Bandwidth, 927.5 MHz, XBX0, Data Rate at 10 kbps

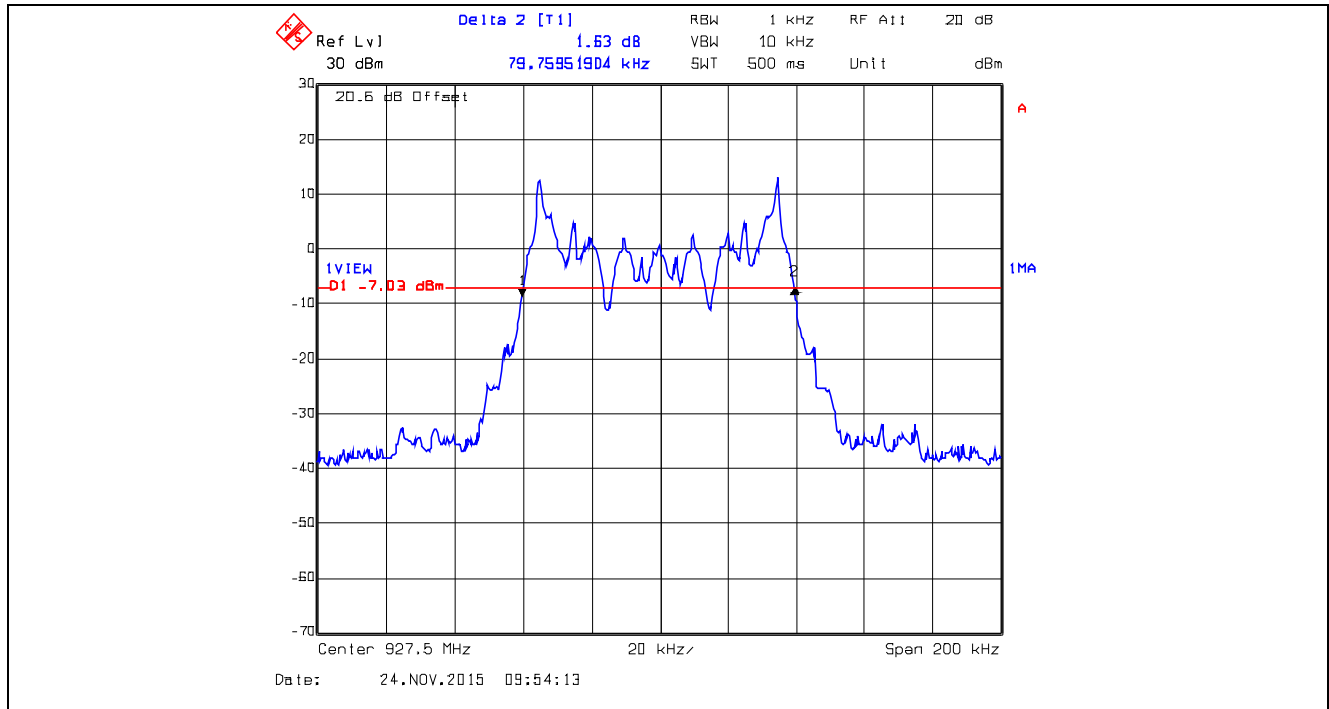

Plot 5.3.4.4. 20 dB Bandwidth, 902.5 MHz, XBX1, Data Rate at 110 kbps

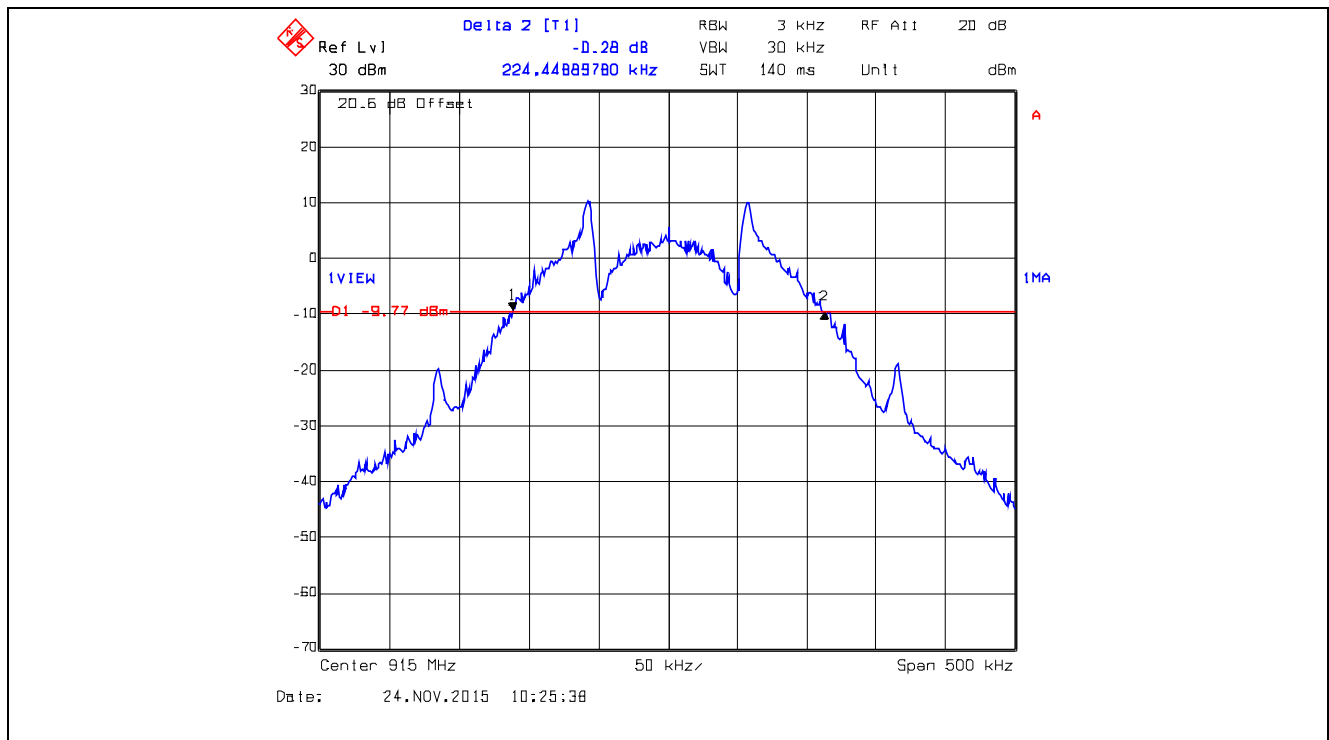

**ULTRATECH GROUP OF LABS**

3000 Bristol Circle, Oakville, Ontario, Canada L6H 6G4  
 Tel. #: 905-829-1570, Fax. #: 905-829-8050, Email: [vic@ultratech-labs.com](mailto:vic@ultratech-labs.com), Website: <http://www.ultratech-labs.com>

File #: 15DIG102\_FCC15C247  
 December 24, 2015

All test results contained in this engineering test report are traceable to National Institute of Standards and Technology (NIST)

Plot 5.3.4.5. 20 dB Bandwidth, 915.0 MHz, XBX1, Data Rate at 110 kbps

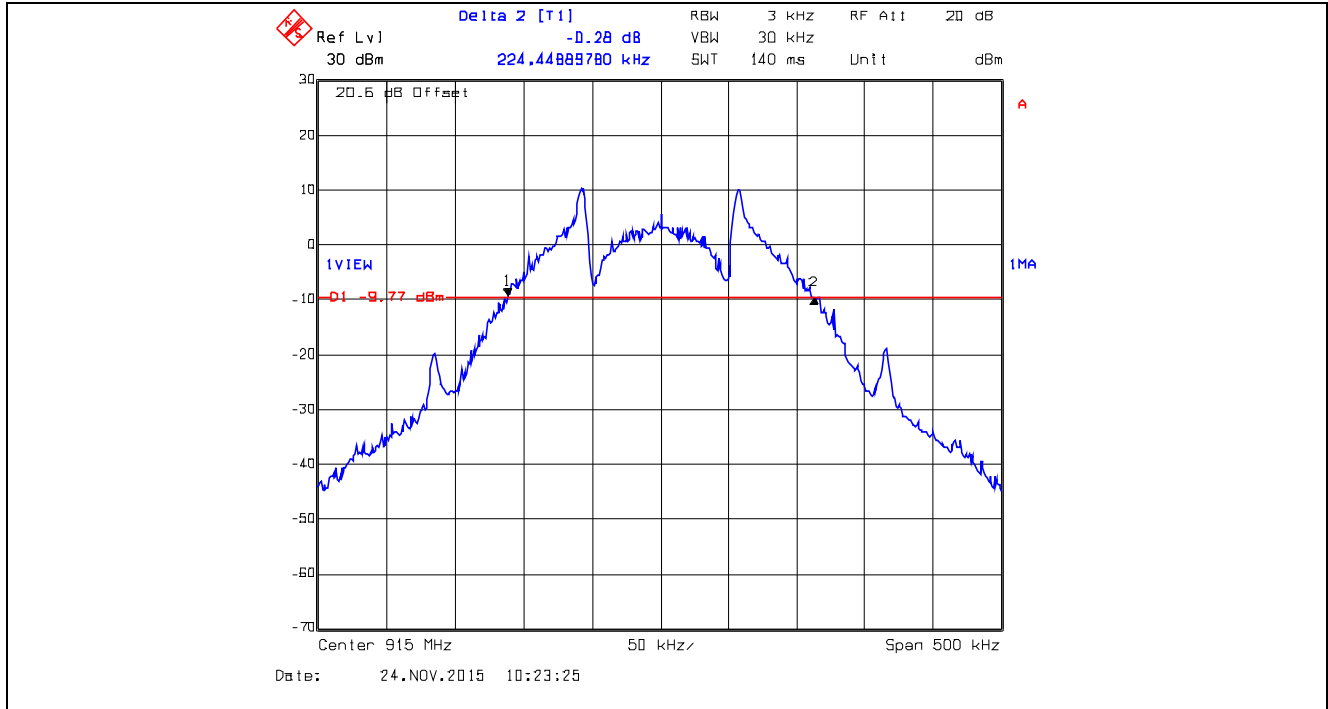

Plot 5.3.4.6. 20 dB Bandwidth, 927.5 MHz, XBX1, Data Rate at 110 kbps

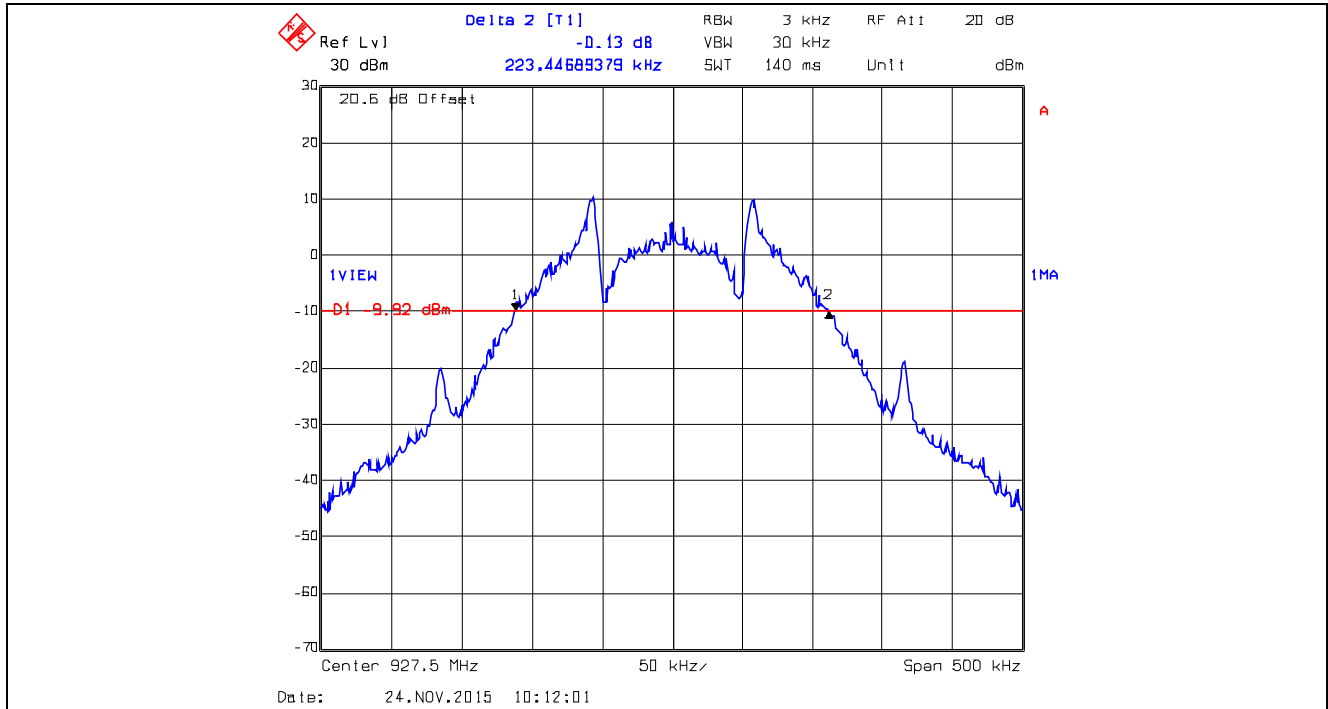

Plot 5.3.4.7. 20 dB Bandwidth, 902.75 MHz, XBX2, Data Rate at 250 kbps

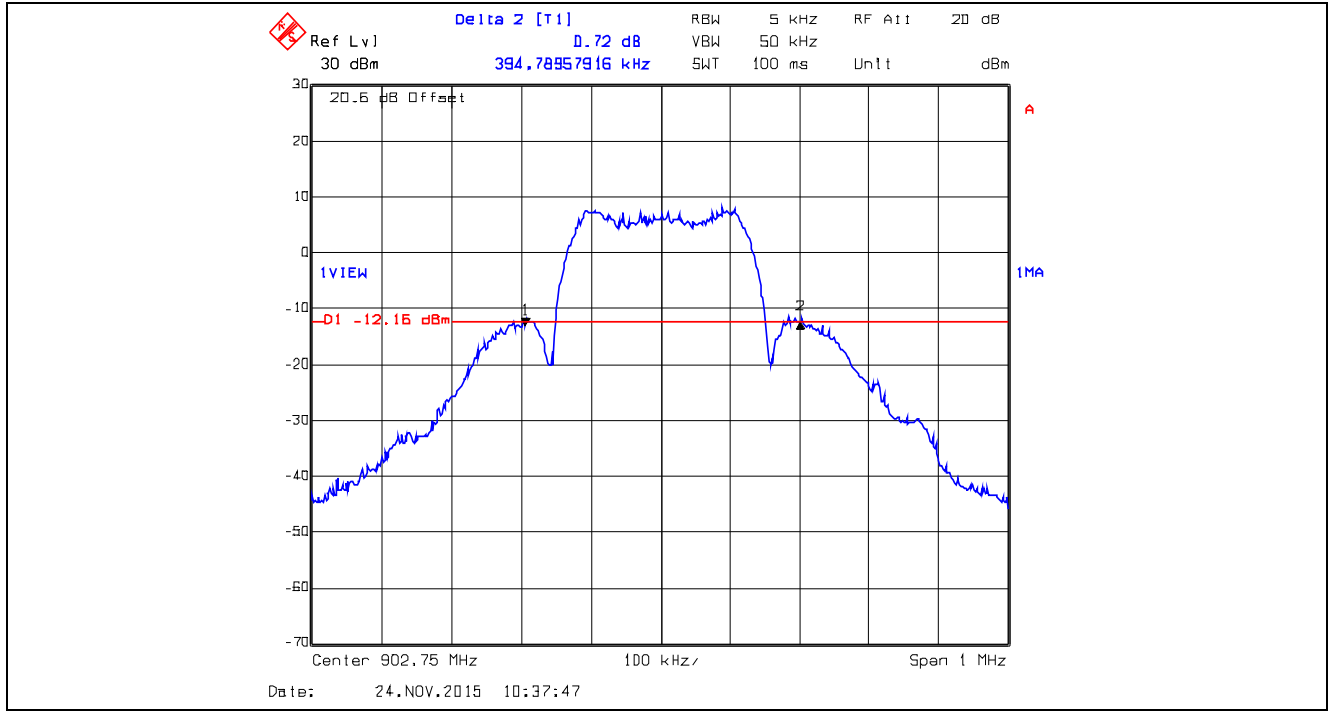

Plot 5.3.4.8. 20 dB Bandwidth, 915.25 MHz, XBX2, Data Rate at 250 kbps

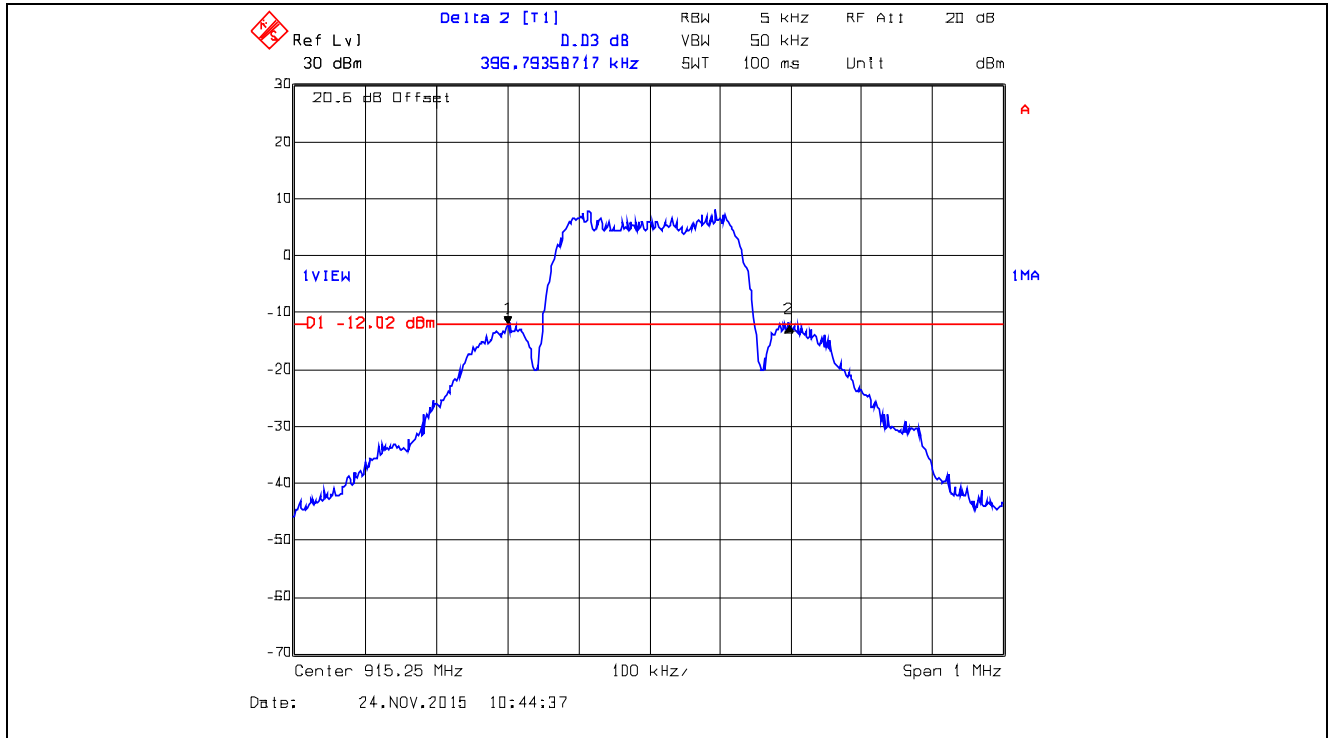

**ULTRATECH GROUP OF LABS**

3000 Bristol Circle, Oakville, Ontario, Canada L6H 6G4  
 Tel. #: 905-829-1570, Fax. #: 905-829-8050, Email: [vic@ultratech-labs.com](mailto:vic@ultratech-labs.com), Website: <http://www.ultratech-labs.com>

File #: 15DIG102\_FCC15C247

December 24, 2015

All test results contained in this engineering test report are traceable to National Institute of Standards and Technology (NIST)

Plot 5.3.4.9. 20 dB Bandwidth, 927.25 MHz, XBX2, Data Rate at 250 kbps

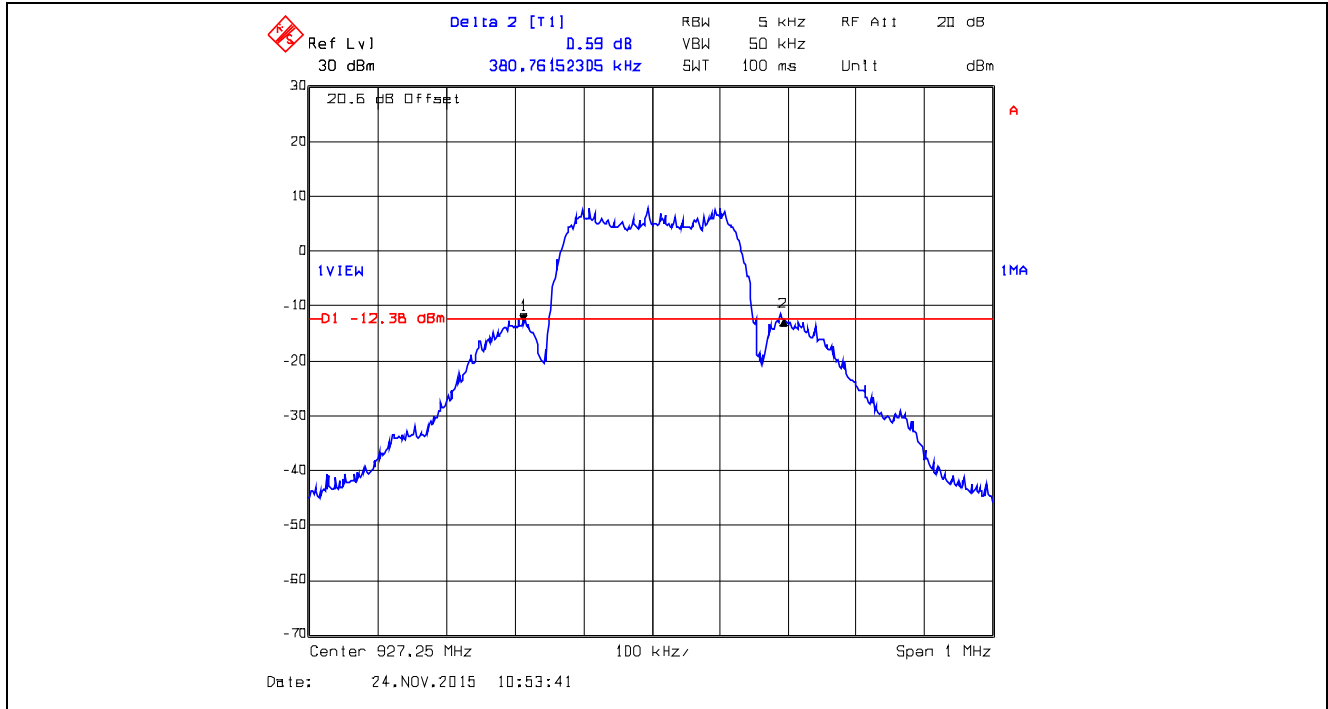

Plot 5.3.4.10. 20 dB Bandwidth, 905 MHz, XTC0, Data Rate at 10 kbps

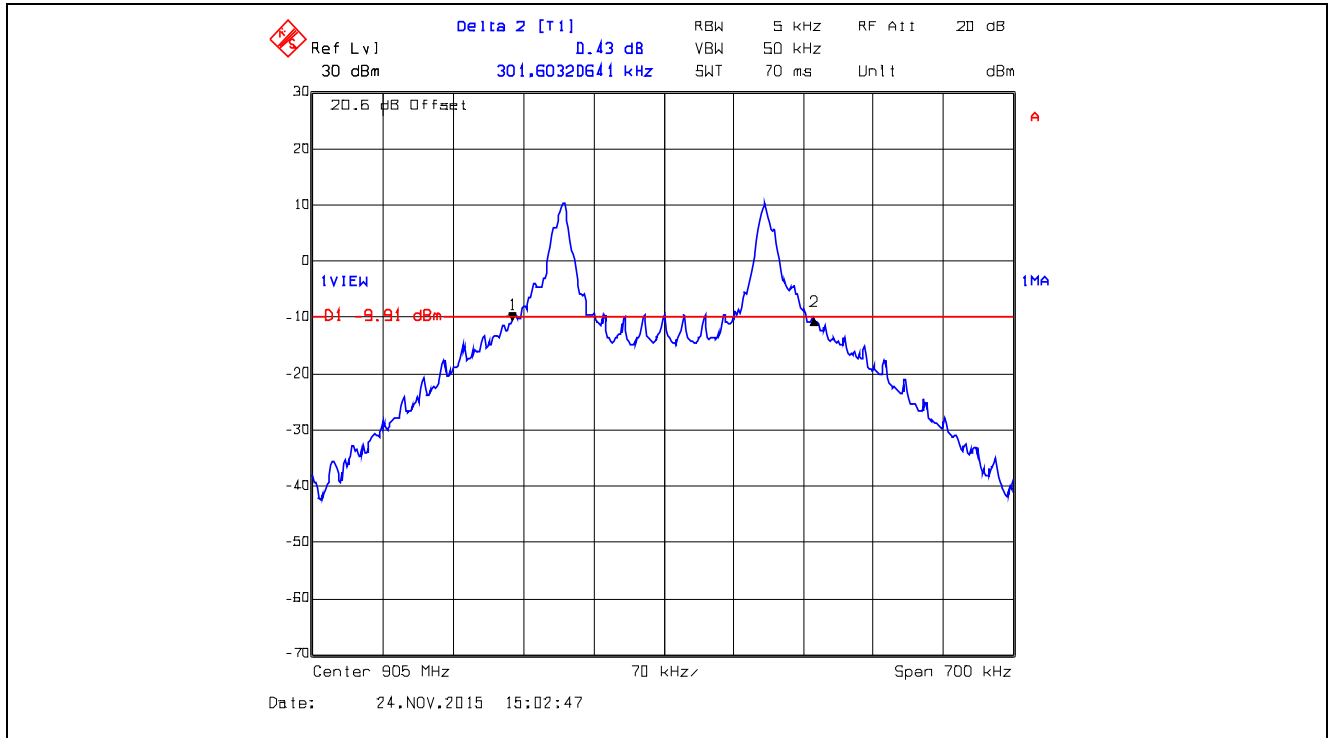

Plot 5.3.4.11. 20 dB Bandwidth, 916.6 MHz, XTC0, Data Rate at 10 kbps

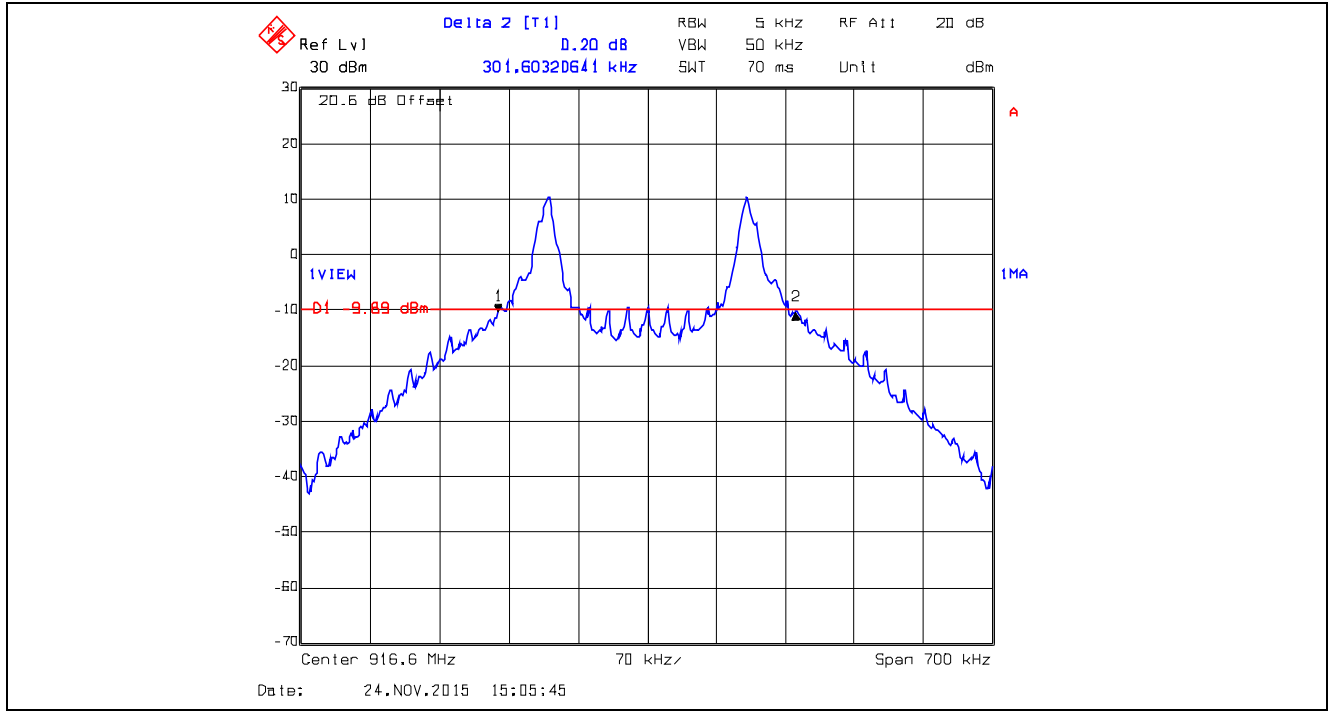

Plot 5.3.4.12. 20 dB Bandwidth, 925 MHz, XTC0, Data Rate at 10 kbps

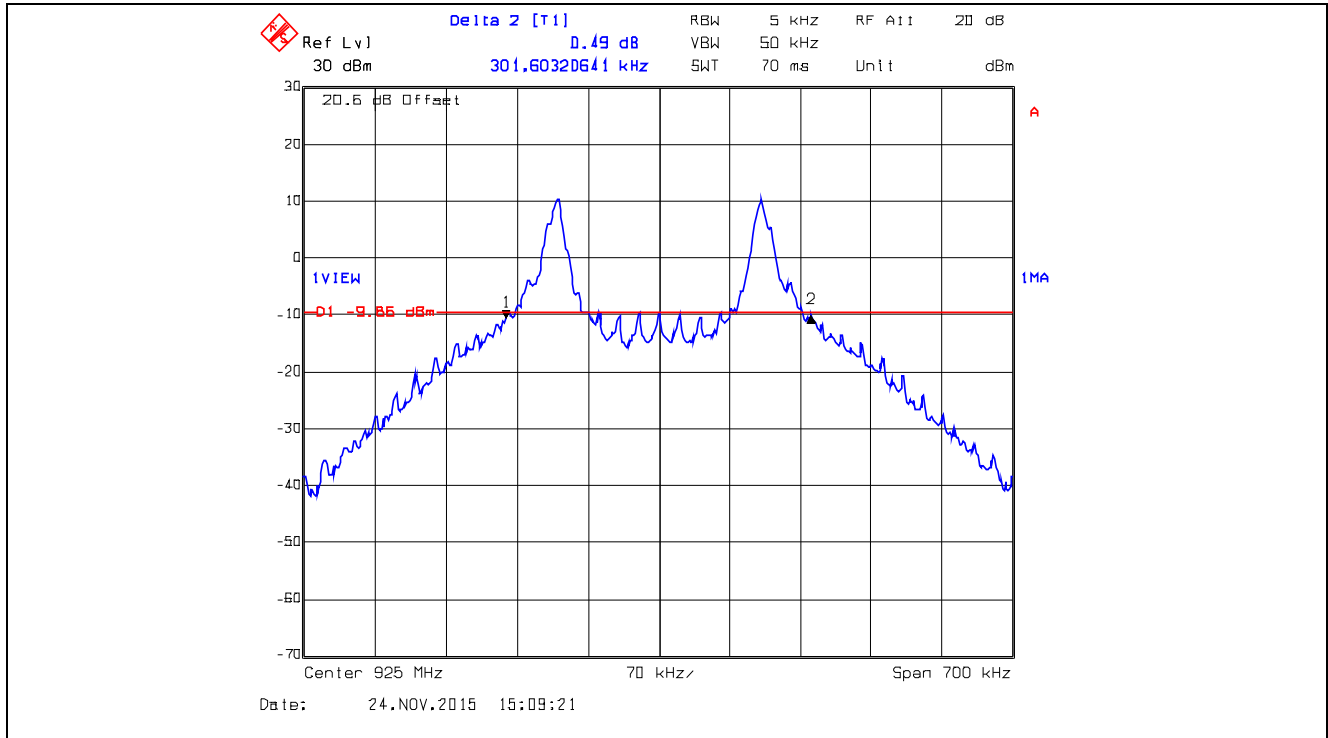

Plot 5.3.4.13. 20 dB Bandwidth, 905 MHz, XTC1, Data Rate at 125 kbps

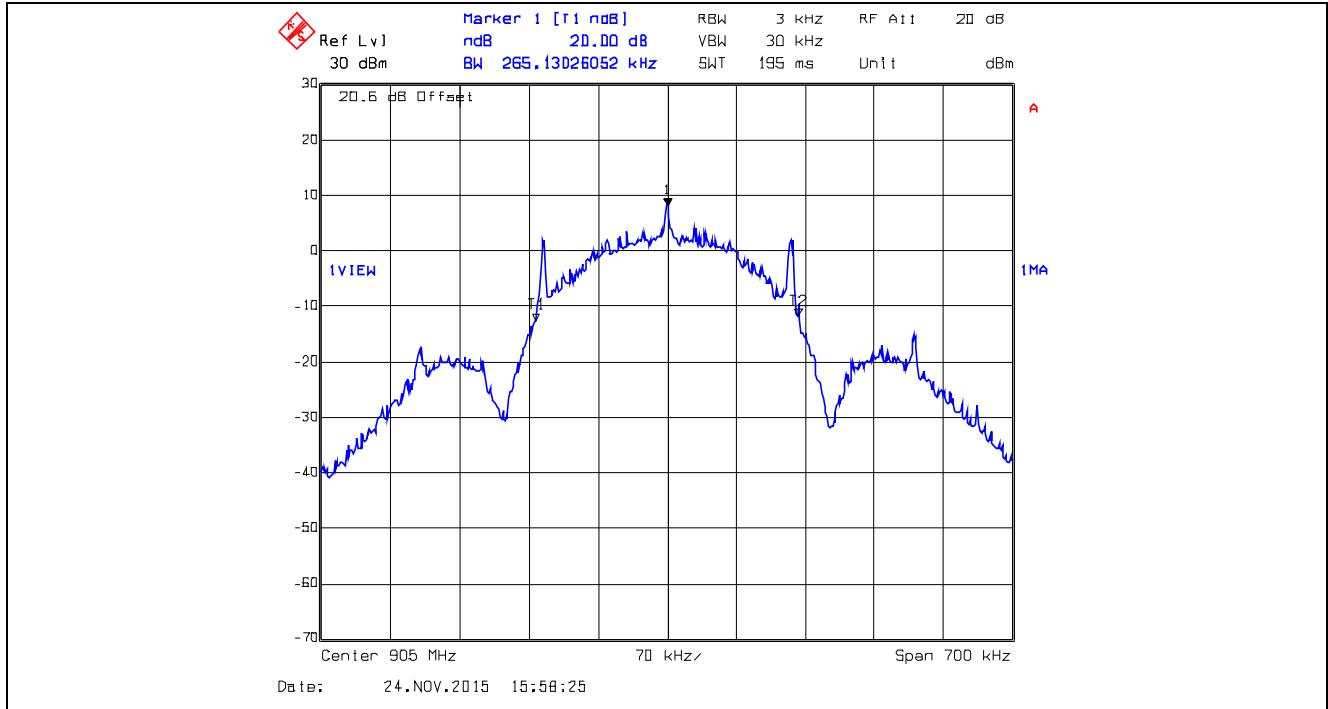

Plot 5.3.4.14. 20 dB Bandwidth, 916.6 MHz, XTC1, Data Rate at 125 kbps

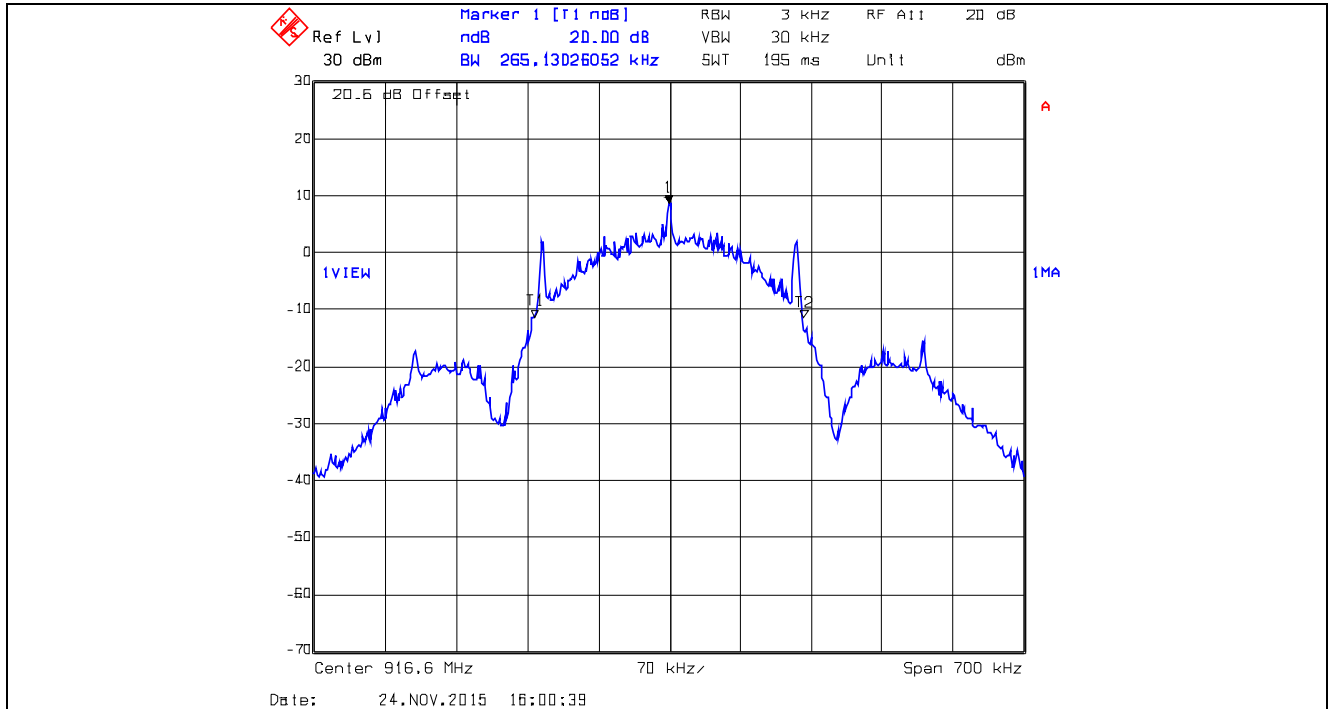



Plot 5.3.4.15. 20 dB Bandwidth, 925 MHz, XTC1, Data Rate at 125 kbps

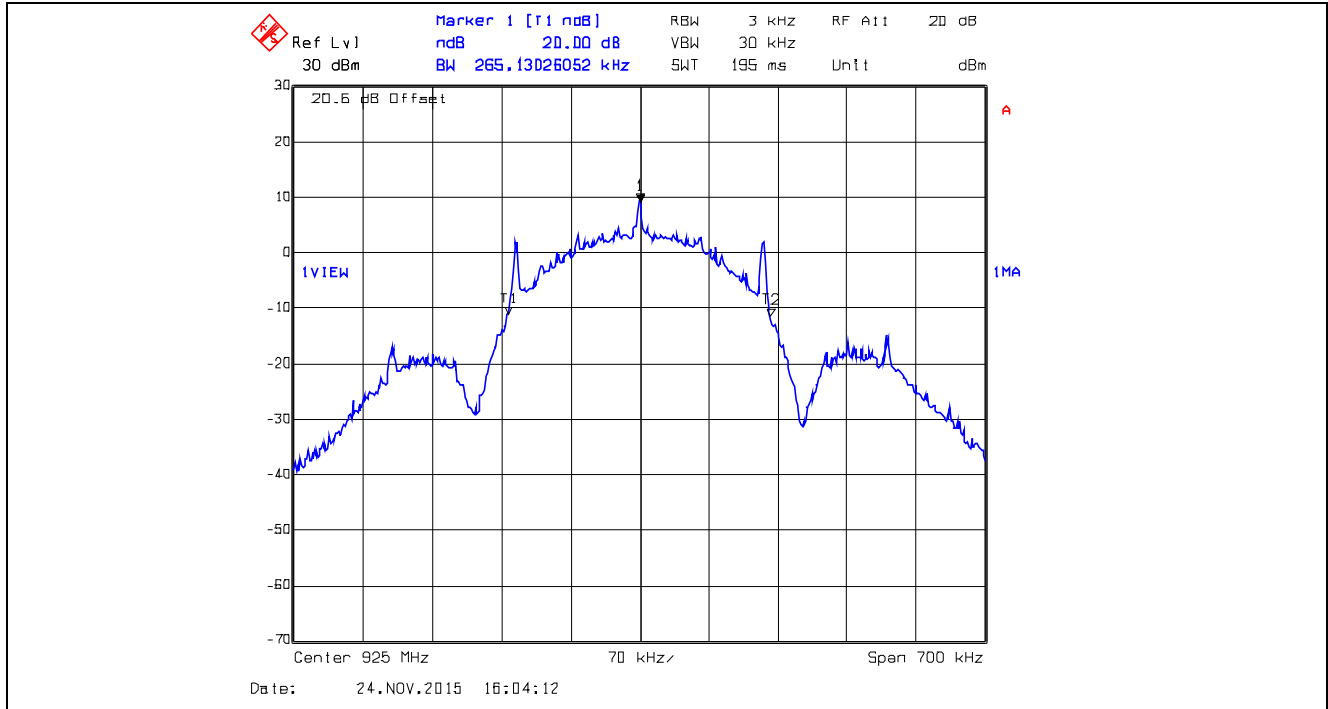

Plot 5.3.4.16. 20 dB Bandwidth, 915.75 MHz, XTCA0, Data Rate at 10 kbps

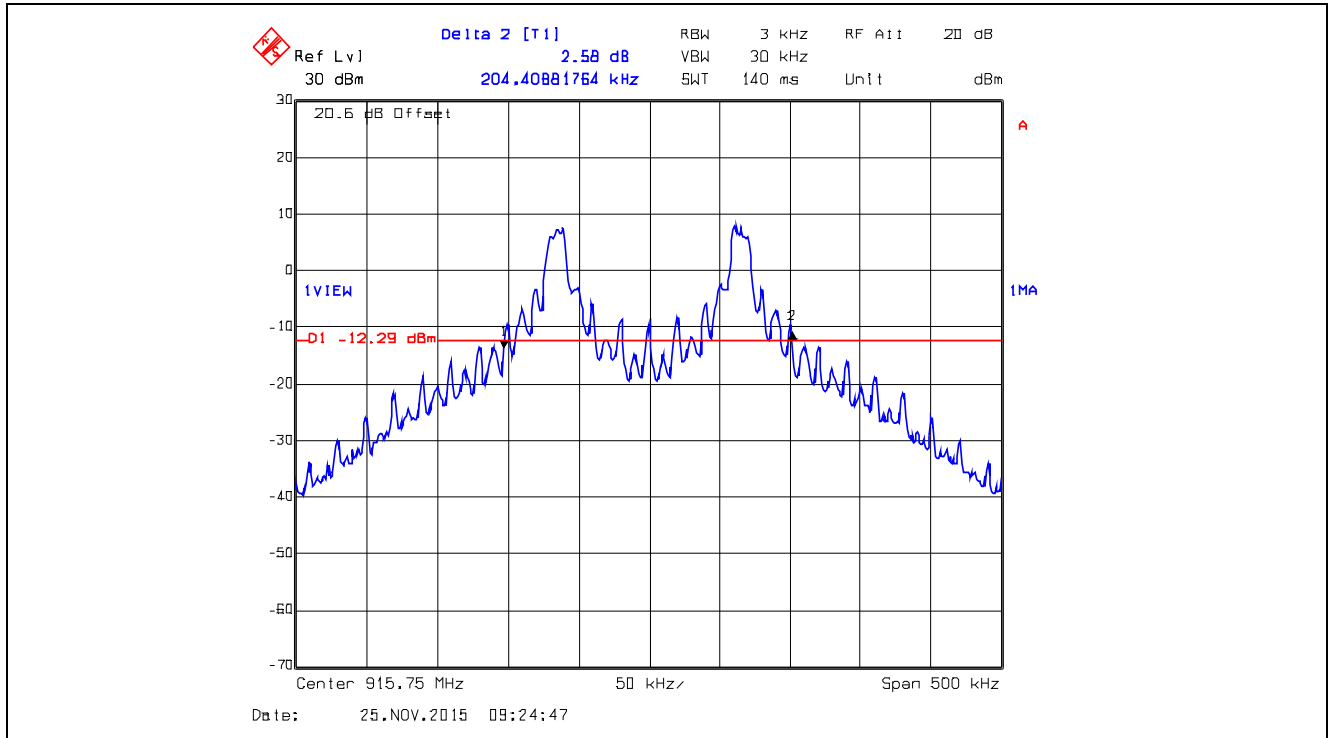

Plot 5.3.4.17. 20 dB Bandwidth, 921.625 MHz, XTCA0, Data Rate at 10 kbps

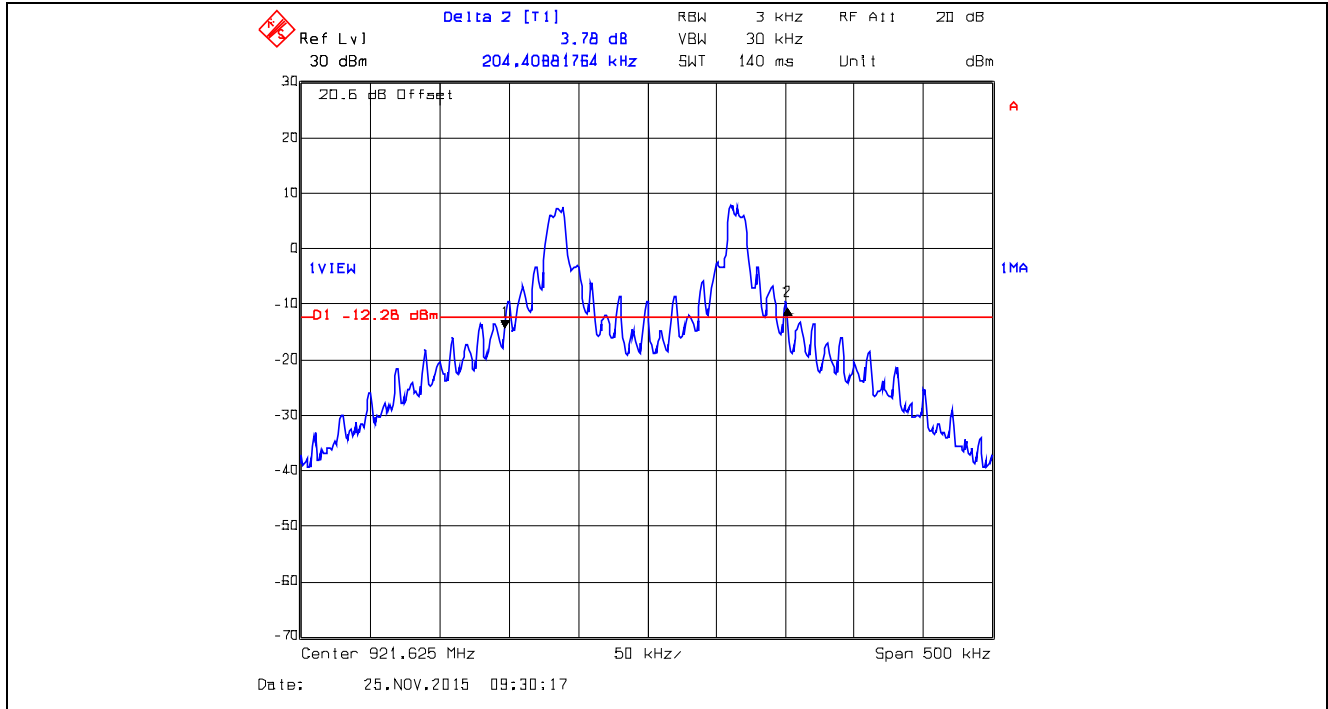

Plot 5.3.4.18. 20 dB Bandwidth, 927.265 MHz, XTCA0, Data Rate at 10 kbps

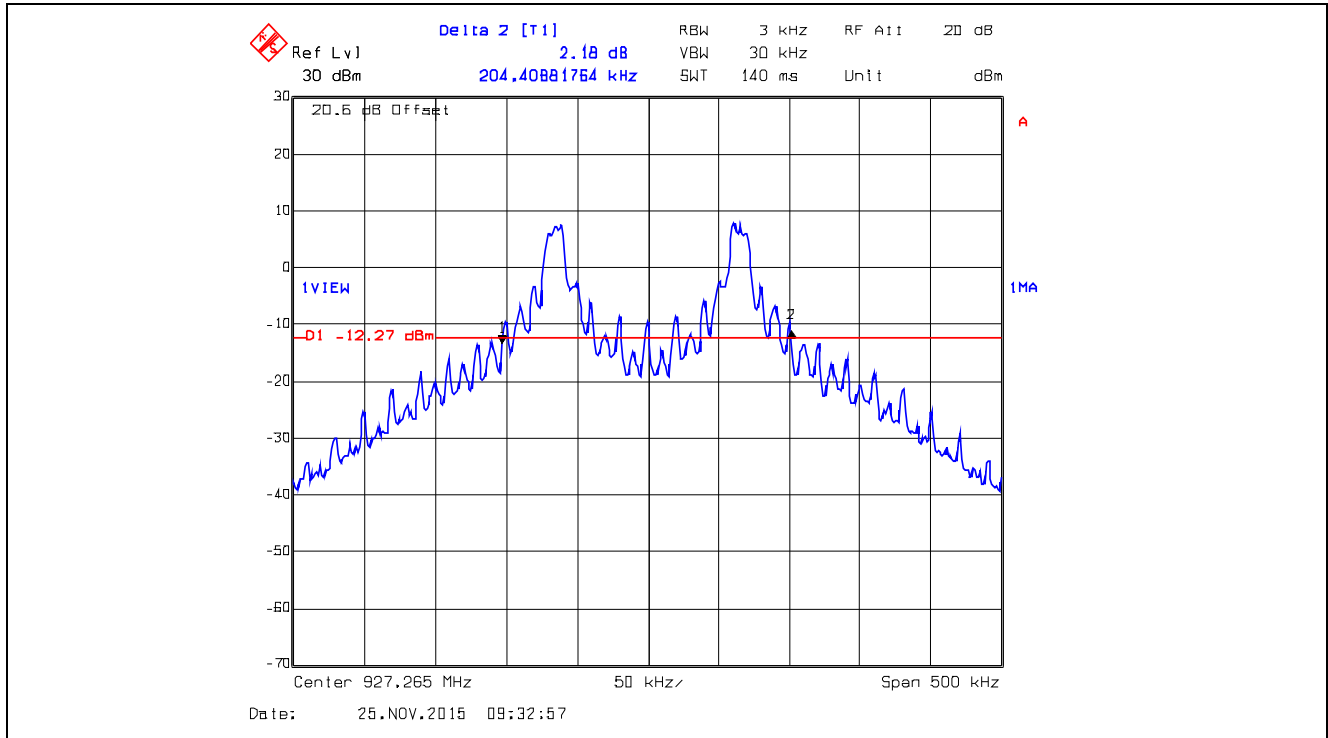

Plot 5.3.4.19. 20 dB Bandwidth, 915.75 MHz, XTCA1, Data Rate at 105 kbps

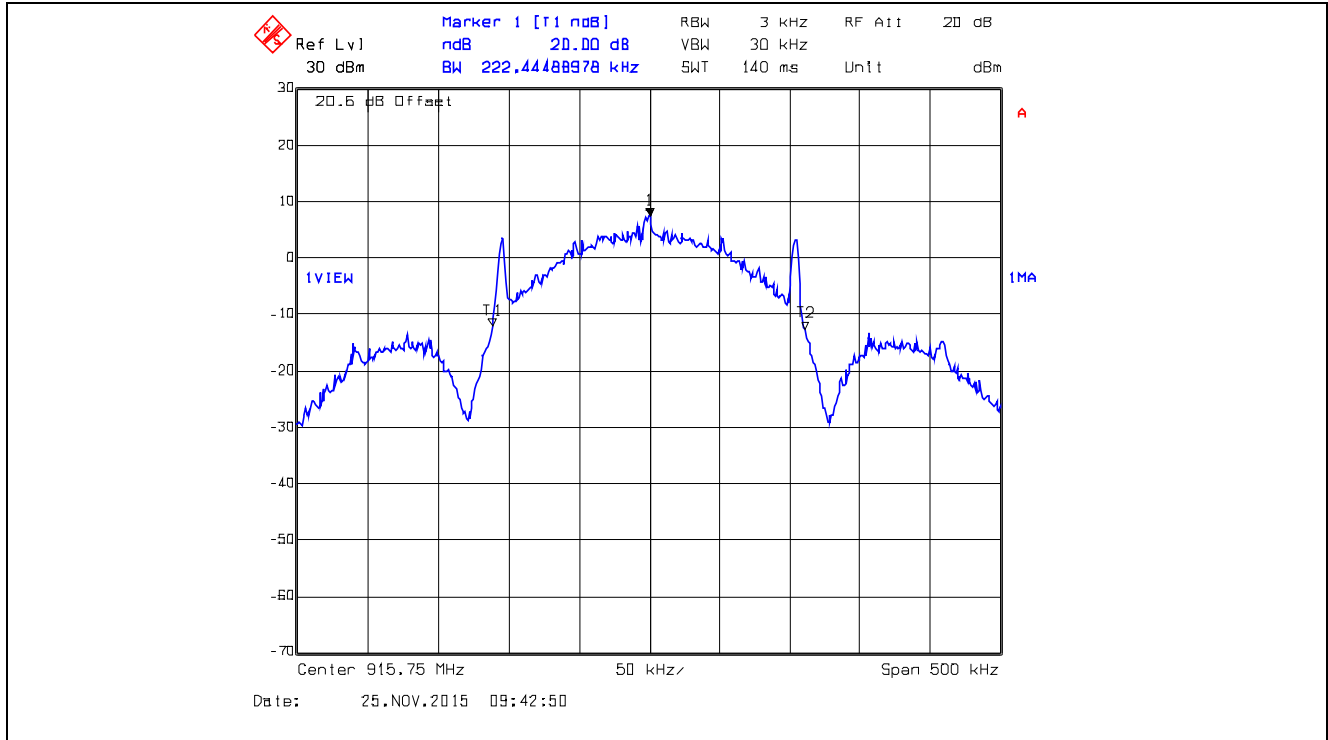

Plot 5.3.4.20. 20 dB Bandwidth, 921.625 MHz, XTCA1, Data Rate at 105 kbps

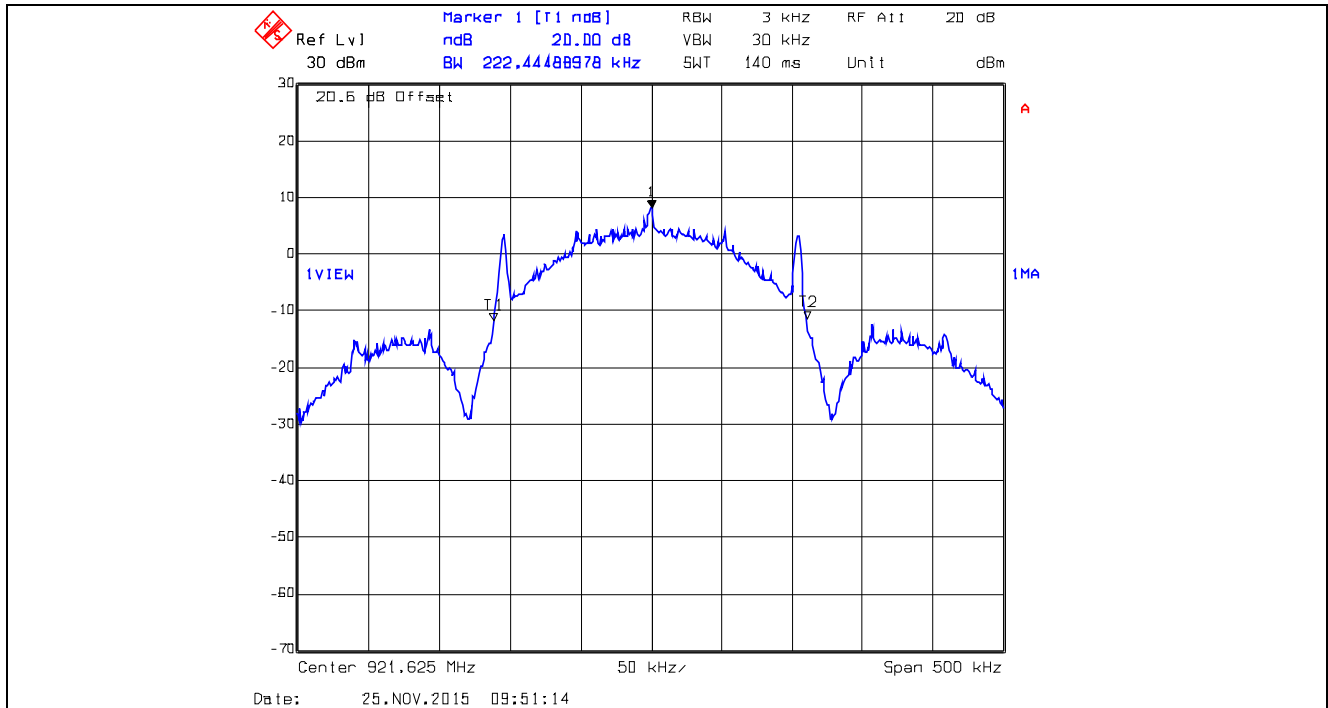

Plot 5.3.4.21. 20 dB Bandwidth, 927.265 MHz, XTCA1, Data Rate at 105 kbps

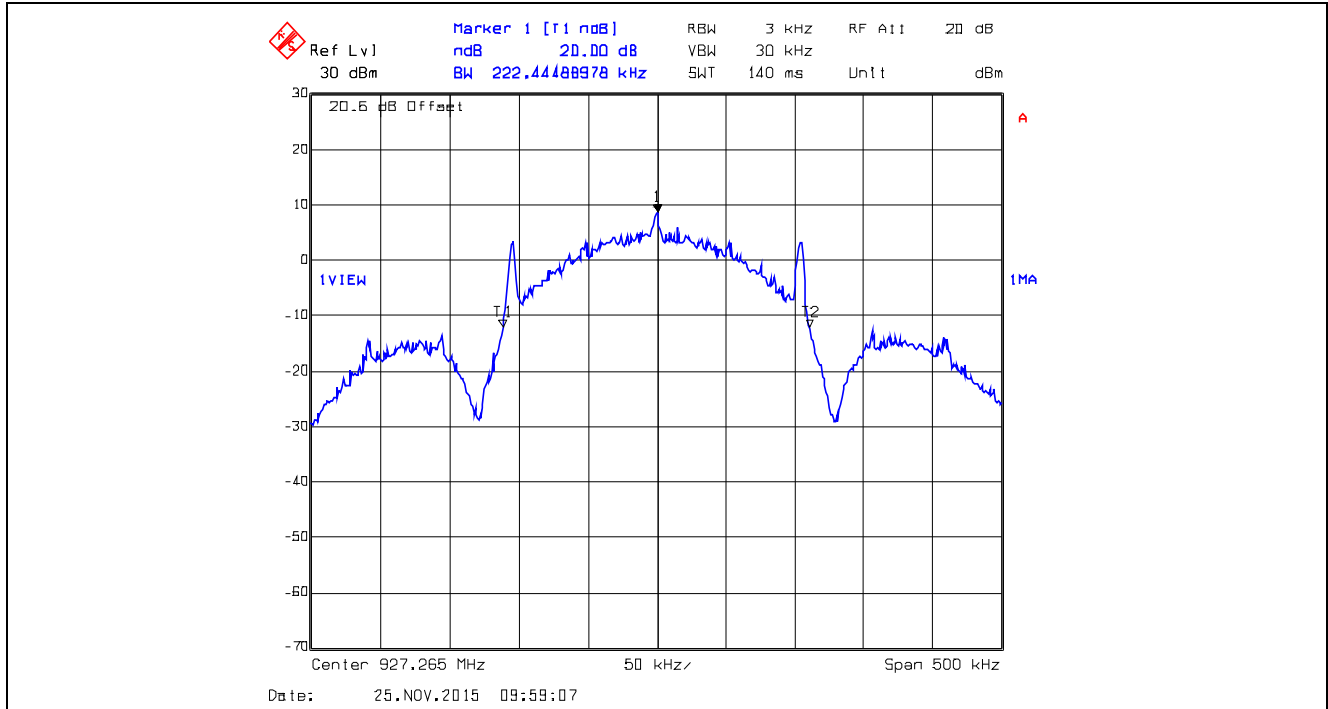

Plot 5.3.4.22. Carrier Frequency Separation, XBX0, Data Rate at 10 kbps

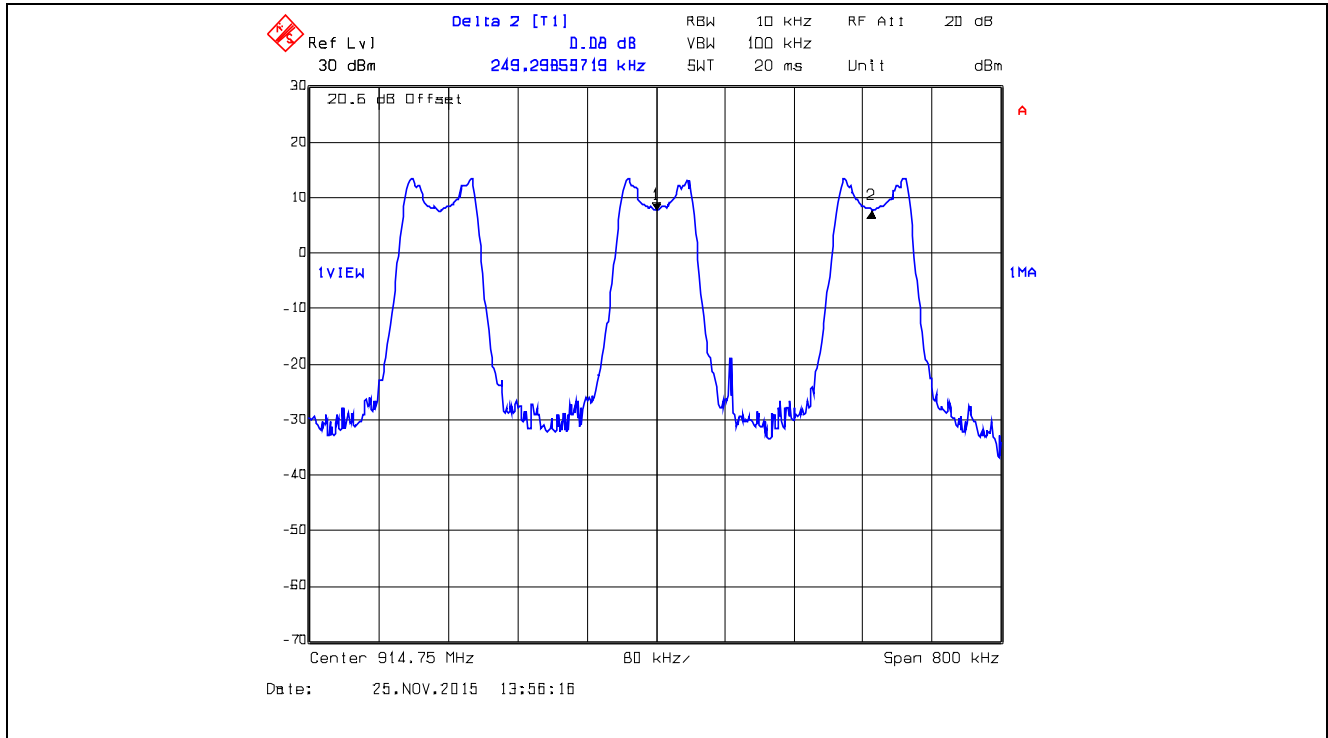

Plot 5.3.4.23. Carrier Frequency Separation, XBX1, Data Rate at 110 kbps

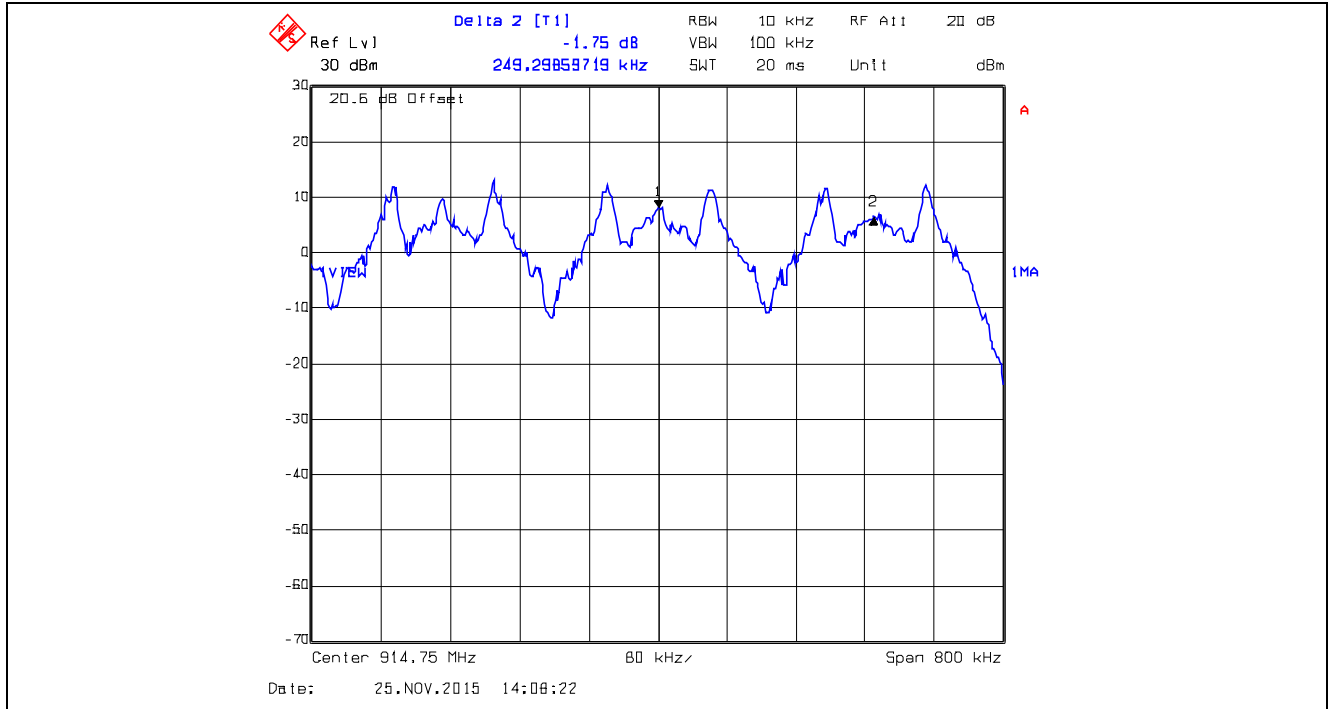

Plot 5.3.4.24. Carrier Frequency Separation, XBX2, Data Rate at 250 kbps

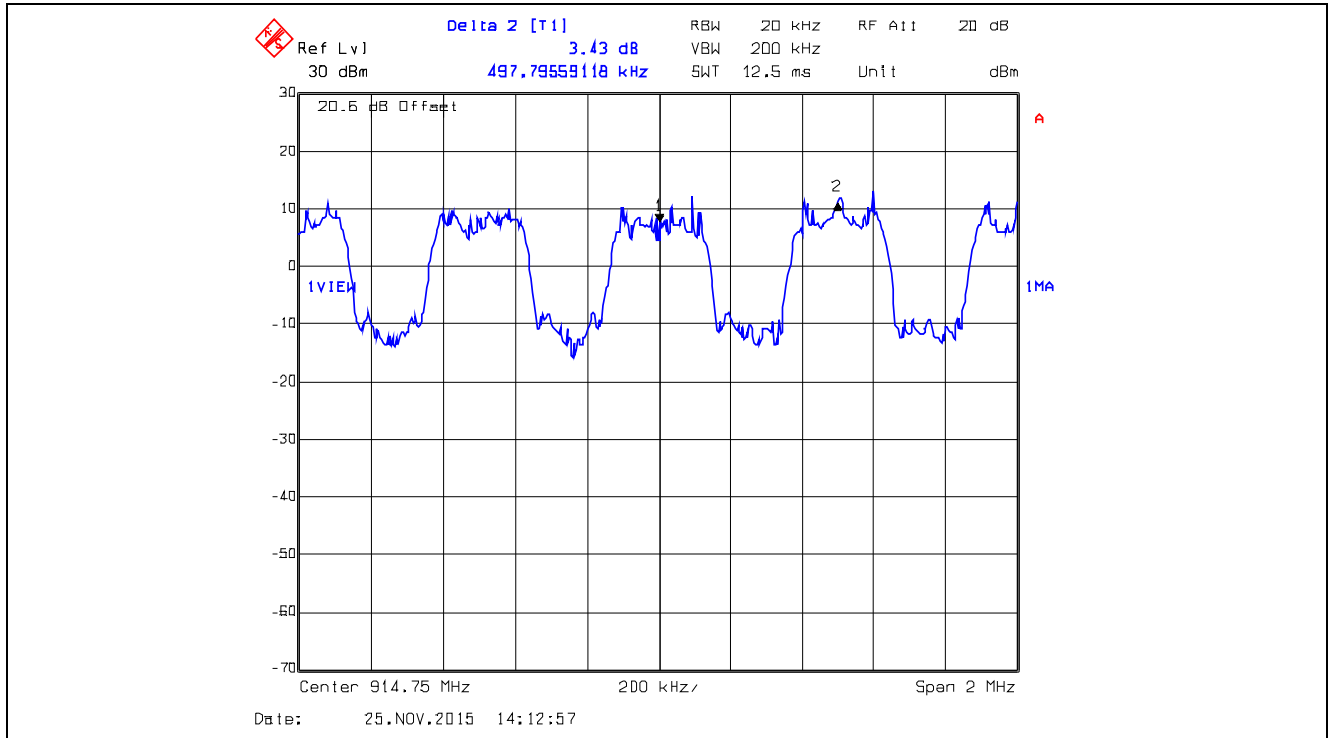

Plot 5.3.4.25. Carrier Frequency Separation, XTC0, Data Rate at 10 kbps

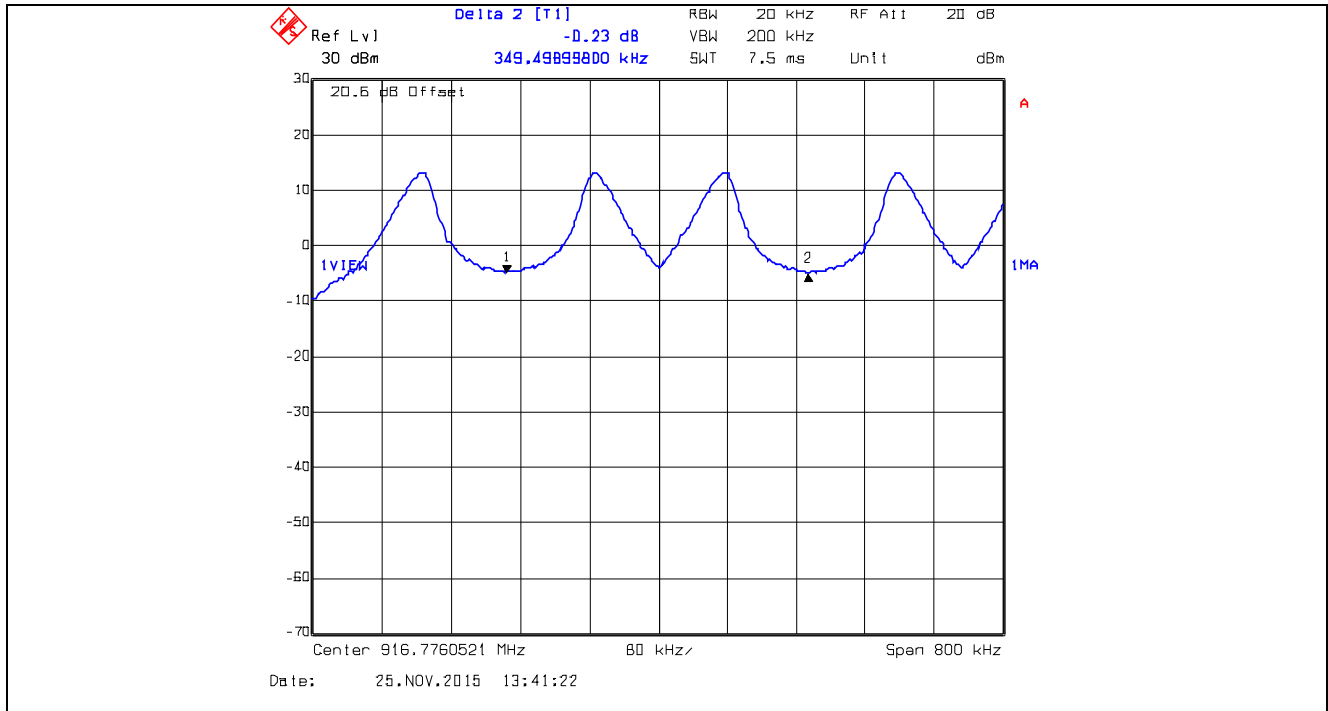

Plot 5.3.4.26. Carrier Frequency Separation, XTC1, Data Rate at 125 kbps

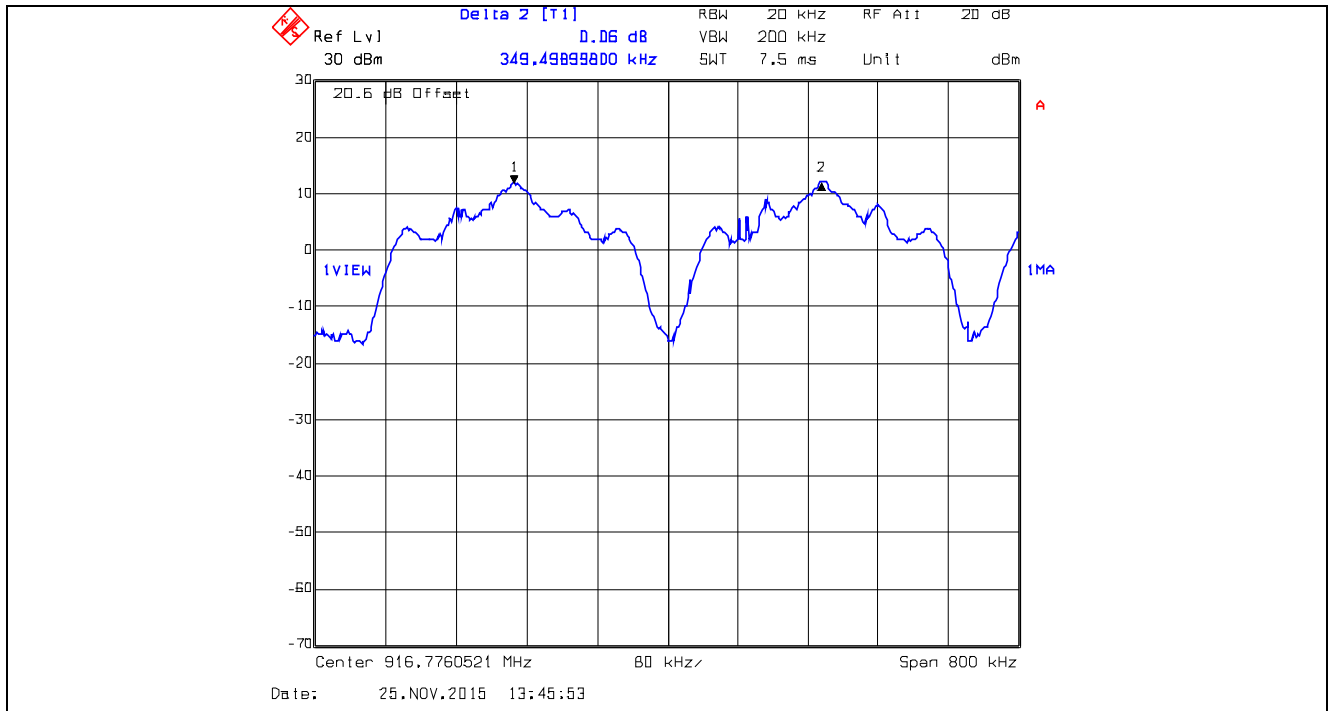

Plot 5.3.4.27. Carrier Frequency Separation, XTCA0, Data Rate at 10 kbps

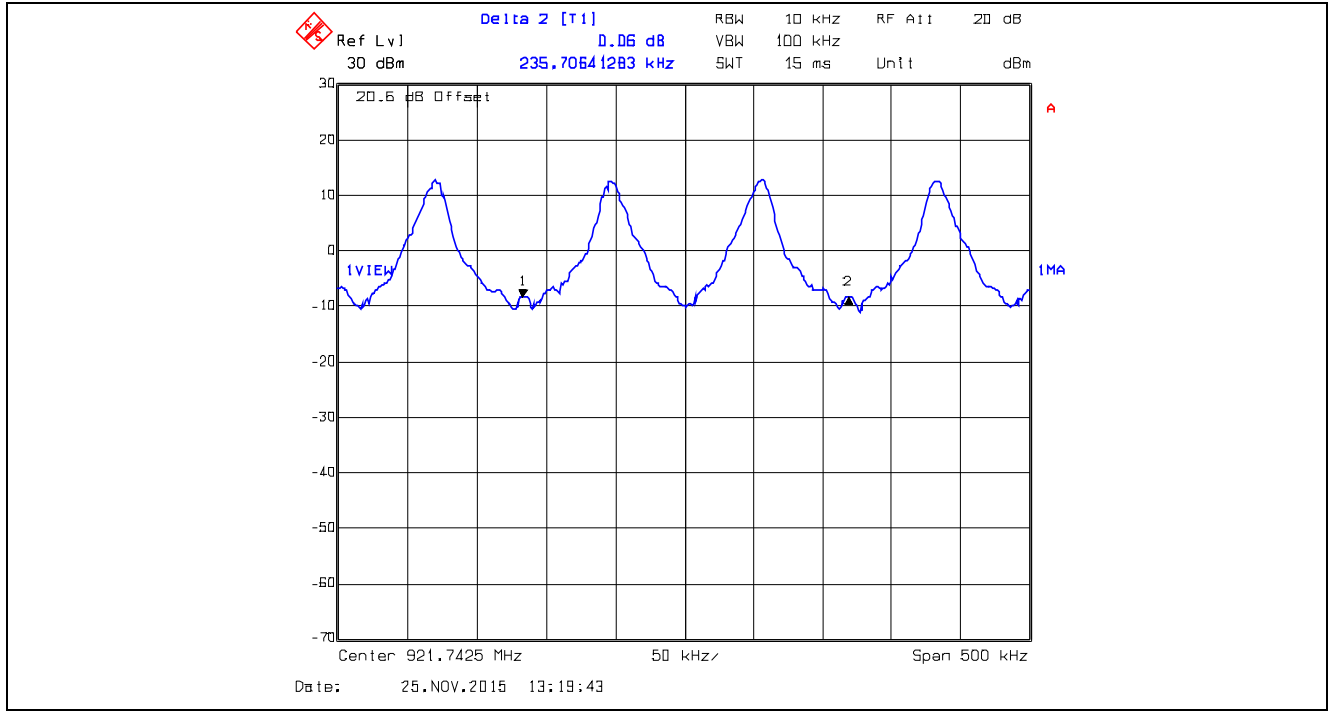

Plot 5.3.4.28. Carrier Frequency Separation, XTCA1, Data Rate at 105 kbps

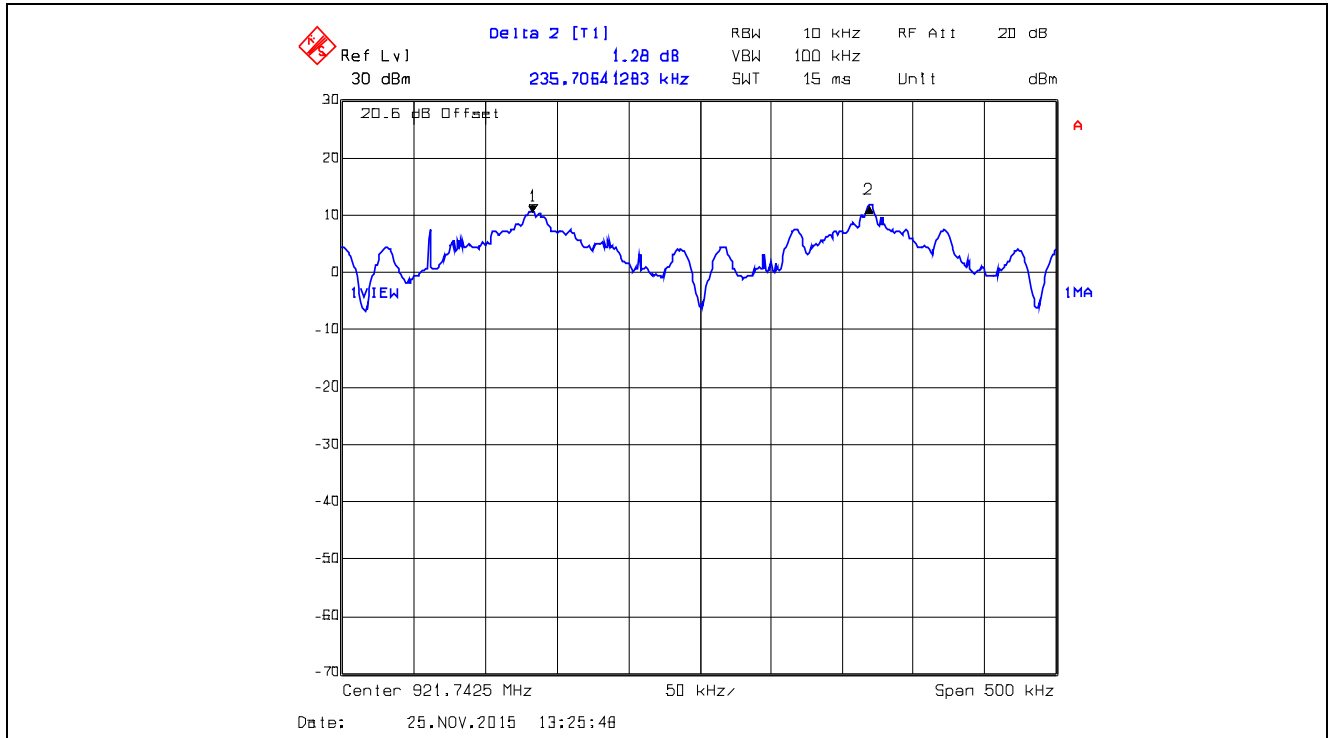

**Plot 5.3.4.29.** Number of Hopping Frequencies, XB0, Data Rate at 10 kbps  
 50 Hopping Channels from 902 – 928 MHz

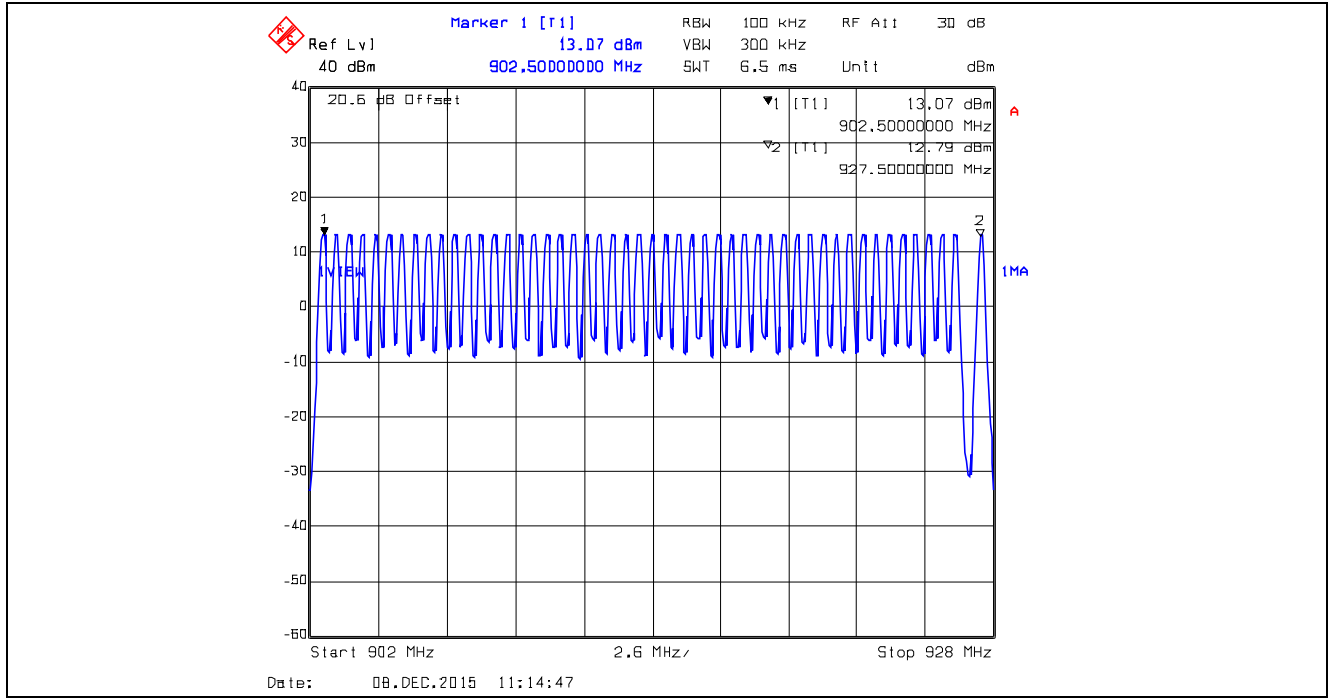

**Plot 5.3.4.30.** Number of Hopping Frequencies, XB1, Data Rate at 110 kbps  
 50 Hopping Channels from 902 – 928 MHz

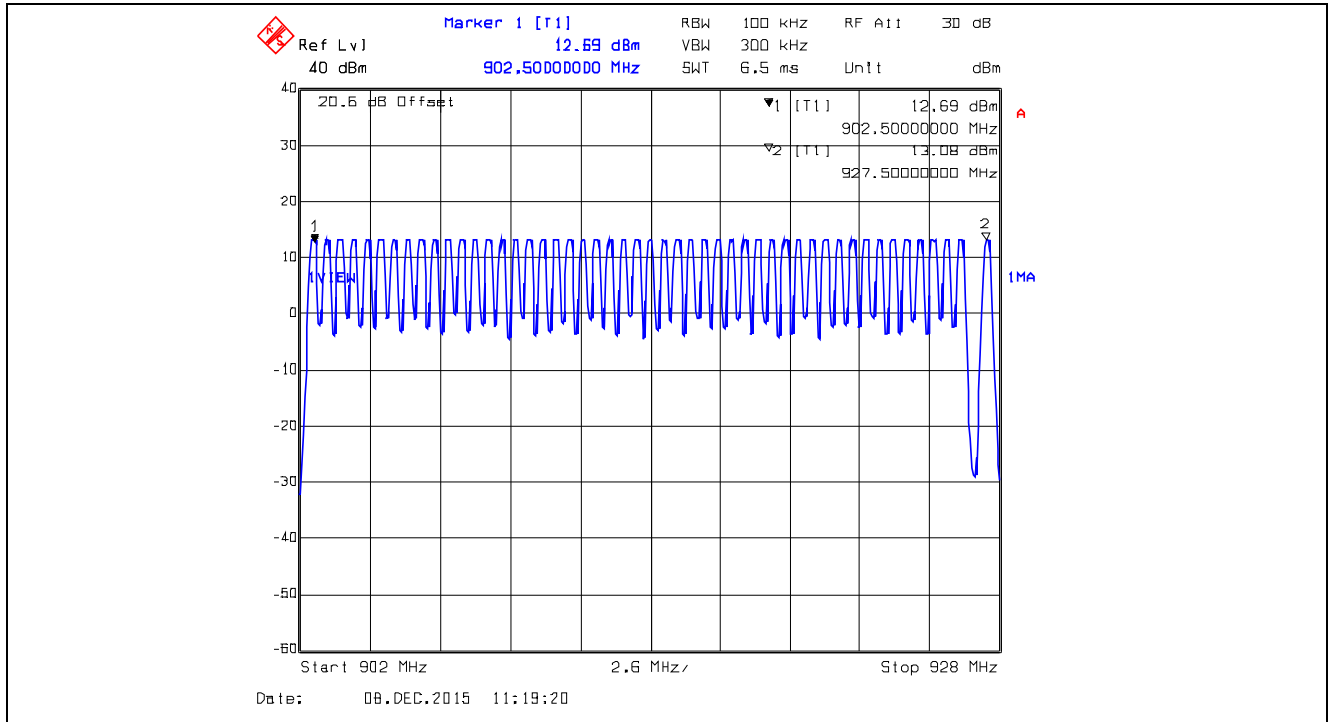



Plot 5.3.4.31. Total Number of Hopping Frequencies, XBX2, Data Rate at 250 kbps  
 50 Hopping Channels from 902 - 928 MHz

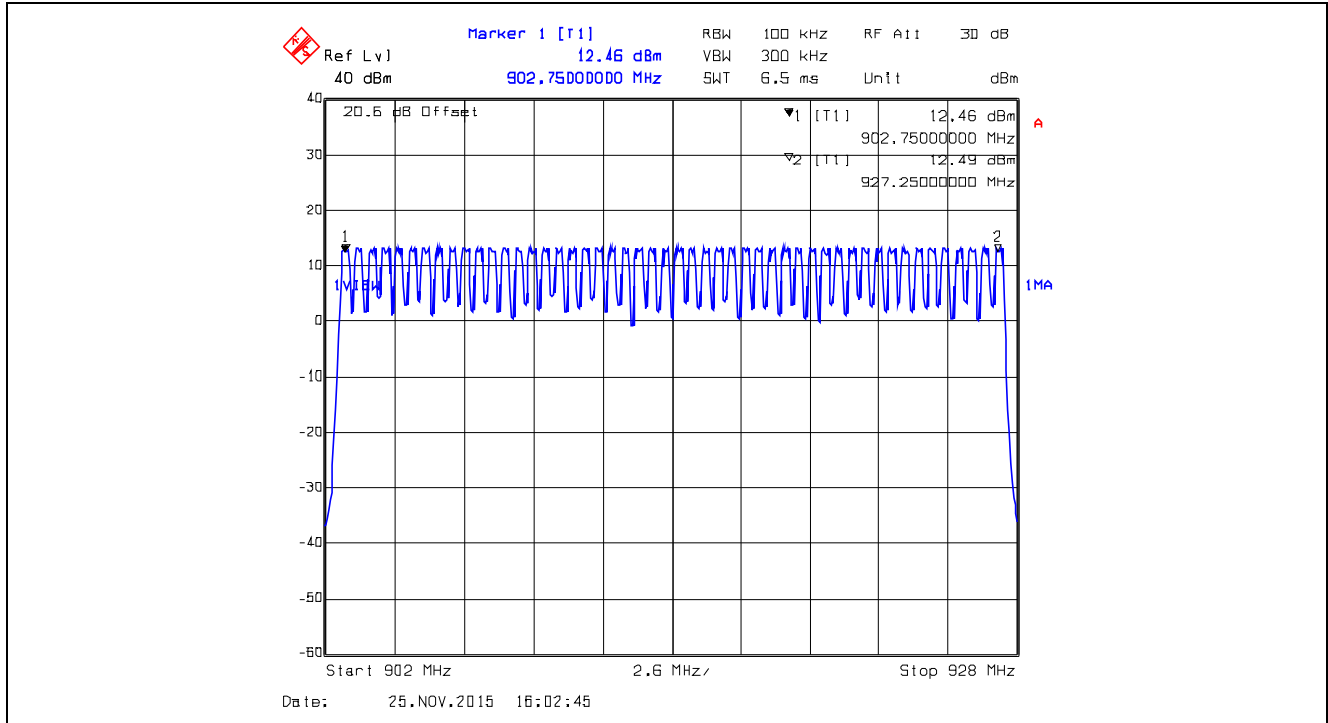

Plot 5.3.4.32. Number of Hopping Frequencies, XTC0, Data Rate at 10 kbps  
 20 Hopping Channels from 902 – 912 MHz

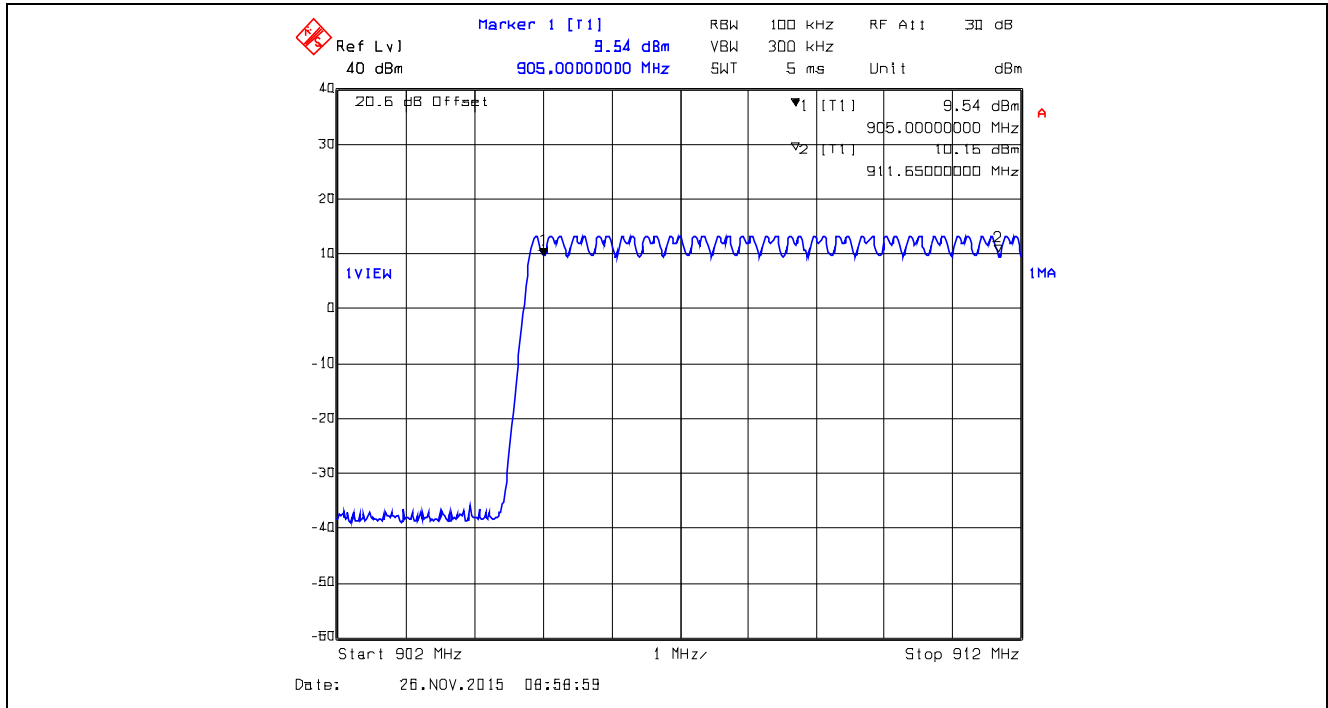

Plot 5.3.4.33. Number of Hopping Frequencies, XTC0, Data Rate at 10 kbps  
 21 Hopping Channels from 912 – 922 MHz

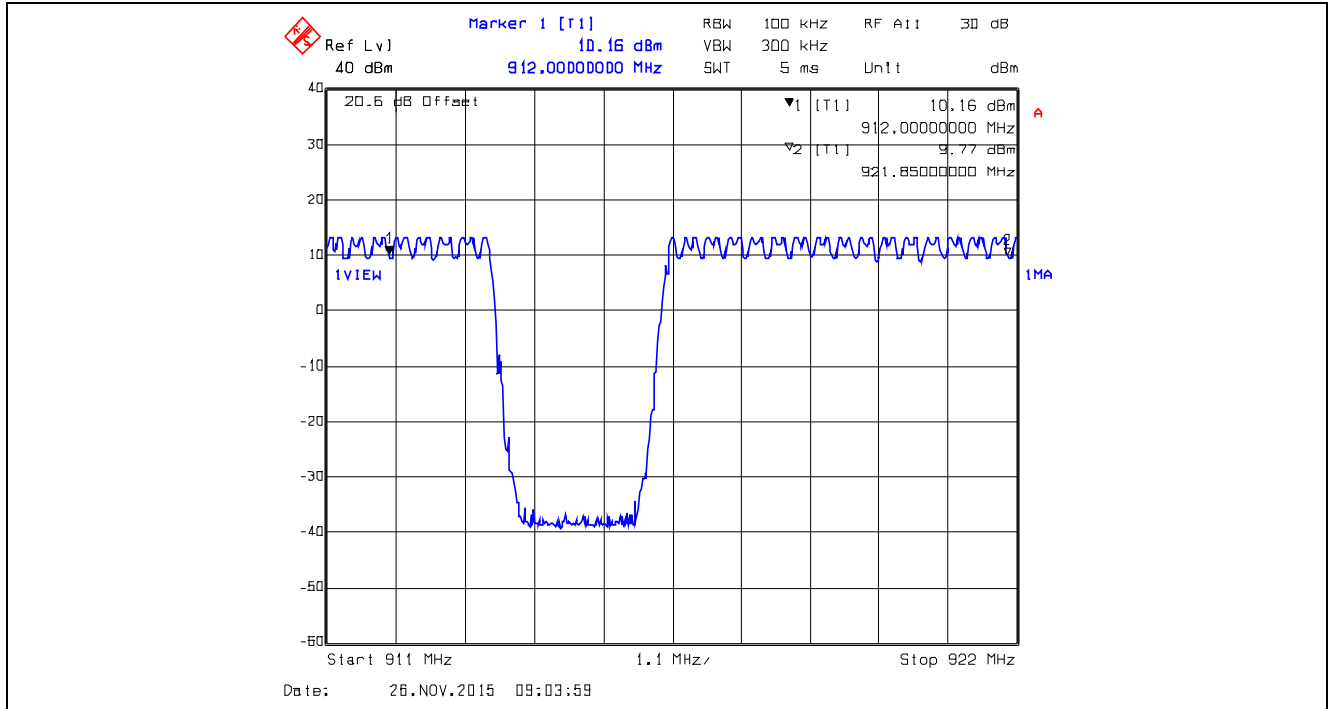

Plot 5.3.4.34. Number of Hopping Frequencies, XTC0, Data Rate at 10 kbps  
 9 Hopping Channels from 922 – 928 MHz

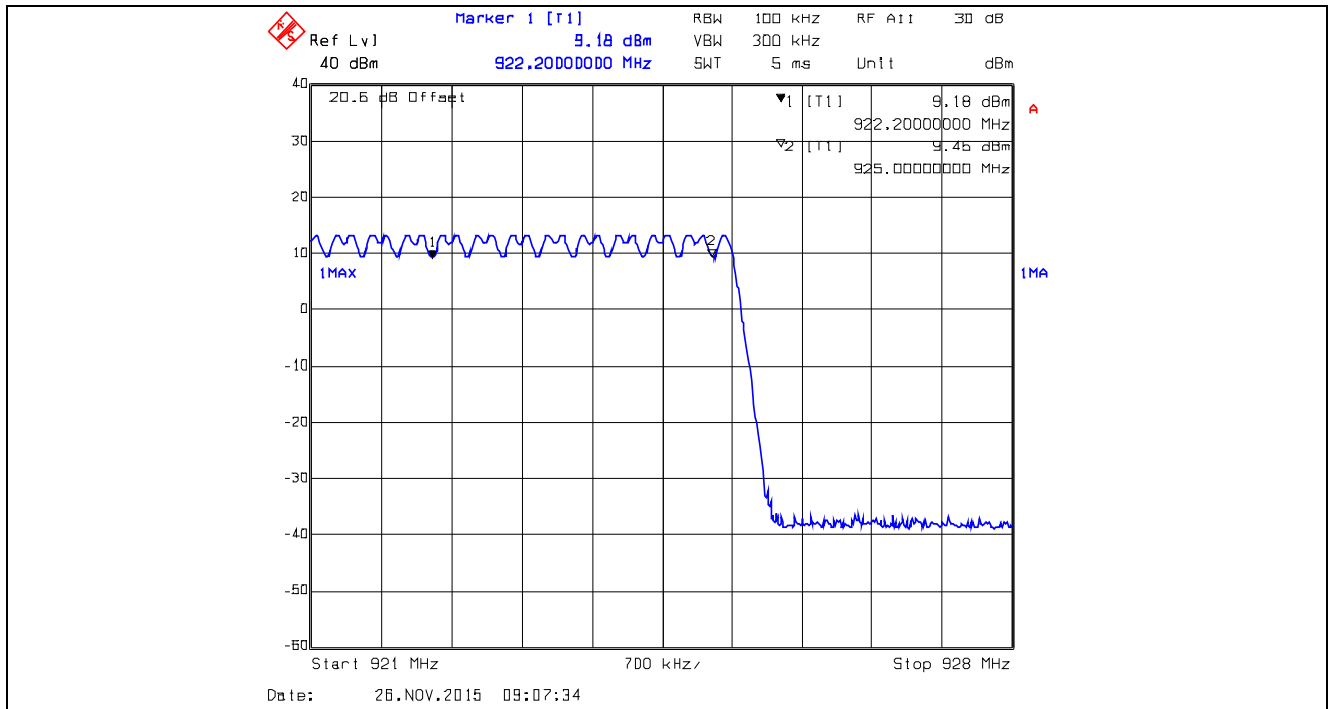

**Plot 5.3.4.35. Total Number of Hopping Frequencies, XTC0, Data Rate at 10 kbps  
 50 Hopping Channels from 902 – 928 MHz (20+21+09 = 50)**

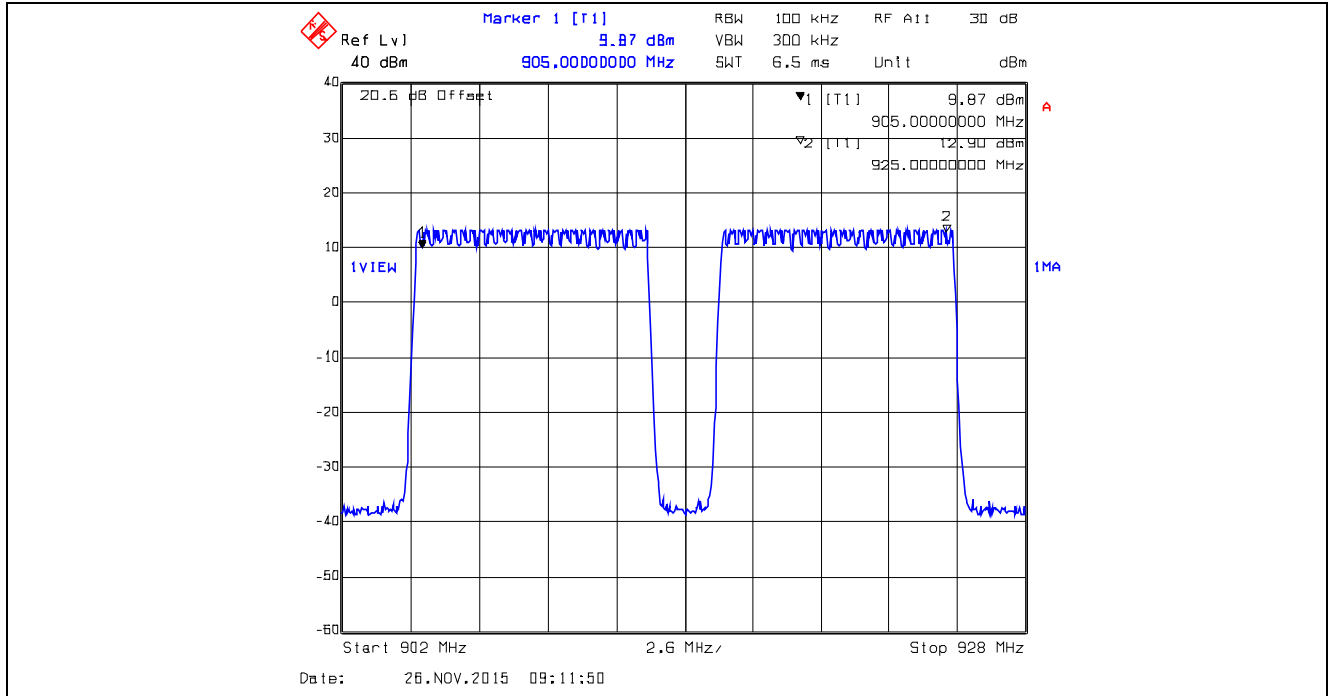

**Plot 5.3.4.36. Number of Hopping Frequencies, XTC1, Data Rate at 125 kbps  
 20 Hopping Channels from 902 – 912 MHz**

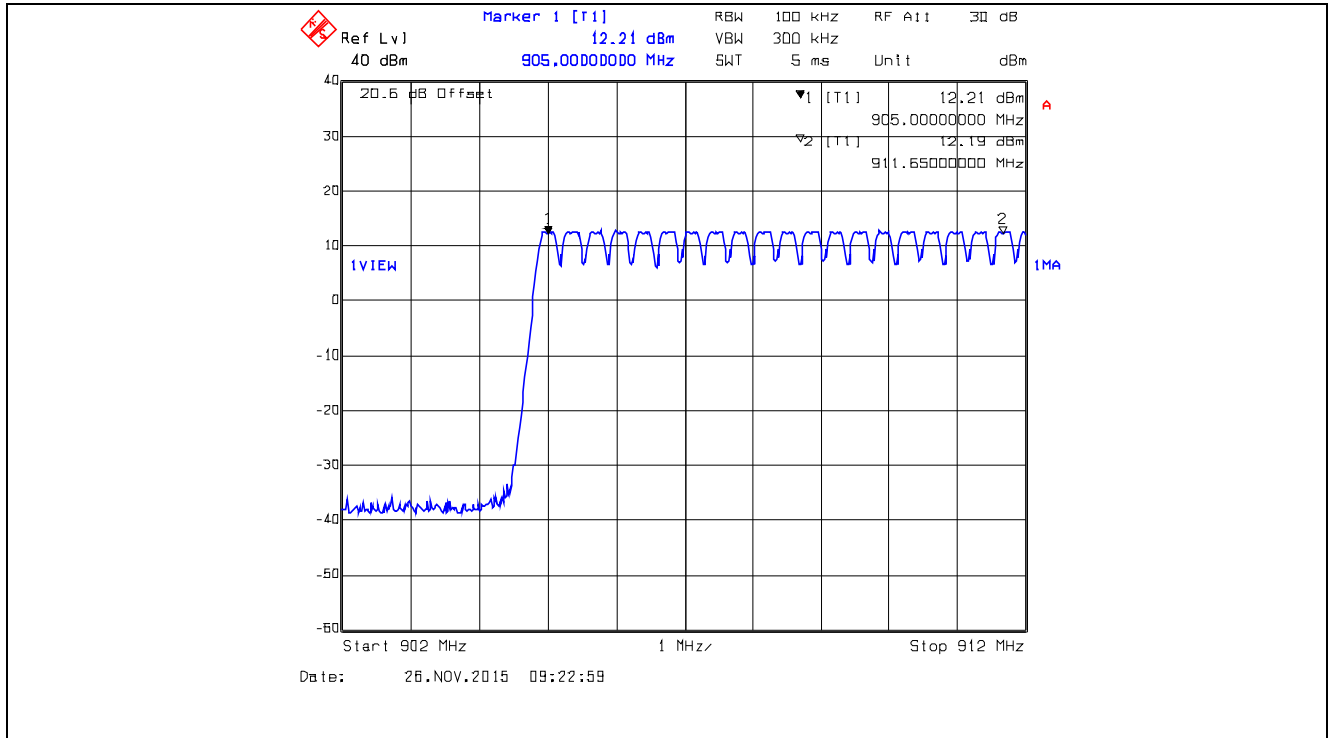

**Plot 5.3.4.37.** Number of Hopping Frequencies, XTC1, Data Rate at 125 kbps  
 21 Hopping Channels from 912 – 922 MHz

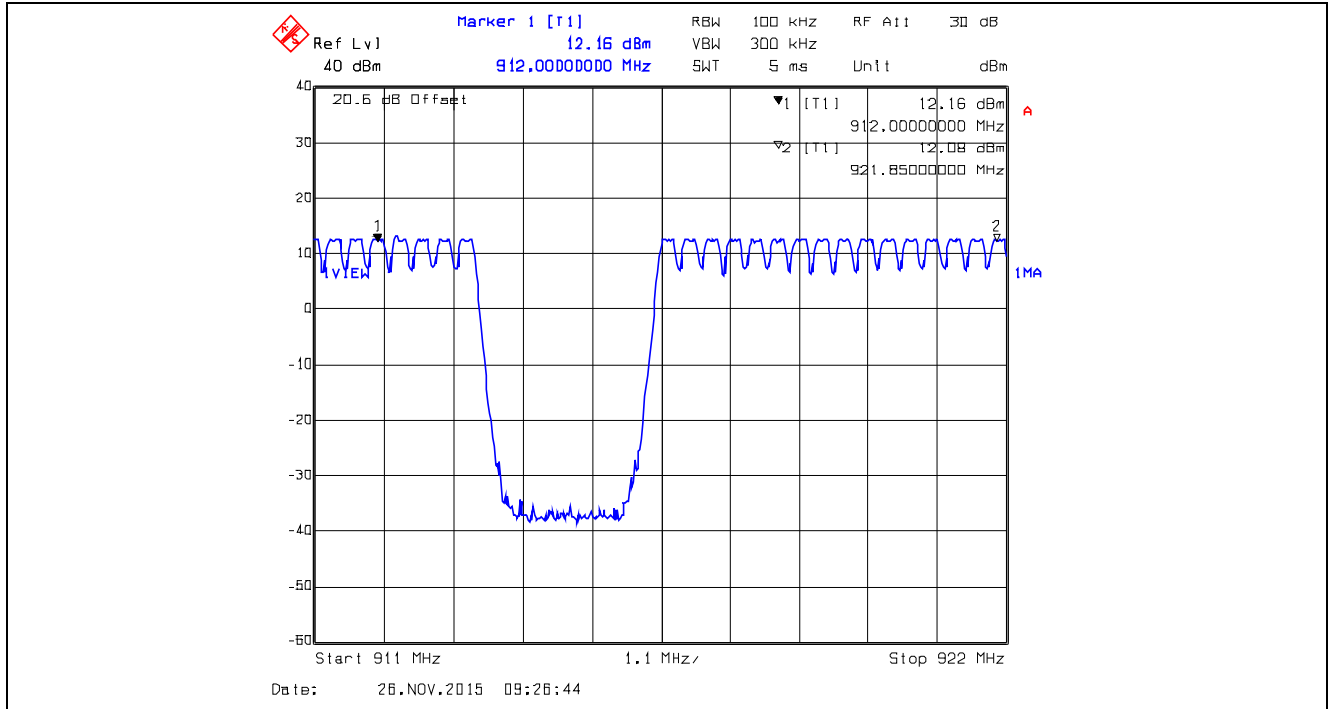

**Plot 5.3.4.38.** Number of Hopping Frequencies, XTC1, Data Rate at 125 kbps  
 09 Hopping Channels from 922 – 928 MHz

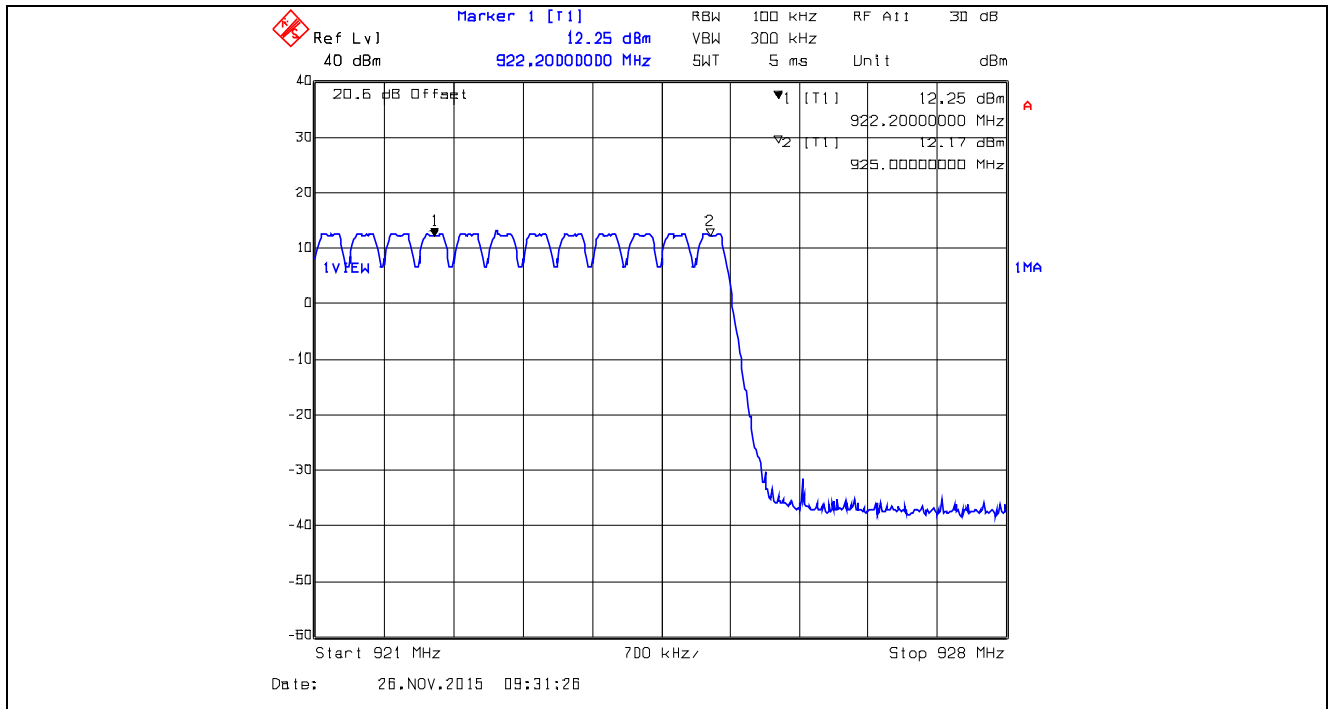

**Plot 5.3.4.39.** Total Number of Hopping Frequencies, XTC1, Data Rate at 125 kbps  
 50 Hopping Channels from 902 – 928 MHz (20+21+09 = 50)

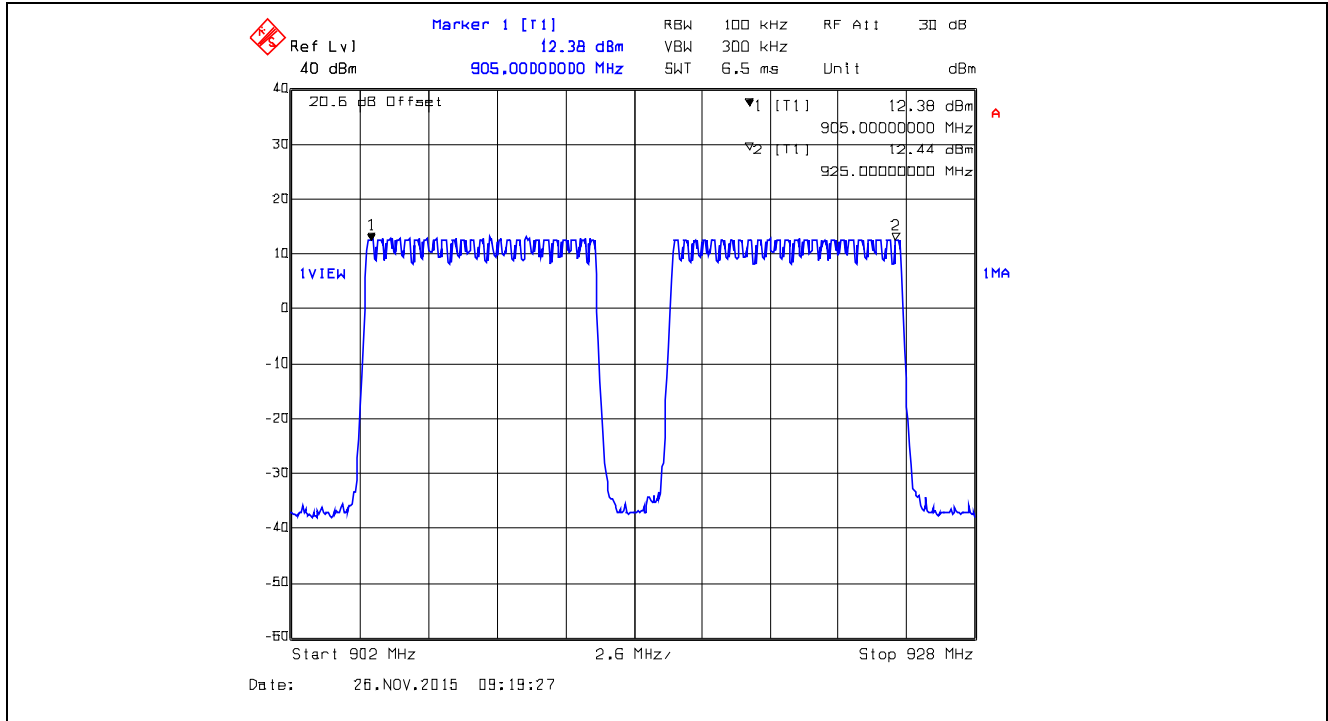

**Plot 5.3.4.40.** Number of Hopping Frequencies, XTCA0, Data Rate at 10 kbps  
 0 Hopping Channels from 902 – 912 MHz

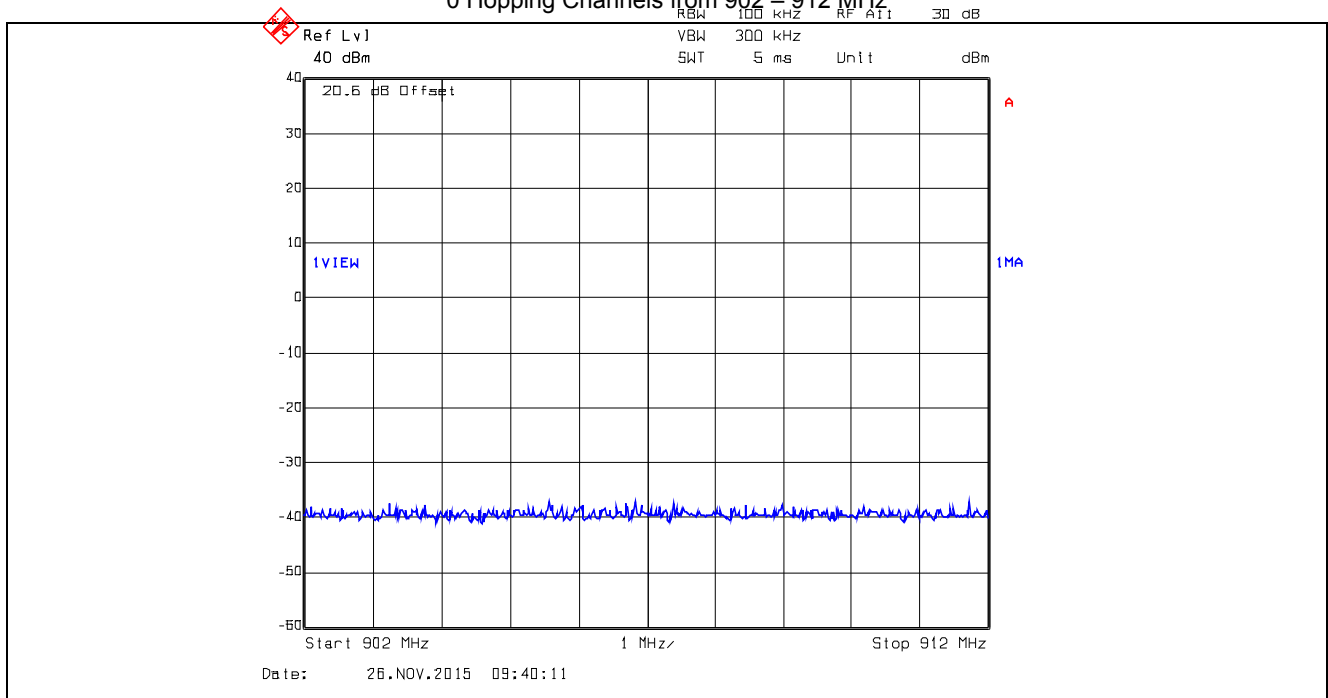

Plot 5.3.4.41. Number of Hopping Frequencies, XTCA0, Data Rate at 10 kbps  
 27 Hopping Channels from 912 – 922 MHz

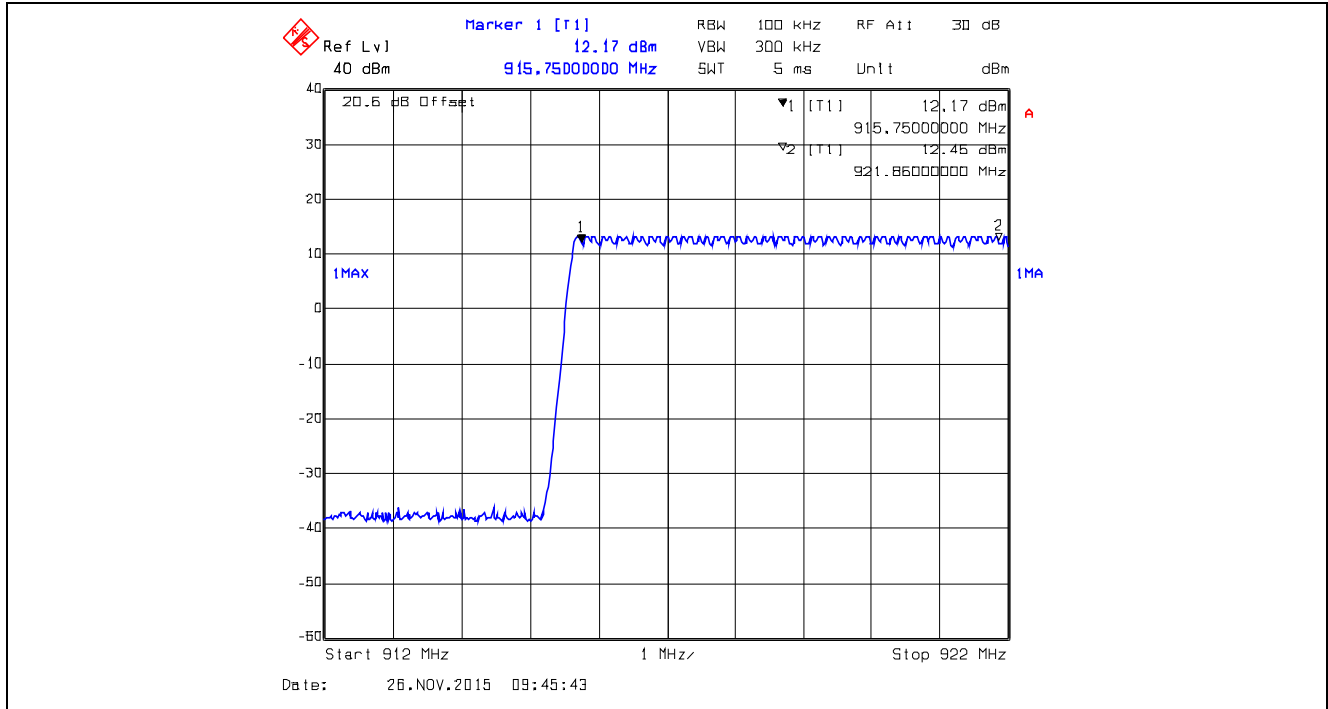

Plot 5.3.4.42. Number of Hopping Frequencies, XTCA0, Data Rate at 10 kbps  
 23 Hopping Channels from 922 – 928 MHz

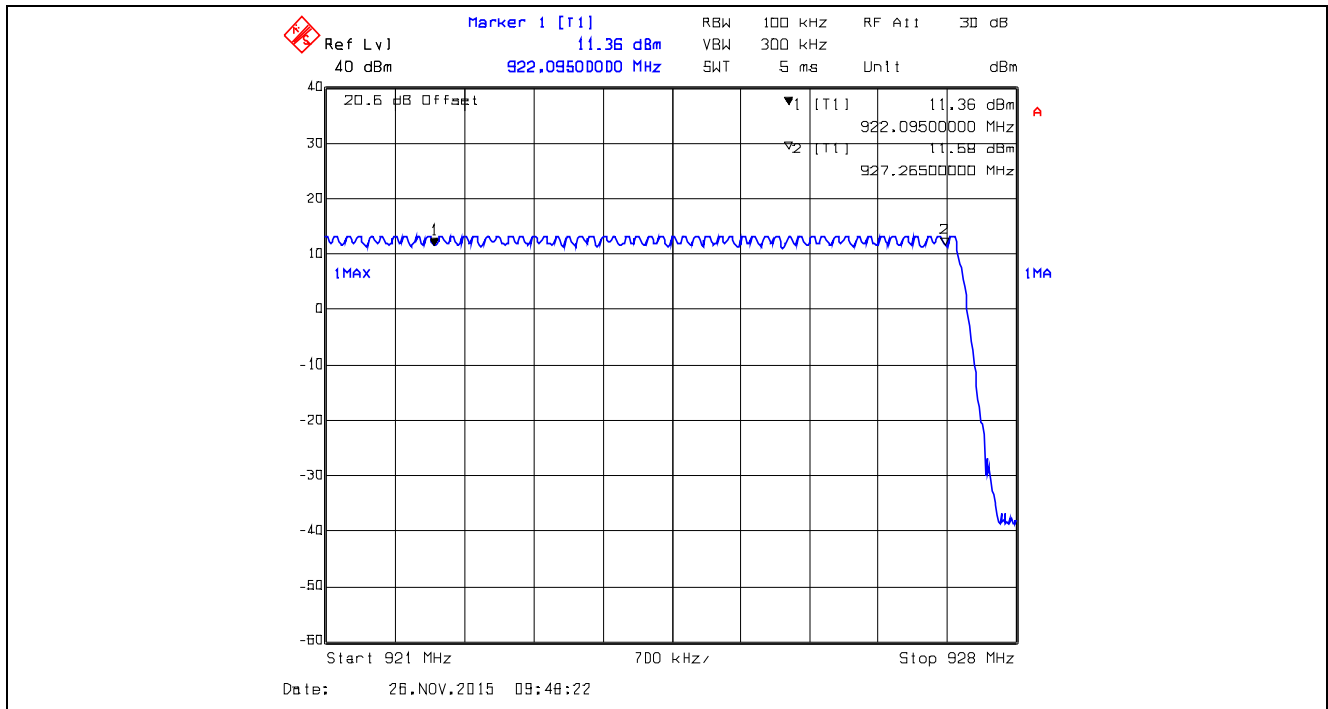

**Plot 5.3.4.43.** Total Number of Hopping Frequencies, XTCA0, Data Rate at 10 kbps  
 50 Hopping Channels from 902 – 928 MHz (20+21+09 = 50)

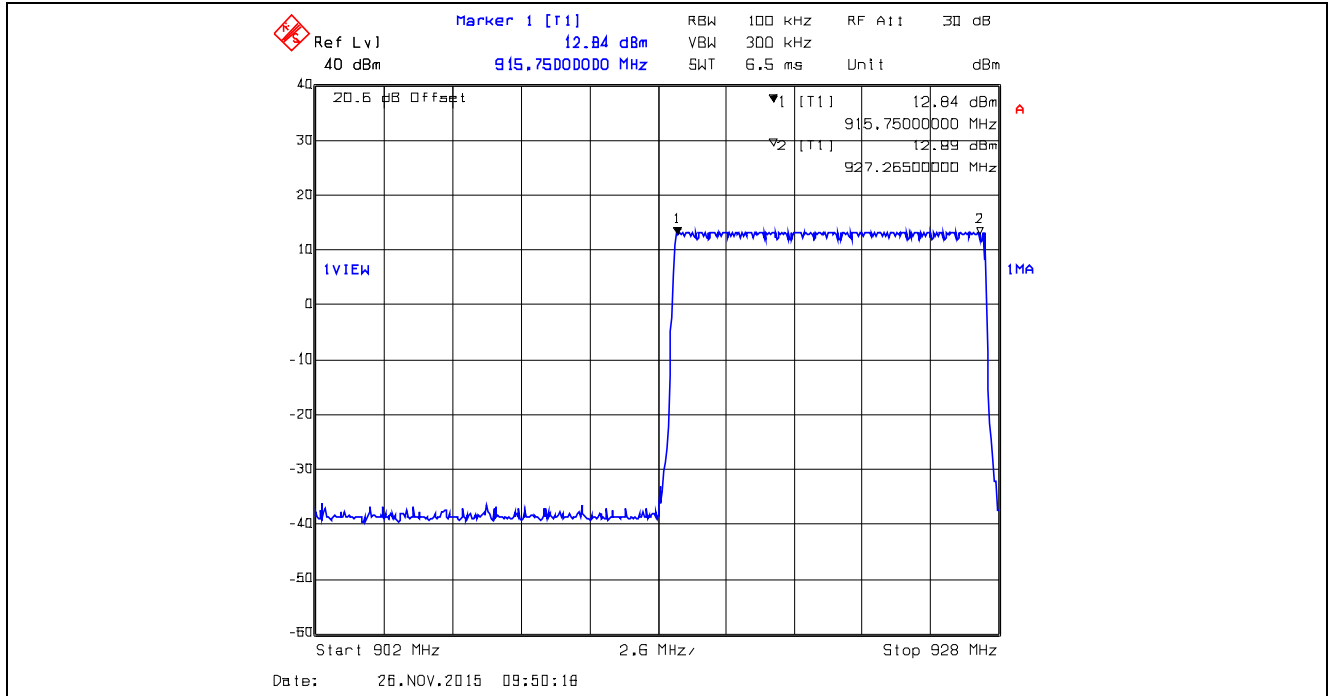

**Plot 5.3.4.44.** Number of Hopping Frequencies, XTCA1, Data Rate at 105 kbps  
 0 Hopping Channels from 902 – 912 MHz

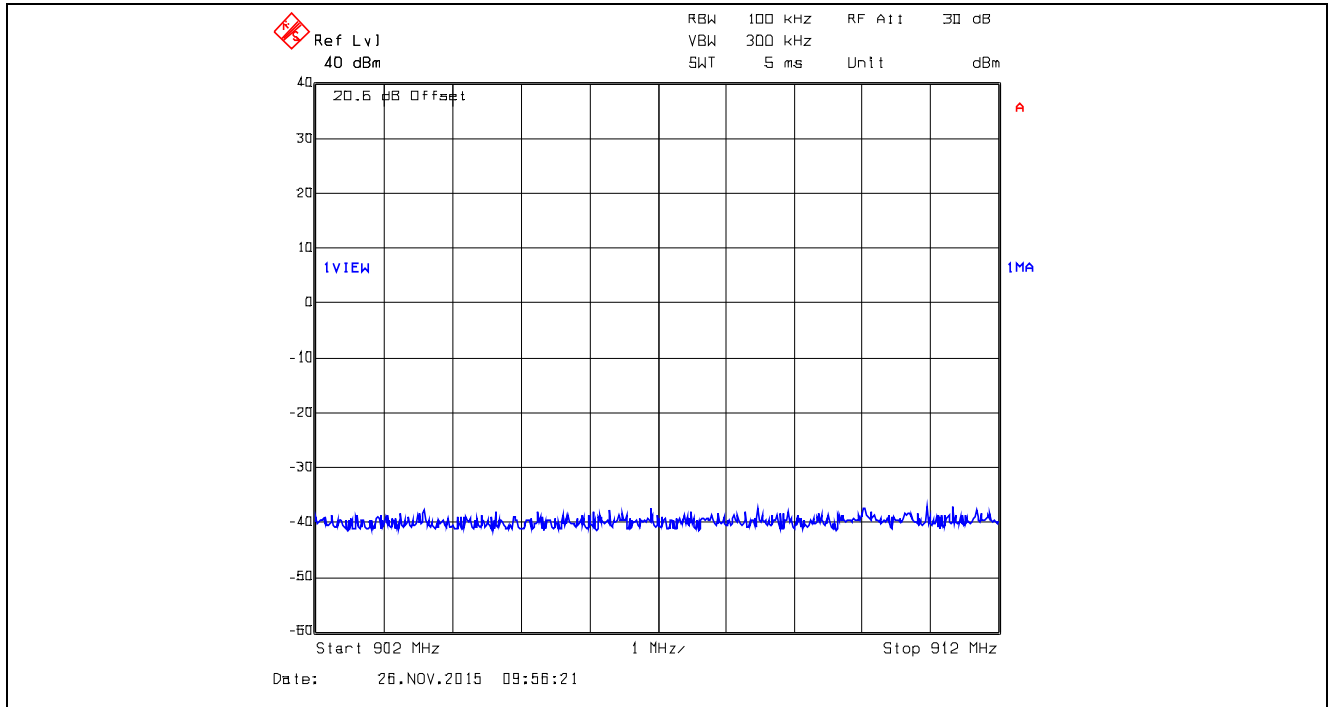

**Plot 5.3.4.45.** Number of Hopping Frequencies, XTCA1, Data Rate at 105 kbps  
 27 Hopping Channels from 912 – 922 MHz

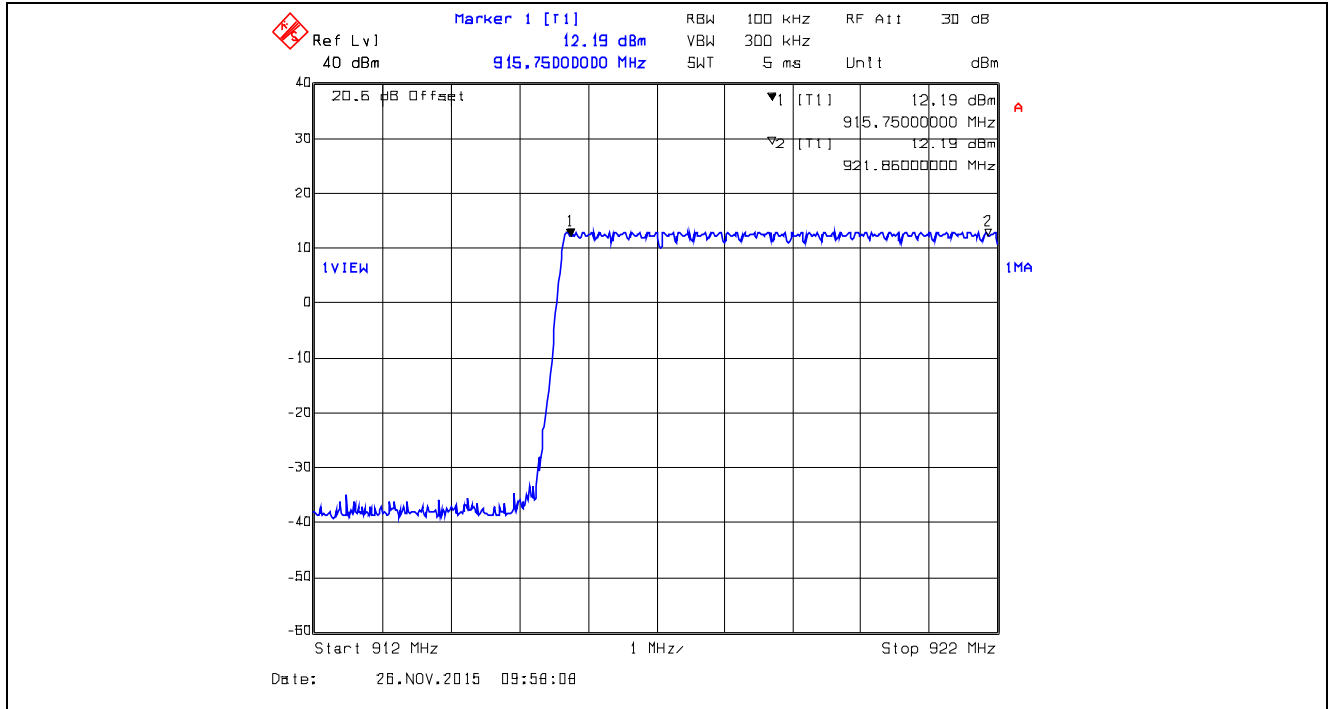

**Plot 5.3.4.46.** Number of Hopping Frequencies, XTCA1, Data Rate at 105 kbps  
 23 Hopping Channels from 922 – 928 MHz

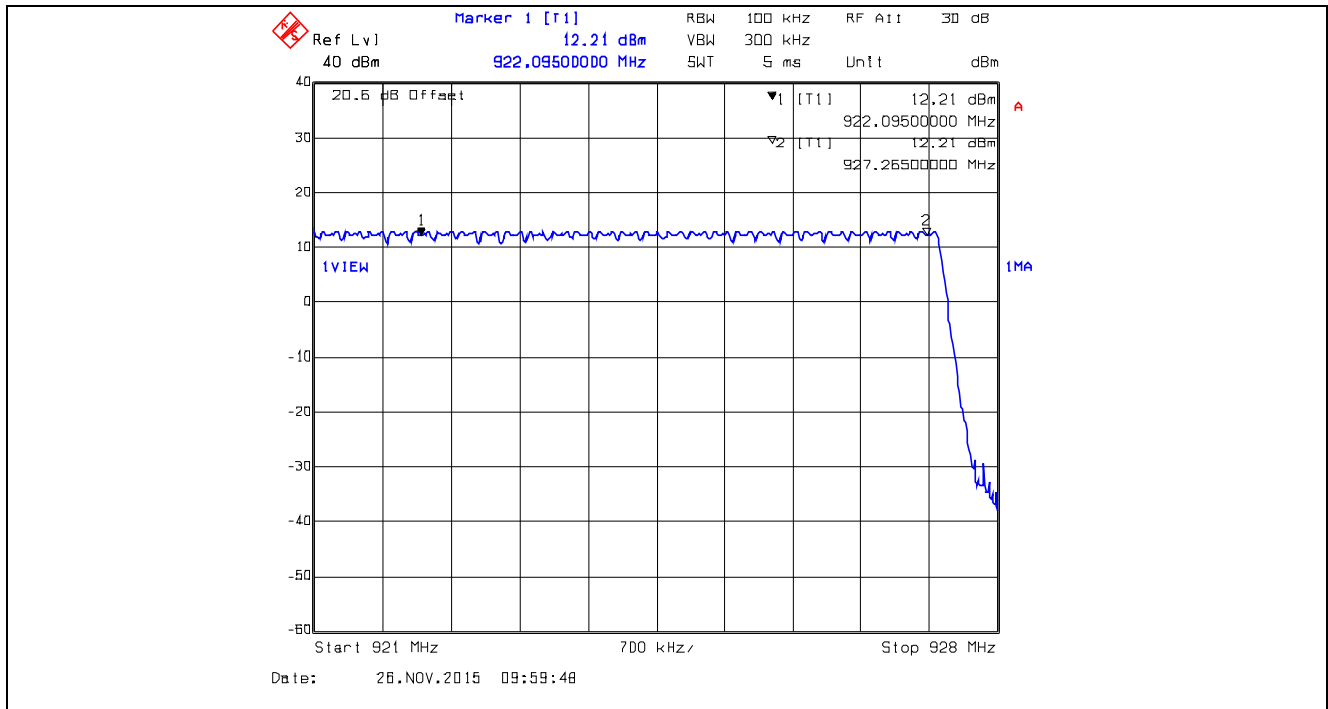



Plot 5.3.4.47. Total Number of Hopping Frequencies, XTCA1, Data Rate at 105 kbps  
 50 Hopping Channels from 902 – 928 MHz

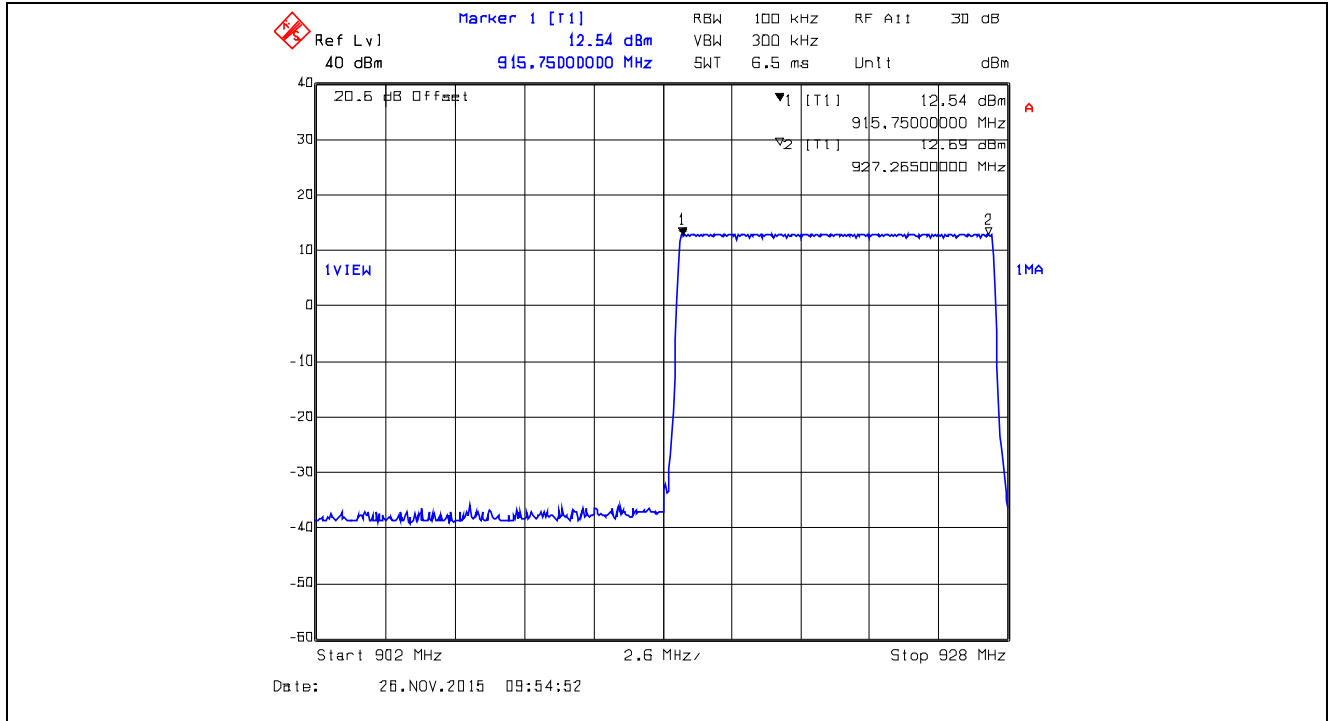

Plot 5.3.4.48. Time of Occupancy, 902.5 MHz, XBX0, Data Rate at 10 kbps  
 Dwell Time @ 902.5 MHz = 300.601202 ms

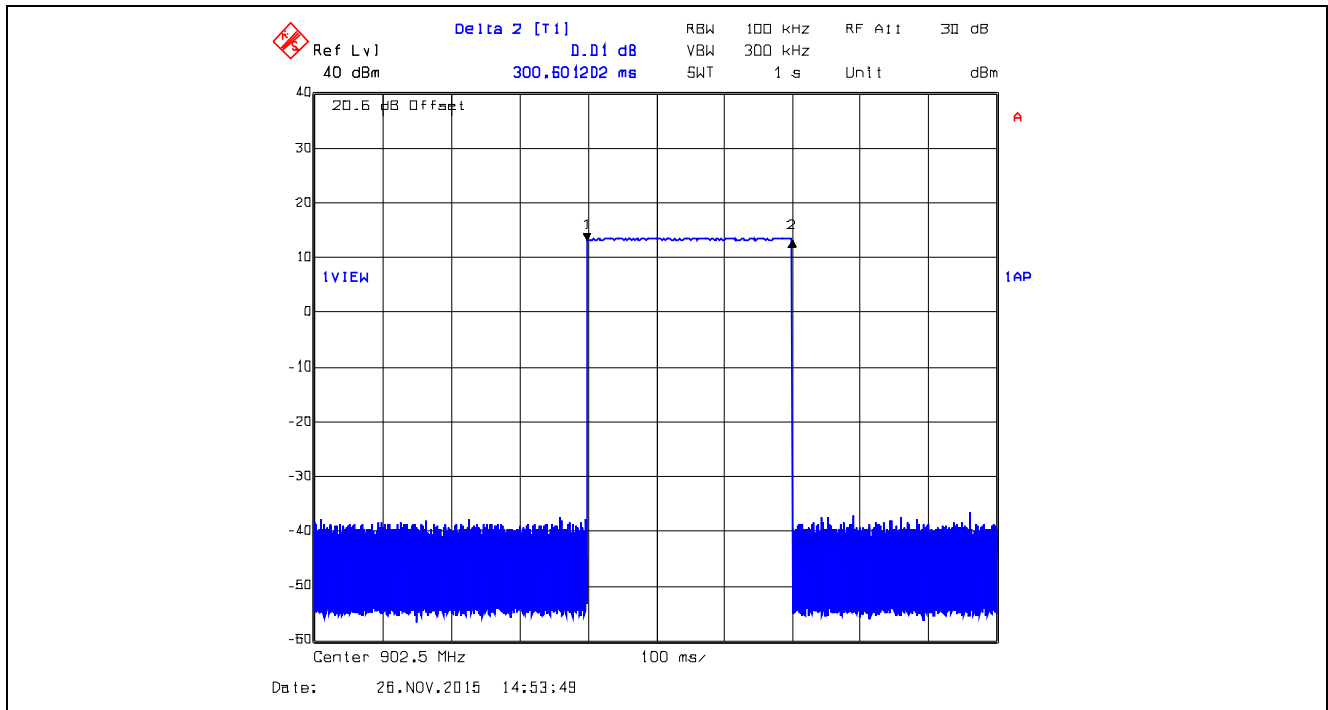

**Plot 5.3.4.49.** Time of Occupancy, 902.5 MHz XB0, Data Rate at 10 kbps  
 Average time of occupancy =  $20 \times (T_{on}) / (T_{total}) = 20 \times 0.3006012s / 18.5752s = 0.3237s < 0.4s$

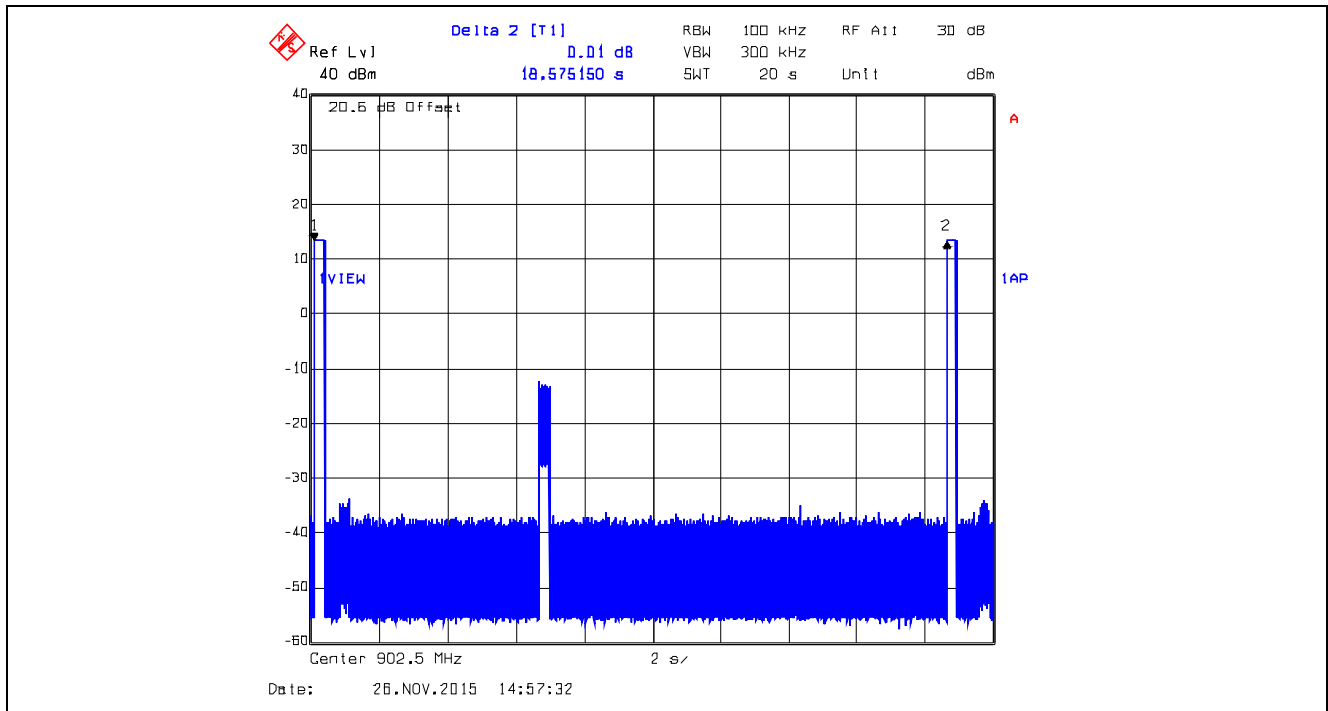

**Plot 5.3.4.50.** Time of Occupancy, 915 MHz, XB0, Data Rate at 10 kbps  
 Dwell Time @ 915 MHz = 300.6012 ms

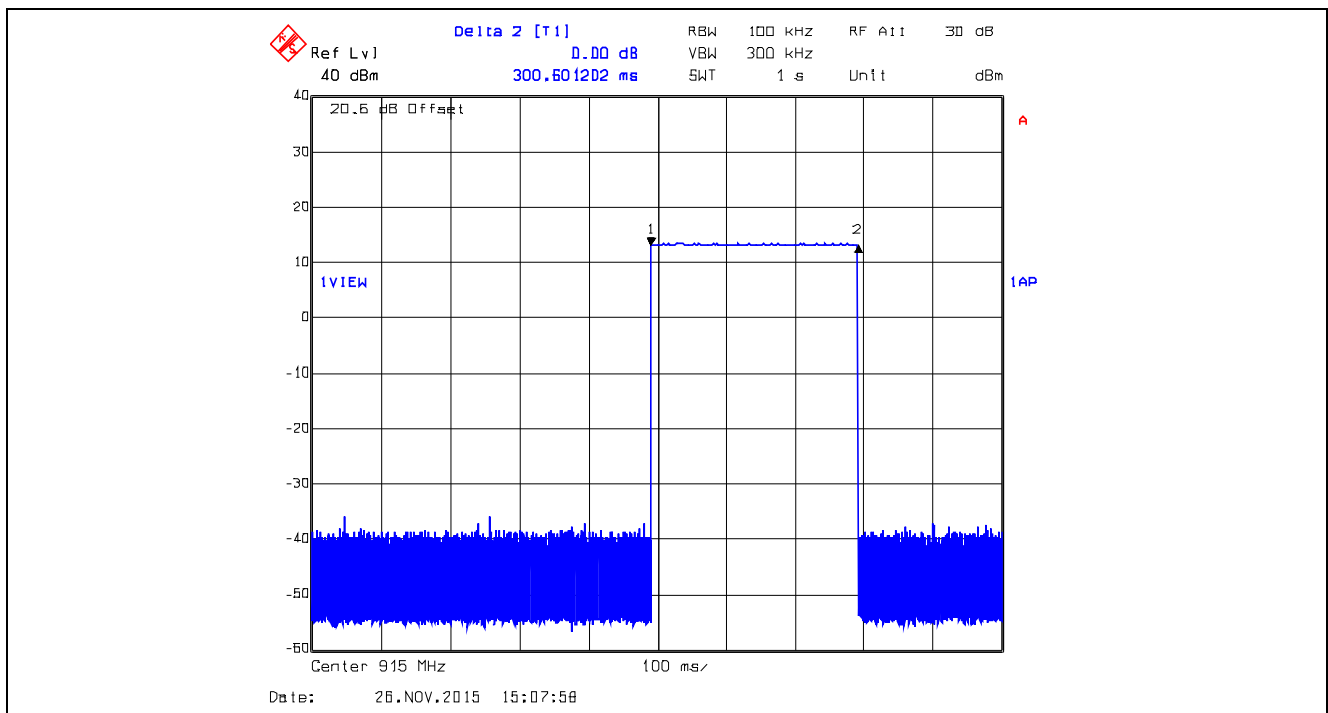

**Plot 5.3.4.51.** Time of Occupancy, 915 MHz XB0, Data Rate at 10 kbps  
Average time of occupancy =  $20 \times (T_{on}) / (T_{total}) = 20 \times 0.3006012s / 19.0962s = 0.3148s < 0.4s$

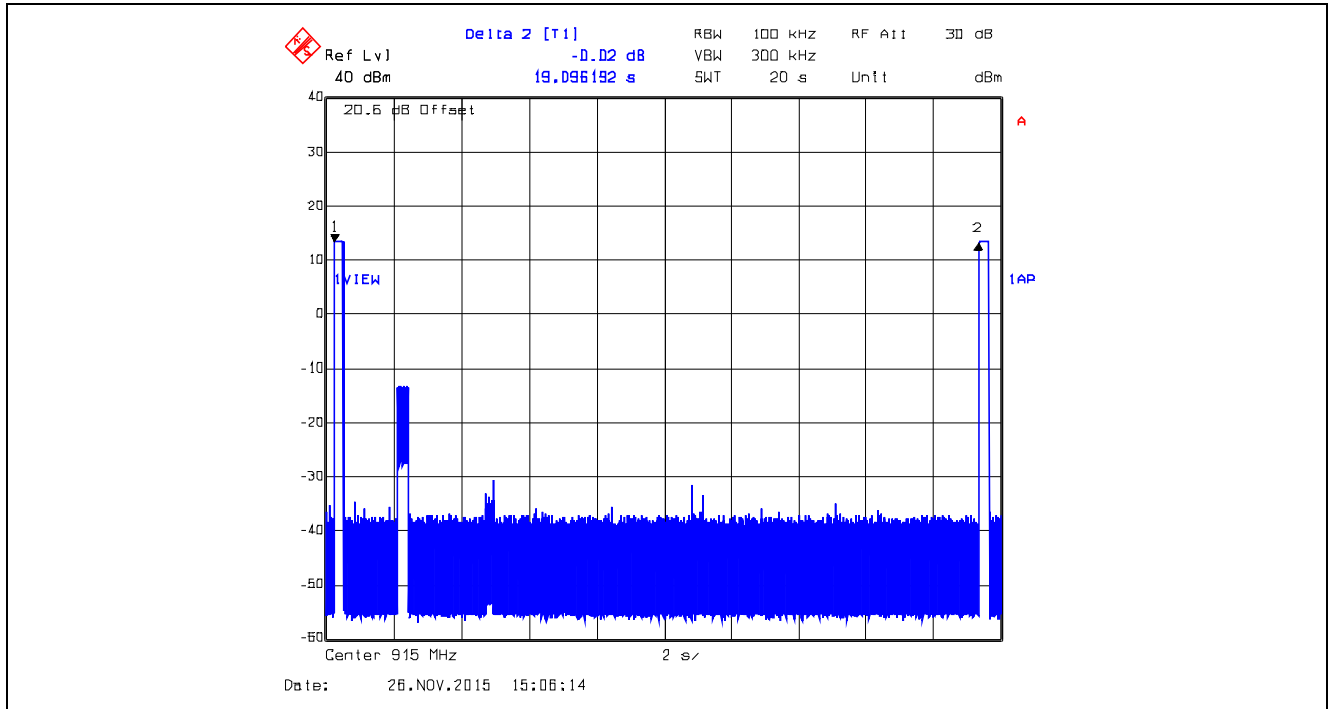

**Plot 5.3.4.52.** Time of Occupancy, 927.5 MHz, XB0, Data Rate at 10 kbps  
Dwell Time @ 927.5 MHz = 300.6012 ms

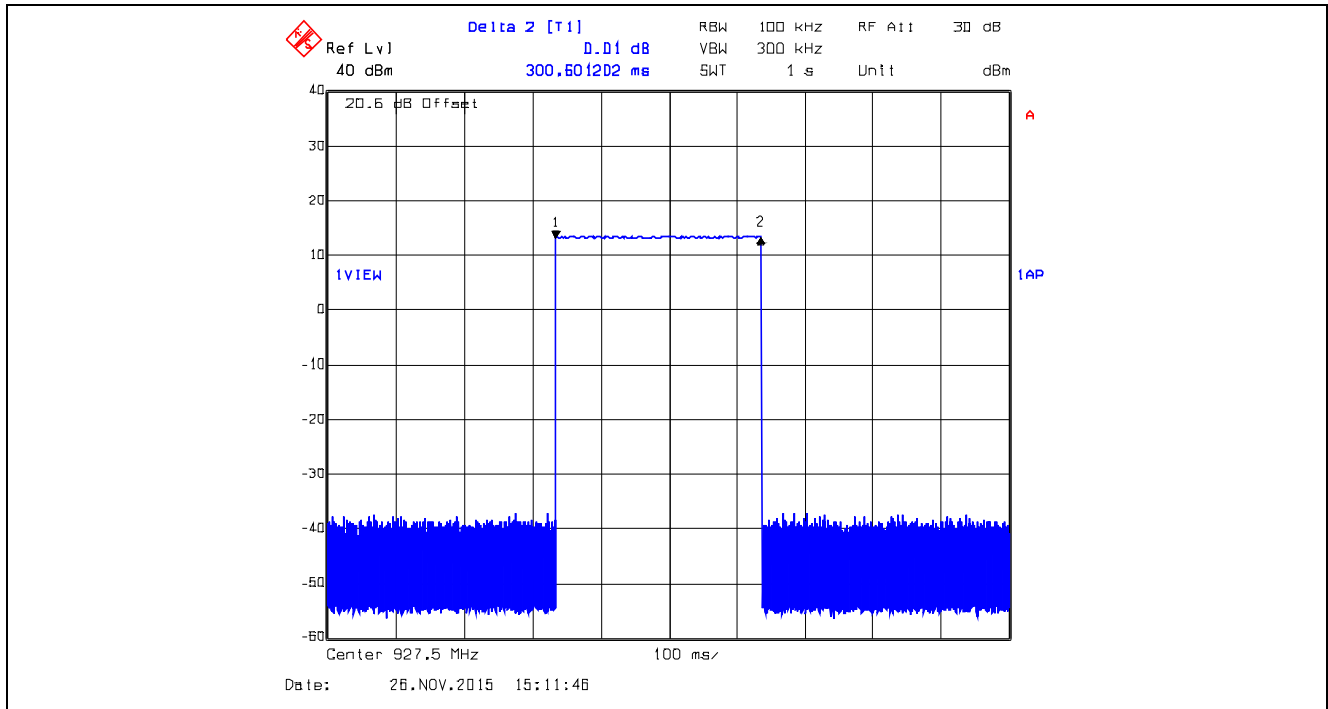

**Plot 5.3.4.53.** Time of Occupancy, 927.5 MHz XB0, Data Rate at 10 kbps  
 Average time of occupancy =  $20 \times (T_{on}) / (T_{total}) = 20 \times 0.3006012s / 18.4970s = 0.3250s < 0.4s$

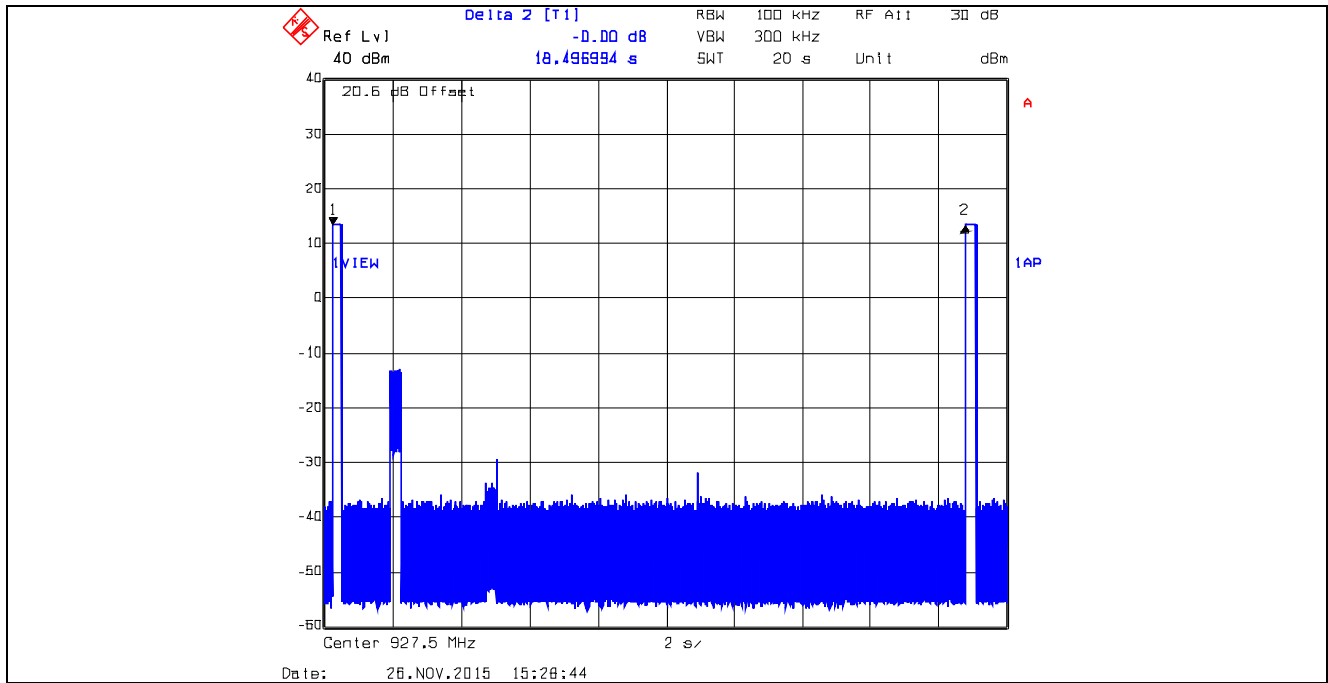

**Plot 5.3.4.54.** Time of Occupancy, 902.5 MHz, XB1, Data Rate at 110 kbps  
 Dwell Time @ 902.5 MHz = 30.4609 ms

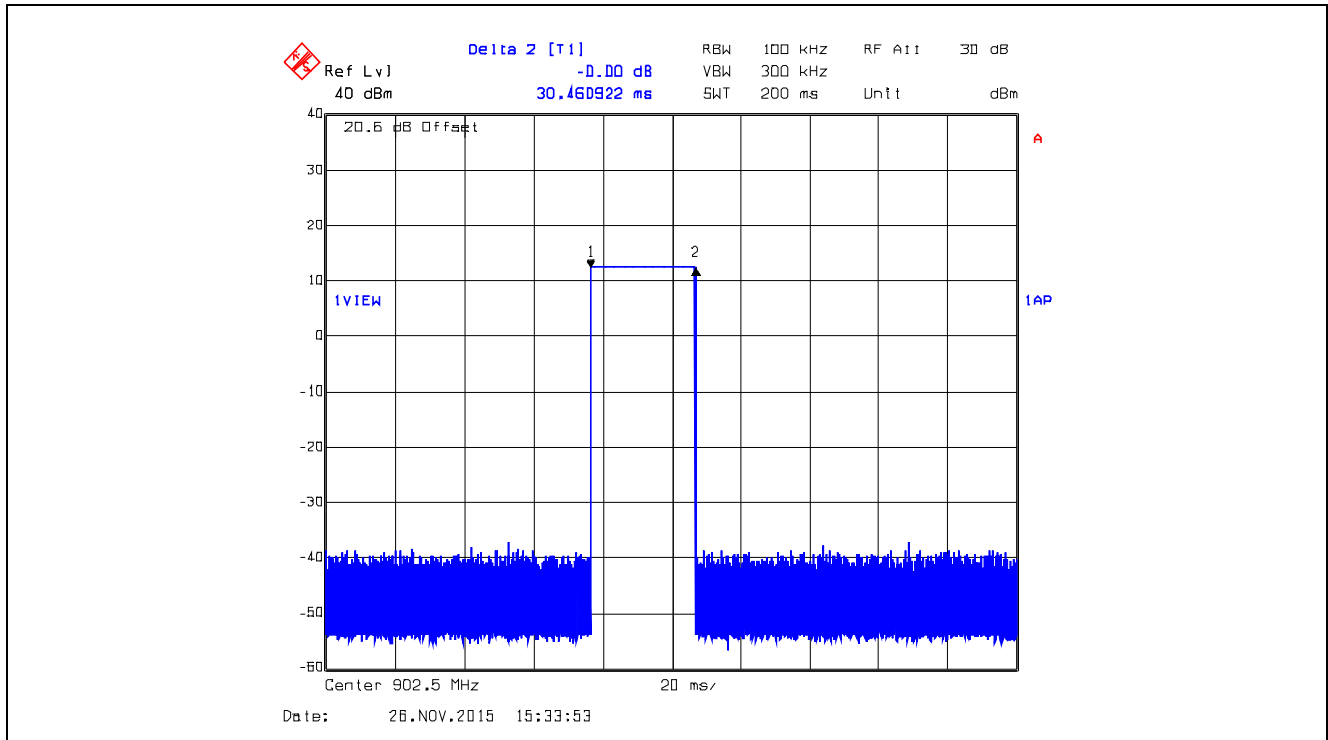

**Plot 5.3.4.55.** Time of Occupancy, 902.5 MHz, XBX1, Data Rate at 110 kbps  
 Average time of occupancy = (Dwell Time) x (number of hops) = 30.4609 ms x 6 = 182.77 ms < 0.4 sec within 20 sec

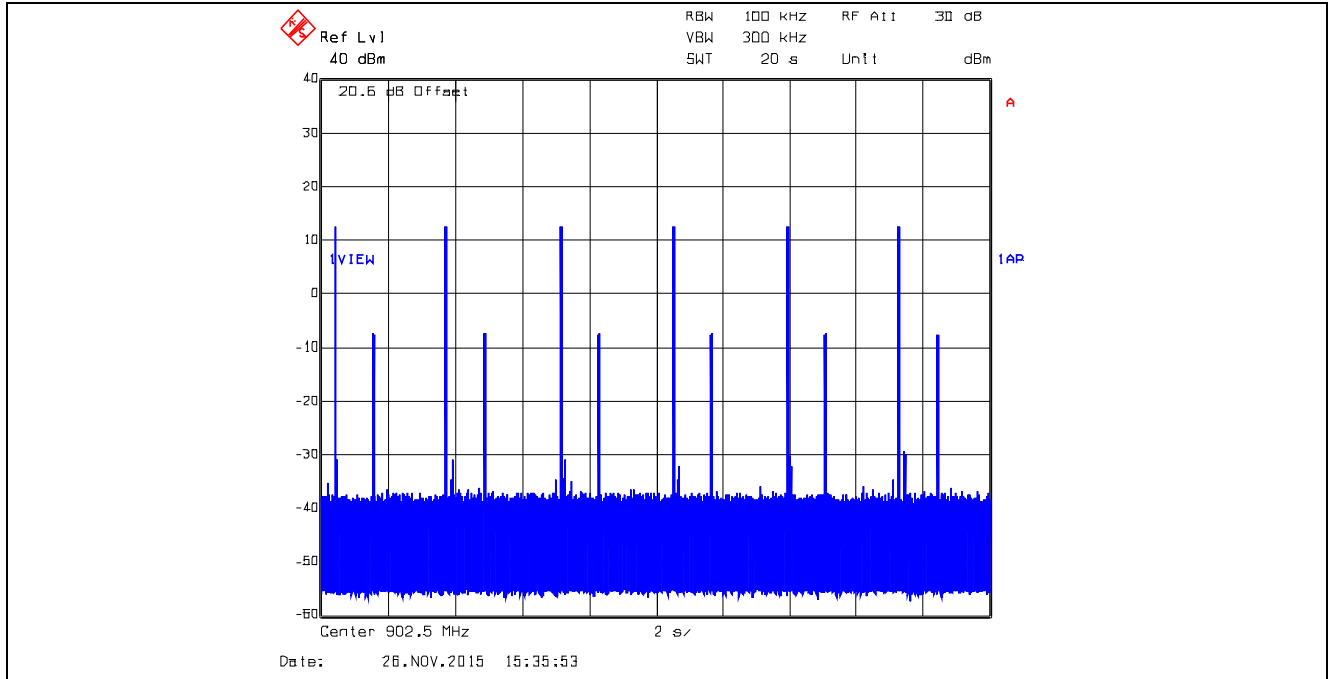

**Plot 5.3.4.56.** Time of Occupancy, 915.0 MHz, XBX1, Data Rate at 110 kbps  
 Dwell Time @ 915.00 MHz = 30.4609 ms

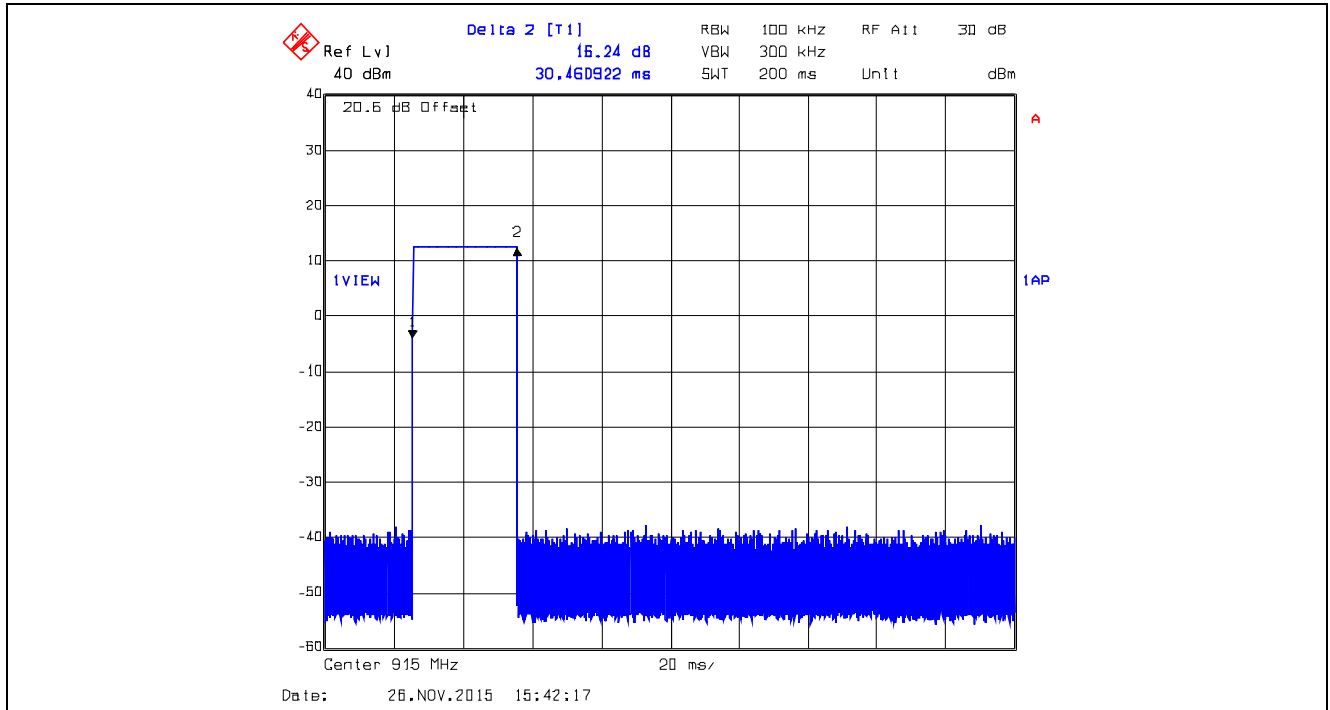

**Plot 5.3.4.57.** Time of Occupancy, 915.0 MHz, XB1, Data Rate at 110 kbps  
 Average time of occupancy = (Dwell Time) x (number of hops) = 30.4609 ms x 6 = 182.77 ms < 0.4 sec within 20 sec

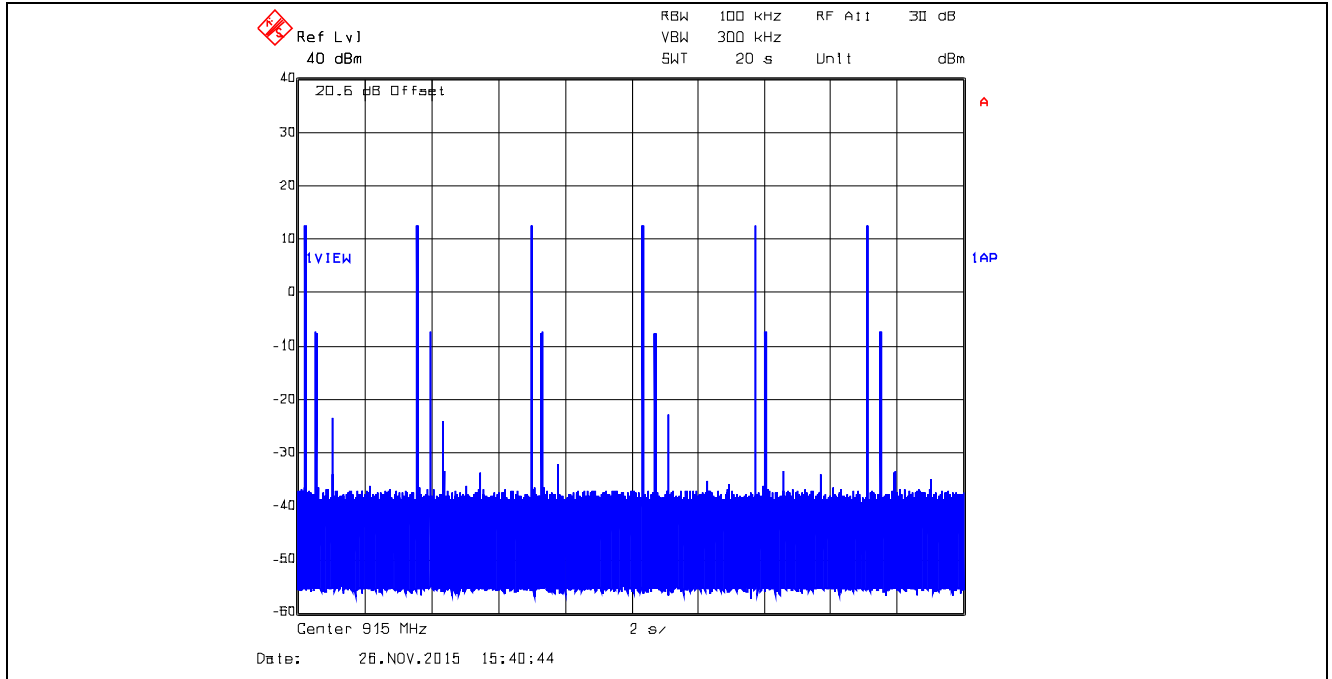

**Plot 5.3.4.58.** Time of Occupancy, 927.5 MHz, XB1, Data Rate at 110 kbps  
 Dwell Time @ 927.5 MHz = 30.4609 ms

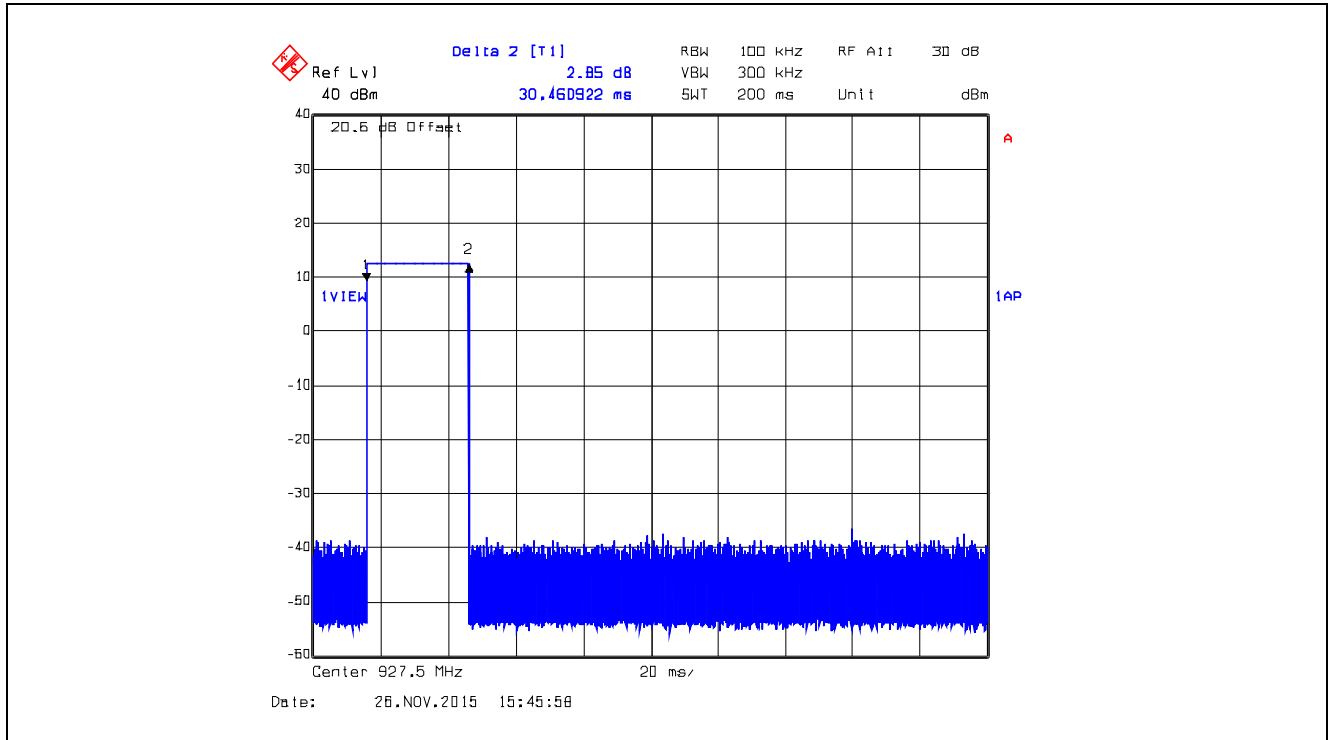

**Plot 5.3.4.59.** Time of Occupancy, 927.5 MHz, XBX1, Data Rate at 110 kbps  
 Average time of occupancy = (Dwell Time) x (number of hops) = 30.4609 ms x 6 = 182.77 ms < 0.4 sec within 20 sec

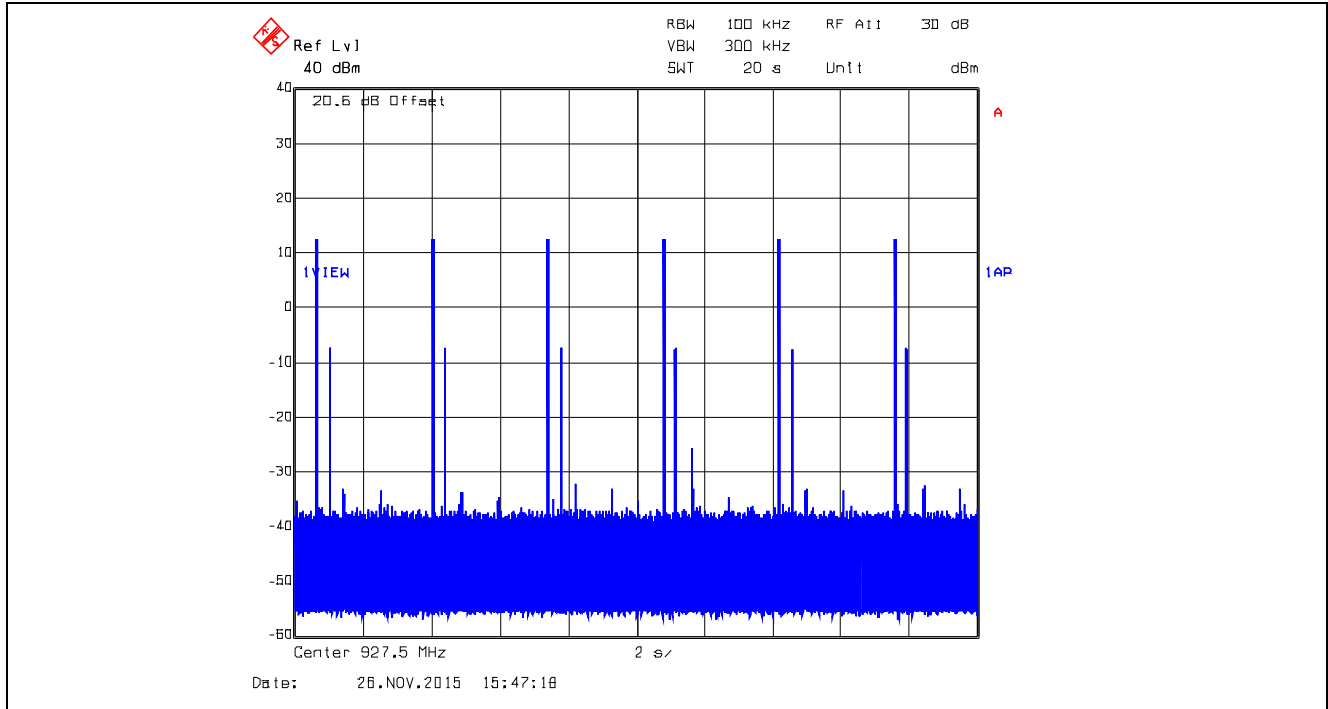

**Plot 5.3.4.60.** Time of Occupancy, 902.75 MHz, XBX2, Data Rate at 250 kbps  
 Dwell Time @ 902.75 MHz = 15.4309 ms

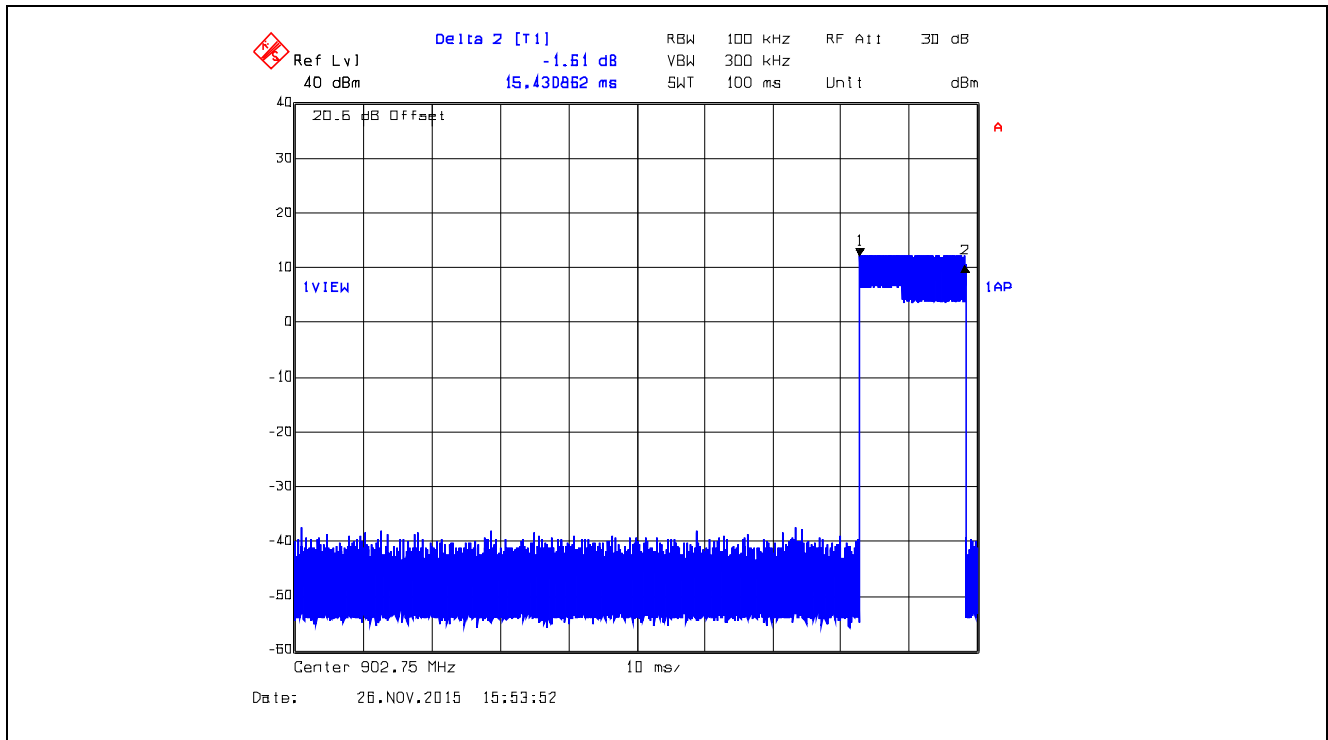

**Plot 5.3.4.61.** Time of Occupancy, 902.75 MHz, XB2, Data Rate at 250 kbps  
 Average time of occupancy = (Dwell Time) x (number of hops) = 15.4309 ms x 3 = 46.2927 ms < 0.4 sec within 10 sec

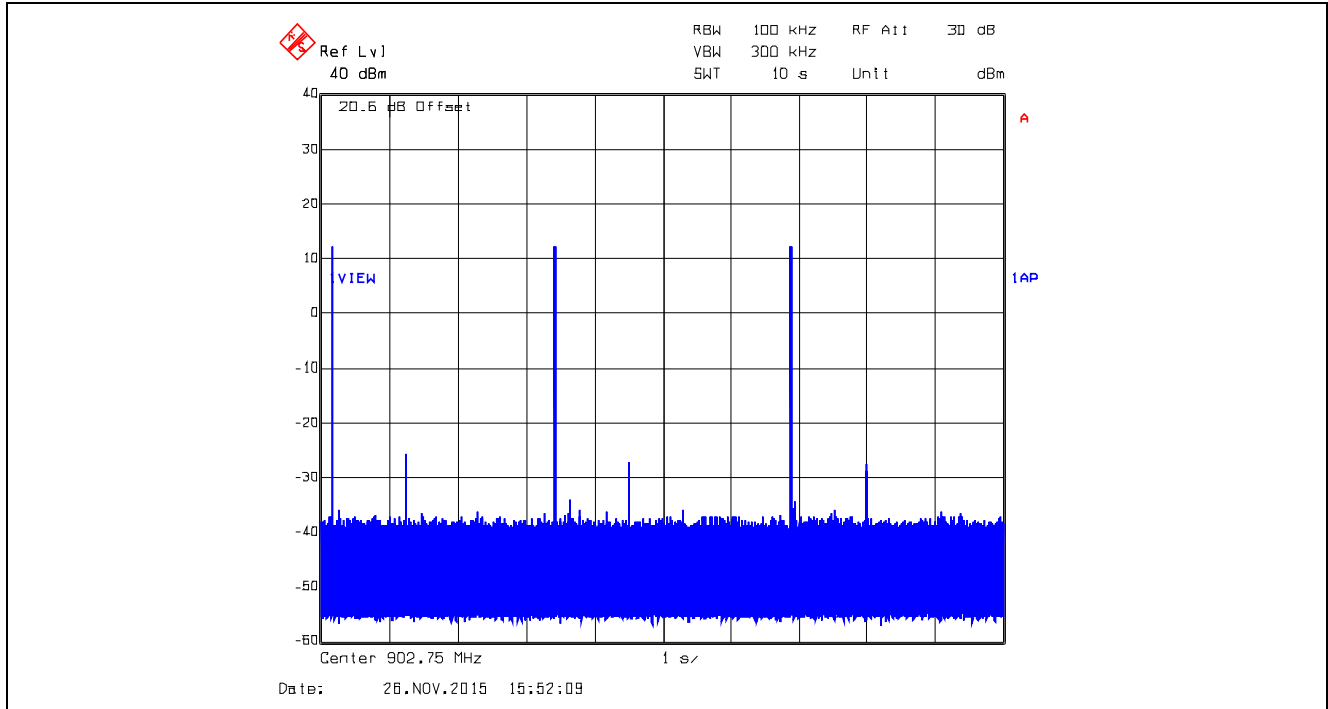

**Plot 5.3.4.62.** Time of Occupancy, 915.25 MHz, XB2, Data Rate at 250 kbps  
 Dwell Time @ 915.25 MHz = 15.4309 ms

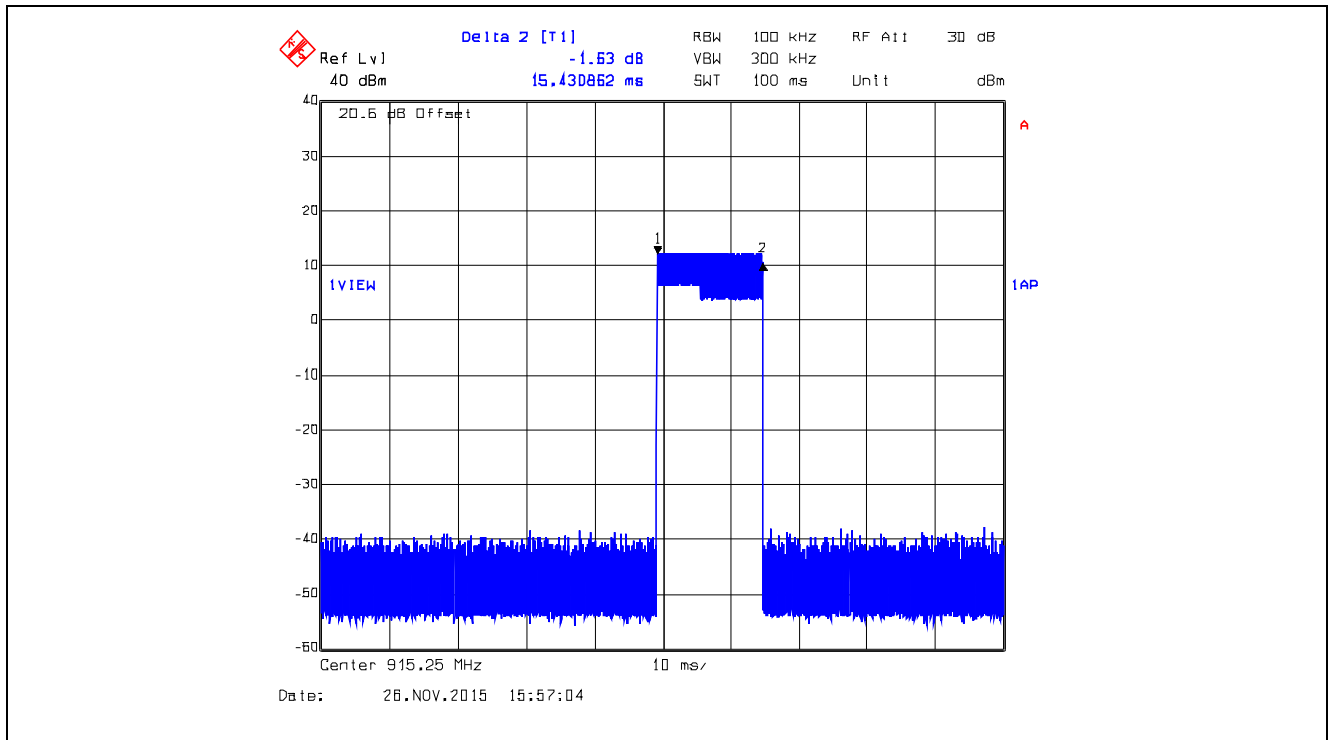



**Plot 5.3.4.63.** Time of Occupancy, 915.25 MHz, XB2, Data Rate at 250 kbps  
 Average time of occupancy = (Dwell Time) x (number of hops) = 15.4309 ms x 3 = 46.2927 ms < 0.4 sec within 10 sec

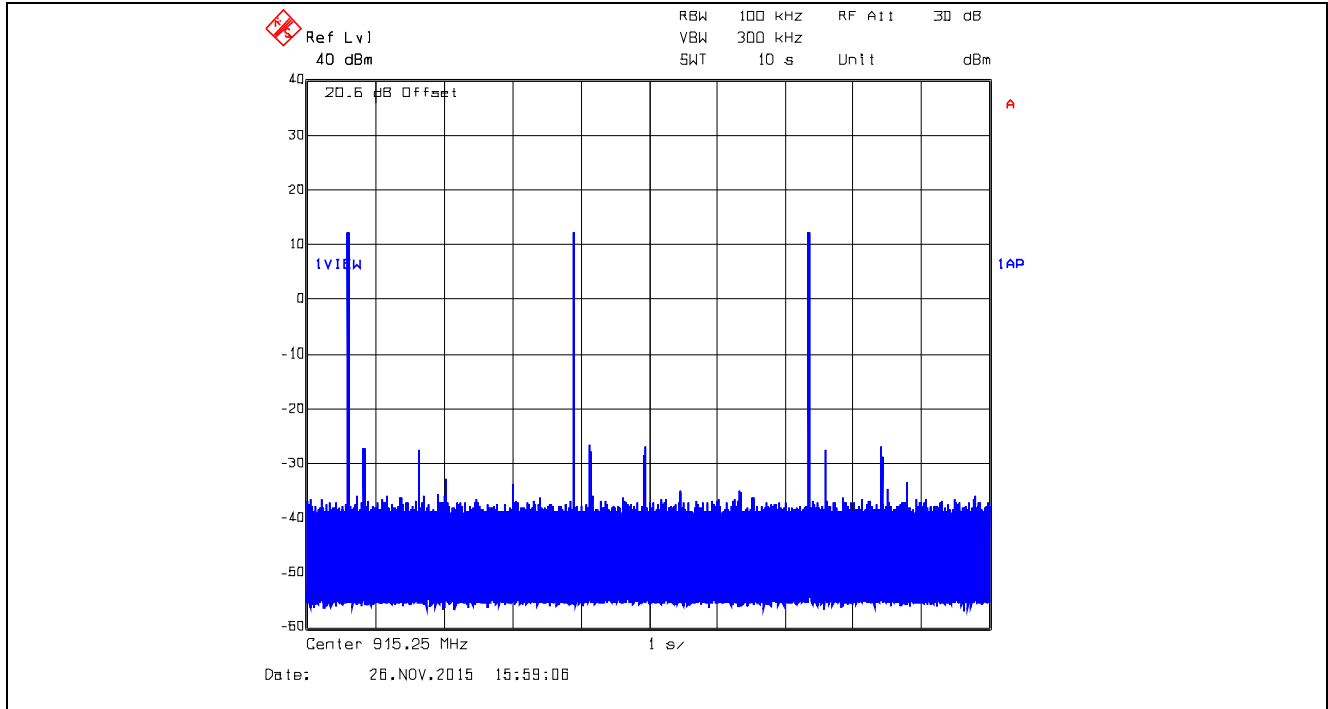

**Plot 5.3.4.64.** Time of Occupancy, 927.25 MHz, XB2, Data Rate at 250 kbps  
 Dwell Time @ 927.25 MHz = 15.4309 ms

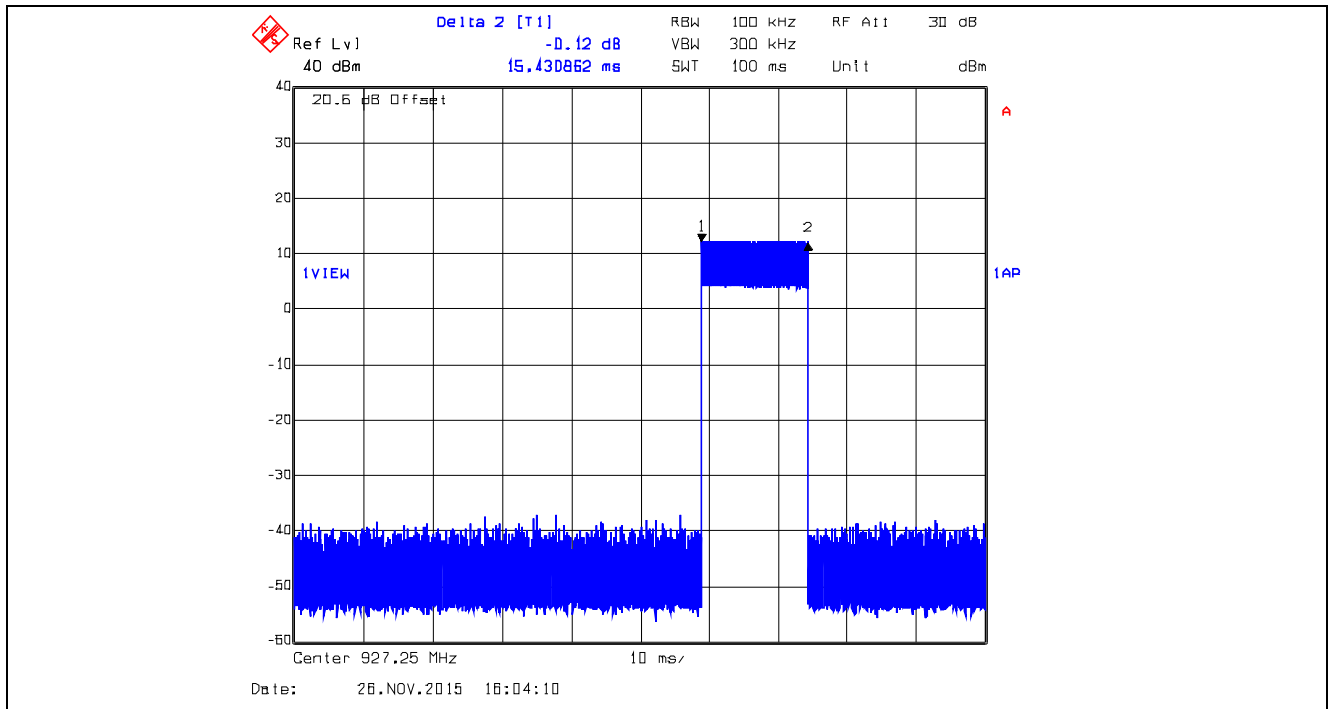

**Plot 5.3.4.65.** Time of Occupancy, 927.25 MHz, XBX2, Data Rate at 250 kbps  
 Average time of occupancy = (Dwell Time) x (number of hops) = 15.4309 ms x 3 = 46.2927 ms < 0.4 sec within 10 sec

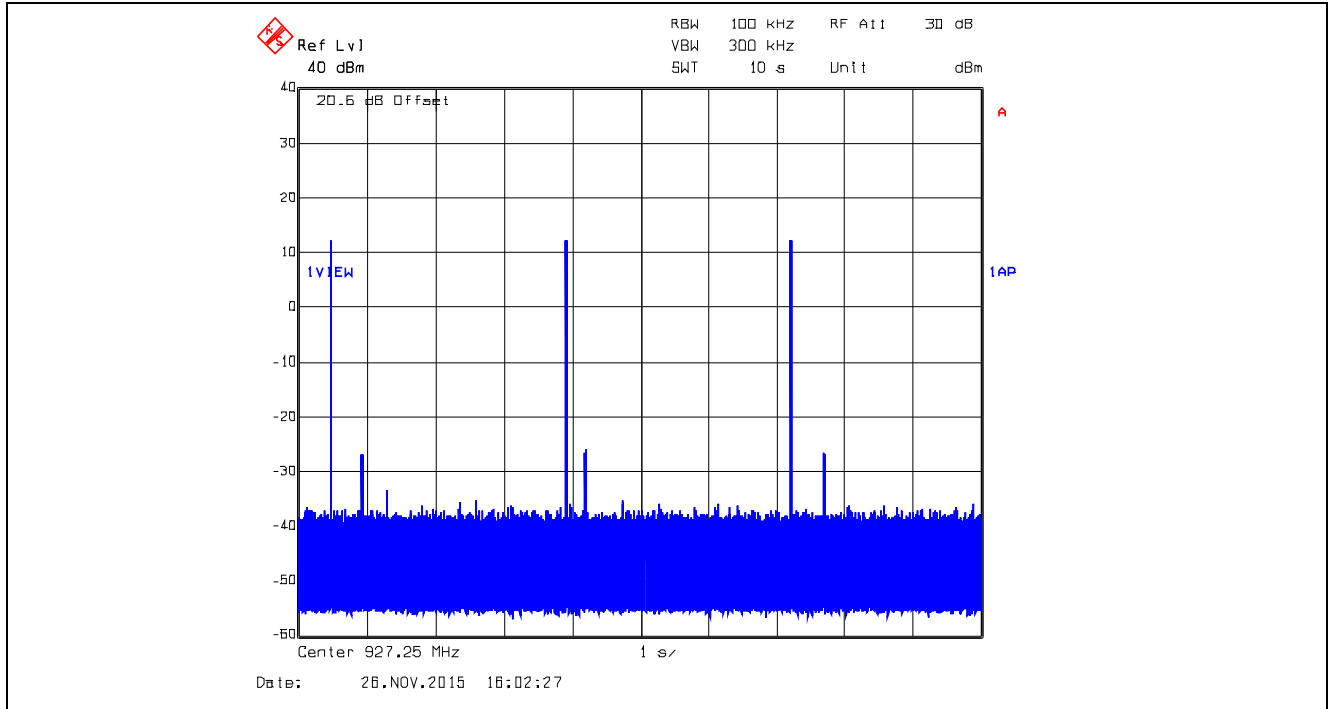

**Plot 5.3.4.66.** Time of Occupancy, 905 MHz, XTC0, Data Rate at 10 kbps  
 Dwell Time @ 902.5 MHz = 272.55 ms

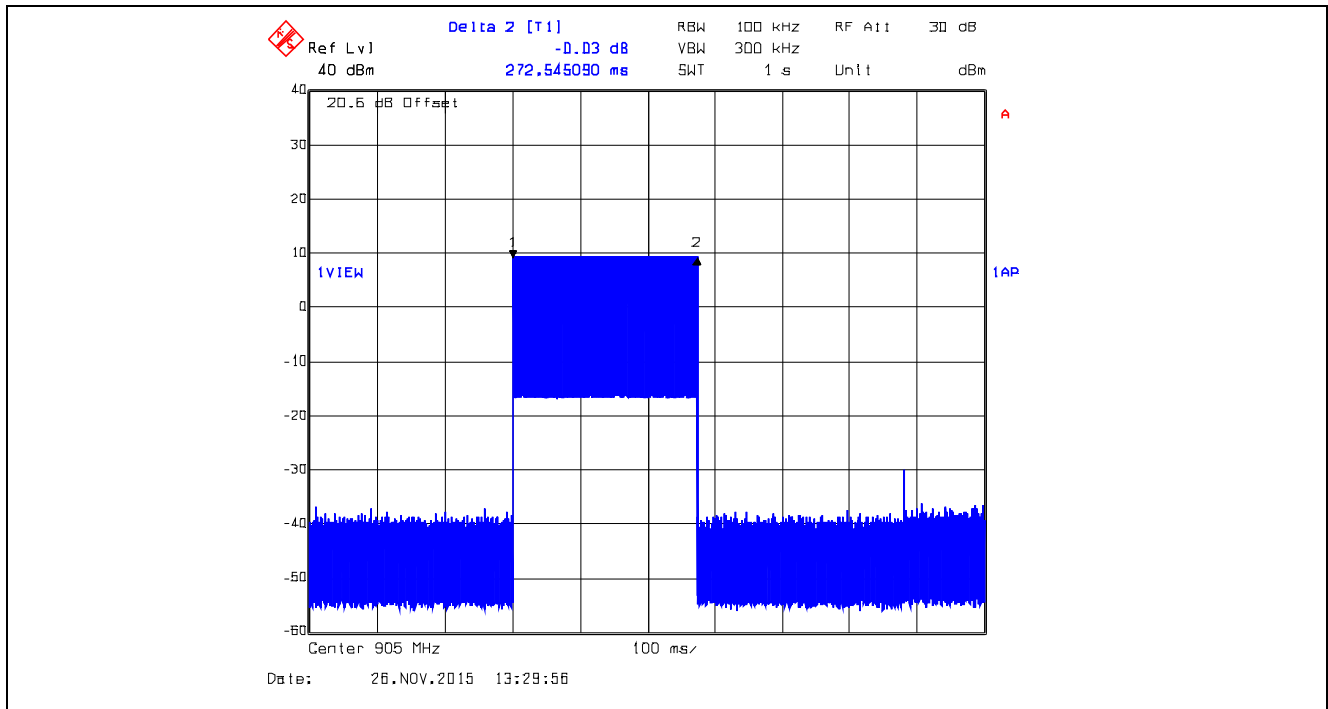

**Plot 5.3.4.67.** Time of Occupancy, 905 MHz, XTC0, Data Rate at 10 kbps  
Average time of occupancy = (Dwell Time) x (number of hops) = 272.55 ms x 1 = 272.55 ms < 0.4 sec within 10 sec

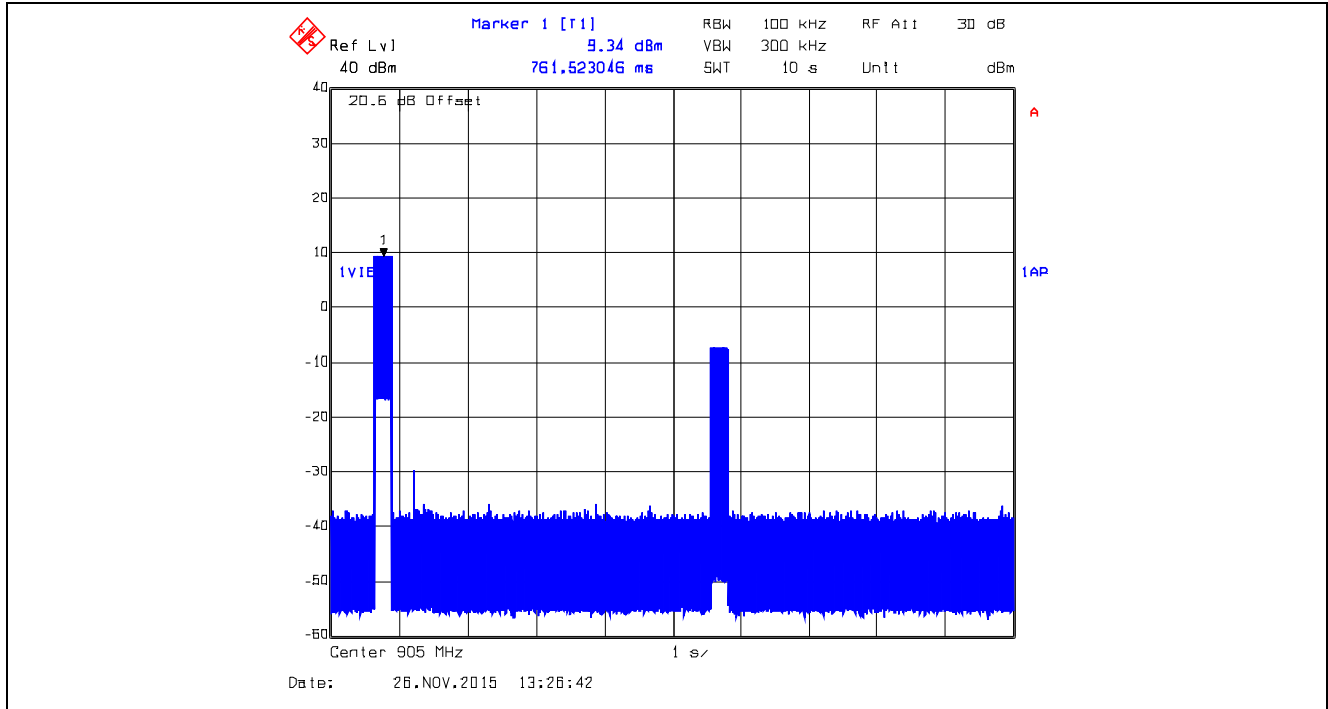

**Plot 5.3.4.68.** Time of Occupancy, 916.6 MHz, XTC0, Data Rate at 10 kbps  
Dwell Time @ 916.6 MHz = 272.55 ms

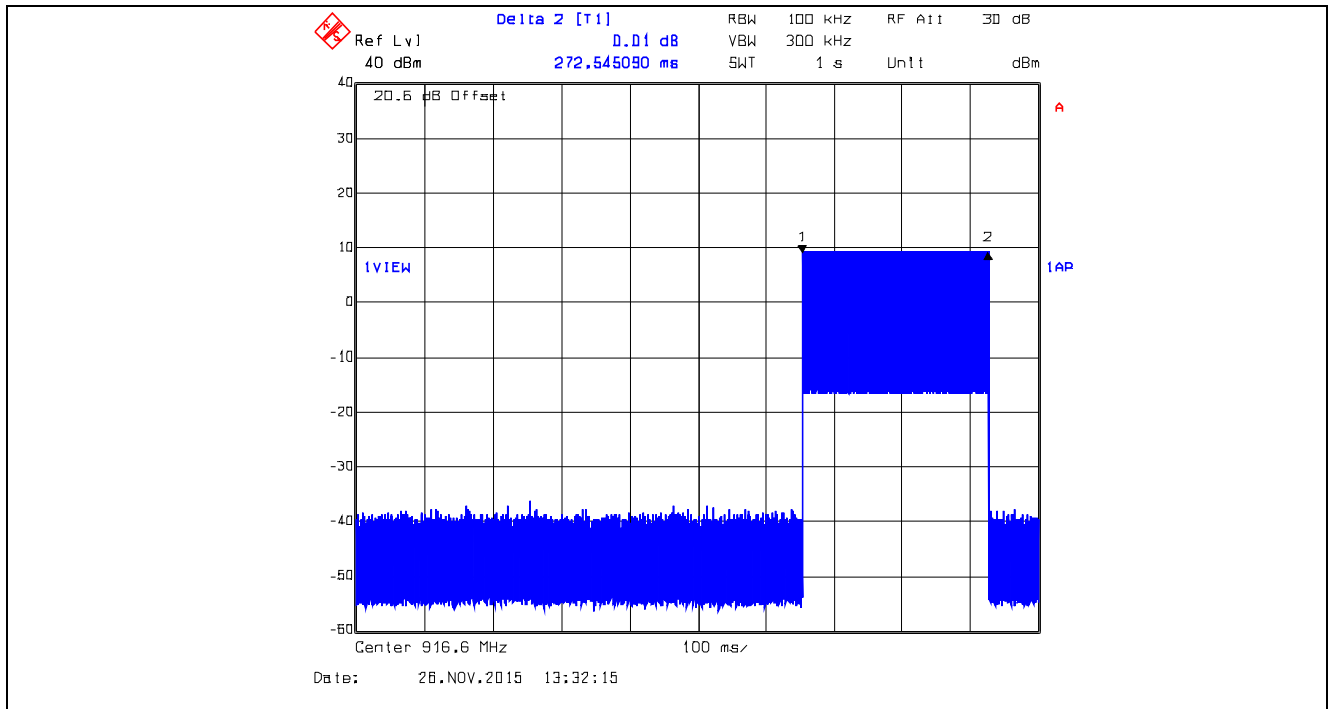

**Plot 5.3.4.69.** Time of Occupancy, 916.6 MHz, XTC0, Data Rate at 10 kbps  
 Average time of occupancy = (Dwell Time) x (number of hops) = 272.55 ms x 1 = 272.55 ms < 0.4 sec within 10 sec

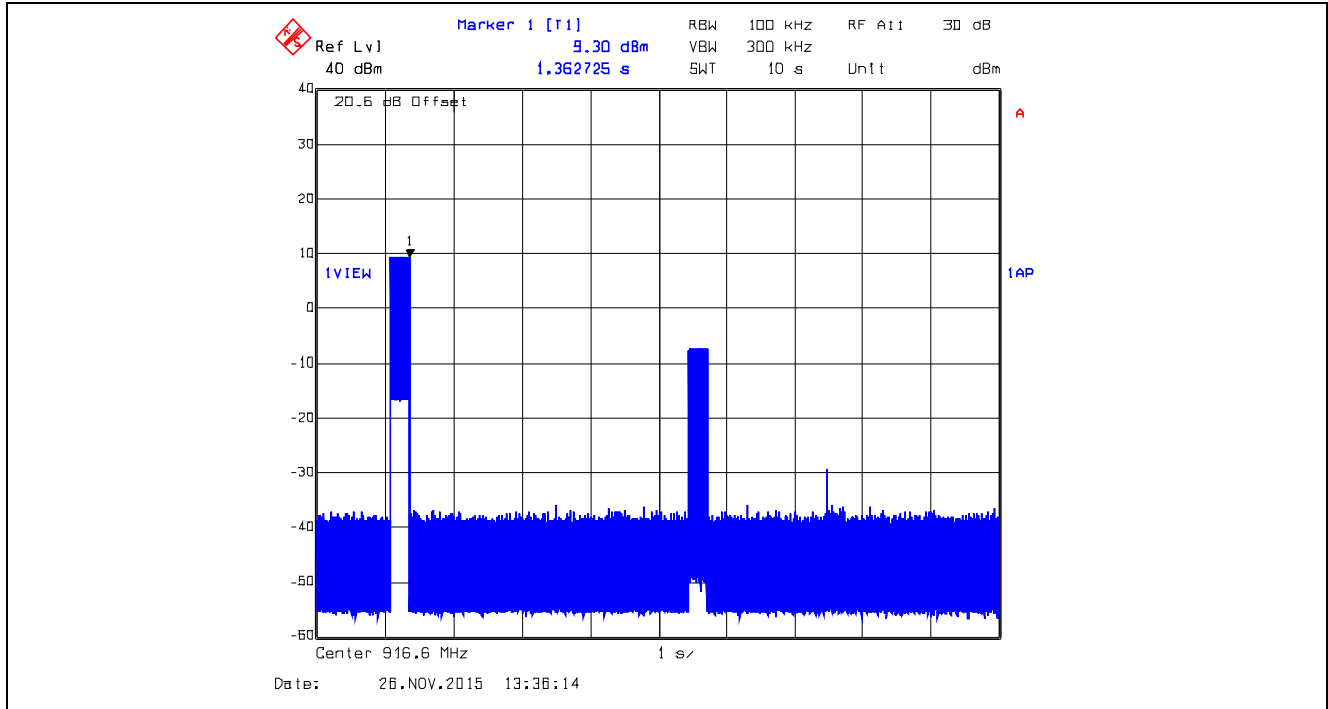

**Plot 5.3.4.70.** Time of Occupancy, 925.0 MHz, XTC0, Data Rate at 10 kbps  
 Dwell Time @ 925.0 MHz = 272.55 ms

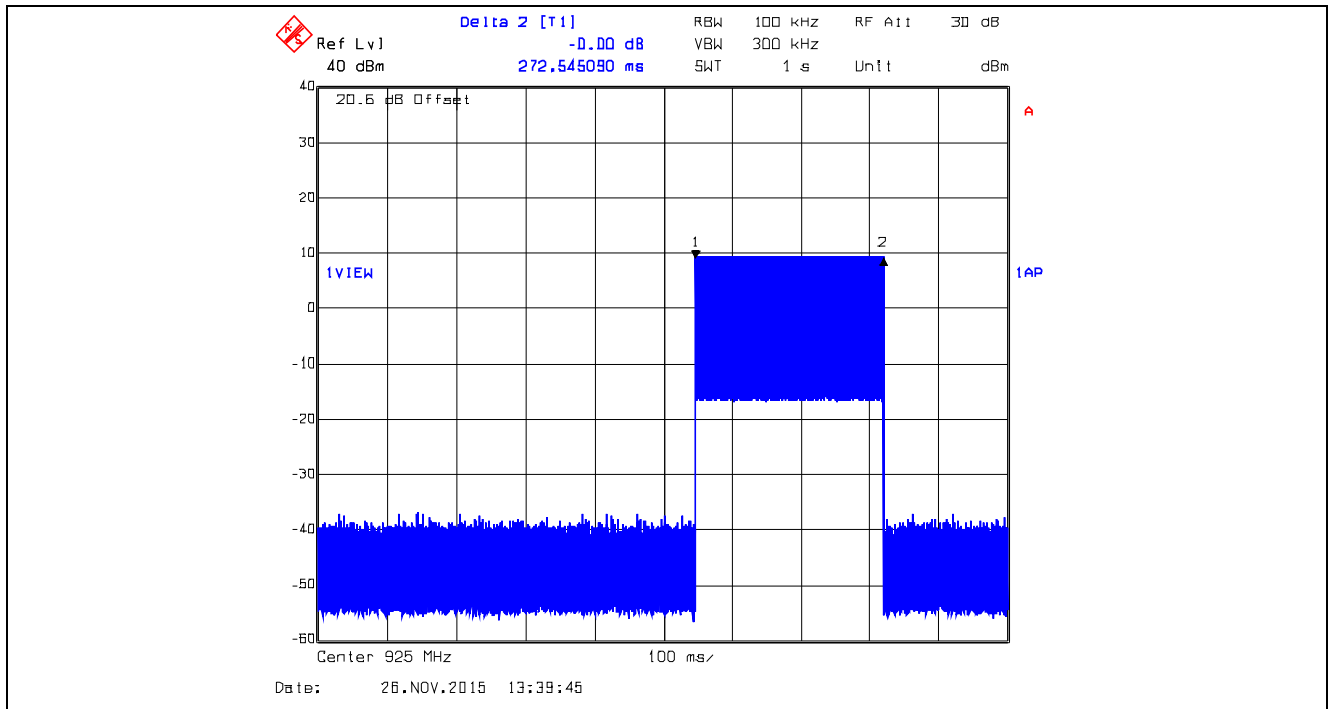

**Plot 5.3.4.71.** Time of Occupancy, 925.0 MHz, XTC0, Data Rate at 10 kbps  
 Average time of occupancy = (Dwell Time) x (number of hops) = 272.55 ms x 1 = 272.55 ms < 0.4 sec within 10 sec

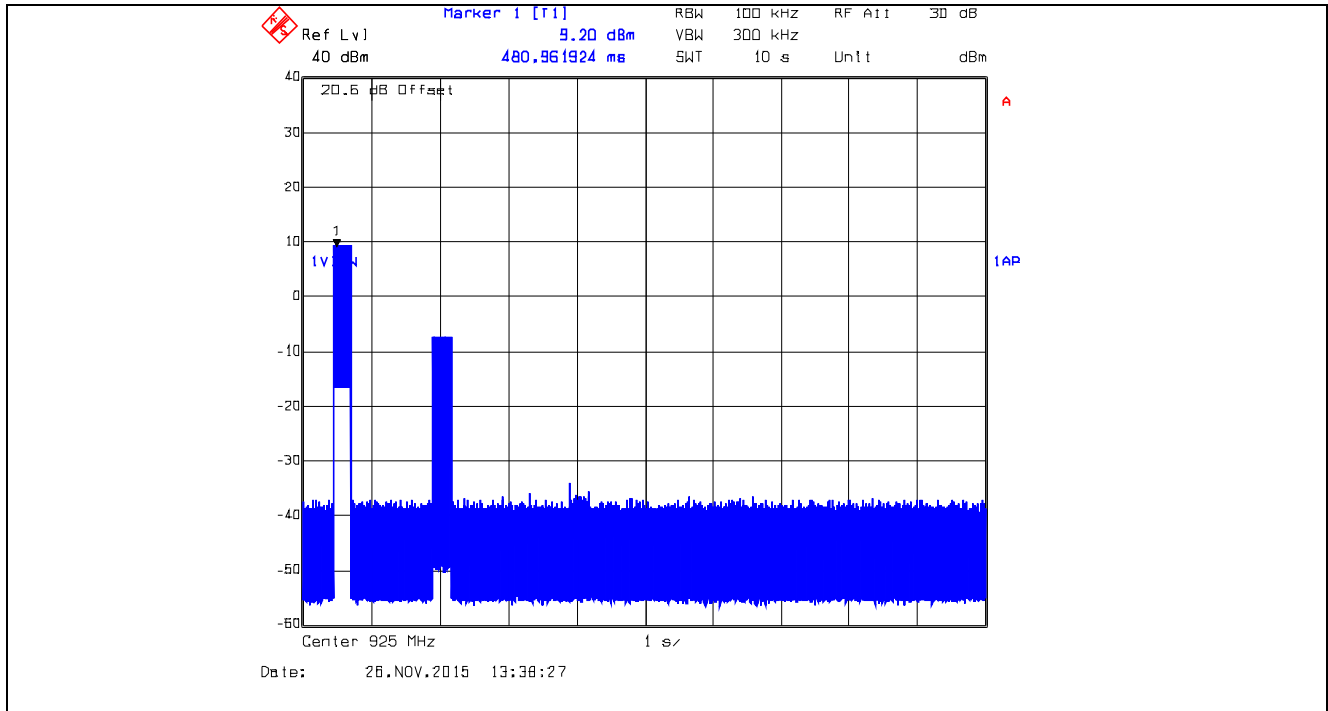

**Plot 5.3.4.72.** Time of Occupancy, 905 MHz, XTC1, Data Rate at 125 kbps  
 Dwell Time @ 905 MHz = 22.8457 ms

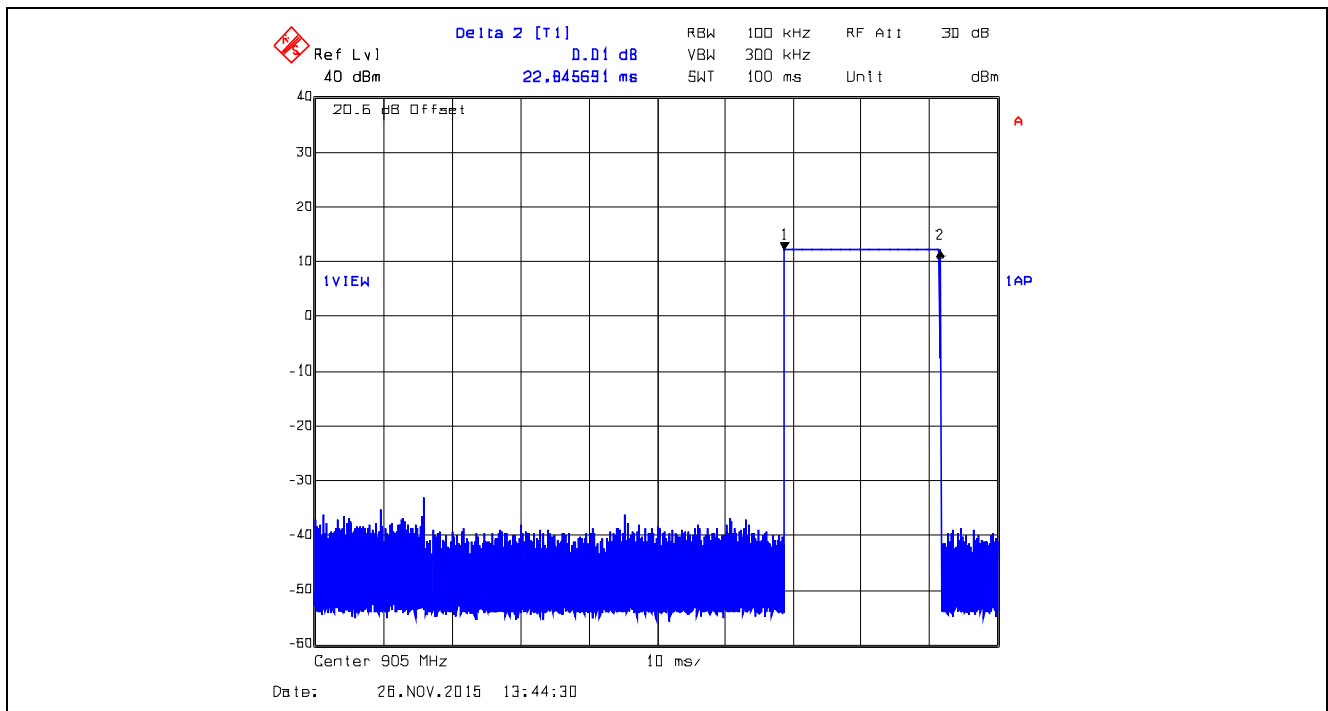

**Plot 5.3.4.73.** Time of Occupancy, 905 MHz, XTC1, Data Rate at 125 kbps  
 Average time of occupancy = (Dwell Time) x (number of hops) = 22.8457ms x 8 = 182.77 ms < 0.4 sec within 10 sec

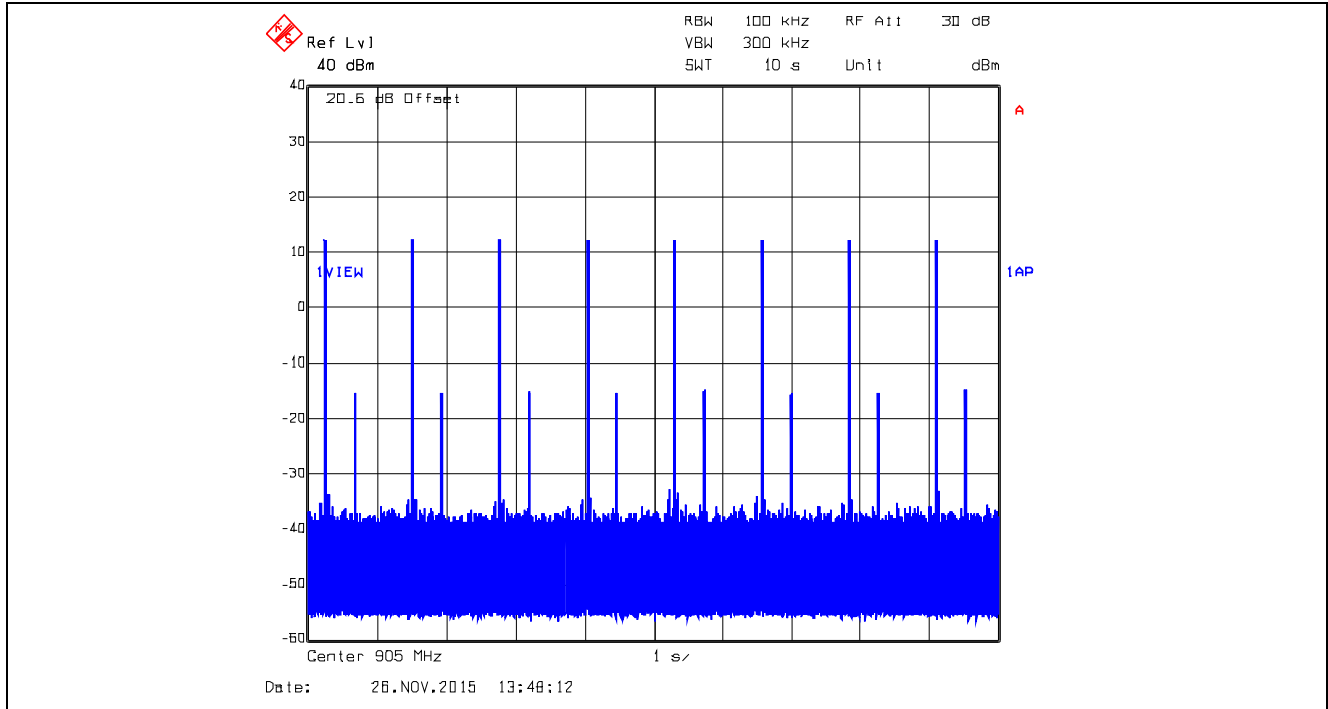

**Plot 5.3.4.74.** Time of Occupancy, 916.6 MHz, XTC1, Data Rate at 125 kbps  
 Dwell Time @ 916.6 MHz = 22.8457 ms

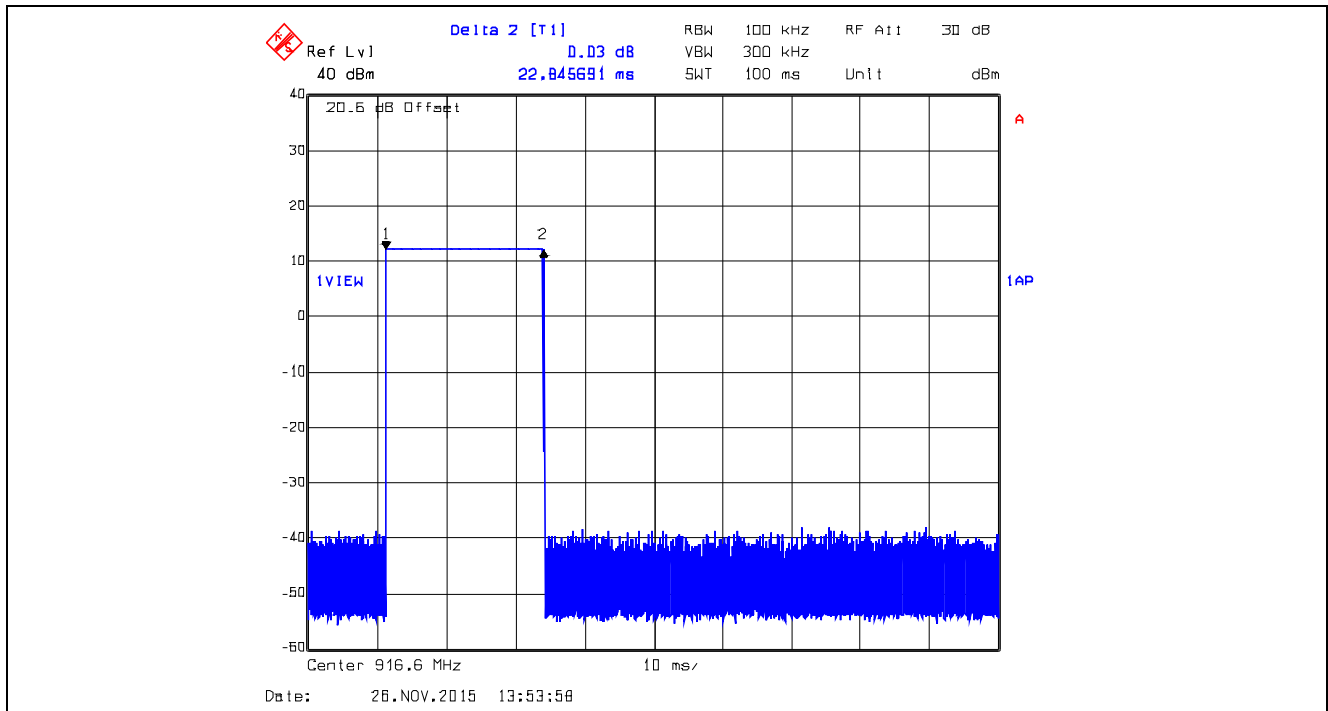

**Plot 5.3.4.75.** Time of Occupancy, 916.6 MHz, XTC1, Data Rate at 125 kbps  
 Average time of occupancy = (Dwell Time) x (number of hops) = 22.8457ms x 8 = 182.77 ms < 0.4 sec within 10 sec

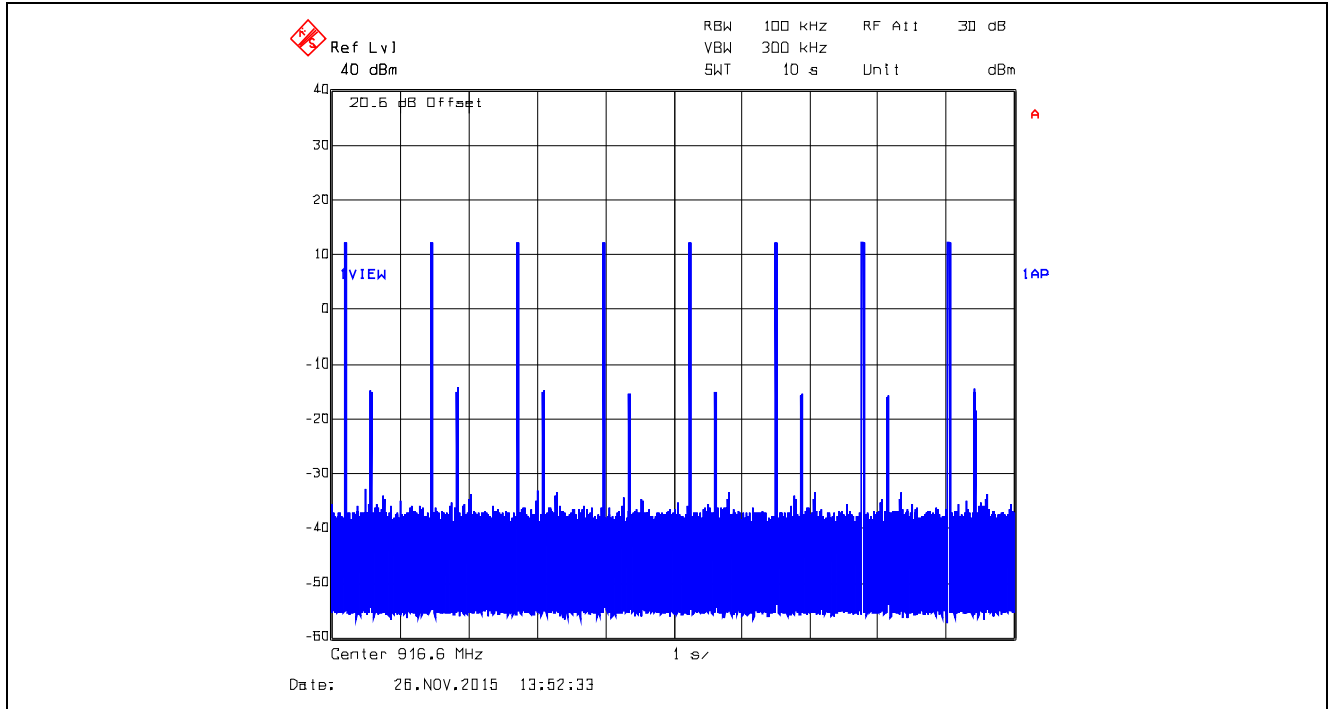

**Plot 5.3.4.76.** Time of Occupancy, 925.0 MHz, XTC1, Data Rate at 125 kbps  
 Dwell Time @ 925.0 MHz = 22.8457 ms

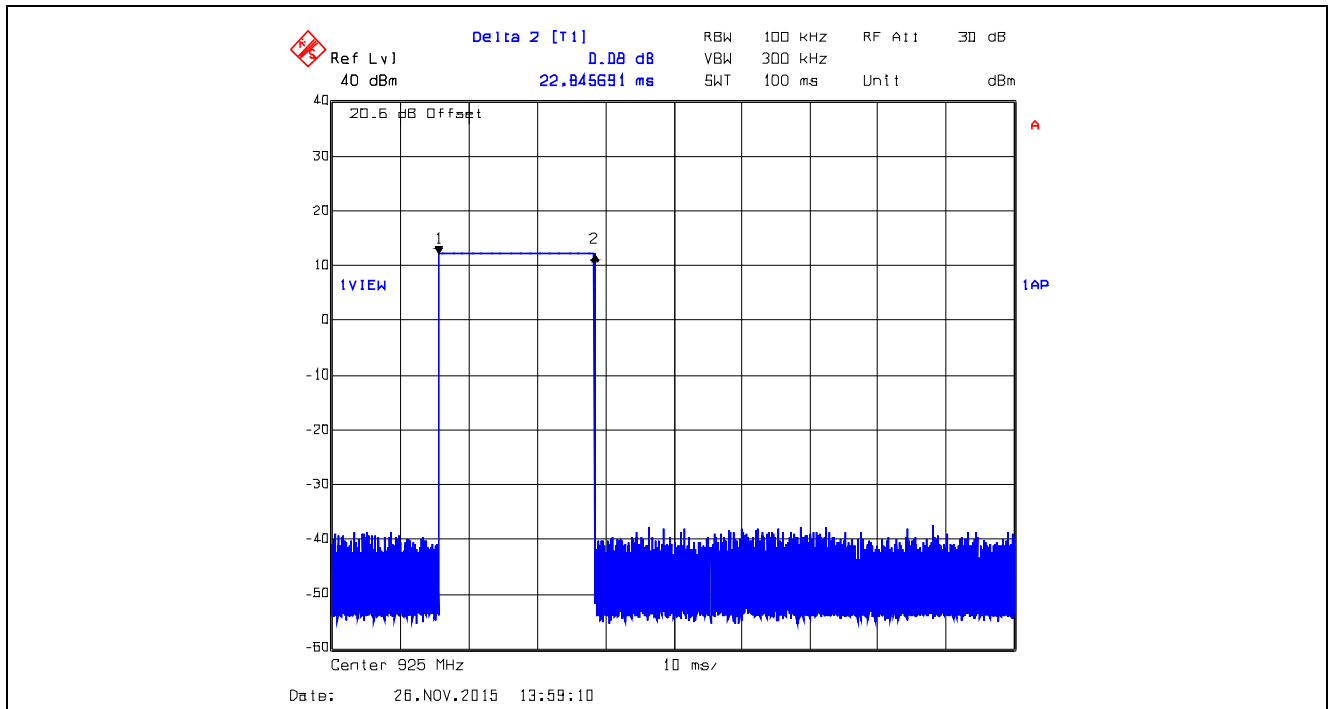

**Plot 5.3.4.77.** Time of Occupancy, 925.0 MHz, XTC1, Data Rate at 125 kbps  
 Average time of occupancy = (Dwell Time) x (number of hops) = 22.8457ms x 8 = 182.77 ms < 0.4 sec within 10 sec

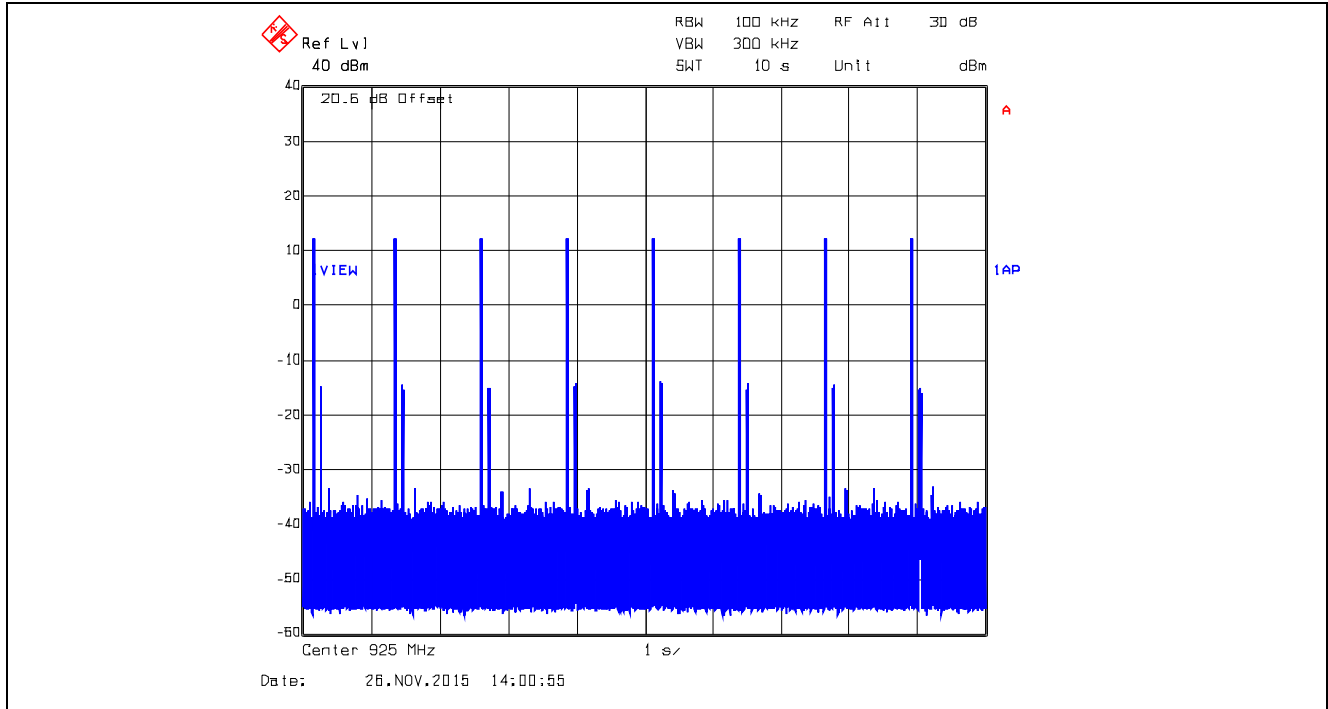

**Plot 5.3.4.78.** Time of Occupancy, 915.75 MHz, XTCA0, Data Rate at 10 kbps  
 Dwell Time @ 915.75 MHz = 272.9459ms

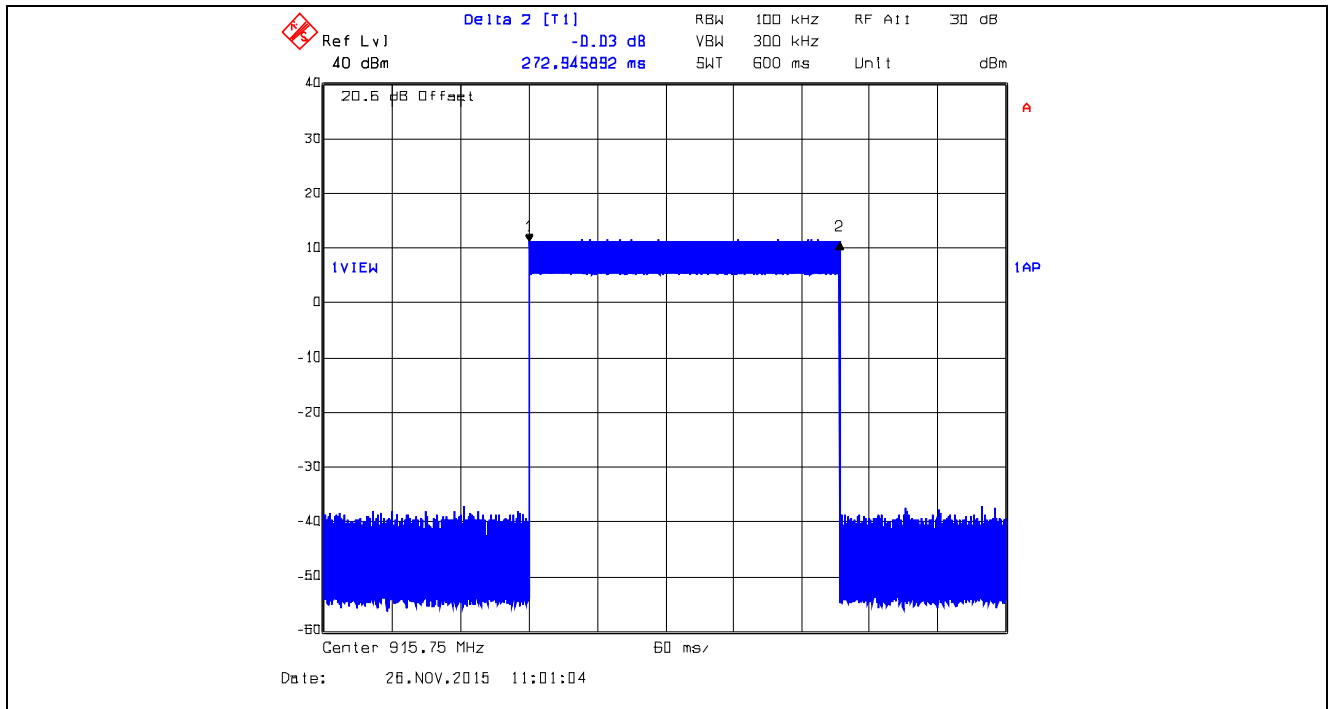



**Plot 5.3.4.79.** Time of Occupancy, 915.75 MHz XTCA0, Data Rate at 10 kbps  
 Average time of occupancy =  $20 \times (T_{on}) / (T_{total}) = 20 \times 0.2729459s / 14.5090s = 0.3762s < 0.4s$

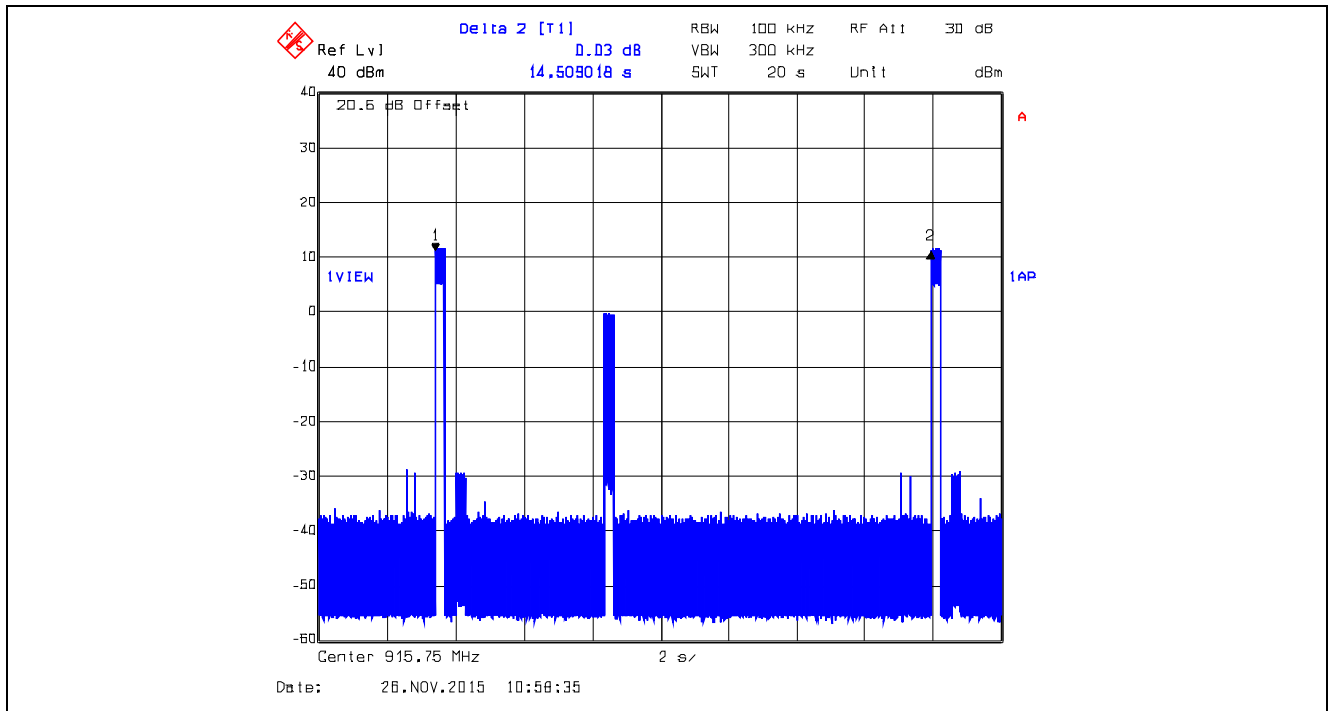

**Plot 5.3.4.80.** Time of Occupancy, 921.625 MHz, XTCA0, Data Rate at 10 kbps  
 Dwell Time @ 921.625 MHz = 274.1483 ms

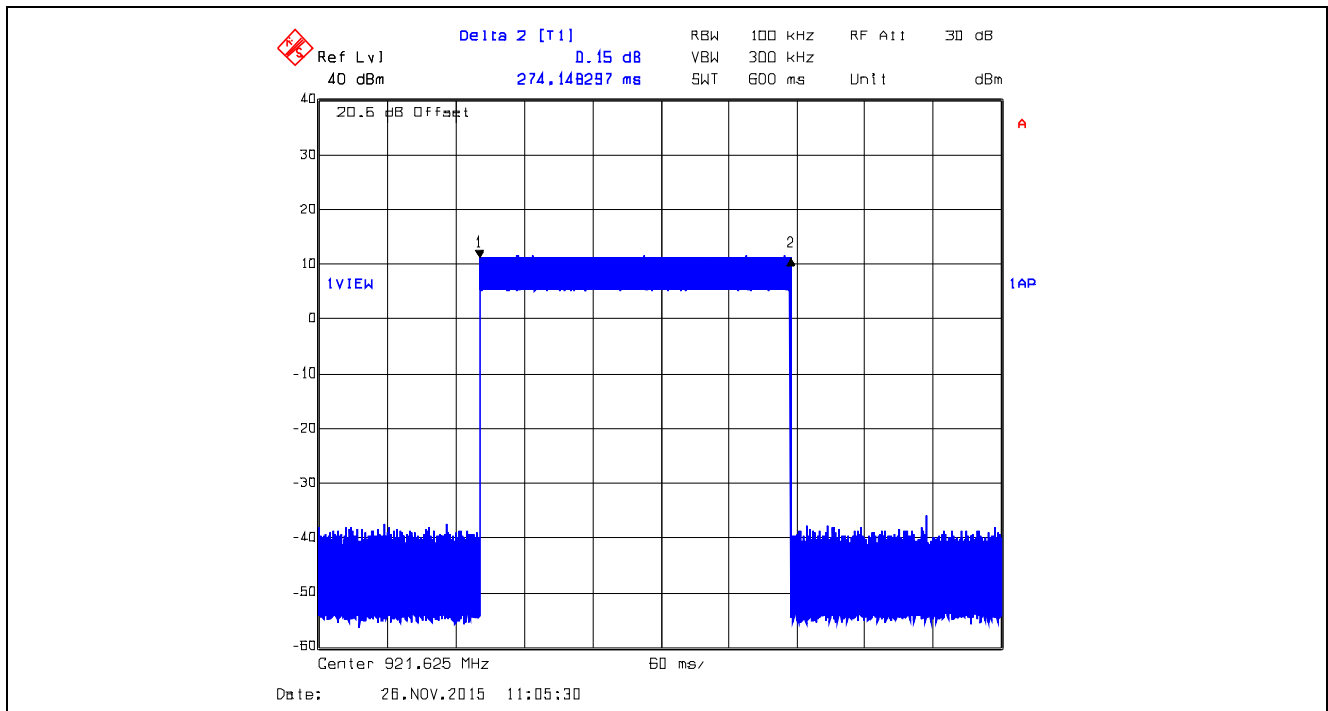

**Plot 5.3.4.81.** Time of Occupancy, 921.625 MHz XTCA0, Data Rate at 10 kbps  
 Average time of occupancy =  $20 \times (T_{on}) / (T_{total}) = 20 \times 0.2741483s / 14.5025s = 0.3781s < 0.4s$

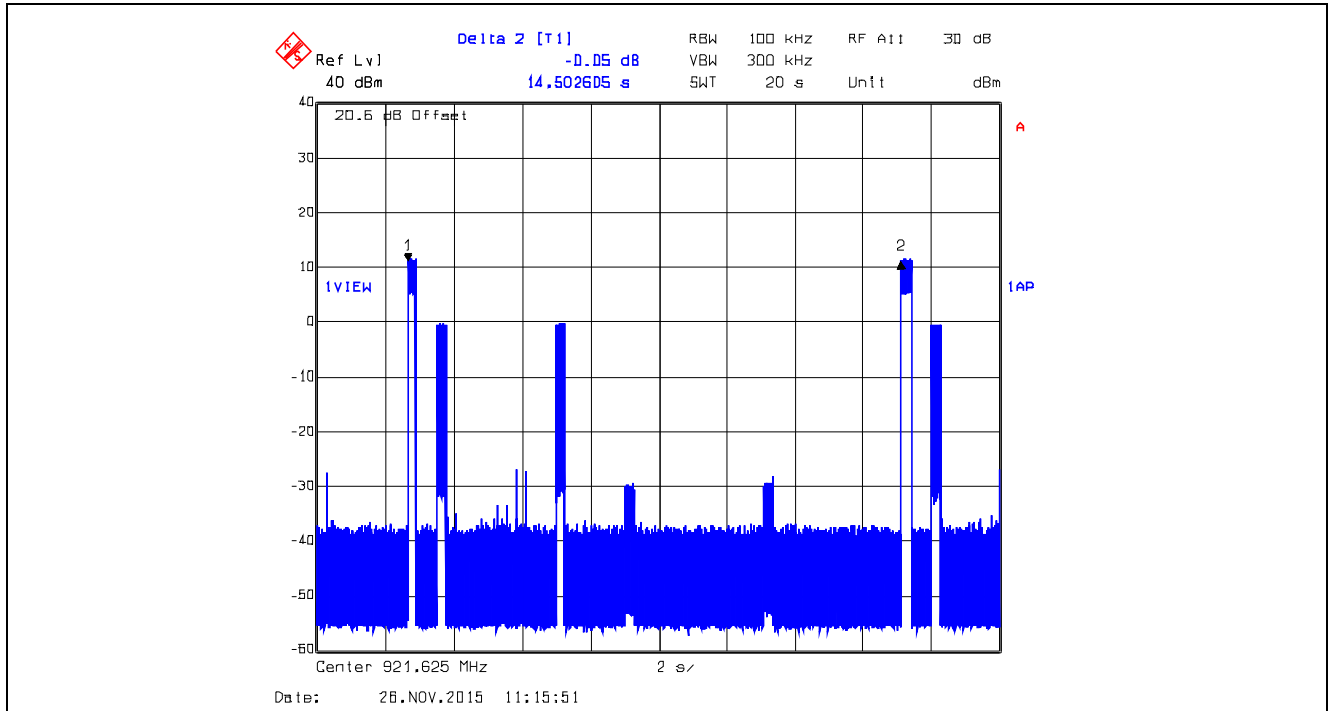

**Plot 5.3.4.82.** Time of Occupancy, 927.265 MHz, XTCA0, Data Rate at 10 kbps  
 Dwell Time @ 927.5 MHz = 272.9459 ms

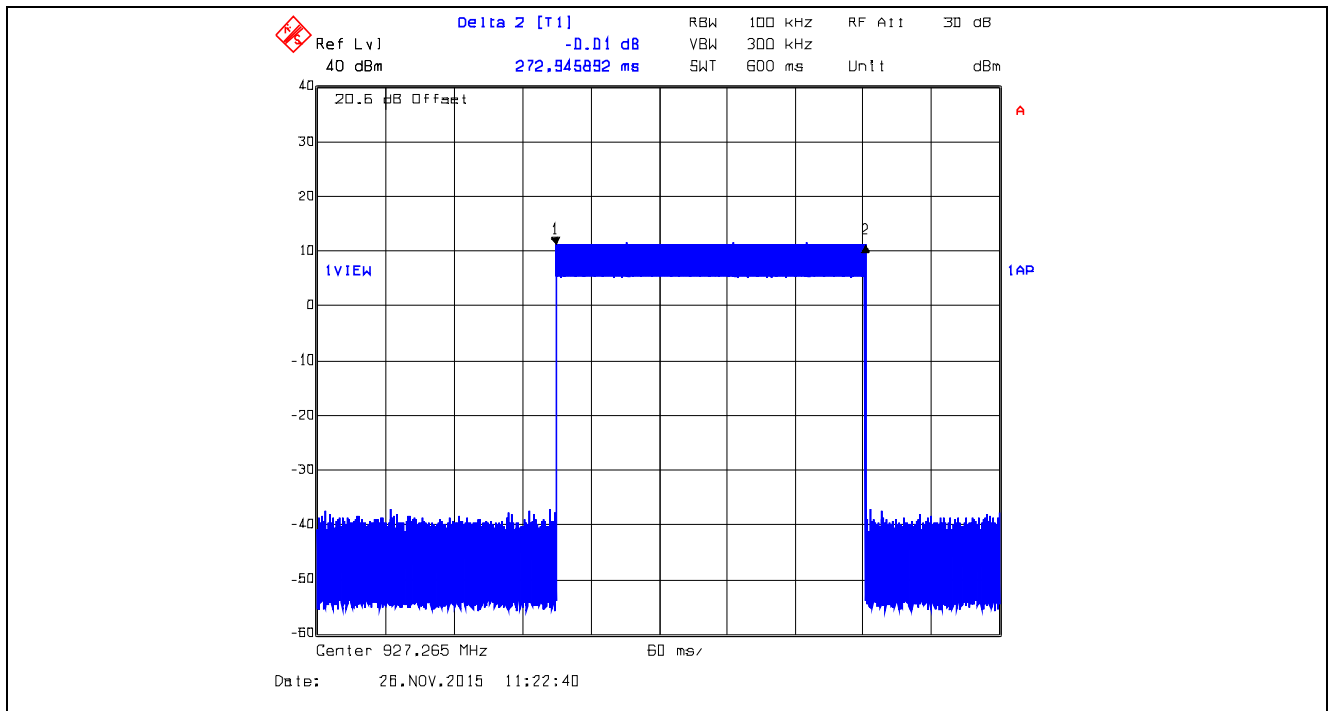

**Plot 5.3.4.83.** Time of Occupancy, 927.265 MHz XTCA0, Data Rate at 10 kbps  
 Average time of occupancy =  $20 \times (T_{on}) / (T_{total}) = 20 \times 0.2729459s / 14.5427s = 0.3754s < 0.4s$

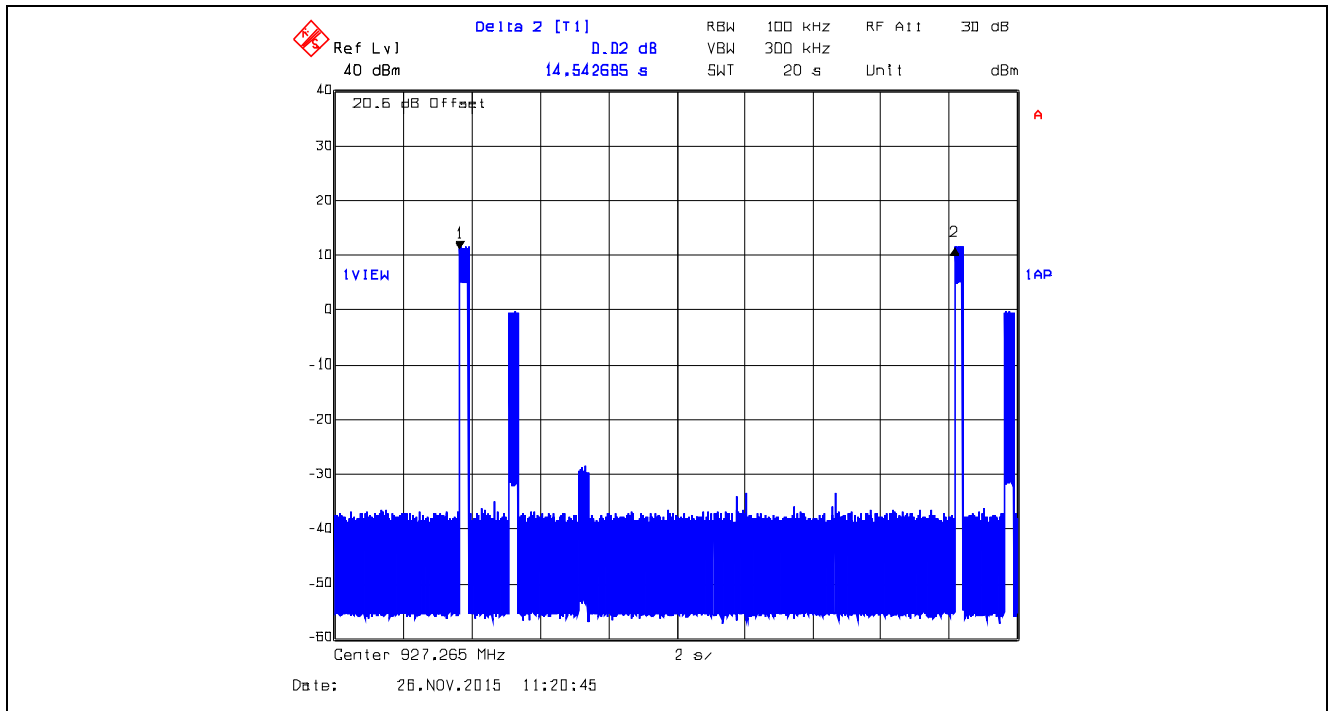

**Plot 5.3.4.84.** Time of Occupancy, 915.75 MHz, XTCA1, Data Rate at 105 kbps  
 Dwell Time @ 915.75 MHz = 27.4549 ms

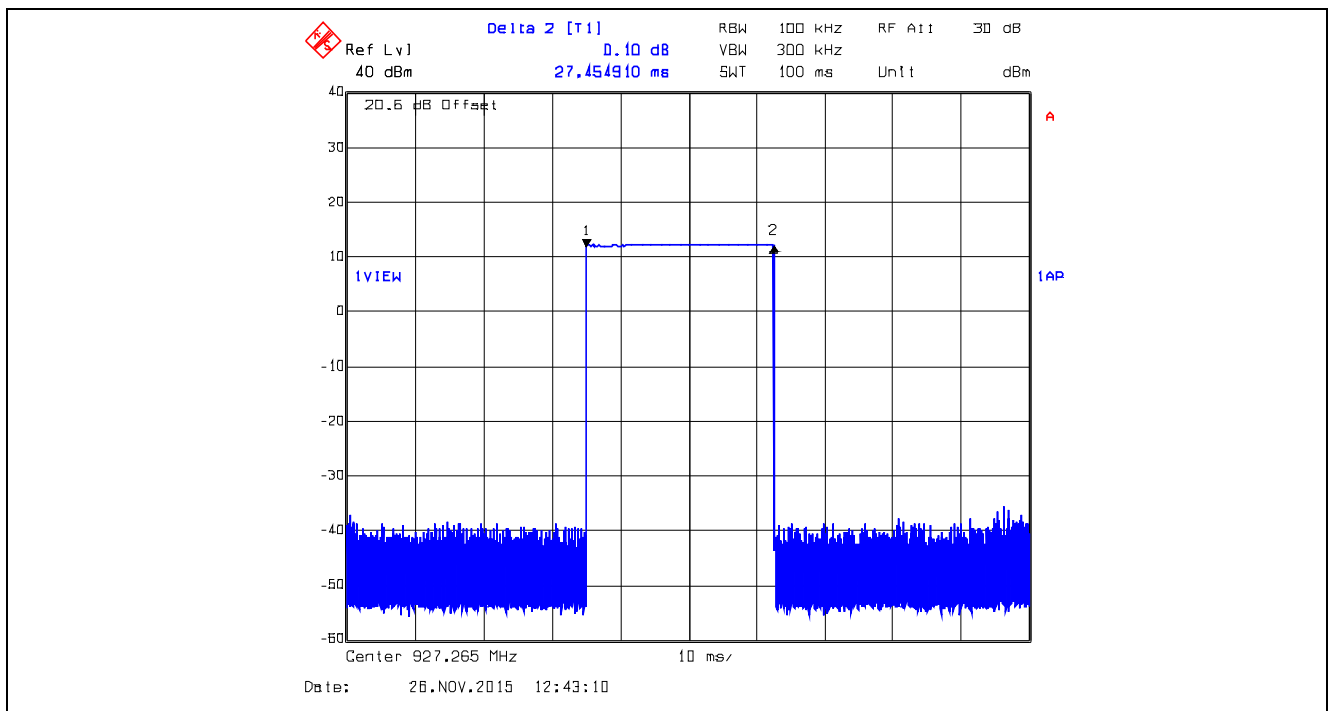

**Plot 5.3.4.85.** Time of Occupancy, 915.75 MHz XTCA1, Data Rate at 105 kbps  
Average time of occupancy = (Dwell Time) x (number of hops) = 27.4519 ms x 14 = 384.3266 ms < 0.4 sec within 20 sec

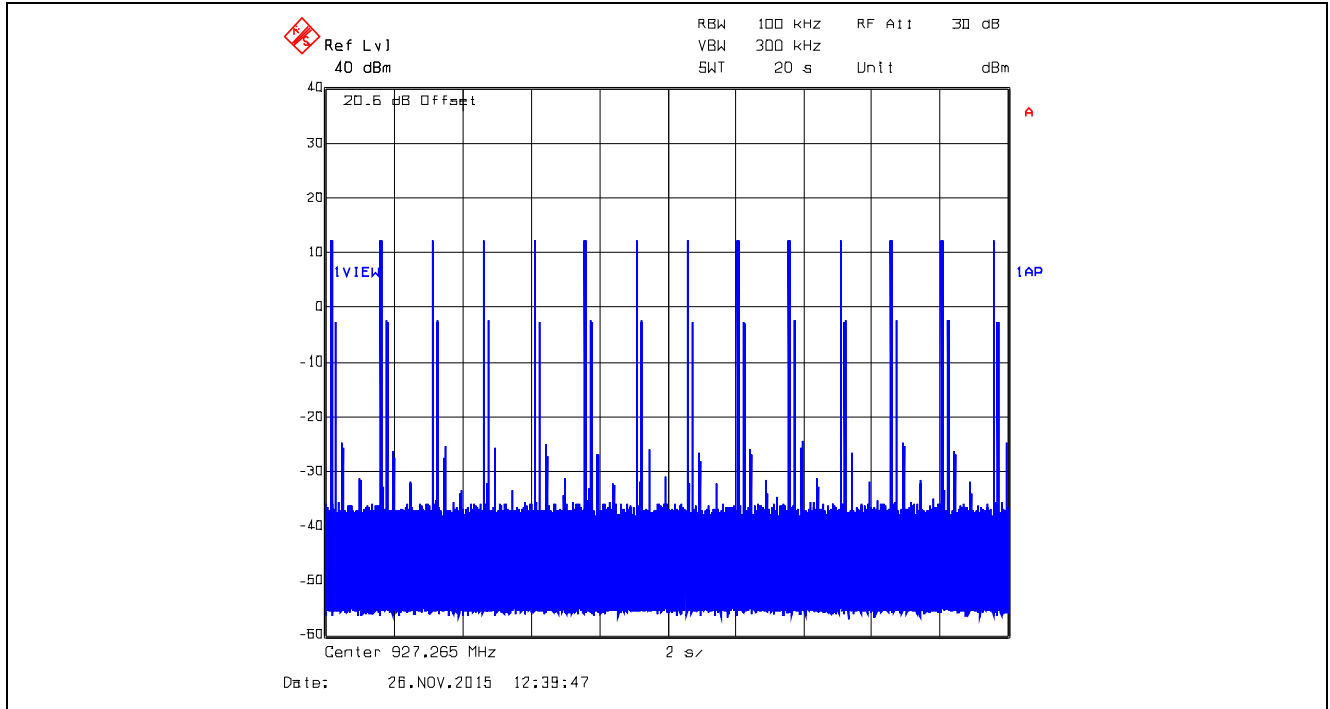

**Plot 5.3.4.86.** Time of Occupancy, 921.625 MHz, XTCA1, Data Rate at 105 kbps  
Dwell Time @ 921.625 MHz = 27.4549 ms

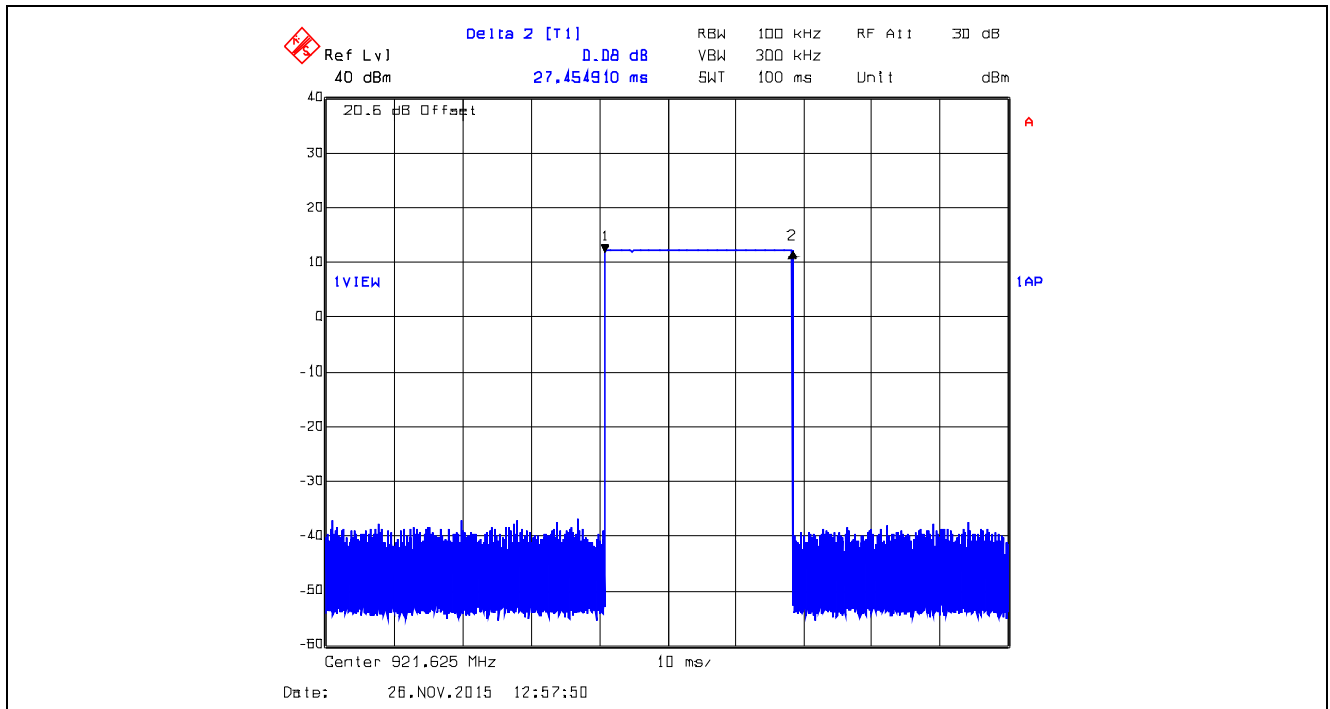

**Plot 5.3.4.87.** Time of Occupancy, 921.625 MHz XTCA1, Data Rate at 105 kbps  
 Average time of occupancy = (Dwell Time) x (number of hops) = 27.4549 ms x 14 = 384.3266 ms < 0.4 sec within 20 sec

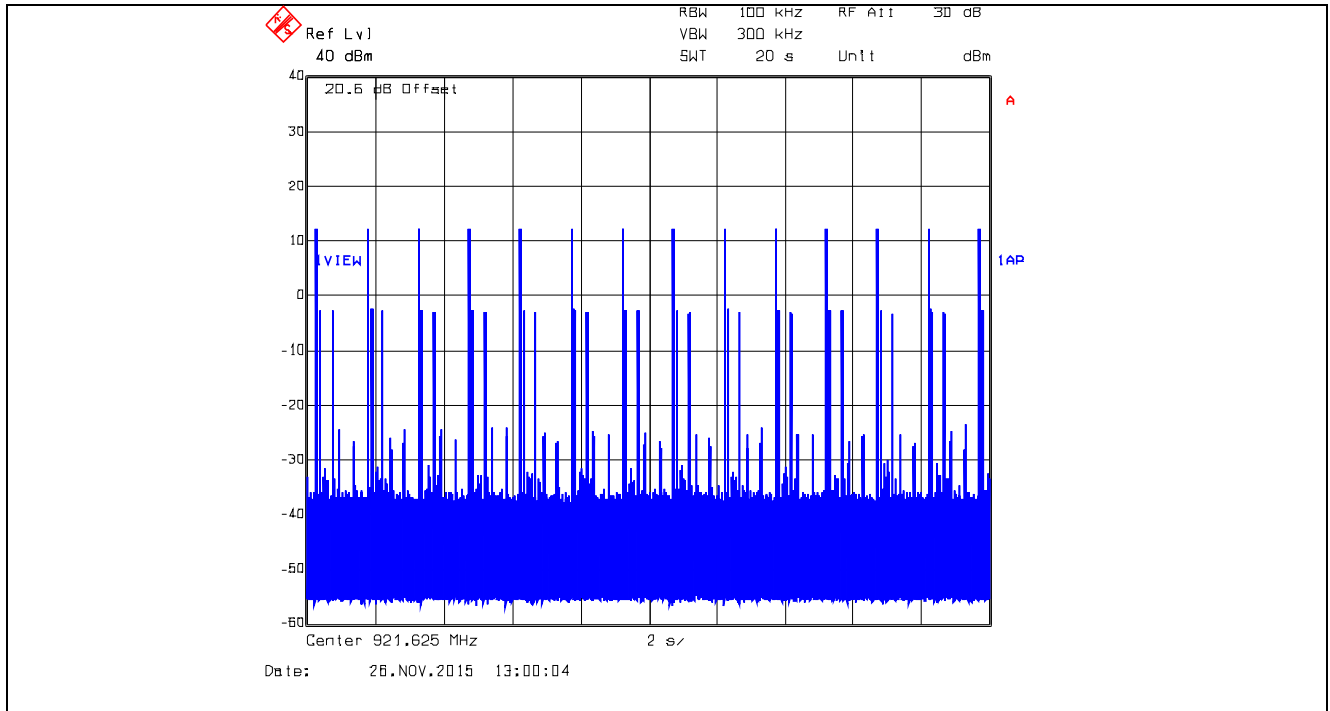

**Plot 5.3.4.88.** Time of Occupancy, 927.265 MHz, XTCA1, Data Rate at 105 kbps  
 Dwell Time @ 927.5 MHz = 27.6553 ms

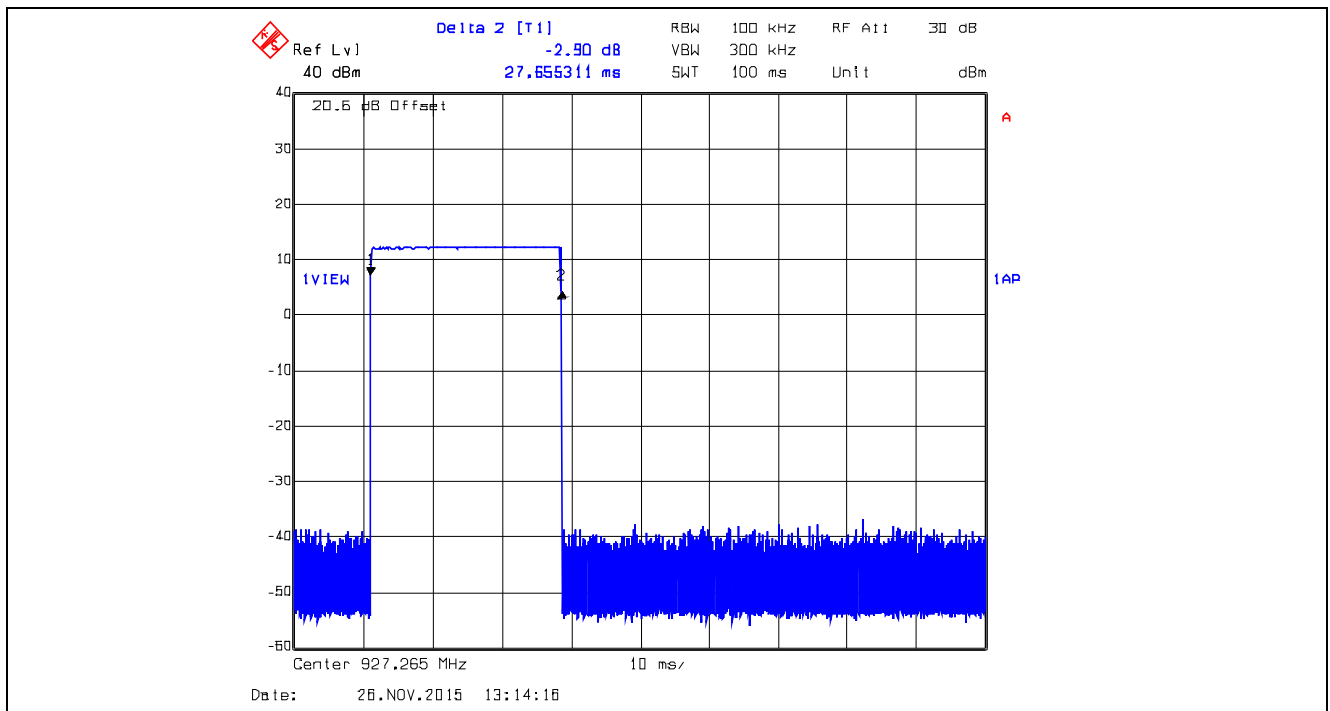

**Plot 5.3.4.89.** Time of Occupancy, 927.265 MHz, XTCA1, Data Rate at 105 kbps

Average time of occupancy = (Dwell Time) x (number of hops) = 27.6553 ms x 14 = 387.1742 ms < 0.4 sec within 20 sec

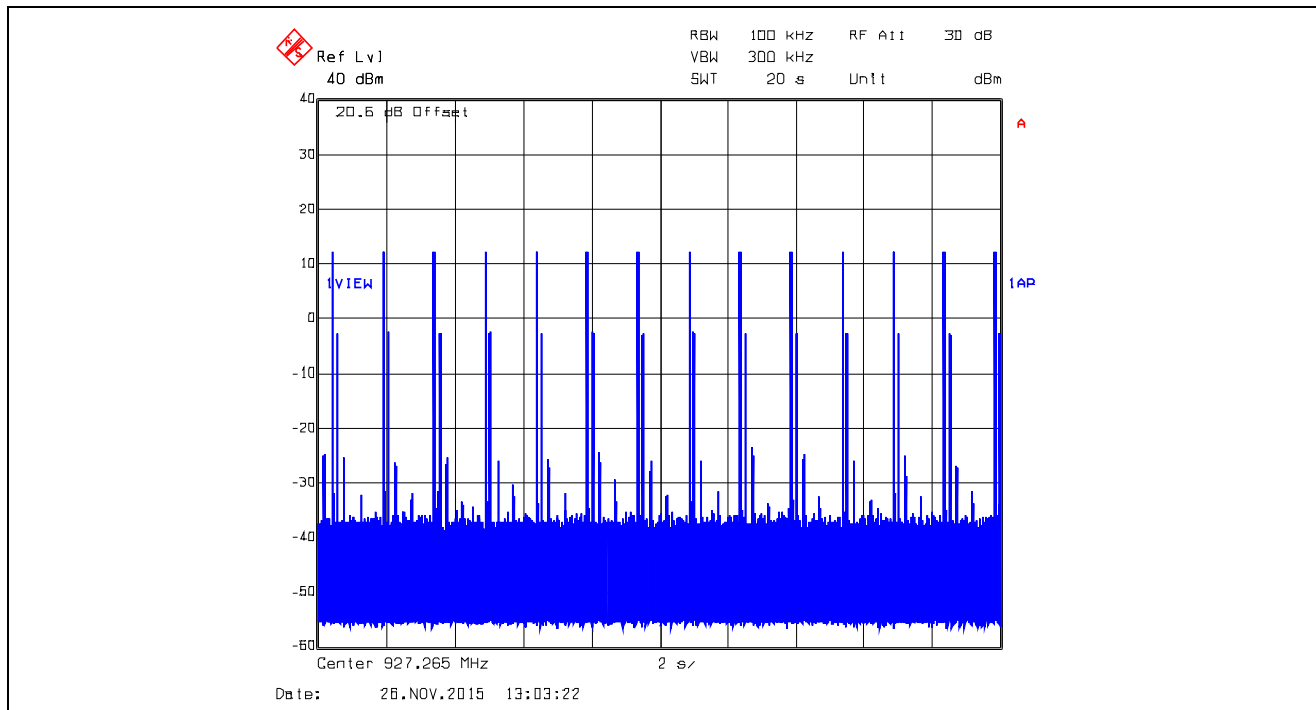

## 5.4. PEAK CONDUCTED OUTPUT POWER [§ 15.247(b)(2)]

### 5.4.1. Limits

**§15.247(b)(2):** For frequency hopping systems operating in the 902-928 MHz band: 1 watt for systems employing at least 50 hopping channels; and, 0.25 watts for systems employing less than 50 hopping channels, but at least 25 hopping channels, as permitted under paragraph (a)(1)(i) of this section.

**§15.247(b)(4):** The conducted output power limit specified in paragraph (b) of this section is based on the use of antennas with directional gains that do not exceed 6 dBi. Except as shown in paragraph (c) of this section, if transmitting antennas of directional gain greater than 6 dBi are used, the conducted output power from the intentional radiator shall be reduced below the stated values in paragraphs (b)(1), (b)(2), and (b)(3) of this section, as appropriate, by the amount in dB that the directional gain of the antenna exceeds 6 dBi.

### 5.4.2. Method of Measurements

FCC Public Notice DA 00-705 and ANSI C63.10.

### 5.4.3. Test Arrangement

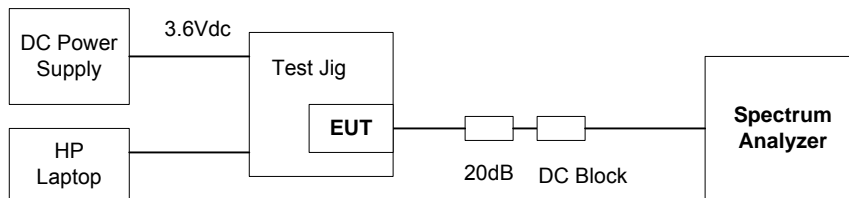

**5.4.4. Test Data**

Remarks:

1. All configuration & data rates employ minimum 50 hopping frequencies, so conducted output power limit is 1W
2. The EIRP shall be calculated based on the transmitter antenna gain ( $G_{dBi}$ ), cable loss ( $CL_{dB}$ ) and peak output power at antenna terminal ( $P_{dBm}$ ). Calculated EIRP =  $P_{dBm} + G_{dBi} - CL_{dB}$ . EIRP shall not exceed 36 dBm for the below conducted output power.

**(a) Peak Conducted Output High Power**

Configuration	Modulation	Data Rate (kbps)	Frequency (MHz)	Peak Output Power at Antenna Terminal (dBm)	Peak Conducted Output Power Limit (dBm)
XTC0	FSK	10	905.0	13.10	30
			916.6	13.10	30
			925.0	13.10	30
XTC1	GFSK	125	905.0	13.10	30
			916.6	13.10	30
			925.0	13.10	30
XTCA0	FSK	10	915.75	12.97	30
			921.625	12.97	30
			927.265	12.97	30
XTCA1	GFSK	105	915.75	12.97	30
			921.625	12.97	30
			927.265	12.97	30
XBX0	GFSK	10	902.5	13.36	30
			915.0	13.49	30
			927.5	13.49	30
XBX1	GFSK	110	902.5	13.36	30
			915.0	13.36	30
			927.5	13.49	30
XBX2	GFSK	250	902.75	13.36	30
			915.25	13.36	30
			927.25	13.49	30



**(b) Peak Conducted Output Low Power**

Configuration	Modulation	Data Rate (kbps)	Frequency (MHz)	Peak Output Power at Antenna Terminal (dBm)	Peak Conducted Output Power Limit (dBm)
XTC0	FSK	10	905.0	-0.10	30
			916.6	-0.21	30
			925.0	-0.33	30
XTC1	GFSK	125	905.0	-0.10	30
			916.6	-0.21	30
			925.0	-0.33	30
XTCA0	FSK	10	915.75	0.28	30
			921.625	0.28	30
			927.265	0.15	30
XTCA1	GFSK	105	915.75	0.28	30
			921.625	0.28	30
			927.265	0.15	30
XBX0	GFSK	10	902.5	0.42	30
			915.0	0.15	30
			927.5	0.02	30
XBX1	GFSK	110	902.5	0.42	30
			915.0	0.15	30
			927.5	-0.10	30
XBX2	GFSK	250	902.75	0.42	30
			915.25	0.15	30
			927.25	0.02	30

**1. EIRP for 2.1dBi Dipole Antenna with 0.36dB Assembly Cable Loss**

Configuration	Modulation	Data Rate (kbps)	Frequency (MHz)	Peak O/p Power at Antenna Terminal (dBm)	Calculated EIRP* (dBm)	EIRP Limit (dBm)
XTC0	FSK	10	905.0	13.10	14.84	36
			916.6	13.10	14.84	36
			925.0	13.10	14.84	36
XTC1	GFSK	125	905.0	13.10	14.84	36
			916.6	13.10	14.84	36
			925.0	13.10	14.84	36
XTCA0	FSK	10	915.75	12.97	14.71	36
			921.625	12.97	14.71	36
			927.265	12.97	14.71	36
XTCA1	GFSK	105	915.75	12.97	14.71	36
			921.625	12.97	14.71	36
			927.265	12.97	14.71	36
XBX0	GFSK	10	902.5	13.36	15.10	36
			915.0	13.49	15.23	36
			927.5	13.49	15.23	36
XBX1	GFSK	110	902.5	13.36	15.10	36
			915.0	13.36	15.10	36
			927.5	13.49	15.23	36
XBX2	GFSK	250	902.75	13.36	15.10	36
			915.25	13.36	15.10	36
			927.25	13.49	15.23	36

\* EIRP = P<sub>dBm</sub> + G<sub>dBi</sub> - CL<sub>dB</sub>

**2. EIRP for 3.0dBi Dome Antenna with 0.44dB Assembly Cable Loss**

Configuration	Modulation	Data Rate (kbps)	Frequency (MHz)	Peak O/p Power at Antenna Terminal (dBm)	Calculated EIRP* (dBm)	EIRP Limit (dBm)
XTC0	FSK	10	905.0	13.10	15.66	36
			916.6	13.10	15.66	36
			925.0	13.10	15.66	36
XTC1	GFSK	125	905.0	13.10	15.66	36
			916.6	13.10	15.66	36
			925.0	13.10	15.66	36
XTCA0	FSK	10	915.75	12.97	15.53	36
			921.625	12.97	15.53	36
			927.265	12.97	15.53	36
XTCA1	GFSK	105	915.75	12.97	15.53	36
			921.625	12.97	15.53	36
			927.265	12.97	15.53	36
XBX0	GFSK	10	902.5	13.36	15.92	36
			915.0	13.49	16.05	36
			927.5	13.49	16.05	36
XBX1	GFSK	110	902.5	13.36	15.92	36
			915.0	13.36	15.92	36
			927.5	13.49	16.05	36
XBX2	GFSK	250	902.75	13.36	15.92	36
			915.25	13.36	15.92	36
			927.25	13.49	16.05	36

\* EIRP = P<sub>dBm</sub> + G<sub>dBi</sub> - CL<sub>dB</sub>

**3. EIRP for 3.3dBi Monopole Antenna with 0.44dB Assembly Cable Loss**

Configuration	Modulation	Data Rate (kbps)	Frequency (MHz)	Peak O/p Power at Antenna Terminal (dBm)	Calculated EIRP* (dBm)	EIRP Limit (dBm)
XTC0	FSK	10	905.0	13.10	15.96	36
			916.6	13.10	15.96	36
			925.0	13.10	15.96	36
XTC1	GFSK	125	905.0	13.10	15.96	36
			916.6	13.10	15.96	36
			925.0	13.10	15.96	36
XTCA0	FSK	10	915.75	12.97	15.83	36
			921.625	12.97	15.83	36
			927.265	12.97	15.83	36
XTCA1	GFSK	105	915.75	12.97	15.83	36
			921.625	12.97	15.83	36
			927.265	12.97	15.83	36
XBX0	GFSK	10	902.5	13.36	16.22	36
			915.0	13.49	16.35	36
			927.5	13.49	16.35	36
XBX1	GFSK	110	902.5	13.36	16.22	36
			915.0	13.36	16.22	36
			927.5	13.49	16.35	36
XBX2	GFSK	250	902.75	13.36	16.22	36
			915.25	13.36	16.22	36
			927.25	13.49	16.35	36

\* EIRP = P<sub>dBm</sub> + G<sub>dBi</sub> - CL<sub>dB</sub>

**4. EIRP for 8.1dBi Omni-directional Antenna with 0.65dB Assembly Cable Loss**

Configuration	Modulation	Data Rate (kbps)	Frequency (MHz)	Peak O/p Power at Antenna Terminal (dBm)	Calculated EIRP* (dBm)	EIRP Limit (dBm)
XTC0	FSK	10	905.0	13.10	20.55	36
			916.6	13.10	20.55	36
			925.0	13.10	20.55	36
XTC1	GFSK	125	905.0	13.10	20.55	36
			916.6	13.10	20.55	36
			925.0	13.10	20.55	36
XTCA0	FSK	10	915.75	12.97	20.42	36
			921.625	12.97	20.42	36
			927.265	12.97	20.42	36
XTCA1	GFSK	105	915.75	12.97	20.42	36
			921.625	12.97	20.42	36
			927.265	12.97	20.42	36
XBX0	GFSK	10	902.5	13.36	20.81	36
			915.0	13.49	20.94	36
			927.5	13.49	20.94	36
XBX1	GFSK	110	902.5	13.36	20.81	36
			915.0	13.36	20.81	36
			927.5	13.49	20.94	36
XBX2	GFSK	250	902.75	13.36	20.81	36
			915.25	13.36	20.81	36
			927.25	13.49	20.94	36

\* EIRP = P<sub>dBm</sub> + G<sub>dBi</sub> - CL<sub>dB</sub>

**5. EIRP for 15.1dBi Yagi Antenna with 0.65dB Assembly Cable Loss**

Configuration	Modulation	Data Rate (kbps)	Frequency (MHz)	Peak O/p Power at Antenna Terminal (dBm)	Calculated EIRP* (dBm)	EIRP Limit (dBm)
XTC0	FSK	10	905.0	13.10	27.55	36
			916.6	13.10	27.55	36
			925.0	13.10	27.55	36
XTC1	GFSK	125	905.0	13.10	27.55	36
			916.6	13.10	27.55	36
			925.0	13.10	27.55	36
XTCA0	FSK	10	915.75	12.97	27.42	36
			921.625	12.97	27.42	36
			927.265	12.97	27.42	36
XTCA1	GFSK	105	915.75	12.97	27.42	36
			921.625	12.97	27.42	36
			927.265	12.97	27.42	36
XBX0	GFSK	10	902.5	13.36	27.81	36
			915.0	13.49	27.94	36
			927.5	13.49	27.94	36
XBX1	GFSK	110	902.5	13.36	27.81	36
			915.0	13.36	27.81	36
			927.5	13.49	27.94	36
XBX2	GFSK	250	902.75	13.36	27.81	36
			915.25	13.36	27.81	36
			927.25	13.49	27.94	36

\* EIRP = P<sub>dBm</sub> + G<sub>dBi</sub> - CL<sub>dB</sub>

**5.5. TRANSMITTER SPURIOUS RADIATED EMISSIONS AT 3 METERS [§§ 15.247(d), 15.209 & 15.205]**

**5.5.1. Limit**

**§ 15.247 (d):** In any 100 kHz bandwidth outside the frequency band in which the spread spectrum or digitally modulated intentional radiator is operating, the radio frequency power that is produced by the intentional radiator shall be at least 20 dB below that in the 100 kHz bandwidth within the band that contains the highest level of the desired power, based on either an RF conducted or a radiated measurement, provided the transmitter demonstrates compliance with the peak conducted power limits. If the transmitter complies with the conducted power limits based on the use of RMS averaging over a time interval, as permitted under paragraph (b)(3) of this section, the attenuation required under this paragraph shall be 30 dB instead of 20 dB. Attenuation below the general limits specified in § 15.209(a) is not required. In addition, radiated emissions which fall in the restricted bands, as defined in § 15.205(a), must also comply with the radiated emission limits specified in § 15.209(a) (see § 15.205(c)).

**Section 15.205(a) - Restricted Bands of Operation**

MHz	MHz	MHz	GHz
0.090–0.110 .....	16.42–16.423	399.9–410	4.5–5.15
<sup>1</sup> 0.495–0.505 .....	16.69475–16.69525	608–614	5.35–5.46
2.1735–2.1905 .....	16.80425–16.80475	960–1240	7.25–7.75
4.125–4.128 .....	25.5–25.67	1300–1427	8.025–8.5
4.17725–4.17775 .....	37.5–38.25	1435–1626.5	9.0–9.2
4.20725–4.20775 .....	73–74.6	1645.5–1646.5	9.3–9.5
6.215–6.218 .....	74.8–75.2	1660–1710	10.6–12.7
6.26775–6.26825 .....	108–121.94	1718.8–1722.2	13.25–13.4
6.31175–6.31225 .....	123–138	2200–2300	14.47–14.5
8.291–8.294 .....	149.9–150.05	2310–2390	15.35–16.2
8.362–8.366 .....	156.52475–156.52525	2483.5–2500	17.7–21.4
8.37625–8.38675 .....	156.7–156.9	2655–2900	22.01–23.12
8.41425–8.41475 .....	162.0125–167.17	3260–3267	23.6–24.0
12.29–12.293 .....	167.72–173.2	3332–3339	31.2–31.8
12.51975–12.52025 .....	240–285	3345.8–3358	36.43–36.5
12.57675–12.57725 .....	322–335.4	3600–4400	( <sup>2</sup> )
13.36–13.41.			

<sup>1</sup> Until February 1, 1999, this restricted band shall be 0.490–0.510 MHz.

<sup>2</sup> Above 38.6

**Section 15.209(a) - Field Strength Limits within Restricted Frequency Bands**

Frequency (MHz)	Field Strength (microvolts/meter)	Measurement Distance (meters)
0.009 - 0.490	2,400 / F (kHz)	300
0.490 - 1.705	24,000 / F (kHz)	30
1.705 - 30.0	30	30
30 – 88	100	3
88 – 216	150	3
216 – 960	200	3
Above 960	500	3

### 5.5.2. Method of Measurements

FCC Public Notice DA 00-705, ANSI C63.10 and ANSI 63.4 procedures.

### 5.5.3. Test Arrangement

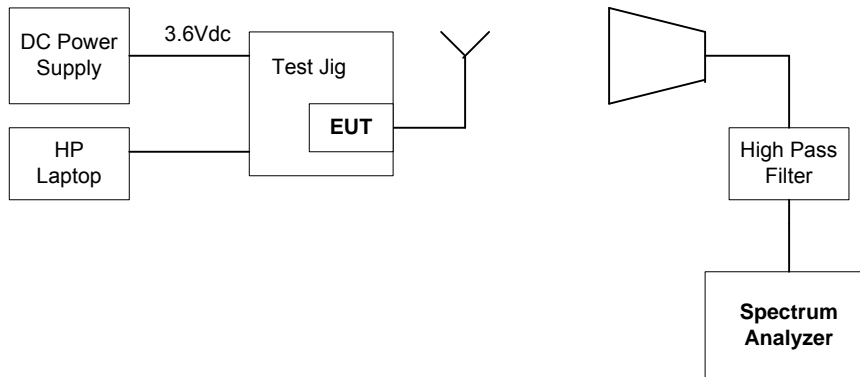

### 5.5.4. Test Data

#### Remark(s):

- All spurious emissions that are in excess of 20 dB below the specified limit shall be recorded.
- EUT shall be tested in three orthogonal positions.
- All 7 data rates XTC0 (10kbps), XTC1 (125kbps), XTCA0 (10kbps), XTCA1 (105kbps), XBX0 (10kbps), XBX1 (110kbps), XBX2 (250kbps) were pre-scan at middle channel to find out XBX0 has the highest field strength and spurious emission level.
- Since XBX0 mode covers the entire frequency band from 902-928 MHz, testing frequencies selected are 902.5, 915.0 and 927.5 MHz to represent all bands worst-case of measurement.
- The following test results are the final worst-case measurements derived from above exploratory tests, performed with EUT.



**5.5.4.1. EUT with 2.1 dBi Dipole Antenna and 0.36 dB Assembly Cable Loss**

**5.5.4.1.1. Spurious Radiated Emissions**

Fundamental Frequency:		902.5 MHz					
Configuration:		XBX0					
Measured Conducted Power:		13.36 dBm					
Frequency Test Range:		30 MHz – 10 GHz					
Frequency (MHz)	RF Peak Level (dBµV/m)	RF Avg Level (dBµV/m)	Antenna Plane (H/V)	Limit 15.209 (dBµV/m)	Limit 15.247 (dBµV/m)	Margin (dB)	Pass/Fail
902.50	113.11	--	V	--	--	--	--
902.50	111.83	--	H	--	--	--	--
2707.50	45.50	35.00	V	54.0	93.1	-19.0	Pass*
2707.50	44.00	30.30	H	54.0	93.1	-23.7	Pass*
3610.00	47.60	34.30	V	54.0	93.1	-19.7	Pass*
3610.00	48.10	34.50	H	54.0	93.1	-19.5	Pass*
4512.50	50.50	40.50	V	54.0	93.1	-13.5	Pass*
4512.50	50.50	42.80	H	54.0	93.1	-11.2	Pass*
5415.00	51.90	40.40	V	54.0	93.1	-13.6	Pass*
5415.00	51.30	40.60	H	54.0	93.1	-13.4	Pass*
All other spurious emissions and harmonics are more than 20 dB below the applicable limit.							

\*Field strength of emissions appearing within restricted frequency bands shall not exceed the limits in § 15.209.

Fundamental Frequency:		915.0 MHz					
Configuration:		XBX0					
Measured Conducted Power:		13.49 dBm					
Frequency Test Range:		30 MHz – 10 GHz					
Frequency (MHz)	RF Peak Level (dBµV/m)	RF Avg Level (dBµV/m)	Antenna Plane (H/V)	Limit 15.209 (dBµV/m)	Limit 15.247 (dBµV/m)	Margin (dB)	Pass/Fail
915.0	111.69	--	V	--	--	--	--
915.0	111.05	--	H	--	--	--	--
2745.0	43.50	32.50	V	54.0	91.7	-21.5	Pass*
2745.0	43.20	29.60	H	54.0	91.7	-24.4	Pass*
3660.0	47.40	35.00	V	54.0	91.7	-19.0	Pass*
3660.0	47.80	34.10	H	54.0	91.7	-19.9	Pass*
4575.0	50.30	40.70	V	54.0	91.7	-13.3	Pass*
4575.0	51.20	44.30	H	54.0	91.7	-9.7	Pass*
All other spurious emissions and harmonics are more than 20 dB below the applicable limit.							

\*Field strength of emissions appearing within restricted frequency bands shall not exceed the limits in § 15.209.

**ULTRATECH GROUP OF LABS**

3000 Bristol Circle, Oakville, Ontario, Canada L6H 6G4  
 Tel. #: 905-829-1570, Fax. #: 905-829-8050, Email: [vic@ultratech-labs.com](mailto:vic@ultratech-labs.com), Website: <http://www.ultratech-labs.com>

File #: 15DIG102\_FCC15C247  
 December 24, 2015

All test results contained in this engineering test report are traceable to National Institute of Standards and Technology (NIST)

Fundamental Frequency:		927.5 MHz					
Configuration:		XBX0					
Measured Conducted Power:		13.49 dBm					
Frequency Test Range:		30 MHz – 10 GHz					
Frequency (MHz)	RF Peak Level (dBµV/m)	RF Avg Level (dBµV/m)	Antenna Plane (H/V)	Limit 15.209 (dBµV/m)	Limit 15.247 (dBµV/m)	Margin (dB)	Pass/Fail
927.5	110.39	--	V	--	--	--	--
927.5	110.19	--	H	--	--	--	--
2782.5	43.80	30.80	V	54.0	90.4	-23.2	Pass*
2782.5	43.70	29.60	H	54.0	90.4	-24.4	Pass*
3710.0	48.80	36.60	V	54.0	90.4	-17.4	Pass*
3710.0	48.10	35.10	H	54.0	90.4	-18.9	Pass*
4637.5	51.90	44.70	V	54.0	90.4	-9.3	Pass*
4637.5	53.40	48.30	H	54.0	90.4	-5.7	Pass*
All other spurious emissions and harmonics are more than 20 dB below the applicable limit.							

**5.5.4.1.2. Band-Edge RF Radiated Emissions**

Refer to the following plots.

**Plot 5.5.4.1.2.1.** Band-Edge RF Radiated Emissions at 3 m, Horizontal Polarization  
 Single Frequency Mode, Low End of Frequency Band, 902.5 MHz, XBX0, Data Rate at 10 kbps

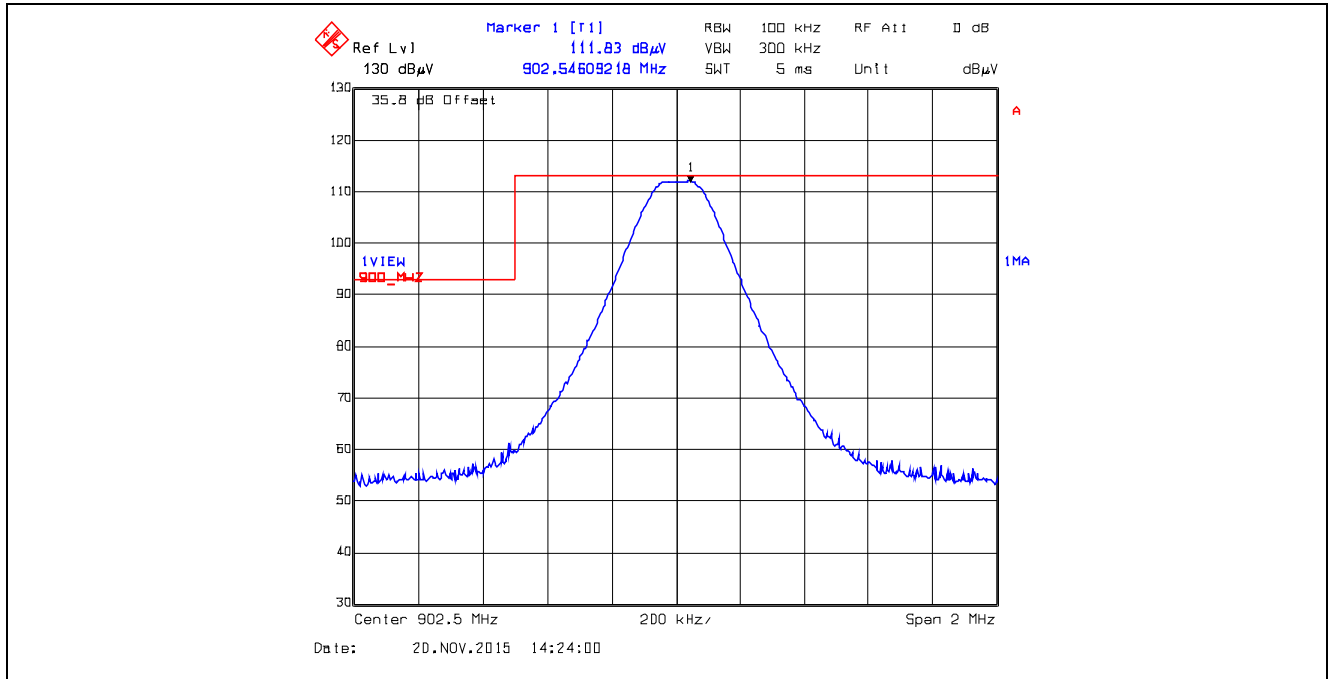

**Plot 5.5.4.1.2.2.** Band-Edge RF Radiated Emissions at 3 m, Horizontal Polarization  
 Pseudorandom Hopping Mode, Low End of Frequency Band, 902.5 MHz, XBX0, Data Rate at 10 kbps

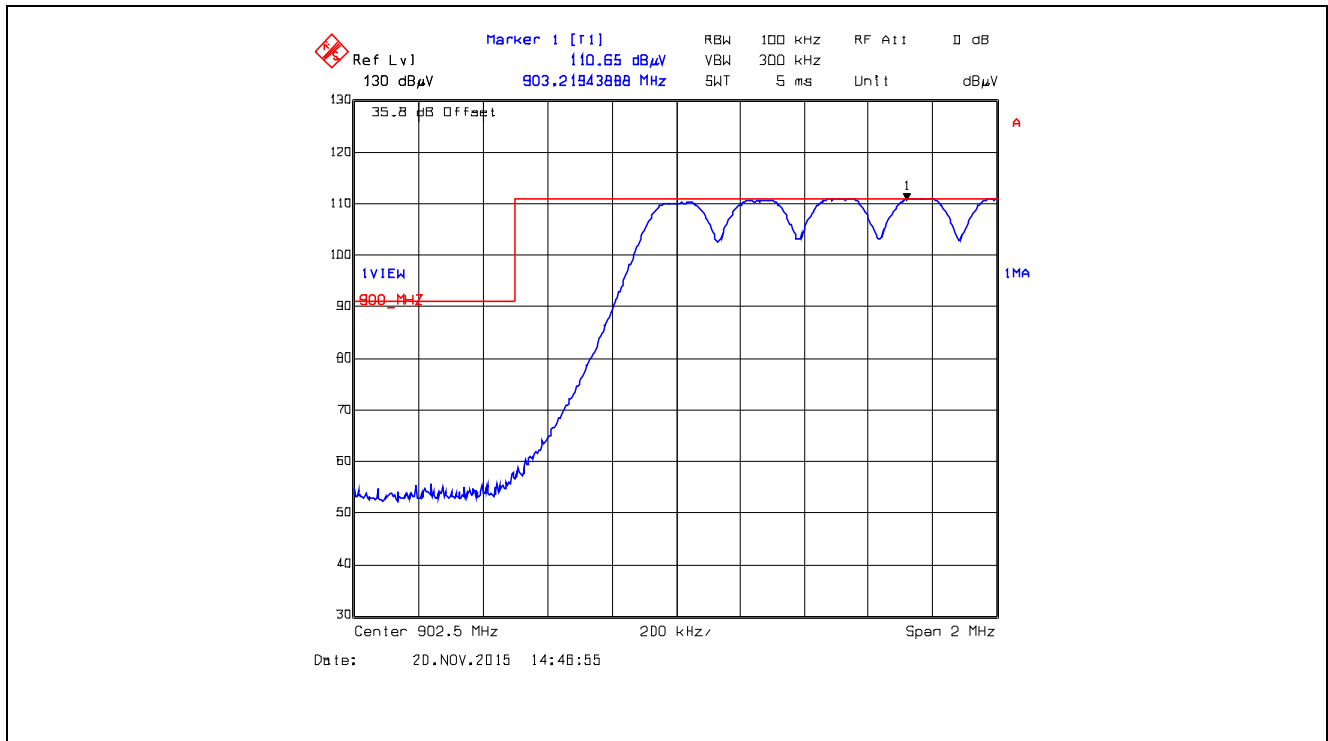

**Plot 5.5.4.1.2.3.** Band-Edge RF Radiated Emissions at 3 m, Vertical Polarization  
Single Frequency Mode, Low End of Frequency Band, 902.5 MHz, XBX0, Data Rate at 10 kbps

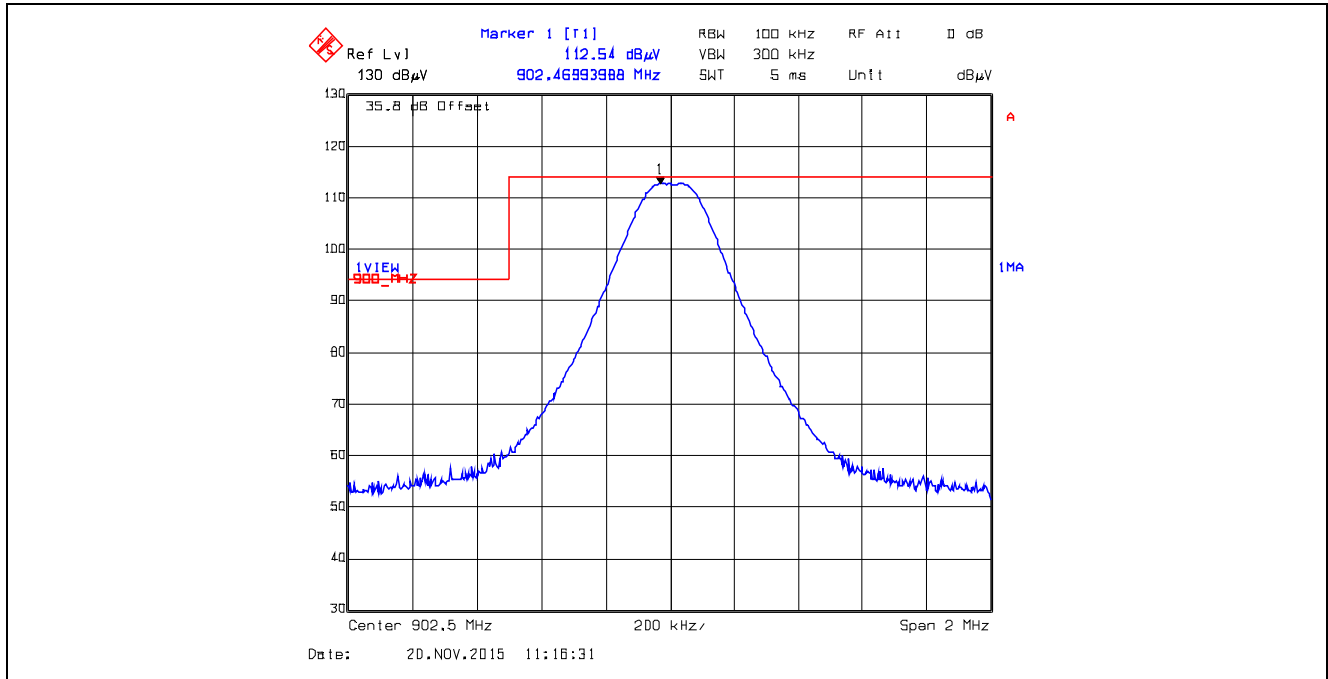

**Plot 5.5.4.1.2.4.** Band-Edge RF Radiated Emissions at 3 m, Vertical Polarization  
Pseudorandom Hopping Mode, Low End of Frequency Band, 902.5 MHz, XBX0, Data Rate at 10 kbps

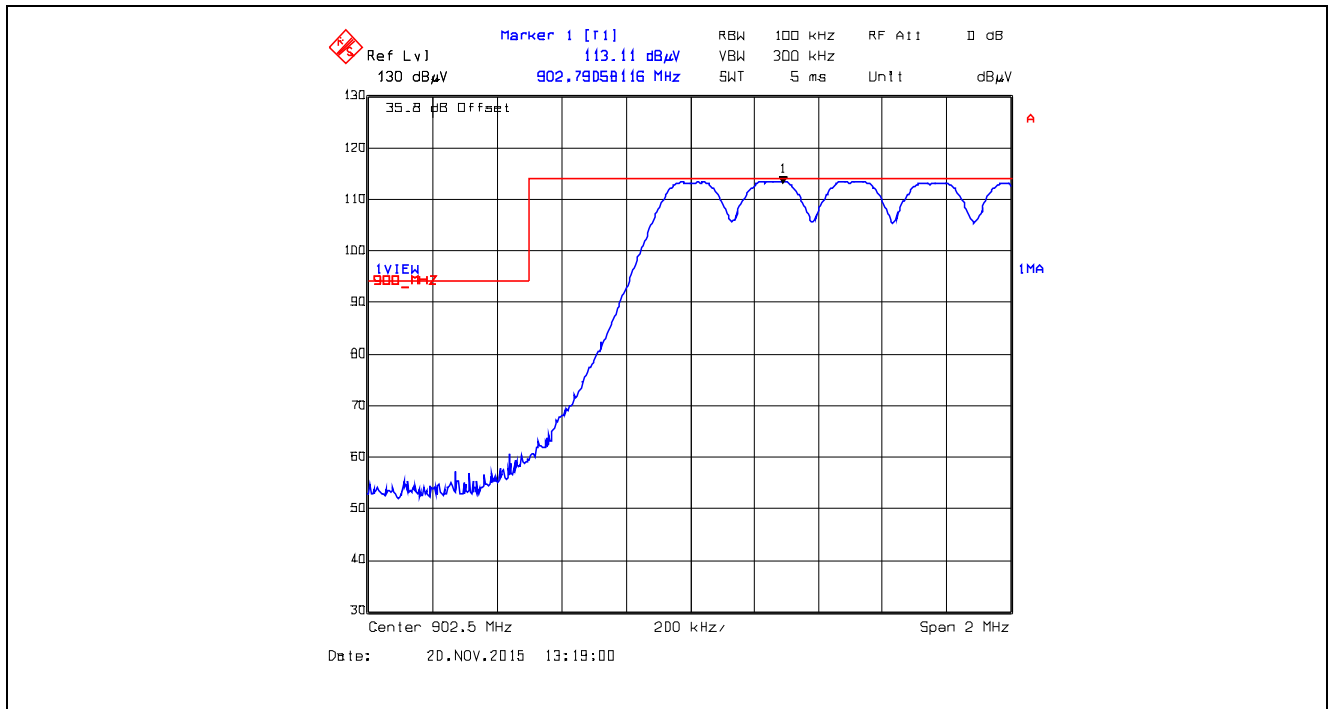

**Plot 5.5.4.1.2.5.** Band-Edge RF Radiated Emissions at 3 m, Horizontal Polarization  
 Single Frequency Mode, High End of Frequency Band, 927.5 MHz, XBX0, Data Rate at 10 kbps

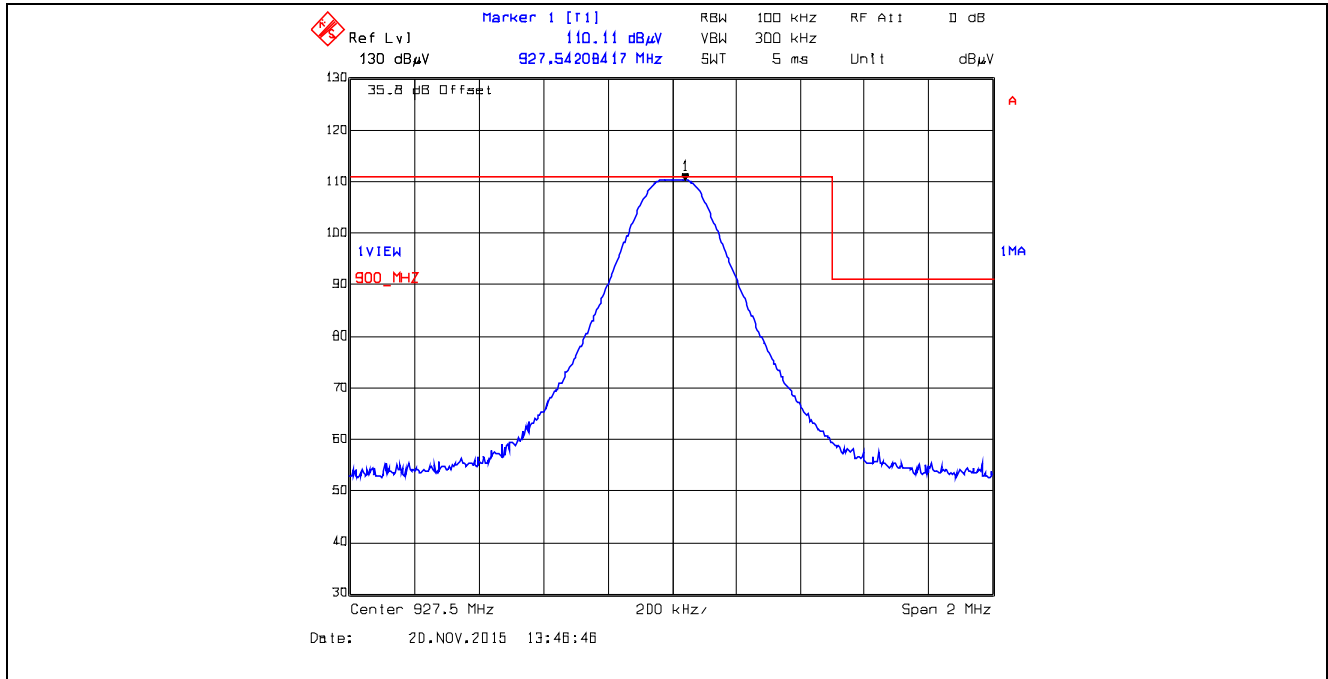

**Plot 5.5.4.1.2.6.** Band-Edge RF Radiated Emissions at 3 m, Horizontal Polarization  
 Pseudorandom Hopping Mode, High End of Frequency Band, 927.5 MHz, XBX0, Data Rate at 10 kbps

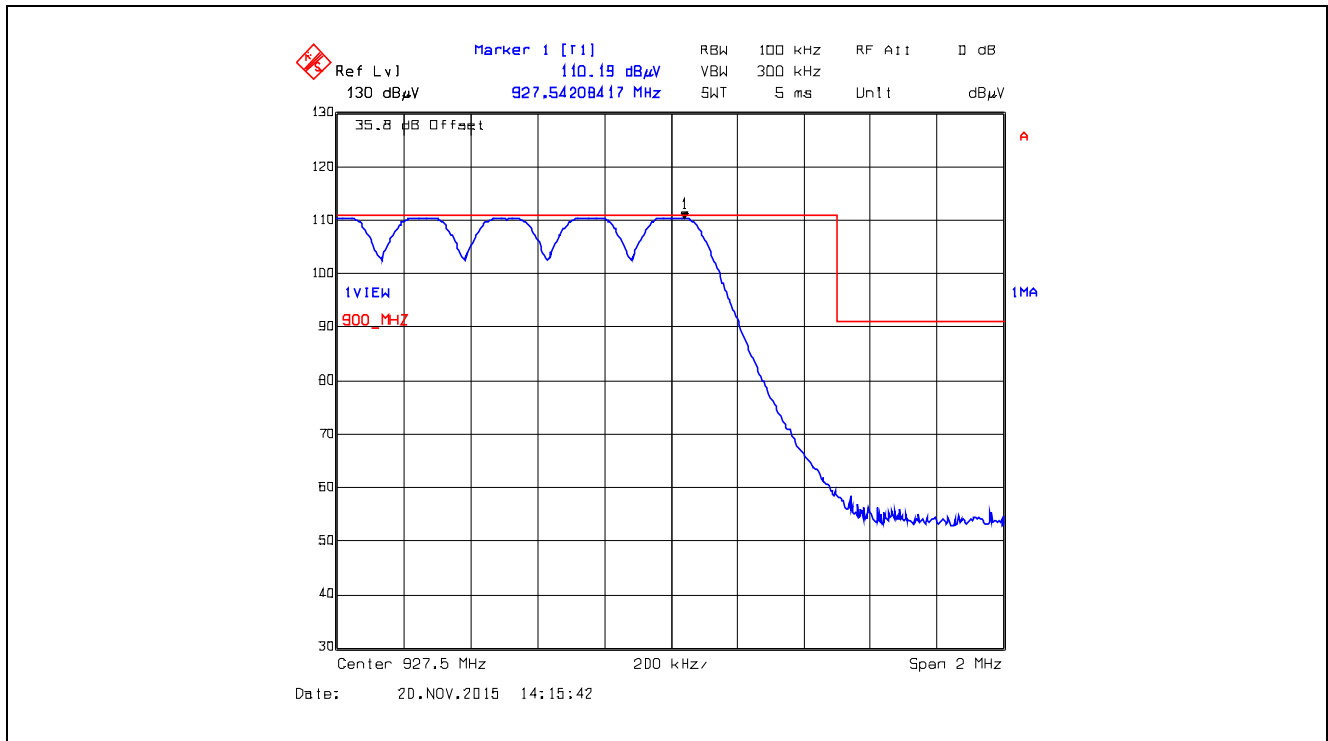

**Plot 5.5.4.1.2.7.** Band-Edge RF Radiated Emissions at 3 m, Vertical Polarization  
 Single Frequency Mode, High End of Frequency Band, 927.5 MHz, XBX0, Data Rate at 10 kbps

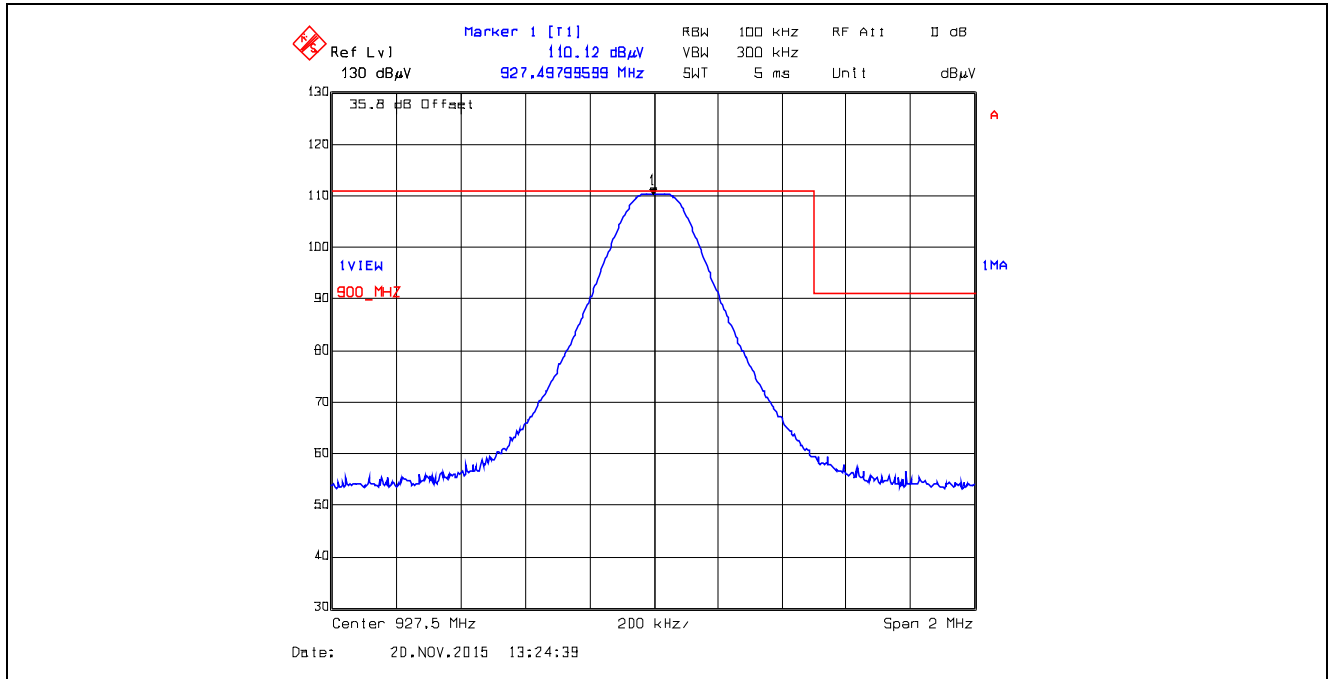

**Plot 5.5.4.1.2.8.** Band-Edge RF Radiated Emissions at 3 m, Vertical Polarization  
 Pseudorandom Hopping Mode, High End of Frequency Band, 927.5 MHz, XBX0, Data Rate at 10 kbps

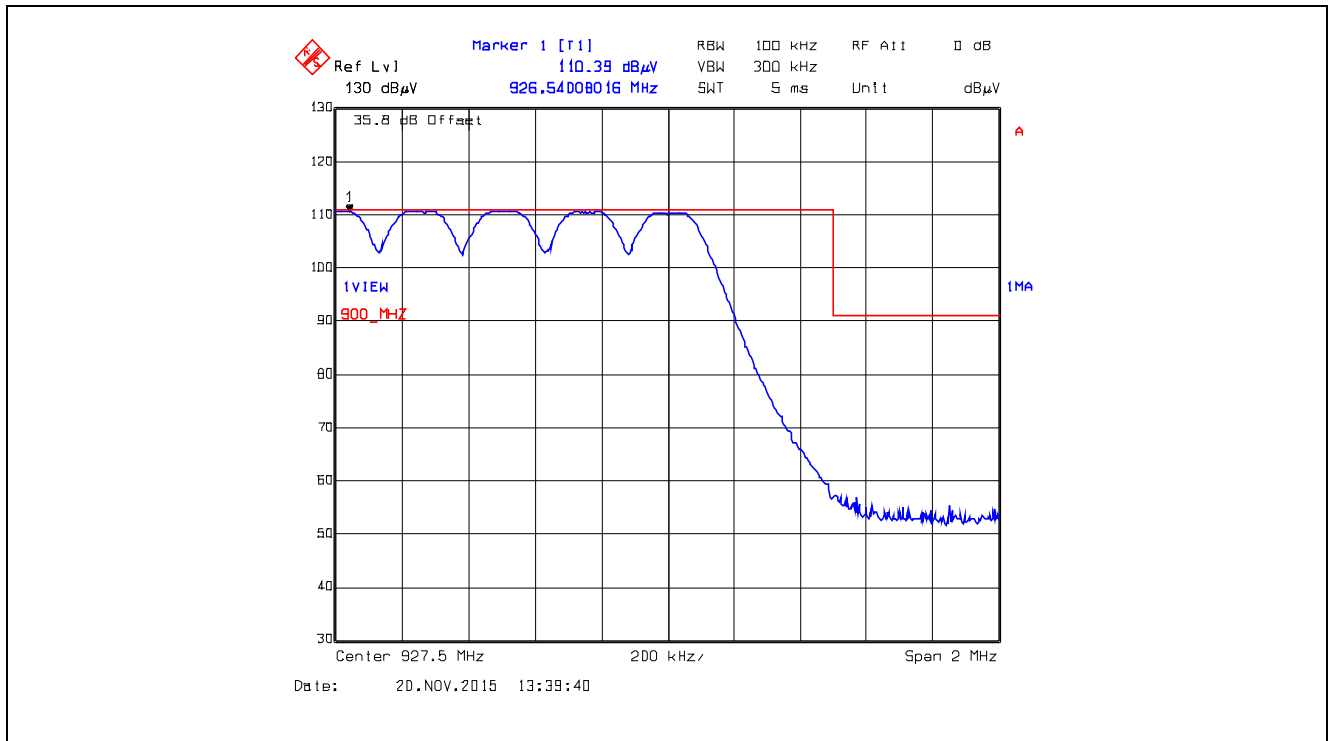

**Plot 5.5.4.1.2.9.** Band-Edge RF Radiated Emissions at 3 m, Horizontal Polarization  
 Single Frequency Mode, Low End of Frequency Band, 902.5 MHz, XBX1, Data Rate at 110 kbps

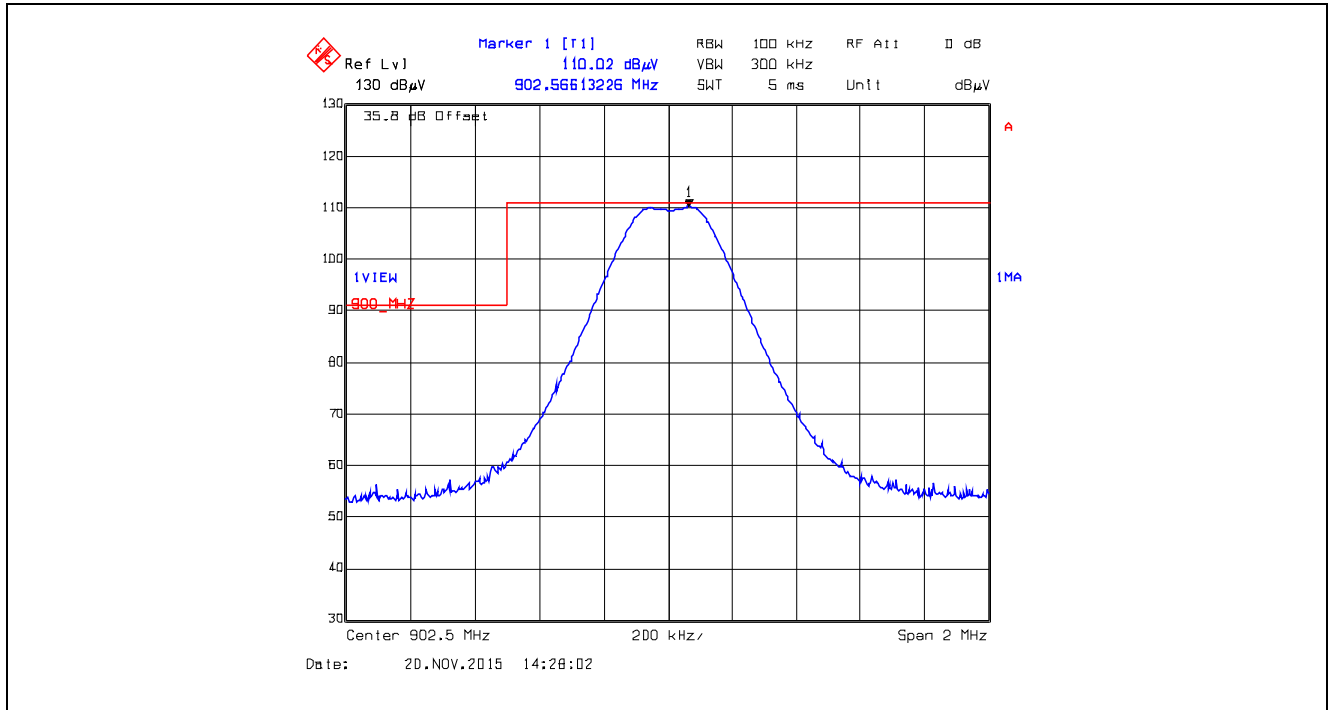

**Plot 5.5.4.1.2.10.** Band-Edge RF Radiated Emissions at 3 m, Horizontal Polarization  
 Pseudorandom Hopping Mode, Low End of Frequency Band, 902.5 MHz, XBX1, Data Rate at 110 kbps

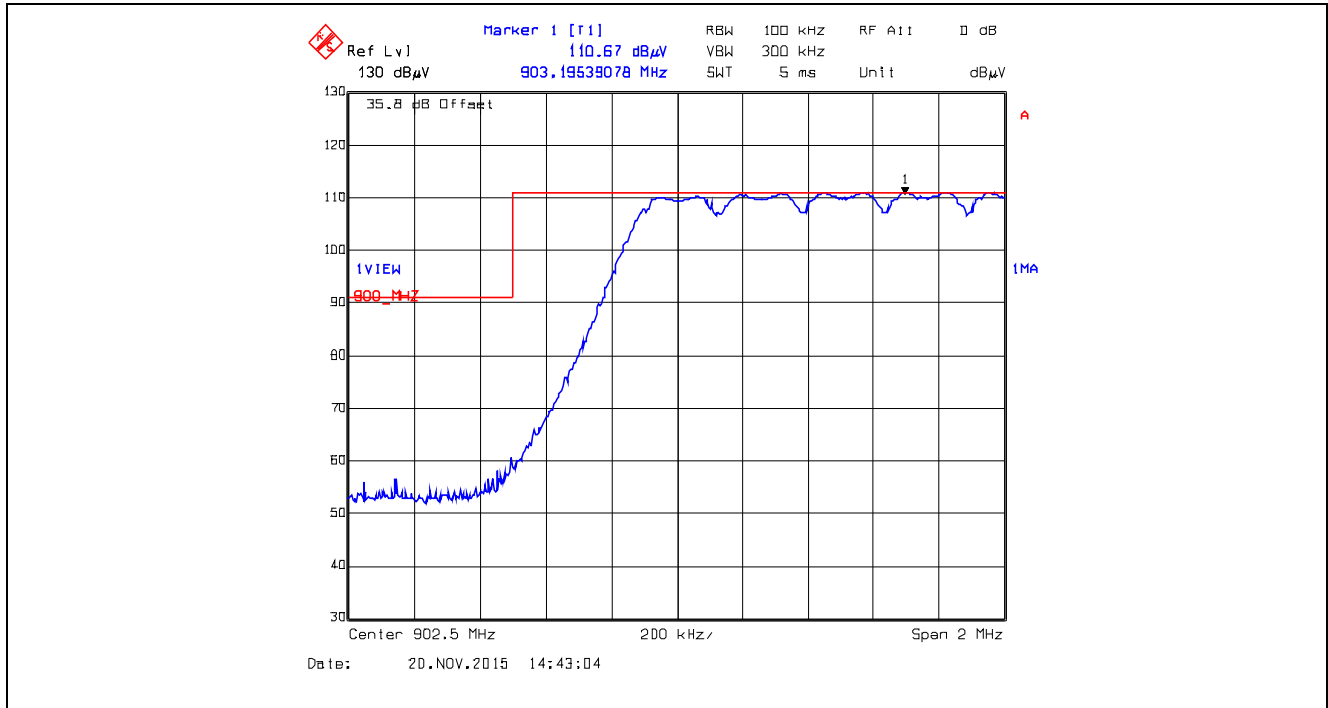

**Plot 5.5.4.1.2.11.** Band-Edge RF Radiated Emissions at 3 m, Vertical Polarization  
Single Frequency Mode, Low End of Frequency Band, 902.5 MHz, XB1, Data Rate at 110 kbps

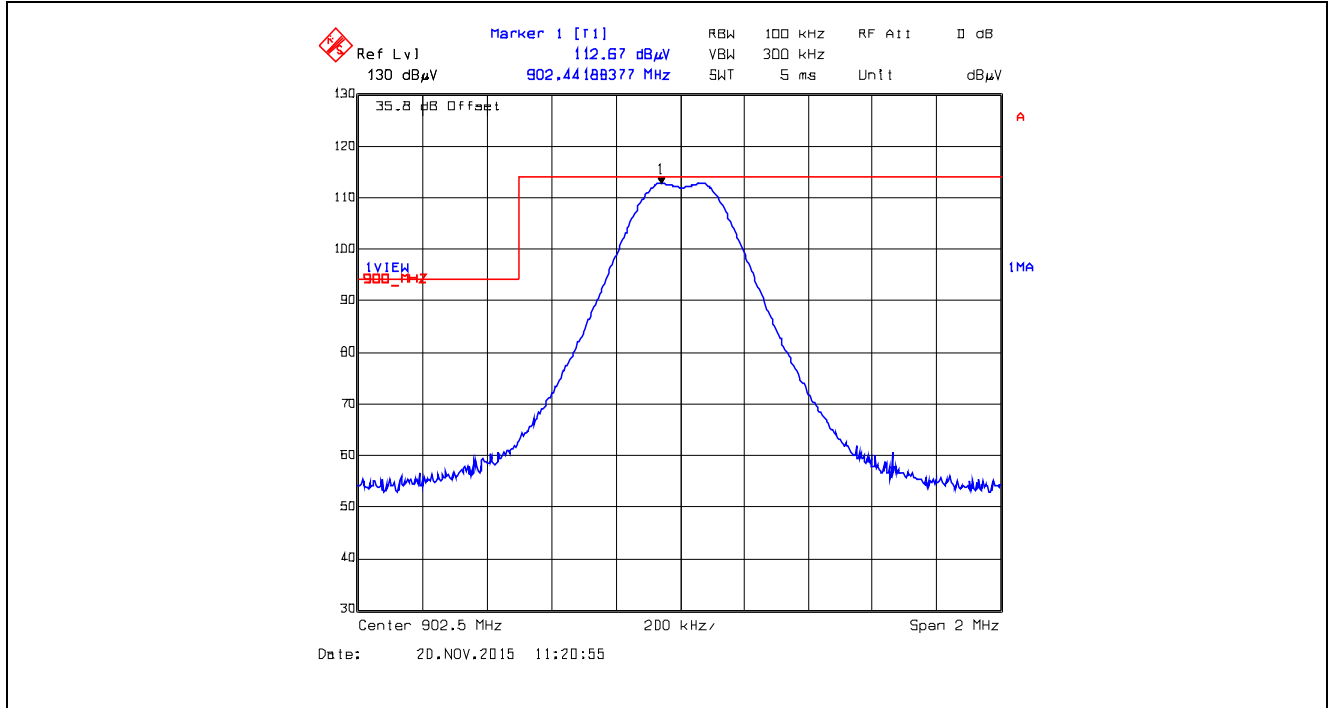

**Plot 5.5.4.1.2.12.** Band-Edge RF Radiated Emissions at 3 m, Vertical Polarization  
Pseudorandom Hopping Mode, Low End of Frequency Band, 902.5 MHz, XB1, Data Rate at 110 kbps

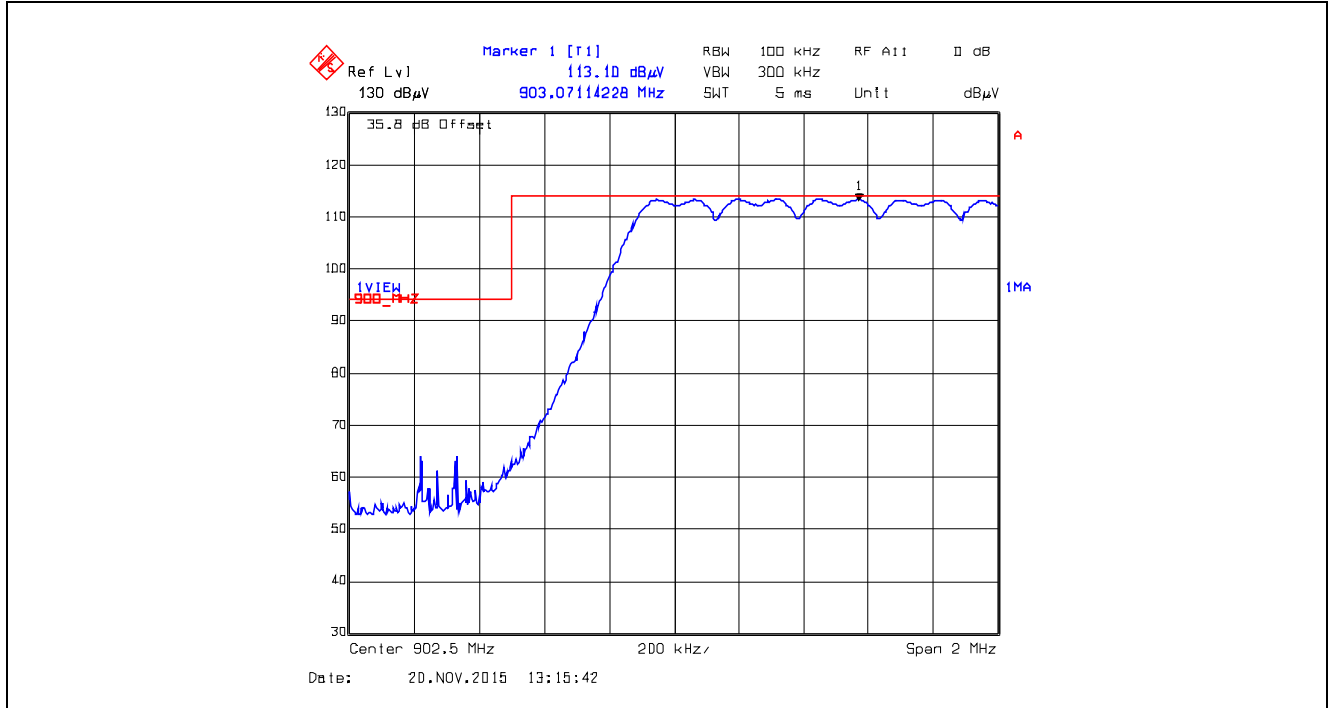



**Plot 5.5.4.1.2.13.** Band-Edge RF Radiated Emissions at 3 m, Horizontal Polarization  
Single Frequency Mode, High End of Frequency Band, 927.5 MHz, XBX1, Data Rate at 110 kbps

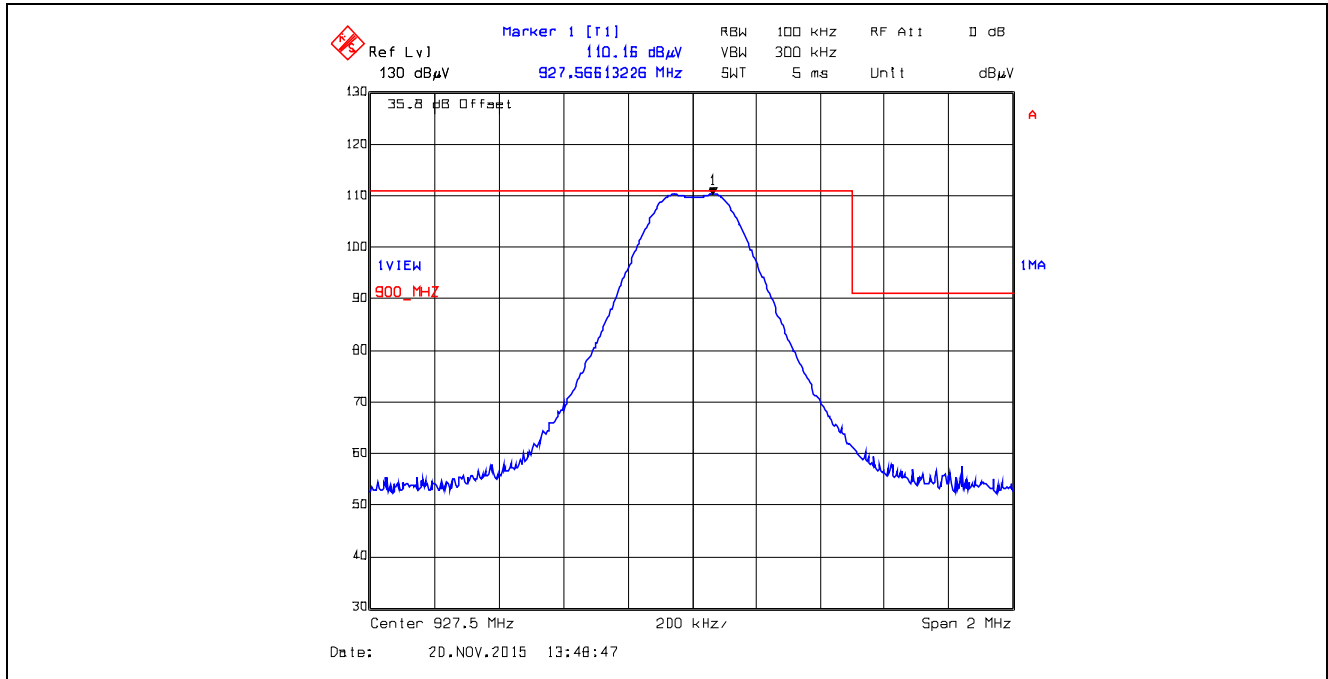

**Plot 5.5.4.1.2.14.** Band-Edge RF Radiated Emissions at 3 m, Horizontal Polarization  
Pseudorandom Hopping Mode, High End of Frequency Band, 927.5 MHz, XBX1, Data Rate at 110 kbps

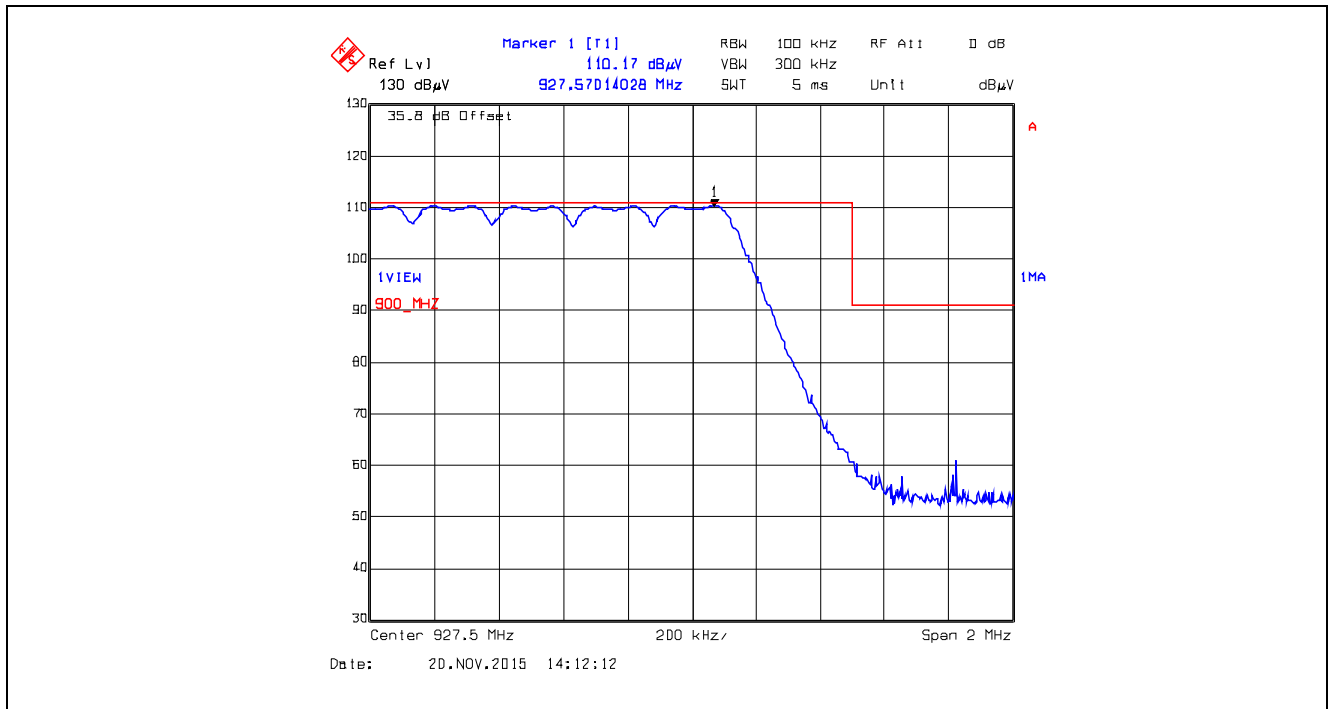

**Plot 5.5.4.1.2.15.** Band-Edge RF Radiated Emissions at 3 m, Vertical Polarization  
 Single Frequency Mode, High End of Frequency Band, 927.5 MHz, XB1, Data Rate at 110 kbps

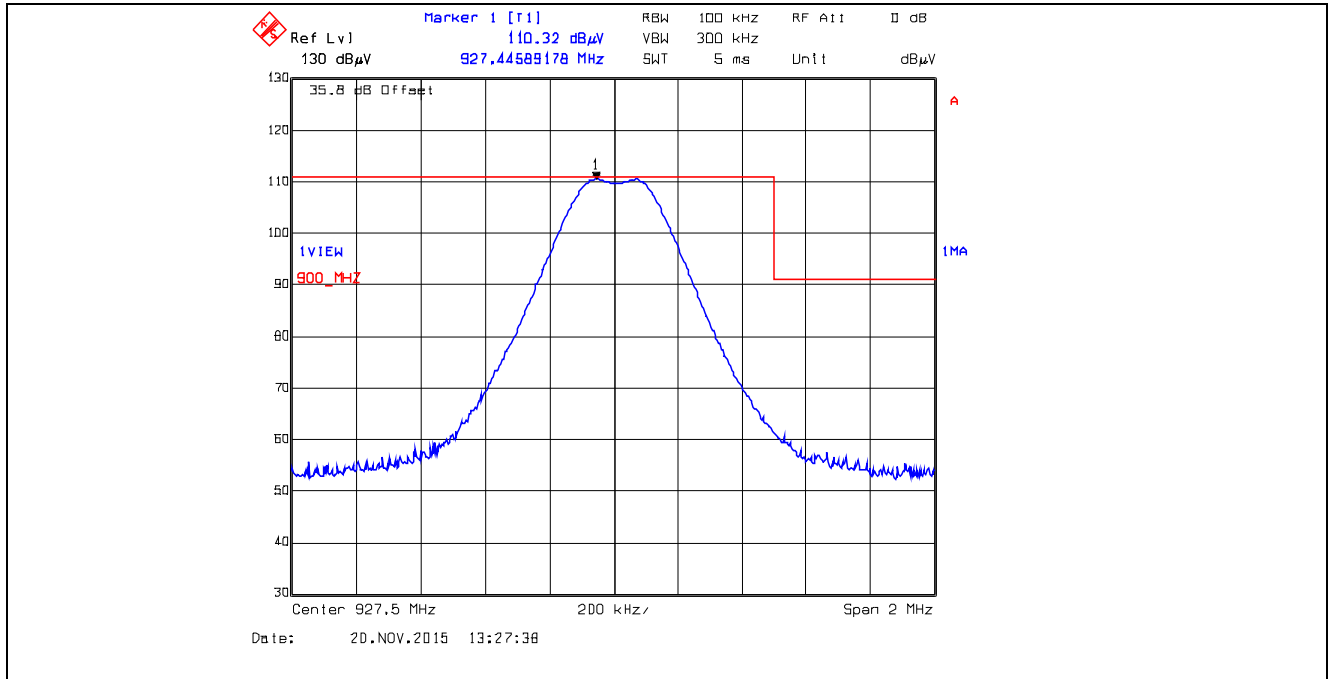

**Plot 5.5.4.1.2.16.** Band-Edge RF Radiated Emissions at 3 m, Vertical Polarization  
 Pseudorandom Hopping Mode, High End of Frequency Band, 927.5 MHz, XB1, Data Rate at 110 kbps

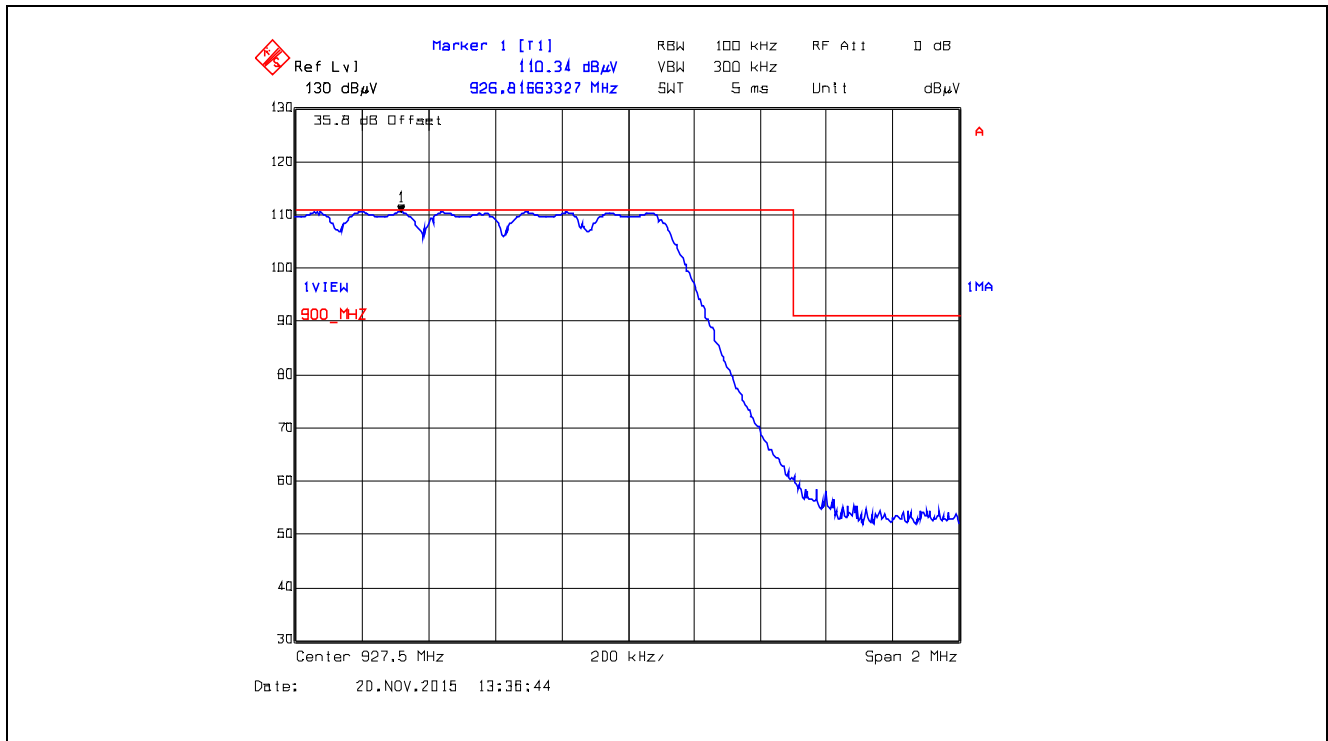

**Plot 5.5.4.1.2.17.** Band-Edge RF Radiated Emissions at 3 m, Horizontal Polarization  
 Single Frequency Mode, Low End of Frequency Band, 902.75 MHz, XB2, Data Rate at 250 kbps

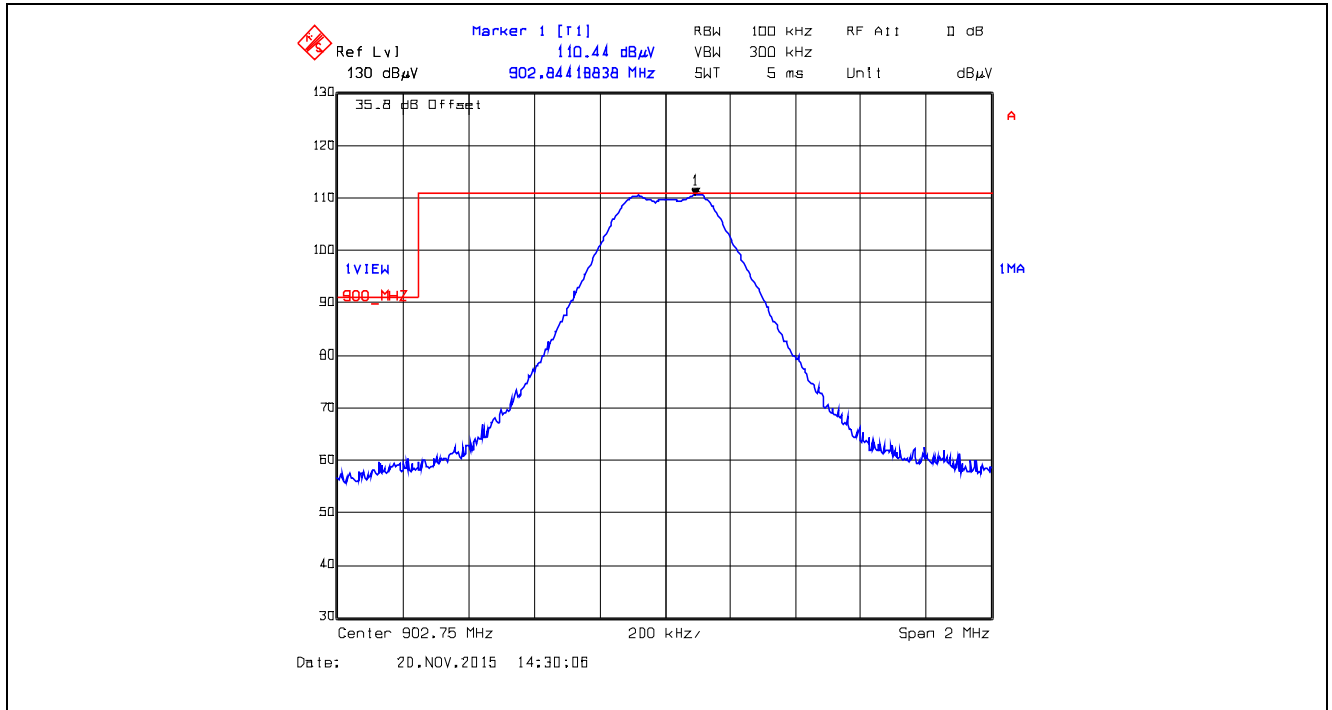

**Plot 5.5.4.1.2.18.** Band-Edge RF Radiated Emissions at 3 m, Horizontal Polarization  
 Pseudorandom Hopping Mode, Low End of Frequency Band, 902.75 MHz, XB2, Data Rate at 250 kbps

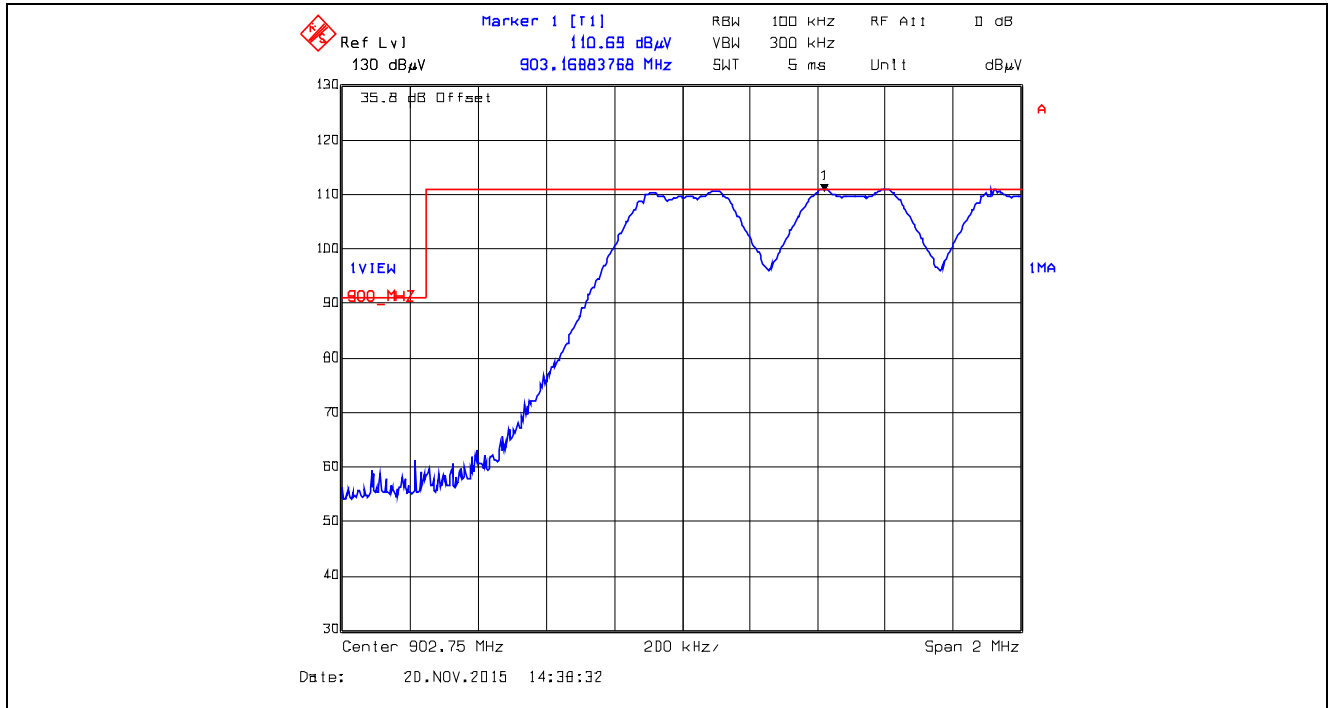

**Plot 5.5.4.1.2.19.** Band-Edge RF Radiated Emissions at 3 m, Vertical Polarization  
 Single Frequency Mode, Low End of Frequency Band, 902.75 MHz, XBX2, Data Rate at 250 kbps

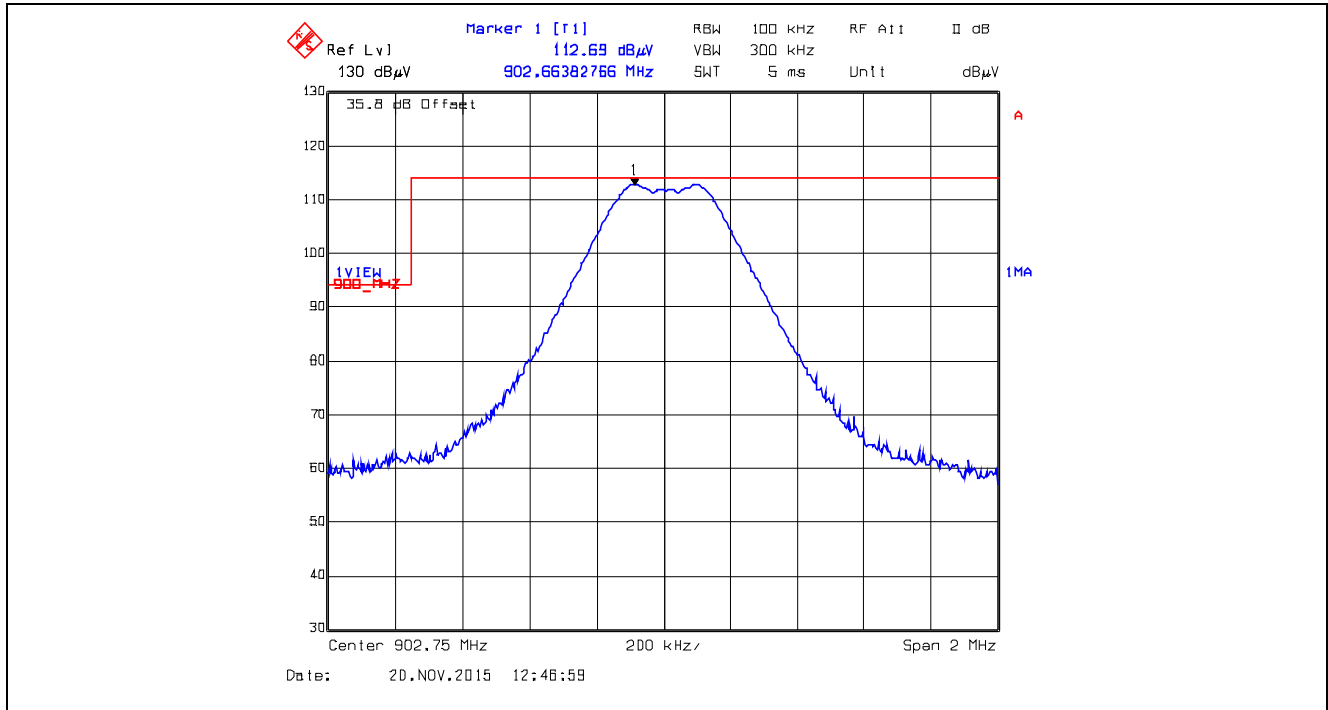

**Plot 5.5.4.1.2.20.** Band-Edge RF Radiated Emissions at 3 m, Vertical Polarization  
 Pseudorandom Hopping Mode, Low End of Frequency Band, 902.75 MHz, XBX2, Data Rate at 250 kbps

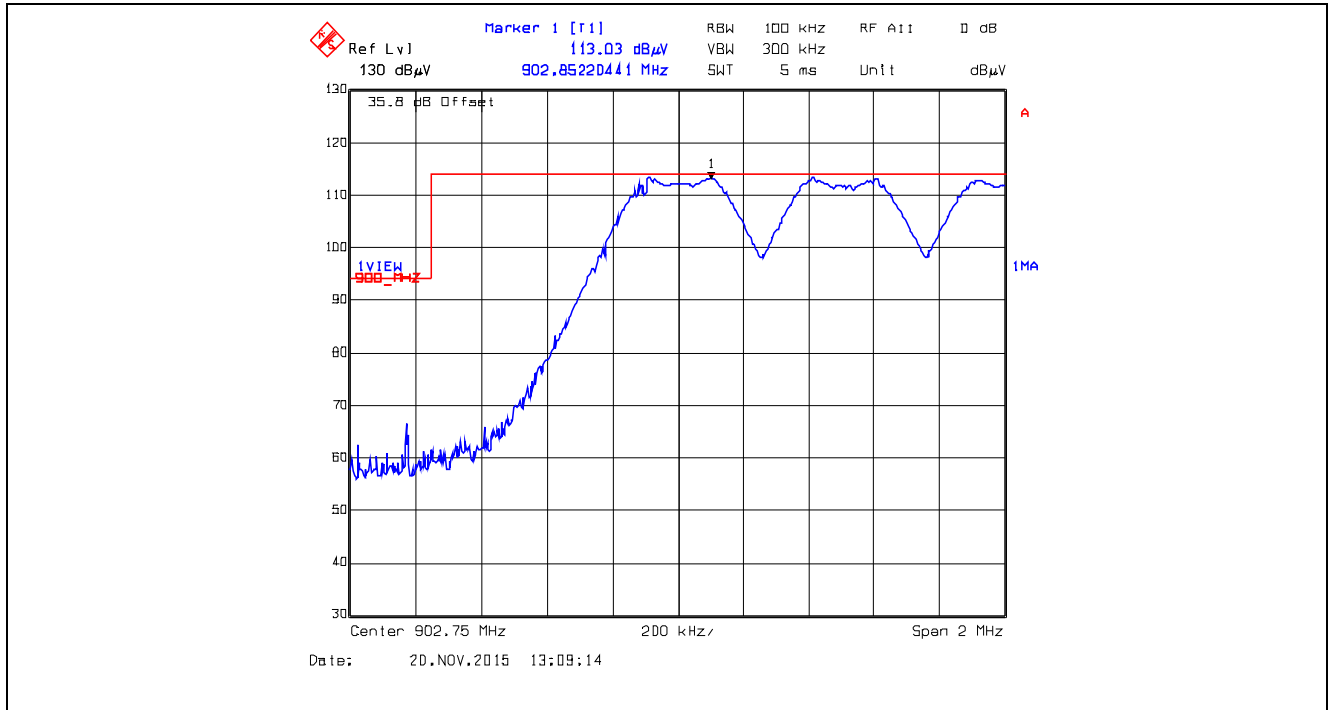

**Plot 5.5.4.1.2.21.** Band-Edge RF Radiated Emissions at 3 m, Horizontal Polarization  
 Single Frequency Mode, High End of Frequency Band, 927.25 MHz, XB2, Data Rate at 250 kbps

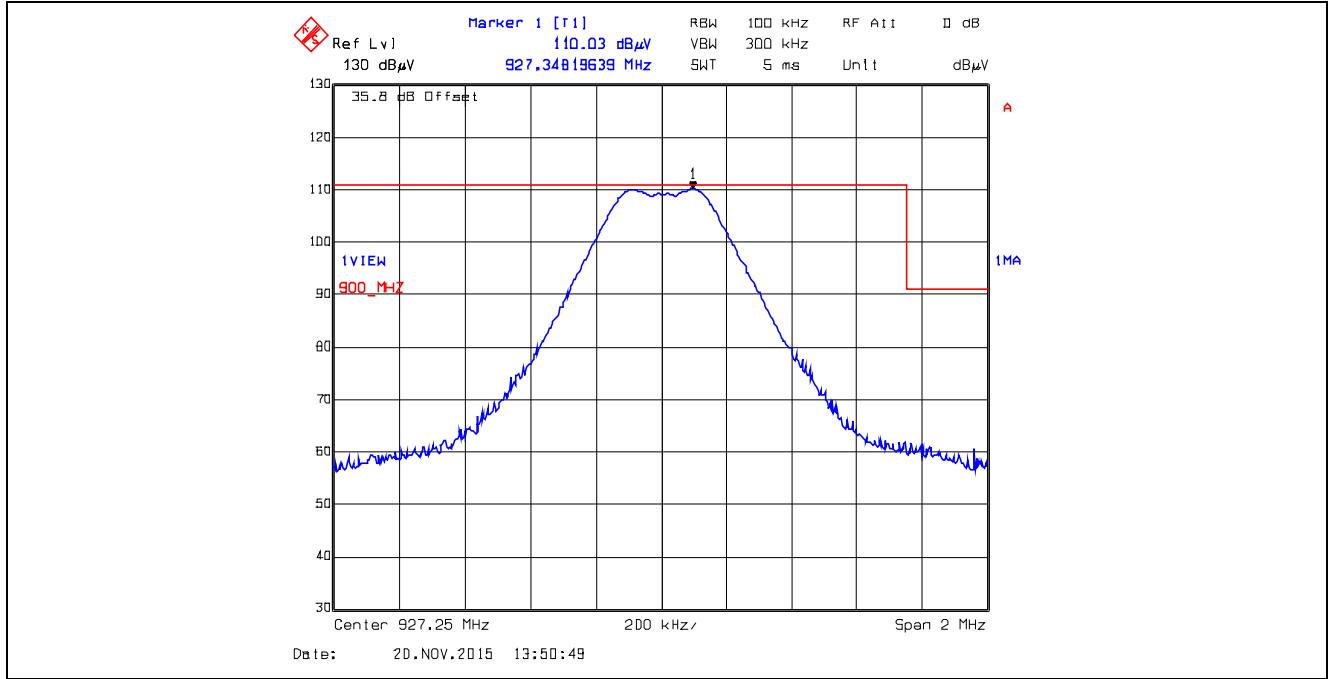

**Plot 5.5.4.1.2.22.** Band-Edge RF Radiated Emissions at 3 m, Horizontal Polarization  
 Pseudorandom Hopping Mode, High End of Frequency Band, 927.25 MHz, XB2, Data Rate at 250 kbps

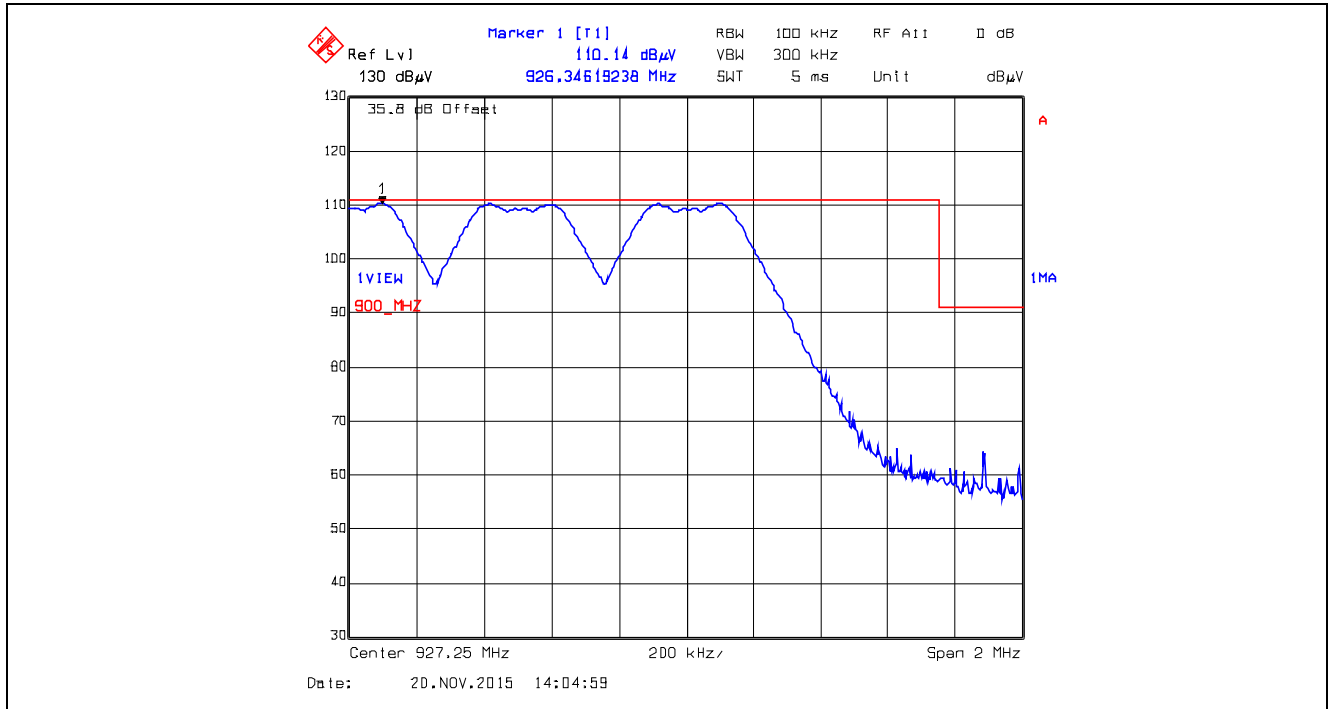

**Plot 5.5.4.1.2.23.** Band-Edge RF Radiated Emissions at 3 m, Vertical Polarization  
 Single Frequency Mode, High End of Frequency Band, 927.25 MHz, XBX2, Data Rate at 250 kbps

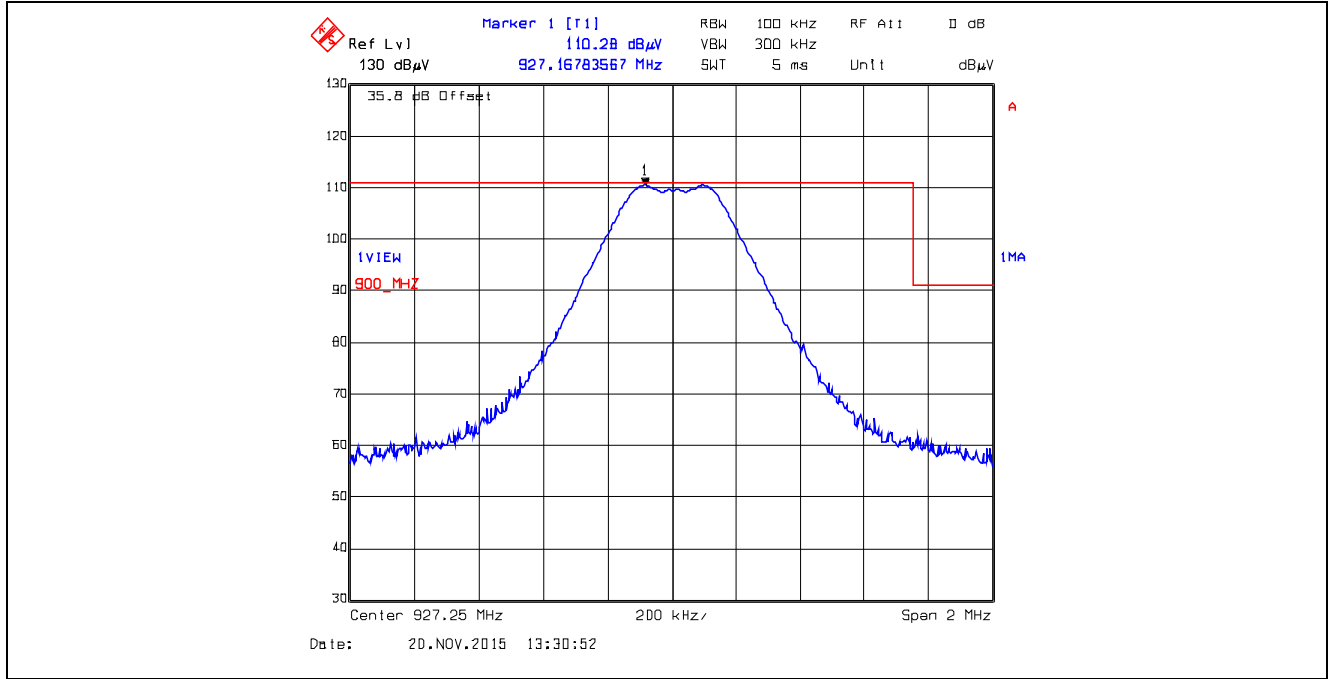

**Plot 5.5.4.1.2.24.** Band-Edge RF Radiated Emissions at 3 m, Vertical Polarization  
 Pseudorandom Hopping Mode, High End of Frequency Band, 927.25 MHz, XBX2, Data Rate at 250 kbps

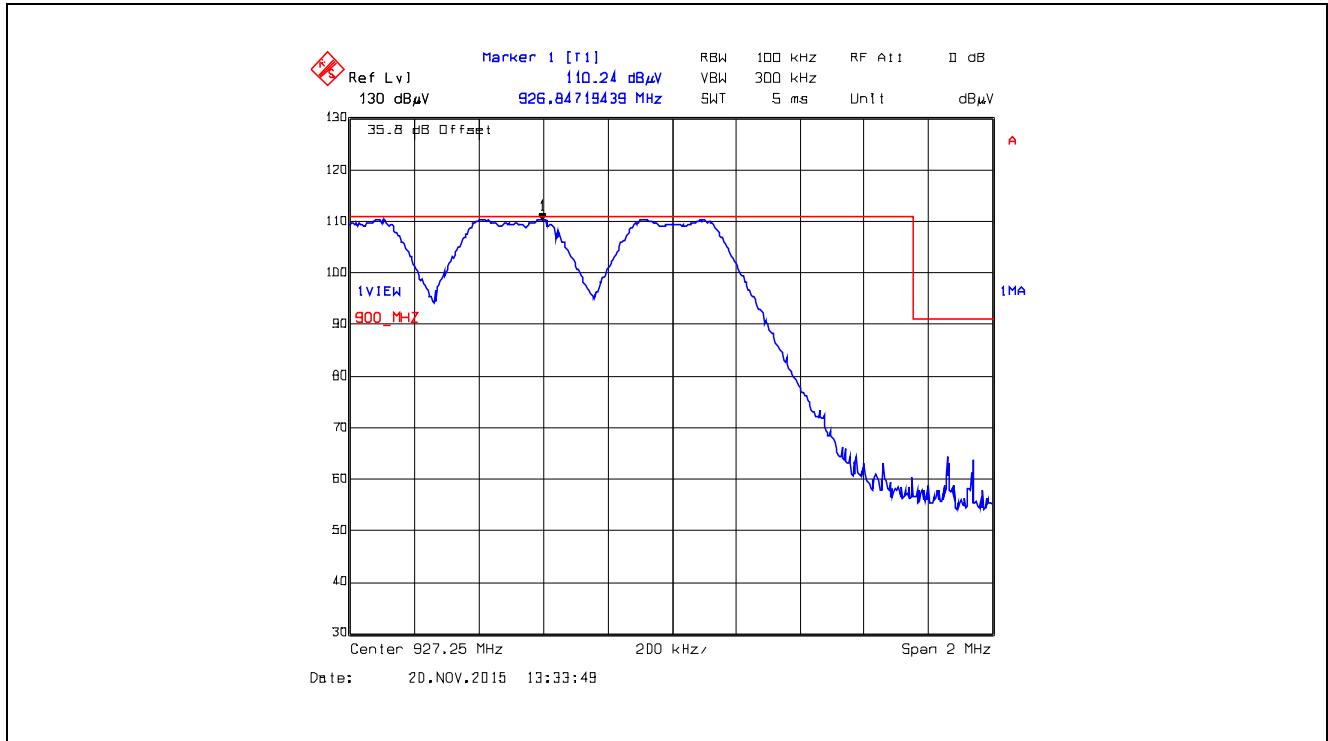

**Plot 5.5.4.1.2.25.** Band-Edge RF Radiated Emissions at 3 m, Horizontal Polarization  
Single Frequency Mode, Low End of Frequency Band, 905.0 MHz, XTC0, Data Rate at 10 kbps

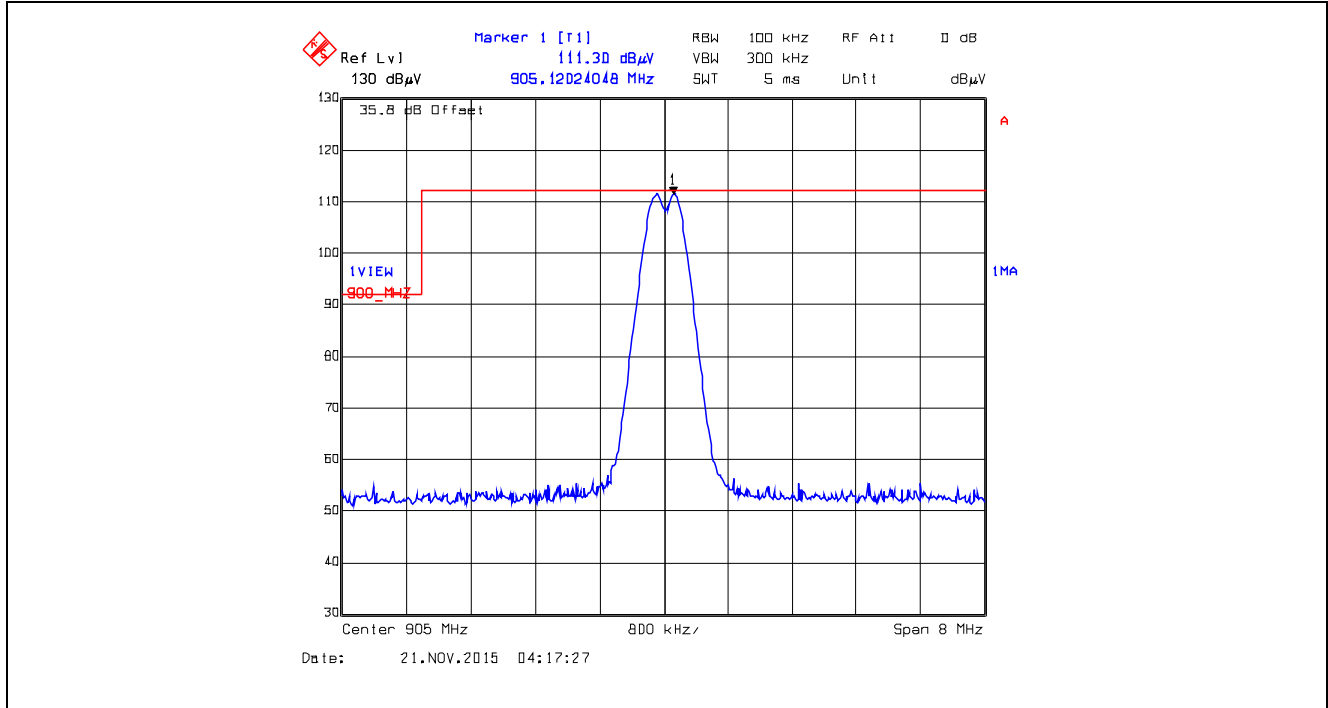

**Plot 5.5.4.1.2.26.** Band-Edge RF Radiated Emissions at 3 m, Horizontal Polarization  
Pseudorandom Hopping Mode, Low End of Frequency Band, 905.0 MHz, XTC0, Data Rate at 10 kbps

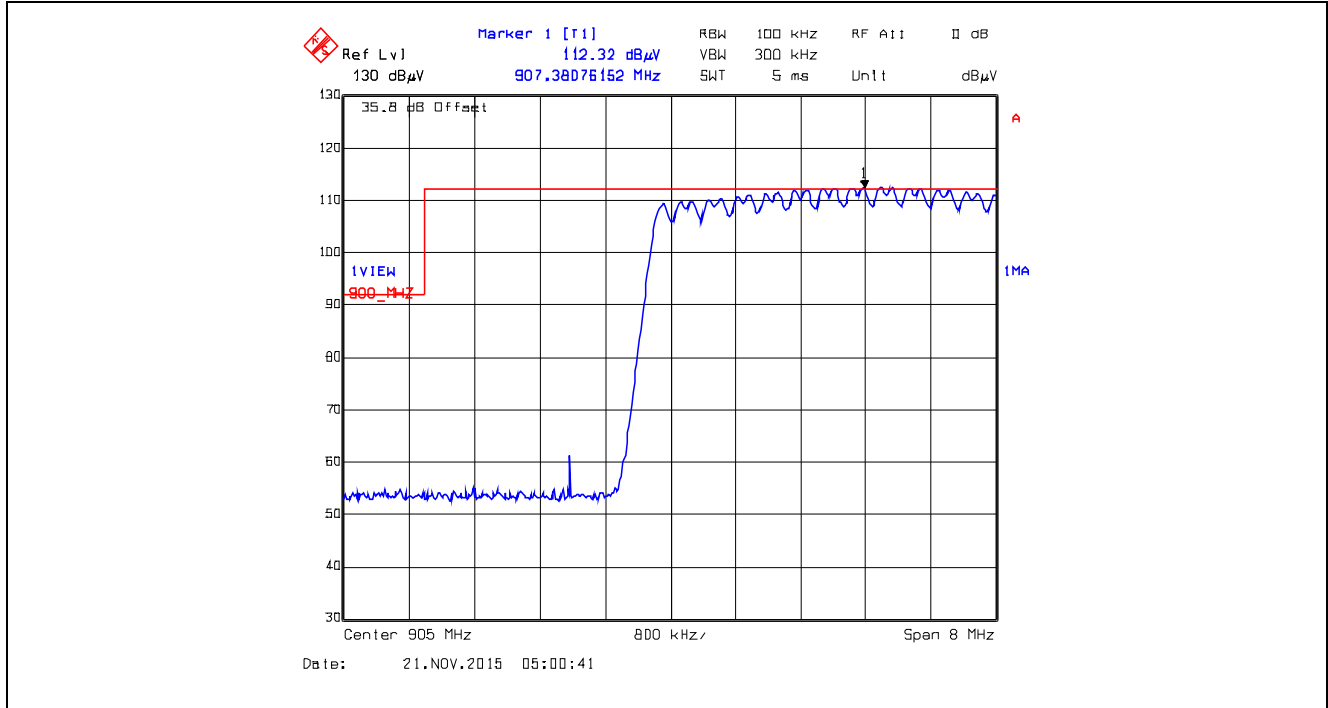

**Plot 5.5.4.1.2.27.** Band-Edge RF Radiated Emissions at 3 m, Vertical Polarization  
 Single Frequency Mode, Low End of Frequency Band, 905.0 MHz, XTC0, Data Rate at 10 kbps

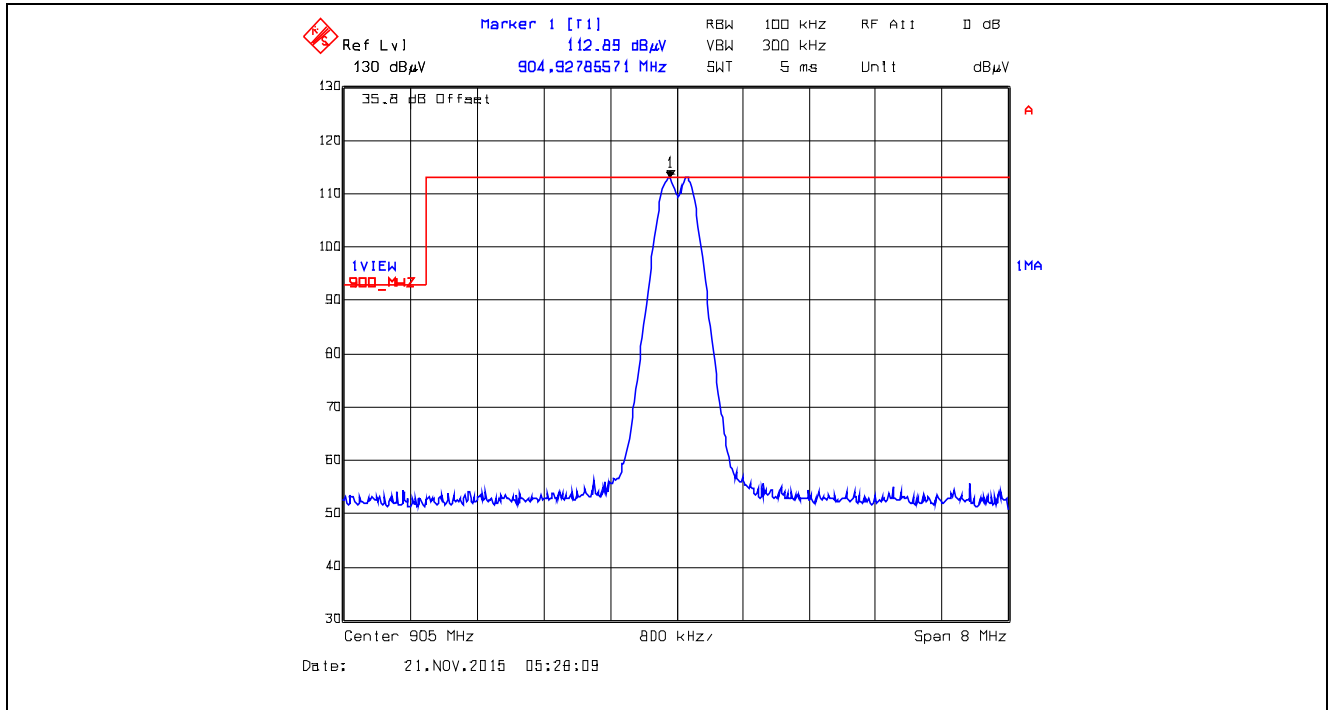

**Plot 5.5.4.1.2.28.** Band-Edge RF Radiated Emissions at 3 m, Vertical Polarization  
 Pseudorandom Hopping Mode, Low End of Frequency Band, 905.0 MHz, XTC0, Data Rate at 10 kbps

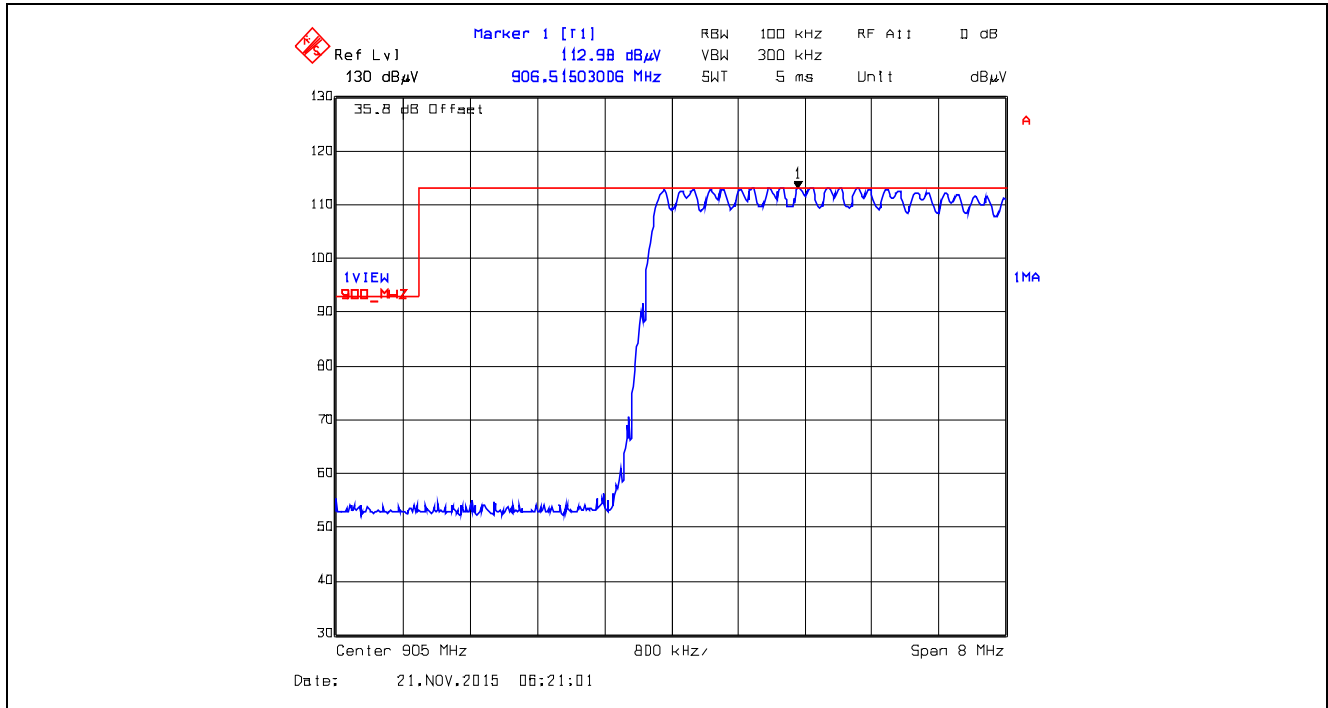



**Plot 5.5.4.1.2.29.** Band-Edge RF Radiated Emissions at 3 m, Horizontal Polarization  
Single Frequency Mode, High End of Frequency Band, 925.0 MHz, XTC0, Data Rate at 10 kbps

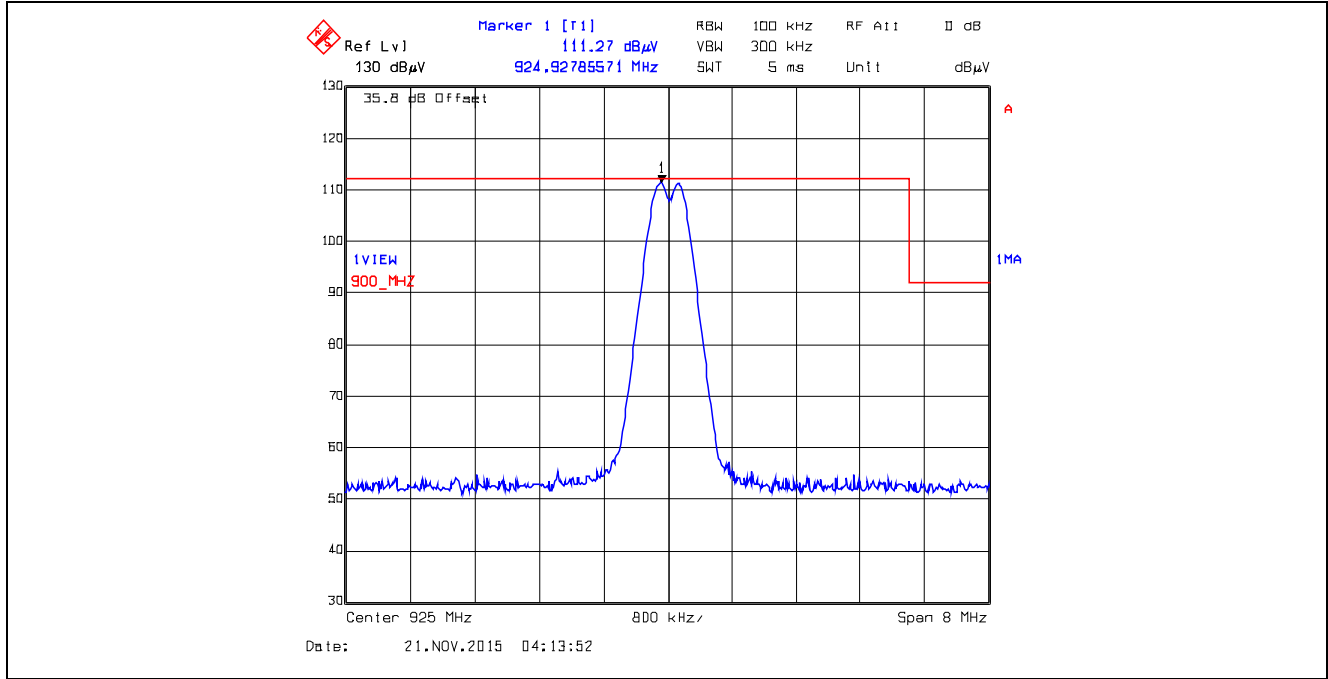

**Plot 5.5.4.1.2.30.** Band-Edge RF Radiated Emissions at 3 m, Horizontal Polarization  
Pseudorandom Hopping Mode, High End of Frequency Band, 925.0 MHz, XTC0, Data Rate at 10 kbps

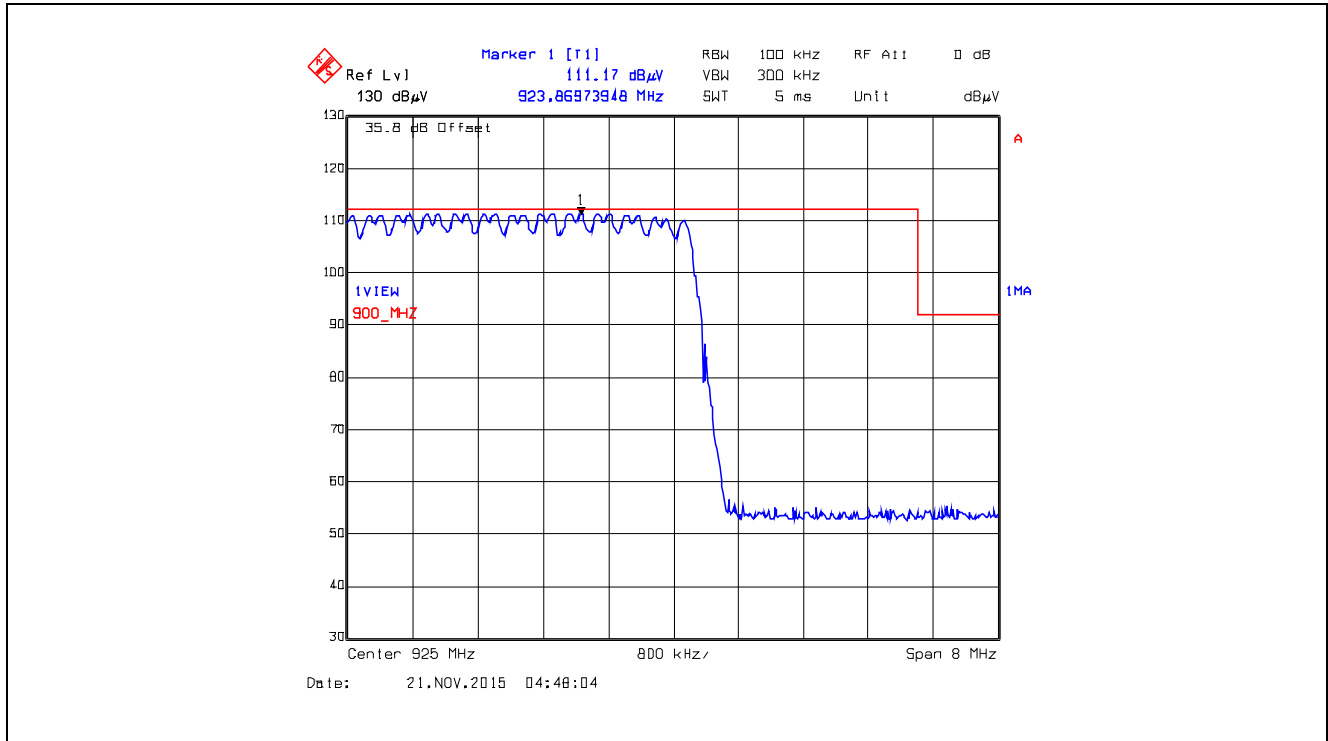

**Plot 5.5.4.1.2.31.** Band-Edge RF Radiated Emissions at 3 m, Vertical Polarization  
 Single Frequency Mode, High End of Frequency Band, 925.0 MHz, XTC0, Data Rate at 10 kbps

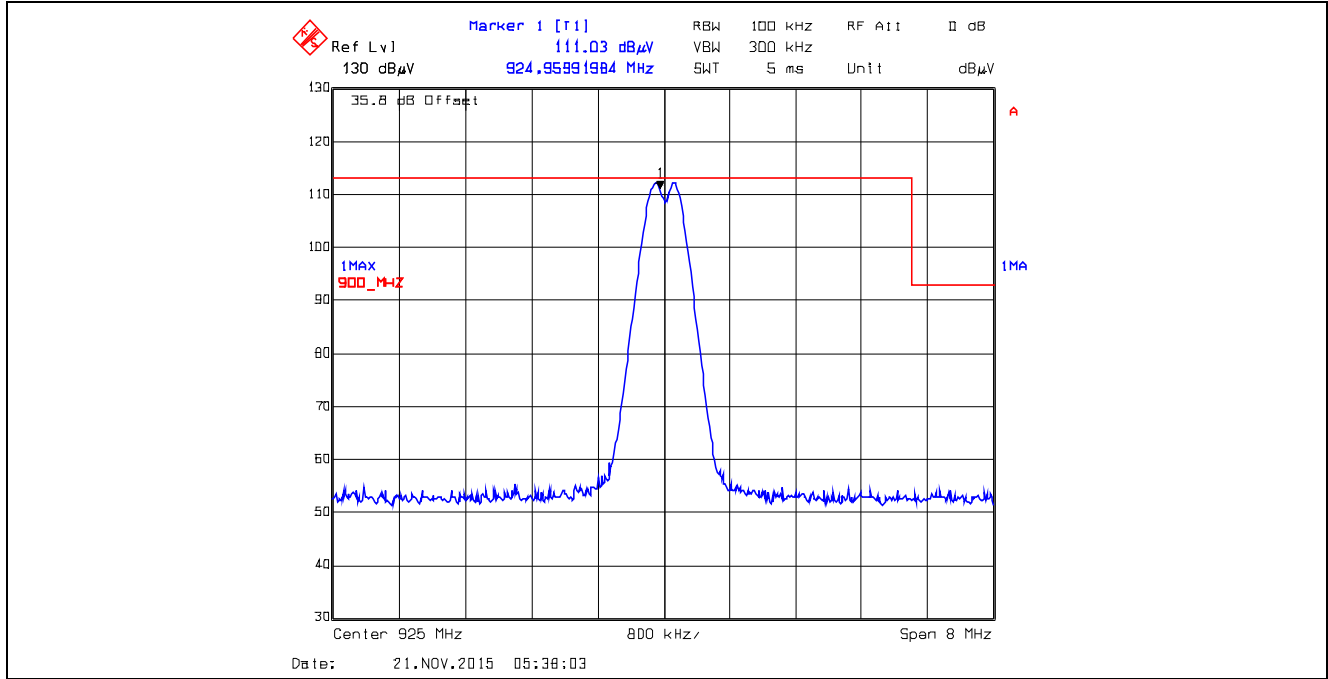

**Plot 5.5.4.1.2.32.** Band-Edge RF Radiated Emissions at 3 m, Vertical Polarization  
 Pseudorandom Hopping Mode, High End of Frequency Band, 925.0 MHz, XTC0, Data Rate at 10 kbps

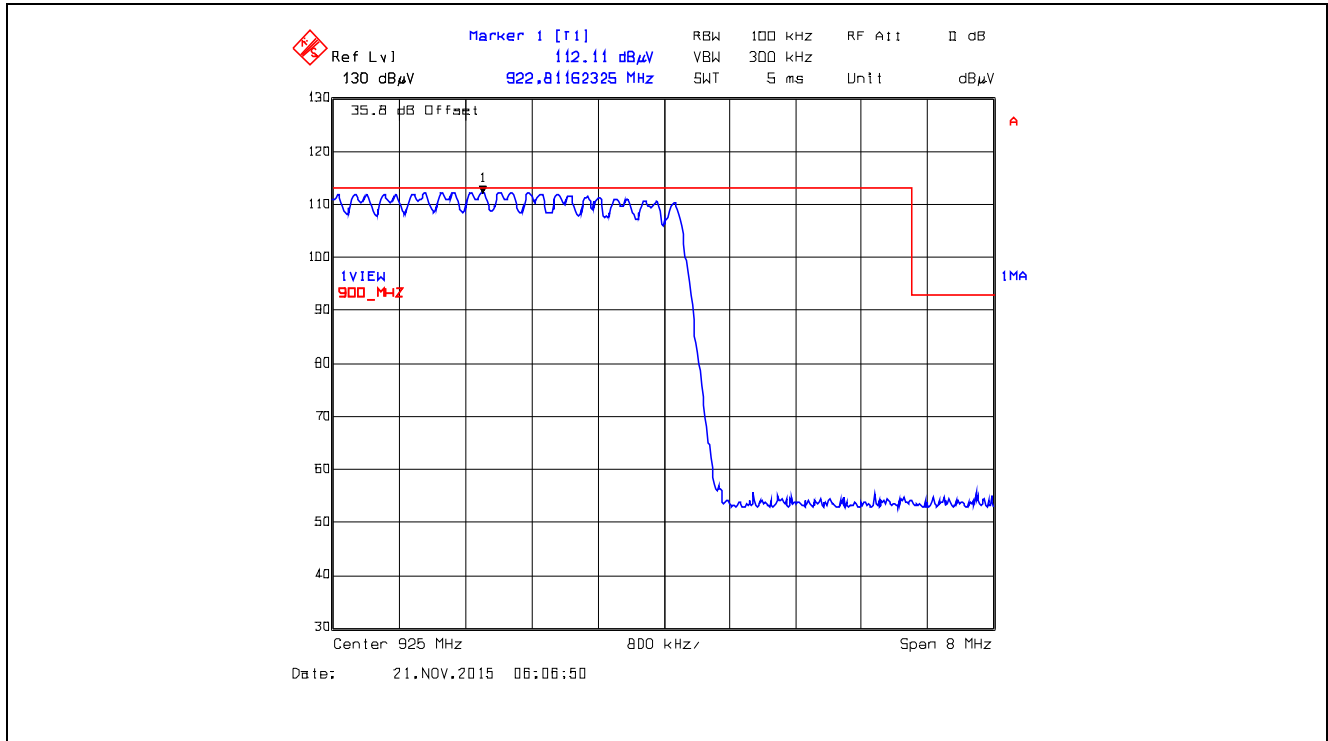

**Plot 5.5.4.1.2.33.** Band-Edge RF Radiated Emissions at 3 m, Horizontal Polarization  
 Single Frequency Mode, Low End of Frequency Band, 905.0 MHz, XTC1, Data Rate at 125 kbps

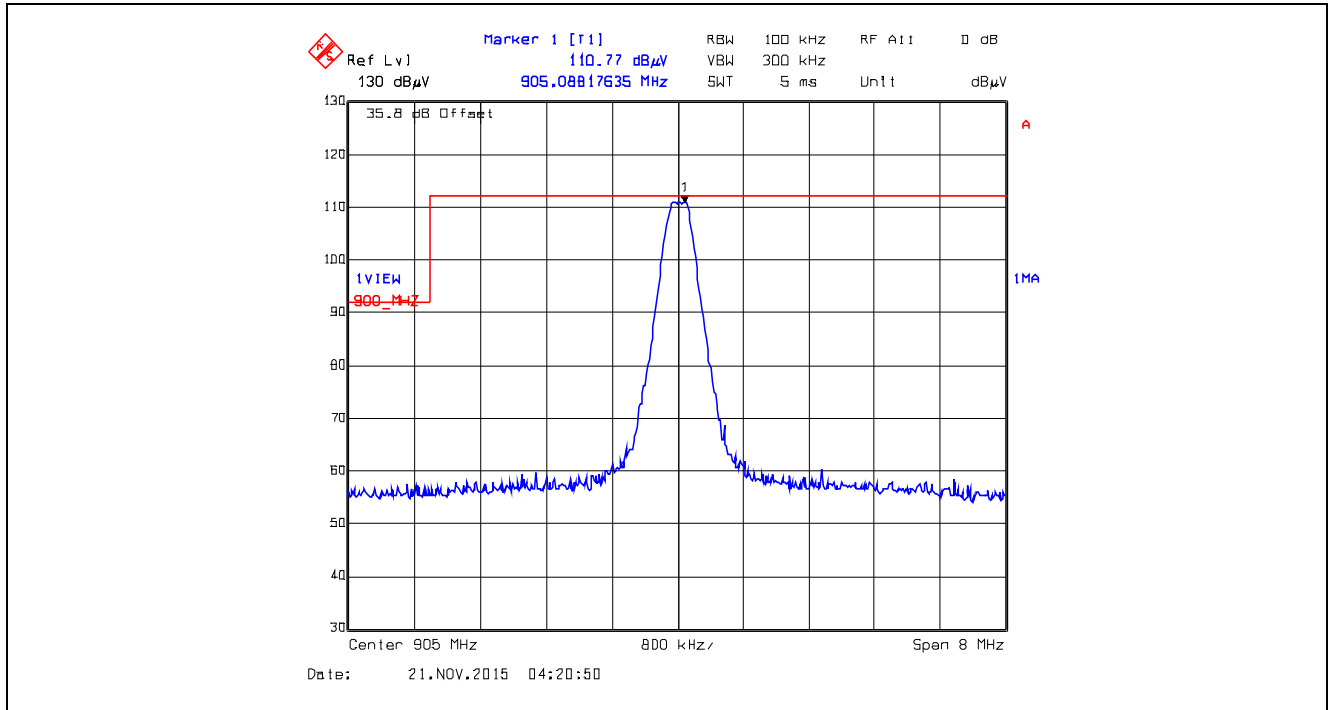

**Plot 5.5.4.1.2.34.** Band-Edge RF Radiated Emissions at 3 m, Horizontal Polarization  
 Pseudorandom Hopping Mode, Low End of Frequency Band, 905.0 MHz, XTC1, Data Rate at 125 kbps

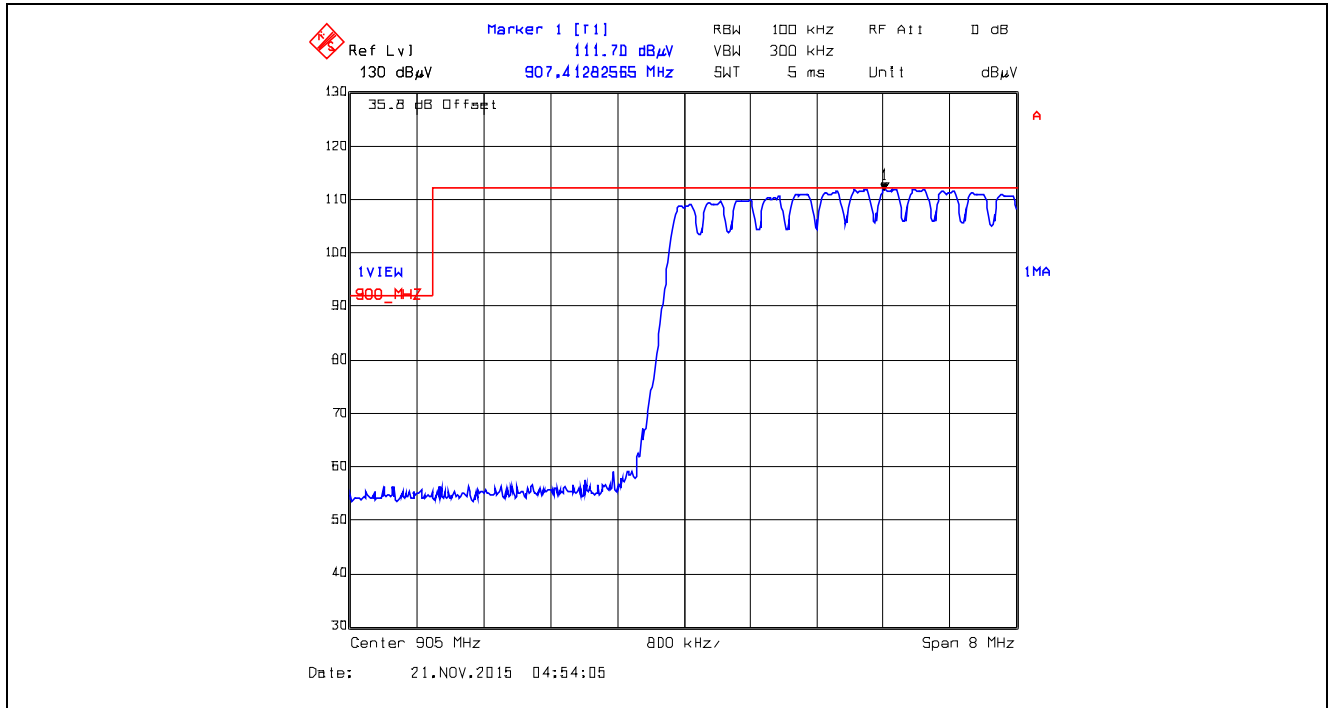

**Plot 5.5.4.1.2.35.** Band-Edge RF Radiated Emissions at 3 m, Vertical Polarization  
Single Frequency Mode, Low End of Frequency Band, 905.0 MHz, XTC1, Data Rate at 125 kbps

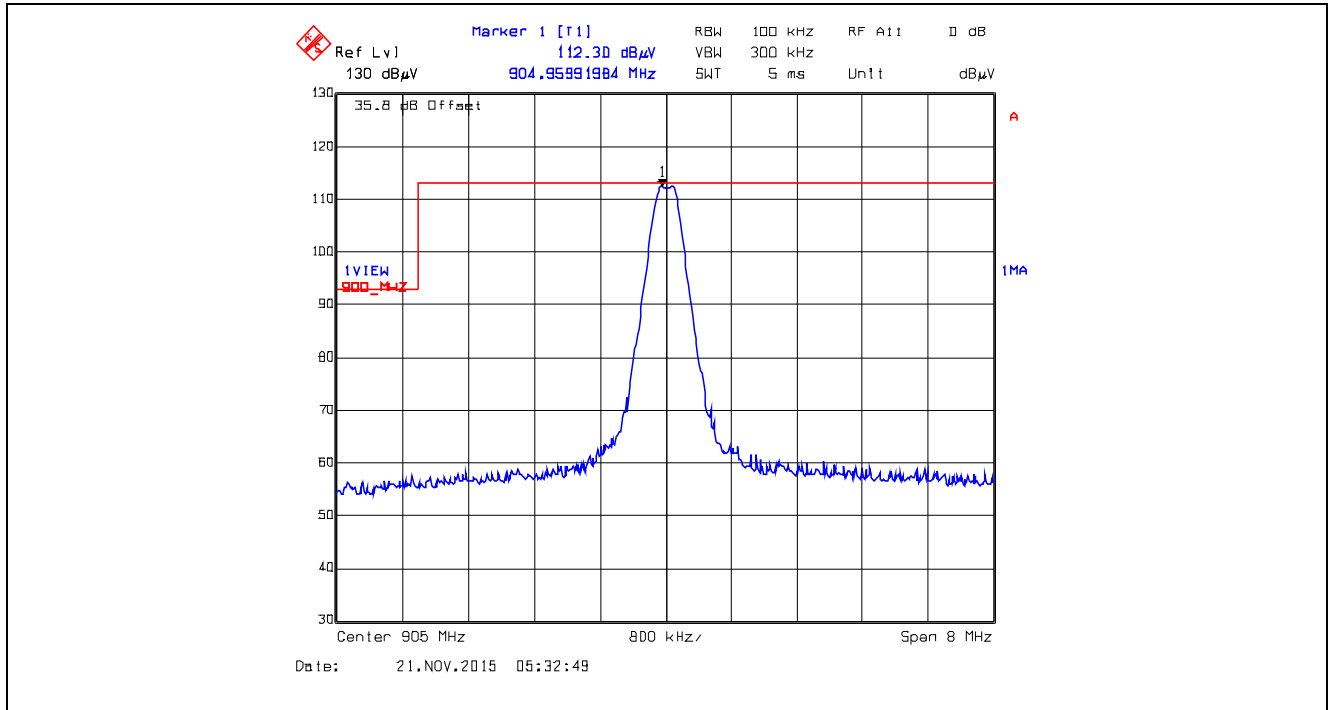

**Plot 5.5.4.1.2.36.** Band-Edge RF Radiated Emissions at 3 m, Vertical Polarization  
Pseudorandom Hopping Mode, Low End of Frequency Band, 905.0 MHz, XTC1, Data Rate at 125 kbps

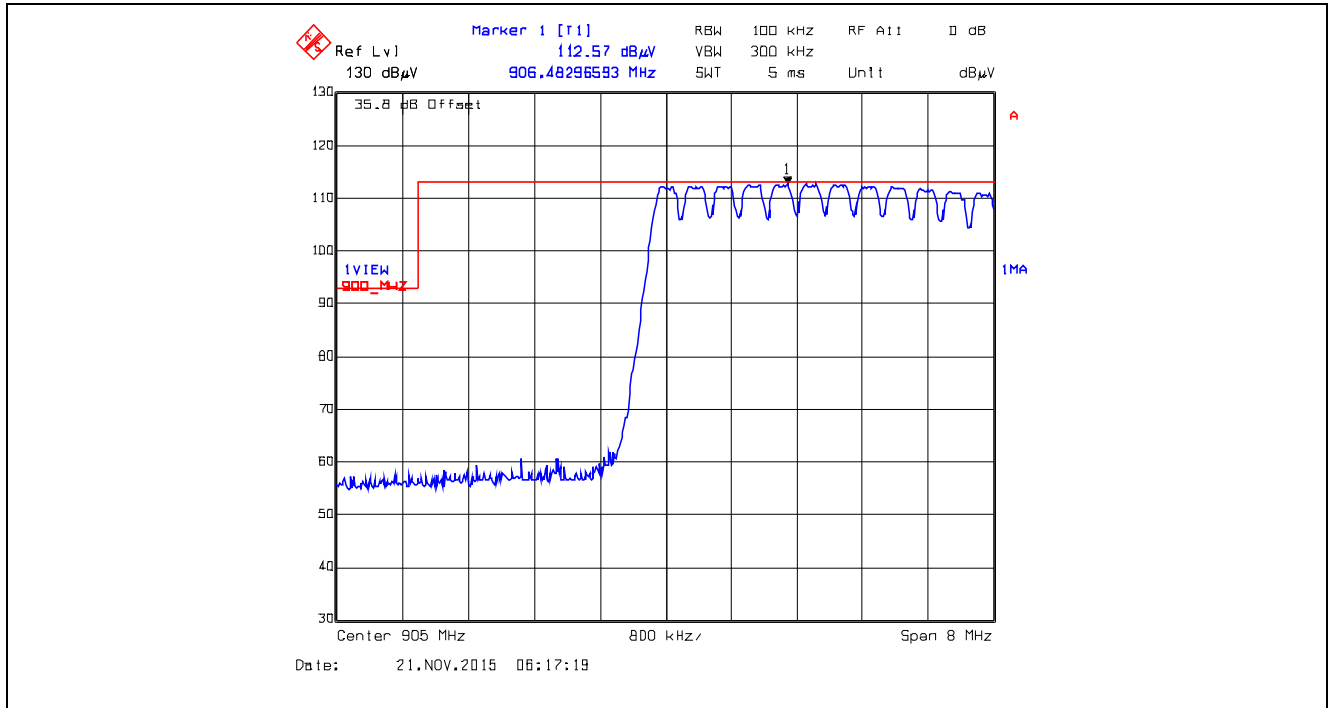

**Plot 5.5.4.1.2.37.** Band-Edge RF Radiated Emissions at 3 m, Horizontal Polarization  
 Single Frequency Mode, High End of Frequency Band, 925.0 MHz, XTC1, Data Rate at 125 kbps

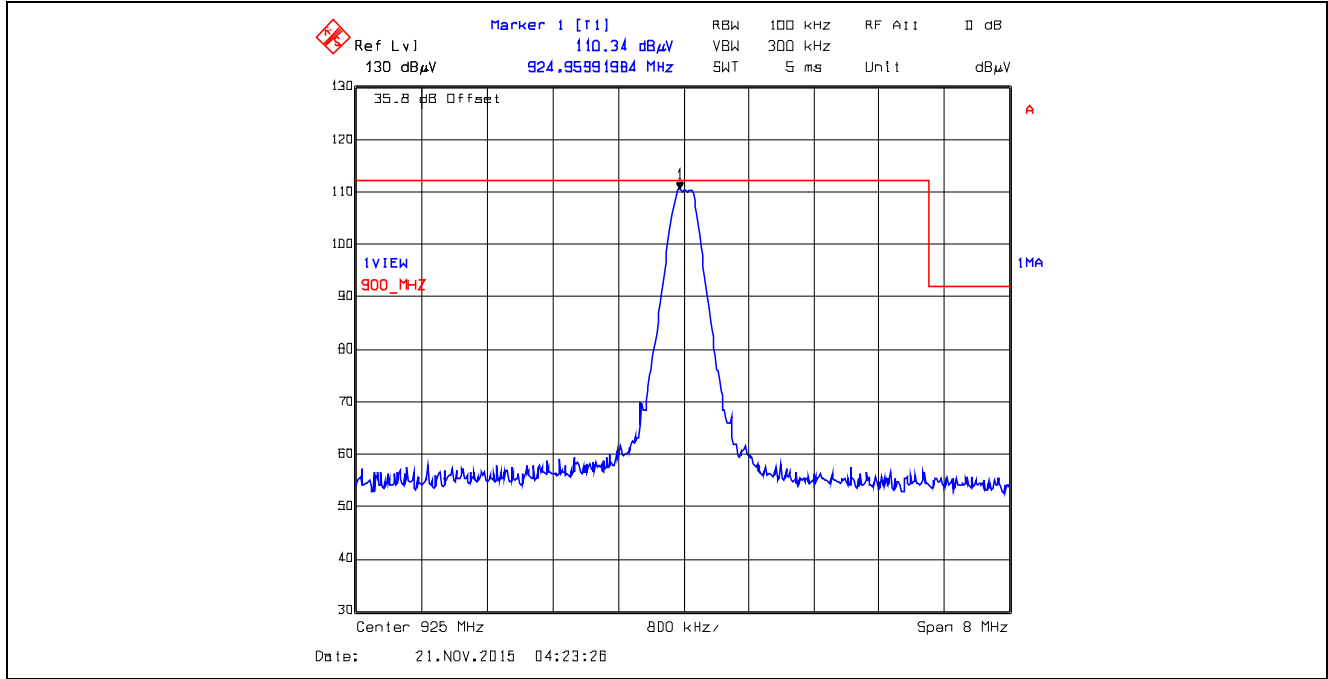

**Plot 5.5.4.1.2.38.** Band-Edge RF Radiated Emissions at 3 m, Horizontal Polarization  
 Pseudorandom Hopping Mode, High End of Frequency Band, 925.0 MHz, XTC1, Data Rate at 125 kbps

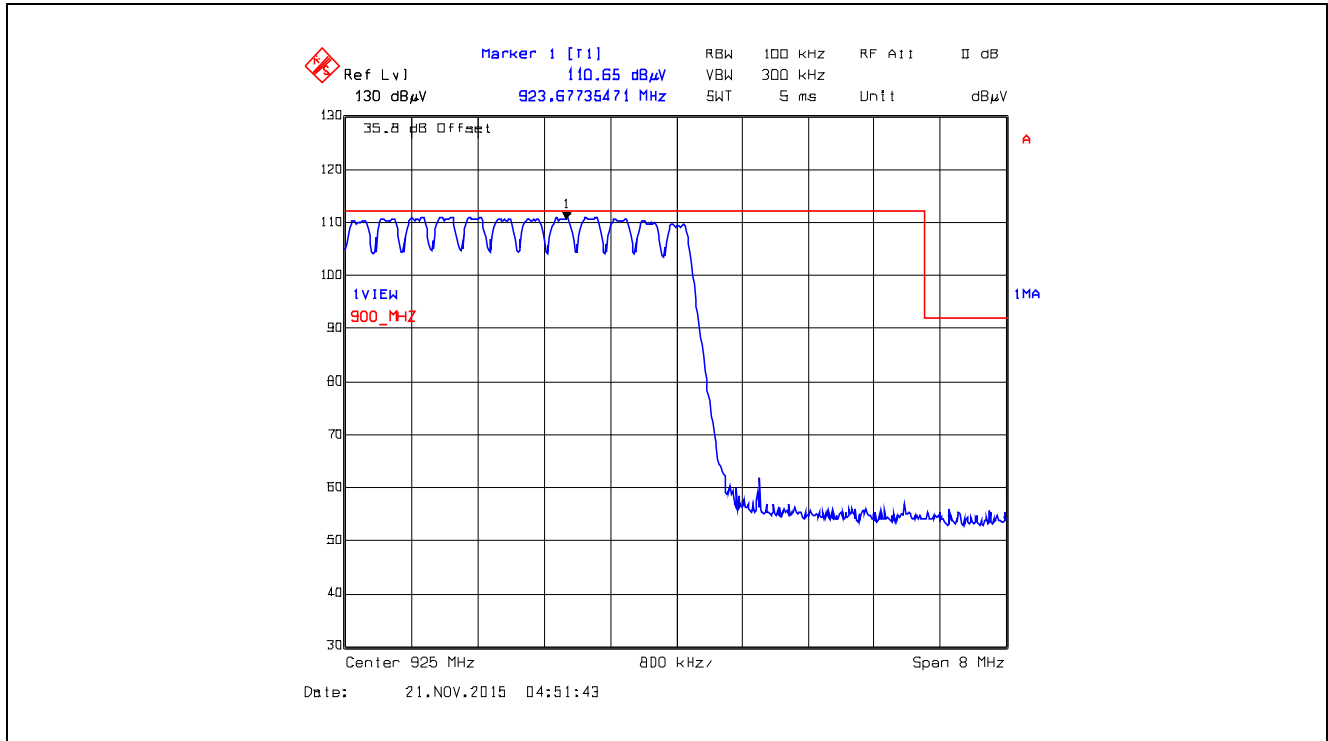

**Plot 5.5.4.1.2.39.** Band-Edge RF Radiated Emissions at 3 m, Vertical Polarization  
Single Frequency Mode, High End of Frequency Band, 925.0 MHz, XTC1, Data Rate at 125 kbps

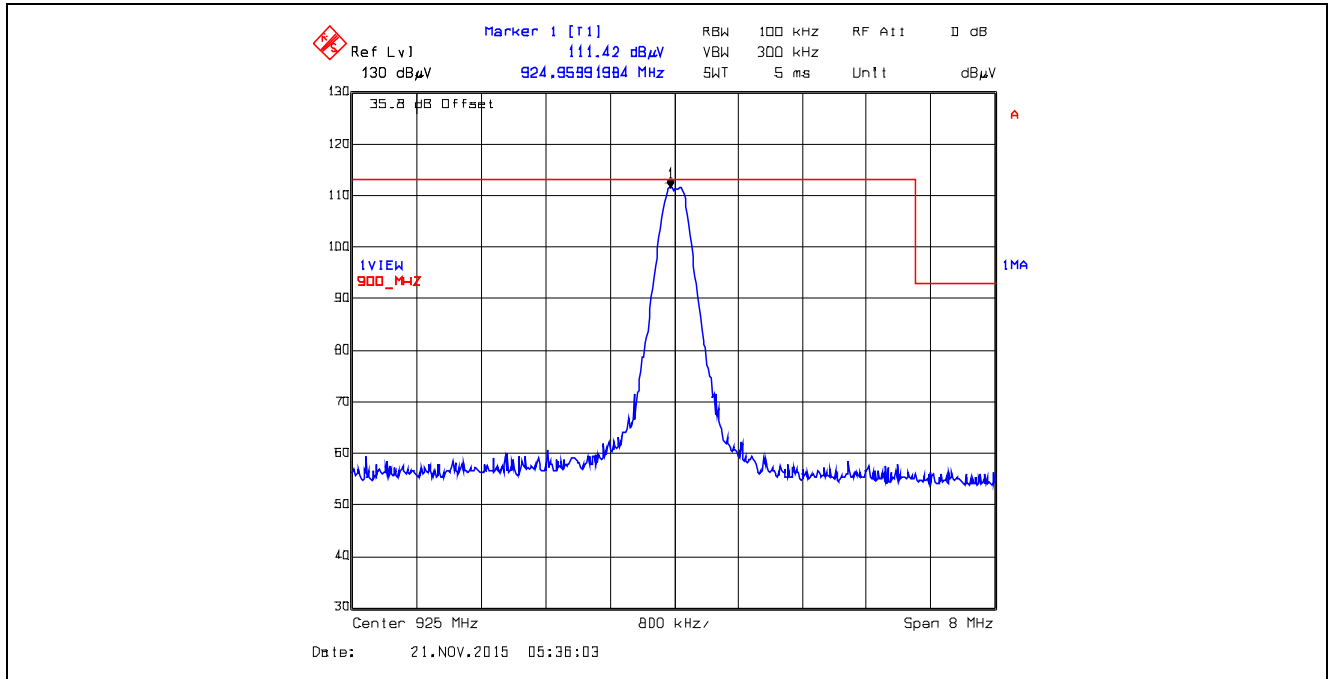

**Plot 5.5.4.1.2.40.** Band-Edge RF Radiated Emissions at 3 m, Vertical Polarization  
Pseudorandom Hopping Mode, High End of Frequency Band, 925.0 MHz, XTC1, Data Rate at 125 kbps

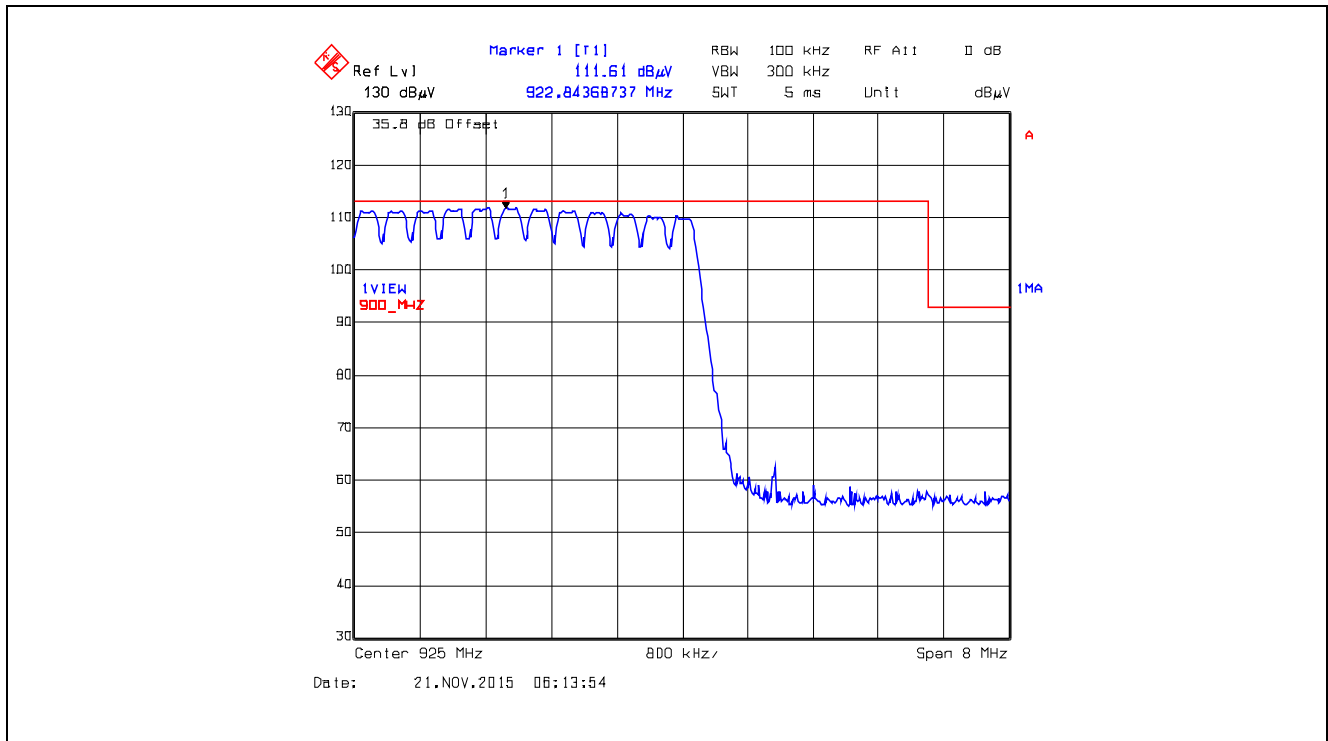

**Plot 5.5.4.1.2.41.** Band-Edge RF Radiated Emissions at 3 m, Horizontal Polarization  
Single Frequency Mode, Low End of Frequency Band, 915.75 MHz, XTCA0, Data Rate at 10 kbps

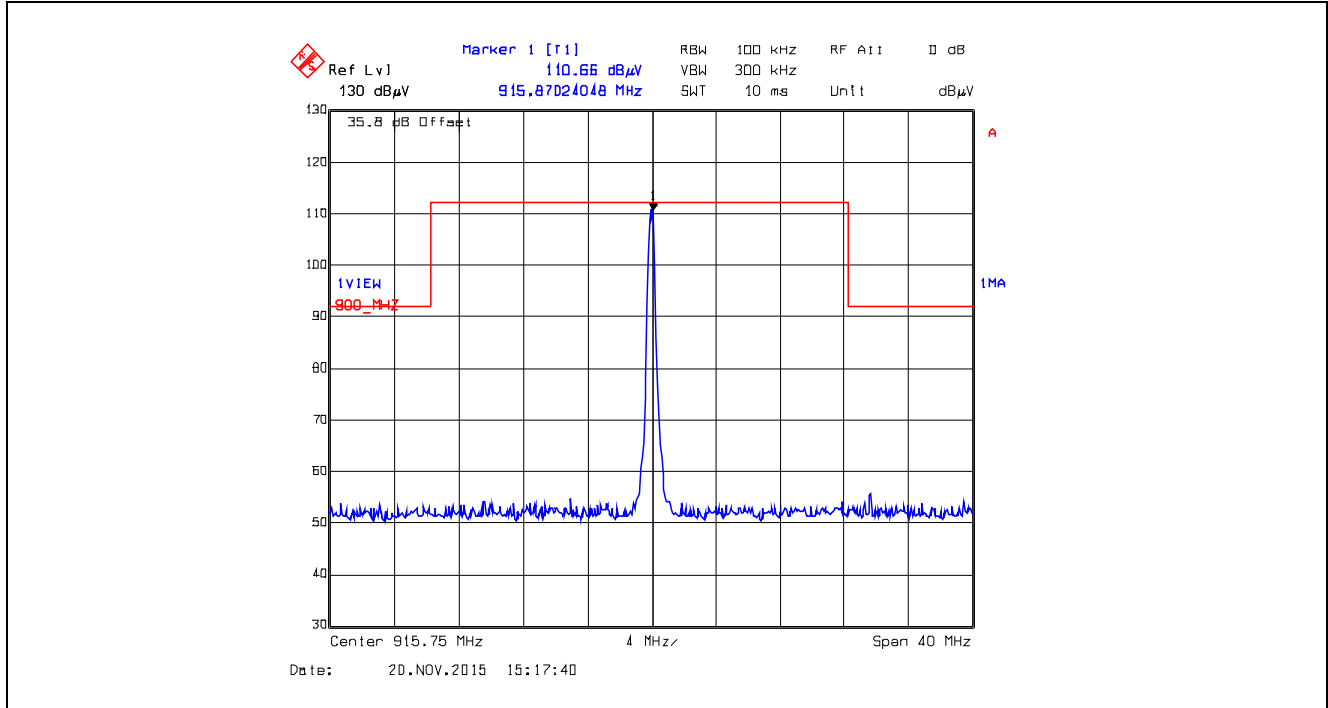

**Plot 5.5.4.1.2.42.** Band-Edge RF Radiated Emissions at 3 m, Horizontal Polarization  
Pseudorandom Hopping Mode, Low End of Frequency Band, 915.75 MHz, XTCA0, Data Rate at 10 kbps

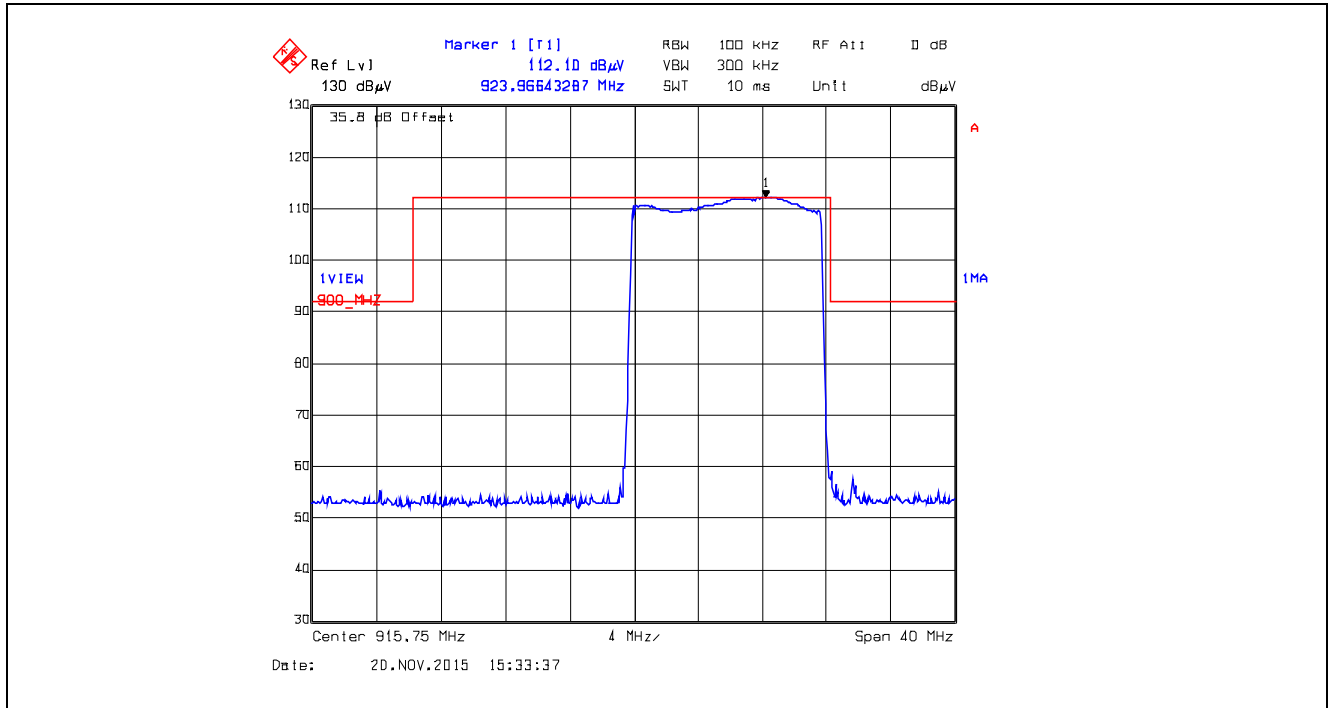

**Plot 5.5.4.1.2.43.** Band-Edge RF Radiated Emissions at 3 m, Vertical Polarization  
Single Frequency Mode, Low End of Frequency Band, 915.75 MHz, XTCA0, Data Rate at 10 kbps

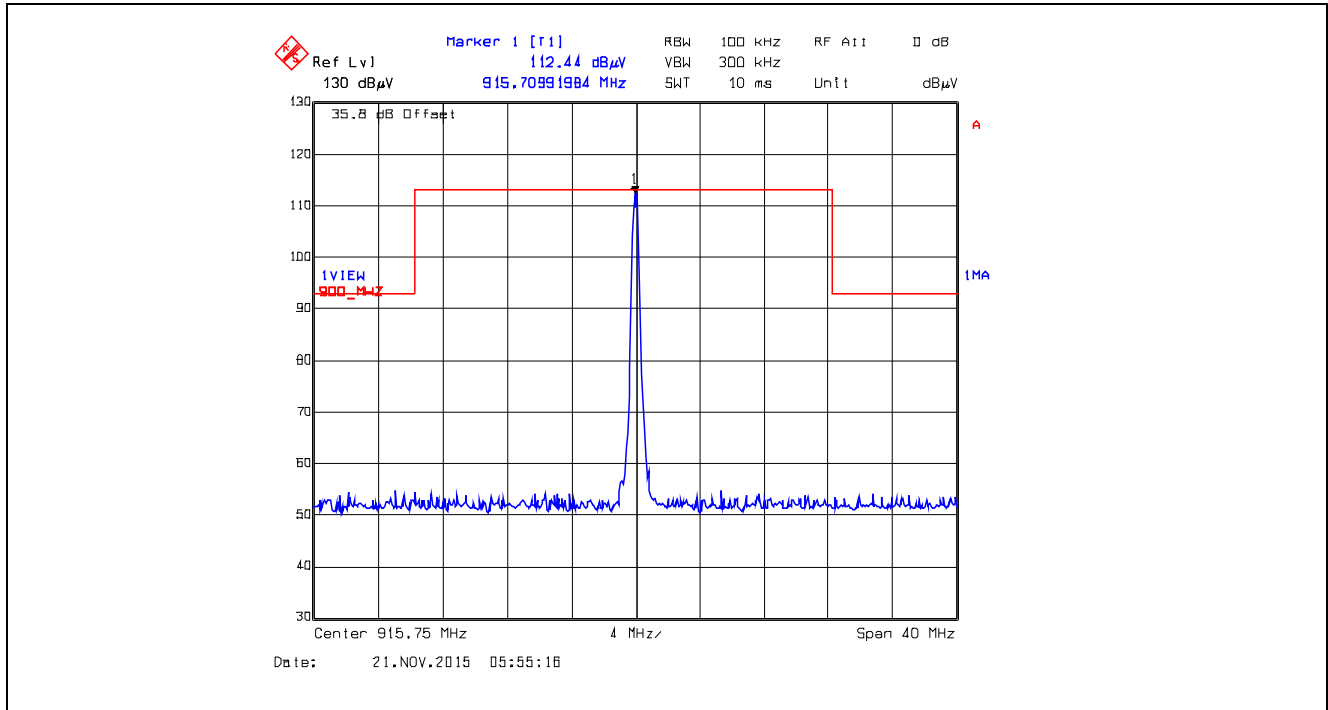

**Plot 5.5.4.1.2.44.** Band-Edge RF Radiated Emissions at 3 m, Vertical Polarization  
Pseudorandom Hopping Mode, Low End of Frequency Band, 915.75 MHz, XTCA0, Data Rate at 10 kbps

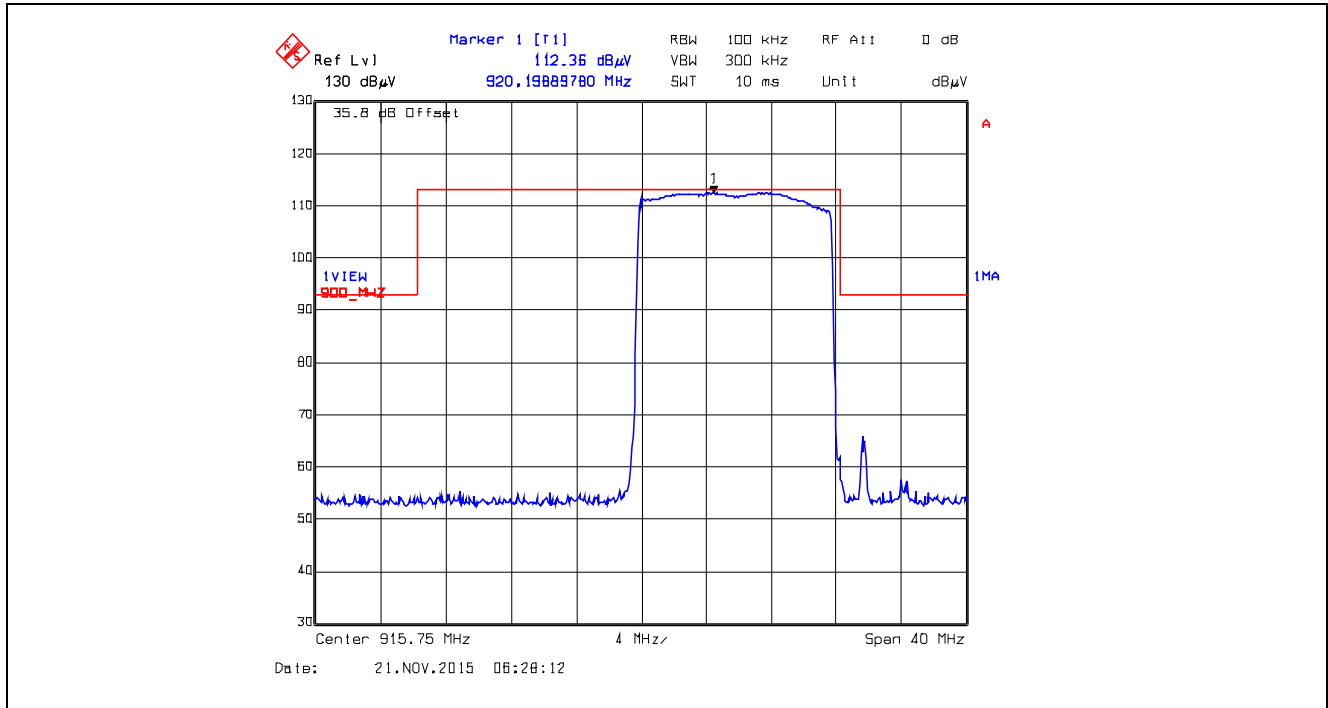



**Plot 5.5.4.1.2.45.** Band-Edge RF Radiated Emissions at 3 m, Horizontal Polarization  
 Single Frequency Mode, High End of Frequency Band, 927.265 MHz, XTCA0, Data Rate at 10 kbps

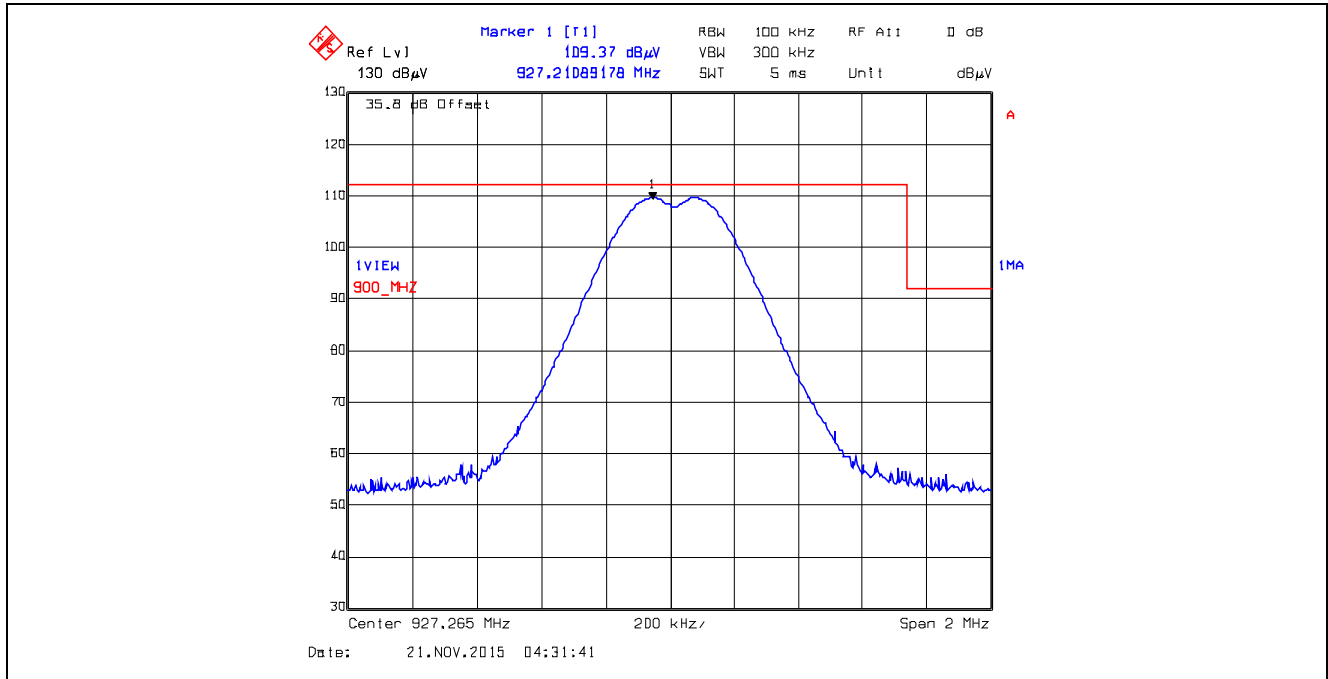

**Plot 5.5.4.1.2.46.** Band-Edge RF Radiated Emissions at 3 m, Horizontal Polarization  
 Pseudorandom Hopping Mode, High End of Frequency Band, 927.265 MHz, XTCA0, Data Rate at 10 kbps

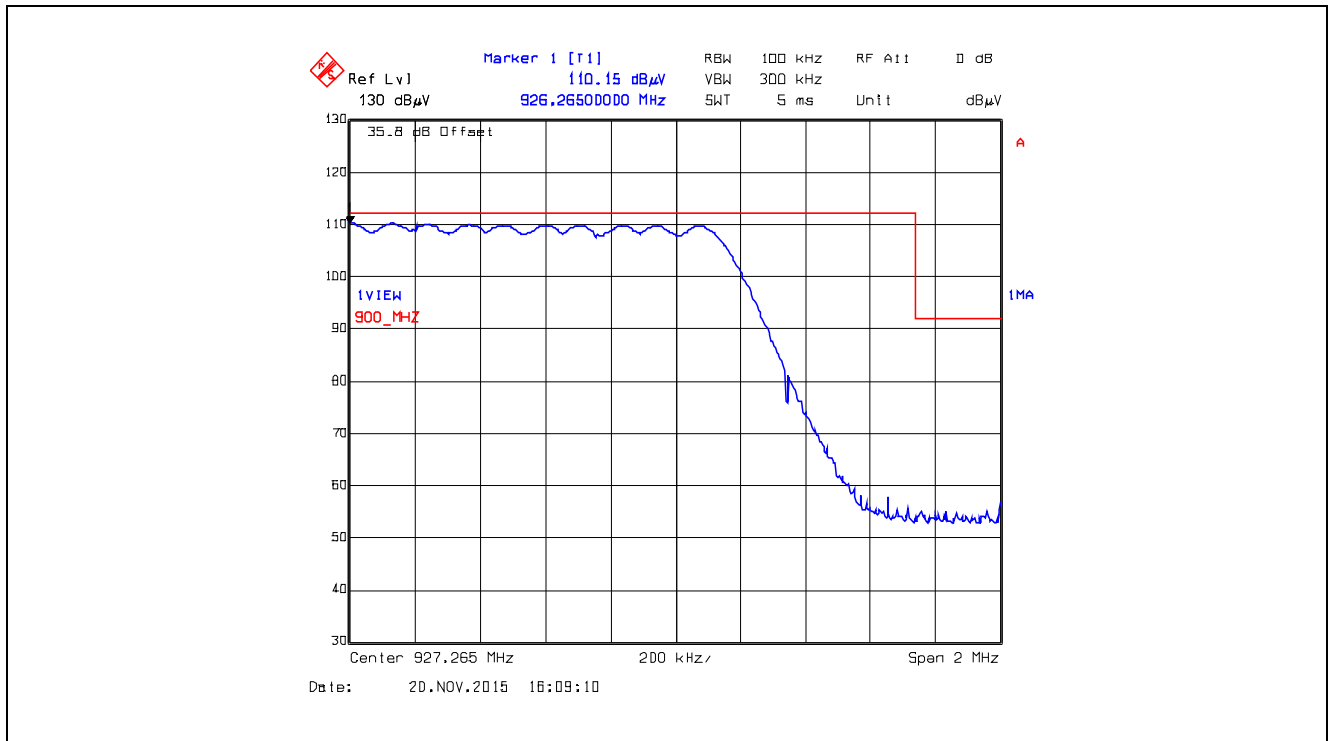

**Plot 5.5.4.1.2.47.** Band-Edge RF Radiated Emissions at 3 m, Vertical Polarization  
Single Frequency Mode, High End of Frequency Band, 927.265 MHz, XTCA0, Data Rate at 10 kbps

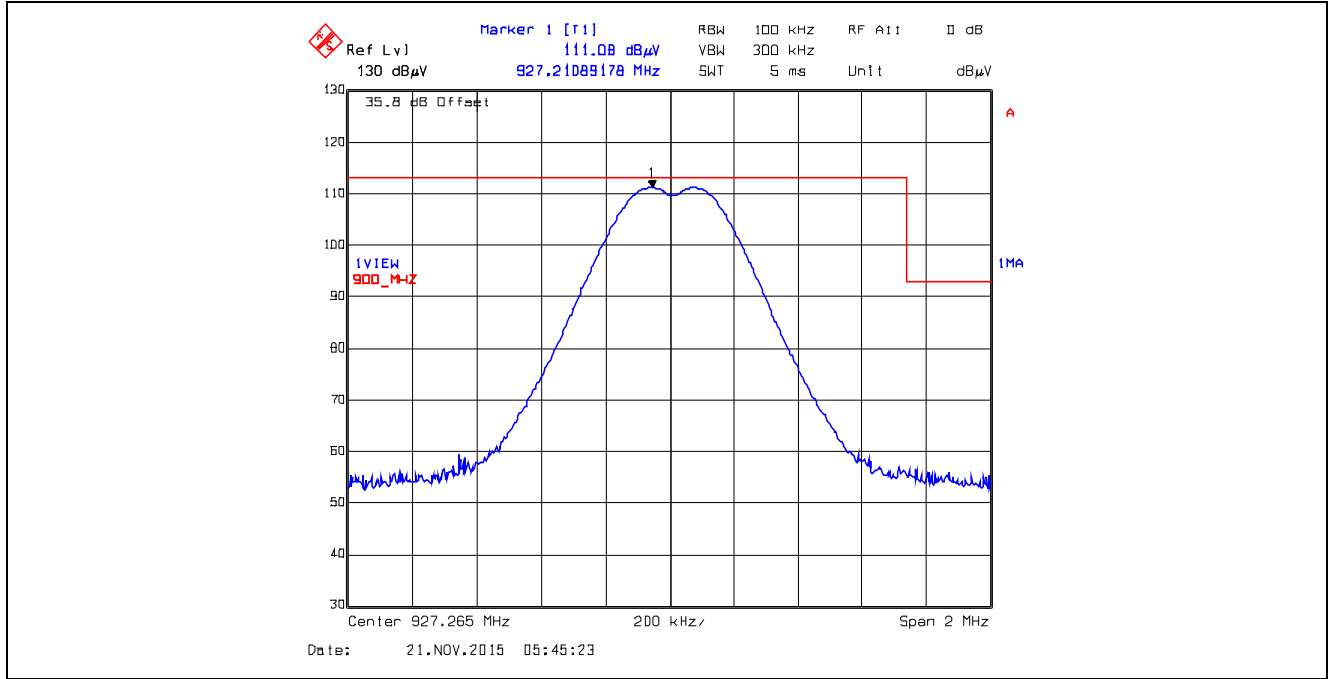

**Plot 5.5.4.1.2.48.** Band-Edge RF Radiated Emissions at 3 m, Vertical Polarization  
Pseudorandom Hopping Mode, High End of Frequency Band, 927.265 MHz, XTCA0, Data Rate at 10 kbps

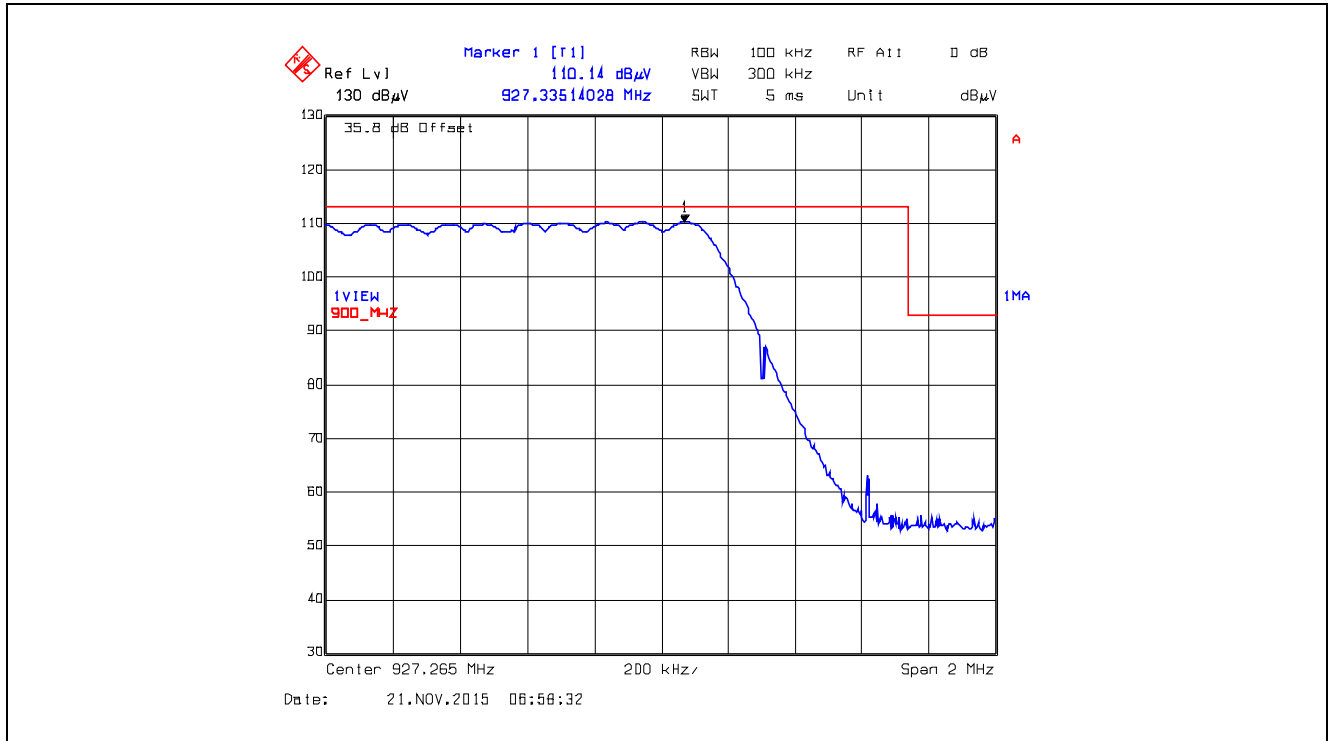

**Plot 5.5.4.1.2.49.** Band-Edge RF Radiated Emissions at 3 m, Horizontal Polarization  
 Single Frequency Mode, Low End of Frequency Band, 915.75 MHz, XTCA1, Data Rate at 105kbps

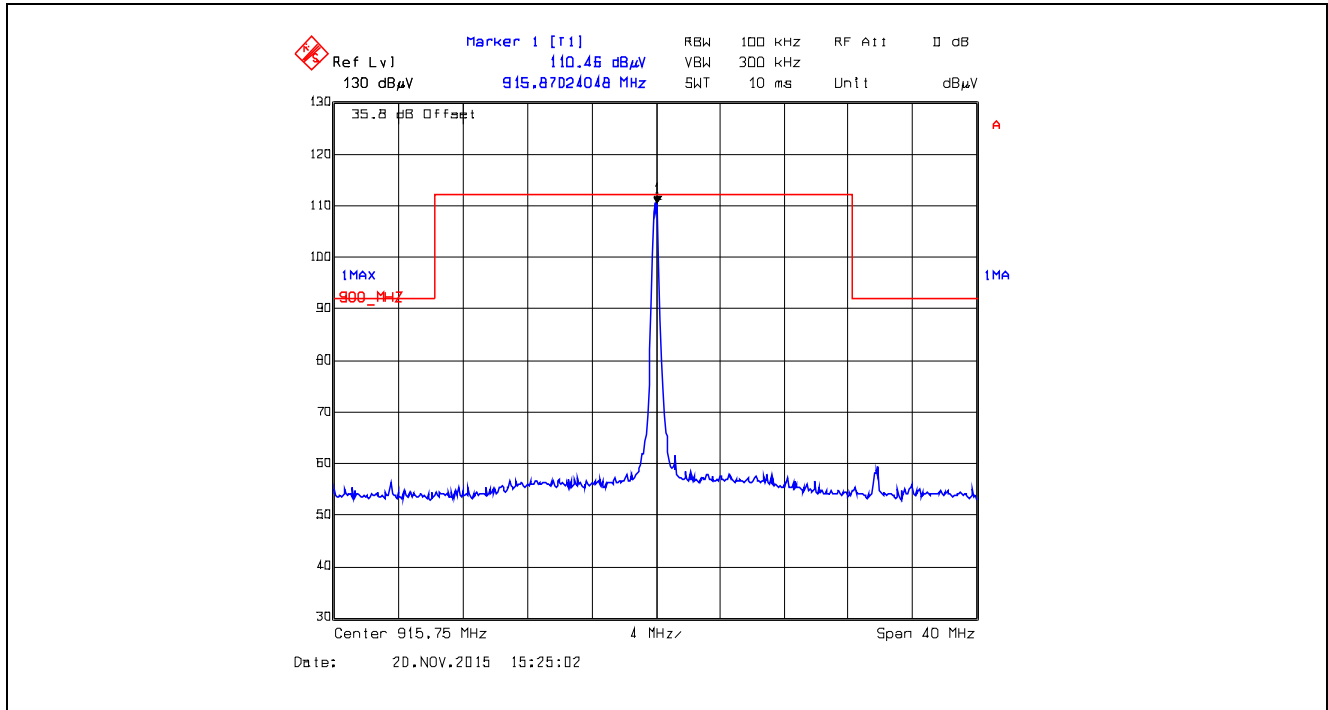

**Plot 5.5.4.1.2.50.** Band-Edge RF Radiated Emissions at 3 m, Horizontal Polarization  
 Pseudorandom Hopping Mode, Low End of Frequency Band, 915.75 MHz, XTCA1, Data Rate at 105kbps

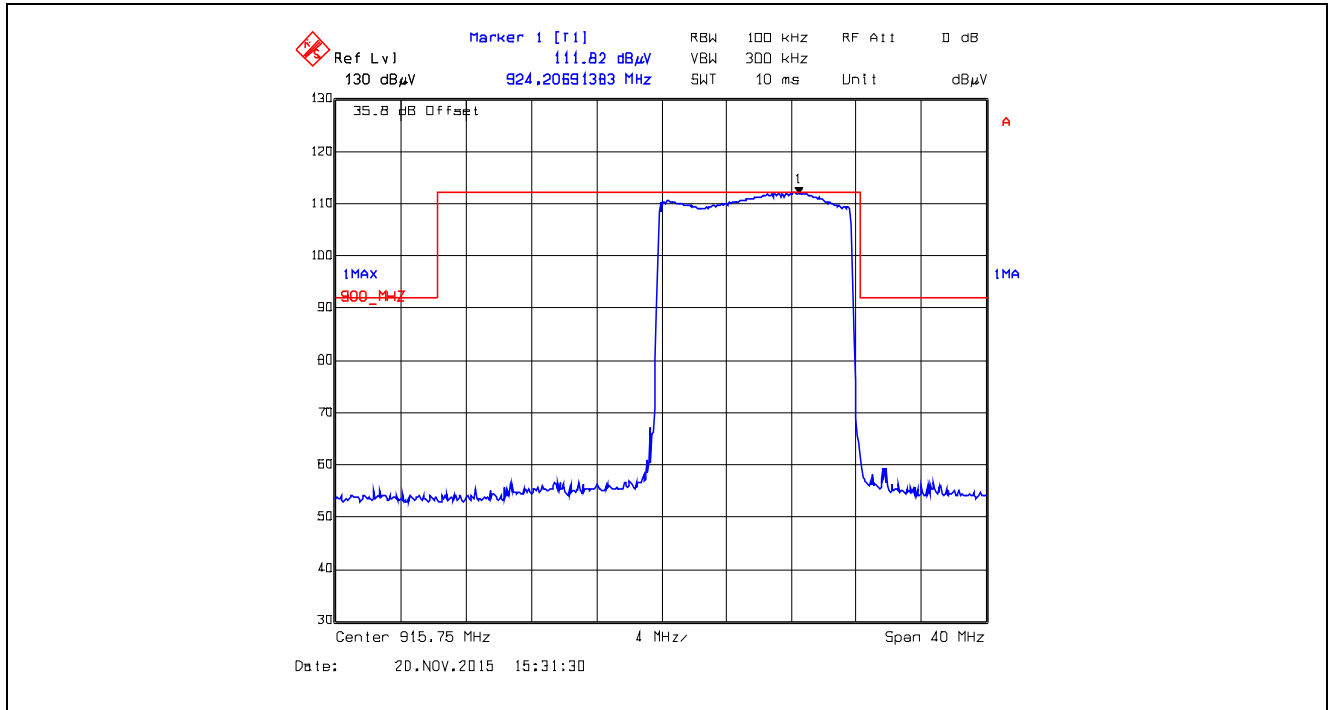

**Plot 5.5.4.1.2.51.** Band-Edge RF Radiated Emissions at 3 m, Vertical Polarization  
Single Frequency Mode, Low End of Frequency Band, 915.75 MHz, XTCA1, Data Rate at 105kbps

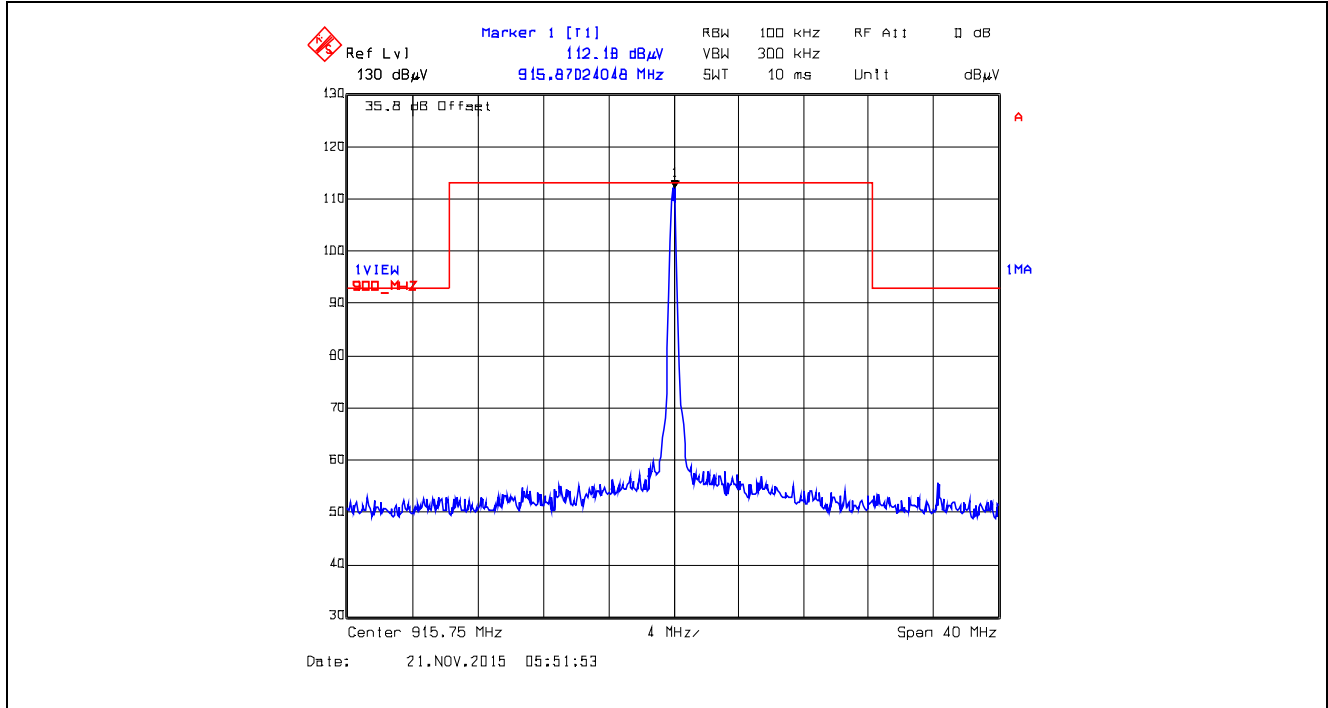

**Plot 5.5.4.1.2.52.** Band-Edge RF Radiated Emissions at 3 m, Vertical Polarization  
Pseudorandom Hopping Mode, Low End of Frequency Band, 915.75 MHz, XTCA1, Data Rate at 105kbps

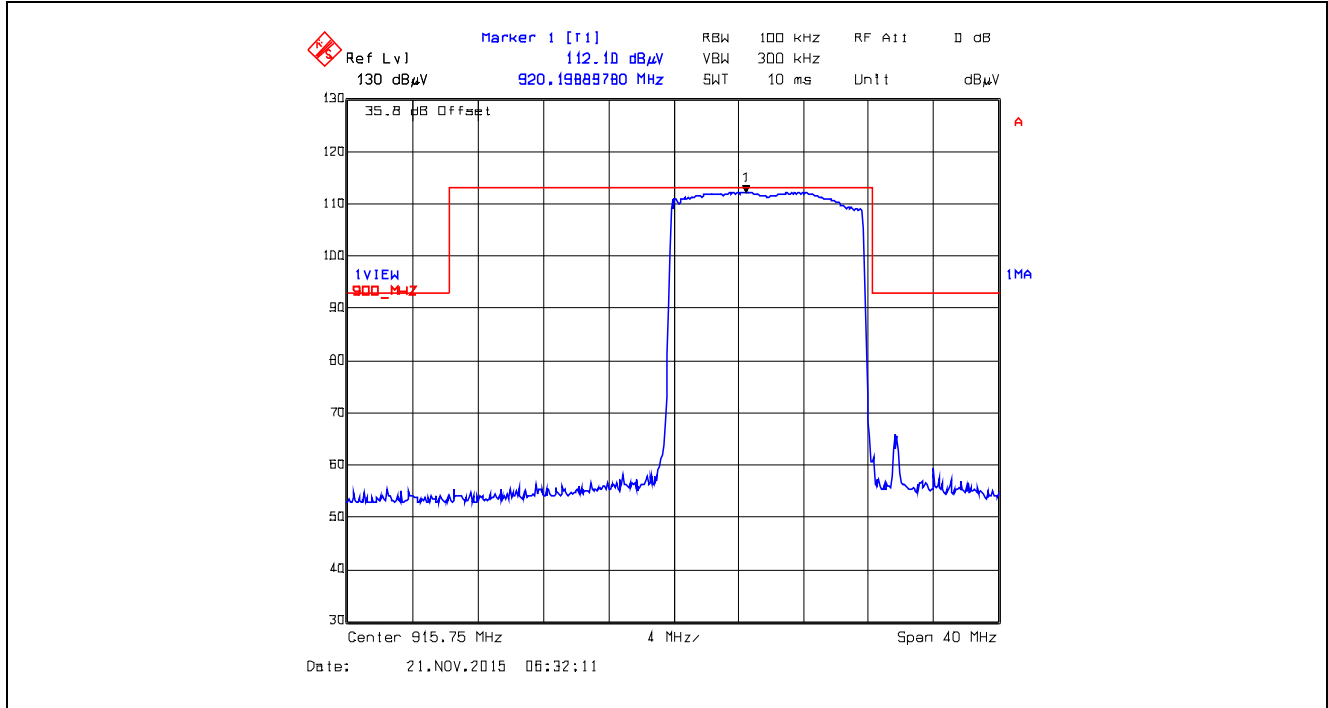

**Plot 5.5.4.1.2.53.** Band-Edge RF Radiated Emissions at 3 m, Horizontal Polarization  
 Single Frequency Mode, High End of Frequency Band, 927.265 MHz, XTCA1, Data Rate at 105kbps

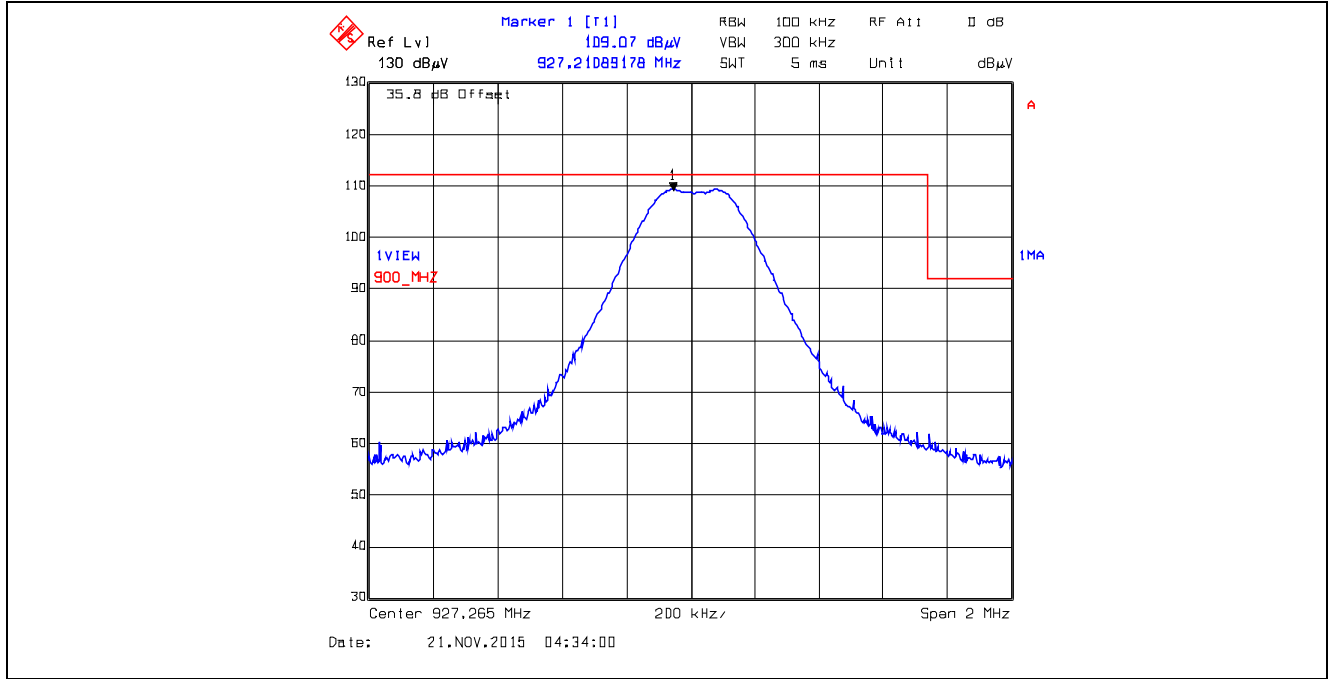

**Plot 5.5.4.1.2.54.** Band-Edge RF Radiated Emissions at 3 m, Horizontal Polarization  
 Pseudorandom Hopping Mode, High End of Frequency Band, 927.265 MHz, XTCA1, Data Rate at 105kbps

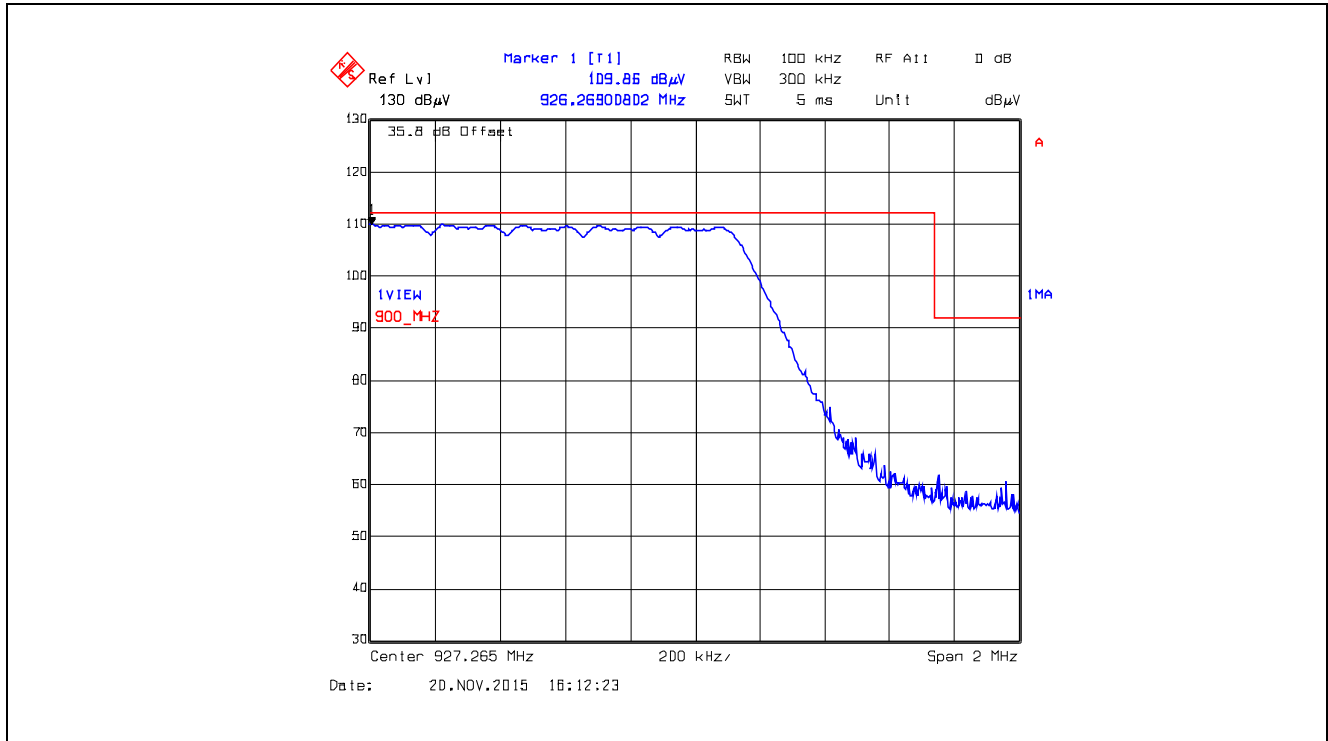

**Plot 5.5.4.1.2.55.** Band-Edge RF Radiated Emissions at 3 m, Vertical Polarization  
Single Frequency Mode, High End of Frequency Band, 927.265 MHz, XTCA1, Data Rate at 105kbps

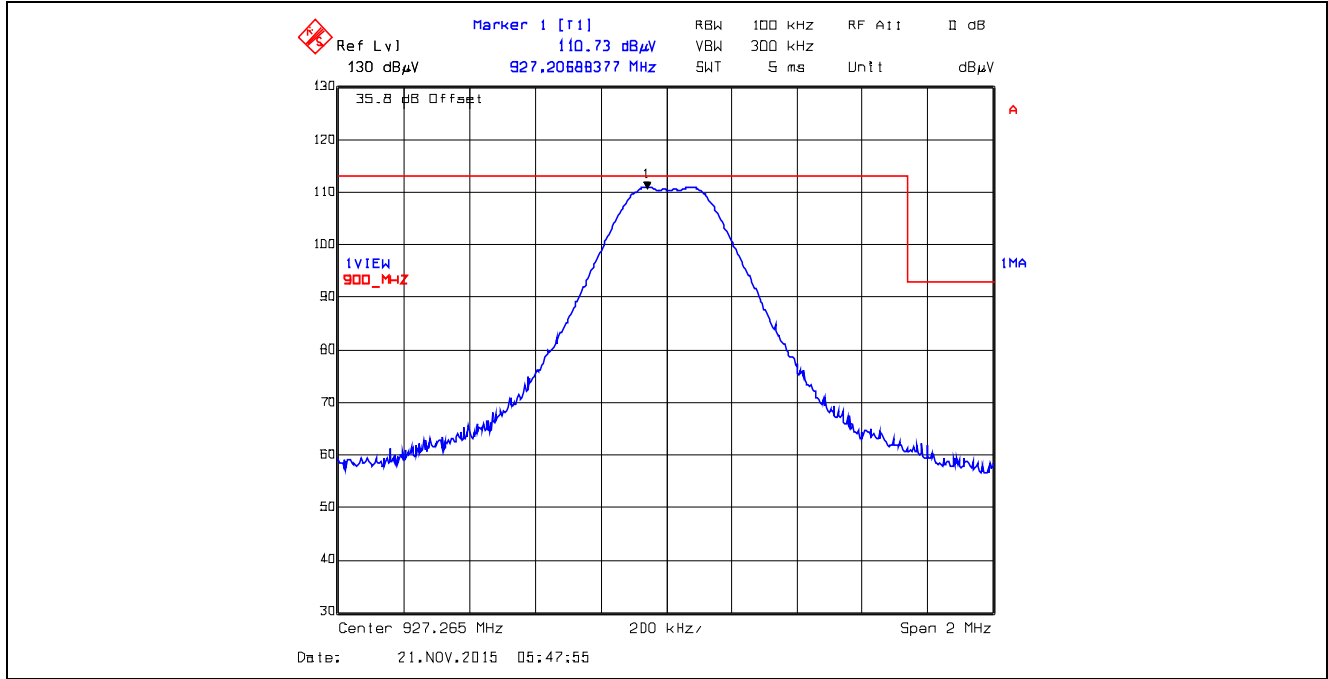

**Plot 5.5.4.1.2.56.** Band-Edge RF Radiated Emissions at 3 m, Vertical Polarization  
Pseudorandom Hopping Mode, High End of Frequency Band, 927.265 MHz, XTCA1, Data Rate at 105kbps

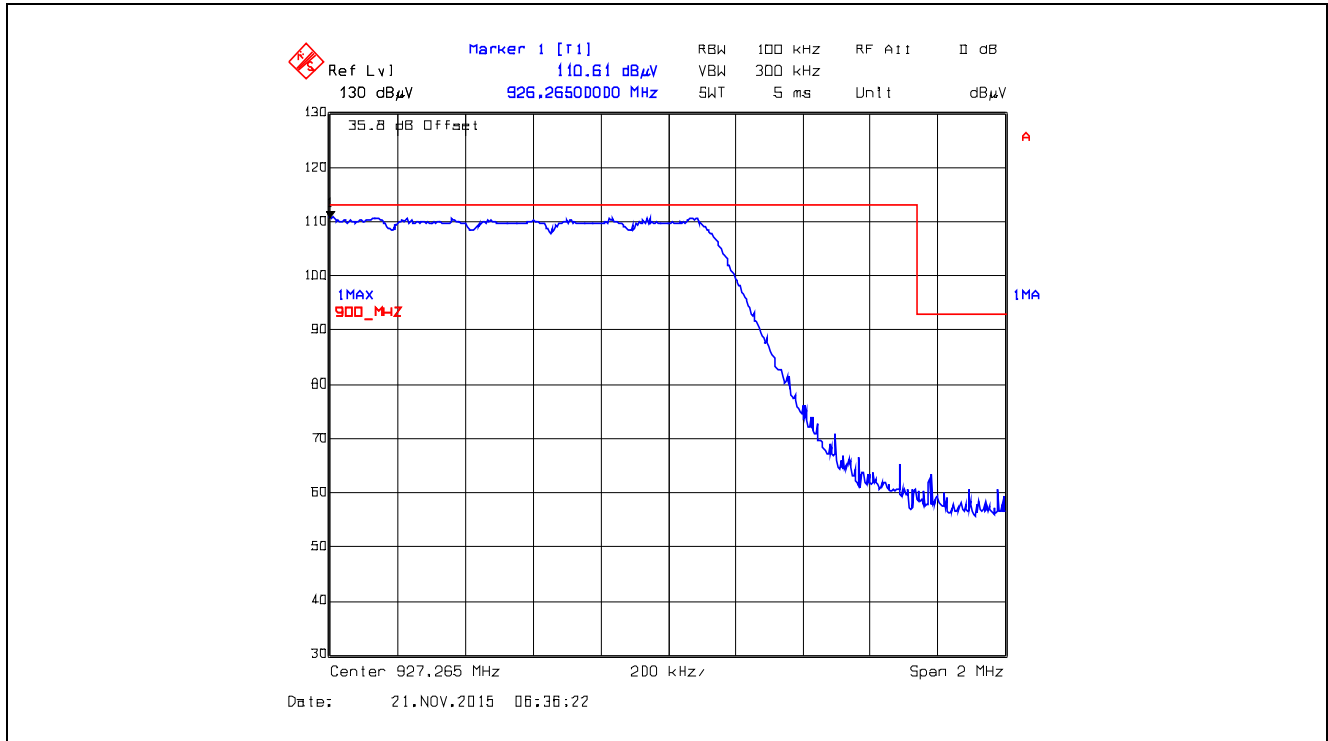

**5.5.4.2. EUT with 3 dBi Dome Antenna and 0.44 dB Assembly Cable Loss**

**5.5.4.2.1. Spurious Radiated Emissions**

Fundamental Frequency:		902.5 MHz					
Configuration:		XBX0					
Measured Conducted Power:		13.36 dBm					
Frequency Test Range:		30 MHz – 10 GHz					
Frequency (MHz)	RF Peak Level (dBµV/m)	RF Avg Level (dBµV/m)	Antenna Plane (H/V)	Limit 15.209 (dBµV/m)	Limit 15.247 (dBµV/m)	Margin (dB)	Pass/Fail
902.50	111.86	--	V	--	--	--	--
902.50	102.29	--	H	--	--	--	--
2707.50	44.80	34.00	V	54.0	91.9	-20.0	Pass*
2707.50	44.90	32.00	H	54.0	91.9	-22.0	Pass*
3610.00	48.00	34.90	V	54.0	91.9	-19.1	Pass*
3610.00	48.00	33.90	H	54.0	91.9	-20.1	Pass*
4512.50	50.10	40.60	V	54.0	91.9	-13.4	Pass*
4512.50	51.00	43.90	H	54.0	91.9	-10.1	Pass*
5415.00	55.70	50.10	V	54.0	91.9	-3.9	Pass*
5415.00	59.20	44.40	H	54.0	91.9	-9.6	Pass*
All other spurious emissions and harmonics are more than 20 dB below the applicable limit.							

\*Field strength of emissions appearing within restricted frequency bands shall not exceed the limits in § 15.209.

Fundamental Frequency:		915.0 MHz					
Configuration:		XBX0					
Measured Conducted Power:		13.49 dBm					
Frequency Test Range:		30 MHz – 10 GHz					
Frequency (MHz)	RF Peak Level (dBµV/m)	RF Avg Level (dBµV/m)	Antenna Plane (H/V)	Limit 15.209 (dBµV/m)	Limit 15.247 (dBµV/m)	Margin (dB)	Pass/Fail
915.0	110.31	--	V	--	--	--	--
915.0	101.25	--	H	--	--	--	--
2745.0	45.60	36.30	V	54.0	90.3	-21.5	Pass*
2745.0	44.60	33.10	H	54.0	90.3	-24.4	Pass*
3660.0	47.80	35.50	V	54.0	90.3	-19.0	Pass*
3660.0	47.50	34.00	H	54.0	90.3	-19.9	Pass*
4575.0	51.00	43.60	V	54.0	90.3	-13.3	Pass*
4575.0	52.50	46.50	H	54.0	90.3	-9.7	Pass*
All other spurious emissions and harmonics are more than 20 dB below the applicable limit.							

\*Field strength of emissions appearing within restricted frequency bands shall not exceed the limits in § 15.209.

**ULTRATECH GROUP OF LABS**

3000 Bristol Circle, Oakville, Ontario, Canada L6H 6G4  
 Tel. #: 905-829-1570, Fax. #: 905-829-8050, Email: [vic@ultratech-labs.com](mailto:vic@ultratech-labs.com), Website: <http://www.ultratech-labs.com>

File #: 15DIG102\_FCC15C247  
 December 24, 2015

*All test results contained in this engineering test report are traceable to National Institute of Standards and Technology (NIST)*

Fundamental Frequency:		927.5 MHz					
Configuration:		XBX0					
Measured Conducted Power:		13.49 dBm					
Frequency Test Range:		30 MHz – 10 GHz					
Frequency (MHz)	RF Peak Level (dBµV/m)	RF Avg Level (dBµV/m)	Antenna Plane (H/V)	Limit 15.209 (dBµV/m)	Limit 15.247 (dBµV/m)	Margin (dB)	Pass/Fail
927.5	109.58	--	V	--	--	--	--
927.5	100.52	--	H	--	--	--	--
2782.5	44.50	35.80	V	54.0	89.6	-18.2	Pass*
2782.5	45.80	33.70	H	54.0	89.6	-20.3	Pass*
3710.0	48.50	36.70	V	54.0	89.6	-17.3	Pass*
3710.0	48.10	35.10	H	54.0	89.6	-18.9	Pass*
4637.5	52.40	46.40	V	54.0	89.6	-7.6	Pass*
4637.5	54.00	48.80	H	54.0	89.6	-5.2	Pass*
All other spurious emissions and harmonics are more than 20 dB below the applicable limit.							

**5.5.4.2.2. Band-Edge RF Radiated Emissions**

Refer to the following plots.



**Plot 5.5.4.2.2.1.** Band-Edge RF Radiated Emissions at 3 m, Horizontal Polarization  
 Single Frequency Mode, Low End of Frequency Band, 902.5 MHz, XBX0, Data Rate at 10 kbps

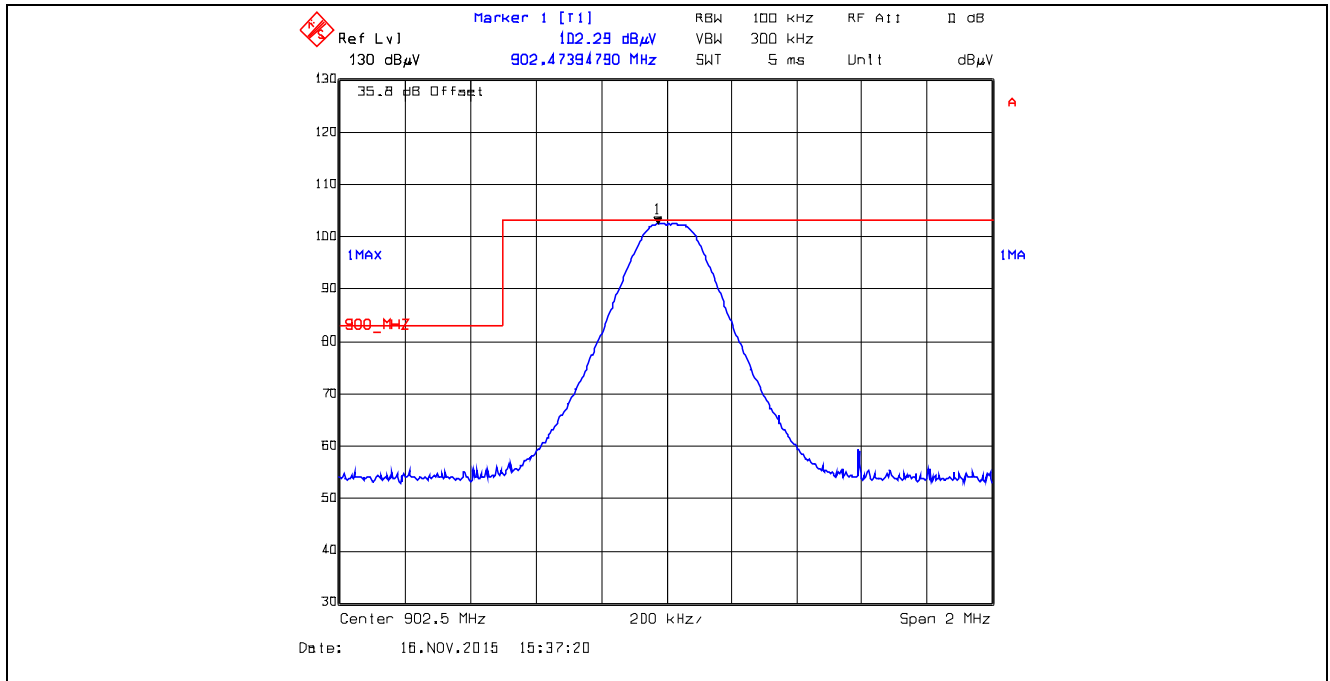

**Plot 5.5.4.2.2.2.** Band-Edge RF Radiated Emissions at 3 m, Horizontal Polarization  
 Pseudorandom Hopping Mode, Low End of Frequency Band, 902.5 MHz, XBX0, Data Rate at 10 kbps

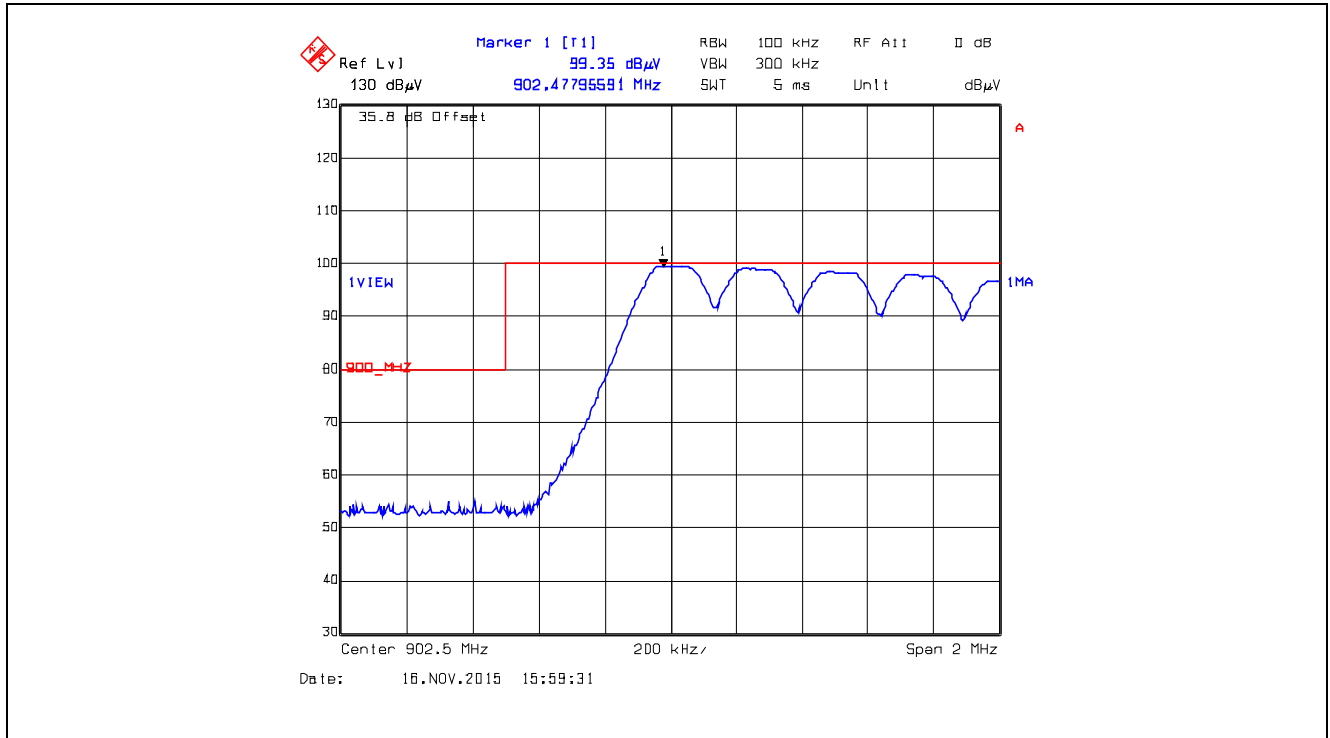



**Plot 5.5.4.2.2.5.** Band-Edge RF Radiated Emissions at 3 m, Horizontal Polarization  
 Single Frequency Mode, High End of Frequency Band, 927.5 MHz, XBX0, Data Rate at 10 kbps

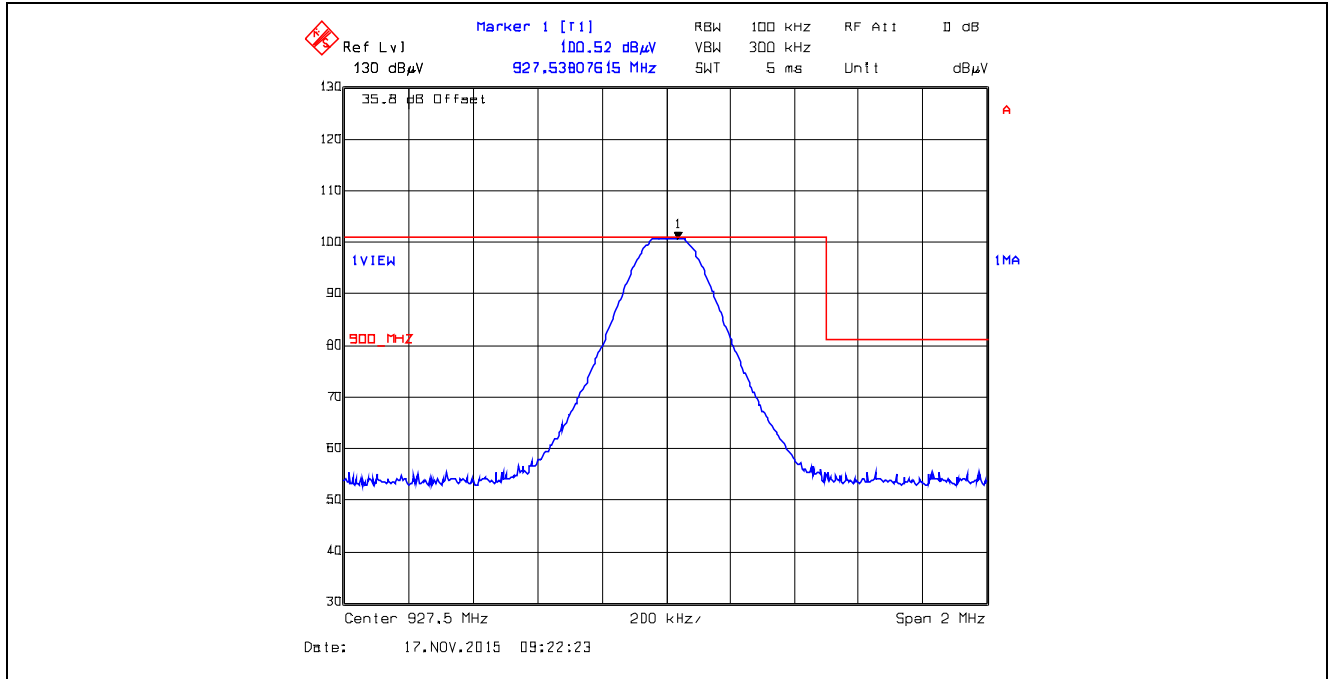

**Plot 5.5.4.2.2.6.** Band-Edge RF Radiated Emissions at 3 m, Horizontal Polarization  
 Pseudorandom Hopping Mode, High End of Frequency Band, 927.5 MHz, XBX0, Data Rate at 10 kbps

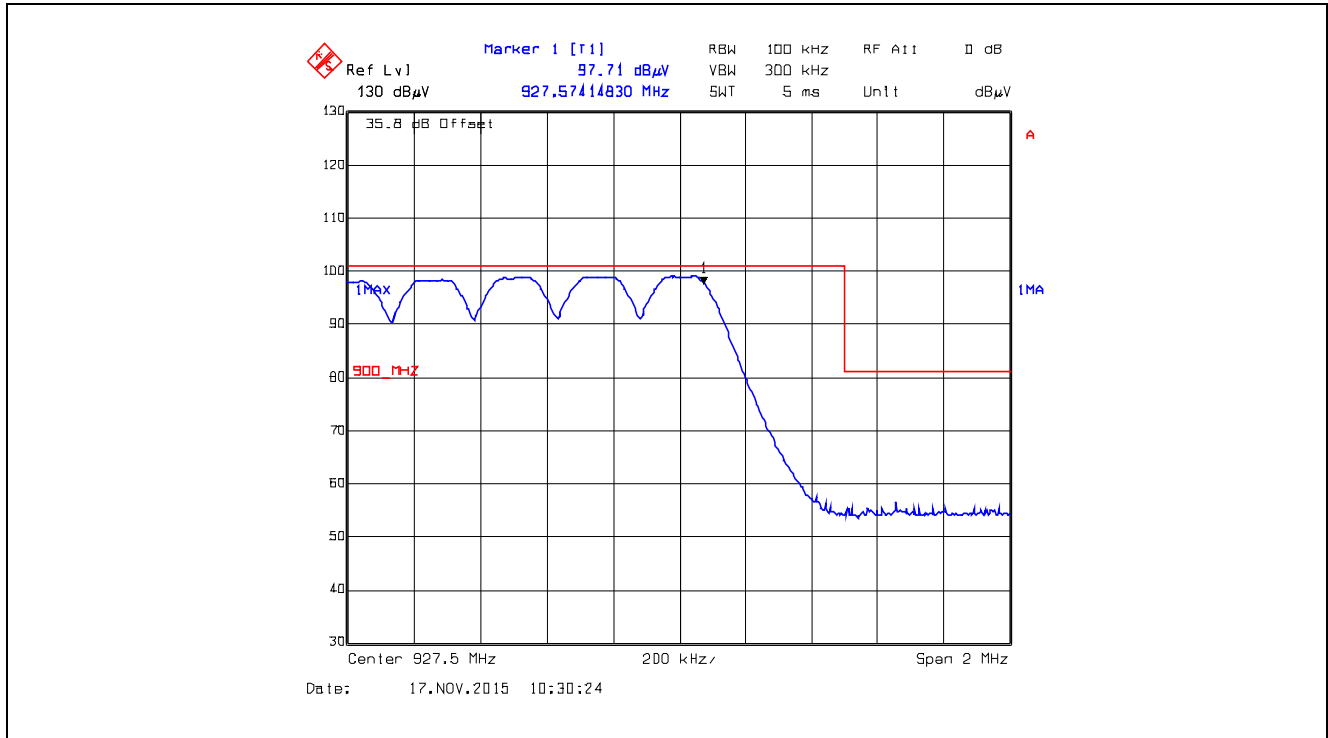

**Plot 5.5.4.2.7.** Band-Edge RF Radiated Emissions at 3 m, Vertical Polarization  
 Single Frequency Mode, High End of Frequency Band, 927.5 MHz, XBX0, Data Rate at 10 kbps

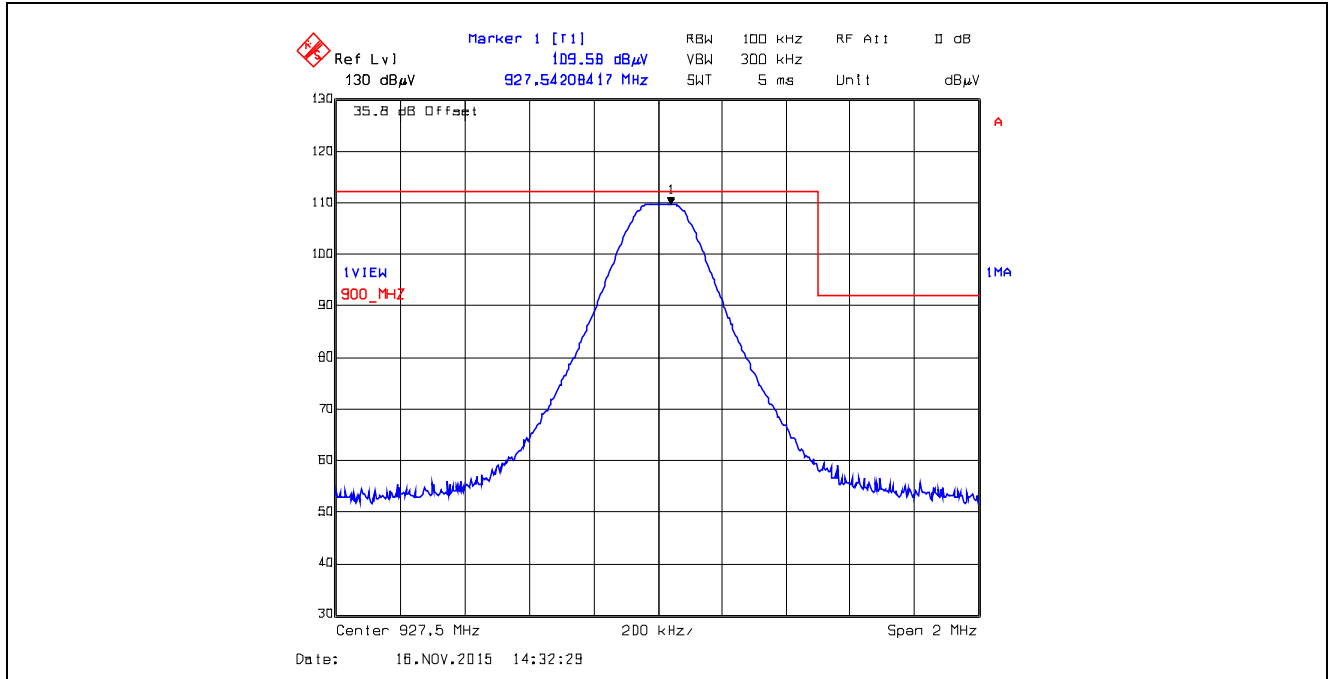

**Plot 5.5.4.2.8.** Band-Edge RF Radiated Emissions at 3 m, Vertical Polarization  
 Pseudorandom Hopping Mode, High End of Frequency Band, 927.5 MHz, XBX0, Data Rate at 10 kbps

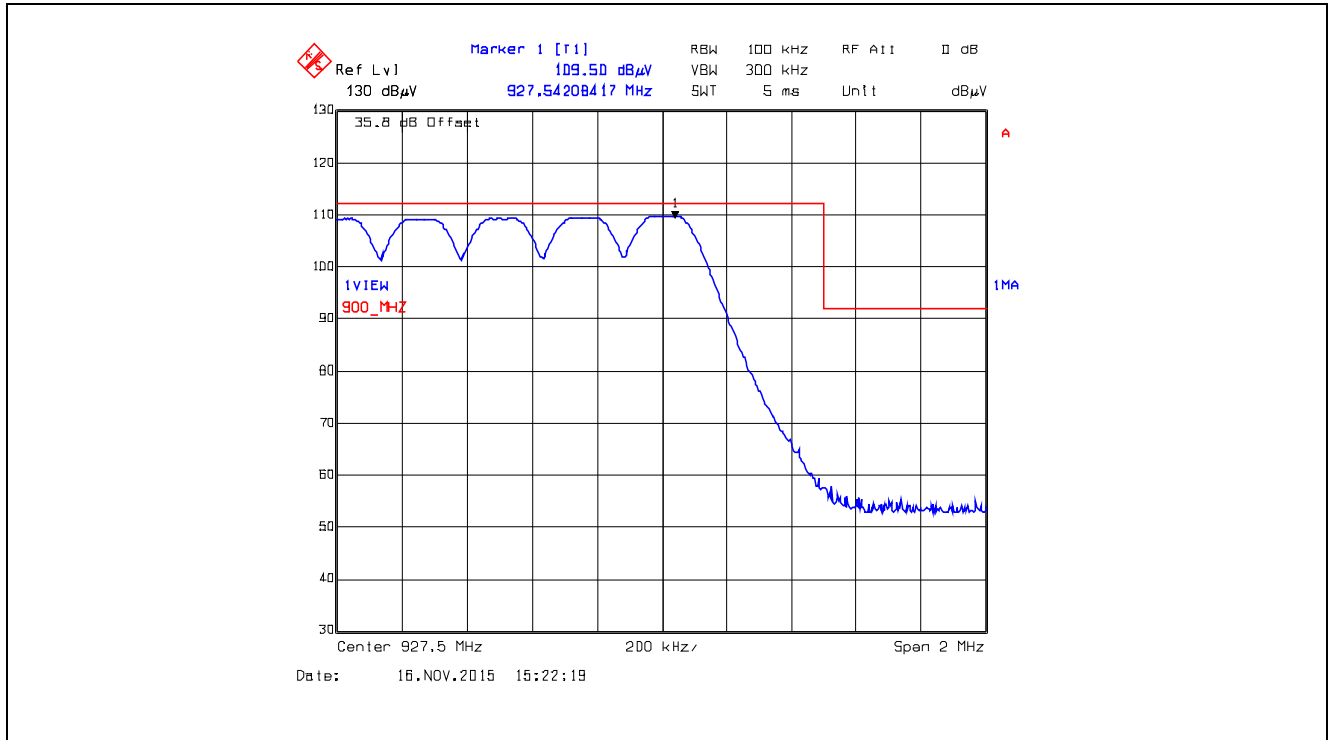

**Plot 5.5.4.2.2.9.** Band-Edge RF Radiated Emissions at 3 m, Horizontal Polarization  
 Single Frequency Mode, Low End of Frequency Band, 902.5 MHz, XB1, Data Rate at 110 kbps

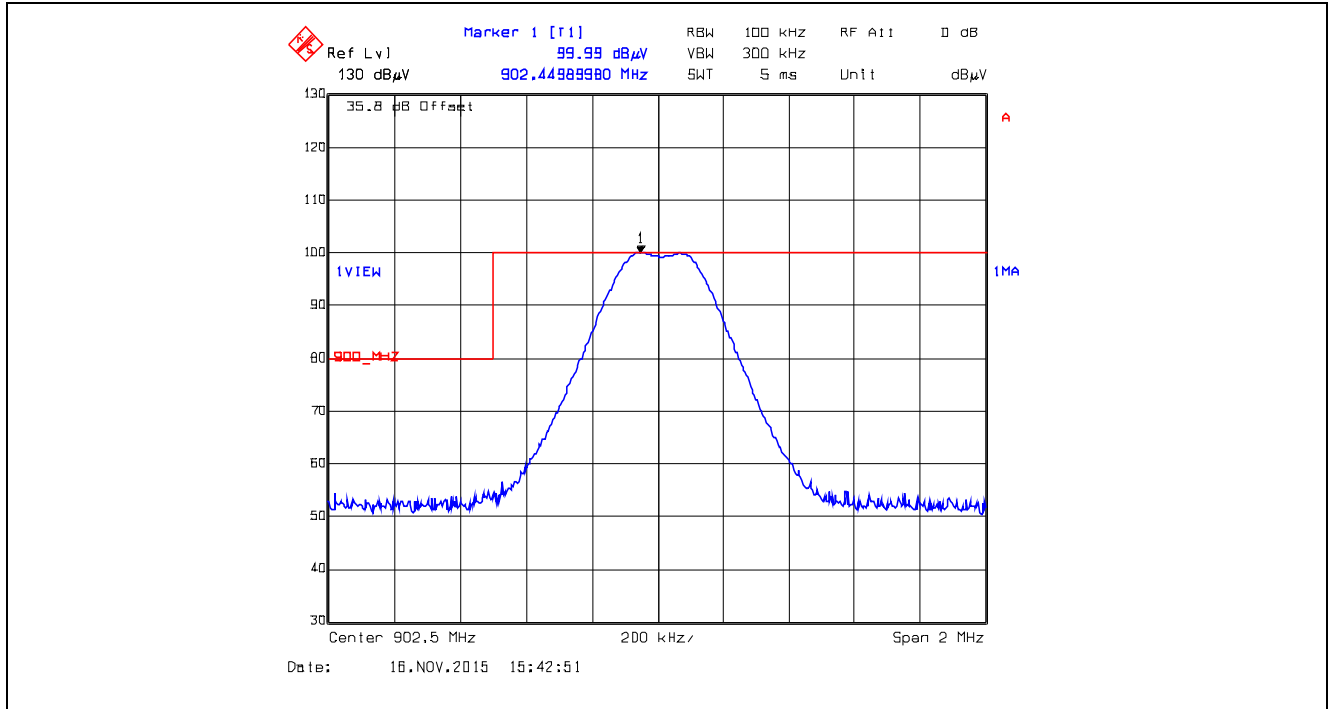

**Plot 5.5.4.2.2.10.** Band-Edge RF Radiated Emissions at 3 m, Horizontal Polarization  
 Pseudorandom Hopping Mode, Low End of Frequency Band, 902.5 MHz, XB1, Data Rate at 110 kbps

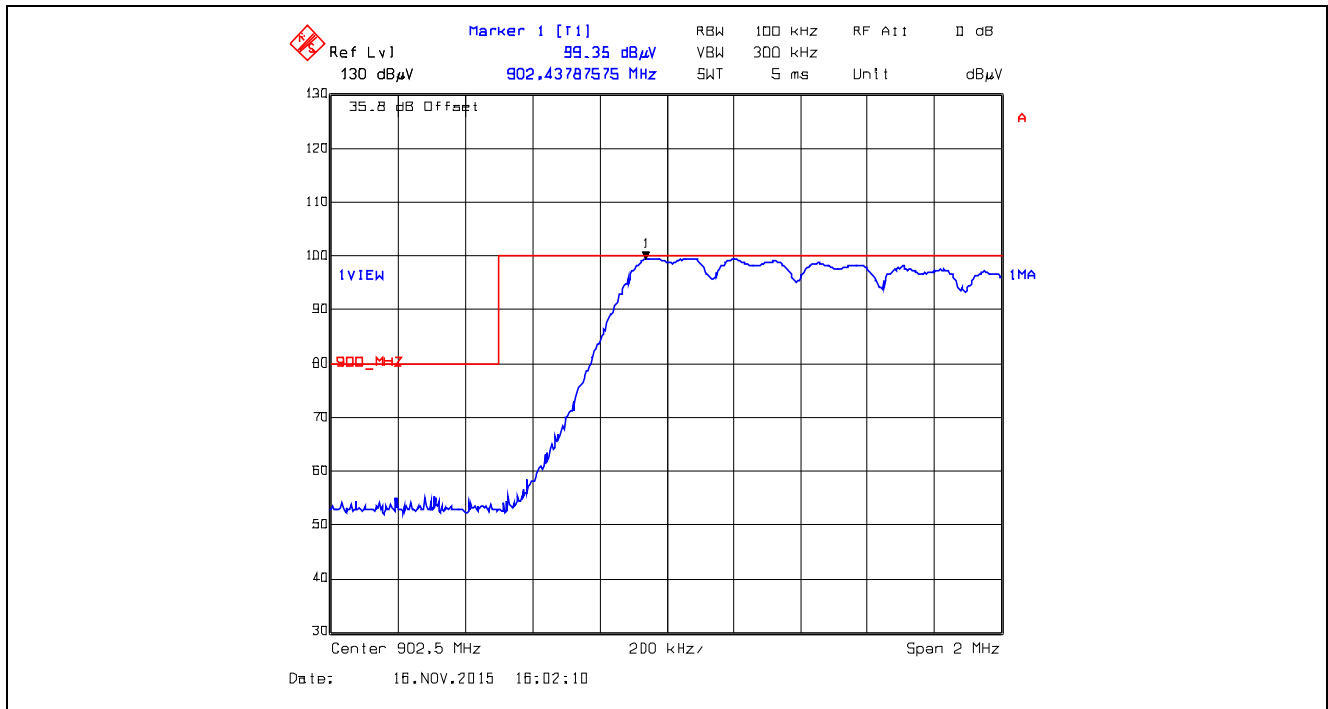

**Plot 5.5.4.2.11.** Band-Edge RF Radiated Emissions at 3 m, Vertical Polarization  
 Single Frequency Mode, Low End of Frequency Band, 902.5 MHz, XB1, Data Rate at 110 kbps

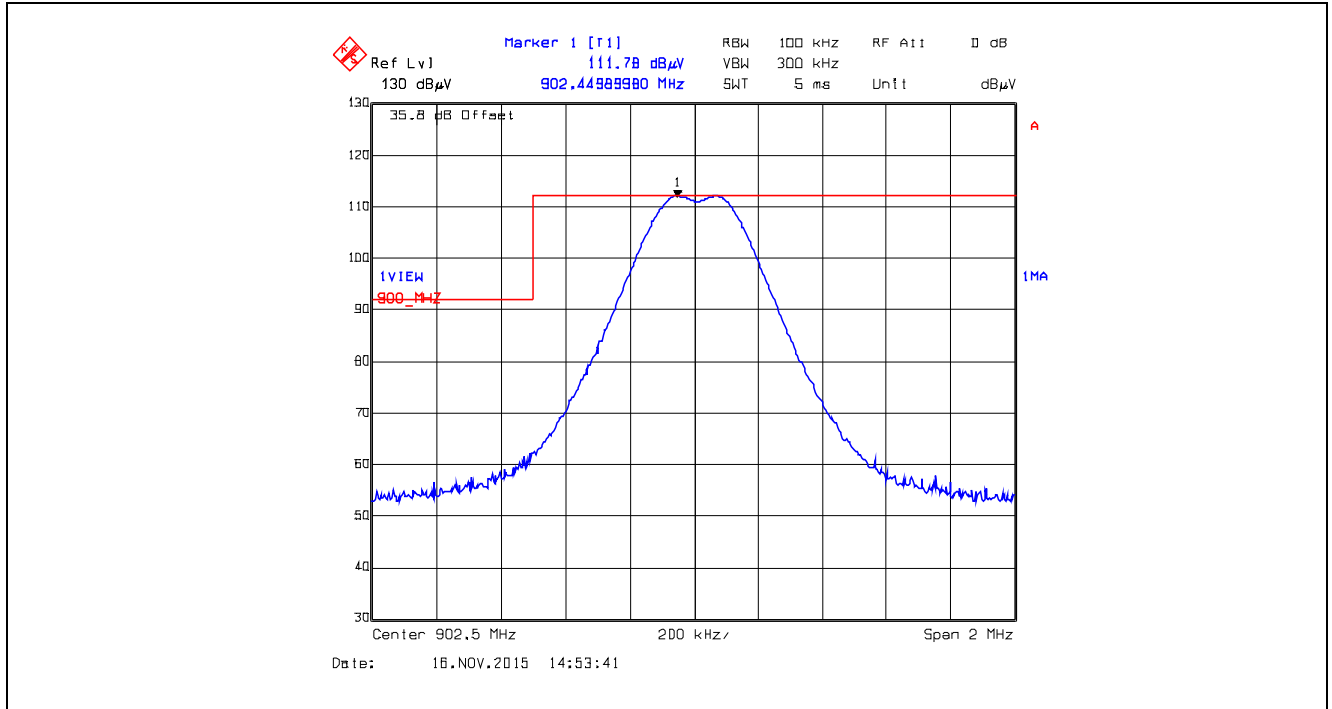

**Plot 5.5.4.2.12.** Band-Edge RF Radiated Emissions at 3 m, Vertical Polarization  
 Pseudorandom Hopping Mode, Low End of Frequency Band, 902.5 MHz, XB1, Data Rate at 110 kbps

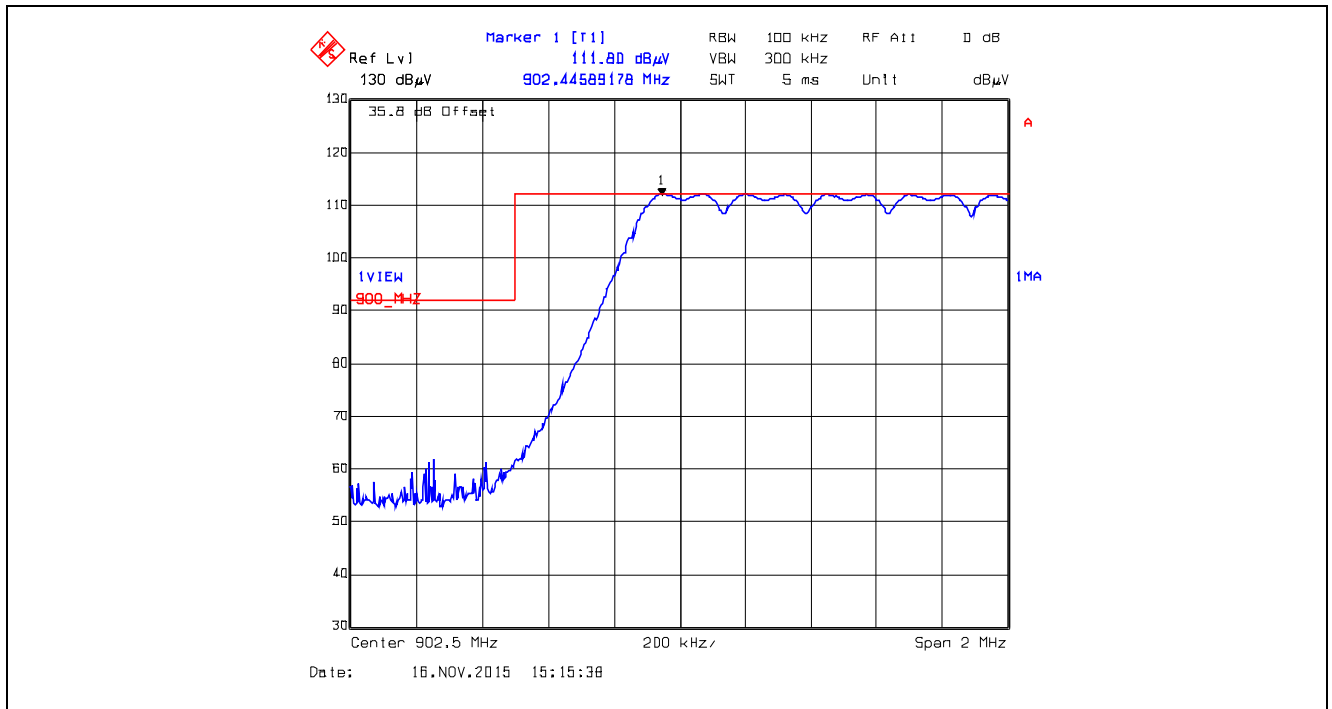

**Plot 5.5.4.2.2.13.** Band-Edge RF Radiated Emissions at 3 m, Horizontal Polarization  
 Single Frequency Mode, High End of Frequency Band, 927.5 MHz, XB1, Data Rate at 110 kbps

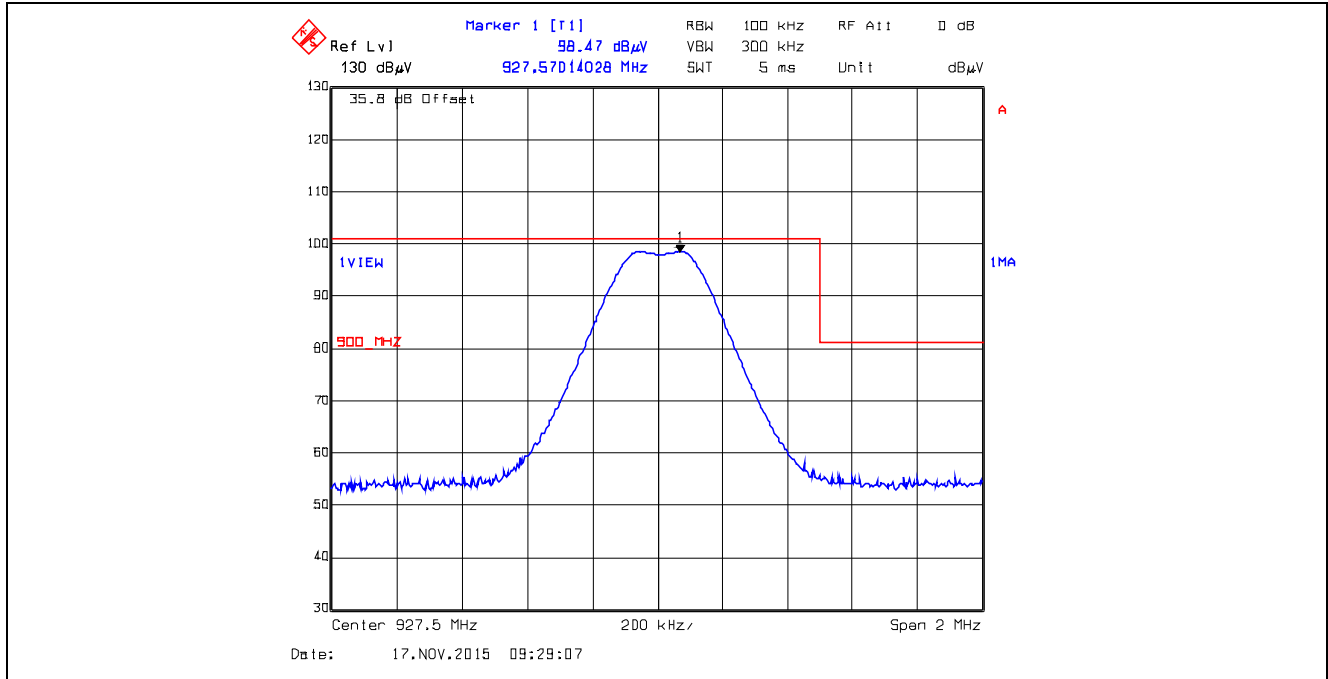

**Plot 5.5.4.2.2.14.** Band-Edge RF Radiated Emissions at 3 m, Horizontal Polarization  
 Pseudorandom Hopping Mode, High End of Frequency Band, 927.5 MHz, XB1, Data Rate at 110 kbps

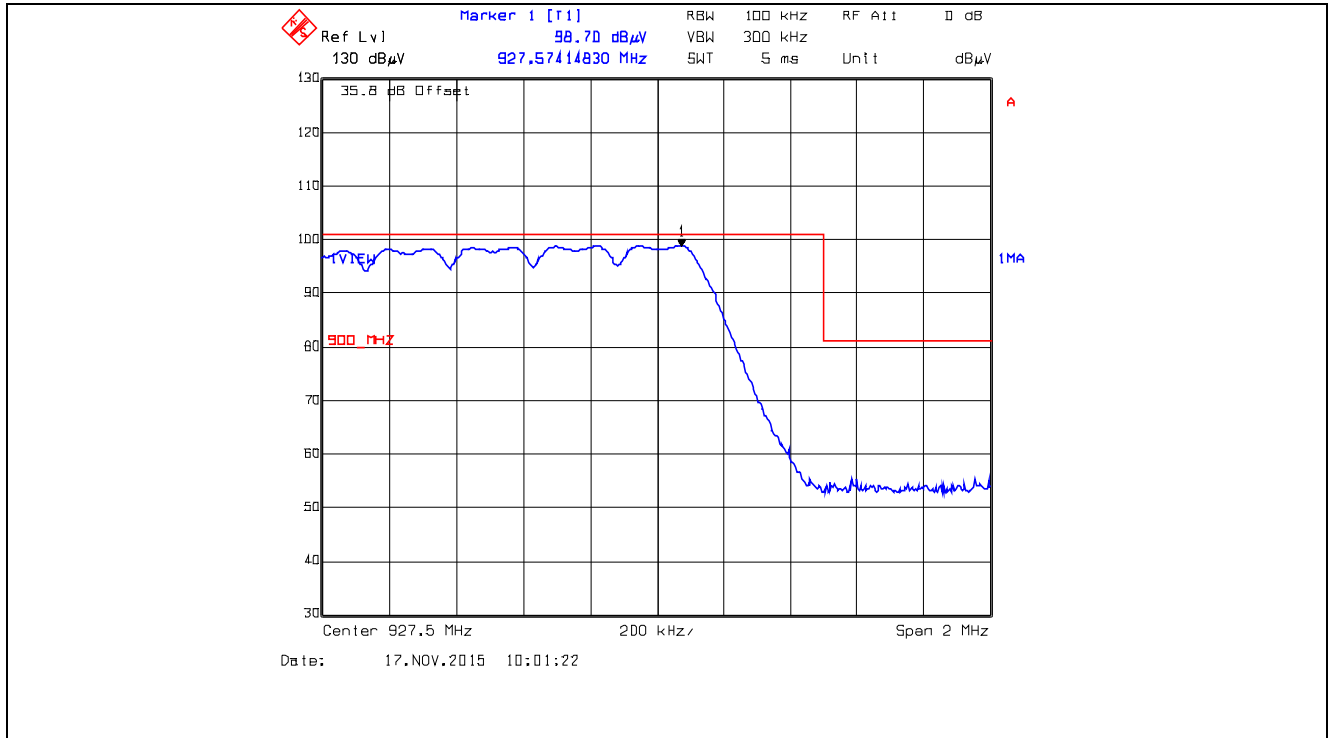

**Plot 5.5.4.2.15.** Band-Edge RF Radiated Emissions at 3 m, Vertical Polarization  
 Single Frequency Mode, High End of Frequency Band, 927.5 MHz, XBX1, Data Rate at 110 kbps

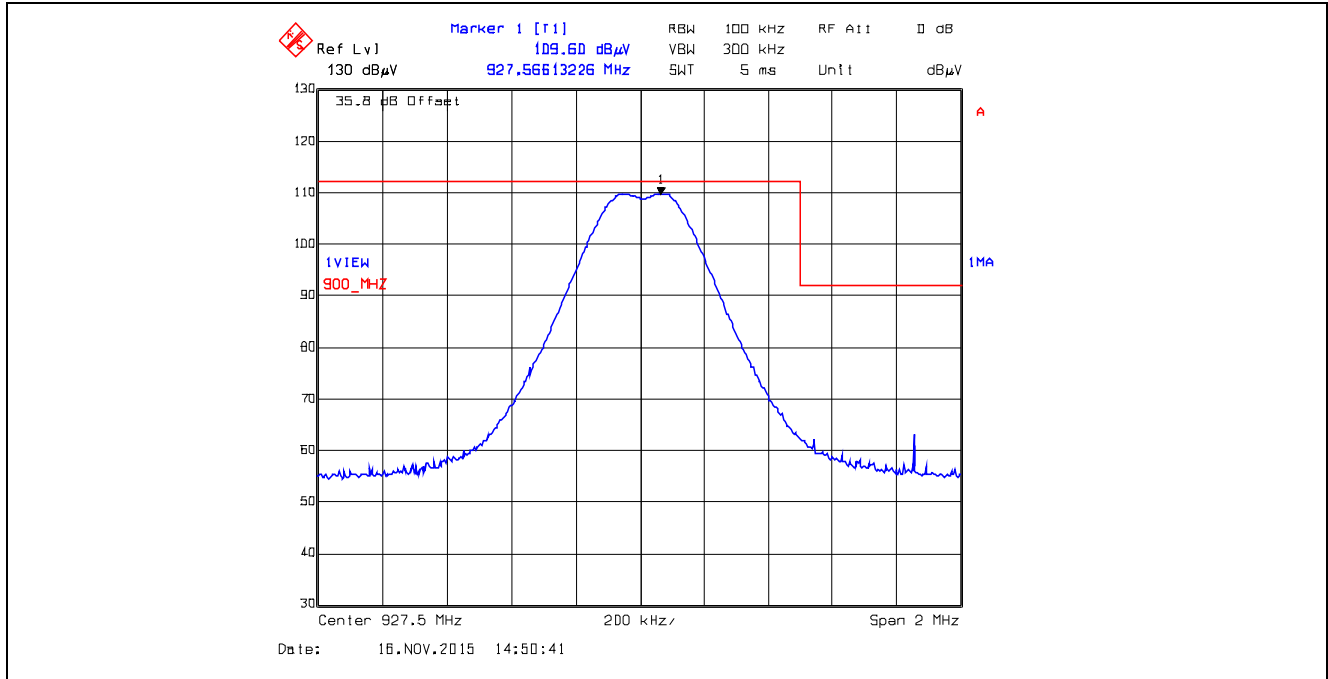

**Plot 5.5.4.2.16.** Band-Edge RF Radiated Emissions at 3 m, Vertical Polarization  
 Pseudorandom Hopping Mode, High End of Frequency Band, 927.5 MHz, XBX1, Data Rate at 110 kbps

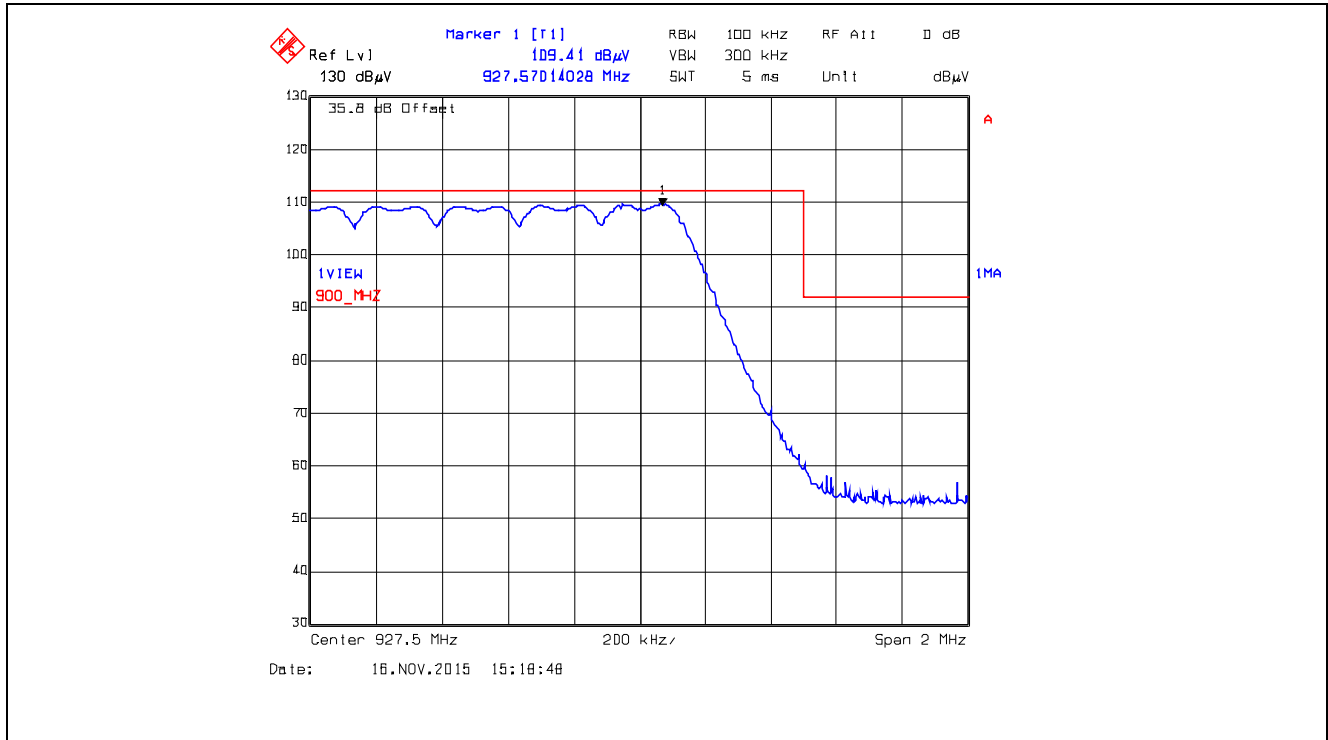



**Plot 5.5.4.2.2.17.** Band-Edge RF Radiated Emissions at 3 m, Horizontal Polarization  
 Single Frequency Mode, Low End of Frequency Band, 902.75 MHz, XB2, Data Rate at 250 kbps

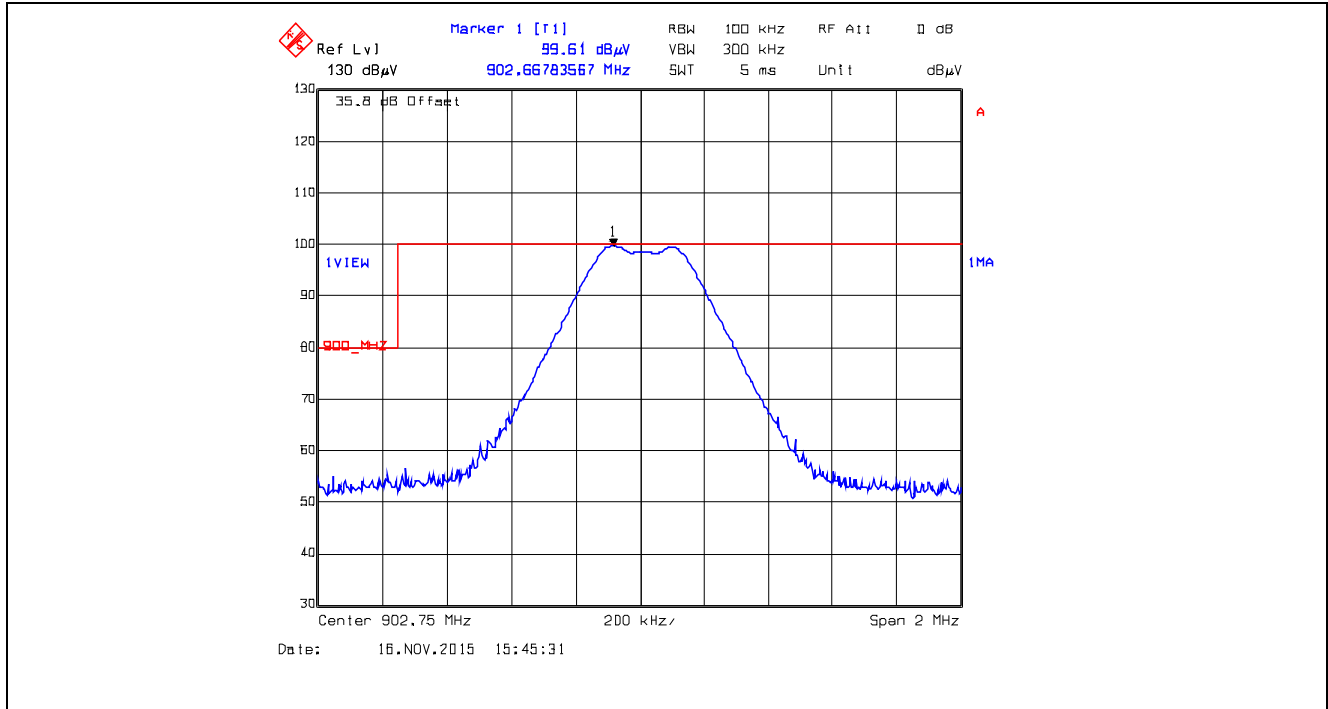

**Plot 5.5.4.2.2.18.** Band-Edge RF Radiated Emissions at 3 m, Horizontal Polarization  
 Pseudorandom Hopping Mode, Low End of Frequency Band, 902.75 MHz, XB2, Data Rate at 250 kbps

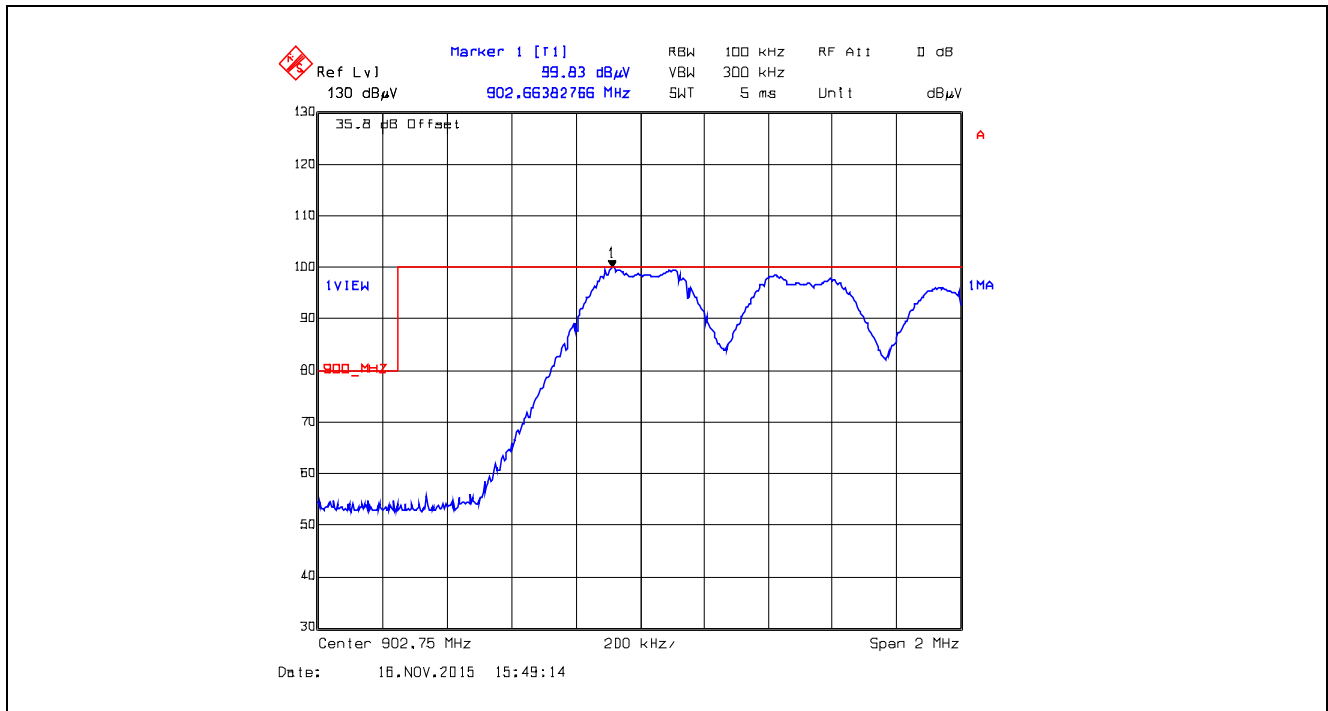

**Plot 5.5.4.2.19.** Band-Edge RF Radiated Emissions at 3 m, Vertical Polarization  
 Single Frequency Mode, Low End of Frequency Band, 902.75 MHz, XBX2, Data Rate at 250 kbps

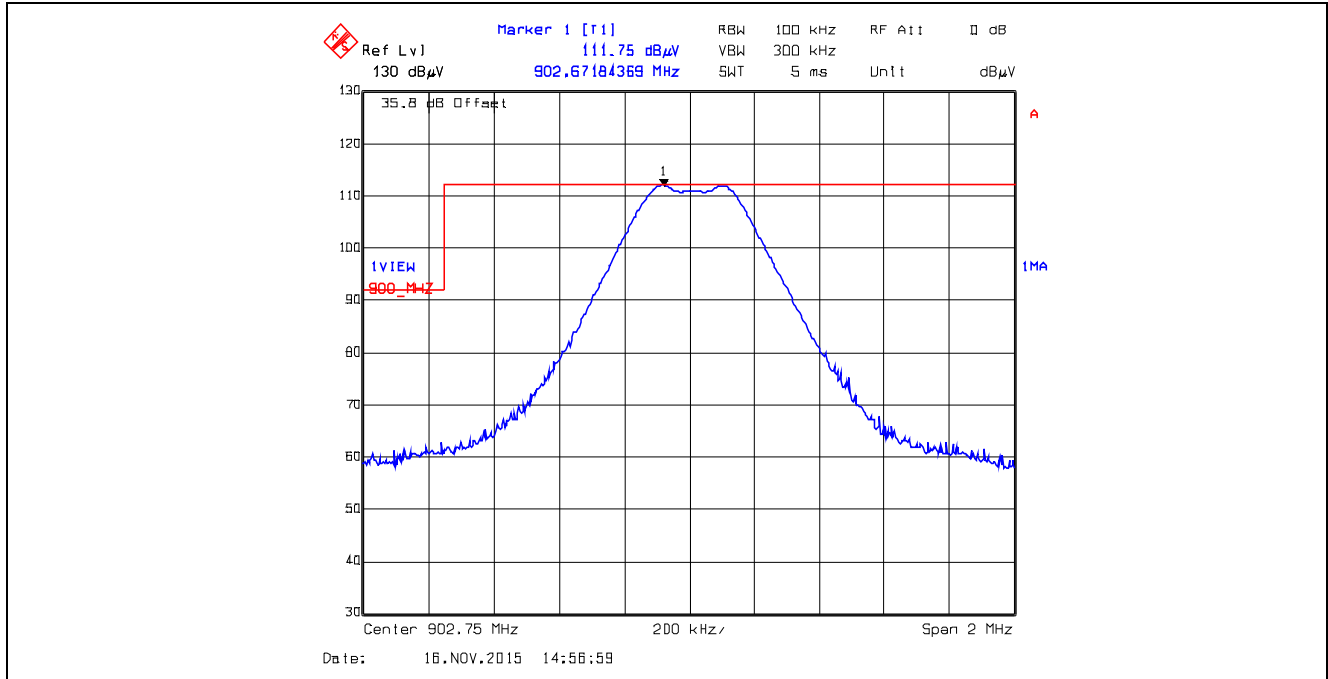

**Plot 5.5.4.2.20.** Band-Edge RF Radiated Emissions at 3 m, Vertical Polarization  
 Pseudorandom Hopping Mode, Low End of Frequency Band, 902.75 MHz, XBX2, Data Rate at 250 kbps

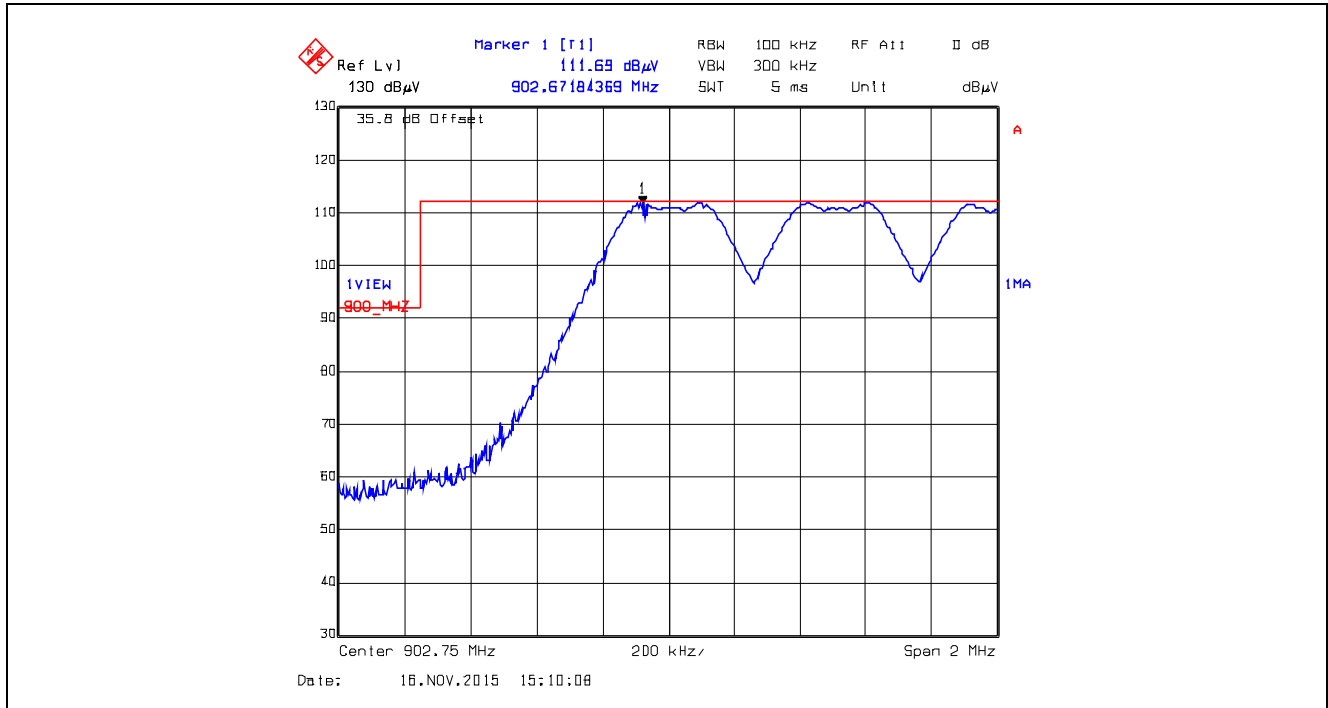

**Plot 5.5.4.2.21.** Band-Edge RF Radiated Emissions at 3 m, Horizontal Polarization  
 Single Frequency Mode, High End of Frequency Band, 927.25 MHz, XBX2, Data Rate at 250 kbps

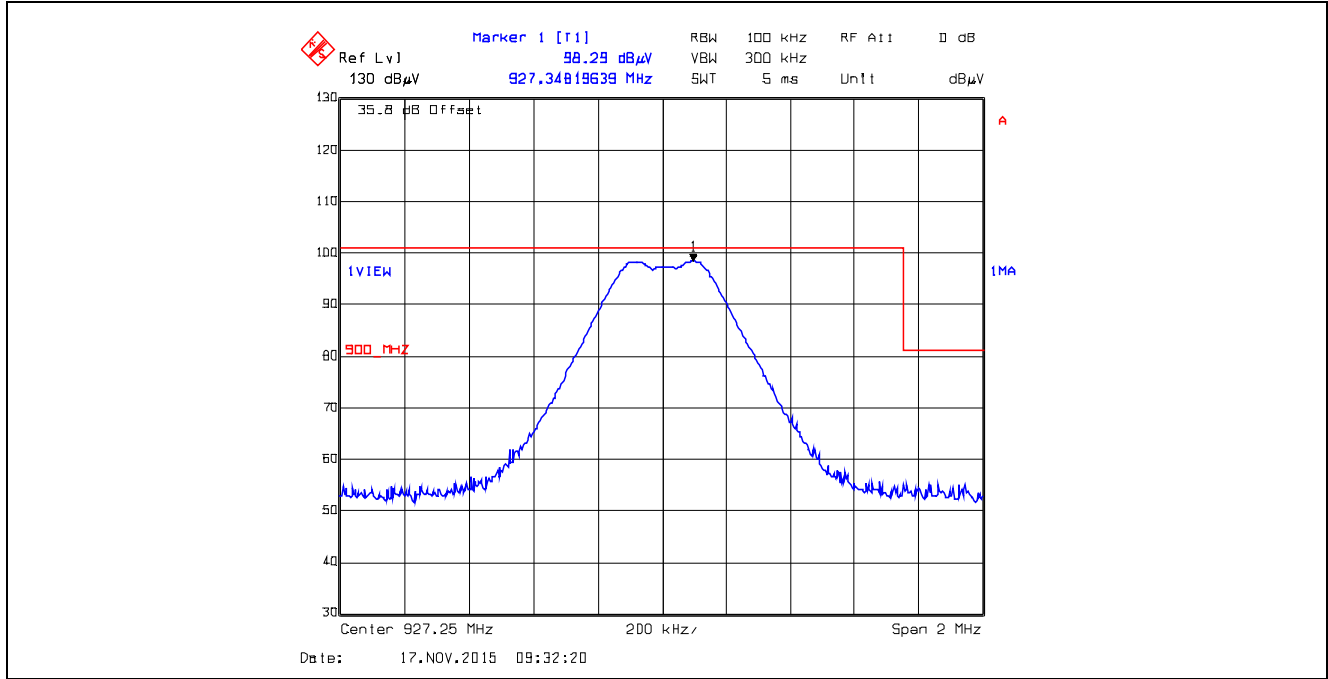

**Plot 5.5.4.2.22.** Band-Edge RF Radiated Emissions at 3 m, Horizontal Polarization  
 Pseudorandom Hopping Mode, High End of Frequency Band, 927.25 MHz, XBX2, Data Rate at 250 kbps

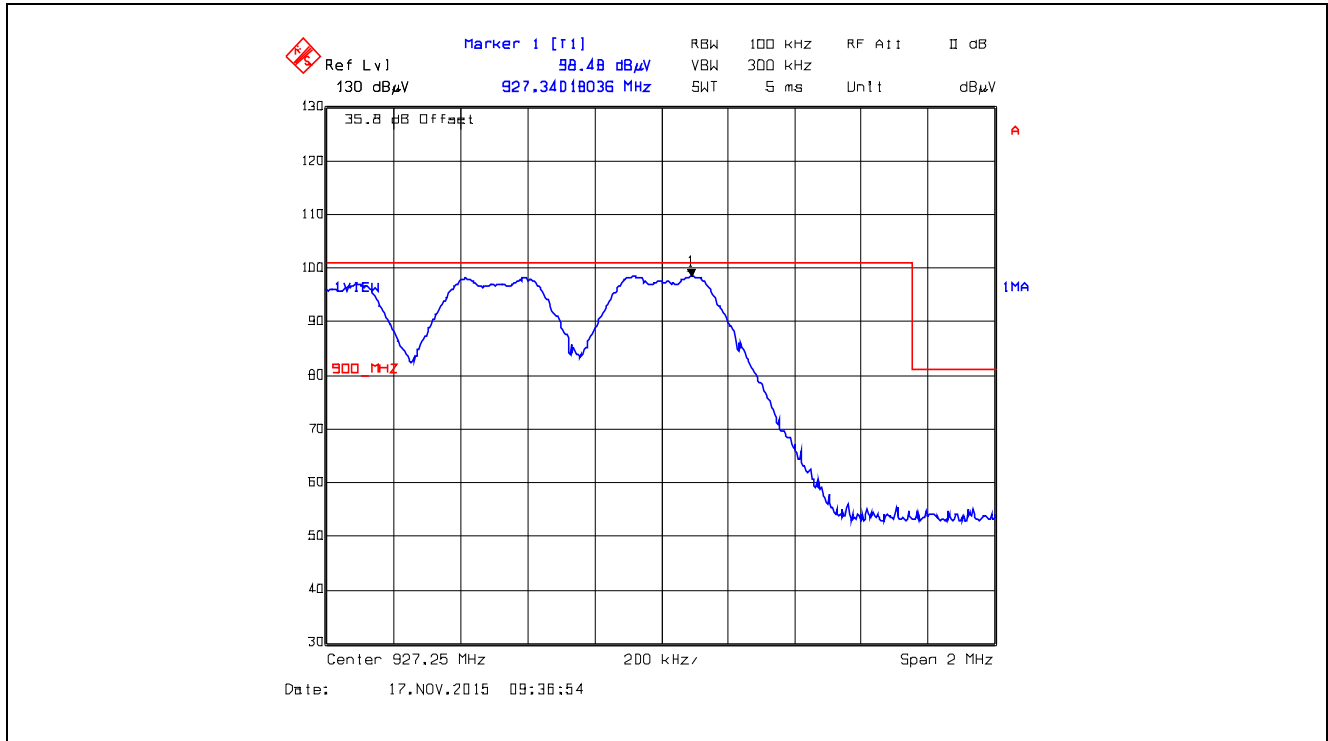

**Plot 5.5.4.2.23.** Band-Edge RF Radiated Emissions at 3 m, Vertical Polarization  
Single Frequency Mode, High End of Frequency Band, 927.25 MHz, XBX2, Data Rate at 250 kbps

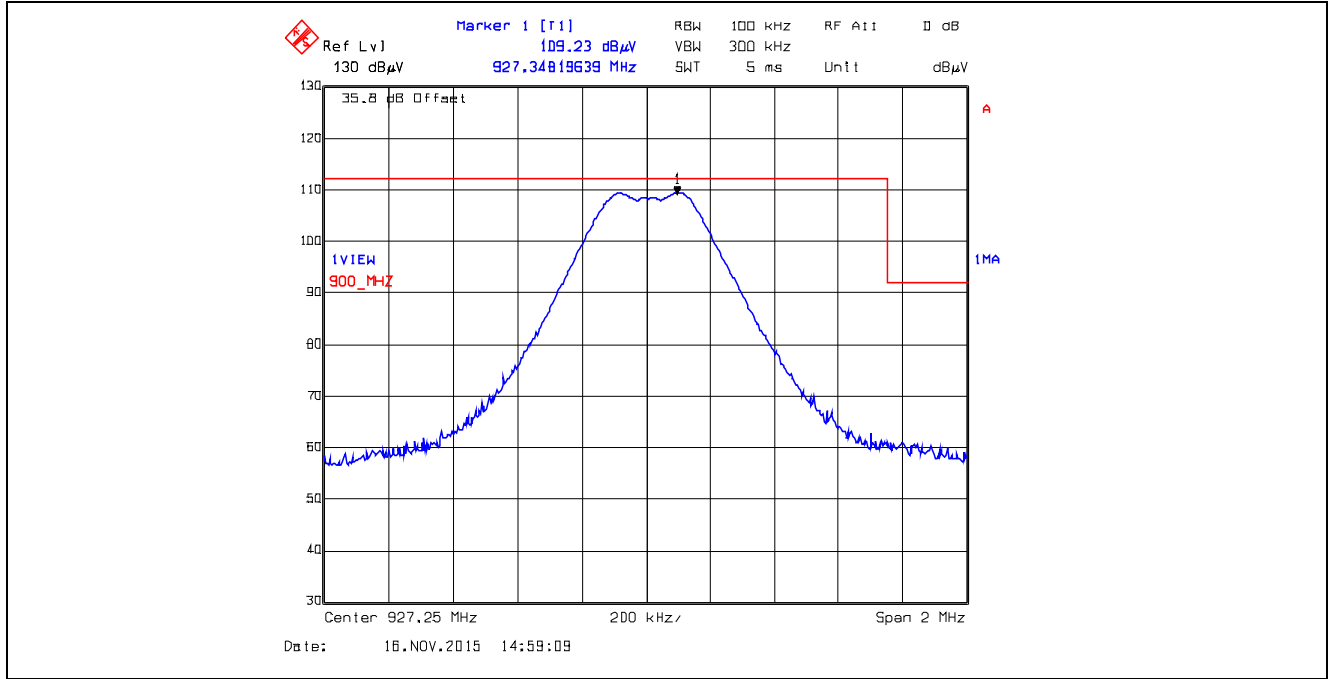

**Plot 5.5.4.2.24.** Band-Edge RF Radiated Emissions at 3 m, Vertical Polarization  
Pseudorandom Hopping Mode, High End of Frequency Band, 927.25 MHz, XBX2, Data Rate at 250 kbps

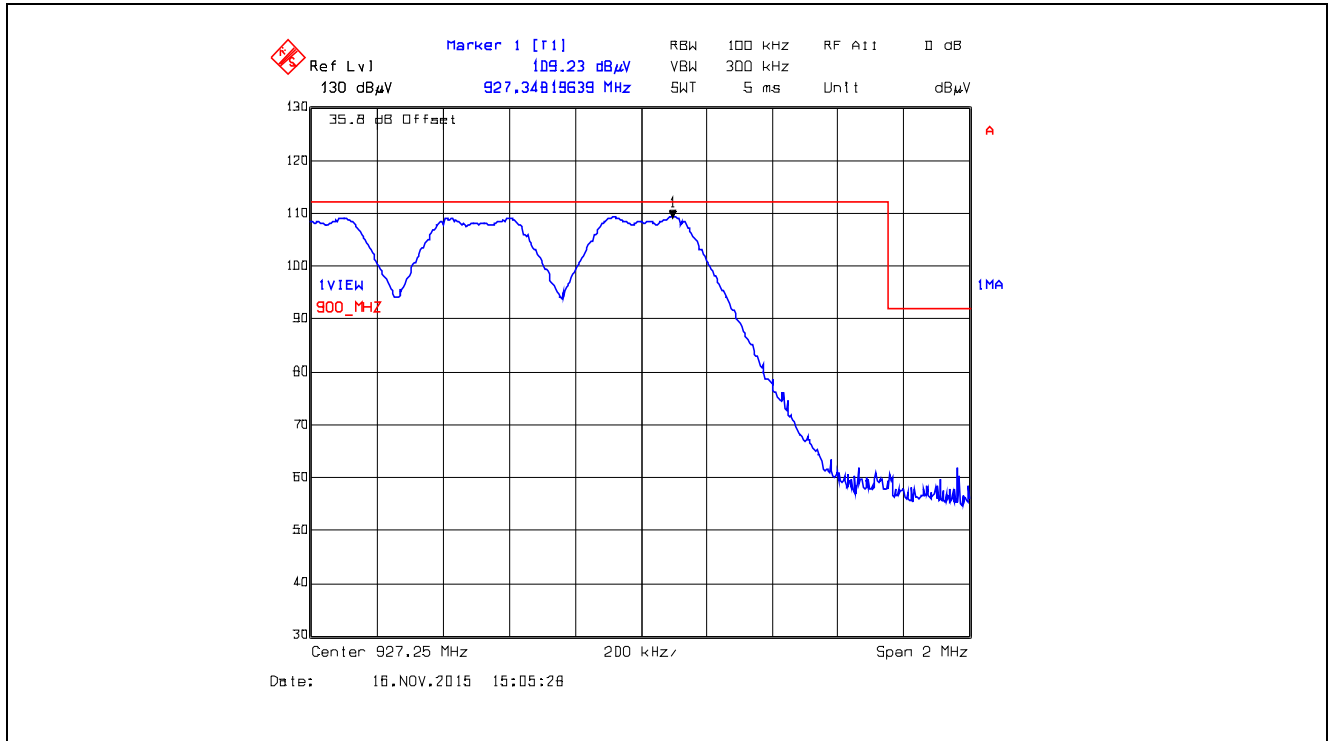

**Plot 5.5.4.2.25.** Band-Edge RF Radiated Emissions at 3 m, Horizontal Polarization  
 Single Frequency Mode, Low End of Frequency Band, 905.0 MHz, XTC0, Data Rate at 10 kbps

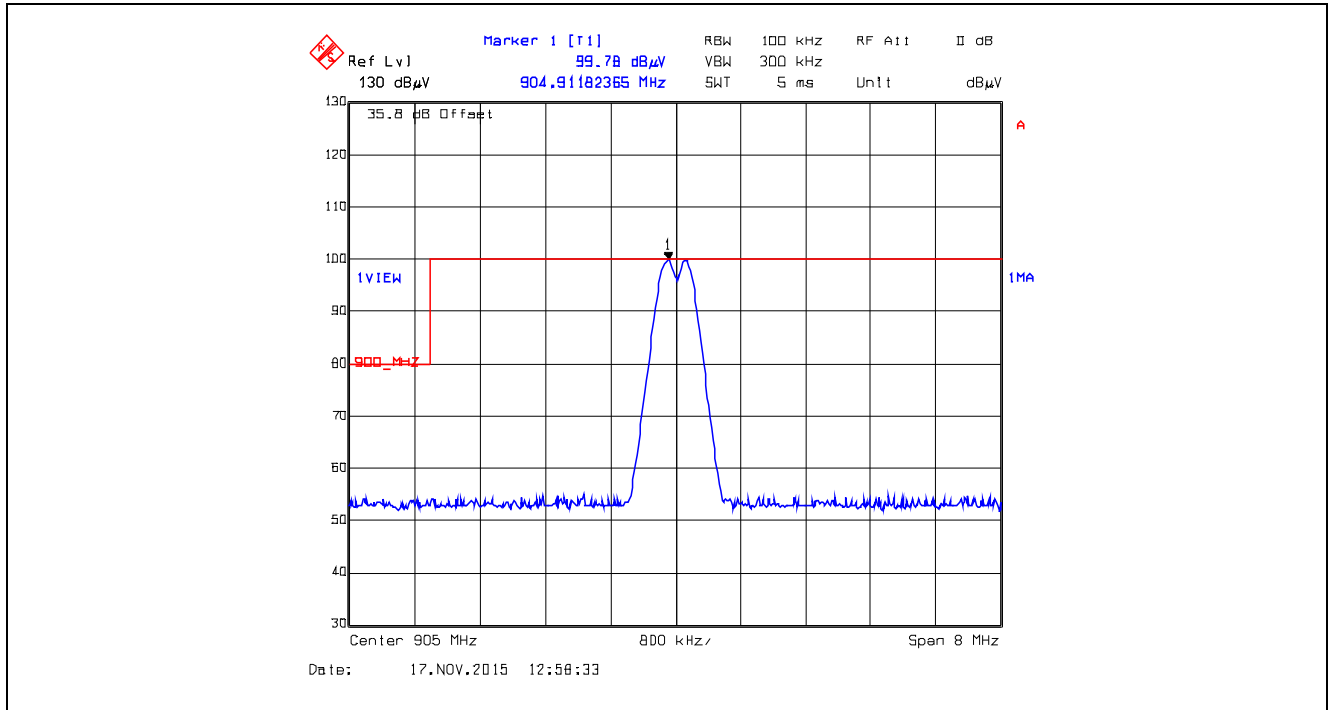

**Plot 5.5.4.2.26.** Band-Edge RF Radiated Emissions at 3 m, Horizontal Polarization  
 Pseudorandom Hopping Mode, Low End of Frequency Band, 905.0 MHz, XTC0, Data Rate at 10 kbps

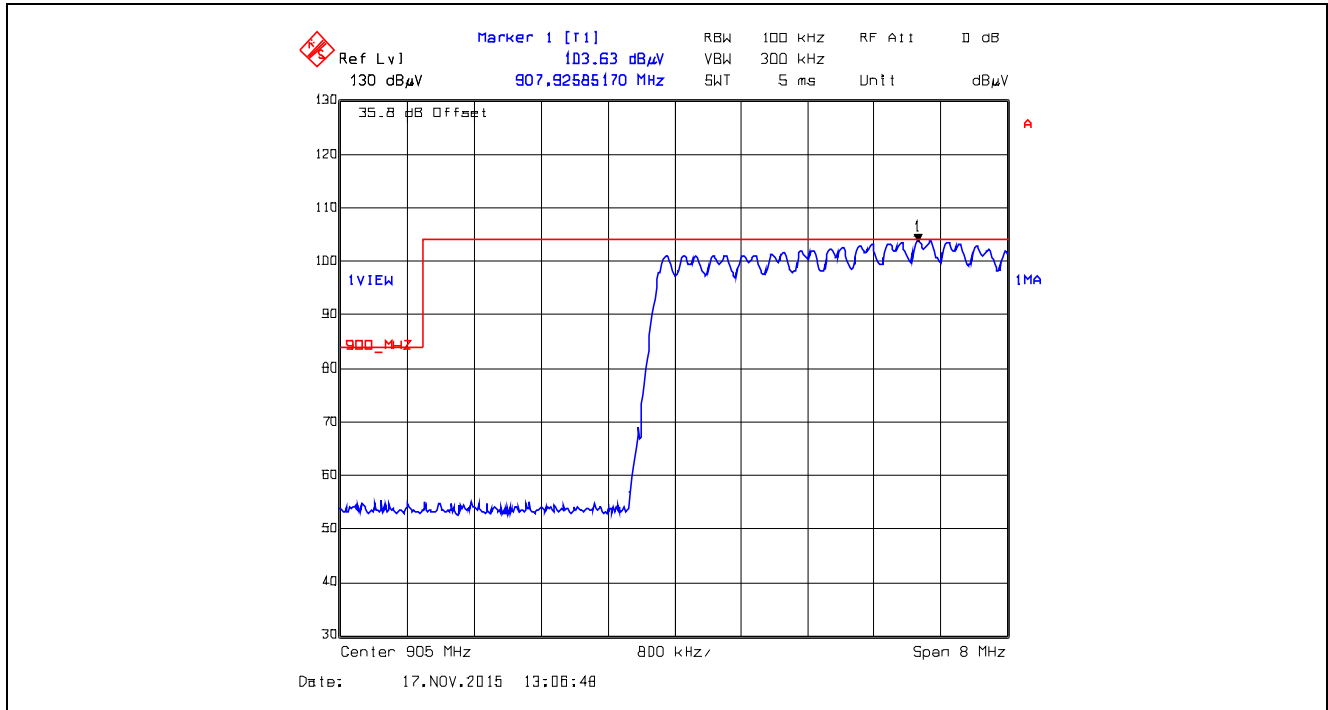

**Plot 5.5.4.2.27.** Band-Edge RF Radiated Emissions at 3 m, Vertical Polarization  
Single Frequency Mode, Low End of Frequency Band, 905.0 MHz, XTC0, Data Rate at 10 kbps

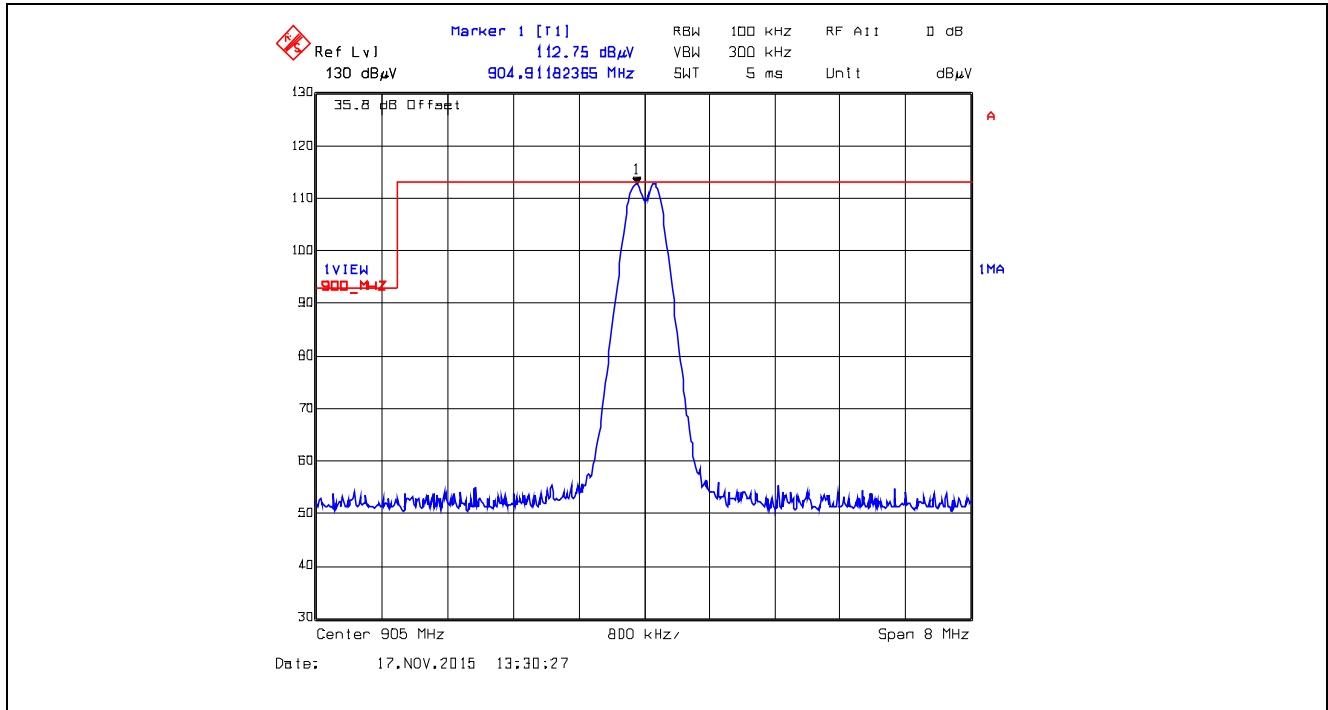

**Plot 5.5.4.2.28.** Band-Edge RF Radiated Emissions at 3 m, Vertical Polarization  
Pseudorandom Hopping Mode, Low End of Frequency Band, 905.0 MHz, XTC0, Data Rate at 10 kbps

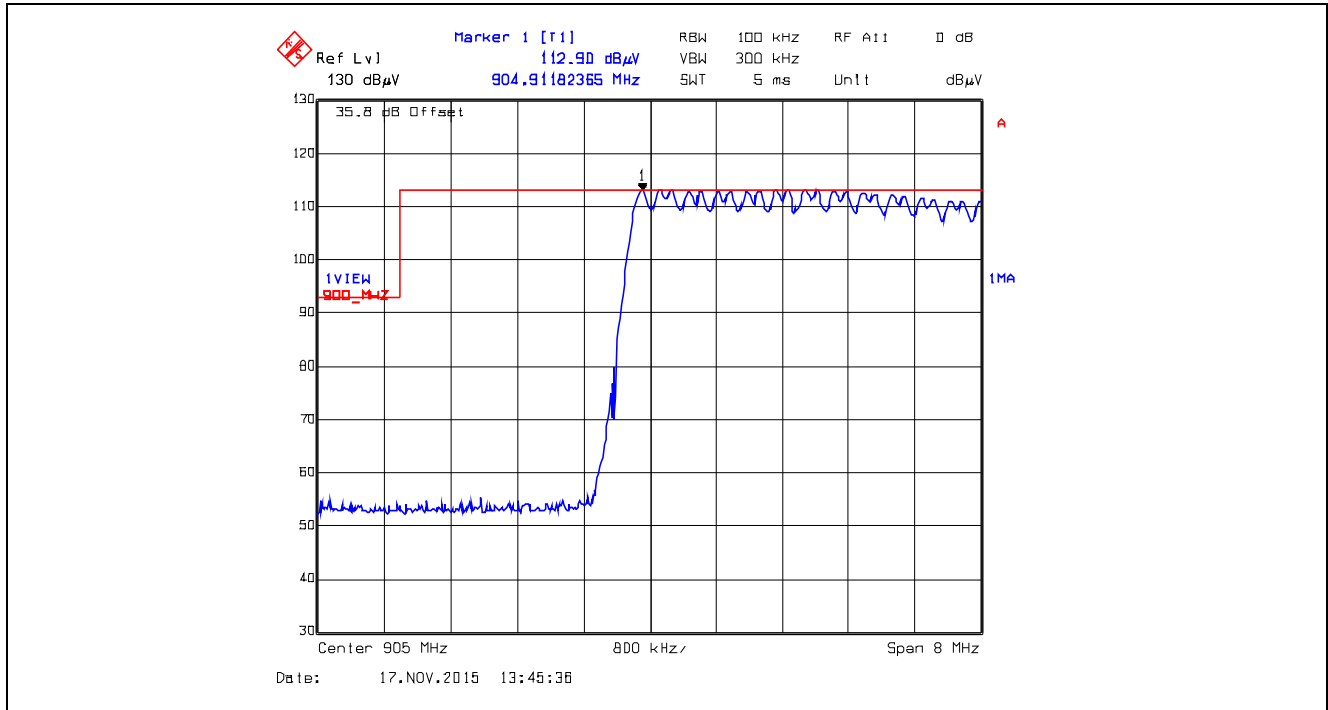

**Plot 5.5.4.2.29.** Band-Edge RF Radiated Emissions at 3 m, Horizontal Polarization  
 Single Frequency Mode, High End of Frequency Band, 925.0 MHz, XTC0, Data Rate at 10 kbps

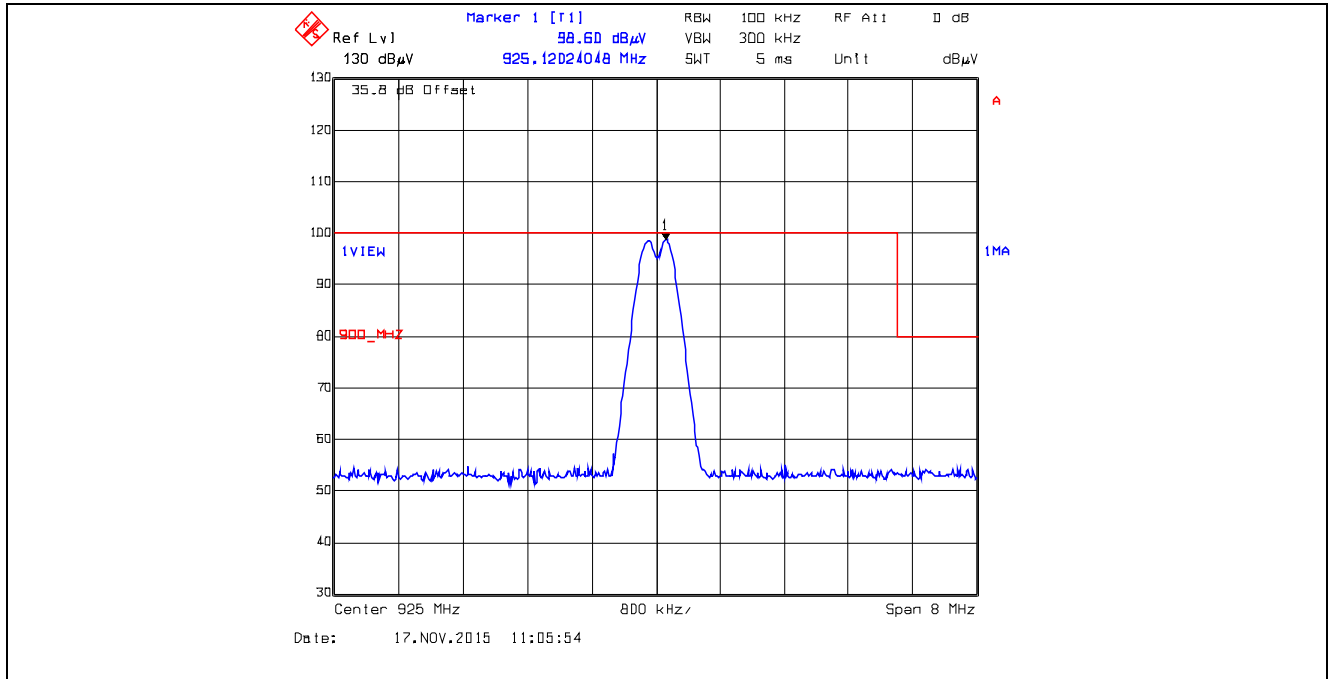

**Plot 5.5.4.2.230.** Band-Edge RF Radiated Emissions at 3 m, Horizontal Polarization  
 Pseudorandom Hopping Mode, High End of Frequency Band, 925.0 MHz, XTC0, Data Rate at 10 kbps

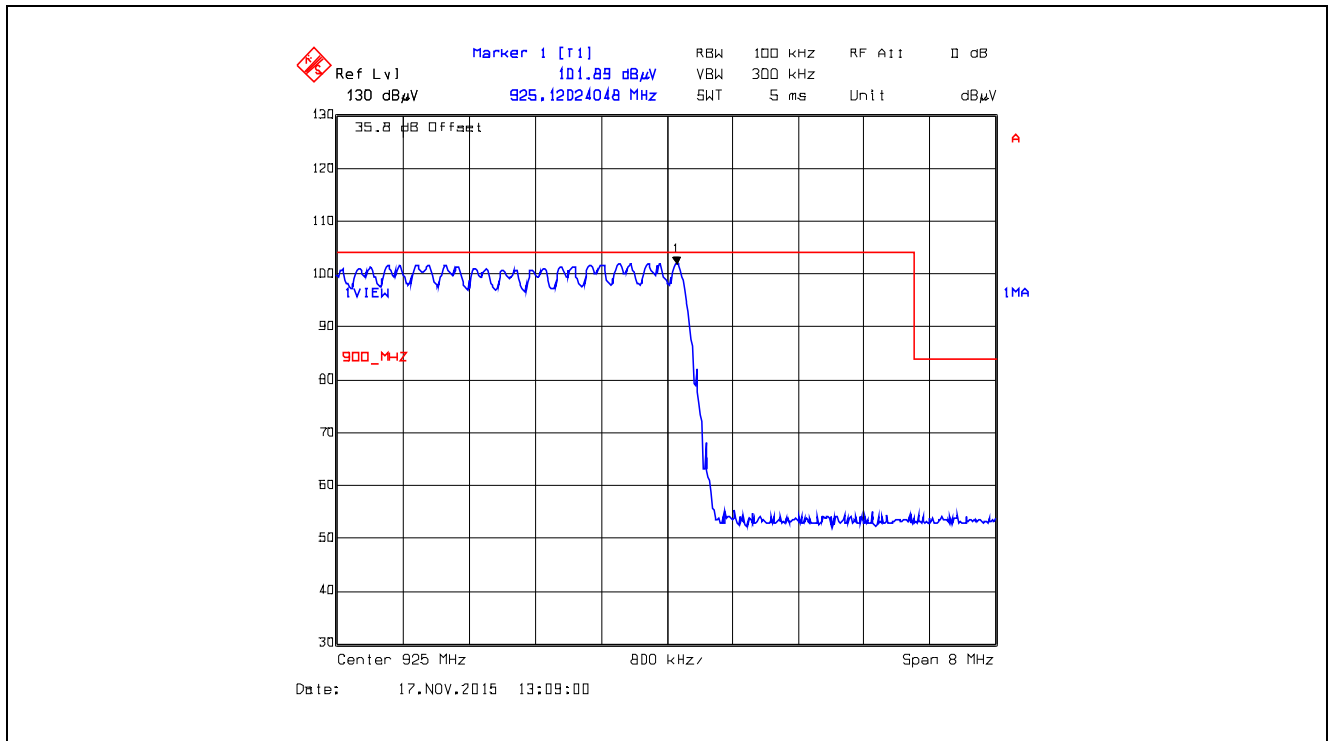

**Plot 5.5.4.2.31.** Band-Edge RF Radiated Emissions at 3 m, Vertical Polarization  
 Single Frequency Mode, High End of Frequency Band, 925.0 MHz, XTC0, Data Rate at 10 kbps

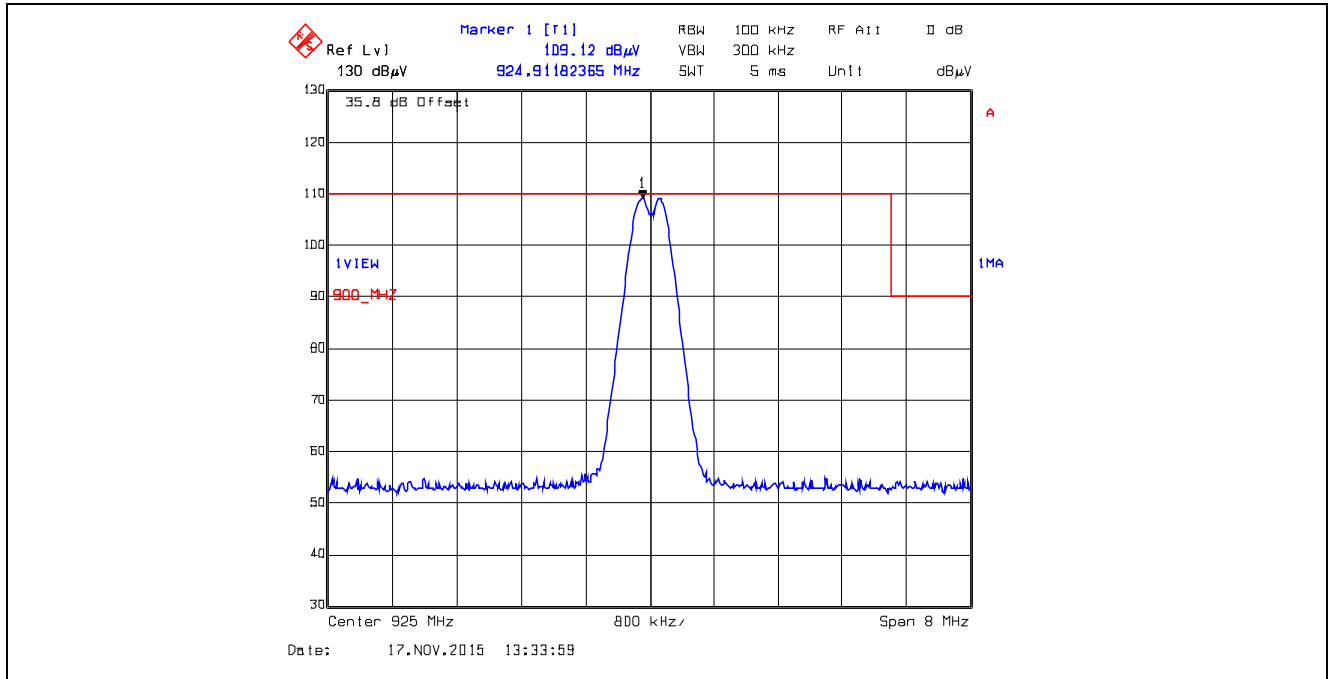

**Plot 5.5.4.2.32.** Band-Edge RF Radiated Emissions at 3 m, Vertical Polarization  
 Pseudorandom Hopping Mode, High End of Frequency Band, 925.0 MHz, XTC0, Data Rate at 10 kbps

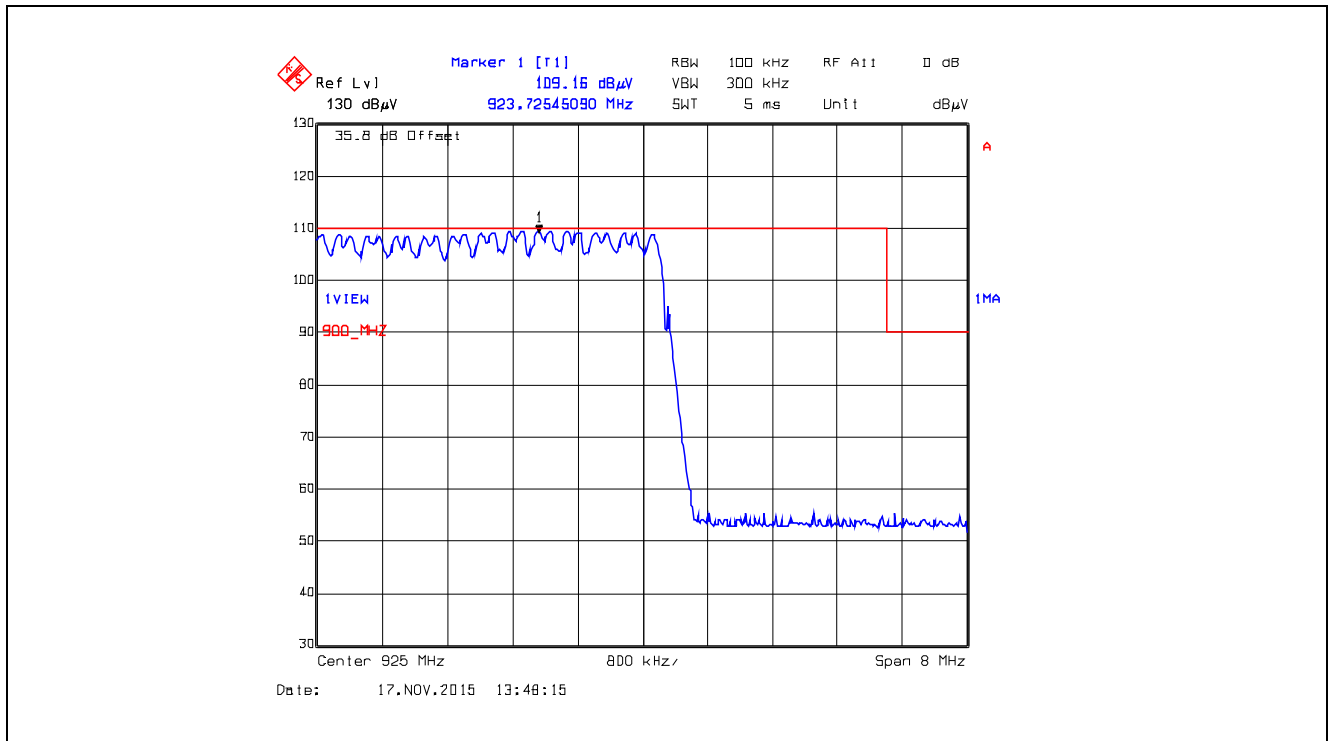



**Plot 5.5.4.2.2.33.** Band-Edge RF Radiated Emissions at 3 m, Horizontal Polarization  
Single Frequency Mode, Low End of Frequency Band, 905.0 MHz, XTC1, Data Rate at 125 kbps

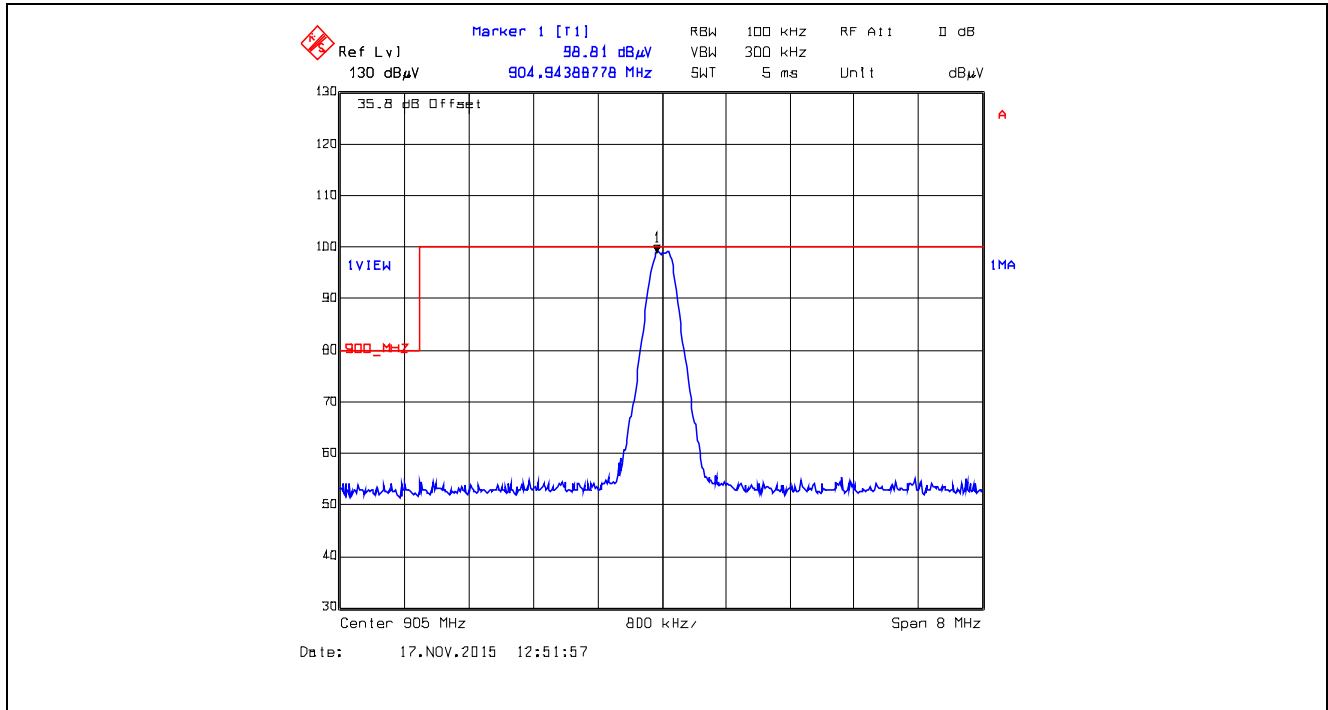

**Plot 5.5.4.2.2.34.** Band-Edge RF Radiated Emissions at 3 m, Horizontal Polarization  
Pseudorandom Hopping Mode, Low End of Frequency Band, 905.0 MHz, XTC1, Data Rate at 125 kbps

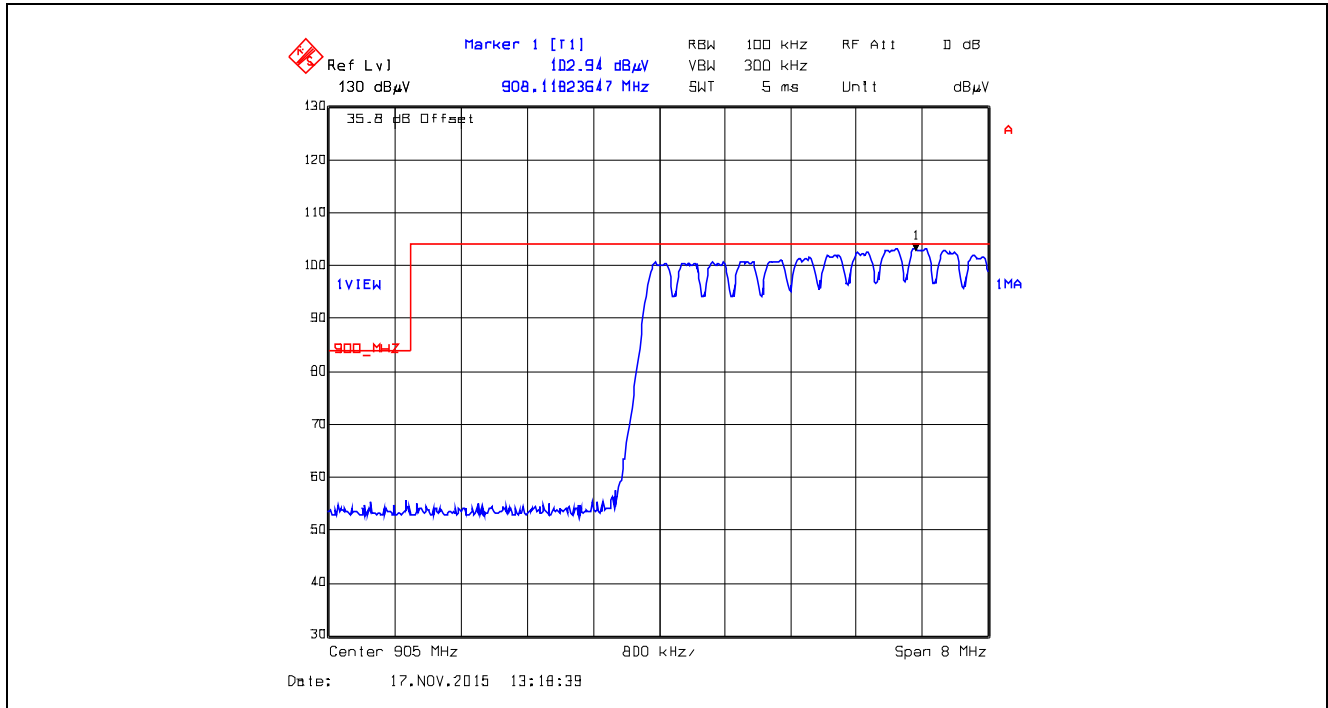

**Plot 5.5.4.2.35.** Band-Edge RF Radiated Emissions at 3 m, Vertical Polarization  
 Single Frequency Mode, Low End of Frequency Band, 905.0 MHz, XTC1, Data Rate at 125 kbps

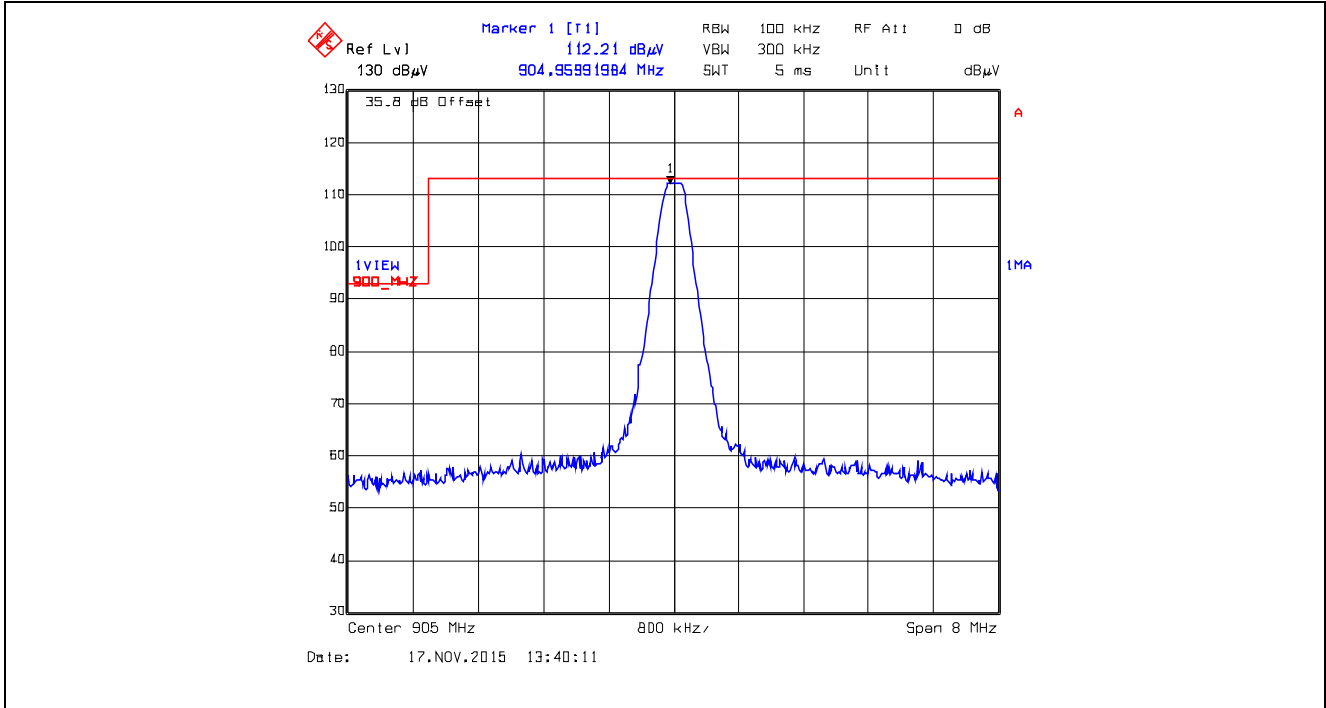

**Plot 5.5.4.2.36.** Band-Edge RF Radiated Emissions at 3 m, Vertical Polarization  
 Pseudorandom Hopping Mode, Low End of Frequency Band, 905.0 MHz, XTC1, Data Rate at 125 kbps

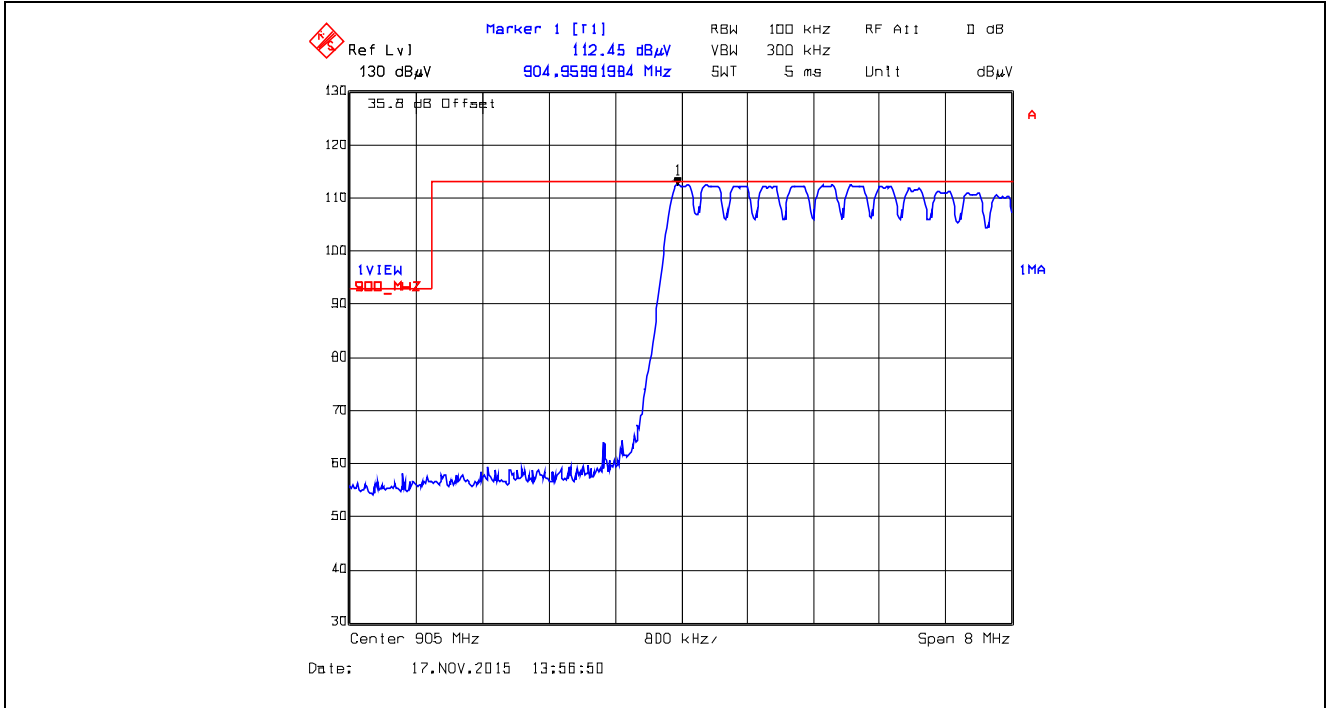

**Plot 5.5.4.2.2.37.** Band-Edge RF Radiated Emissions at 3 m, Horizontal Polarization  
Single Frequency Mode, High End of Frequency Band, 925.0 MHz, XTC1, Data Rate at 125 kbps

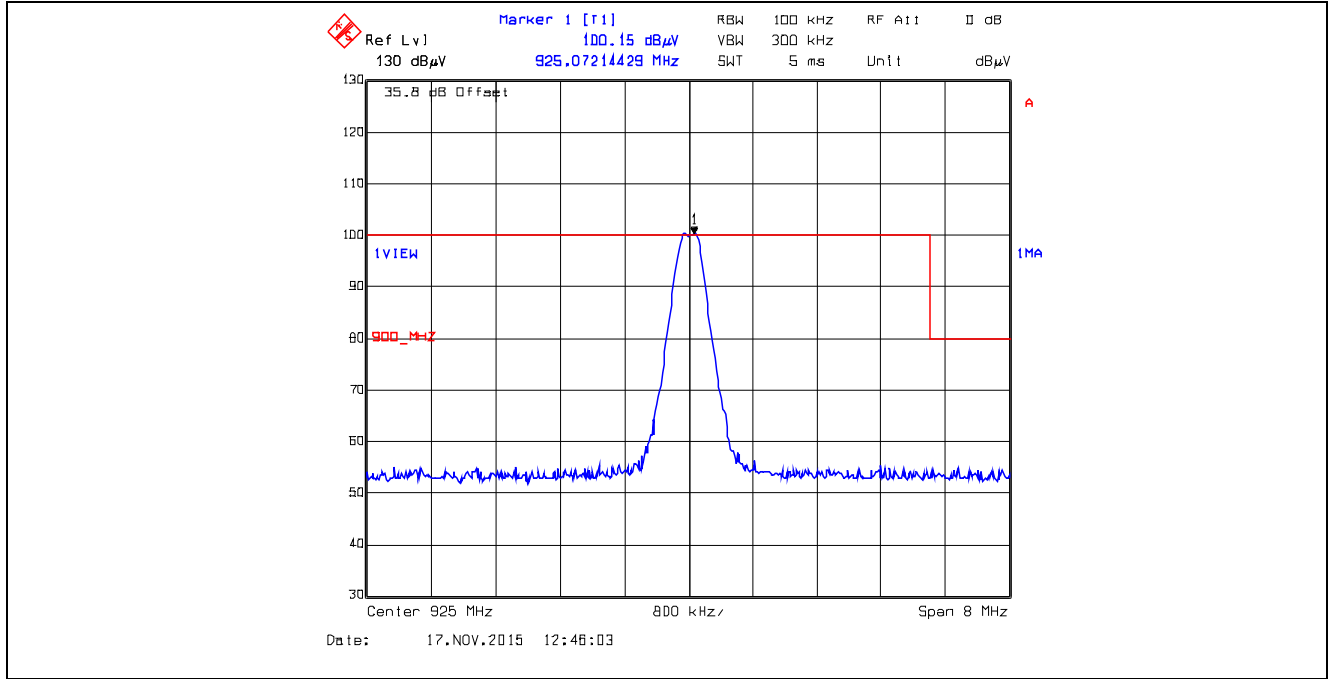

**Plot 5.5.4.2.2.38.** Band-Edge RF Radiated Emissions at 3 m, Horizontal Polarization  
Pseudorandom Hopping Mode, High End of Frequency Band, 925.0 MHz, XTC1, Data Rate at 125 kbps

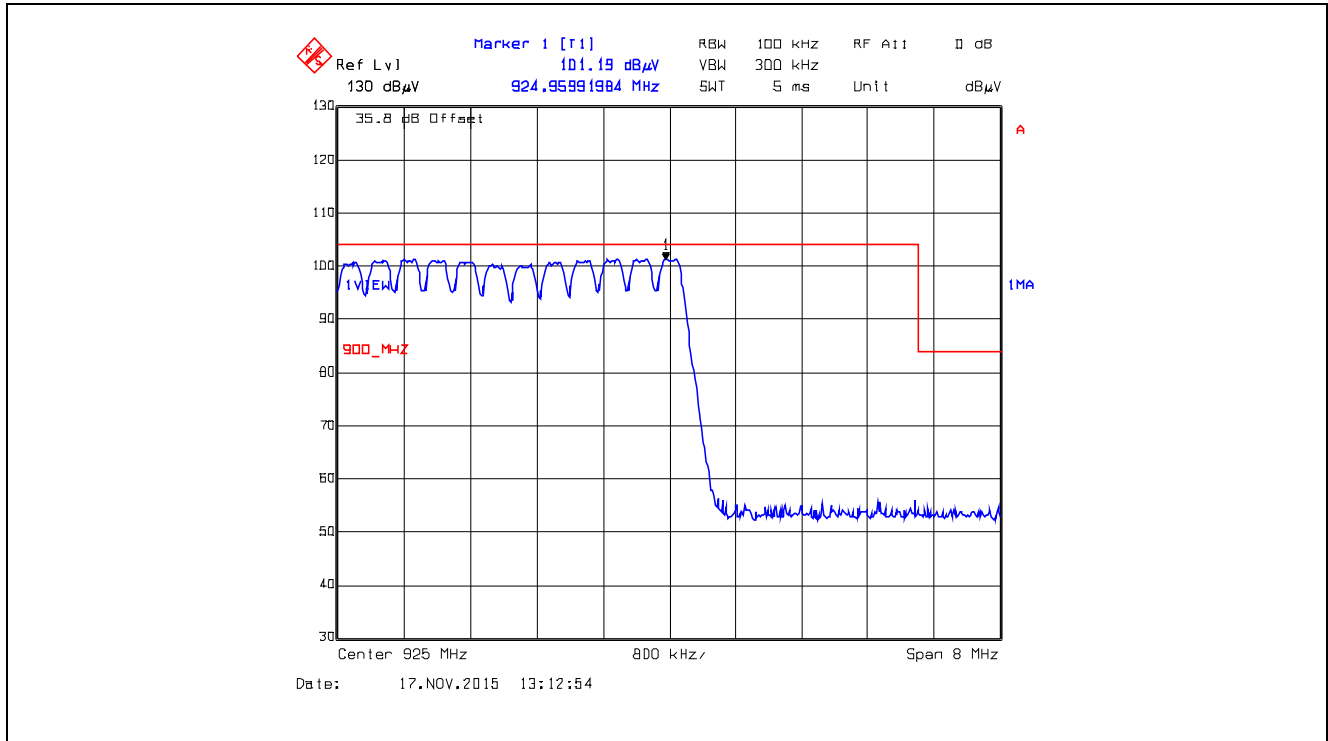

**Plot 5.5.4.2.39.** Band-Edge RF Radiated Emissions at 3 m, Vertical Polarization  
 Single Frequency Mode, High End of Frequency Band, 925.0 MHz, XTC1, Data Rate at 125 kbps

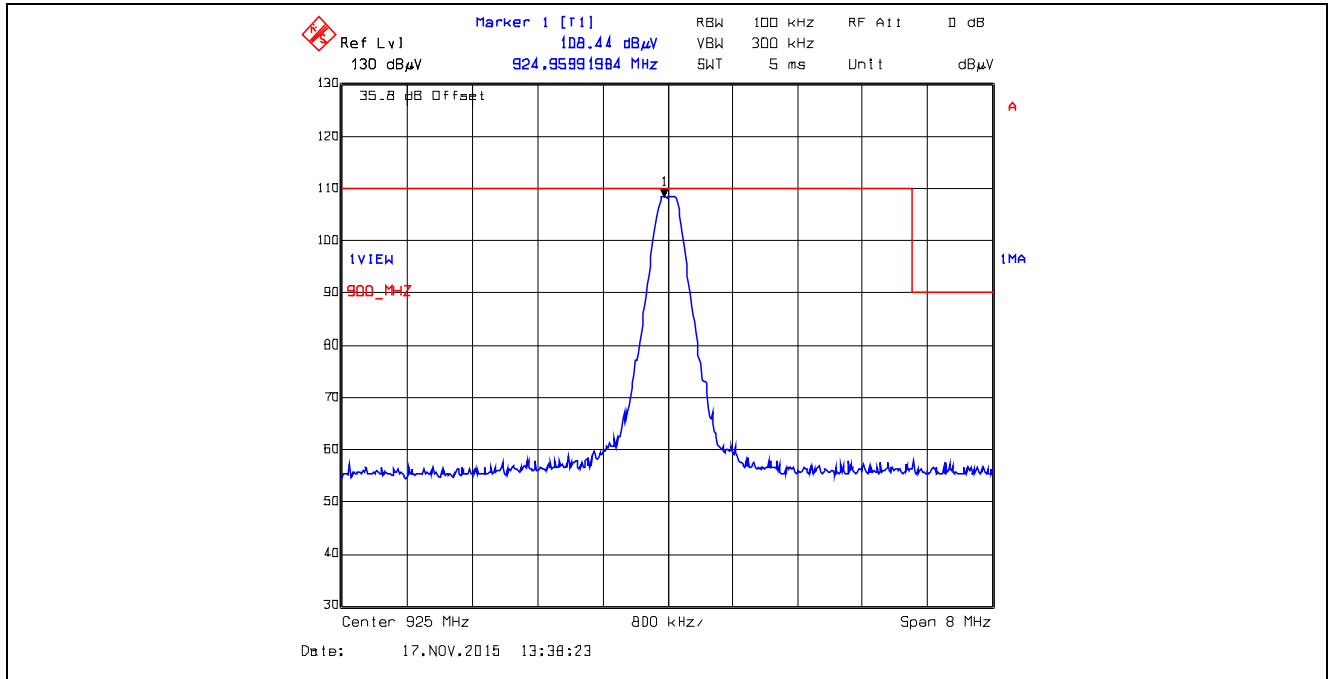

**Plot 5.5.4.2.40.** Band-Edge RF Radiated Emissions at 3 m, Vertical Polarization  
 Pseudorandom Hopping Mode, High End of Frequency Band, 925.0 MHz, XTC1, Data Rate at 125 kbps

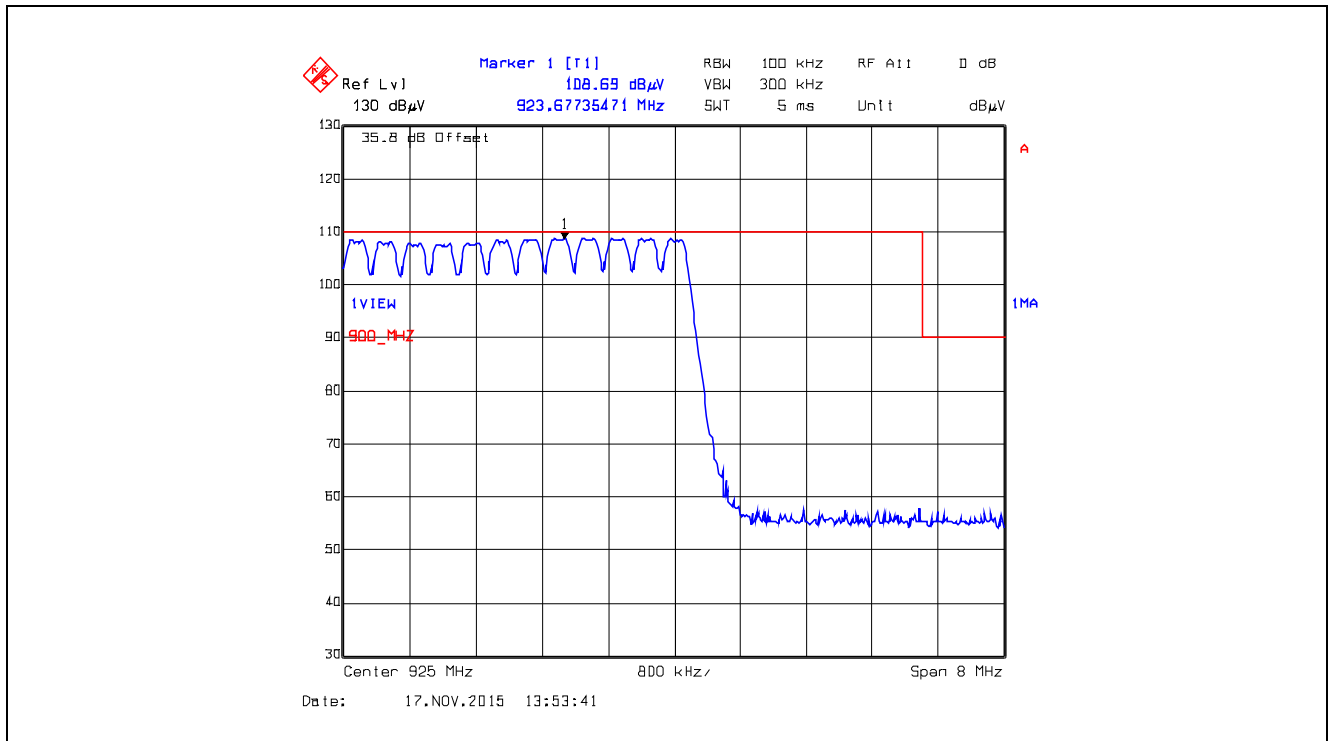

**Plot 5.5.4.2.2.41.** Band-Edge RF Radiated Emissions at 3 m, Horizontal Polarization  
Single Frequency Mode, Low End of Frequency Band, 915.75 MHz, XTCA0, Data Rate at 10 kbps

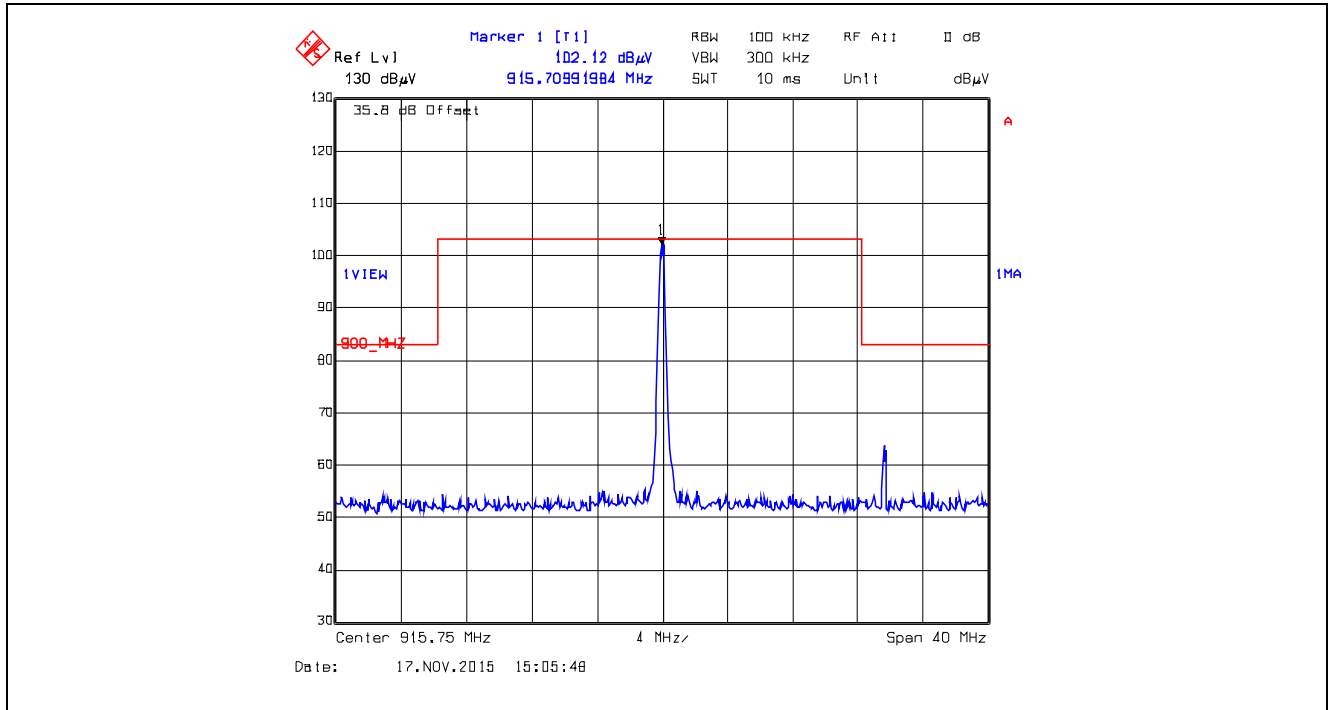

**Plot 5.5.4.2.2.42.** Band-Edge RF Radiated Emissions at 3 m, Horizontal Polarization  
Pseudorandom Hopping Mode, Low End of Frequency Band, 915.75 MHz, XTCA0, Data Rate at 10 kbps

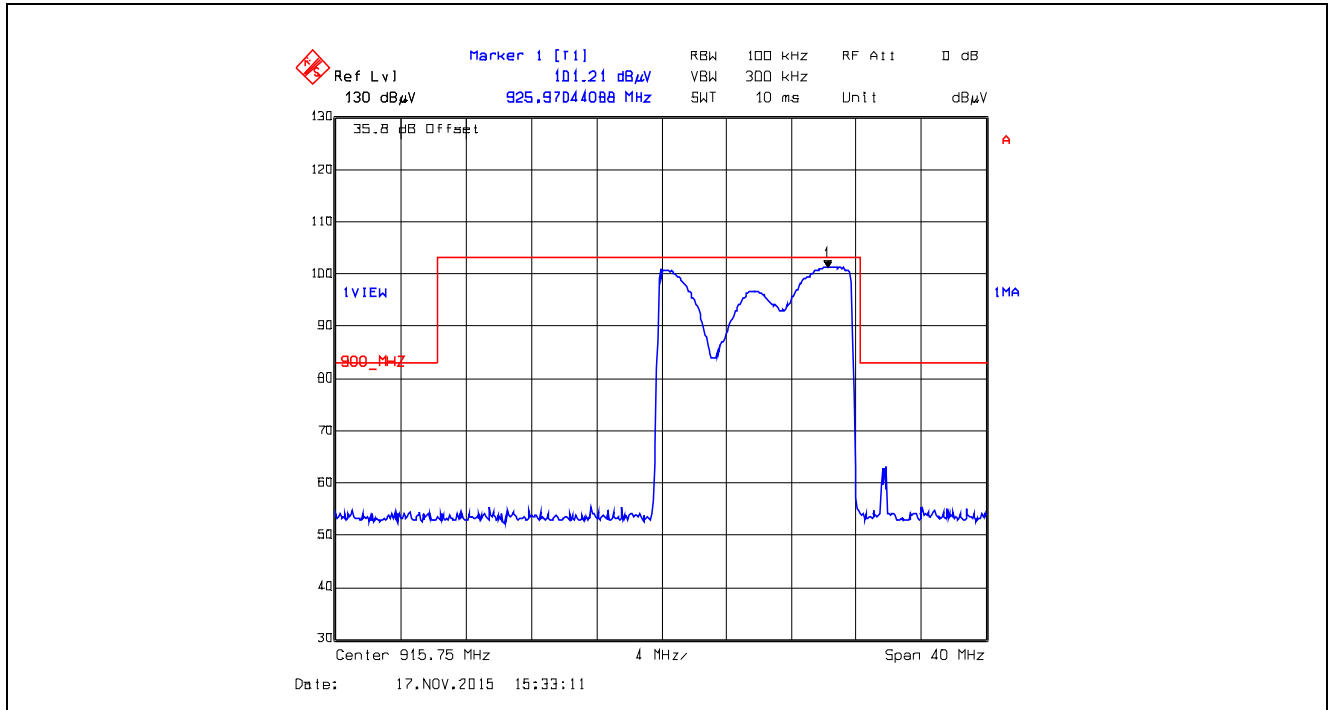

**Plot 5.5.4.2.43.** Band-Edge RF Radiated Emissions at 3 m, Vertical Polarization  
Single Frequency Mode, Low End of Frequency Band, 915.75 MHz, XTCA0, Data Rate at 10 kbps

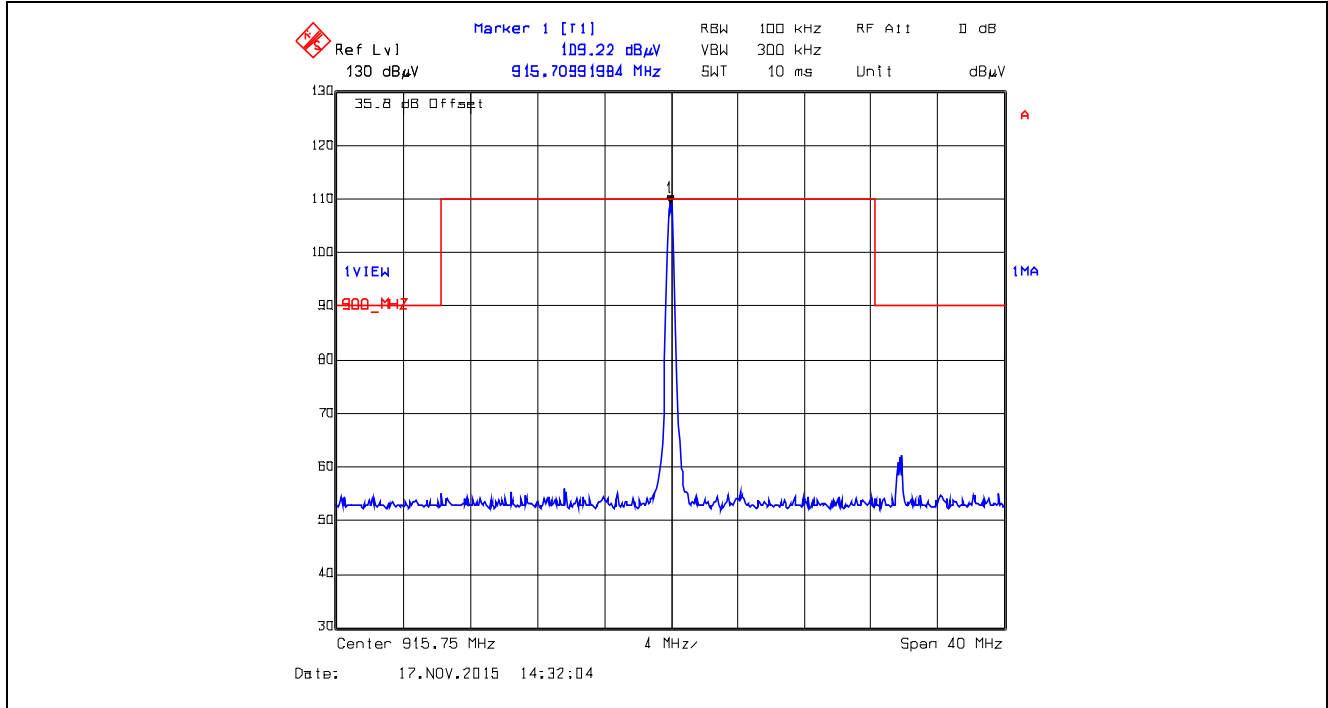

**Plot 5.5.4.2.44.** Band-Edge RF Radiated Emissions at 3 m, Vertical Polarization  
Pseudorandom Hopping Mode, Low End of Frequency Band, 915.75 MHz, XTCA0, Data Rate at 10 kbps

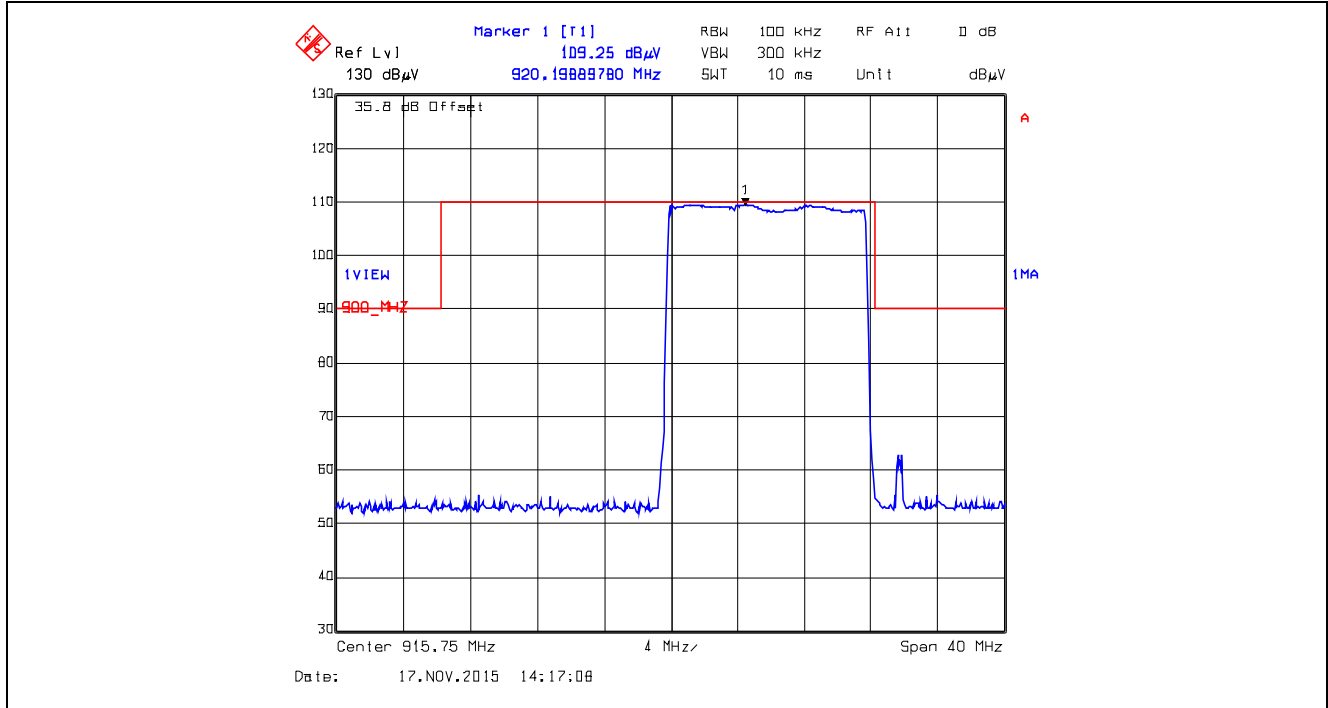

**Plot 5.5.4.2.2.45.** Band-Edge RF Radiated Emissions at 3 m, Horizontal Polarization  
 Single Frequency Mode, High End of Frequency Band, 927.265 MHz, XTCA0, Data Rate at 10 kbps

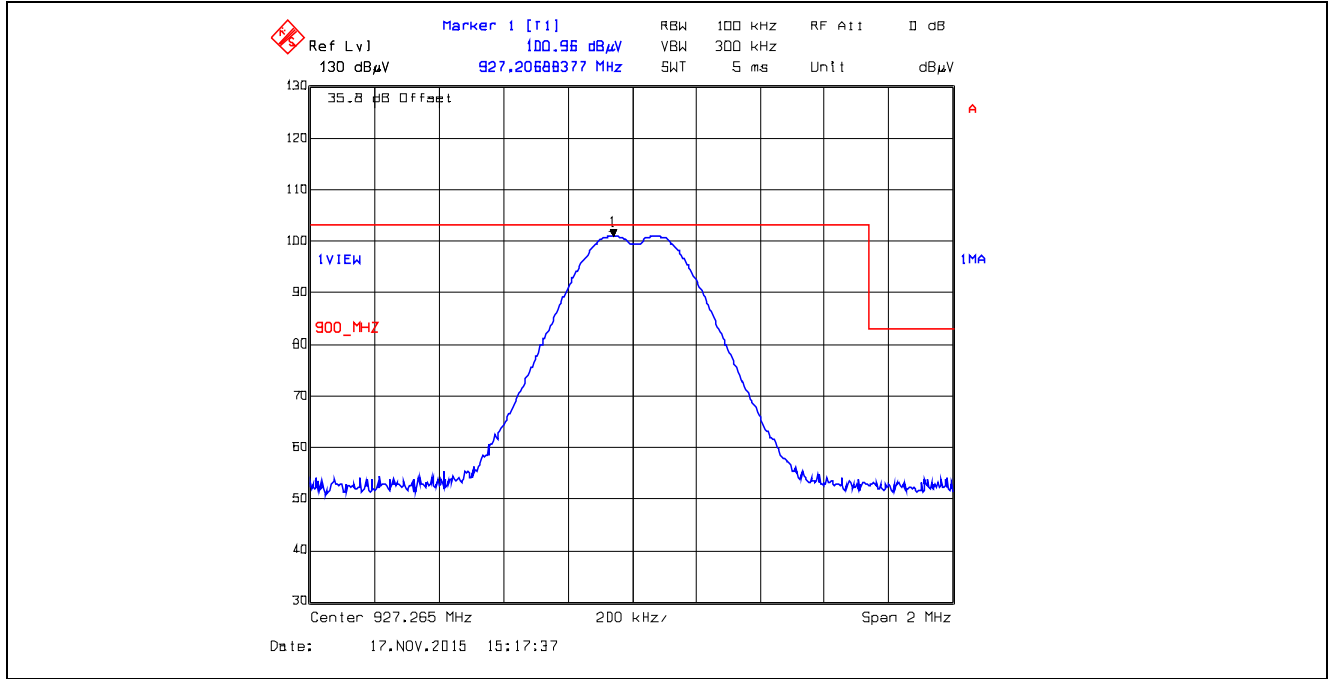

**Plot 5.5.4.2.2.46.** Band-Edge RF Radiated Emissions at 3 m, Horizontal Polarization  
 Pseudorandom Hopping Mode, High End of Frequency Band, 927.265 MHz, XTCA0, Data Rate at 10 kbps

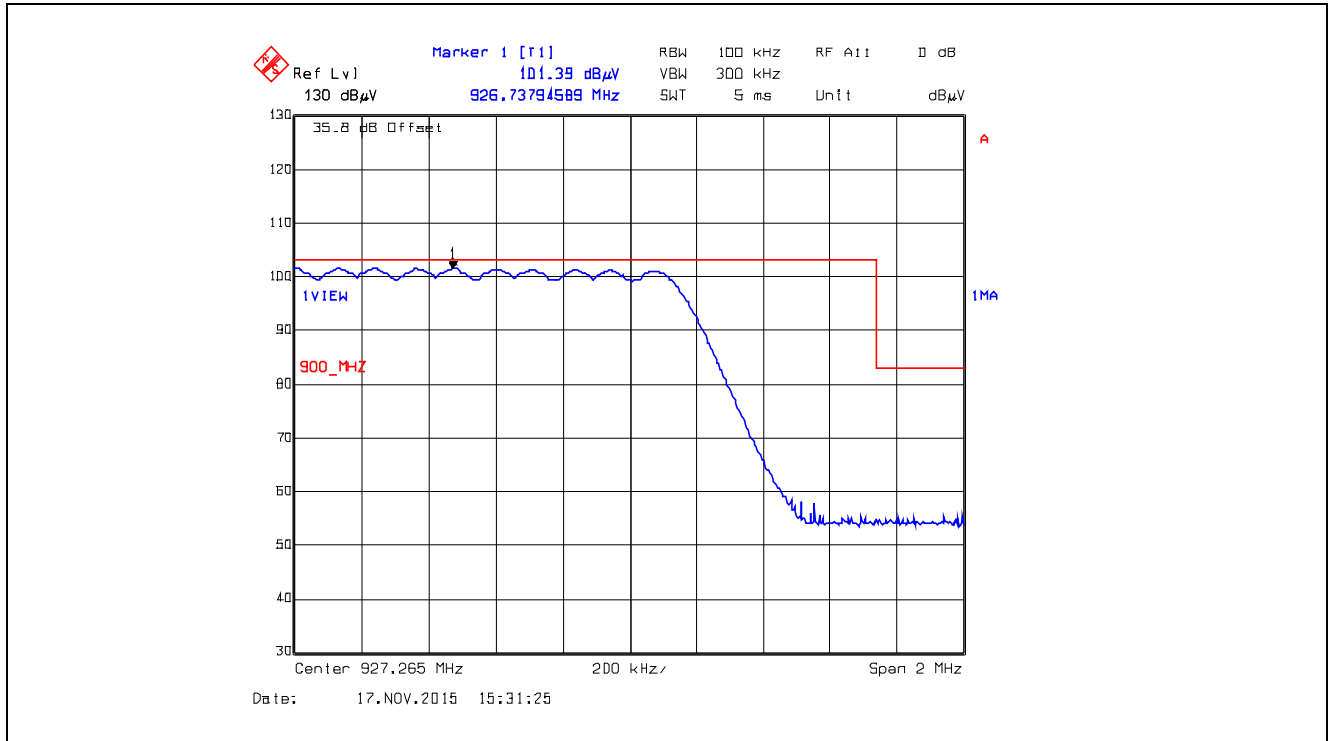

**Plot 5.5.4.2.47.** Band-Edge RF Radiated Emissions at 3 m, Vertical Polarization  
Single Frequency Mode, High End of Frequency Band, 927.265 MHz, XTCA0, Data Rate at 10 kbps

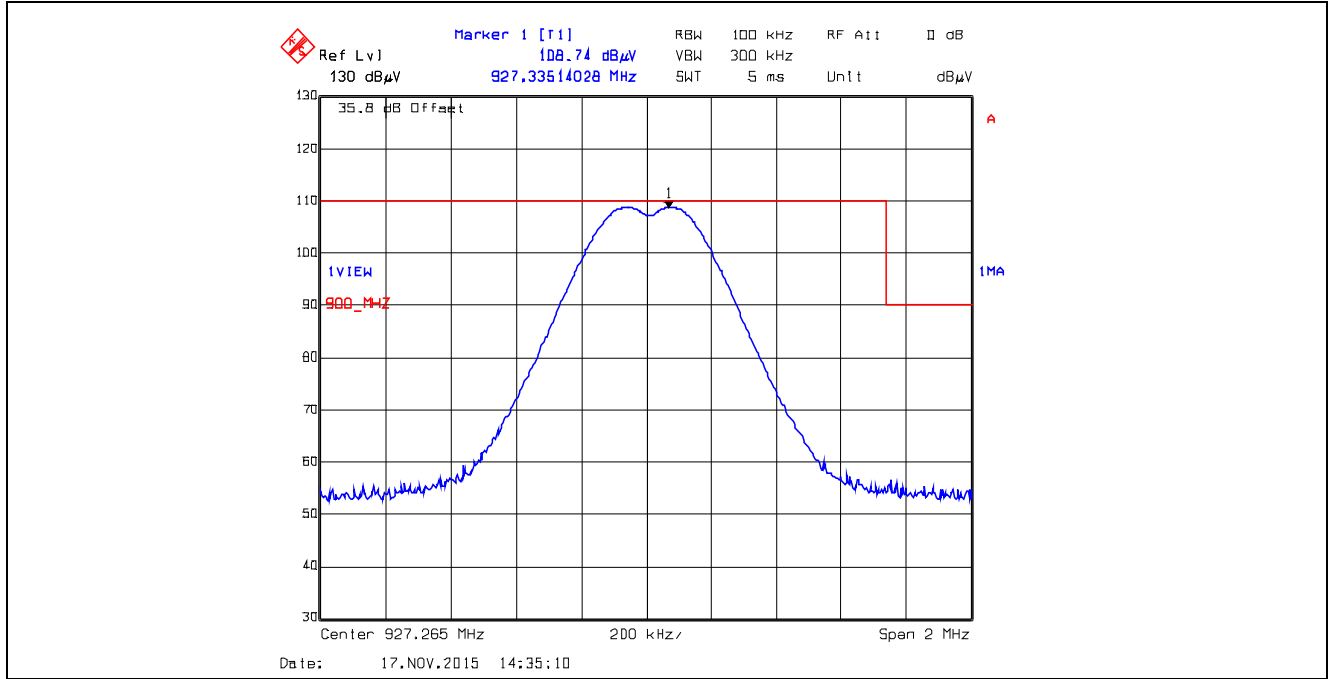

**Plot 5.5.4.2.48.** Band-Edge RF Radiated Emissions at 3 m, Vertical Polarization  
Pseudorandom Hopping Mode, High End of Frequency Band, 927.265 MHz, XTCA0, Data Rate at 10 kbps

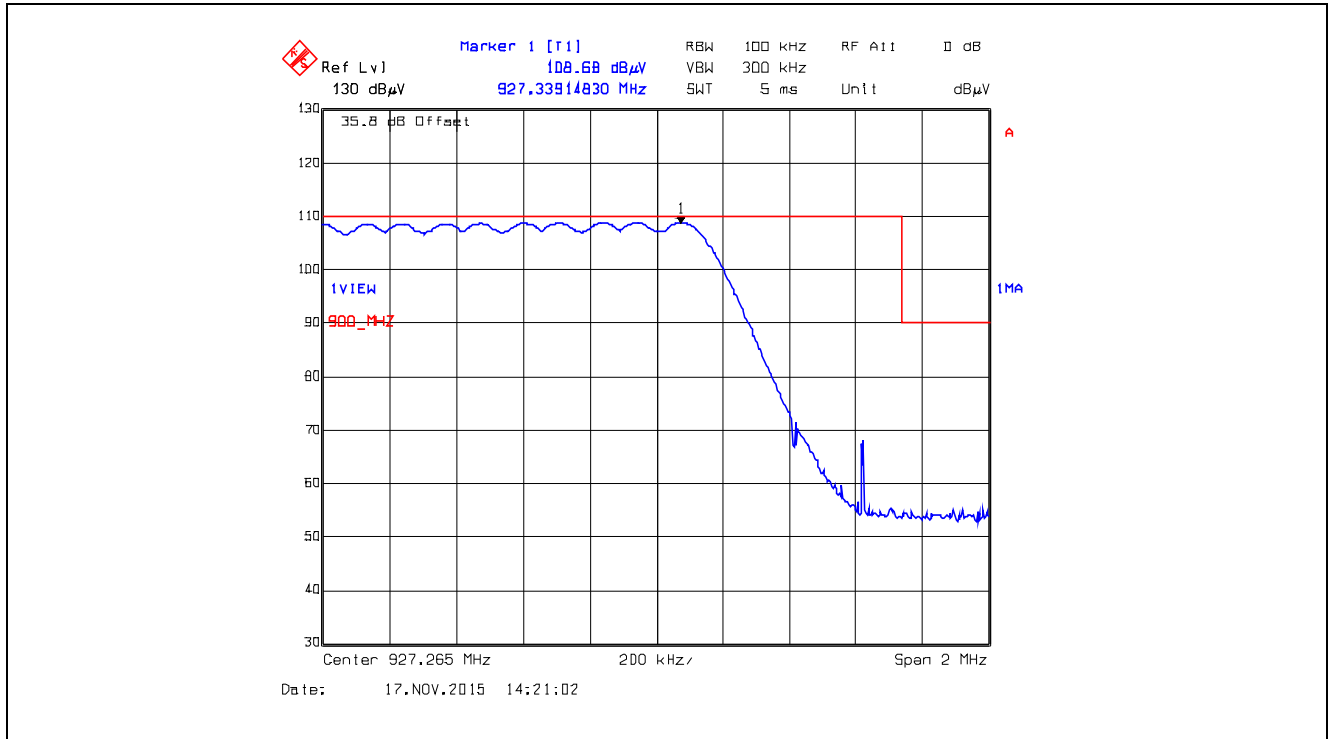



**Plot 5.5.4.2.2.49.** Band-Edge RF Radiated Emissions at 3 m, Horizontal Polarization  
 Single Frequency Mode, Low End of Frequency Band, 915.75 MHz, XTCA1, Data Rate at 105kbps

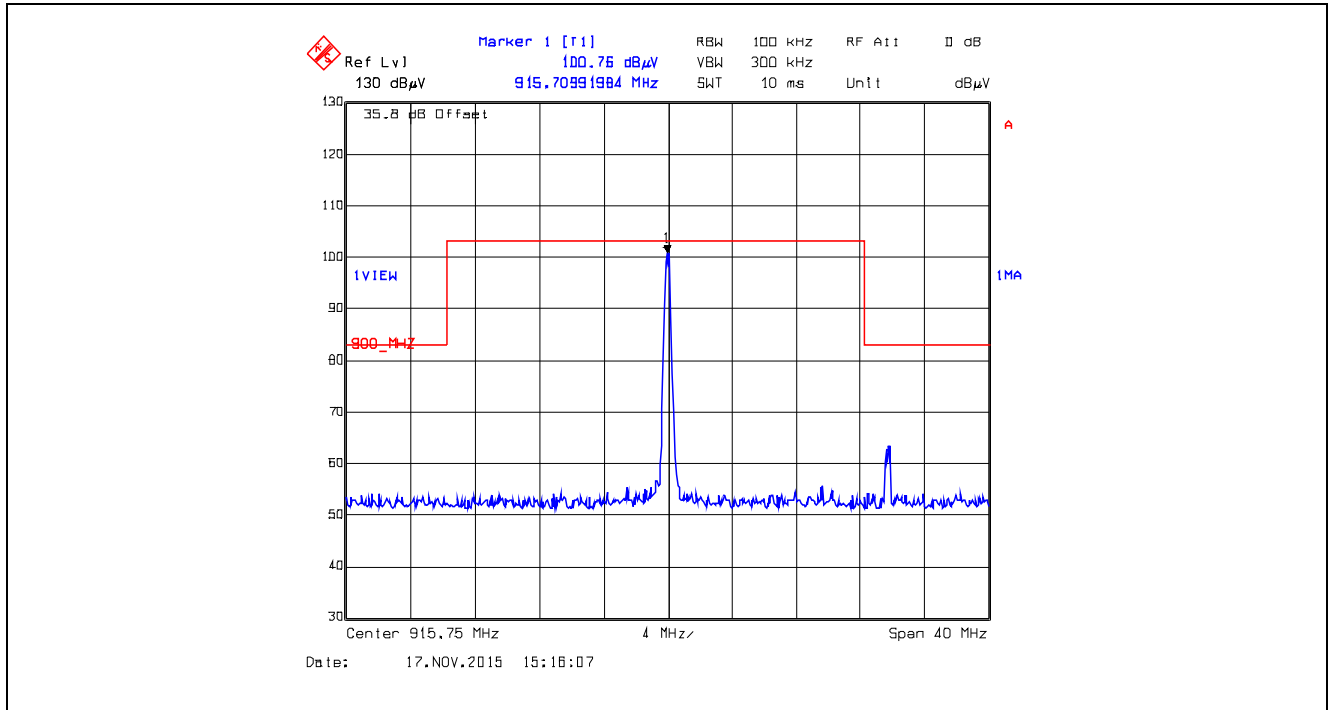

**Plot 5.5.4.2.2.50.** Band-Edge RF Radiated Emissions at 3 m, Horizontal Polarization  
 Pseudorandom Hopping Mode, Low End of Frequency Band, 915.75 MHz, XTCA1, Data Rate at 105kbps

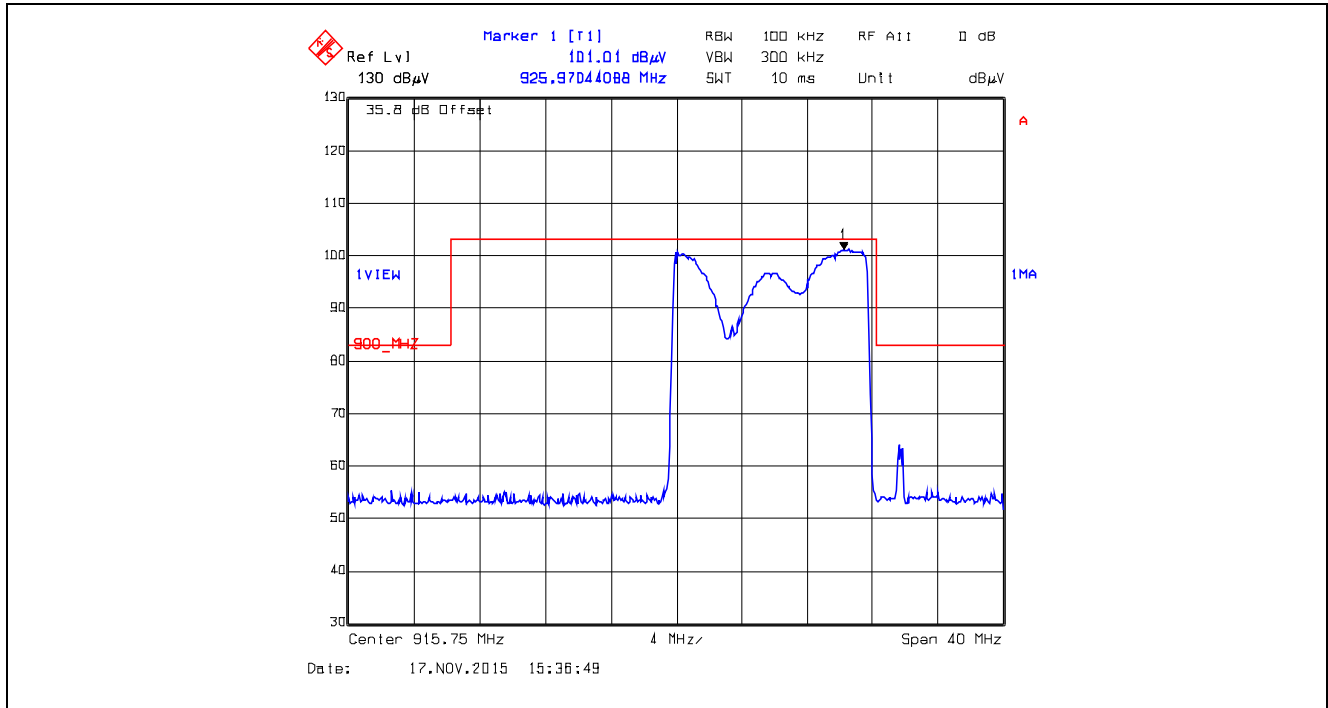

**Plot 5.5.4.2.51.** Band-Edge RF Radiated Emissions at 3 m, Vertical Polarization  
 Single Frequency Mode, Low End of Frequency Band, 915.75 MHz, XTCA1, Data Rate at 105kbps

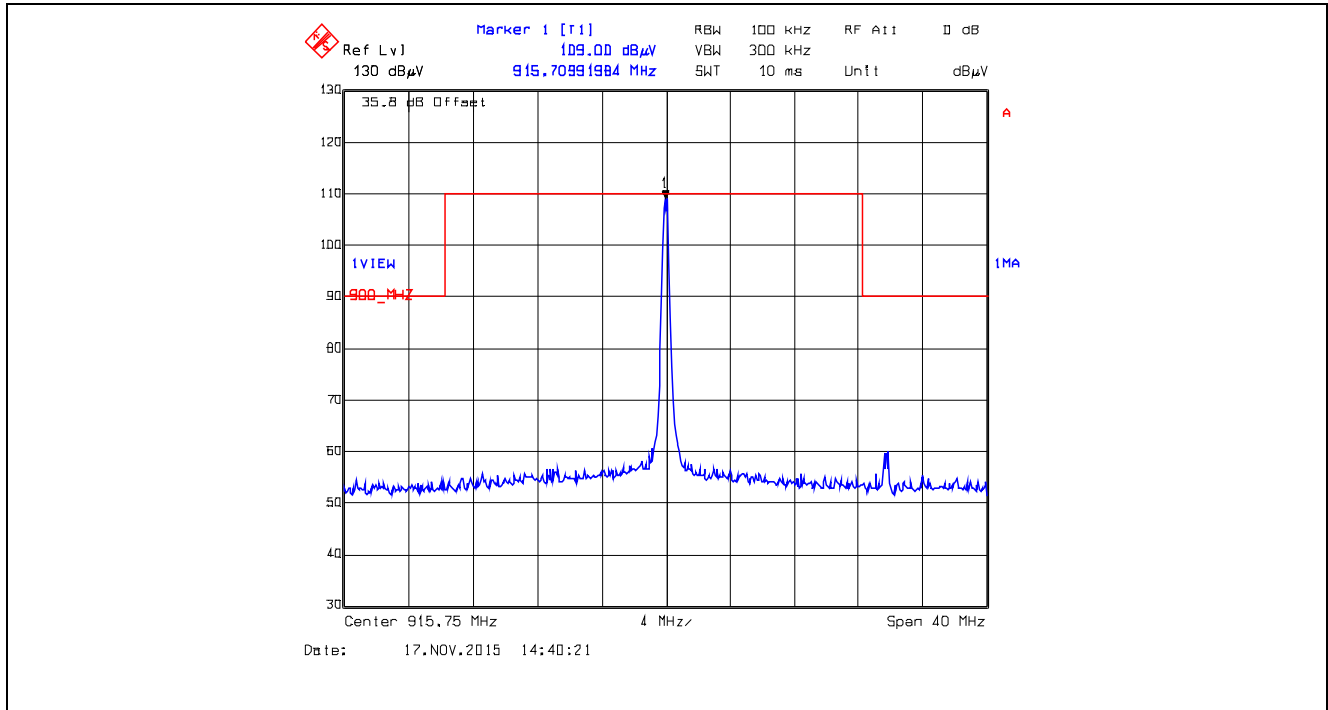

**Plot 5.5.4.2.52.** Band-Edge RF Radiated Emissions at 3 m, Vertical Polarization  
 Pseudorandom Hopping Mode, Low End of Frequency Band, 915.75 MHz, XTCA1, Data Rate at 105kbps

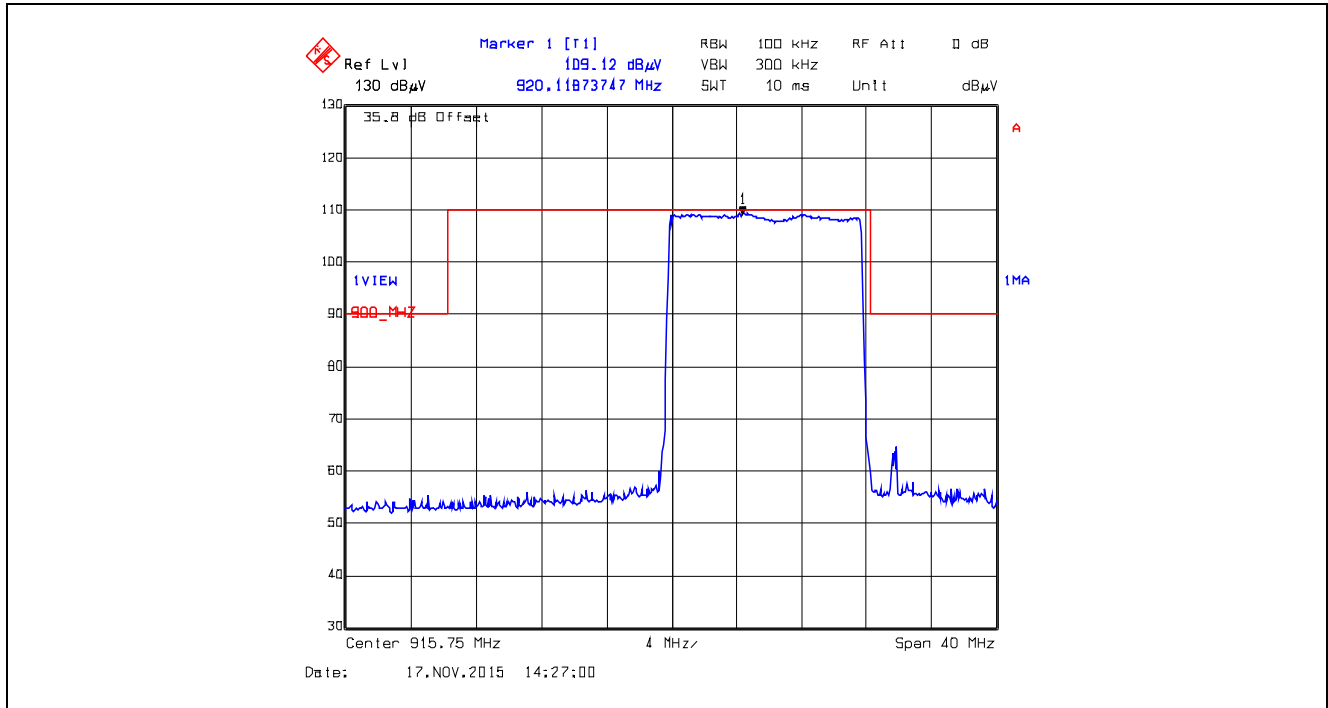

**Plot 5.5.4.2.2.53.** Band-Edge RF Radiated Emissions at 3 m, Horizontal Polarization  
 Single Frequency Mode, High End of Frequency Band, 927.265 MHz, XTCA1, Data Rate at 105kbps

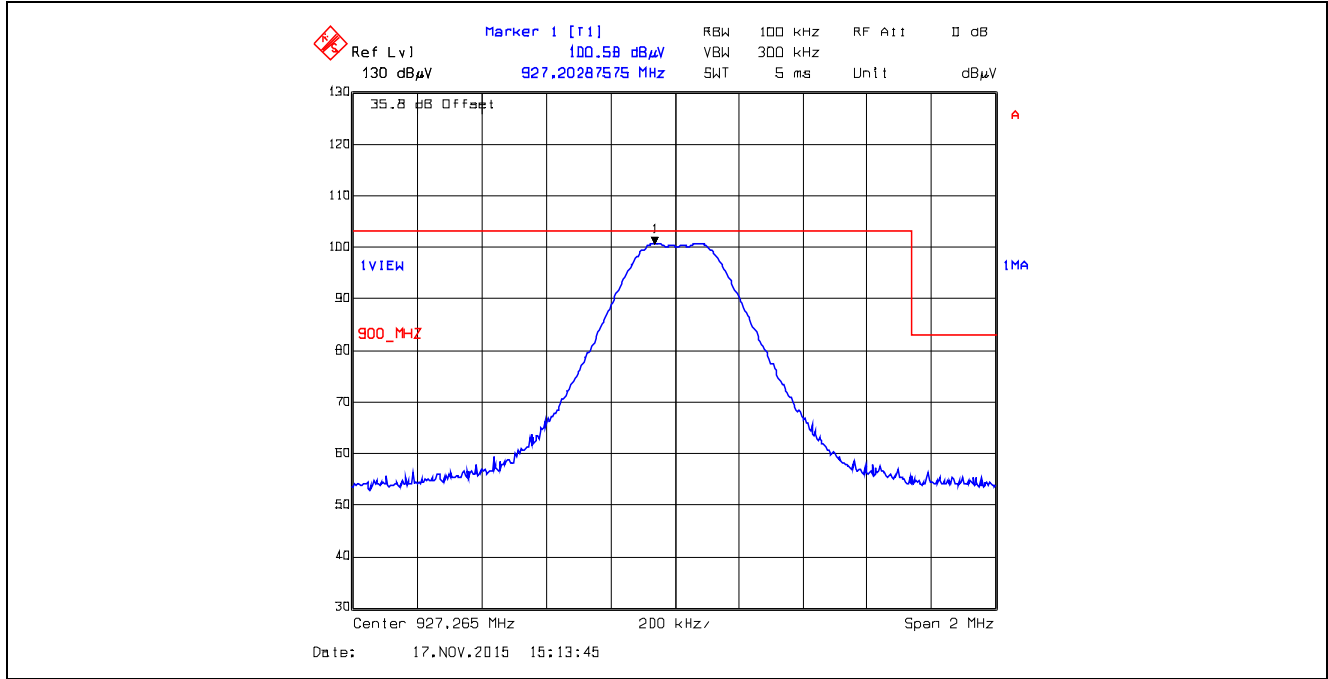

**Plot 5.5.4.2.2.54.** Band-Edge RF Radiated Emissions at 3 m, Horizontal Polarization  
 Pseudorandom Hopping Mode, High End of Frequency Band, 927.265 MHz, XTCA1, Data Rate at 105kbps

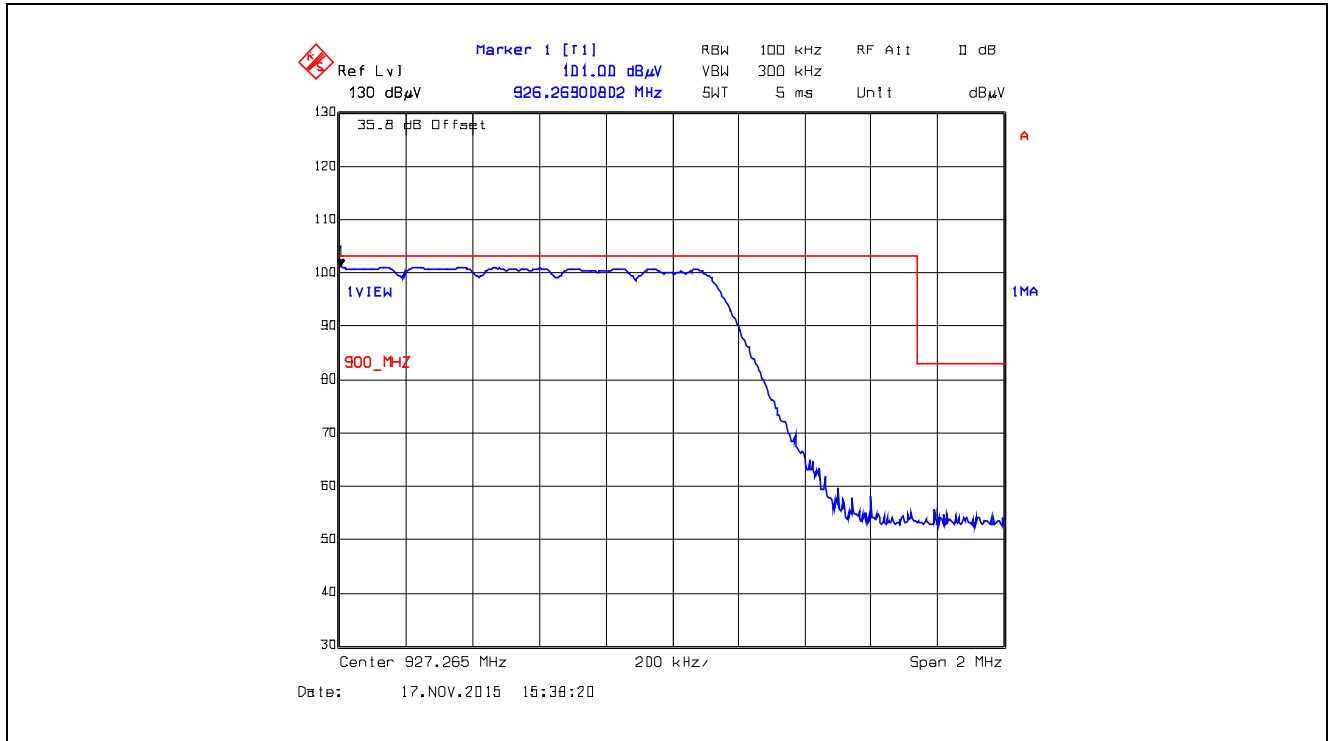

**Plot 5.5.4.2.255.** Band-Edge RF Radiated Emissions at 3 m, Vertical Polarization  
 Single Frequency Mode, High End of Frequency Band, 927.265 MHz, XTCA1, Data Rate at 105kbps

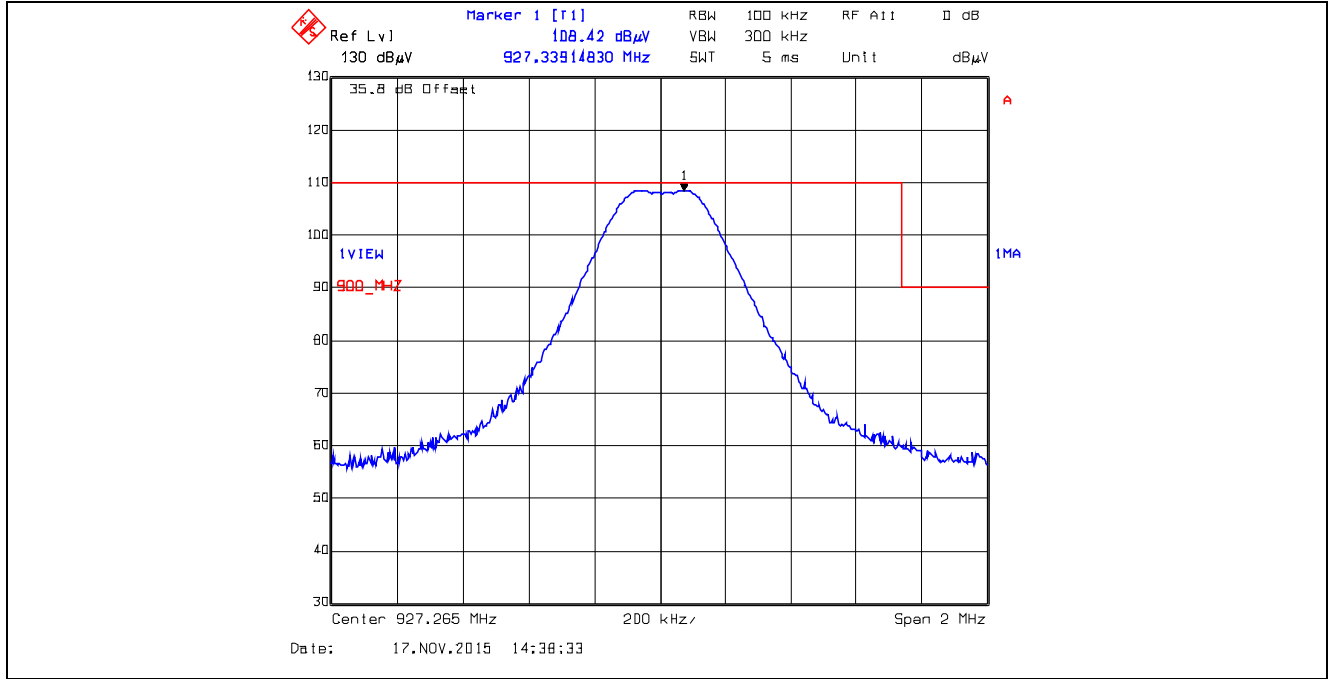

**Plot 5.5.4.2.256.** Band-Edge RF Radiated Emissions at 3 m, Vertical Polarization  
 Pseudorandom Hopping Mode, High End of Frequency Band, 927.265 MHz, XTCA1, Data Rate at 105kbps

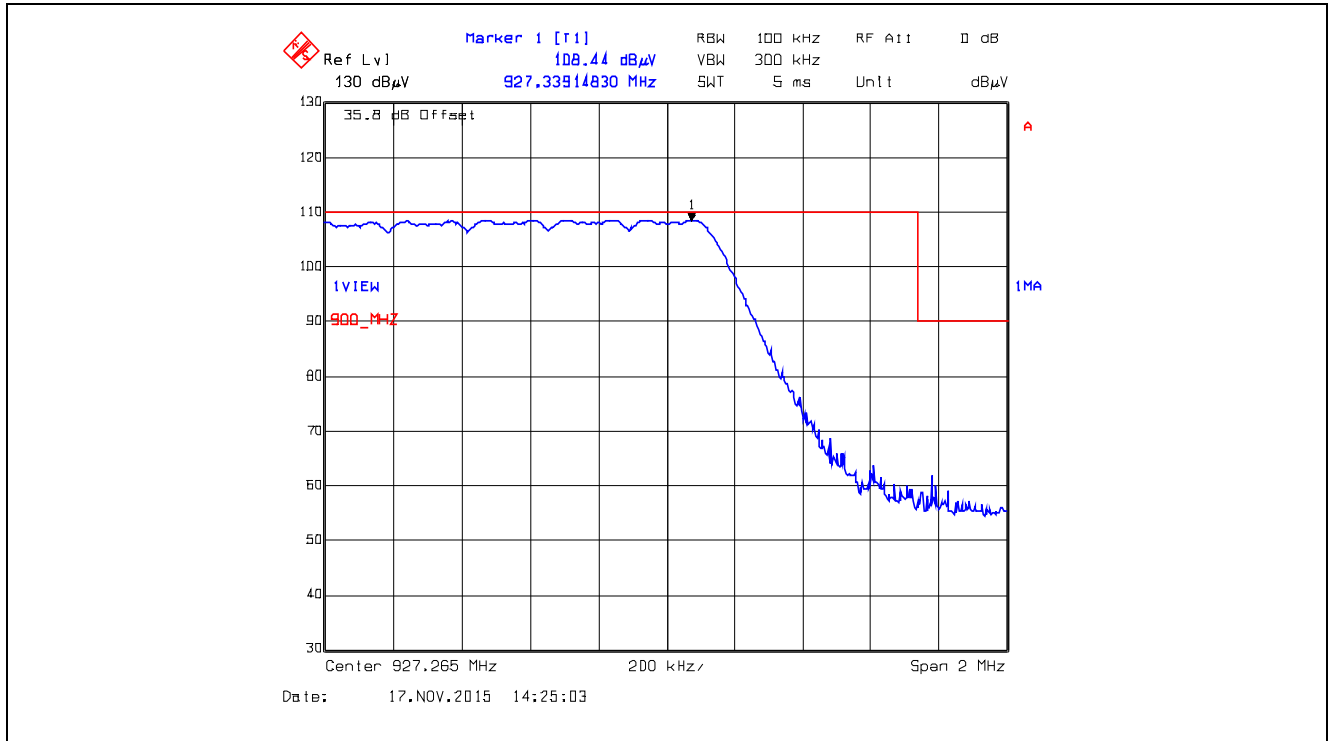

**5.5.4.3. EUT with 3.3 dBi Monopole Antenna and 0.44 dB Assembly Cable Loss**

**5.5.4.3.1. Spurious Radiated Emissions**

Fundamental Frequency:		902.5 MHz					
Configuration:		XBX0					
Measured Conducted Power:		13.36 dBm					
Frequency Test Range:		30 MHz – 10 GHz					
Frequency (MHz)	RF Peak Level (dBµV/m)	RF Avg Level (dBµV/m)	Antenna Plane (H/V)	Limit 15.209 (dBµV/m)	Limit 15.247 (dBµV/m)	Margin (dB)	Pass/Fail
902.50	110.30	--	V	--	--	--	--
902.50	100.33	--	H	--	--	--	--
2707.50	48.53	42.81	V	54.0	90.3	-11.2	Pass*
2707.50	49.30	42.30	H	54.0	90.3	-11.7	Pass*
3610.00	48.20	34.20	V	54.0	90.3	-19.8	Pass*
3610.00	47.80	34.10	H	54.0	90.3	-19.9	Pass*
4512.50	57.90	41.30	V	54.0	90.3	-12.7	Pass*
4512.50	52.70	42.50	H	54.0	90.3	-11.5	Pass*
5415.00	53.50	46.30	V	54.0	90.3	-7.7	Pass*
5415.00	53.00	43.80	H	54.0	90.3	-10.2	Pass*
All other spurious emissions and harmonics are more than 20 dB below the applicable limit.							

\*Field strength of emissions appearing within restricted frequency bands shall not exceed the limits in § 15.209.

Fundamental Frequency:		915.0 MHz					
Configuration:		XBX0					
Measured Conducted Power:		13.49 dBm					
Frequency Test Range:		30 MHz – 10 GHz					
Frequency (MHz)	RF Peak Level (dBµV/m)	RF Avg Level (dBµV/m)	Antenna Plane (H/V)	Limit 15.209 (dBµV/m)	Limit 15.247 (dBµV/m)	Margin (dB)	Pass/Fail
915.0	109.33	--	V	--	--	--	--
915.0	100.69	--	H	--	--	--	--
2745.0	48.60	41.22	V	54.0	89.3	-12.8	Pass*
2745.0	47.50	42.20	H	54.0	89.3	-11.8	Pass*
3660.0	48.20	34.70	V	54.0	89.3	-19.3	Pass*
3660.0	47.50	34.10	H	54.0	89.3	-19.9	Pass*
4575.0	55.50	43.40	V	54.0	89.3	-10.6	Pass*
4575.0	54.70	46.20	H	54.0	89.3	-7.8	Pass*
All other spurious emissions and harmonics are more than 20 dB below the applicable limit.							

\*Field strength of emissions appearing within restricted frequency bands shall not exceed the limits in § 15.209.

**ULTRATECH GROUP OF LABS**

3000 Bristol Circle, Oakville, Ontario, Canada L6H 6G4  
 Tel. #: 905-829-1570, Fax. #: 905-829-8050, Email: [vic@ultratech-labs.com](mailto:vic@ultratech-labs.com), Website: <http://www.ultratech-labs.com>

File #: 15DIG102\_FCC15C247  
 December 24, 2015

All test results contained in this engineering test report are traceable to National Institute of Standards and Technology (NIST)

Fundamental Frequency:		927.5 MHz					
Configuration:		XBX0					
Measured Conducted Power:		13.49 dBm					
Frequency Test Range:		30 MHz – 10 GHz					
Frequency (MHz)	RF Peak Level (dBµV/m)	RF Avg Level (dBµV/m)	Antenna Plane (H/V)	Limit 15.209 (dBµV/m)	Limit 15.247 (dBµV/m)	Margin (dB)	Pass/Fail
927.5	108.41	--	V	--	--	--	--
927.5	101.95	--	H	--	--	--	--
2782.5	48.19	40.60	V	54.0	88.4	-13.4	Pass*
2782.5	42.10	42.30	H	54.0	88.4	-11.7	Pass*
3710.0	48.90	36.70	V	54.0	88.4	-17.3	Pass*
3710.0	48.50	34.60	H	54.0	88.4	-19.4	Pass*
4637.5	57.30	43.50	V	54.0	88.4	-10.5	Pass*
4637.5	53.70	48.00	H	54.0	88.4	-8.0	Pass*
All other spurious emissions and harmonics are more than 20 dB below the applicable limit.							

**5.5.4.3.2. Band-Edge RF Radiated Emissions**

Refer to the following plots.

**Plot 5.5.4.3.2.1.** Band-Edge RF Radiated Emissions at 3 m, Horizontal Polarization  
 Single Frequency Mode, Low End of Frequency Band, 902.5 MHz, XB0, Data Rate at 10 kbps

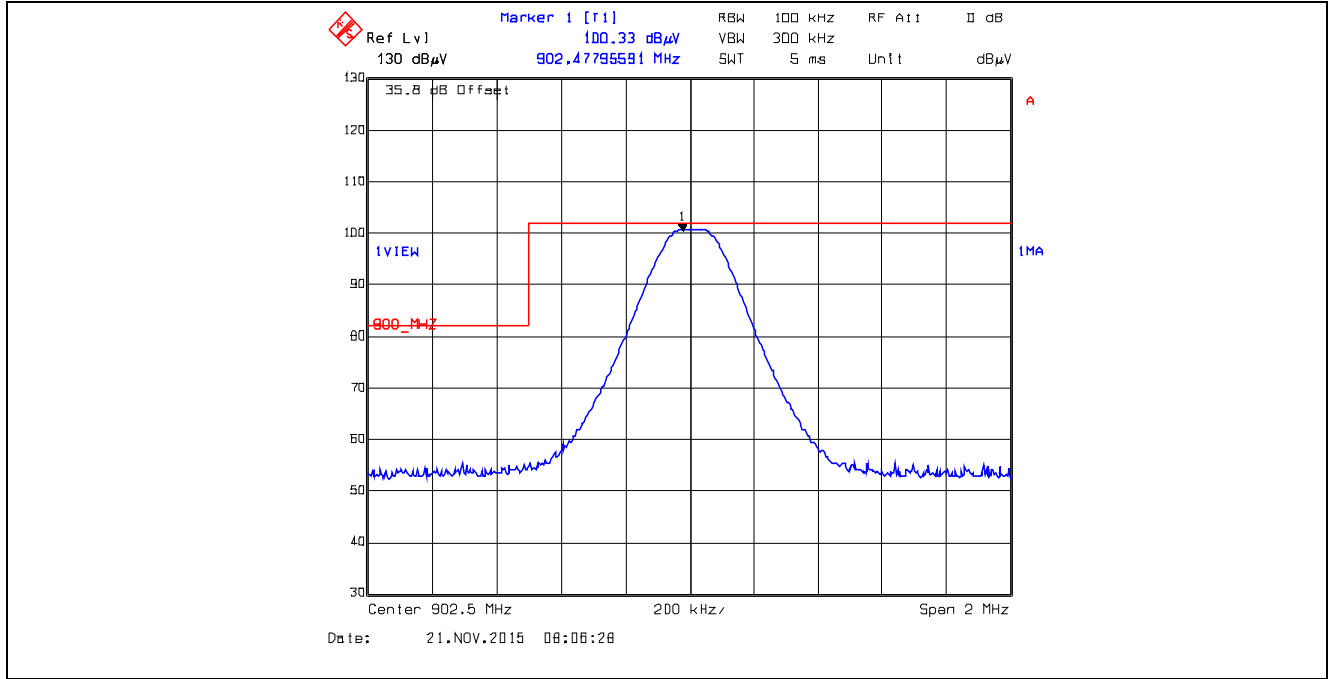

**Plot 5.5.4.3.2.2.** Band-Edge RF Radiated Emissions at 3 m, Horizontal Polarization  
 Pseudorandom Hopping Mode, Low End of Frequency Band, 902.5 MHz, XB0, Data Rate at 10 kbps

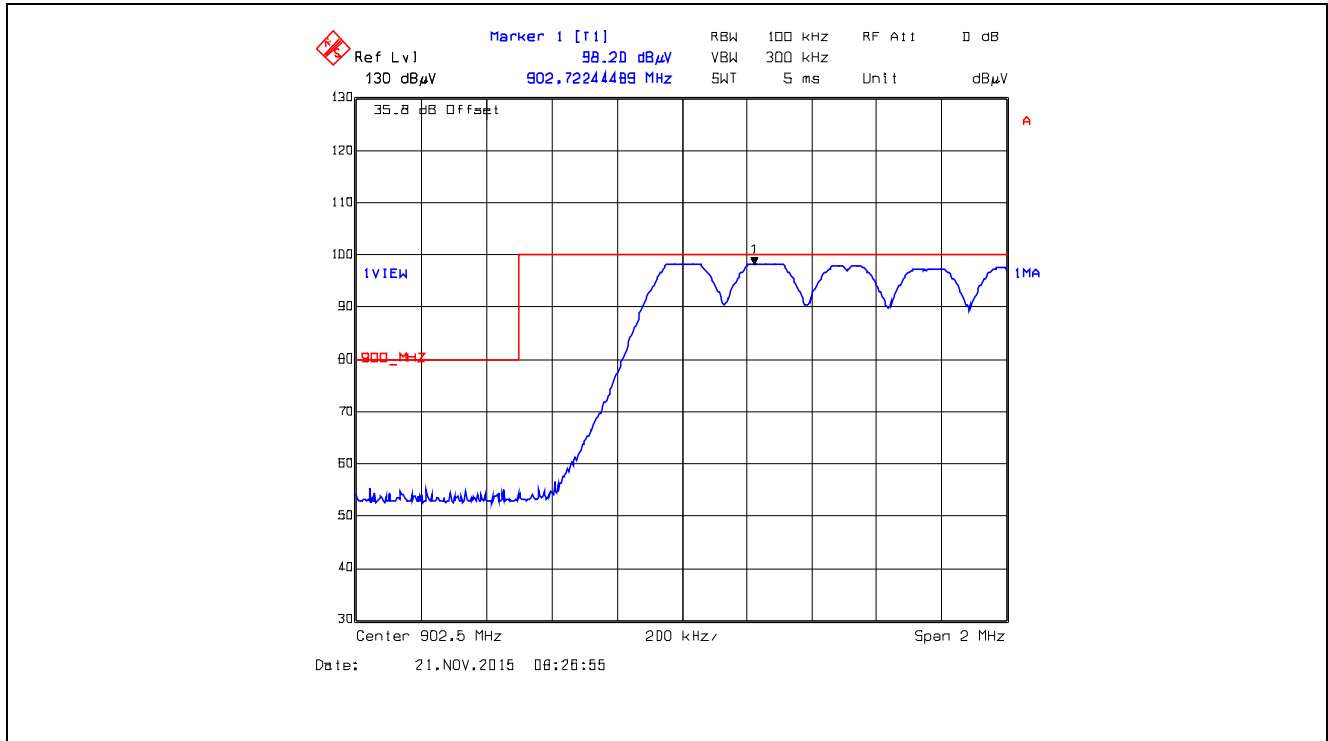

**Plot 5.5.4.3.2.3.** Band-Edge RF Radiated Emissions at 3 m, Vertical Polarization  
 Single Frequency Mode, Low End of Frequency Band, 902.5 MHz, XBX0, Data Rate at 10 kbps

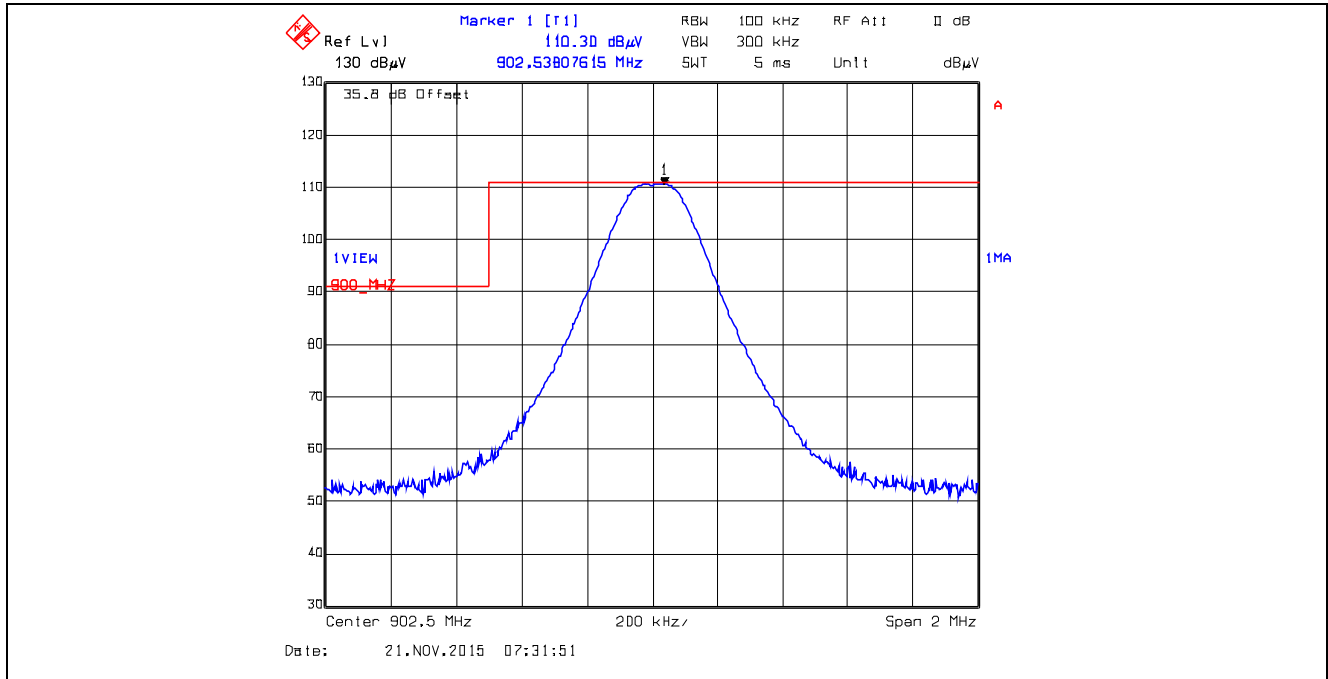

**Plot 5.5.4.3.2.4.** Band-Edge RF Radiated Emissions at 3 m, Vertical Polarization  
 Pseudorandom Hopping Mode, Low End of Frequency Band, 902.5 MHz, XBX0, Data Rate at 10 kbps

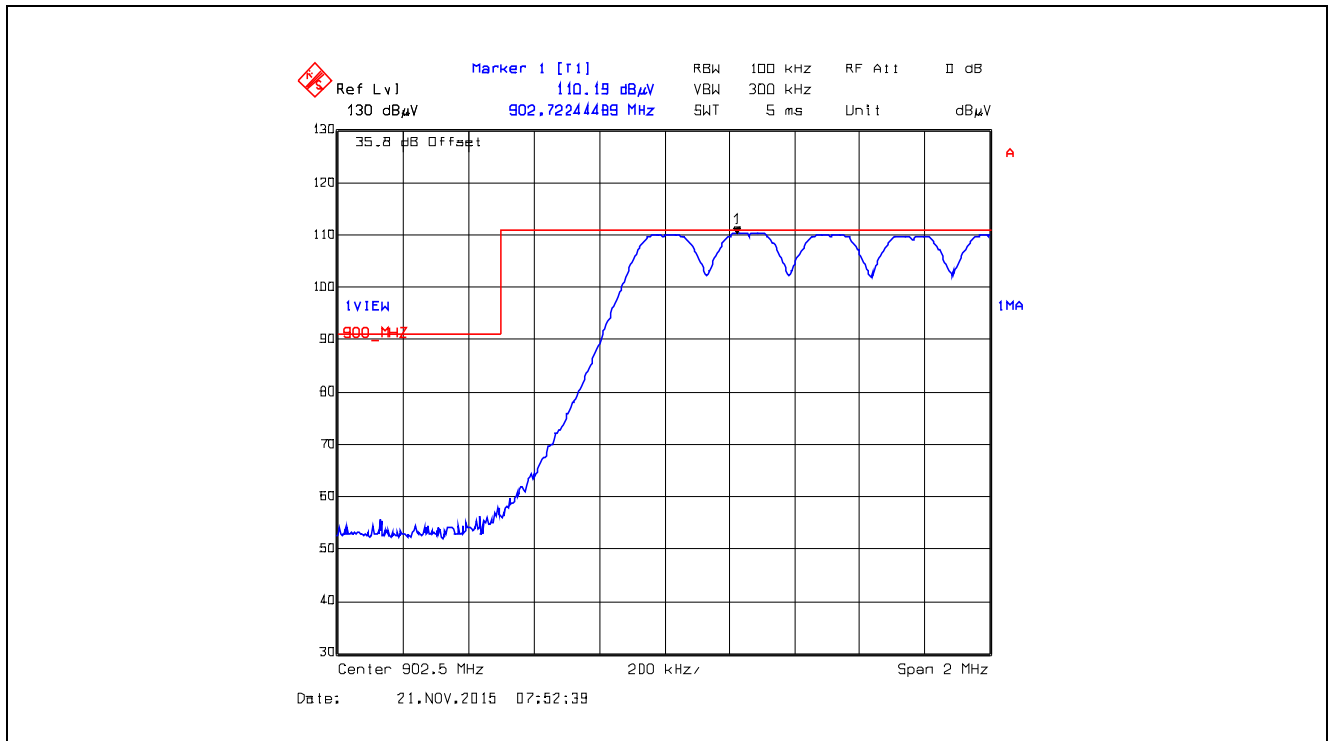



**Plot 5.5.4.3.2.5.** Band-Edge RF Radiated Emissions at 3 m, Horizontal Polarization  
 Single Frequency Mode, High End of Frequency Band, 927.5 MHz, XB0, Data Rate at 10 kbps

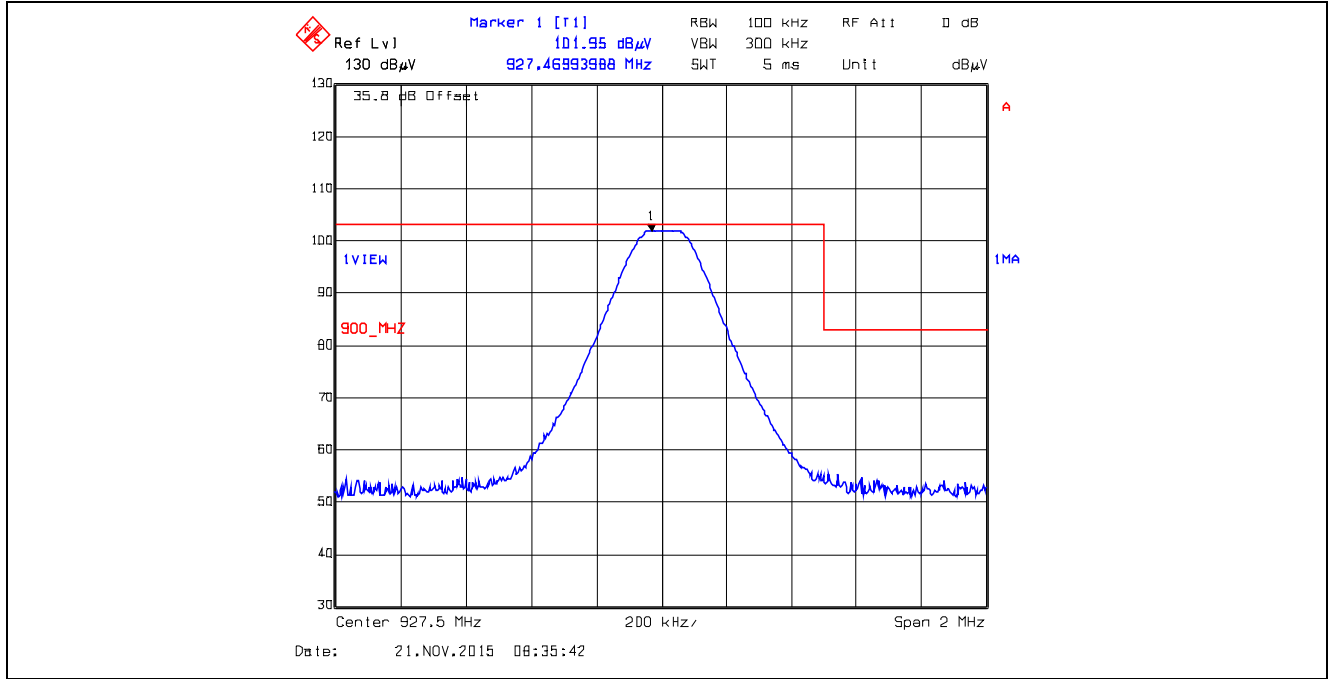

**Plot 5.5.4.3.2.6.** Band-Edge RF Radiated Emissions at 3 m, Horizontal Polarization  
 Pseudorandom Hopping Mode, High End of Frequency Band, 927.5 MHz, XB0, Data Rate at 10 kbps

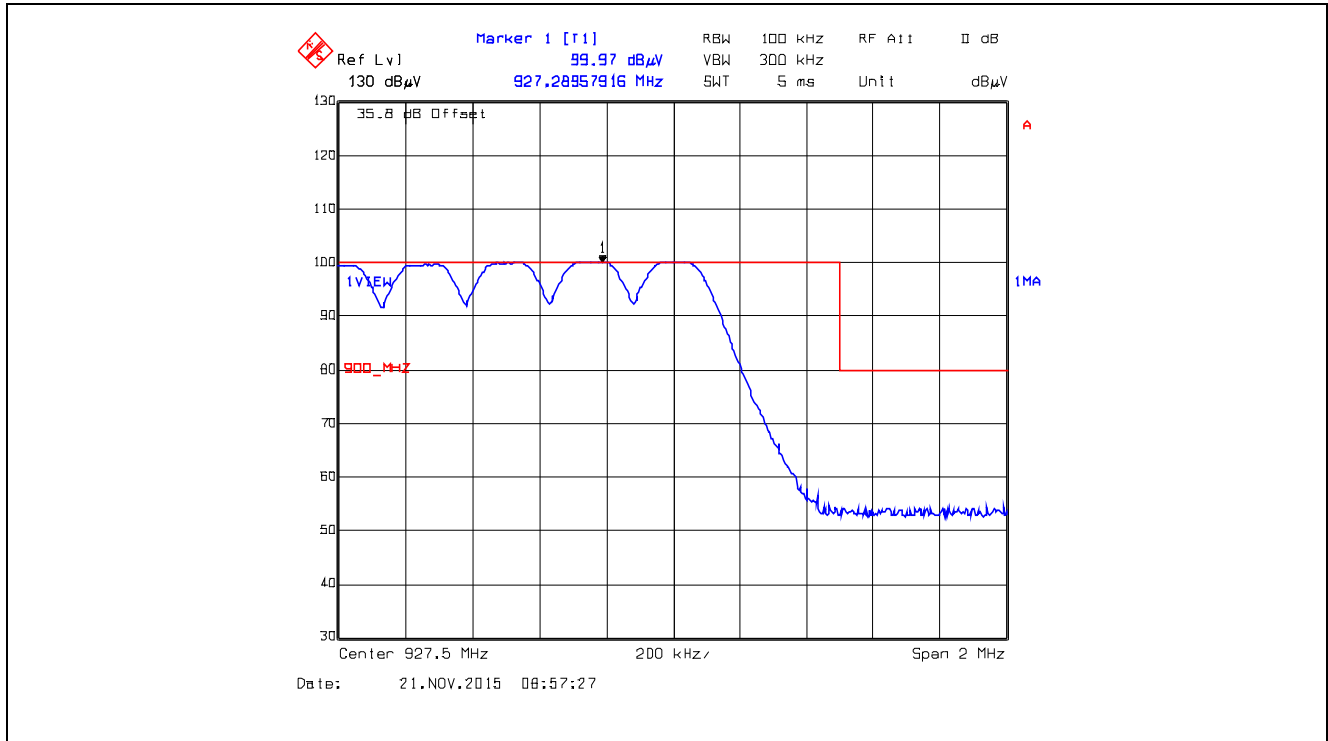

**Plot 5.5.4.3.2.7.** Band-Edge RF Radiated Emissions at 3 m, Vertical Polarization  
 Single Frequency Mode, High End of Frequency Band, 927.5 MHz, XBX0, Data Rate at 10 kbps

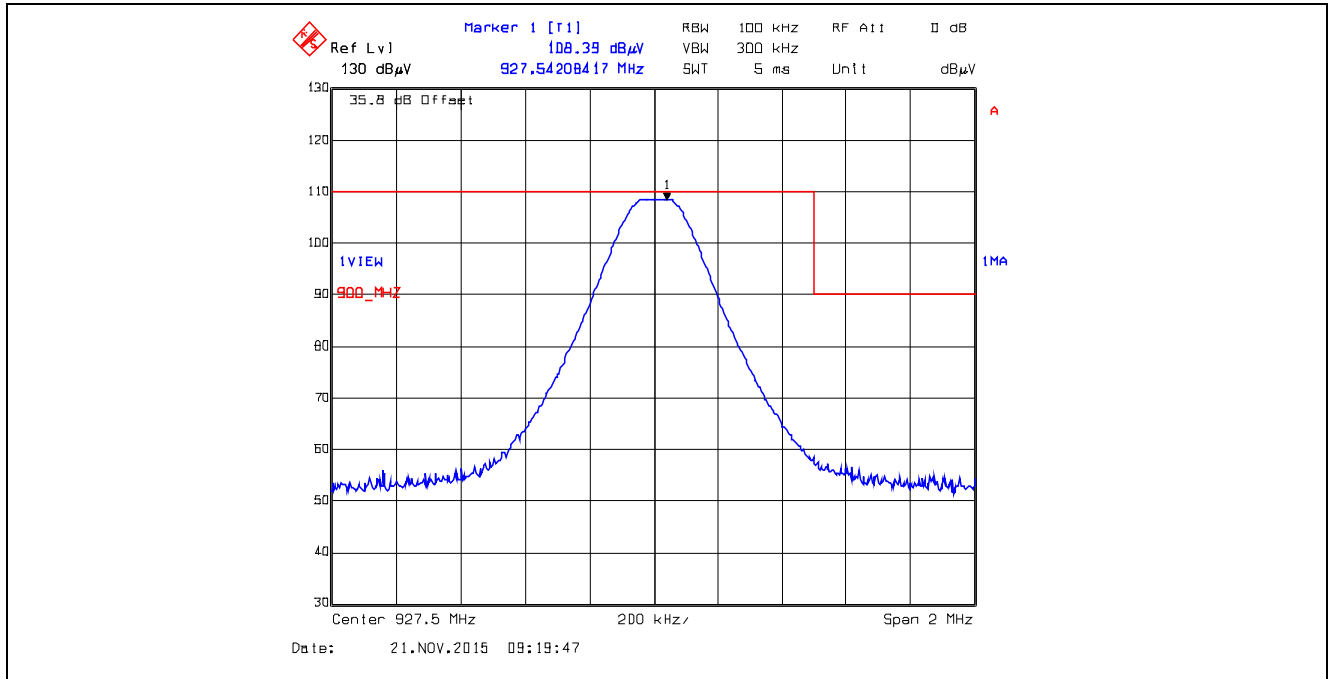

**Plot 5.5.4.3.2.8.** Band-Edge RF Radiated Emissions at 3 m, Vertical Polarization  
 Pseudorandom Hopping Mode, High End of Frequency Band, 927.5 MHz, XBX0, Data Rate at 10 kbps

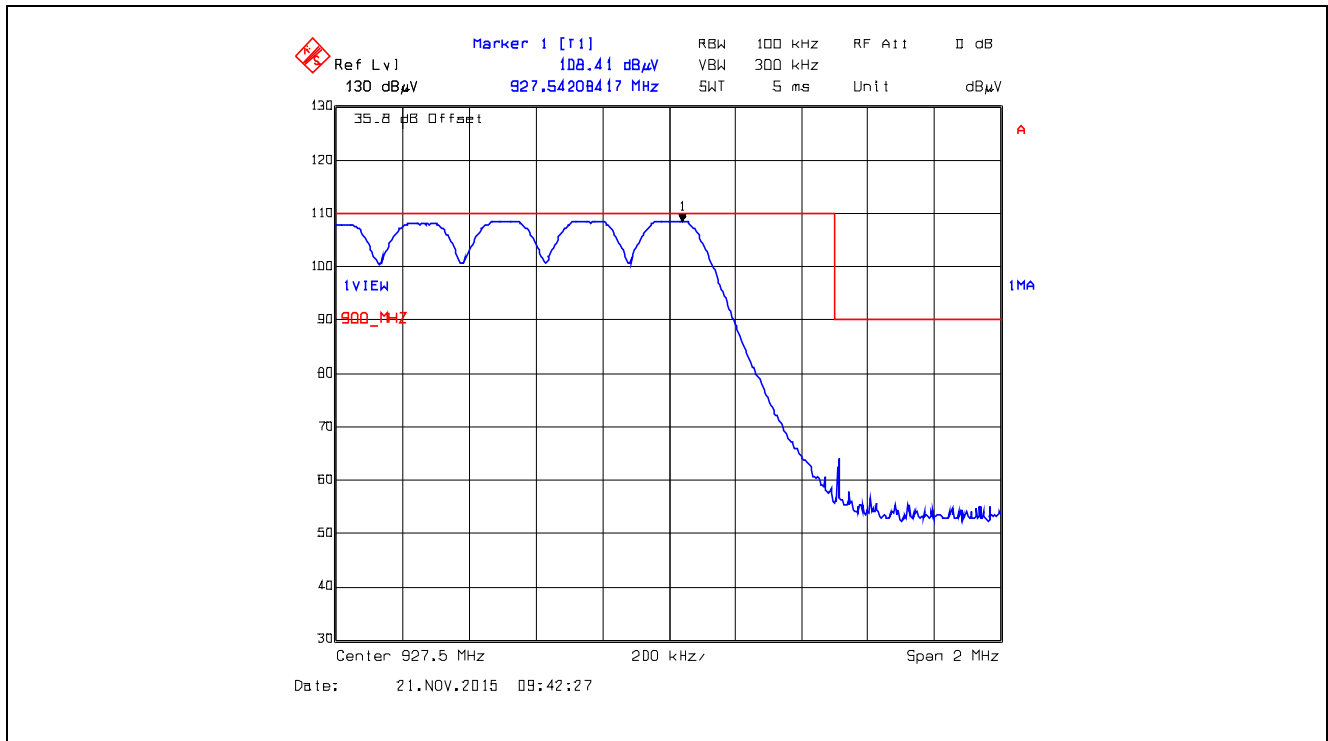

**Plot 5.5.4.3.2.9.** Band-Edge RF Radiated Emissions at 3 m, Horizontal Polarization  
Single Frequency Mode, Low End of Frequency Band, 902.5 MHz, XB1, Data Rate at 110 kbps

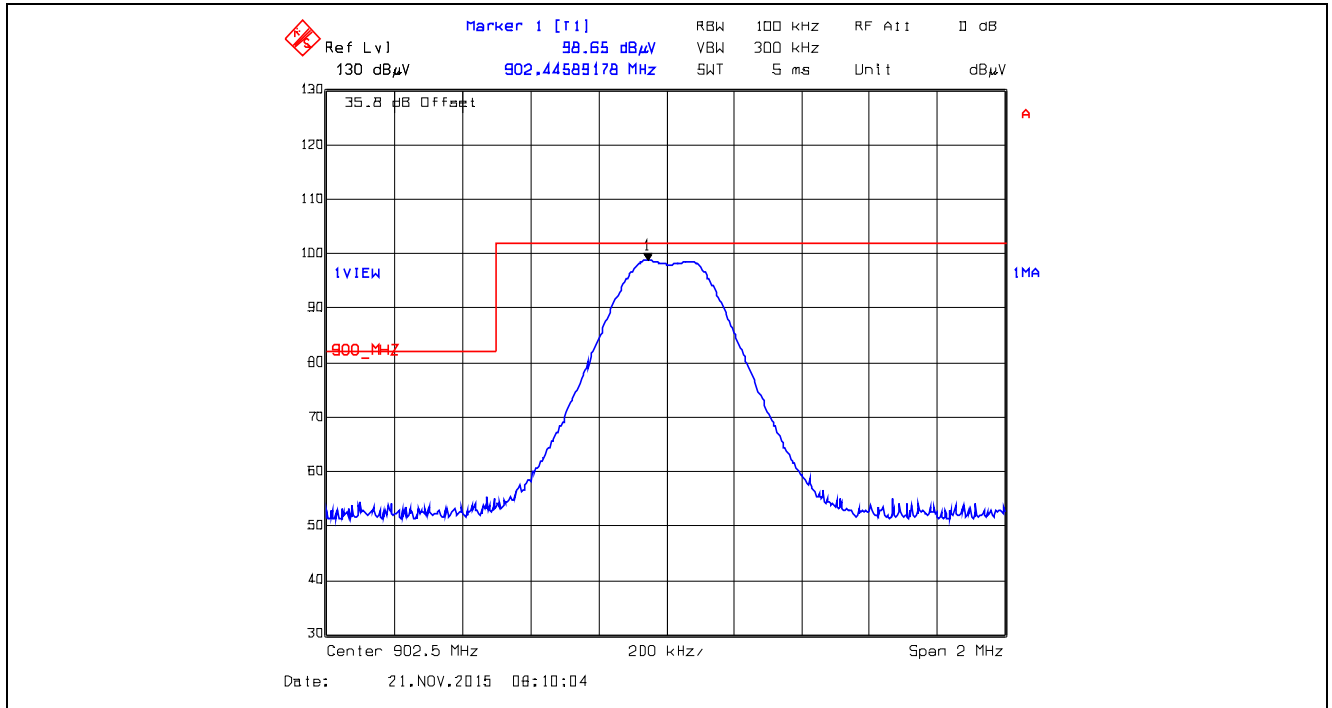

**Plot 5.5.4.3.2.10.** Band-Edge RF Radiated Emissions at 3 m, Horizontal Polarization  
Pseudorandom Hopping Mode, Low End of Frequency Band, 902.5 MHz, XB1, Data Rate at 110 kbps

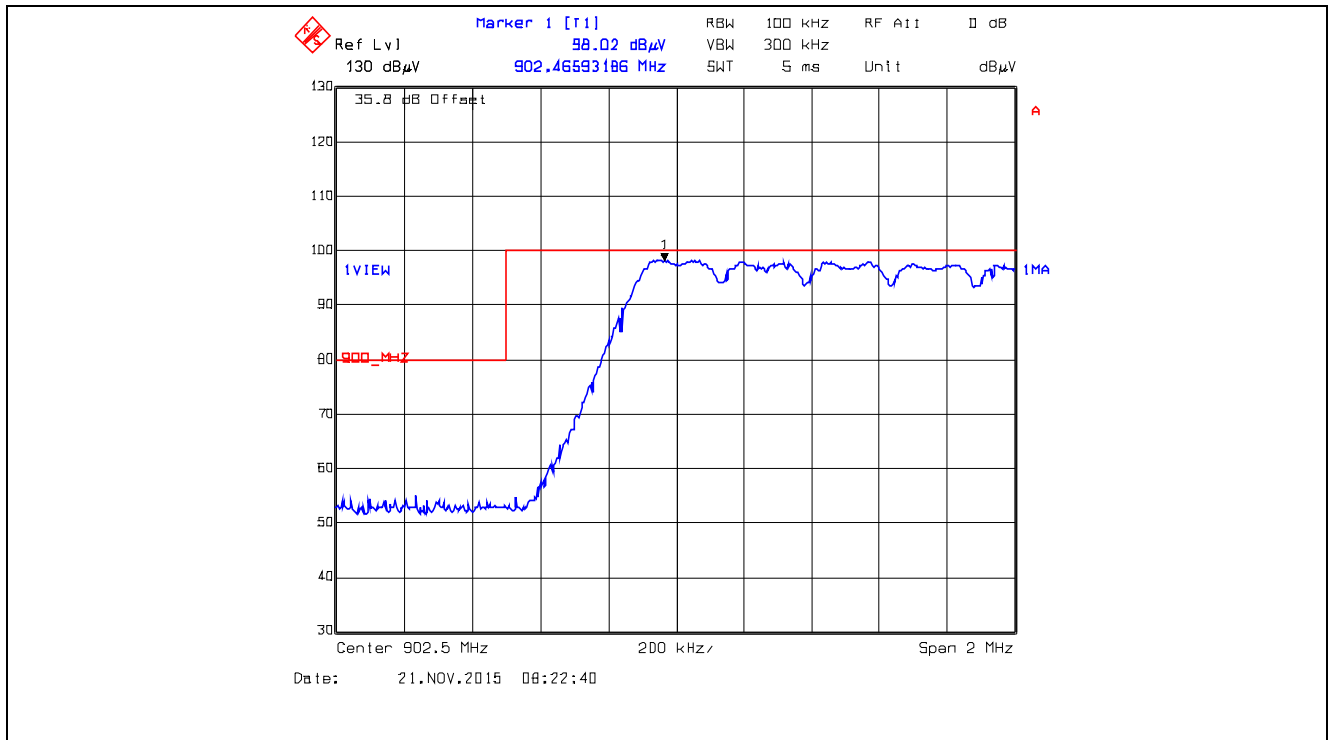

**Plot 5.5.4.3.2.11.** Band-Edge RF Radiated Emissions at 3 m, Vertical Polarization  
 Single Frequency Mode, Low End of Frequency Band, 902.5 MHz, XB1, Data Rate at 110 kbps

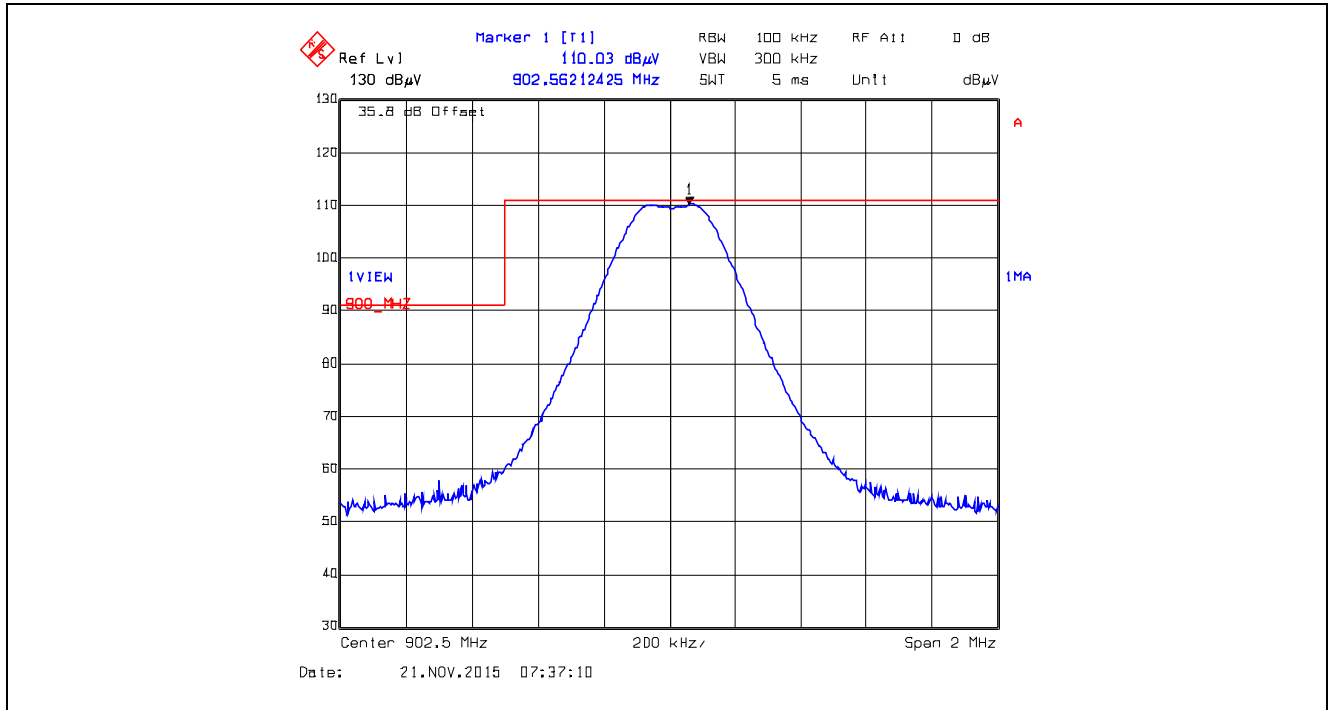

**Plot 5.5.4.3.2.12.** Band-Edge RF Radiated Emissions at 3 m, Vertical Polarization  
 Pseudorandom Hopping Mode, Low End of Frequency Band, 902.5 MHz, XB1, Data Rate at 110 kbps

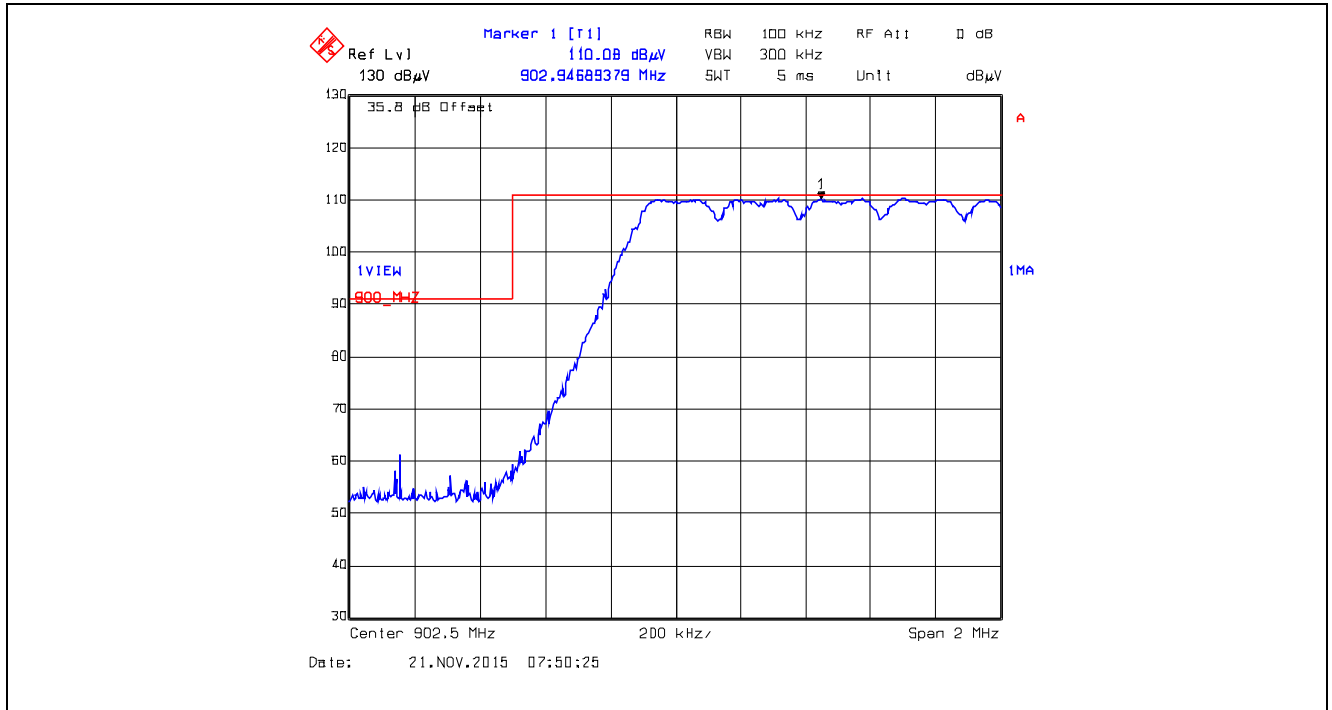

**Plot 5.5.4.3.2.13.** Band-Edge RF Radiated Emissions at 3 m, Horizontal Polarization  
 Single Frequency Mode, High End of Frequency Band, 927.5 MHz, XB1, Data Rate at 110 kbps

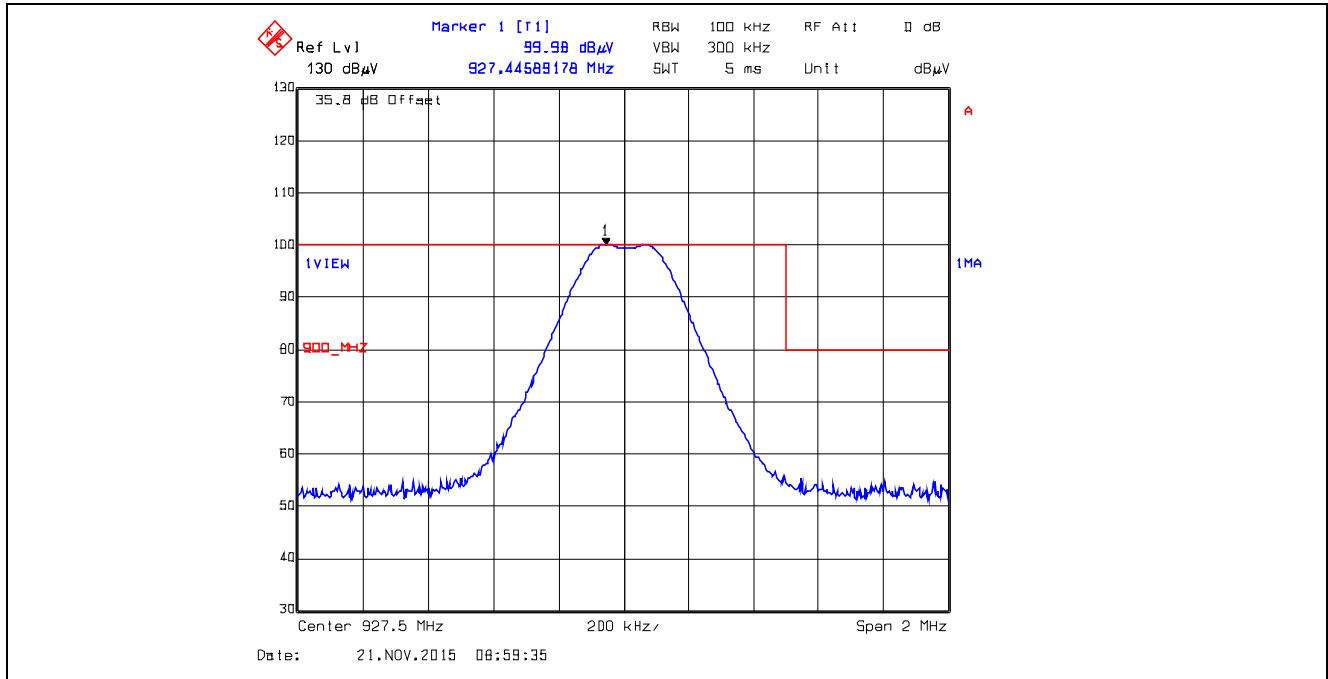

**Plot 5.5.4.3.2.14.** Band-Edge RF Radiated Emissions at 3 m, Horizontal Polarization  
 Pseudorandom Hopping Mode, High End of Frequency Band, 927.5 MHz, XB1, Data Rate at 110 kbps

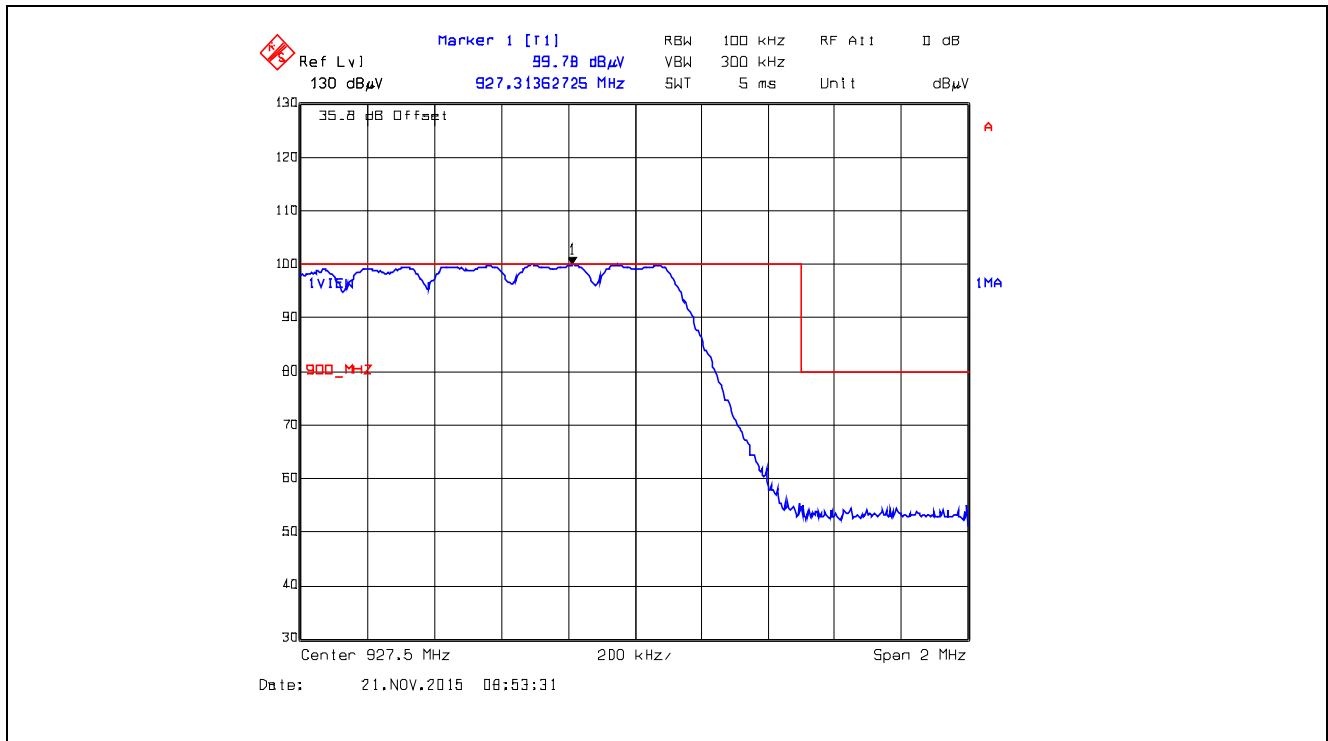

**Plot 5.5.4.3.2.15.** Band-Edge RF Radiated Emissions at 3 m, Vertical Polarization  
Single Frequency Mode, High End of Frequency Band, 927.5 MHz, XB1, Data Rate at 110 kbps

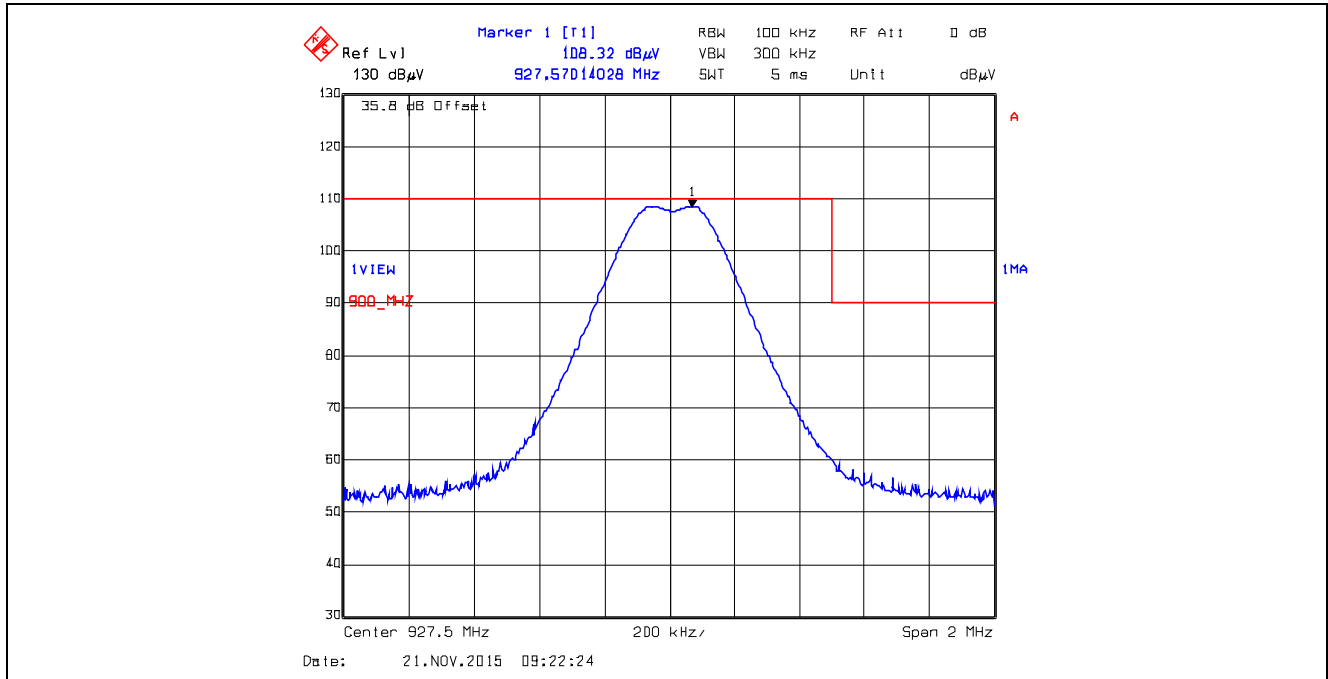

**Plot 5.5.4.3.2.16.** Band-Edge RF Radiated Emissions at 3 m, Vertical Polarization  
Pseudorandom Hopping Mode, High End of Frequency Band, 927.5 MHz, XB1, Data Rate at 110 kbps

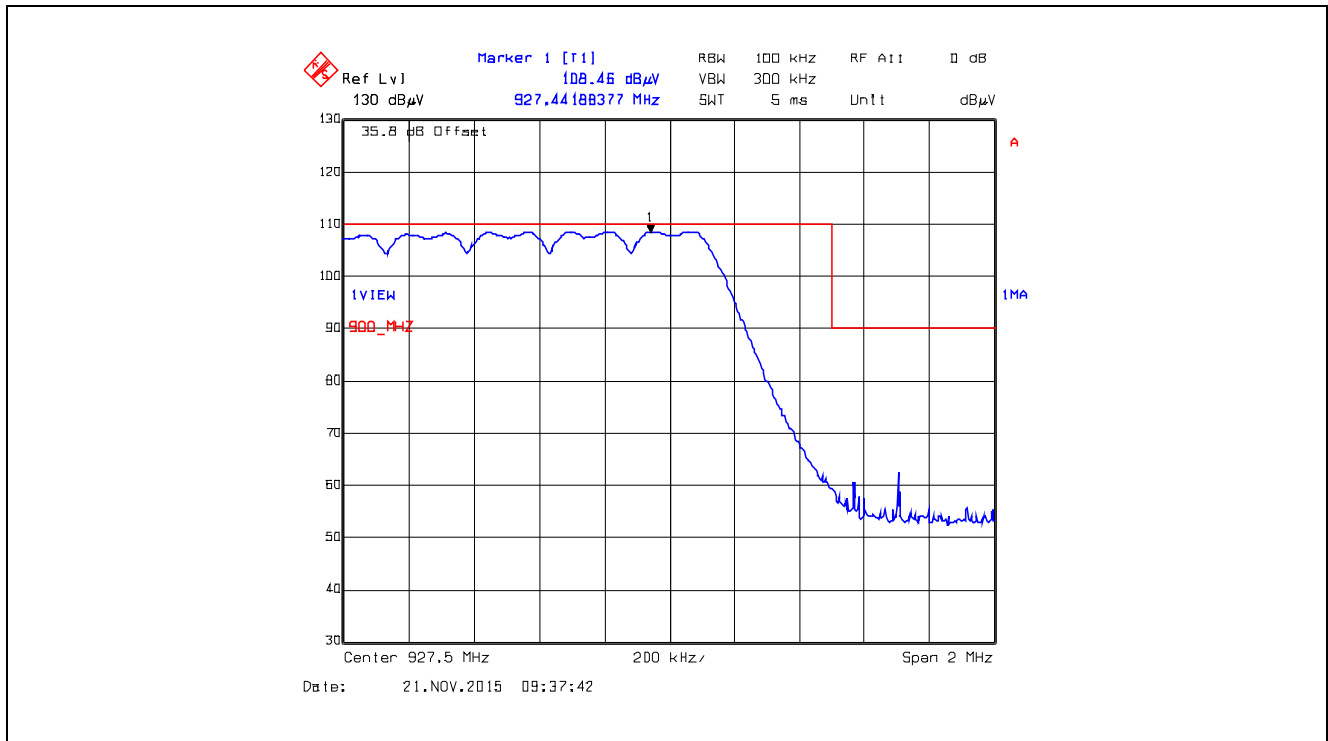

**Plot 5.5.4.3.2.17.** Band-Edge RF Radiated Emissions at 3 m, Horizontal Polarization  
 Single Frequency Mode, Low End of Frequency Band, 902.75 MHz, XB2, Data Rate at 250 kbps

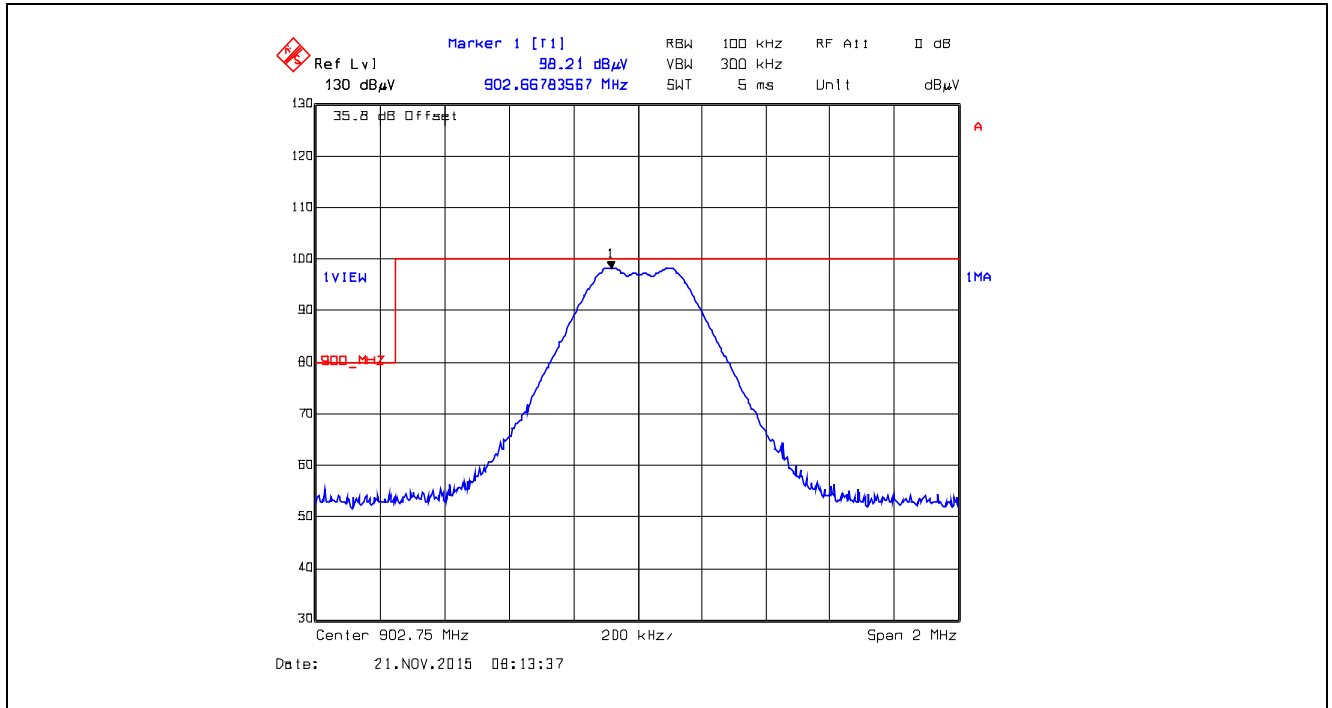

**Plot 5.5.4.3.2.18.** Band-Edge RF Radiated Emissions at 3 m, Horizontal Polarization  
 Pseudorandom Hopping Mode, Low End of Frequency Band, 902.75 MHz, XB2, Data Rate at 250 kbps

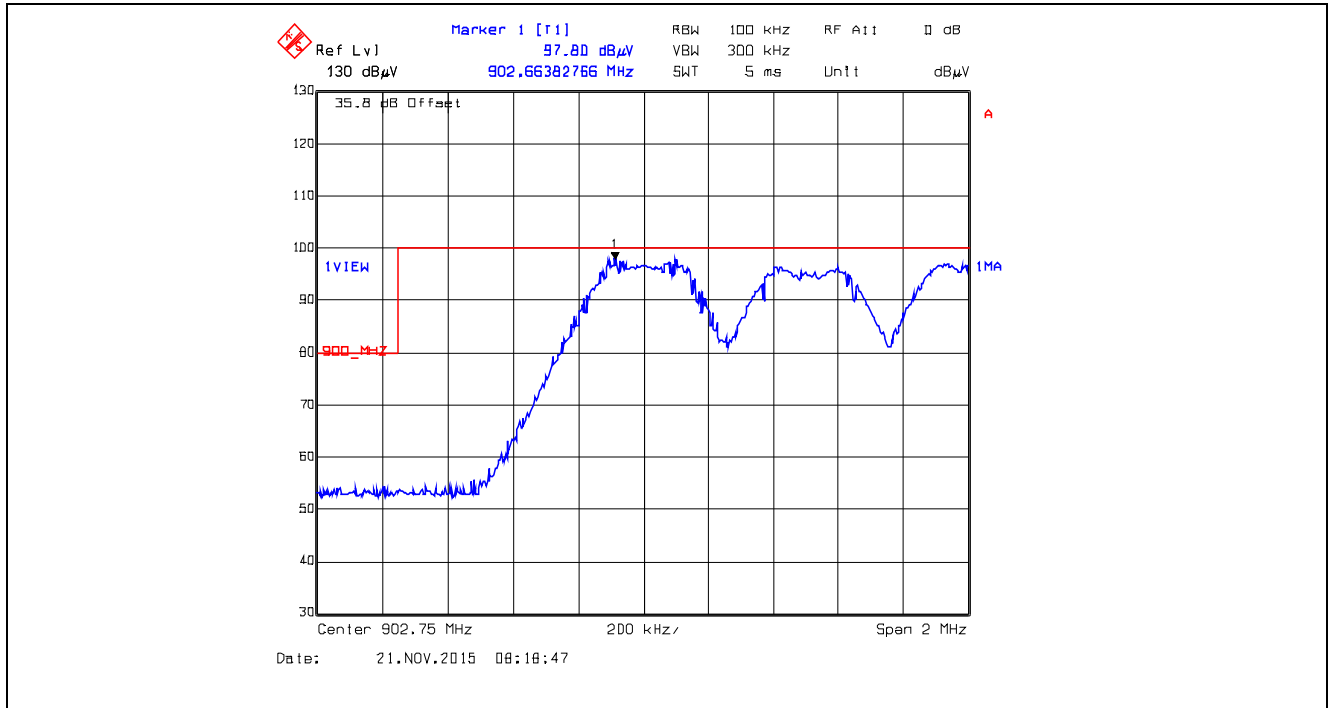

**Plot 5.5.4.3.2.19.** Band-Edge RF Radiated Emissions at 3 m, Vertical Polarization  
Single Frequency Mode, Low End of Frequency Band, 902.75 MHz, XB2, Data Rate at 250 kbps

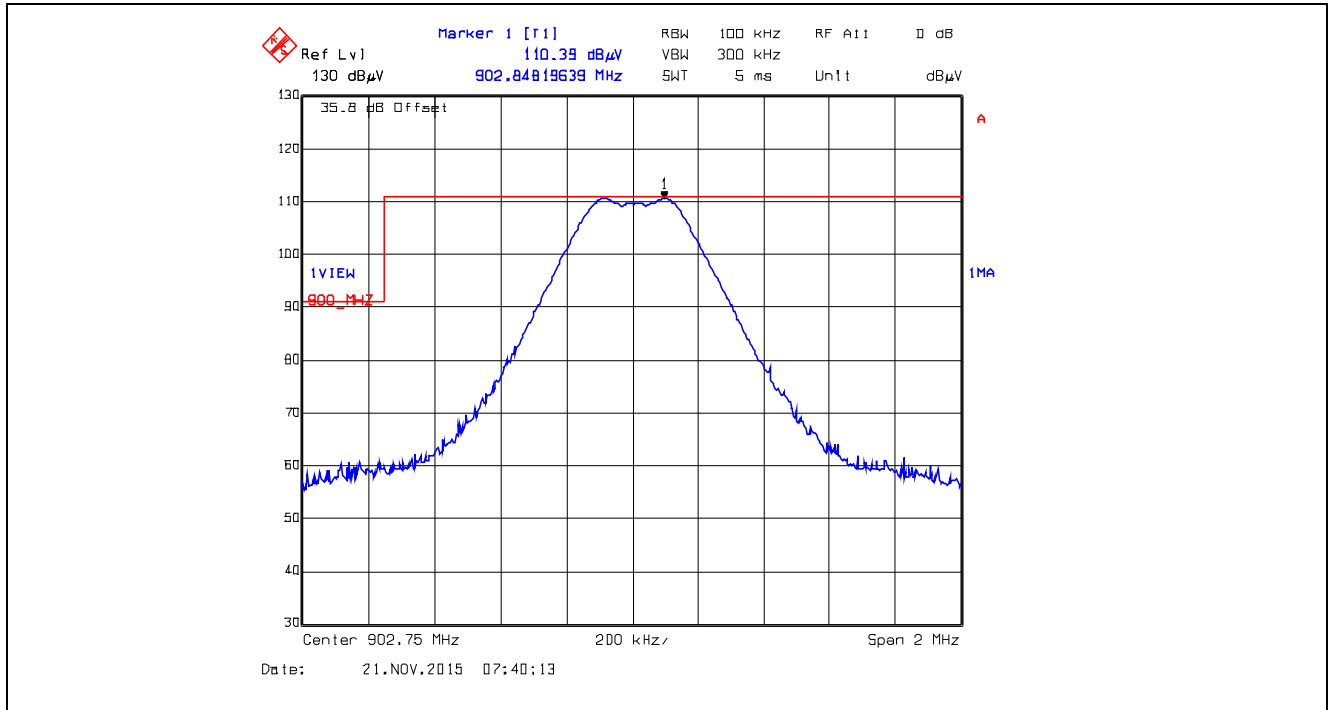

**Plot 5.5.4.3.2.20.** Band-Edge RF Radiated Emissions at 3 m, Vertical Polarization  
Pseudorandom Hopping Mode, Low End of Frequency Band, 902.75 MHz, XB2, Data Rate at 250 kbps

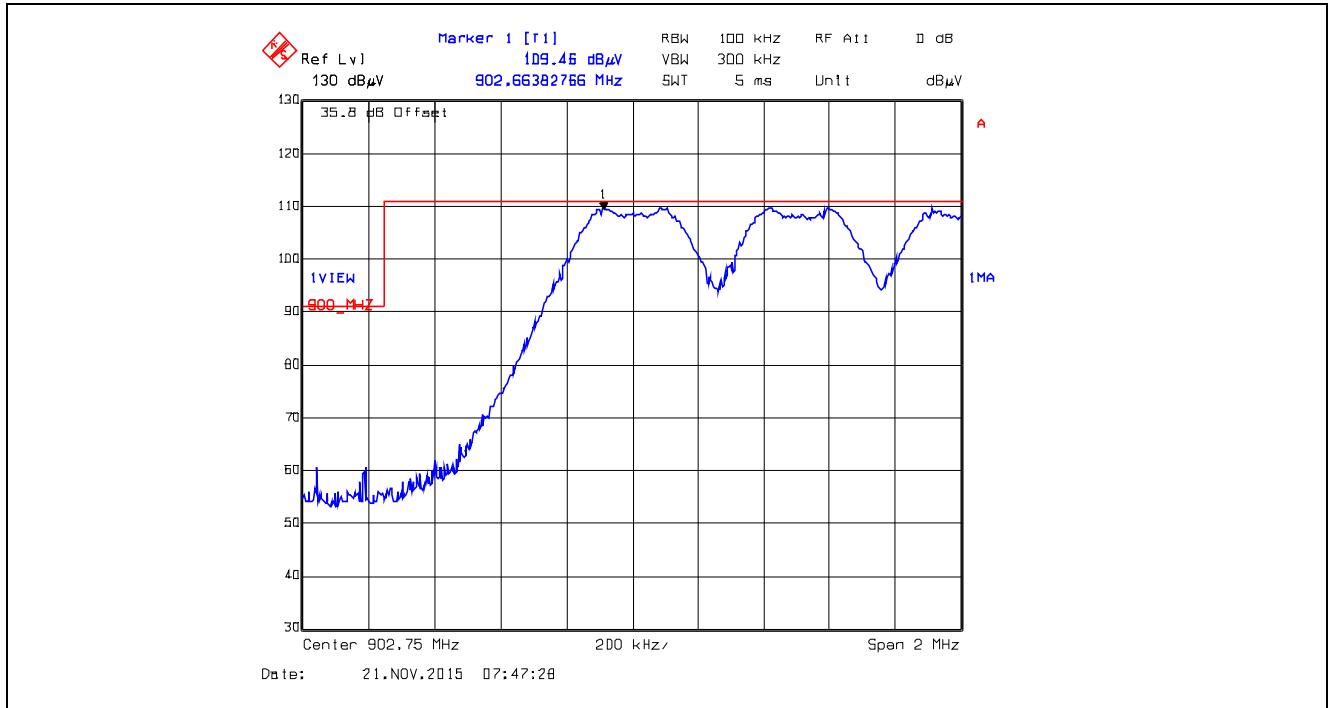



**Plot 5.5.4.3.2.21.** Band-Edge RF Radiated Emissions at 3 m, Horizontal Polarization  
 Single Frequency Mode, High End of Frequency Band, 927.25 MHz, XB2, Data Rate at 250 kbps

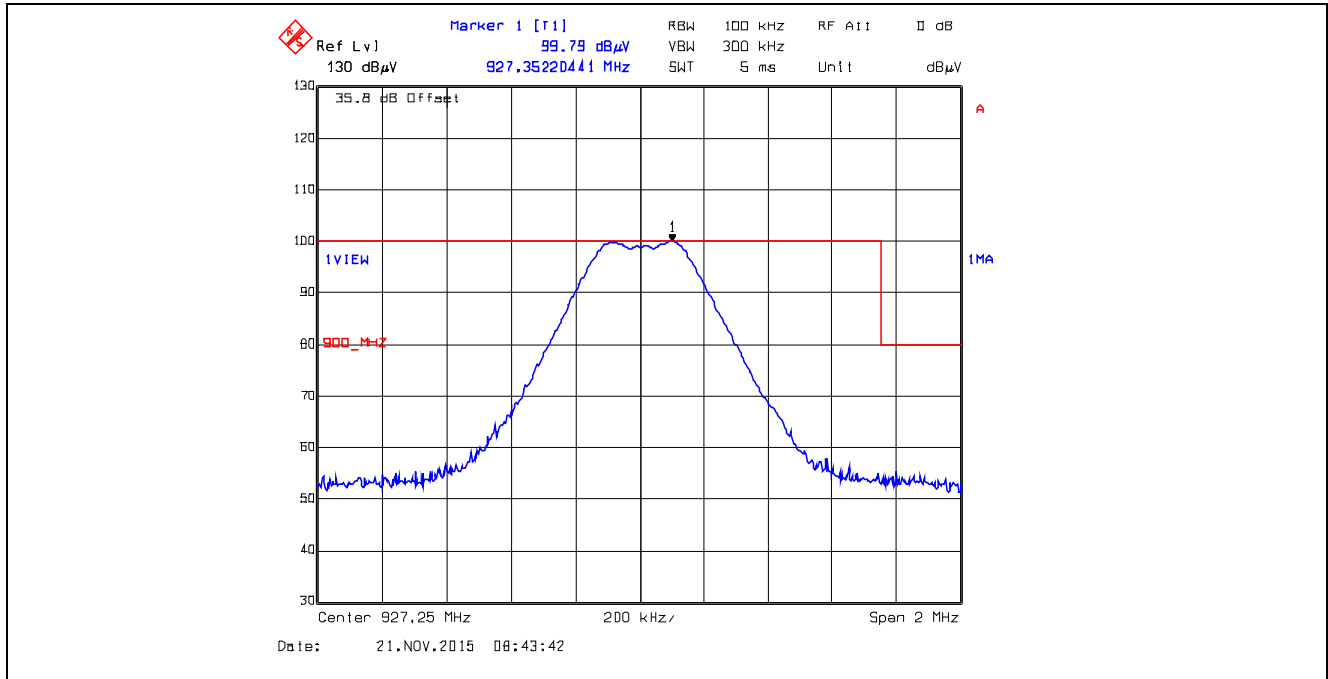

**Plot 5.5.4.3.2.22.** Band-Edge RF Radiated Emissions at 3 m, Horizontal Polarization  
 Pseudorandom Hopping Mode, High End of Frequency Band, 927.25 MHz, XB2, Data Rate at 250 kbps

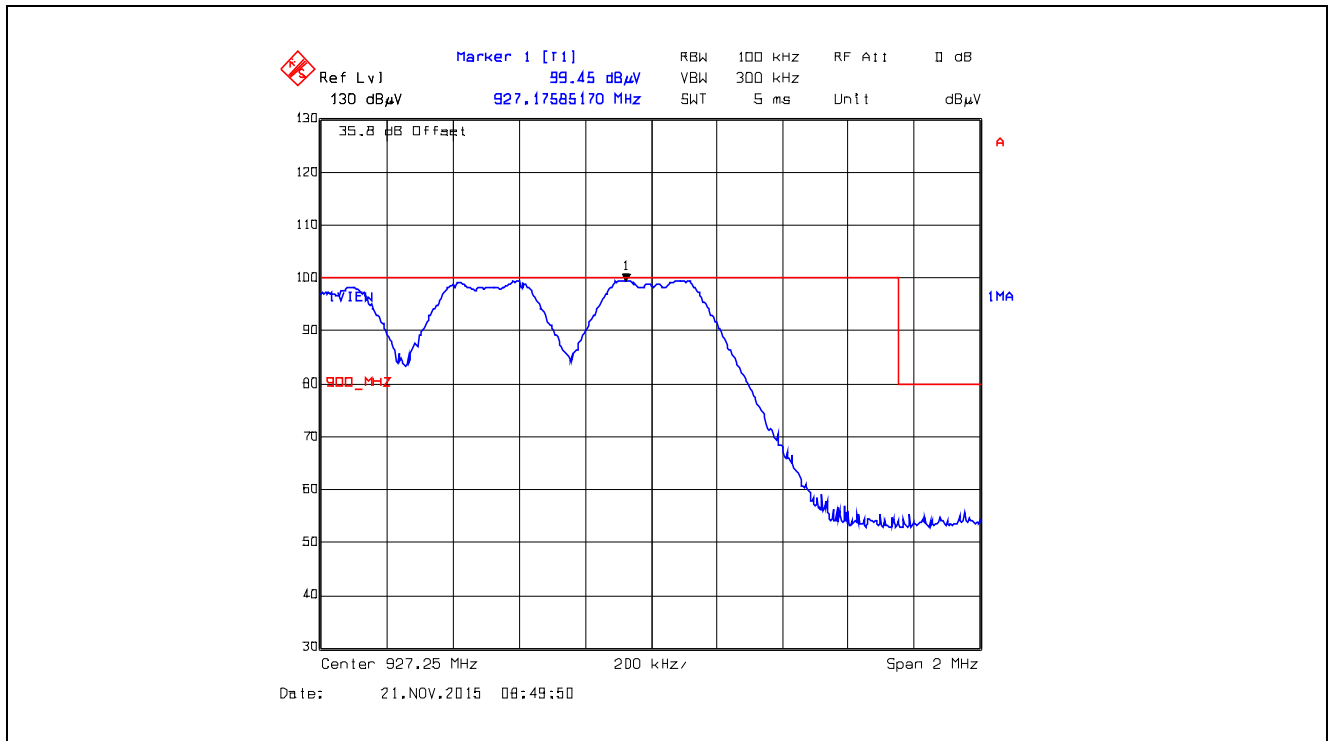

**Plot 5.5.4.3.2.23.** Band-Edge RF Radiated Emissions at 3 m, Vertical Polarization  
 Single Frequency Mode, High End of Frequency Band, 927.25 MHz, XB2, Data Rate at 250 kbps

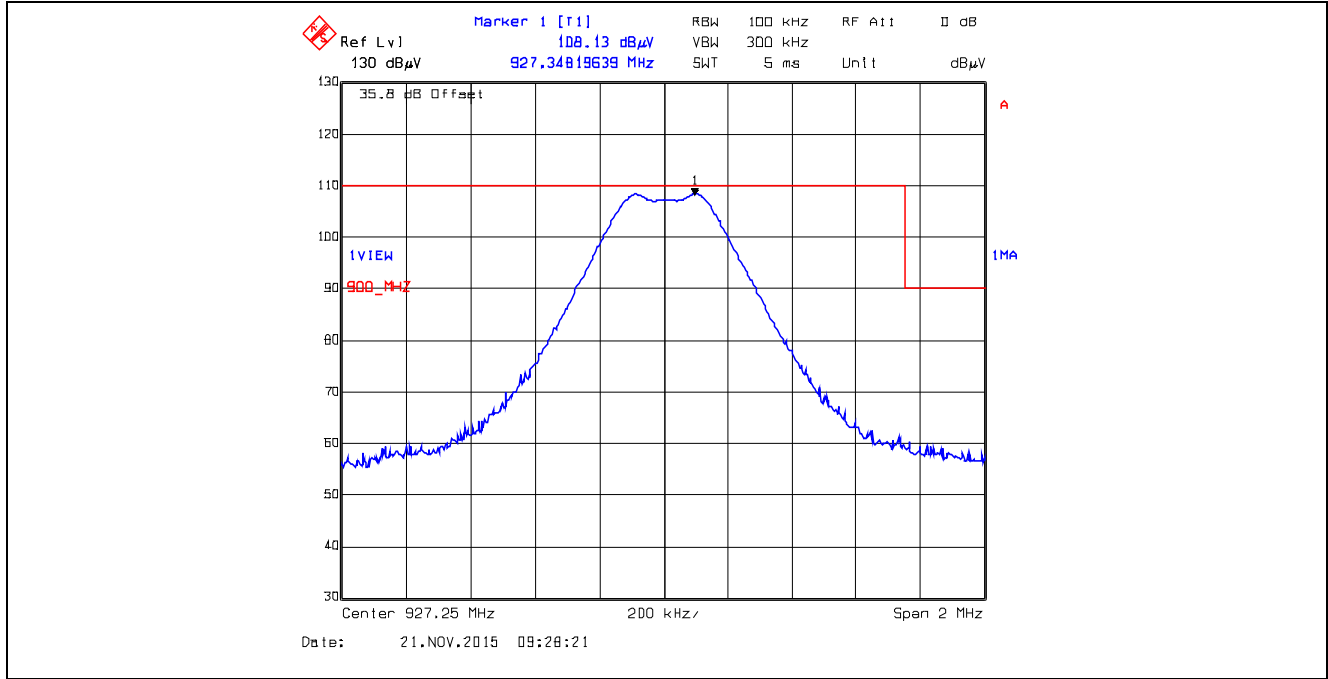

**Plot 5.5.4.3.2.24.** Band-Edge RF Radiated Emissions at 3 m, Vertical Polarization  
 Pseudorandom Hopping Mode, High End of Frequency Band, 927.25 MHz, XB2, Data Rate at 250 kbps

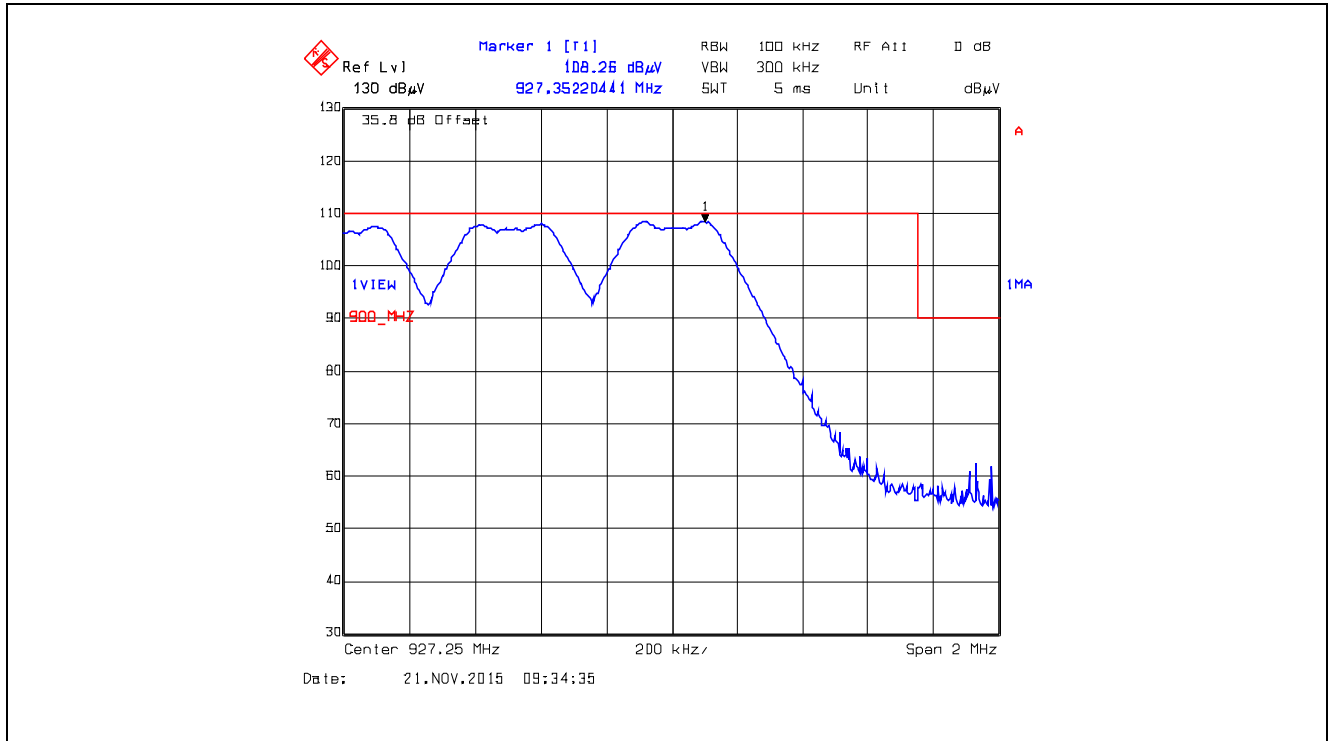

**Plot 5.5.4.3.2.25.** Band-Edge RF Radiated Emissions at 3 m, Horizontal Polarization  
 Single Frequency Mode, Low End of Frequency Band, 905.0 MHz, XTC0, Data Rate at 10 kbps

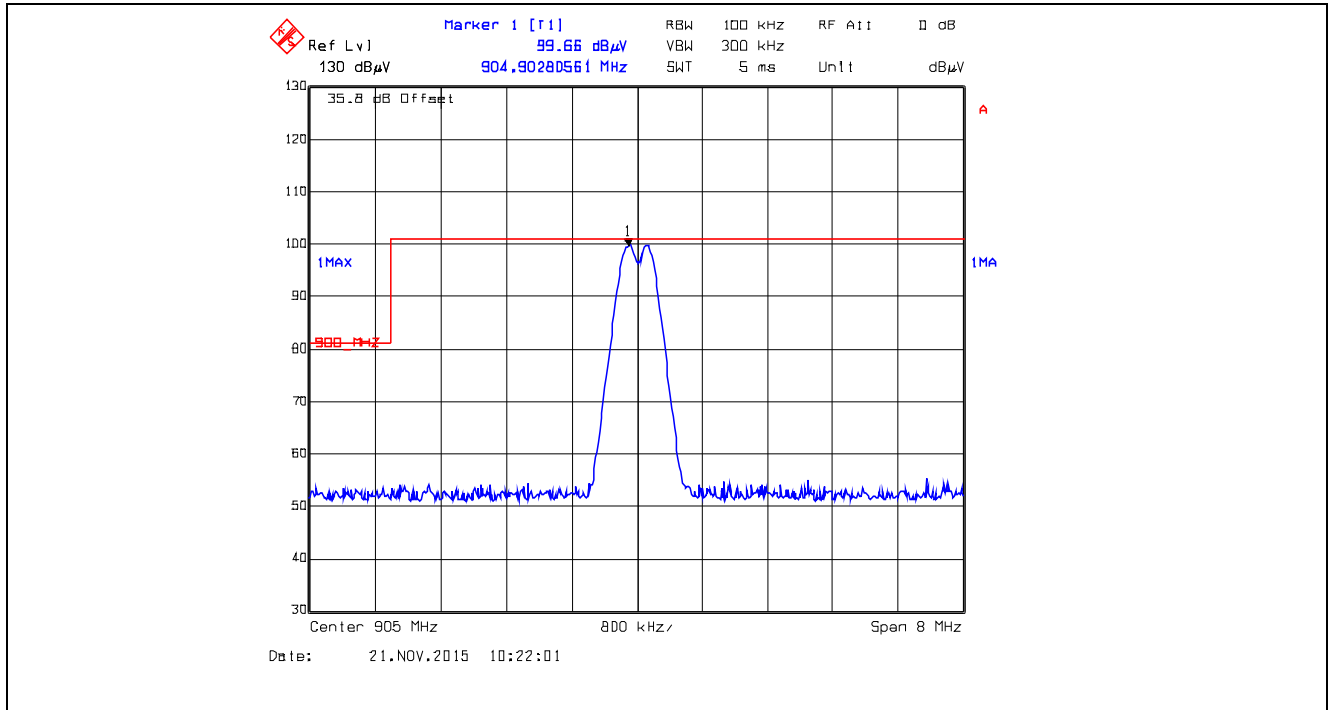

**Plot 5.5.4.3.2.26.** Band-Edge RF Radiated Emissions at 3 m, Horizontal Polarization  
 Pseudorandom Hopping Mode, Low End of Frequency Band, 905.0 MHz, XTC0, Data Rate at 10 kbps

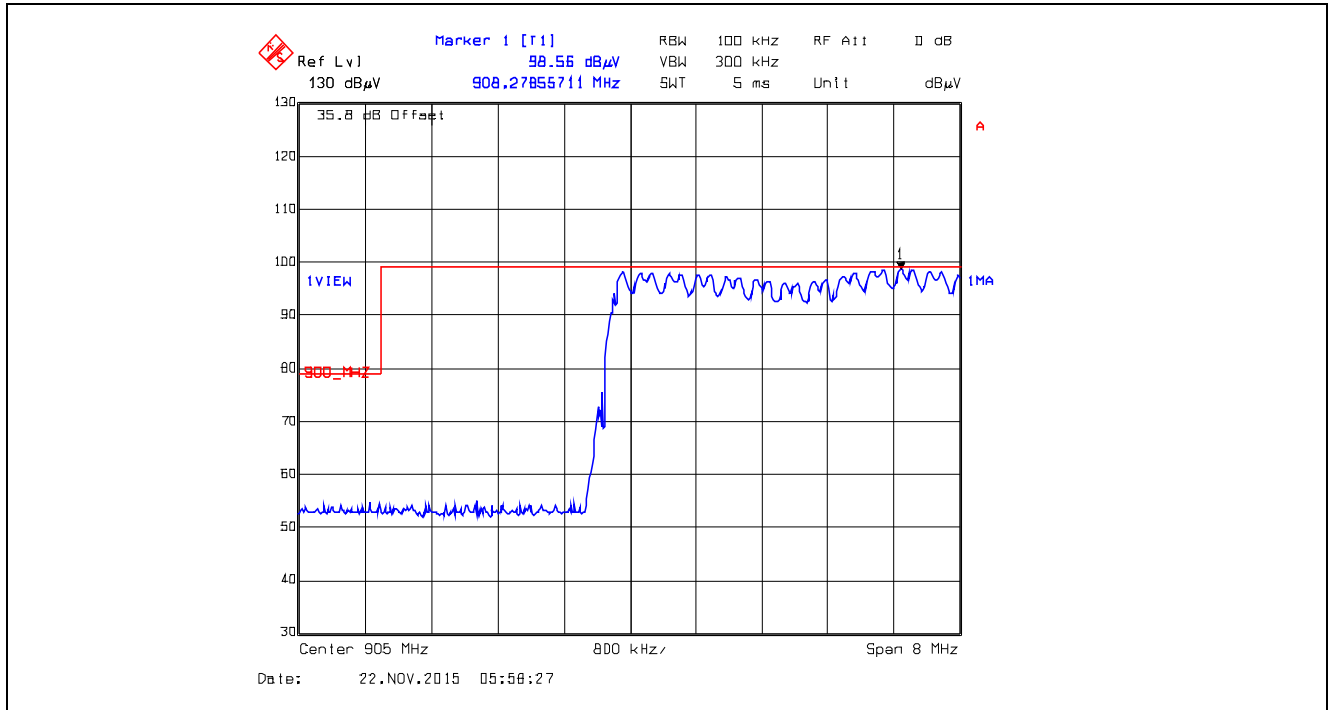

**Plot 5.5.4.3.2.27.** Band-Edge RF Radiated Emissions at 3 m, Vertical Polarization  
 Single Frequency Mode, Low End of Frequency Band, 905.0 MHz, XTC0, Data Rate at 10 kbps

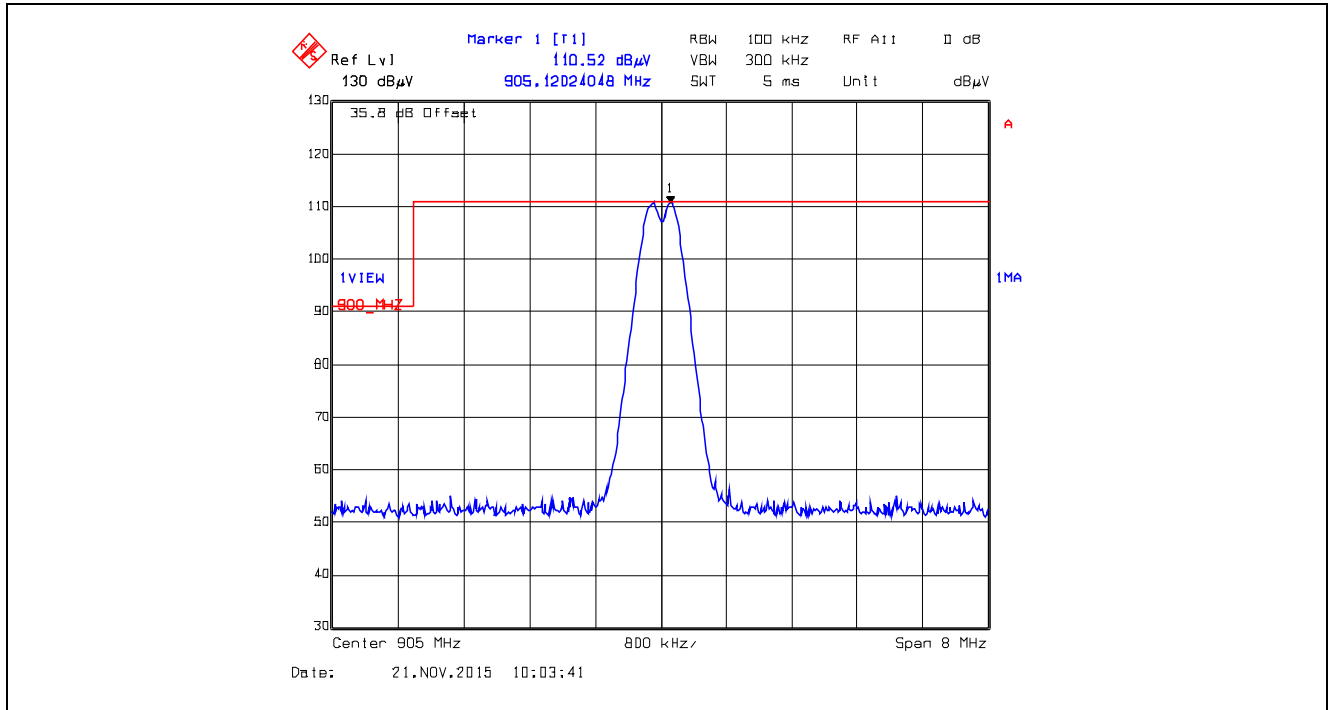

**Plot 5.5.4.3.2.28.** Band-Edge RF Radiated Emissions at 3 m, Vertical Polarization  
 Pseudorandom Hopping Mode, Low End of Frequency Band, 905.0 MHz, XTC0, Data Rate at 10 kbps

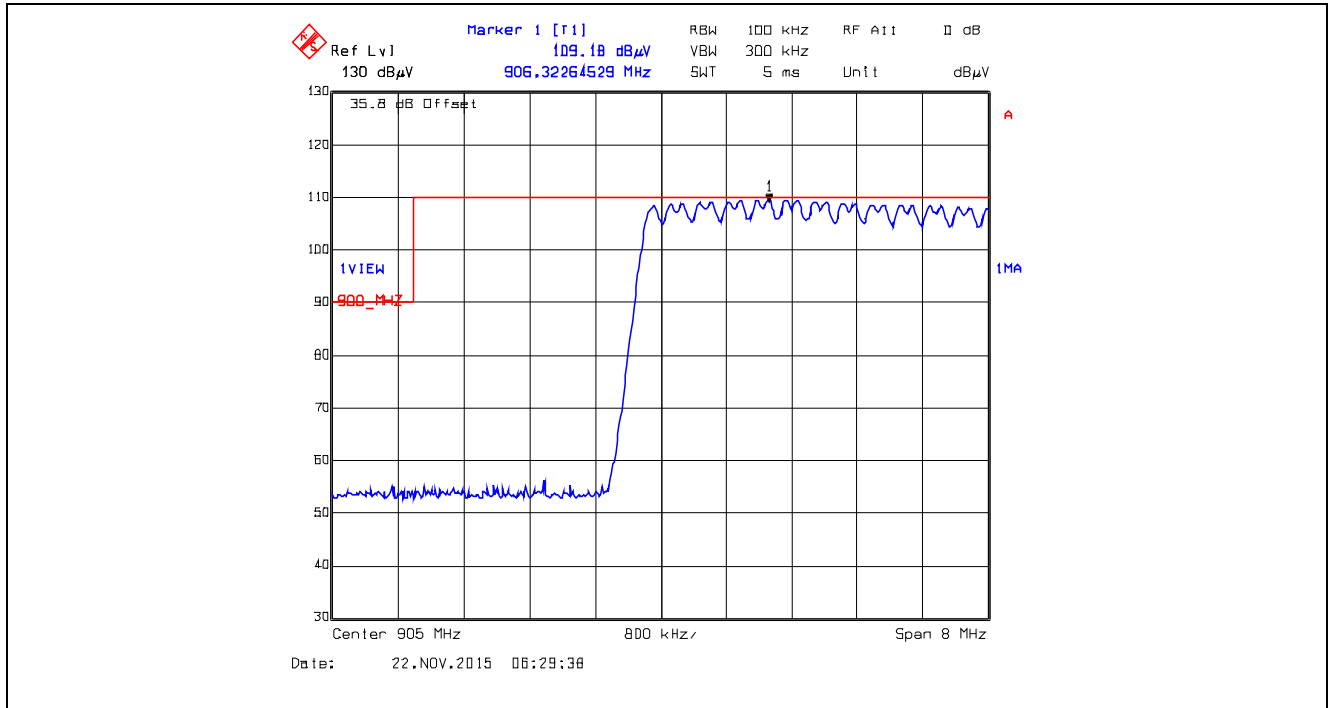

**Plot 5.5.4.3.2.29.** Band-Edge RF Radiated Emissions at 3 m, Horizontal Polarization  
 Single Frequency Mode, High End of Frequency Band, 925.0 MHz, XTC0, Data Rate at 10 kbps

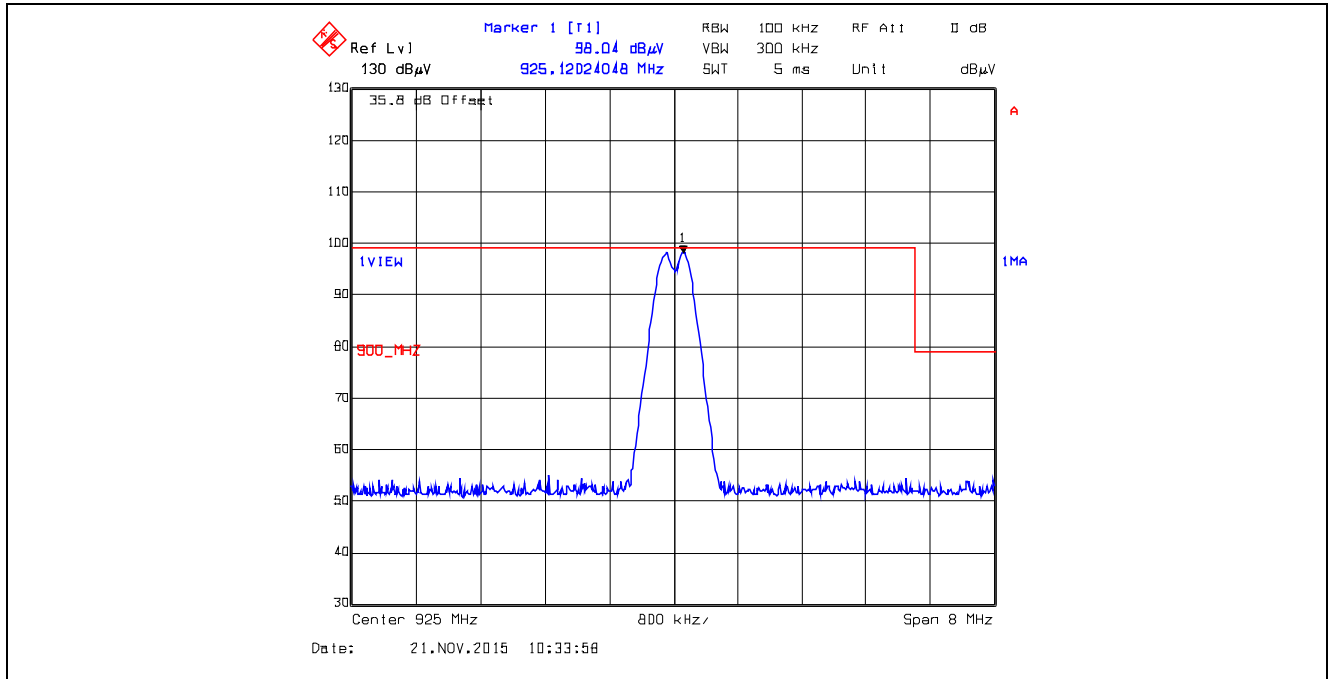

**Plot 5.5.4.3.2.30.** Band-Edge RF Radiated Emissions at 3 m, Horizontal Polarization  
 Pseudorandom Hopping Mode, High End of Frequency Band, 925.0 MHz, XTC0, Data Rate at 10 kbps

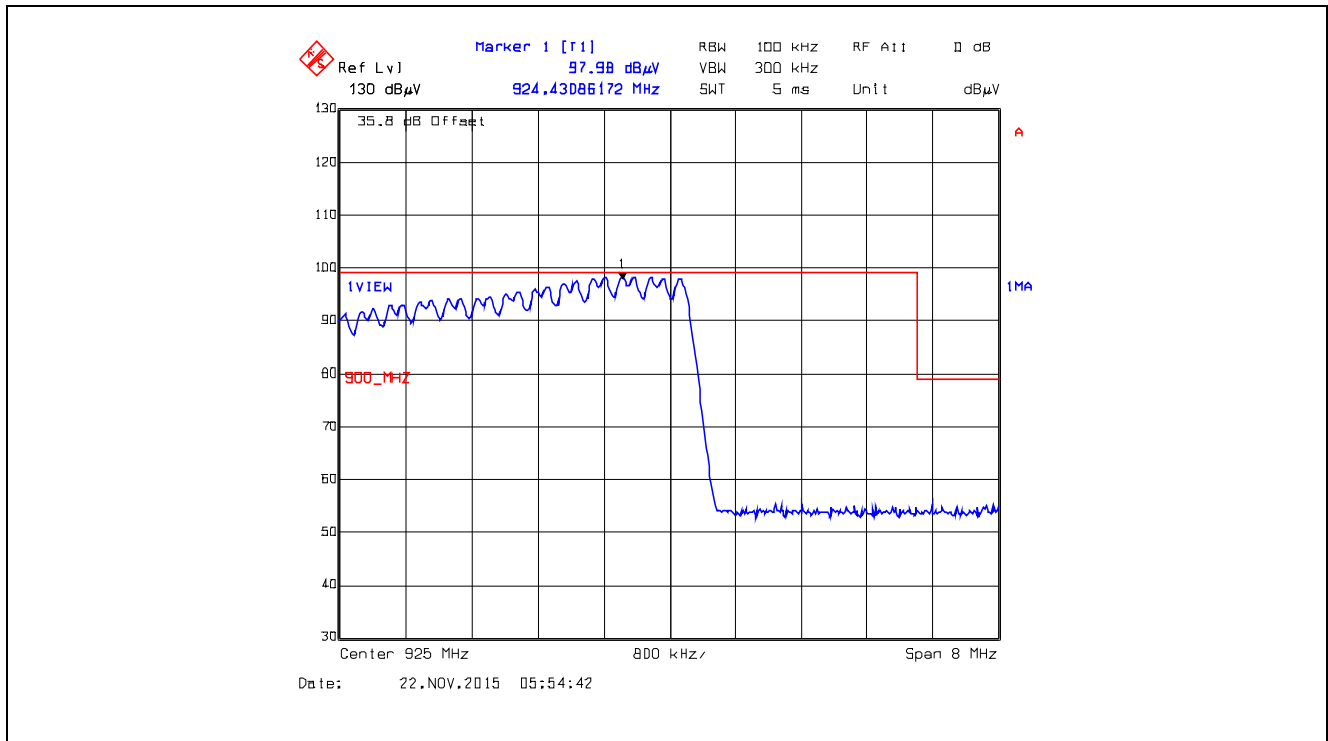

**Plot 5.5.4.3.2.31.** Band-Edge RF Radiated Emissions at 3 m, Vertical Polarization  
Single Frequency Mode, High End of Frequency Band, 925.0 MHz, XTC0, Data Rate at 10 kbps

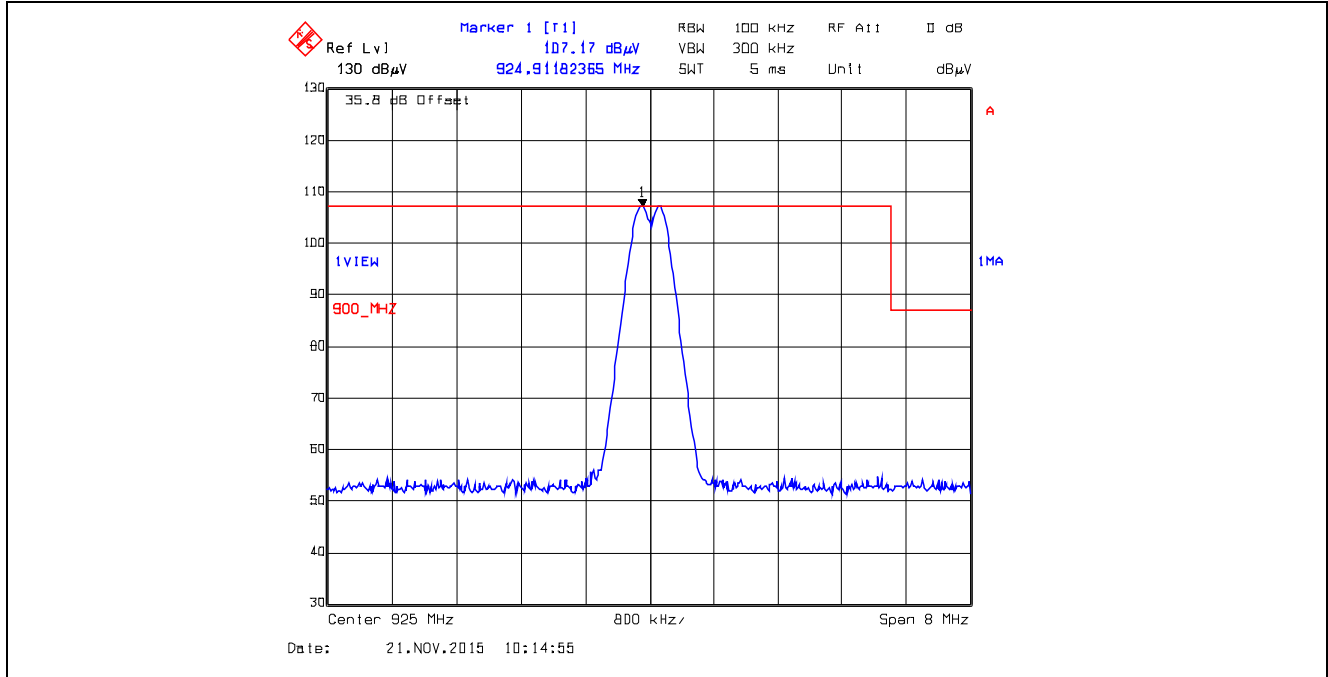

**Plot 5.5.4.3.2.32.** Band-Edge RF Radiated Emissions at 3 m, Vertical Polarization  
Pseudorandom Hopping Mode, High End of Frequency Band, 925.0 MHz, XTC0, Data Rate at 10 kbps

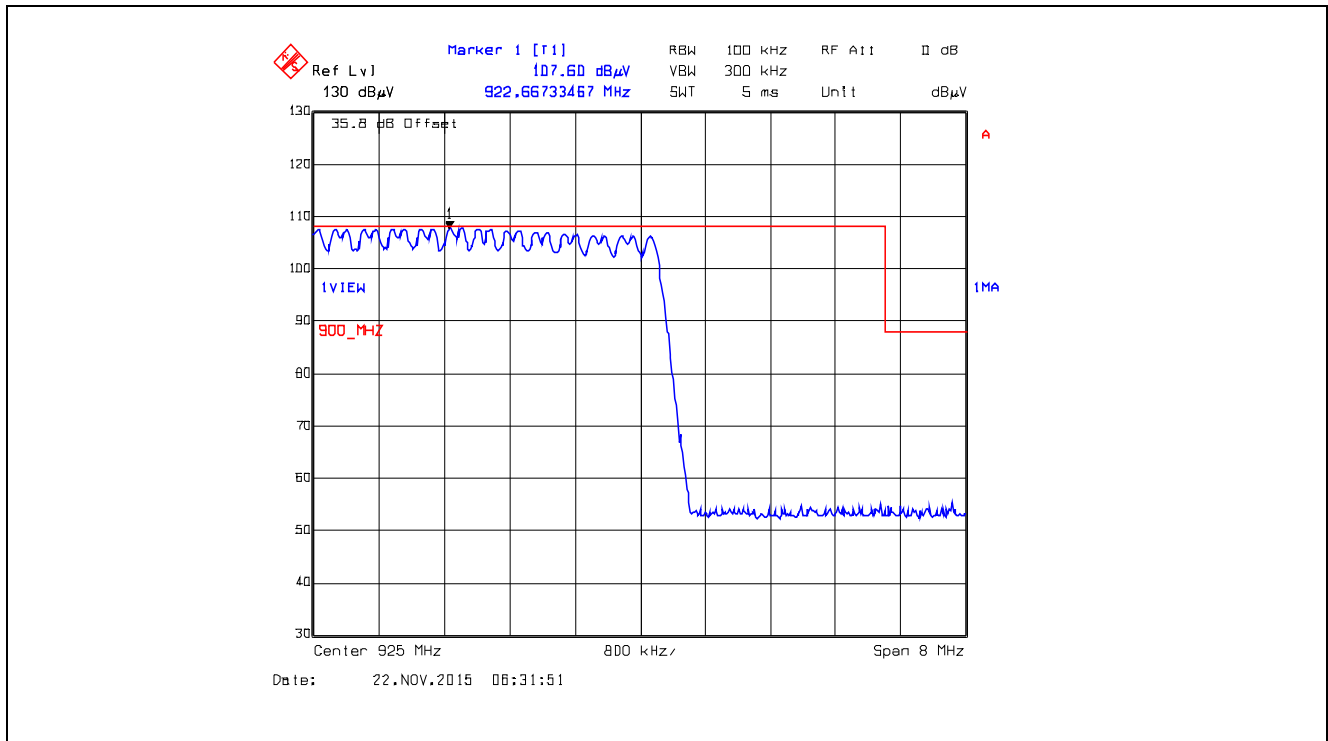

**Plot 5.5.4.3.2.33.** Band-Edge RF Radiated Emissions at 3 m, Horizontal Polarization  
 Single Frequency Mode, Low End of Frequency Band, 905.0 MHz, XTC1, Data Rate at 125 kbps

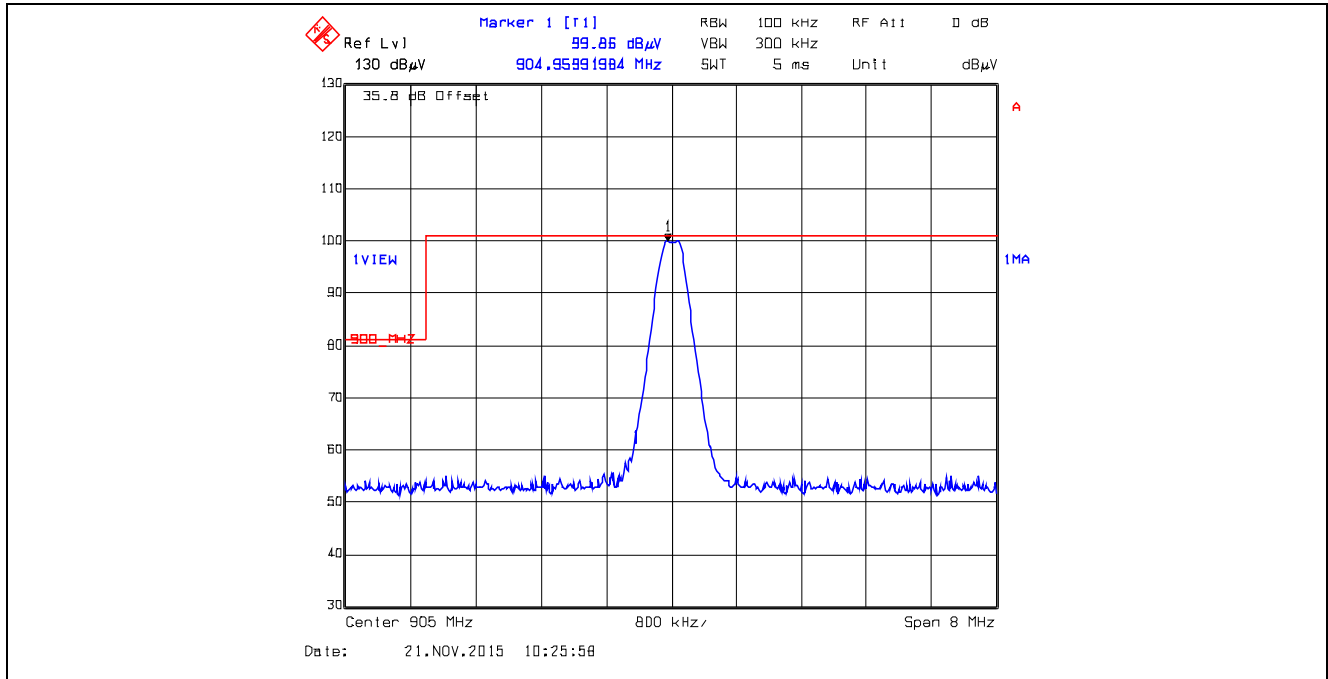

**Plot 5.5.4.3.2.34.** Band-Edge RF Radiated Emissions at 3 m, Horizontal Polarization  
 Pseudorandom Hopping Mode, Low End of Frequency Band, 905.0 MHz, XTC1, Data Rate at 125 kbps

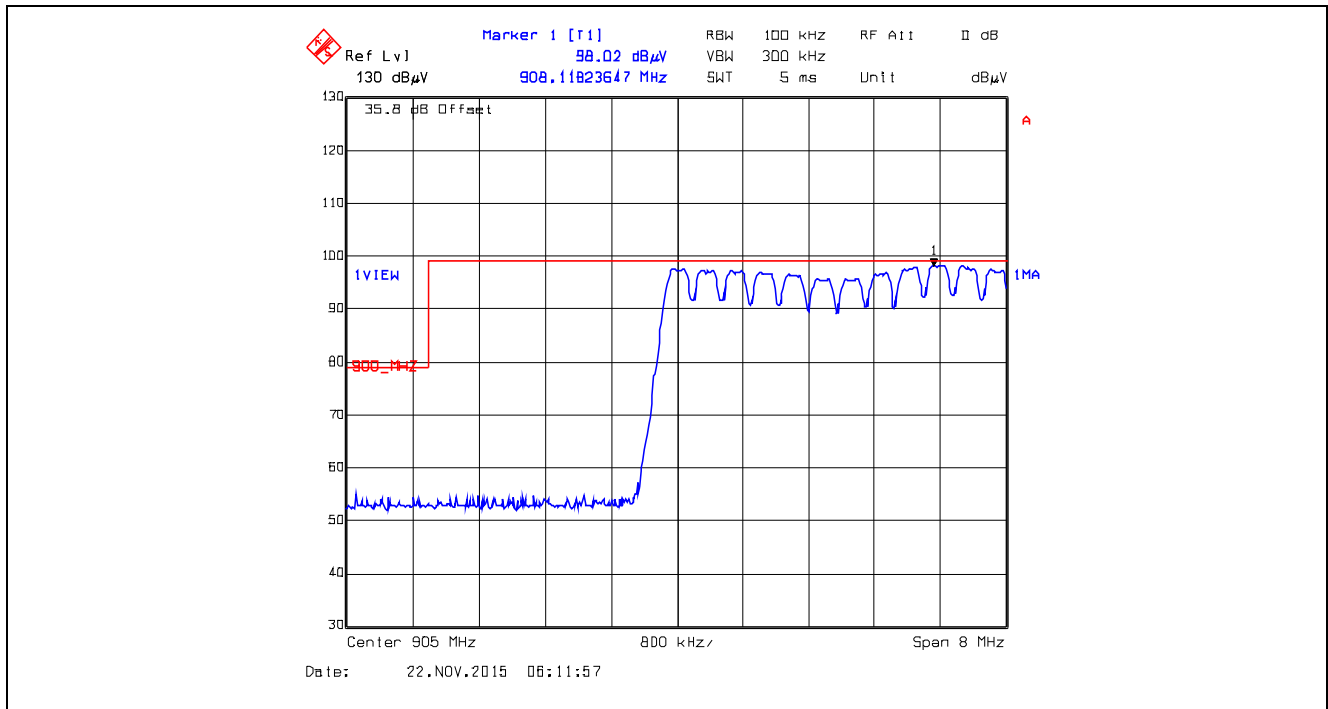

**Plot 5.5.4.3.2.35.** Band-Edge RF Radiated Emissions at 3 m, Vertical Polarization  
Single Frequency Mode, Low End of Frequency Band, 905.0 MHz, XTC1, Data Rate at 125 kbps

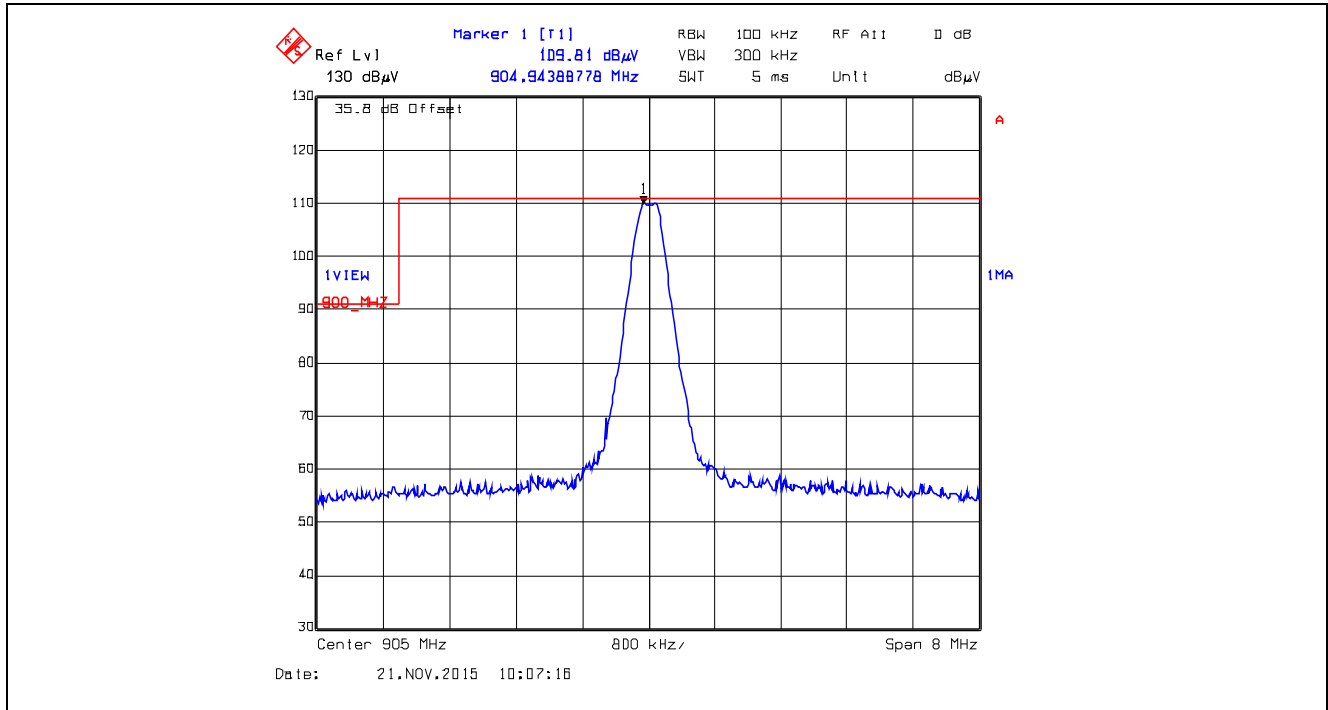

**Plot 5.5.4.3.2.36.** Band-Edge RF Radiated Emissions at 3 m, Vertical Polarization  
Pseudorandom Hopping Mode, Low End of Frequency Band, 905.0 MHz, XTC1, Data Rate at 125 kbps

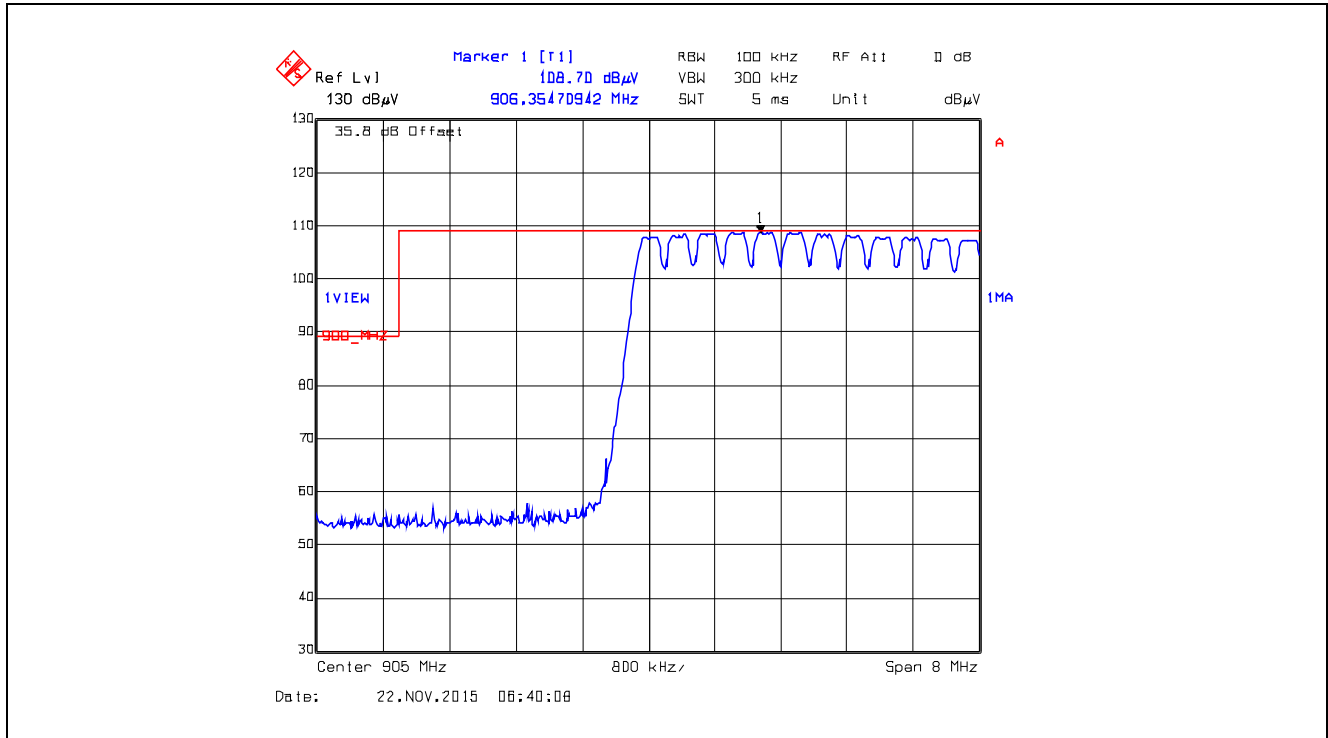



**Plot 5.5.4.3.2.37.** Band-Edge RF Radiated Emissions at 3 m, Horizontal Polarization  
 Single Frequency Mode, High End of Frequency Band, 925.0 MHz, XTC1, Data Rate at 125 kbps

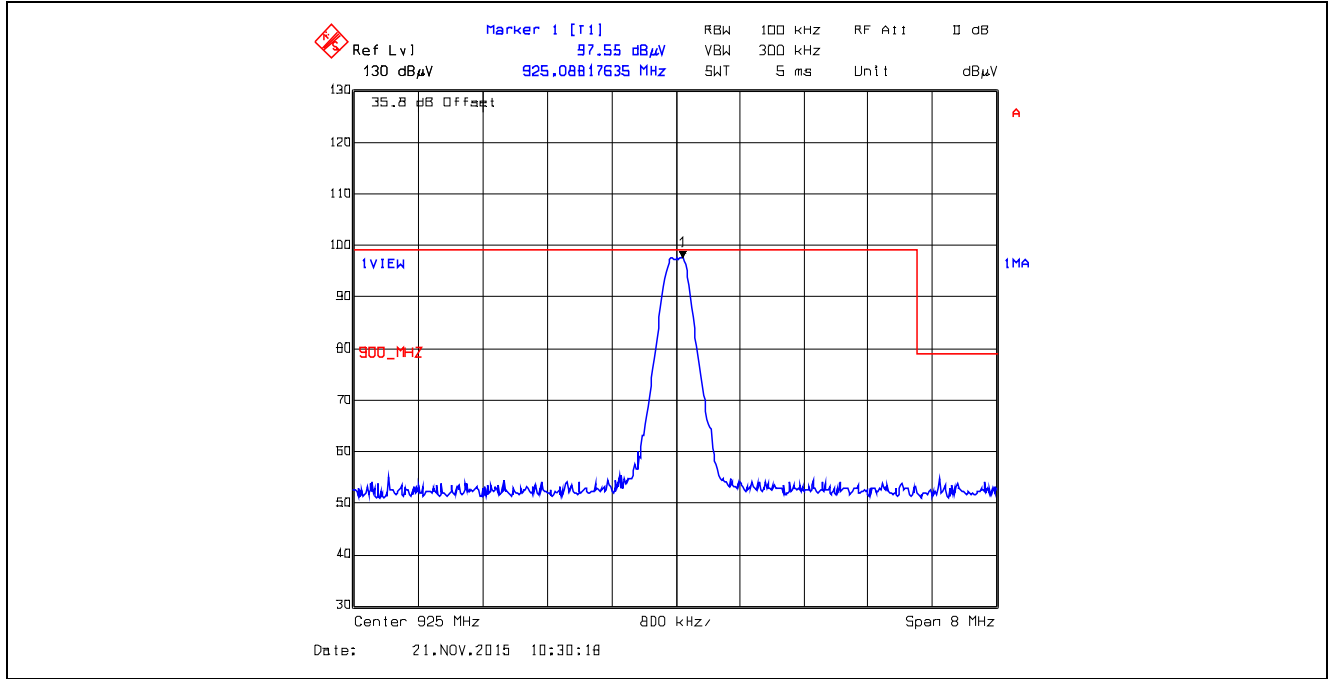

**Plot 5.5.4.3.2.38.** Band-Edge RF Radiated Emissions at 3 m, Horizontal Polarization  
 Pseudorandom Hopping Mode, High End of Frequency Band, 925.0 MHz, XTC1, Data Rate at 125 kbps

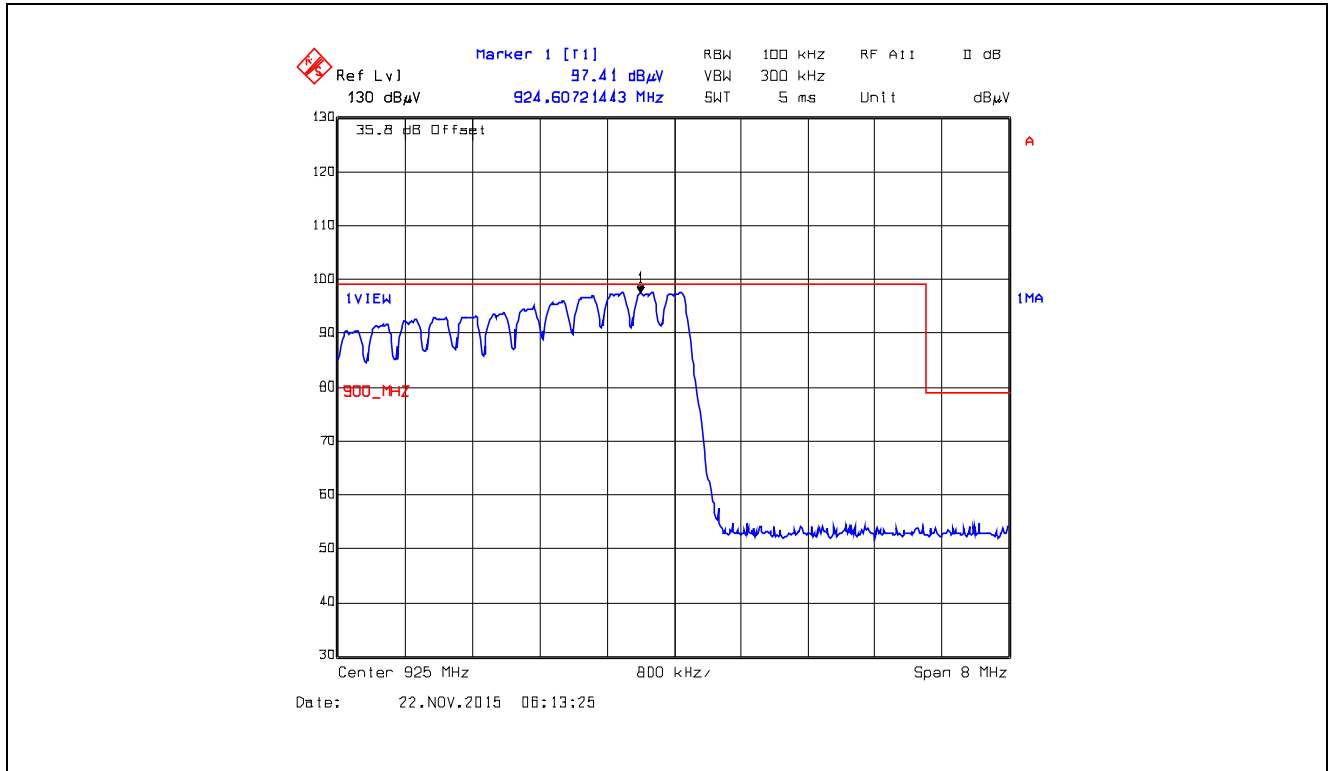

**Plot 5.5.4.3.2.39.** Band-Edge RF Radiated Emissions at 3 m, Vertical Polarization  
Single Frequency Mode, High End of Frequency Band, 925.0 MHz, XTC1, Data Rate at 125 kbps

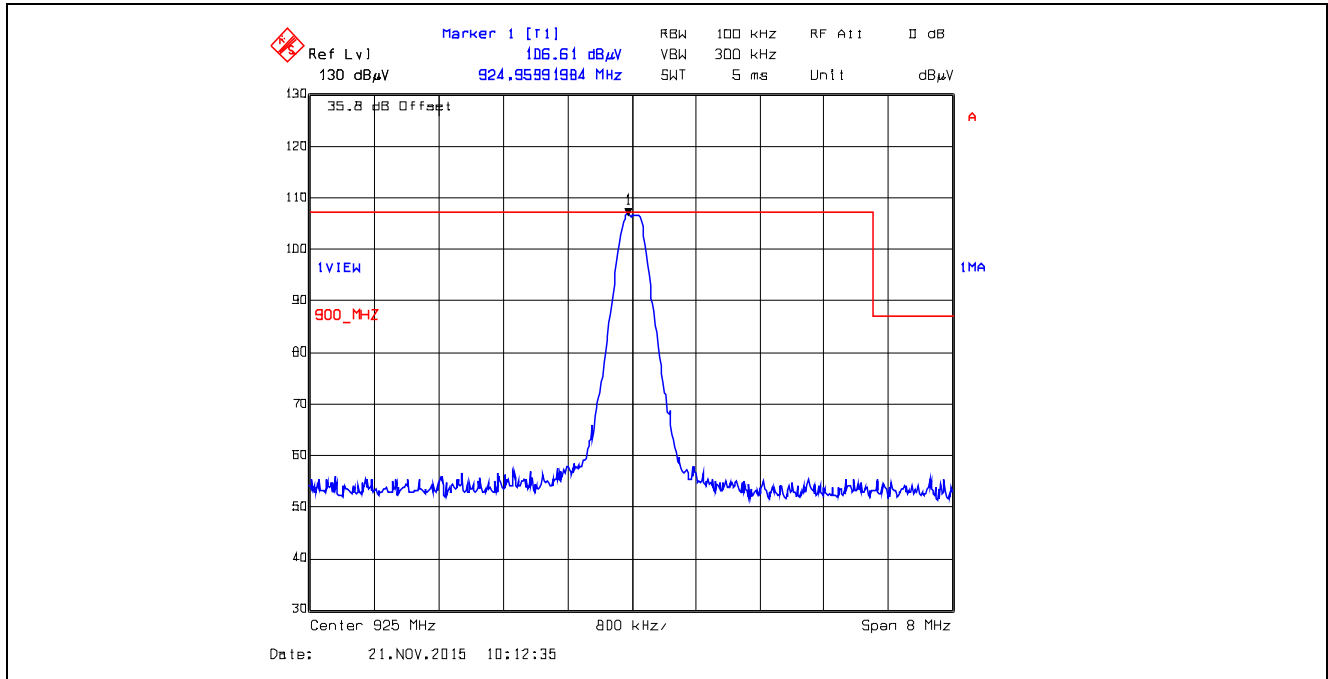

**Plot 5.5.4.3.2.40.** Band-Edge RF Radiated Emissions at 3 m, Vertical Polarization  
Pseudorandom Hopping Mode, High End of Frequency Band, 925.0 MHz, XTC1, Data Rate at 125 kbps

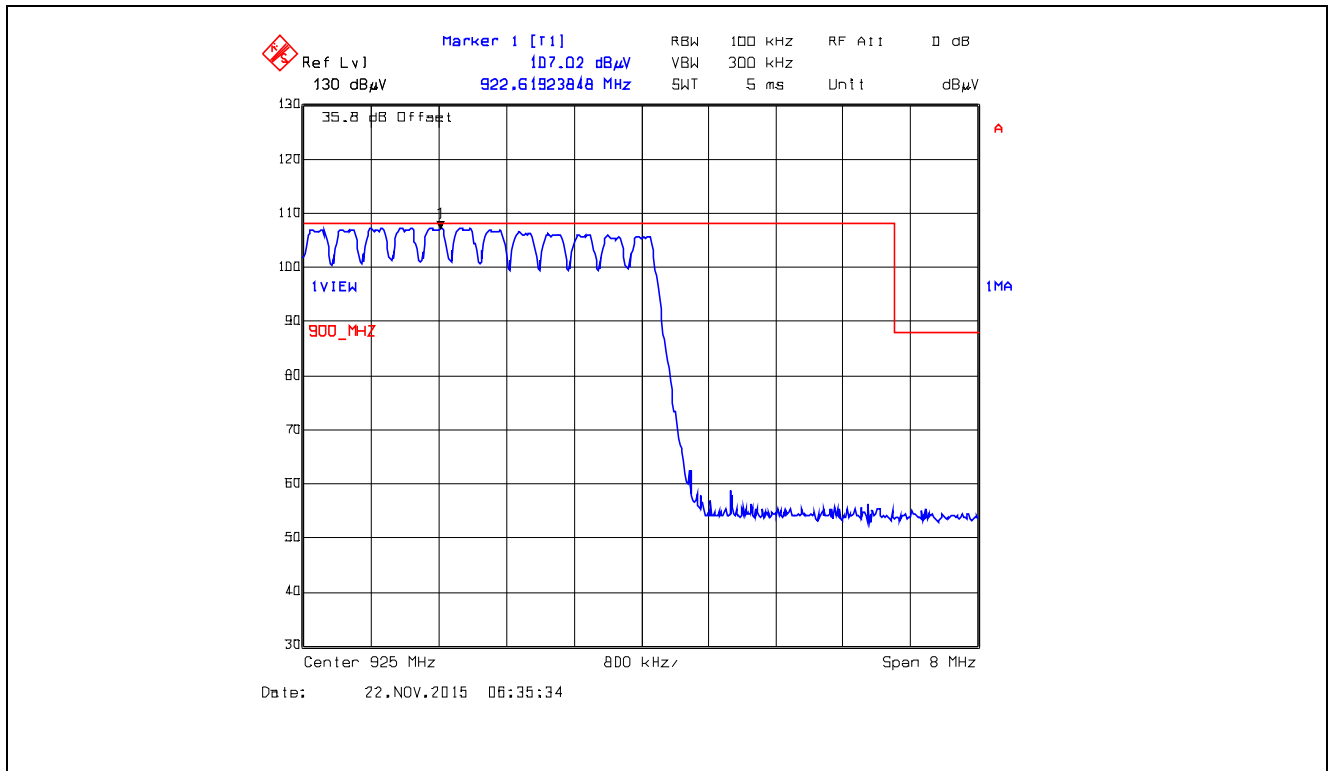

**Plot 5.5.4.3.2.41.** Band-Edge RF Radiated Emissions at 3 m, Horizontal Polarization  
 Single Frequency Mode, Low End of Frequency Band, 915.75 MHz, XTCA0, Data Rate at 10 kbps

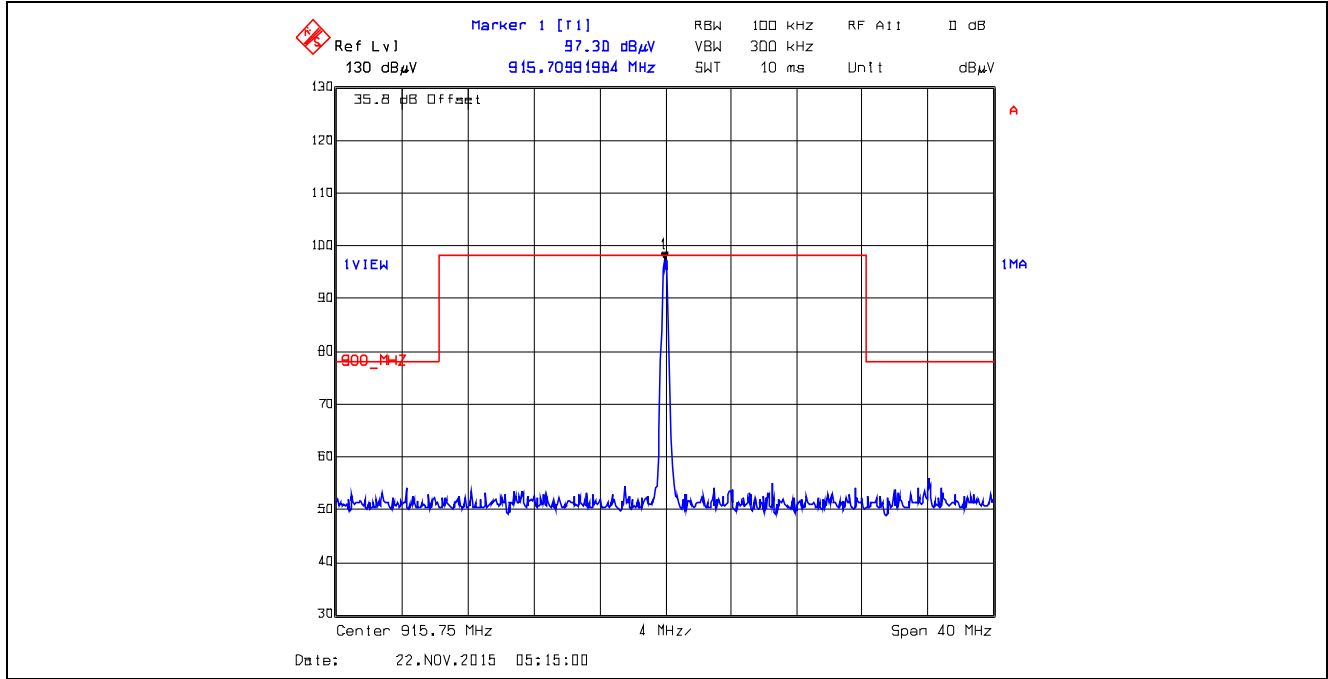

**Plot 5.5.4.3.2.42.** Band-Edge RF Radiated Emissions at 3 m, Horizontal Polarization  
 Pseudorandom Hopping Mode, Low End of Frequency Band, 915.75 MHz, XTCA0, Data Rate at 10 kbps

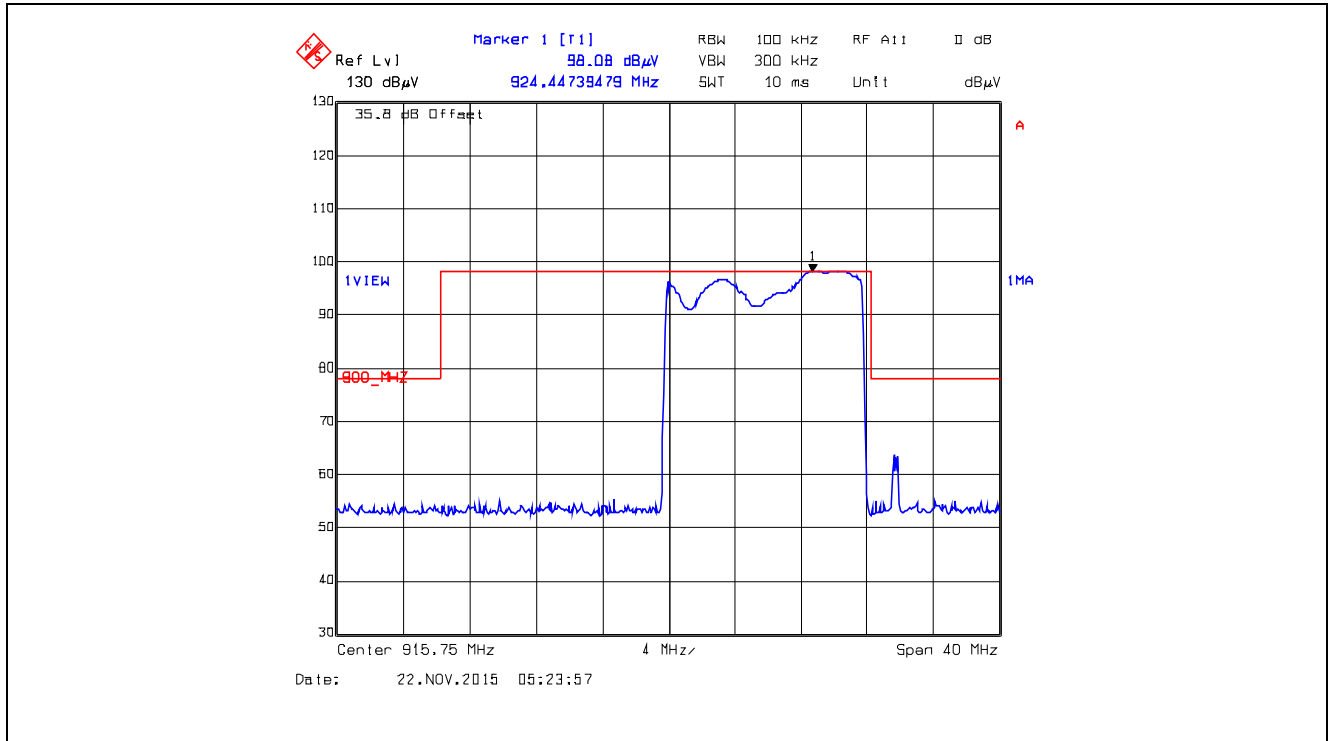

**Plot 5.5.4.3.2.43.** Band-Edge RF Radiated Emissions at 3 m, Vertical Polarization  
 Single Frequency Mode, Low End of Frequency Band, 915.75 MHz, XTCA0, Data Rate at 10 kbps

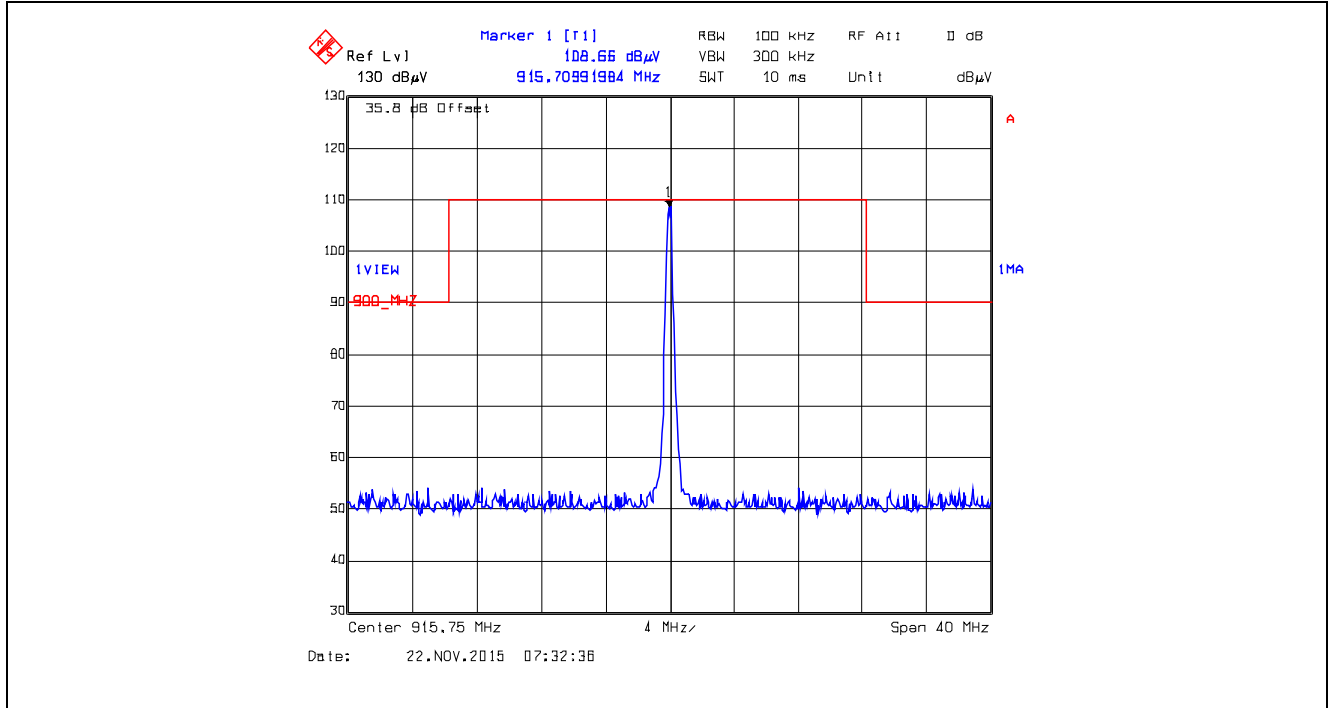

**Plot 5.5.4.3.2.44.** Band-Edge RF Radiated Emissions at 3 m, Vertical Polarization  
 Pseudorandom Hopping Mode, Low End of Frequency Band, 915.75 MHz, XTCA0, Data Rate at 10 kbps

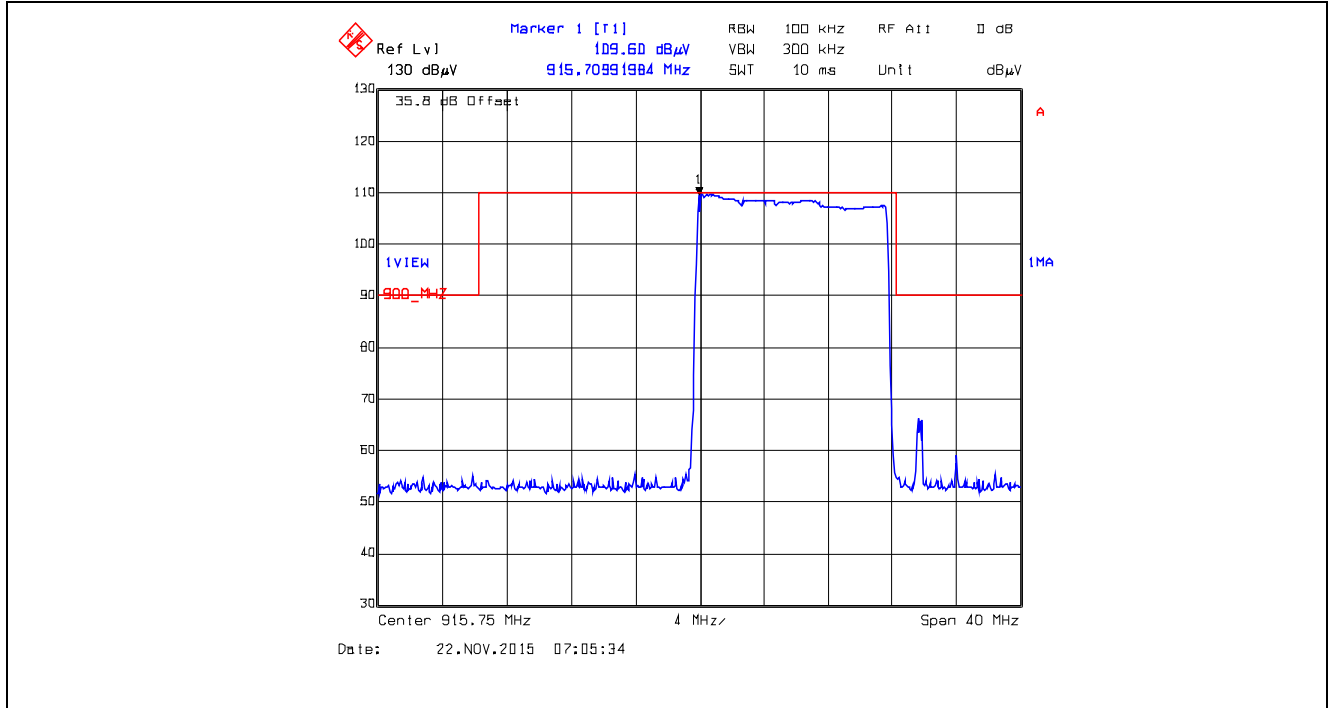

**Plot 5.5.4.3.2.45.** Band-Edge RF Radiated Emissions at 3 m, Horizontal Polarization  
 Single Frequency Mode, High End of Frequency Band, 927.265 MHz, XTCA0, Data Rate at 10 kbps

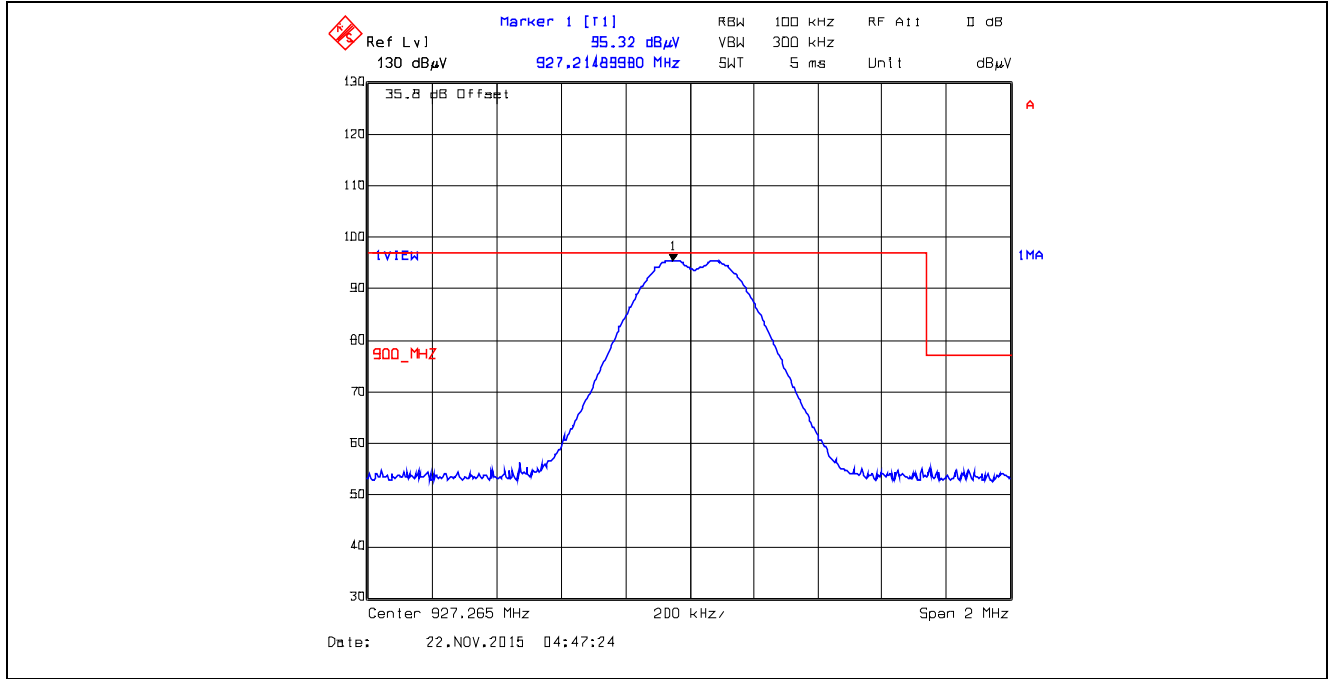

**Plot 5.5.4.3.2.46.** Band-Edge RF Radiated Emissions at 3 m, Horizontal Polarization  
 Pseudorandom Hopping Mode, High End of Frequency Band, 927.265 MHz, XTCA0, Data Rate at 10 kbps

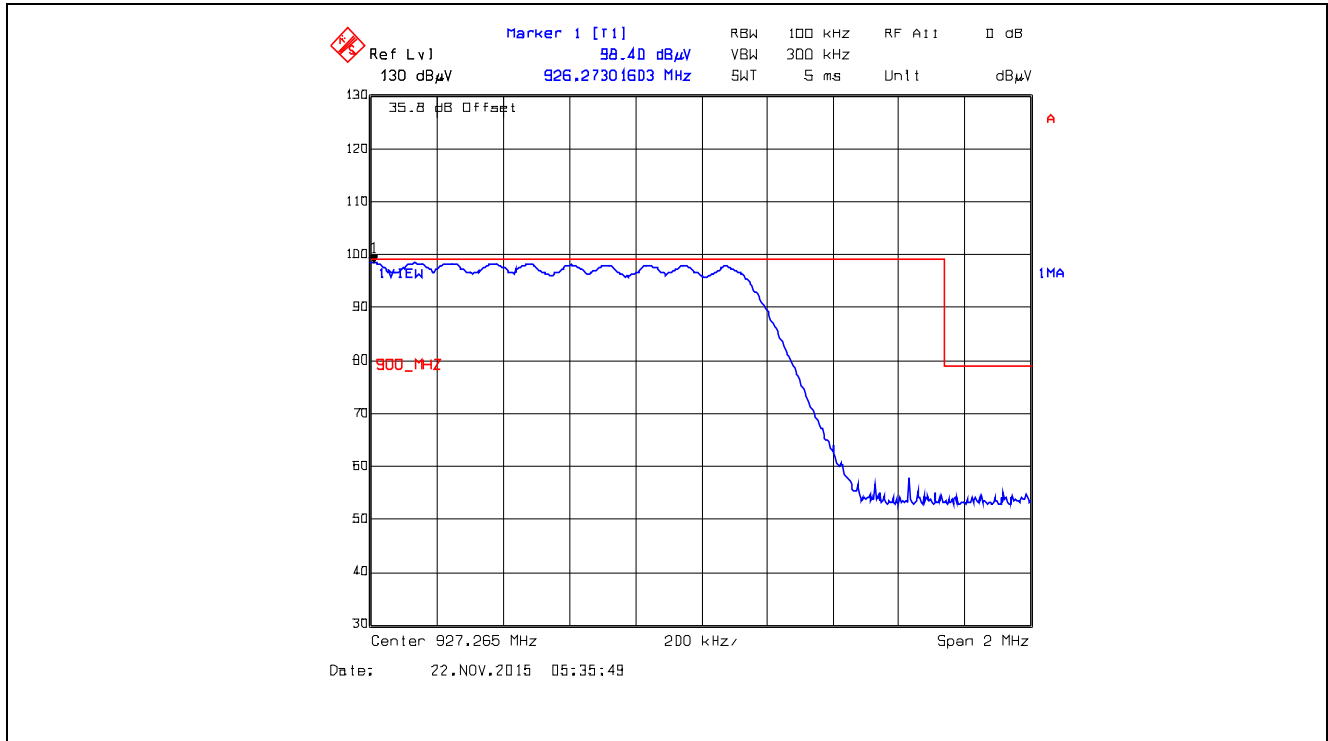

**Plot 5.5.4.3.2.47.** Band-Edge RF Radiated Emissions at 3 m, Vertical Polarization  
 Single Frequency Mode, High End of Frequency Band, 927.265 MHz, XTCA0, Data Rate at 10 kbps

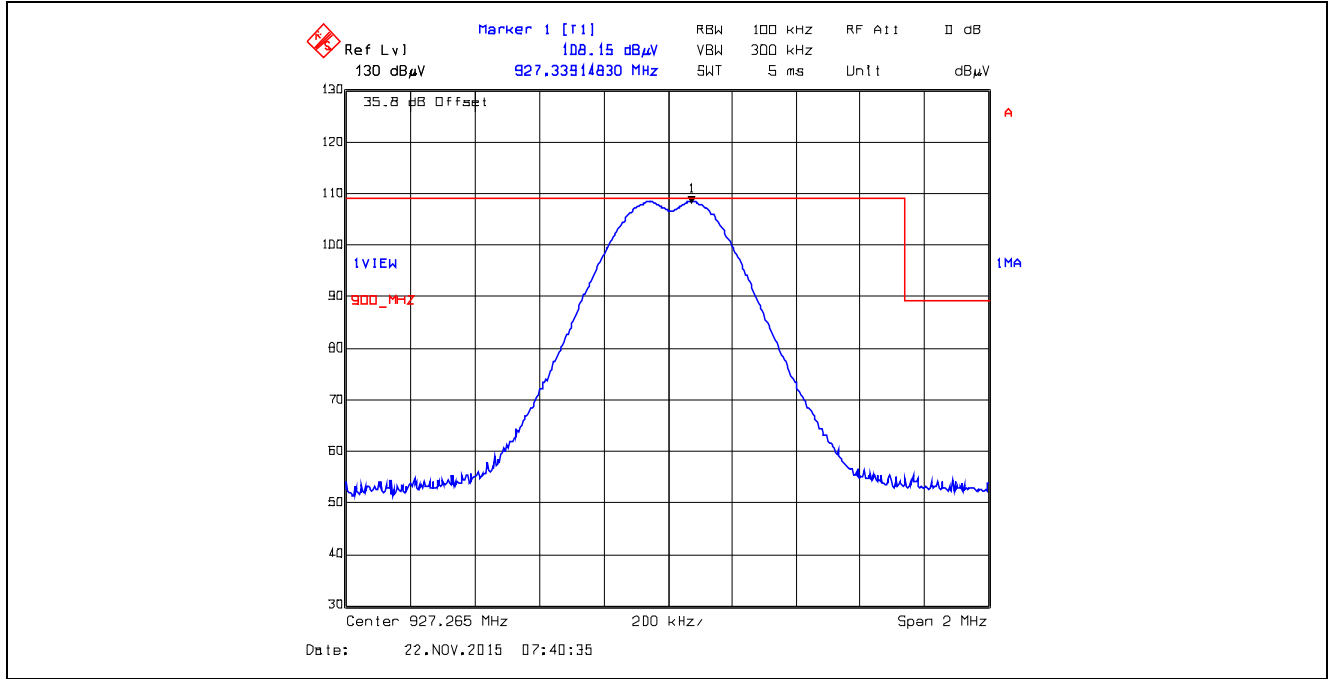

**Plot 5.5.4.3.2.48.** Band-Edge RF Radiated Emissions at 3 m, Vertical Polarization  
 Pseudorandom Hopping Mode, High End of Frequency Band, 927.265 MHz, XTCA0, Data Rate at 10 kbps

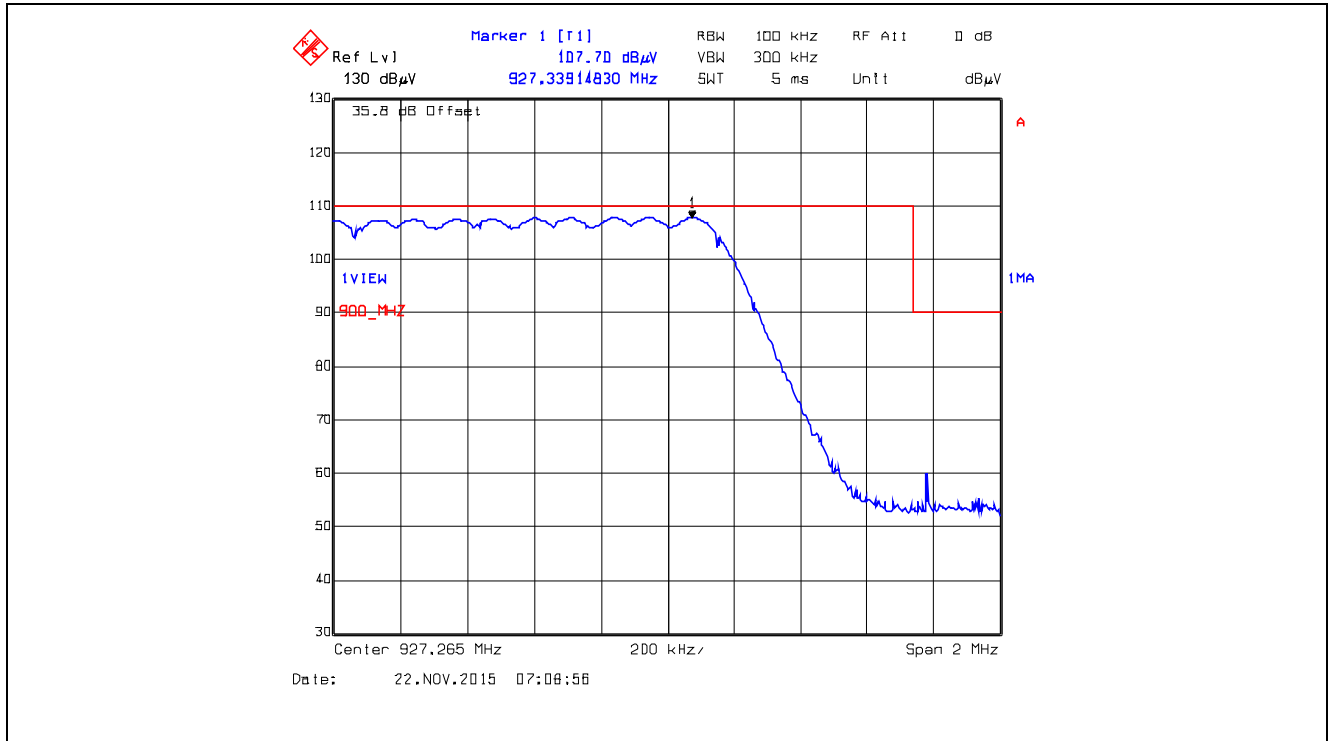

**Plot 5.5.4.3.2.49.** Band-Edge RF Radiated Emissions at 3 m, Horizontal Polarization  
Single Frequency Mode, Low End of Frequency Band, 915.75 MHz, XTCA1, Data Rate at 105kbps

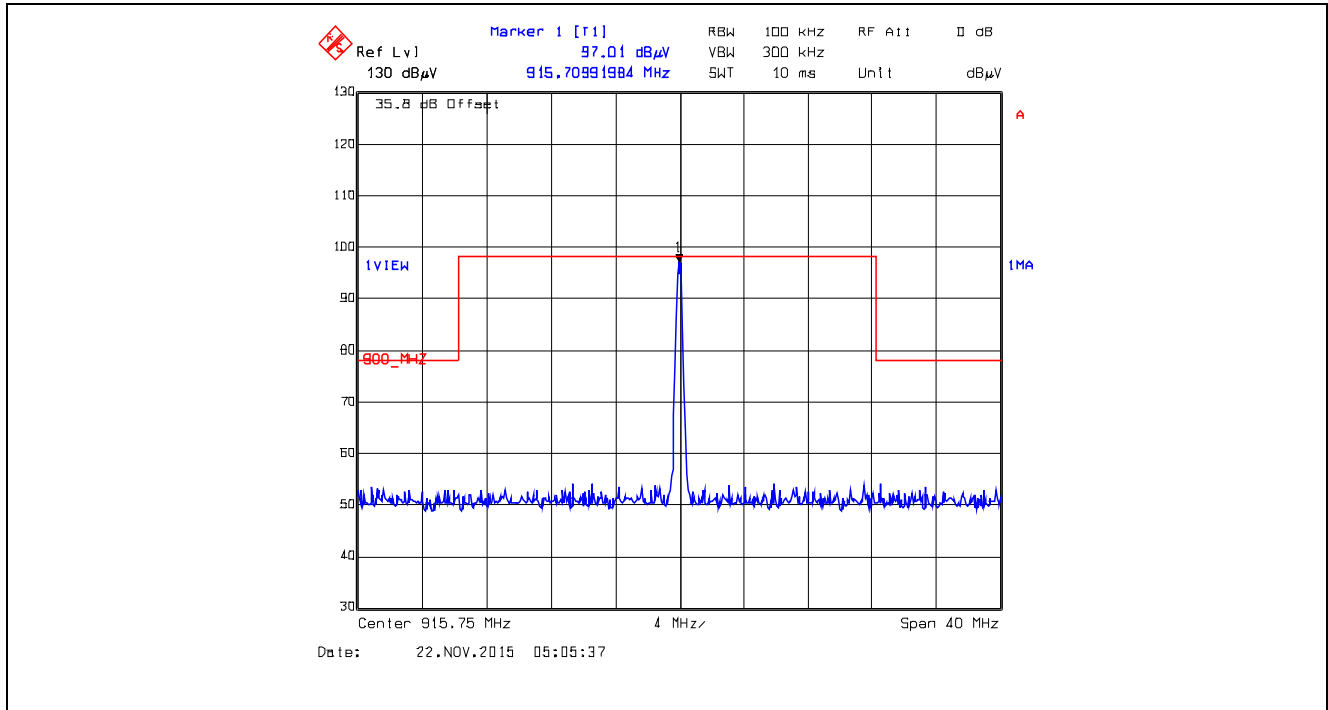

**Plot 5.5.4.3.2.50.** Band-Edge RF Radiated Emissions at 3 m, Horizontal Polarization  
Pseudorandom Hopping Mode, Low End of Frequency Band, 915.75 MHz, XTCA1, Data Rate at 105kbps

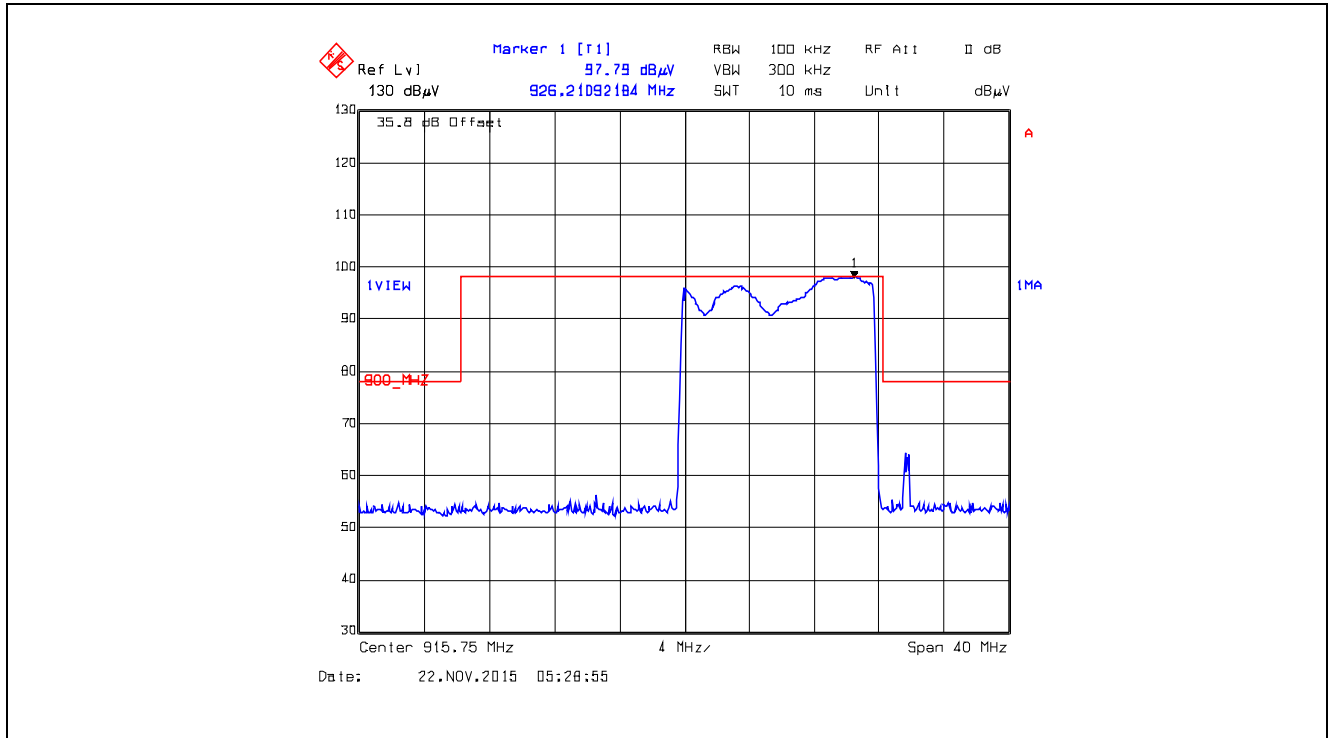

**Plot 5.5.4.3.251.** Band-Edge RF Radiated Emissions at 3 m, Vertical Polarization  
 Single Frequency Mode, Low End of Frequency Band, 915.75 MHz, XTCA1, Data Rate at 105kbps

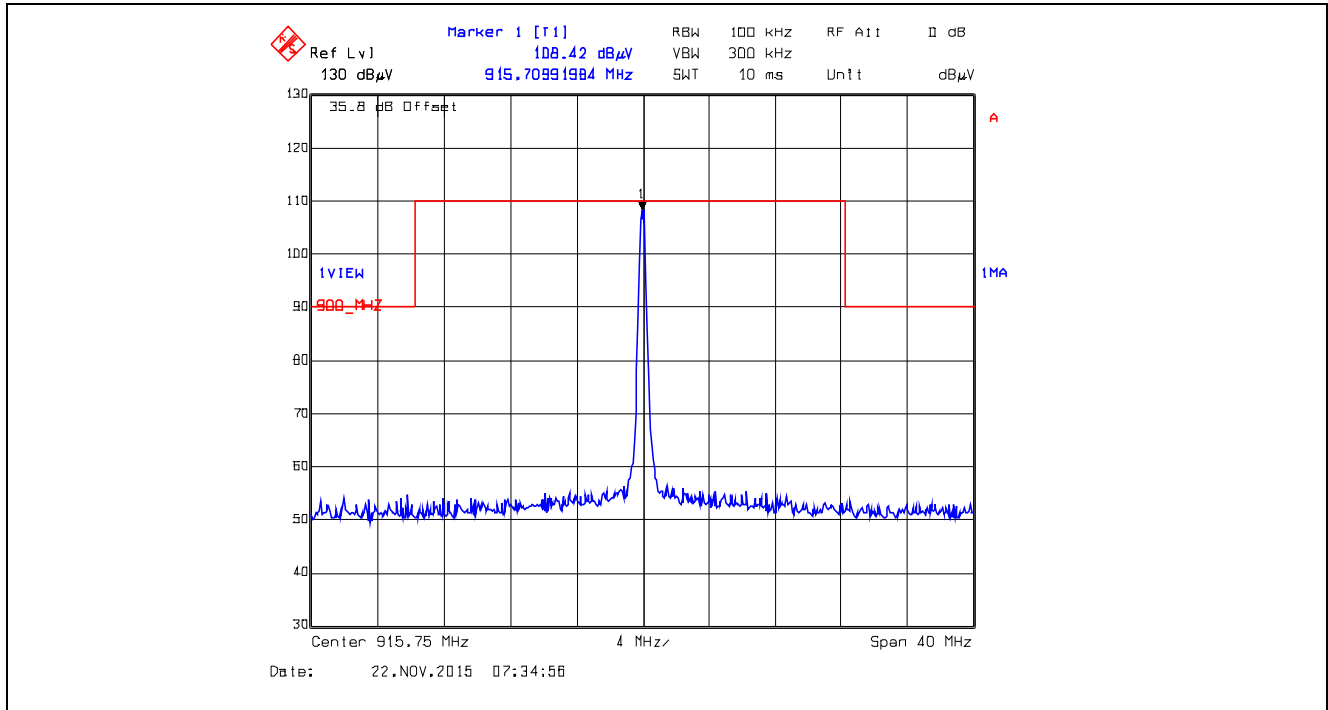

**Plot 5.5.4.3.252.** Band-Edge RF Radiated Emissions at 3 m, Vertical Polarization  
 Pseudorandom Hopping Mode, Low End of Frequency Band, 915.75 MHz, XTCA1, Data Rate at 105kbps

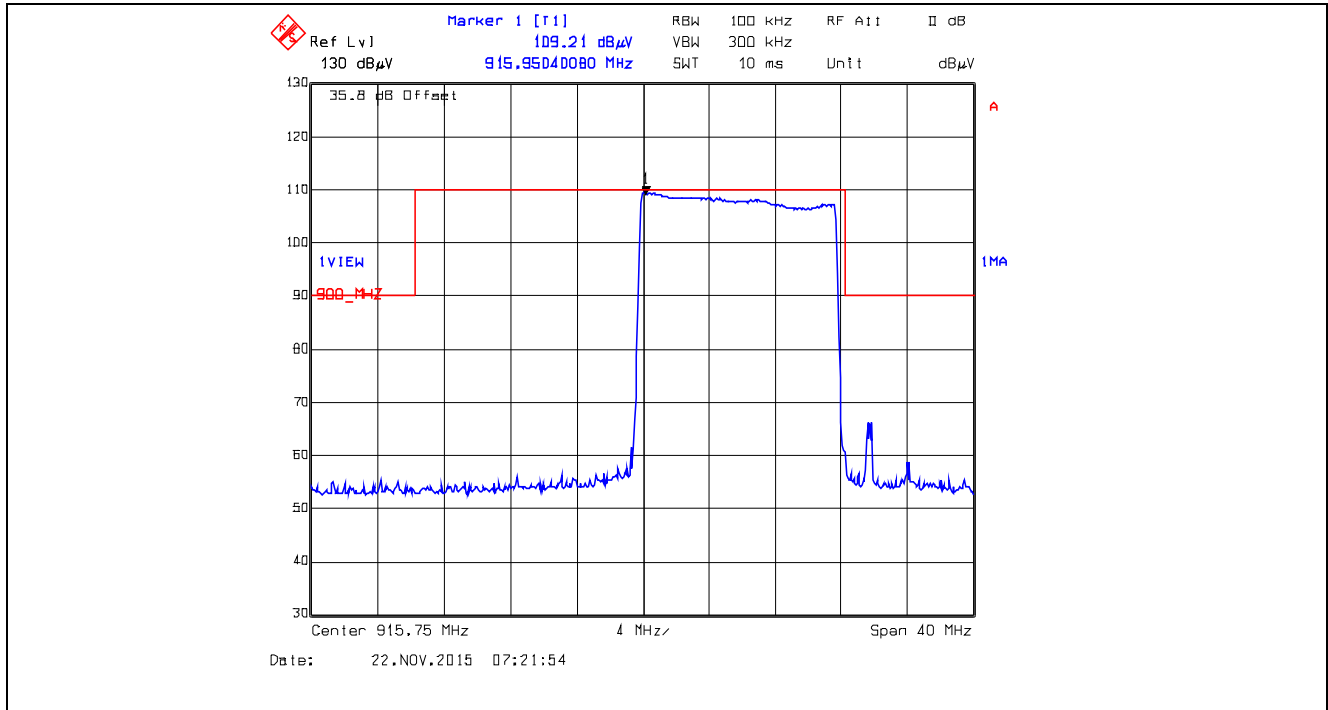



**Plot 5.5.4.3.2.53.** Band-Edge RF Radiated Emissions at 3 m, Horizontal Polarization  
 Single Frequency Mode, High End of Frequency Band, 927.265 MHz, XTCA1, Data Rate at 105kbps

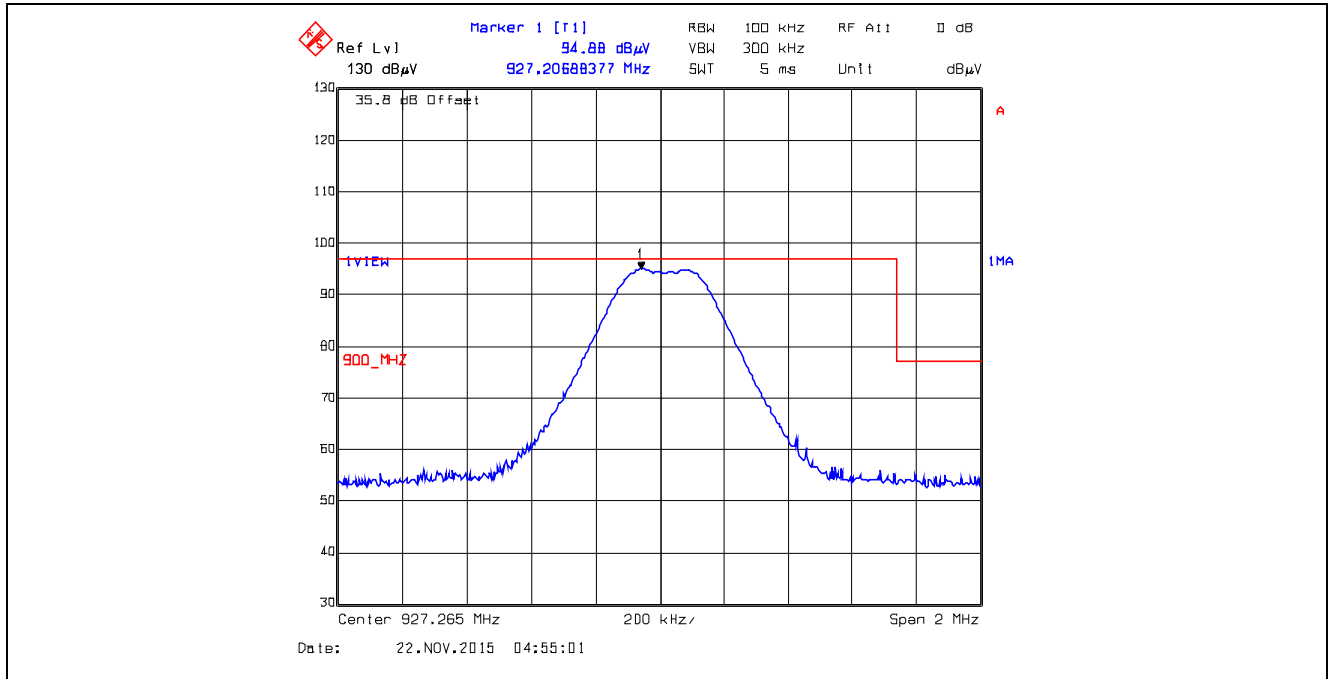

**Plot 5.5.4.3.2.54.** Band-Edge RF Radiated Emissions at 3 m, Horizontal Polarization  
 Pseudorandom Hopping Mode, High End of Frequency Band, 927.265 MHz, XTCA1, Data Rate at 105kbps

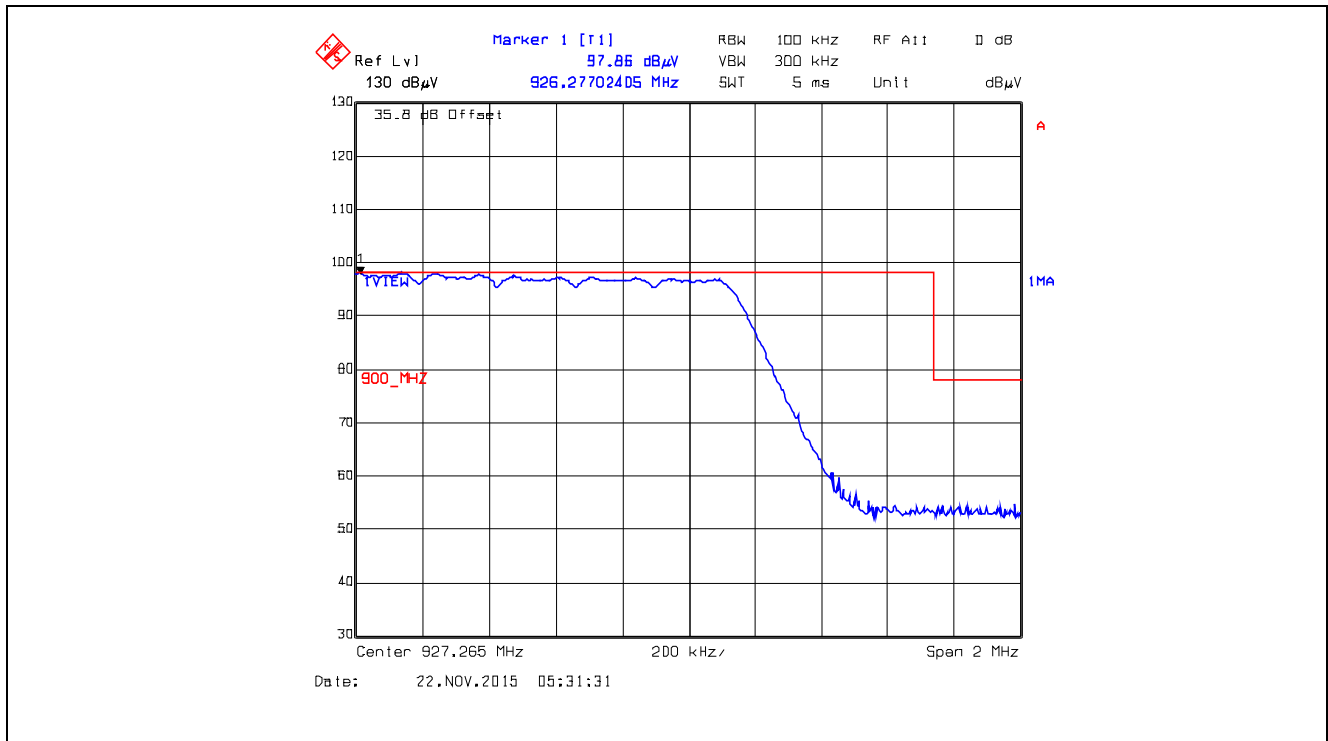

**Plot 5.5.4.3.2.55.** Band-Edge RF Radiated Emissions at 3 m, Vertical Polarization  
 Single Frequency Mode, High End of Frequency Band, 927.265 MHz, XTCA1, Data Rate at 105kbps

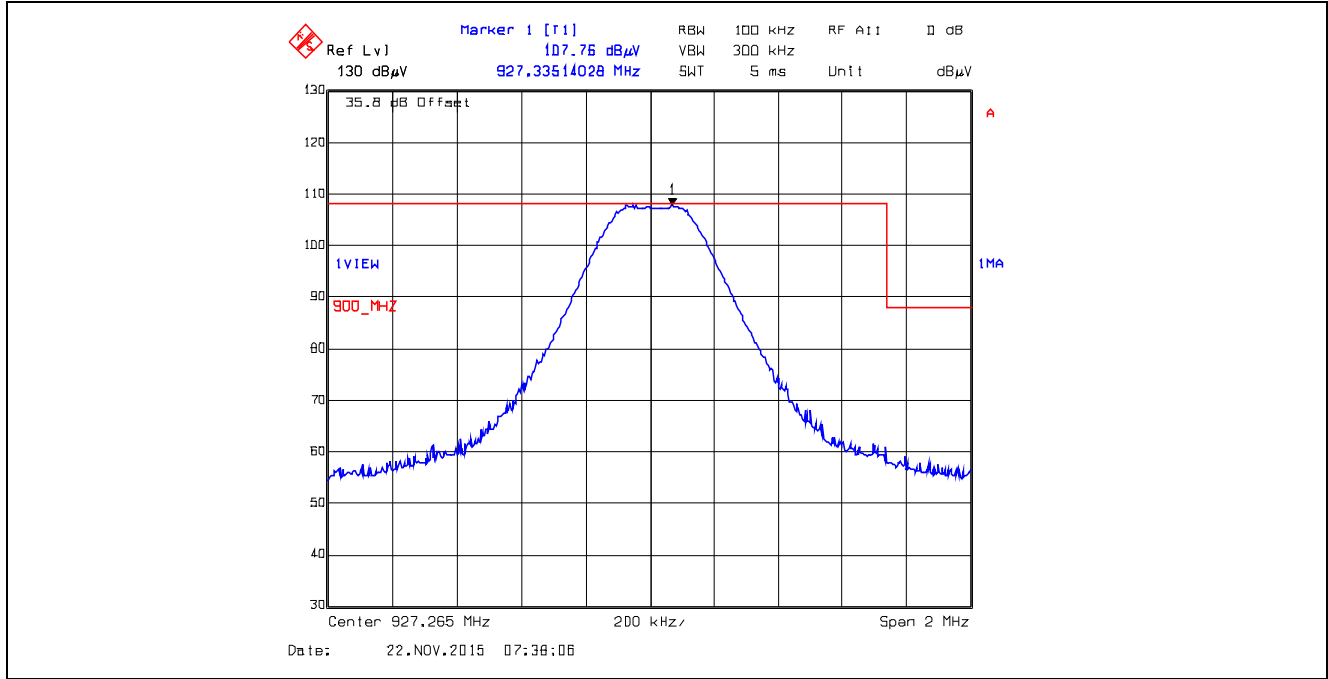

**Plot 5.5.4.3.2.56.** Band-Edge RF Radiated Emissions at 3 m, Vertical Polarization  
 Pseudorandom Hopping Mode, High End of Frequency Band, 927.265 MHz, XTCA1, Data Rate at 105kbps

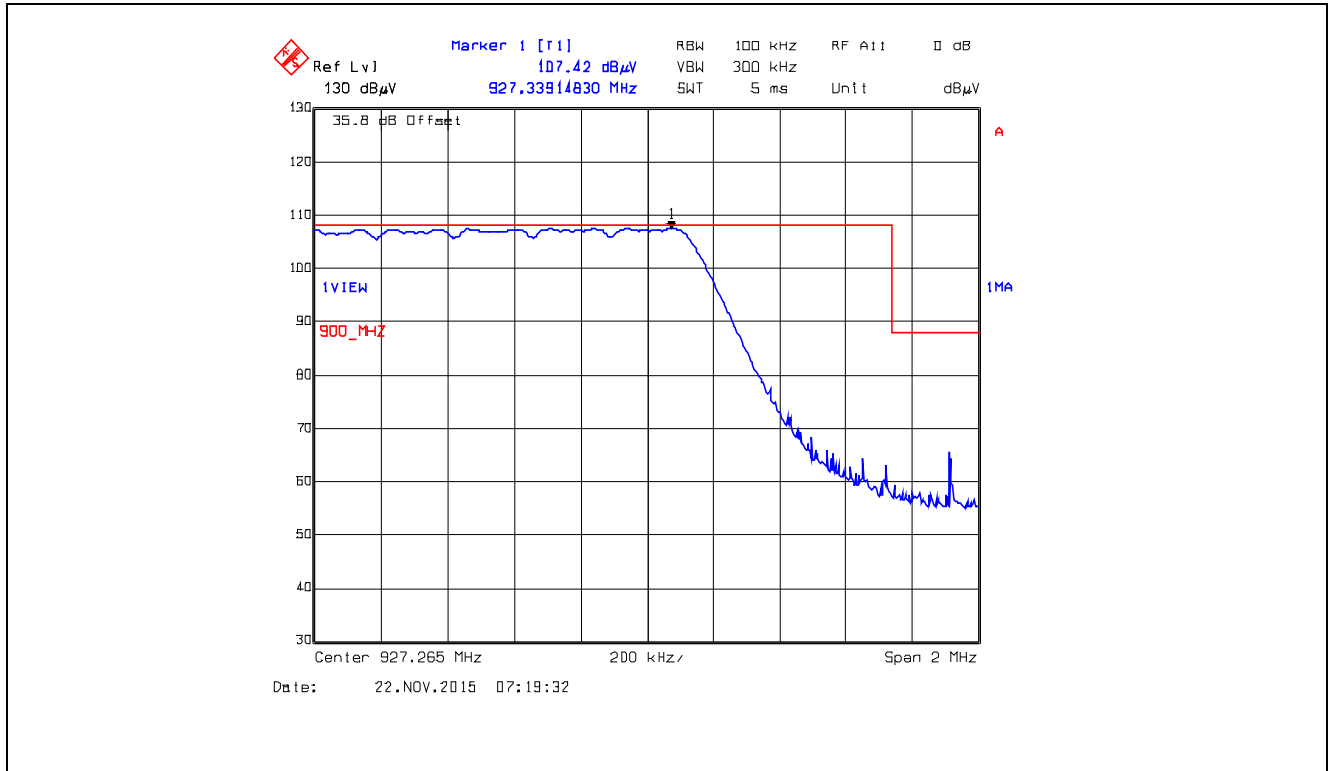

**5.5.4.4. EUT with 8.1 dBi Omni Directional Antenna and 0.65 dB Assembly Cable Loss**

**5.5.4.4.1. Spurious Radiated Emissions**

Fundamental Frequency:		902.5 MHz					
Configuration:		XBX0					
Measured Conducted Power:		13.36 dBm					
Frequency Test Range:		30 MHz – 10 GHz					
Frequency (MHz)	RF Peak Level (dBµV/m)	RF Avg Level (dBµV/m)	Antenna Plane (H/V)	Limit 15.209 (dBµV/m)	Limit 15.247 (dBµV/m)	Margin (dB)	Pass/Fail
902.50	116.41	--	V	--	--	--	--
902.50	117.77	--	H	--	--	--	--
2707.50	44.30	31.10	V	54.0	97.8	-22.9	Pass*
2707.50	44.50	31.10	H	54.0	97.8	-22.9	Pass*
3610.00	48.40	35.20	V	54.0	97.8	-18.8	Pass*
3610.00	47.70	34.00	H	54.0	97.8	-20.0	Pass*
4512.50	50.90	41.50	V	54.0	97.8	-12.5	Pass*
4512.50	52.50	45.10	H	54.0	97.8	-8.9	Pass*
5415.00	53.10	44.80	V	54.0	97.8	-9.2	Pass*
5415.00	52.40	41.20	H	54.0	97.8	-12.8	Pass*
All other spurious emissions and harmonics are more than 20 dB below the applicable limit.							

\*Field strength of emissions appearing within restricted frequency bands shall not exceed the limits in § 15.209.

Fundamental Frequency:		915.0 MHz					
Configuration:		XBX0					
Measured Conducted Power:		13.49 dBm					
Frequency Test Range:		30 MHz – 10 GHz					
Frequency (MHz)	RF Peak Level (dBµV/m)	RF Avg Level (dBµV/m)	Antenna Plane (H/V)	Limit 15.209 (dBµV/m)	Limit 15.247 (dBµV/m)	Margin (dB)	Pass/Fail
915.0	116.25	--	V	--	--	--	--
915.0	117.08	--	H	--	--	--	--
2745.0	43.80	31.20	V	54.0	97.1	-22.8	Pass*
2745.0	44.10	30.20	H	54.0	97.1	-23.8	Pass*
3660.0	47.70	34.30	V	54.0	97.1	-19.7	Pass*
3660.0	47.50	34.00	H	54.0	97.1	-20.0	Pass*
4575.0	50.80	41.70	V	54.0	97.1	-12.3	Pass*
4575.0	51.90	45.80	H	54.0	97.1	-8.2	Pass*
All other spurious emissions and harmonics are more than 20 dB below the applicable limit.							

\*Field strength of emissions appearing within restricted frequency bands shall not exceed the limits in § 15.209.

**ULTRATECH GROUP OF LABS**

3000 Bristol Circle, Oakville, Ontario, Canada L6H 6G4  
 Tel. #: 905-829-1570, Fax. #: 905-829-8050, Email: [vic@ultratech-labs.com](mailto:vic@ultratech-labs.com), Website: <http://www.ultratech-labs.com>

File #: 15DIG102\_FCC15C247  
 December 24, 2015

All test results contained in this engineering test report are traceable to National Institute of Standards and Technology (NIST)

Fundamental Frequency:		927.5 MHz					
Configuration:		XBX0					
Measured Conducted Power:		13.49 dBm					
Frequency Test Range:		30 MHz – 10 GHz					
Frequency (MHz)	RF Peak Level (dBµV/m)	RF Avg Level (dBµV/m)	Antenna Plane (H/V)	Limit 15.209 (dBµV/m)	Limit 15.247 (dBµV/m)	Margin (dB)	Pass/Fail
927.5	116.10	--	V	--	--	--	--
927.5	117.98	--	H	--	--	--	--
2782.5	44.10	31.10	V	54.0	98.0	-22.9	Pass*
2782.5	43.24	29.90	H	54.0	98.0	-24.1	Pass*
3710.0	48.60	34.80	V	54.0	98.0	-19.2	Pass*
3710.0	48.50	34.50	H	54.0	98.0	-19.5	Pass*
4637.5	52.60	46.00	V	54.0	98.0	-8.0	Pass*
4637.5	54.20	49.10	H	54.0	98.0	-4.9	Pass*
All other spurious emissions and harmonics are more than 20 dB below the applicable limit.							

**5.5.4.4.2. Band-Edge RF Radiated Emissions**

Refer to the following plots.

**Plot 5.5.4.4.2.1.** Band-Edge RF Radiated Emissions at 3 m, Horizontal Polarization  
Single Frequency Mode, Low End of Frequency Band, 902.5 MHz, XB0, Data Rate at 10 kbps

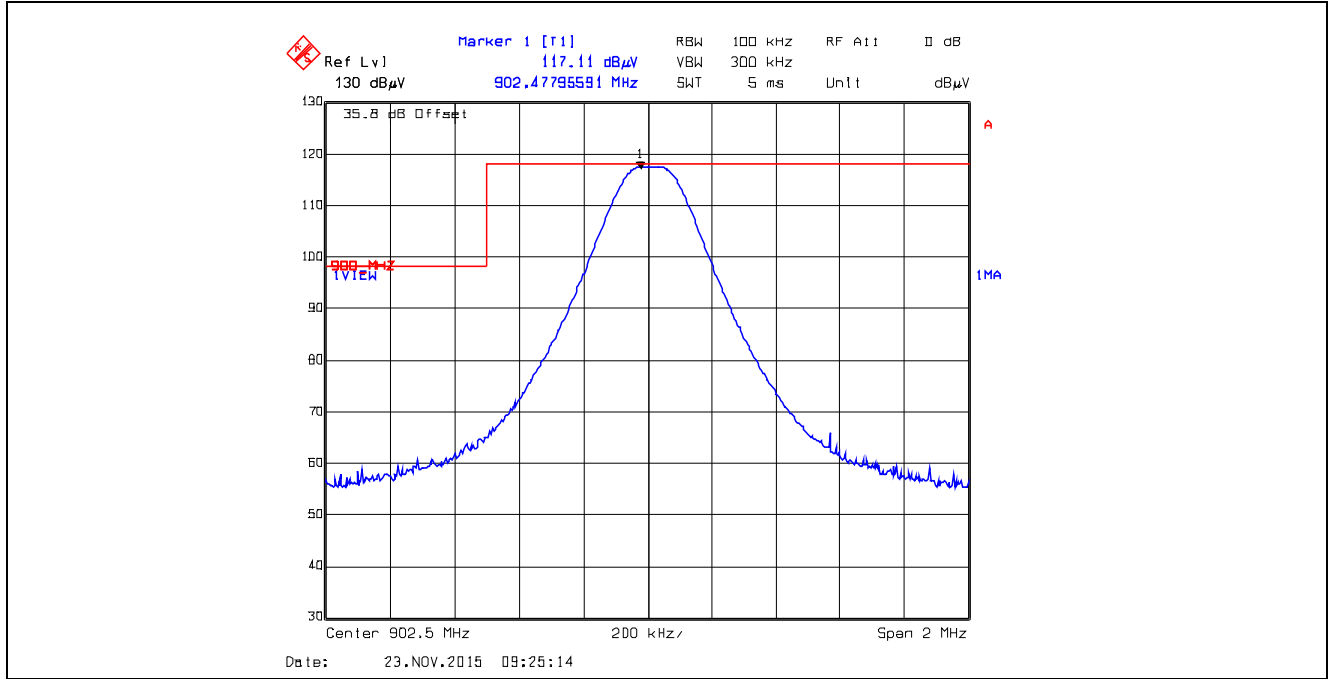

**Plot 5.5.4.4.2.2.** Band-Edge RF Radiated Emissions at 3 m, Horizontal Polarization  
Pseudorandom Hopping Mode, Low End of Frequency Band, 902.5 MHz, XB0, Data Rate at 10 kbps

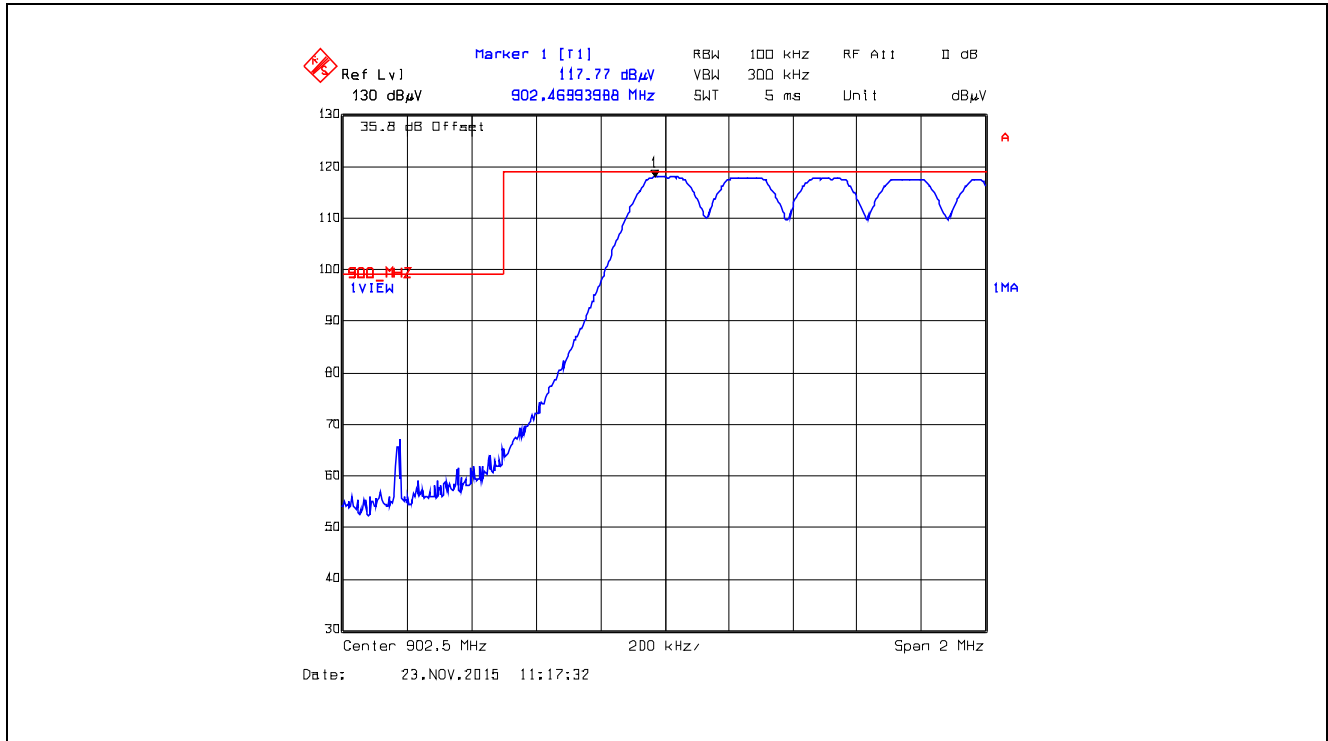

**Plot 5.5.4.4.2.3.** Band-Edge RF Radiated Emissions at 3 m, Vertical Polarization  
 Single Frequency Mode, Low End of Frequency Band, 902.5 MHz, XB0, Data Rate at 10 kbps

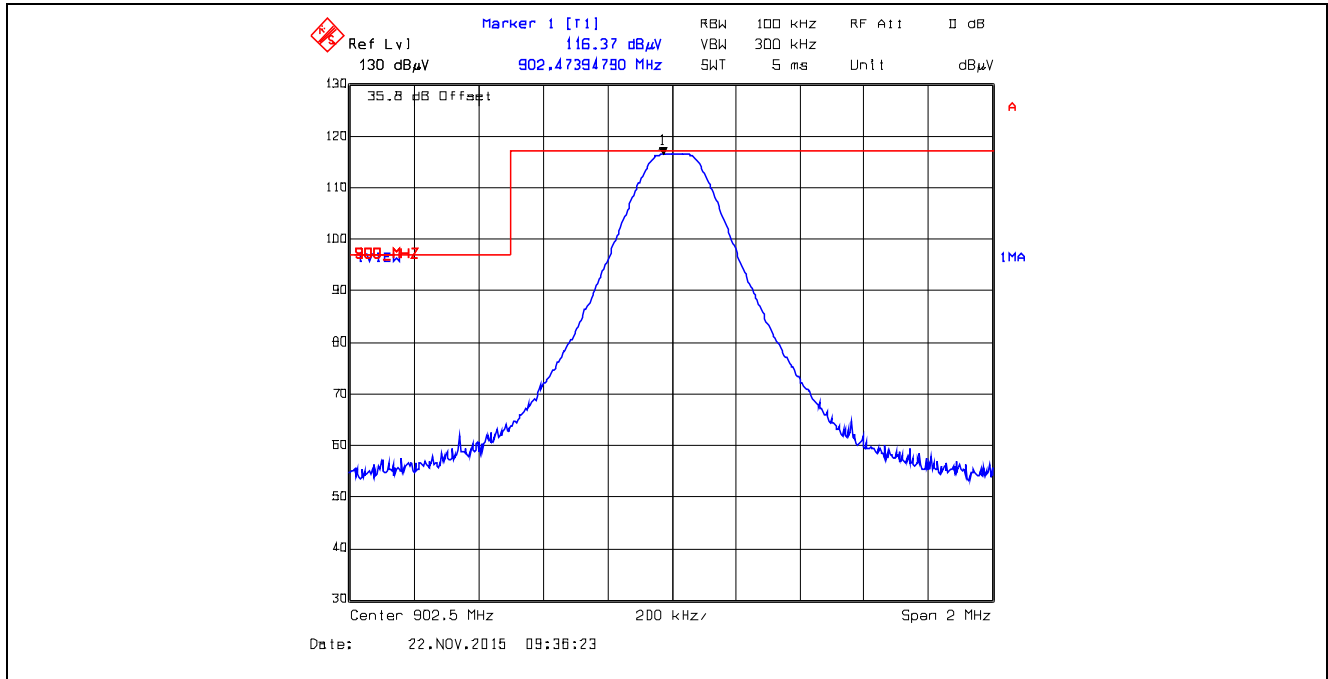

**Plot 5.5.4.4.2.4.** Band-Edge RF Radiated Emissions at 3 m, Vertical Polarization  
 Pseudorandom Hopping Mode, Low End of Frequency Band, 902.5 MHz, XB0, Data Rate at 10 kbps

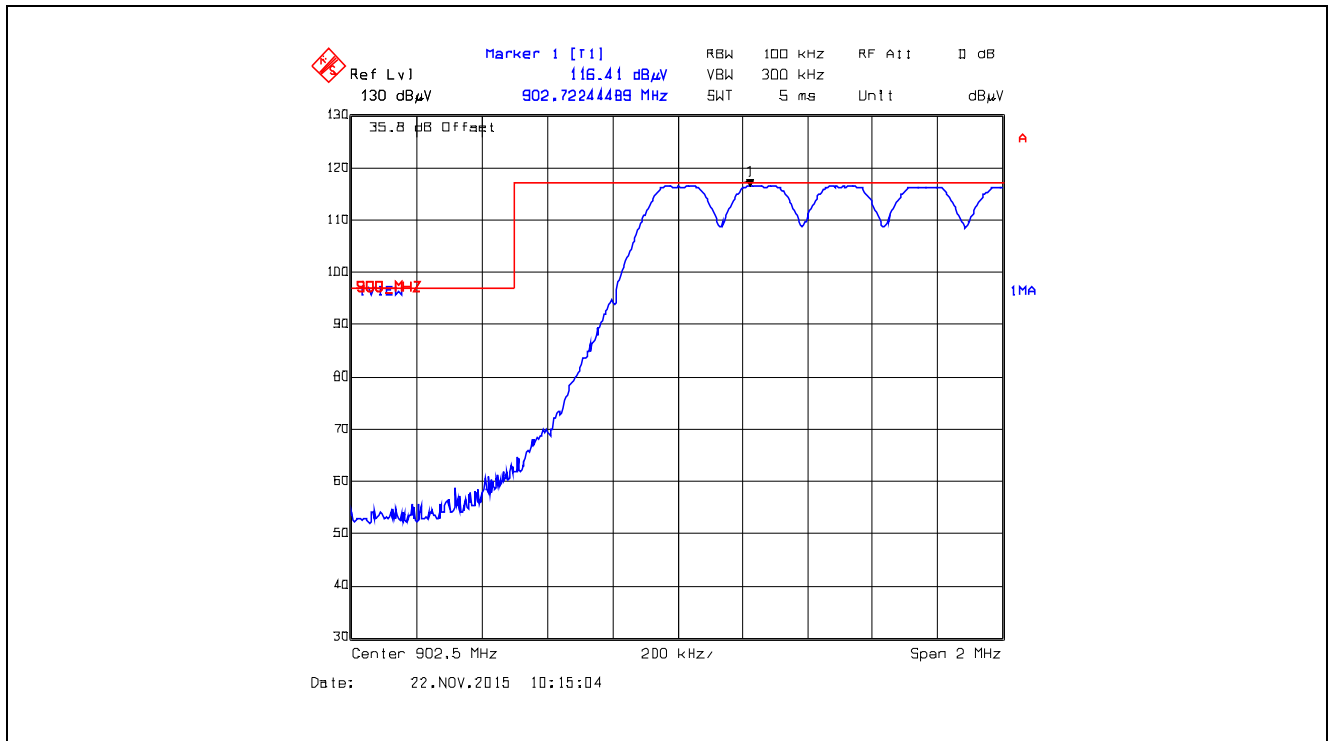

**Plot 5.5.4.4.2.5.** Band-Edge RF Radiated Emissions at 3 m, Horizontal Polarization  
Single Frequency Mode, High End of Frequency Band, 927.5 MHz, XB0, Data Rate at 10 kbps

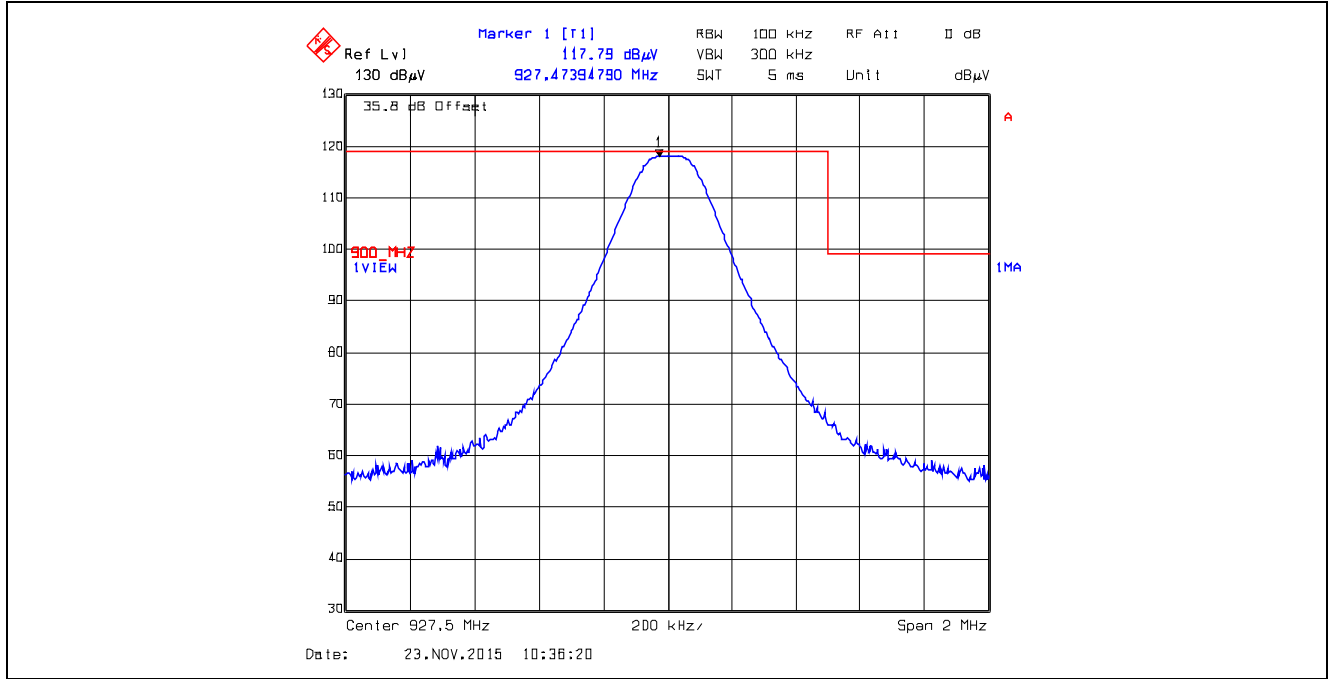

**Plot 5.5.4.4.2.6.** Band-Edge RF Radiated Emissions at 3 m, Horizontal Polarization  
Pseudorandom Hopping Mode, High End of Frequency Band, 927.5 MHz, XB0, Data Rate at 10 kbps

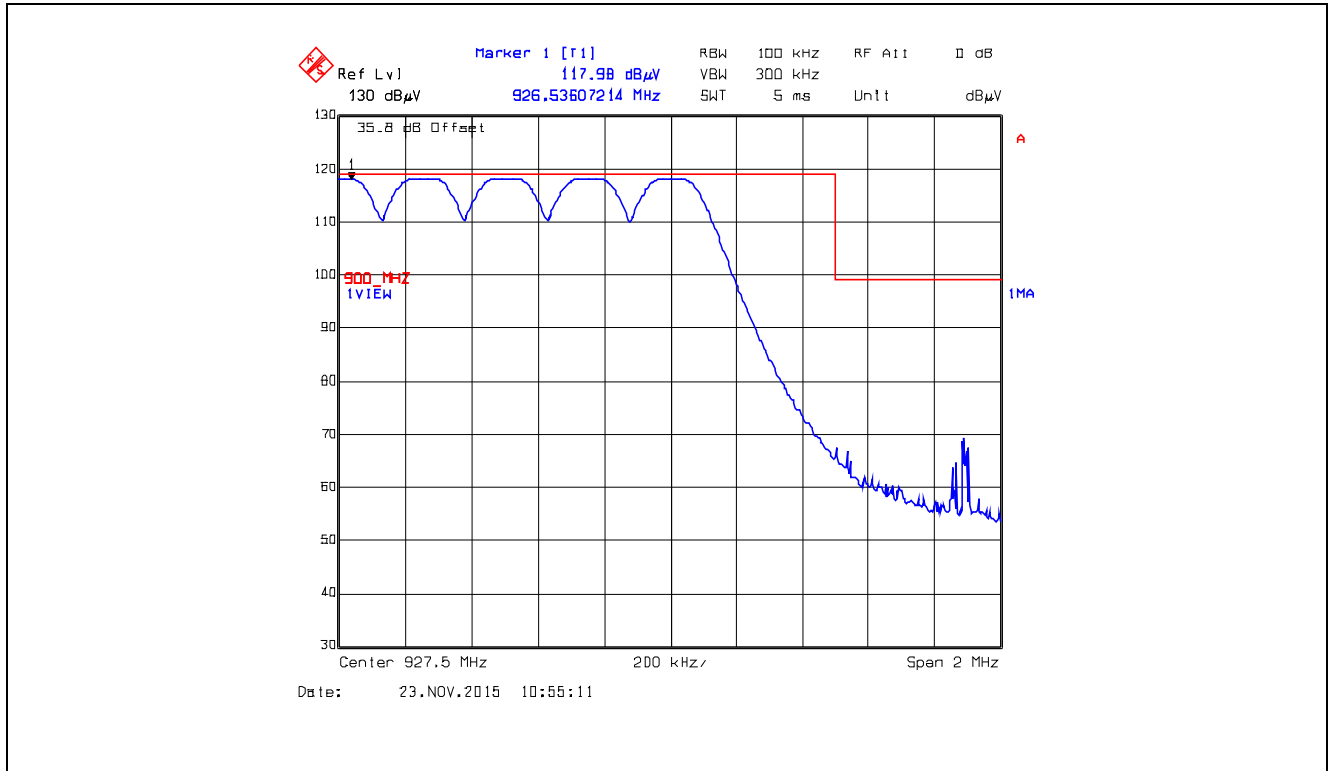

**Plot 5.5.4.4.2.7.** Band-Edge RF Radiated Emissions at 3 m, Vertical Polarization  
Single Frequency Mode, High End of Frequency Band, 927.5 MHz, XBX0, Data Rate at 10 kbps

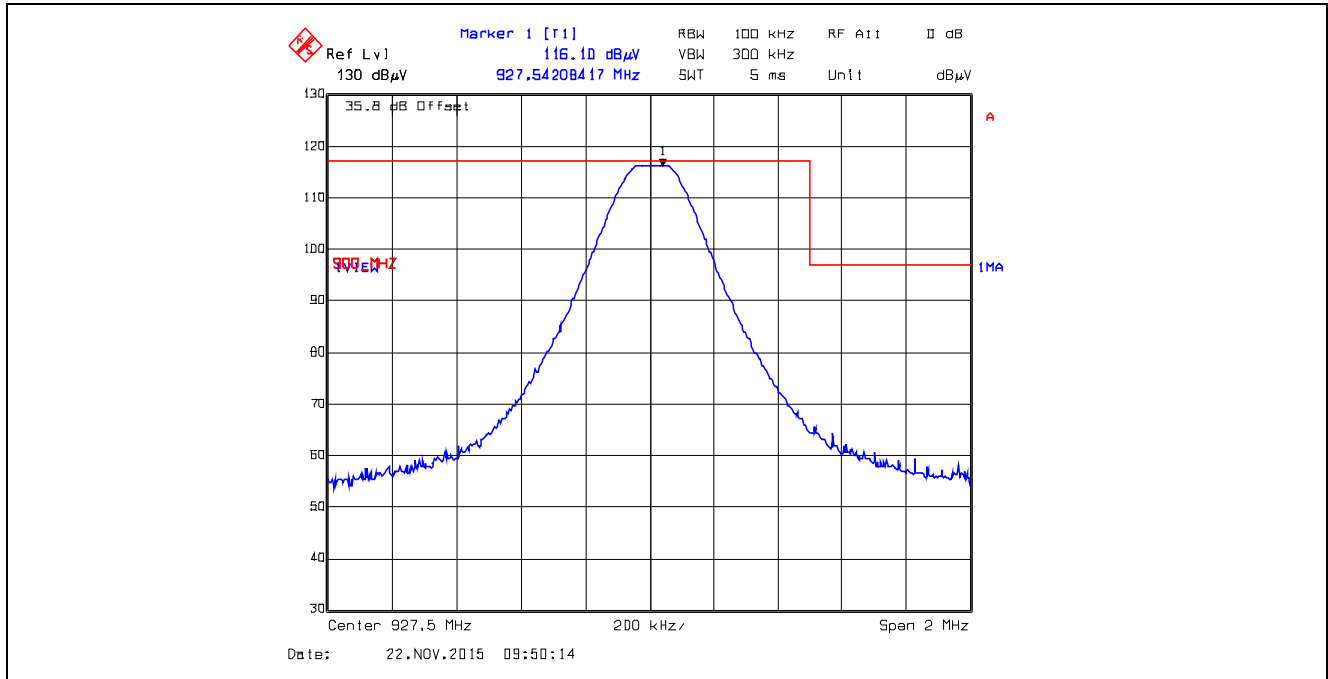

**Plot 5.5.4.4.2.8.** Band-Edge RF Radiated Emissions at 3 m, Vertical Polarization  
Pseudorandom Hopping Mode, High End of Frequency Band, 927.5 MHz, XBX0, Data Rate at 10 kbps

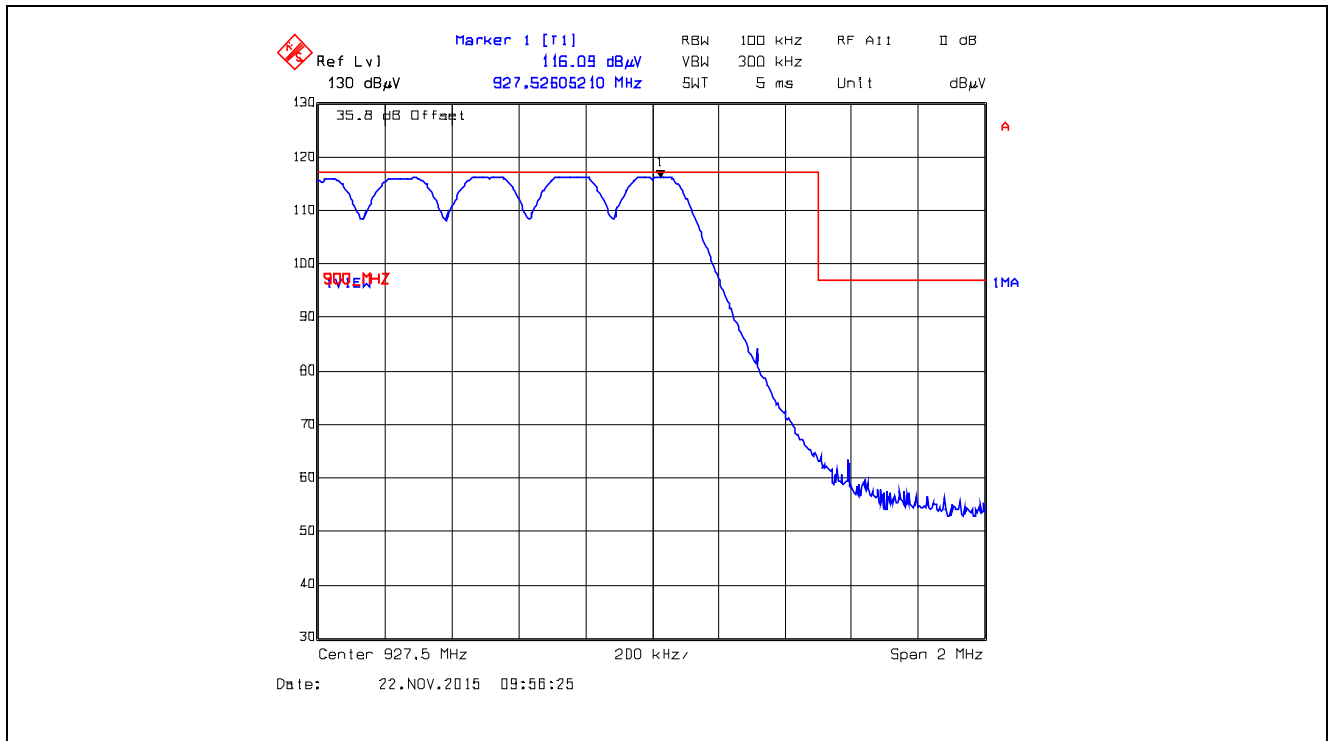



**Plot 5.5.4.4.2.9.** Band-Edge RF Radiated Emissions at 3 m, Horizontal Polarization  
Single Frequency Mode, Low End of Frequency Band, 902.5 MHz, XBX1, Data Rate at 110 kbps

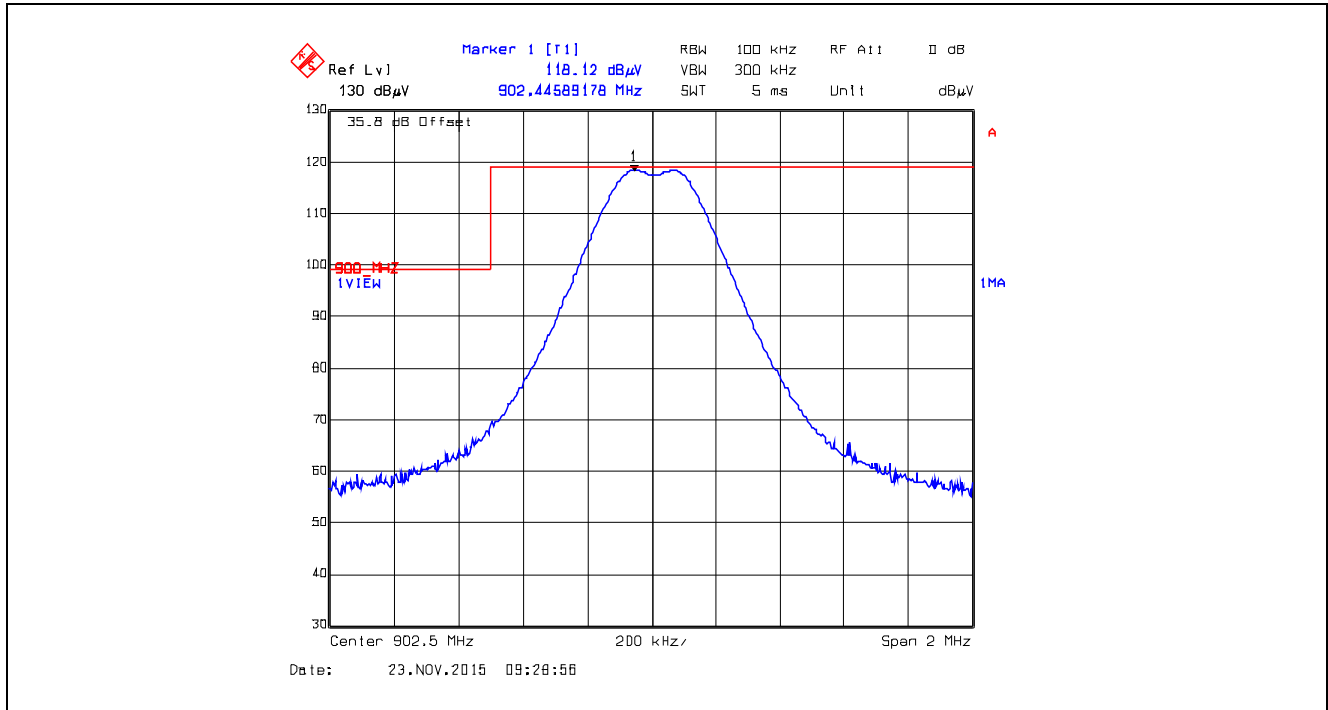

**Plot 5.5.4.4.2.10.** Band-Edge RF Radiated Emissions at 3 m, Horizontal Polarization  
Pseudorandom Hopping Mode, Low End of Frequency Band, 902.5 MHz, XBX1, Data Rate at 110 kbps

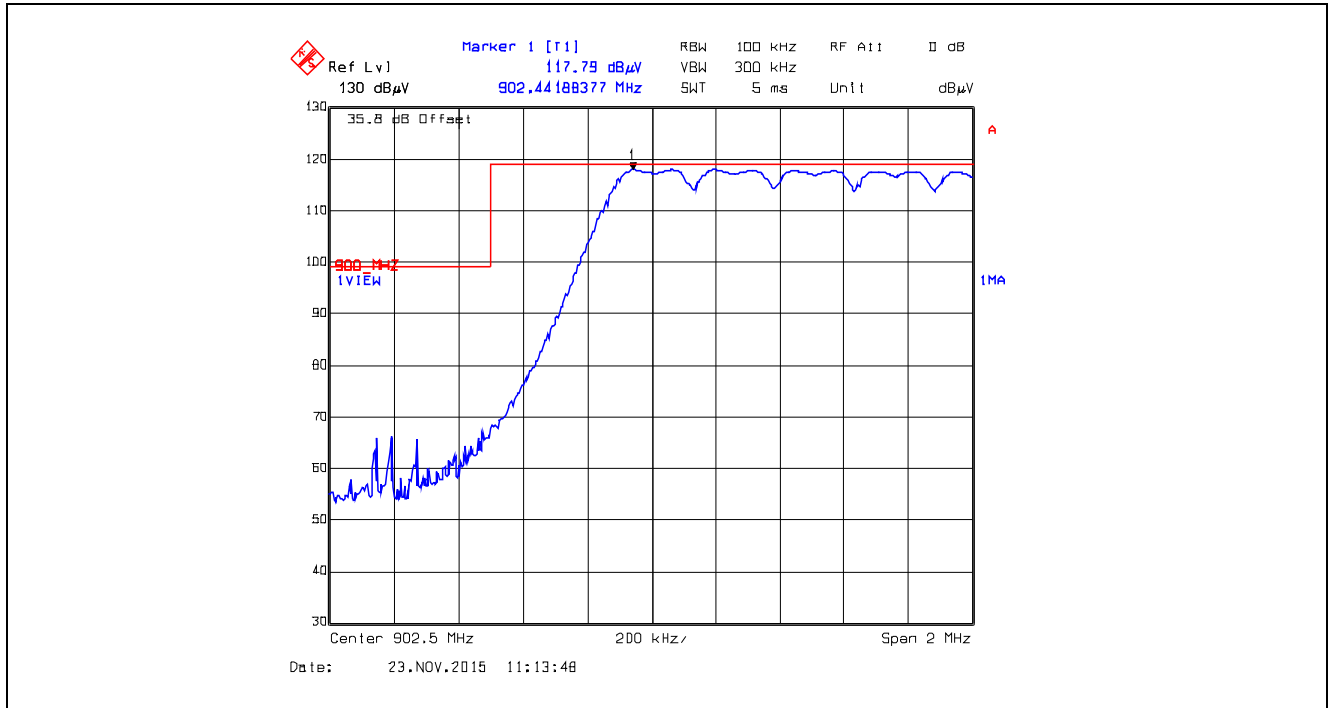

**Plot 5.5.4.4.2.11.** Band-Edge RF Radiated Emissions at 3 m, Vertical Polarization  
Single Frequency Mode, Low End of Frequency Band, 902.5 MHz, XB1, Data Rate at 110 kbps

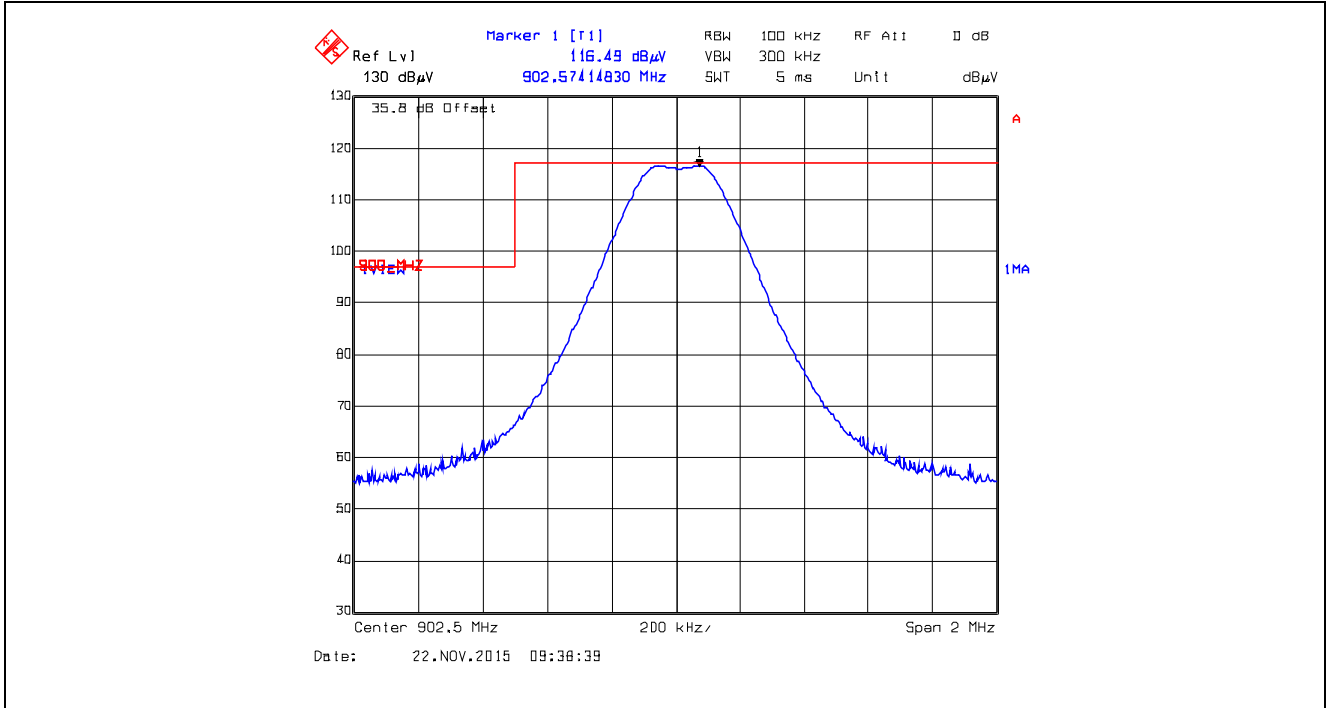

**Plot 5.5.4.4.2.12.** Band-Edge RF Radiated Emissions at 3 m, Vertical Polarization  
Pseudorandom Hopping Mode, Low End of Frequency Band, 902.5 MHz, XB1, Data Rate at 110 kbps

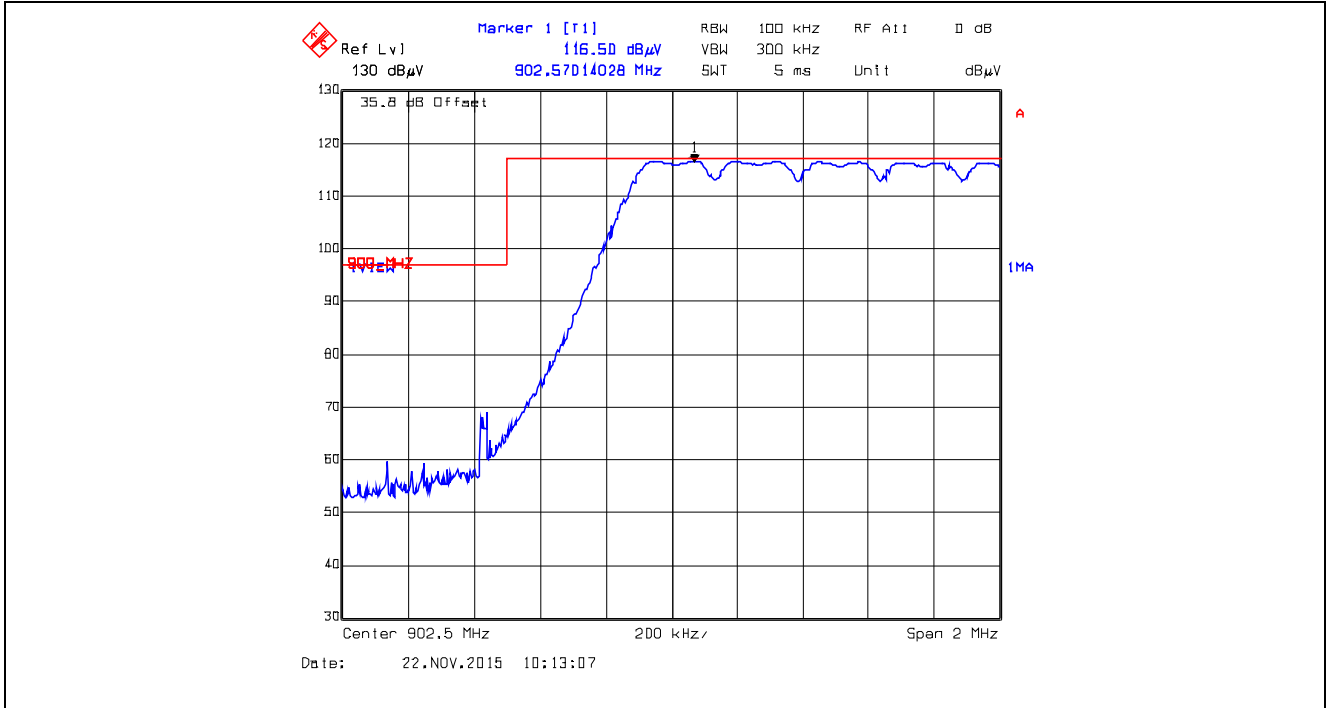

**Plot 5.5.4.4.2.13.** Band-Edge RF Radiated Emissions at 3 m, Horizontal Polarization  
 Single Frequency Mode, High End of Frequency Band, 927.5 MHz, XBX1, Data Rate at 110 kbps

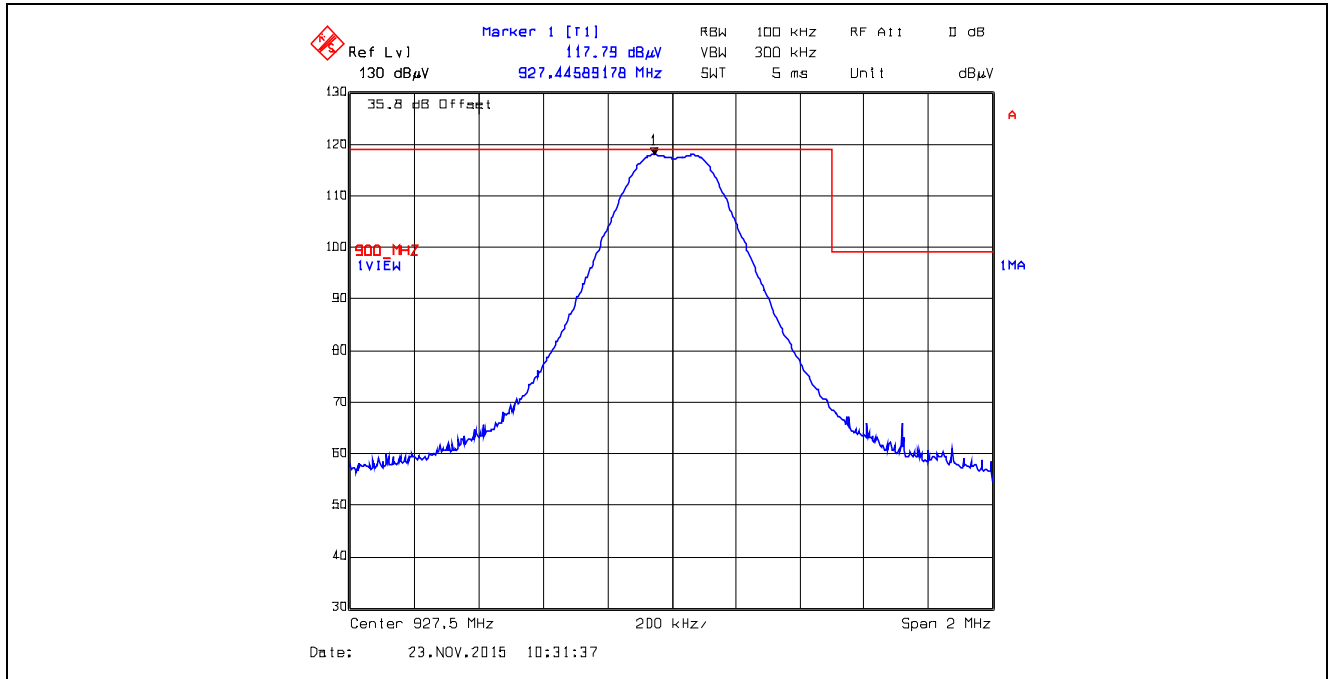

**Plot 5.5.4.4.2.14.** Band-Edge RF Radiated Emissions at 3 m, Horizontal Polarization  
 Pseudorandom Hopping Mode, High End of Frequency Band, 927.5 MHz, XBX1, Data Rate at 110 kbps

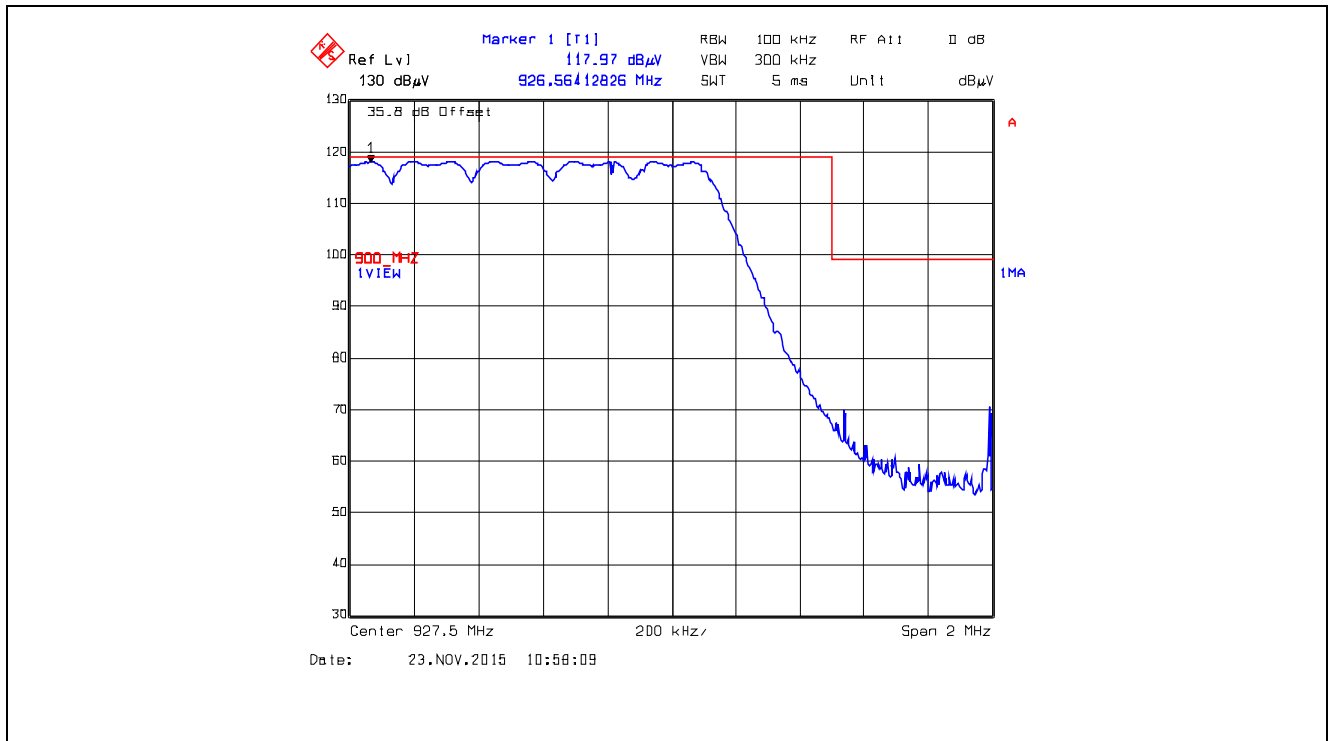

**Plot 5.5.4.4.2.15.** Band-Edge RF Radiated Emissions at 3 m, Vertical Polarization  
 Single Frequency Mode, High End of Frequency Band, 927.5 MHz, XB1, Data Rate at 110 kbps

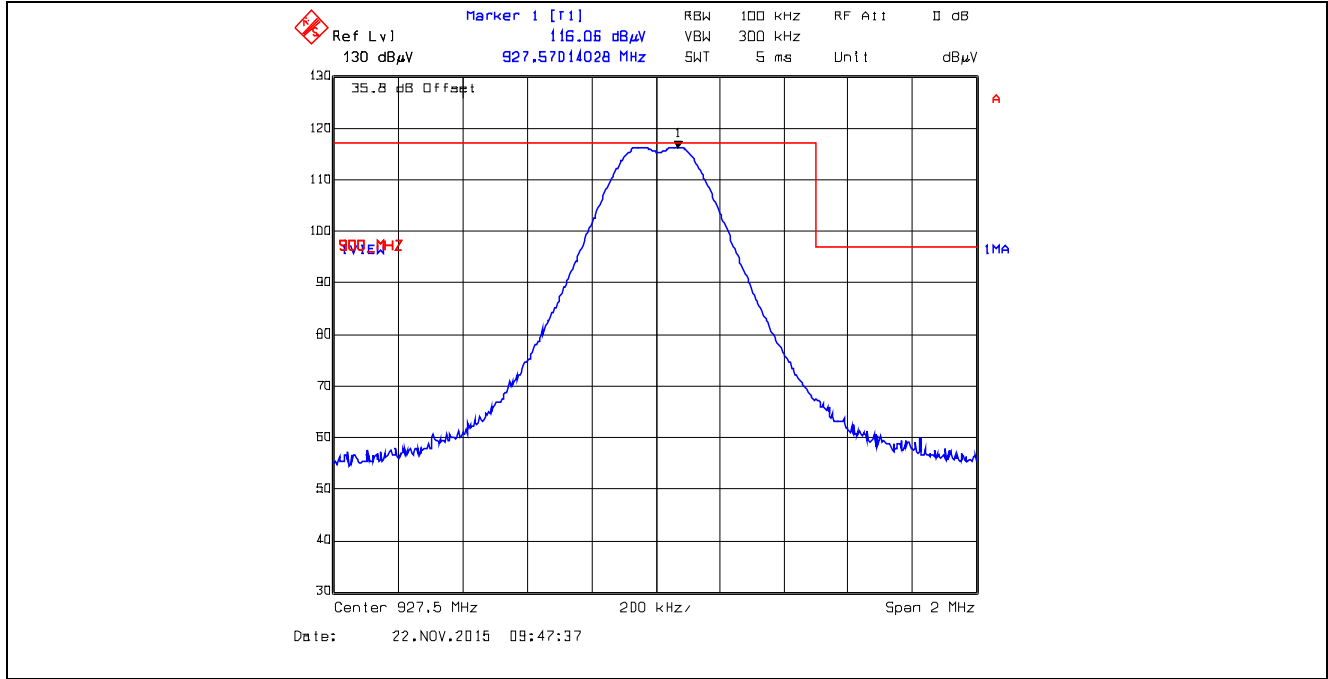

**Plot 5.5.4.4.2.16.** Band-Edge RF Radiated Emissions at 3 m, Vertical Polarization  
 Pseudorandom Hopping Mode, High End of Frequency Band, 927.5 MHz, XB1, Data Rate at 110 kbps

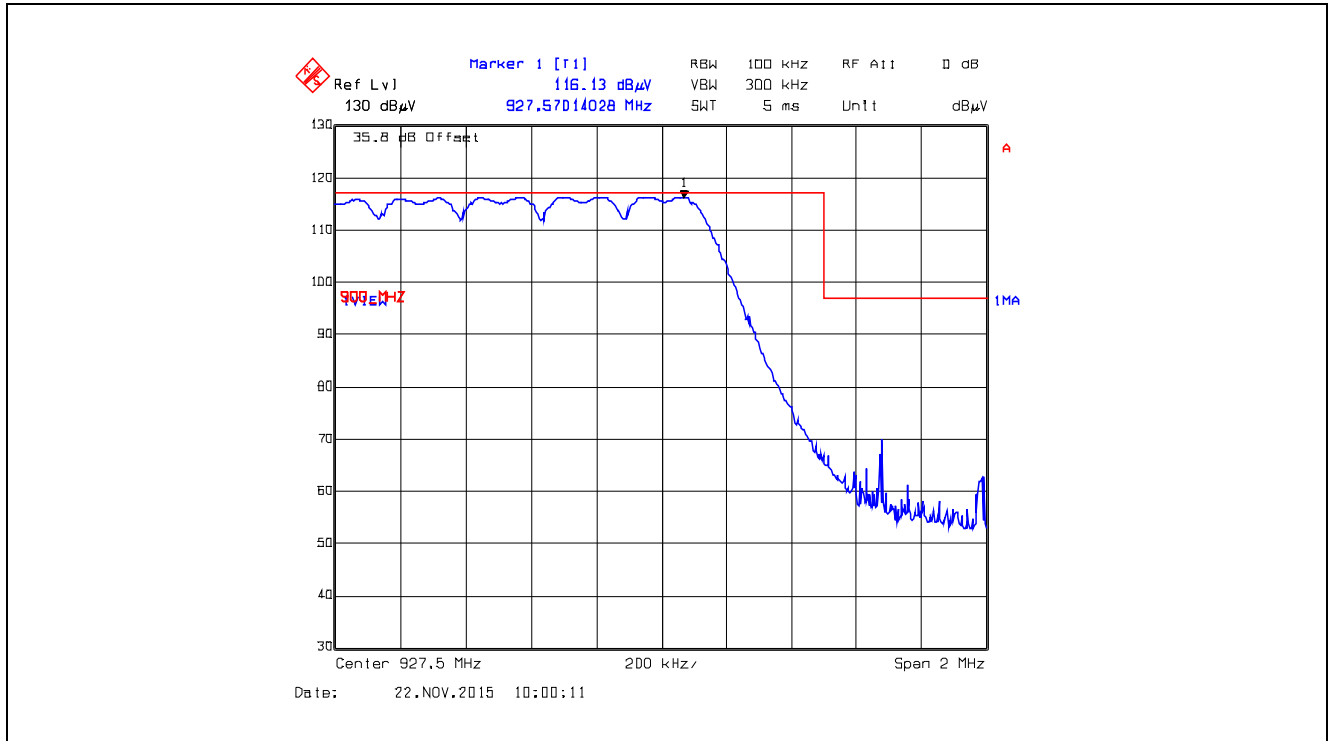

**Plot 5.5.4.4.2.17.** Band-Edge RF Radiated Emissions at 3 m, Horizontal Polarization  
 Single Frequency Mode, Low End of Frequency Band, 902.75 MHz, XB2, Data Rate at 250 kbps

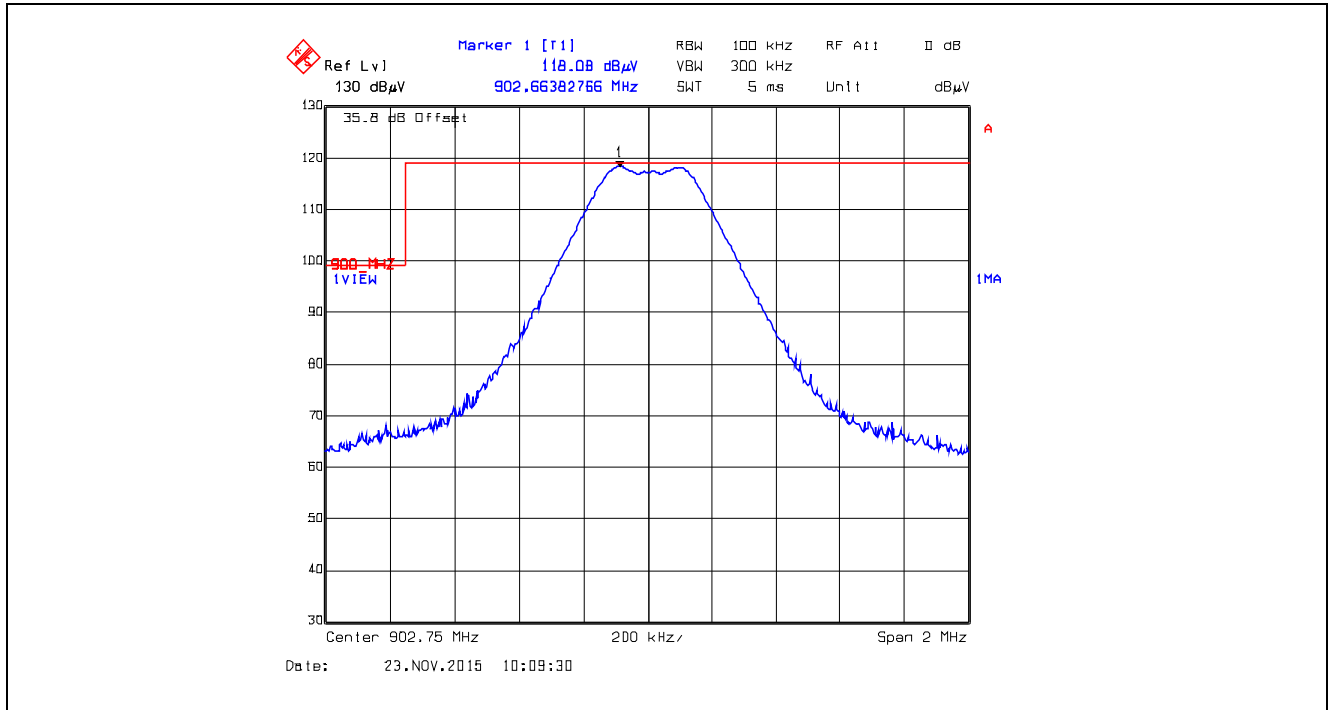

**Plot 5.5.4.4.2.18.** Band-Edge RF Radiated Emissions at 3 m, Horizontal Polarization  
 Pseudorandom Hopping Mode, Low End of Frequency Band, 902.75 MHz, XB2, Data Rate at 250 kbps

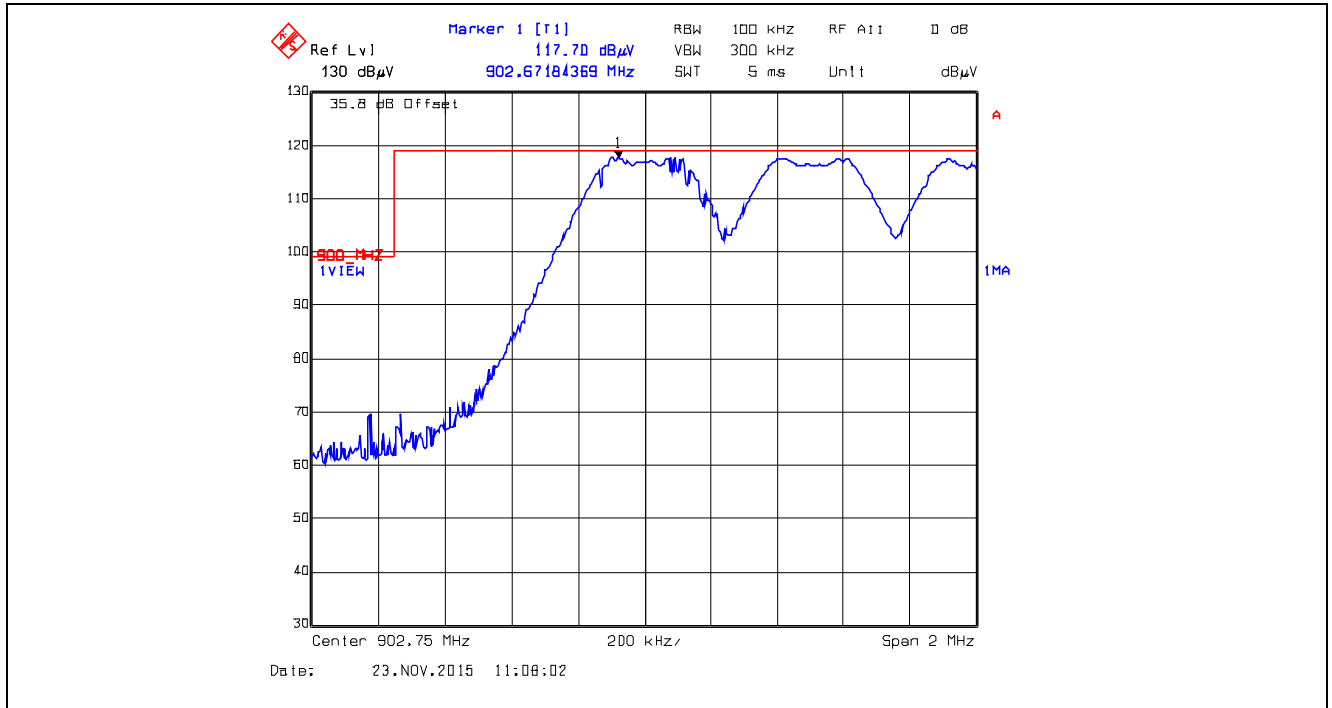

**Plot 5.5.4.4.2.19.** Band-Edge RF Radiated Emissions at 3 m, Vertical Polarization  
 Single Frequency Mode, Low End of Frequency Band, 902.75 MHz, XBX2, Data Rate at 250 kbps

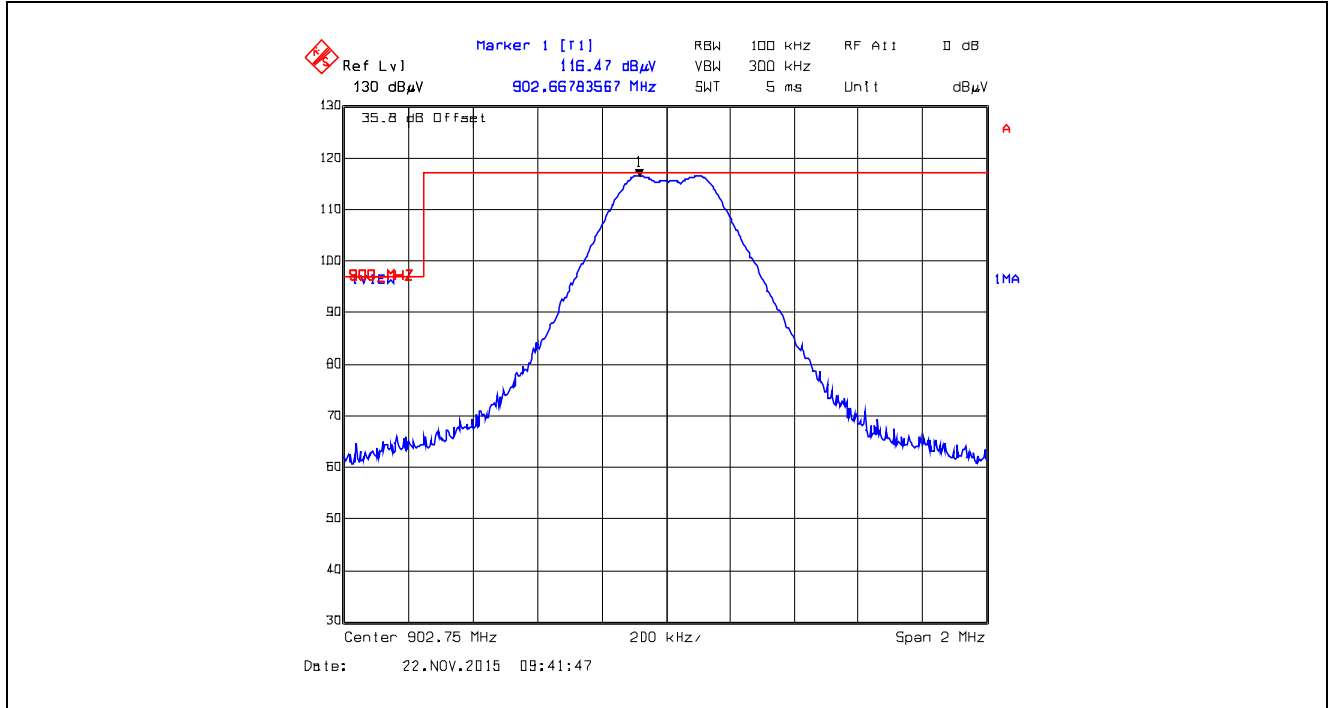

**Plot 5.5.4.4.2.20.** Band-Edge RF Radiated Emissions at 3 m, Vertical Polarization  
 Pseudorandom Hopping Mode, Low End of Frequency Band, 902.75 MHz, XBX2, Data Rate at 250 kbps

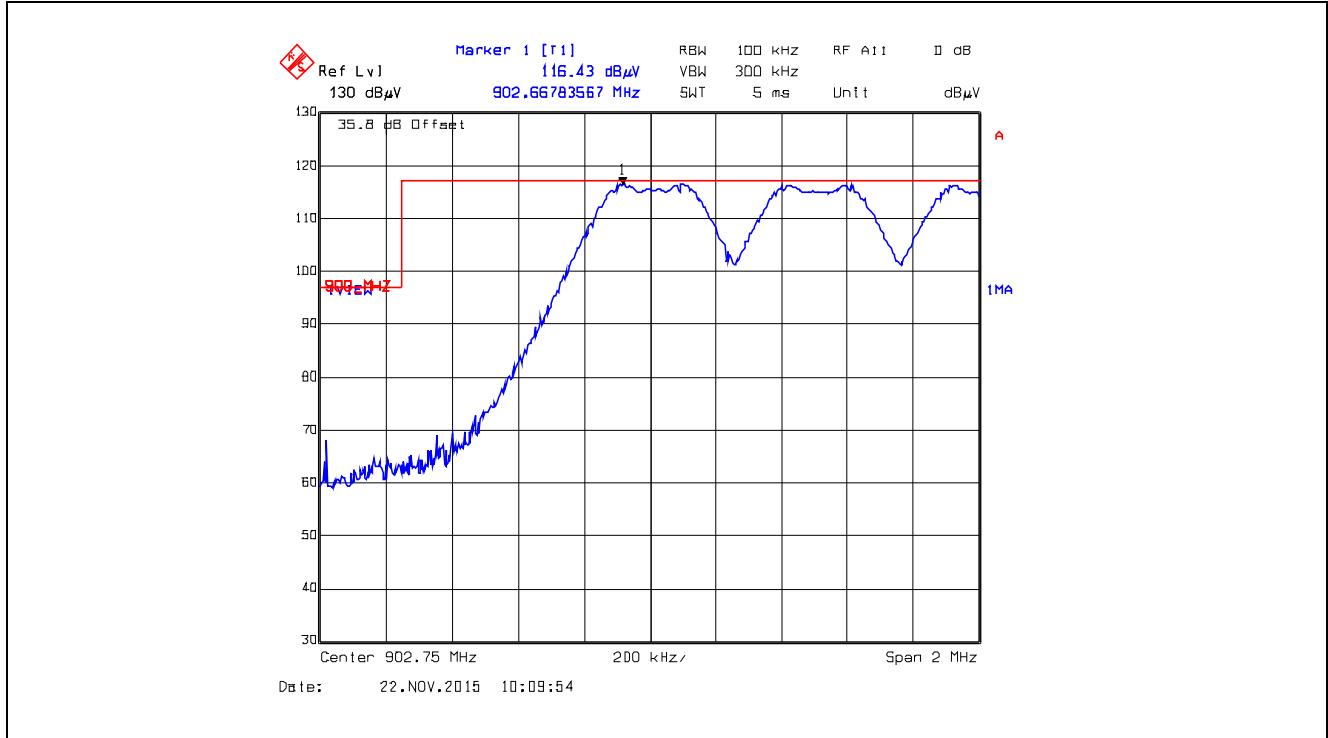

**Plot 5.5.4.4.2.21.** Band-Edge RF Radiated Emissions at 3 m, Horizontal Polarization  
 Single Frequency Mode, High End of Frequency Band, 927.25 MHz, XB2, Data Rate at 250 kbps

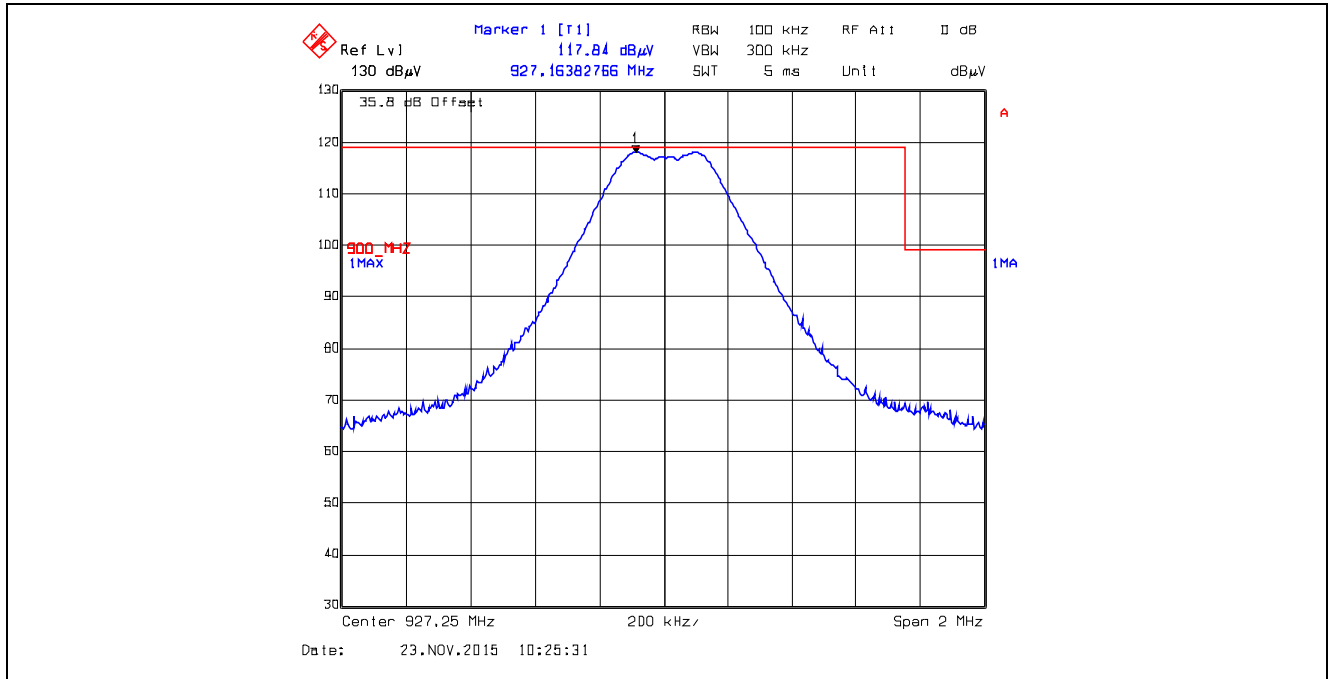

**Plot 5.5.4.4.2.22.** Band-Edge RF Radiated Emissions at 3 m, Horizontal Polarization  
 Pseudorandom Hopping Mode, High End of Frequency Band, 927.25 MHz, XB2, Data Rate at 250 kbps

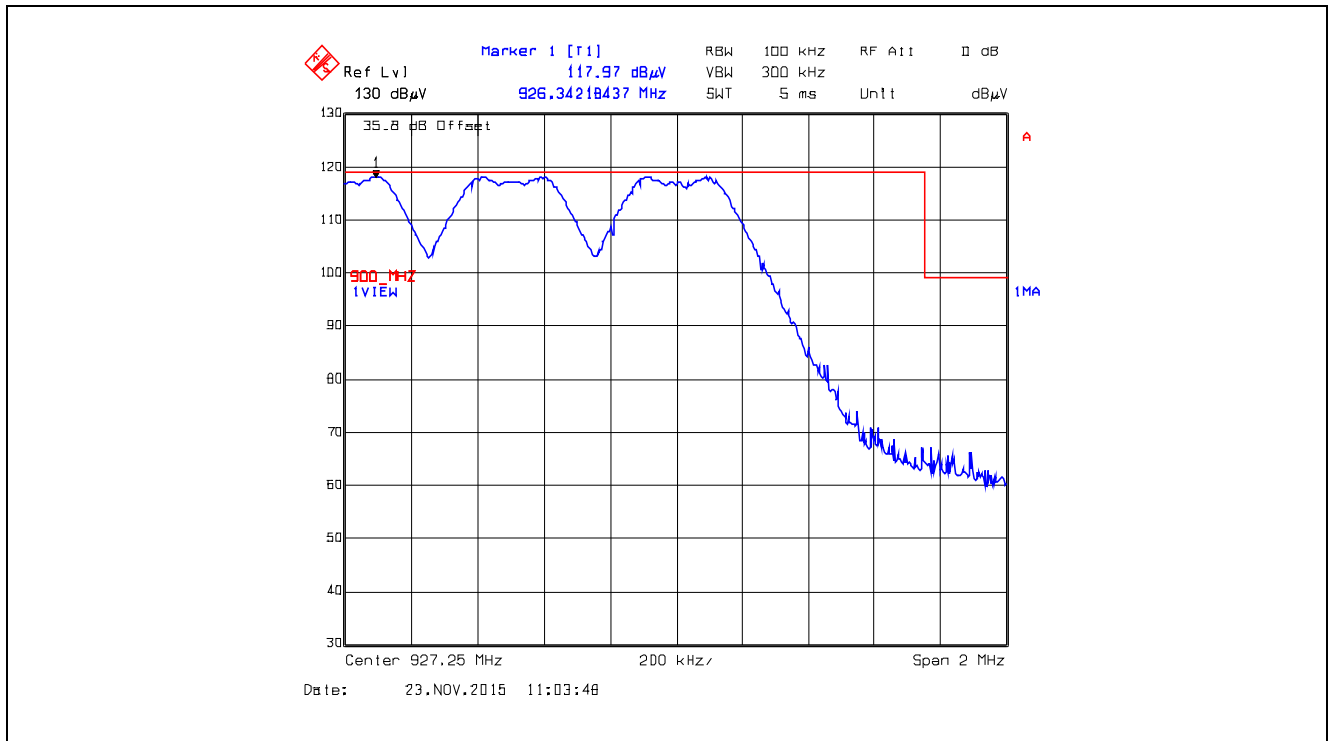

**Plot 5.5.4.4.23.** Band-Edge RF Radiated Emissions at 3 m, Vertical Polarization  
 Single Frequency Mode, High End of Frequency Band, 927.25 MHz, XB2, Data Rate at 250 kbps

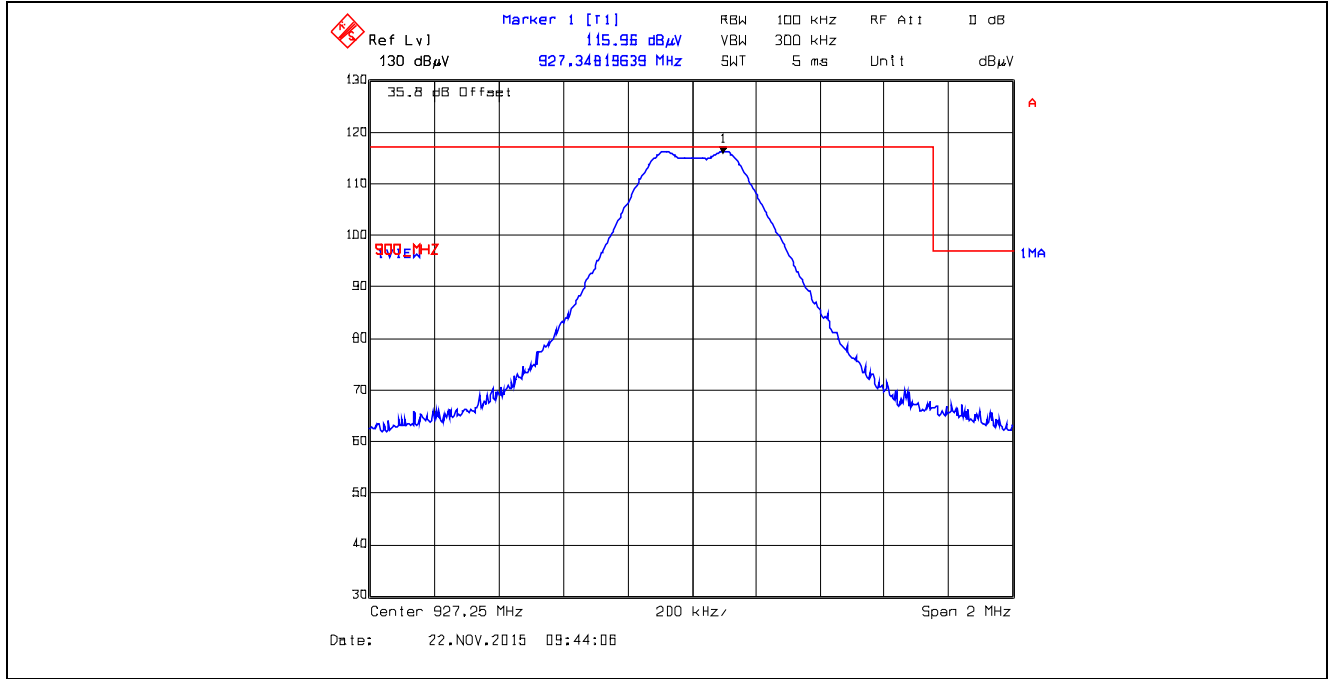

**Plot 5.5.4.4.24.** Band-Edge RF Radiated Emissions at 3 m, Vertical Polarization  
 Pseudorandom Hopping Mode, High End of Frequency Band, 927.25 MHz, XB2, Data Rate at 250 kbps

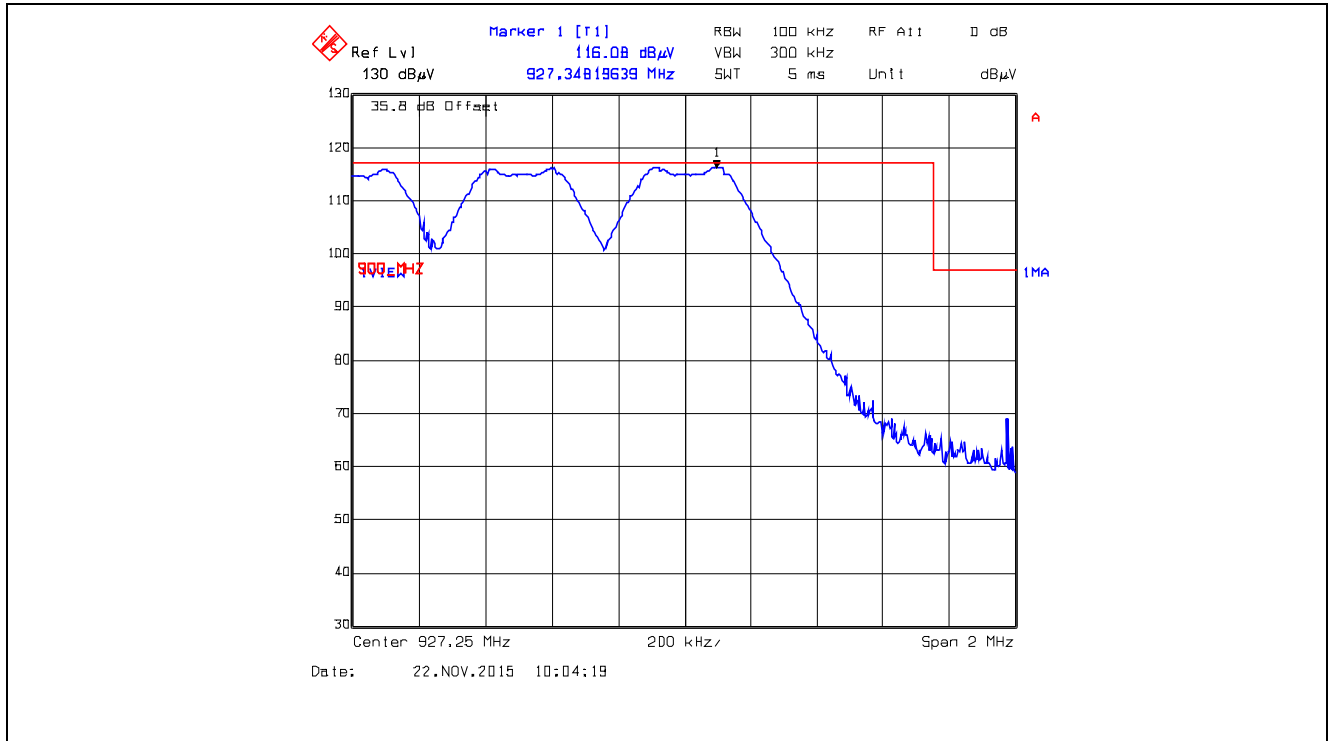



**Plot 5.5.4.4.25.** Band-Edge RF Radiated Emissions at 3 m, Horizontal Polarization  
 Single Frequency Mode, Low End of Frequency Band, 905.0 MHz, XTC0, Data Rate at 10 kbps

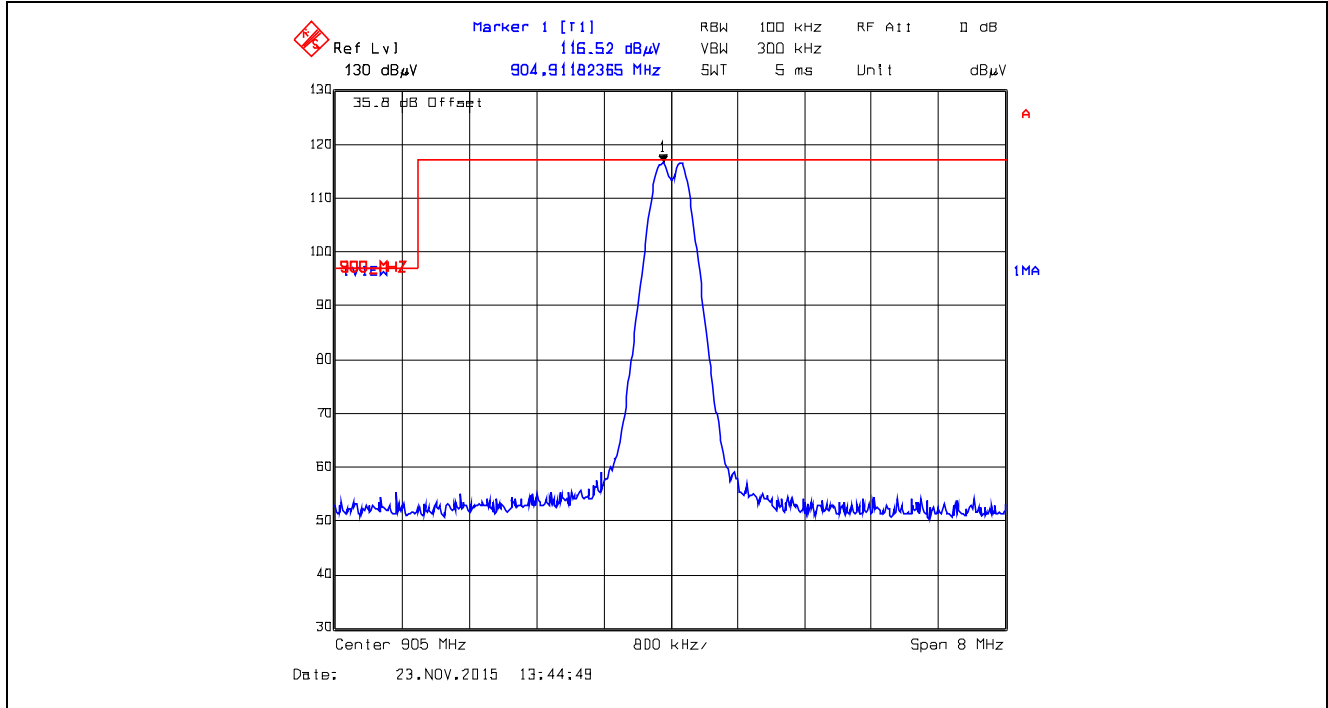

**Plot 5.5.4.4.26.** Band-Edge RF Radiated Emissions at 3 m, Horizontal Polarization  
 Pseudorandom Hopping Mode, Low End of Frequency Band, 905.0 MHz, XTC0, Data Rate at 10 kbps

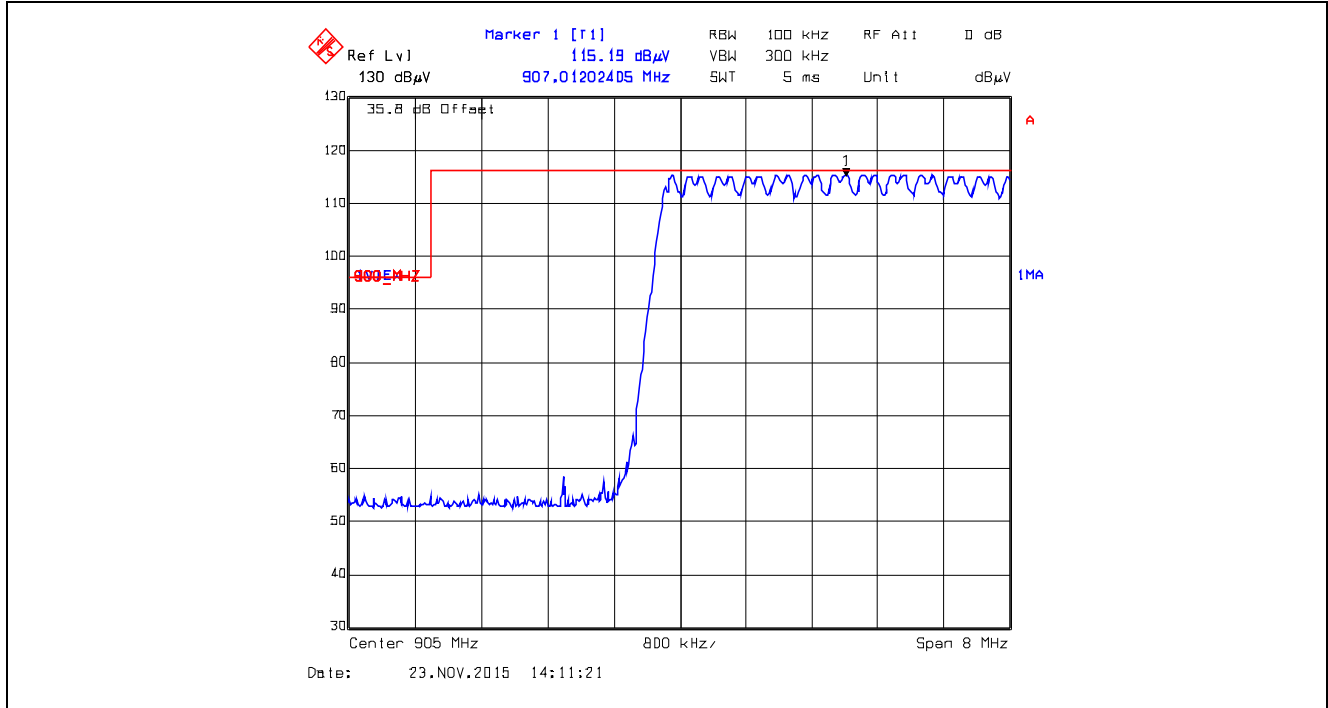

**Plot 5.5.4.4.27.** Band-Edge RF Radiated Emissions at 3 m, Vertical Polarization  
 Single Frequency Mode, Low End of Frequency Band, 905.0 MHz, XTC0, Data Rate at 10 kbps

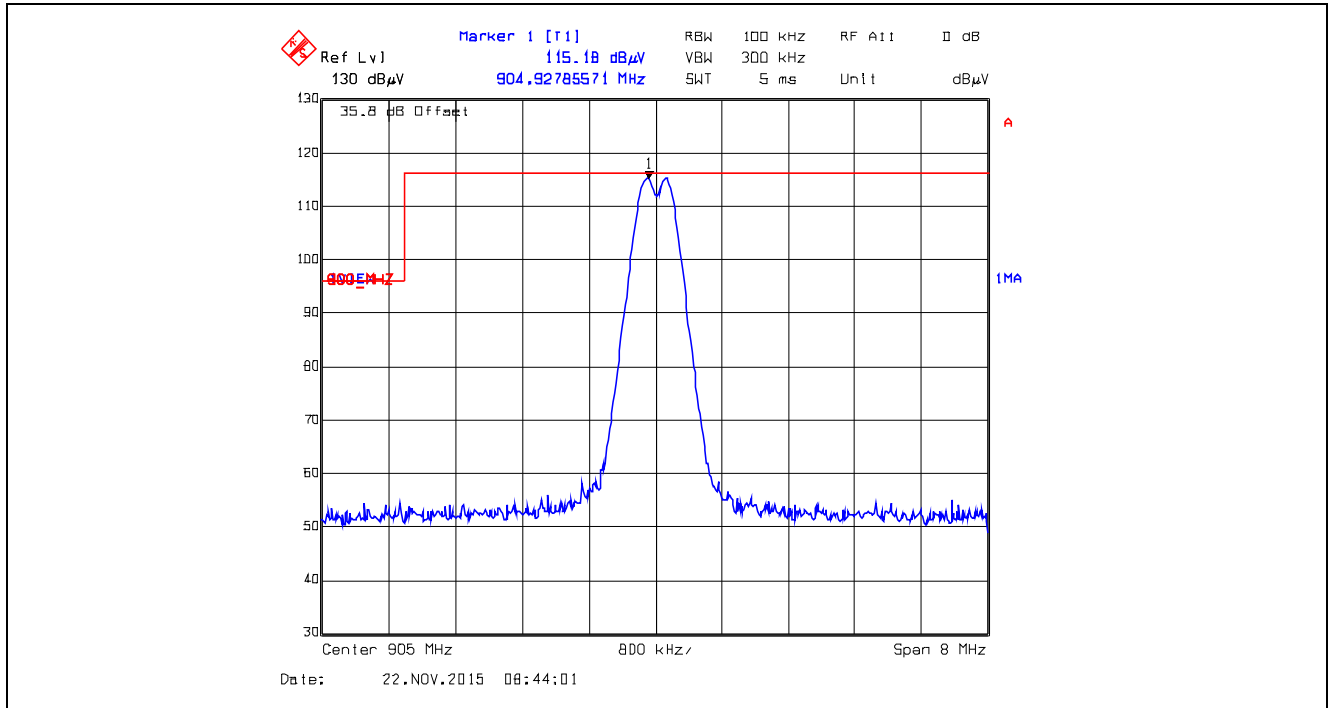

**Plot 5.5.4.4.28.** Band-Edge RF Radiated Emissions at 3 m, Vertical Polarization  
 Pseudorandom Hopping Mode, Low End of Frequency Band, 905.0 MHz, XTC0, Data Rate at 10 kbps

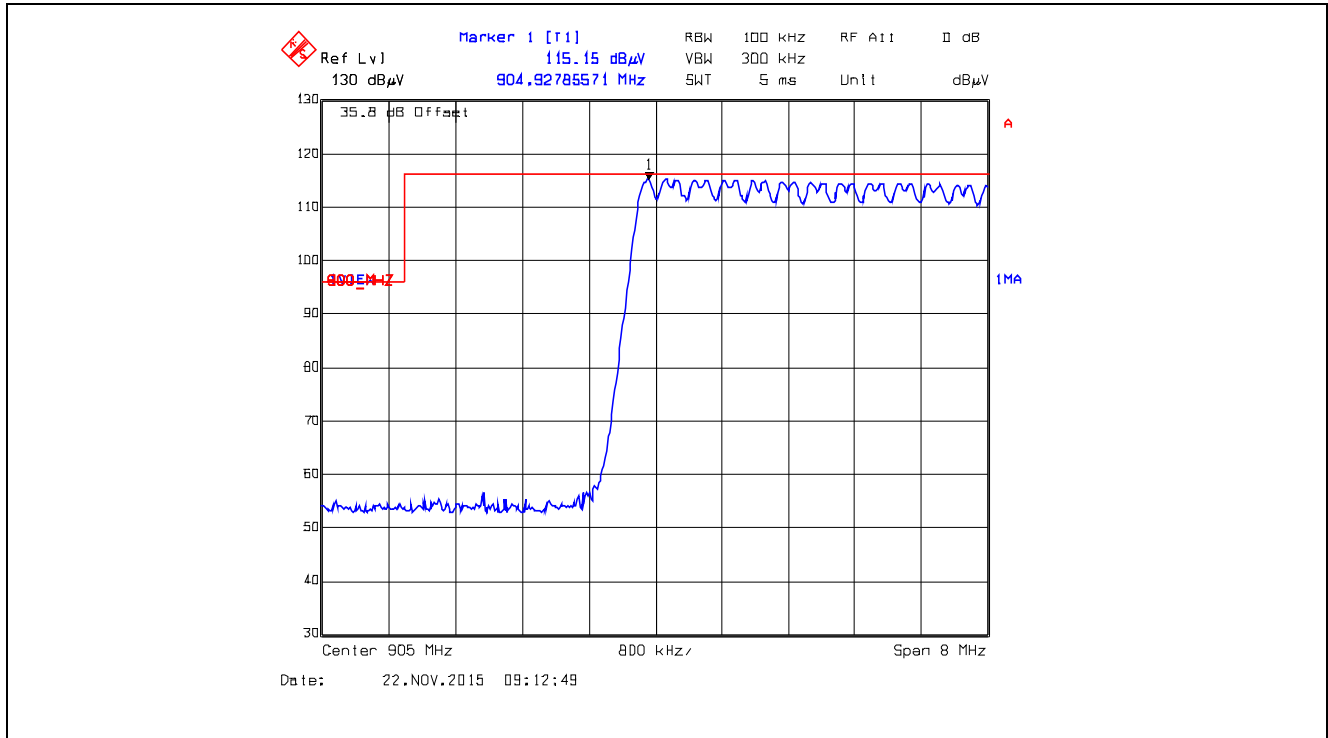

**Plot 5.5.4.4.2.29.** Band-Edge RF Radiated Emissions at 3 m, Horizontal Polarization  
 Single Frequency Mode, High End of Frequency Band, 925.0 MHz, XTC0, Data Rate at 10 kbps

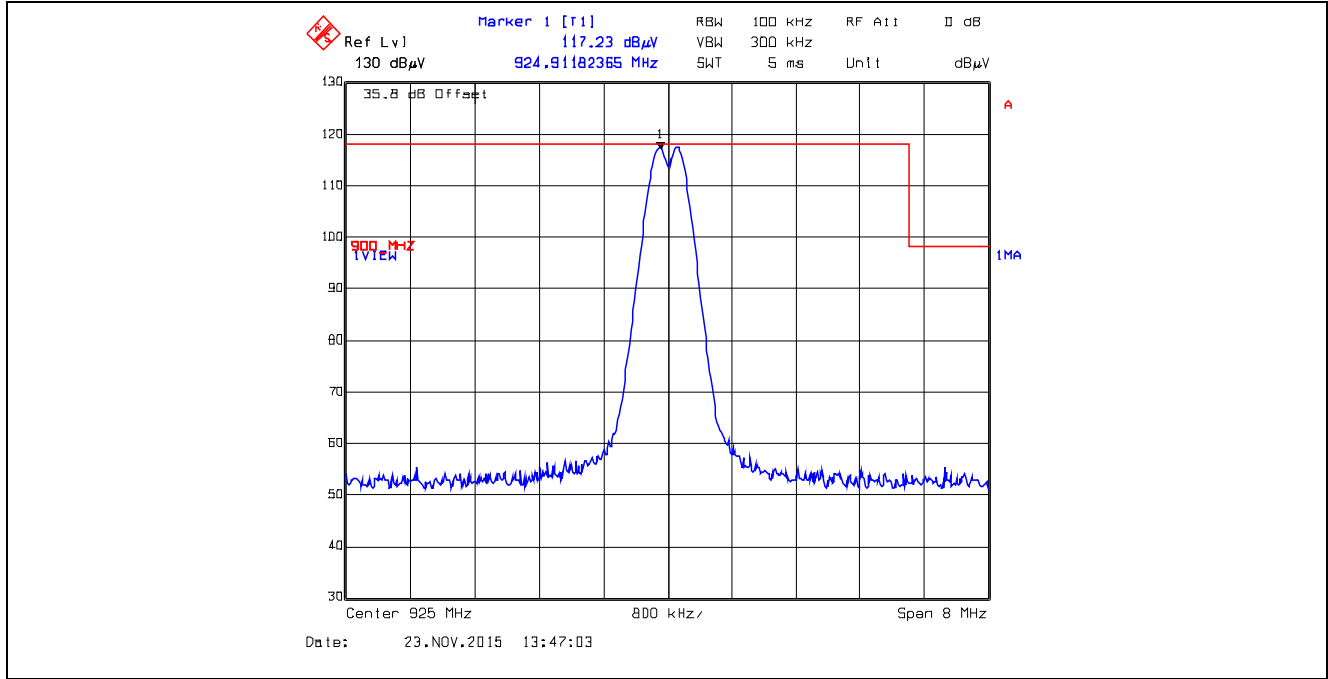

**Plot 5.5.4.4.2.30.** Band-Edge RF Radiated Emissions at 3 m, Horizontal Polarization  
 Pseudorandom Hopping Mode, High End of Frequency Band, 925.0 MHz, XTC0, Data Rate at 10 kbps

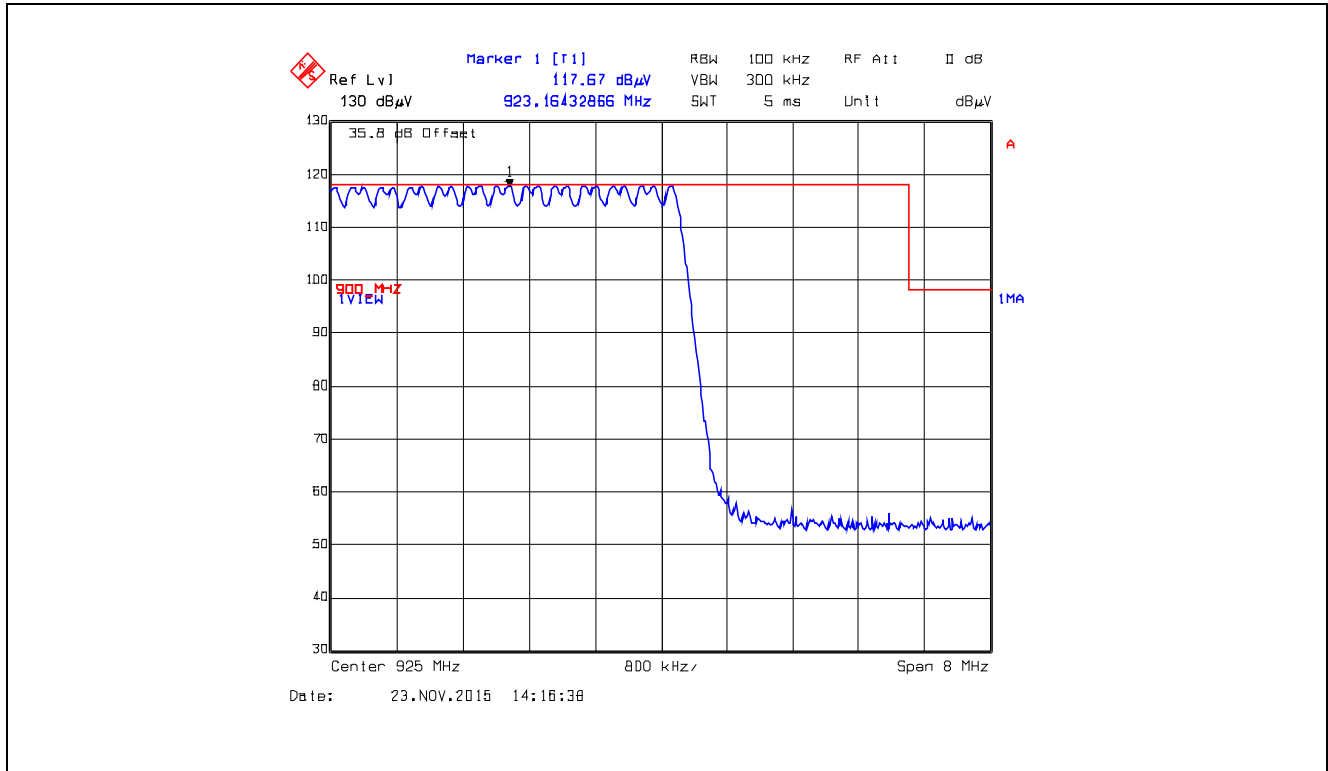

**Plot 5.5.4.4.2.31.** Band-Edge RF Radiated Emissions at 3 m, Vertical Polarization  
 Single Frequency Mode, High End of Frequency Band, 925.0 MHz, XTC0, Data Rate at 10 kbps

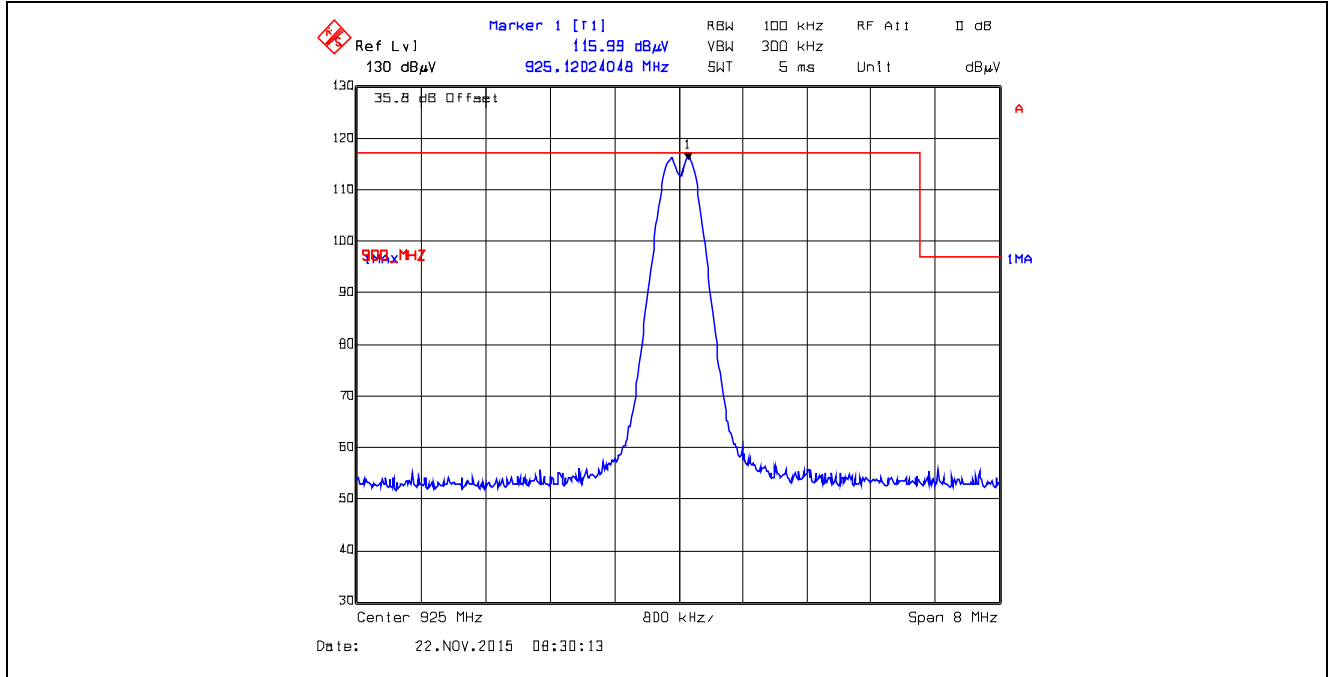

**Plot 5.5.4.4.2.32.** Band-Edge RF Radiated Emissions at 3 m, Vertical Polarization  
 Pseudorandom Hopping Mode, High End of Frequency Band, 925.0 MHz, XTC0, Data Rate at 10 kbps

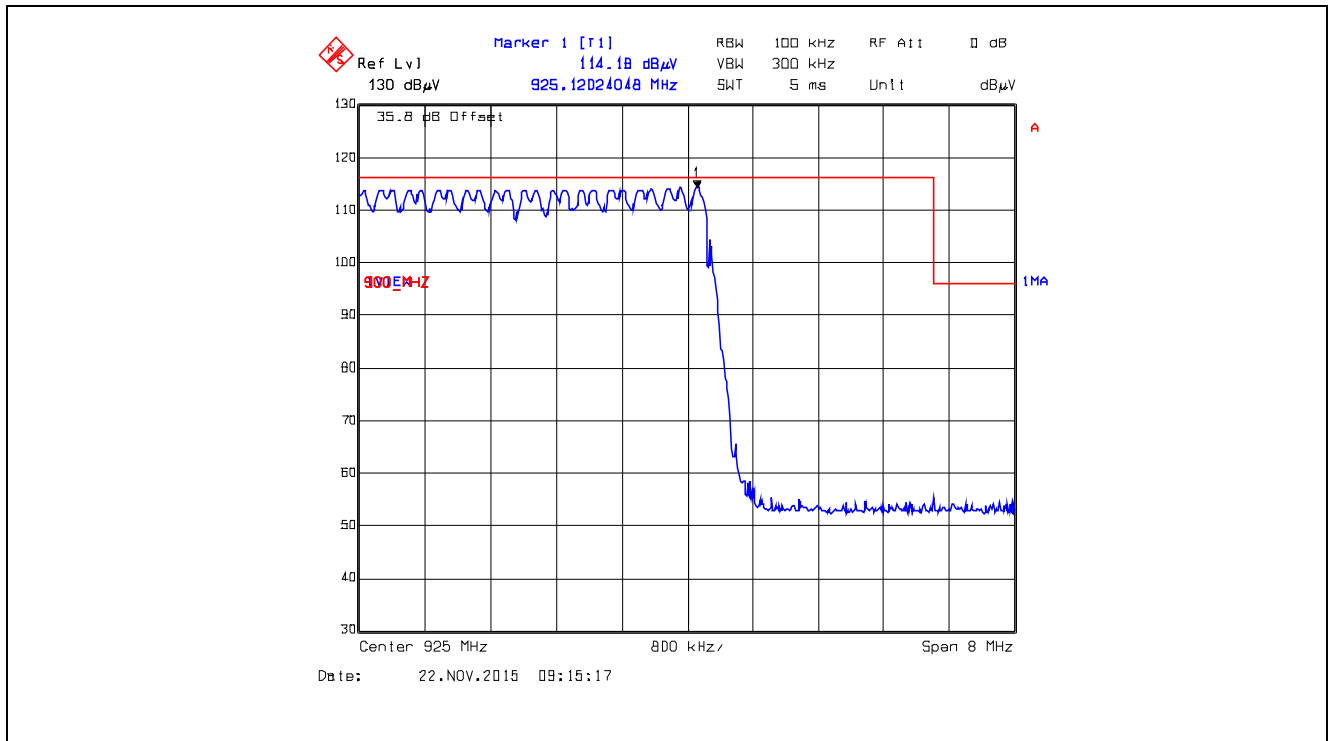

**Plot 5.5.4.4.2.33.** Band-Edge RF Radiated Emissions at 3 m, Horizontal Polarization  
 Single Frequency Mode, Low End of Frequency Band, 905.0 MHz, XTC1, Data Rate at 125 kbps

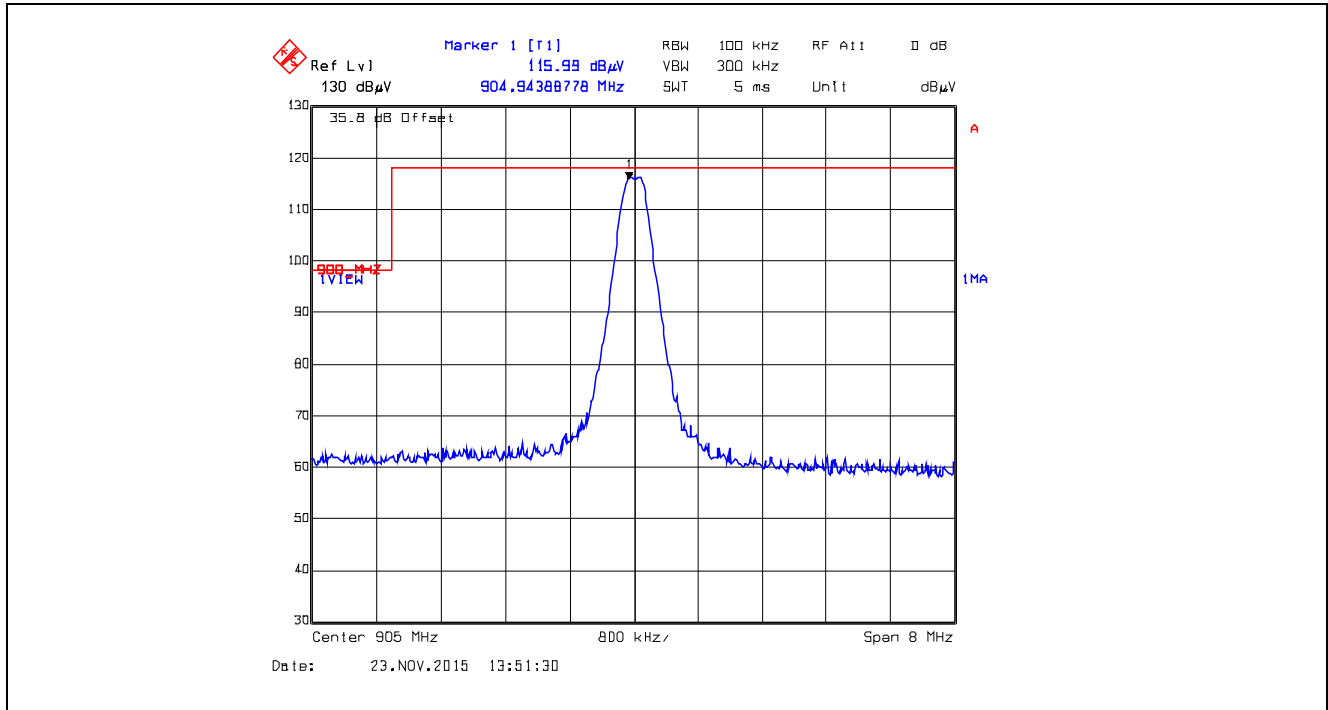

**Plot 5.5.4.4.2.34.** Band-Edge RF Radiated Emissions at 3 m, Horizontal Polarization  
 Pseudorandom Hopping Mode, Low End of Frequency Band, 905.0 MHz, XTC1, Data Rate at 125 kbps

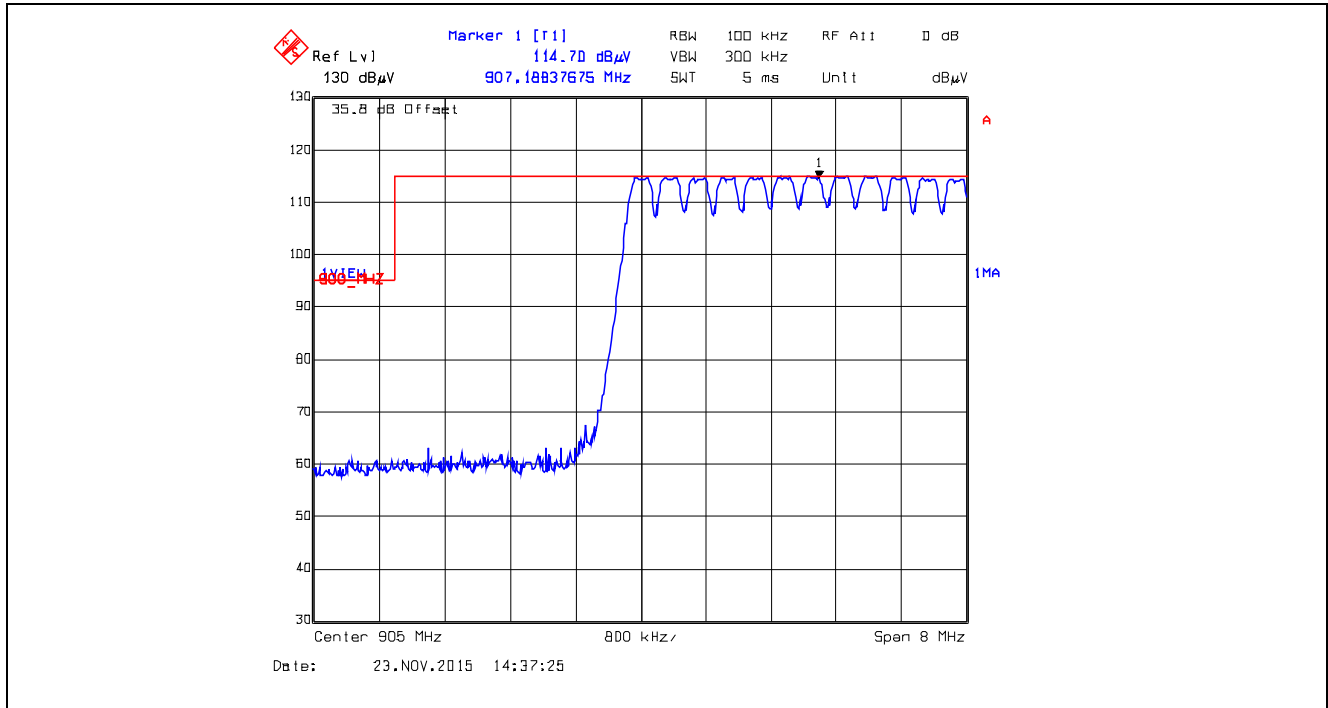

**Plot 5.5.4.4.2.35.** Band-Edge RF Radiated Emissions at 3 m, Vertical Polarization  
 Single Frequency Mode, Low End of Frequency Band, 905.0 MHz, XTC1, Data Rate at 125 kbps

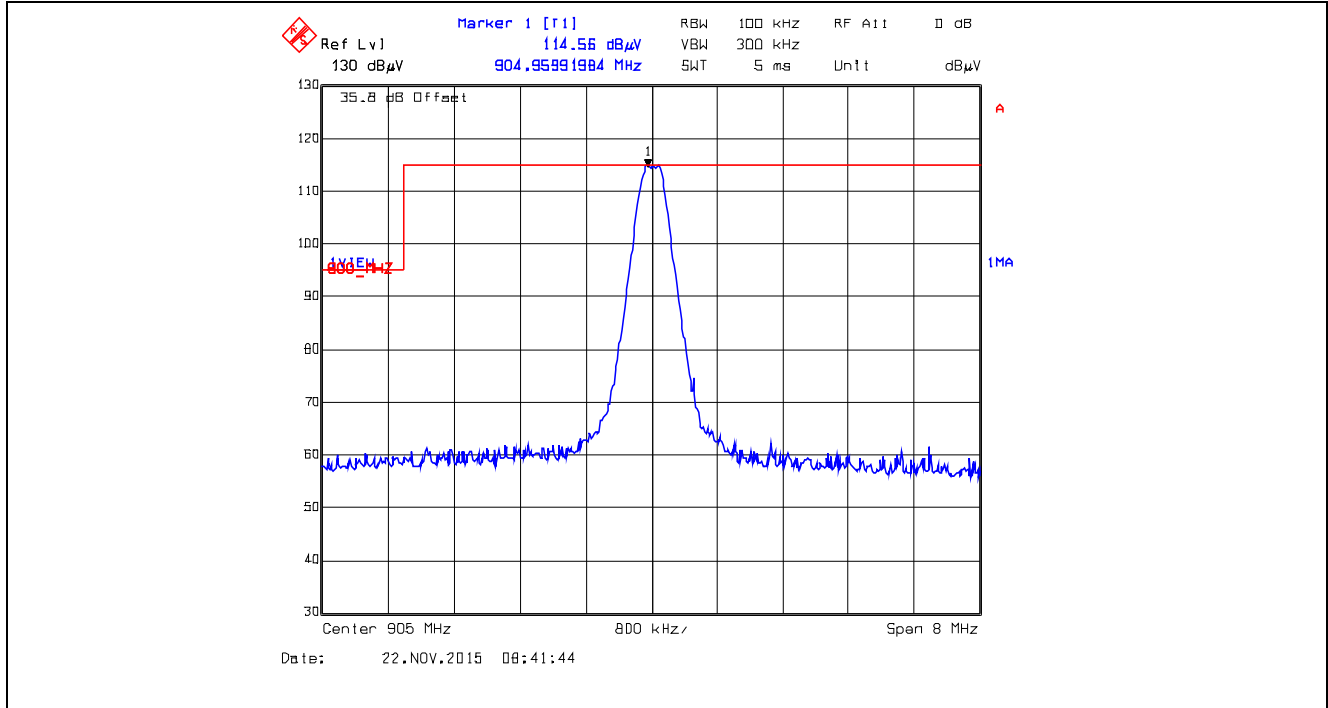

**Plot 5.5.4.4.2.36.** Band-Edge RF Radiated Emissions at 3 m, Vertical Polarization  
 Pseudorandom Hopping Mode, Low End of Frequency Band, 905.0 MHz, XTC1, Data Rate at 125 kbps

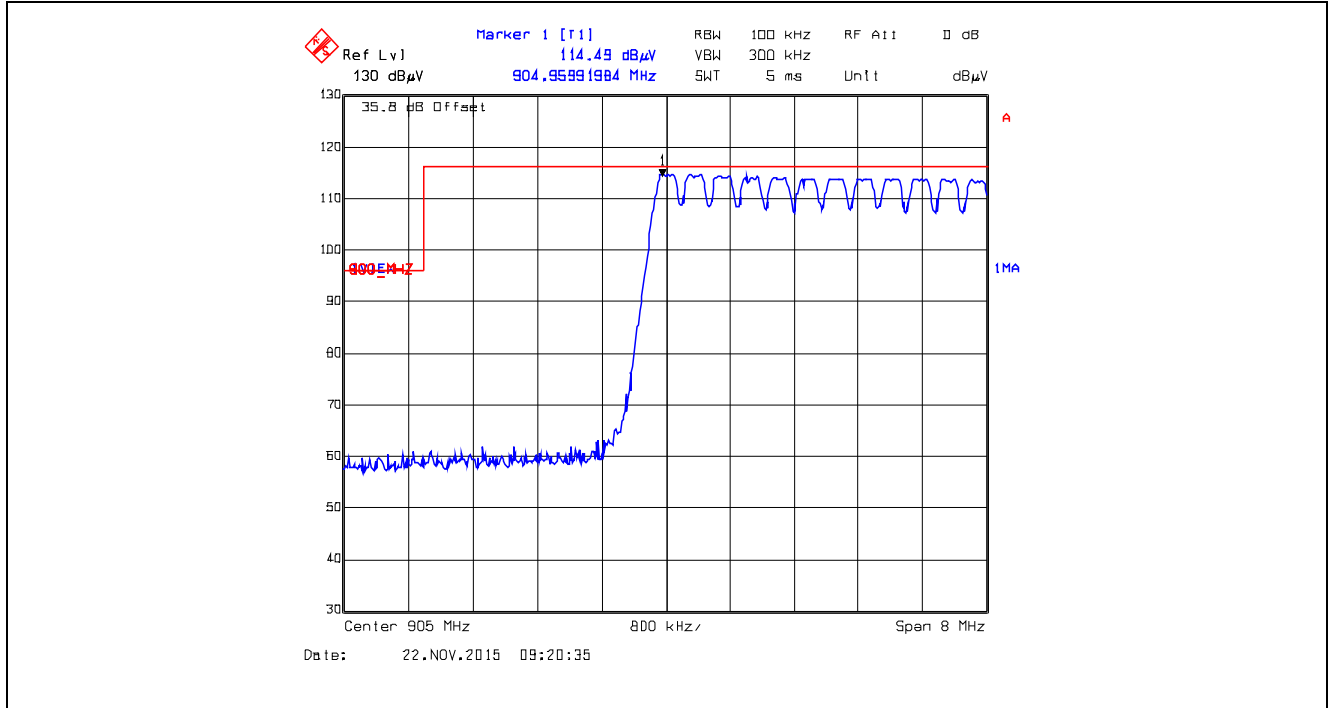

**Plot 5.5.4.4.2.37.** Band-Edge RF Radiated Emissions at 3 m, Horizontal Polarization  
 Single Frequency Mode, High End of Frequency Band, 925.0 MHz, XTC1, Data Rate at 125 kbps

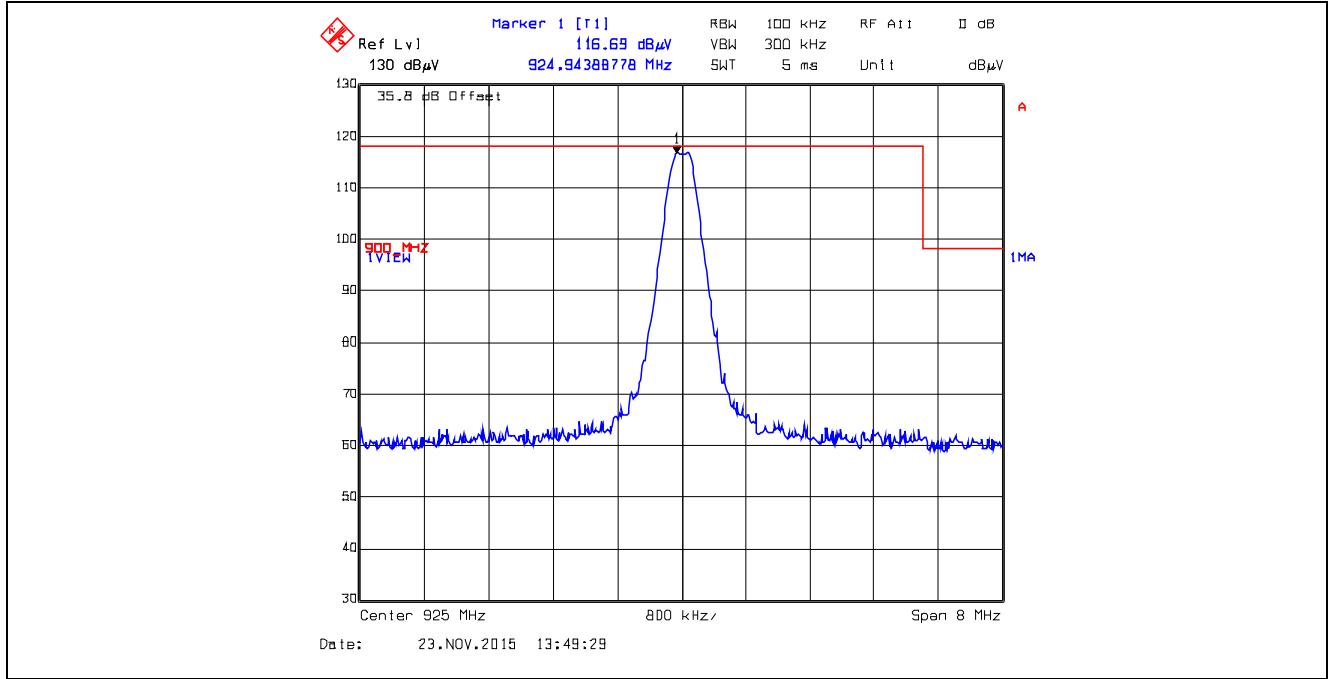

**Plot 5.5.4.4.2.38.** Band-Edge RF Radiated Emissions at 3 m, Horizontal Polarization  
 Pseudorandom Hopping Mode, High End of Frequency Band, 925.0 MHz, XTC1, Data Rate at 125 kbps

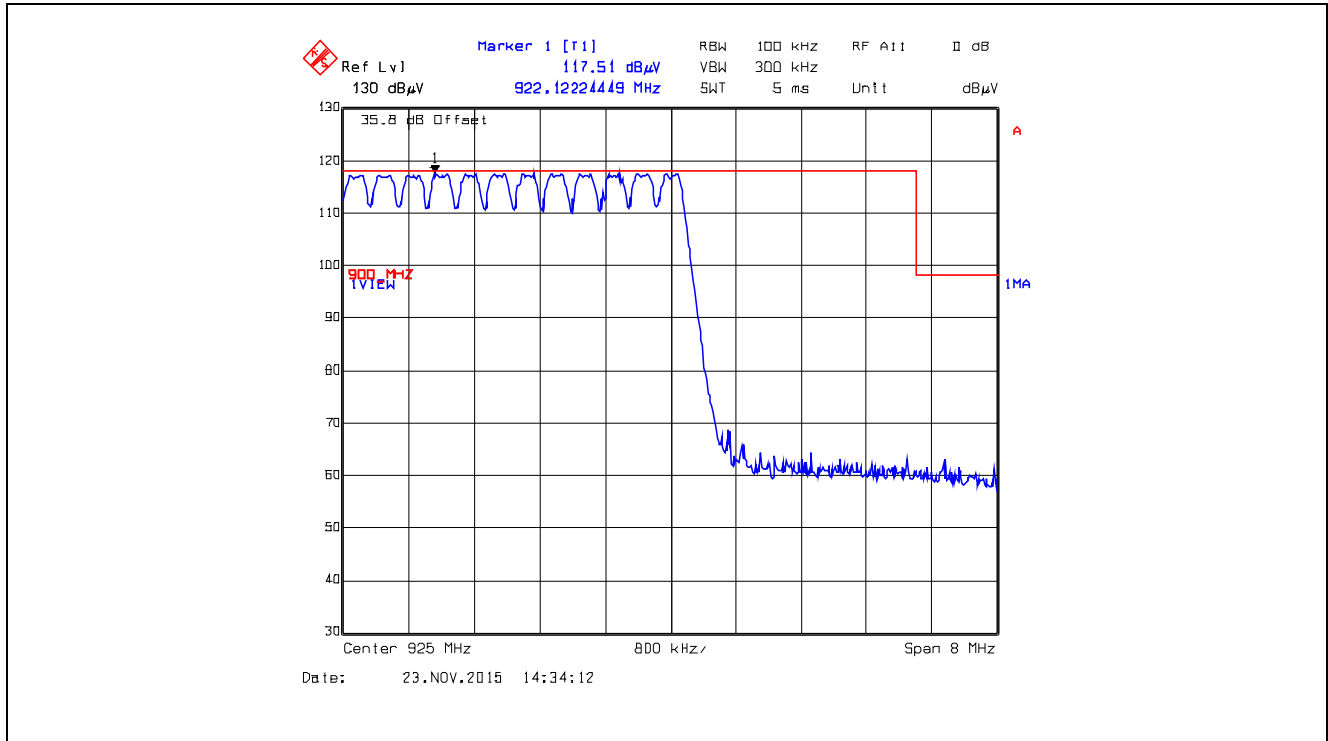

**Plot 5.5.4.4.2.39.** Band-Edge RF Radiated Emissions at 3 m, Vertical Polarization  
Single Frequency Mode, High End of Frequency Band, 925.0 MHz, XTC1, Data Rate at 125 kbps

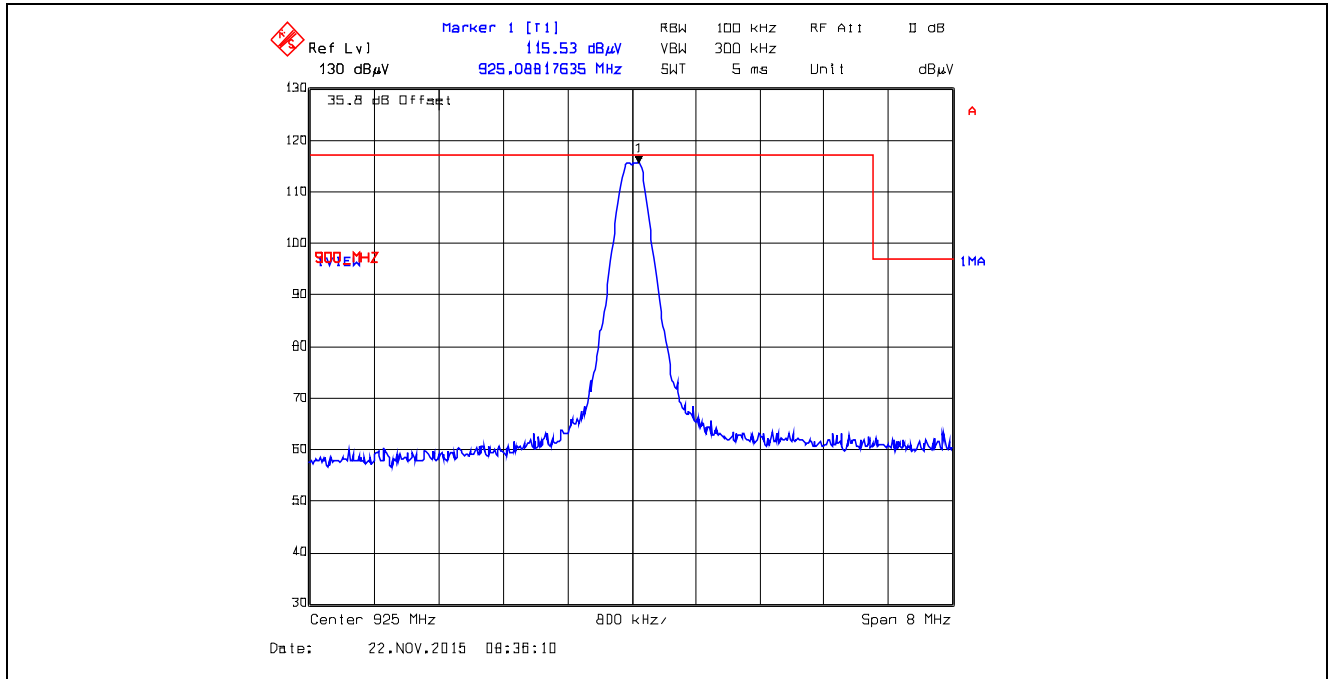

**Plot 5.5.4.4.2.40.** Band-Edge RF Radiated Emissions at 3 m, Vertical Polarization  
Pseudorandom Hopping Mode, High End of Frequency Band, 925.0 MHz, XTC1, Data Rate at 125 kbps

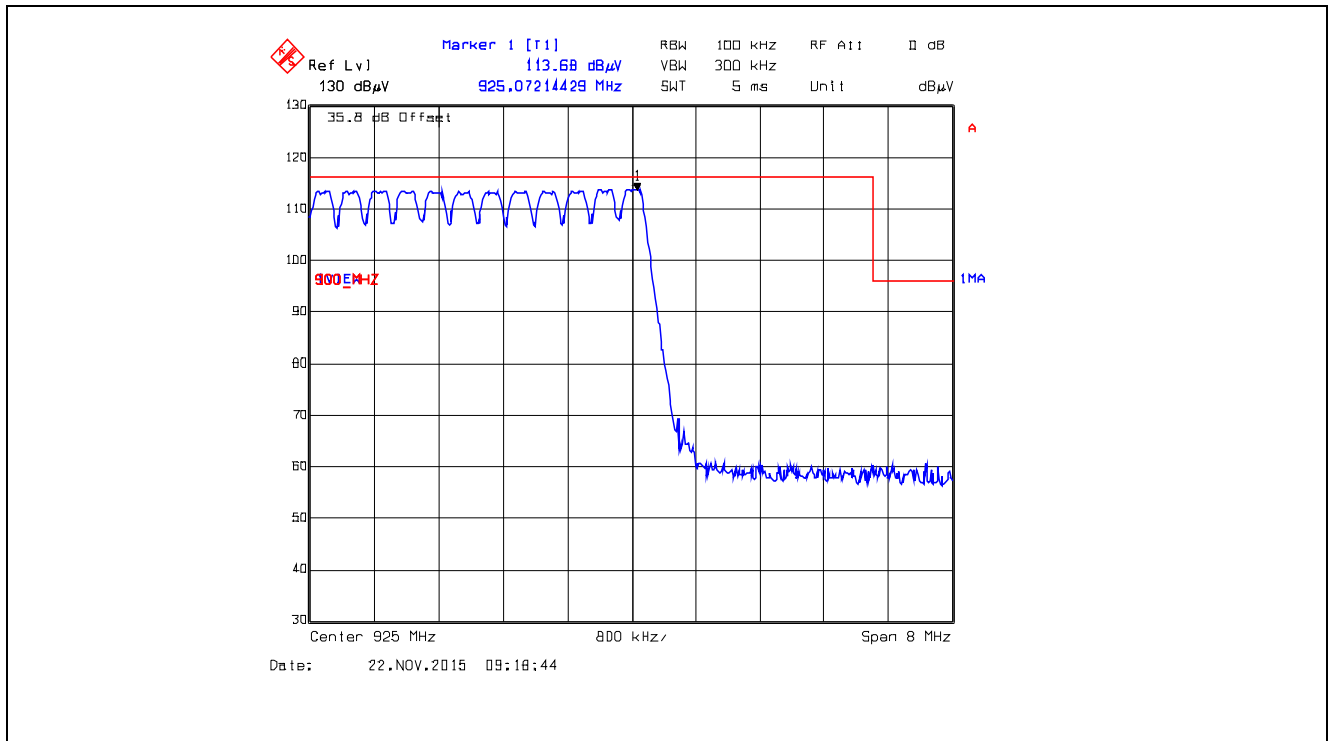



**Plot 5.5.4.4.2.41.** Band-Edge RF Radiated Emissions at 3 m, Horizontal Polarization  
 Single Frequency Mode, Low End of Frequency Band, 915.75 MHz, XTCA0, Data Rate at 10 kbps

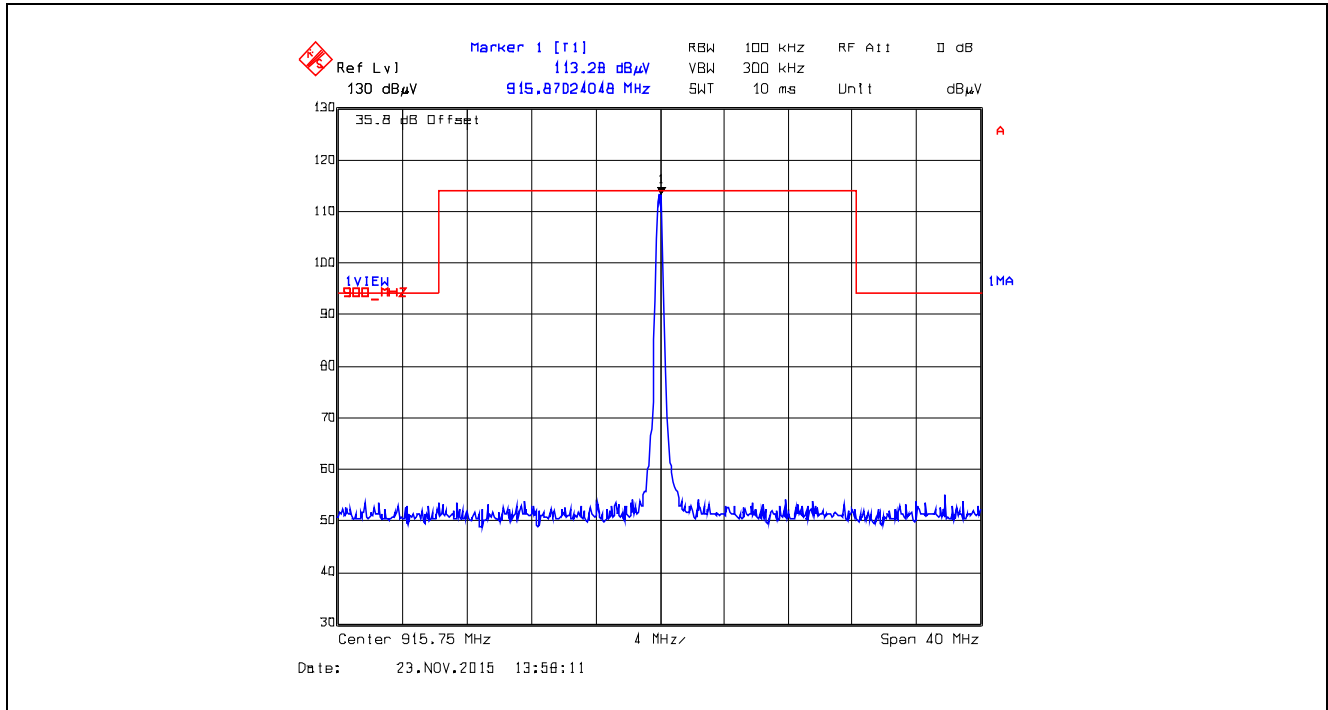

**Plot 5.5.4.4.2.42.** Band-Edge RF Radiated Emissions at 3 m, Horizontal Polarization  
 Pseudorandom Hopping Mode, Low End of Frequency Band, 915.75 MHz, XTCA0, Data Rate at 10 kbps

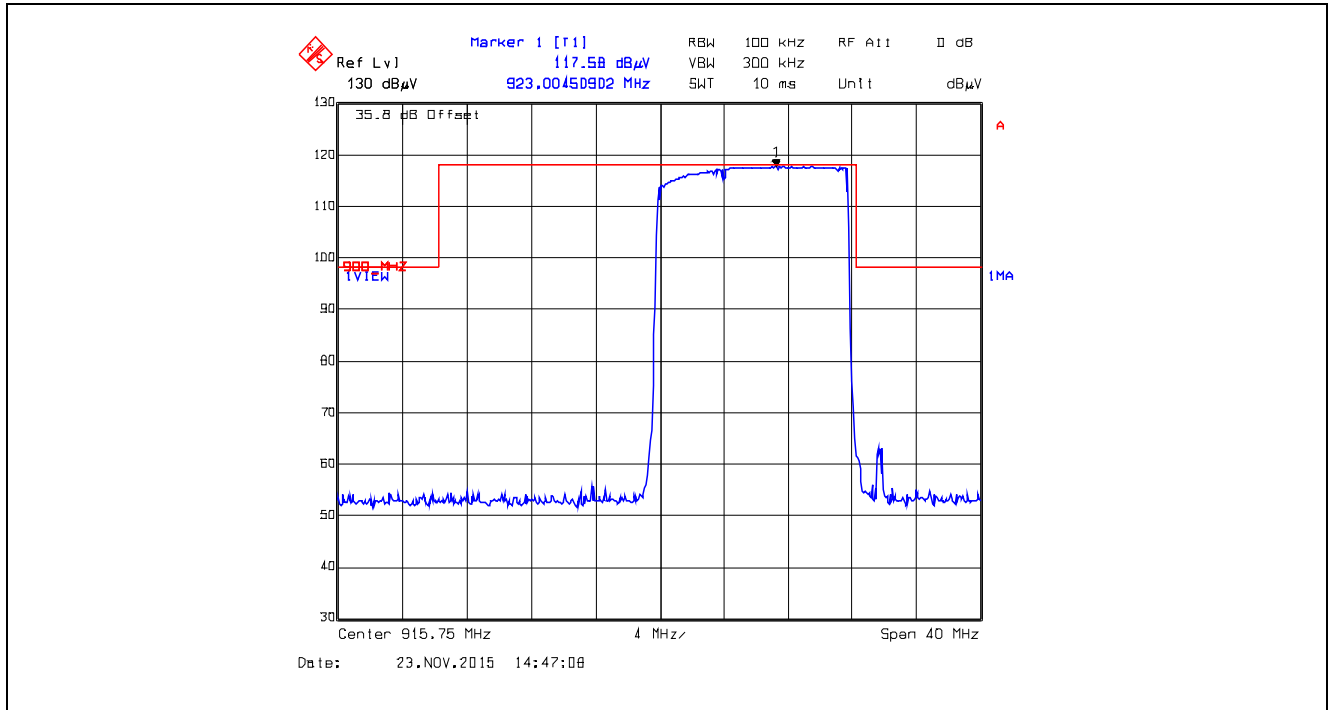

**Plot 5.5.4.4.2.43.** Band-Edge RF Radiated Emissions at 3 m, Vertical Polarization  
Single Frequency Mode, Low End of Frequency Band, 915.75 MHz, XTCA0, Data Rate at 10 kbps

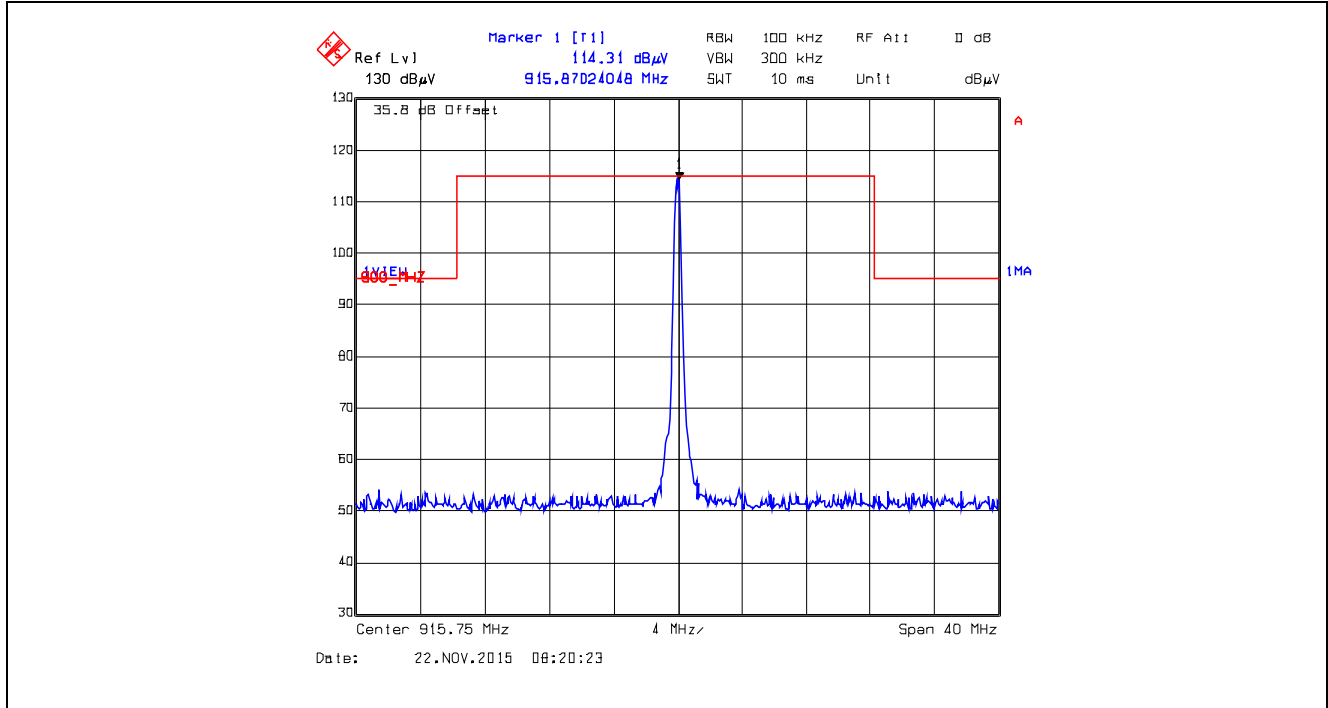

**Plot 5.5.4.4.2.44.** Band-Edge RF Radiated Emissions at 3 m, Vertical Polarization  
Pseudorandom Hopping Mode, Low End of Frequency Band, 915.75 MHz, XTCA0, Data Rate at 10 kbps

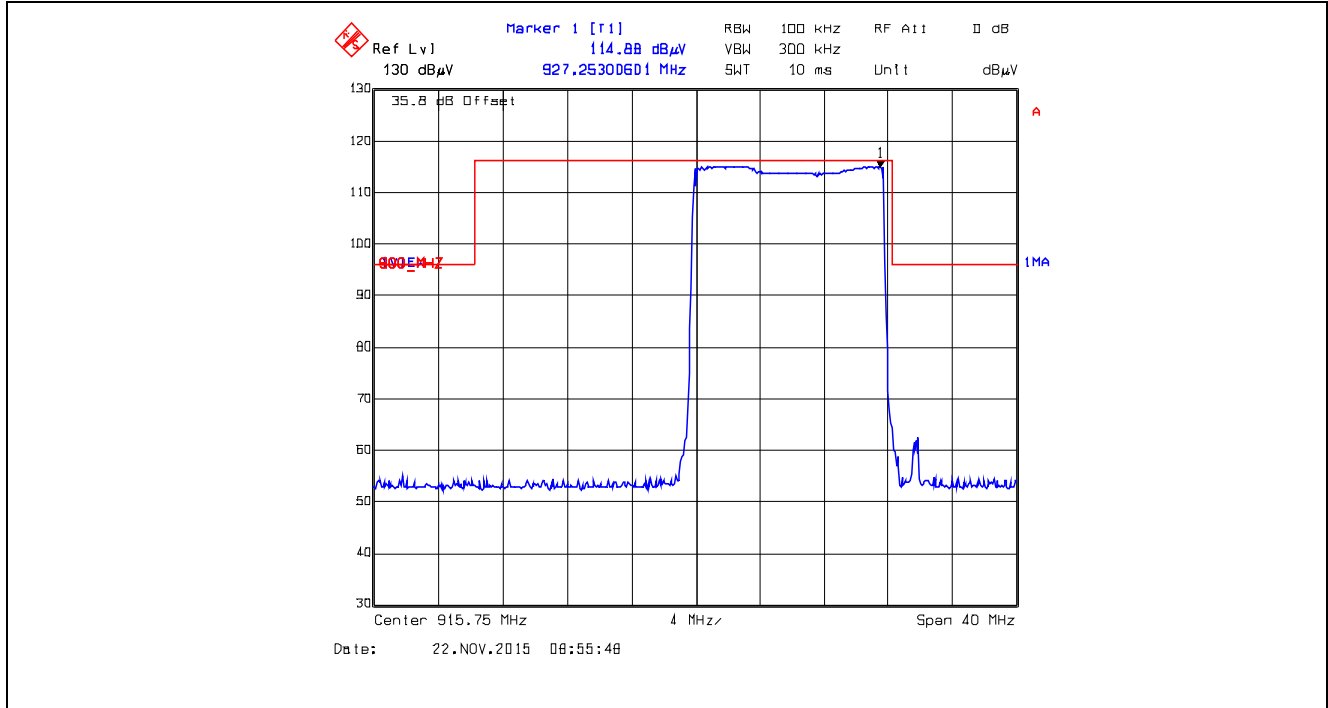

**Plot 5.5.4.4.2.45.** Band-Edge RF Radiated Emissions at 3 m, Horizontal Polarization  
 Single Frequency Mode, High End of Frequency Band, 927.265 MHz, XTCA0, Data Rate at 10 kbps

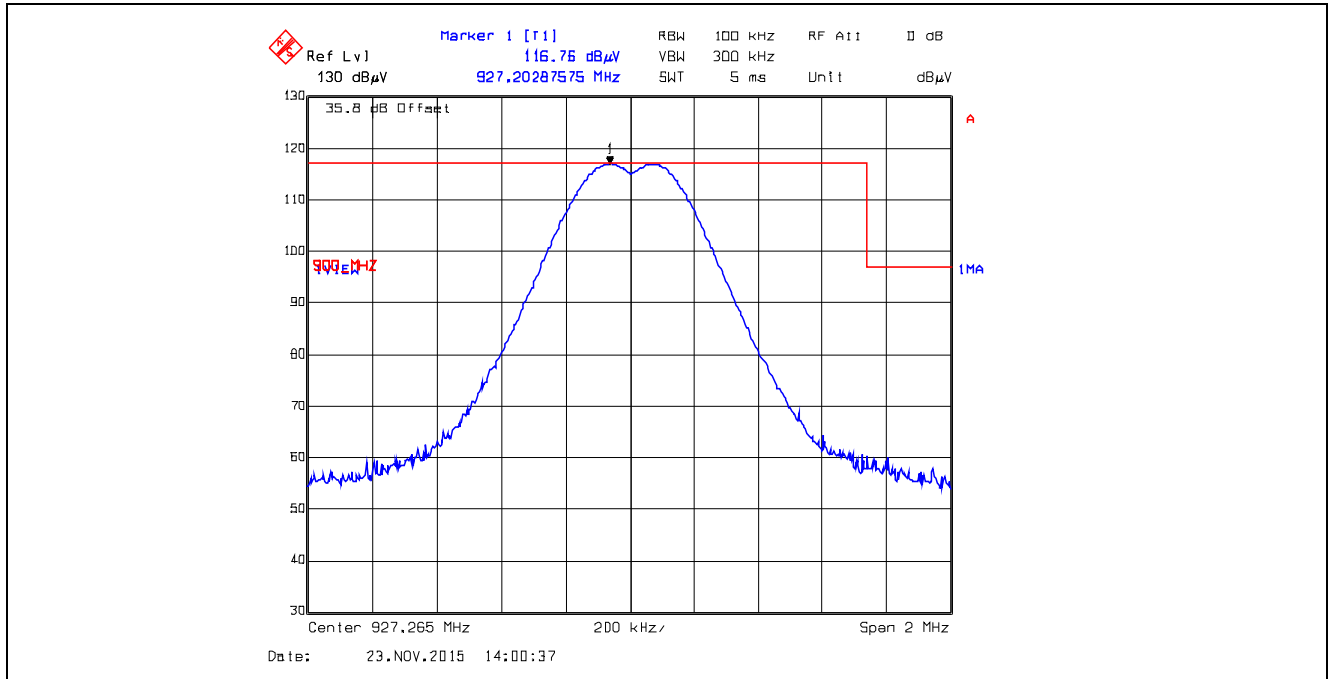

**Plot 5.5.4.4.2.46.** Band-Edge RF Radiated Emissions at 3 m, Horizontal Polarization  
 Pseudorandom Hopping Mode, High End of Frequency Band, 927.265 MHz, XTCA0, Data Rate at 10 kbps

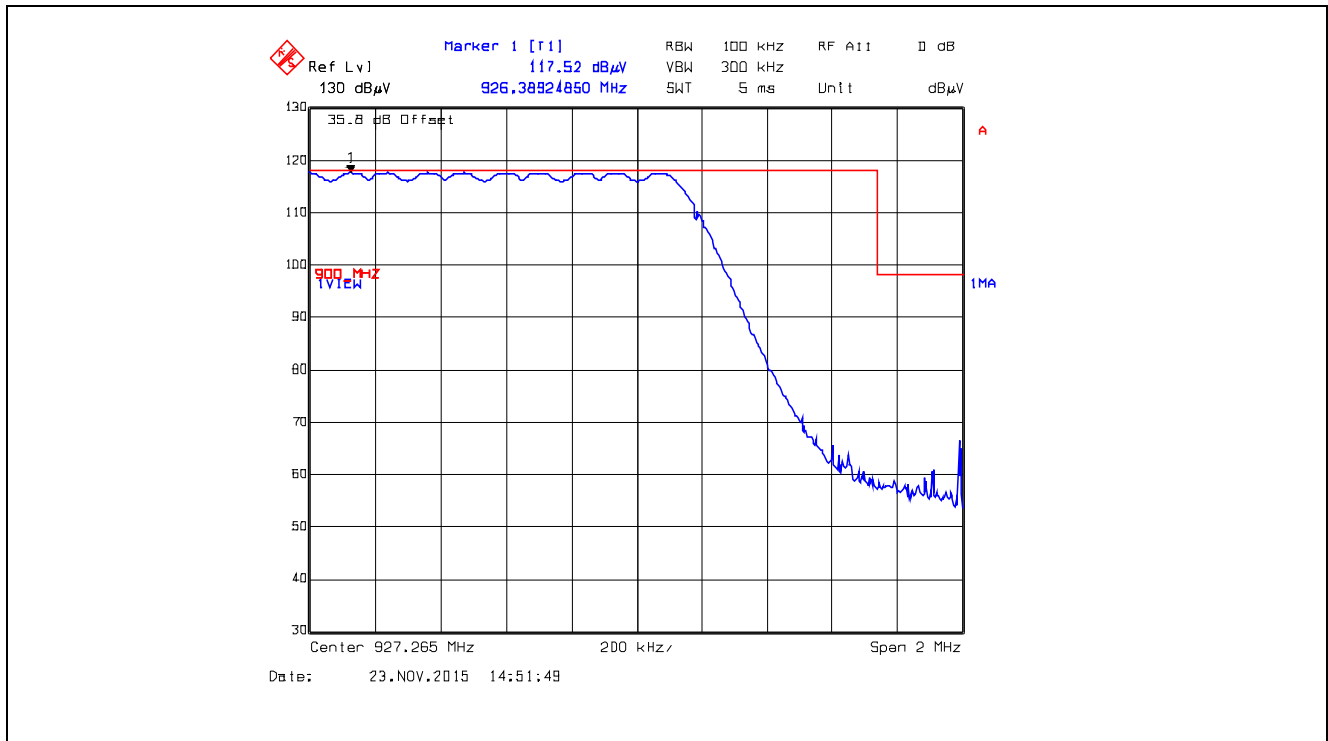

**Plot 5.5.4.4.27. Band-Edge RF Radiated Emissions at 3 m, Vertical Polarization**  
 Single Frequency Mode, High End of Frequency Band, 927.265 MHz, XTCA0, Data Rate at 10 kbps

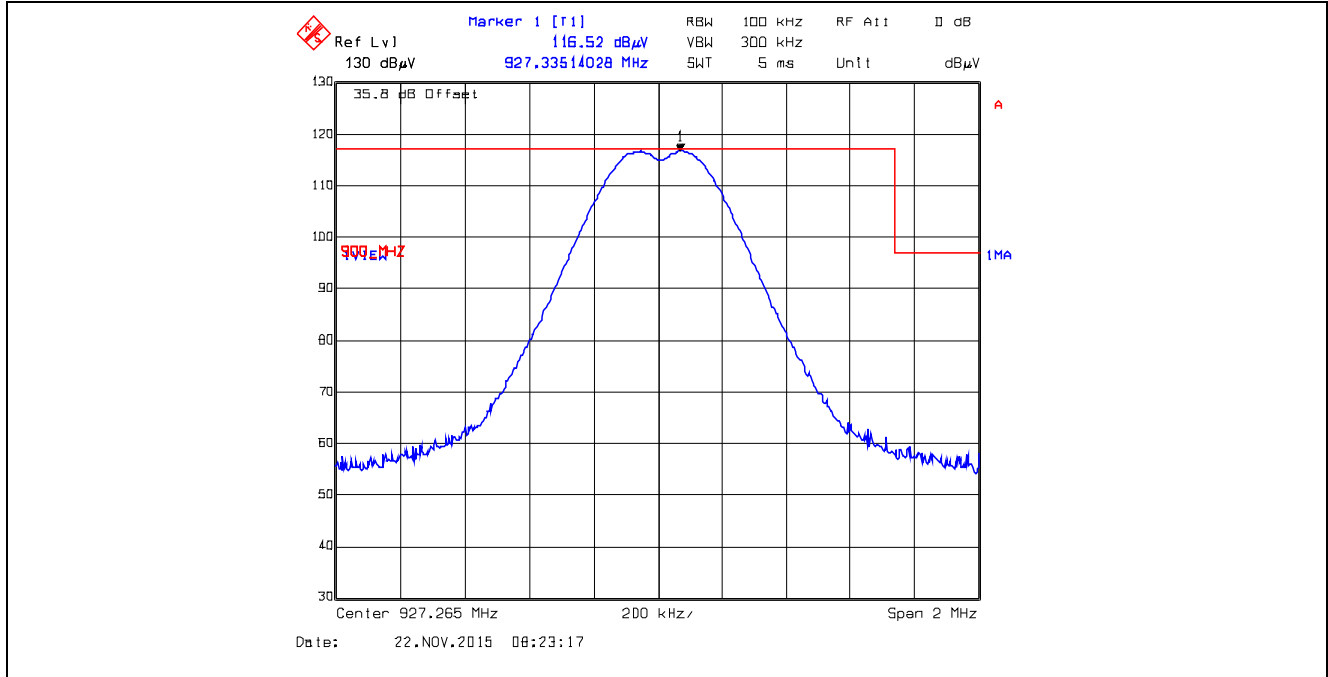

**Plot 5.5.4.4.28. Band-Edge RF Radiated Emissions at 3 m, Vertical Polarization**  
 Pseudorandom Hopping Mode, High End of Frequency Band, 927.265 MHz, XTCA0, Data Rate at 10 kbps

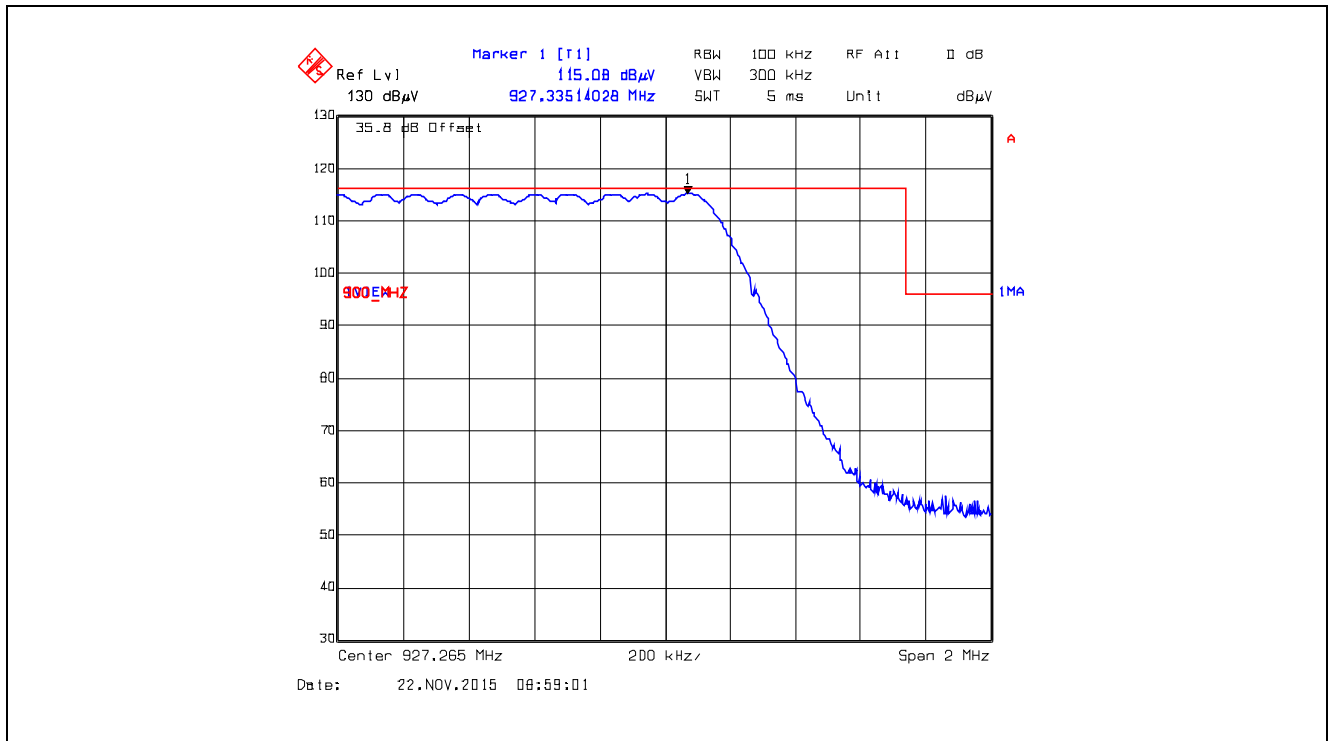

**Plot 5.5.4.4.2.49.** Band-Edge RF Radiated Emissions at 3 m, Horizontal Polarization  
 Single Frequency Mode, Low End of Frequency Band, 915.75 MHz, XTCA1, Data Rate at 105kbps

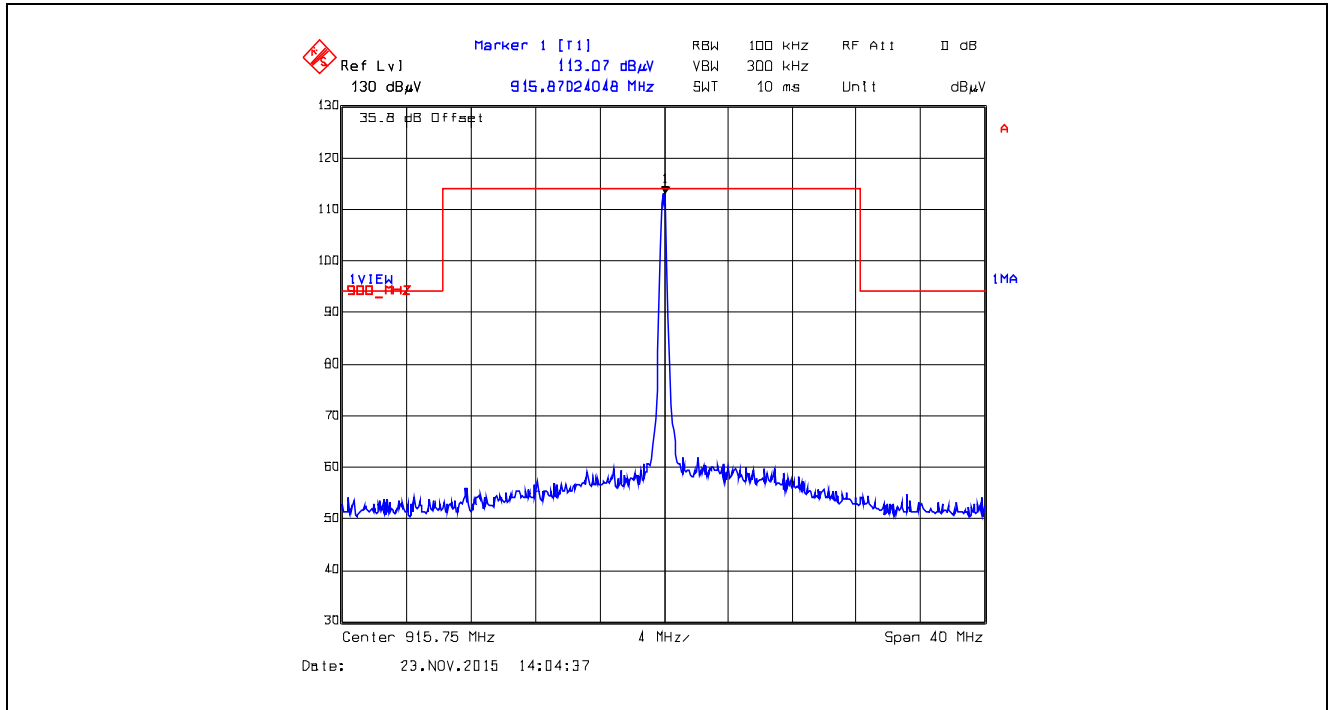

**Plot 5.5.4.4.2.50.** Band-Edge RF Radiated Emissions at 3 m, Horizontal Polarization  
 Pseudorandom Hopping Mode, Low End of Frequency Band, 915.75 MHz, XTCA1, Data Rate at 105kbps

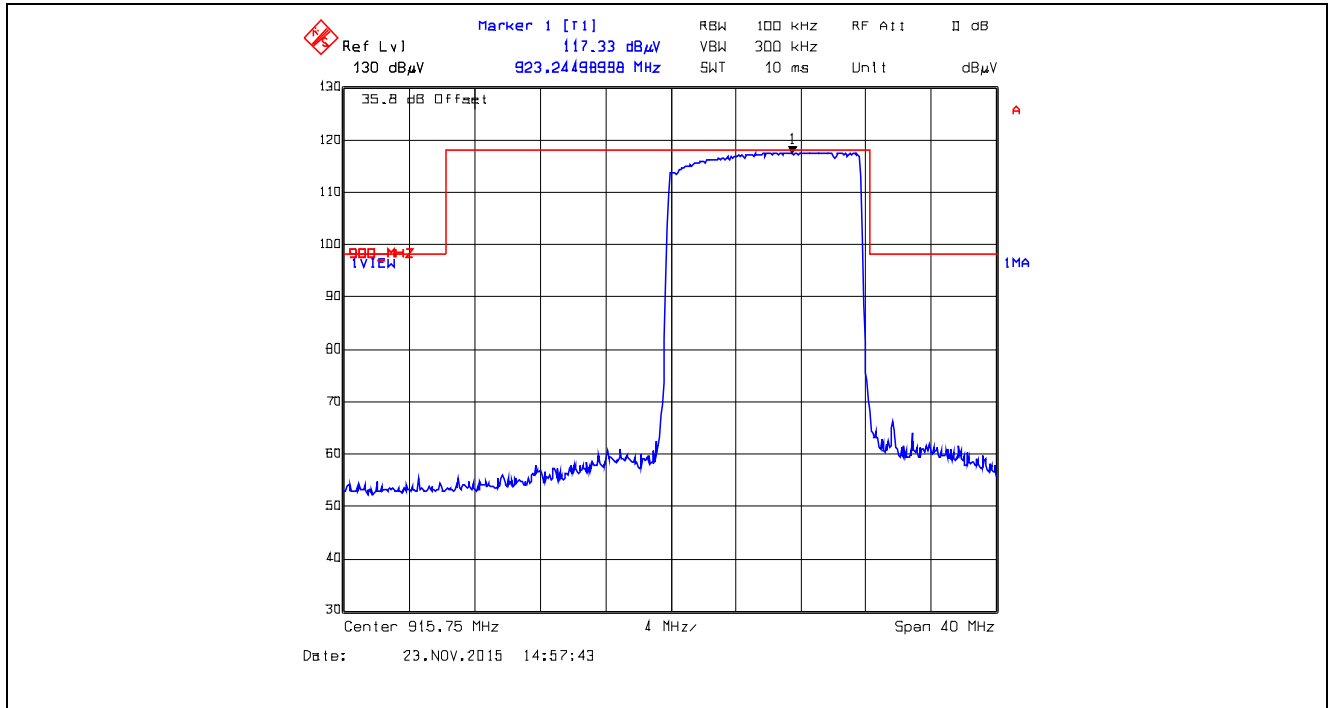

**Plot 5.5.4.4.251.** Band-Edge RF Radiated Emissions at 3 m, Vertical Polarization  
 Single Frequency Mode, Low End of Frequency Band, 915.75 MHz, XTCA1, Data Rate at 105kbps

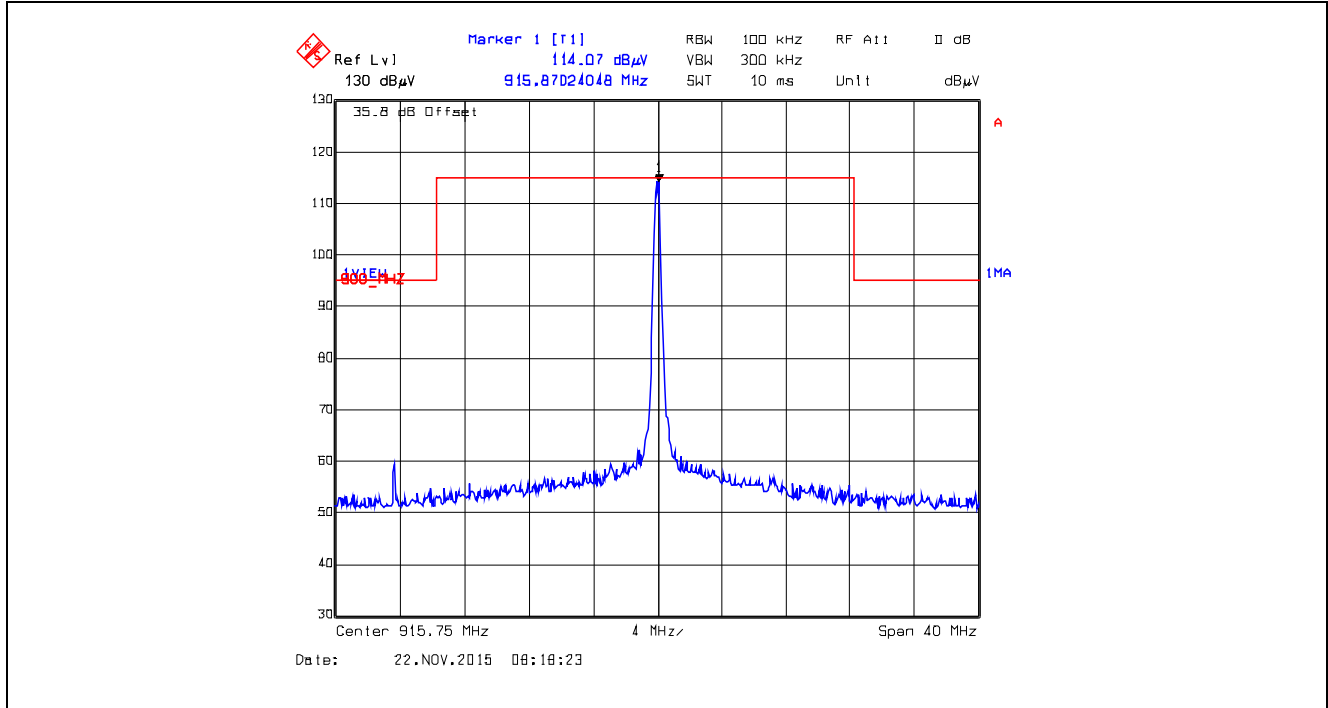

**Plot 5.5.4.4.252.** Band-Edge RF Radiated Emissions at 3 m, Vertical Polarization  
 Pseudorandom Hopping Mode, Low End of Frequency Band, 915.75 MHz, XTCA1, Data Rate at 105kbps

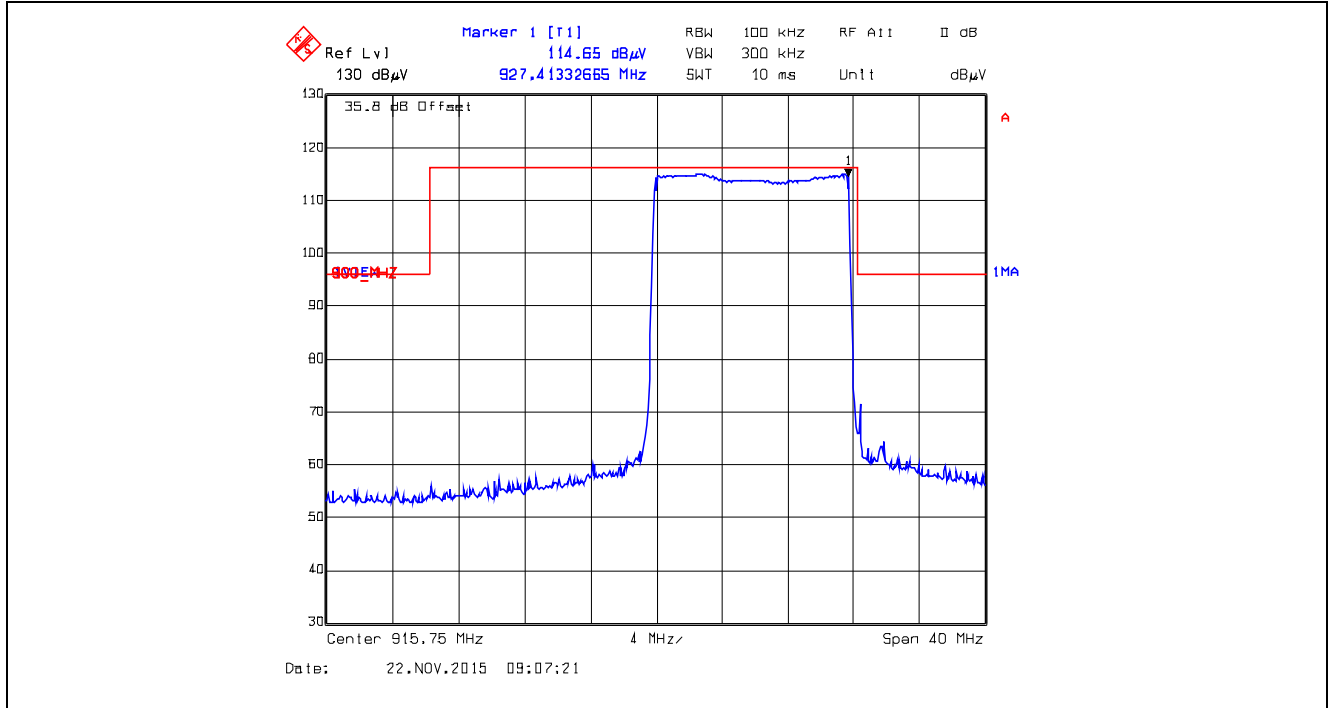

**Plot 5.5.4.4.2.53.** Band-Edge RF Radiated Emissions at 3 m, Horizontal Polarization  
 Single Frequency Mode, High End of Frequency Band, 927.265 MHz, XTCA1, Data Rate at 105kbps

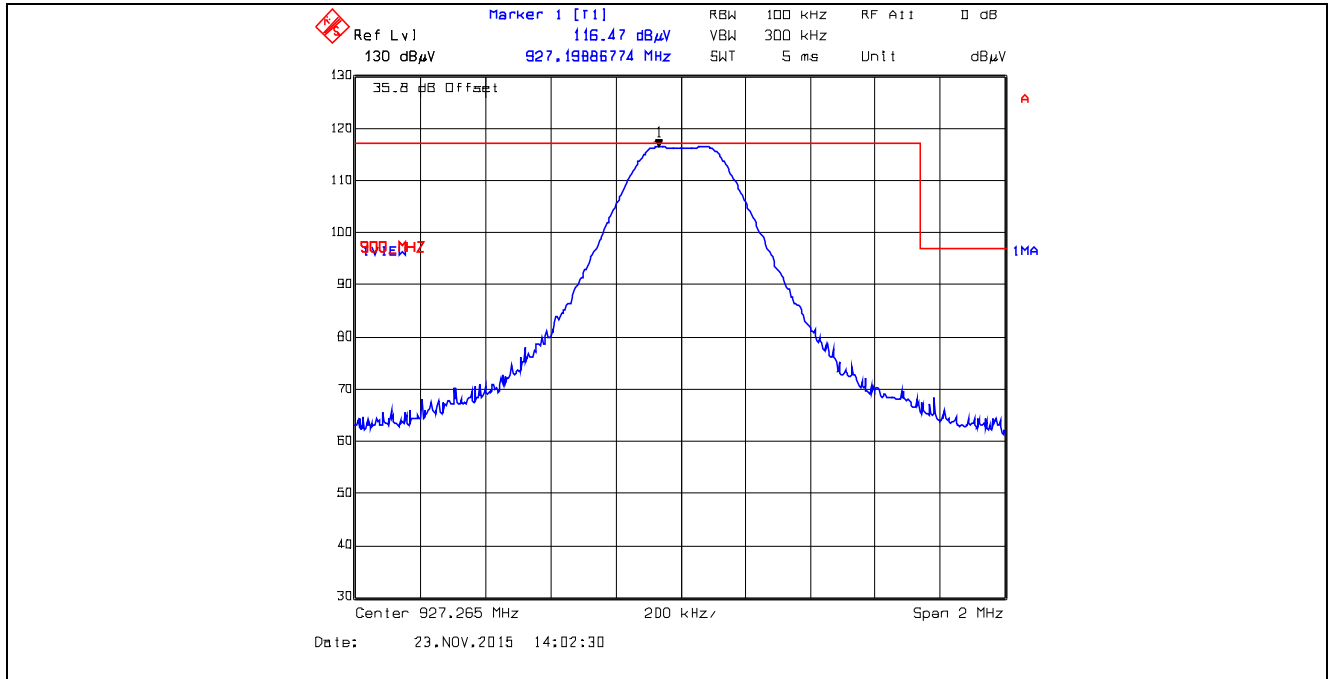

**Plot 5.5.4.4.2.54.** Band-Edge RF Radiated Emissions at 3 m, Horizontal Polarization  
 Pseudorandom Hopping Mode, High End of Frequency Band, 927.265 MHz, XTCA1, Data Rate at 105kbps

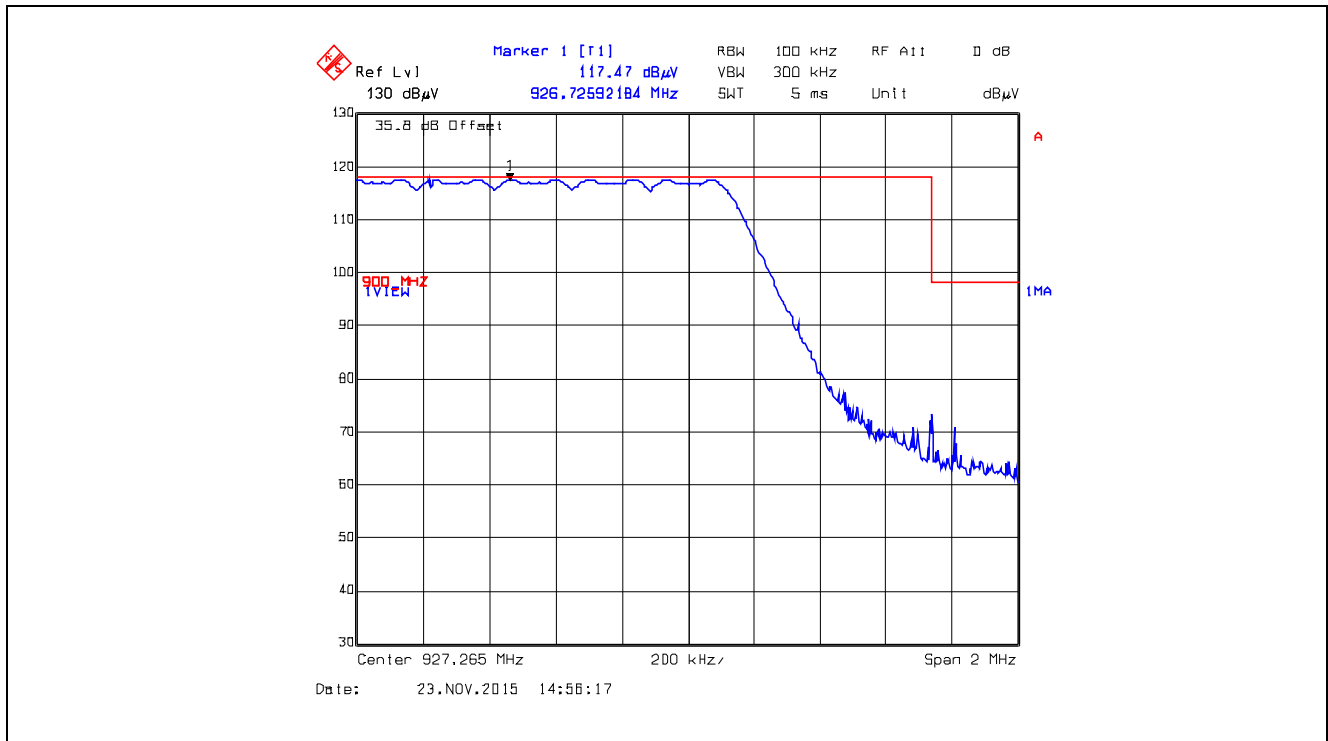

**Plot 5.5.4.4.2.55.** Band-Edge RF Radiated Emissions at 3 m, Vertical Polarization  
 Single Frequency Mode, High End of Frequency Band, 927.265 MHz, XTCA1, Data Rate at 105kbps

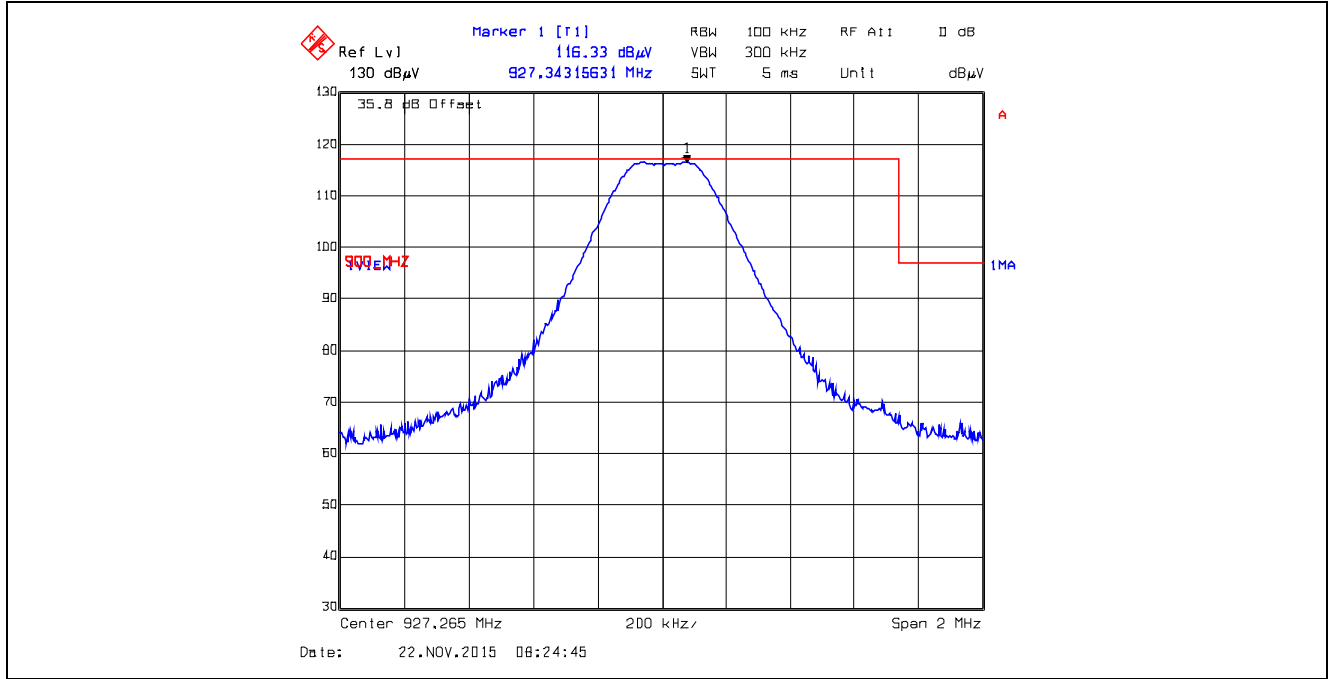

**Plot 5.5.4.4.2.56.** Band-Edge RF Radiated Emissions at 3 m, Vertical Polarization  
 Pseudorandom Hopping Mode, High End of Frequency Band, 927.265 MHz, XTCA1, Data Rate at 105kbps

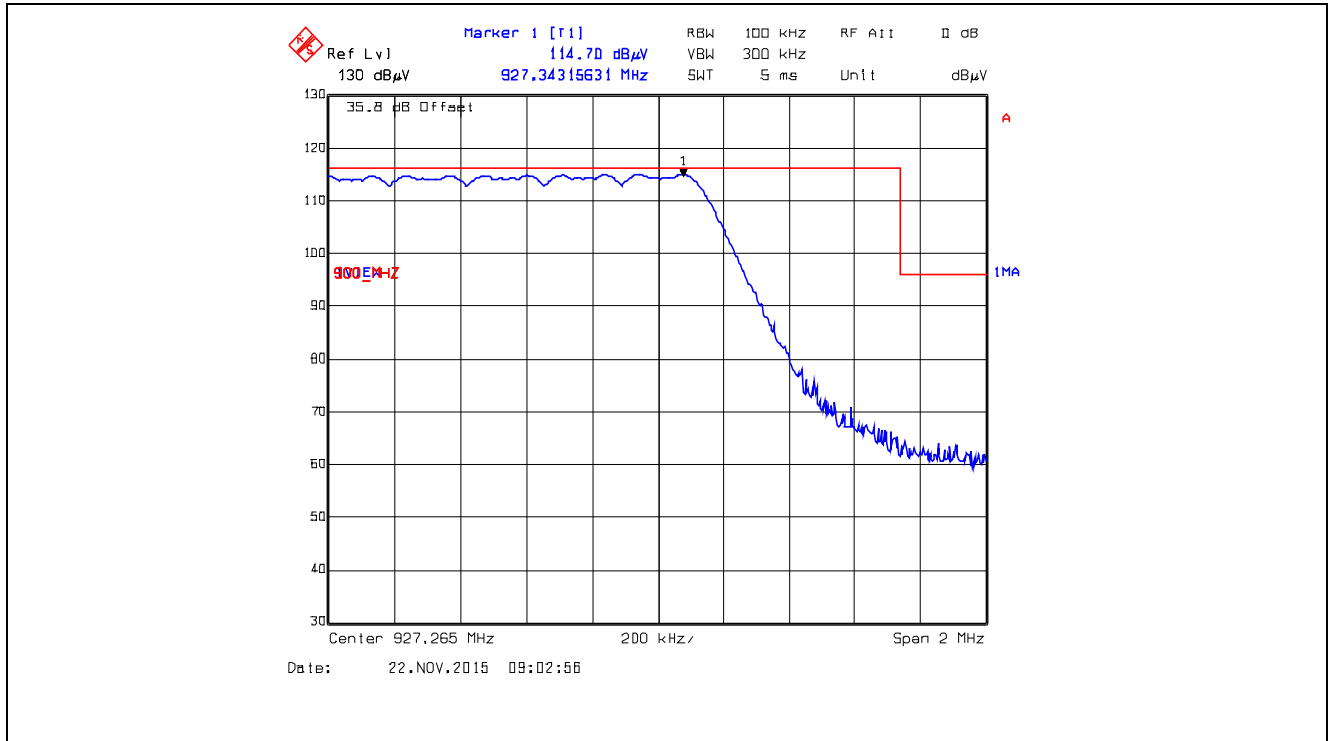



**5.5.4.5. EUT with 15.1 dBi Yagi Antenna and 0.65 dB Assembly Cable Loss**

**5.5.4.5.1. Spurious Radiated Emissions**

Fundamental Frequency:		902.5 MHz					
Configuration:		XBX0					
Measured Conducted Power:		13.36 dBm					
Frequency Test Range:		30 MHz – 10 GHz					
Frequency (MHz)	RF Peak Level (dBµV/m)	RF Avg Level (dBµV/m)	Antenna Plane (H/V)	Limit 15.209 (dBµV/m)	Limit 15.247 (dBµV/m)	Margin (dB)	Pass/Fail
902.50	125.09	--	V	--	--	--	--
902.50	125.47	--	H	--	--	--	--
2707.50	44.80	33.00	V	54.0	105.5	-21.0	Pass*
2707.50	45.90	37.80	H	54.0	105.5	-16.2	Pass*
3610.00	47.50	33.70	V	54.0	105.5	-20.3	Pass*
3610.00	48.30	36.00	H	54.0	105.5	-18.0	Pass*
4512.50	50.20	41.50	V	54.0	105.5	-12.5	Pass*
4512.50	50.40	42.70	H	54.0	105.5	-11.3	Pass*
5415.00	51.70	40.70	V	54.0	105.5	-13.3	Pass*
5415.00	52.20	41.60	H	54.0	105.5	-12.4	Pass*
All other spurious emissions and harmonics are more than 20 dB below the applicable limit.							

\*Field strength of emissions appearing within restricted frequency bands shall not exceed the limits in § 15.209.

Fundamental Frequency:		915.0 MHz					
Configuration:		XBX0					
Measured Conducted Power:		13.49 dBm					
Frequency Test Range:		30 MHz – 10 GHz					
Frequency (MHz)	RF Peak Level (dBµV/m)	RF Avg Level (dBµV/m)	Antenna Plane (H/V)	Limit 15.209 (dBµV/m)	Limit 15.247 (dBµV/m)	Margin (dB)	Pass/Fail
915.0	125.47	--	V	--	--	--	--
915.0	125.26	--	H	--	--	--	--
2745.0	44.60	33.20	V	54.0	105.5	-20.8	Pass*
2745.0	45.70	36.90	H	54.0	105.5	-17.1	Pass*
3660.0	47.80	34.40	V	54.0	105.5	-19.6	Pass*
3660.0	48.10	35.60	H	54.0	105.5	-18.4	Pass*
4575.0	50.60	42.40	V	54.0	105.5	-11.6	Pass*
4575.0	51.60	43.50	H	54.0	105.5	-10.5	Pass*
All other spurious emissions and harmonics are more than 20 dB below the applicable limit.							

\*Field strength of emissions appearing within restricted frequency bands shall not exceed the limits in § 15.209.

**ULTRATECH GROUP OF LABS**

3000 Bristol Circle, Oakville, Ontario, Canada L6H 6G4  
 Tel. #: 905-829-1570, Fax. #: 905-829-8050, Email: [vic@ultratech-labs.com](mailto:vic@ultratech-labs.com), Website: <http://www.ultratech-labs.com>

File #: 15DIG102\_FCC15C247  
 December 24, 2015

*All test results contained in this engineering test report are traceable to National Institute of Standards and Technology (NIST)*

Fundamental Frequency:		927.5 MHz					
Configuration:		XBX0					
Measured Conducted Power:		13.49 dBm					
Frequency Test Range:		30 MHz – 10 GHz					
Frequency (MHz)	RF Peak Level (dBµV/m)	RF Avg Level (dBµV/m)	Antenna Plane (H/V)	Limit 15.209 (dBµV/m)	Limit 15.247 (dBµV/m)	Margin (dB)	Pass/Fail
927.5	125.57	--	V	--	--	--	--
927.5	124.86	--	H	--	--	--	--
2782.5	43.80	31.30	V	54.0	105.6	-22.7	Pass*
2782.5	44.00	33.70	H	54.0	105.6	-20.3	Pass*
3710.0	48.40	34.80	V	54.0	105.6	-19.2	Pass*
3710.0	47.50	34.50	H	54.0	105.6	-19.5	Pass*
4637.5	53.20	46.90	V	54.0	105.6	-7.1	Pass*
4637.5	54.30	49.30	H	54.0	105.6	-4.7	Pass*
All other spurious emissions and harmonics are more than 20 dB below the applicable limit.							

**5.5.4.5.2. Band-Edge RF Radiated Emissions**

Refer to attached plots.

**Plot 5.5.4.5.2.1.** Band-Edge RF Radiated Emissions at 3 m, Horizontal Polarization  
Single Frequency Mode, Low End of Frequency Band, 902.5 MHz, XBX0, Data Rate at 10 kbps

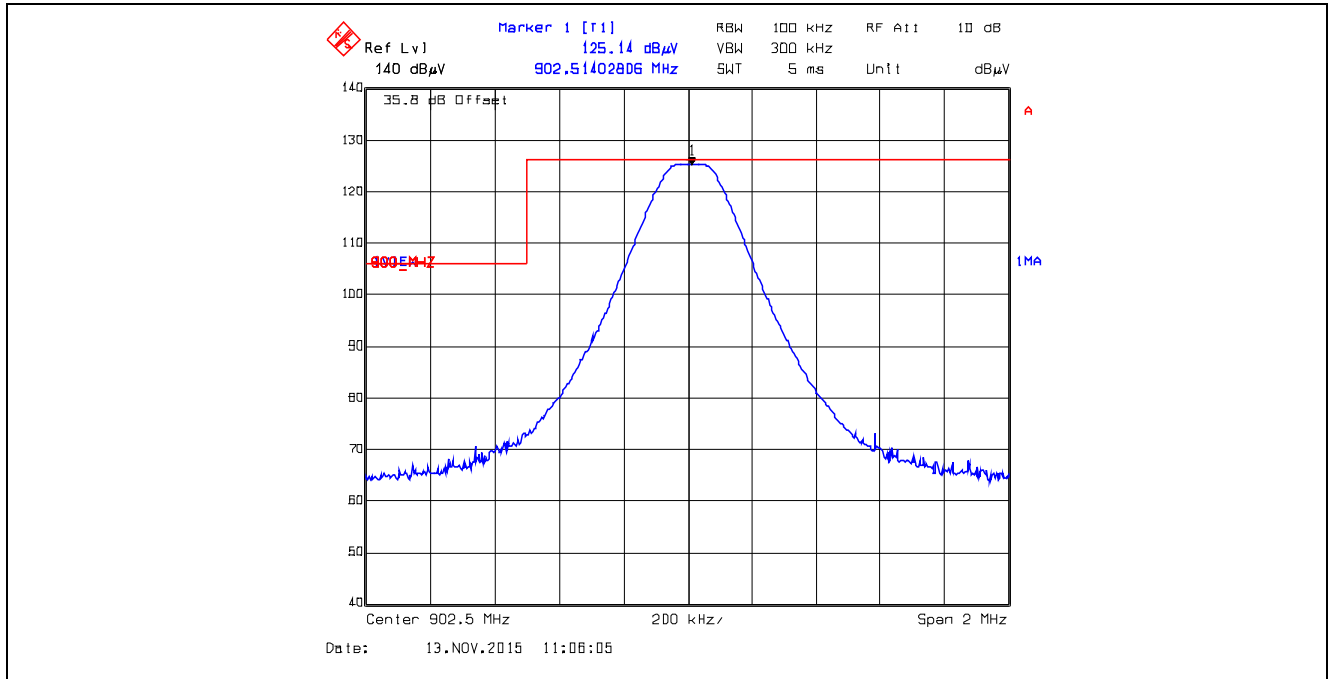

**Plot 5.5.4.5.2.2.** Band-Edge RF Radiated Emissions at 3 m, Horizontal Polarization  
Pseudorandom Hopping Mode, Low End of Frequency Band, 902.5 MHz, XBX0, Data Rate at 10 kbps

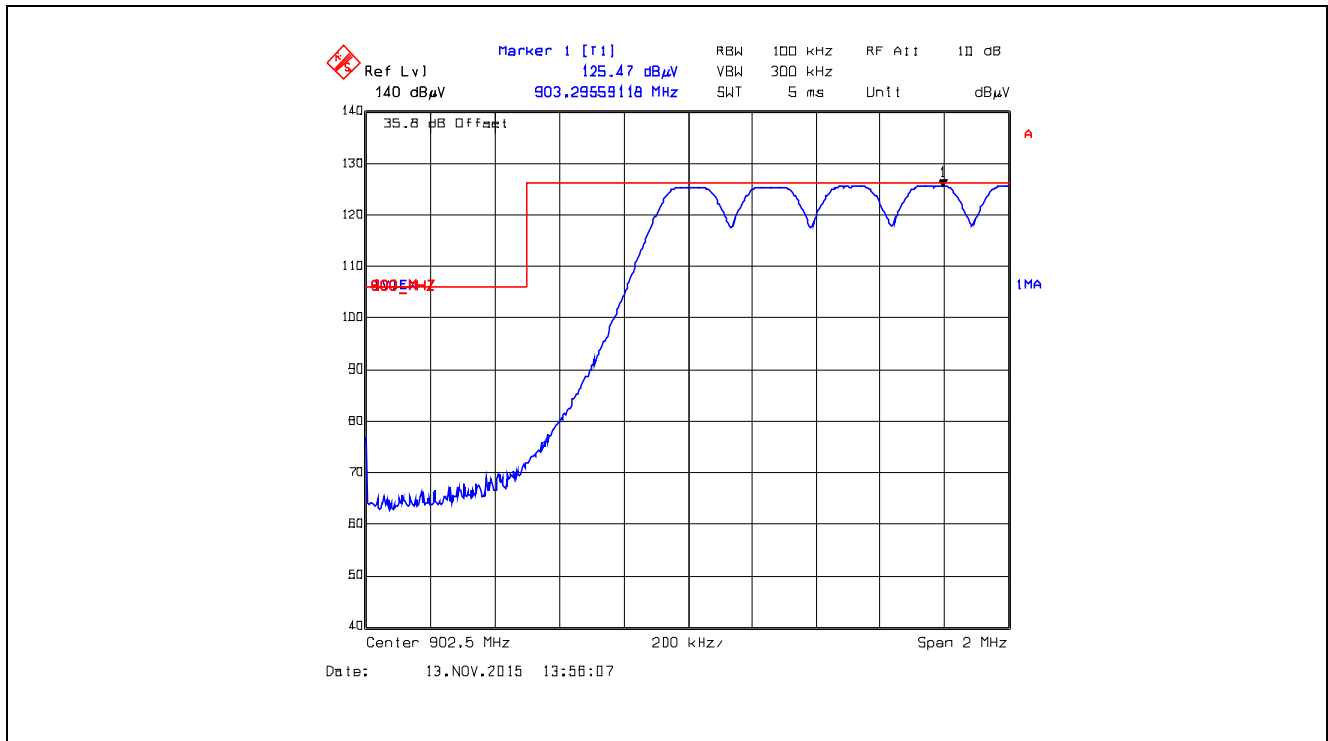

**Plot 5.5.4.5.2.3.** Band-Edge RF Radiated Emissions at 3 m, Vertical Polarization  
 Single Frequency Mode, Low End of Frequency Band, 902.5 MHz, XBX0, Data Rate at 10 kbps

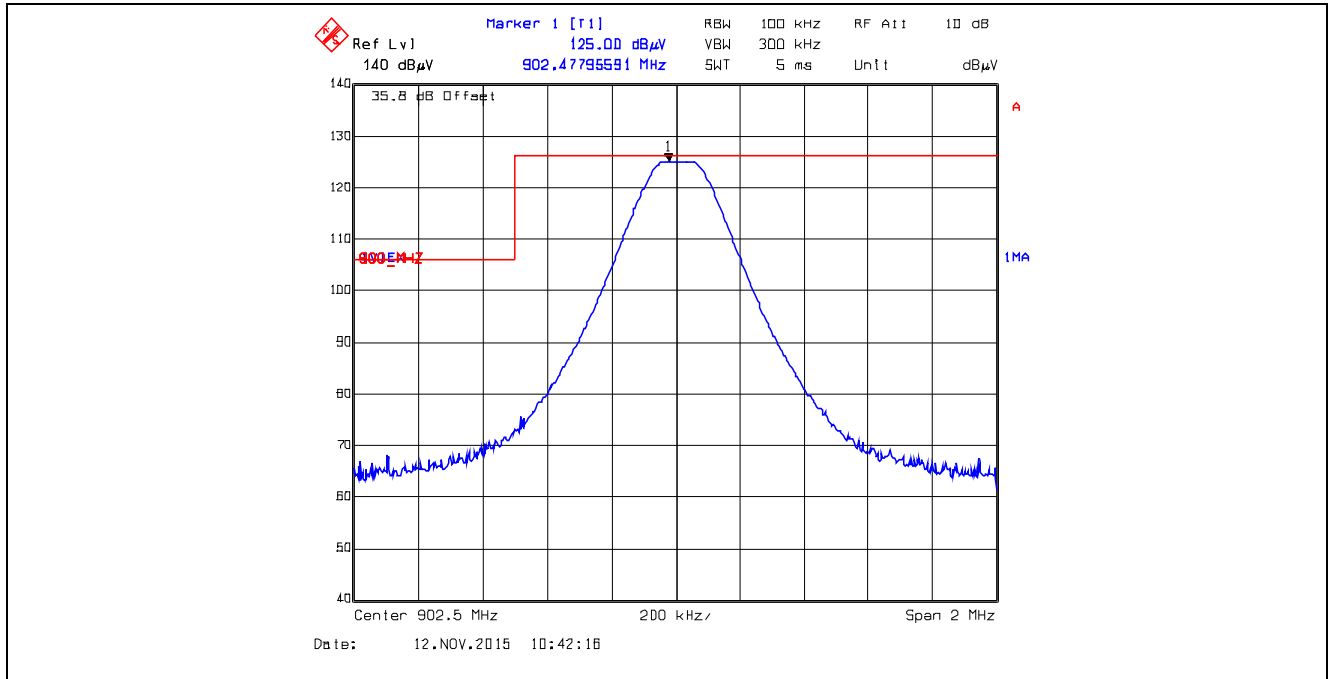

**Plot 5.5.4.5.2.4.** Band-Edge RF Radiated Emissions at 3 m, Vertical Polarization  
 Pseudorandom Hopping Mode, Low End of Frequency Band, 902.5 MHz, XBX0, Data Rate at 10 kbps

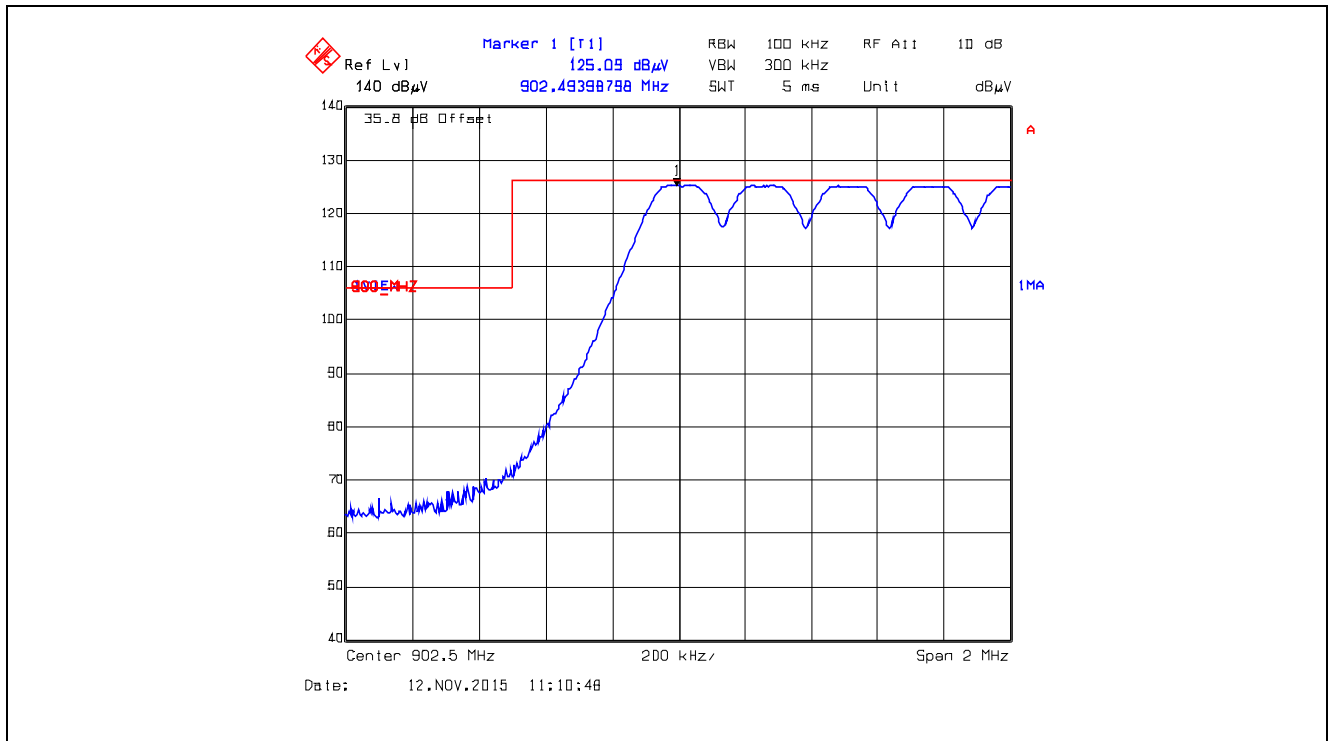

**Plot 5.5.4.5.2.5.** Band-Edge RF Radiated Emissions at 3 m, Horizontal Polarization  
 Single Frequency Mode, High End of Frequency Band, 927.5 MHz, XB0, Data Rate at 10 kbps

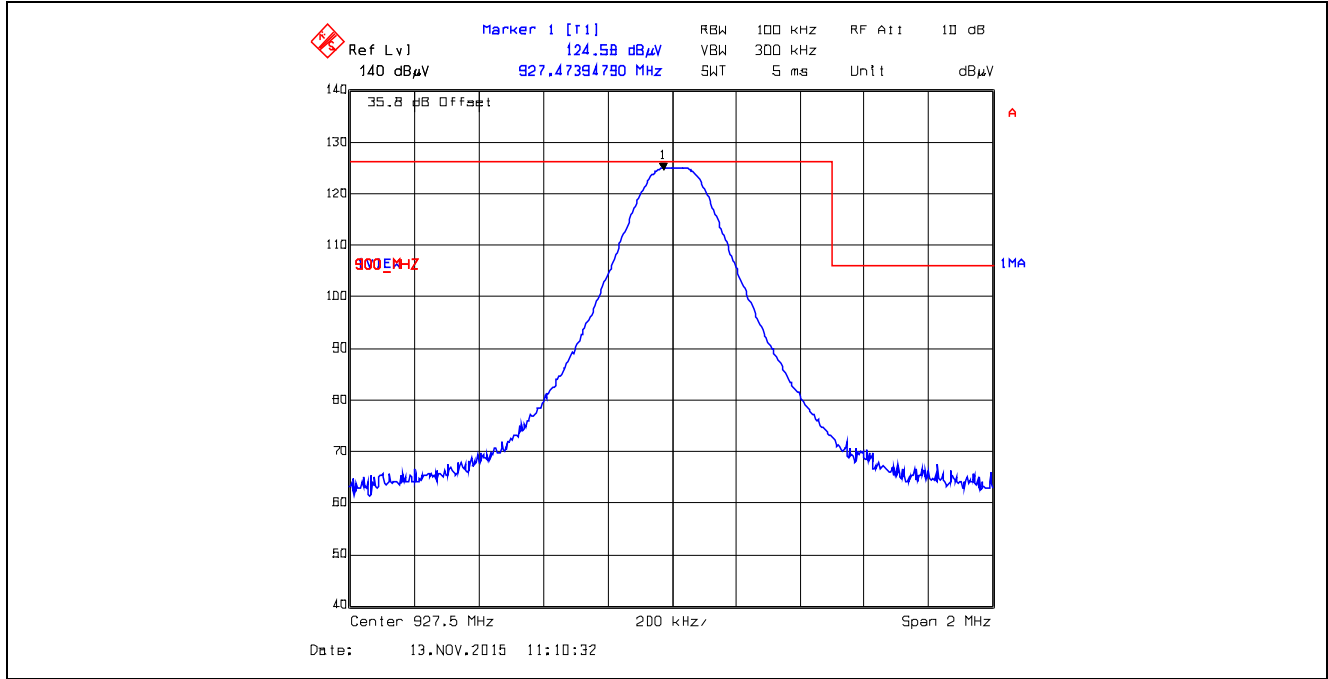

**Plot 5.5.4.5.2.6.** Band-Edge RF Radiated Emissions at 3 m, Horizontal Polarization  
 Pseudorandom Hopping Mode, High End of Frequency Band, 927.5 MHz, XB0, Data Rate at 10 kbps

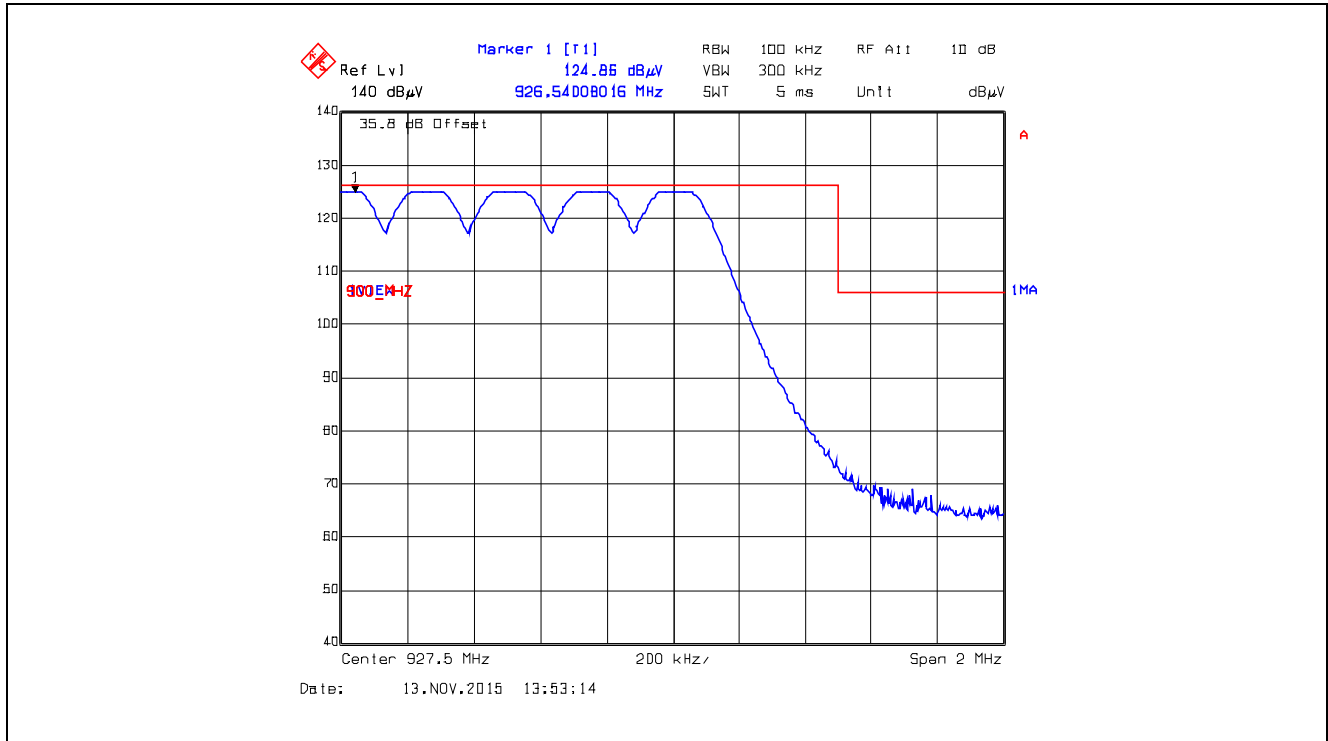

**Plot 5.5.4.5.2.7.** Band-Edge RF Radiated Emissions at 3 m, Vertical Polarization  
Single Frequency Mode, High End of Frequency Band, 927.5 MHz, XBX0, Data Rate at 10 kbps

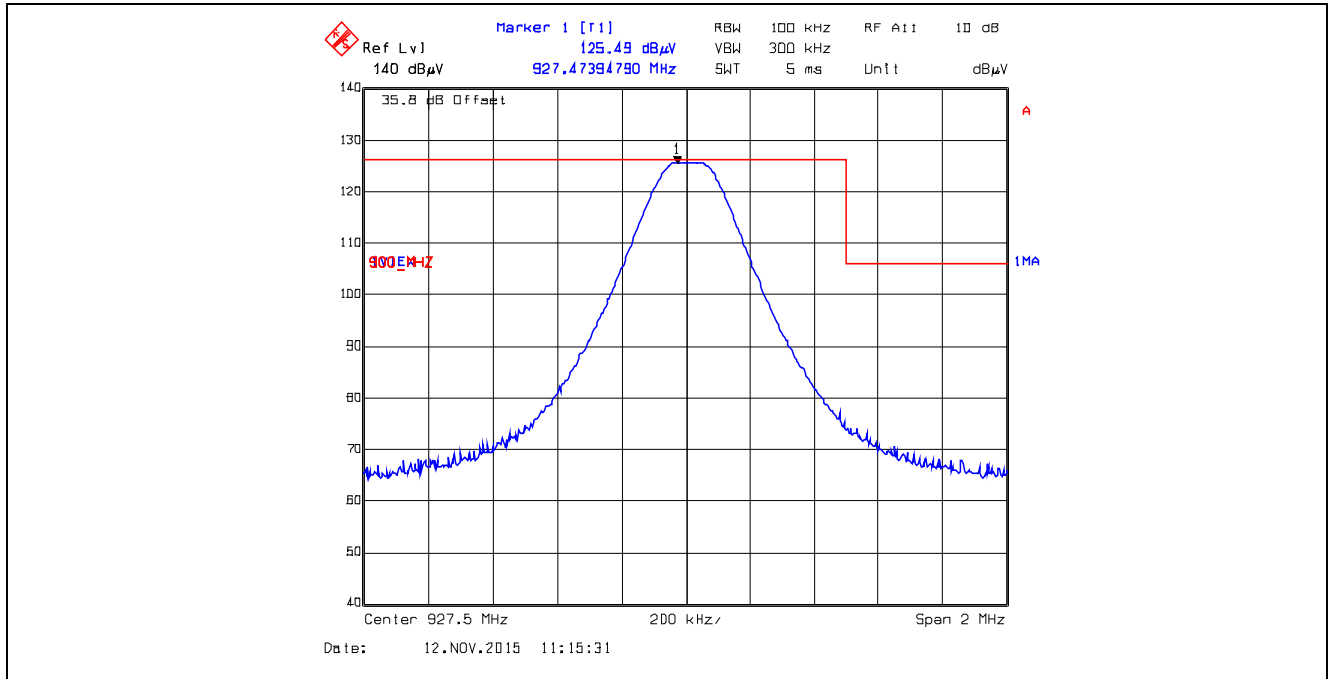

**Plot 5.5.4.5.2.8.** Band-Edge RF Radiated Emissions at 3 m, Vertical Polarization  
Pseudorandom Hopping Mode, High End of Frequency Band, 927.5 MHz, XBX0, Data Rate at 10 kbps

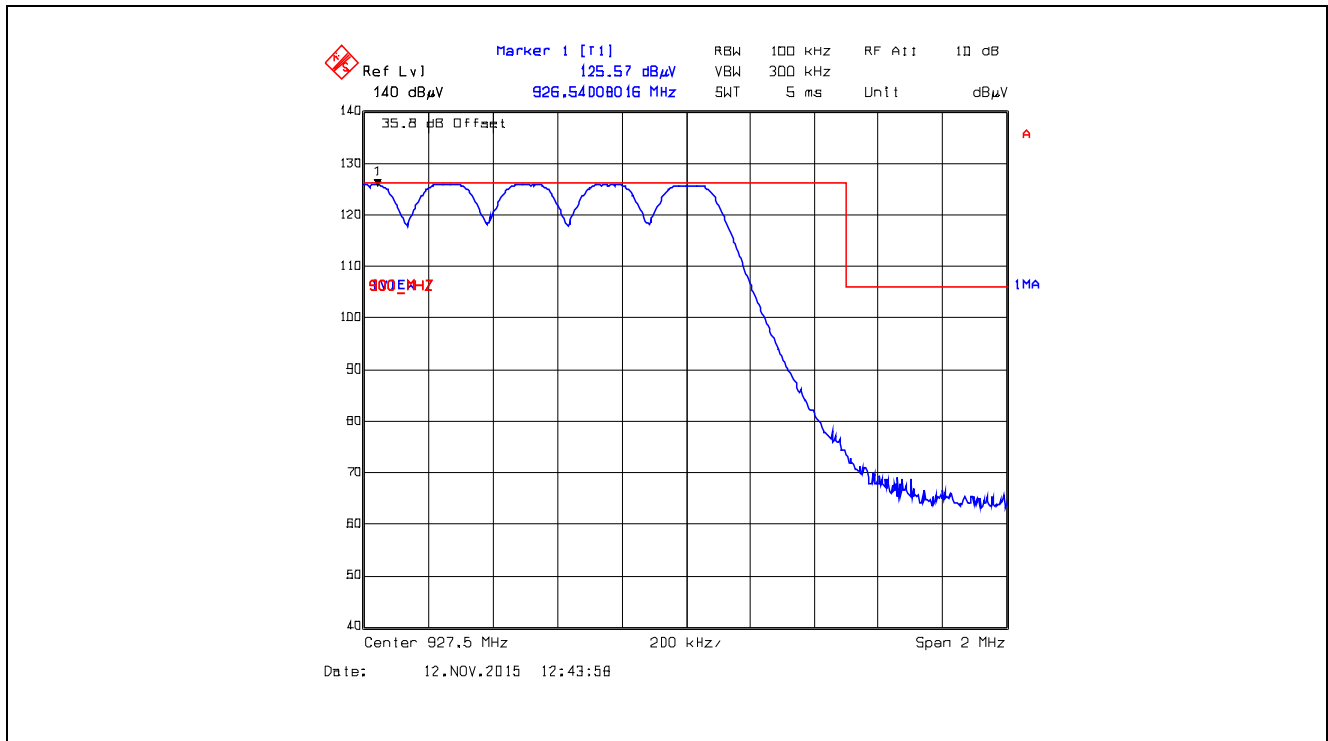

**Plot 5.5.4.5.2.9.** Band-Edge RF Radiated Emissions at 3 m, Horizontal Polarization  
 Single Frequency Mode, Low End of Frequency Band, 902.5 MHz, XBX1, Data Rate at 110 kbps

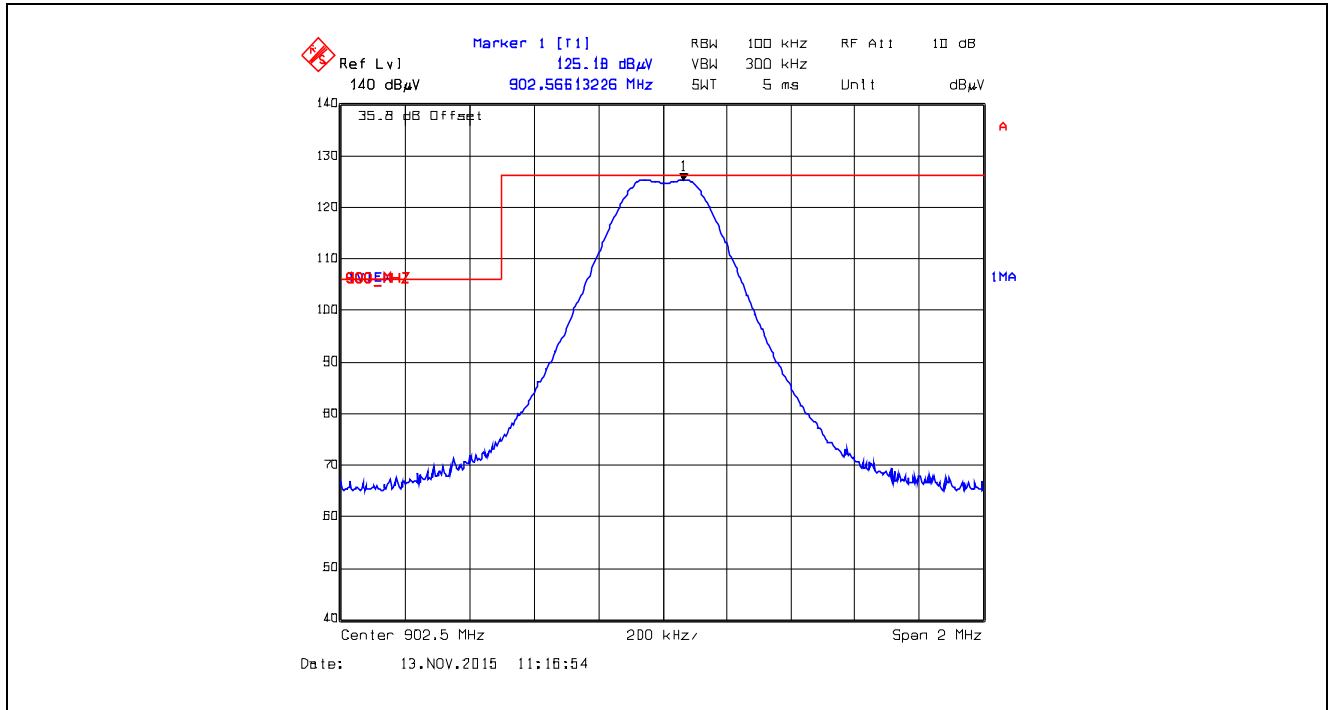

**Plot 5.5.4.5.2.10.** Band-Edge RF Radiated Emissions at 3 m, Horizontal Polarization  
 Pseudorandom Hopping Mode, Low End of Frequency Band, 902.5 MHz, XBX1, Data Rate at 110 kbps

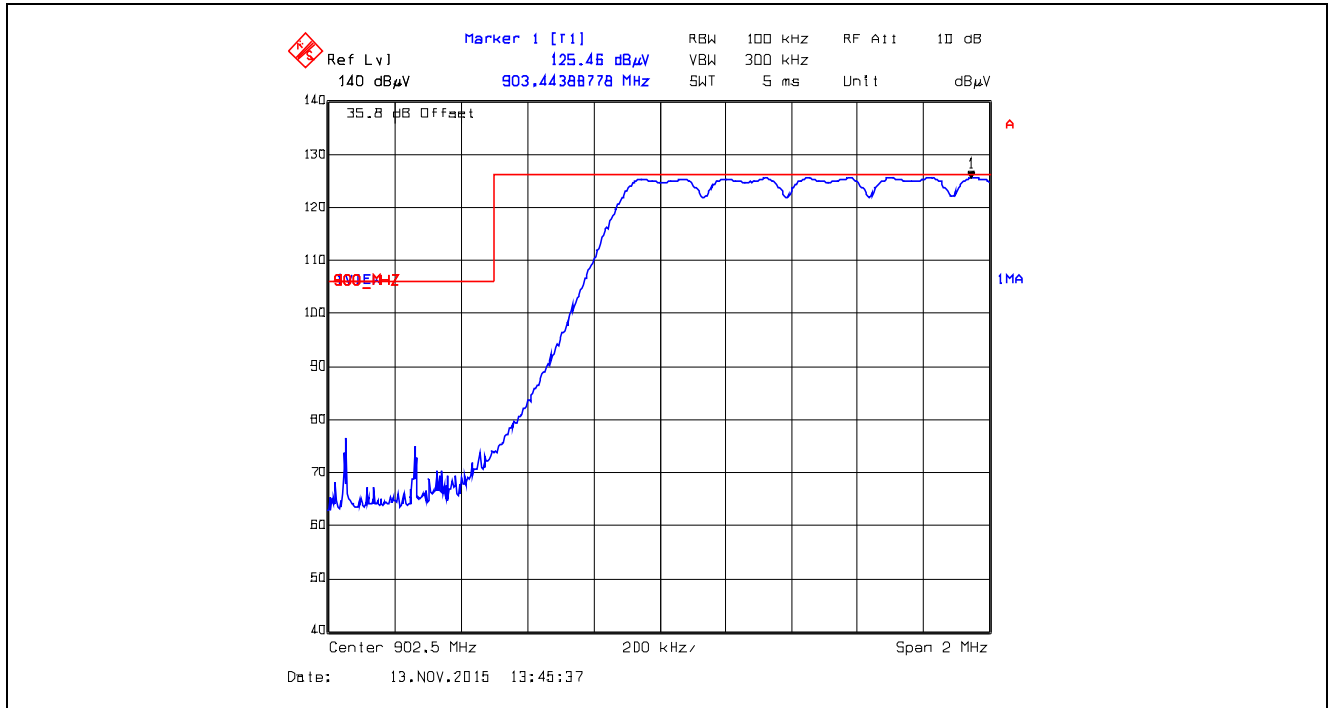

**Plot 5.5.4.5.2.11.** Band-Edge RF Radiated Emissions at 3 m, Vertical Polarization  
Single Frequency Mode, Low End of Frequency Band, 902.5 MHz, XB1, Data Rate at 110 kbps

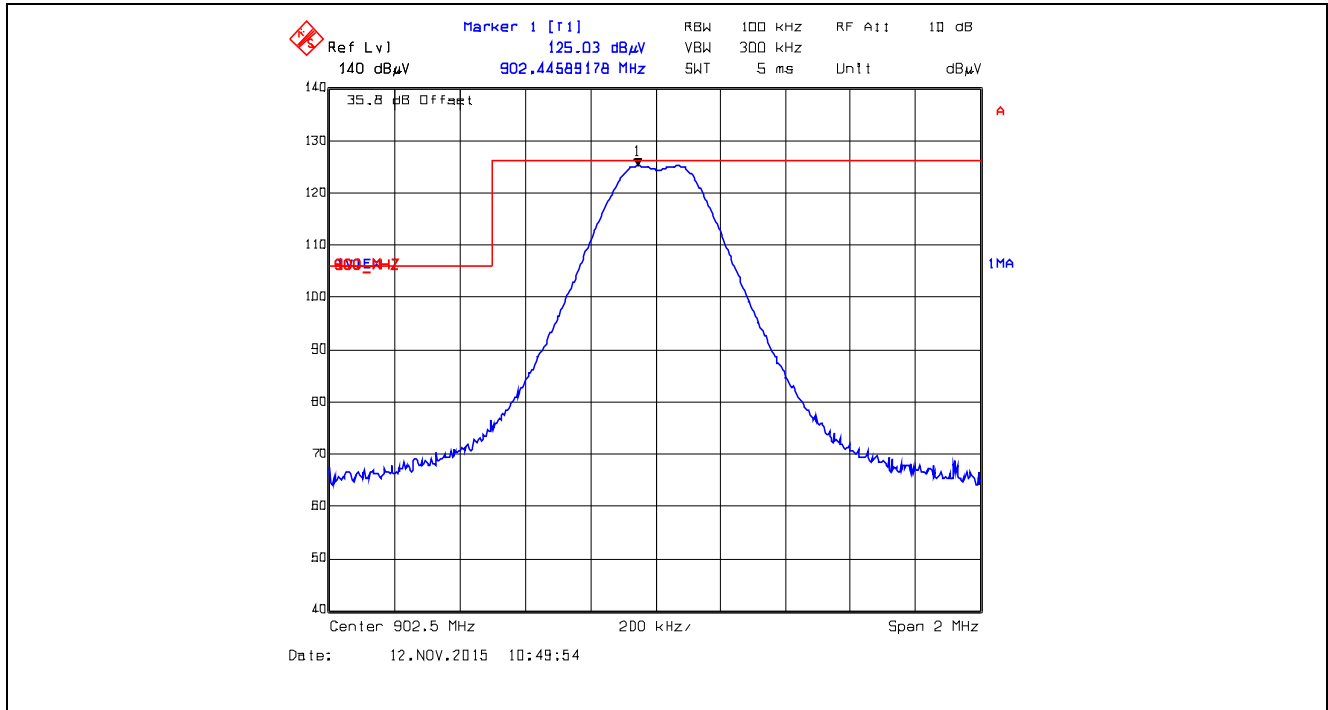

**Plot 5.5.4.5.2.12.** Band-Edge RF Radiated Emissions at 3 m, Vertical Polarization  
Pseudorandom Hopping Mode, Low End of Frequency Band, 902.5 MHz, XB1, Data Rate at 110 kbps

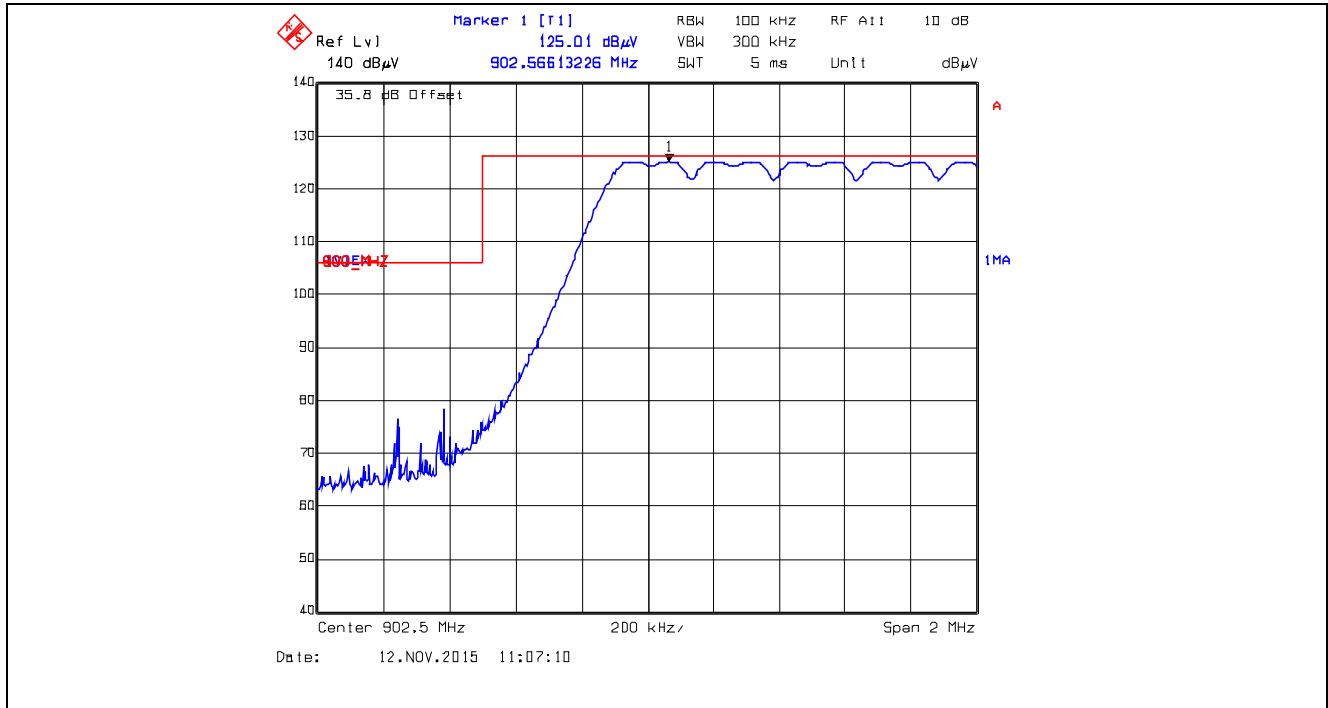



**Plot 5.5.4.5.2.13.** Band-Edge RF Radiated Emissions at 3 m, Horizontal Polarization  
 Single Frequency Mode, High End of Frequency Band, 927.5 MHz, XBX1, Data Rate at 110 kbps

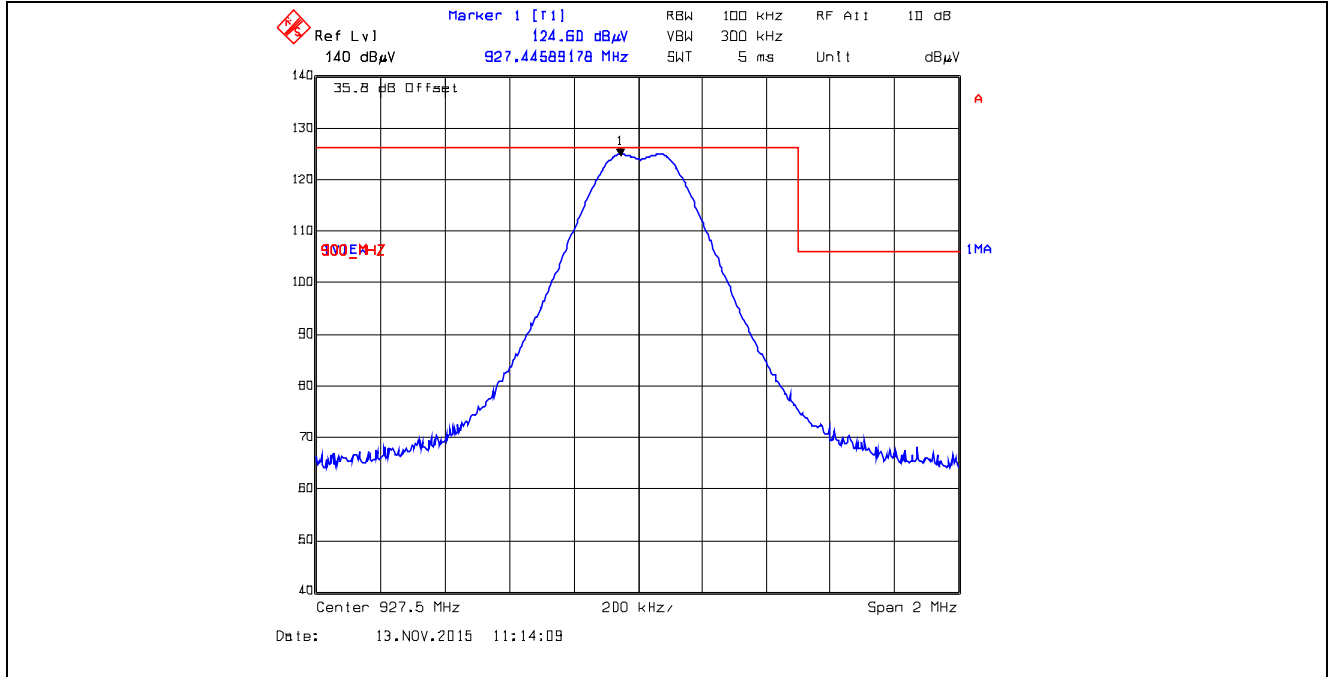

**Plot 5.5.4.5.2.14.** Band-Edge RF Radiated Emissions at 3 m, Horizontal Polarization  
 Pseudorandom Hopping Mode, High End of Frequency Band, 927.5 MHz, XBX1, Data Rate at 110 kbps

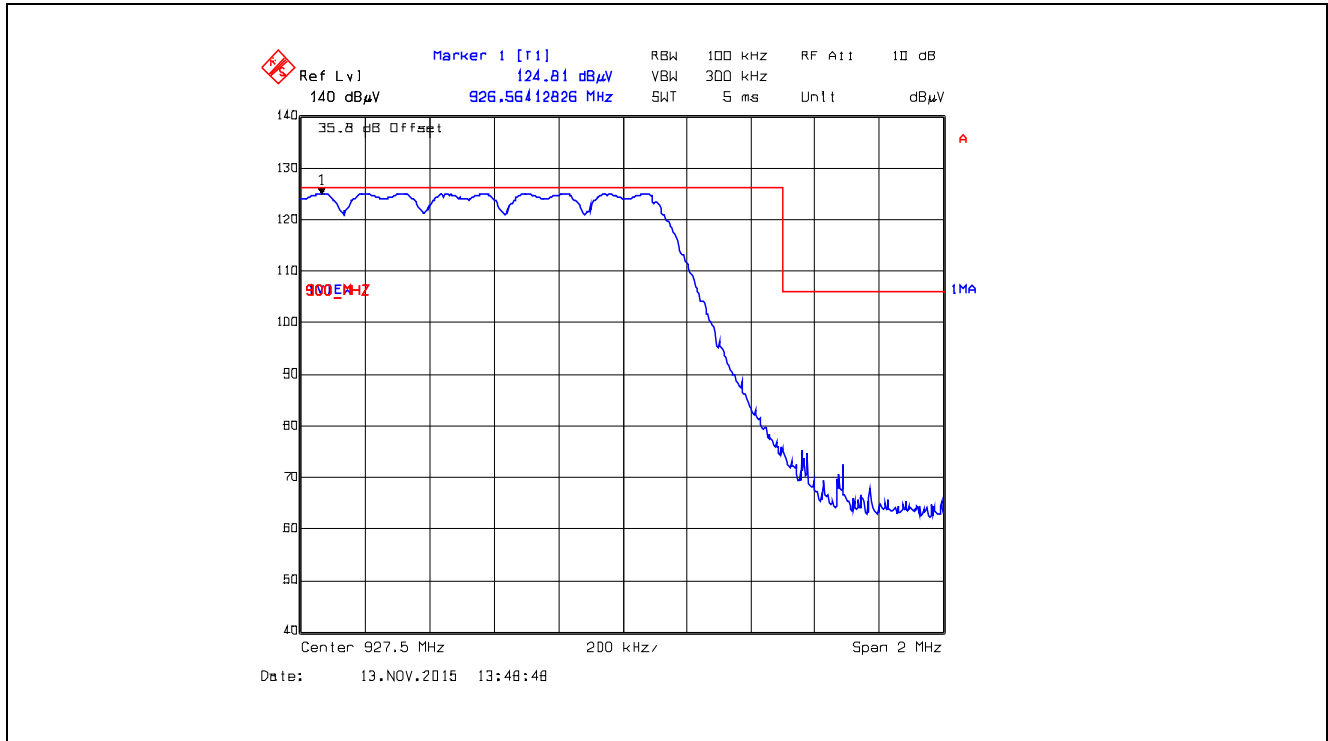

**Plot 5.5.4.5.2.15.** Band-Edge RF Radiated Emissions at 3 m, Vertical Polarization  
 Single Frequency Mode, High End of Frequency Band, 927.5 MHz, XB1, Data Rate at 110 kbps

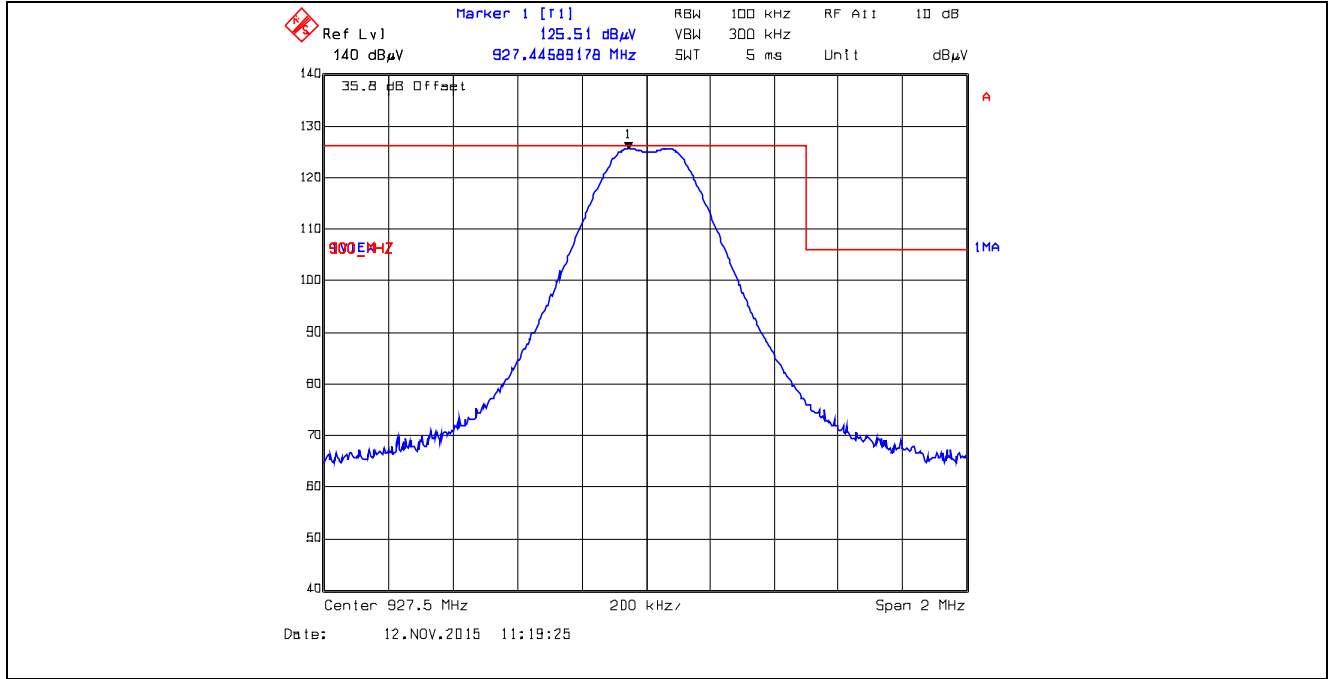

**Plot 5.5.4.5.2.16.** Band-Edge RF Radiated Emissions at 3 m, Vertical Polarization  
 Pseudorandom Hopping Mode, High End of Frequency Band, 927.5 MHz, XB1, Data Rate at 110 kbps

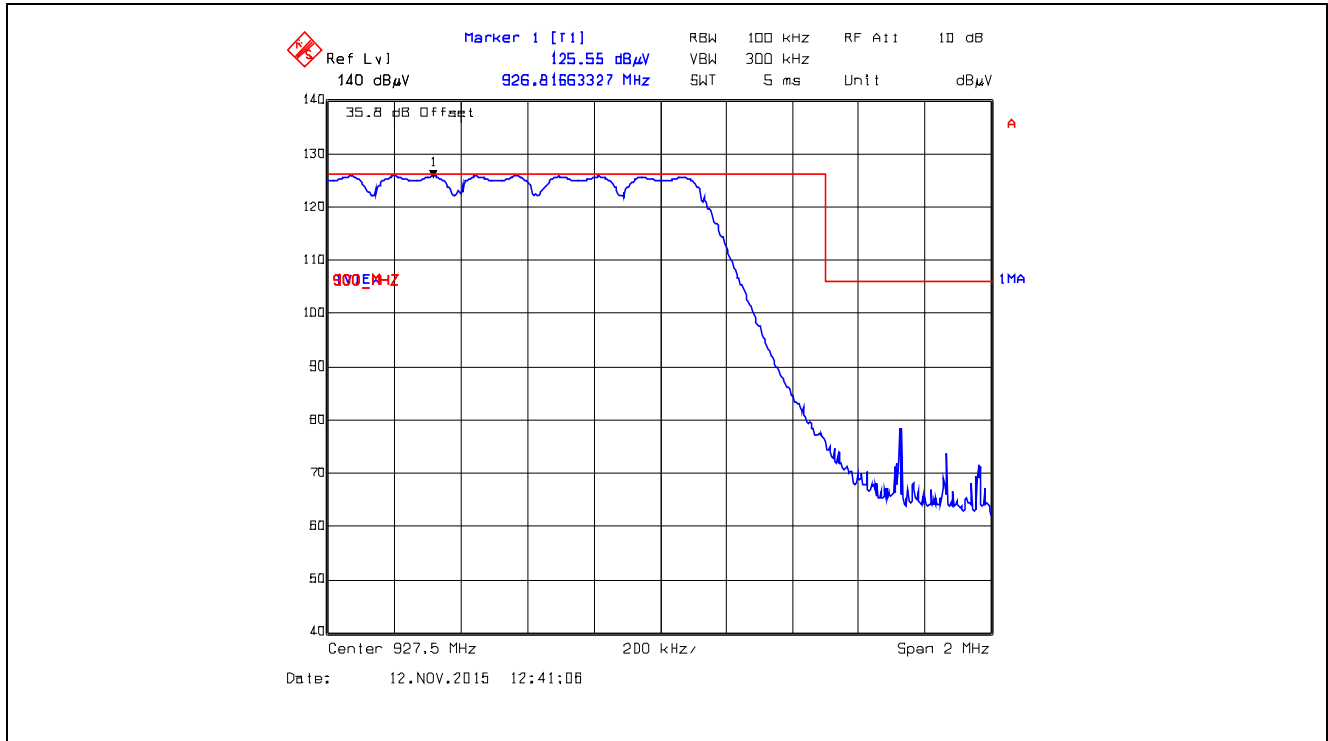

**Plot 5.5.4.5.2.17.** Band-Edge RF Radiated Emissions at 3 m, Horizontal Polarization  
 Single Frequency Mode, Low End of Frequency Band, 902.75 MHz, XB2, Data Rate at 250 kbps

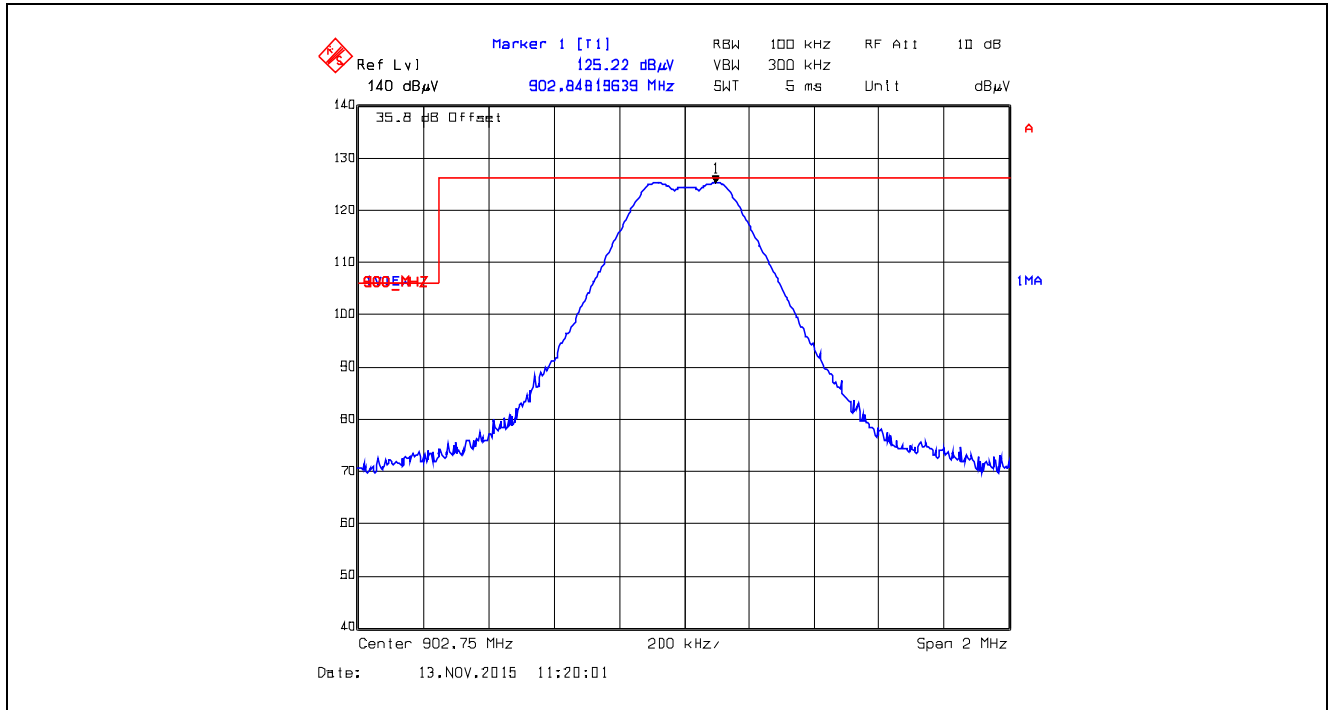

**Plot 5.5.4.5.2.18.** Band-Edge RF Radiated Emissions at 3 m, Horizontal Polarization  
 Pseudorandom Hopping Mode, Low End of Frequency Band, 902.75 MHz, XB2, Data Rate at 250 kbps

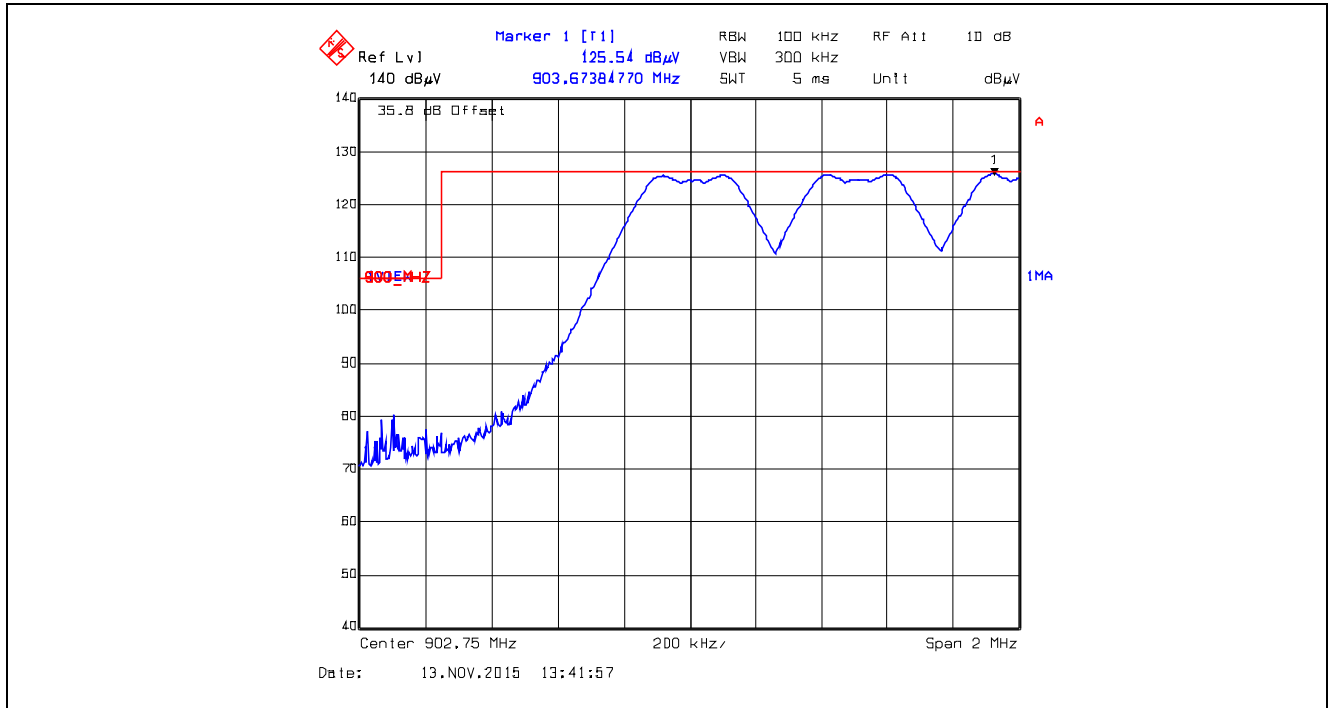

**Plot 5.5.4.5.2.19.** Band-Edge RF Radiated Emissions at 3 m, Vertical Polarization  
 Single Frequency Mode, Low End of Frequency Band, 902.75 MHz, XBX2, Data Rate at 250 kbps

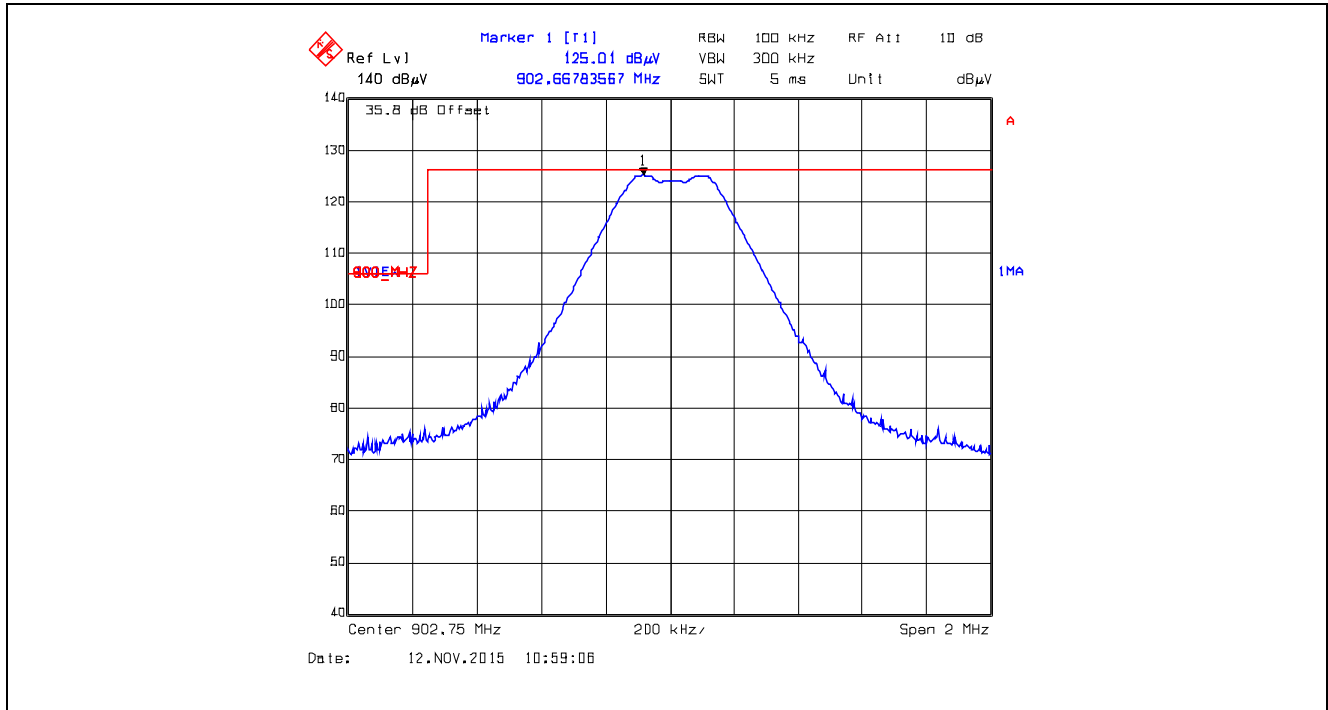

**Plot 5.5.4.5.2.20.** Band-Edge RF Radiated Emissions at 3 m, Vertical Polarization  
 Pseudorandom Hopping Mode, Low End of Frequency Band, 902.75 MHz, XBX2, Data Rate at 250 kbps

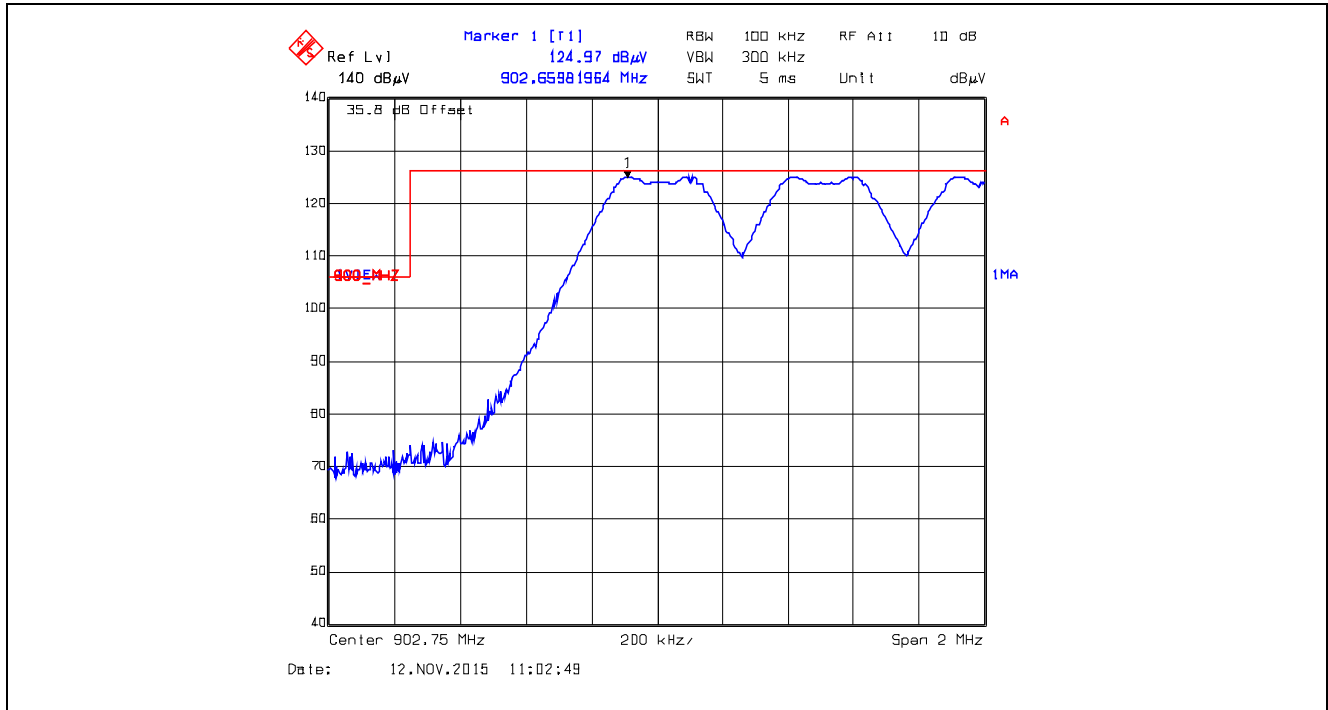

**Plot 5.5.4.5.2.21.** Band-Edge RF Radiated Emissions at 3 m, Horizontal Polarization  
 Single Frequency Mode, High End of Frequency Band, 927.25 MHz, XB2, Data Rate at 250 kbps

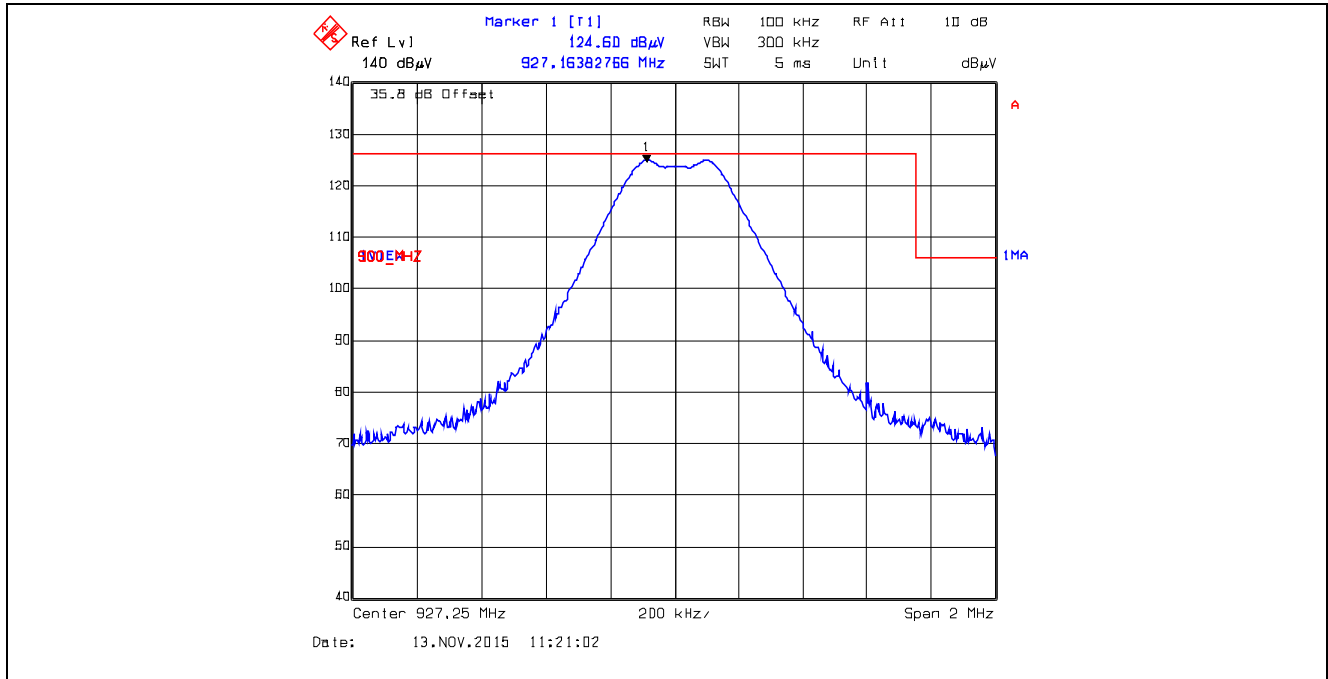

**Plot 5.5.4.5.2.22.** Band-Edge RF Radiated Emissions at 3 m, Horizontal Polarization  
 Pseudorandom Hopping Mode, High End of Frequency Band, 927.25 MHz, XB2, Data Rate at 250 kbps

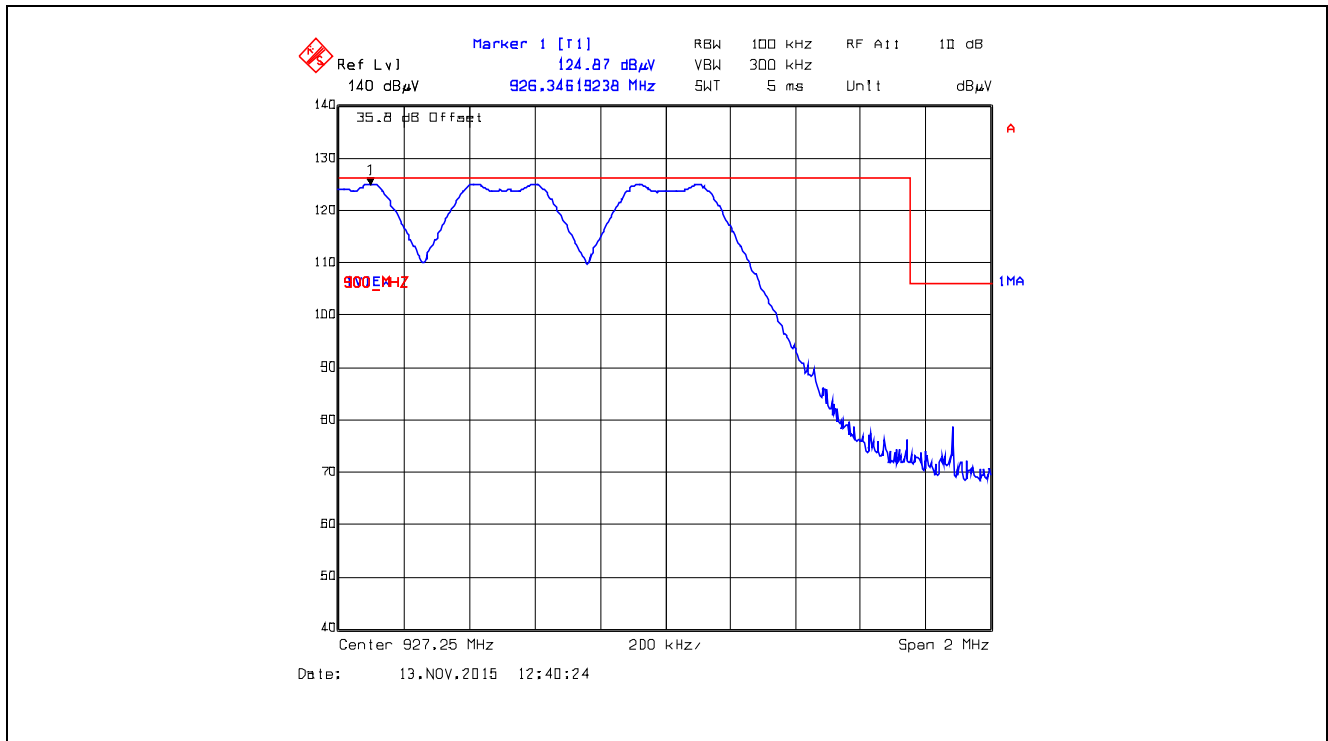

**Plot 5.5.4.5.2.23.** Band-Edge RF Radiated Emissions at 3 m, Vertical Polarization  
 Single Frequency Mode, High End of Frequency Band, 927.25 MHz, XBX2, Data Rate at 250 kbps

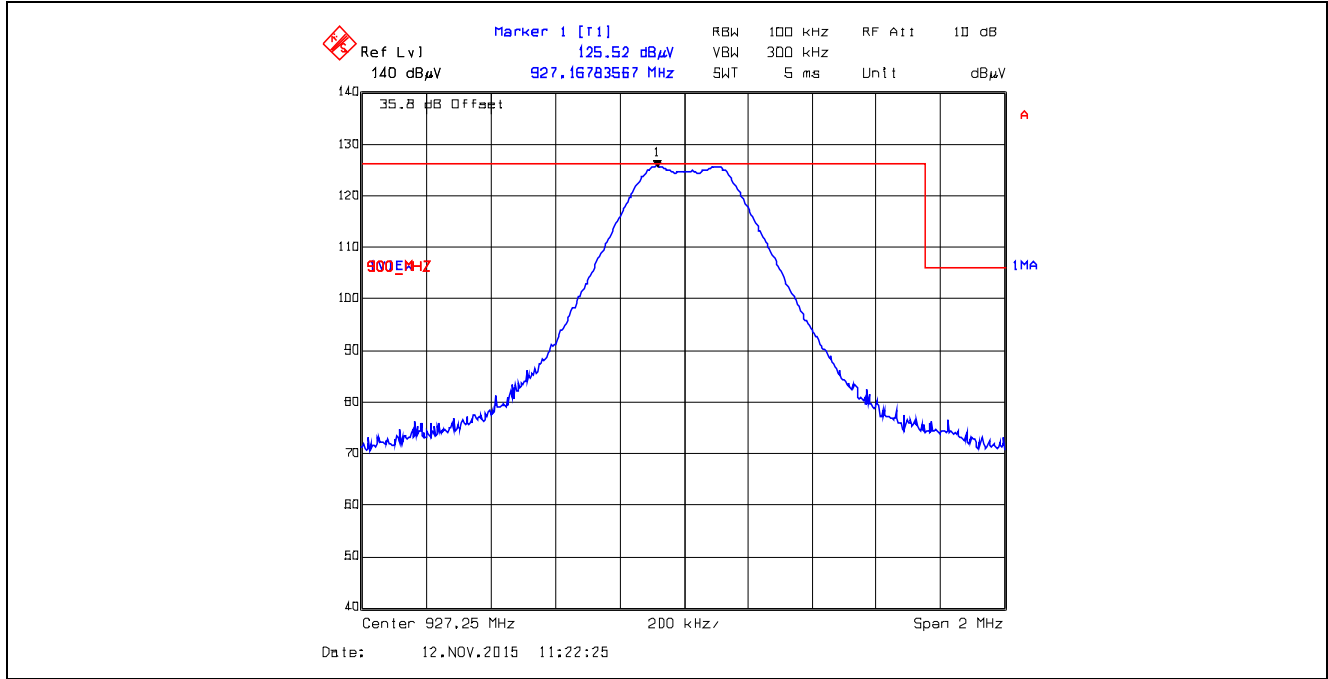

**Plot 5.5.4.5.2.24.** Band-Edge RF Radiated Emissions at 3 m, Vertical Polarization  
 Pseudorandom Hopping Mode, High End of Frequency Band, 927.25 MHz, XBX2, Data Rate at 250 kbps

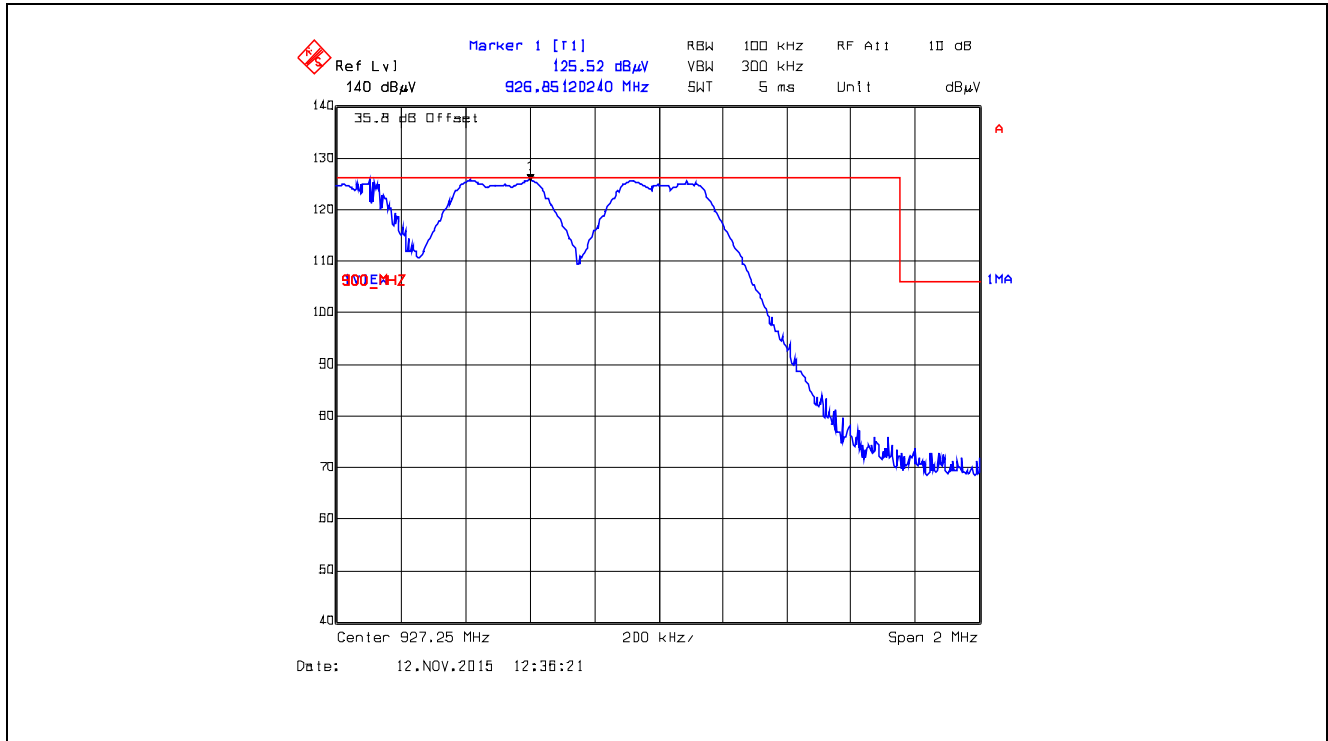

**Plot 5.5.4.5.2.25.** Band-Edge RF Radiated Emissions at 3 m, Horizontal Polarization  
 Single Frequency Mode, Low End of Frequency Band, 905.0 MHz, XTC0, Data Rate at 10 kbps

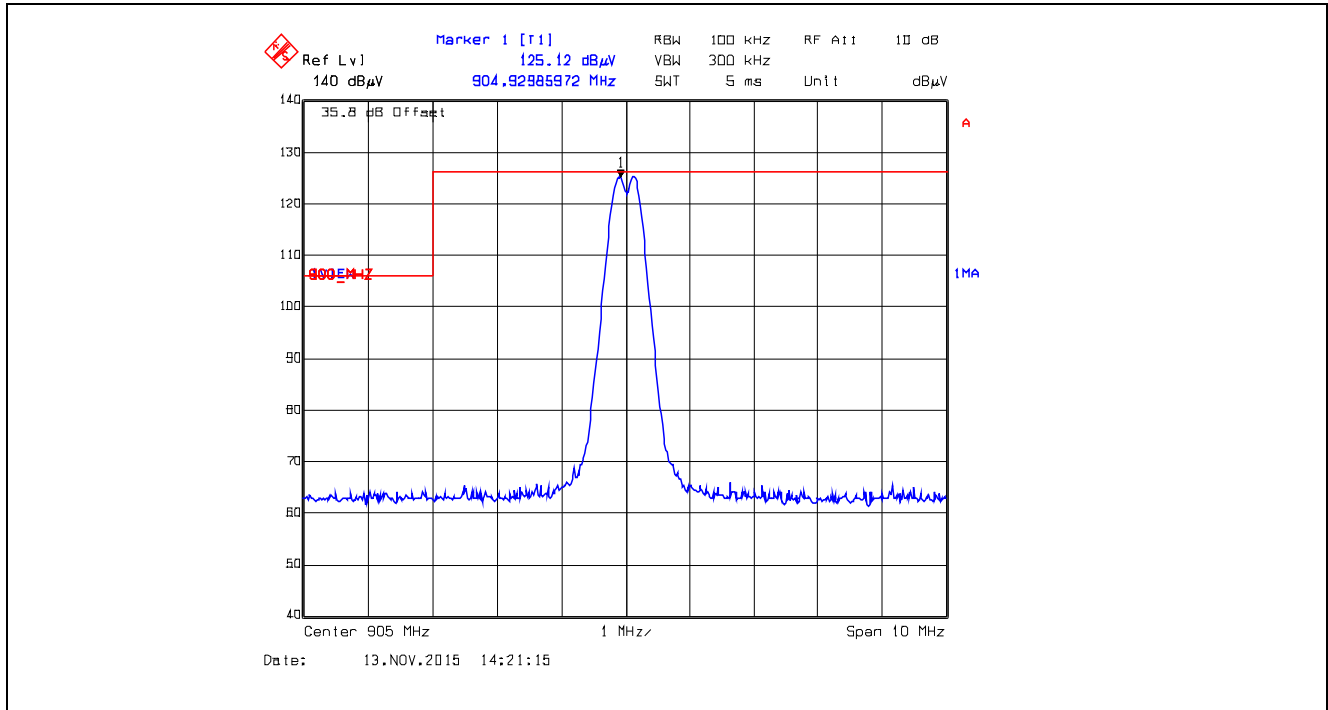

**Plot 5.5.4.5.2.26.** Band-Edge RF Radiated Emissions at 3 m, Horizontal Polarization  
 Pseudorandom Hopping Mode, Low End of Frequency Band, 905.0 MHz, XTC0, Data Rate at 10 kbps

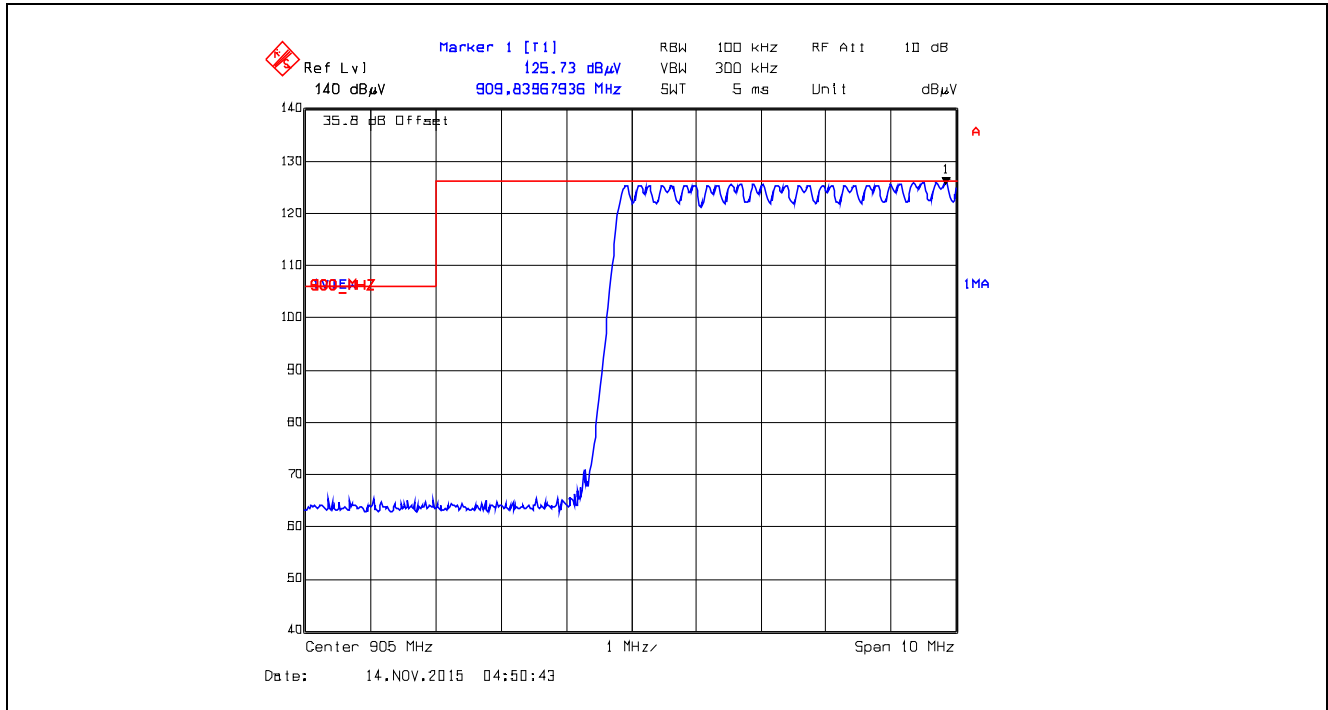

**Plot 5.5.4.5.27.** Band-Edge RF Radiated Emissions at 3 m, Vertical Polarization  
Single Frequency Mode, Low End of Frequency Band, 905.0 MHz, XTC0, Data Rate at 10 kbps

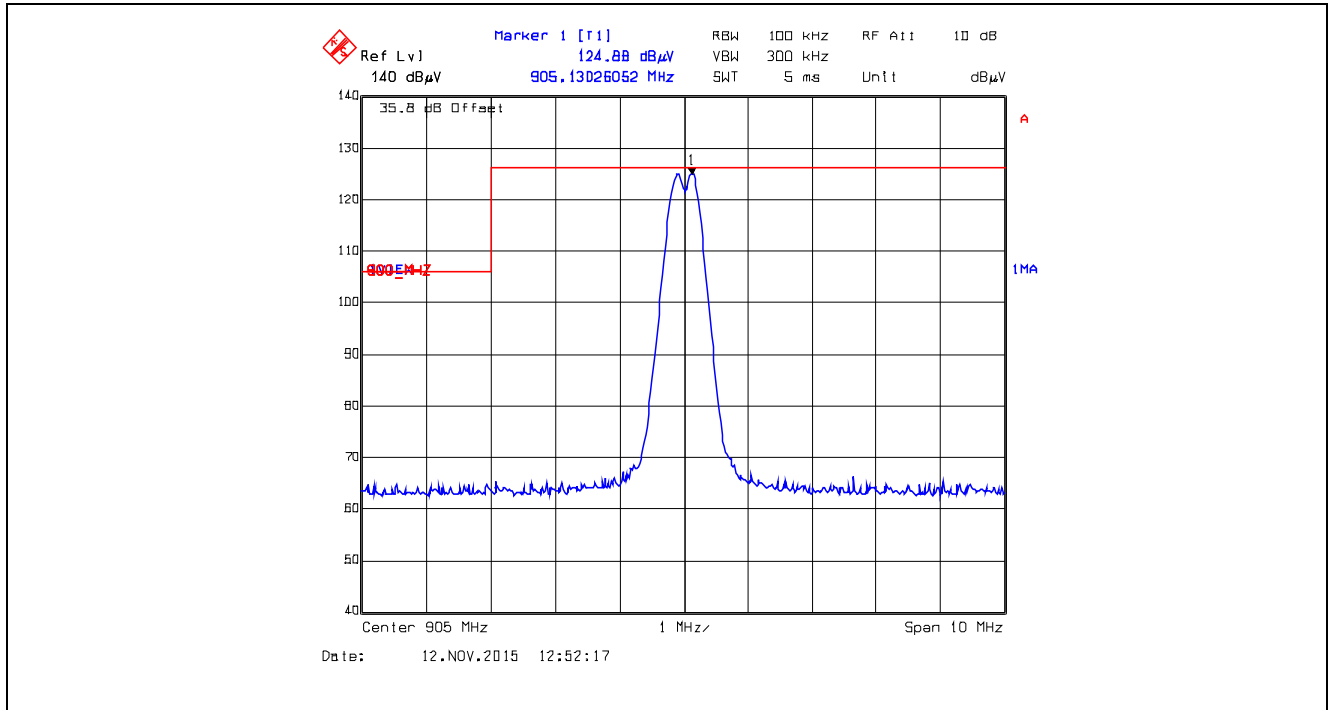

**Plot 5.5.4.5.28.** Band-Edge RF Radiated Emissions at 3 m, Vertical Polarization  
Pseudorandom Hopping Mode, Low End of Frequency Band, 905.0 MHz, XTC0, Data Rate at 10 kbps

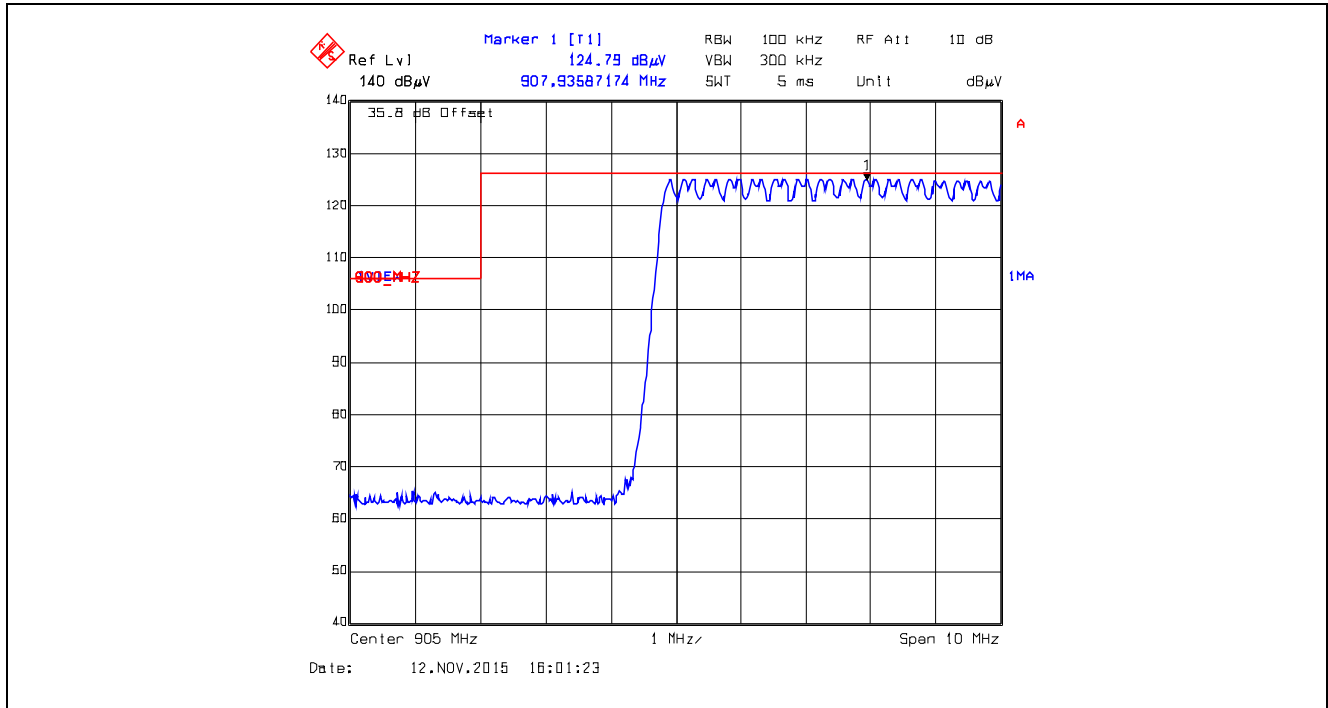



**Plot 5.5.4.5.2.29.** Band-Edge RF Radiated Emissions at 3 m, Horizontal Polarization  
Single Frequency Mode, High End of Frequency Band, 925.0 MHz, XTC0, Data Rate at 10 kbps

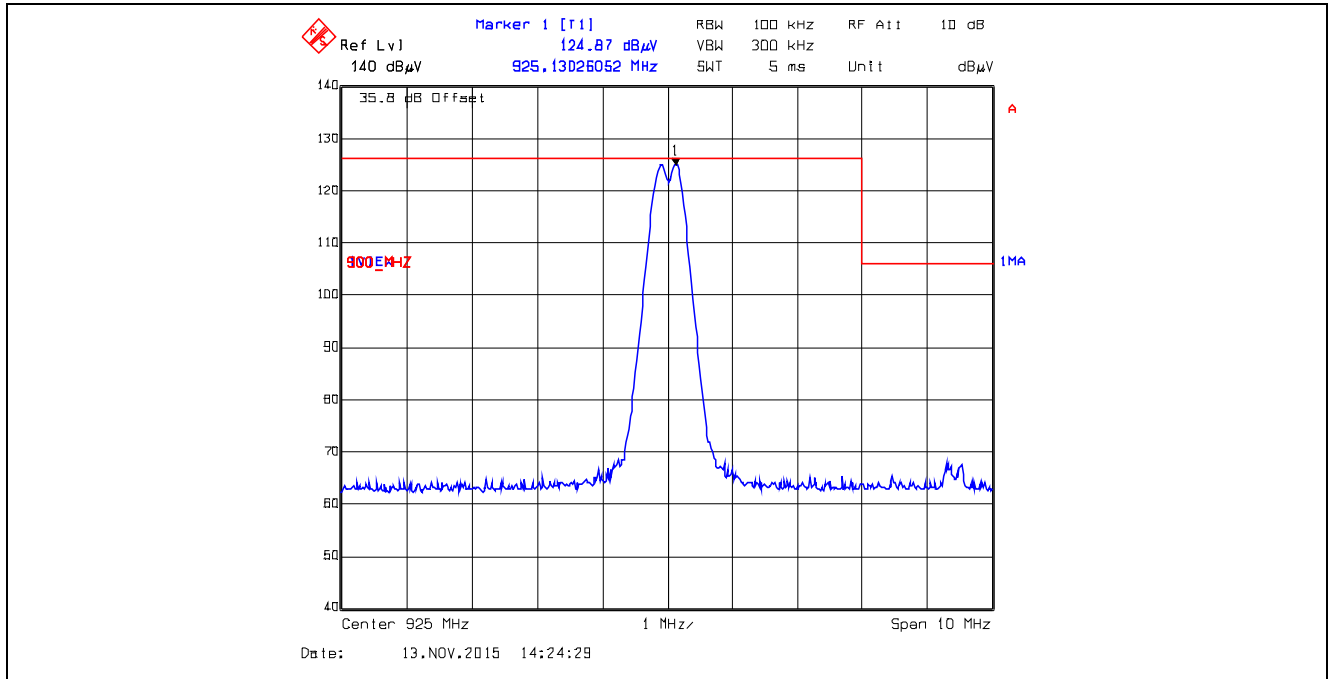

**Plot 5.5.4.5.2.30.** Band-Edge RF Radiated Emissions at 3 m, Horizontal Polarization  
Pseudorandom Hopping Mode, High End of Frequency Band, 925.0 MHz, XTC0, Data Rate at 10 kbps

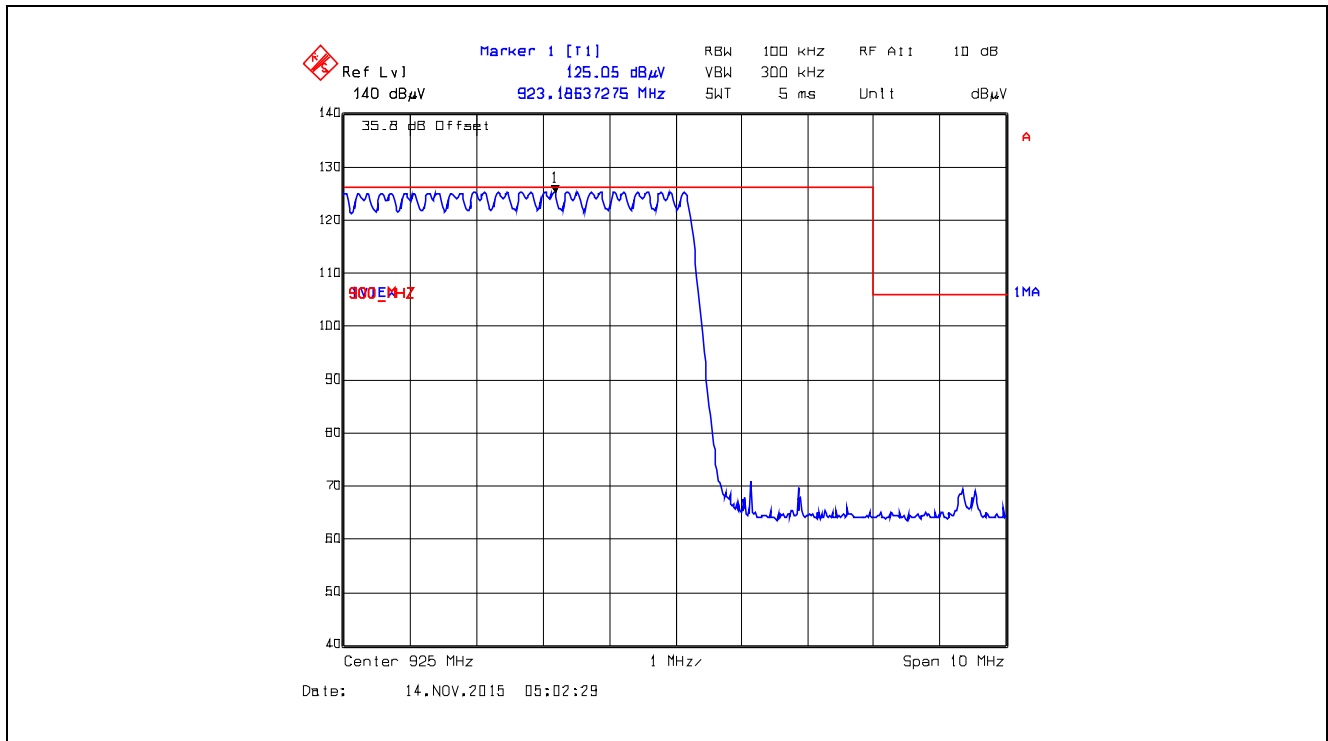

**Plot 5.5.4.5.2.31.** Band-Edge RF Radiated Emissions at 3 m, Vertical Polarization  
 Single Frequency Mode, High End of Frequency Band, 925.0 MHz, XTC0, Data Rate at 10 kbps

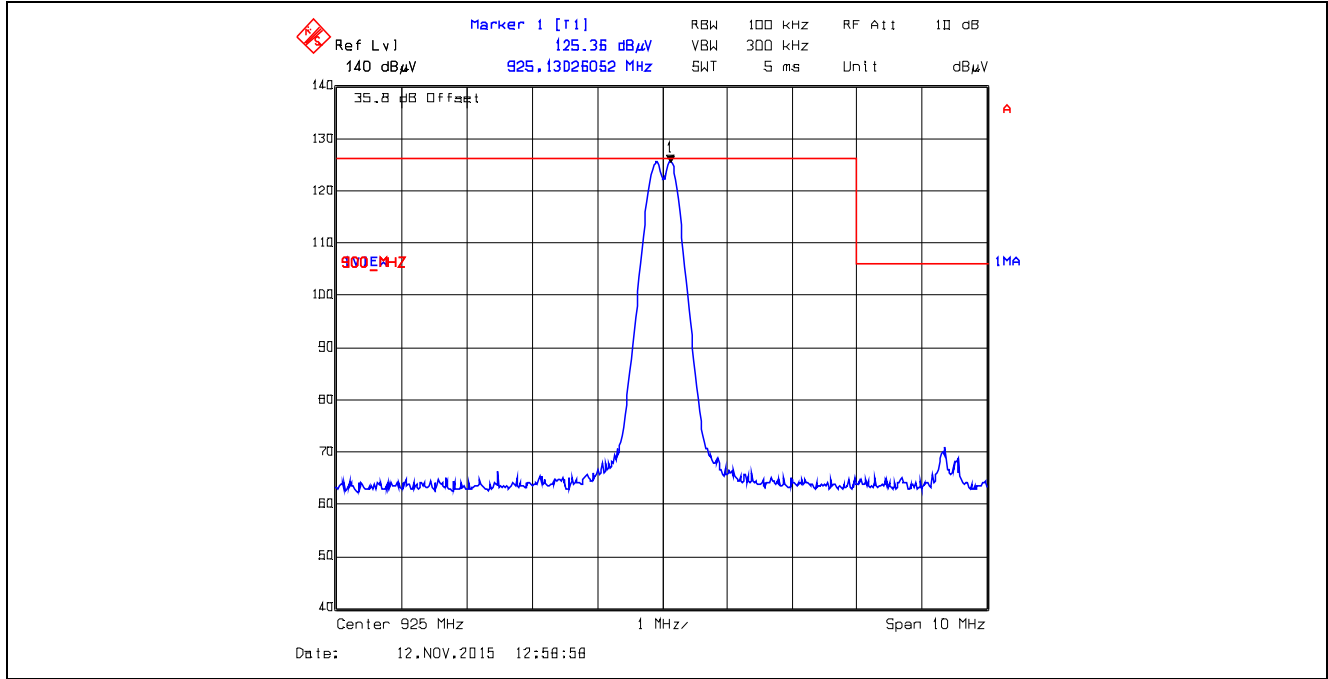

**Plot 5.5.4.5.2.32.** Band-Edge RF Radiated Emissions at 3 m, Vertical Polarization  
 Pseudorandom Hopping Mode, High End of Frequency Band, 925.0 MHz, XTC0, Data Rate at 10 kbps

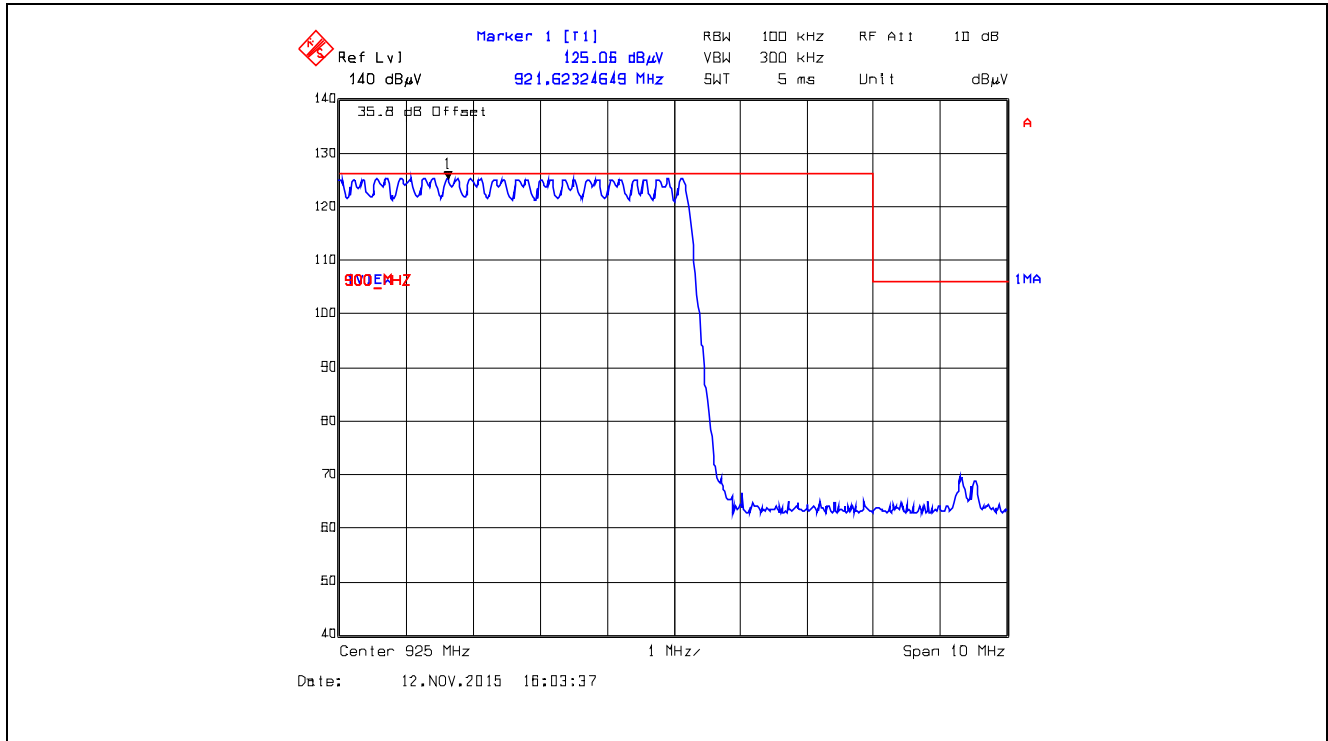

**Plot 5.5.4.5.2.33.** Band-Edge RF Radiated Emissions at 3 m, Horizontal Polarization  
 Single Frequency Mode, Low End of Frequency Band, 905.0 MHz, XTC1, Data Rate at 125 kbps

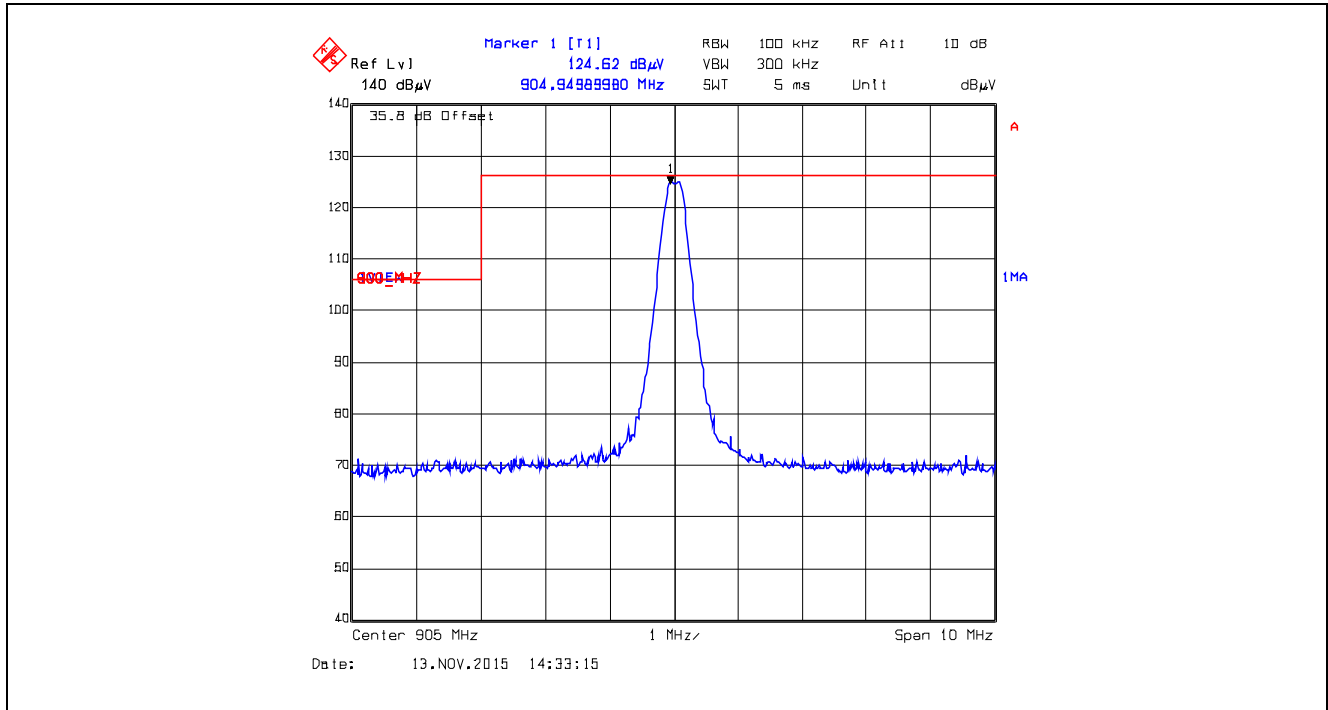

**Plot 5.5.4.5.2.34.** Band-Edge RF Radiated Emissions at 3 m, Horizontal Polarization  
 Pseudorandom Hopping Mode, Low End of Frequency Band, 905.0 MHz, XTC1, Data Rate at 125 kbps

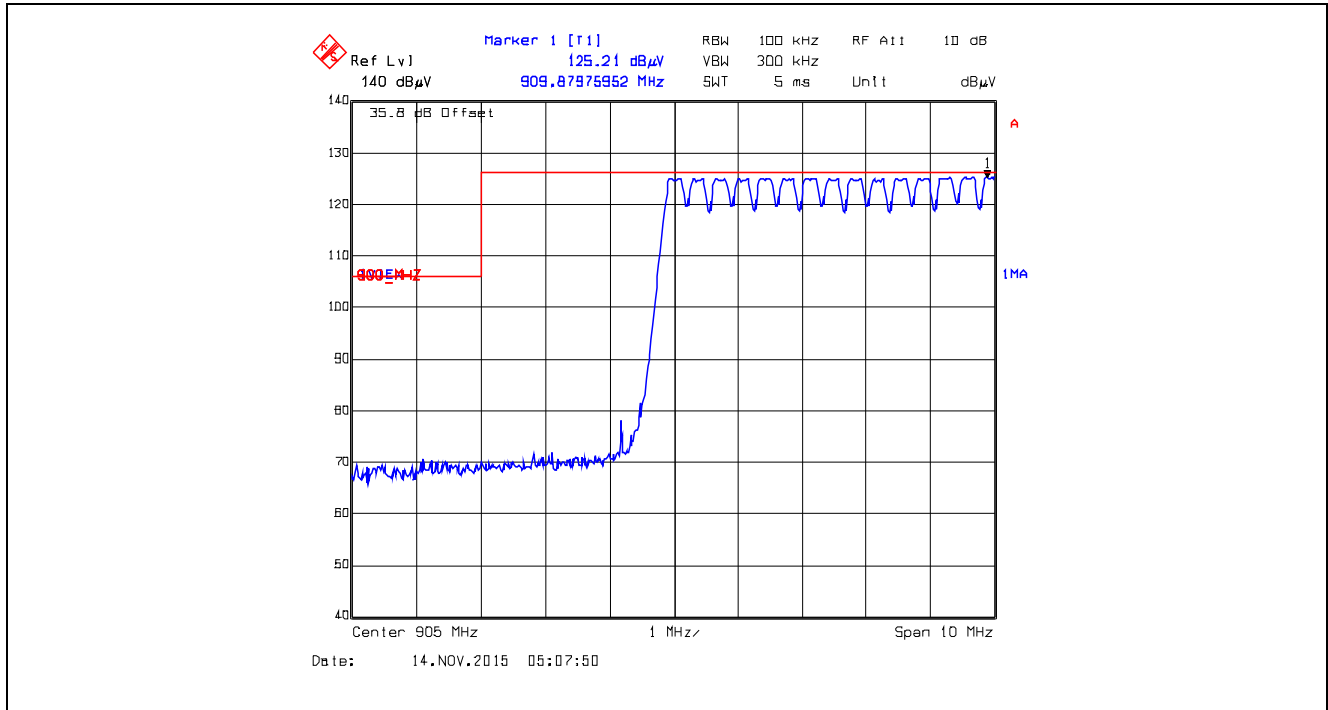

**Plot 5.5.4.5.2.35.** Band-Edge RF Radiated Emissions at 3 m, Vertical Polarization  
Single Frequency Mode, Low End of Frequency Band, 905.0 MHz, XTC1, Data Rate at 125 kbps

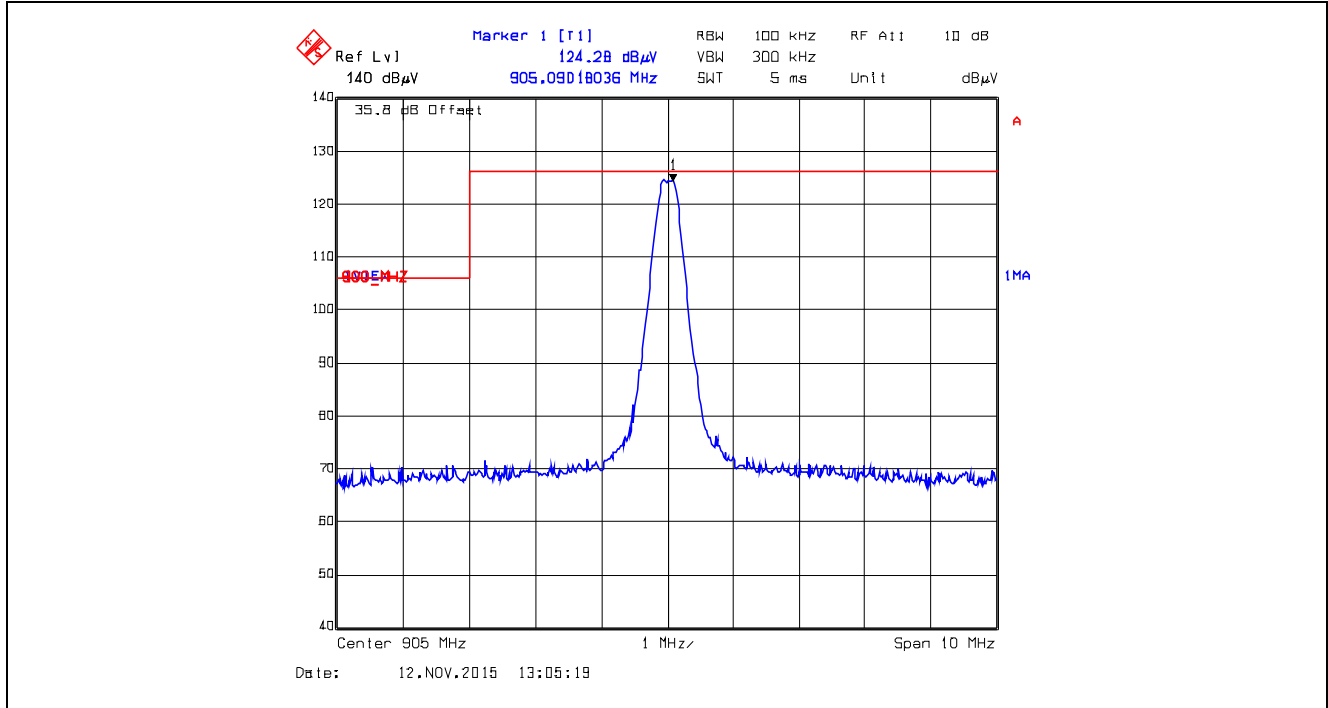

**Plot 5.5.4.5.2.36.** Band-Edge RF Radiated Emissions at 3 m, Vertical Polarization  
Pseudorandom Hopping Mode, Low End of Frequency Band, 905.0 MHz, XTC1, Data Rate at 125 kbps

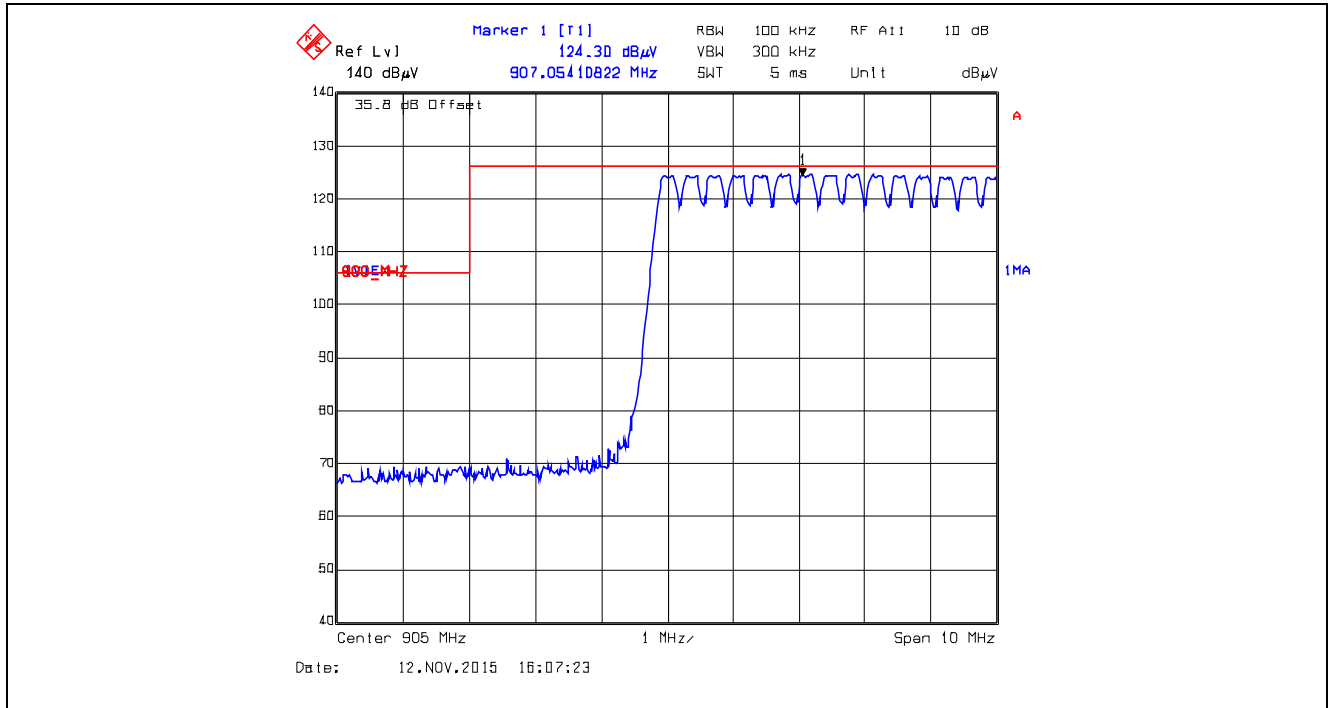

**Plot 5.5.4.5.2.37.** Band-Edge RF Radiated Emissions at 3 m, Horizontal Polarization  
 Single Frequency Mode, High End of Frequency Band, 925.0 MHz, XTC1, Data Rate at 125 kbps

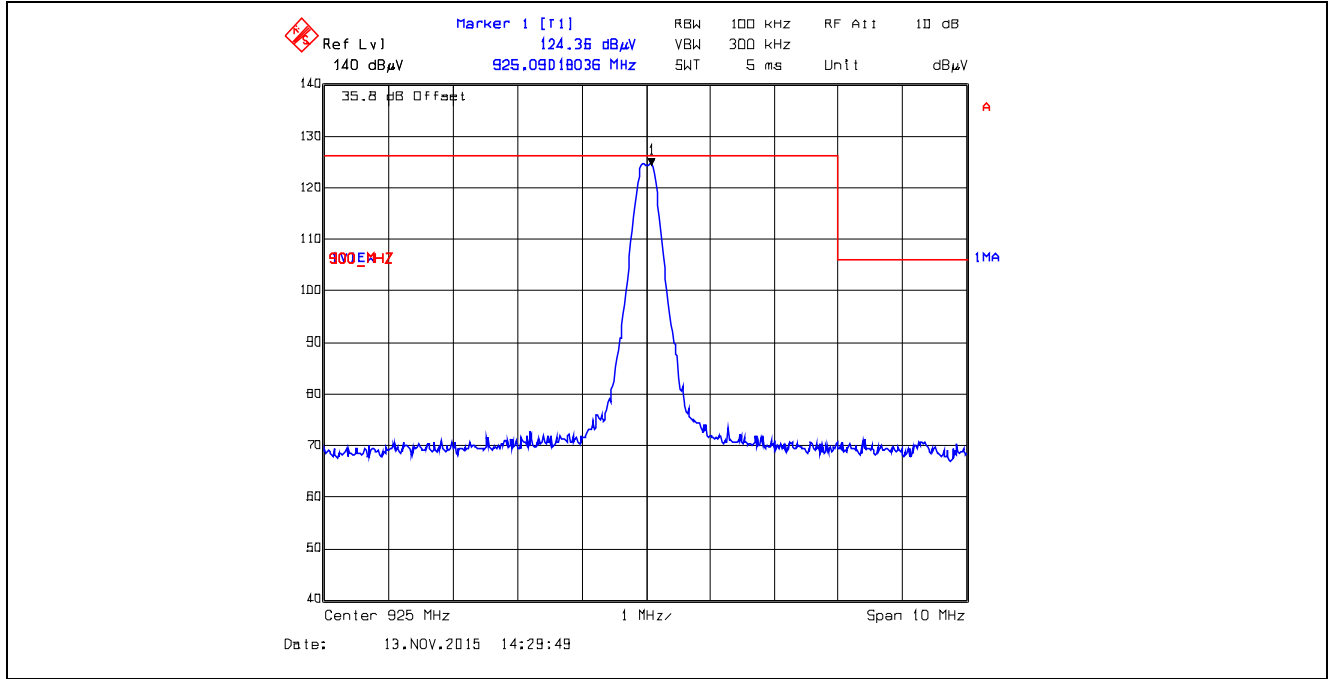

**Plot 5.5.4.5.2.38.** Band-Edge RF Radiated Emissions at 3 m, Horizontal Polarization  
 Pseudorandom Hopping Mode, High End of Frequency Band, 925.0 MHz, XTC1, Data Rate at 125 kbps

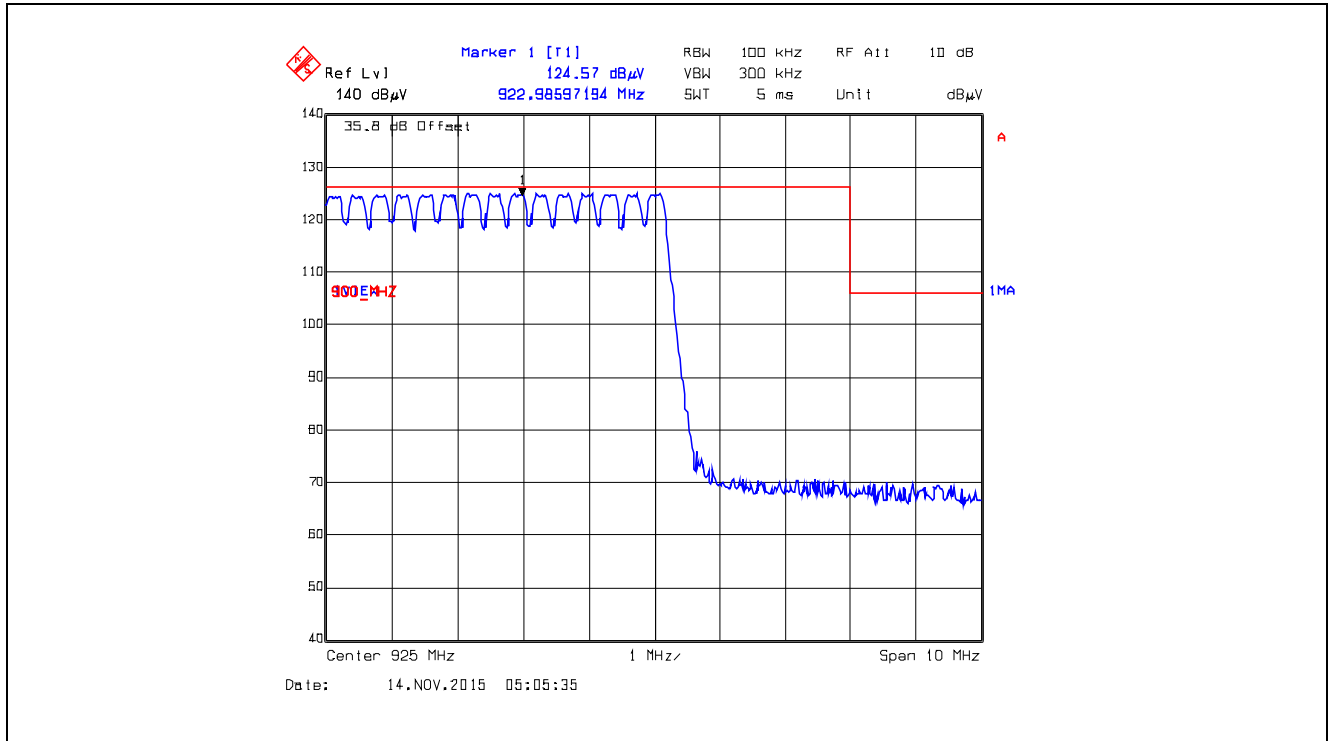

**Plot 5.5.4.5.2.39.** Band-Edge RF Radiated Emissions at 3 m, Vertical Polarization  
Single Frequency Mode, High End of Frequency Band, 925.0 MHz, XTC1, Data Rate at 125 kbps

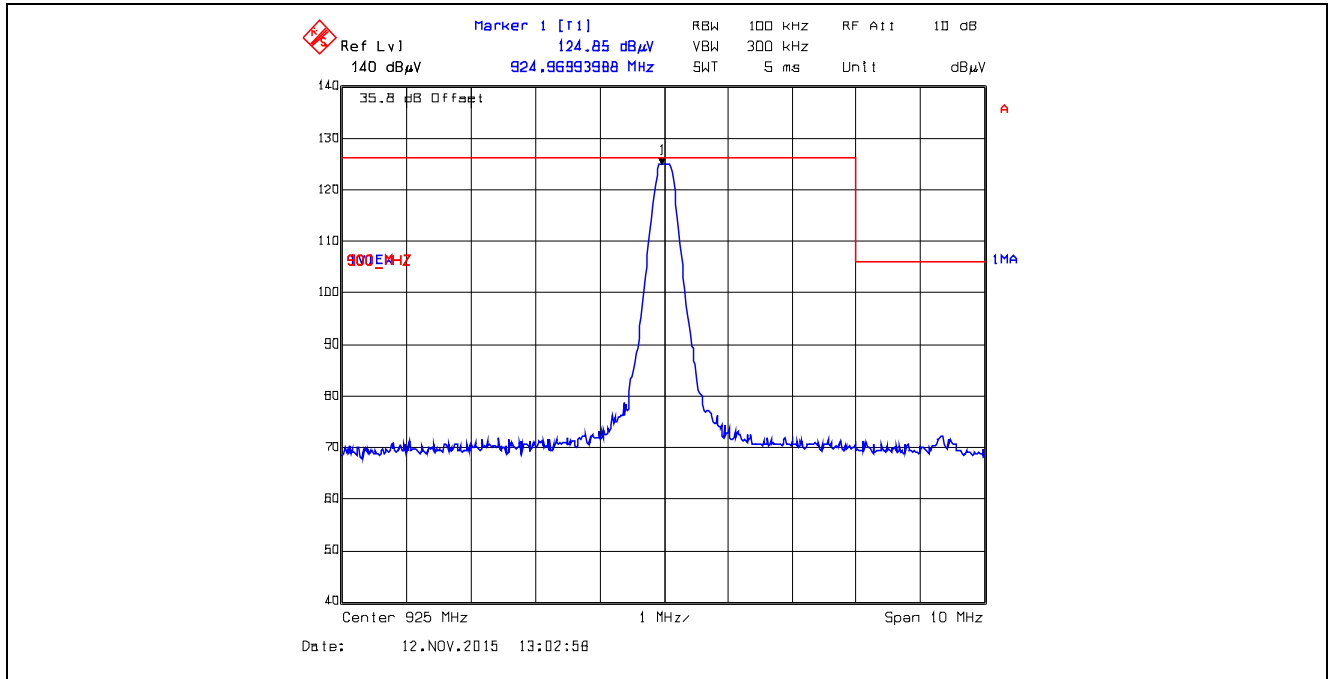

**Plot 5.5.4.5.2.40.** Band-Edge RF Radiated Emissions at 3 m, Vertical Polarization  
Pseudorandom Hopping Mode, High End of Frequency Band, 925.0 MHz, XTC1, Data Rate at 125 kbps

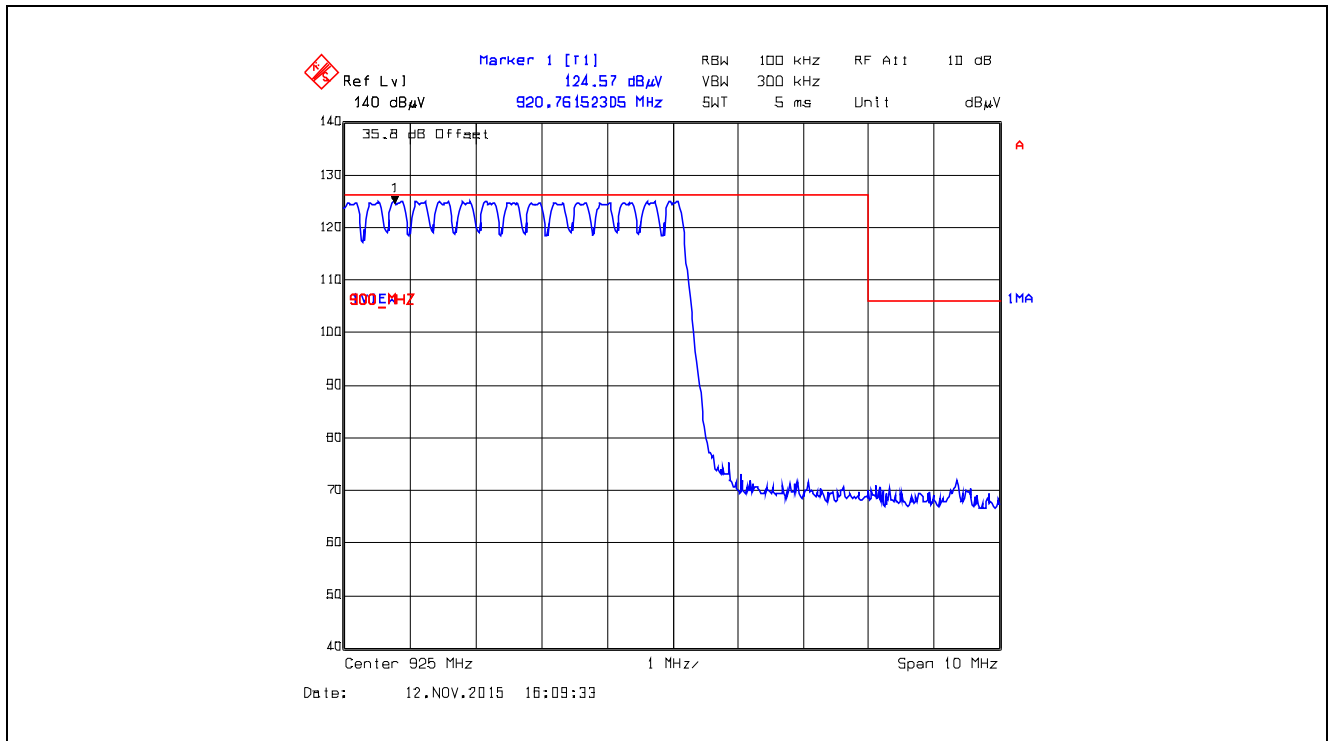

**Plot 5.5.4.5.2.41.** Band-Edge RF Radiated Emissions at 3 m, Horizontal Polarization  
 Single Frequency Mode, Low End of Frequency Band, 915.75 MHz, XTCA0, Data Rate at 10 kbps

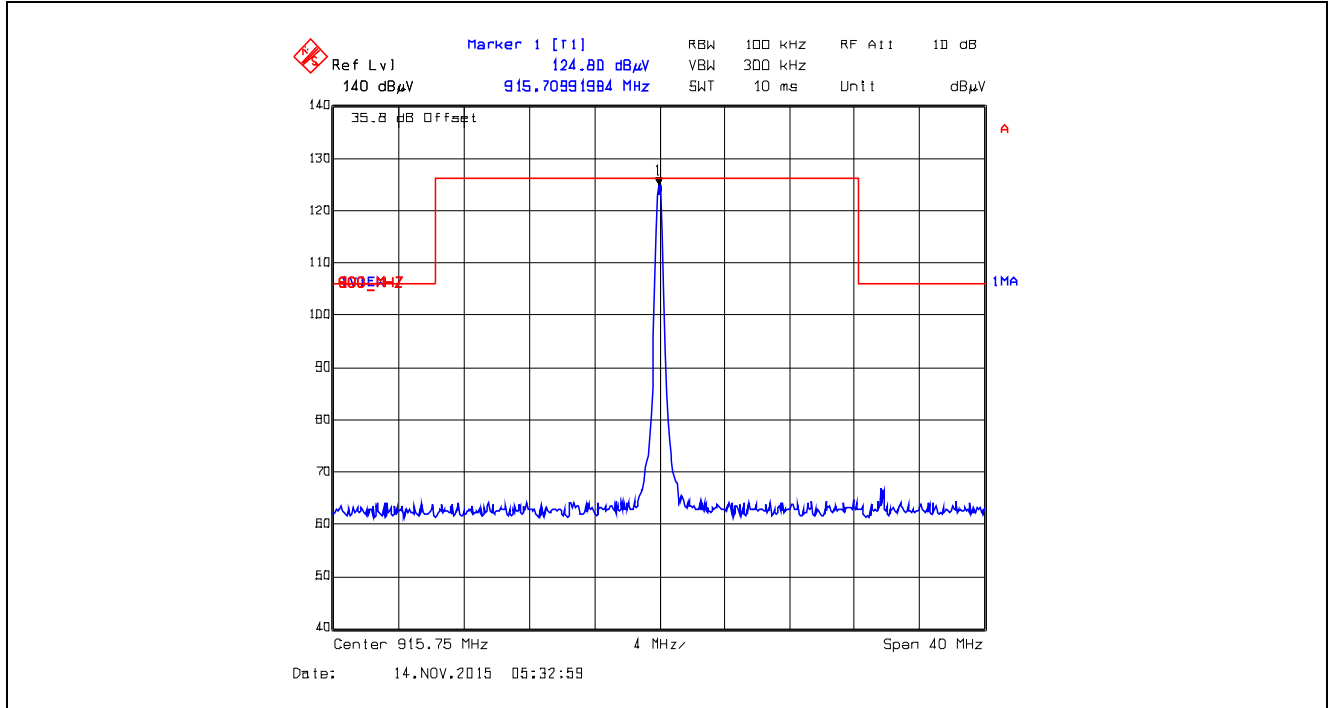

**Plot 5.5.4.5.2.42.** Band-Edge RF Radiated Emissions at 3 m, Horizontal Polarization  
 Pseudorandom Hopping Mode, Low End of Frequency Band, 915.75 MHz, XTCA0, Data Rate at 10 kbps

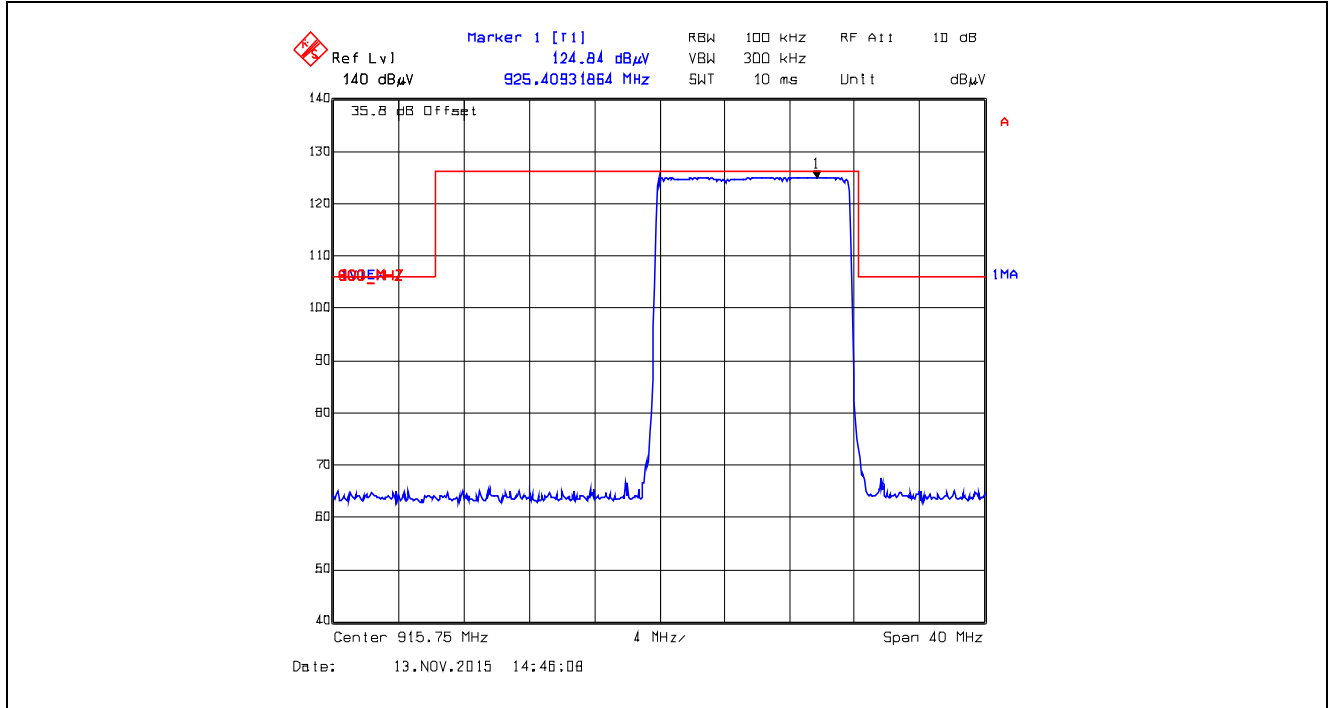

**Plot 5.5.4.5.2.43.** Band-Edge RF Radiated Emissions at 3 m, Vertical Polarization  
 Single Frequency Mode, Low End of Frequency Band, 915.75 MHz, XTCA0, Data Rate at 10 kbps

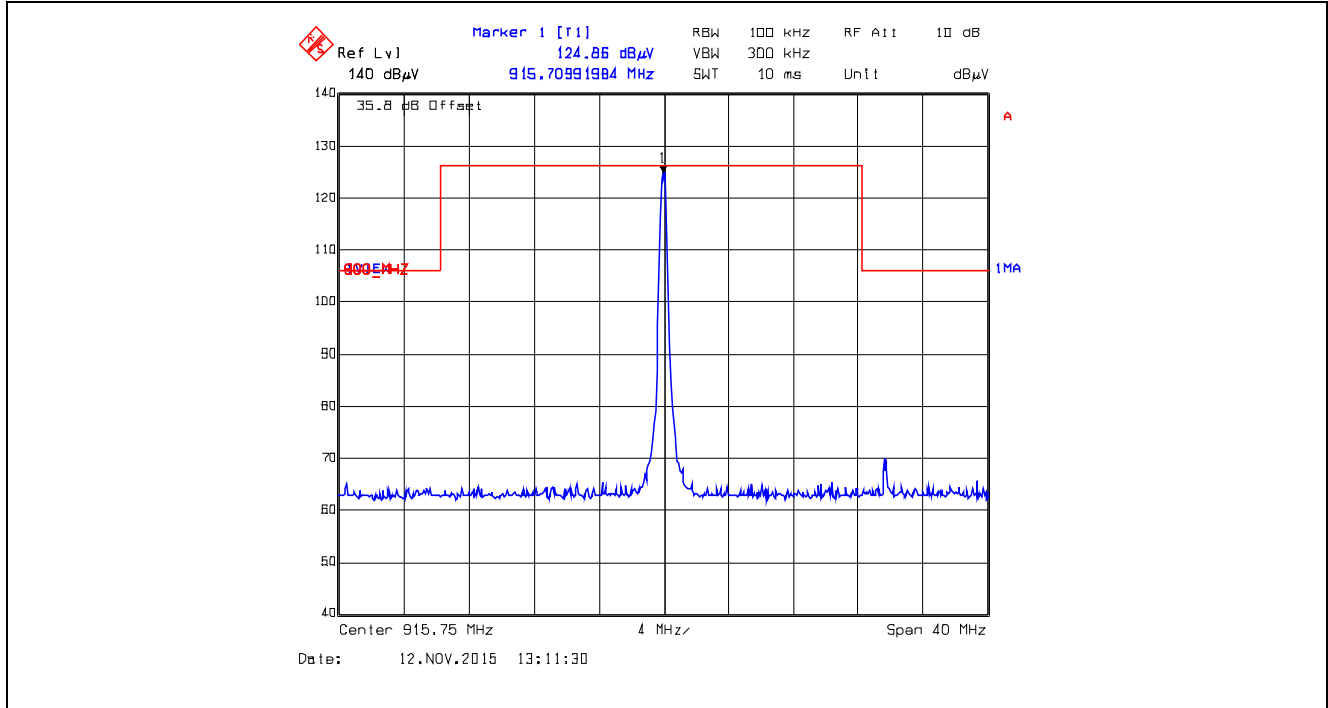

**Plot 5.5.4.5.2.44.** Band-Edge RF Radiated Emissions at 3 m, Vertical Polarization  
 Pseudorandom Hopping Mode, Low End of Frequency Band, 915.75 MHz, XTCA0, Data Rate at 10 kbps

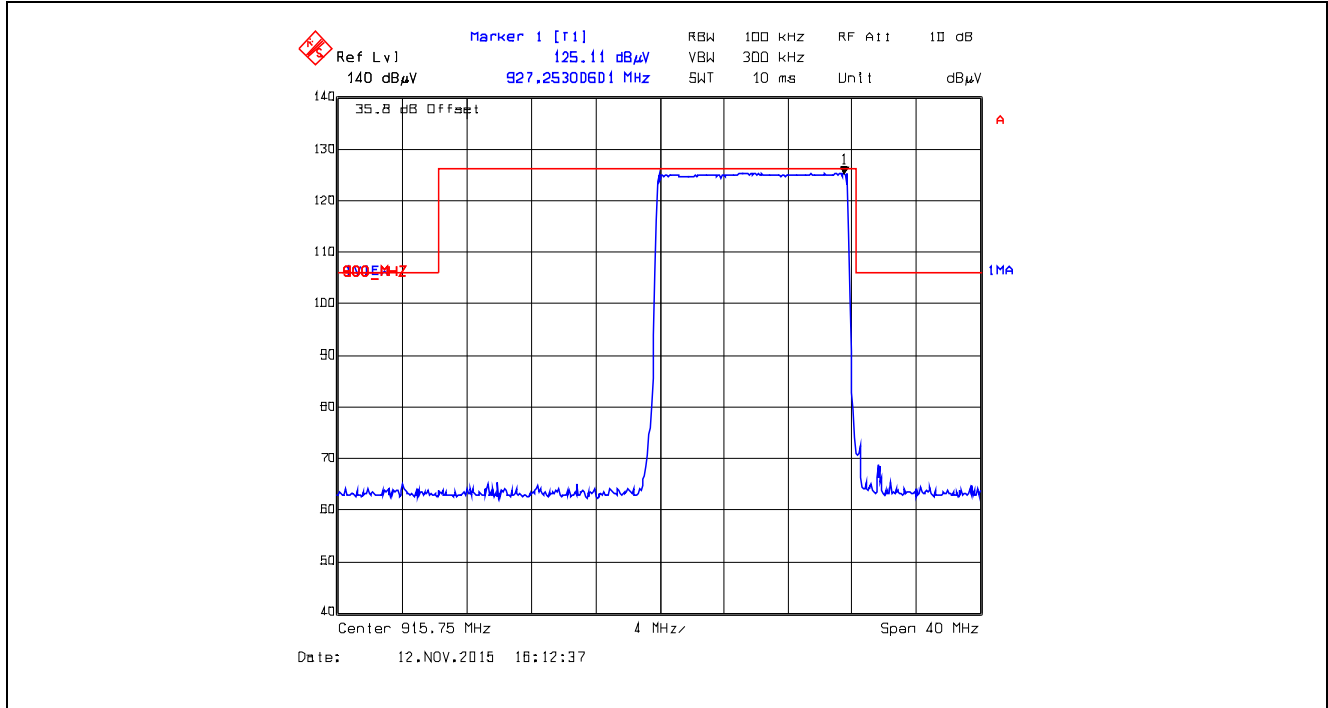



**Plot 5.5.4.5.2.45.** Band-Edge RF Radiated Emissions at 3 m, Horizontal Polarization  
 Single Frequency Mode, High End of Frequency Band, 927.265 MHz, XTCA0, Data Rate at 10 kbps

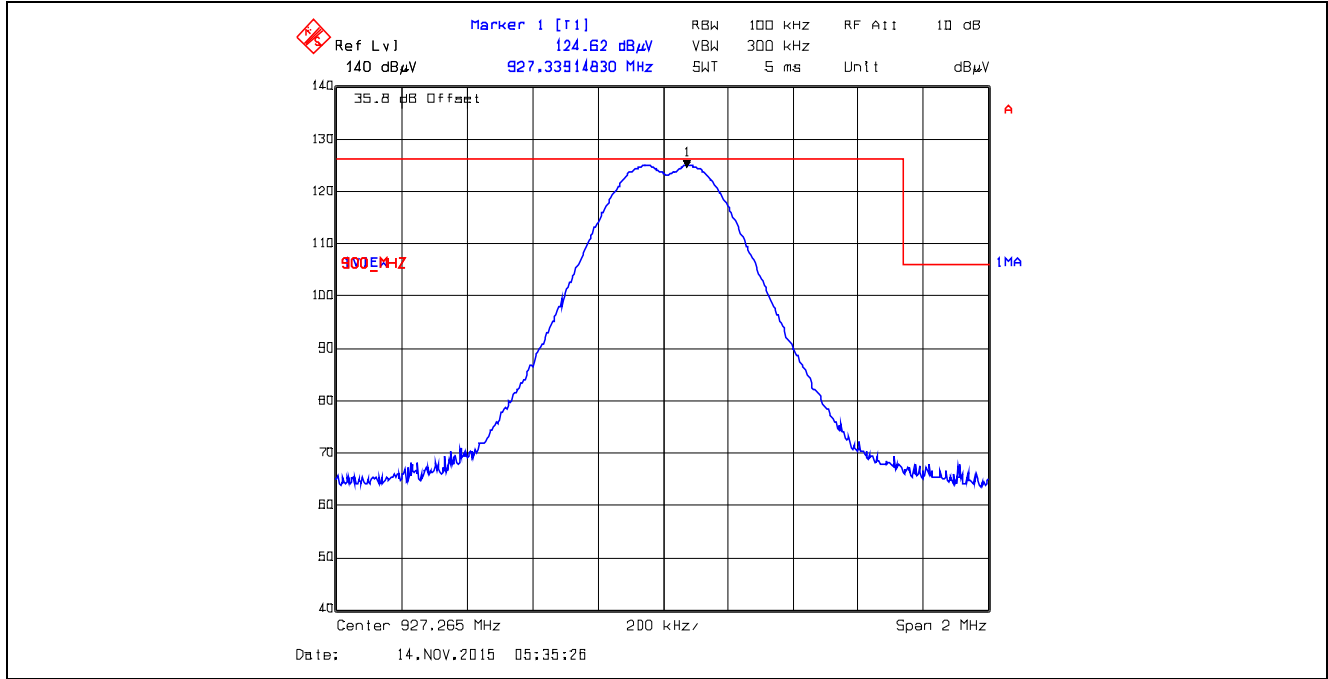

**Plot 5.5.4.5.2.46.** Band-Edge RF Radiated Emissions at 3 m, Horizontal Polarization  
 Pseudorandom Hopping Mode, High End of Frequency Band, 927.265 MHz, XTCA0, Data Rate at 10 kbps

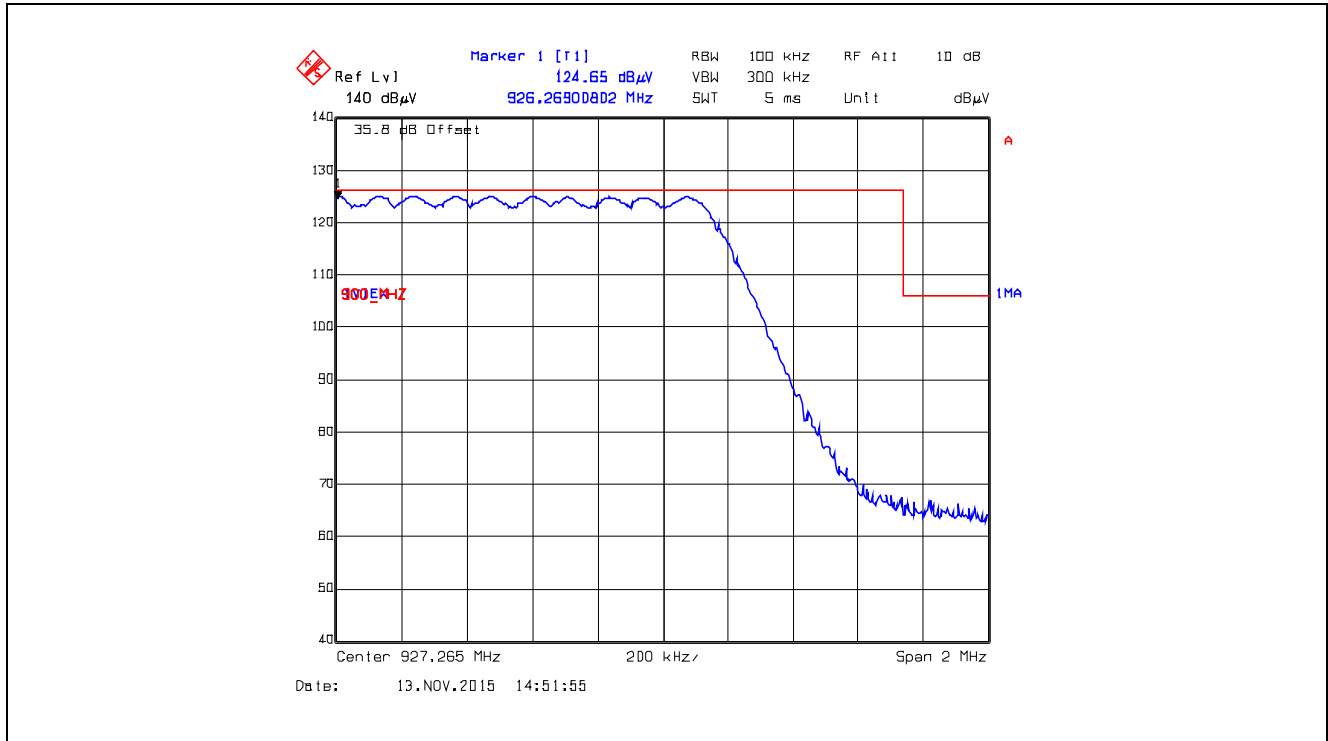

**Plot 5.5.4.5.2.47.** Band-Edge RF Radiated Emissions at 3 m, Vertical Polarization  
 Single Frequency Mode, High End of Frequency Band, 927.265 MHz, XTCA0, Data Rate at 10 kbps

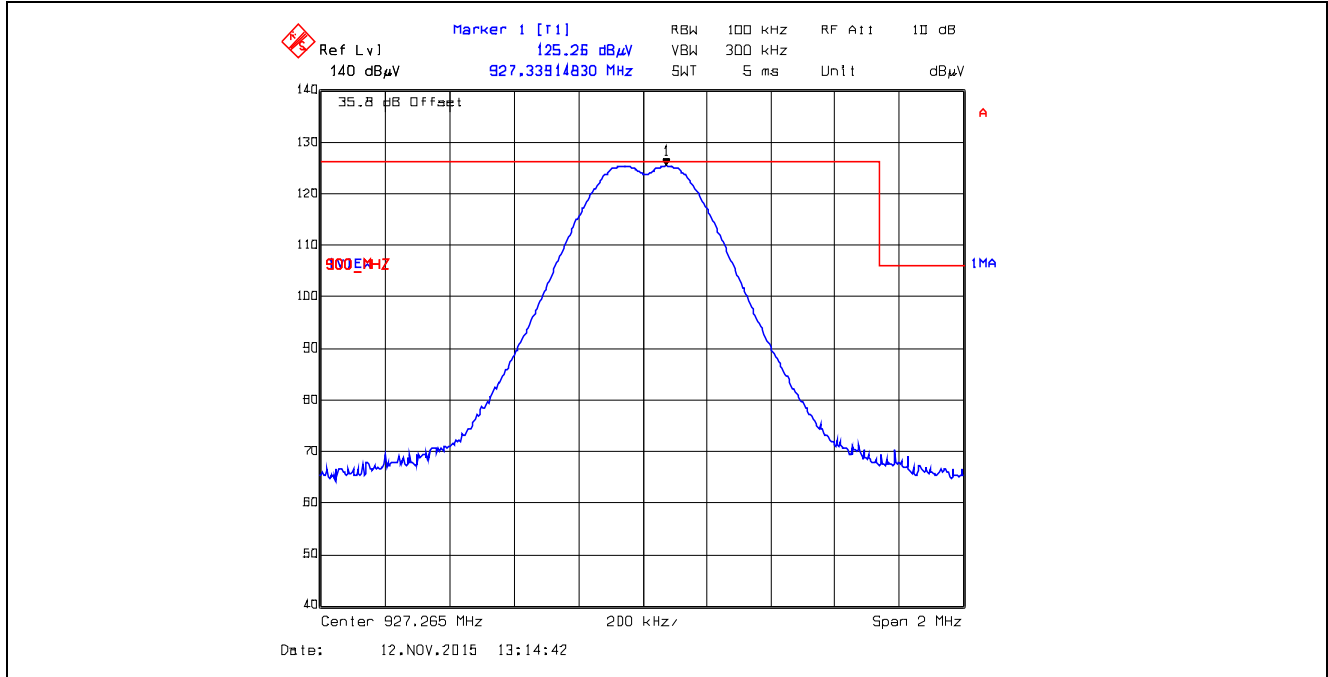

**Plot 5.5.4.5.2.48.** Band-Edge RF Radiated Emissions at 3 m, Vertical Polarization  
 Pseudorandom Hopping Mode, High End of Frequency Band, 927.265 MHz, XTCA0, Data Rate at 10 kbps

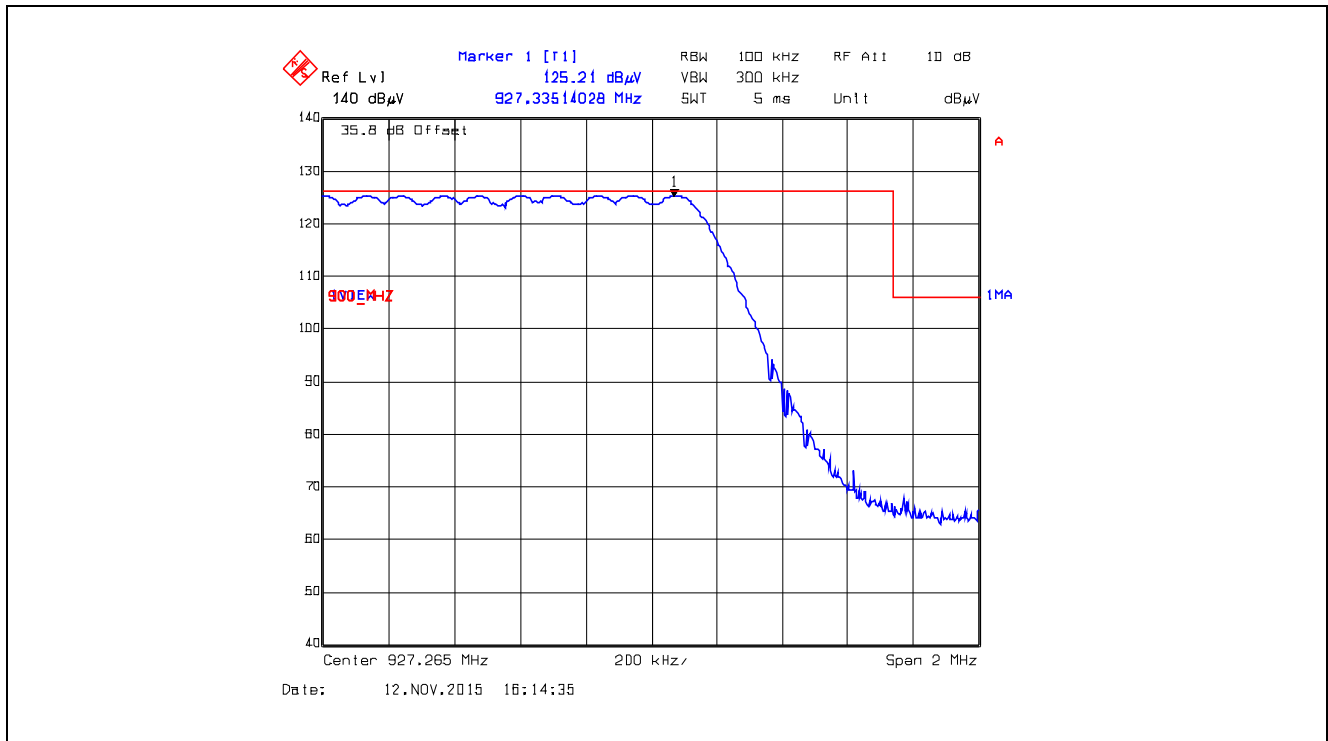

**Plot 5.5.4.5.2.49.** Band-Edge RF Radiated Emissions at 3 m, Horizontal Polarization  
Single Frequency Mode, Low End of Frequency Band, 915.75 MHz, XTCA1, Data Rate at 105kbps

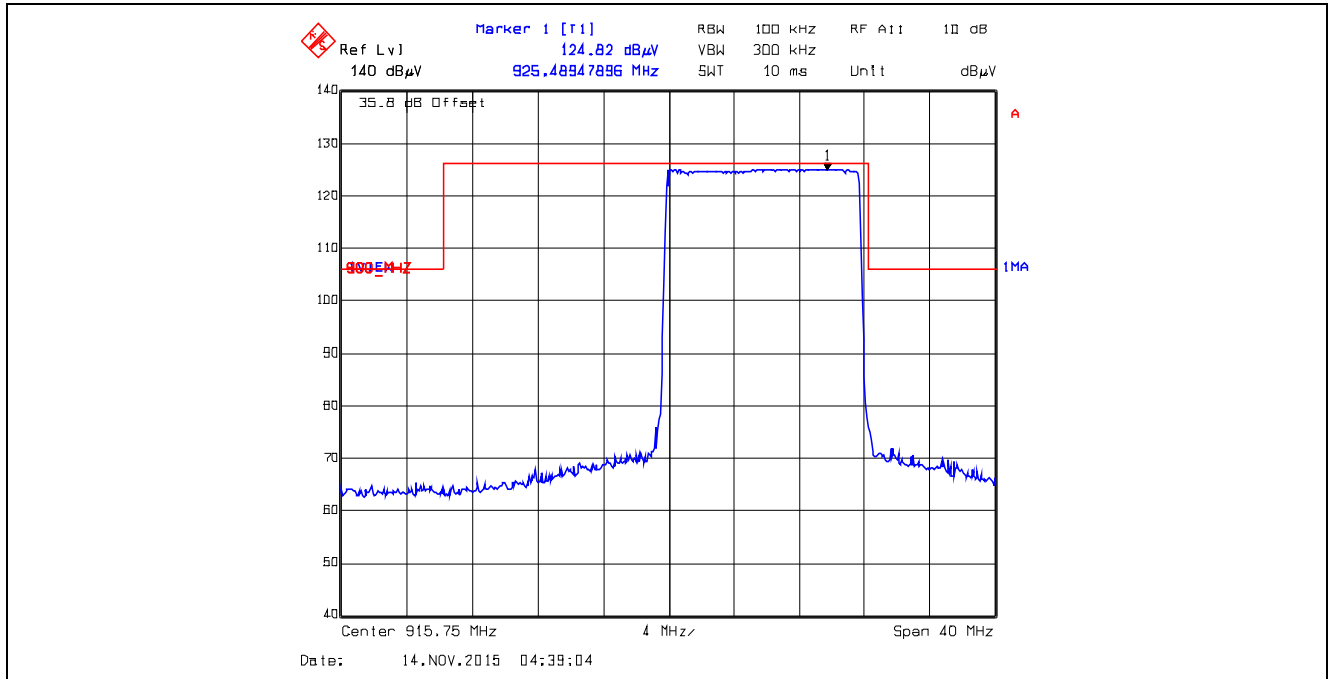

**Plot 5.5.4.5.2.50.** Band-Edge RF Radiated Emissions at 3 m, Horizontal Polarization  
Pseudorandom Hopping Mode, Low End of Frequency Band, 915.75 MHz, XTCA1, Data Rate at 105kbps

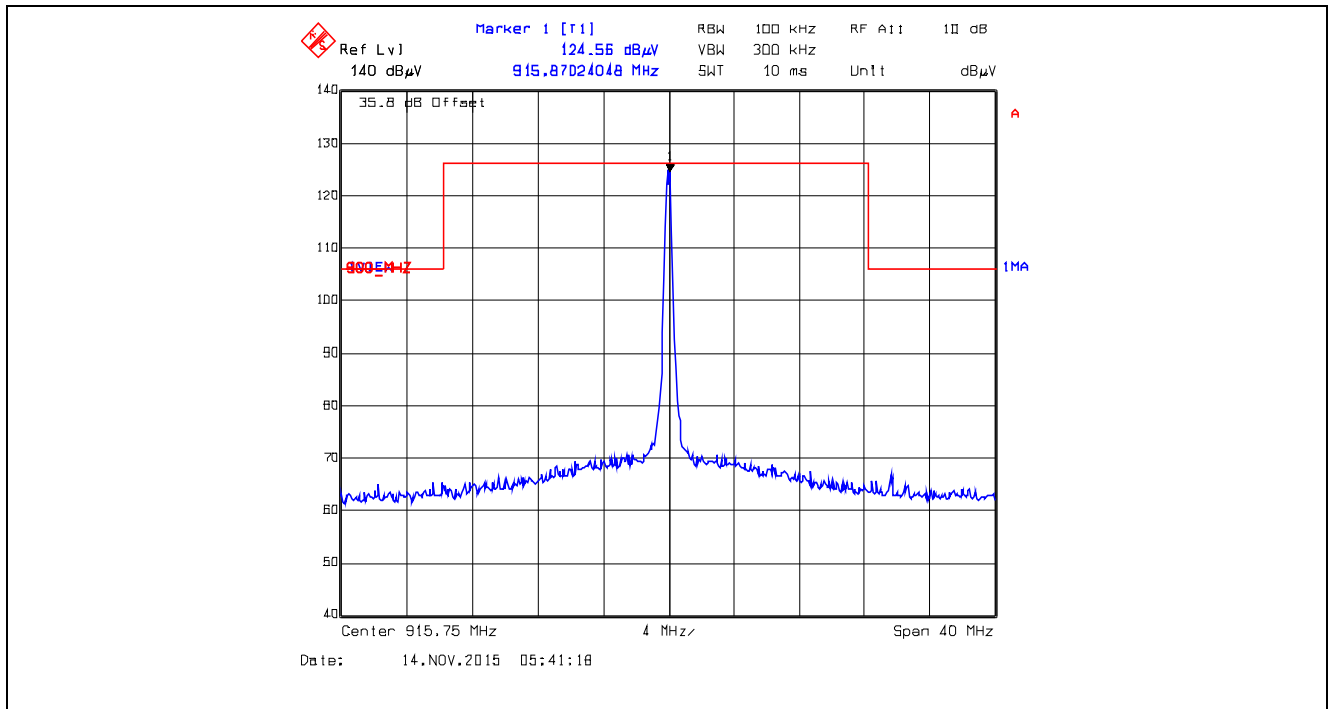

**Plot 5.5.4.5.251.** Band-Edge RF Radiated Emissions at 3 m, Vertical Polarization  
 Single Frequency Mode, Low End of Frequency Band, 915.75 MHz, XTCA1, Data Rate at 105kbps

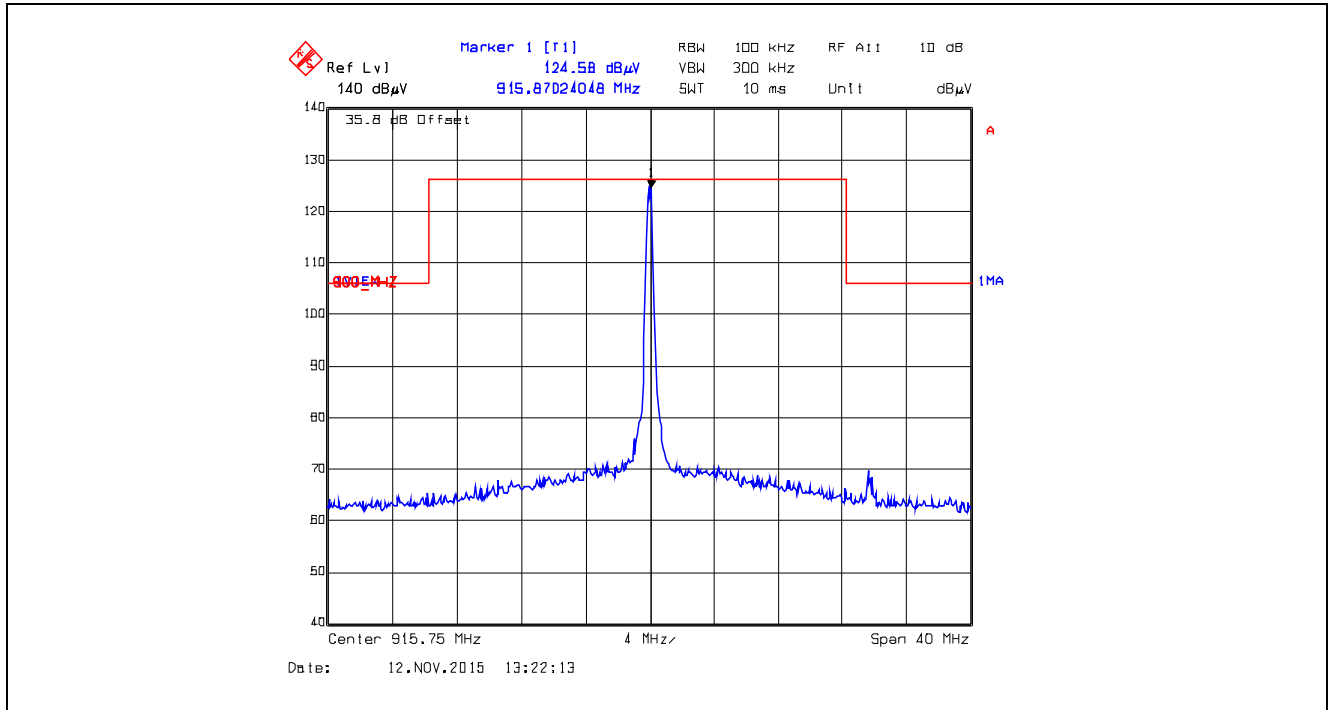

**Plot 5.5.4.5.252.** Band-Edge RF Radiated Emissions at 3 m, Vertical Polarization  
 Pseudorandom Hopping Mode, Low End of Frequency Band, 915.75 MHz, XTCA1, Data Rate at 105kbps

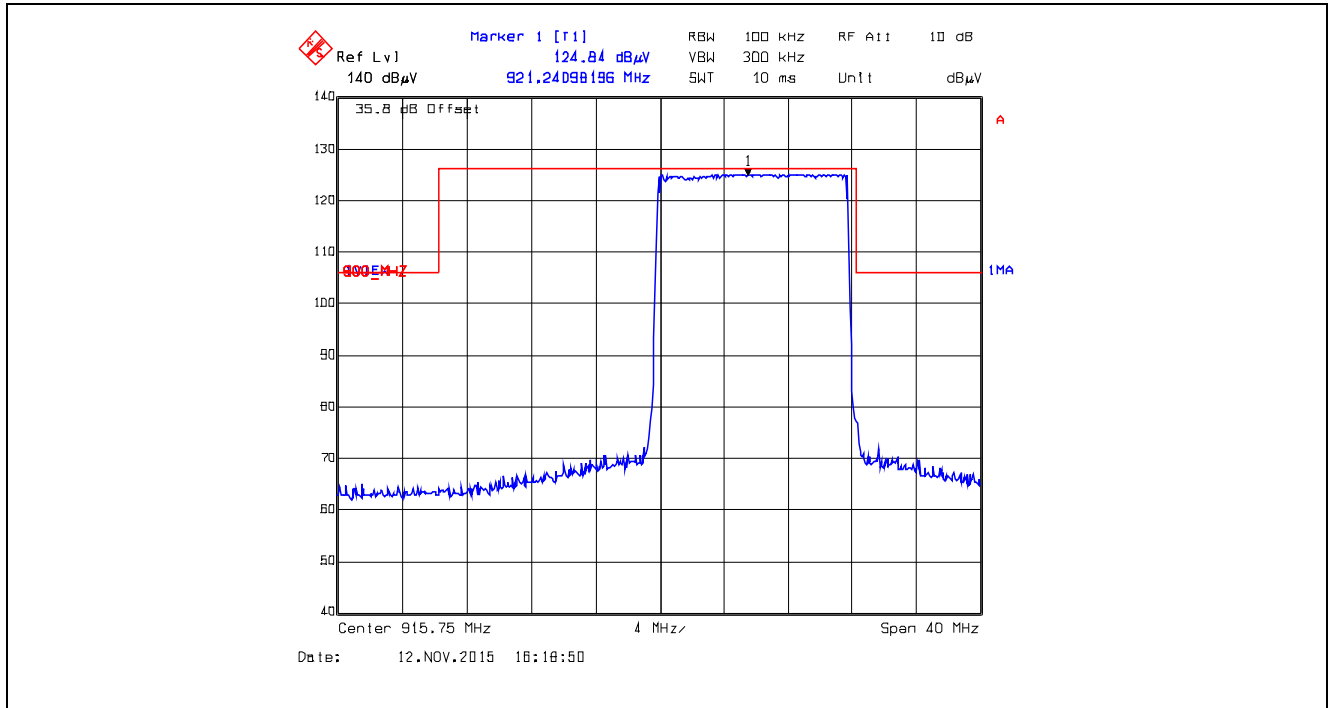

**Plot 5.5.4.5.2.53.** Band-Edge RF Radiated Emissions at 3 m, Horizontal Polarization  
 Single Frequency Mode, High End of Frequency Band, 927.265 MHz, XTCA1, Data Rate at 105kbps

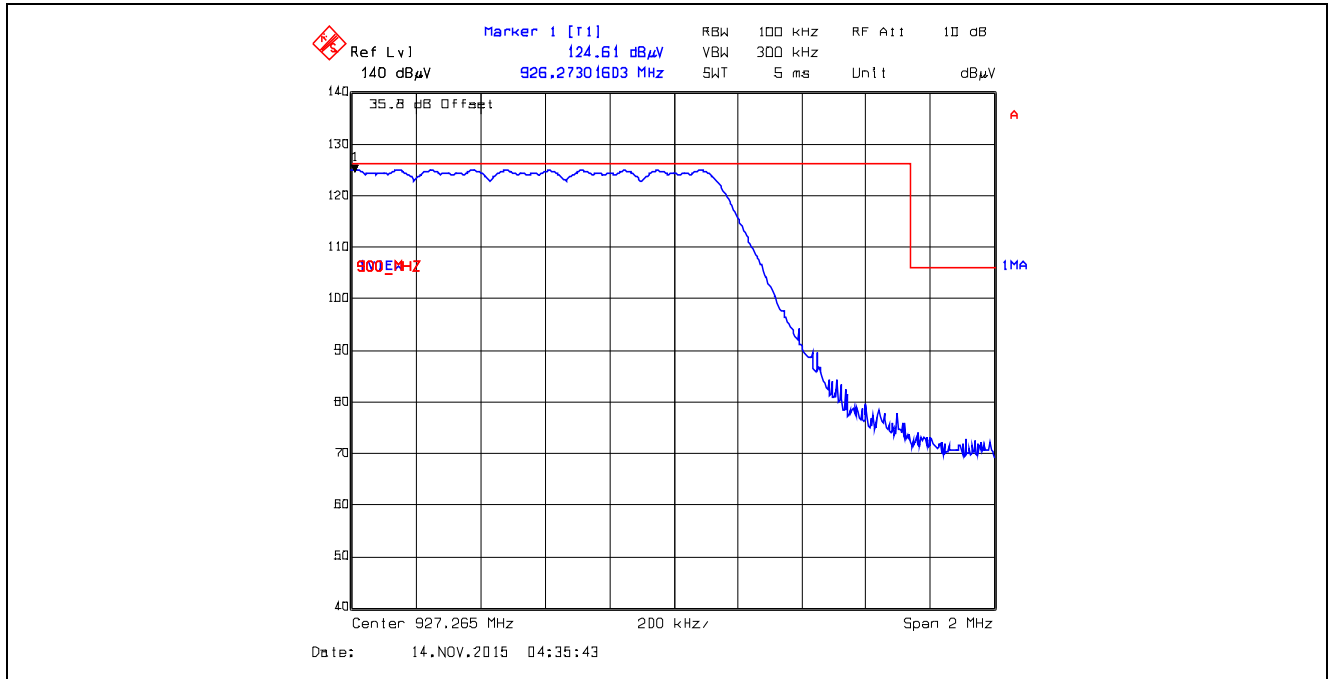

**Plot 5.5.4.5.2.54.** Band-Edge RF Radiated Emissions at 3 m, Horizontal Polarization  
 Pseudorandom Hopping Mode, High End of Frequency Band, 927.265 MHz, XTCA1, Data Rate at 105kbps

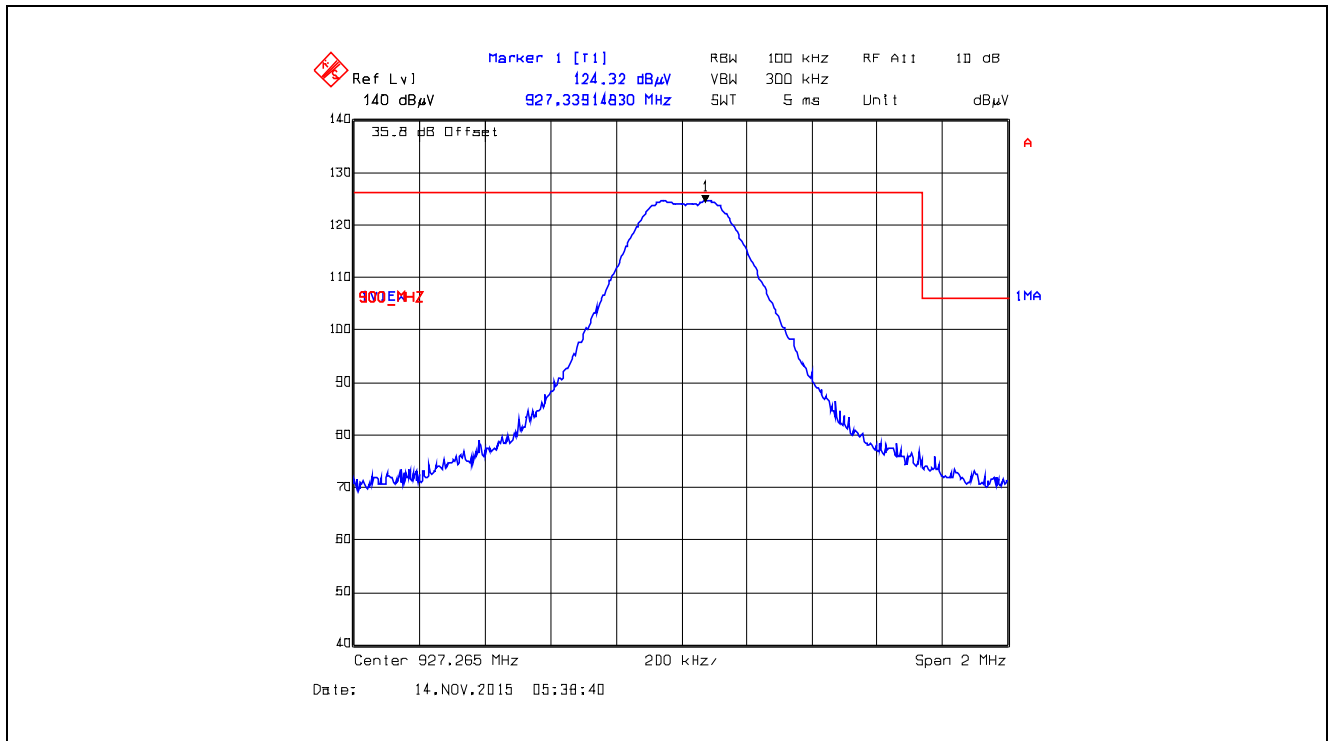

**Plot 5.5.4.5.255.** Band-Edge RF Radiated Emissions at 3 m, Vertical Polarization  
 Single Frequency Mode, High End of Frequency Band, 927.265 MHz, XTCA1, Data Rate at 105kbps

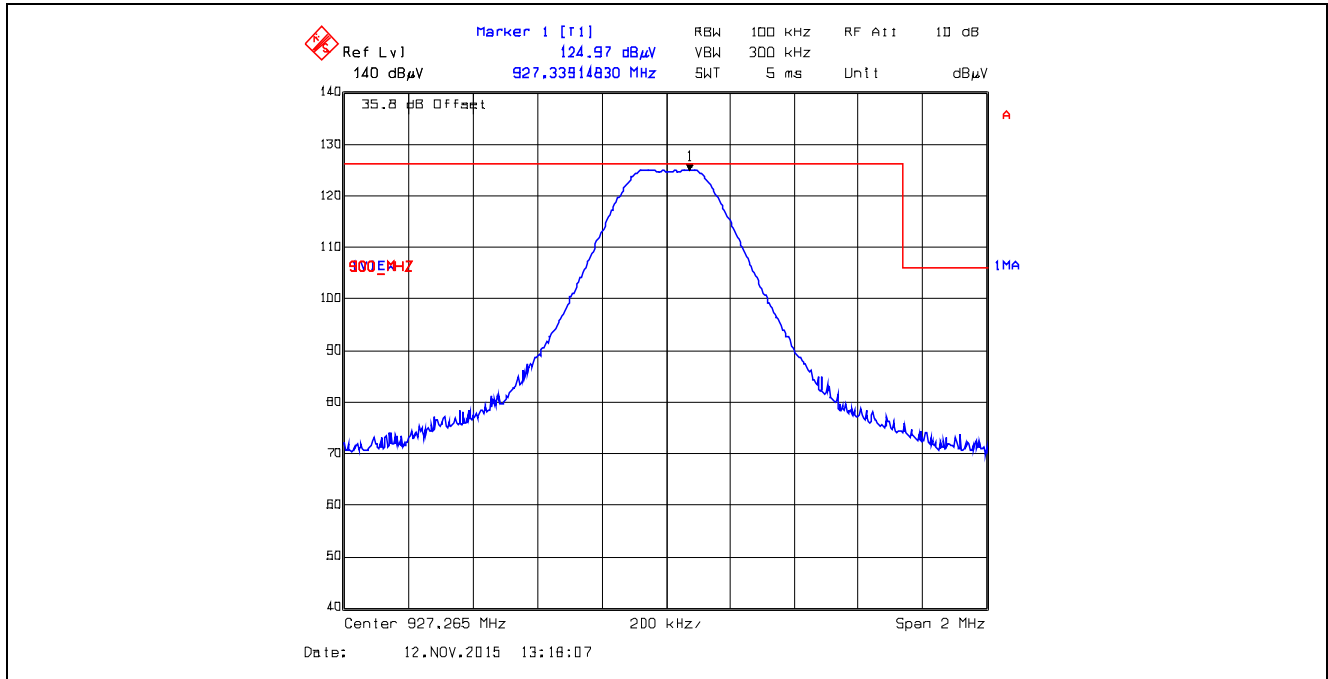

**Plot 5.5.4.5.256.** Band-Edge RF Radiated Emissions at 3 m, Vertical Polarization  
 Pseudorandom Hopping Mode, High End of Frequency Band, 927.265 MHz, XTCA1, Data Rate at 105kbps

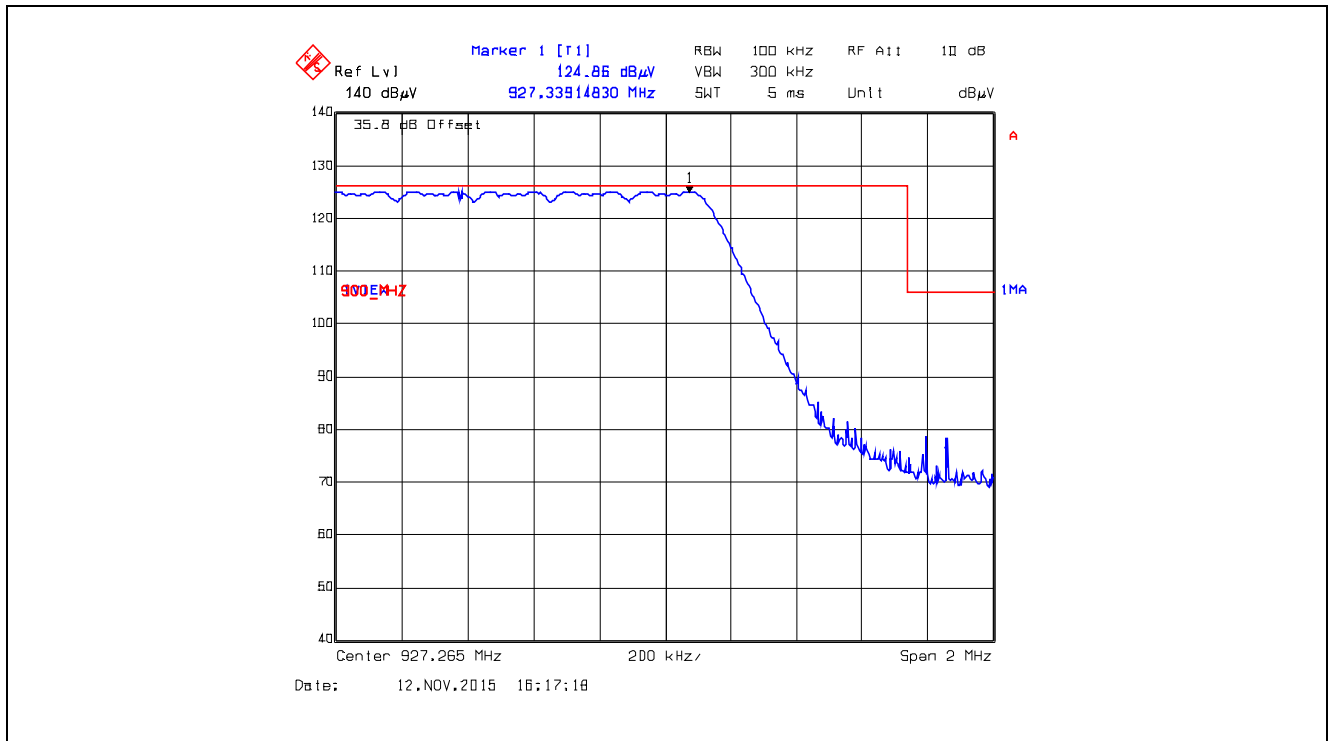

**5.6. RF EXPOSURE REQUIRMENTS [§§ 15.247(i), 1.1310 & 2.1091]**

The criteria listed in the following table shall be used to evaluate the environmental impact of human exposure to radio-frequency (RF) radiation.

**FCC 47 CFR § 1.1310:**

**TABLE 1—LIMITS FOR MAXIMUM PERMISSIBLE EXPOSURE (MPE)**

Frequency range (MHz)	Electric field strength (V/m)	Magnetic field strength (A/m)	Power density (mW/cm <sup>2</sup> )	Averaging time (minutes)
<b>(A) Limits for Occupational/Controlled Exposures</b>				
0.3–3.0 .....	614	1.63	*(100)	6
3.0–30 .....	1842/f	4.89/f	*(900/f <sup>2</sup> )	6
30–300 .....	61.4	0.163	1.0	6
300–1500 .....	.....	.....	f/300	6
1500–100,000 .....	.....	.....	5	6
<b>(B) Limits for General Population/Uncontrolled Exposure</b>				
0.3–1.34 .....	614	1.63	*(100)	30
1.34–30 .....	824/f	2.19/f	*(180/f <sup>2</sup> )	30
30–300 .....	27.5	0.073	0.2	30
300–1500 .....	.....	.....	f/1500	30
1500–100,000 .....	.....	.....	1.0	30

f = frequency in MHz

\* = Plane-wave equivalent power density

NOTE 1 TO TABLE 1: Occupational/controlled limits apply in situations in which persons are exposed as a consequence of their employment provided those persons are fully aware of the potential for exposure and can exercise control over their exposure. Limits for occupational/controlled exposure also apply in situations when an individual is transient through a location where occupational/controlled limits apply provided he or she is made aware of the potential for exposure.

NOTE 2 TO TABLE 1: General population/uncontrolled exposures apply in situations in which the general public may be exposed, or in which persons that are exposed as a consequence of their employment may not be fully aware of the potential for exposure or can not exercise control over their exposure.

**5.6.1. Method of Measurements**

Refer to Sections 1.1310, 2.1091

In order to demonstrate compliance with MPE requirements (see Section 2.1091), the following information is typically needed:

- (1) Calculation that estimates the minimum separation distance (20 cm or more) between an antenna and persons required to satisfy power density limits defined for free space.
- (2) Antenna installation and device operating instructions for installers (professional/unskilled users), and the parties responsible for ensuring compliance with the RF exposure requirement
- (3) Any caution statements and/or warning labels that are necessary in order to comply with the exposure limits
- (4) Any other RF exposure related issues that may affect MPE compliance

**Calculation Method of RF Safety Distance:**

$$S = \frac{P \cdot G}{4 \cdot \pi \cdot r^2} = \frac{EIRP}{4 \cdot \pi \cdot r^2}$$

Where: P: power input to the antenna in mW  
 EIRP: Equivalent (effective) isotropic radiated power  
 S: power density mW/cm<sup>2</sup>  
 G: numeric gain of antenna relative to isotropic radiator  
 r: distance to centre of radiation in cm

**5.6.2. RF Evaluation**

Evaluation of RF Exposure Compliance Requirements	
RF Exposure Requirements	Compliance with FCC Rules
Minimum calculated separation distance between antenna and persons required: <b>*23 cm</b>	Manufacturer’ instruction for separation distance between antenna and persons required: <b>34 cm.</b>
Antenna installation and device operating instructions for installers (professional/unskilled users), and the parties responsible for ensuring compliance with the RF exposure requirement	Antenna installation and device operating instructions shall be provided to installers to maintain and ensure compliance with RF exposure requirements.
Caution statements and/or warning labels that are necessary in order to comply with the exposure limits	Refer to User’s Manual for RF Exposure Information.
Any other RF exposure related issues that may affect MPE compliance	None.

\*The minimum separation distance between the antenna and bodies of users are calculated using the following formula:

**RF EXPOSURE DISTANCE LIMITS**

$$r = \sqrt{\frac{P \cdot G}{4 \cdot \pi \cdot S}} = \sqrt{\frac{EIRP}{4 \cdot \pi \cdot S}}$$

S = f/1500 = 902.5/1500 = 0.6 mW/cm<sup>2</sup>  
 EIRP = 36.0 dBm = 10<sup>36/10</sup> mW = 3981 mW (Worst Case)

(Minimum Safe Distance, r) =  $\sqrt{\frac{EIRP}{4 \cdot \pi \cdot S}} = \sqrt{\frac{3981}{4 \cdot \pi \cdot (0.6)}} \approx 23cm$



**EXHIBIT 6. TEST EQUIPMENT LIST**

Test Instruments	Manufacturer	Model No.	Serial No.	Frequency Range	Cal. Due Date
Spectrum Analyzer	Hewlett Packard	HP 8593EM	3412A00103	9 kHz–26.5 GHz	09 Apr 2017
Attenuator	Pasternack	PE7010-20	-	DC–2 GHz	03 Feb 2017
L.I.S.N	EMCO	3825/2	2209	0.01 -100 MHz	29 Sep 2016
Signal Generator	Hewlett Packard	8648C	3443U00391	100 kHz – 3200 MHz	02 Feb 2017
Spectrum Analyzer	Rohde & Schwarz	FSEK30	100077	20Hz–40 GHz	21 Nov 2016
Attenuator	Pasternack	PE7024-20	6	DC–26.5 GHz	Cal on use
DC Block	Hewlett Packard	11742A	12460	0.045–26.5 GHz	Cal on use
High Pass Filter	K & L	11SH10-1500/T8000	2	Cut off 900 MHz	Cal on use
Spectrum Analyzer	Rohde & Schwarz	ESU40	100037	20 Hz – 40 GHz	08 May 2017
RF Amplifier	Com Power	PAM-118A	551016	0.5 – 18 GHz	06 Jan 2016
RF Amplifier	Hewlett Packard	84498	3008A00769	1 – 26.5 GHz	25 Nov 2015*
Biconi-Log Antenna	ETS Lindgren	3142C	26873	26 – 3000 MHz	14 Apr 2016
Horn Antenna	EMCO	3155	5955	1 – 18 GHz	26 Mar 2016
High Pass Filter	K & L	11SH10-1500/T8000	2	Cut off 900 MHz	Cal on use
Band Reject Filter	Micro-Tronics	BRC50722	001	Cut off 902-928 MHz	Cal on use
Attenuator	Pasternack	PE7024-10	4	DC–26.5 GHz	Cal on use

\*Test instrument used before its cal due date

## EXHIBIT 7. MEASUREMENT UNCERTAINTY

The measurement uncertainties stated were calculated in accordance with the requirements of CISPR 16-4-2 @ IEC:2003 and JCGM 100:2008 (GUM 1995) – Guide to the Expression of Uncertainty in Measurement.

### 7.1. LINE CONDUCTED EMISSION MEASUREMENT UNCERTAINTY

	Line Conducted Emission Measurement Uncertainty (9 kHz – 30 MHz):	Measured	Limit
<b>u<sub>c</sub></b>	<b>Combined standard uncertainty:</b> $u_c(y) = \sqrt{\sum_{i=1}^m u_i^2(y)}$	± 1.44	± 1.8
<b>U</b>	<b>Expanded uncertainty U:</b> $U = 2u_c(y)$	± 2.89	± 3.6

### 7.2. RADIATED EMISSION MEASUREMENT UNCERTAINTY

	Radiated Emission Measurement Uncertainty @ 3m, Horizontal (30-1000 MHz):	Measured (dB)	Limit (dB)
<b>u<sub>c</sub></b>	<b>Combined standard uncertainty:</b> $u_c(y) = \sqrt{\sum_{i=1}^m u_i^2(y)}$	± 2.39	± 2.6
<b>U</b>	<b>Expanded uncertainty U:</b> $U = 2u_c(y)$	± 4.79	± 5.2

	Radiated Emission Measurement Uncertainty @ 3m, Vertical (30-1000 MHz):	Measured (dB)	Limit (dB)
<b>u<sub>c</sub></b>	<b>Combined standard uncertainty:</b> $u_c(y) = \sqrt{\sum_{i=1}^m u_i^2(y)}$	± 2.39	± 2.6
<b>U</b>	<b>Expanded uncertainty U:</b> $U = 2u_c(y)$	± 4.78	± 5.2

	Radiated Emission Measurement Uncertainty @ 3 m, Horizontal & Vertical (1 – 18 GHz):	Measured (dB)	Limit (dB)
<b>u<sub>c</sub></b>	<b>Combined standard uncertainty:</b> $u_c(y) = \sqrt{\sum_{i=1}^m u_i^2(y)}$	± 1.87	Under consideration
<b>U</b>	<b>Expanded uncertainty U:</b> $U = 2u_c(y)$	± 3.75	Under consideration