

ENGINEERING TEST REPORT

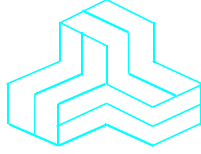

XBee S6B
Model: XBEE56B
FCC ID: MCQ-XBS6B

Applicant:

Digi International Inc.
11001 Bren Road East
Minnetonka, MN 55343

In Accordance With

Federal Communications Commission (FCC)
Part 15, Subpart C, Section 15.247
Digital Modulation Systems (DTS) Operating in 2400 – 2483.5 MHz Band

UltraTech's File No.: DIGI-064F15C247

This Test report is Issued under the Authority of
Tri M. Luu
Vice President of Engineering
UltraTech Group of Labs

Date: October 26, 2012

Report Prepared by: Dan Huynh

Tested by: Mr. Hung Trinh

Issued Date: October 26, 2012

Test Dates: October 2 -10, 2012

- *The results in this Test Report apply only to the sample(s) tested, and the sample tested is randomly selected.*
- *This report must not be used by the client to claim product endorsement by NVLAP or any agency of the US Government.*

UltraTech

3000 Bristol Circle, Oakville, Ontario, Canada, L6H 6G4
Tel.: (905) 829-1570 Fax.: (905) 829-8050
Website: www.ultratech-labs.com, Email: vic@ultratech-labs.com, Email: tri@ultratech-labs.com

FCC

91038



1309



46390-2049



NVLap Lab Code 200093-0



SL2-IN-E-1119R



Korea KCC-RRL
CA2049

TABLE OF CONTENTS

EXHIBIT 1. INTRODUCTION..... 1

1.1. SCOPE 1

1.2. RELATED SUBMITTAL(S)/GRANT(S) 1

1.3. NORMATIVE REFERENCES 1

EXHIBIT 2. PERFORMANCE ASSESSMENT..... 2

2.1. CLIENT INFORMATION 2

2.2. EQUIPMENT UNDER TEST (EUT) INFORMATION 2

2.3. EUT’S TECHNICAL SPECIFICATIONS..... 3

2.4. ASSOCIATED ANTENNA DESCRIPTIONS 3

2.5. LIST OF EUT’S PORTS..... 3

2.6. ANCILLARY EQUIPMENT 4

EXHIBIT 3. EUT OPERATING CONDITIONS AND CONFIGURATIONS DURING TESTS..... 5

3.1. CLIMATE TEST CONDITIONS 5

3.2. OPERATIONAL TEST CONDITIONS & ARRANGEMENT FOR TESTS..... 5

EXHIBIT 4. SUMMARY OF TEST RESULTS 6

4.1. LOCATION OF TESTS 6

4.2. APPLICABILITY & SUMMARY OF EMC EMISSION TEST RESULTS 6

4.3. MODIFICATIONS INCORPORATED IN THE EUT FOR COMPLIANCE PURPOSES..... 6

EXHIBIT 5. TEST DATA 7

5.1. POWER LINE CONDUCTED EMISSIONS [§15.207(a)]..... 7

5.2. OCCUPIED BANDWIDTH [§ 15.247(a)(2)]..... 10

5.3. PEAK CONDUCTED OUTPUT POWER - DTS [§ 15.247(b)(3)] 58

5.4. TRANSMITTER BAND-EDGE & SPURIOUS CONDUCTED EMISSIONS [§ 15.247(d)] 61

5.5. TRANSMITTER SPURIOUS RADIATED EMISSIONS AT 3 METERS [§§ 15.247(d), 15.209 & 15.205] 136

5.6. POWER SPECTRAL DENSITY [§ 15.247(e)]..... 142

5.7. RF EXPOSURE REQUIRMENTS [§§ 15.247(e)(i), 1.1310 & 2.1091] 167

EXHIBIT 6. TEST EQUIPMENT LIST 169

EXHIBIT 7. MEASUREMENT UNCERTAINTY 170

7.1. LINE CONDUCTED EMISSION MEASUREMENT UNCERTAINTY 170

7.2. RADIATED EMISSION MEASUREMENT UNCERTAINTY 170

EXHIBIT 1. INTRODUCTION

1.1. SCOPE

Reference:	FCC Part 15, Subpart C, Section 15.247
Title:	Code of Federal Regulations (CFR), Title 47 – Telecommunication, Part 15 – Radio Frequency Devices
Purpose of Test:	Equipment Certification for Digital Modulation Systems (DTS) Transmitter Operating in the Frequency Band 2400-2483.5 MHz.
Test Procedures:	<ul style="list-style-type: none"> ▪ ANSI C63.4 ▪ ANSI C63.10 ▪ FCC, KDB Publication No. 558074 D01
Environmental Classification:	<input checked="" type="checkbox"/> Commercial, industrial or business environment <input checked="" type="checkbox"/> Residential environment

1.2. RELATED SUBMITTAL(S)/GRANT(S)

None.

1.3. NORMATIVE REFERENCES

Publication	Year	Title
47 CFR Parts 0-19	2011	Code of Federal Regulations (CFR), Title 47 – Telecommunication
ANSI C63.4	2009	American National Standard for Methods of Measurement of Radio-Noise Emissions from Low-Voltage Electrical and Electronic Equipment in the Range of 9 KHz to 40 GHz
ANSI C63.10	2009	American National Standard for Testing Unlicensed Wireless Devices
CISPR 22 & EN 55022	2008-09, Edition 6.0 2006	Information Technology Equipment - Radio Disturbance Characteristics - Limits and Methods of Measurement
CISPR 16-1-1 +A1 +A2	2006 2006 2007	Specification for radio disturbance and immunity measuring apparatus and methods. Part 1-1: Measuring Apparatus
CISPR 16-1-2 +A1 +A2	2003 2004 2006	Specification for radio disturbance and immunity measuring apparatus and methods. Part 1-2: Conducted disturbances
FCC, KDB Publication No. 558074 D01 DTS Meas Guidance v01	2012	Guidance on Measurements for Digital Transmission Systems (47 CFR 15.247)

EXHIBIT 2. PERFORMANCE ASSESSMENT

2.1. CLIENT INFORMATION

APPLICANT	
Name:	Digi International Inc.
Address:	11001 Bren Road East Minnetonka, MN 55343 USA
Contact Person:	Mr. Paul Dahl Phone #: 801-765-9885 Fax #: 801-765-9895 Email Address: paul.dahl@digi.com

MANUFACTURER	
Name:	Digi International Inc.
Address:	11001 Bren Road East Minnetonka, MN 55343 USA
Contact Person:	Mr. Paul Dahl Phone #: 801-765-9885 Fax #: 801-765-9895 Email Address: paul.dahl@digi.com

2.2. EQUIPMENT UNDER TEST (EUT) INFORMATION

The following information (with the exception of the Date of Receipt) has been supplied by the applicant.

Brand Name:	Digi International Inc.
Product Name:	XBee S6B
Model Name or Number:	XBEE6B
Serial Number:	Test Sample
Type of Equipment:	Digital Transmission System (DTS)
Input Power Supply Type:	External DC Power Supply
Primary User Functions of EUT:	802.11bgn wireless connectivity of embedded devices.

2.3. EUT’S TECHNICAL SPECIFICATIONS

Transmitter	
Equipment Type:	<ul style="list-style-type: none"> • Mobile • Base Station (fixed use)
Intended Operating Environment:	<ul style="list-style-type: none"> ▪ Commercial, industrial or business environment ▪ Residential environment
Power Supply Requirement:	3.1 - 3.5 VDC
RF Output Power Rating:	802.11b: 2.73 - 26.81dBm (1.87 - 479.73 mW) Peak 802.11g: 7.87 - 28.52 dBm (6.12 - 711.21 mW) Peak 802.11n 800ns: 8.03 - 28.75 dBm (6.35 - 749.89 mW) Peak 802.11n 400ns: 8.04 - 28.64 dBm (6.37 - 731.14 mW) Peak
Operating Frequency Range:	2412 – 2462 MHz
RF Output Impedance:	50 Ω
Channel Spacing:	5 MHz
Duty Cycle:	100%
Modulation Type:	OFDM, DSSS
Oscillator Frequency(ies):	48 MHz
Antenna Connector Types:	Integral, RPSMA or U.FL

2.4. ASSOCIATED ANTENNA DESCRIPTIONS

Antenna Type	Maximum Gain (dBi)
Omni-directional antenna	15
Yagi antenna	15.0
Panel antenna	19.0
Dipole antenna	2.1
Integral antenna	1.5

The highest gain antenna from each of the above antenna types were selected for testing to represents the worst-case. Refer to user manual for antennas list information.

2.5. LIST OF EUT’S PORTS

Port Number	EUT’s Port Description	Number of Identical Ports	Connector Type	Cable Type (Shielded/Non-shielded)
1	RF port	1	Integral antenna, RPSMA or U.FL	Shielded cable (N/A for integral antenna)
2	DC supply and I/O port	1	Pin header	Direct connection (no cable)

2.6. ANCILLARY EQUIPMENT

The EUT was tested while connected to the following representative configuration of ancillary equipment necessary to exercise the ports during tests:

Ancillary Equipment # 1	
Description:	Test Jig
Brand name:	Digi International
Model Name or Number:	N/A
Serial Number:	N/A
Connected to EUT's Port:	Module pin signals

EXHIBIT 3. EUT OPERATING CONDITIONS AND CONFIGURATIONS DURING TESTS

3.1. CLIMATE TEST CONDITIONS

The climate conditions of the test environment are as follows:

Temperature:	21 to 23 °C
Humidity:	45 to 58%
Pressure:	102 kPa
Power Input Source:	3.5 VDC

3.2. OPERATIONAL TEST CONDITIONS & ARRANGEMENT FOR TESTS

Operating Modes:	The transmitter was operated in a continuous transmission mode with the carrier modulated as specified in the Test Data.
Special Test Software:	Special software provided by the Applicant to operate the EUT at each channel frequency continuously and in the range of typical modes of operation.
Special Hardware Used:	Test Jig
Transmitter Test Antenna:	The EUT is tested with the antenna fitted in a manner typical of normal intended use as integral / non-integral antenna equipment as described with the test results.

Transmitter Test Signals	
Frequency Band(s):	2412 - 2462 MHz
Frequency(ies) Tested: (Near lowest, near middle & near highest frequencies in the frequency range of operation.)	2412, 2442 and 2462 MHz
RF Power Output: (measured maximum output power at antenna terminals)	28.75 dBm (749.89 mW) Peak
Normal Test Modulation:	OFDM, DSSS
Modulating Signal Source:	Internal

EXHIBIT 4. SUMMARY OF TEST RESULTS

4.1. LOCATION OF TESTS

All of the measurements described in this report were performed at Ultratech Group of Labs located in the city of Oakville, Province of Ontario, Canada.

- AC Power Line Conducted Emissions were performed in UltraTech's shielded room, 24'(L) by 16'(W) by 8'(H).
- Radiated Emissions were performed at the Ultratech's 3-10 TDK Semi-Anechoic Chamber situated in the Town of Oakville, province of Ontario. This test site been calibrated in accordance with ANSI C63.4, and found to be in compliance with the requirements of Sec. 2.948 of the FCC Rules. The descriptions and site measurement data of the Oakville 3-10 TDK Semi-Anechoic Chamber has been filed with FCC office (FCC File No.: 91038) and Industry Canada office (Industry Canada File No.: 2049A-3). Expiry Date: 2014-04-04.

4.2. APPLICABILITY & SUMMARY OF EMC EMISSION TEST RESULTS

FCC Section(s)	Test Requirements	Compliance (Yes/No)
15.203	Antenna requirements	Yes*
15.207(a)	AC Power Line Conducted Emissions	Yes
15.247(a)(2)	6 dB Bandwidth	Yes
15.247(b)(3)	Peak Conducted Output Power - DTS	Yes
15.247(d)	Band-Edge and RF Conducted Spurious Emissions at the Transmitter Antenna Terminal	Yes
15.247(d), 15.209 & 15.205	Transmitter Spurious Radiated Emissions	Yes
15.247(e)	Power Spectral Density	Yes
15.247(i), 1.1307, 1.1310, 2.1091	RF Exposure	Yes

* The EUT complies with the requirement; it employs a unique (non-standard) antenna connector or integral antenna (PCB Antenna, U.FL Connector, RPSMA Connector, or Integrated Wire).

4.3. MODIFICATIONS INCORPORATED IN THE EUT FOR COMPLIANCE PURPOSES

None.

EXHIBIT 5. TEST DATA

5.1. POWER LINE CONDUCTED EMISSIONS [§15.207(a)]

5.1.1. Limit(s)

The equipment shall meet the limits of the following table:

Frequency of emission (MHz)	Conducted Limits (dB μ V)	
	Quasi-peak	Average
0.15–0.5	66 to 56*	56 to 46*
0.5–5	56	46
5–30	60	50

*Decreases linearly with the logarithm of the frequency

5.1.2. Method of Measurements

ANSI C63.4-2009

5.1.3. Test Arrangement

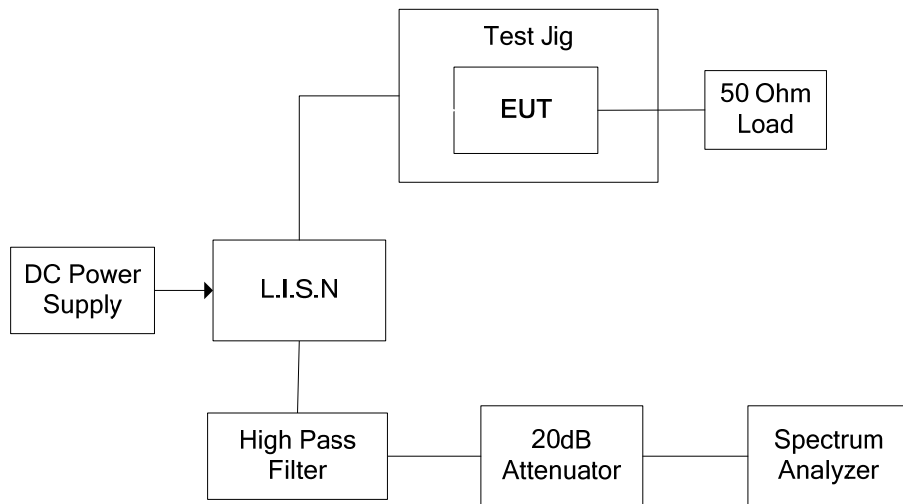

5.1.4. Test Data

Plot 5.1.4.1. Power Line Conducted Emissions; Line Voltage: 3.5 V DC; Line Tested: Positive

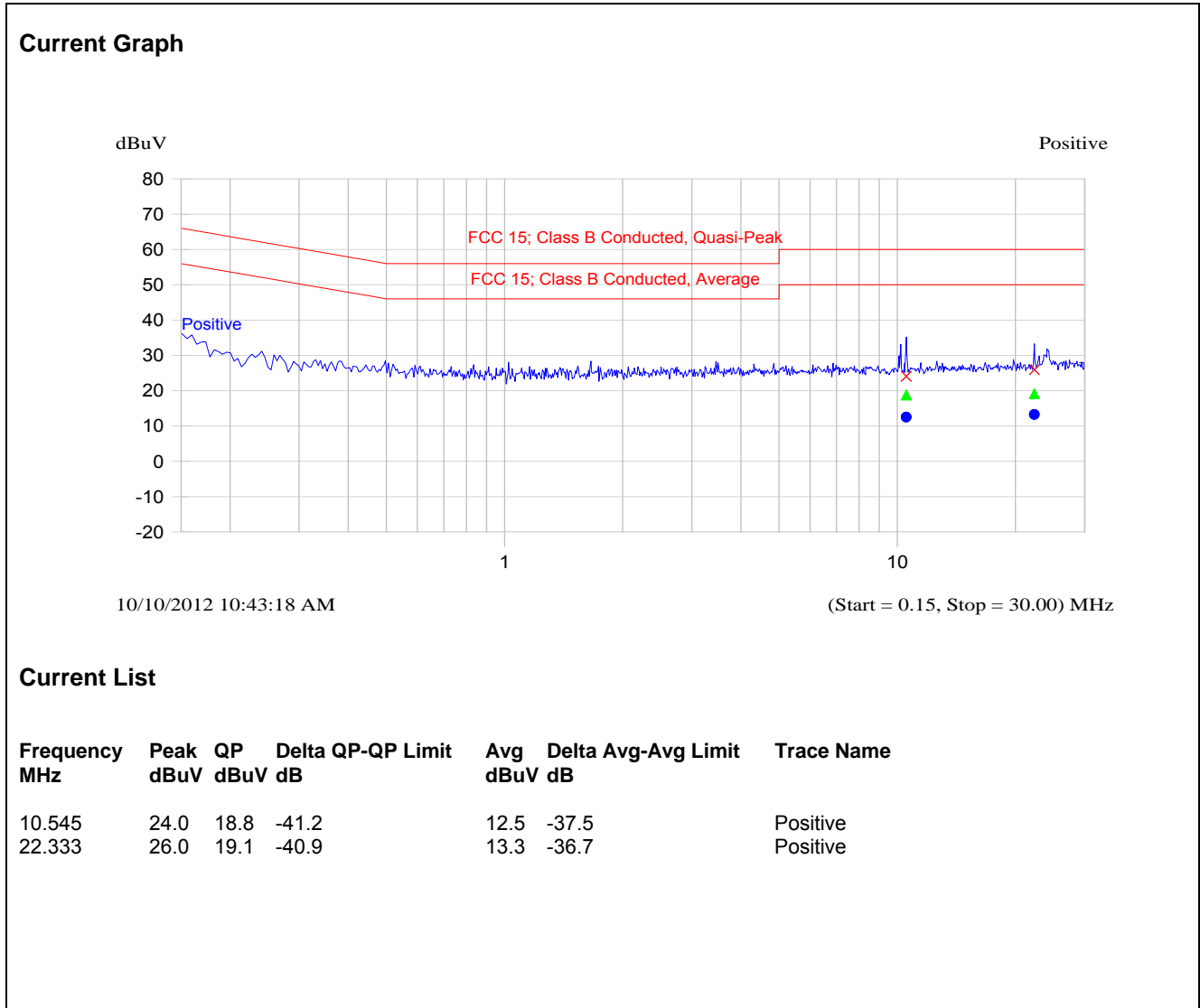

Plot 5.1.4.2. Power Line Conducted Emissions; Line Voltage: 3.5 V DC; Line Tested: Negative

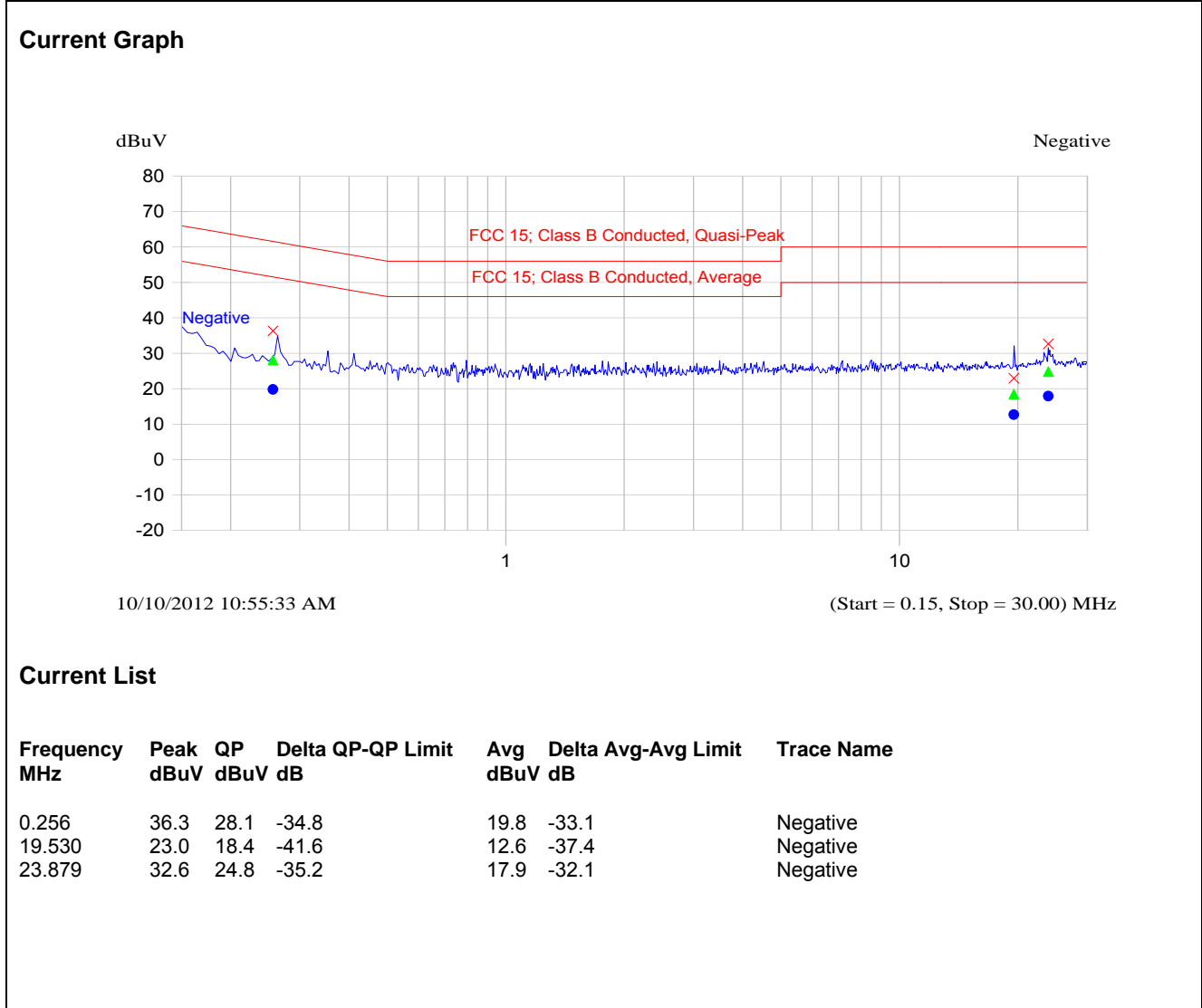

5.2. OCCUPIED BANDWIDTH [§ 15.247(a)(2)]

5.2.1. Limit(s)

The minimum 6 dB bandwidth shall be at least 500 kHz.

5.2.2. Method of Measurements

KDB Publication No. 558074 D01 Section 5.1 Emission Bandwidth.

5.2.3. Test Arrangement

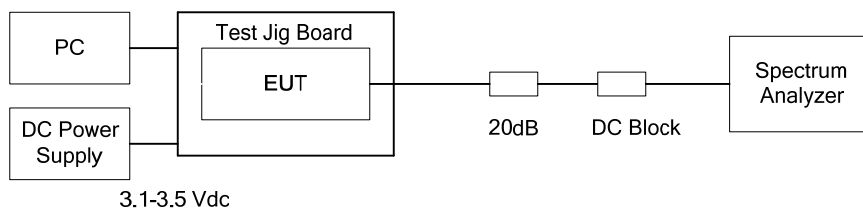

5.2.4. Test Data

802.11b Mode			
Operating Mode	Frequency (MHz)	6 dB Bandwidth (MHz)	99% Occupied Bandwidth (MHz)
1 Mbps DBPSK	2412	10.37	15.01
	2442	10.37	14.94
	2462	10.37	15.01
2 Mbps DQPSK	2412	10.32	14.94
	2442	10.27	14.87
	2462	10.27	14.87
11 Mbps CCK	2412	10.72	14.31
	2442	10.37	14.24
	2462	10.52	14.24

802.11g Mode			
Operating Mode	Frequency (MHz)	6 dB Bandwidth (MHz)	99% Occupied Bandwidth (MHz)
9 Mbps BPSK	2412	16.67	23.04
	2442	16.67	26.01
	2462	16.75	26.78
18 Mbps QPSK	2412	16.51	21.05
	2442	16.51	21.93
	2462	16.43	22.37
36 Mbps 16-QAM	2412	16.59	19.40
	2442	16.83	20.06
	2462	16.75	21.27
54 Mbps 64-QAM	2412	16.59	19.07
	2442	16.43	20.50
	2462	16.59	21.05

802.11n 800ns Mode			
Operating Mode	Frequency (MHz)	6 dB Bandwidth (MHz)	99% Occupied Bandwidth (MHz)
6.5 Mbps BPSK1/2	2412	17.79	24.80
	2442	17.80	24.91
	2462	17.80	26.67
19.5 Mbps QPSK 3/4	2412	17.80	21.60
	2442	17.88	22.71
	2462	17.31	24.14
39 Mbps 16-QAM 3/4	2412	17.88	19.95
	2442	17.56	20.83
	2462	17.80	21.82
65 Mbps 64-QAM 5/6	2412	17.72	19.95
	2442	17.72	21.16
	2462	17.80	21.60

ULTRATECH GROUP OF LABS

3000 Bristol Circle, Oakville, Ontario, Canada L6H 6G4
 Tel. #: 905-829-1570, Fax. #: 905-829-8050, Email: vic@ultratech-labs.com, Website: <http://www.ultratech-labs.com>

File #: DIGI-064F15C247

October 26, 2012

All test results contained in this engineering test report are traceable to National Institute of Standards and Technology (NIST)

802.11n 400ns Mode			
Operating Mode	Frequency (MHz)	6 dB Bandwidth (MHz)	99% Occupied Bandwidth (MHz)
7.2 Mbps BPSK1/2	2412	17.72	22.82
	2442	17.72	23.70
	2462	17.72	24.69
21.7 Mbps QPSK 3/4	2412	17.80	21.49
	2442	17.72	23.26
	2462	17.63	23.59
43.3 Mbps 16-QAM 3/4	2412	17.72	19.95
	2442	17.88	20.50
	2462	17.56	21.93
72.2 Mbps 64-QAM 5/6	2412	17.64	19.62
	2442	17.72	20.83
	2462	17.80	21.27

See the following plots for detailed measurements.

Plot 5.2.4.1. 6 dB Bandwidth, 802.11b, 1 Mbps DBPSK, 2412 MHz, Setting 23

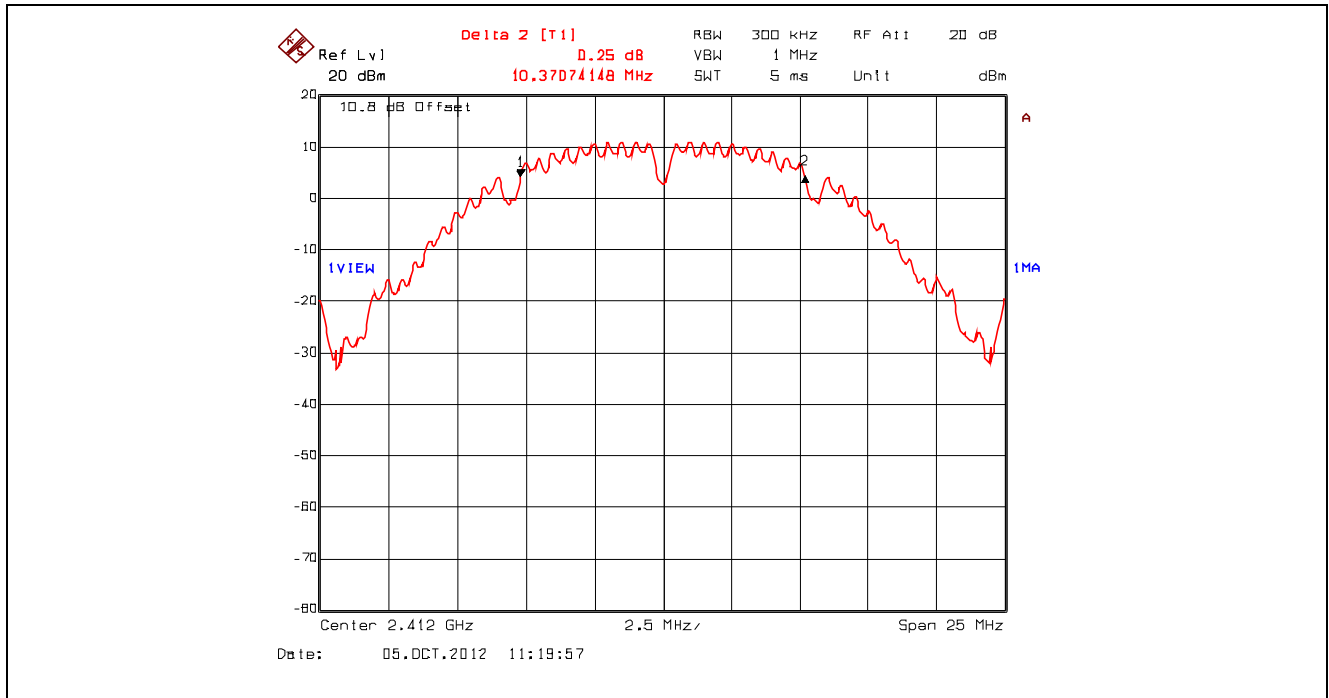

Plot 5.2.4.2. 6 dB Bandwidth, 802.11b, 1 Mbps DBPSK, 2442 MHz, Setting 23

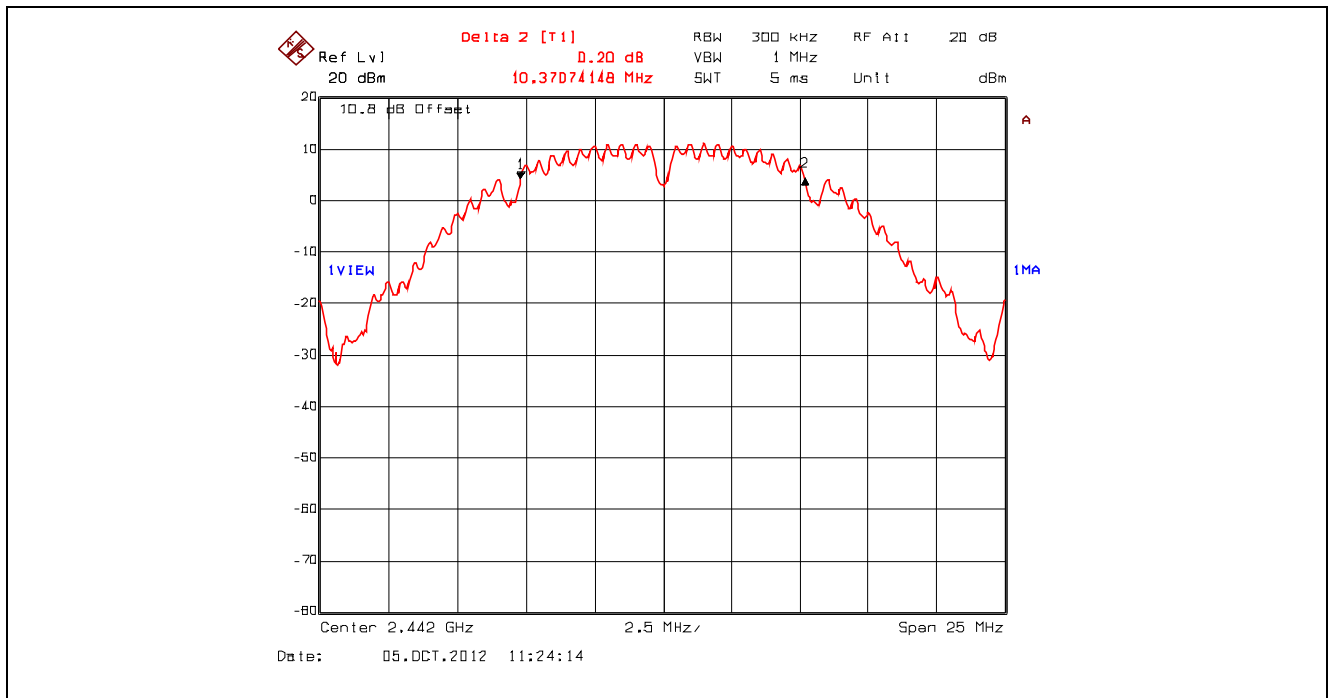

Plot 5.2.4.3. 6 dB Bandwidth, 802.11b, 1 Mbps DBPSK, 2462 MHz, Setting 23

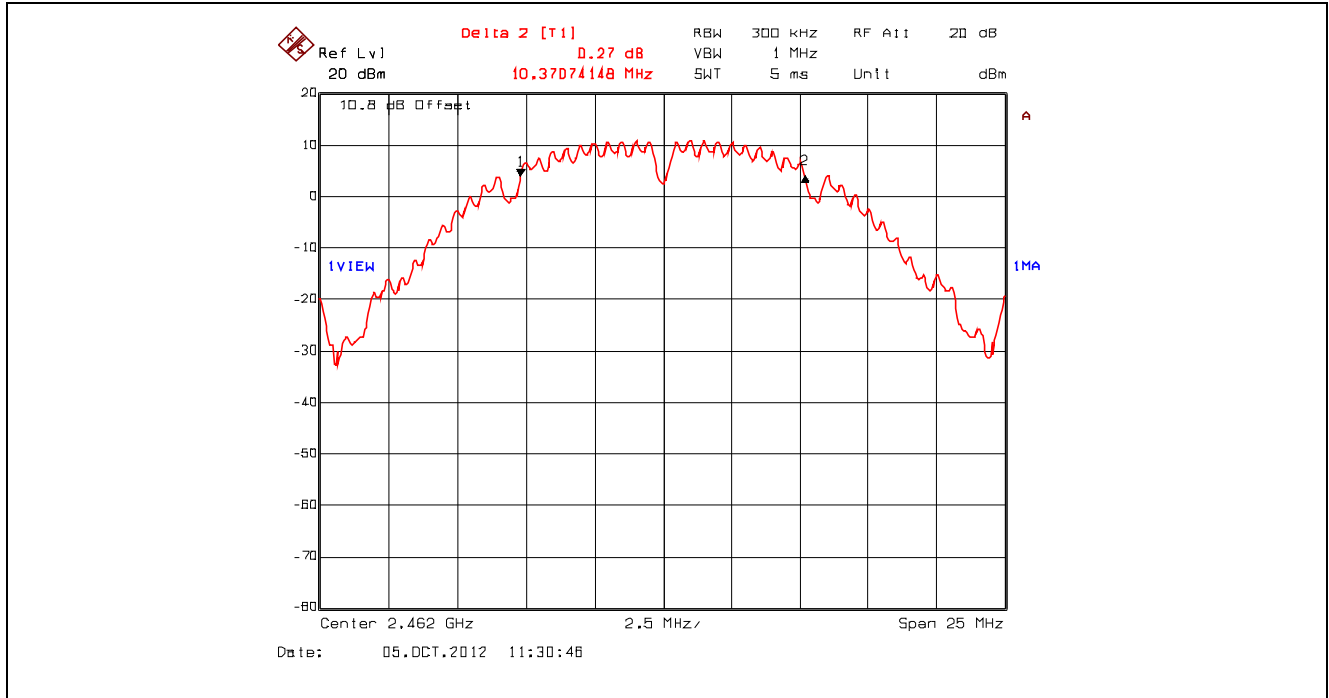

Plot 5.2.4.4. 6 dB Bandwidth, 802.11b, 2 Mbps DQPSK, 2412 MHz, Setting 23

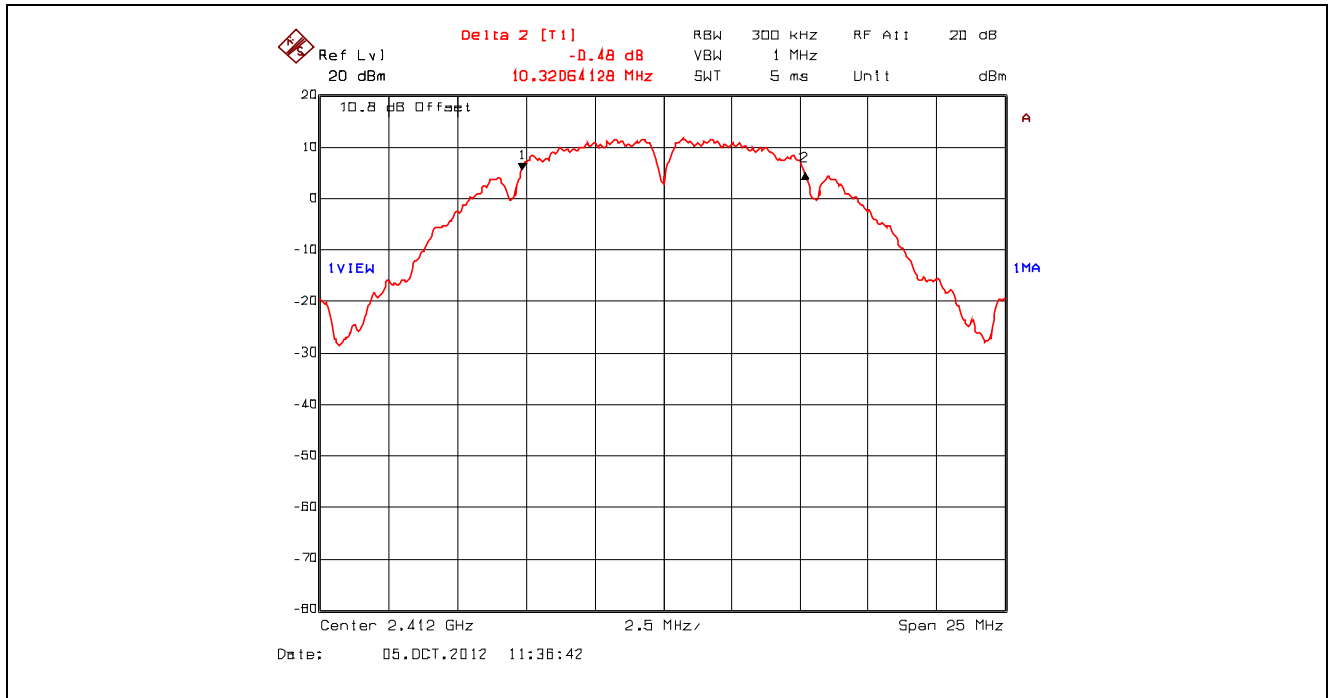

Plot 5.2.4.5. 6 dB Bandwidth, 802.11b, 2 Mbps DQPSK, 2442 MHz, Setting 23

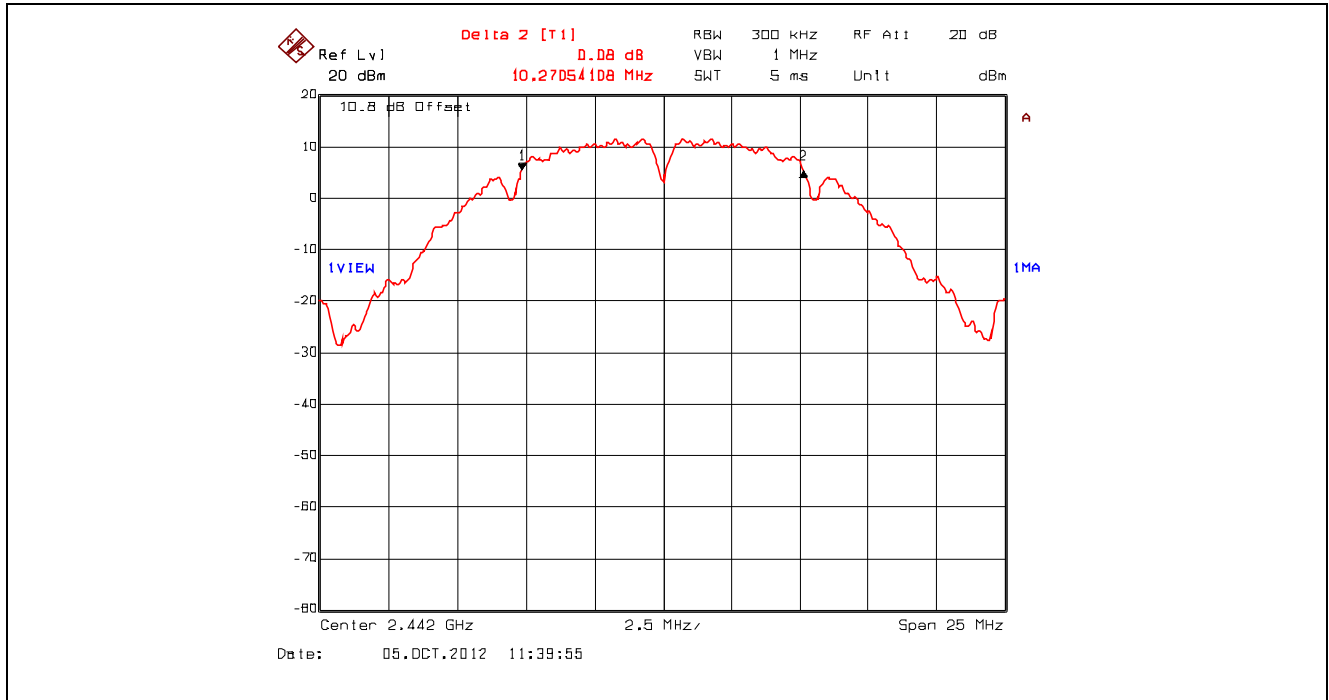

Plot 5.2.4.6. 6 dB Bandwidth, 802.11b, 2 Mbps DQPSK, 2462 MHz, Setting 23

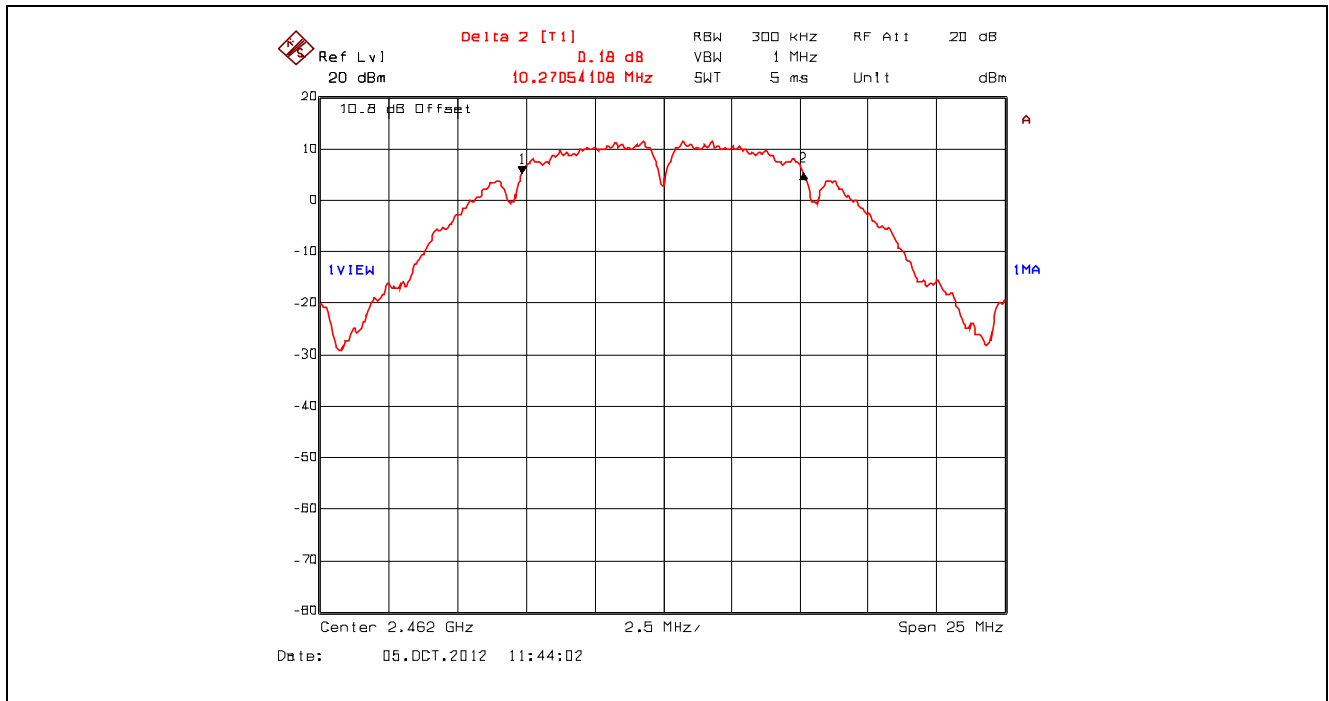

Plot 5.2.4.7. 6 dB Bandwidth, 802.11b, 11 Mbps CCK, 2412 MHz, Setting 23

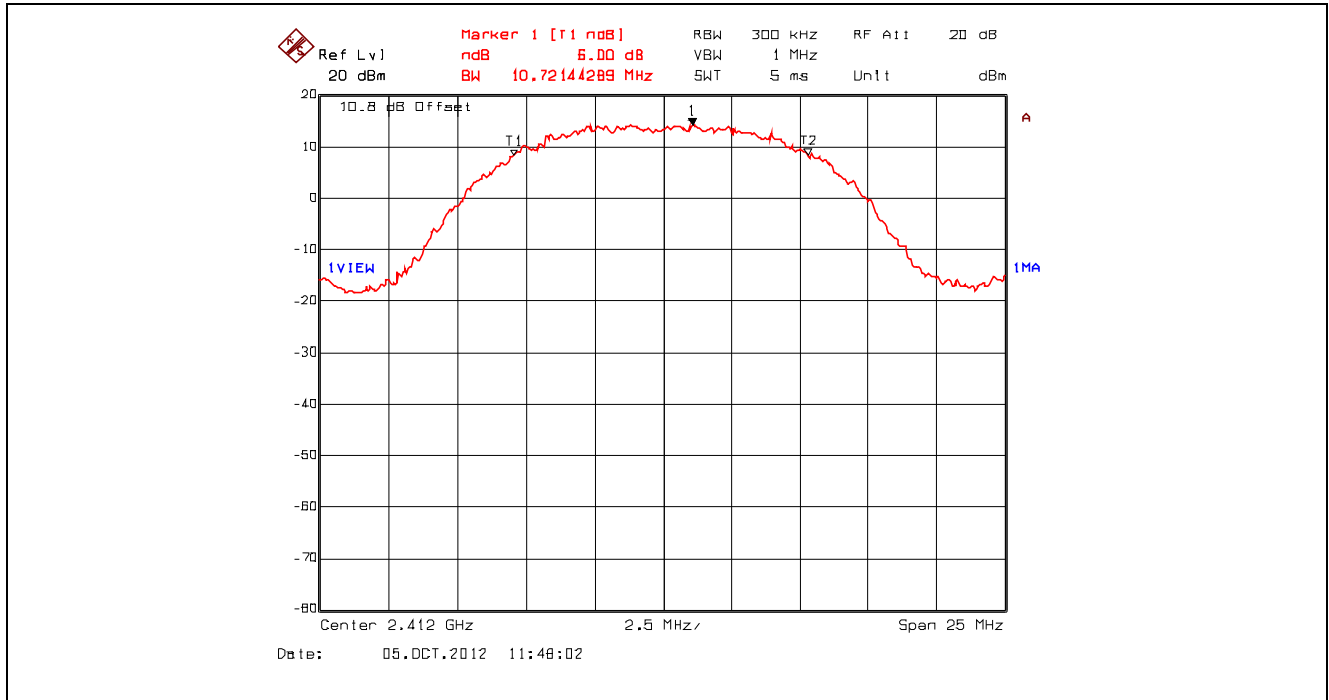

Plot 5.2.4.8. 6 dB Bandwidth, 802.11b, 11 Mbps CCK, 2442 MHz, Setting 23

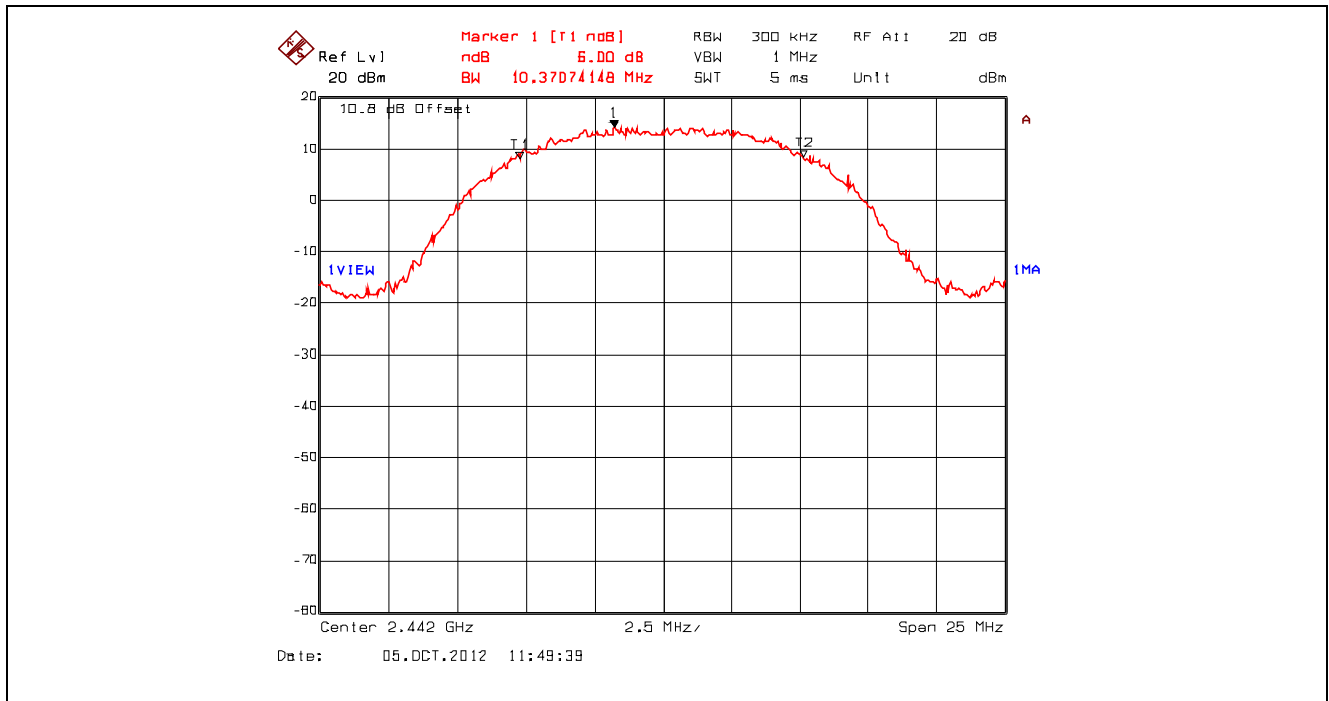

Plot 5.2.4.9. 6 dB Bandwidth, 802.11b, 11 Mbps CCK, 2462 MHz, Setting 23

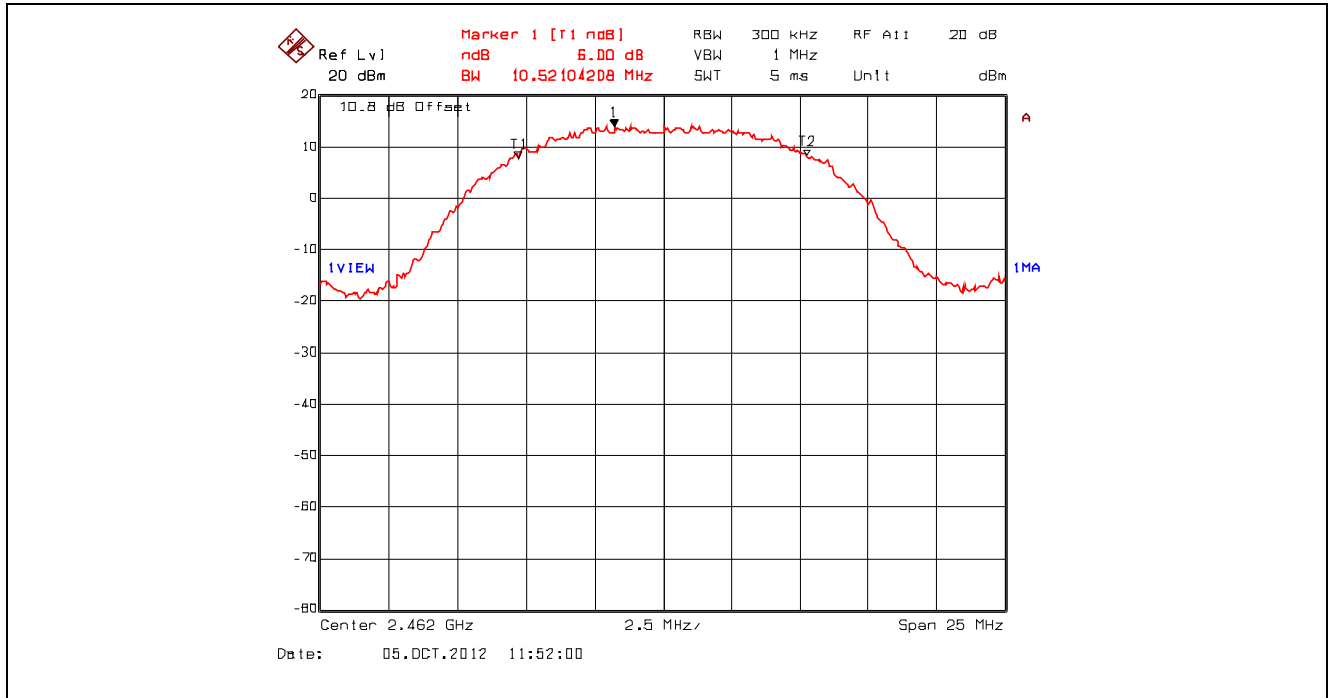

Plot 5.2.4.10. 6 dB Bandwidth, 802.11g, 9 Mbps BPSK, 2412 MHz, Setting 23

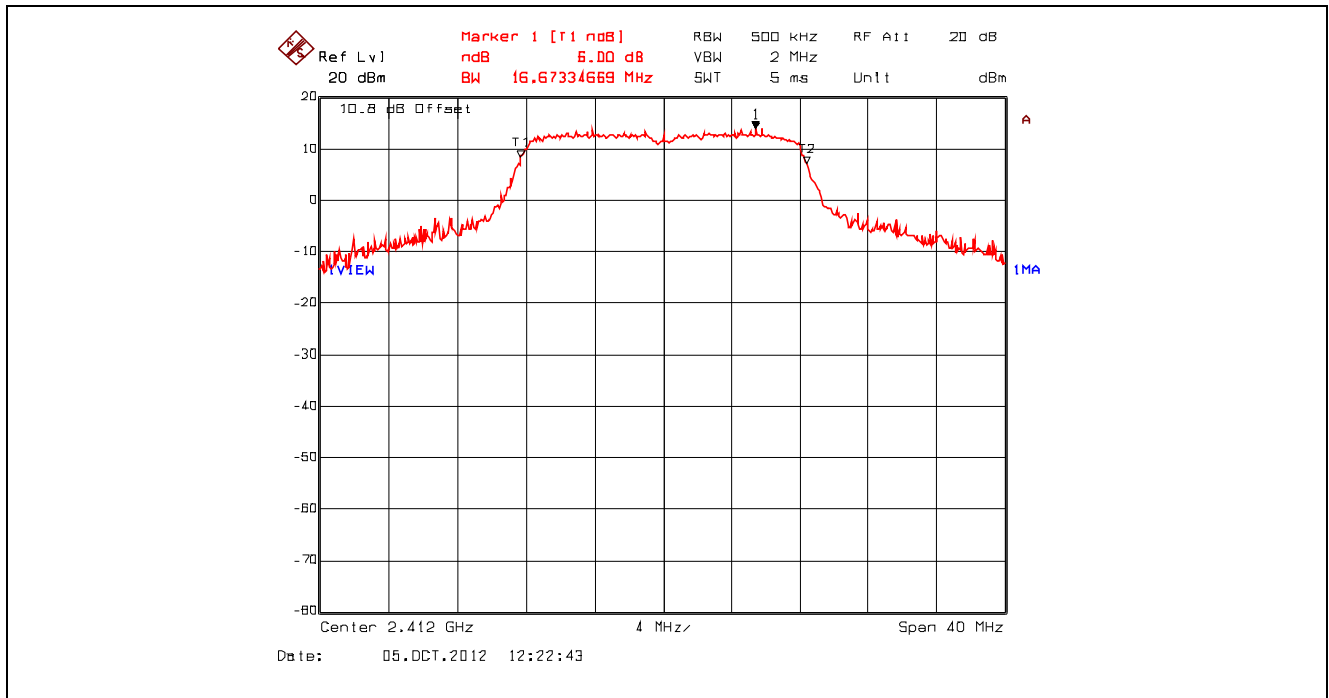

Plot 5.2.4.11. 6 dB Bandwidth, 802.11g, 9 Mbps BPSK, 2442 MHz, Setting 23

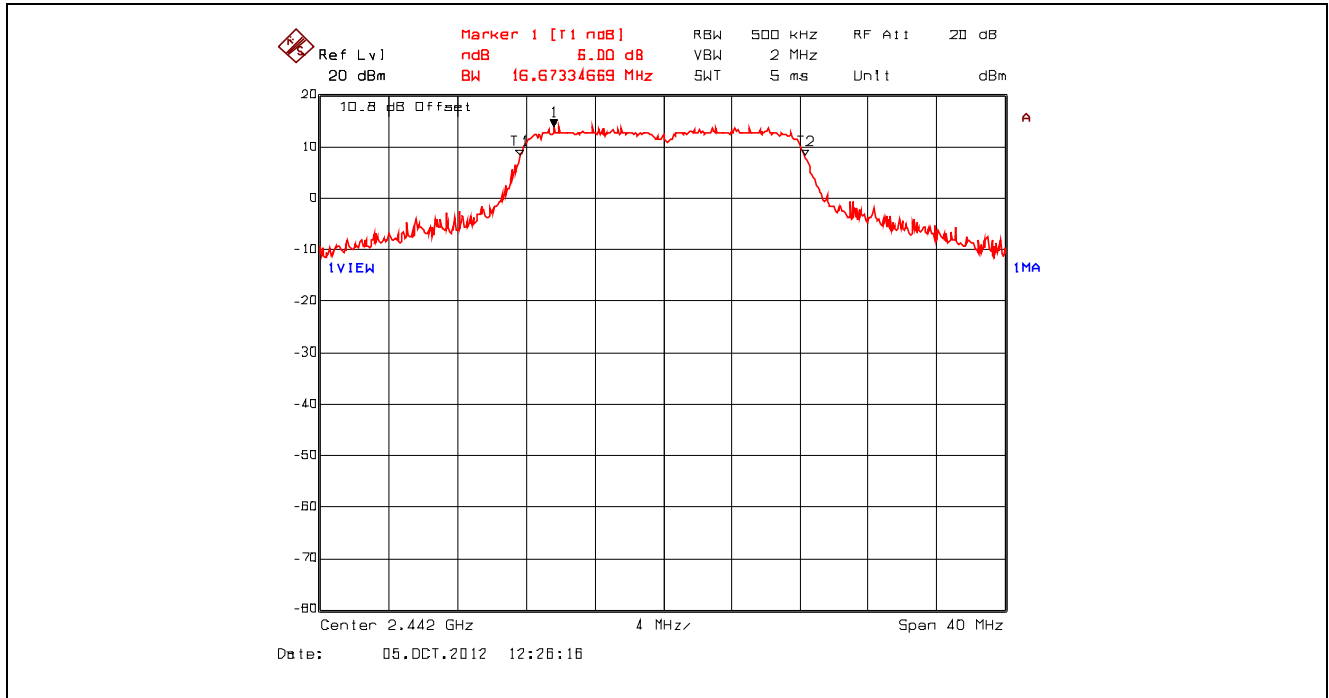

Plot 5.2.4.12. 6 dB Bandwidth, 802.11g, 9 Mbps BPSK, 2462 MHz, Setting 23

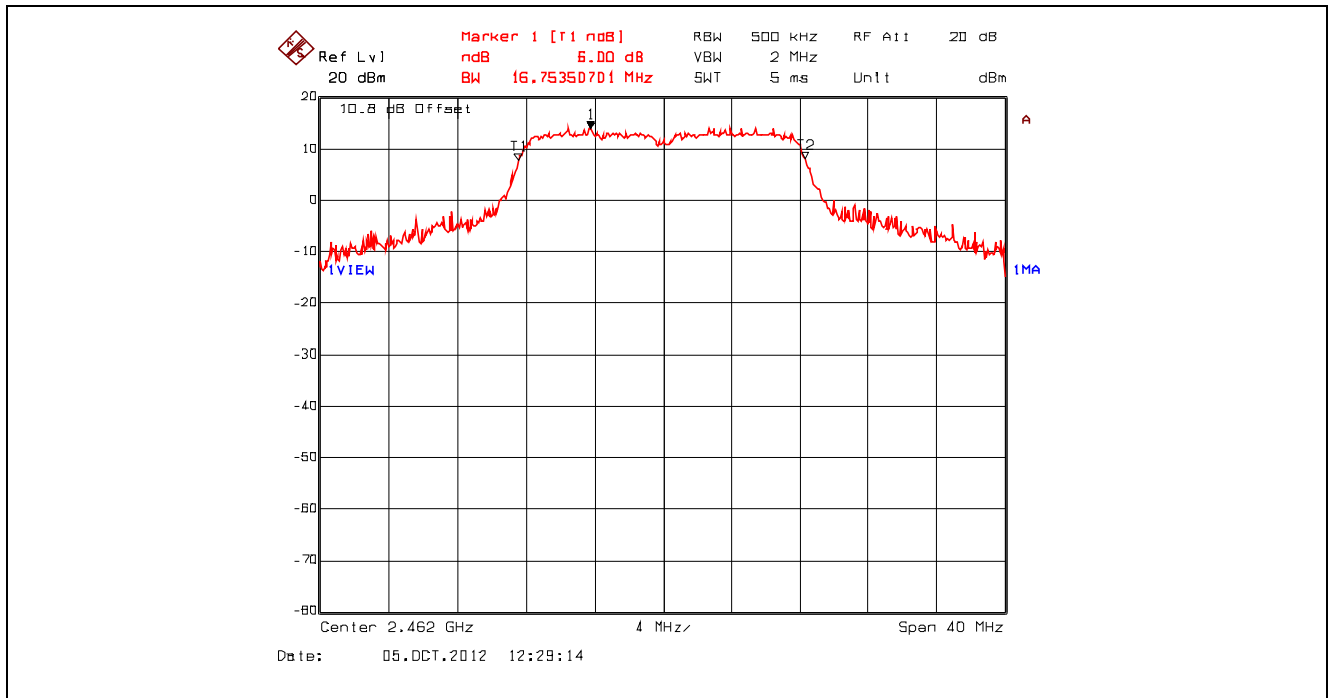

Plot 5.2.4.13. 6 dB Bandwidth, 802.11g, 18 Mbps QPSK, 2412 MHz, Setting 23

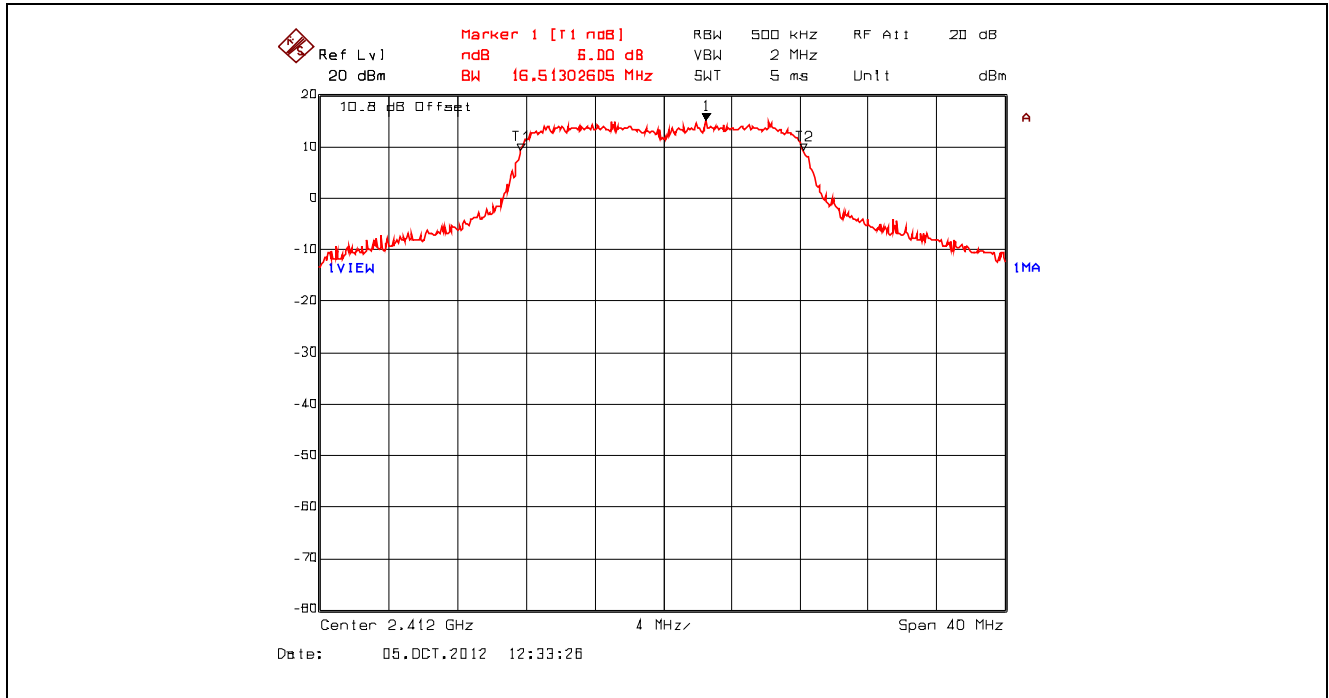

Plot 5.2.4.14. 6 dB Bandwidth, 802.11g, 18 Mbps QPSK, 2442 MHz, Setting 23

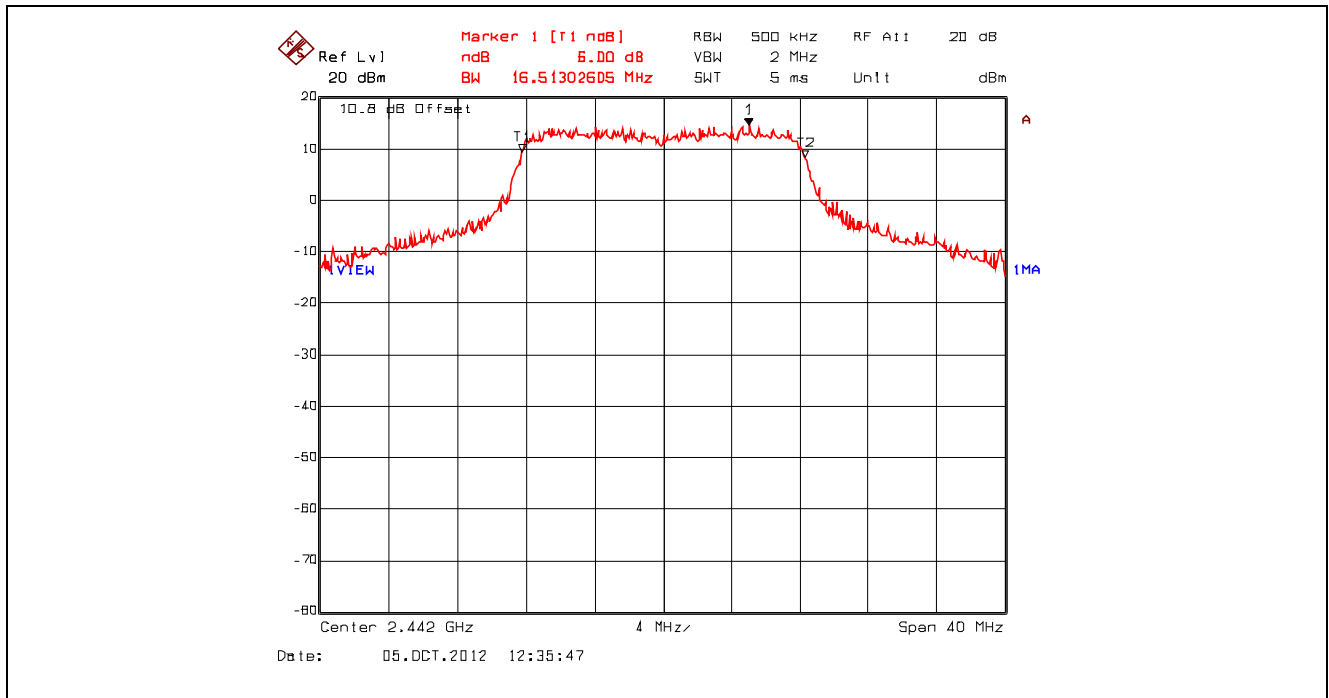

Plot 5.2.4.15. 6 dB Bandwidth, 802.11g, 18 Mbps QPSK, 2462 MHz, Setting 23

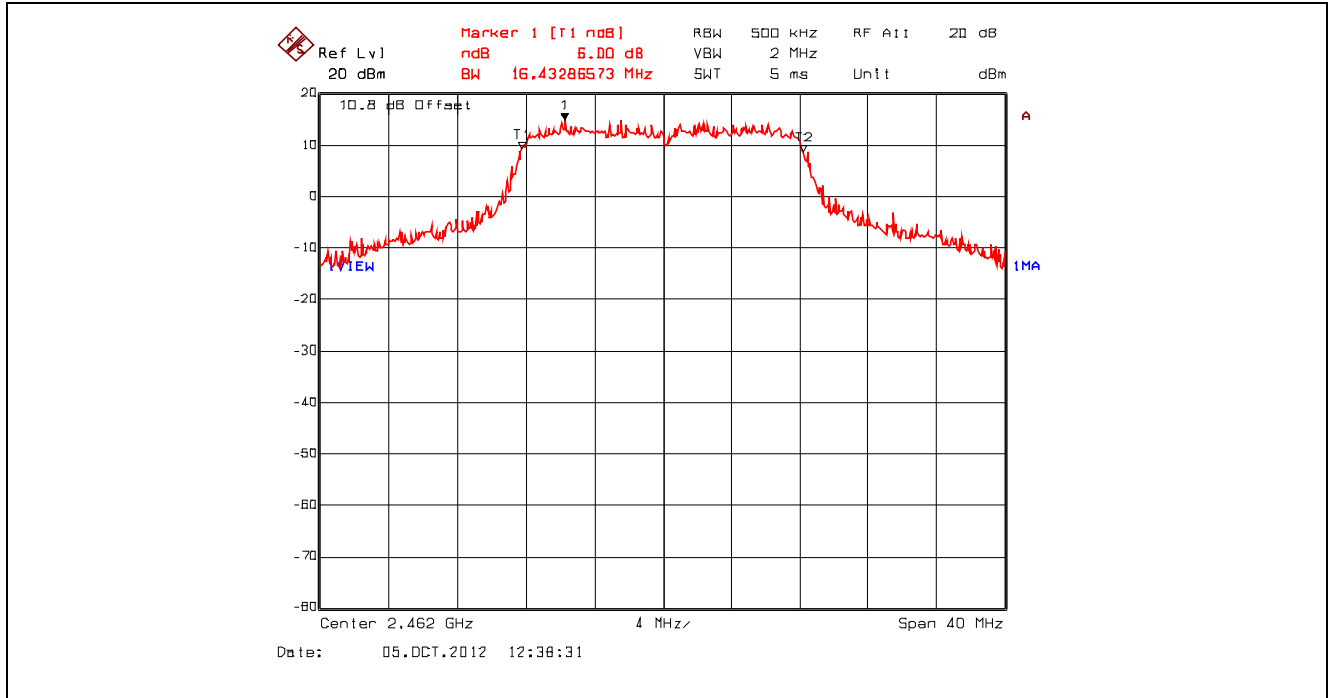

Plot 5.2.4.16. 6 dB Bandwidth, 802.11g, 36 Mbps 16-QAM, 2412 MHz, Setting 23

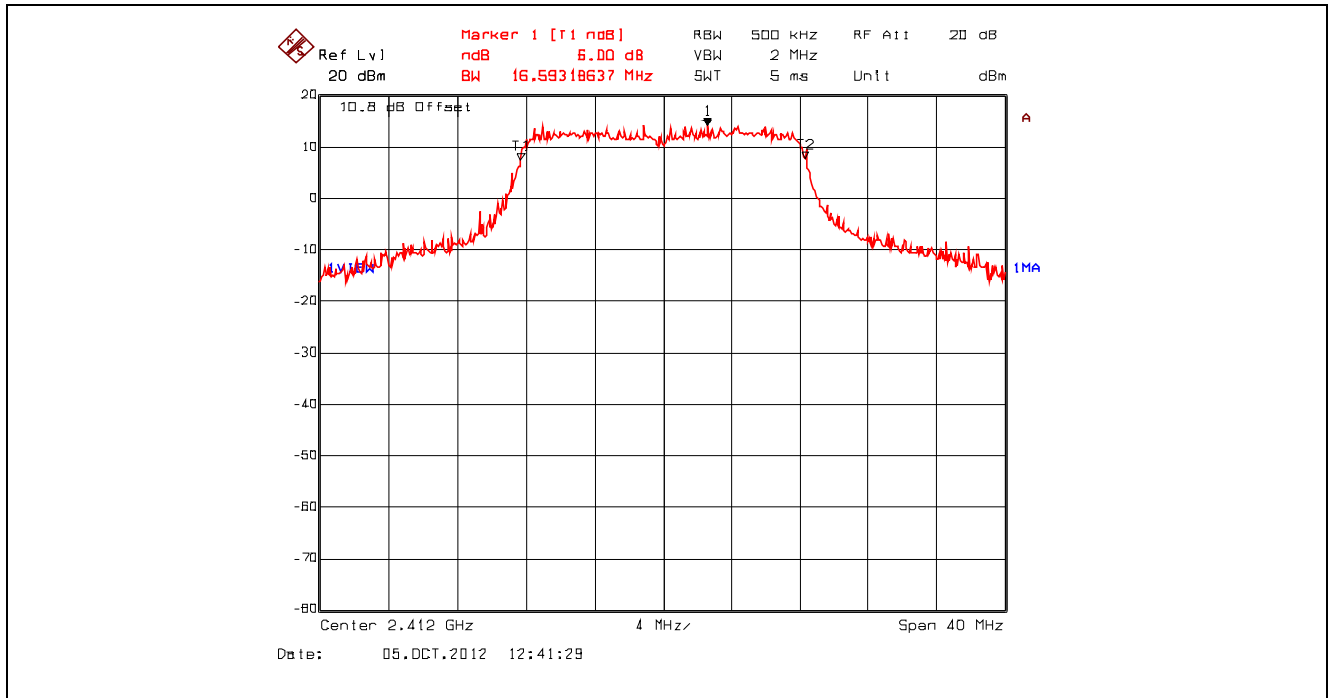

Plot 5.2.4.17. 6 dB Bandwidth, 802.11g, 36 Mbps 16-QAM, 2442 MHz, Setting 23

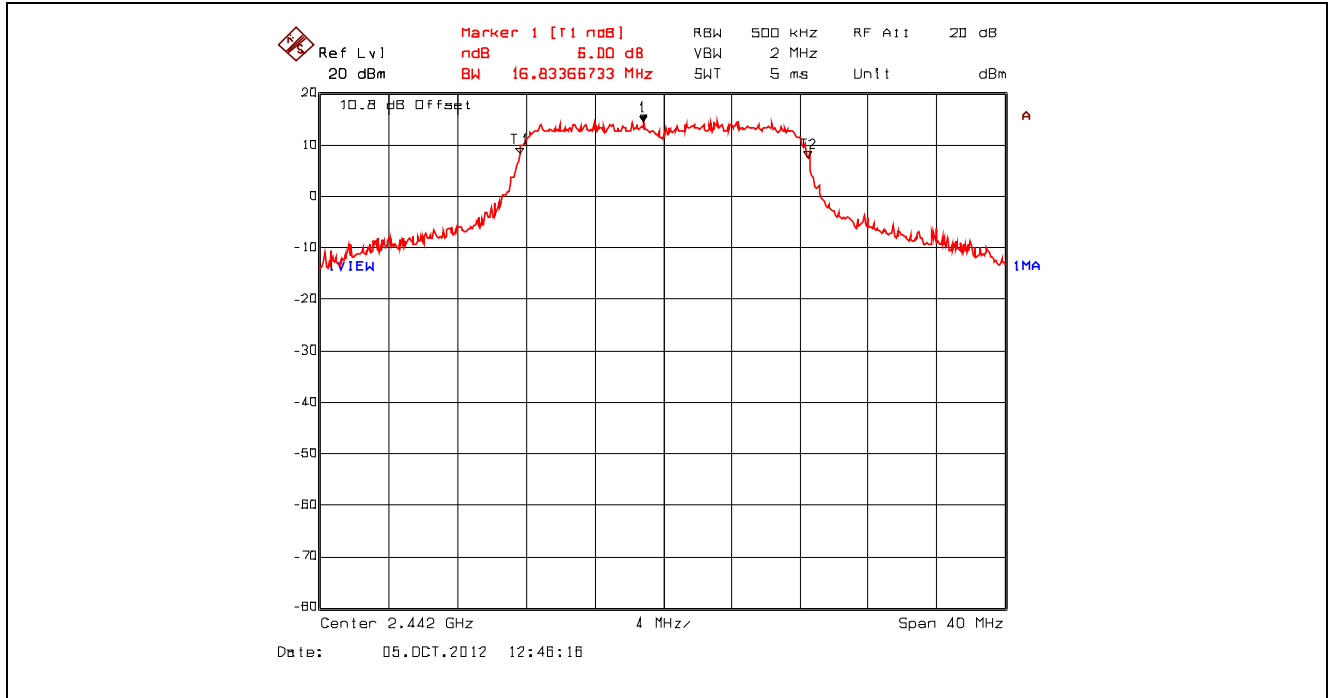

Plot 5.2.4.18. 6 dB Bandwidth, 802.11g, 36 Mbps 16-QAM, 2462 MHz, Setting 23

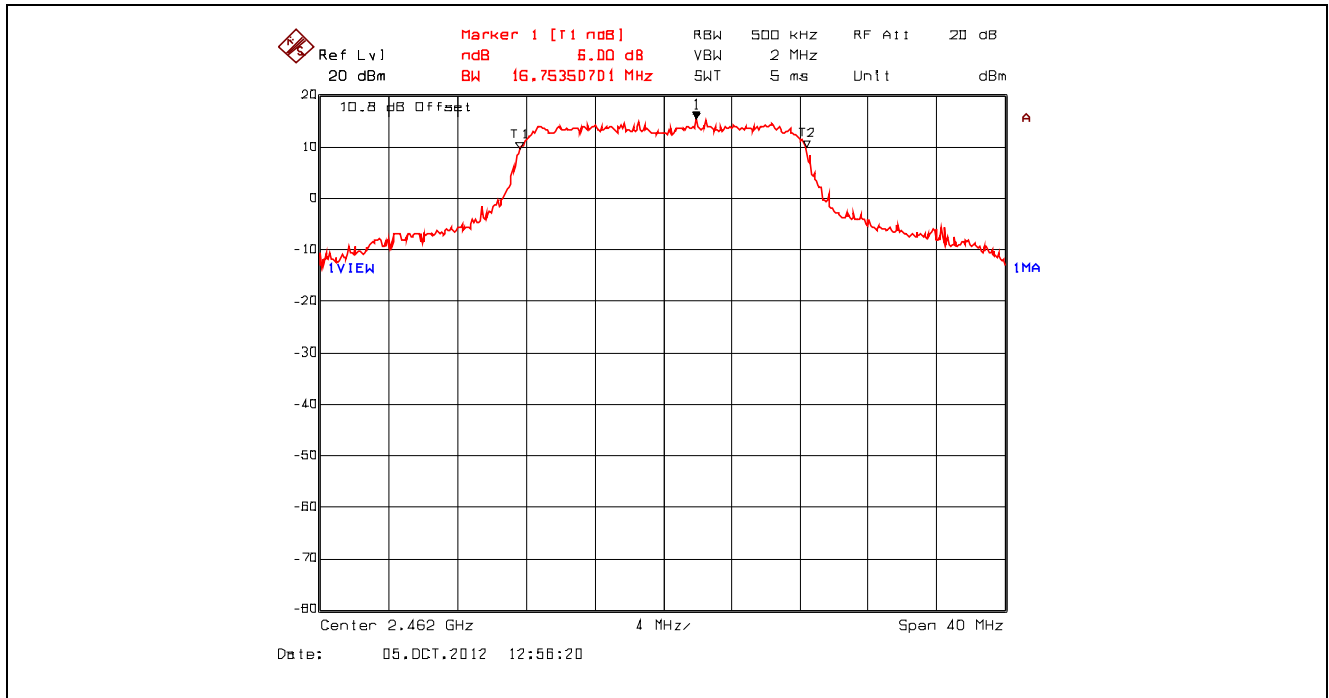

Plot 5.2.4.19. 6 dB Bandwidth, 802.11g, 54 Mbps 64-QAM, 2412 MHz, Setting 23

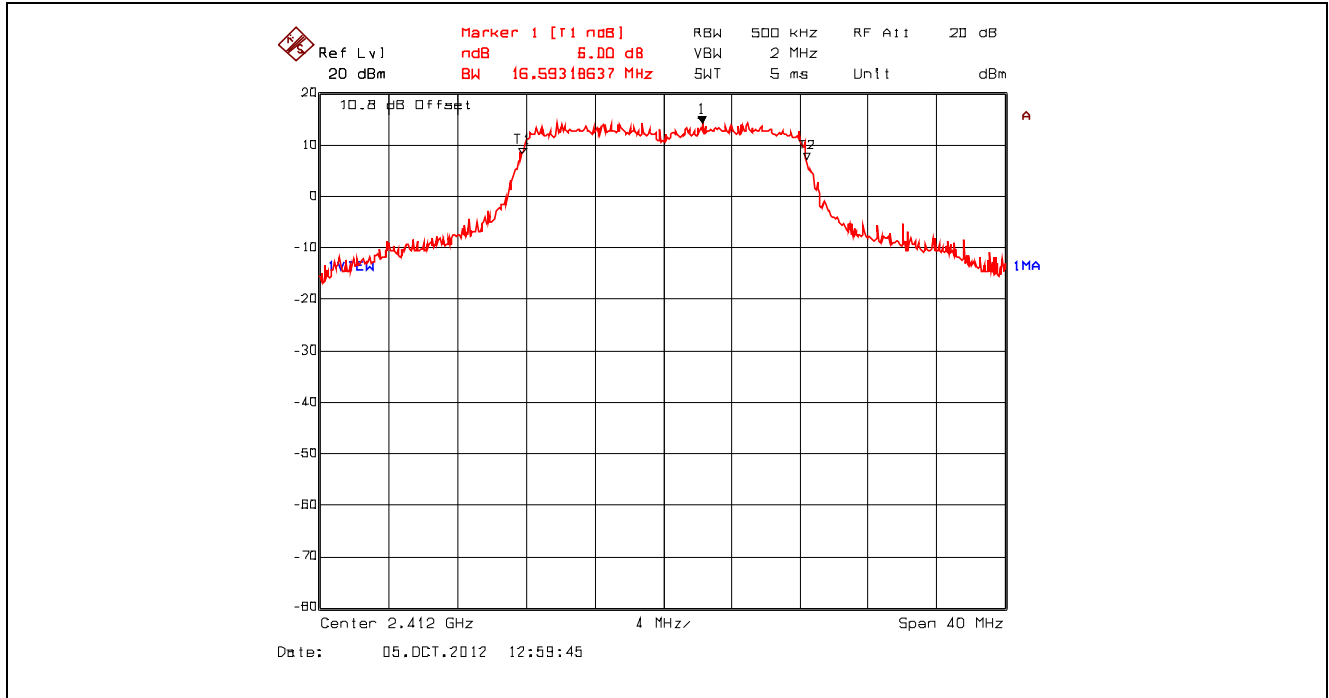

Plot 5.2.4.20. 6 dB Bandwidth, 802.11g, 54 Mbps 64-QAM, 2442 MHz, Setting 23

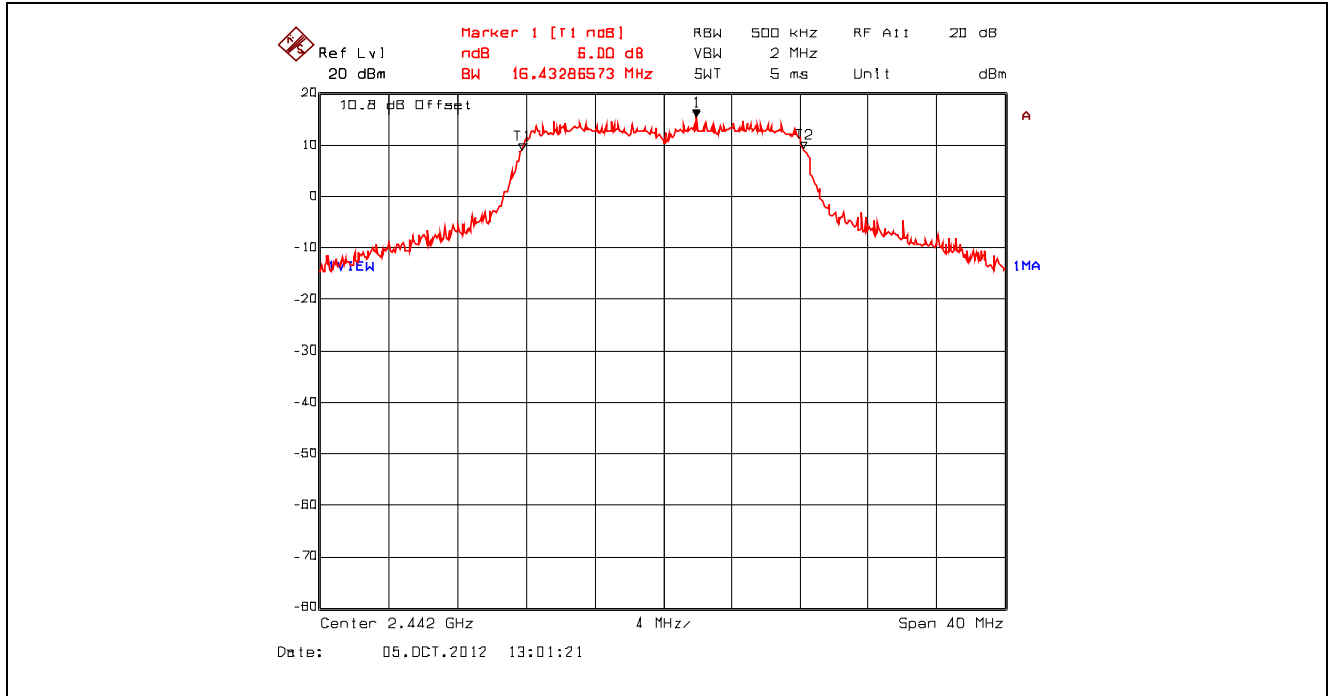

Plot 5.2.4.21. 6 dB Bandwidth, 802.11g, 54 Mbps 64-QAM, 2462 MHz, Setting 23

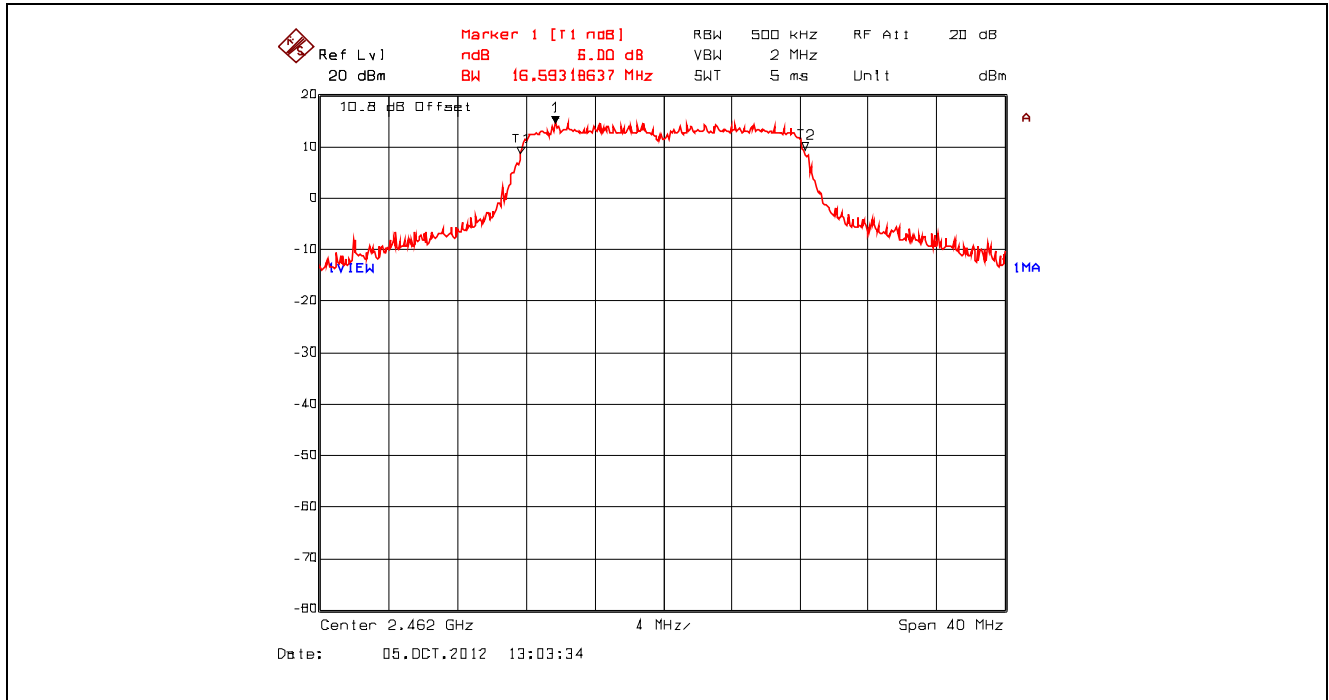

Plot 5.2.4.22. 6 dB Bandwidth, 802.11n 800ns, 6.5 Mbps BPSK1/2, 2412 MHz, Setting 23

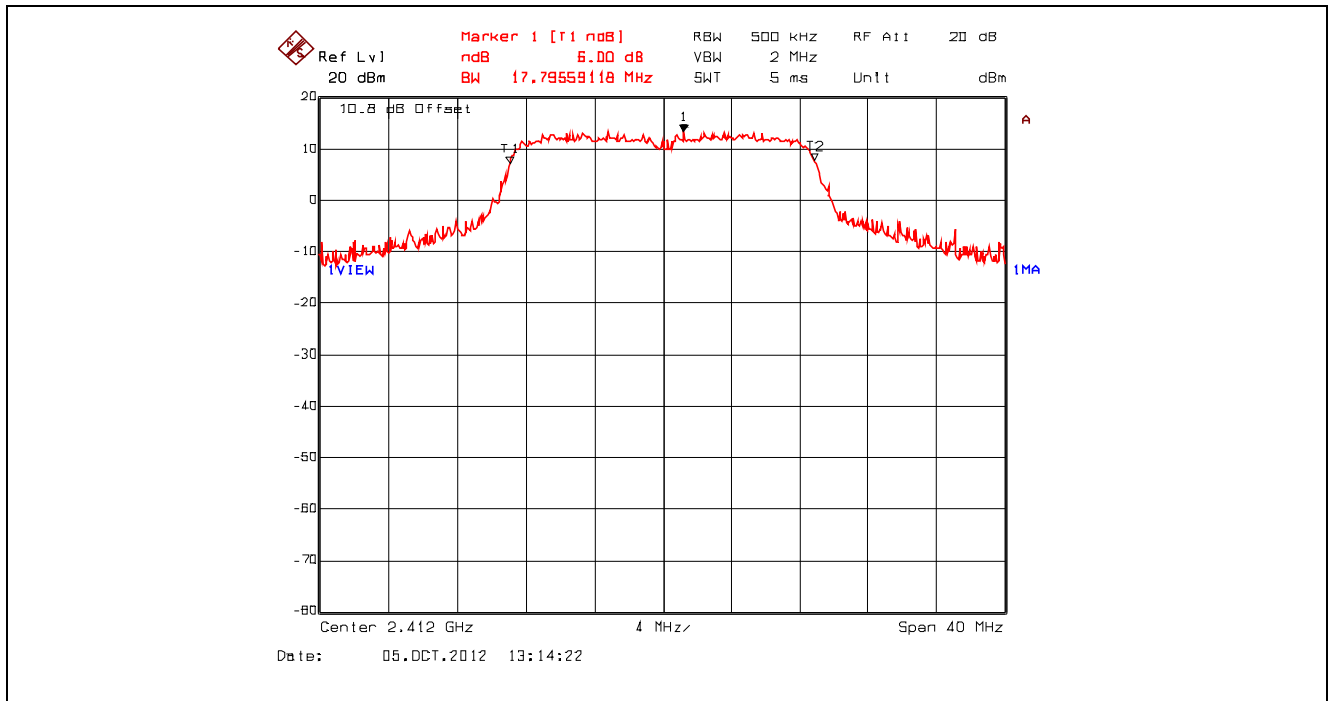

Plot 5.2.4.23. 6 dB Bandwidth, 802.11n 800ns, 6.5 Mbps BPSK1/2, 2442 MHz, Setting 23

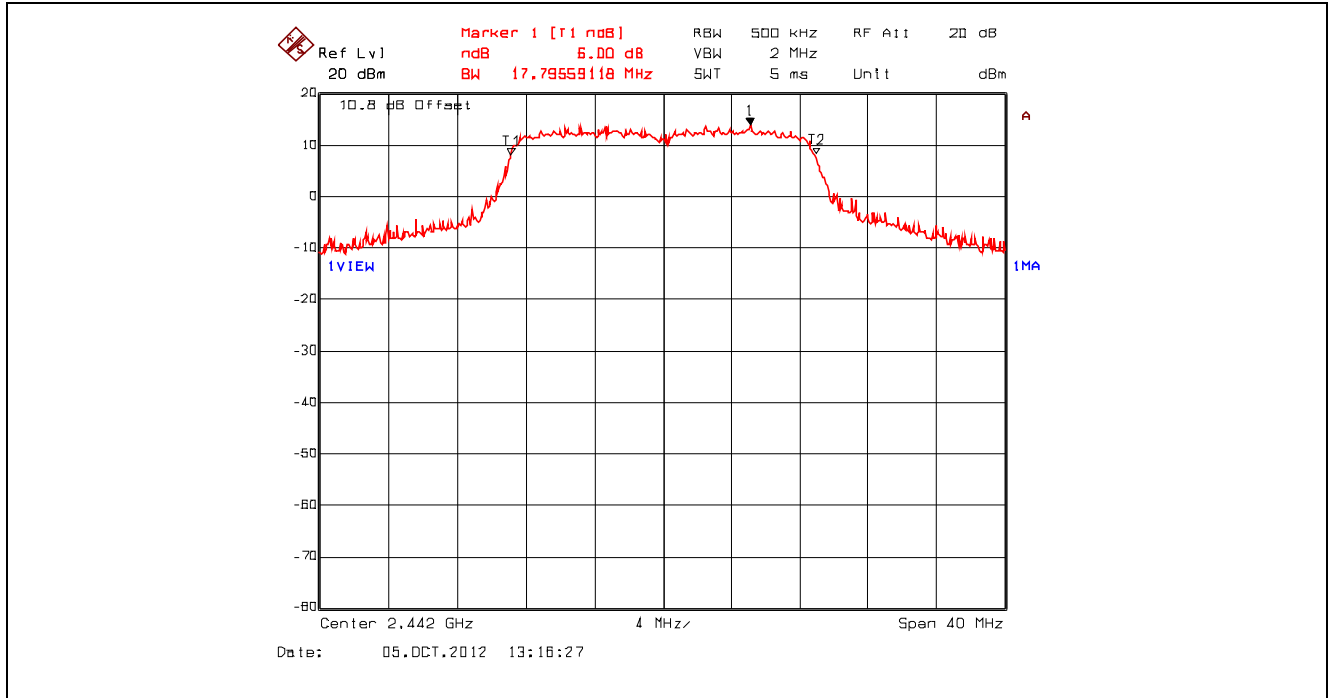

Plot 5.2.4.24. 6 dB Bandwidth, 802.11n 800ns, 6.5 Mbps BPSK1/2, 2462 MHz, Setting 23

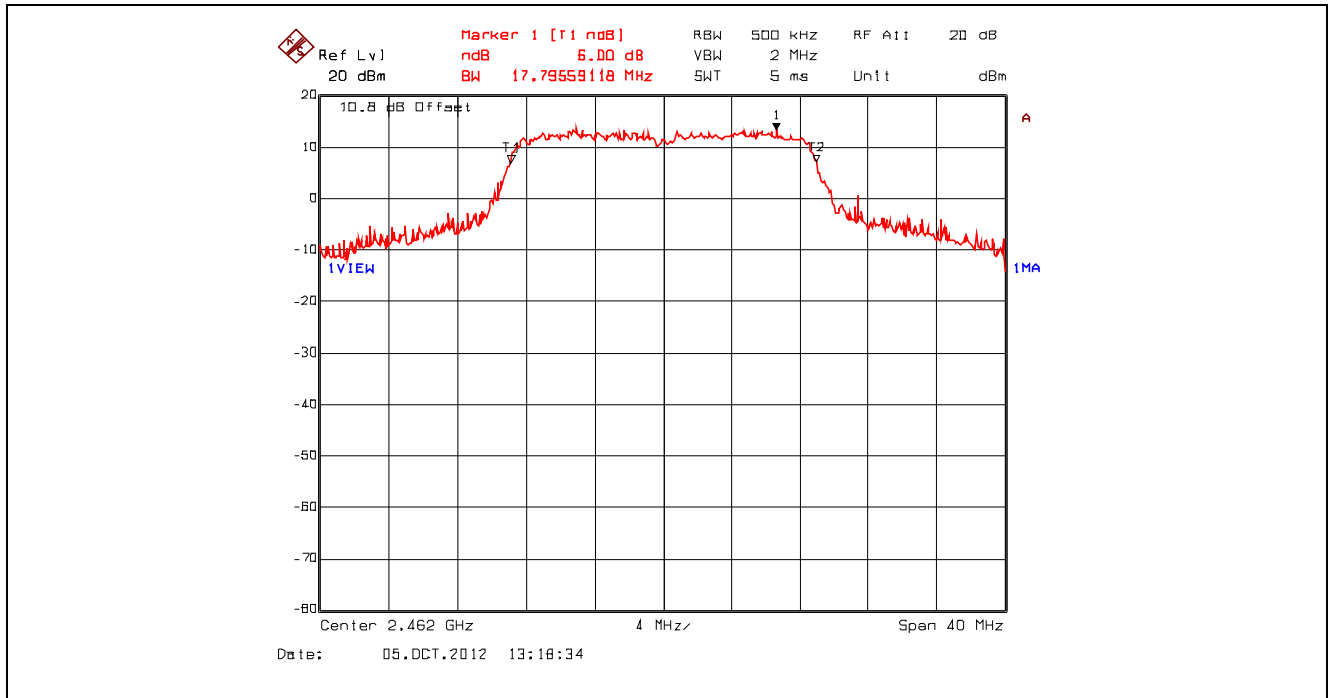

Plot 5.2.4.25. 6 dB Bandwidth, 802.11n 800ns, 19.5 Mbps QPSK 3/4, 2412 MHz, Setting 23

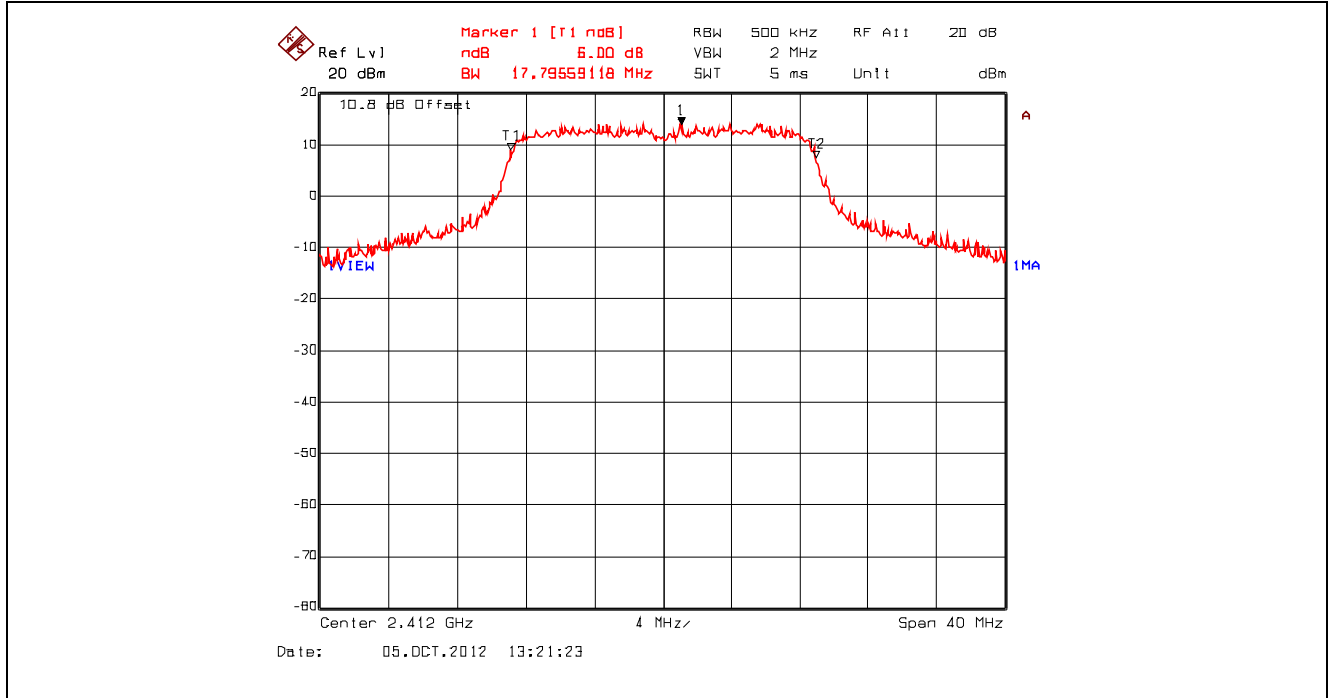

Plot 5.2.4.26. 6 dB Bandwidth, 802.11n 800ns, 19.5 Mbps QPSK 3/4, 2442 MHz, Setting 23

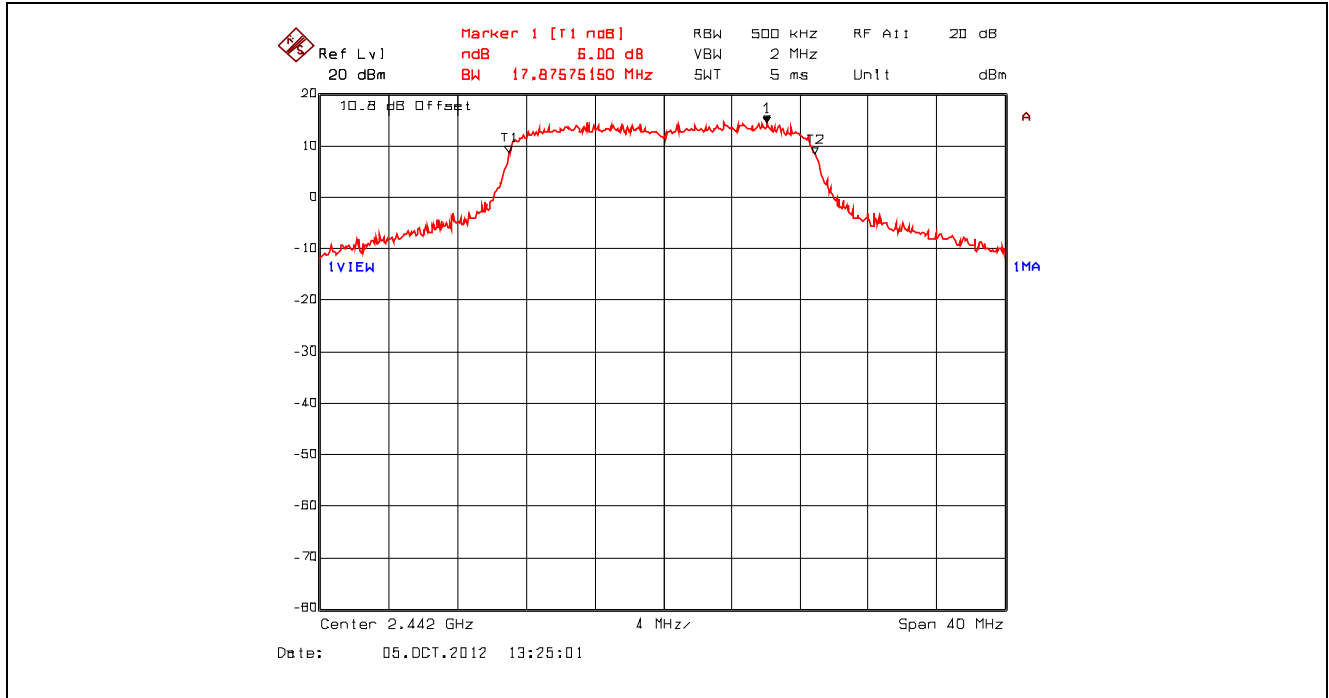

Plot 5.2.4.27. 6 dB Bandwidth, 802.11n 800ns, 19.5 Mbps QPSK 3/4, 2462 MHz, Setting 23

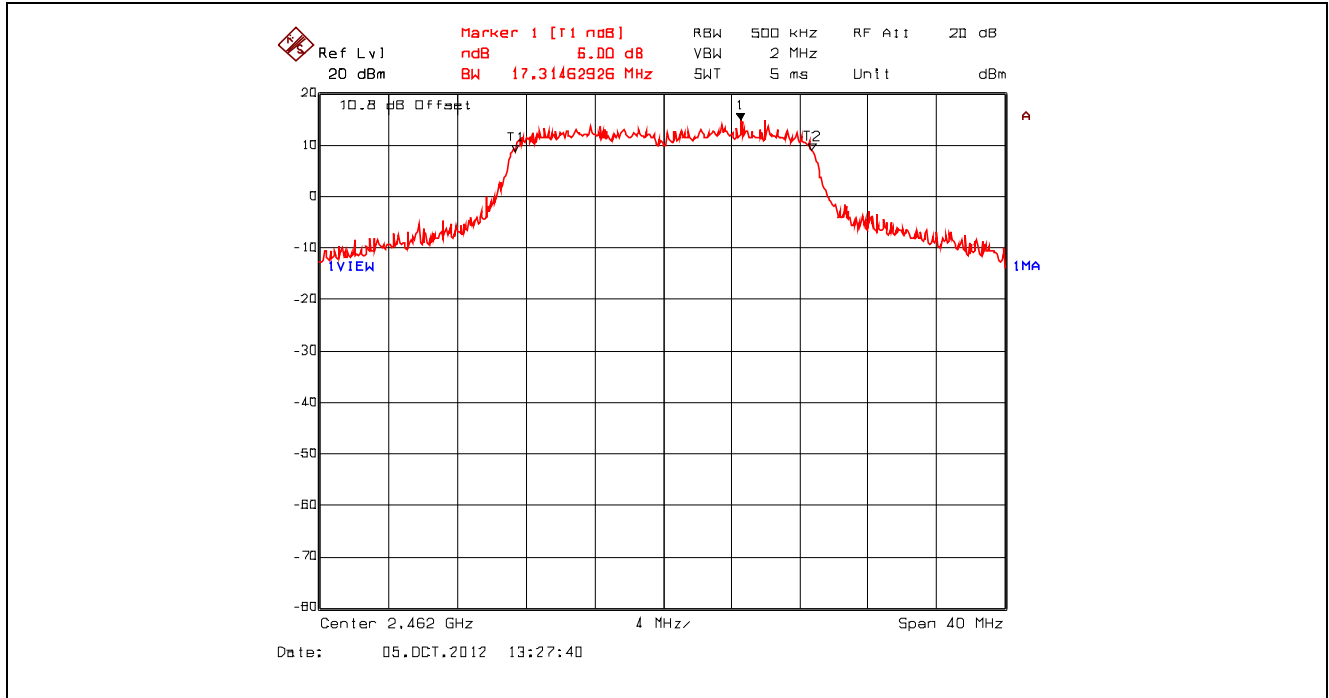

Plot 5.2.4.28. 6 dB Bandwidth, 802.11n 800ns, 39 Mbps 16-QAM 3/4, 2412 MHz, Setting 23

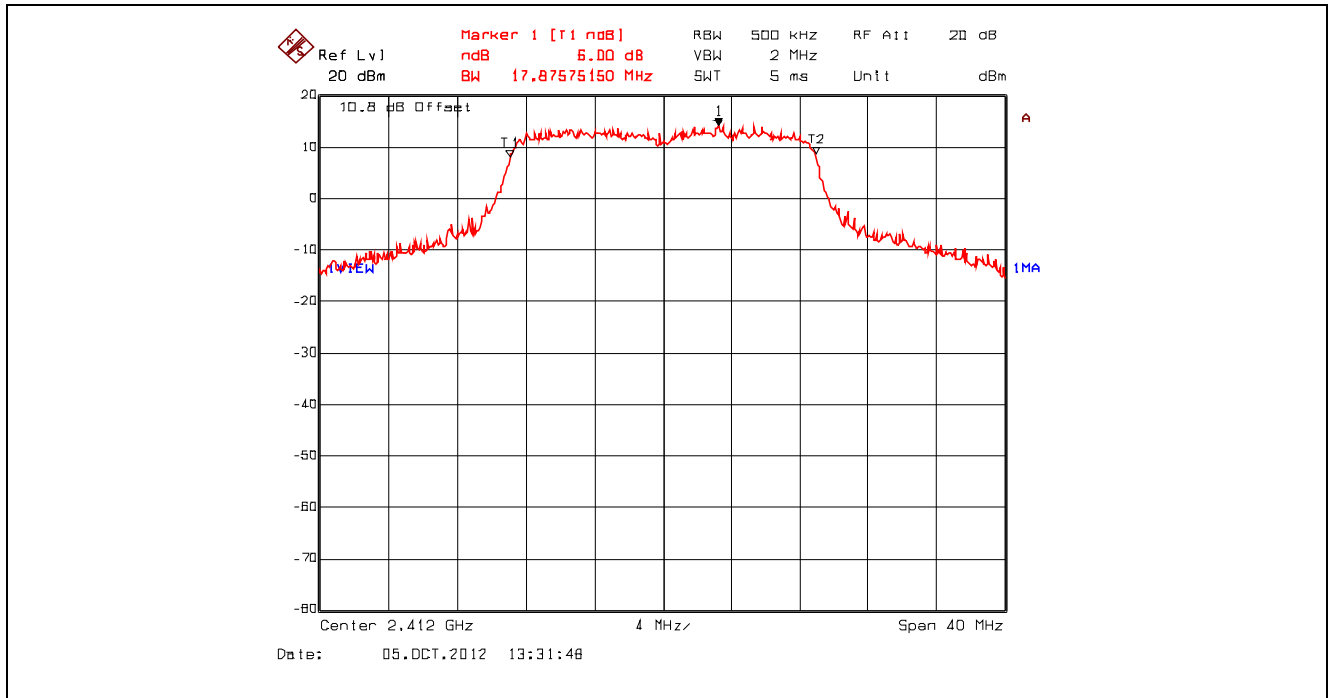

Plot 5.2.4.29. 6 dB Bandwidth, 802.11n 800ns, 39 Mbps 16-QAM 3/4, 2442 MHz, Setting 23

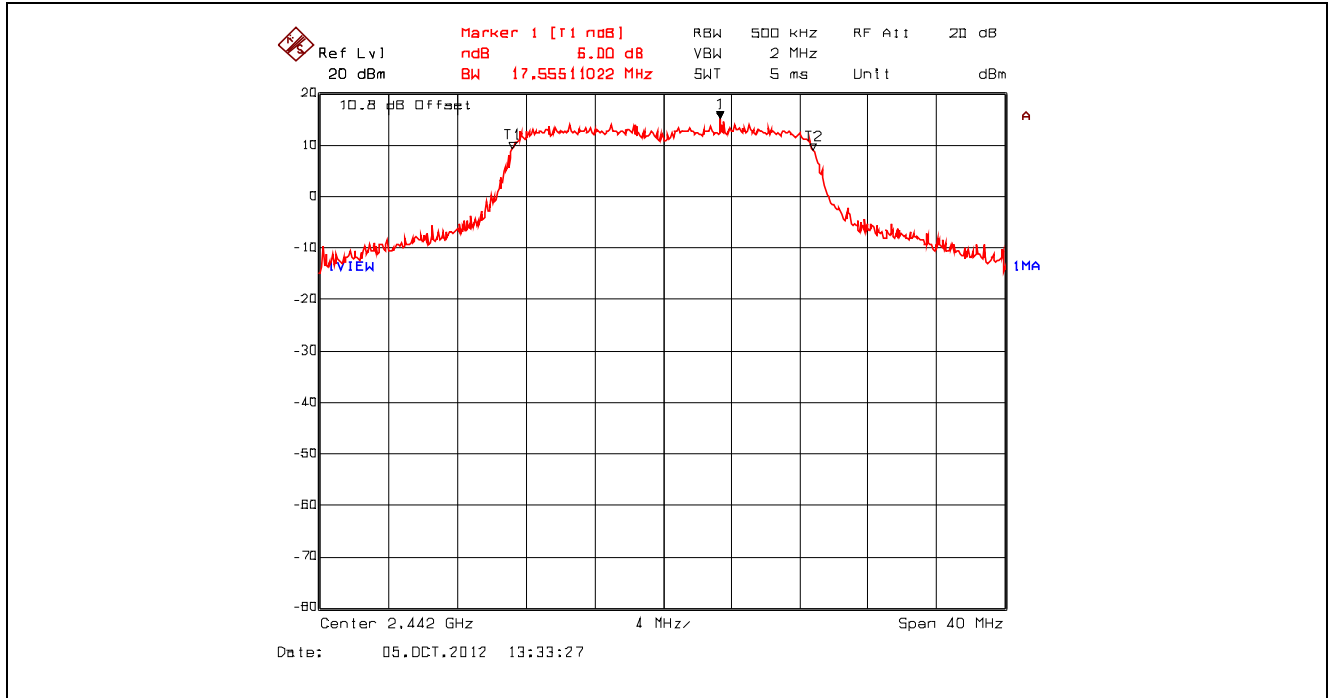

Plot 5.2.4.30. 6 dB Bandwidth, 802.11n 800ns, 39 Mbps 16-QAM 3/4, 2462 MHz, Setting 23

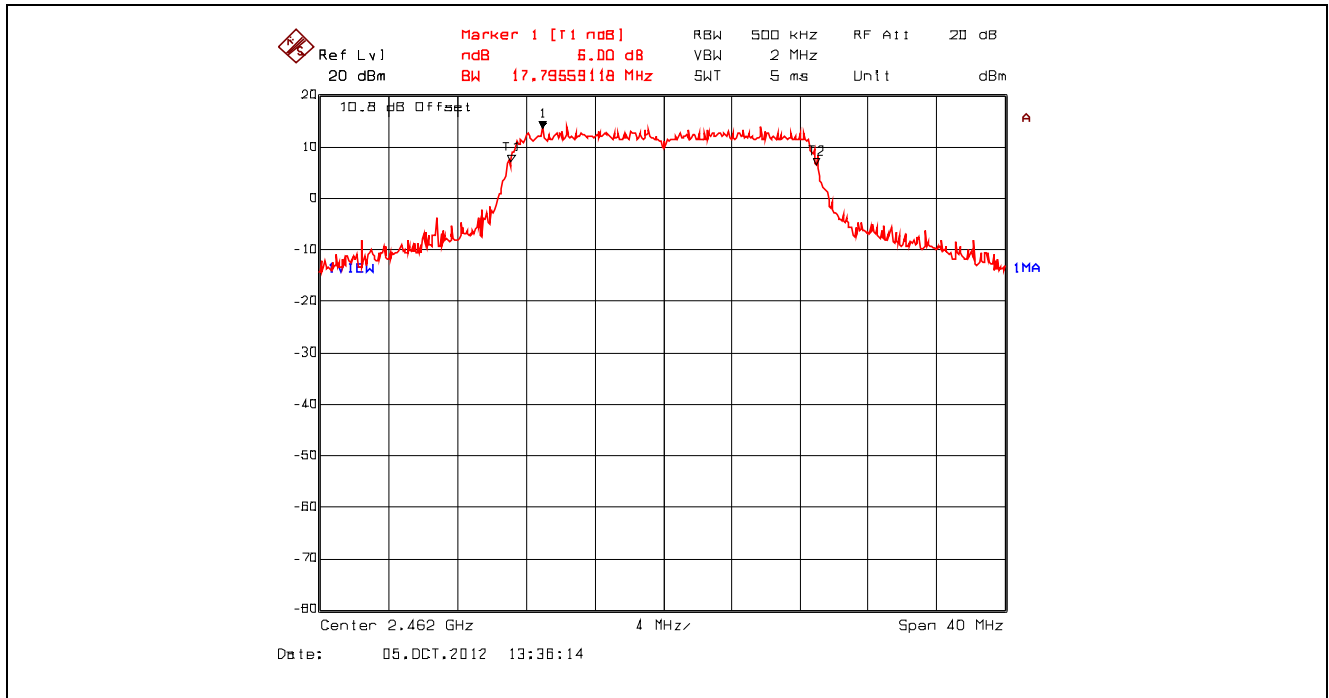

Plot 5.2.4.31. 6 dB Bandwidth, 802.11n 800ns, 65 Mbps 64-QAM 5/6, 2412 MHz, Setting 23

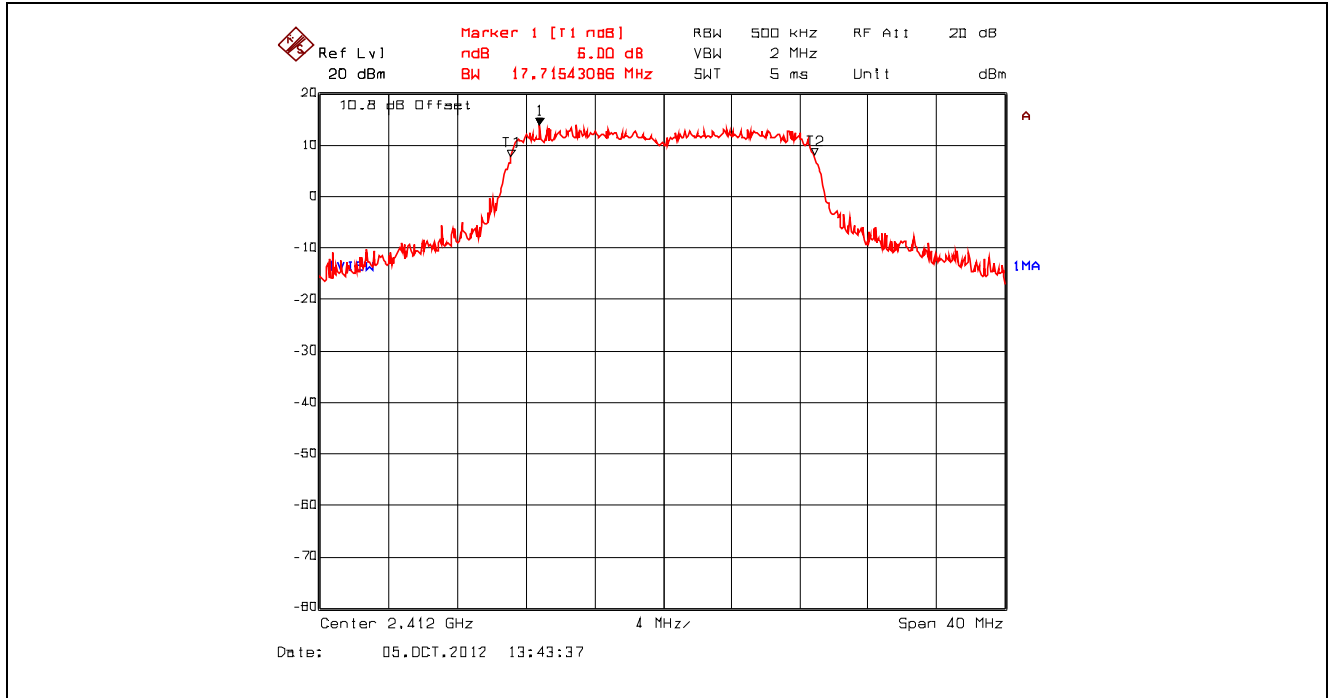

Plot 5.2.4.32. 6 dB Bandwidth, 802.11n 800ns, 65 Mbps 64-QAM 5/6, 2442 MHz, Setting 23

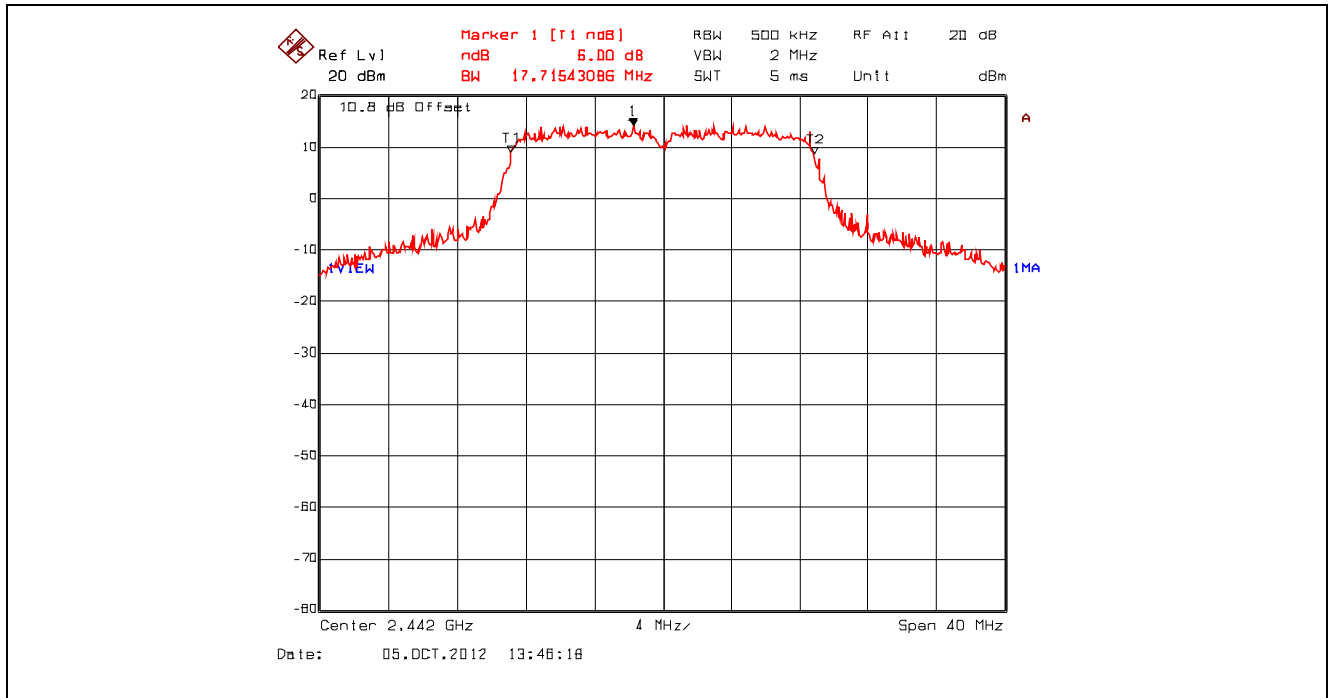

Plot 5.2.4.33. 6 dB Bandwidth, 802.11n 800ns, 65 Mbps 64-QAM 5/6, 2462 MHz, Setting 23

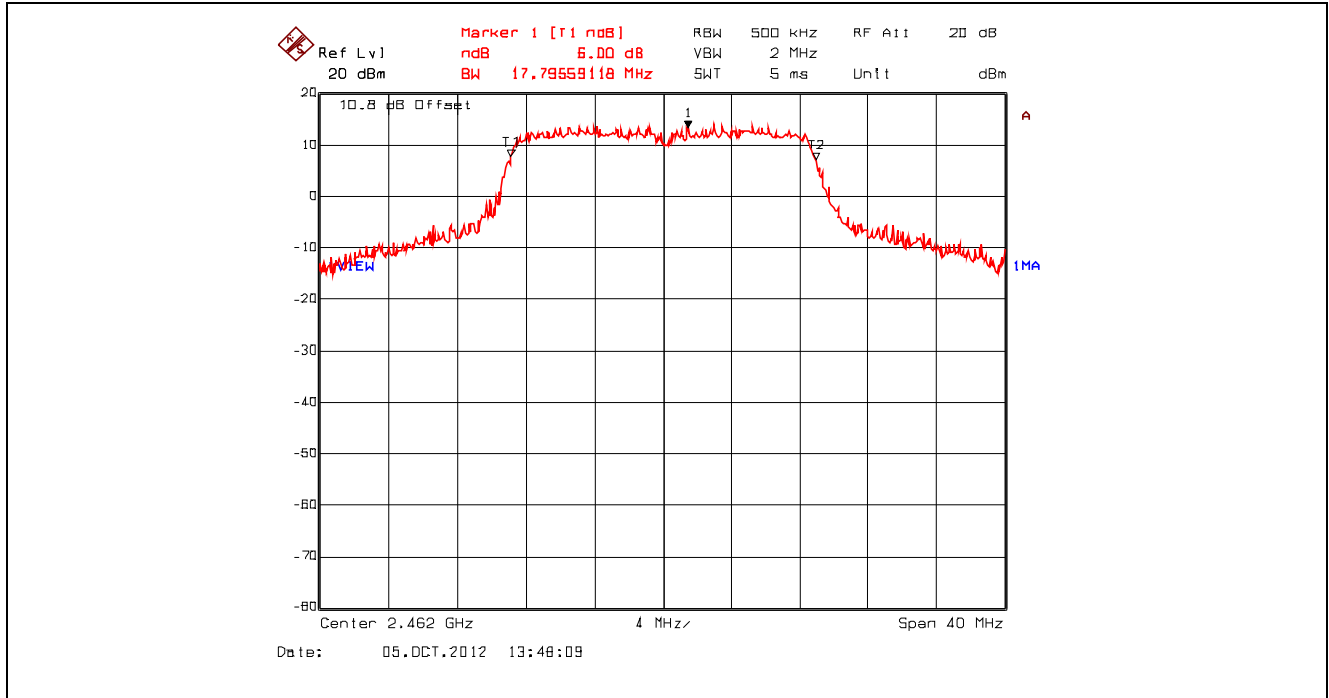

Plot 5.2.4.34. 6 dB Bandwidth, 802.11n 400ns, 7.2 Mbps BPSK1/2, 2412 MHz, Setting 23

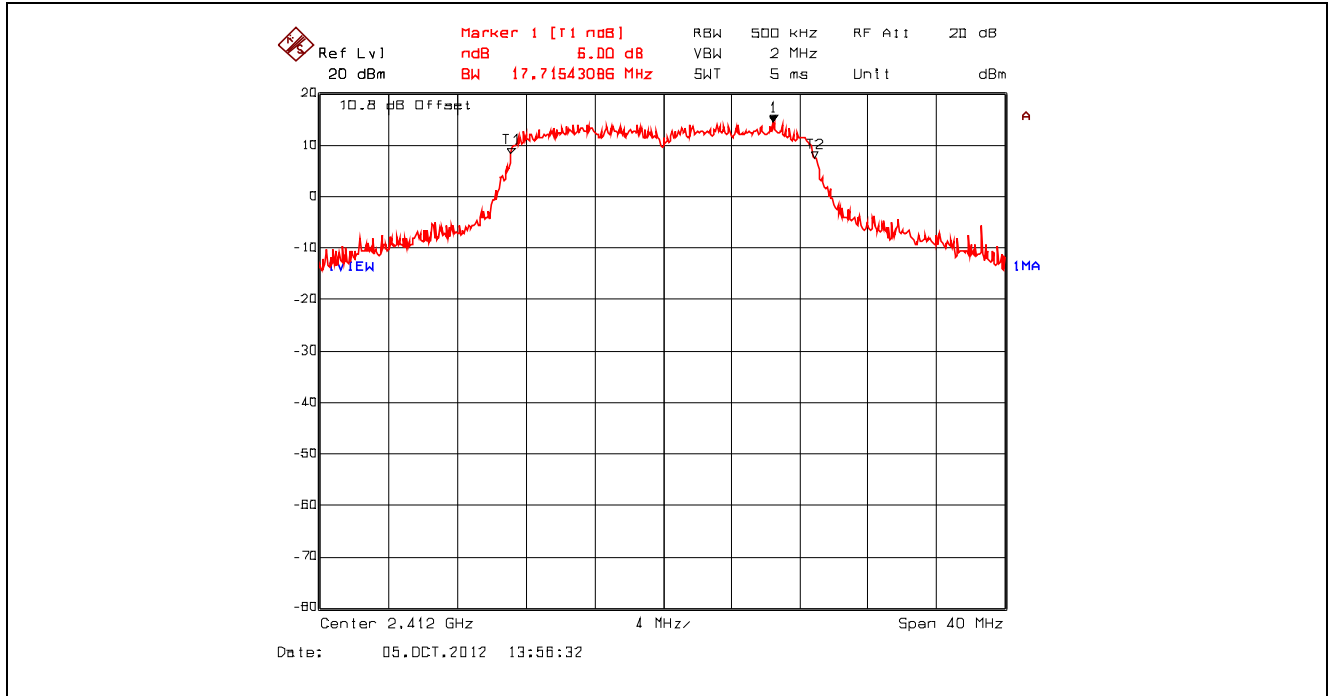

Plot 5.2.4.35. 6 dB Bandwidth, 802.11n 400ns, 7.2 Mbps BPSK1/2, 2442 MHz, Setting 23

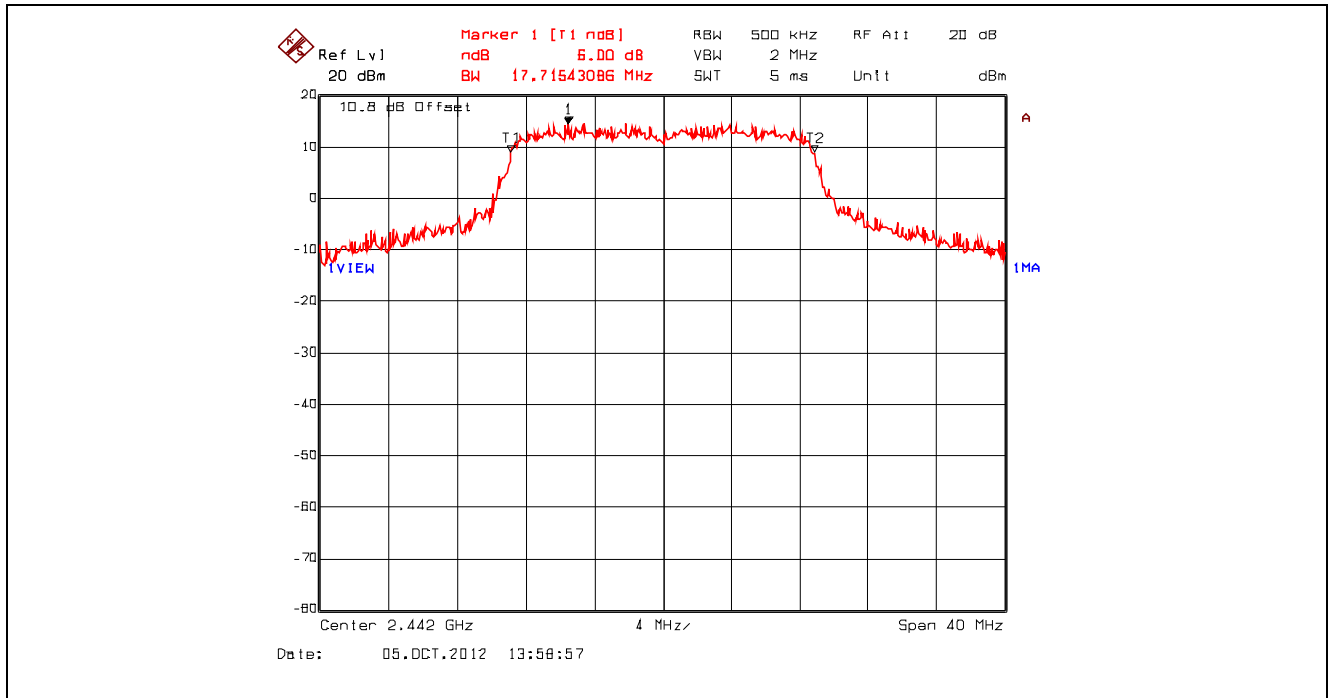

Plot 5.2.4.36. 6 dB Bandwidth, 802.11n 400ns, 7.2 Mbps BPSK1/2, 2462 MHz, Setting 23

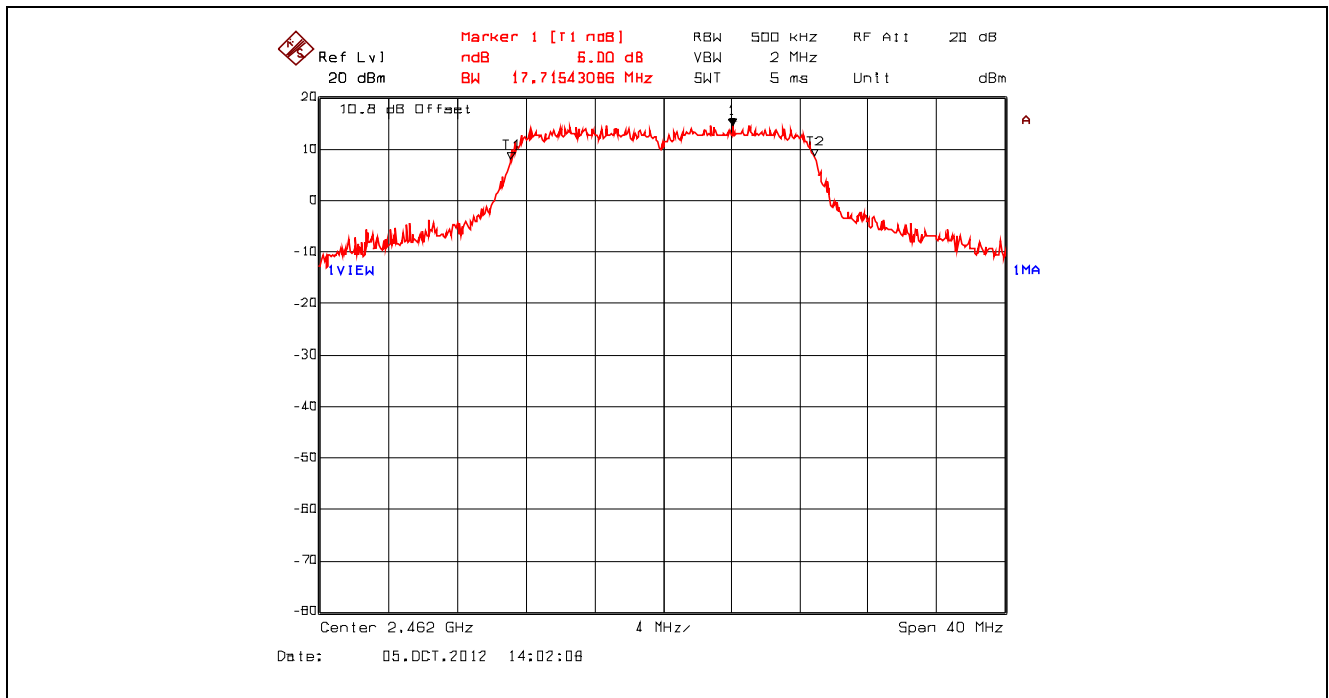

Plot 5.2.4.37. 6 dB Bandwidth, 802.11n 400ns, 21.7 Mbps QPSK 3/4, 2412 MHz, Setting 23

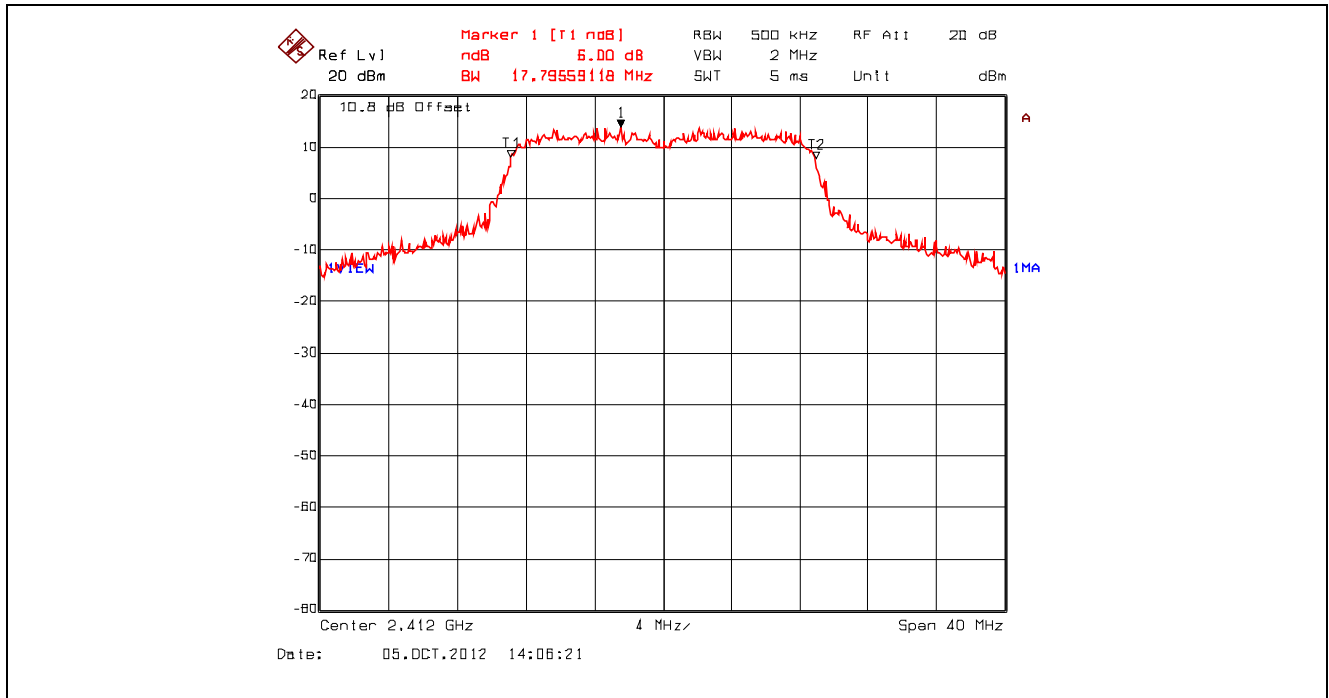

Plot 5.2.4.38. 6 dB Bandwidth, 802.11n 400ns, 21.7 Mbps QPSK 3/4, 2442 MHz, Setting 23

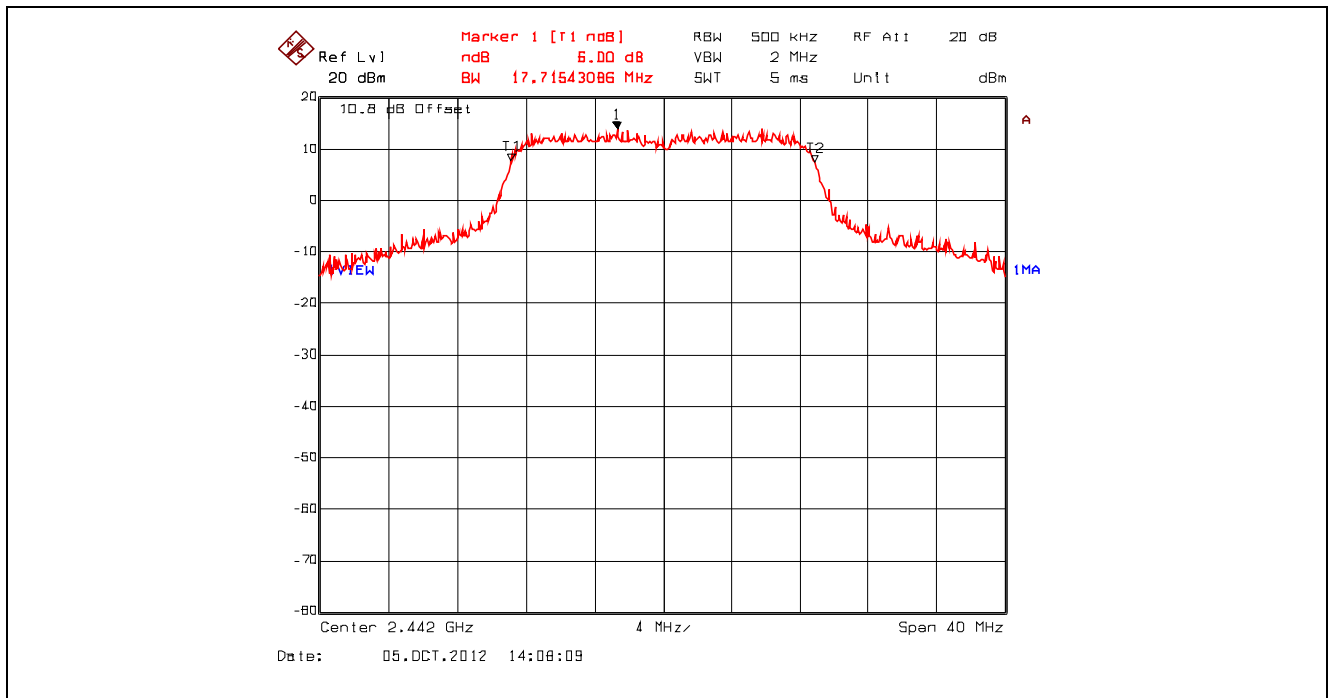

Plot 5.2.4.39. 6 dB Bandwidth, 802.11n 400ns, 21.7 Mbps QPSK 3/4, 2462 MHz, Setting 23

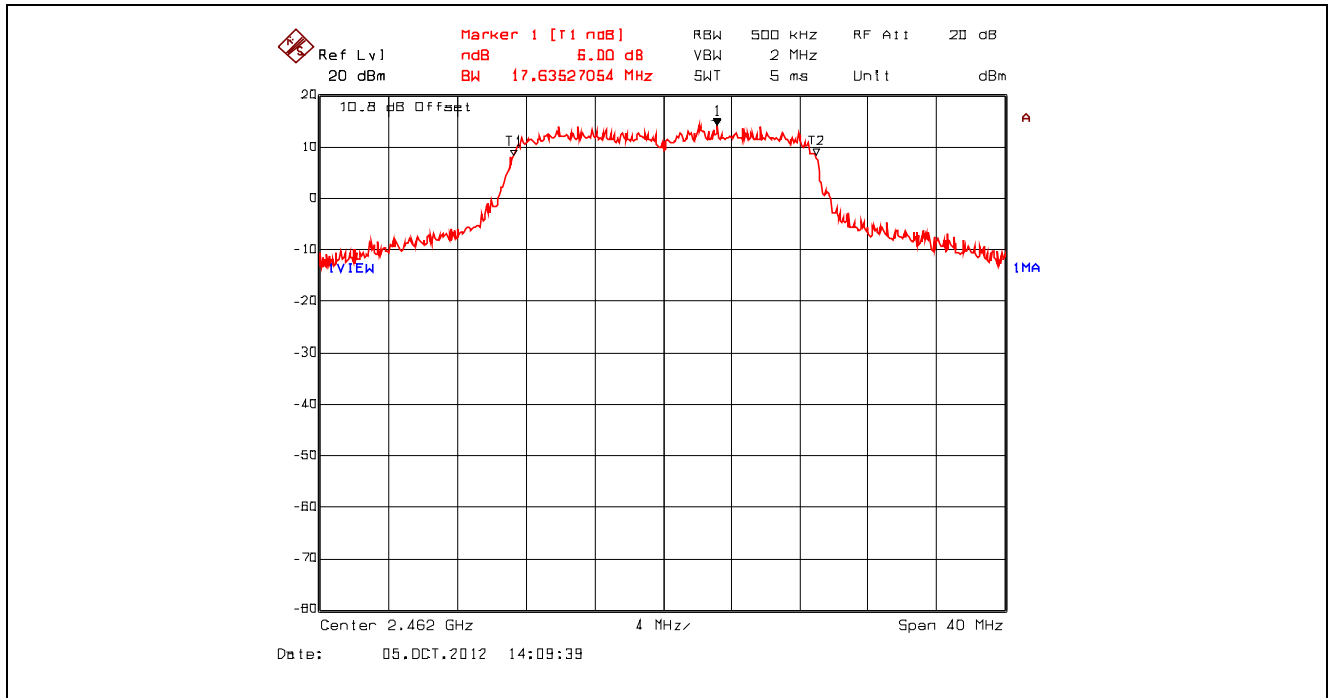

Plot 5.2.4.40. 6 dB Bandwidth, 802.11n 400ns, 43.3 Mbps 16-QAM 3/4, 2412 MHz, Setting 23

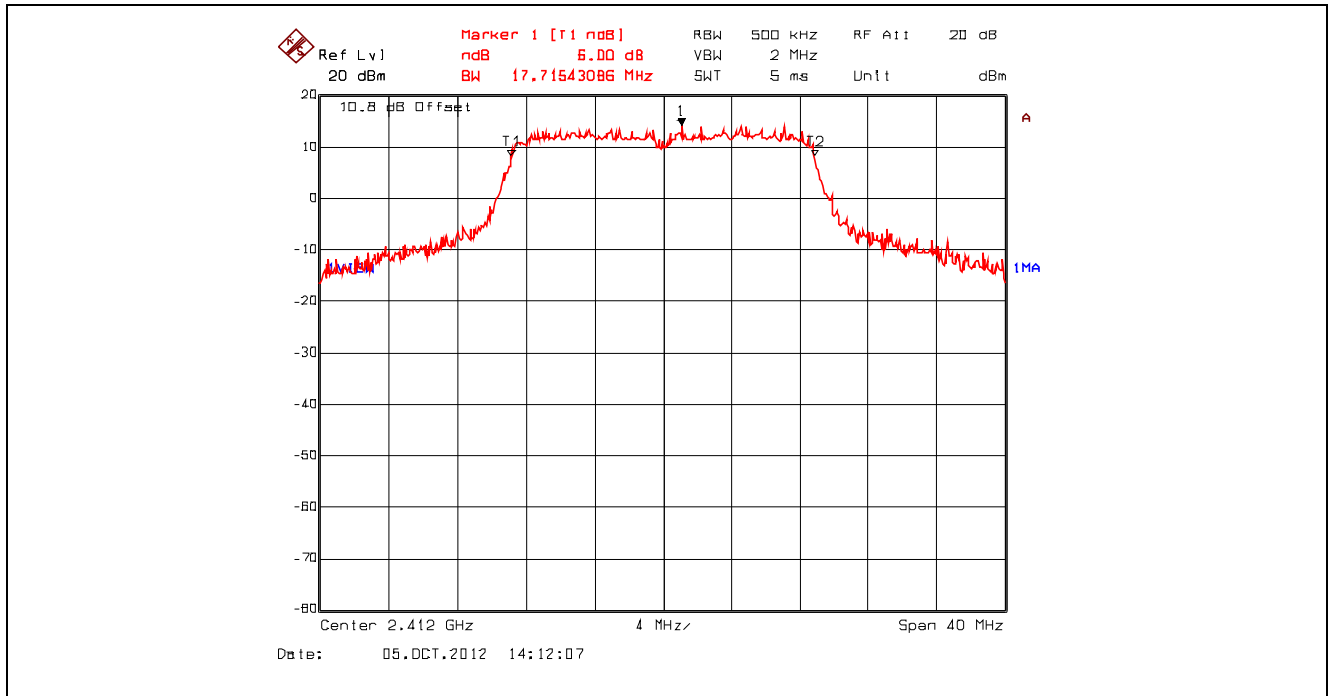

Plot 5.2.4.41. 6 dB Bandwidth, 802.11n 400ns, 43.3 Mbps 16-QAM 3/4, 2442 MHz, Setting 23

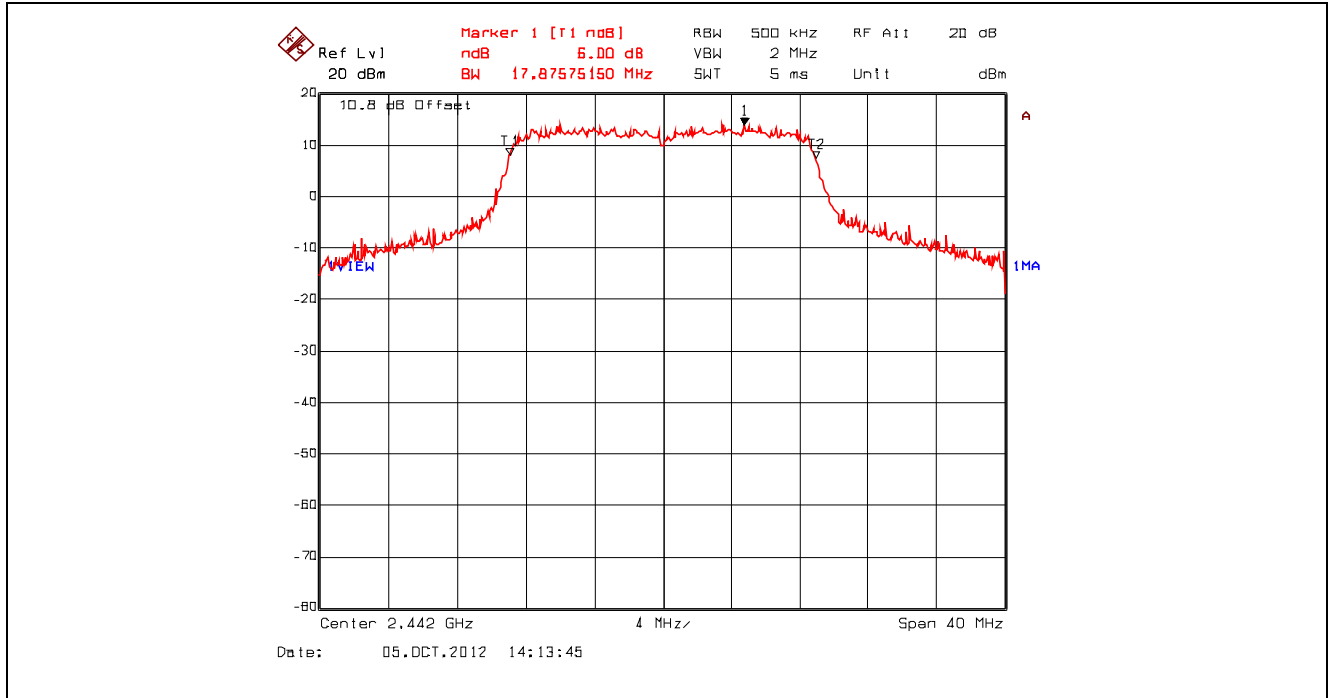

Plot 5.2.4.42. 6 dB Bandwidth, 802.11n 400ns, 43.3 Mbps 16-QAM 3/4, 2462 MHz, Setting 23

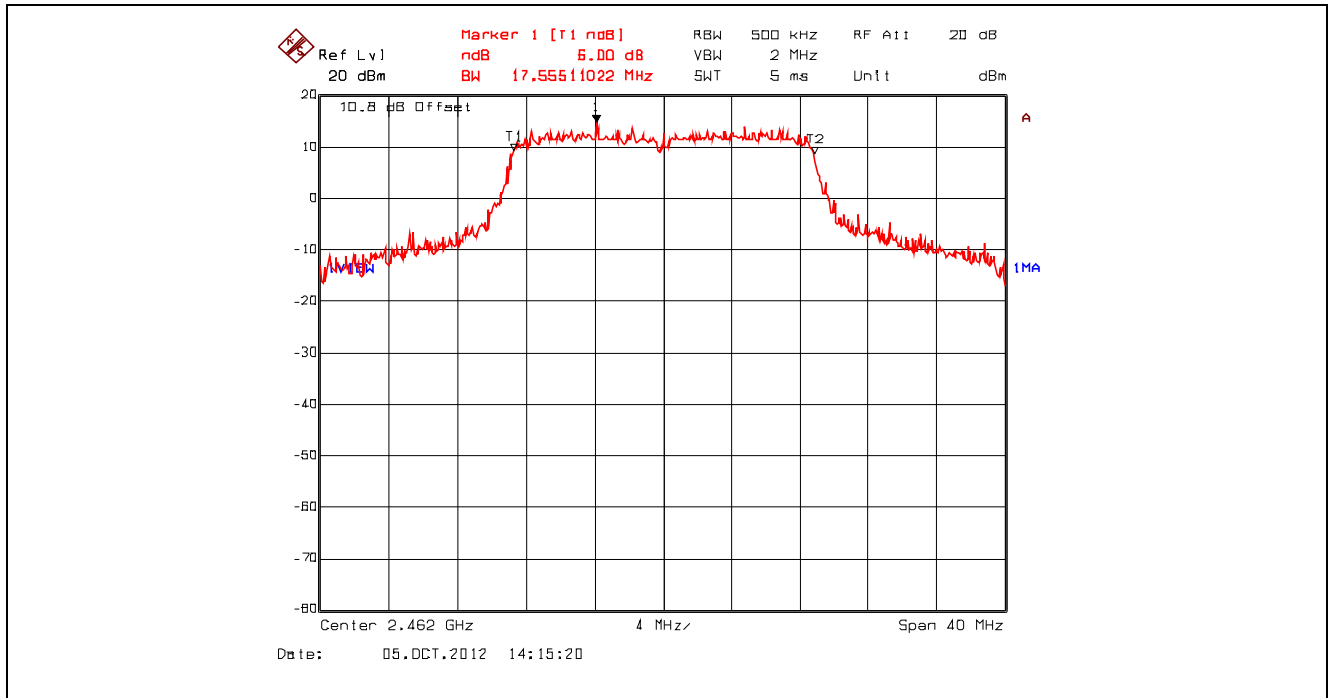

Plot 5.2.4.43. 6 dB Bandwidth, 802.11n 400ns, 72.2 Mbps 64-QAM 5/6, 2412 MHz, Setting 23

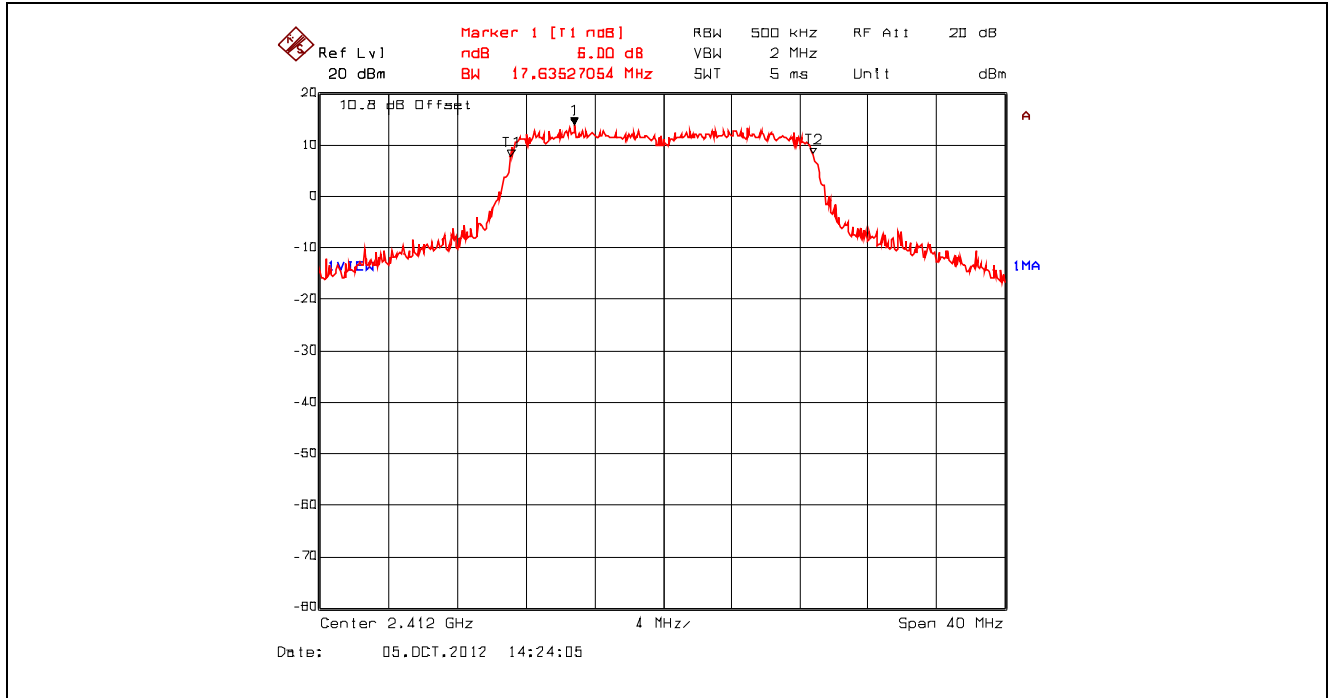

Plot 5.2.4.44. 6 dB Bandwidth, 802.11n 400ns, 72.2 Mbps 64-QAM 5/6, 2442 MHz, Setting 23

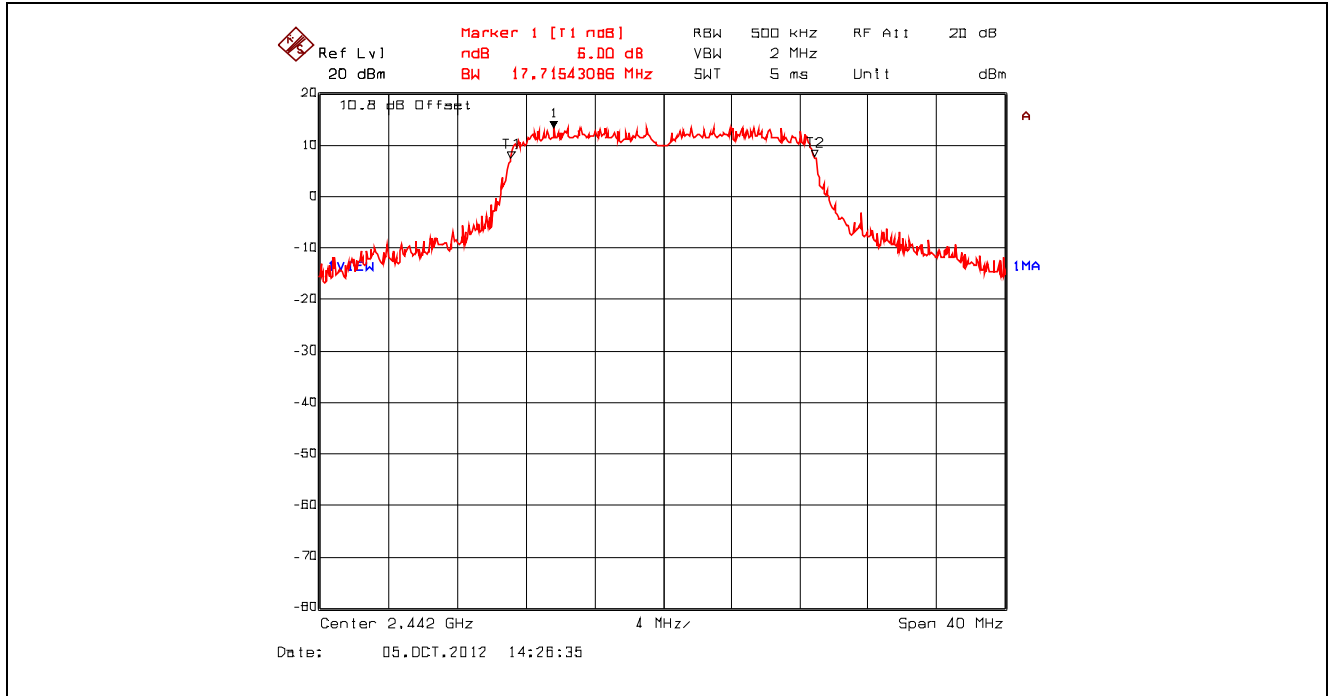

Plot 5.2.4.45. 6 dB Bandwidth, 802.11n 400ns, 72.2 Mbps 64-QAM 5/6, 2462 MHz, Setting 23

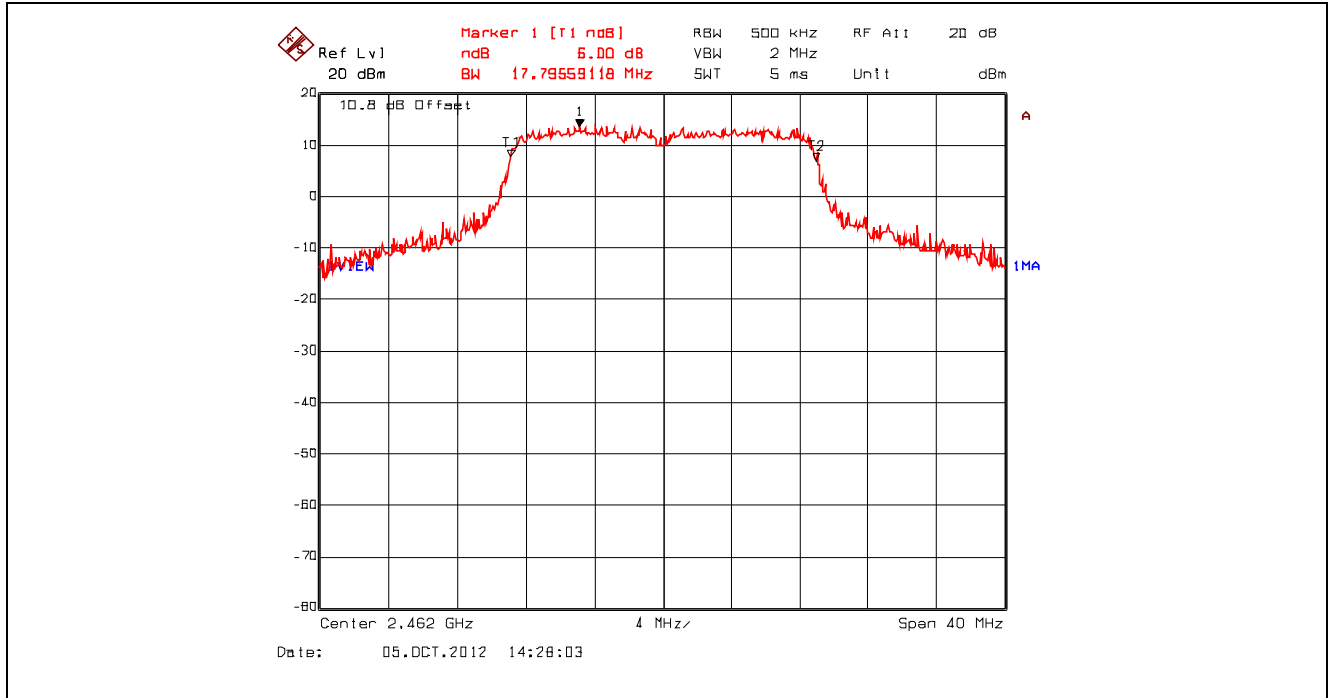

Plot 5.2.4.46. 99% Occupied Bandwidth, 802.11b, 1 Mbps DBPSK, 2412 MHz, Setting 23

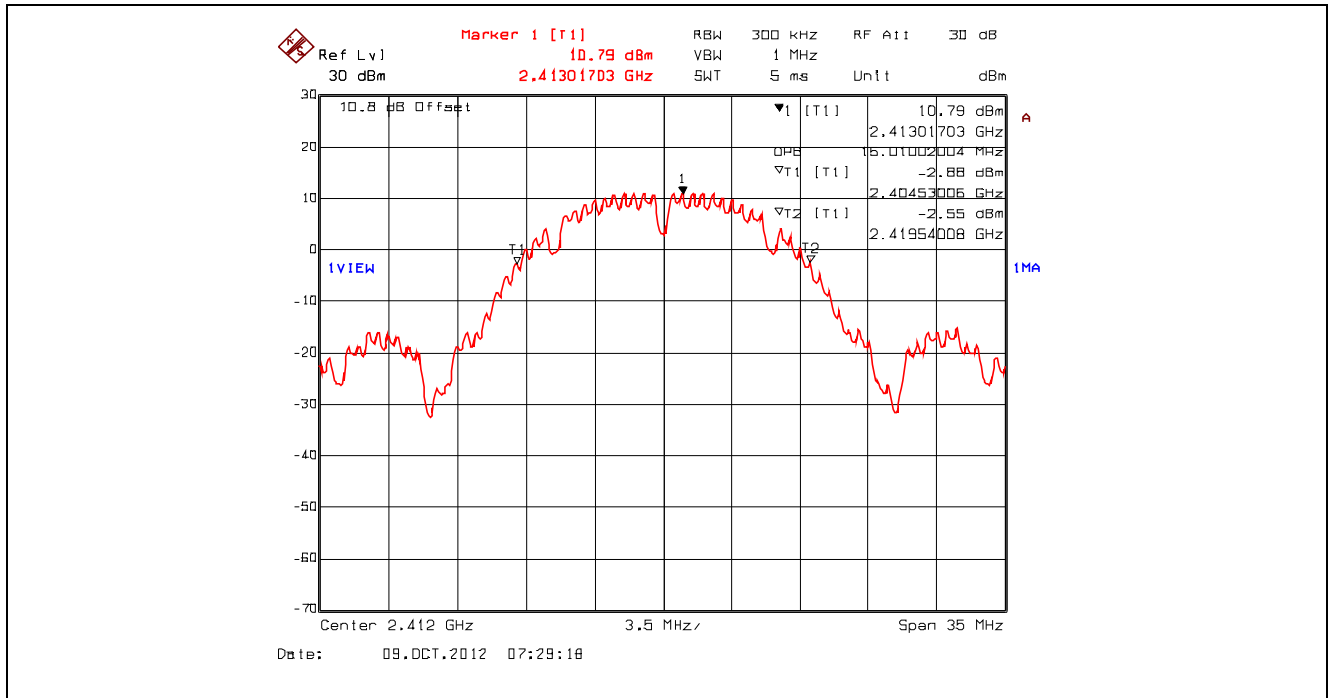

Plot 5.2.4.47. 99% Occupied Bandwidth, 802.11b, 1 Mbps DBPSK, 2442 MHz, Setting 23

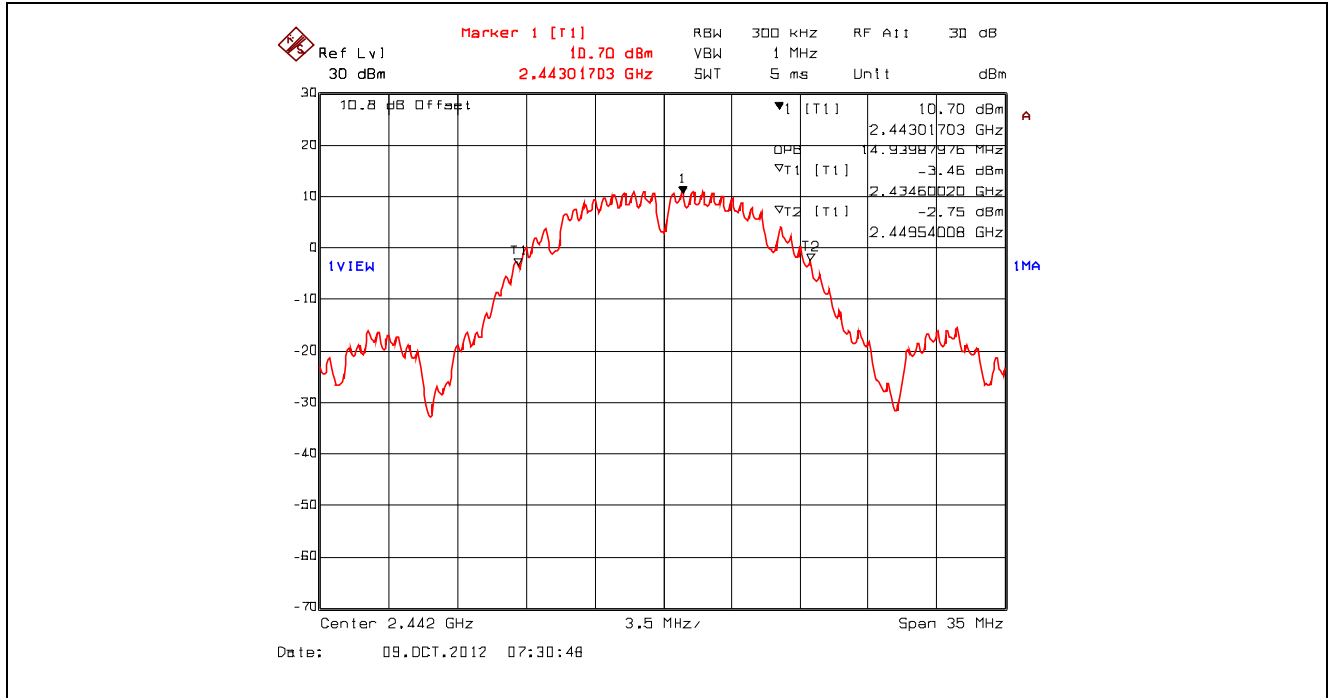

Plot 5.2.4.48. 99% Occupied Bandwidth, 802.11b, 1 Mbps DBPSK, 2462 MHz, Setting 23

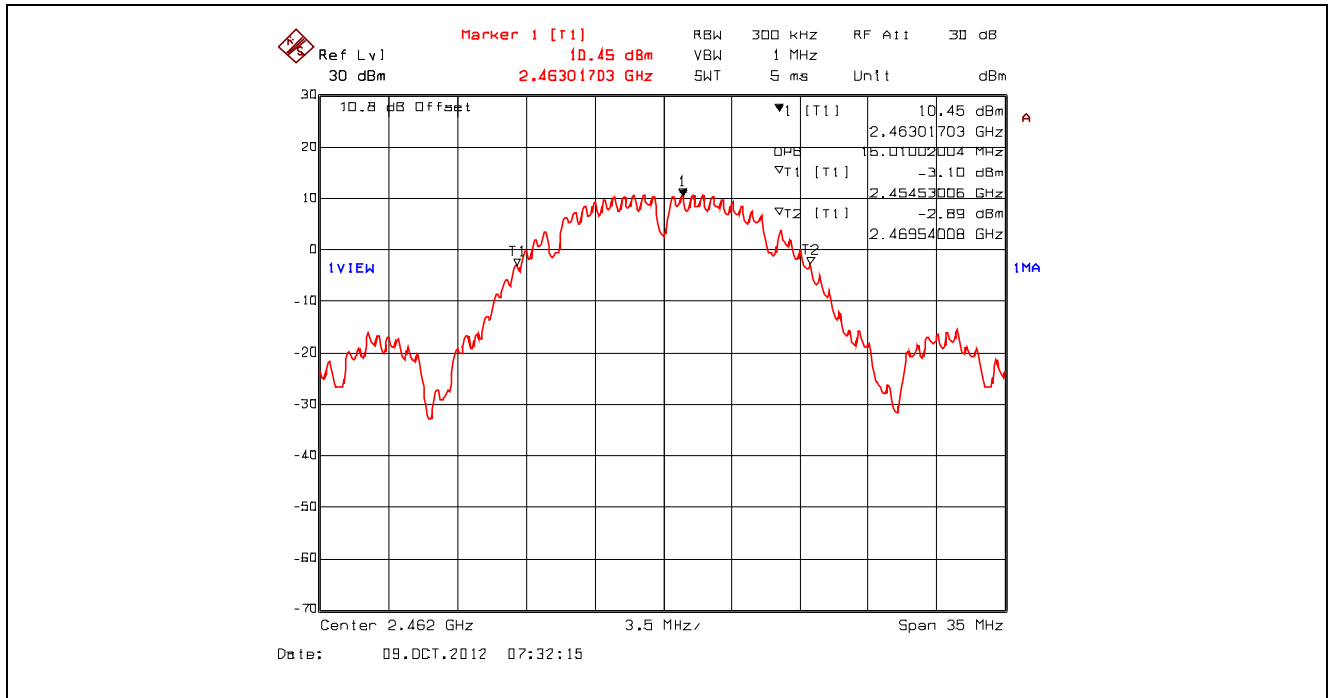

Plot 5.2.4.49. 99% Occupied Bandwidth, 802.11b, 2 Mbps DQPSK, 2412 MHz, Setting 23

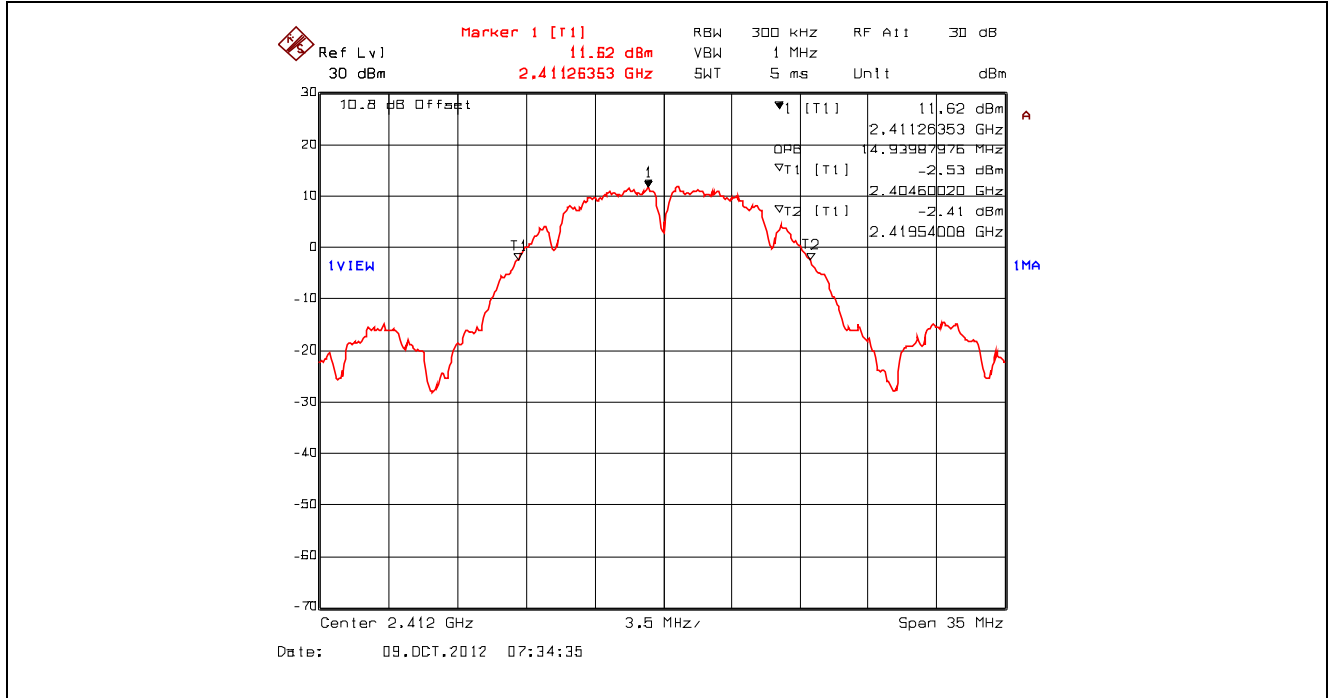

Plot 5.2.4.50. 99% Occupied Bandwidth, 802.11b, 2 Mbps DQPSK, 2442 MHz, Setting 23

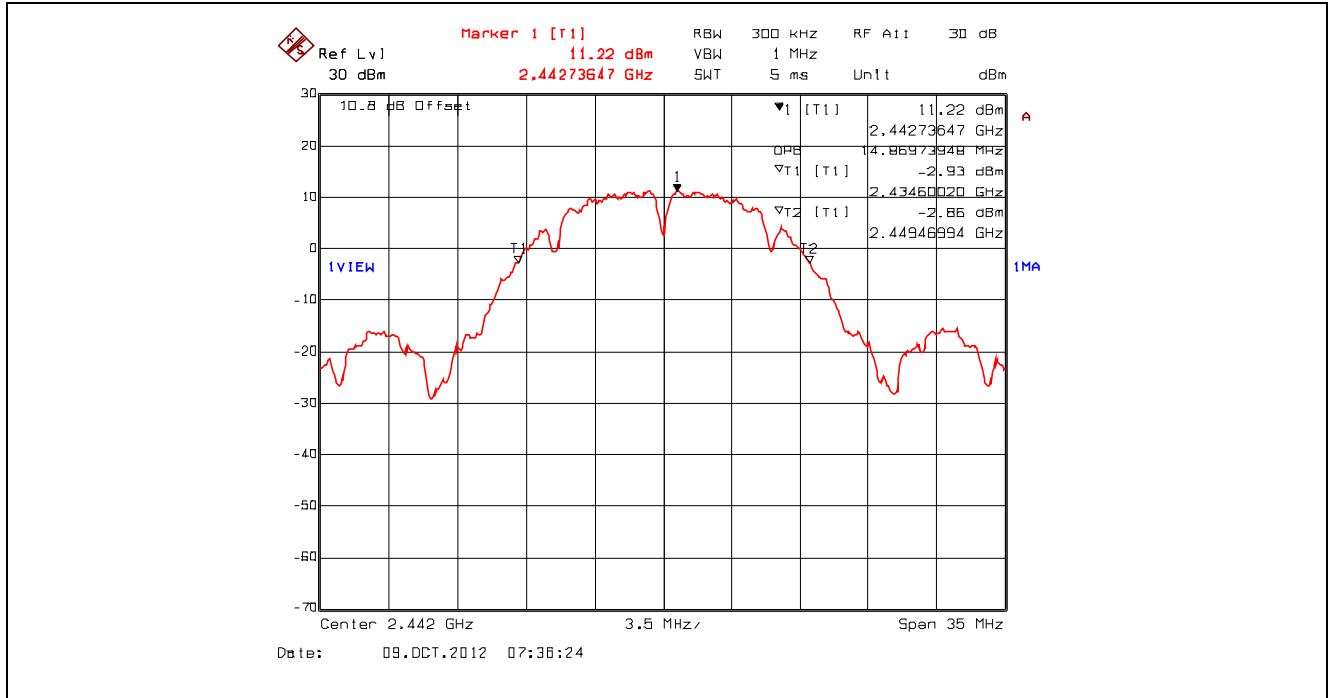

Plot 5.2.4.51. 99% Occupied Bandwidth, 802.11b, 2 Mbps DQPSK, 2462 MHz, Setting 23

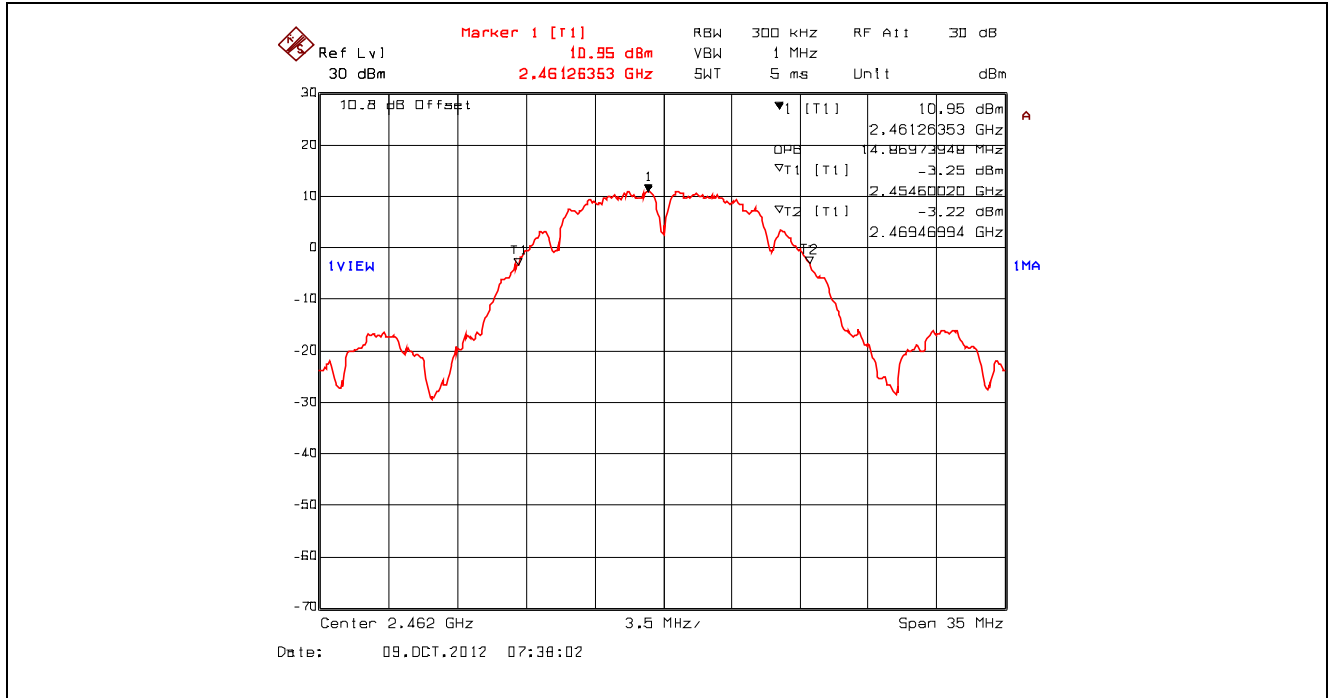

Plot 5.2.4.52. 99% Occupied Bandwidth, 802.11b, 11 Mbps CCK, 2412 MHz, Setting 23

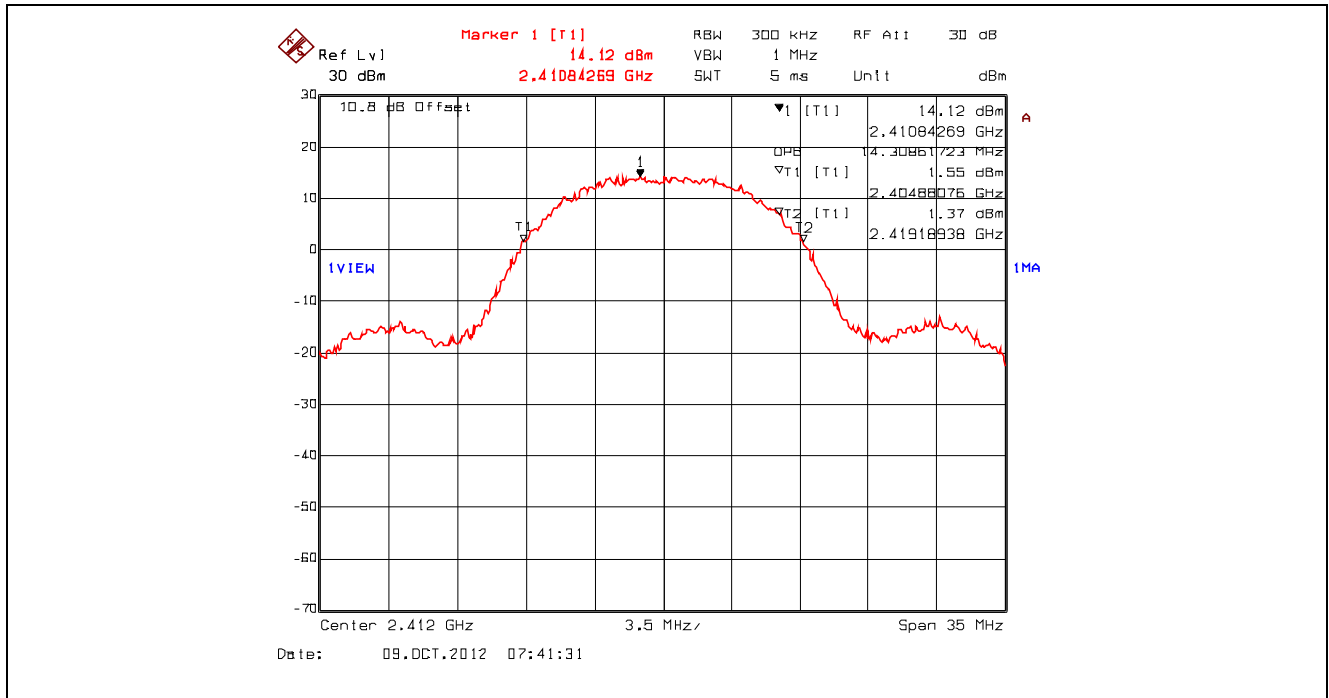

Plot 5.2.4.53. 99% Occupied Bandwidth, 802.11b, 11 Mbps CCK, 2442 MHz, Setting 23

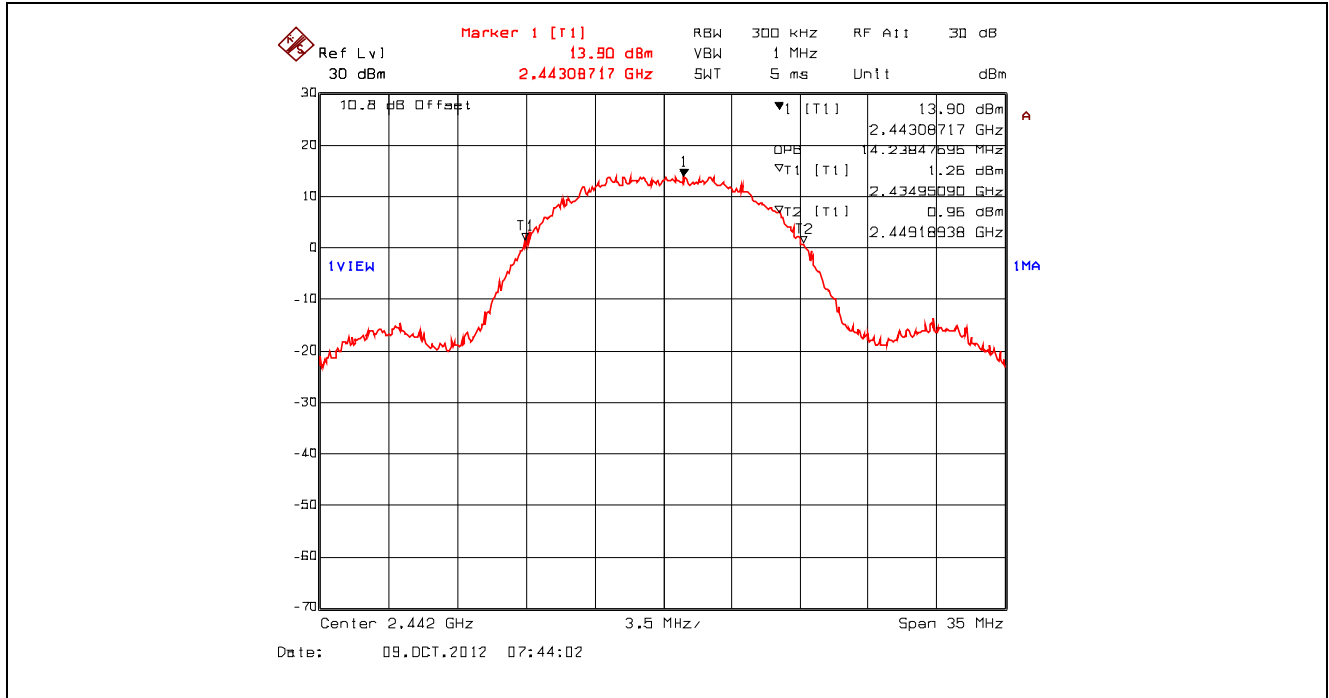

Plot 5.2.4.54. 99% Occupied Bandwidth, 802.11b, 11 Mbps CCK, 2462 MHz, Setting 23

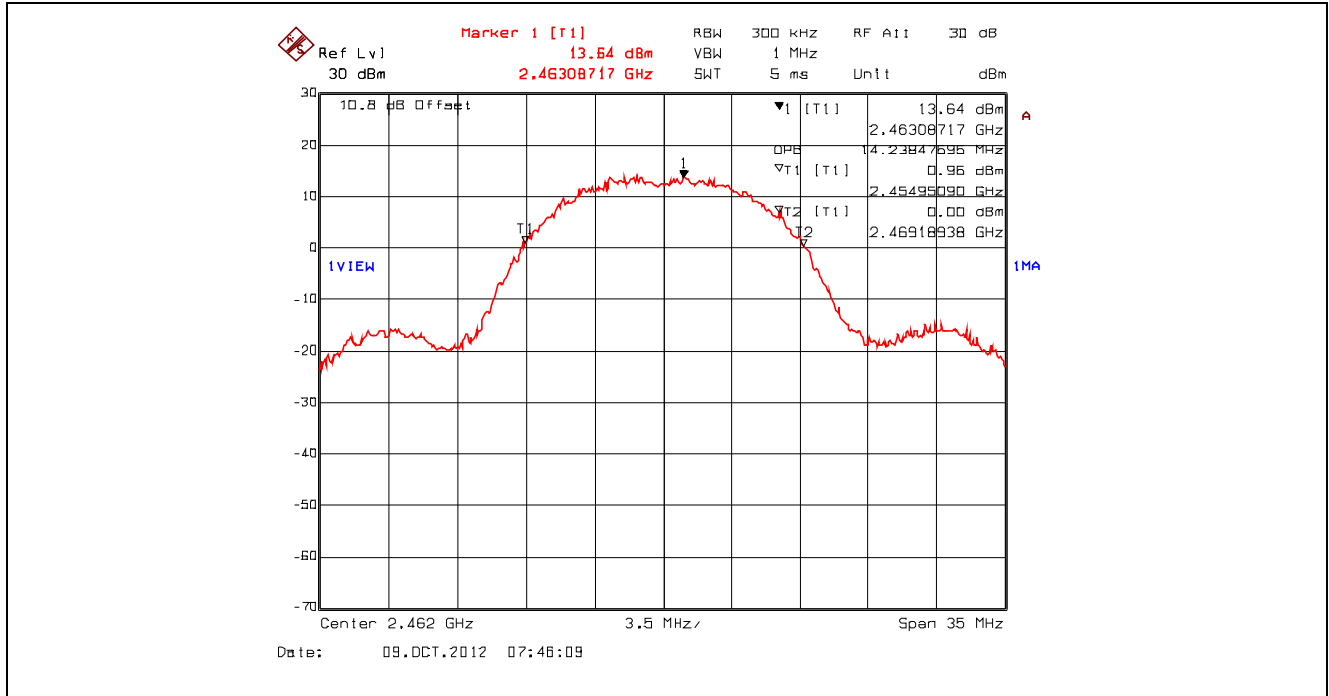

Plot 5.2.4.55. 99% Occupied Bandwidth, 802.11g, 9 Mbps BPSK, 2412 MHz, Setting 23

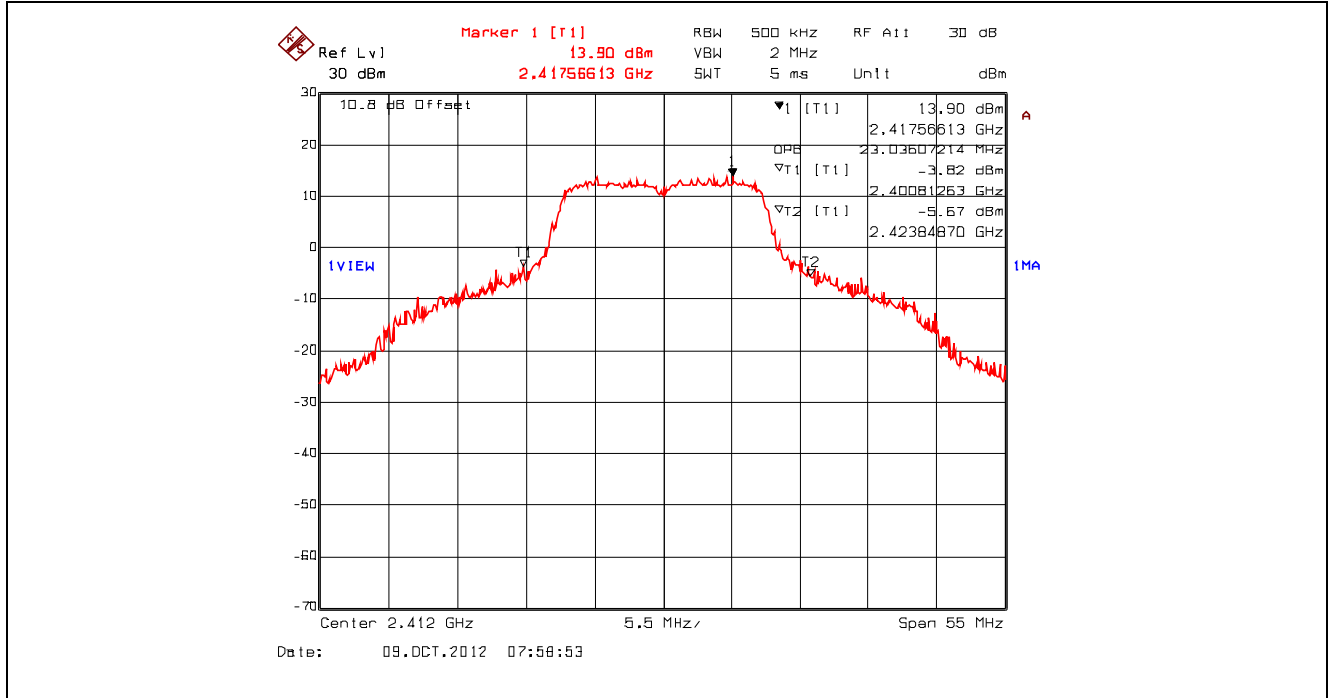

Plot 5.2.4.56. 99% Occupied Bandwidth, 802.11g, 9 Mbps BPSK, 2442 MHz, Setting 23

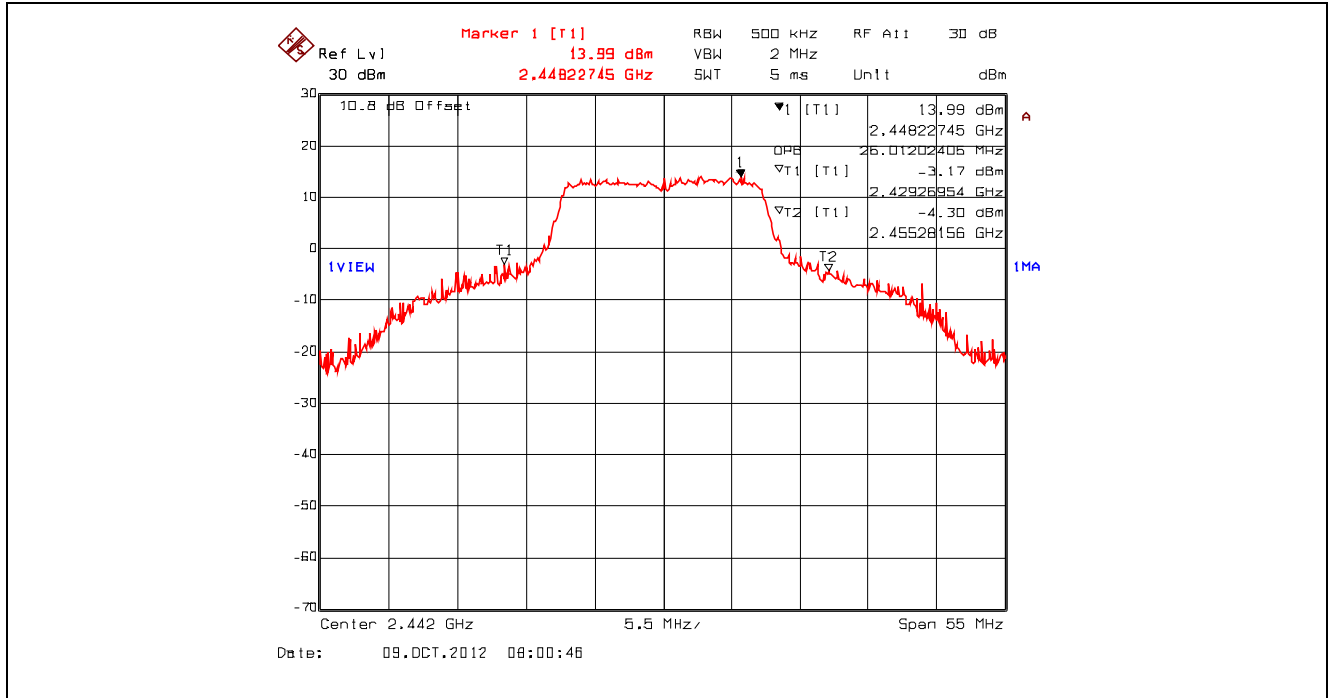

Plot 5.2.4.57. 99% Occupied Bandwidth, 802.11g, 9 Mbps BPSK, 2462 MHz, Setting 23

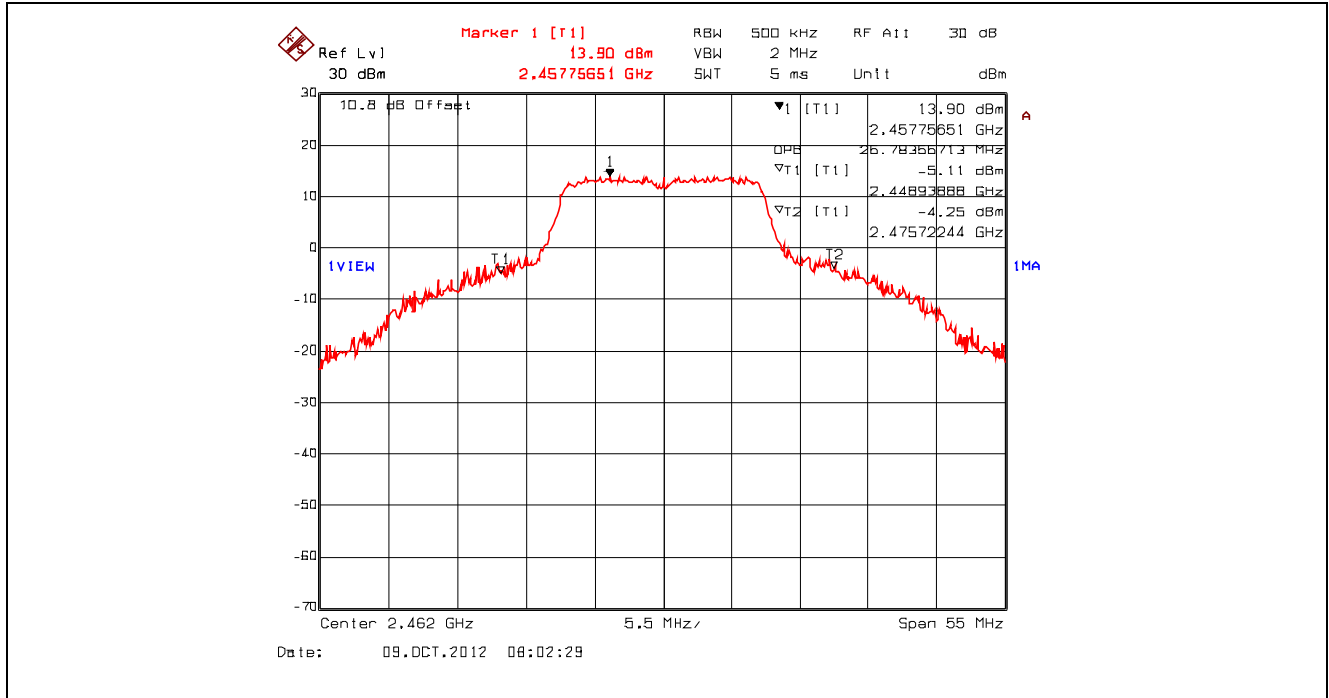

Plot 5.2.4.58. 99% Occupied Bandwidth, 802.11g, 18 Mbps QPSK, 2412 MHz, Setting 23

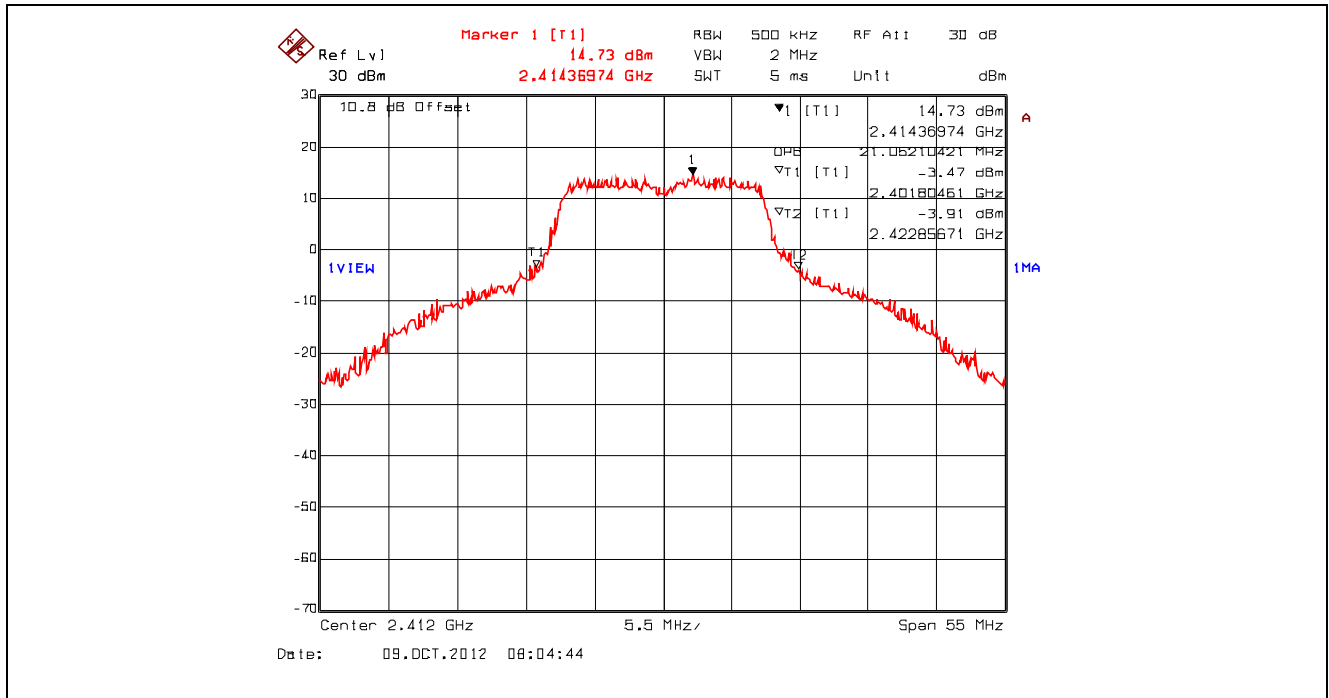

Plot 5.2.4.59. 99% Occupied Bandwidth, 802.11g, 18 Mbps QPSK, 2442 MHz, Setting 23

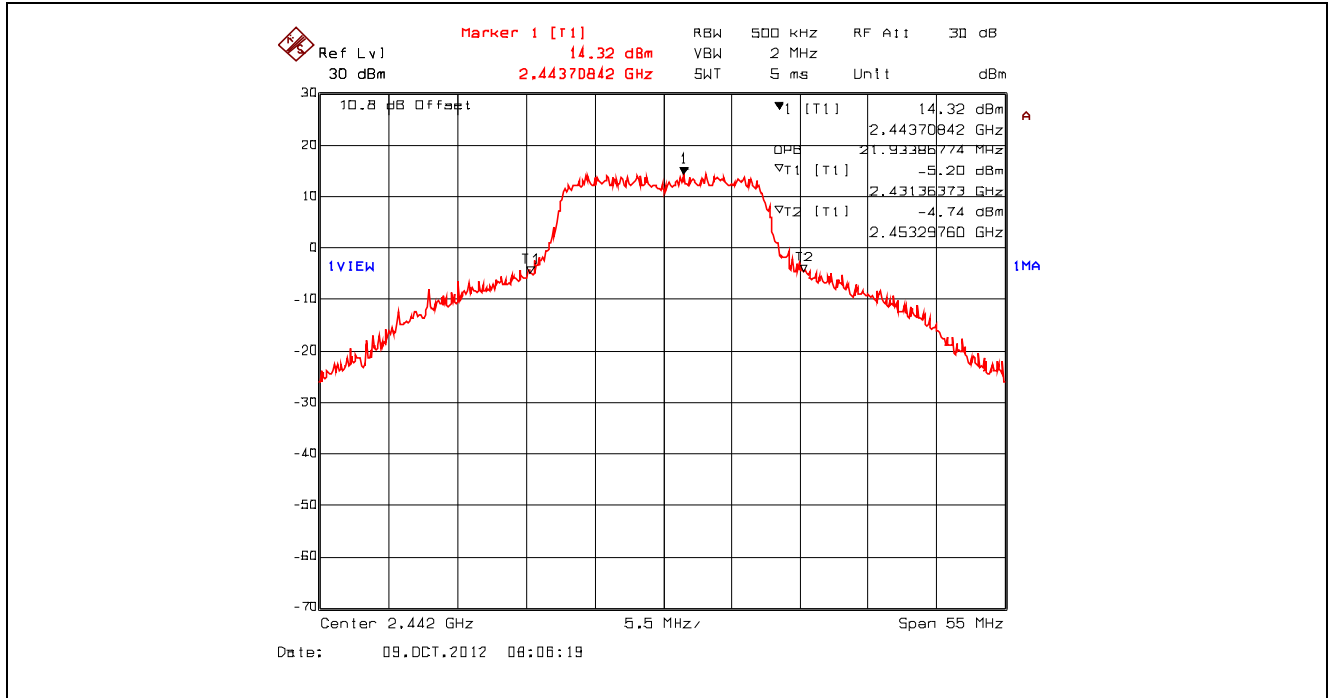

Plot 5.2.4.60. 99% Occupied Bandwidth, 802.11g, 18 Mbps QPSK, 2462 MHz, Setting 23

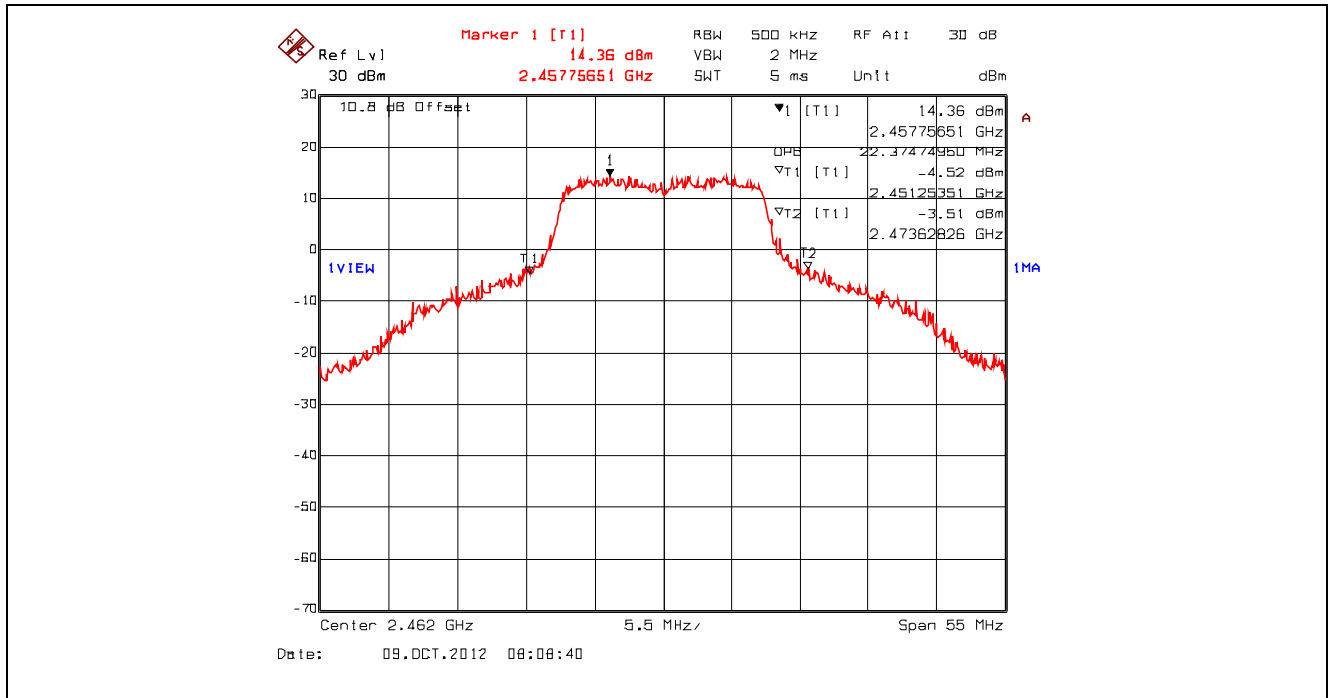

Plot 5.2.4.61. 99% Occupied Bandwidth, 802.11g, 36 Mbps 16-QAM, 2412 MHz, Setting 23

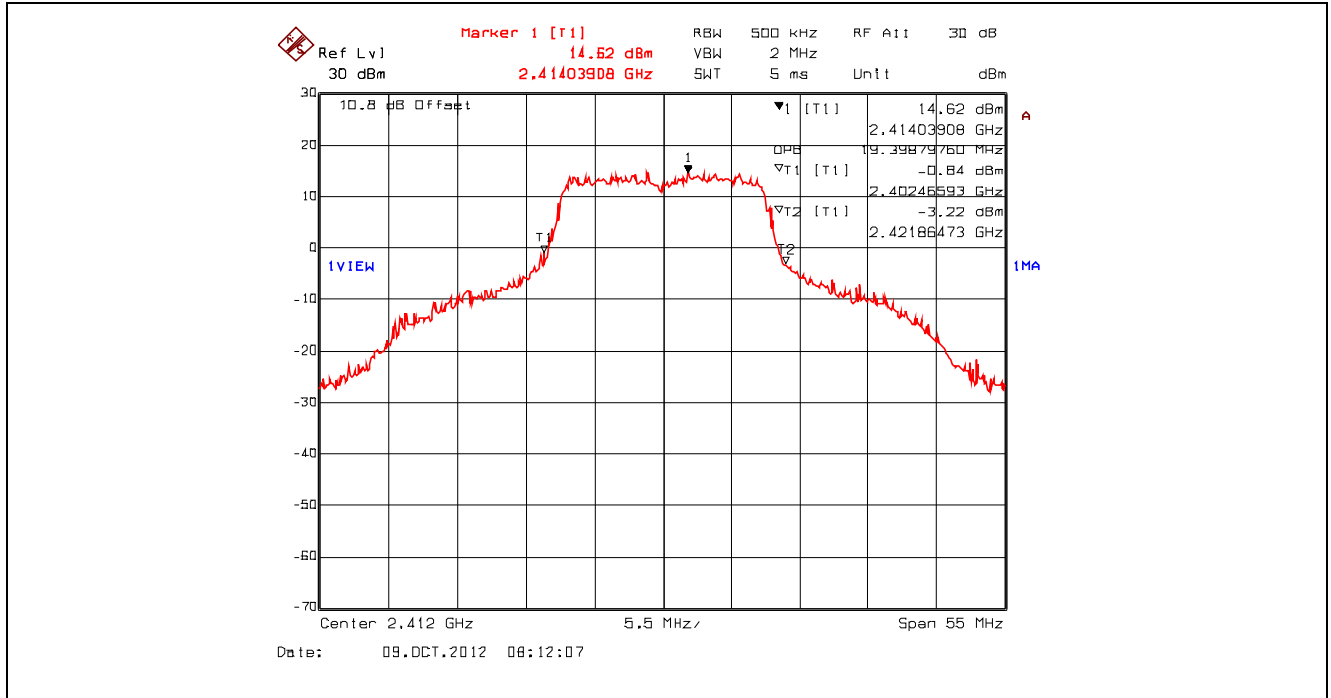

Plot 5.2.4.62. 99% Occupied Bandwidth, 802.11g, 36 Mbps 16-QAM, 2442 MHz, Setting 23

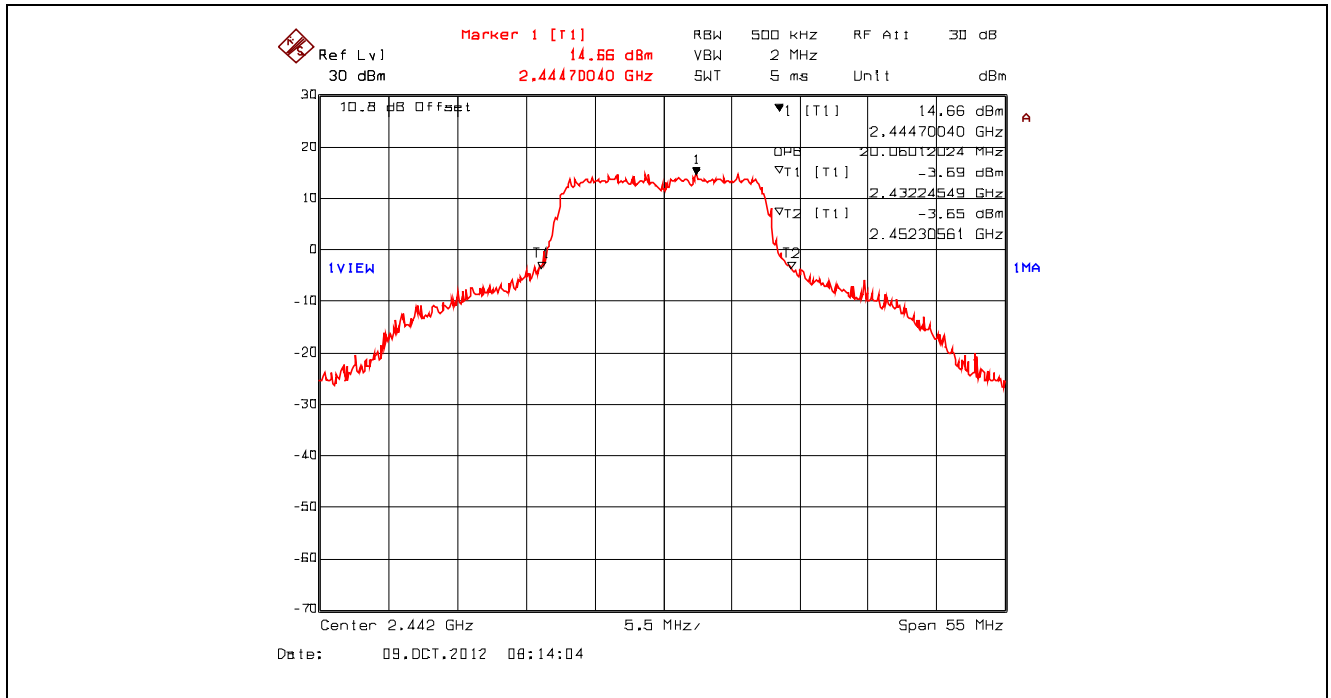

Plot 5.2.4.63. 99% Occupied Bandwidth, 802.11g, 36 Mbps 16-QAM, 2462 MHz, Setting 23

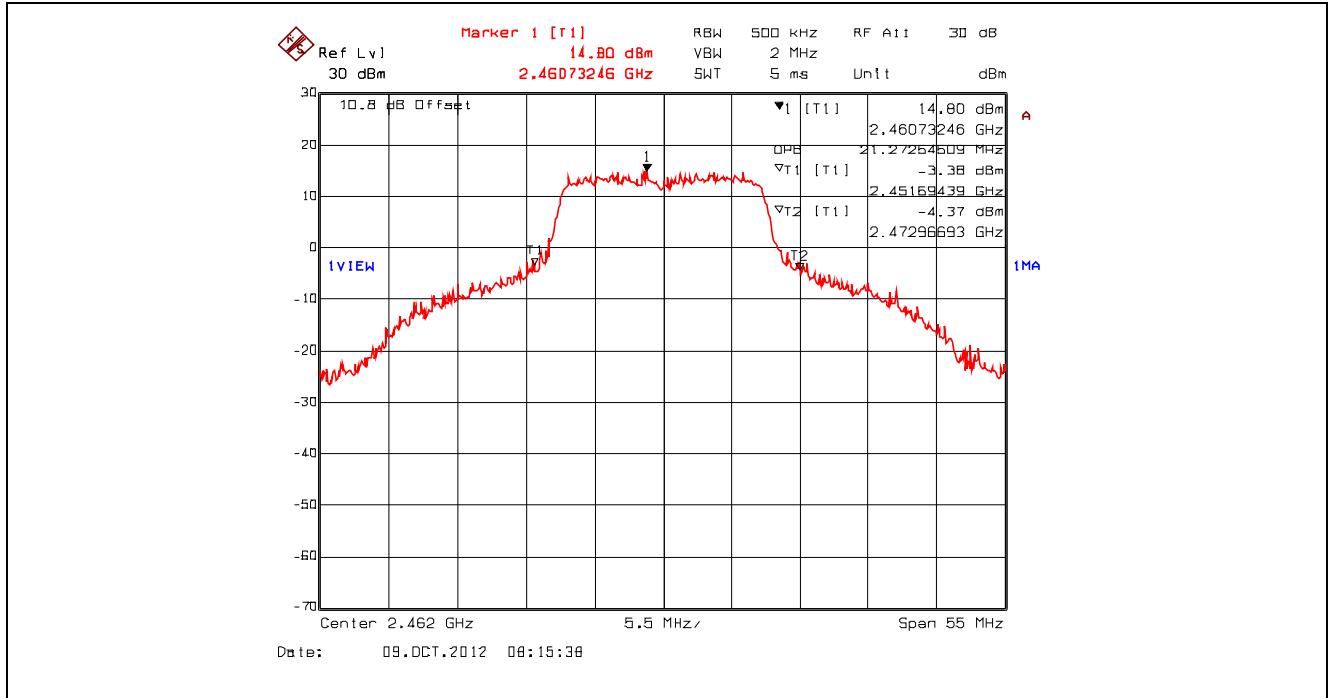

Plot 5.2.4.64. 99% Occupied Bandwidth, 802.11g, 54 Mbps 64-QAM, 2412 MHz, Setting 23

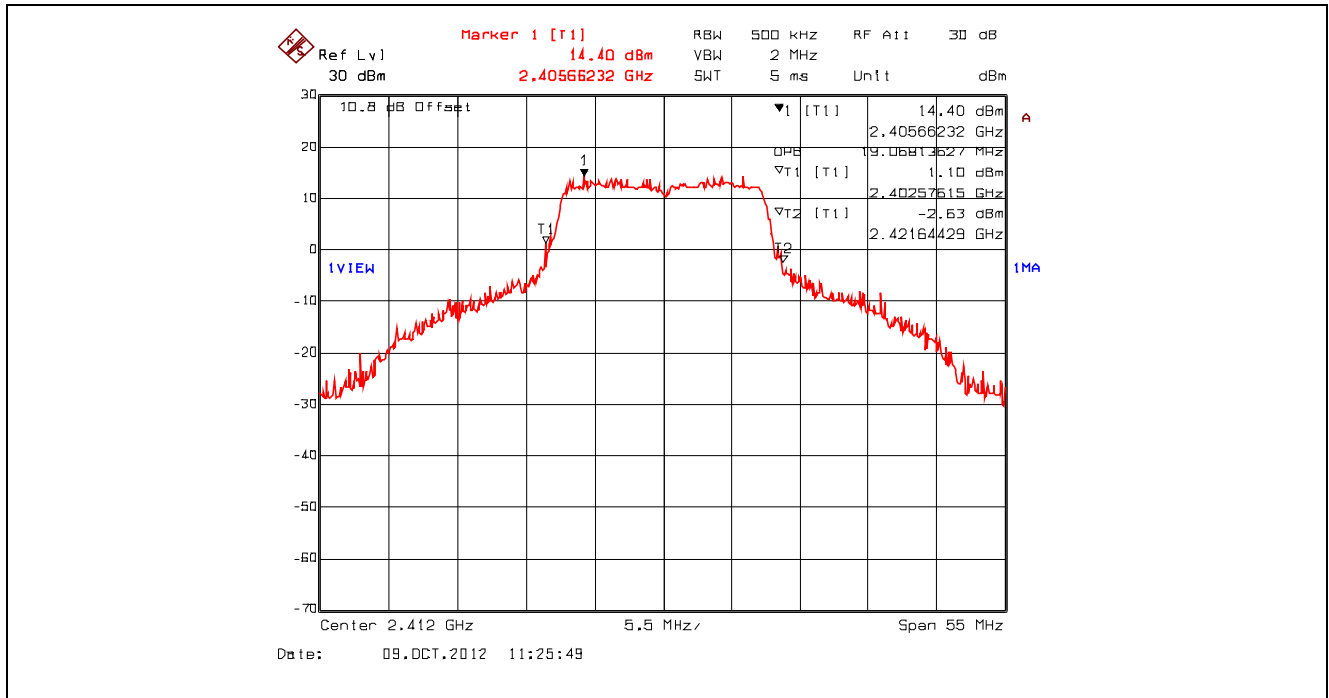

Plot 5.2.4.65. 99% Occupied Bandwidth, 802.11g, 54 Mbps 64-QAM, 2442 MHz, Setting 23

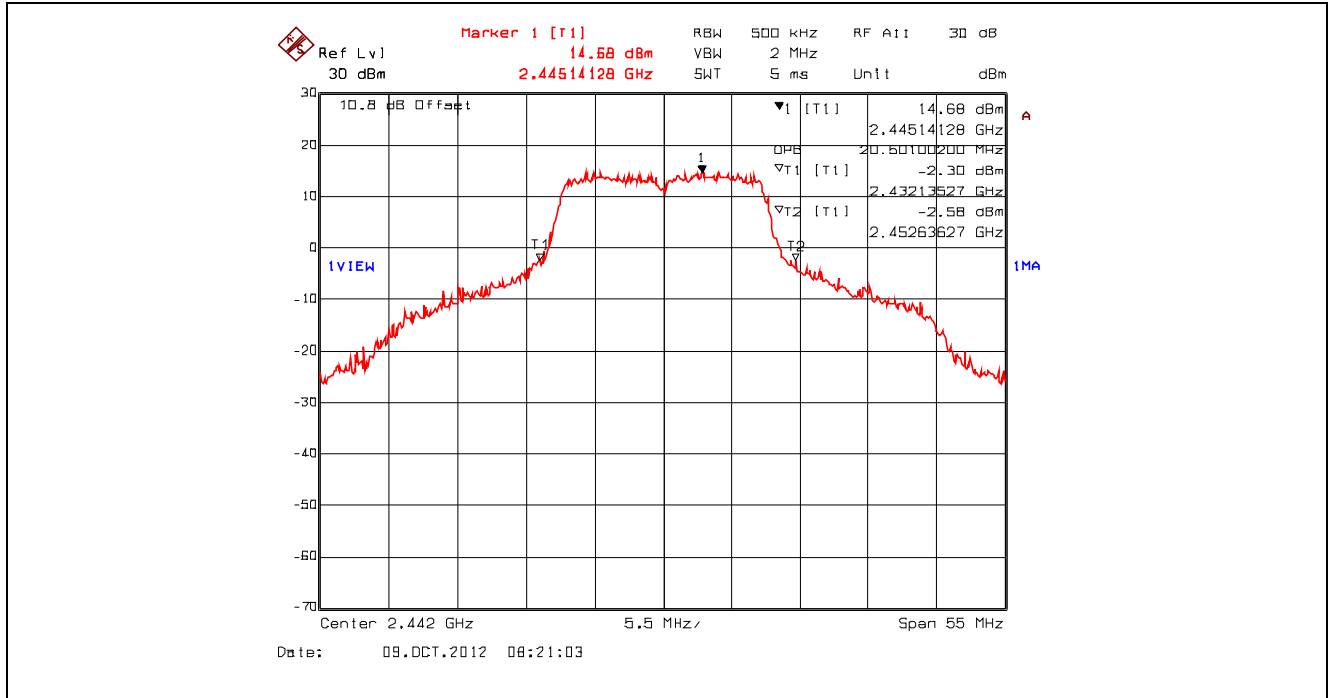

Plot 5.2.4.66. 99% Occupied Bandwidth, 802.11g, 54 Mbps 64-QAM, 2462 MHz, Setting 23

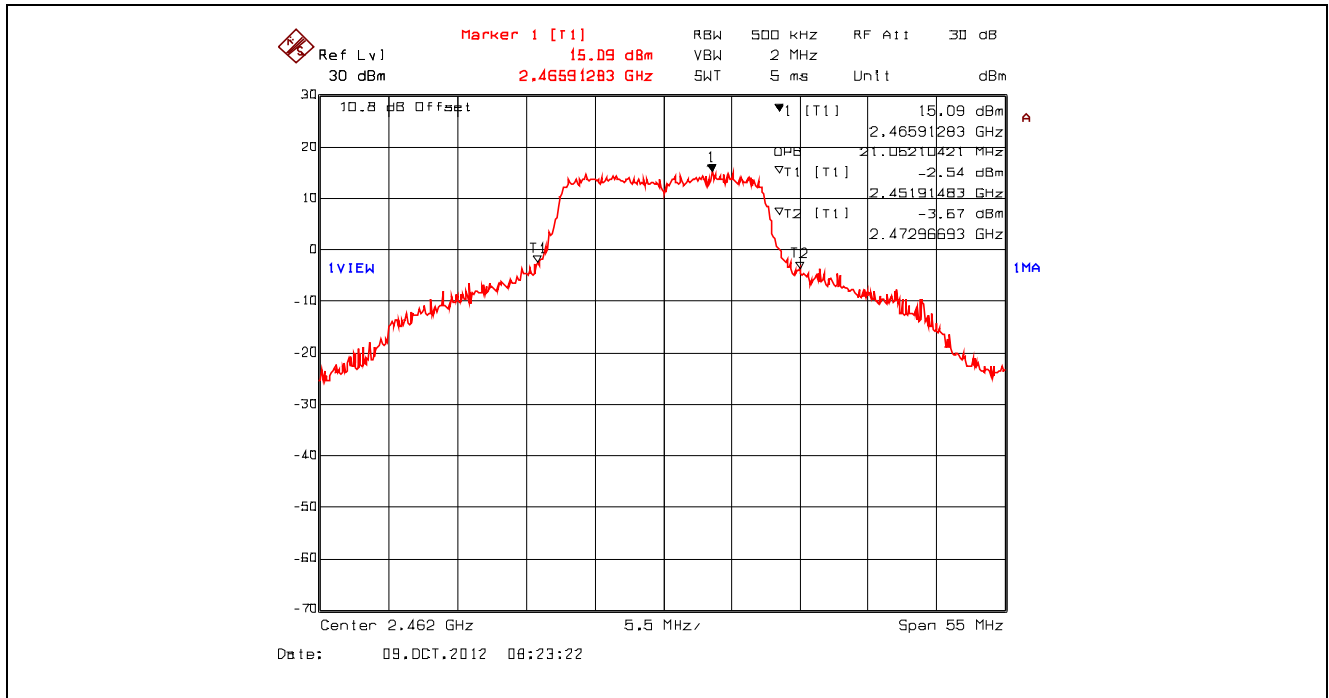

Plot 5.2.4.67. 99% Occupied Bandwidth, 802.11n 800ns, 6.5 Mbps BPSK1/2, 2412 MHz, Setting 23

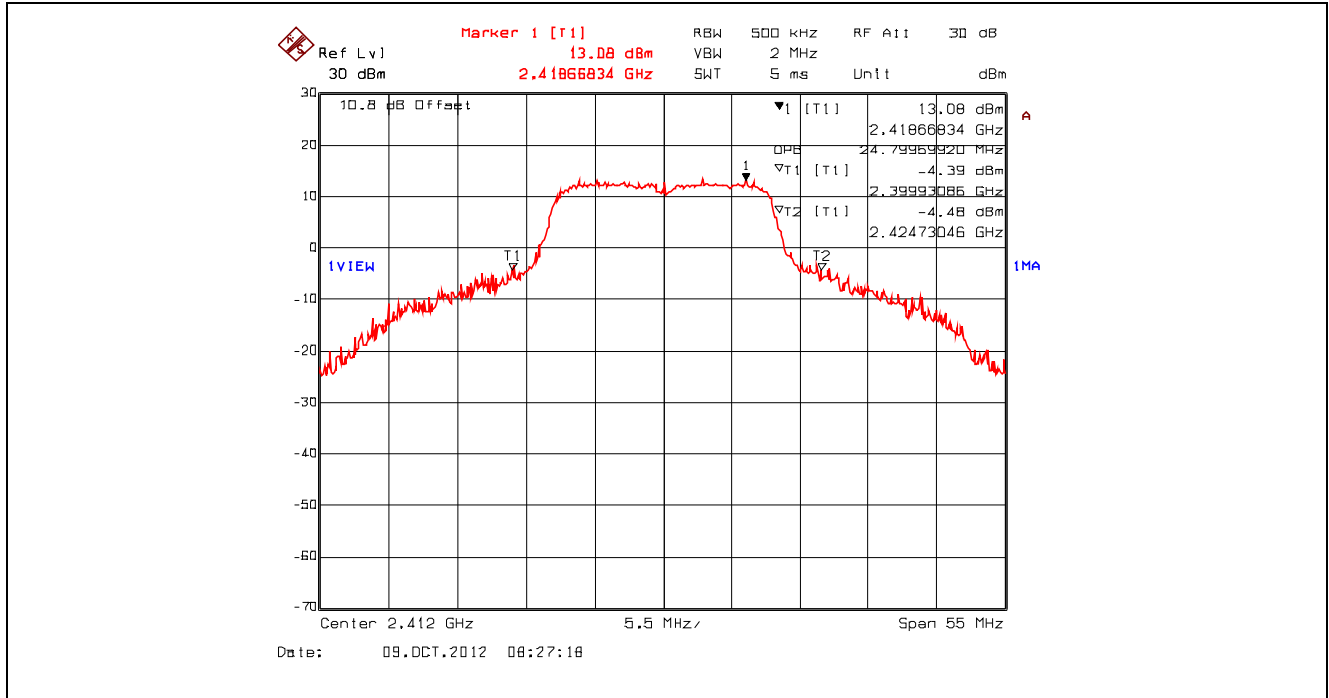

Plot 5.2.4.68. 99% Occupied Bandwidth, 802.11n 800ns, 6.5 Mbps BPSK1/2, 2442 MHz, Setting 23

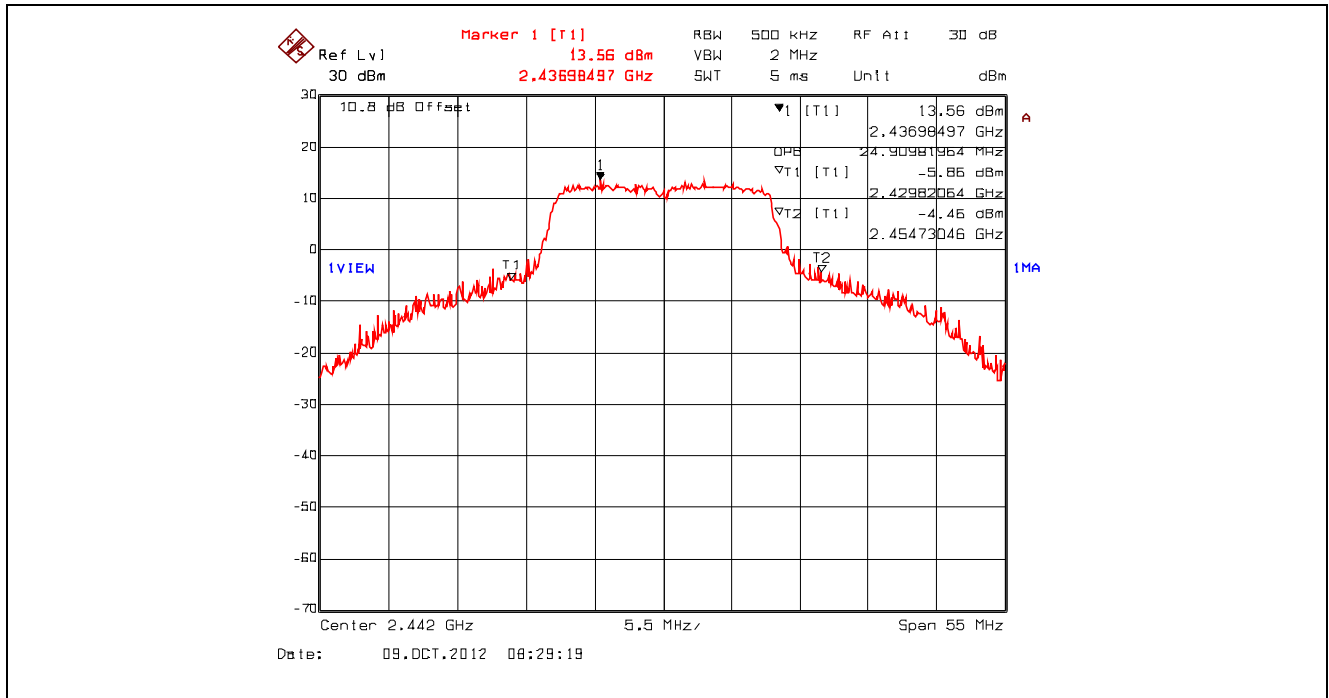

Plot 5.2.4.69. 99% Occupied Bandwidth, 802.11n 800ns, 6.5 Mbps BPSK1/2, 2462 MHz, Setting 23

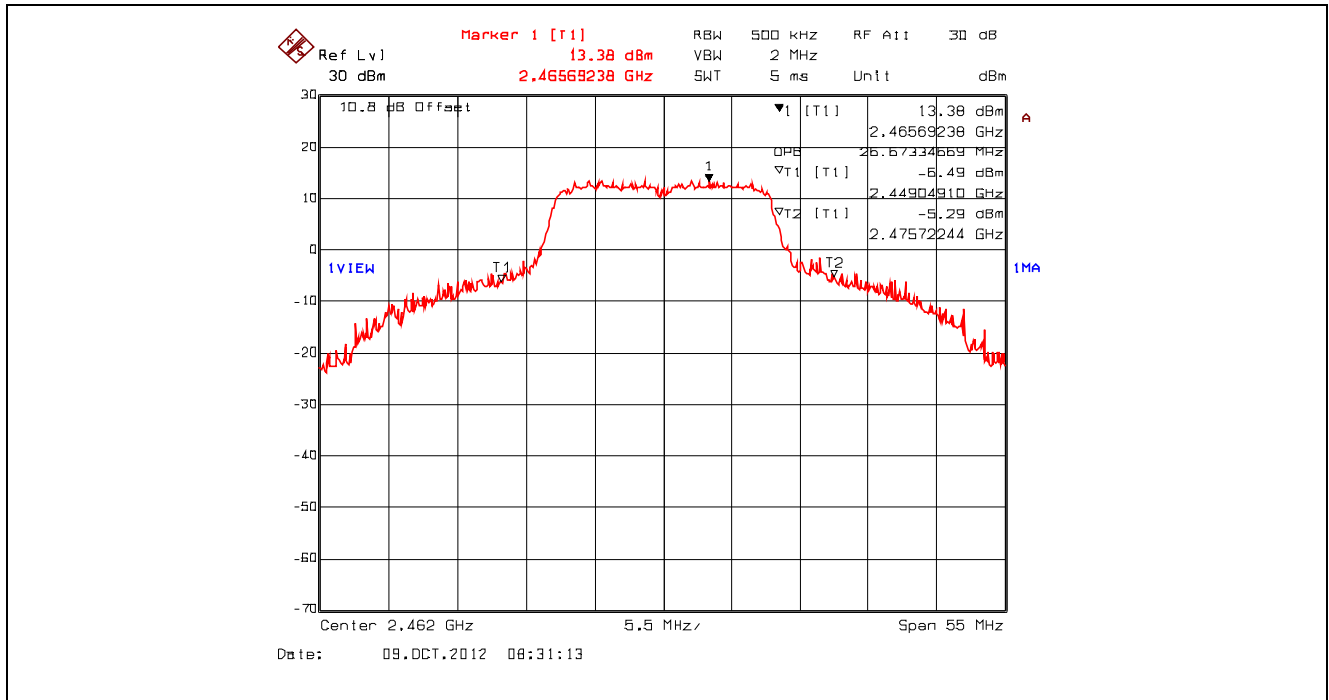

Plot 5.2.4.70. 99% Occupied Bandwidth, 802.11n 800ns, 19.5 Mbps QPSK 3/4, 2412 MHz, Setting 23

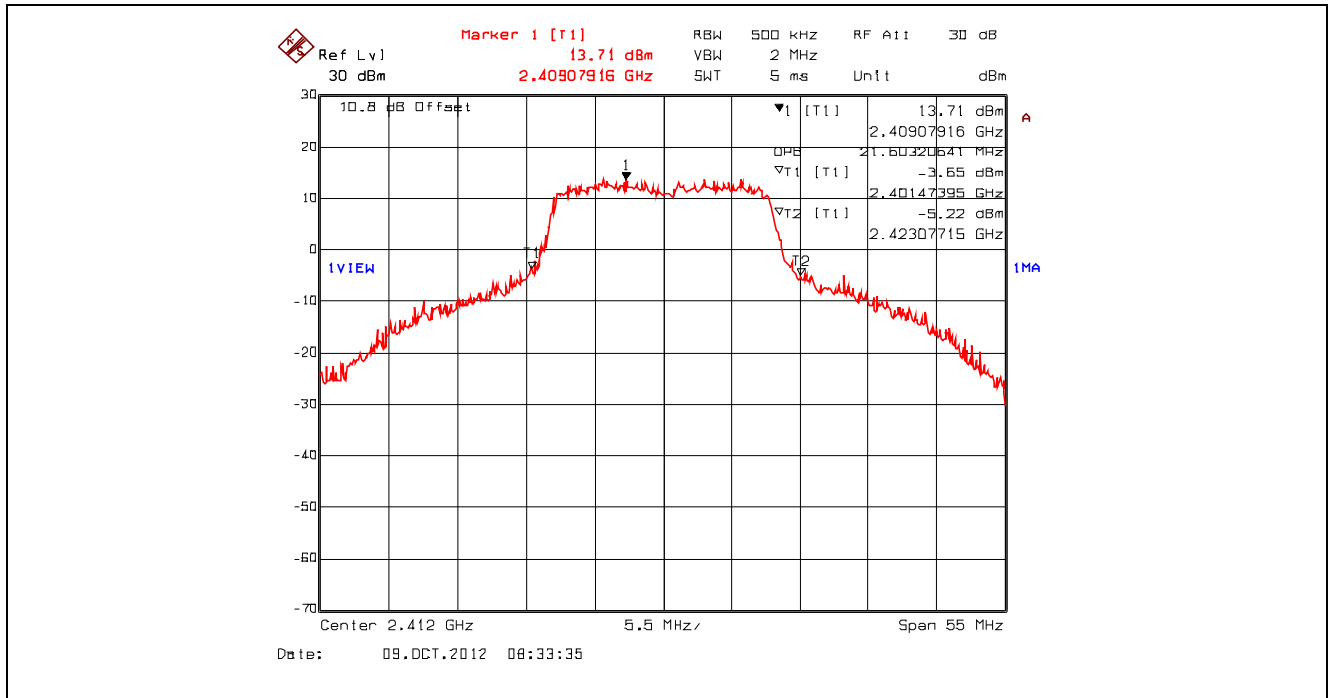

Plot 5.2.4.71. 99% Occupied Bandwidth, 802.11n 800ns, 19.5 Mbps QPSK 3/4, 2442 MHz, Setting 23

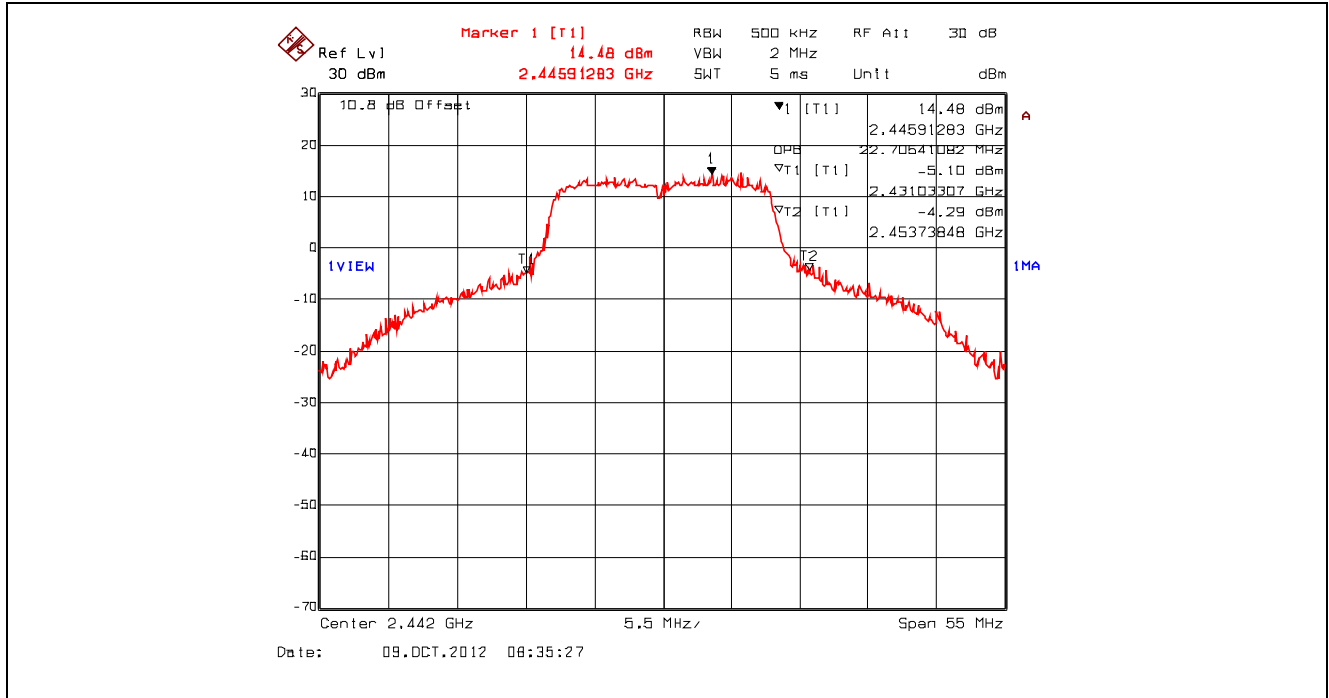

Plot 5.2.4.72. 99% Occupied Bandwidth, 802.11n 800ns, 19.5 Mbps QPSK 3/4, 2462 MHz, Setting 23

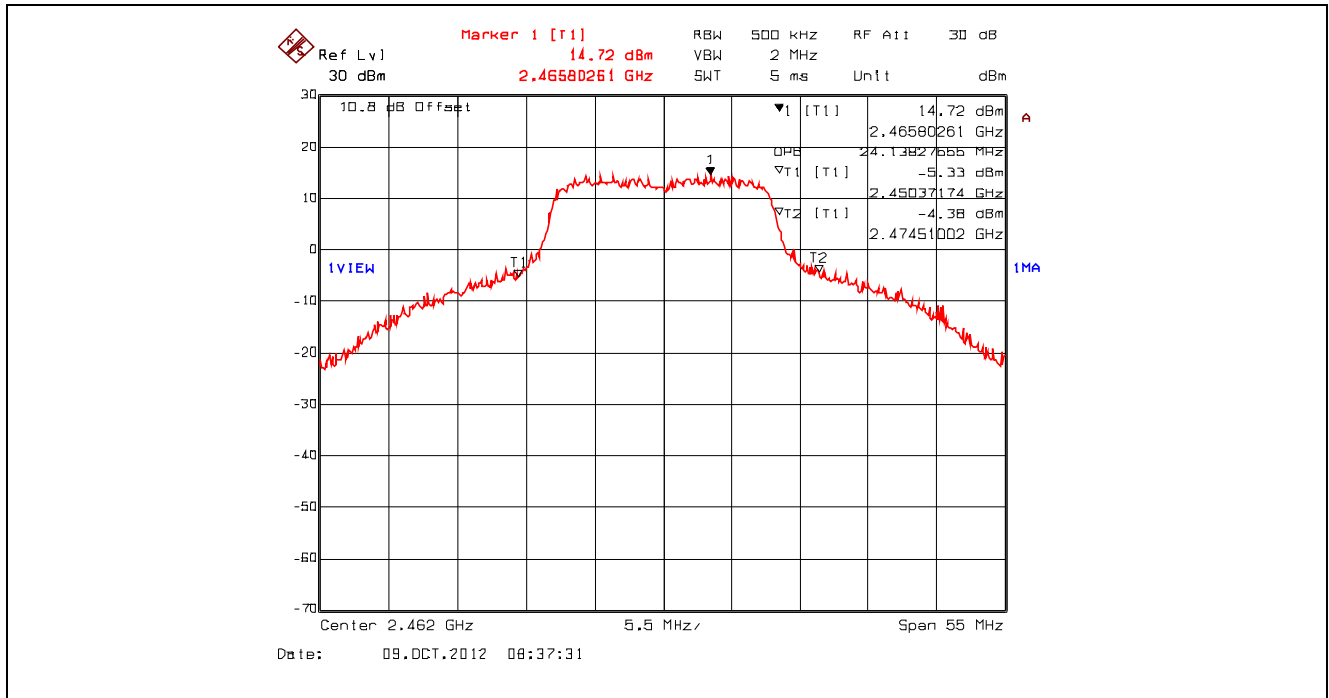

Plot 5.2.4.73. 99% Occupied Bandwidth, 802.11n 800ns, 39 Mbps 16-QAM 3/4, 2412 MHz, Setting 23

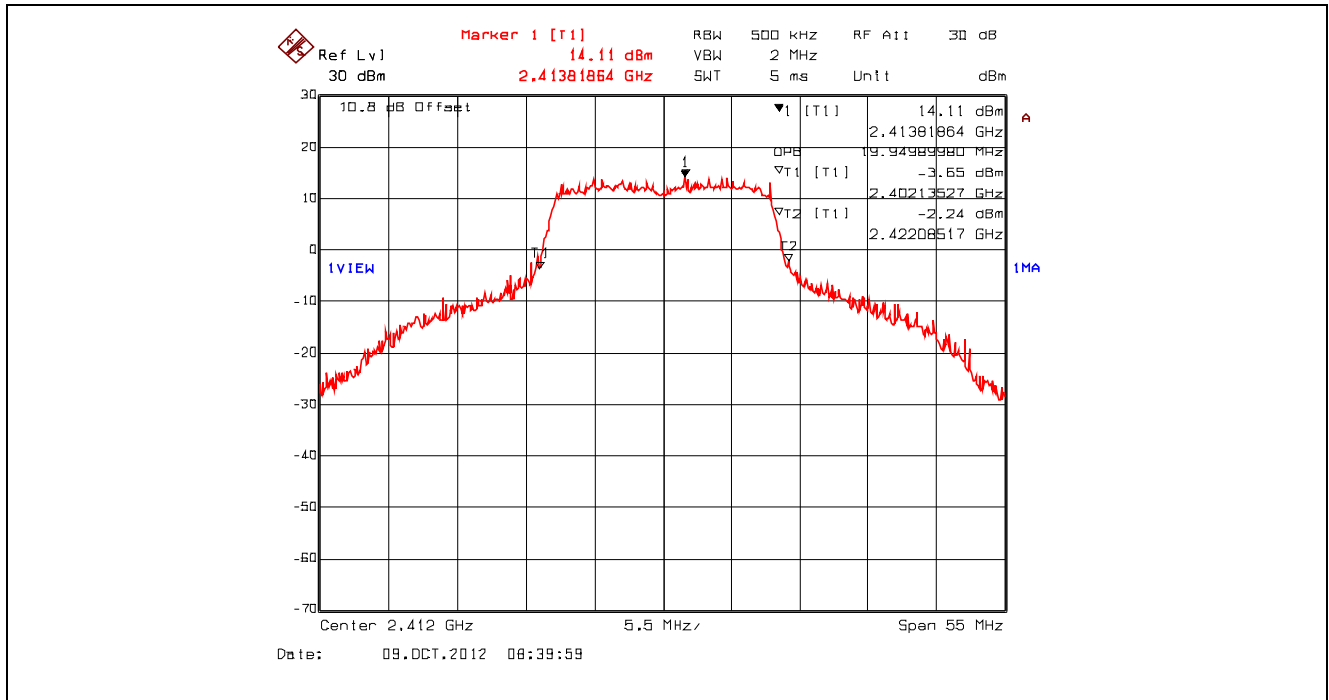

Plot 5.2.4.74. 99% Occupied Bandwidth, 802.11n 800ns, 39 Mbps 16-QAM 3/4, 2442 MHz, Setting 23

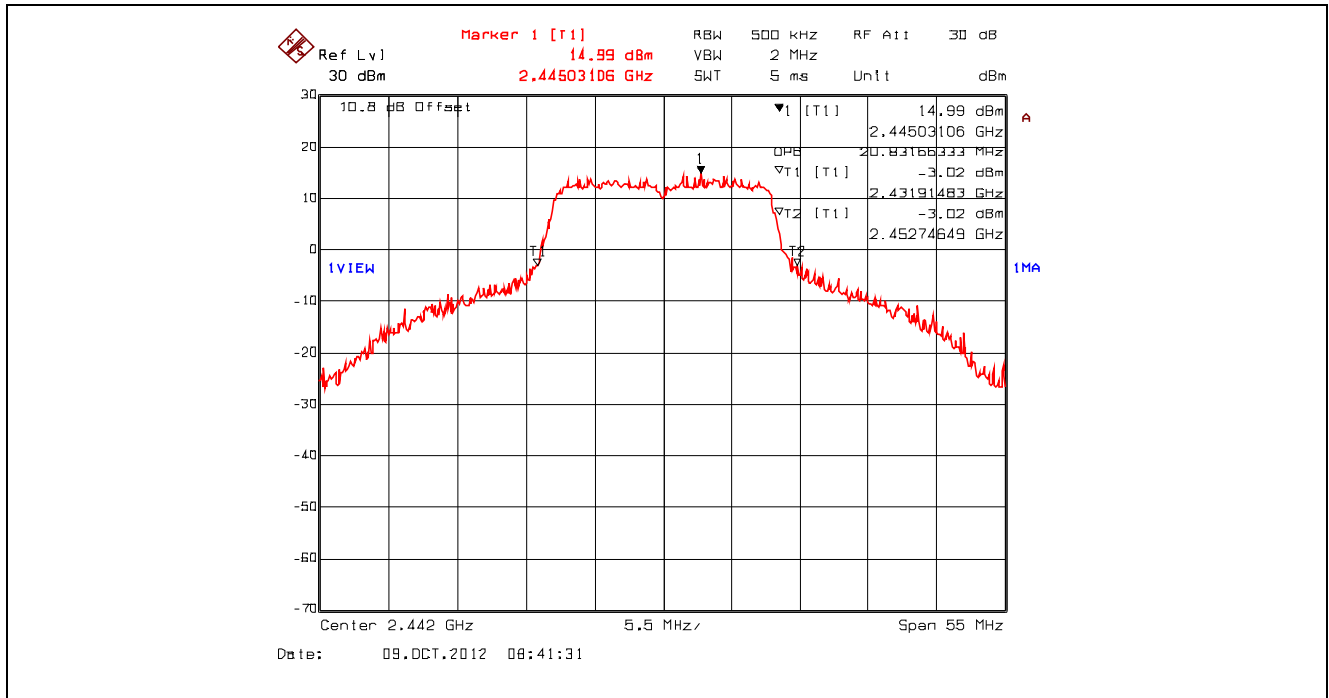

Plot 5.2.4.75. 99% Occupied Bandwidth, 802.11n 800ns, 39 Mbps 16-QAM 3/4, 2462 MHz, Setting 23

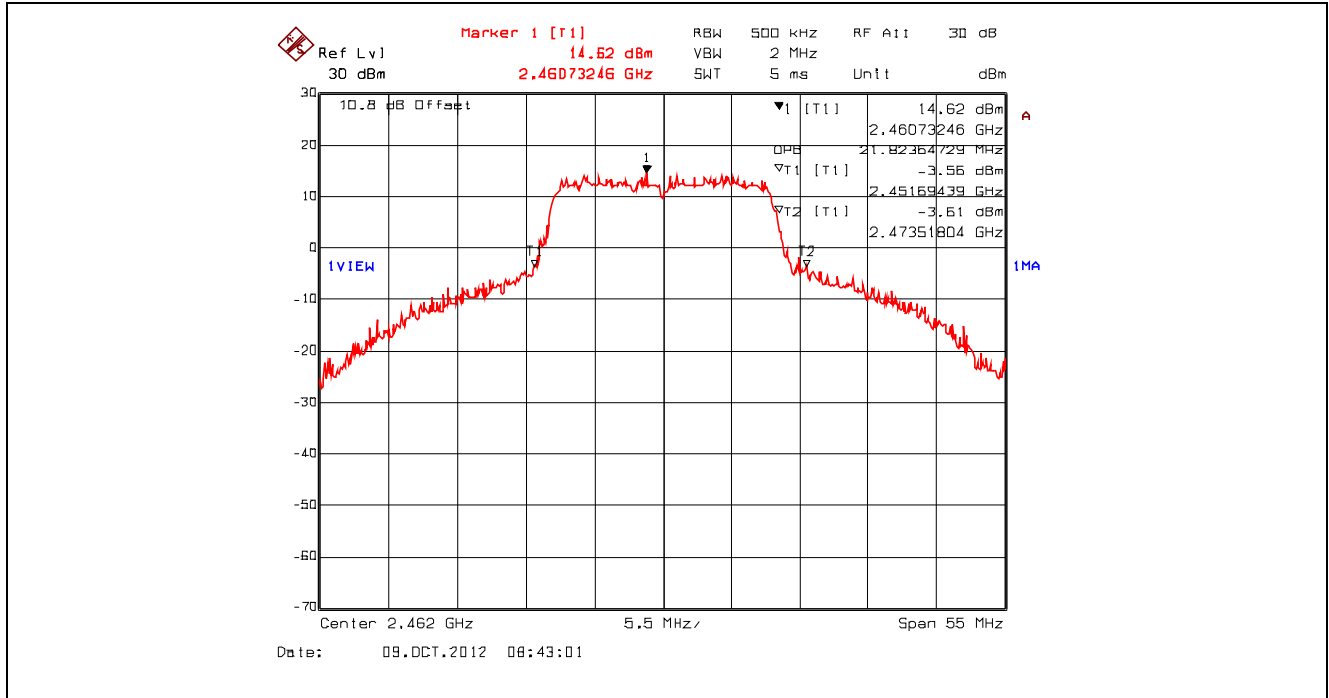

Plot 5.2.4.76. 99% Occupied Bandwidth, 802.11n 800ns, 65 Mbps 64-QAM 5/6, 2412 MHz, Setting 23

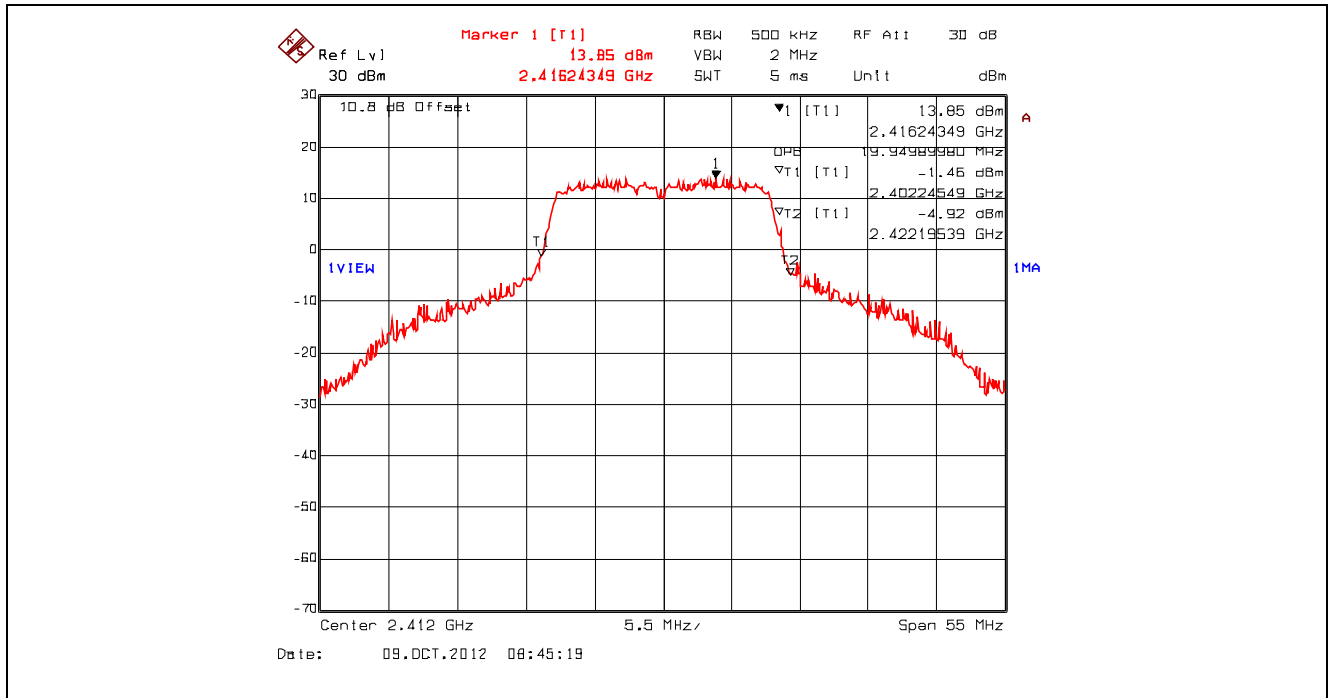

Plot 5.2.4.77. 99% Occupied Bandwidth, 802.11n 800ns, 65 Mbps 64-QAM 5/6, 2442 MHz, Setting 23

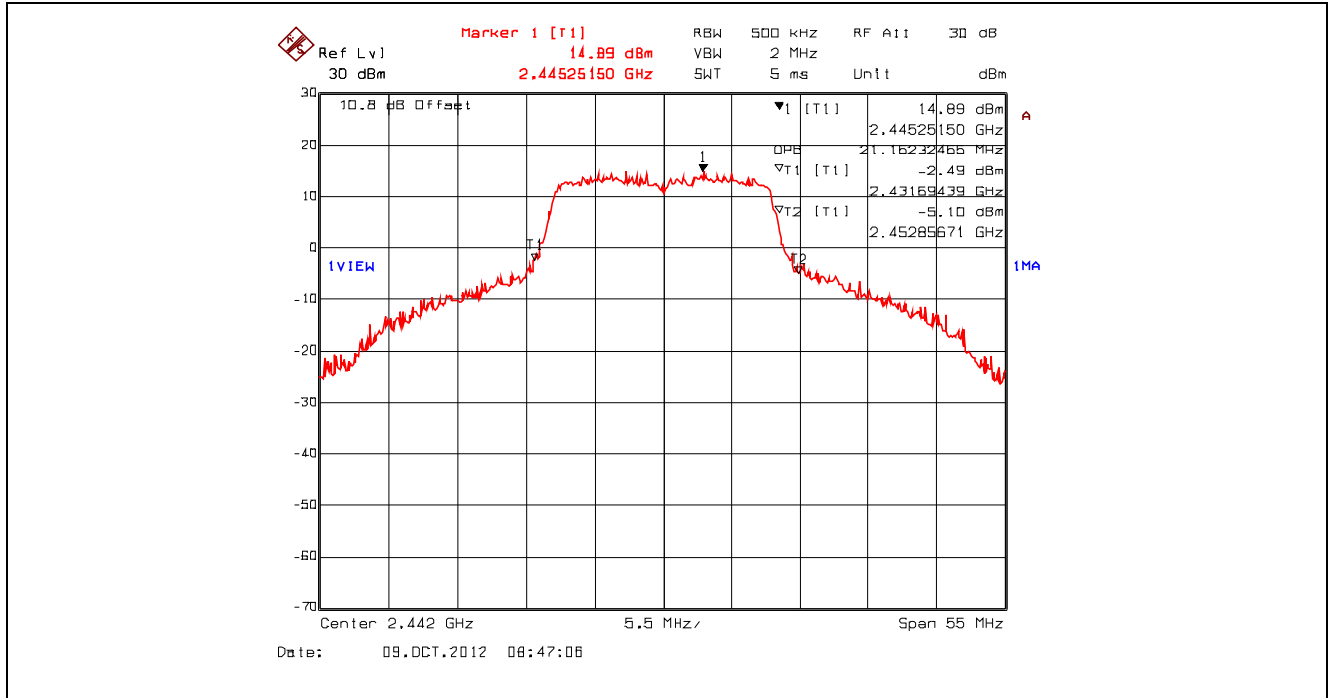

Plot 5.2.4.78. 99% Occupied Bandwidth, 802.11n 800ns, 65 Mbps 64-QAM 5/6, 2462 MHz, Setting 23

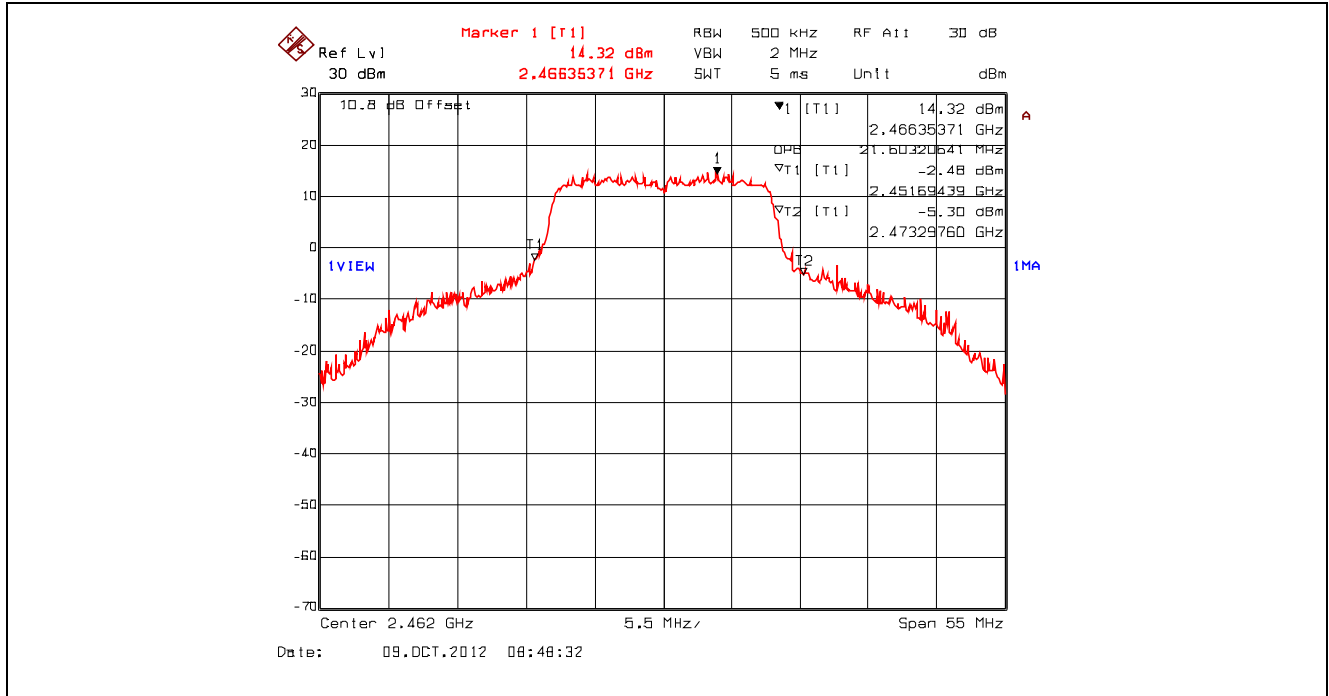

Plot 5.2.4.79. 99% Occupied Bandwidth, 802.11n 400ns, 7.2 Mbps BPSK1/2, 2412 MHz, Setting 23

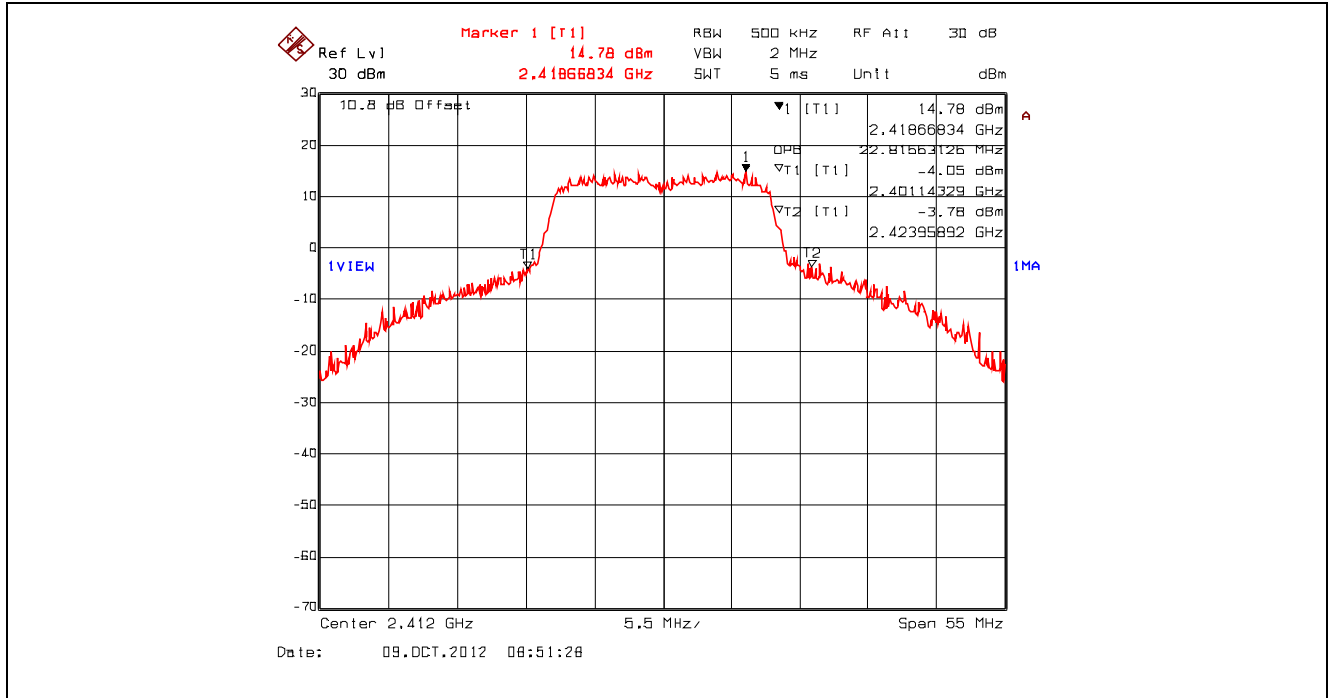

Plot 5.2.4.80. 99% Occupied Bandwidth, 802.11n 400ns, 7.2 Mbps BPSK1/2, 2442 MHz, Setting 23

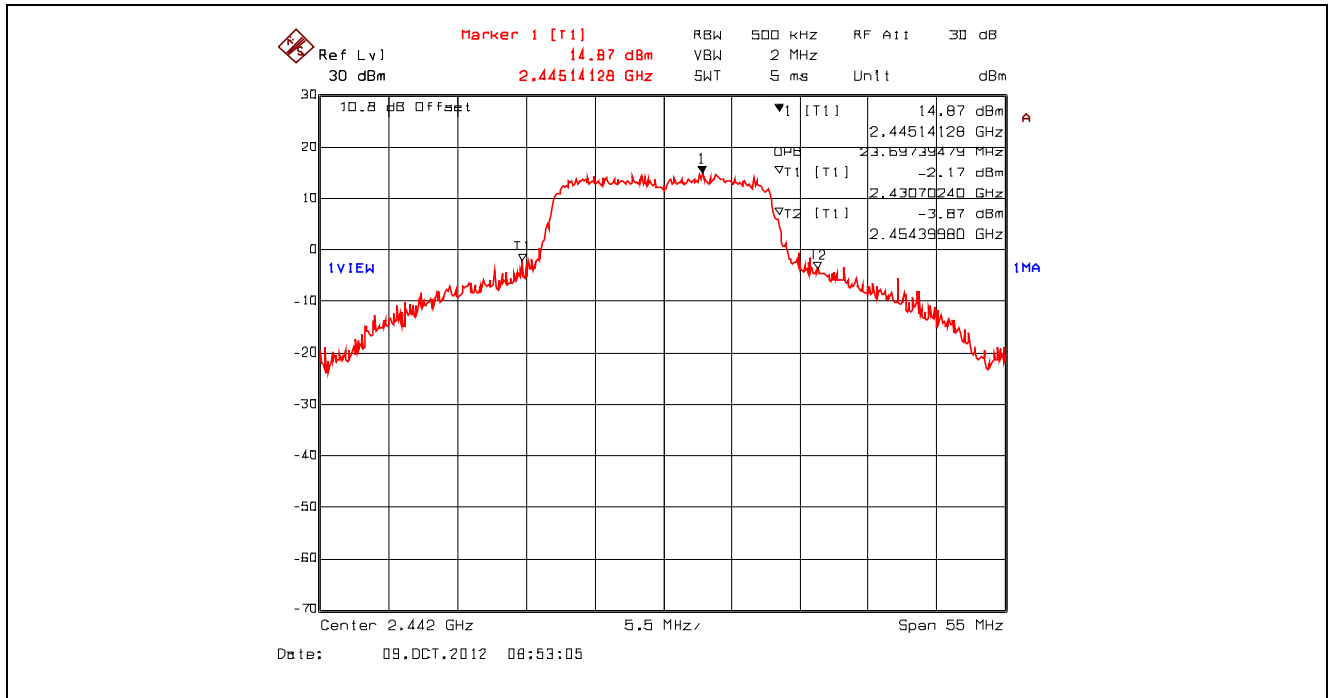

Plot 5.2.4.81. 99% Occupied Bandwidth, 802.11n 400ns, 7.2 Mbps BPSK1/2, 2462 MHz, Setting 23

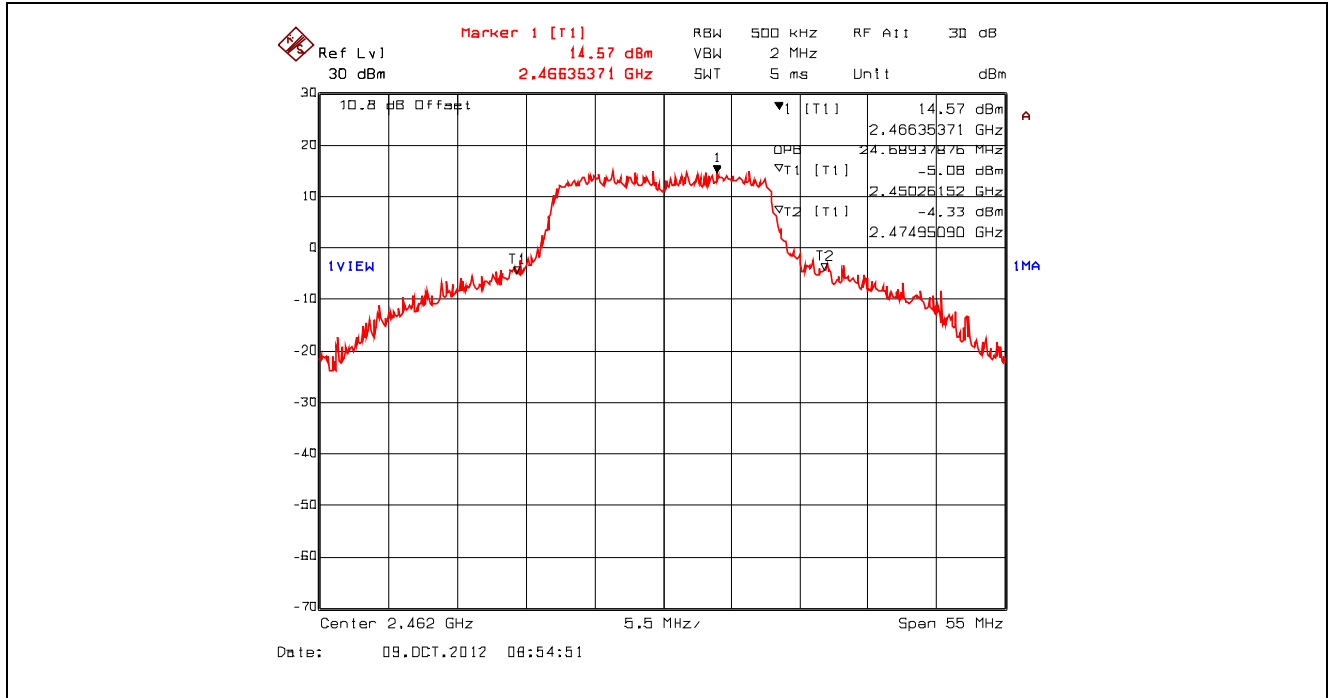

Plot 5.2.4.82. 99% Occupied Bandwidth, 802.11n 400ns, 21.7 Mbps QPSK 3/4, 2412 MHz, Setting 23

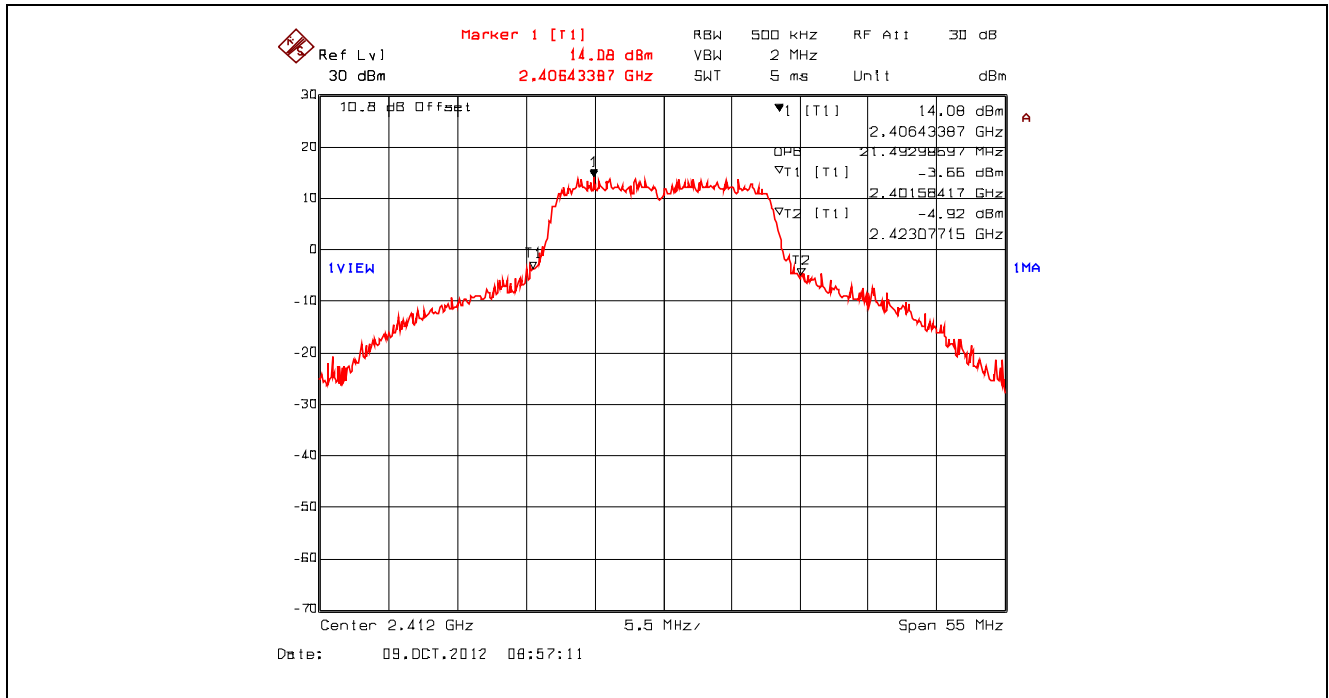

Plot 5.2.4.83. 99% Occupied Bandwidth, 802.11n 400ns, 21.7 Mbps QPSK 3/4, 2442 MHz, Setting 23

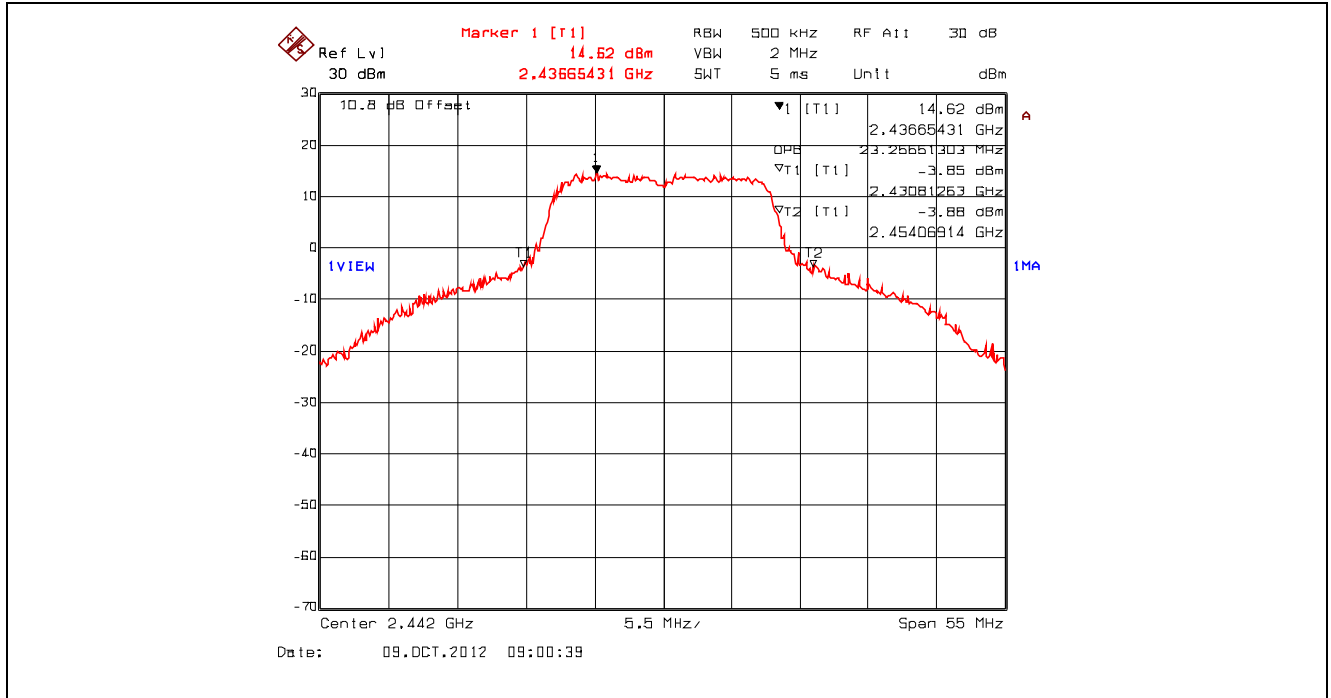

Plot 5.2.4.84. 99% Occupied Bandwidth, 802.11n 400ns, 21.7 Mbps QPSK 3/4, 2462 MHz, Setting 23

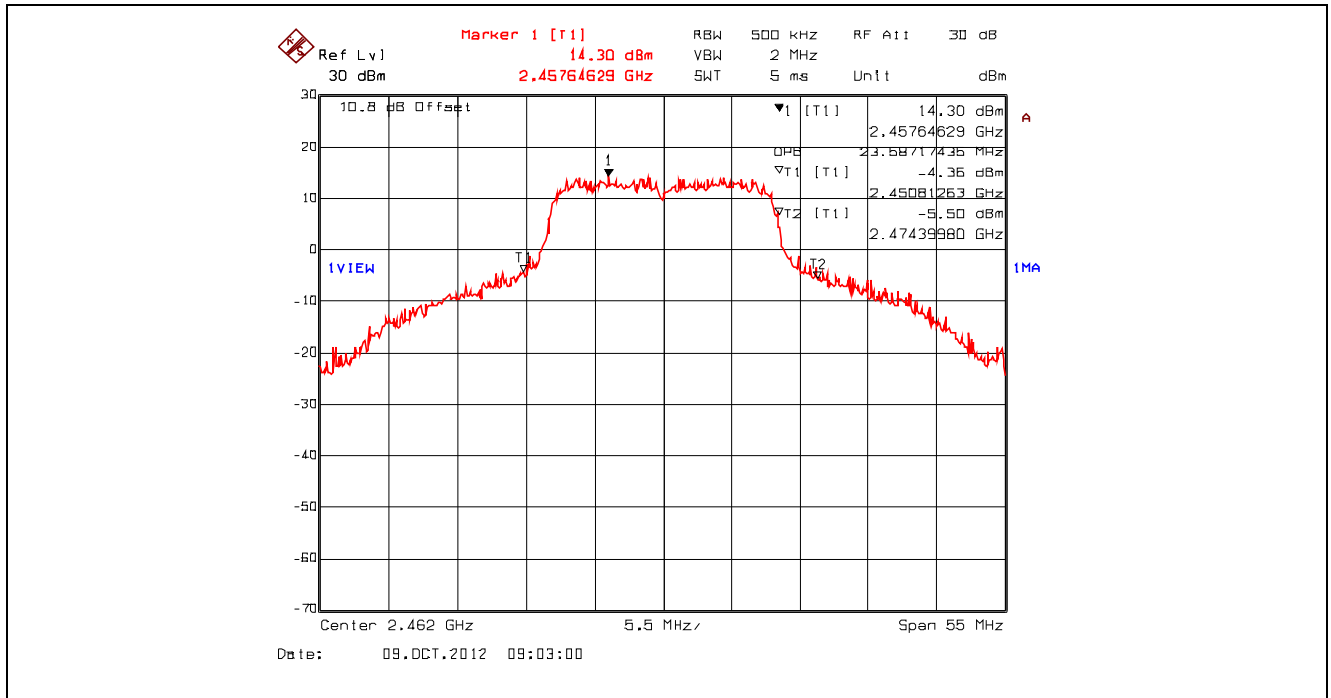

Plot 5.2.4.85. 99% Occupied Bandwidth, 802.11n 400ns, 43.3 Mbps 16-QAM 3/4, 2412 MHz, Setting 23

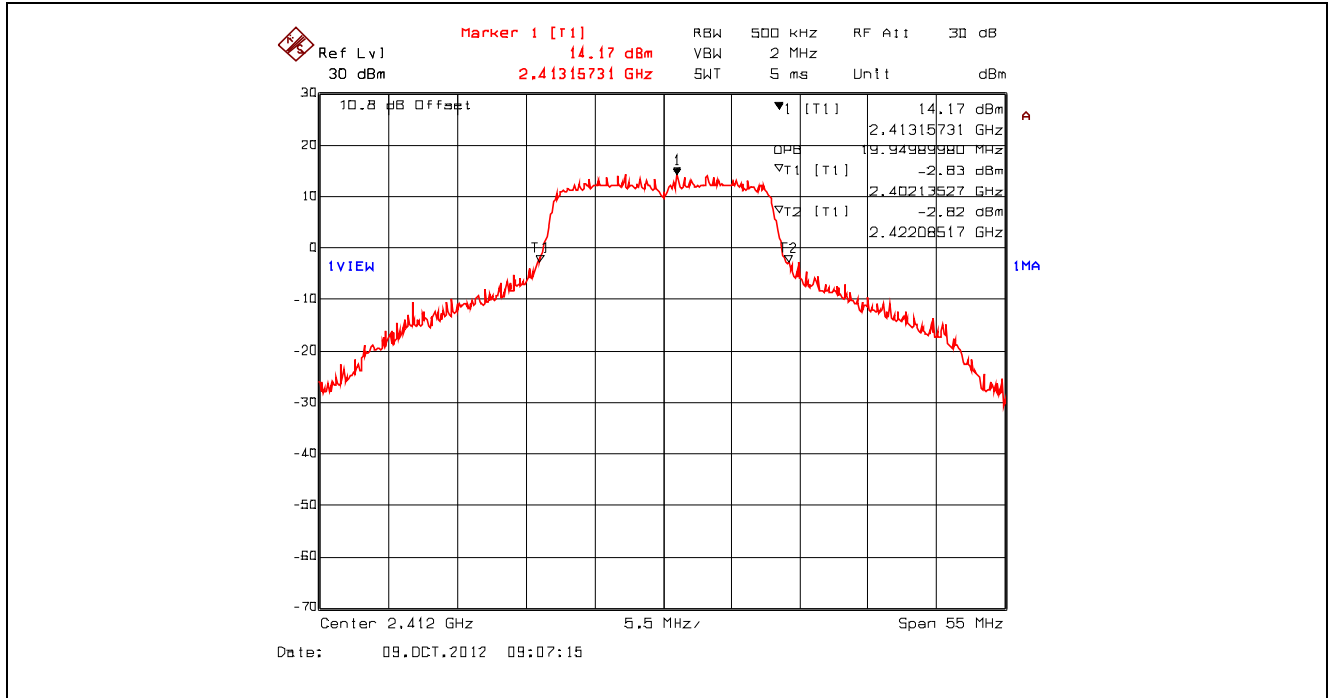

Plot 5.2.4.86. 99% Occupied Bandwidth, 802.11n 400ns, 43.3 Mbps 16-QAM 3/4, 2442 MHz, Setting 23

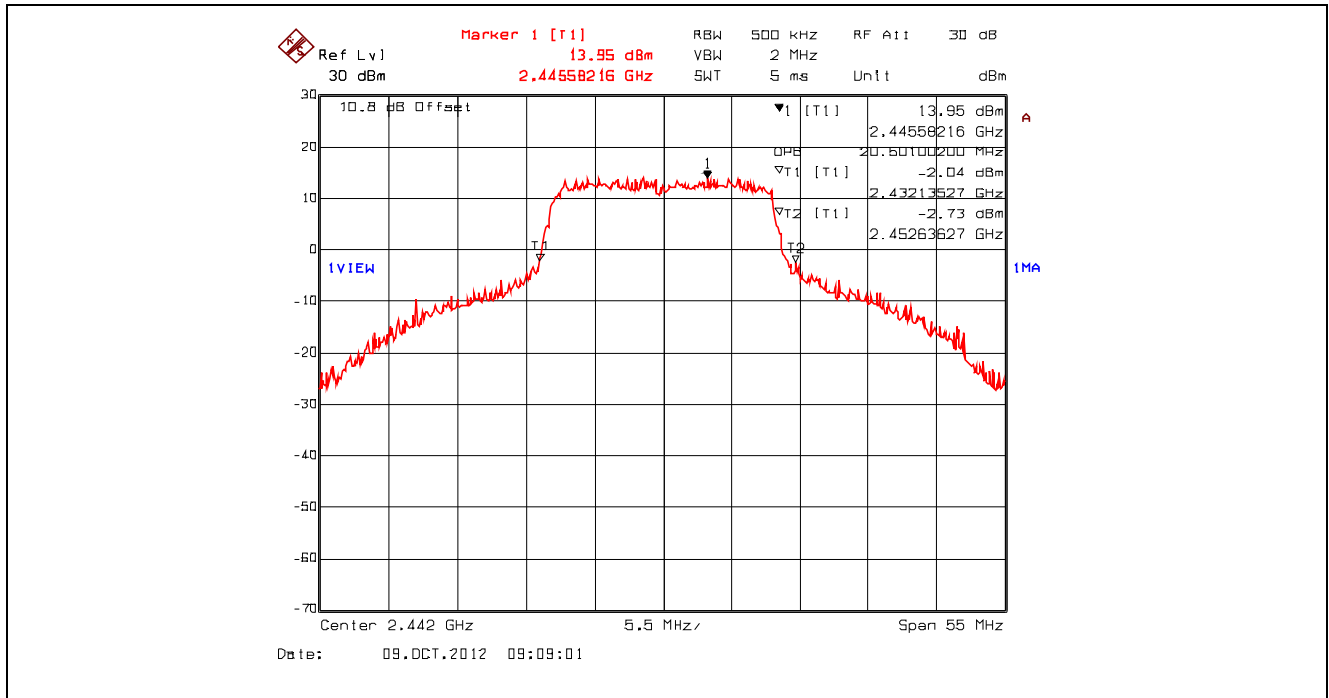

Plot 5.2.4.87. 99% Occupied Bandwidth, 802.11n 400ns, 43.3 Mbps 16-QAM 3/4, 2462 MHz, Setting 23

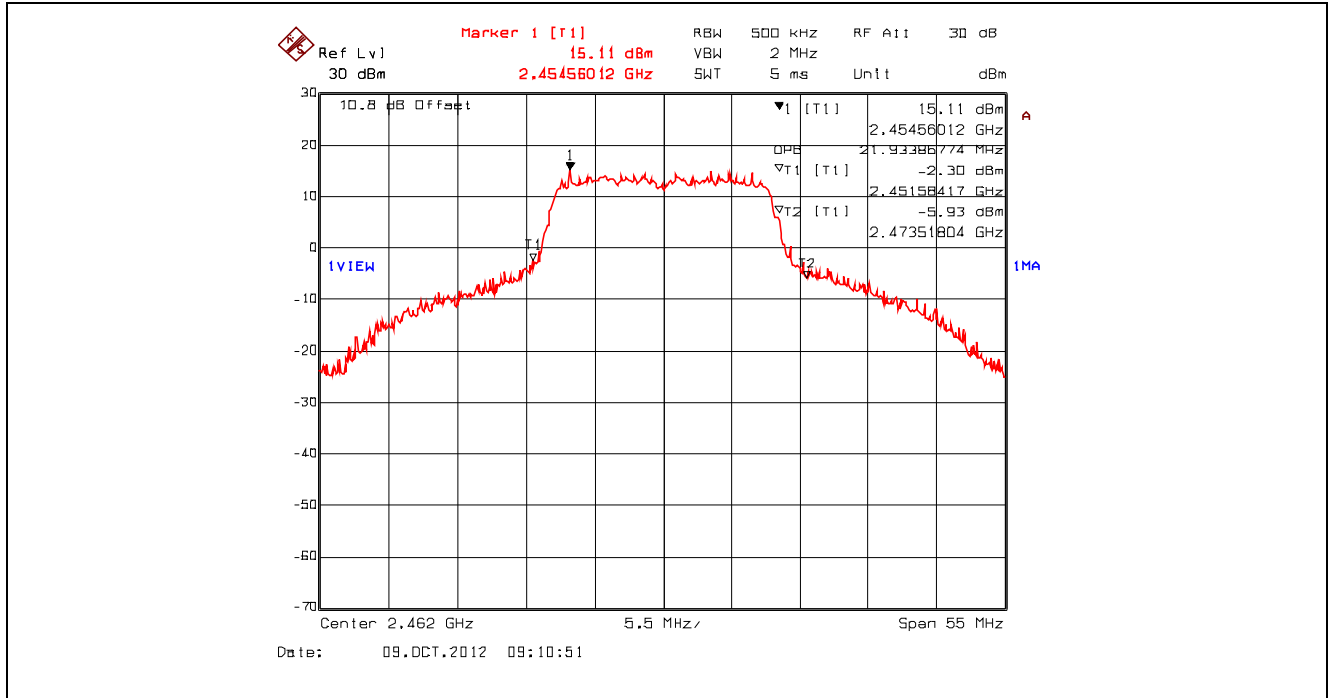

Plot 5.2.4.88. 99% Occupied Bandwidth, 802.11n 400ns, 72.2 Mbps 64-QAM 5/6, 2412 MHz, Setting 23

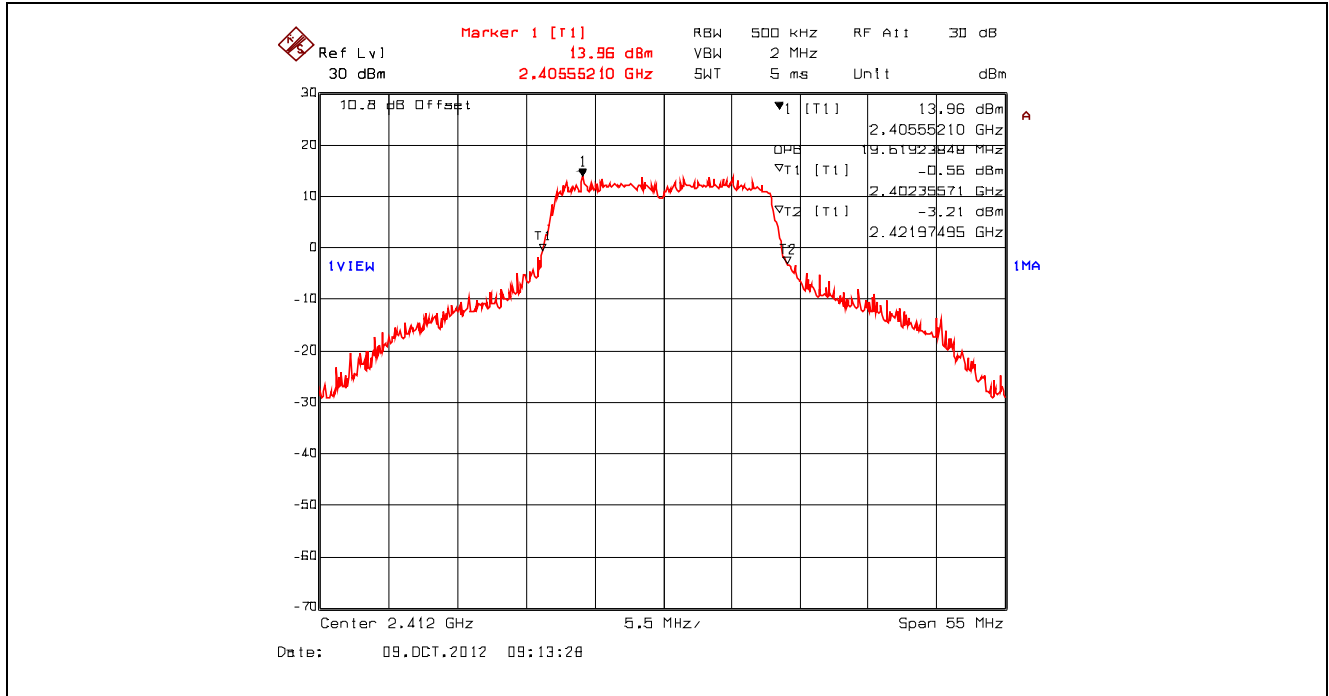

Plot 5.2.4.89. 99% Occupied Bandwidth, 802.11n 400ns, 72.2 Mbps 64-QAM 5/6, 2442 MHz, Setting 23

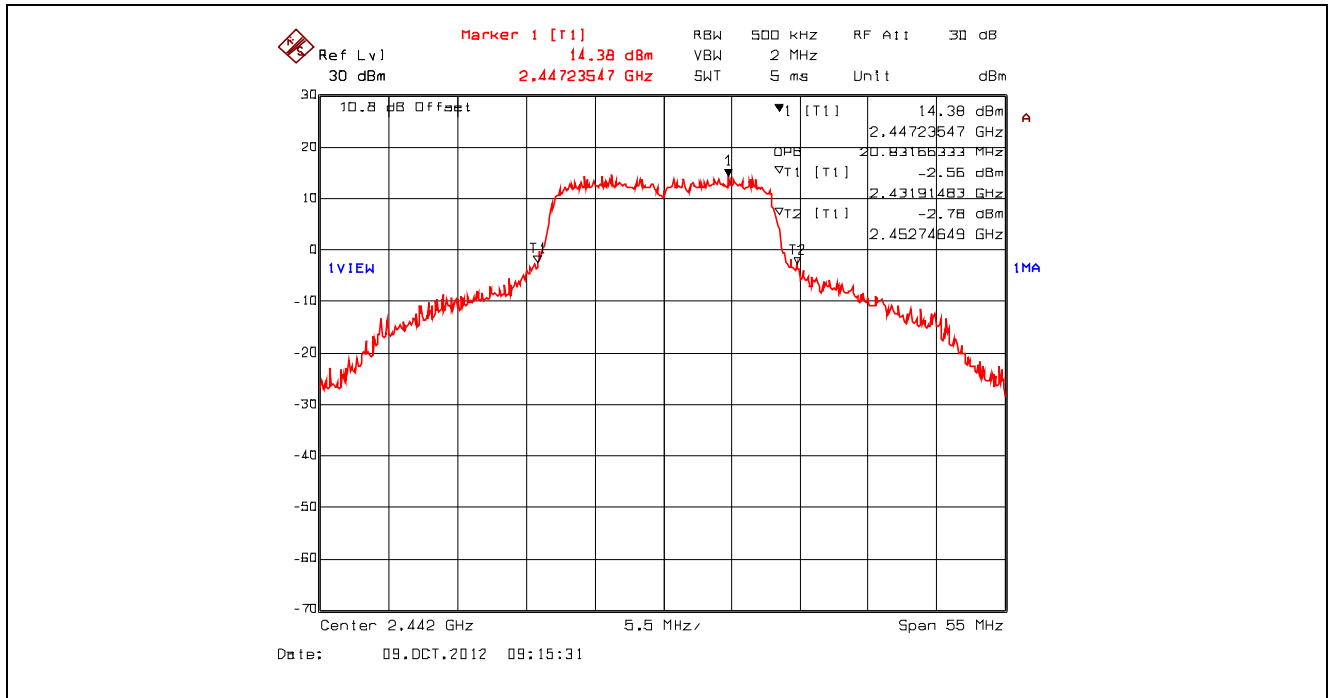

Plot 5.2.4.90. 99% Occupied Bandwidth, 802.11n 400ns, 72.2 Mbps 64-QAM 5/6, 2462 MHz, Setting 23

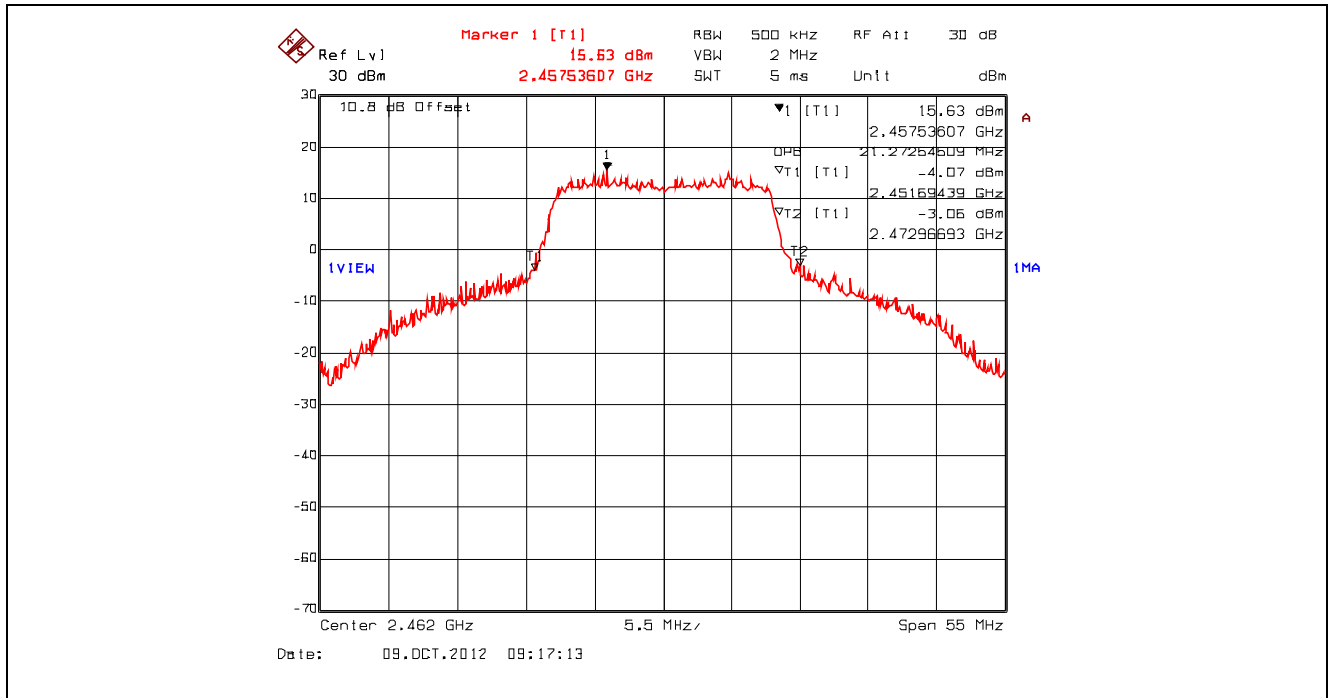

5.3. PEAK CONDUCTED OUTPUT POWER - DTS [§ 15.247(b)(3)]

5.3.1. Limit(s)

§ 15.247(b)(3): For systems using digital modulation in the 902-928 MHz, 2400-2483.5 MHz, and 5725-5850 MHz bands: 1 Watt. As an alternative to a peak power measurement, compliance with the one Watt limit can be based on a measurement of the maximum conducted output power. Maximum Conducted Output Power is defined as the total transmit power delivered to all antennas and antenna elements averaged across all symbols in the signaling alphabet when the transmitter is operating at its maximum power control level. Power must be summed across all antennas and antenna elements. The average must not include any time intervals during which the transmitter is off or is transmitting at a reduced power level. If multiple modes of operation are possible (e.g., alternative modulation methods), the *maximum conducted output power* is the highest total transmit power occurring in any mode.

§15.247(b)(4): The conducted output power limit specified in paragraph (b) of this section is based on the use of antennas with directional gains that do not exceed 6 dBi. Except as shown in paragraph (c) of this section, if transmitting antennas of directional gain greater than 6 dBi are used, the conducted output power from the intentional radiator shall be reduced below the stated values in paragraphs (b)(1), (b)(2), and (b)(3) of this section, as appropriate, by the amount in dB that the directional gain of the antenna exceeds 6 dBi.

5.3.2. Method of Measurements & Test Arrangement

KDB Publication No. 558074 D01 Section 5.2.1.2 Measurement Procedure PK2.

5.3.3. Test Arrangement

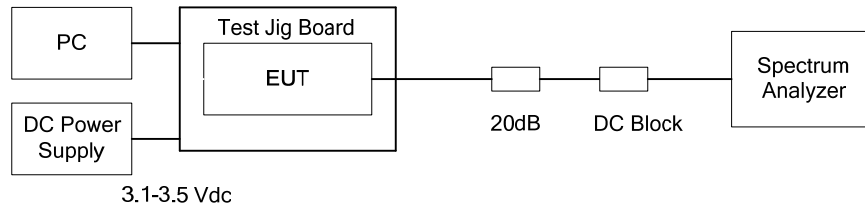

5.3.4. Test Data

Operating Mode	Modulation	Frequency (MHz)	Peak Conducted Power (dBm)	Peak Conducted Power Limit (dBm)	Margin (dBm)
High Power Setting 23					
802.11b High Power Setting 23	1 Mbps DBPSK	2412	23.77	30	-6.23
		2442	23.43	30	-6.57
		2462	23.19	30	-6.81
	2 Mbps DQPSK	2412	23.77	30	-6.23
		2442	23.61	30	-6.39
		2462	23.44	30	-6.56
	11 Mbps CCK	2412	26.81	30	-3.19
		2442	26.68	30	-3.32
		2462	26.46	30	-3.54
802.11g High Power Setting 23	9 Mbps BPSK	2412	28.26	30	-1.74
		2442	28.42	30	-1.58
		2462	28.46	30	-1.54
	18 Mbps QPSK	2412	28.01	30	-1.99
		2442	28.43	30	-1.57
		2462	28.24	30	-1.76
	36 Mbps 16-QAM	2412	28.03	30	-1.97
		2442	28.18	30	-1.82
		2462	28.32	30	-1.68
	54 Mbps 64-QAM	2412	28.15	30	-1.85
		2442	28.43	30	-1.57
		2462	28.52	30	-1.48
802.11n 800ns High Power Setting 23	6.5 Mbps BPSK 1/2	2412	28.75	30	-1.25
		2442	28.71	30	-1.29
		2462	28.72	30	-1.28
	19.5 Mbps QPSK 3/4	2412	28.17	30	-1.83
		2442	28.22	30	-1.78
		2462	28.24	30	-1.76
	39 Mbps 16-QAM 3/4	2412	28.01	30	-1.99
		2442	28.33	30	-1.67
		2462	28.07	30	-1.93
	65 Mbps 64-QAM 5/6	2412	28.09	30	-1.91
		2442	28.27	30	-1.73
		2462	28.43	30	-1.57

ULTRATECH GROUP OF LABS

3000 Bristol Circle, Oakville, Ontario, Canada L6H 6G4
 Tel. #: 905-829-1570, Fax. #: 905-829-8050, Email: vic@ultratech-labs.com, Website: <http://www.ultratech-labs.com>

File #: DIGI-064F15C247
 October 26, 2012

All test results contained in this engineering test report are traceable to National Institute of Standards and Technology (NIST)

Operating Mode	Modulation	Frequency (MHz)	Peak Conducted Power (dBm)	Peak Conducted Power Limit (dBm)	Margin (dBm)
High Power Setting 23					
802.11n 400ns High Power Setting 23	7.2 Mbps BPSK1/2	2412	28.48	30	-1.52
		2442	28.64	30	-1.36
		2462	28.61	30	-1.39
	21.7 Mbps QPSK 3/4	2412	28.06	30	-1.94
		2442	28.09	30	-1.91
		2462	28.08	30	-1.92
	43.3 Mbps 16-QAM 3/4	2412	28.14	30	-1.86
		2442	28.23	30	-1.77
		2462	28.16	30	-1.84
	72.2 Mbps 64-QAM 5/6	2412	28.14	30	-1.86
		2442	28.20	30	-1.80
		2462	28.17	30	-1.83
The following is the lowest power range at Low Power Setting 0					
802.11b	1 Mbps DBPSK	2412	3.67	30	-26.33
		2442	3.51	30	-26.49
		2462	2.73	30	-27.27
802.11g	54 Mbps 64-QAM	2412	7.87	30	-22.13
		2442	8.15	30	-21.85
		2462	8.04	30	-21.96
802.11n 800ns	65 Mbps 64-QAM 5/6	2412	8.03	30	-21.97
		2442	8.15	30	-21.85
		2462	8.22	30	-21.78
802.11n 400ns	72.2 Mbps 64-QAM 5/6	2412	8.07	30	-21.93
		2442	8.16	30	-21.84
		2462	8.04	30	-21.96
Note: The EIRP shall not exceed 36 dBm for all proposed antennas.					

5.4. TRANSMITTER BAND-EDGE & SPURIOUS CONDUCTED EMISSIONS [§ 15.247(d)]

5.4.1. Limit(s)

§ 15.247 (d): In any 100 kHz bandwidth outside the frequency band in which the spread spectrum or digitally modulated intentional radiator is operating, the radio frequency power that is produced by the intentional radiator shall be at least 20 dB below that in the 100 kHz bandwidth within the band that contains the highest level of the desired power, based on either an RF conducted or a radiated measurement, provided the transmitter demonstrates compliance with the peak conducted power limits. If the transmitter complies with the conducted power limits based on the use of RMS averaging over a time interval, as permitted under paragraph (b)(3) of this section, the attenuation required under this paragraph shall be 30 dB instead of 20 dB.

5.4.2. Method of Measurements

KDB Publication No. 558074 D01, Sections 5.4.2.2.4 Band-Edge Measurements, 5.4.1 Unwanted Emissions into Non-Restricted Bands, 5.4.2 Unwanted Emissions into Restricted Frequency Bands, 5.4.2.2.1.1 Peak Power Procedure, 5.4.2.2.2.1 Measurement Procedure RBAVG1 (Power Averaging) and 5.4.2.2.3 Applicability of §15.35(b) and §15.35(c).

5.4.3. Test Arrangement

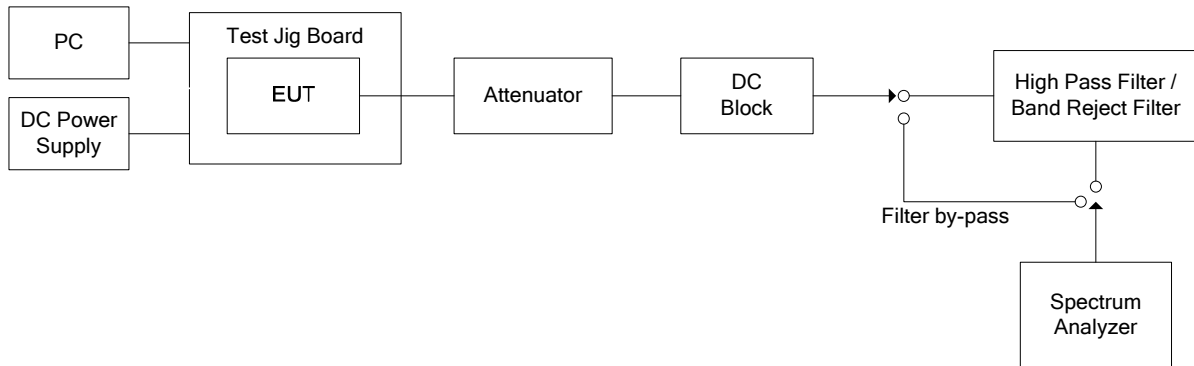

5.4.4. Test Data

5.4.4.1. Band-Edge RF Conducted Emissions

Remark: The following test results at high power setting represent the worst case, derived from exploratory tests.

Plot 5.4.4.1.1. Band-Edge RF Conducted Emissions, Lower Band-edge, 2412 MHz, 802.11b, 1 Mbps DBPSK

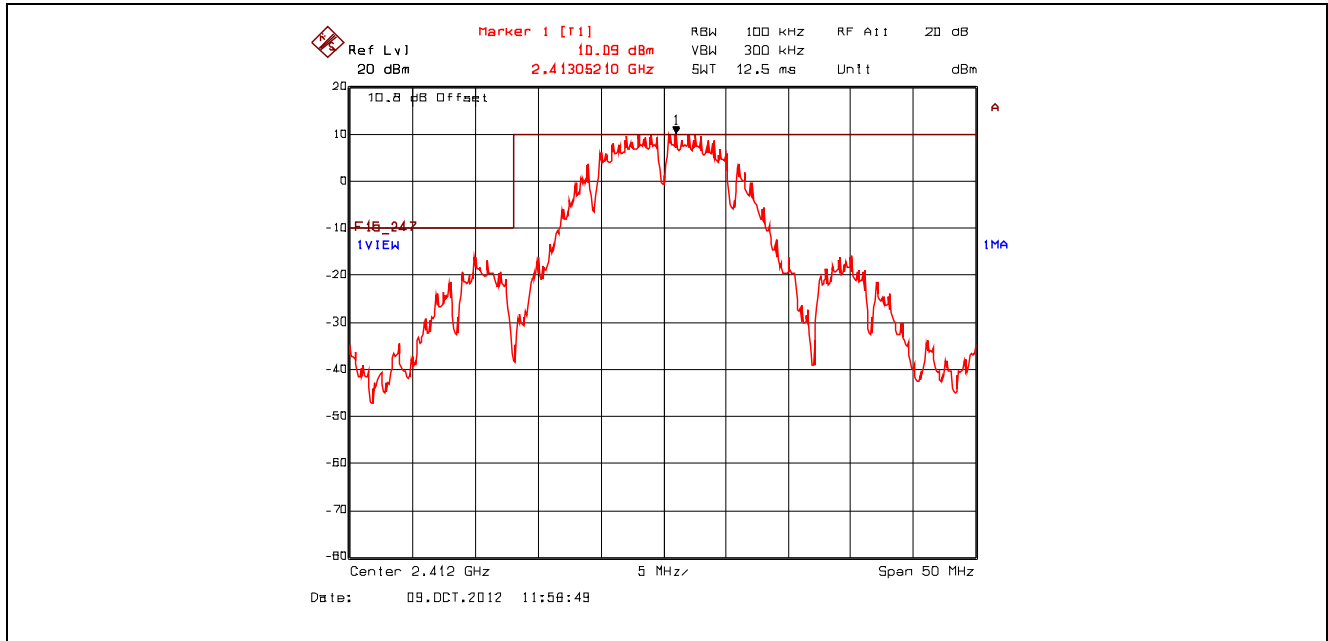

Plot 5.4.4.1.2. Band-Edge RF Conducted Emissions, Upper Band-edge, 2462 MHz, 802.11b, 1 Mbps DBPSK

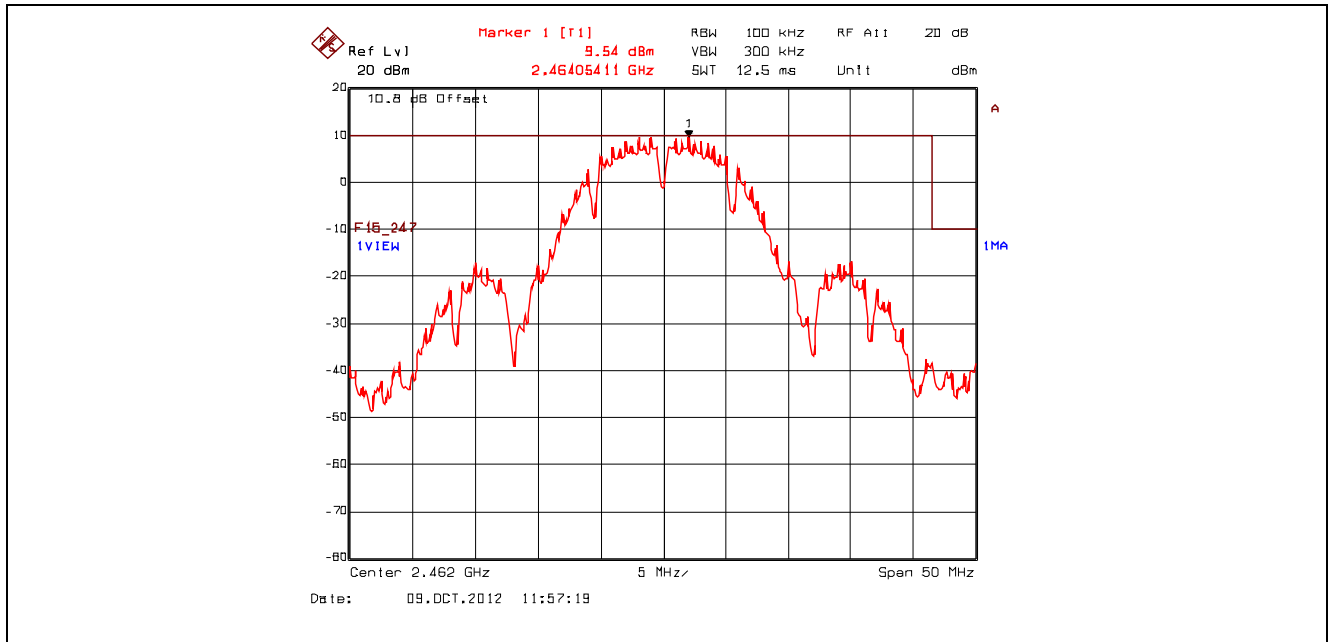

Plot 5.4.4.1.3. Band-Edge RF Conducted Emissions, Lower Band-edge, 2412 MHz, 802.11g, 9 Mbps BPSK

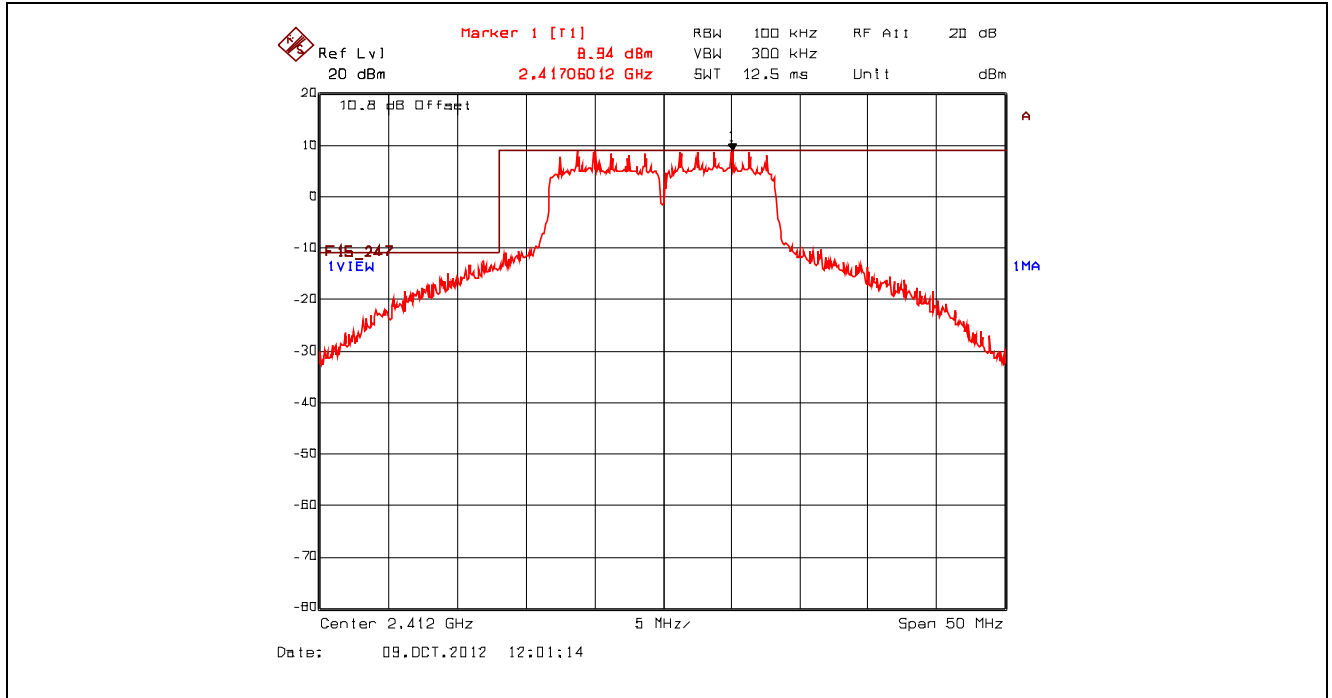

Plot 5.4.4.1.4. Band-Edge RF Conducted Emissions, Upper Band-edge, 2462 MHz, 802.11g, 9 Mbps BPSK

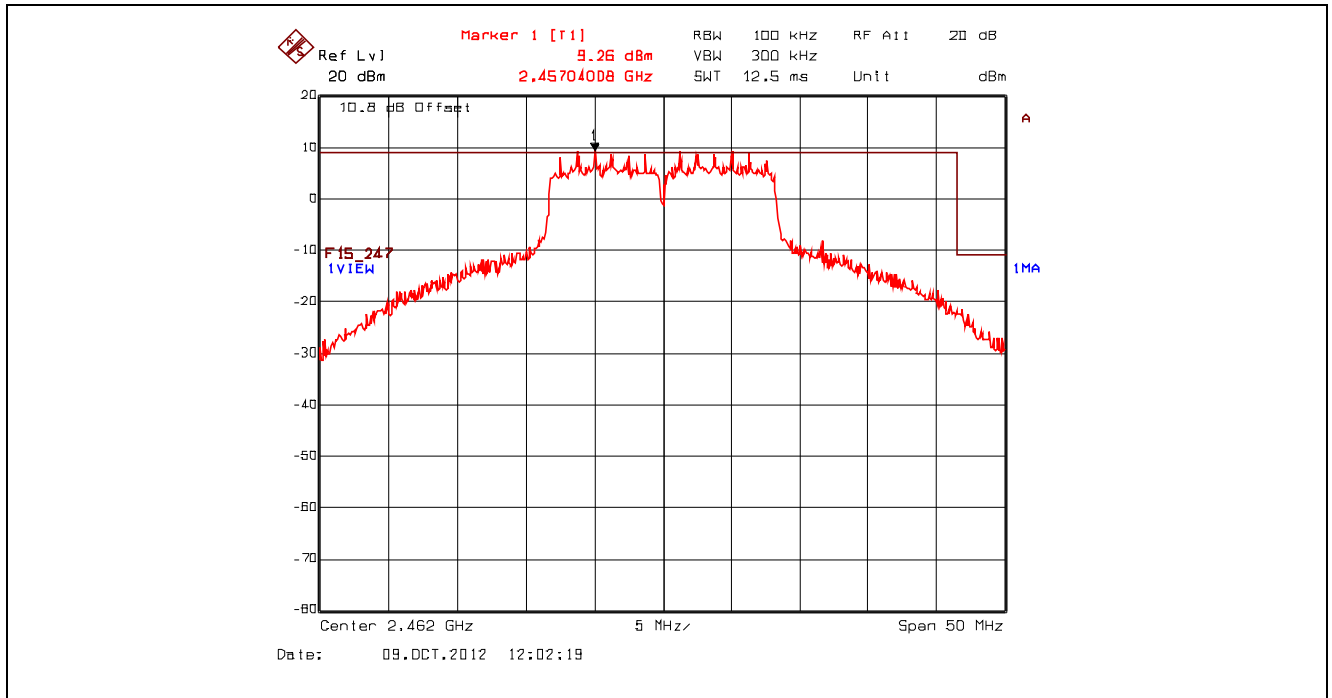

Plot 5.4.4.1.5. Band-Edge RF Conducted Emissions, Lower Band-edge, 2412 MHz, 802.11n 800ns, 6.5 Mbps BPSK 1/2

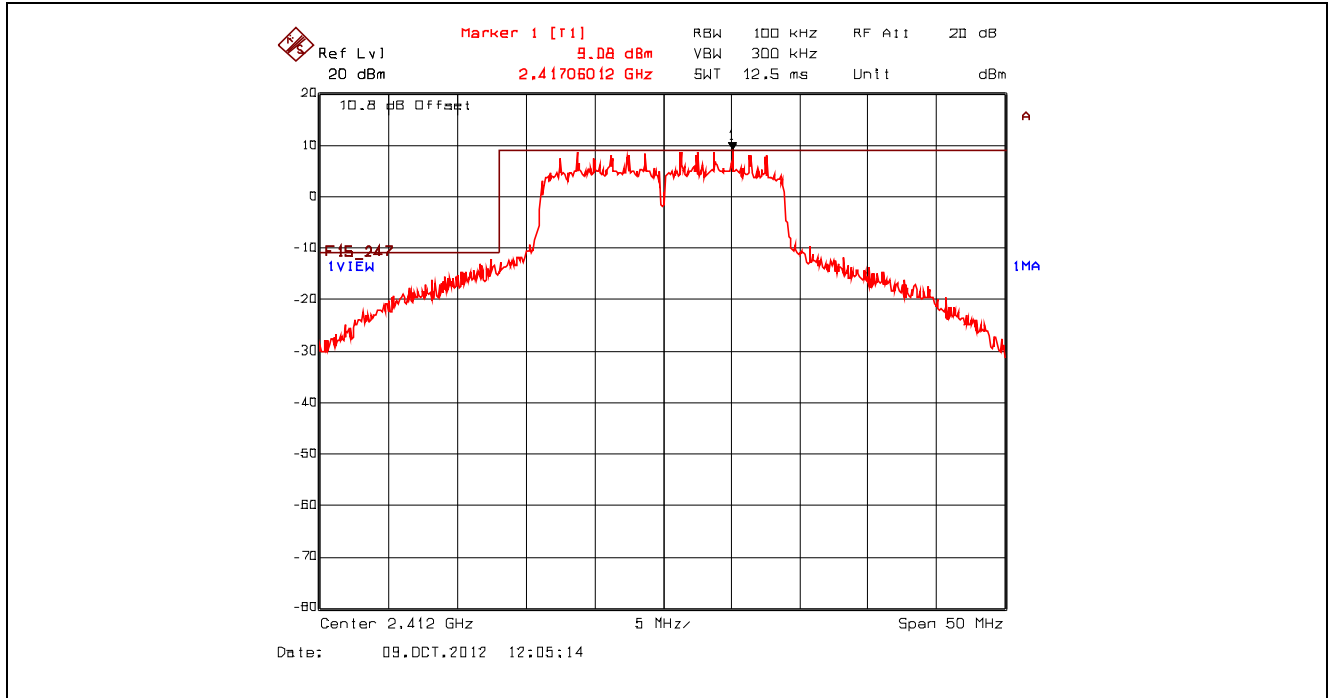

Plot 5.4.4.1.6. Band-Edge RF Conducted Emissions, Upper Band-edge, 2462 MHz, 802.11n 800ns, 6.5 Mbps BPSK 1/2

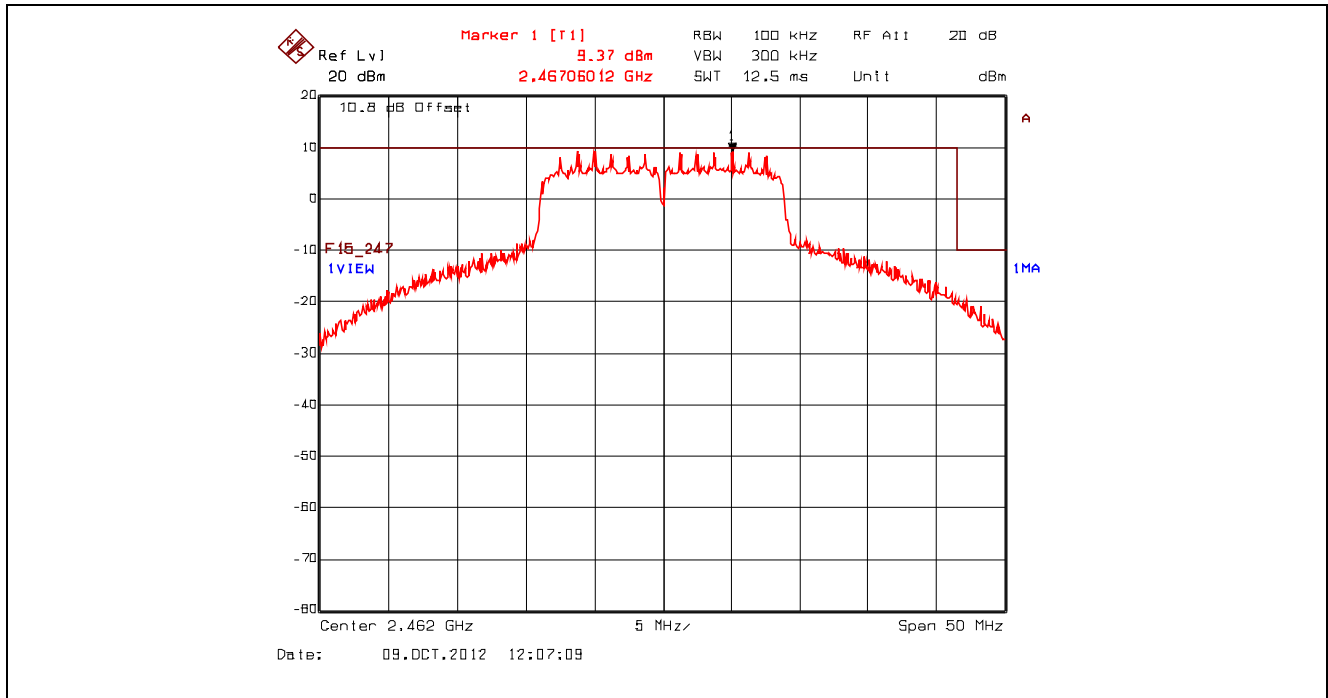

Plot 5.4.4.1.7. Band-Edge RF Conducted Emissions, Lower Band-edge, 2412 MHz, 802.11n 400ns, 7.2 Mbps BPSK 1/2

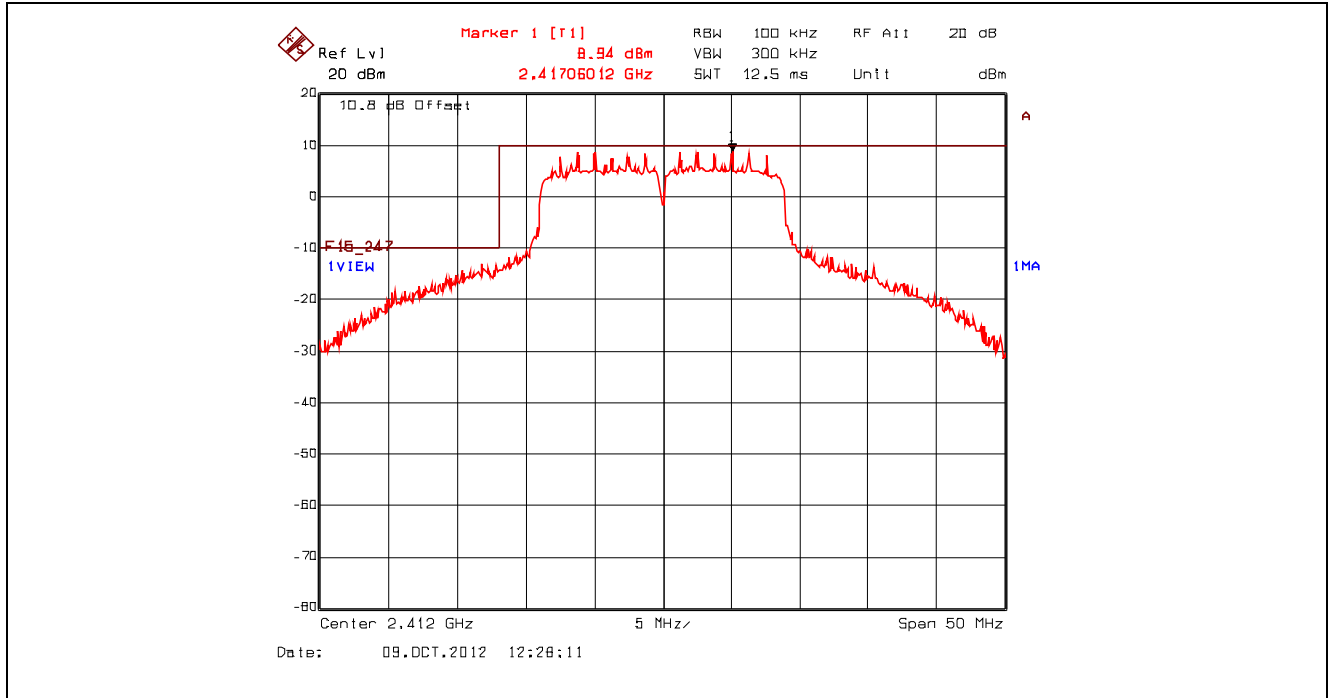

Plot 5.4.4.1.8. Band-Edge RF Conducted Emissions, Upper Band-edge, 2462 MHz, 802.11n 400ns, 7.2 Mbps BPSK 1/2

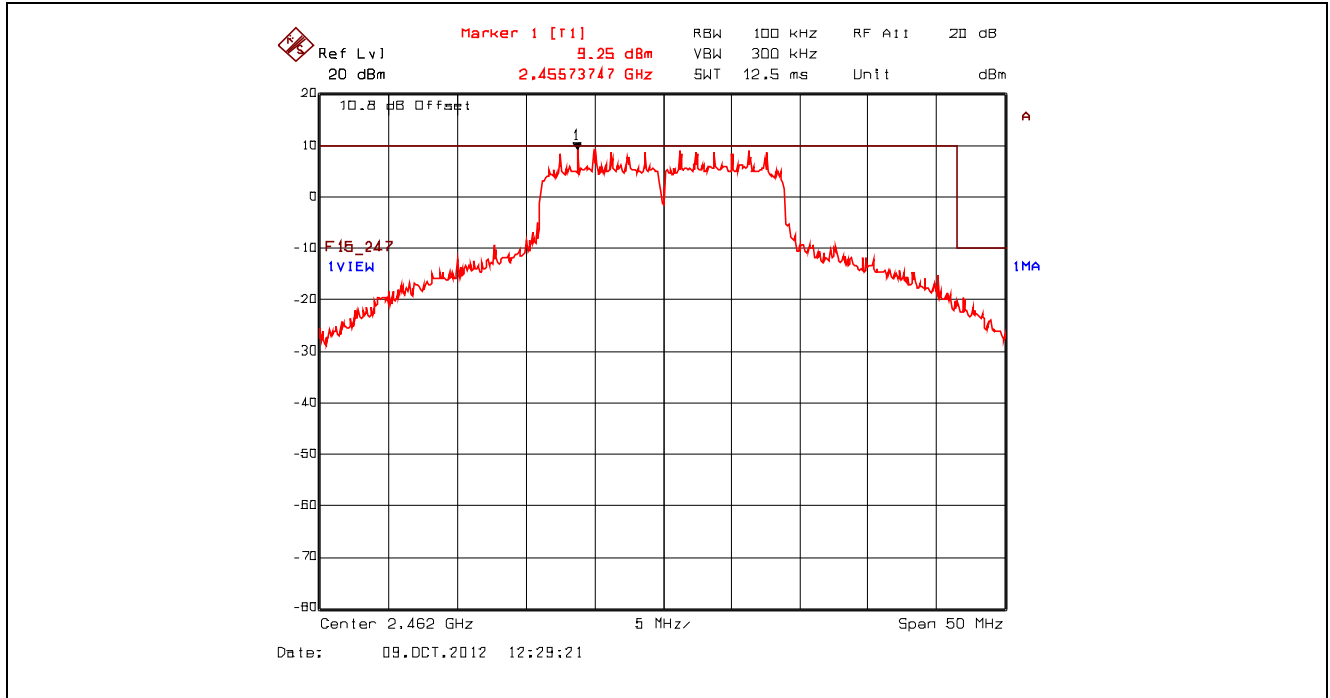

5.4.4.2. Spurious RF Conducted Emissions – Non Restricted Frequency Bands

Remark: The highest level from peak power and PSD test results were used to represent the final test configurations.

Plot 5.4.4.2.1. Conducted Spurious Emissions - Non Restricted Frequency Bands, 802.11b, 10 MHz – 4 GHz
 2412 MHz, High Power, 11 Mbps CCK, Power Setting 23 dBm

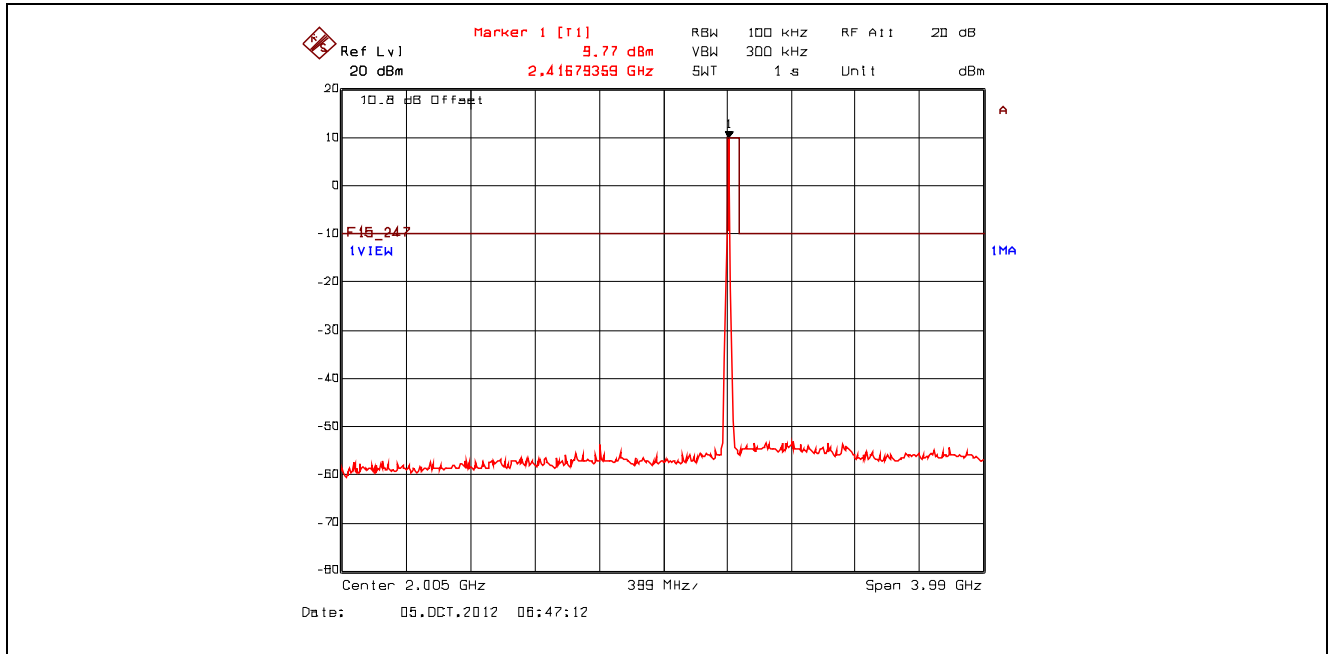

Plot 5.4.4.2.2. Conducted Spurious Emissions - Non Restricted Frequency Bands, 802.11b, 4 GHz – 25 GHz
 2412 MHz, High Power, 11 Mbps CCK, Power Setting 23 dBm

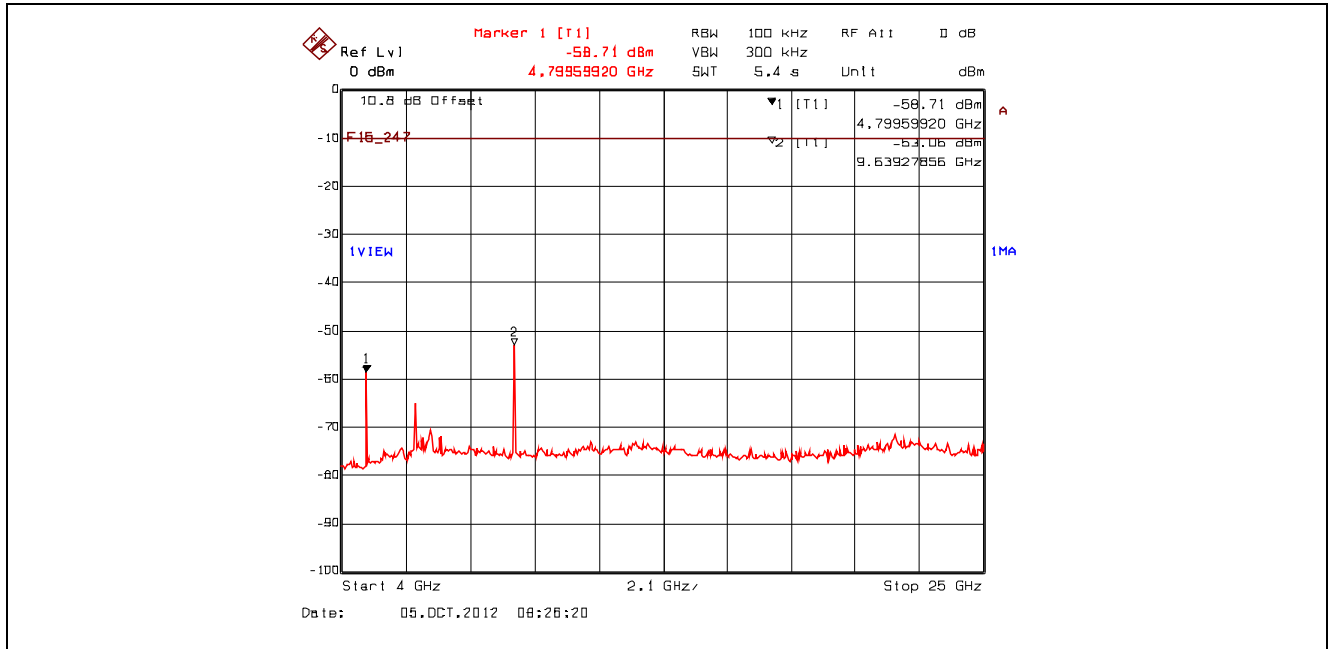

Plot 5.4.4.2.3. Conducted Spurious Emissions - Non Restricted Frequency Bands, 802.11b, 10 MHz – 4 GHz
 2442 MHz, High Power, 11 Mbps CCK, Power Setting 23 dBm

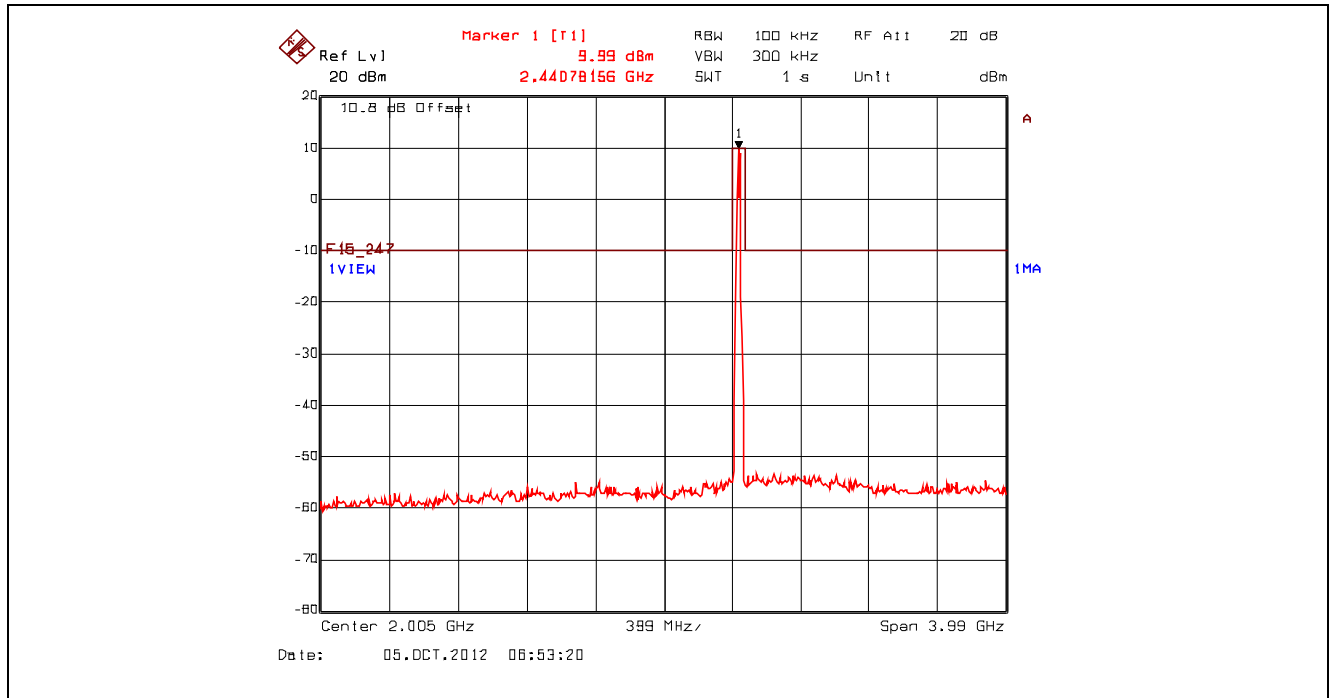

Plot 5.4.4.2.4. Conducted Spurious Emissions - Non Restricted Frequency Bands, 802.11b, 4 GHz – 25 GHz
 2442 MHz, High Power, 11 Mbps CCK, Power Setting 23 dBm

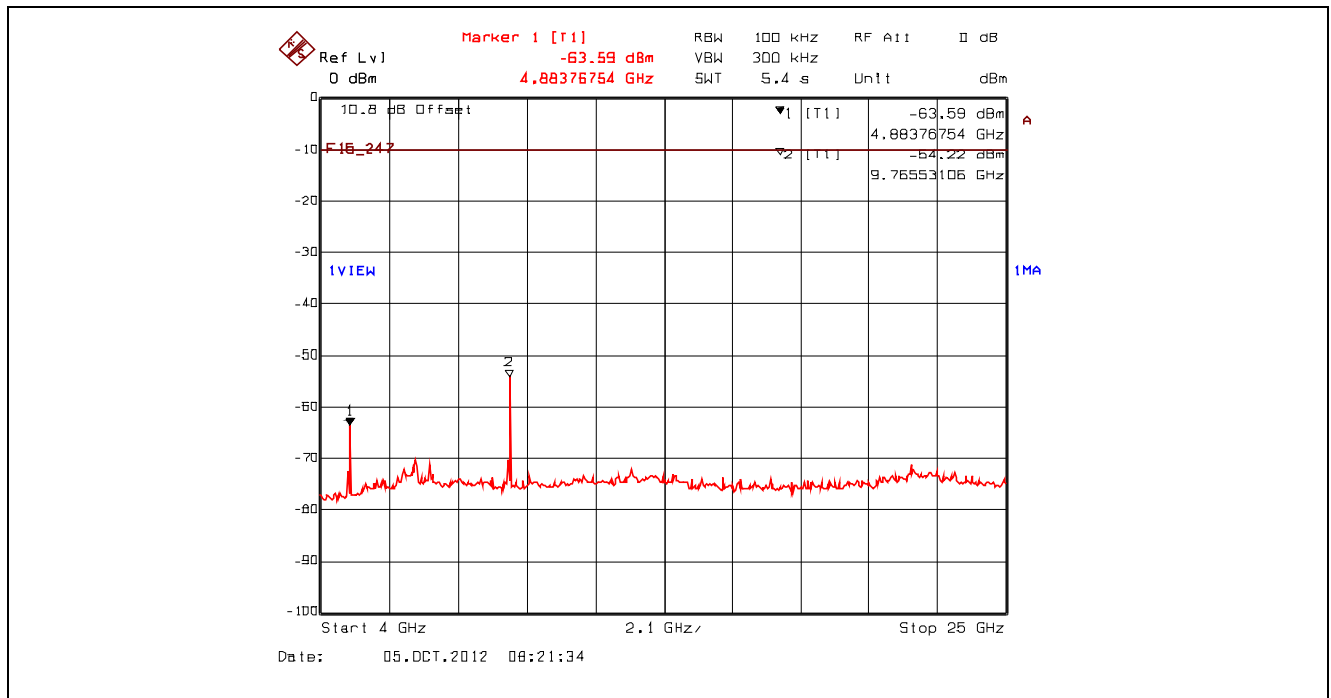

Plot 5.4.4.2.5. Conducted Spurious Emissions - Non Restricted Frequency Bands, 802.11b, 10 MHz – 4 GHz
 2462 MHz, High Power, 11 Mbps CCK, Power Setting 23 dBm

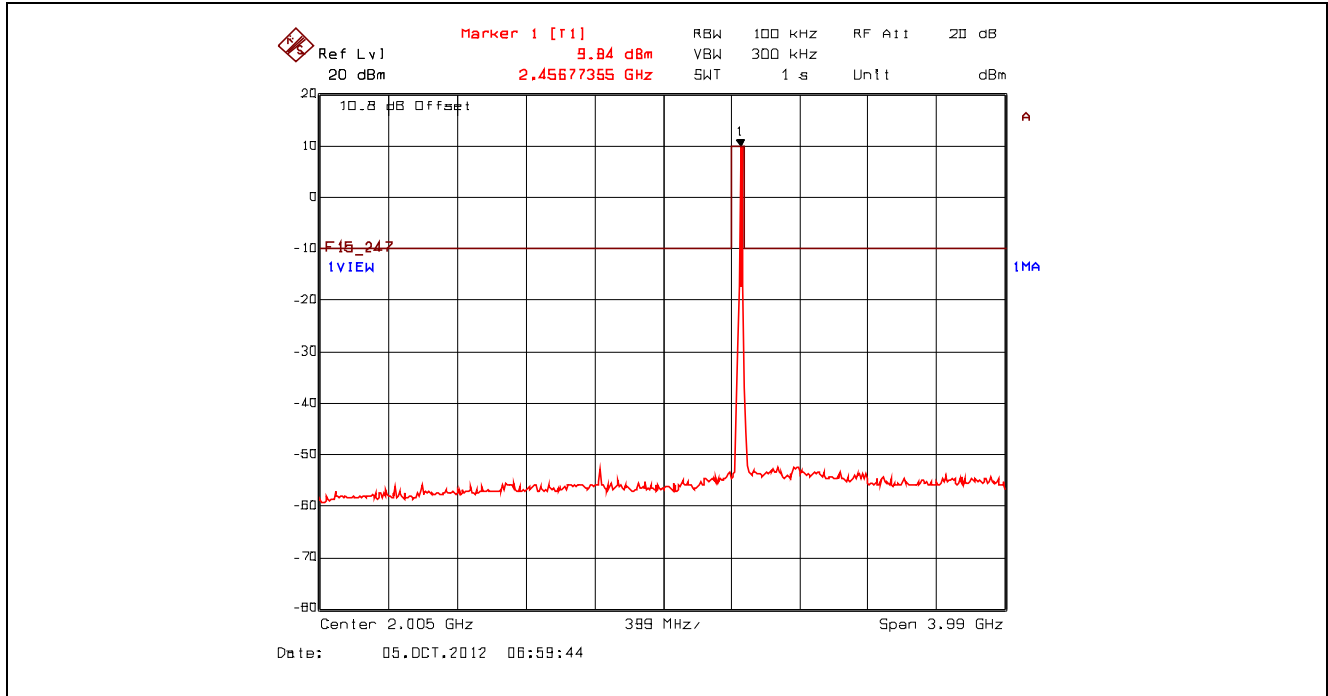

Plot 5.4.4.2.6. Conducted Spurious Emissions - Non Restricted Frequency Bands, 802.11b, 4 GHz – 25 GHz
 2462 MHz, High Power, 11 Mbps CCK, Power Setting 23 dBm

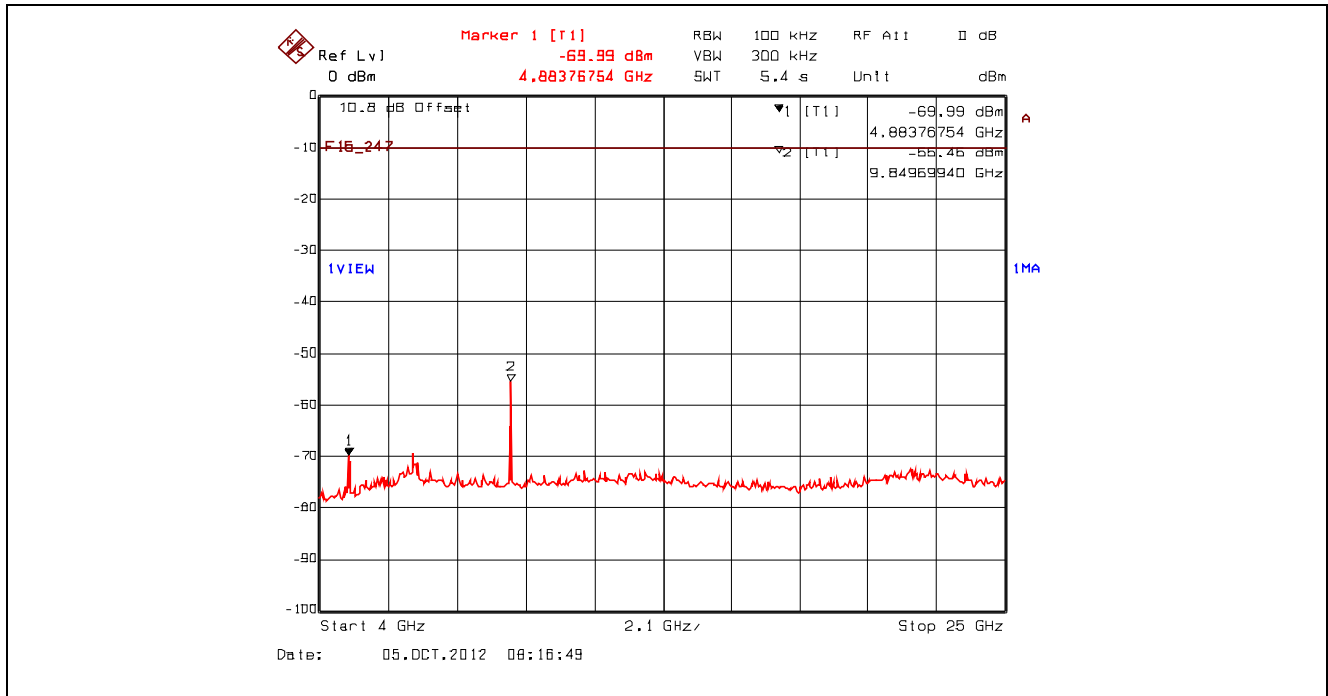

Plot 5.4.4.2.7. Conducted Spurious Emissions - Non Restricted Frequency Bands, 802.11g, 10 MHz – 4 GHz
 2412 MHz, High Power, 9 Mbps BPSK, Power Setting 23 dBm

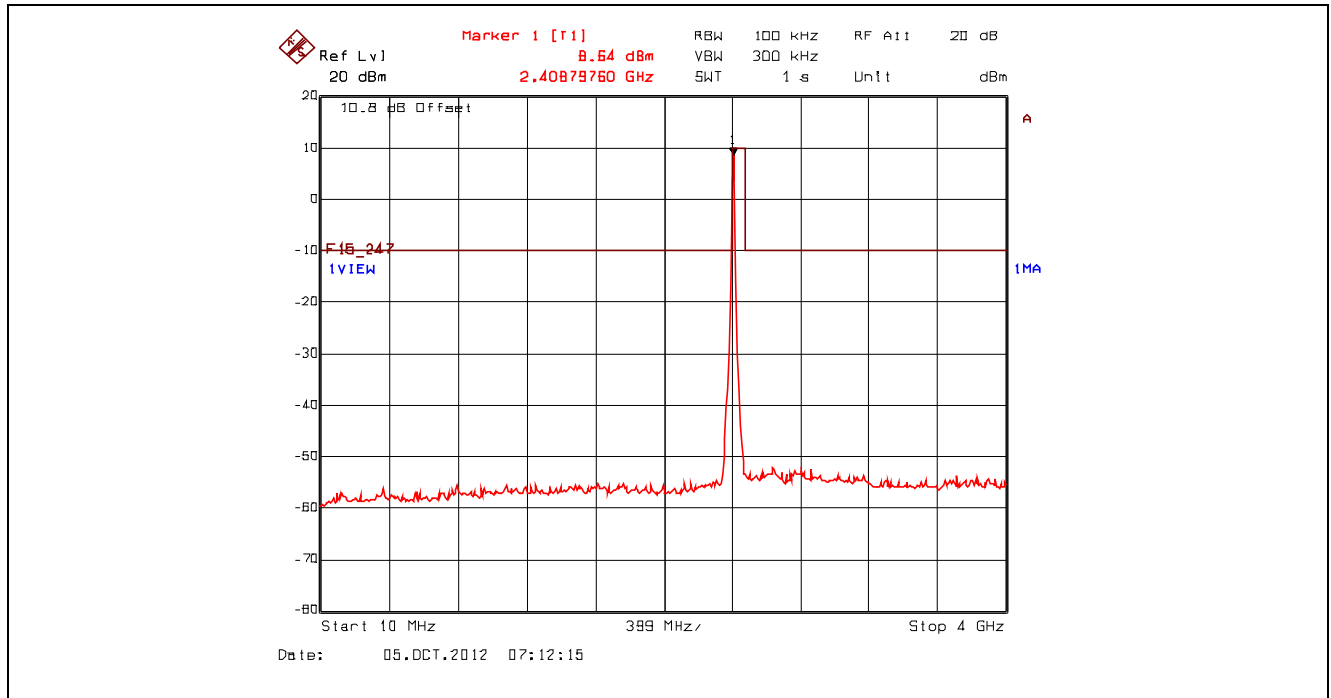

Plot 5.4.4.2.8. Conducted Spurious Emissions - Non Restricted Frequency Bands, 802.11g, 4 GHz – 25 GHz
 2412 MHz, High Power, 9 Mbps BPSK, Power Setting 23 dBm

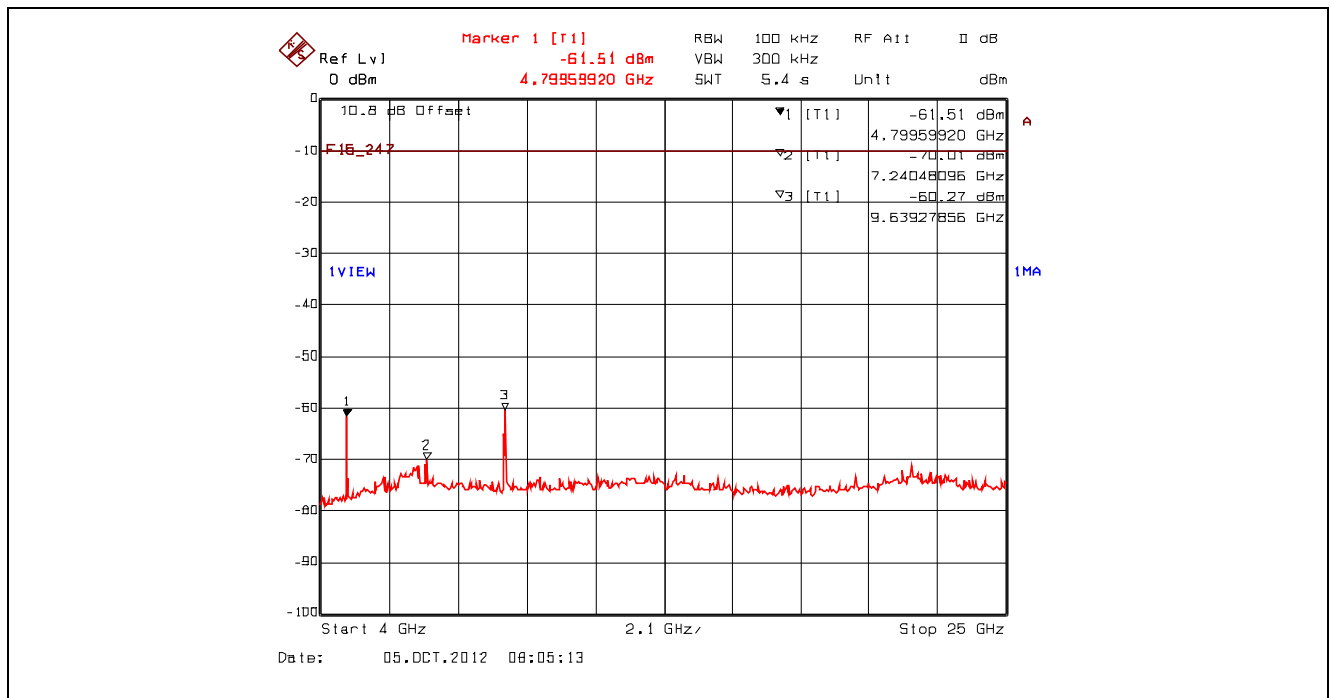

Plot 5.4.4.2.9. Conducted Spurious Emissions - Non Restricted Frequency Bands, 802.11g, 10 MHz – 4 GHz
 2442 MHz, High Power, 9 Mbps BPSK, Power Setting 23 dBm

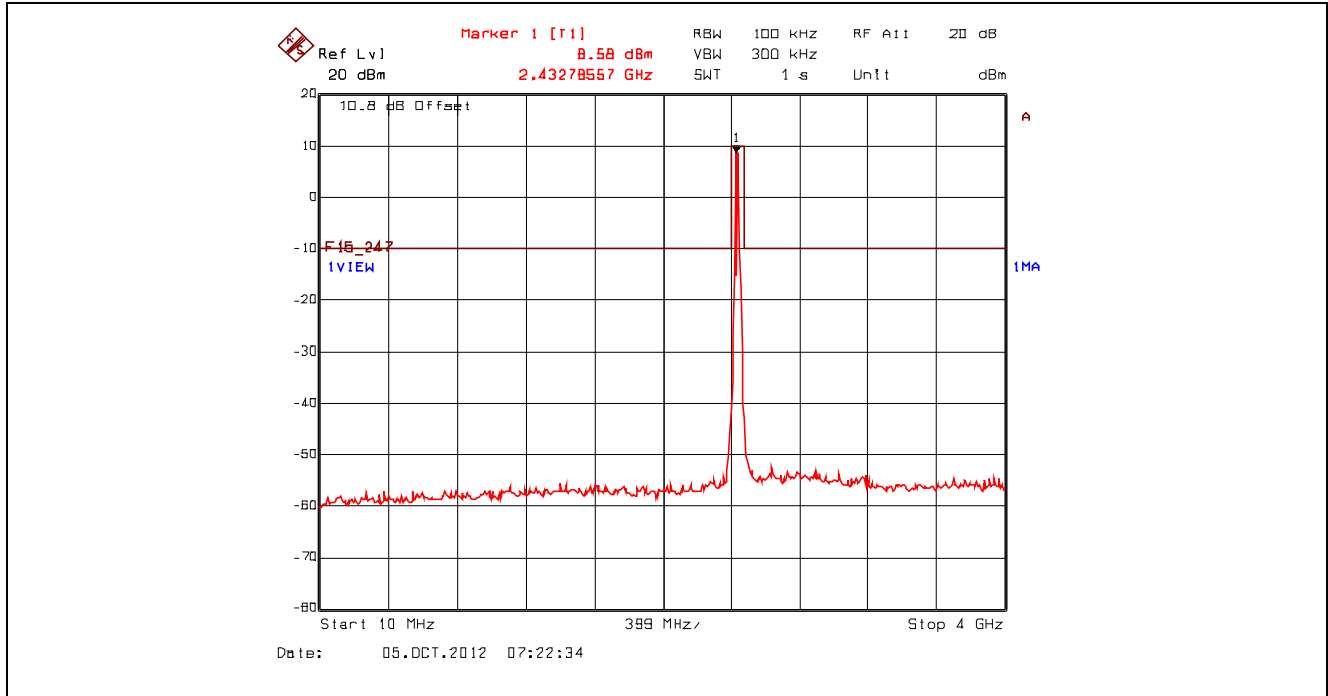

Plot 5.4.4.2.10. Conducted Spurious Emissions - Non Restricted Frequency Bands, 802.11g, 4 GHz – 25 GHz
 2442 MHz, High Power, 9 Mbps BPSK, Power Setting 23 dBm

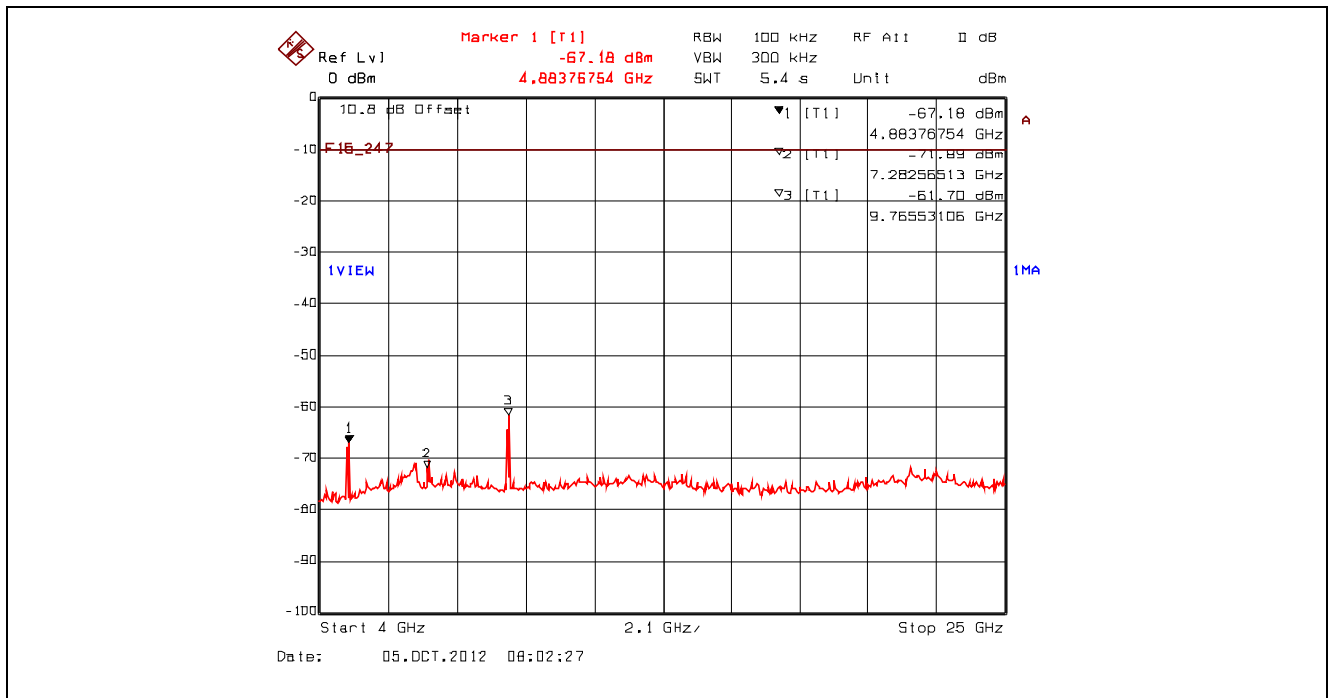

Plot 5.4.4.2.11. Conducted Spurious Emissions - Non Restricted Frequency Bands, 802.11g, 10 MHz – 4 GHz
 2462 MHz, High Power, 9 Mbps BPSK, Power Setting 23 dBm

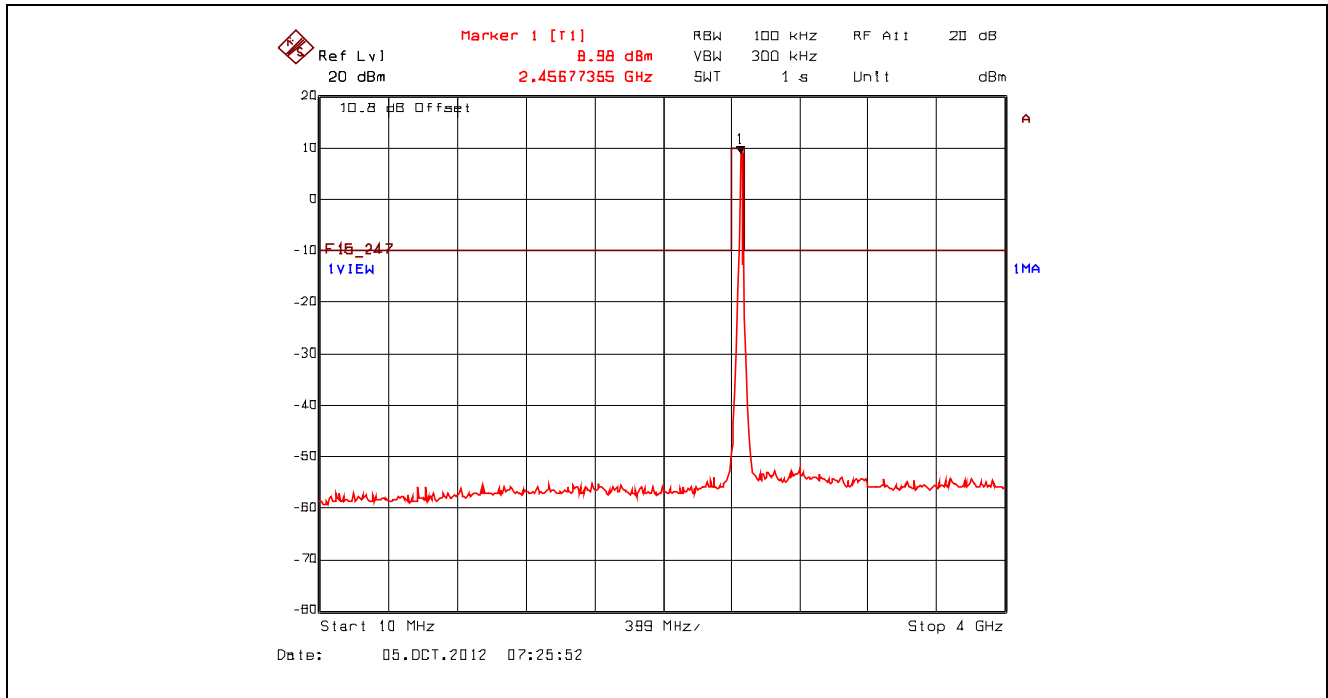

Plot 5.4.4.2.12. Conducted Spurious Emissions - Non Restricted Frequency Bands, 802.11g, 4 GHz – 25 GHz
 2462 MHz, High Power, 9 Mbps BPSK, Power Setting 23 dBm

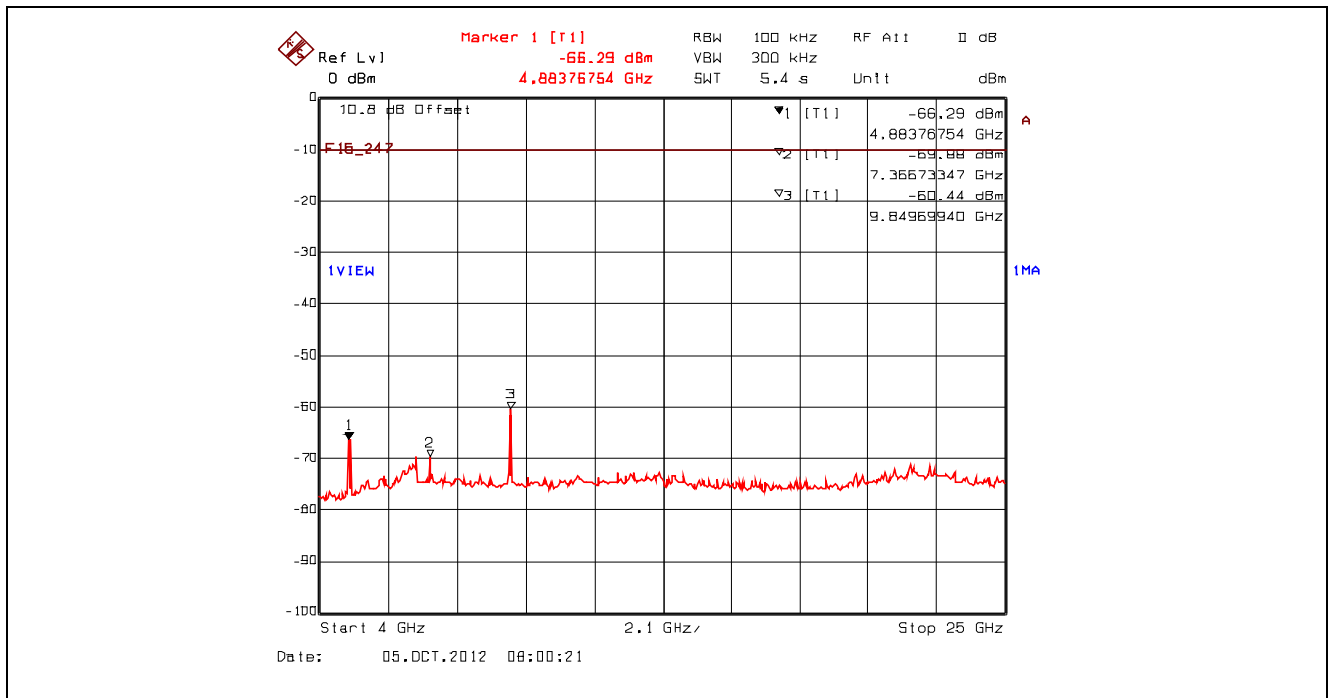

Plot 5.4.4.2.13. Conducted Spurious Emissions - Non Restricted Frequency Bands, 802.11n 800ns, 10 MHz – 4 GHz
 2412 MHz, High Power, 6.5 Mbps BPSK 1/2, Power Setting 23 dBm

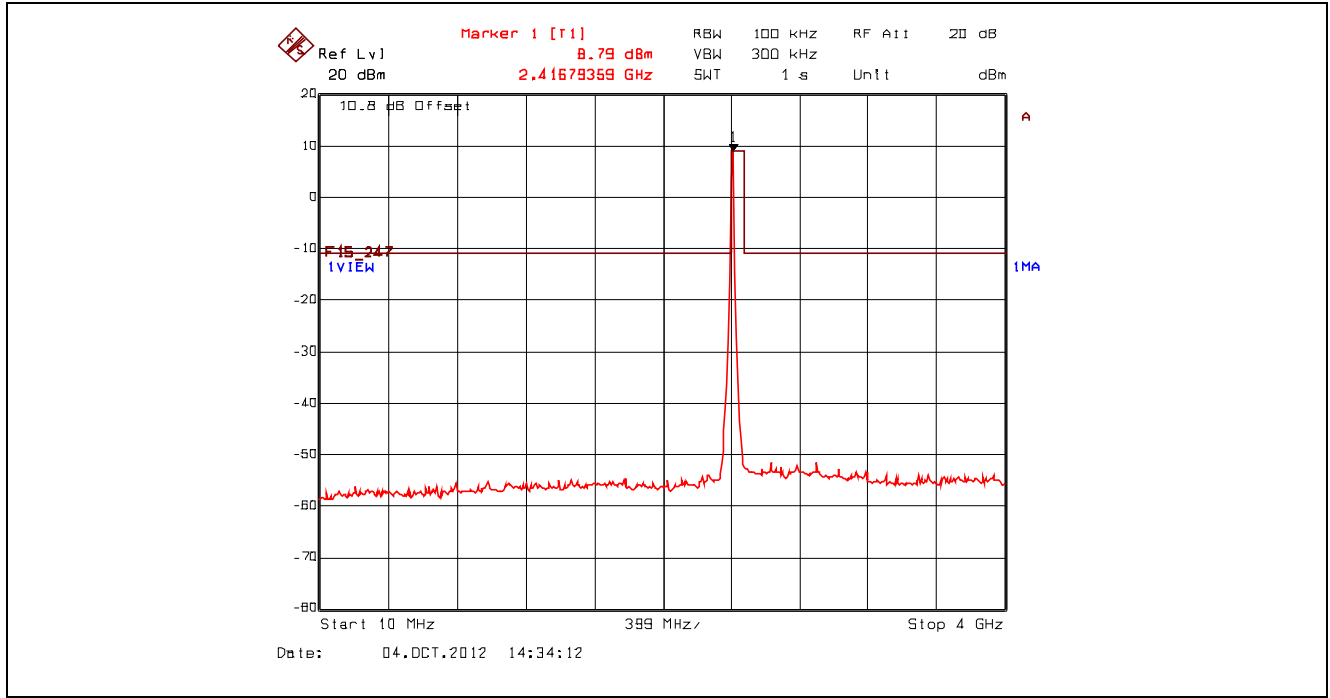

Plot 5.4.4.2.14. Conducted Spurious Emissions - Non Restricted Frequency Bands, 802.11n 800ns, 4 GHz – 25 GHz
 2412 MHz, High Power, 6.5 Mbps BPSK 1/2, Power Setting 23 dBm

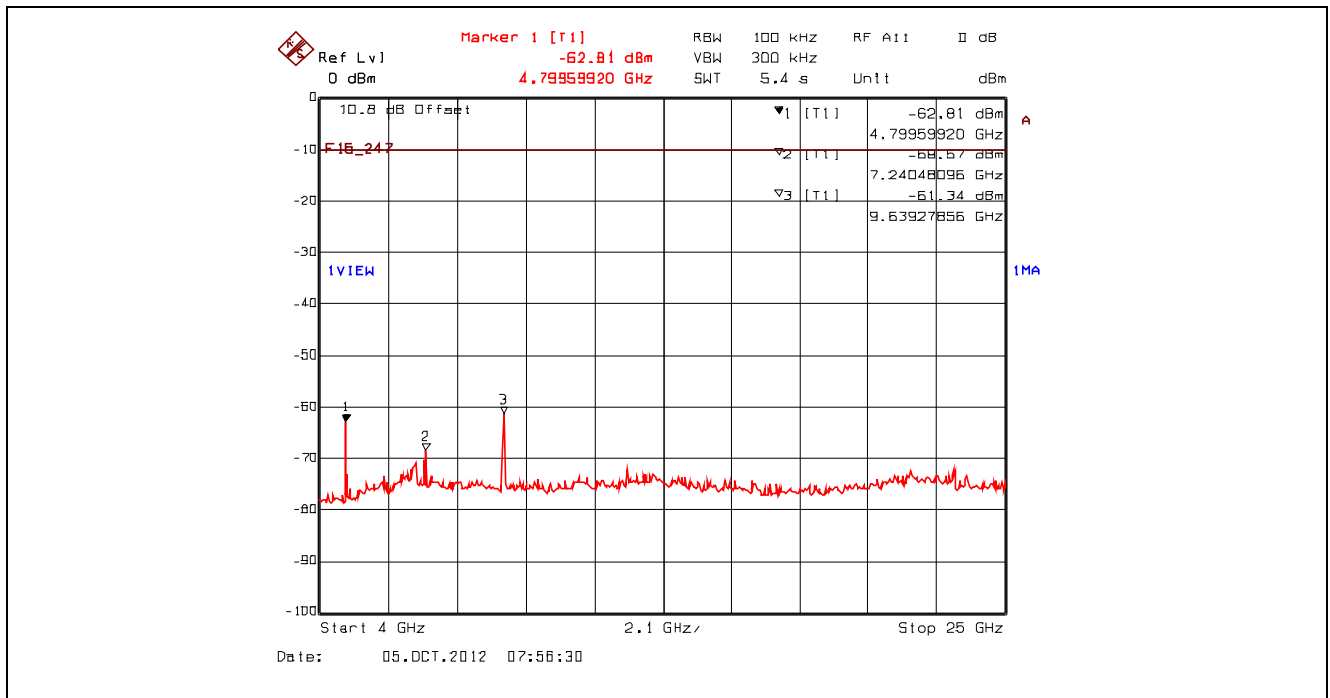

Plot 5.4.4.2.15. Conducted Spurious Emissions - Non Restricted Frequency Bands, 802.11n 800ns, 10 MHz – 4 GHz
 2442 MHz, High Power, 6.5 Mbps BPSK 1/2, Power Setting 23 dBm

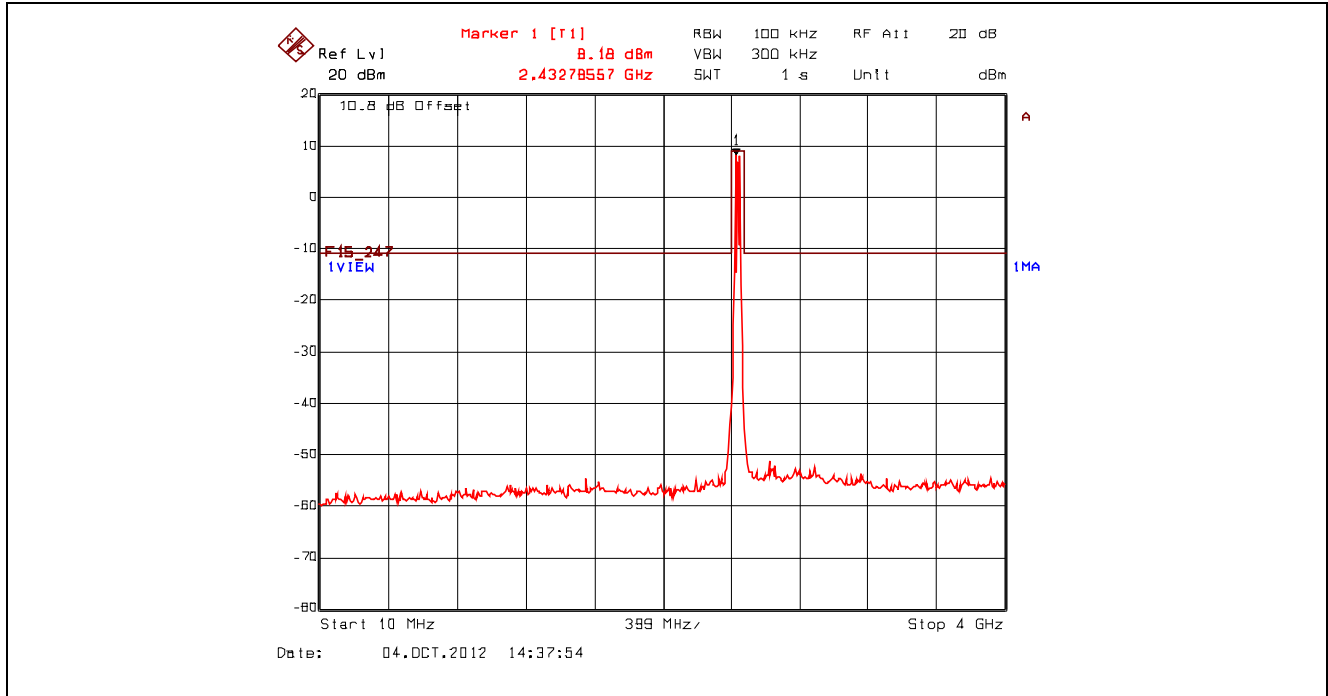

Plot 5.4.4.2.16. Conducted Spurious Emissions - Non Restricted Frequency Bands, 802.11n 800ns, 4 GHz – 25 GHz
 2442 MHz, High Power, 6.5 Mbps BPSK 1/2, Power Setting 23 dBm

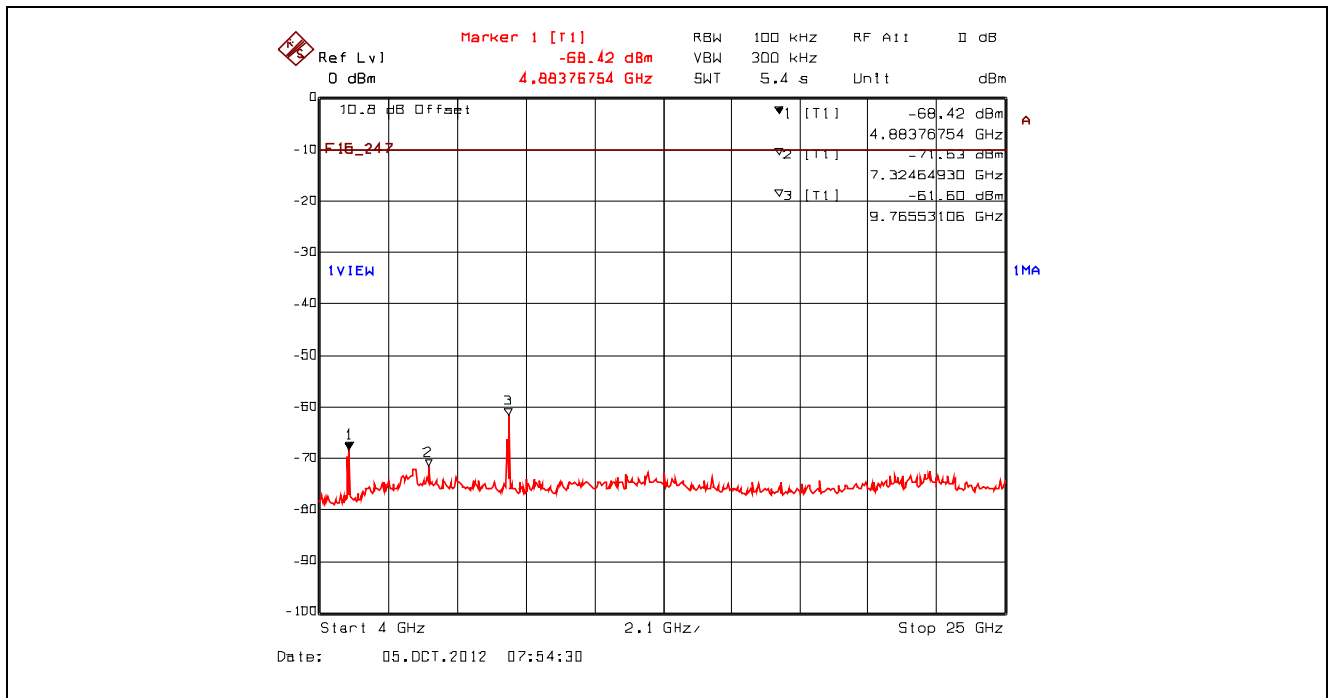

Plot 5.4.4.2.17. Conducted Spurious Emissions - Non Restricted Frequency Bands, 802.11n 800ns, 10 MHz – 4 GHz
 2462 MHz, High Power, 6.5 Mbps BPSK 1/2, Power Setting 23 dBm

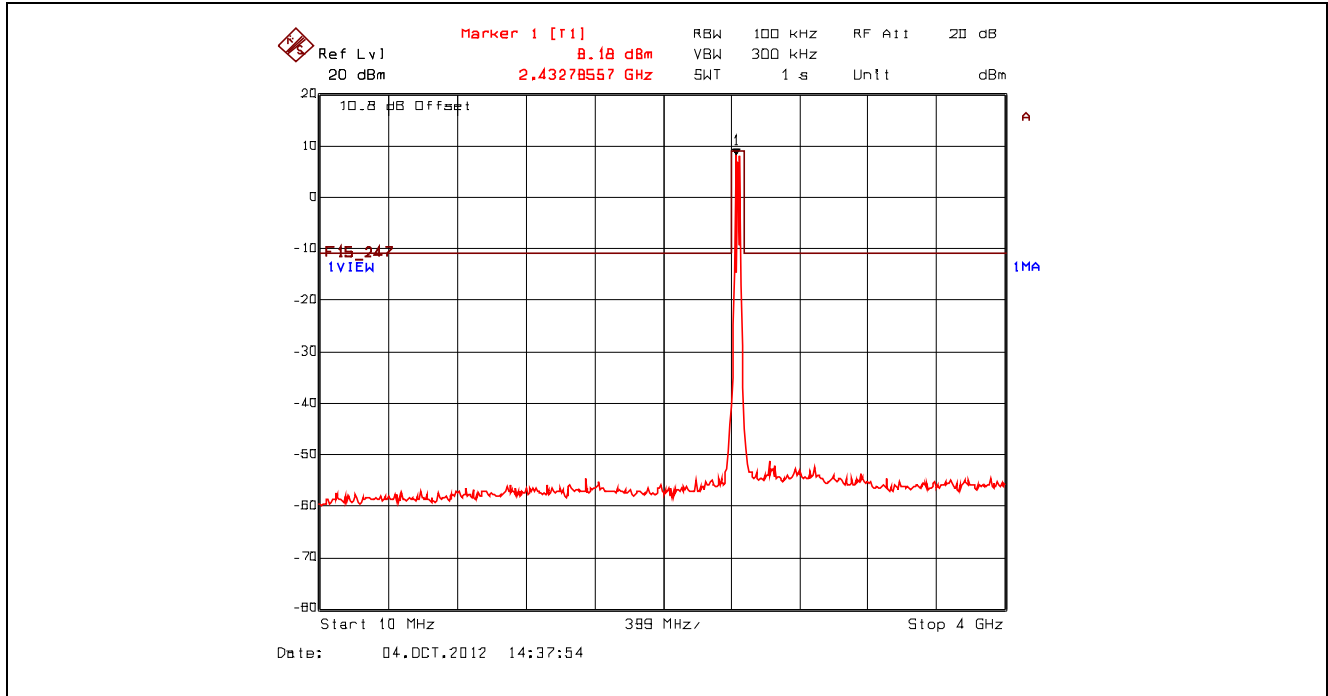

Plot 5.4.4.2.18. Conducted Spurious Emissions - Non Restricted Frequency Bands, 802.11n 800ns, 4 GHz – 25 GHz
 2462 MHz, High Power, 6.5 Mbps BPSK 1/2, Power Setting 23 dBm

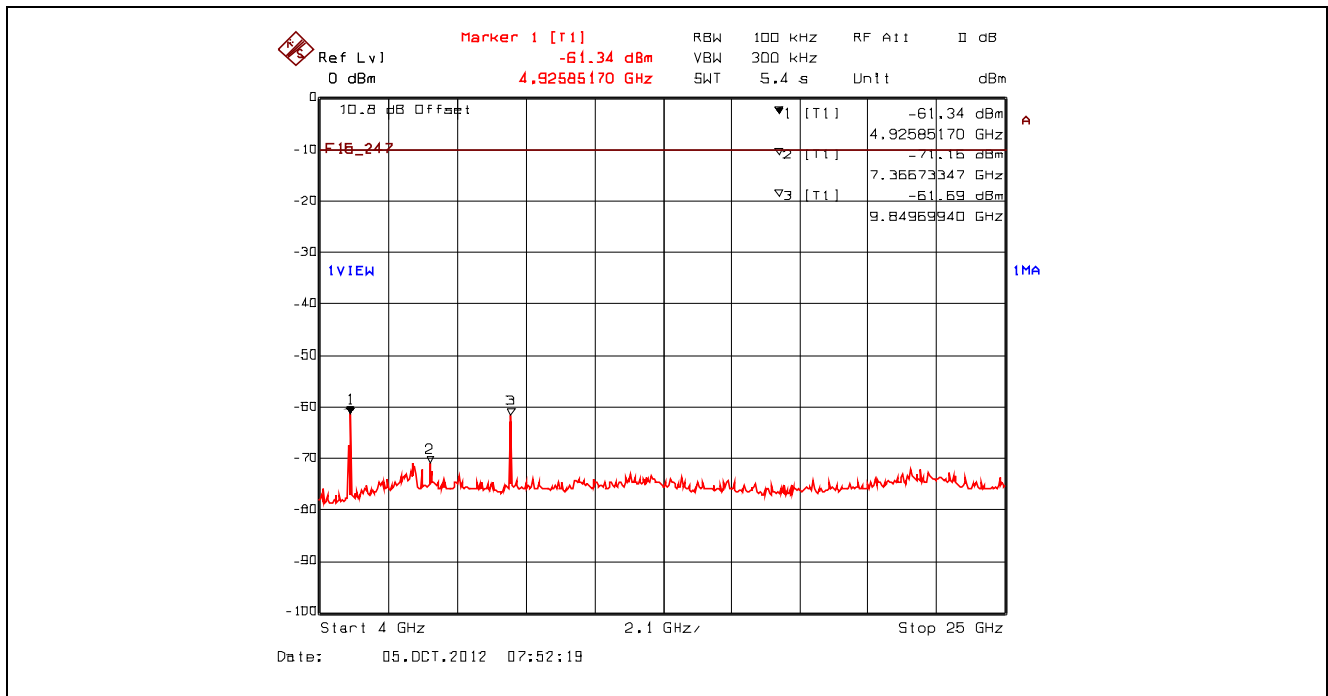

Plot 5.4.4.2.19. Conducted Spurious Emissions - Non Restricted Frequency Bands, 802.11n 400ns, 10 MHz – 4 GHz
 2412 MHz, High Power, 7.2 Mbps BPSK 1/2, Power Setting 23 dBm

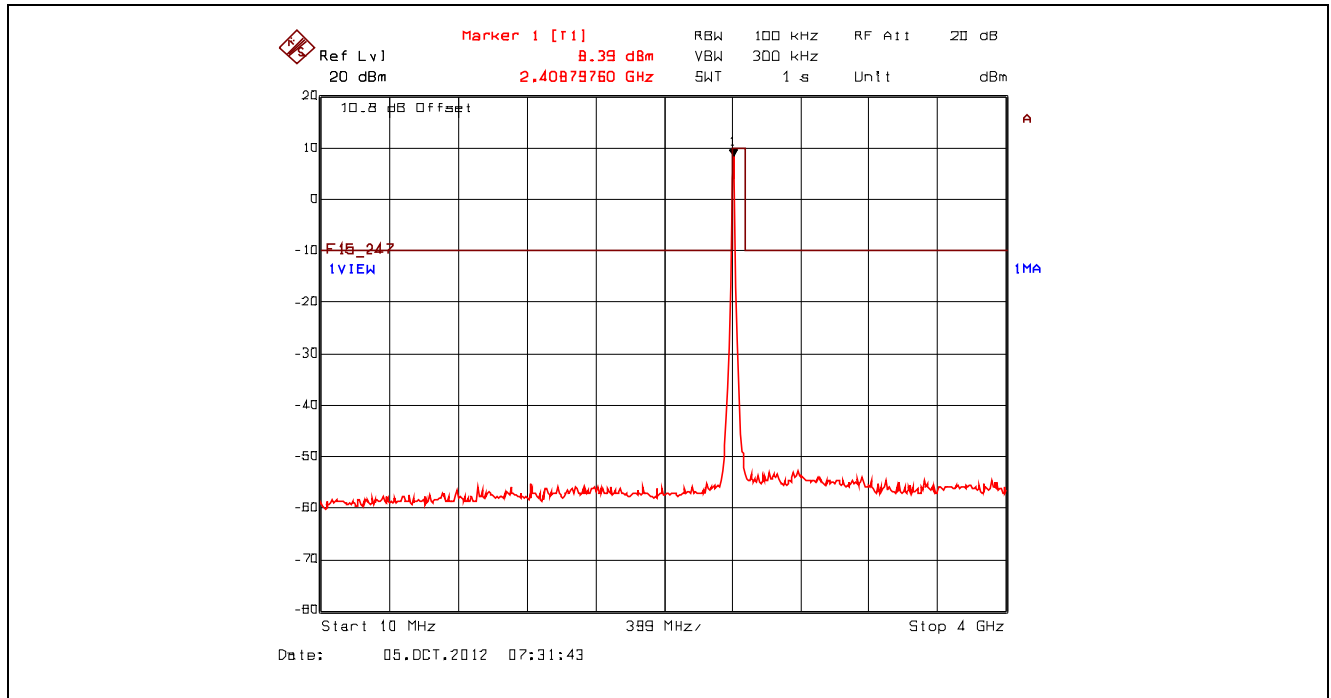

Plot 5.4.4.2.20. Conducted Spurious Emissions - Non Restricted Frequency Bands, 802.11n 400ns, 4 GHz – 25 GHz
 2412 MHz, High Power, 7.2 Mbps BPSK 1/2, Power Setting 23 dBm

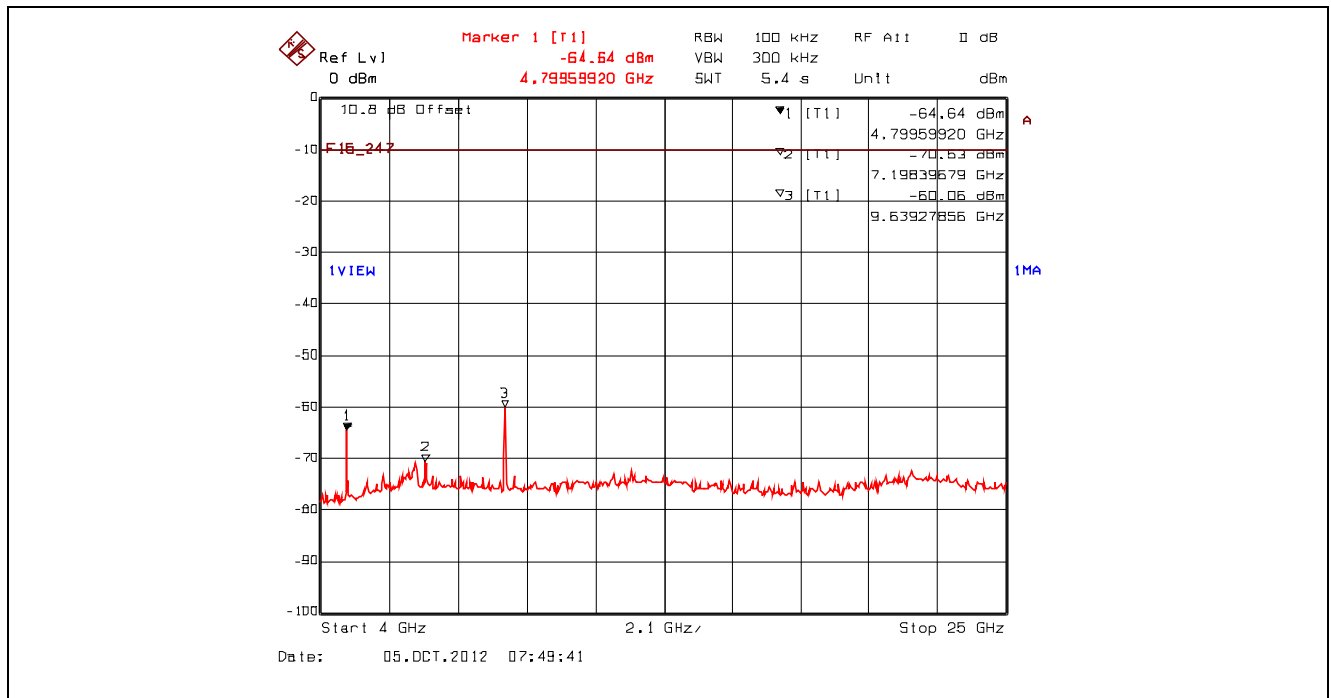

Plot 5.4.4.2.21. Conducted Spurious Emissions - Non Restricted Frequency Bands, 802.11n 400ns, 10 MHz – 4 GHz
 2442 MHz, High Power, 7.2 Mbps BPSK 1/2, Power Setting 23 dBm

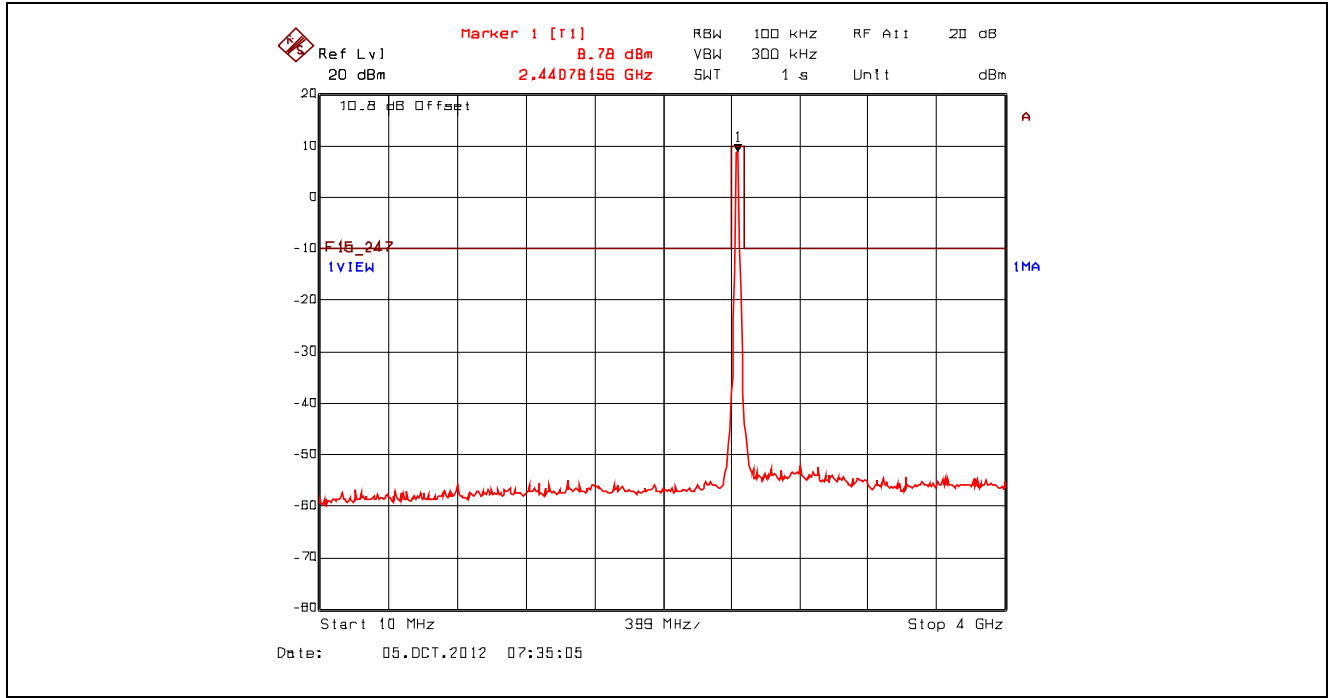

Plot 5.4.4.2.22. Conducted Spurious Emissions - Non Restricted Frequency Bands, 802.11n 400ns, 4 GHz – 25 GHz
 2442 MHz, High Power, 7.2 Mbps BPSK 1/2, Power Setting 23 dBm

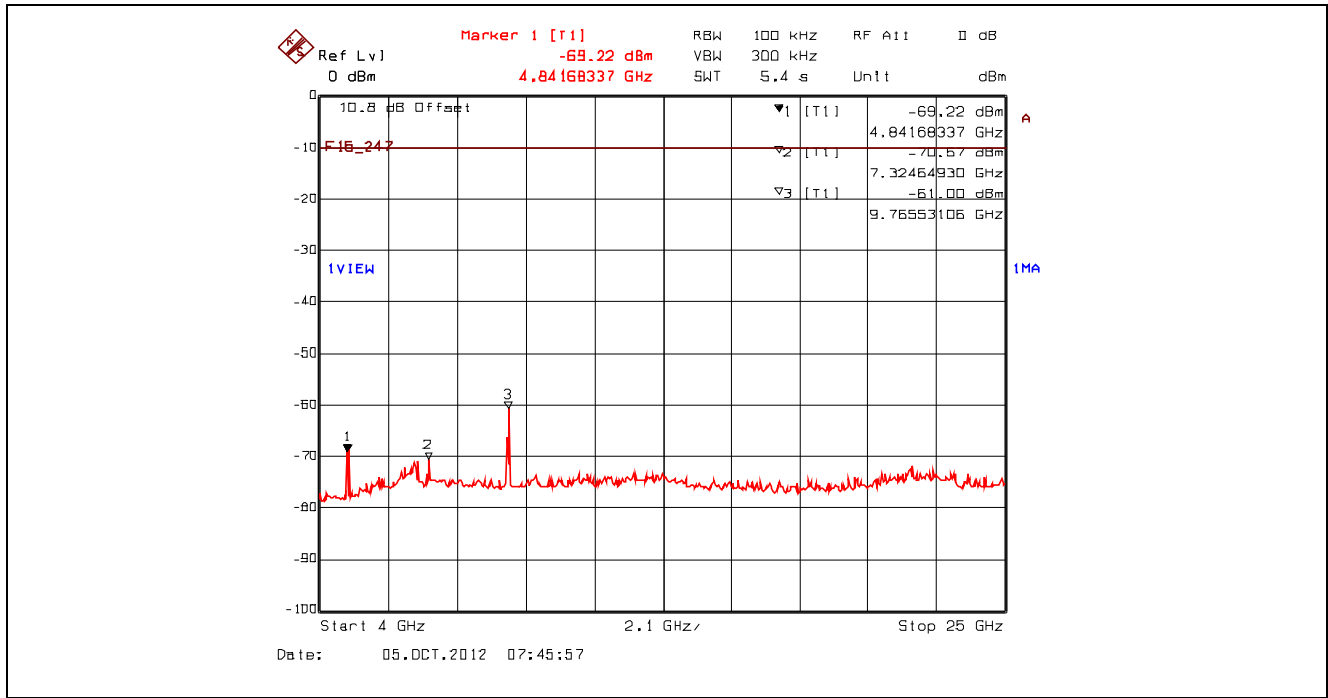

Plot 5.4.4.2.23. Conducted Spurious Emissions - Non Restricted Frequency Bands, 802.11n 400ns, 10 MHz – 4 GHz
 2462 MHz, High Power, 7.2 Mbps BPSK 1/2, Power Setting 23 dBm

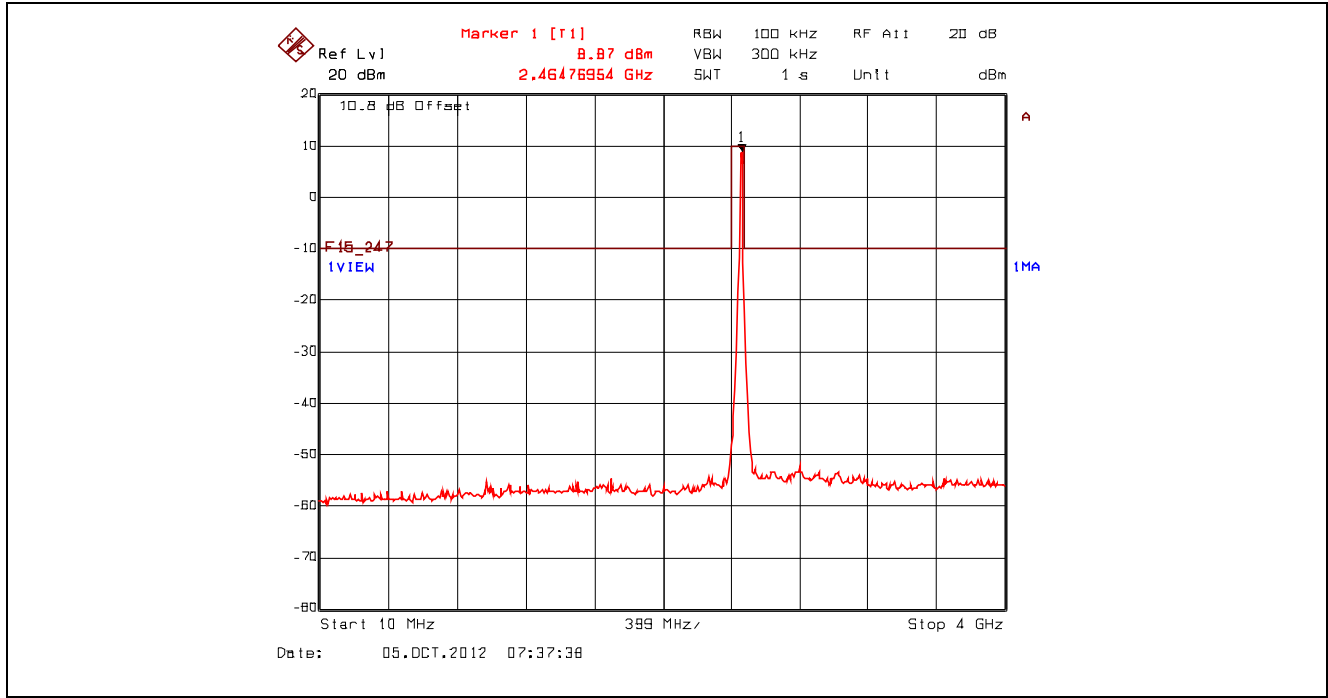

Plot 5.4.4.2.24. Conducted Spurious Emissions - Non Restricted Frequency Bands, 802.11n 400ns, 4 GHz – 25 GHz
 2462 MHz, High Power, 7.2 Mbps BPSK 1/2, Power Setting 23 dBm

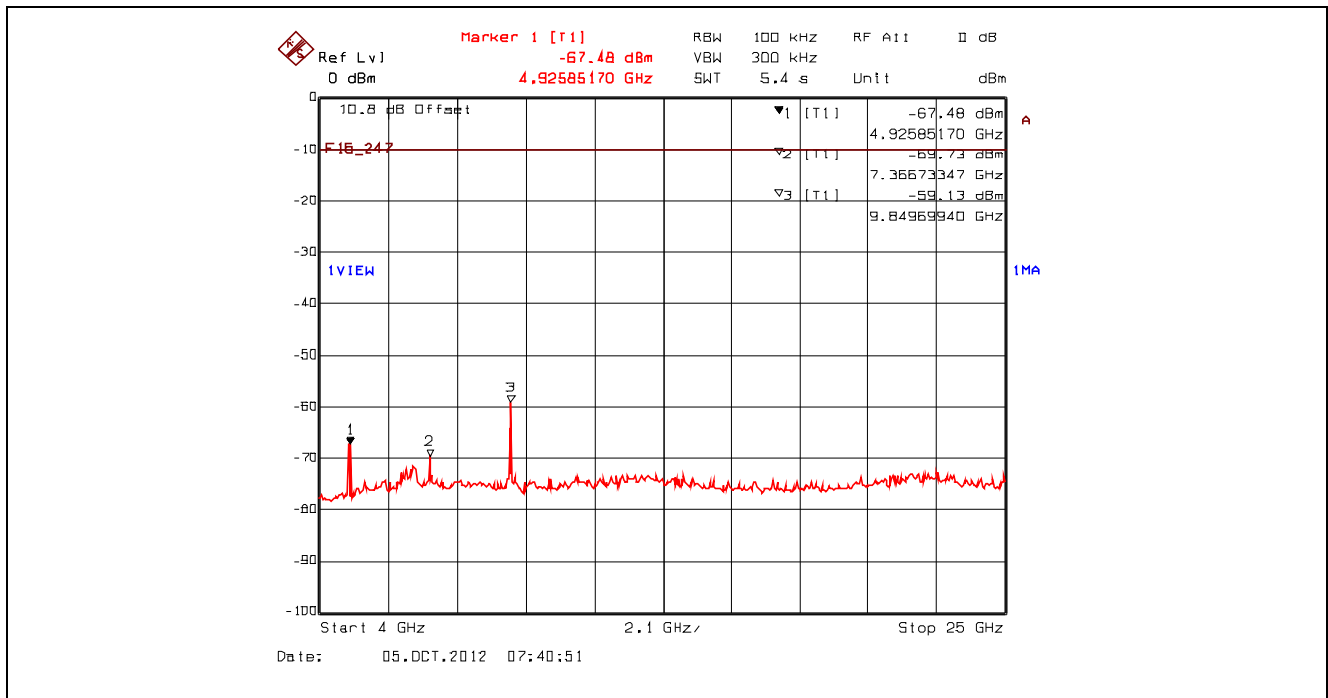

5.4.4.3. Conducted Spurious Emissions – Restricted Bands, Highest Power Setting (23) with Highest Gain Antenna (15 dBi)

Remark(s):

- Based on the peak power and PSD measurements, the highest power from each mode of operation were selected as the final test configurations.
- Offset = Insertion Loss (10.79 dB) + Highest Antenna Gain (19 dBi) - Minimum Antenna Feedline Loss (9.89 dB) = 19.90 dB

**Plot 5.4.4.3.1. Conducted Spurious Emissions – Restricted Bands, 802.11b, 11 Mbps CCK
 2412 MHz, 9 kHz - 150 kHz, Peak Detector with Band (Notch) Reject Filter**

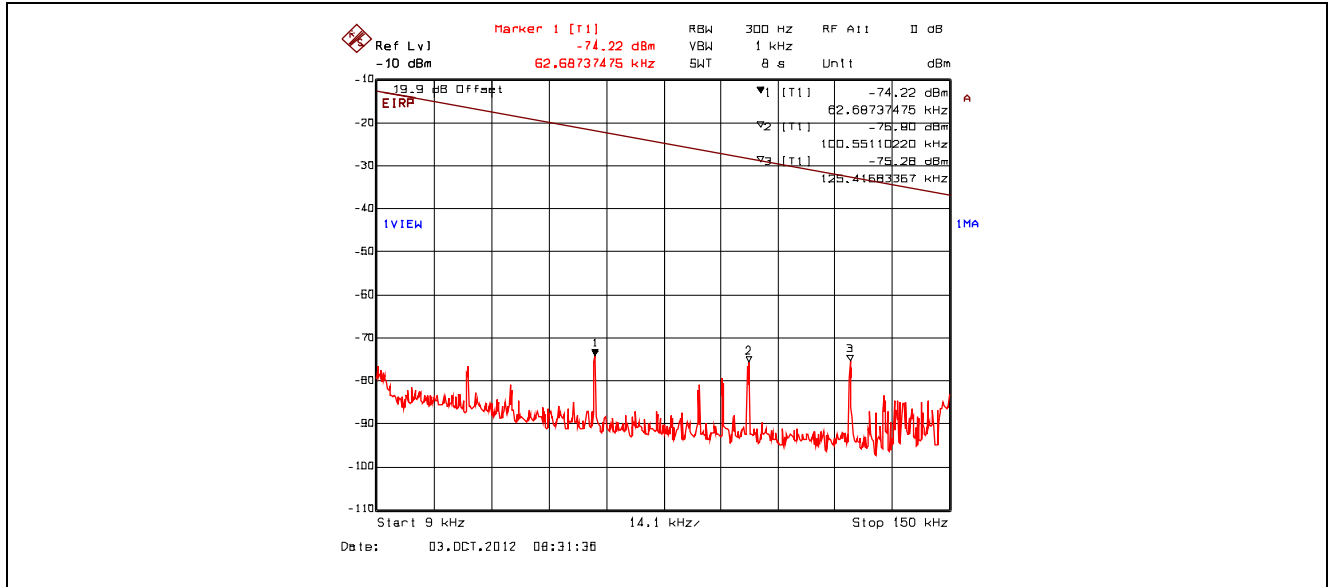

**Plot 5.4.4.3.2. Conducted Spurious Emissions – Restricted Bands, 802.11b, 11 Mbps CCK
 2412 MHz, 150 kHz - 30 MHz, Peak Detector with Band (Notch) Reject Filter**

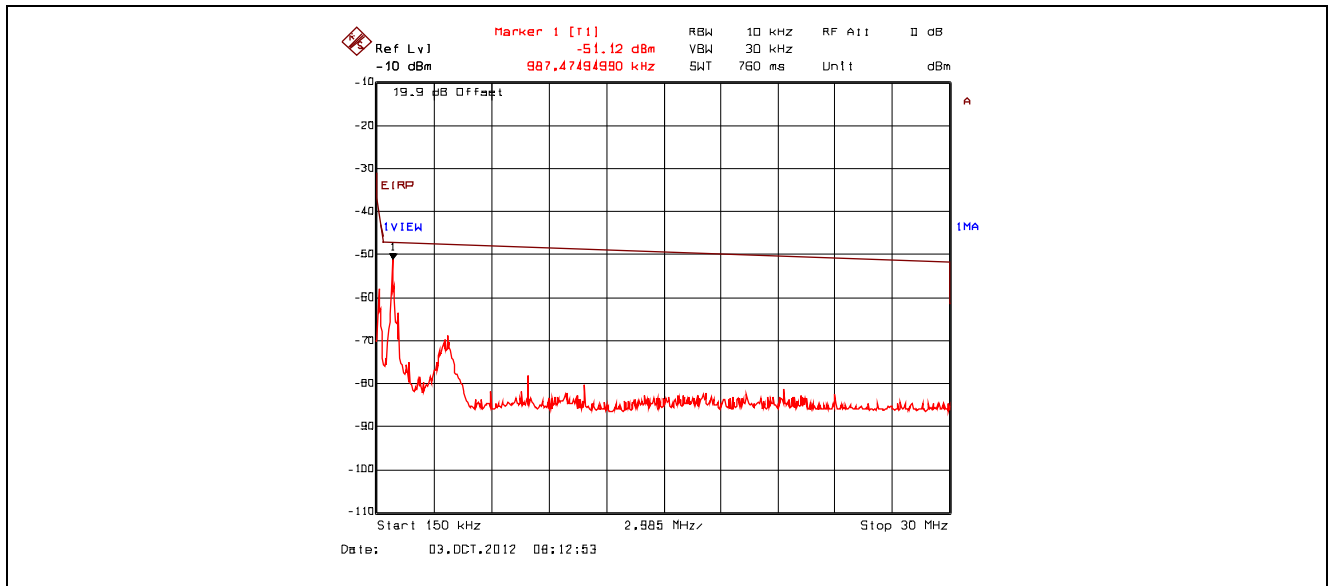

Plot 5.4.4.3.3. Conducted Spurious Emissions – Restricted Bands, 802.11b, 11 Mbps CCK
 2412 MHz, 30 MHz - 1 GHz, Peak Detector with Band (Notch) Reject Filter

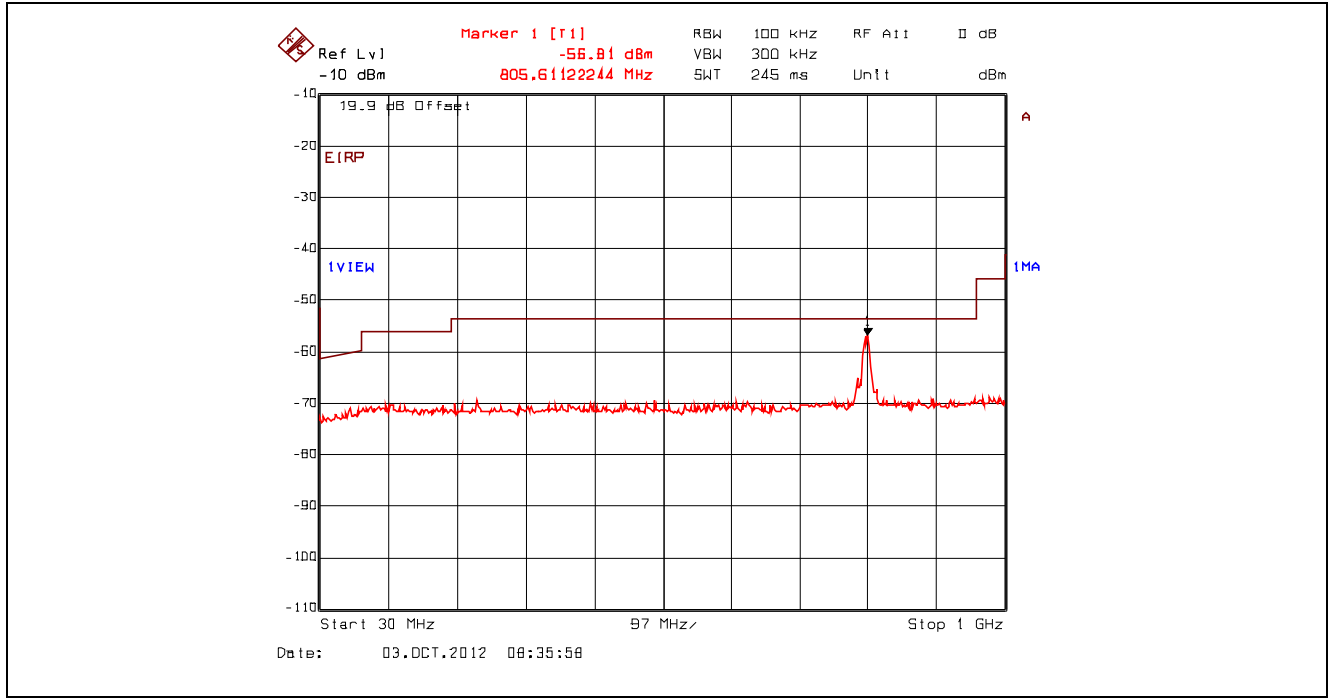

Plot 5.4.4.3.4. Conducted Spurious Emissions – Restricted Bands, 802.11b, 11 Mbps CCK
 2412 MHz, 1 GHz - 4 GHz, Power Averaging with Band (Notch) Reject Filter

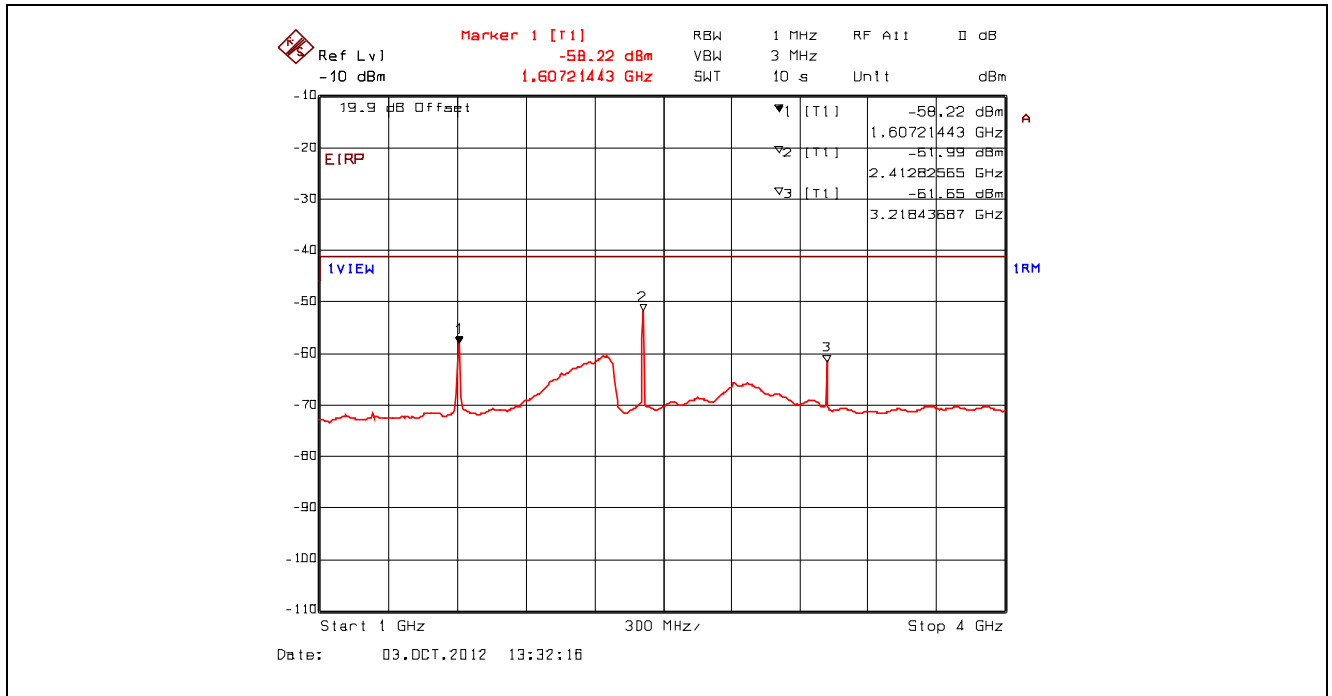

Plot 5.4.4.3.5. Conducted Spurious Emissions – Restricted Bands, 802.11b, 11 Mbps CCK
 2412 MHz, 4 GHz - 25 GHz, Power Averaging with High Pass Filter

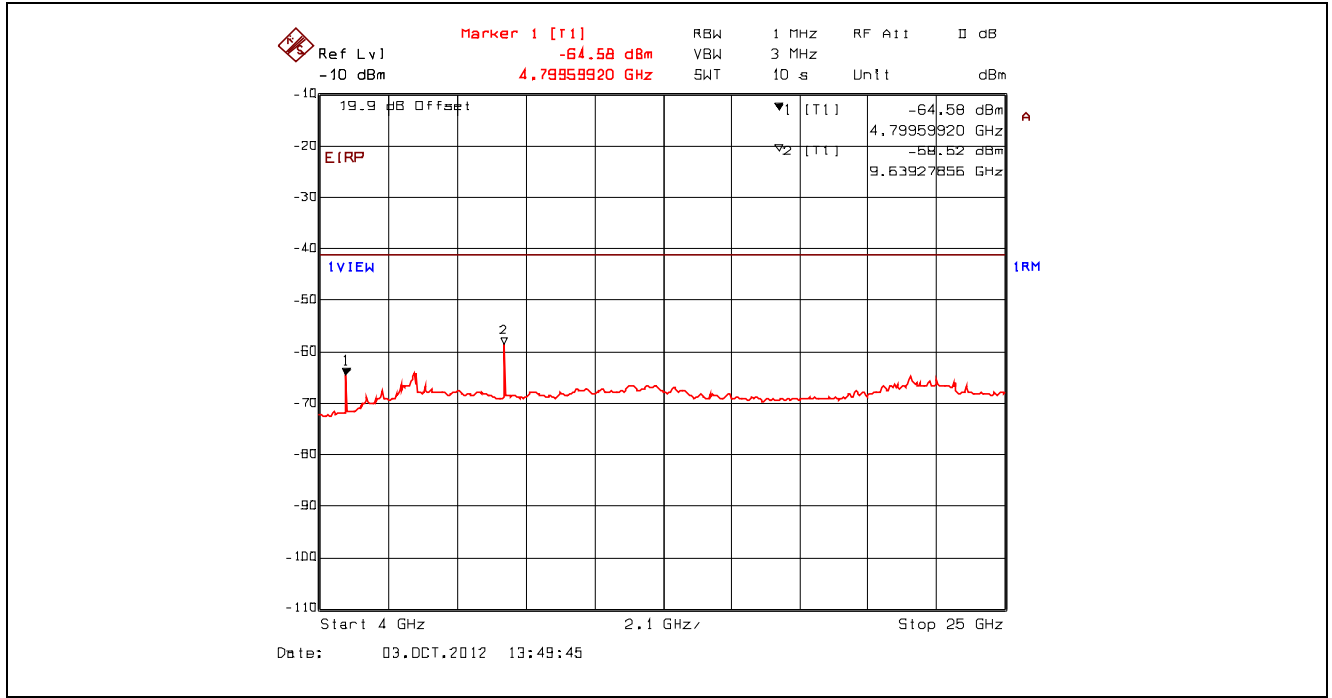

Plot 5.4.4.3.6. Conducted Spurious Emissions – Restricted Bands, 802.11b, 11 Mbps CCK
 2412 MHz, Peak Power at 1.61 GHz with Band (Notch) Reject Filter

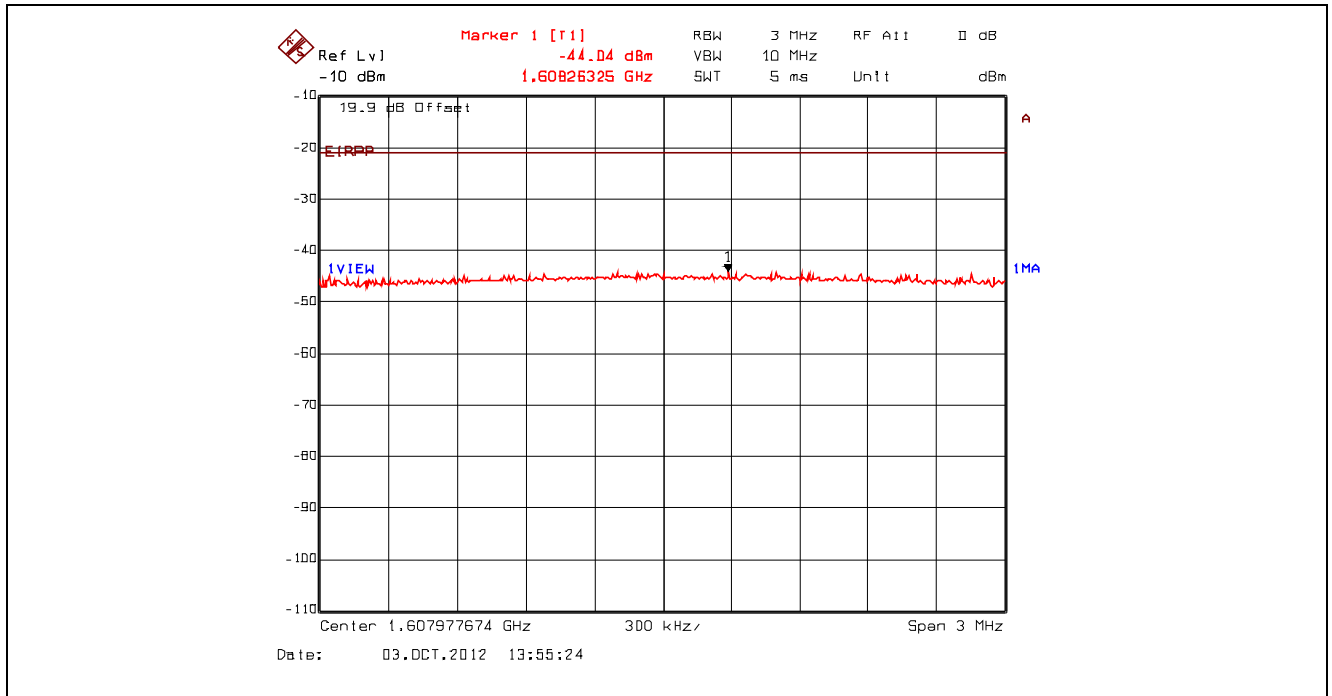

Plot 5.4.4.3.7. Conducted Spurious Emissions – Restricted Bands, 802.11b, 11 Mbps CCK
 2412 MHz, Peak Power at 3.22 GHz with Band (Notch) Reject Filter

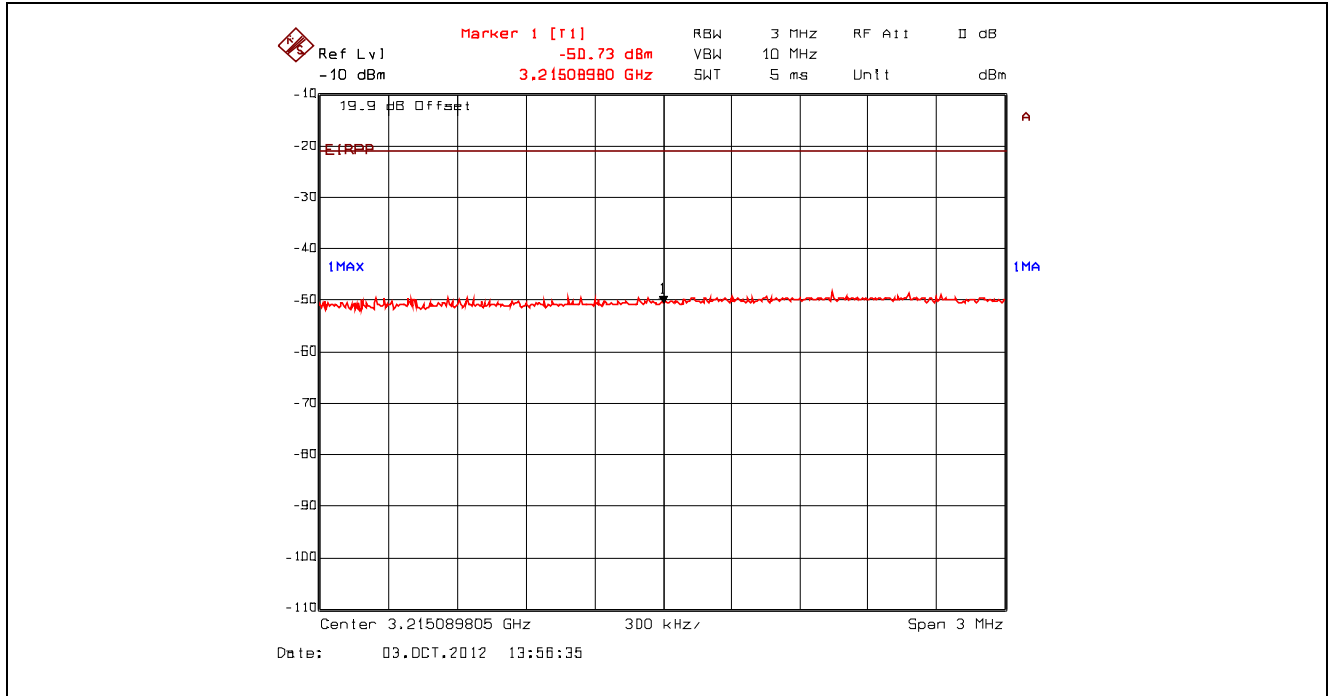

Plot 5.4.4.3.8. Conducted Spurious Emissions – Restricted Bands, 802.11b, 11 Mbps CCK
 2412 MHz, Peak Power at 4.82 GHz with High Pass Filter

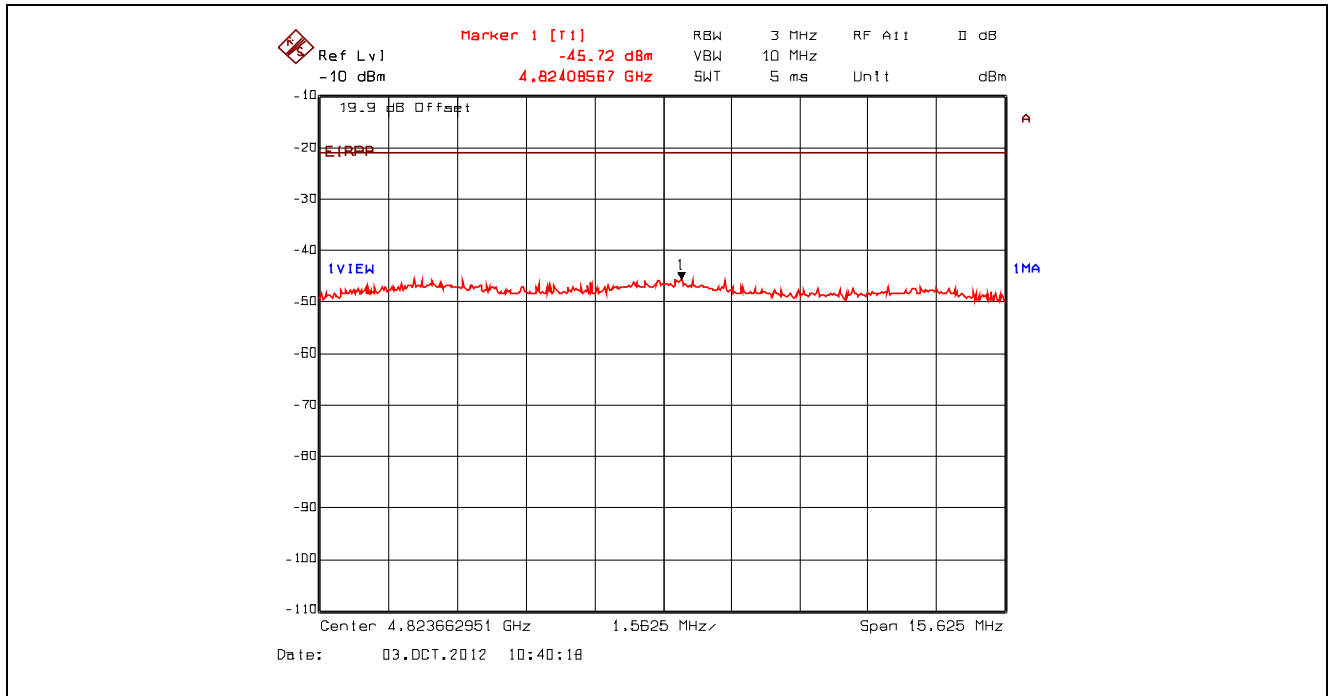

Plot 5.4.4.3.9. Conducted Spurious Emissions – Restricted Bands, 802.11b, 11 Mbps CCK
 2412 MHz, Peak Power at 4.82 GHz with High Pass Filter

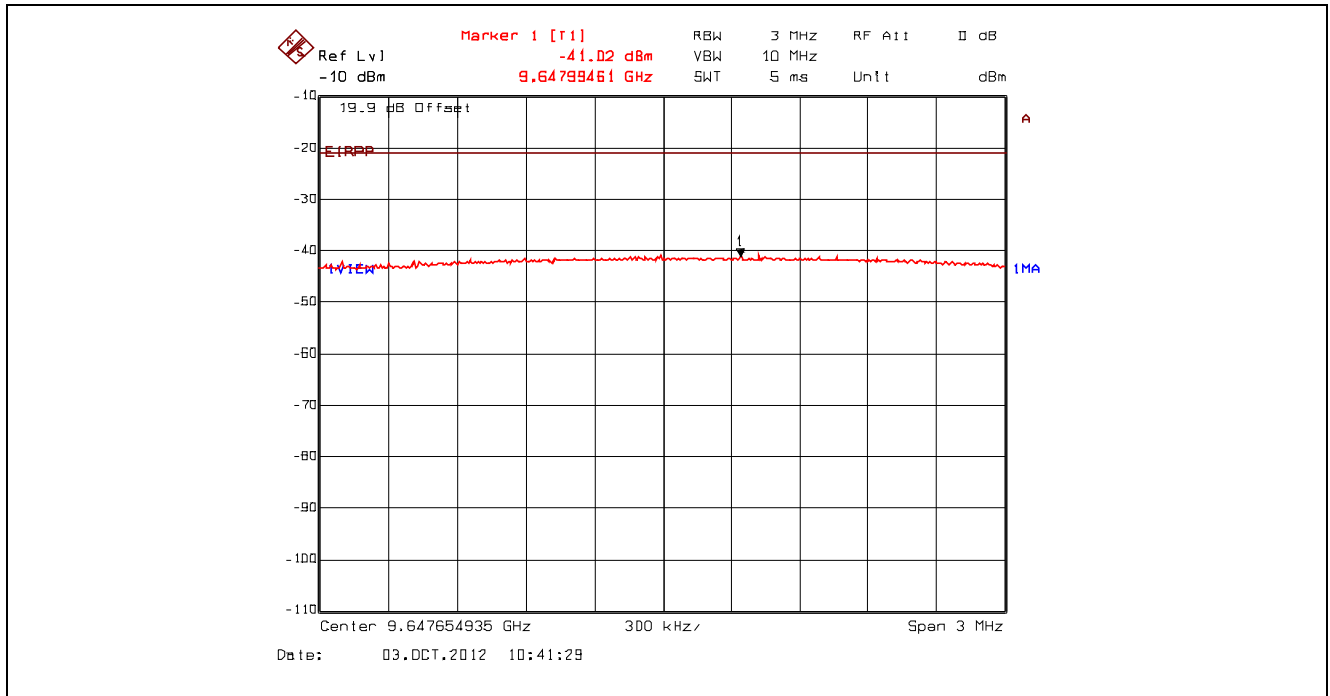

Plot 5.4.4.3.10. Conducted Spurious Emissions – Restricted Bands, 802.11b, 11 Mbps CCK
 2442 MHz, 9 kHz - 150 kHz, Peak Detector with Band (Notch) Reject Filter

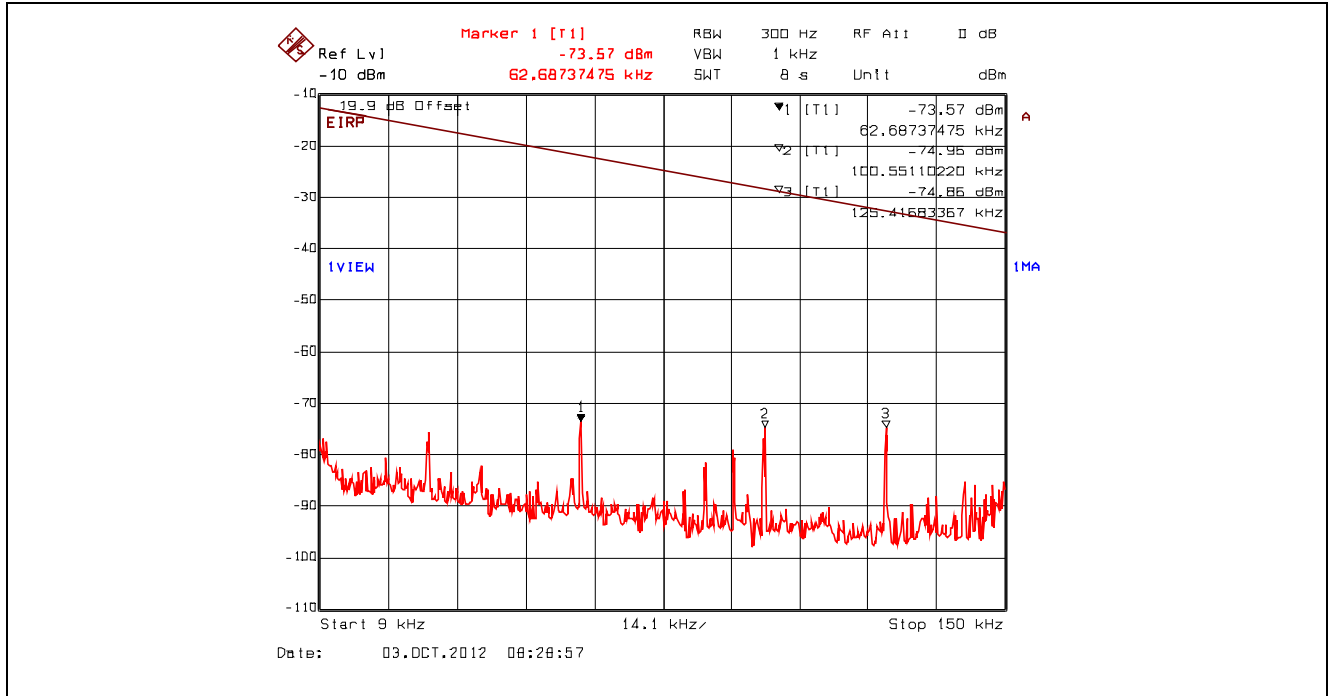

Plot 5.4.4.3.11. Conducted Spurious Emissions – Restricted Bands, 802.11b, 11 Mbps CCK
 2442 MHz, 150 kHz - 30 MHz, Peak Detector with Band (Notch) Reject Filter

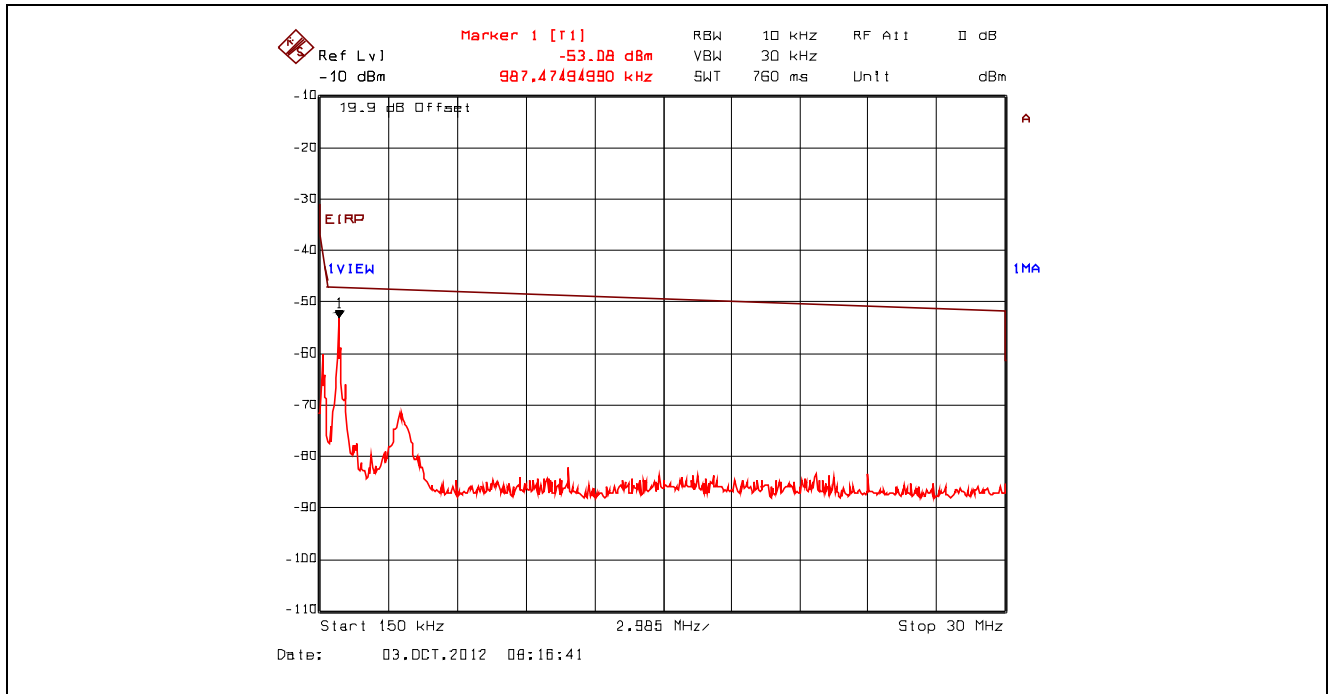

Plot 5.4.4.3.12. Conducted Spurious Emissions – Restricted Bands, 802.11b, 11 Mbps CCK
 2442 MHz, 30 MHz - 1 GHz, Peak Detector with Band (Notch) Reject Filter

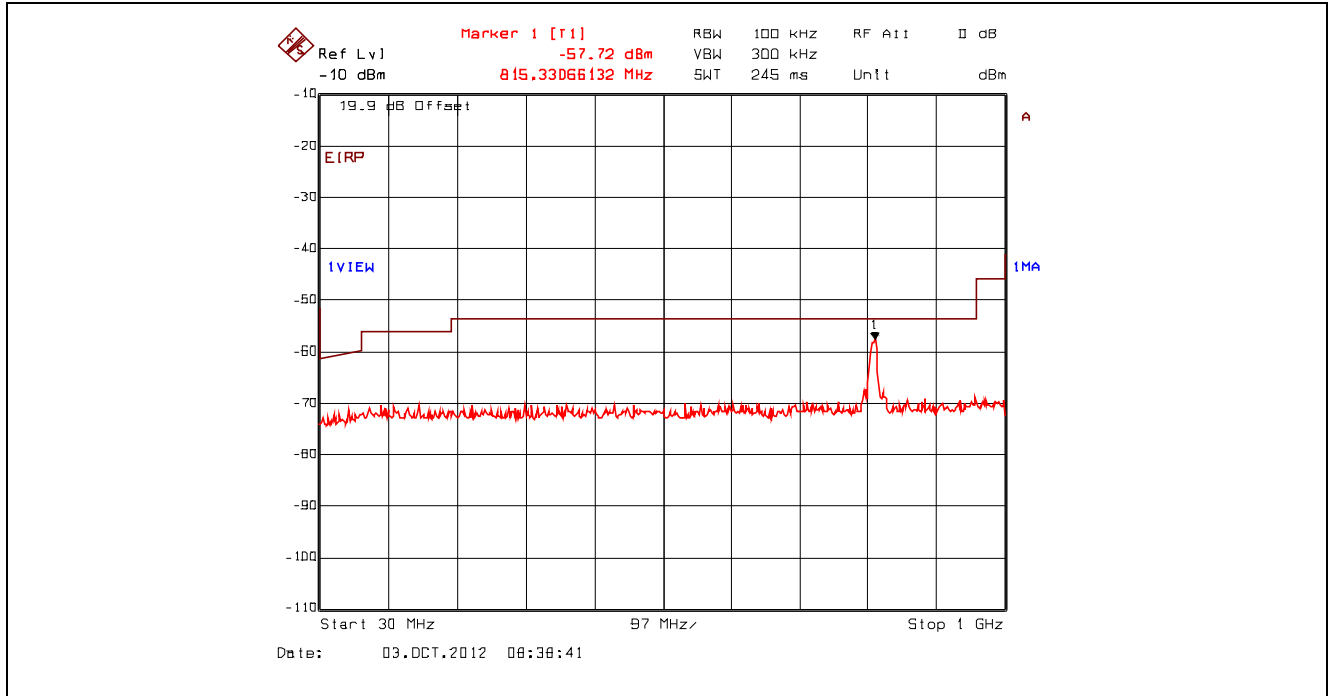

Plot 5.4.4.3.13. Conducted Spurious Emissions – Restricted Bands, 802.11b, 11 Mbps CCK
 2442 MHz, 1 GHz - 4 GHz, Power Averaging with Band (Notch) Reject Filter

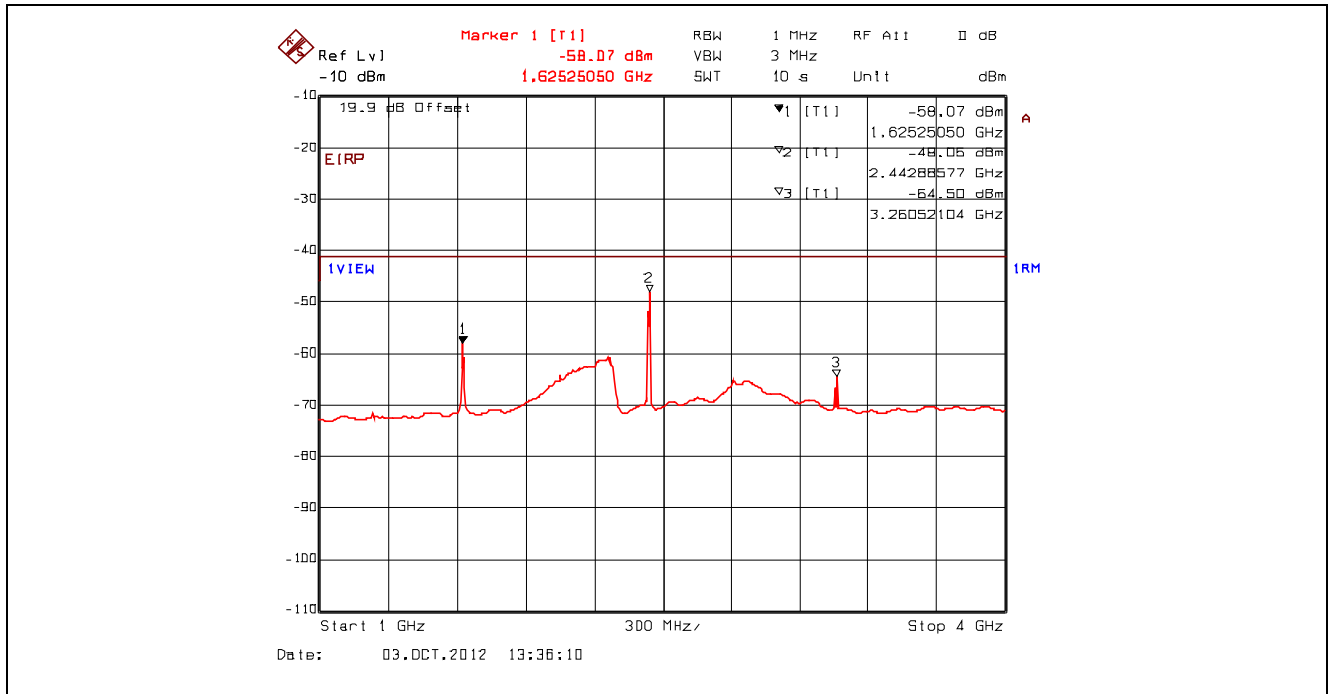

Plot 5.4.4.3.14. Conducted Spurious Emissions – Restricted Bands, 802.11b, 11 Mbps CCK
 2442 MHz, 4 GHz - 25 GHz, Power Averaging with High Pass Filter

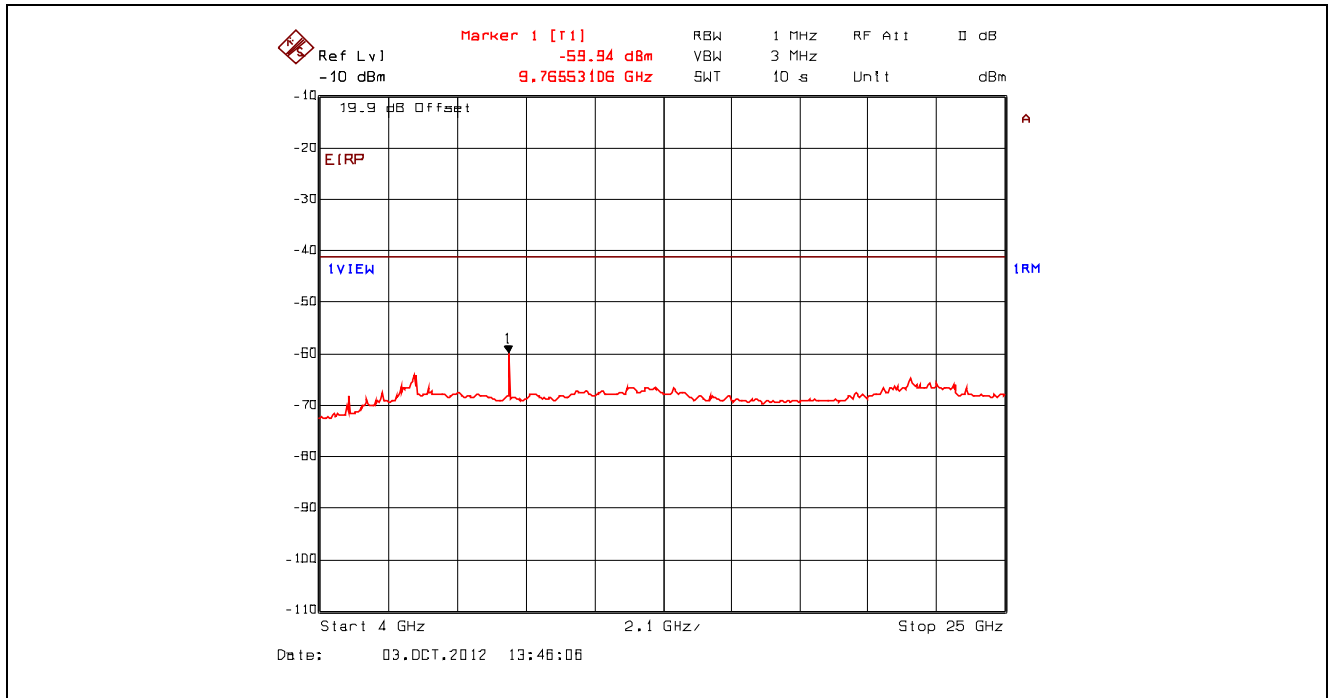

Plot 5.4.4.3.15. Conducted Spurious Emissions – Restricted Bands, 802.11b, 11 Mbps CCK
 2442 MHz, Peak Power at 1.63 GHz with Band (Notch) Reject Filter

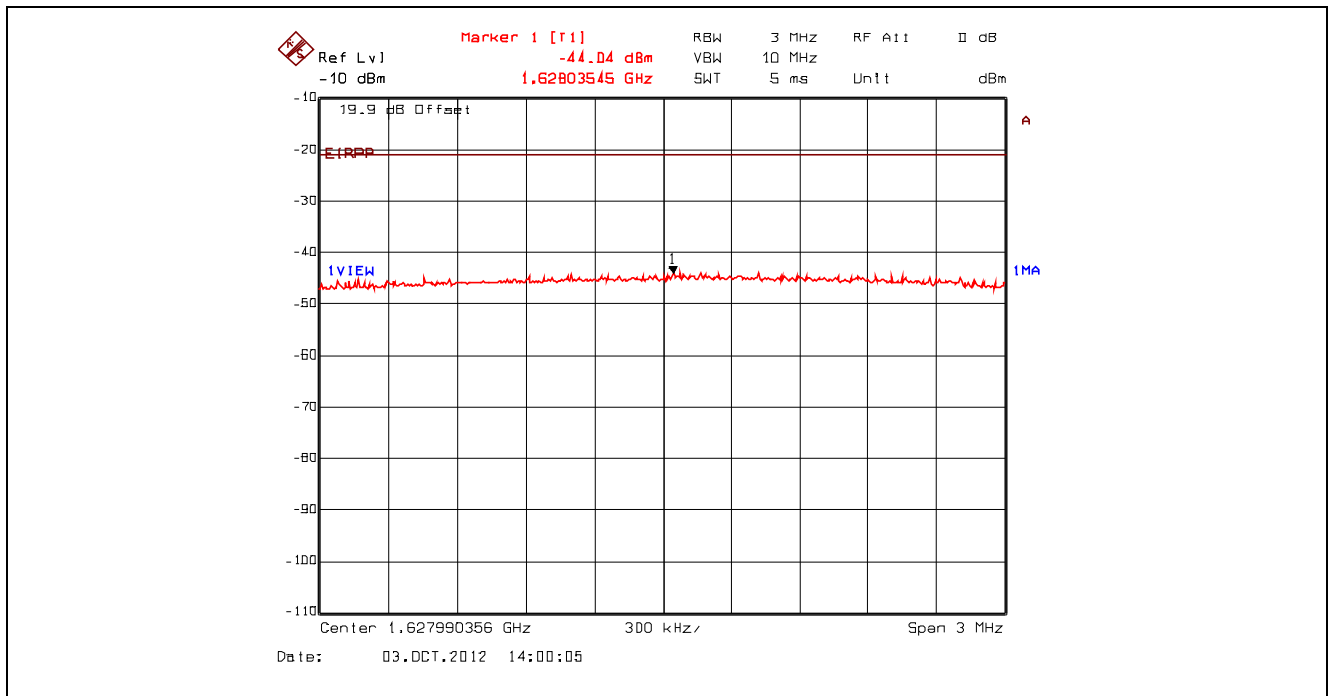

Plot 5.4.4.3.16. Conducted Spurious Emissions – Restricted Bands, 802.11b, 11 Mbps CCK
 2442 MHz, Peak Power at 3.26 GHz with Band (Notch) Reject Filter

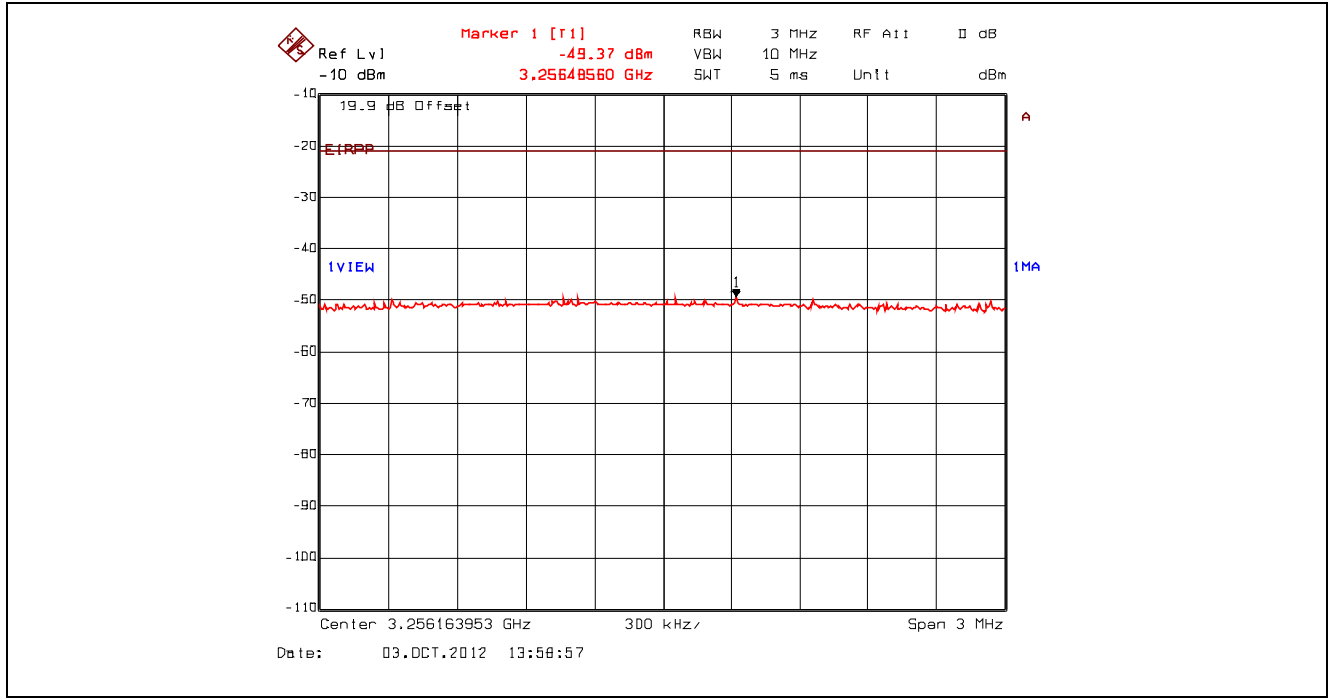

Plot 5.4.4.3.17. Conducted Spurious Emissions – Restricted Bands, 802.11b, 11 Mbps CCK
 2442 MHz, Peak Power at 9.77 GHz with High Pass Filter

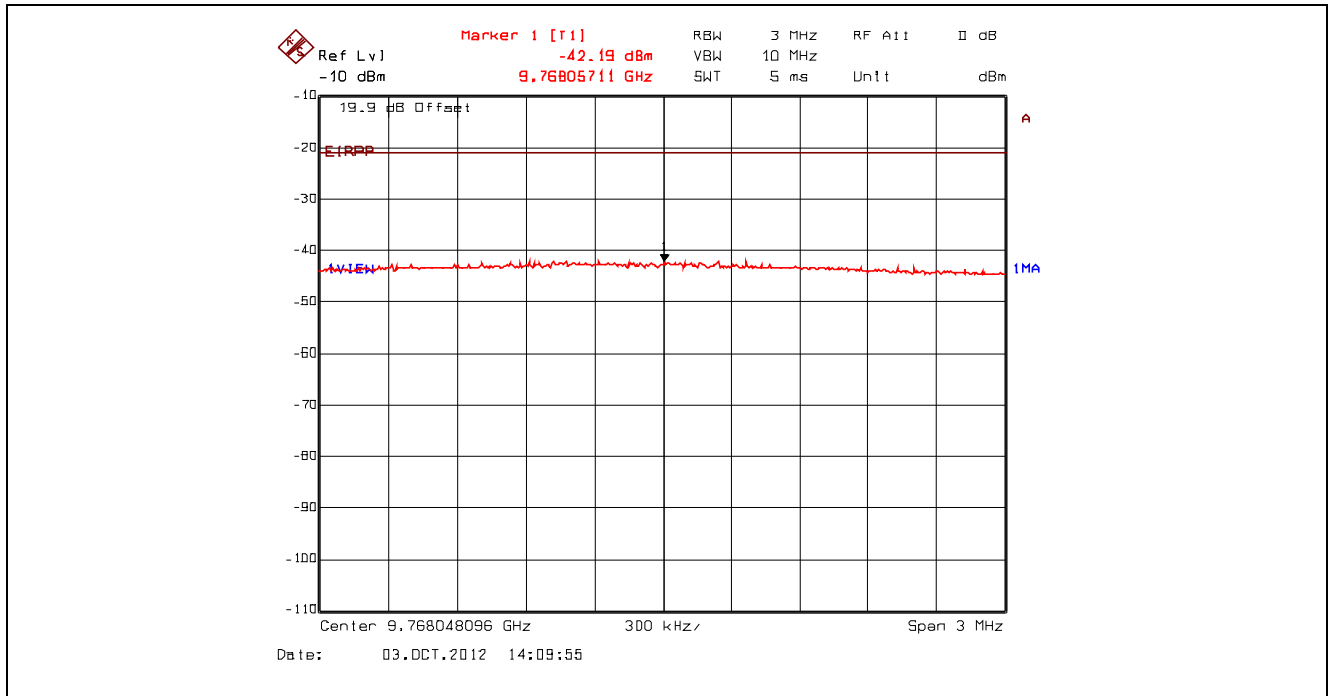

Plot 5.4.4.3.18. Conducted Spurious Emissions – Restricted Bands, 802.11b, 11 Mbps CCK
 2462 MHz, 9 kHz - 150 kHz, Peak Detector with Band (Notch) Reject Filter

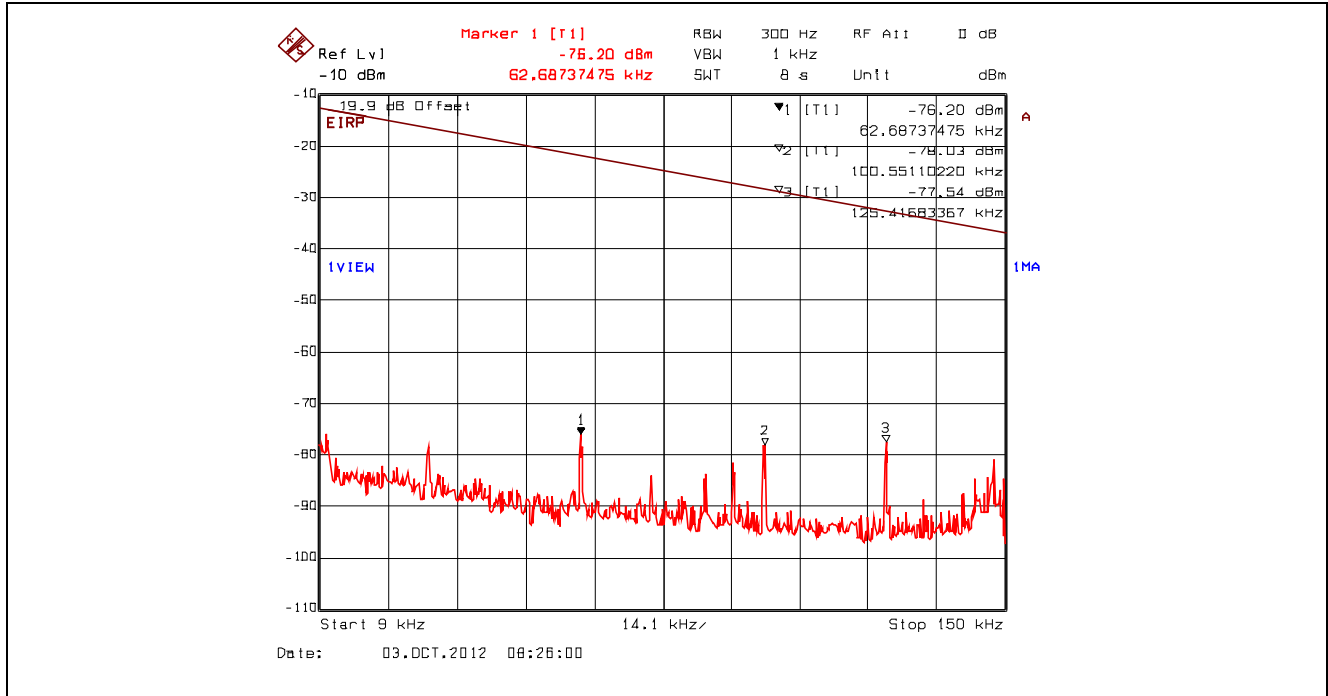

Plot 5.4.4.3.19. Conducted Spurious Emissions – Restricted Bands, 802.11b, 11 Mbps CCK
 2462 MHz, 150 kHz - 30 MHz, Peak Detector with Band (Notch) Reject Filter

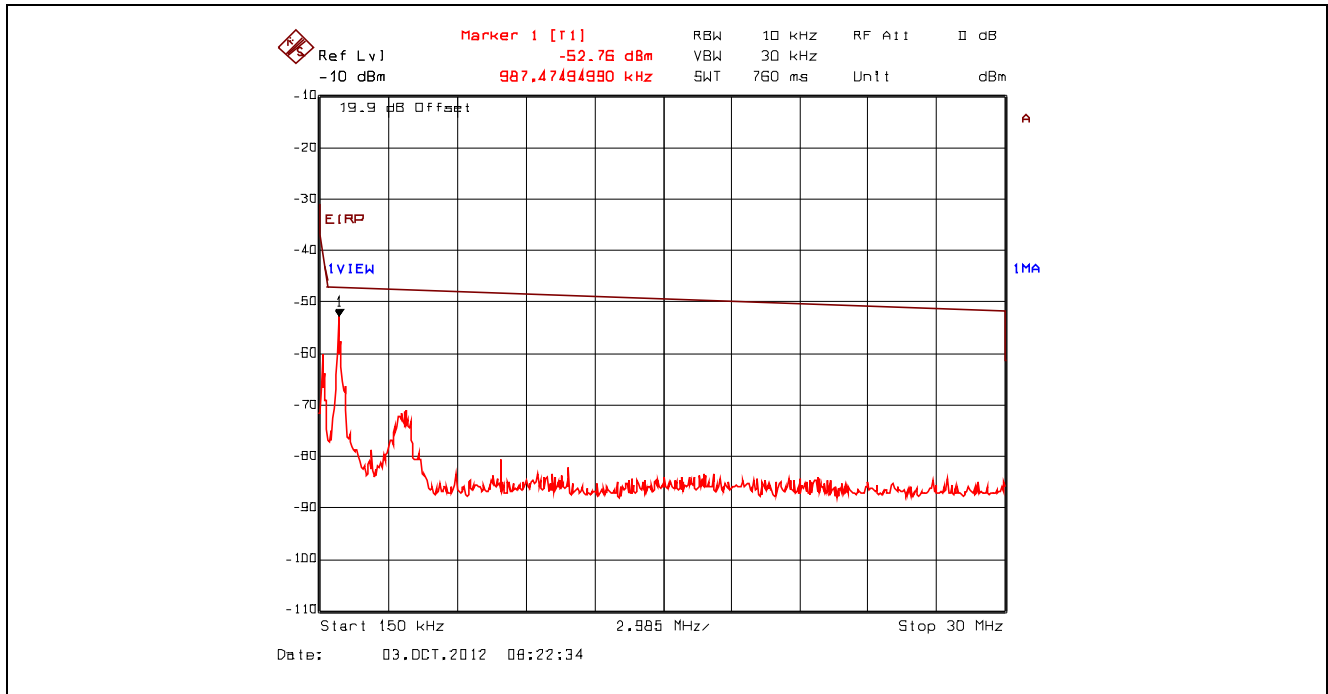

Plot 5.4.4.3.20. Conducted Spurious Emissions – Restricted Bands, 802.11b, 11 Mbps CCK
 2462 MHz, 30 MHz - 1 GHz, Peak Detector with Band (Notch) Reject Filter

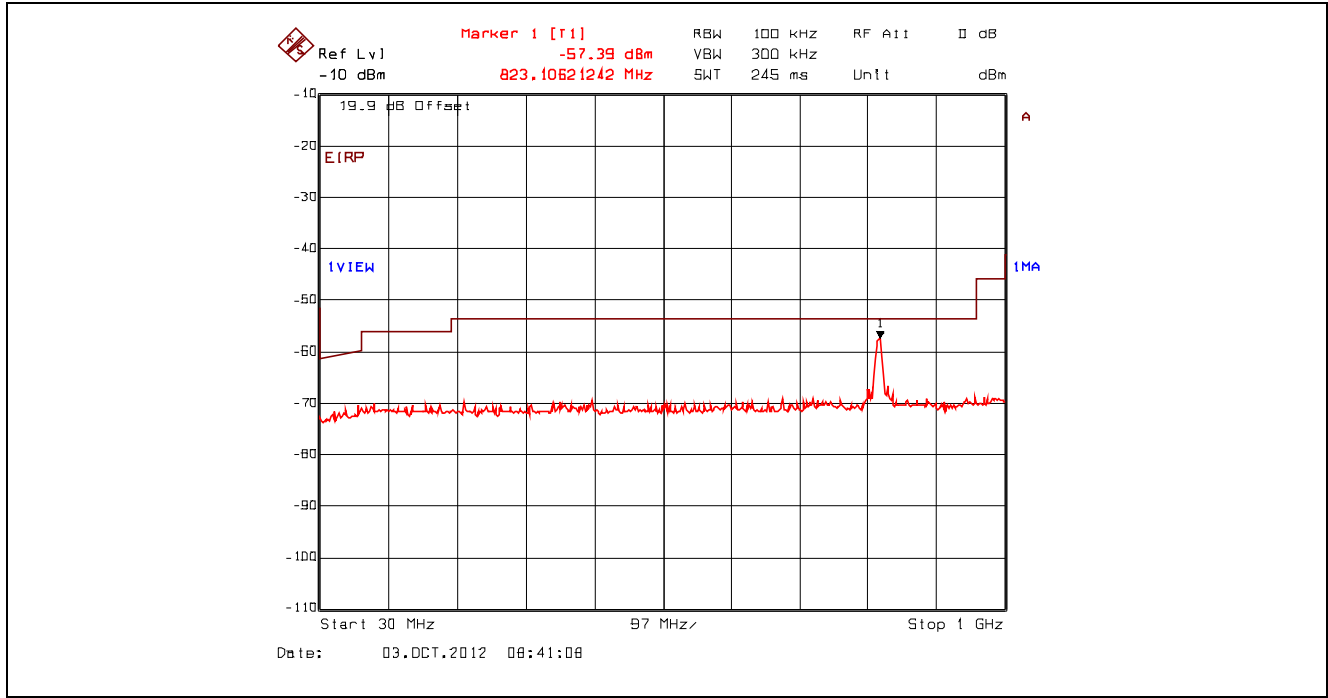

Plot 5.4.4.3.21. Conducted Spurious Emissions – Restricted Bands, 802.11b, 11 Mbps CCK
 2462 MHz, 1 GHz - 4 GHz, Power Averaging with Band (Notch) Reject Filter

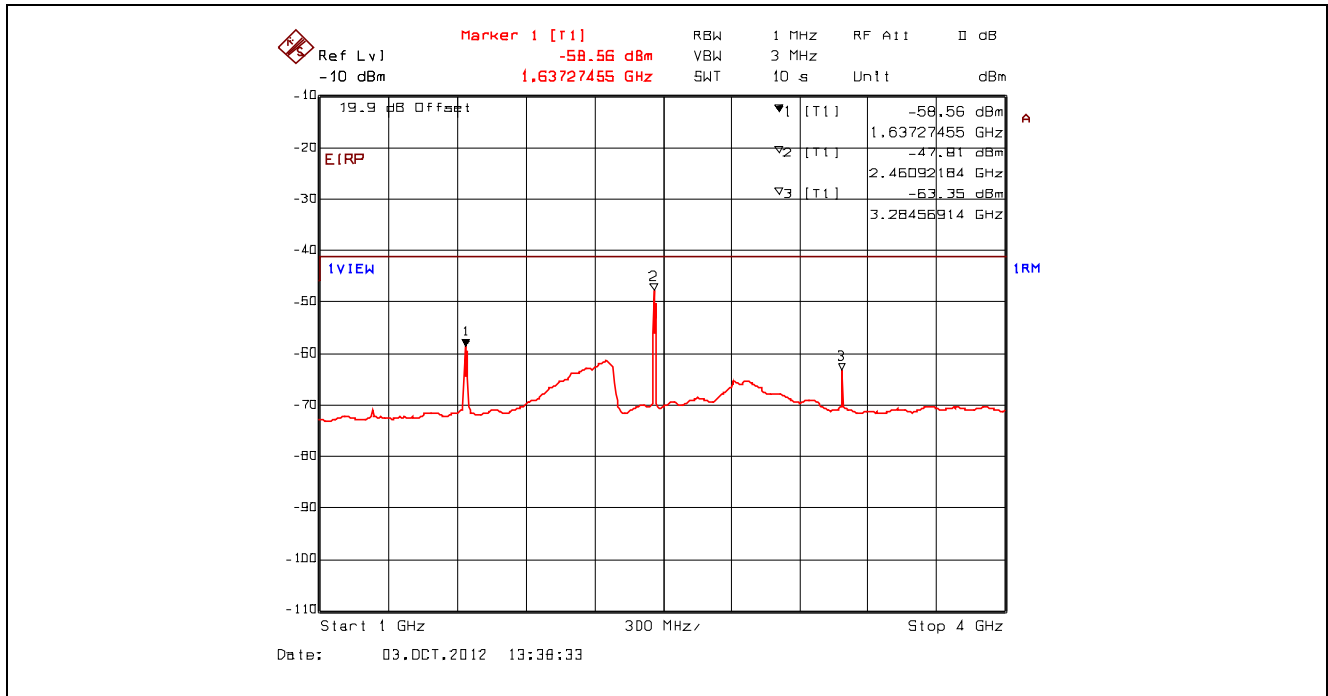

Plot 5.4.4.3.22. Conducted Spurious Emissions – Restricted Bands, 802.11b, 11 Mbps CCK
 2462 MHz, 4 GHz - 25 GHz, Power Averaging with High Pass Filter

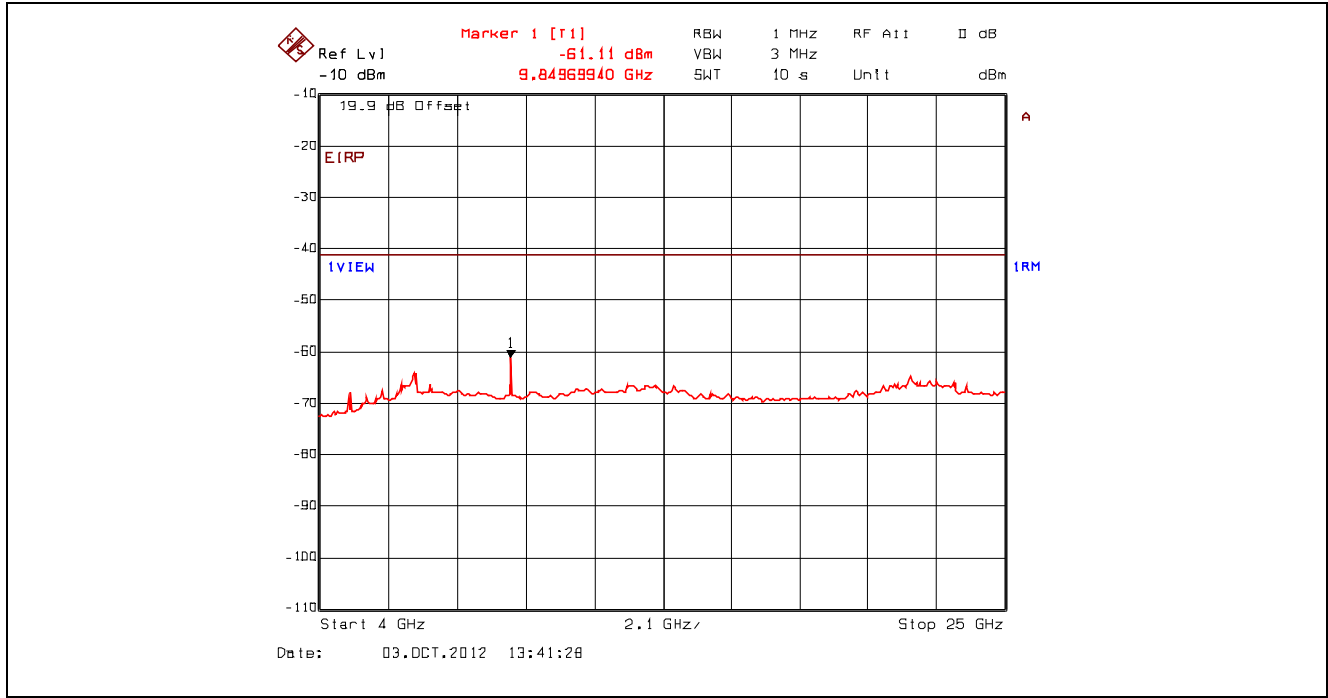

Plot 5.4.4.3.23. Conducted Spurious Emissions – Restricted Bands, 802.11b, 11 Mbps CCK
 2462 MHz, Peak Power at 1.64 GHz with Band (Notch) Reject Filter

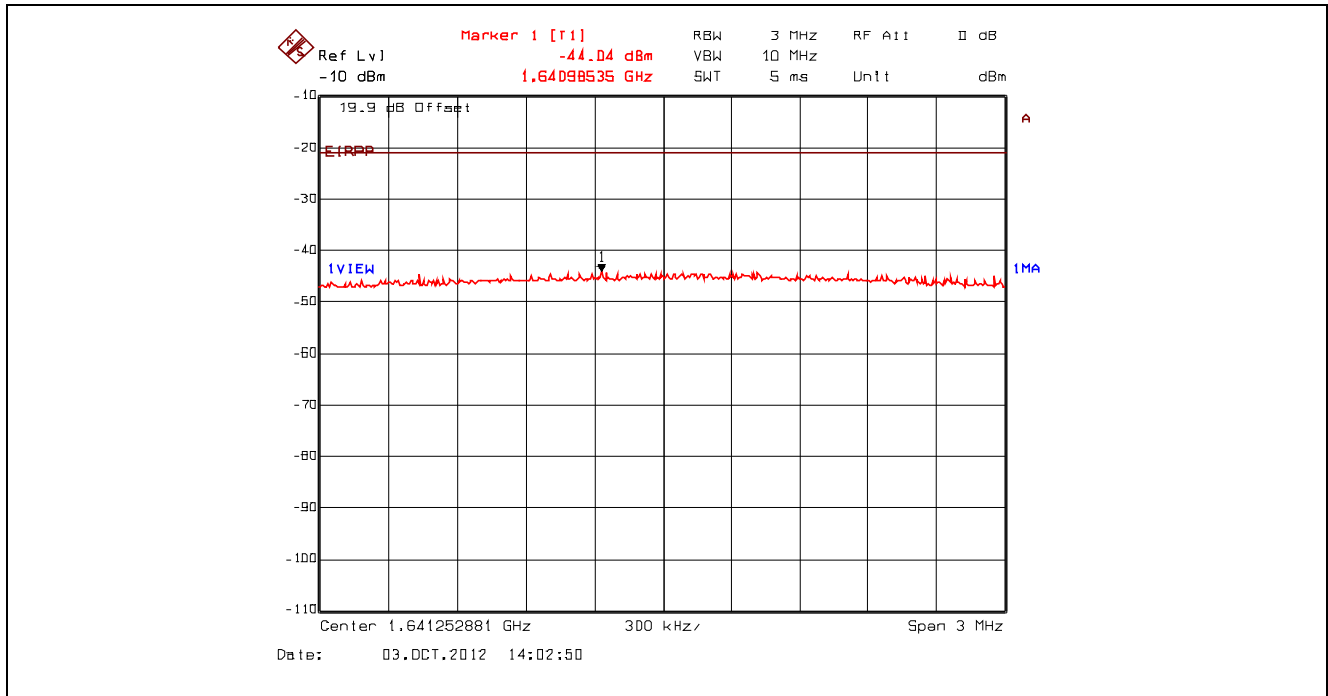

Plot 5.4.4.3.24. Conducted Spurious Emissions – Restricted Bands, 802.11b, 11 Mbps CCK
2462 MHz, Peak Power at 3.28 GHz with Band (Notch) Reject Filter

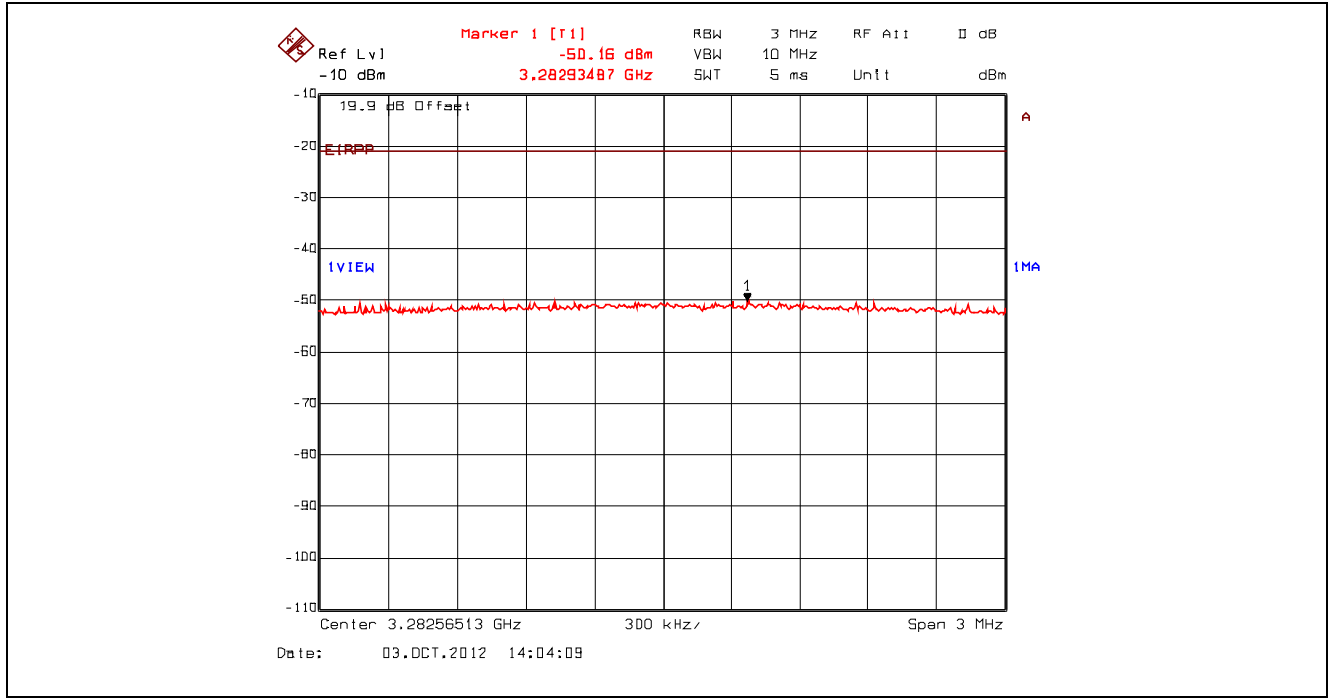

Plot 5.4.4.3.25. Conducted Spurious Emissions – Restricted Bands, 802.11b, 11 Mbps CCK
2462 MHz, Peak Power at 9.85 GHz with High Pass Filter

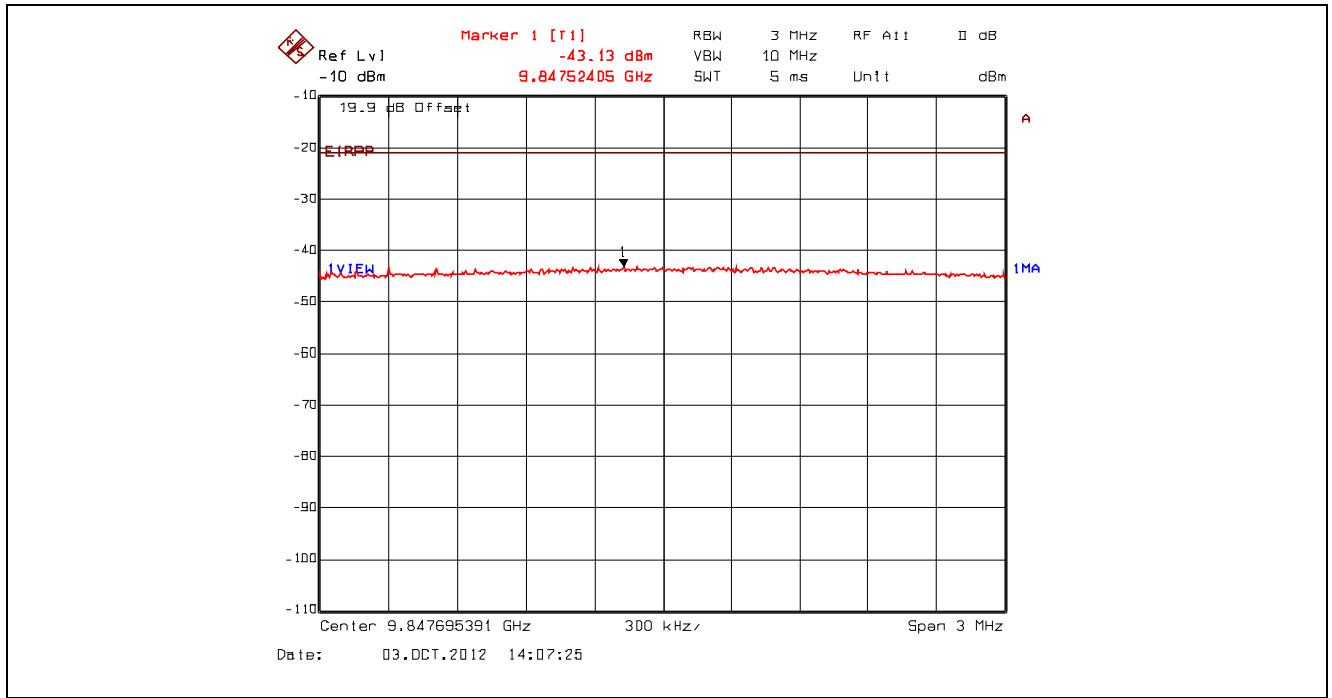

Plot 5.4.4.3.26. Conducted Spurious Emissions – Restricted Bands, 802.11g, 9 Mbps BPSK
 2412 MHz, 9 kHz - 150 kHz, Peak Detector with Band (Notch) Reject Filter

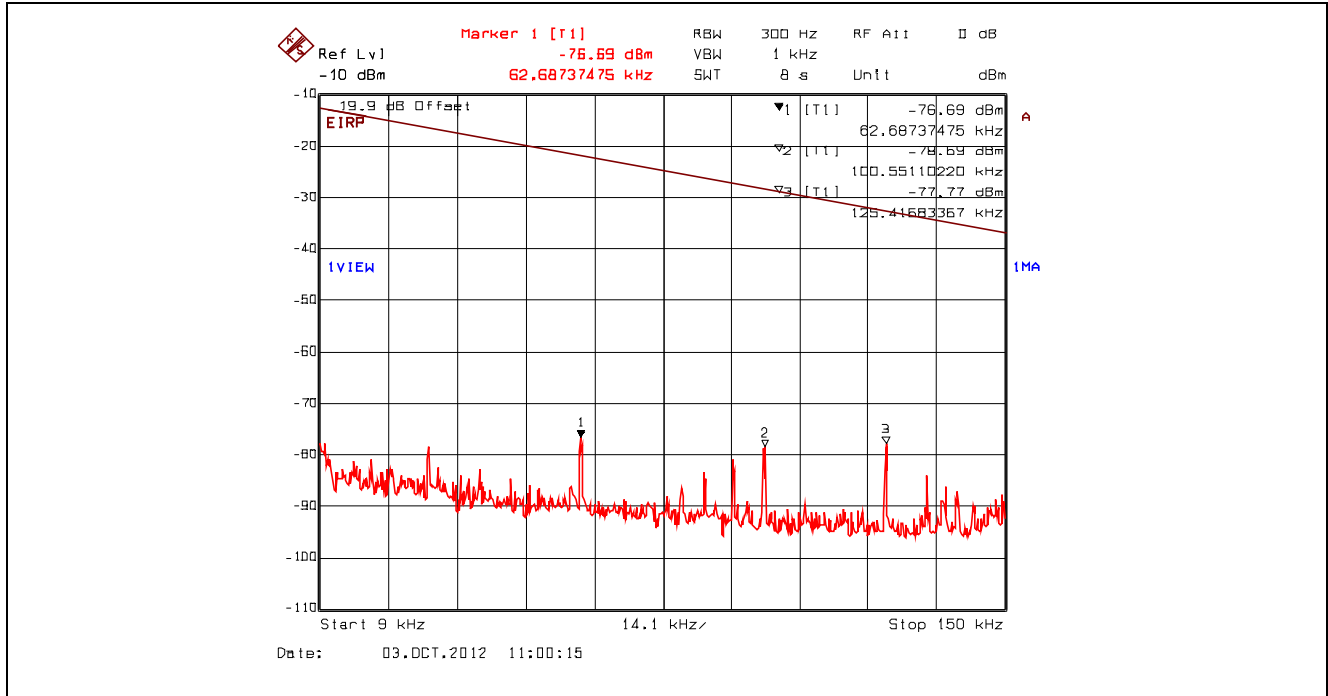

Plot 5.4.4.3.27. Conducted Spurious Emissions – Restricted Bands, 802.11g, 9 Mbps BPSK
 2412 MHz, 150 kHz - 30 MHz, Peak Detector with Band (Notch) Reject Filter

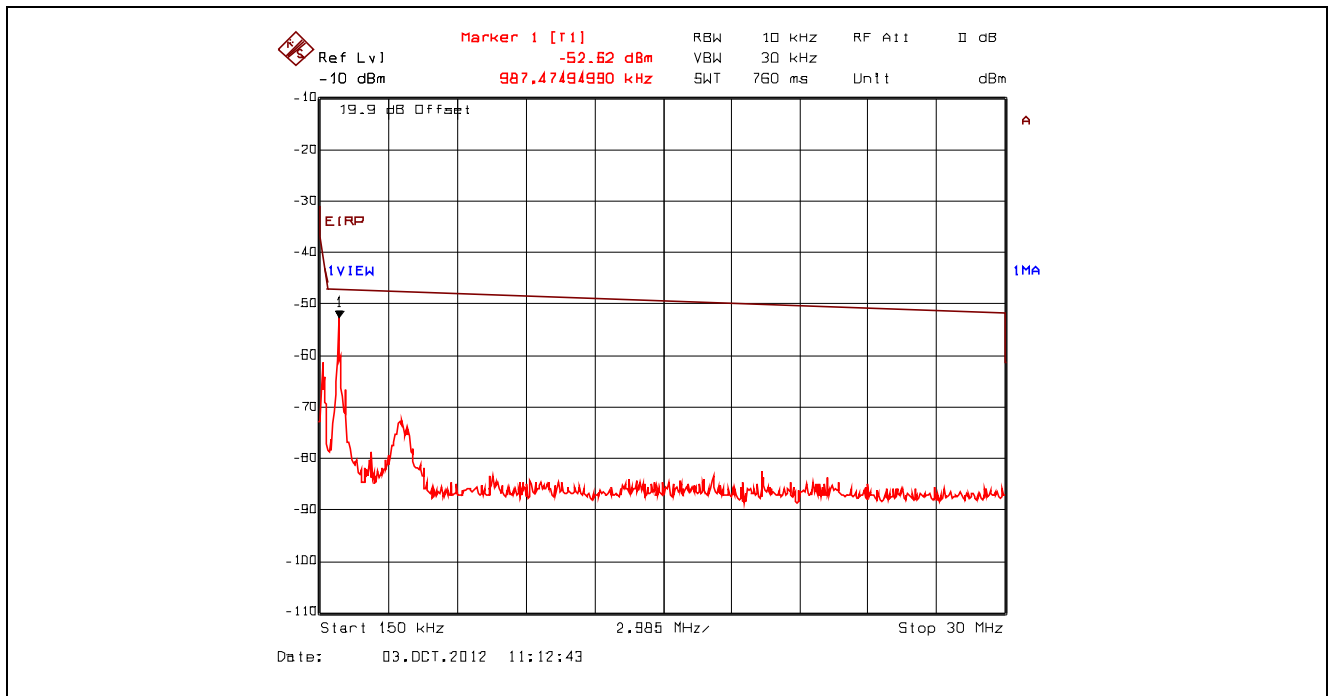

Plot 5.4.4.3.28. Conducted Spurious Emissions – Restricted Bands, 802.11g, 9 Mbps BPSK
 2412 MHz, 30 MHz - 1 GHz, Peak Detector with Band (Notch) Reject Filter

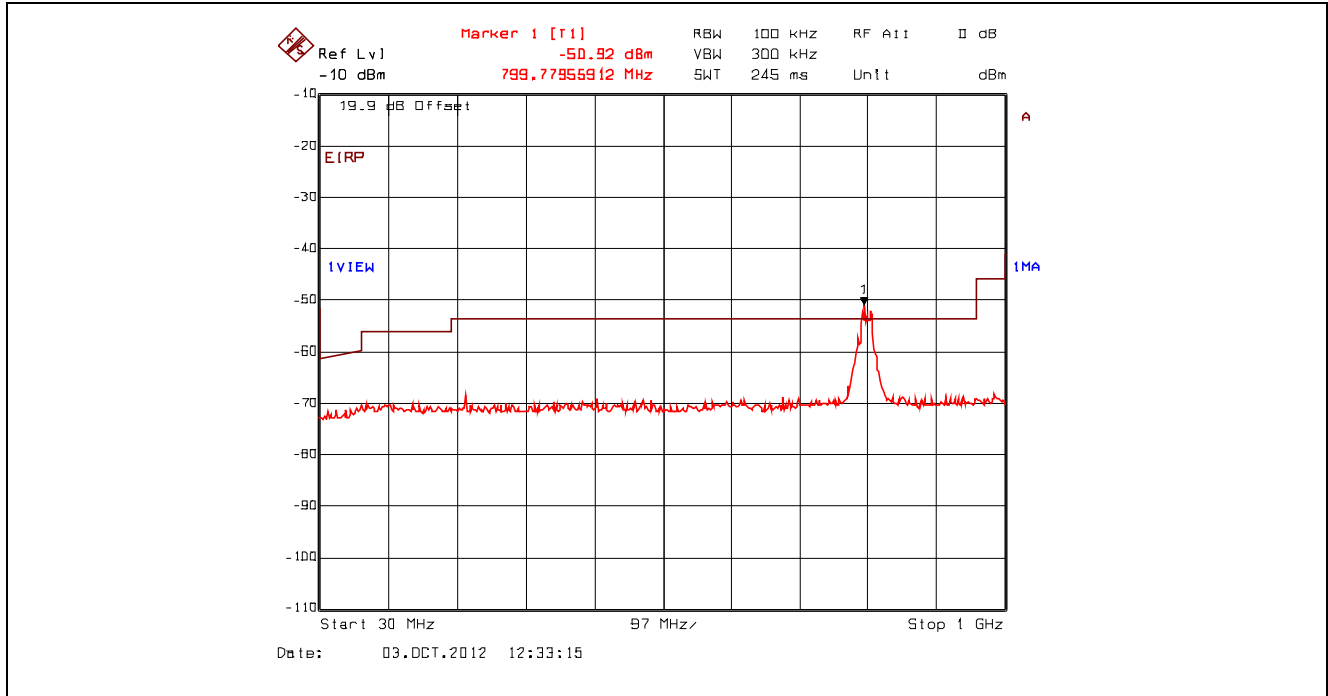

Plot 5.4.4.3.29. Conducted Spurious Emissions – Restricted Bands, 802.11g, 9 Mbps BPSK
 2412 MHz, QP Power at 809.04 MHz with Band (Notch) Reject Filter

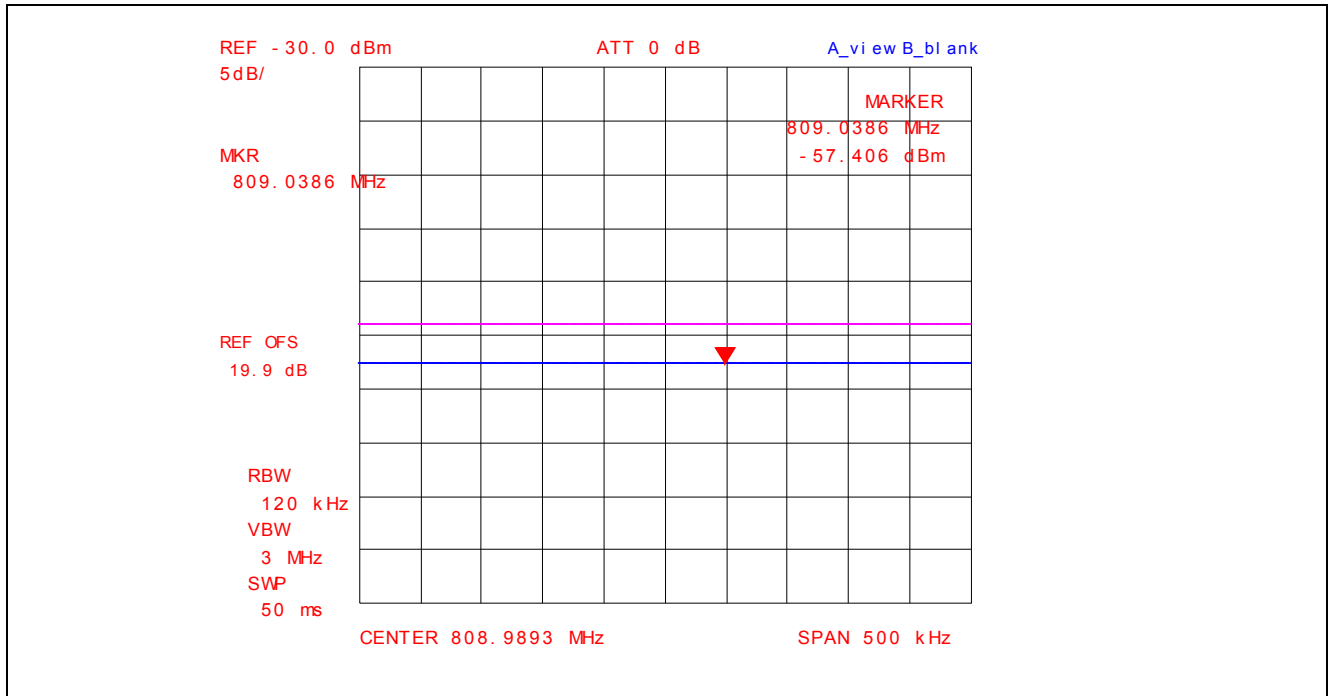

Plot 5.4.4.3.30. Conducted Spurious Emissions – Restricted Bands, 802.11g, 9 Mbps BPSK
 2412 MHz, 1 GHz - 4 GHz, Power Averaging with Band (Notch) Reject Filter

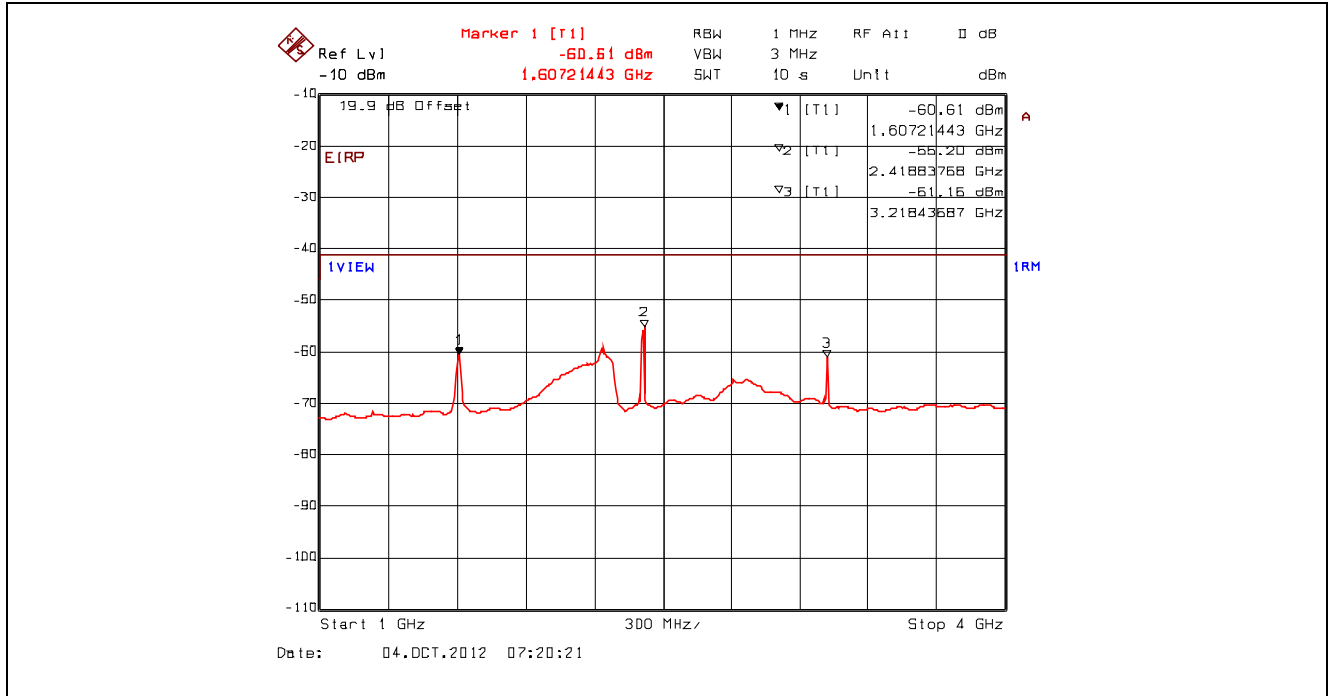

Plot 5.4.4.3.31. Conducted Spurious Emissions – Restricted Bands, 802.11g, 9 Mbps BPSK
 2412 MHz, 4 GHz - 25 GHz, Power Averaging with High Pass Filter

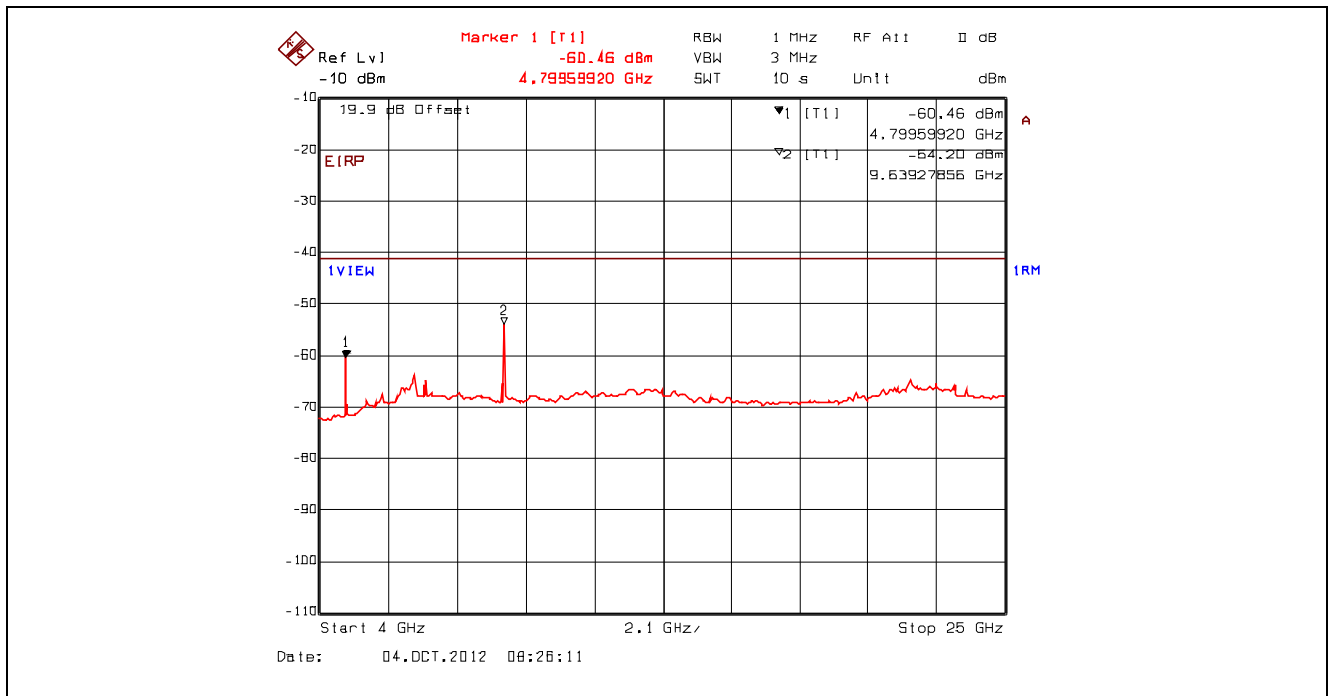

Plot 5.4.4.3.32. Conducted Spurious Emissions – Restricted Bands, 802.11g, 9 Mbps BPSK
 2412 MHz, Peak Power at 1.61 GHz with Band (Notch) Reject Filter

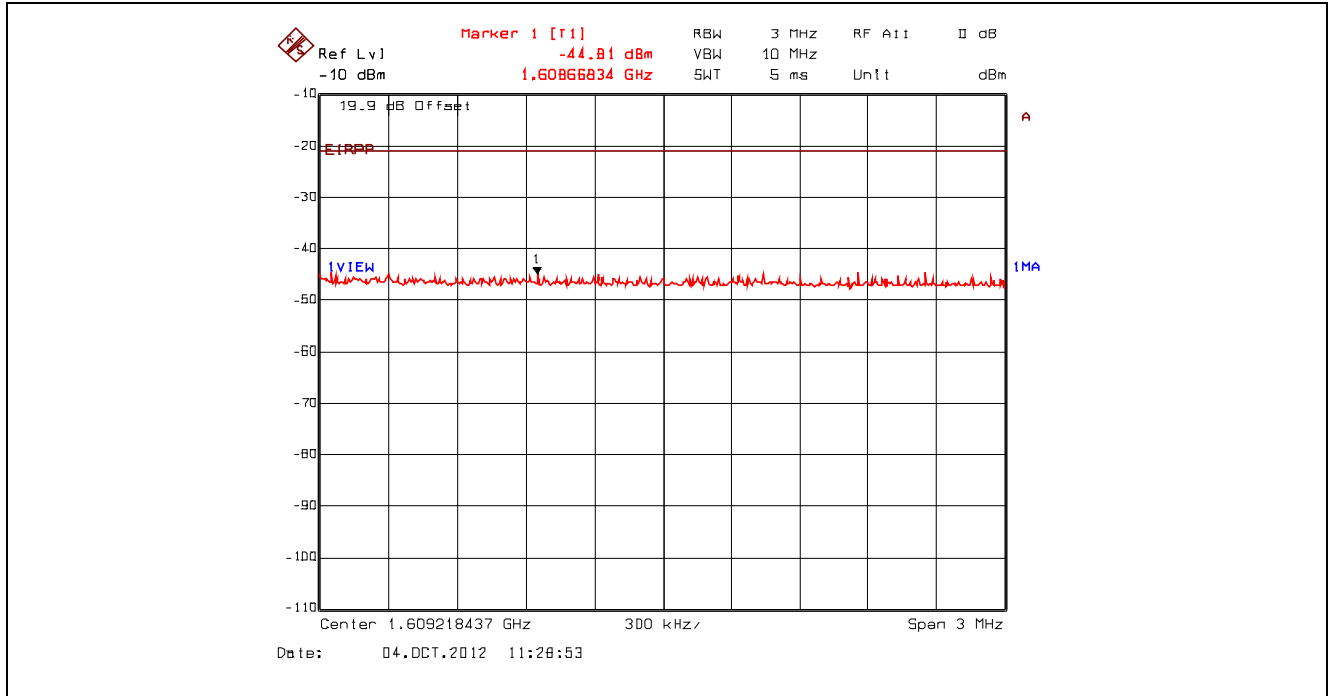

Plot 5.4.4.3.33. Conducted Spurious Emissions – Restricted Bands, 802.11g, 9 Mbps BPSK
 2412 MHz, Peak Power at 3.22 GHz with High Pass Filter

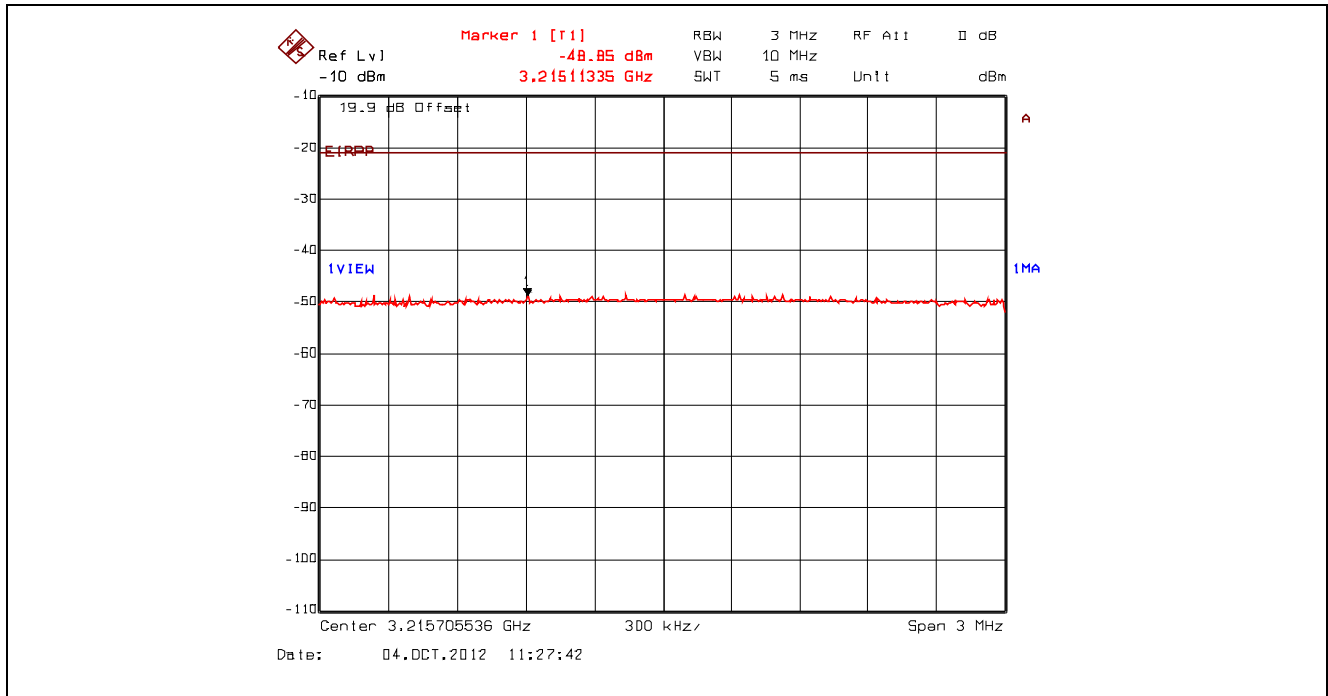

Plot 5.4.4.3.34. Conducted Spurious Emissions – Restricted Bands, 802.11g, 9 Mbps BPSK
 2412 MHz, Peak Power at 4.82 GHz with High Pass Filter

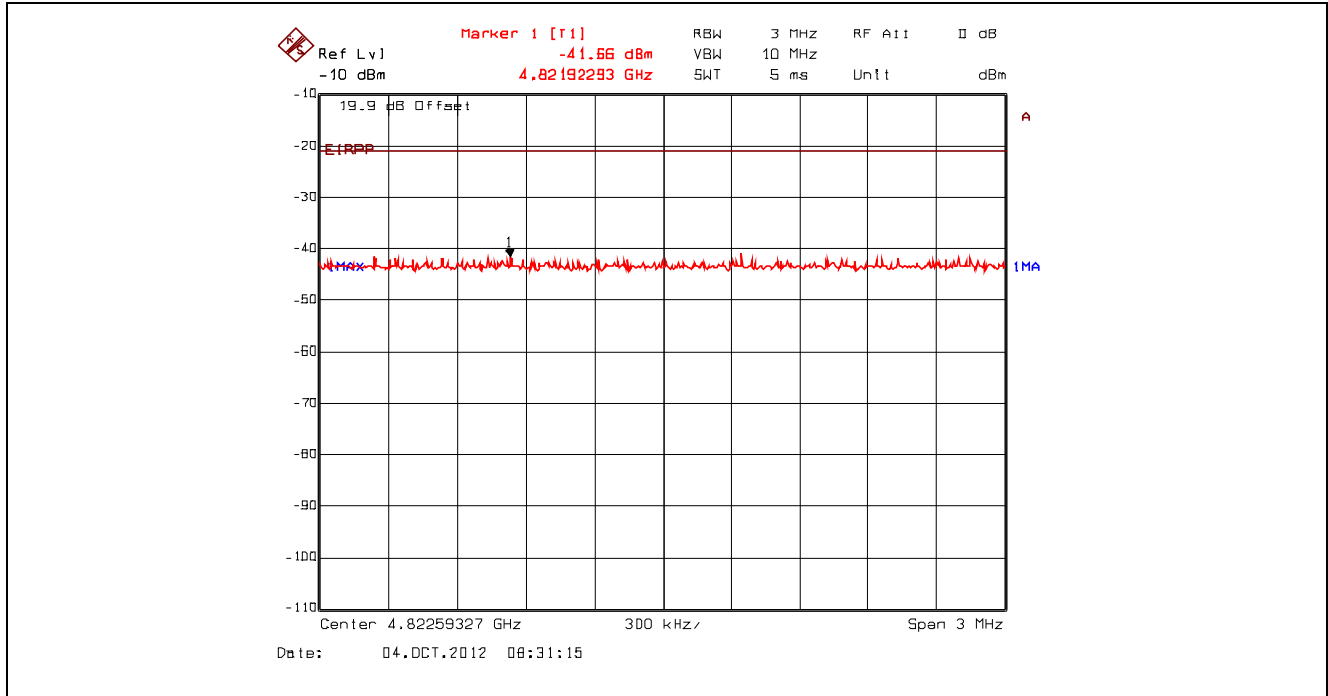

Plot 5.4.4.3.35. Conducted Spurious Emissions – Restricted Bands, 802.11g, 9 Mbps BPSK
 2412 MHz, Peak Power at 9.64 GHz with High Pass Filter

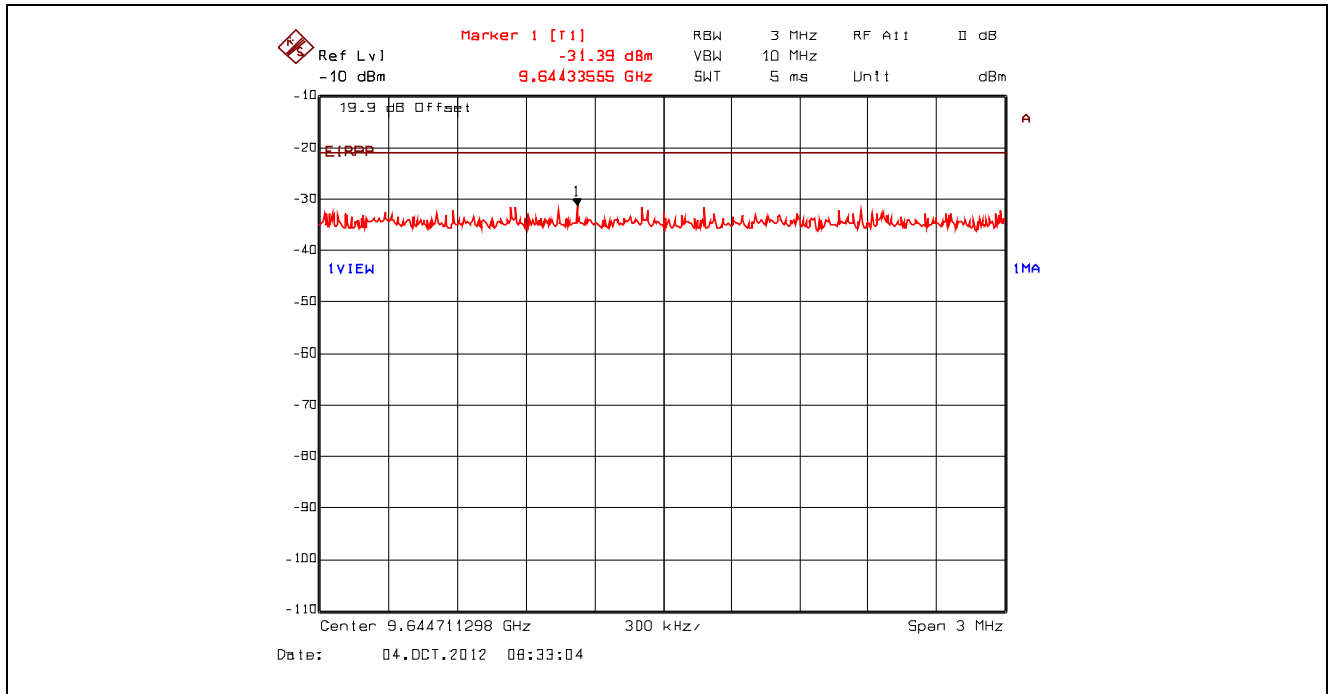

Plot 5.4.4.3.36. Conducted Spurious Emissions – Restricted Bands, 802.11g, 9 Mbps BPSK
 2442 MHz, 9 kHz - 150 kHz, Peak Detector with Band (Notch) Reject Filter

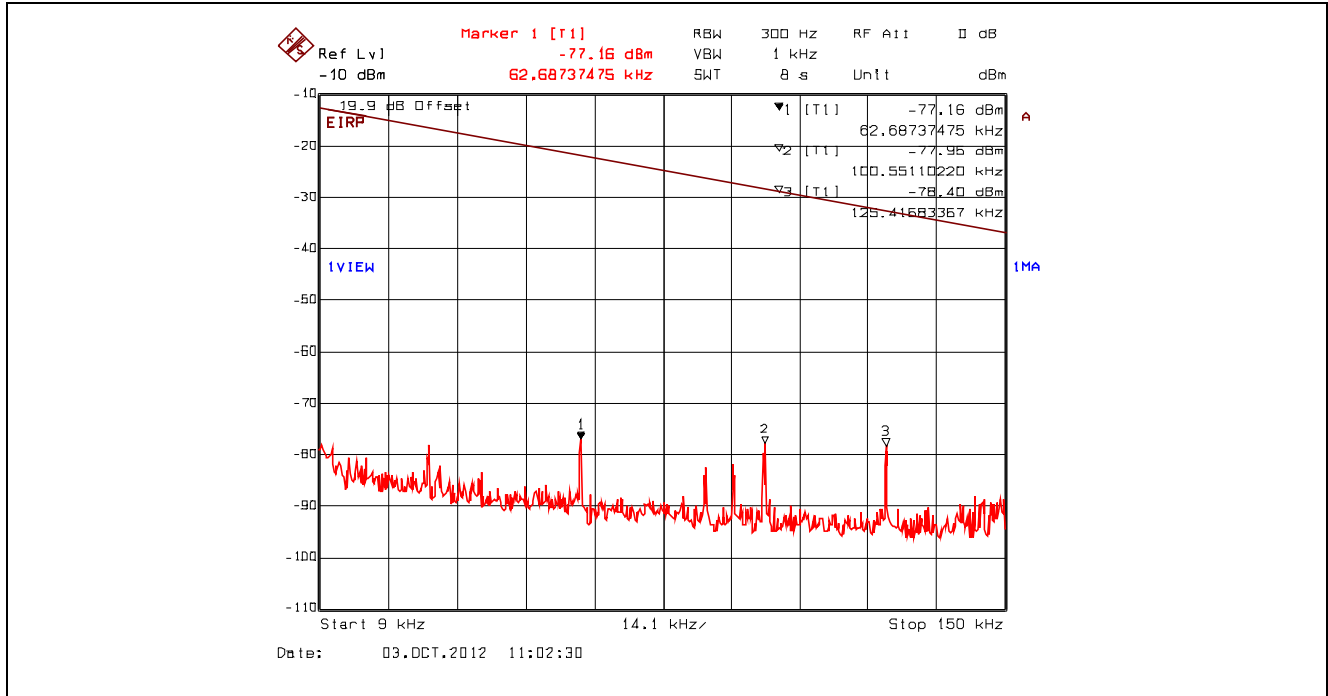

Plot 5.4.4.3.37. Conducted Spurious Emissions – Restricted Bands, 802.11g, 9 Mbps BPSK
 2442 MHz, 150 kHz - 30 MHz, Peak Detector with Band (Notch) Reject Filter

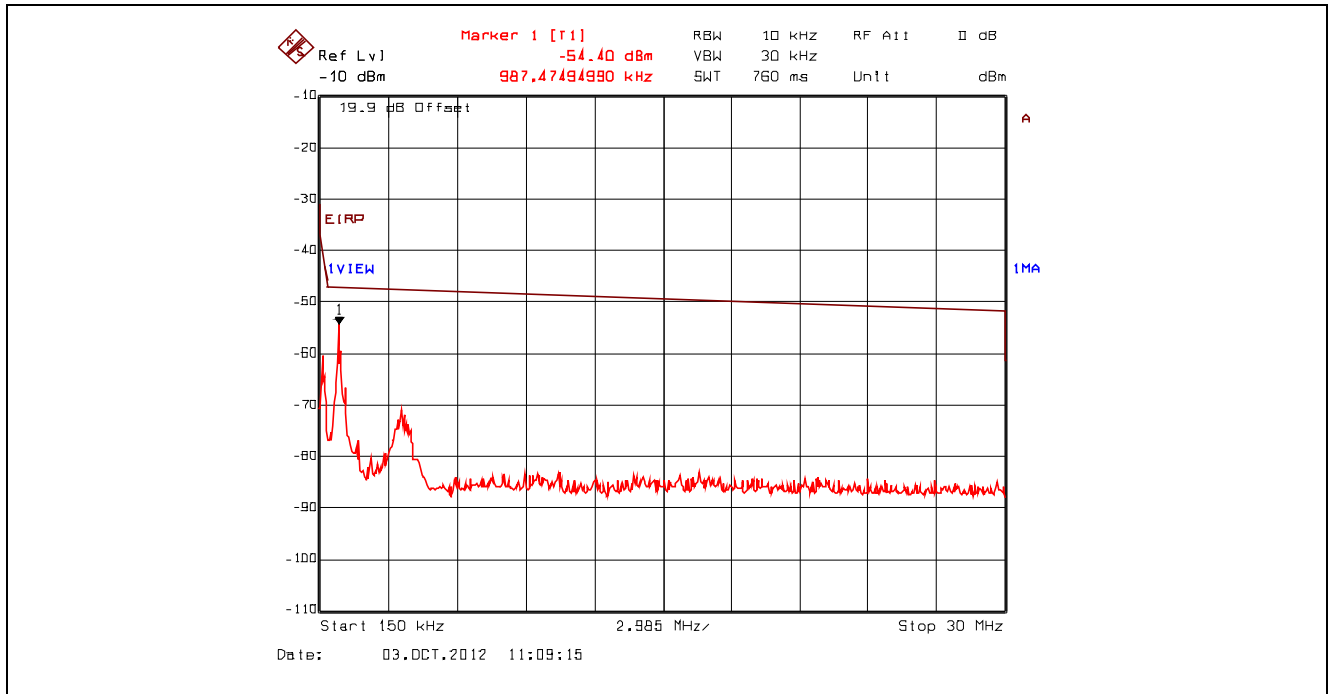

Plot 5.4.4.3.38. Conducted Spurious Emissions – Restricted Bands, 802.11g, 9 Mbps BPSK
 2442 MHz, 30 MHz - 1 GHz, Peak Detector with Band (Notch) Reject Filter

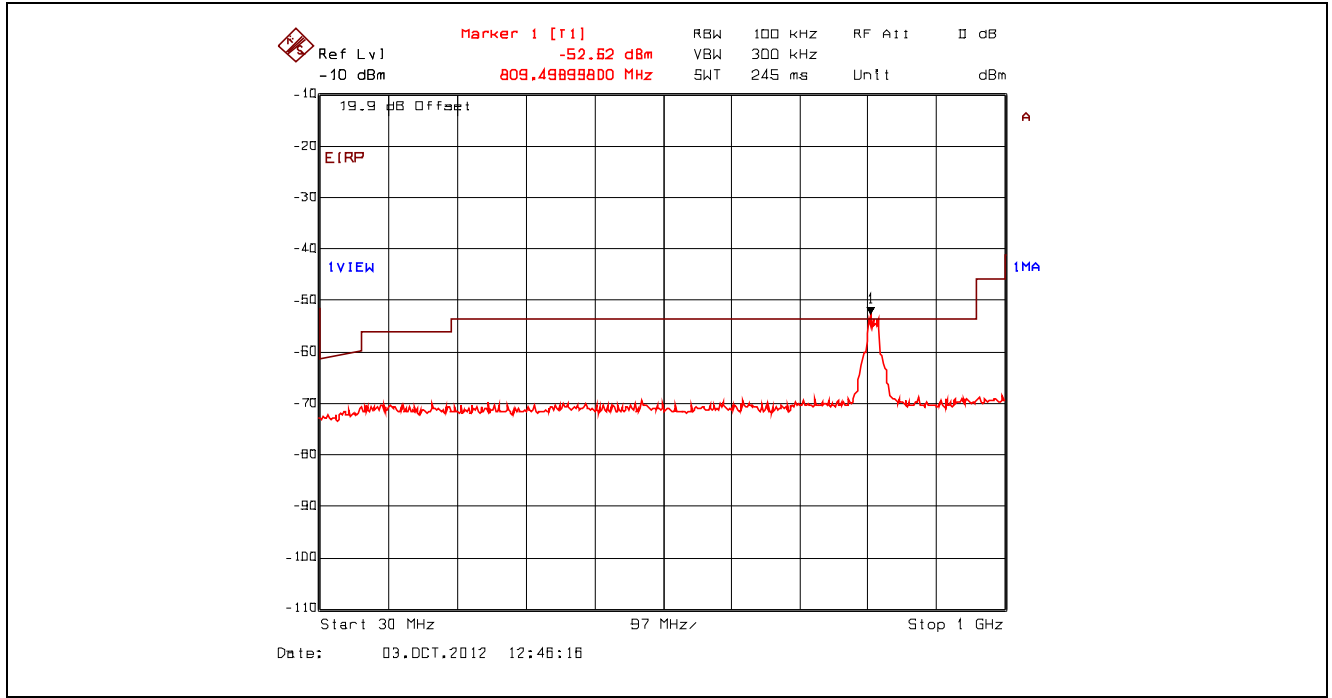

Plot 5.4.4.3.39. Conducted Spurious Emissions – Restricted Bands, 802.11g, 9 Mbps BPSK
 2442 MHz, QP Power at 818.98 MHz with Band (Notch) Reject Filter

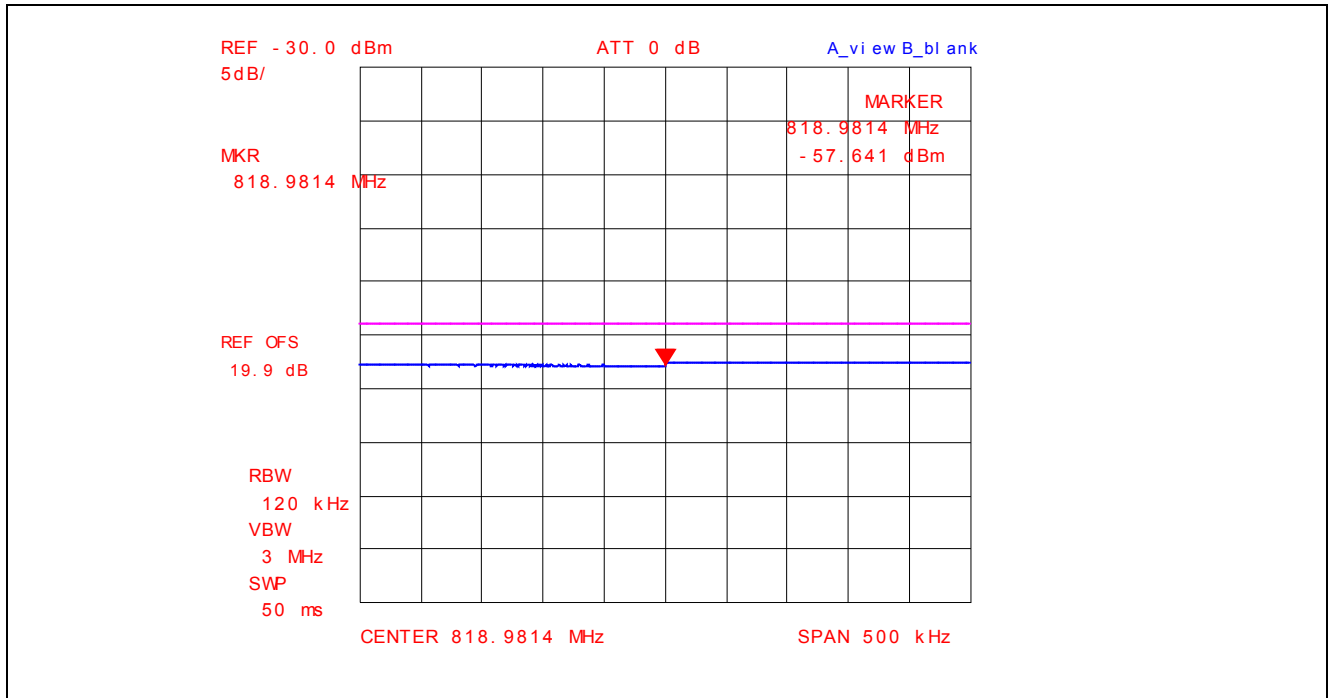

Plot 5.4.4.3.40. Conducted Spurious Emissions – Restricted Bands, 802.11g, 9 Mbps BPSK
 2442 MHz, 1 GHz - 4 GHz, Power Averaging with Band (Notch) Reject Filter

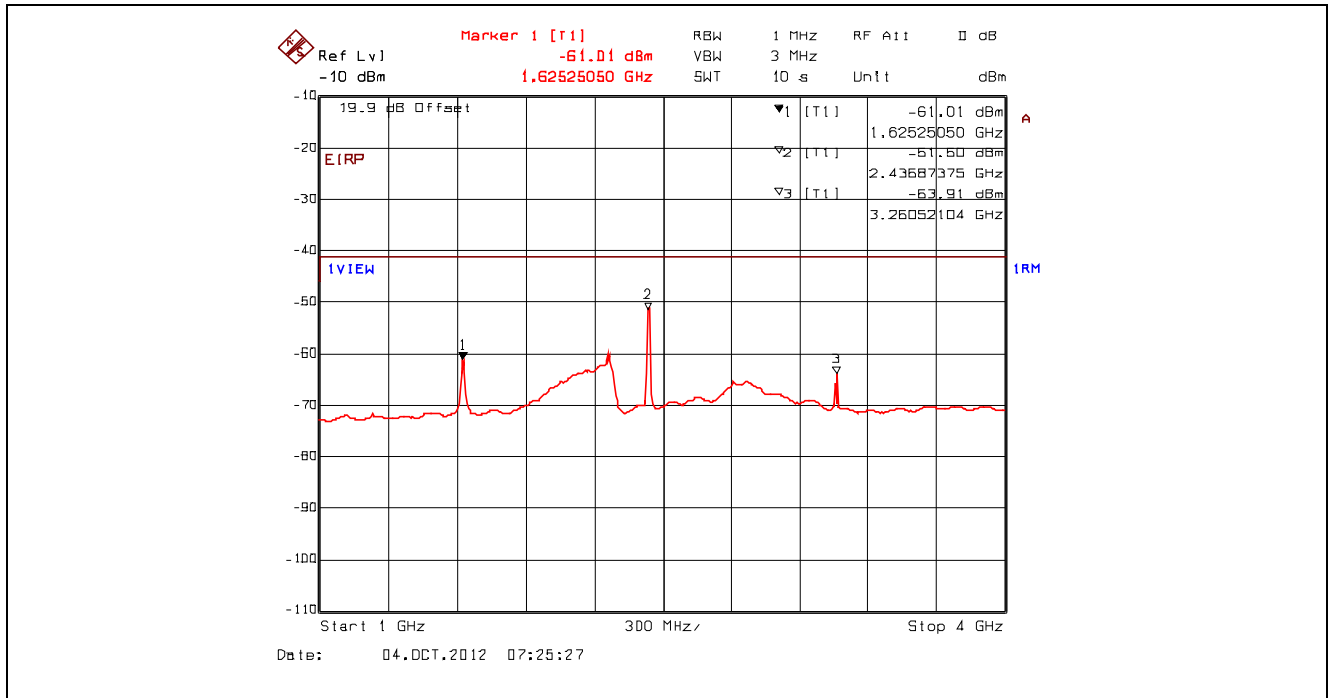

Plot 5.4.4.3.41. Conducted Spurious Emissions – Restricted Bands, 802.11g, 9 Mbps BPSK
 2442 MHz, 4 GHz - 25 GHz, Power Averaging with High Pass Filter

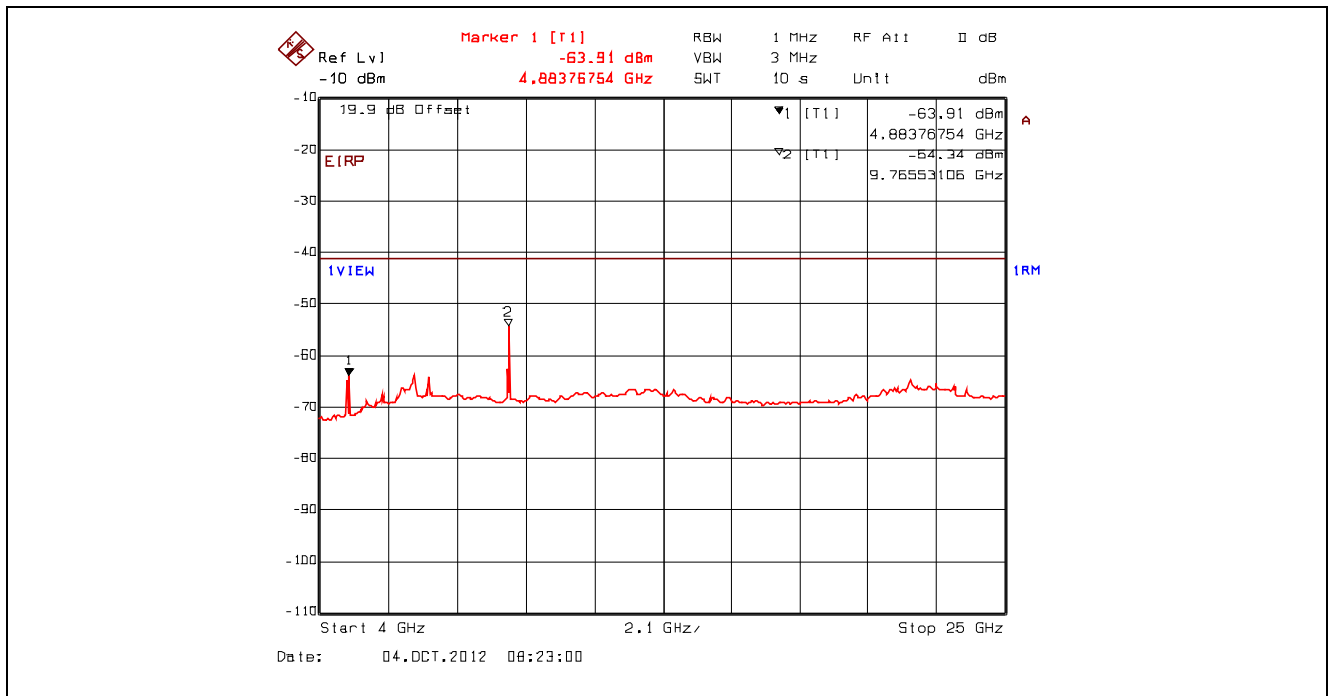

Plot 5.4.4.3.42. Conducted Spurious Emissions – Restricted Bands, 802.11g, 9 Mbps BPSK
2442 MHz, Peak Power at 1.63 GHz with Band (Notch) Reject Filter

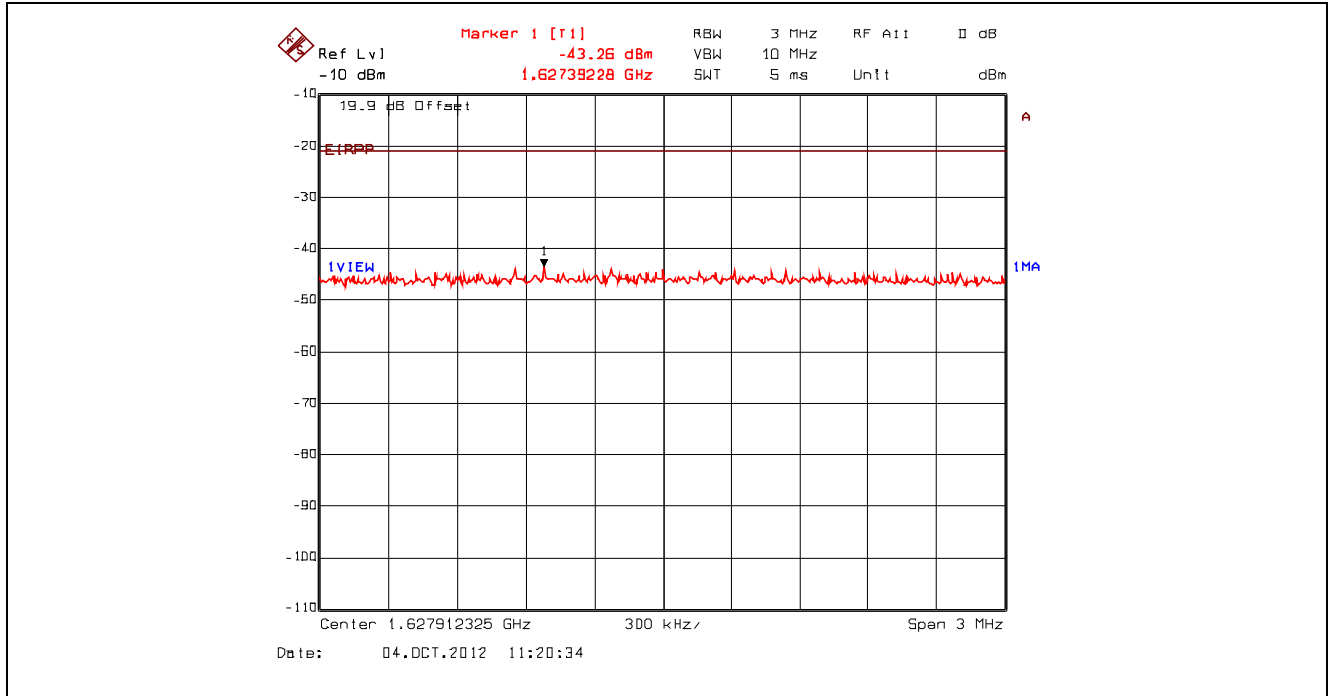

Plot 5.4.4.3.43. Conducted Spurious Emissions – Restricted Bands, 802.11g, 9 Mbps BPSK
2442 MHz, Peak Power at 3.26 GHz with Band (Notch) Reject Filter

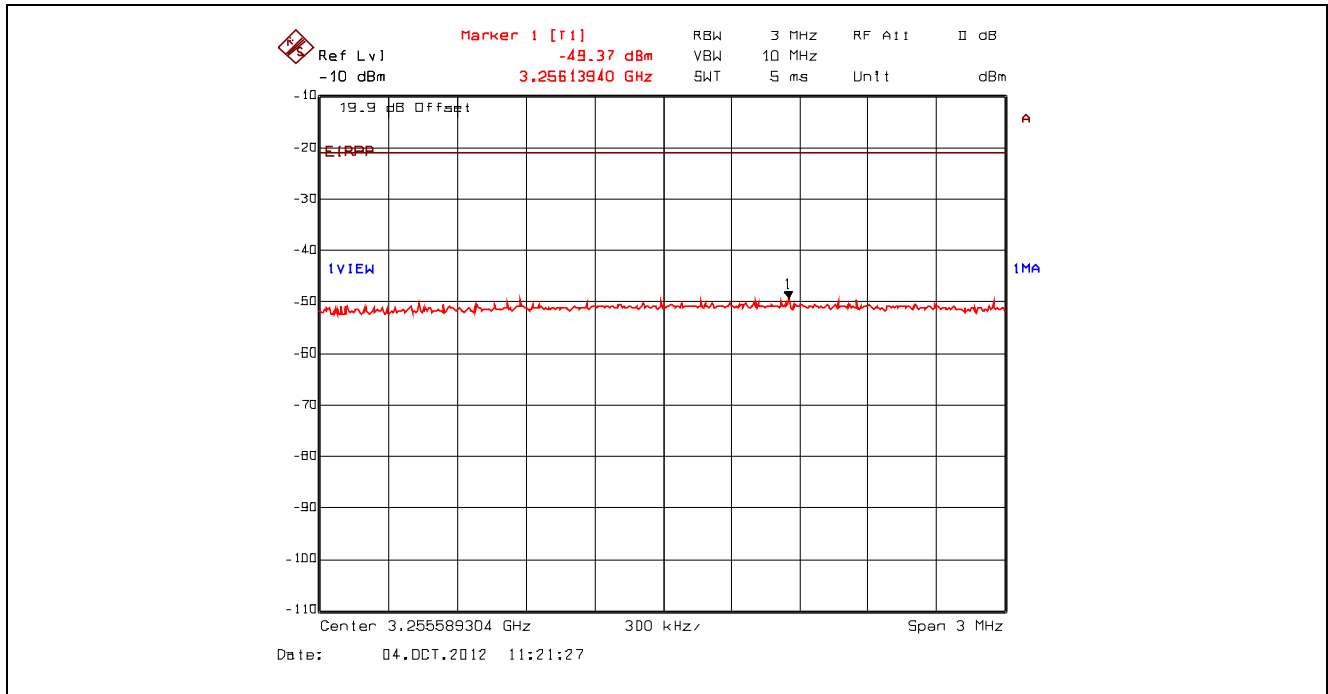

Plot 5.4.4.3.44. Conducted Spurious Emissions – Restricted Bands, 802.11g, 9 Mbps BPSK
 2442 MHz, Peak Power at 4.88 GHz with High Pass Filter

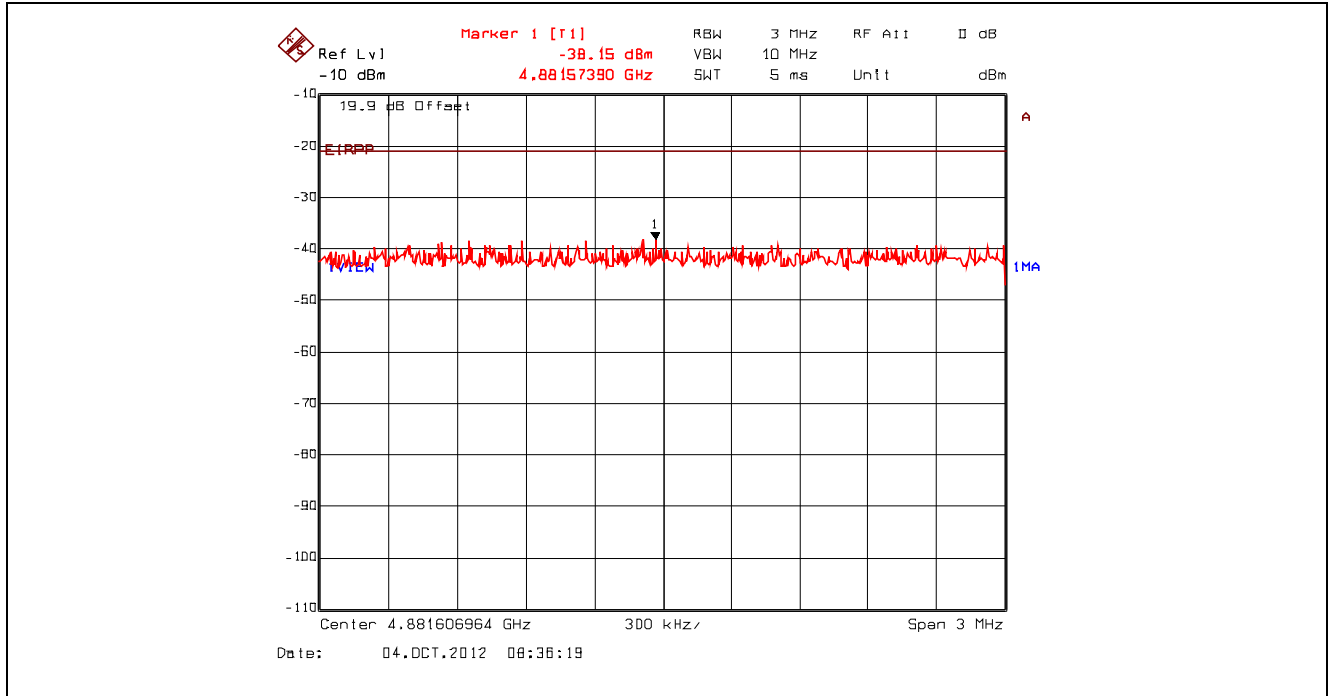

Plot 5.4.4.3.45. Conducted Spurious Emissions – Restricted Bands, 802.11g, 9 Mbps BPSK
 2442 MHz, Peak Power at 9.77 GHz with High Pass Filter

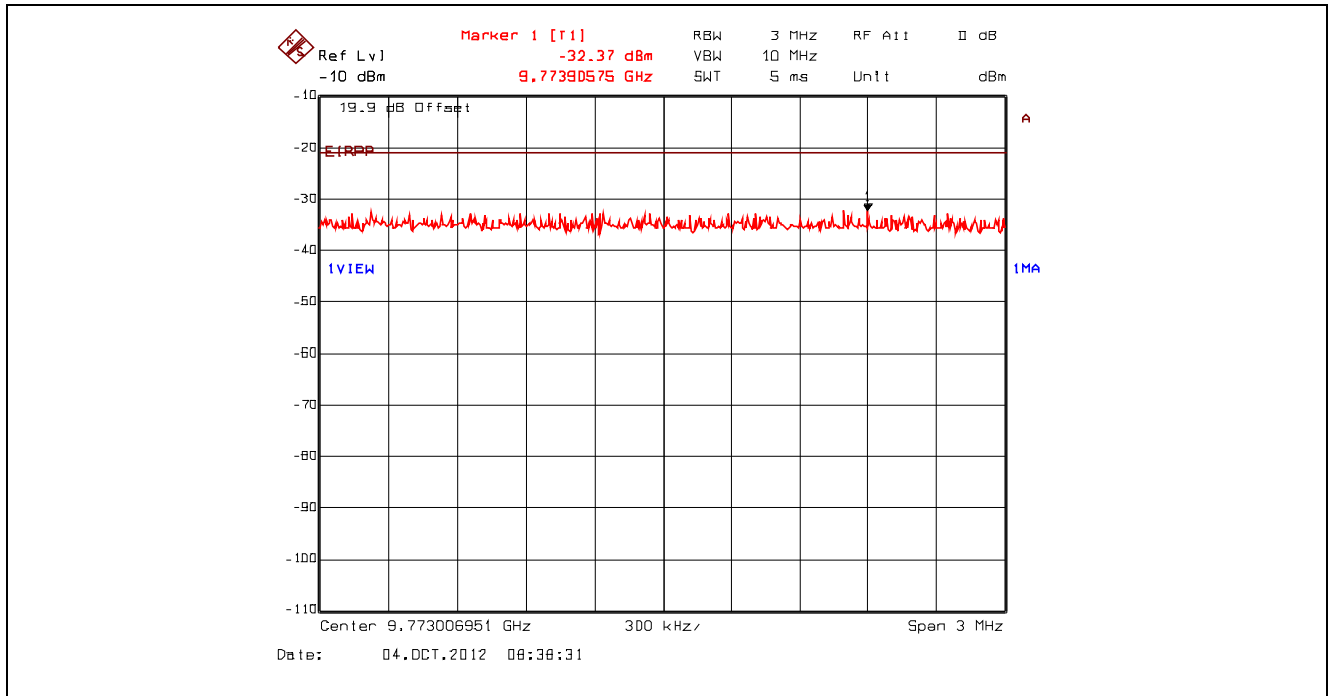

Plot 5.4.4.3.46. Conducted Spurious Emissions – Restricted Bands, 802.11g, 9 Mbps BPSK
 2462 MHz, 9 kHz - 150 kHz, Peak Detector with Band (Notch) Reject Filter

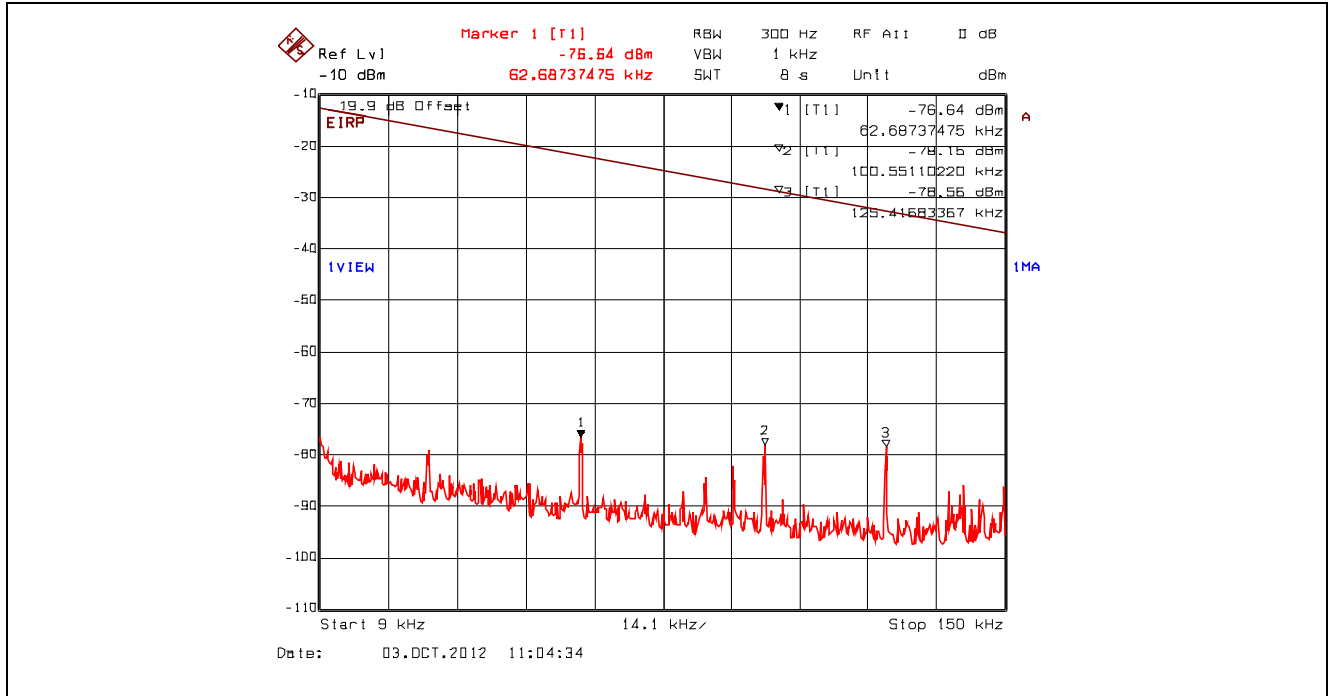

Plot 5.4.4.3.47. Conducted Spurious Emissions – Restricted Bands, 802.11g, 9 Mbps BPSK
 2462 MHz, 150 kHz - 30 MHz, Peak Detector with Band (Notch) Reject Filter

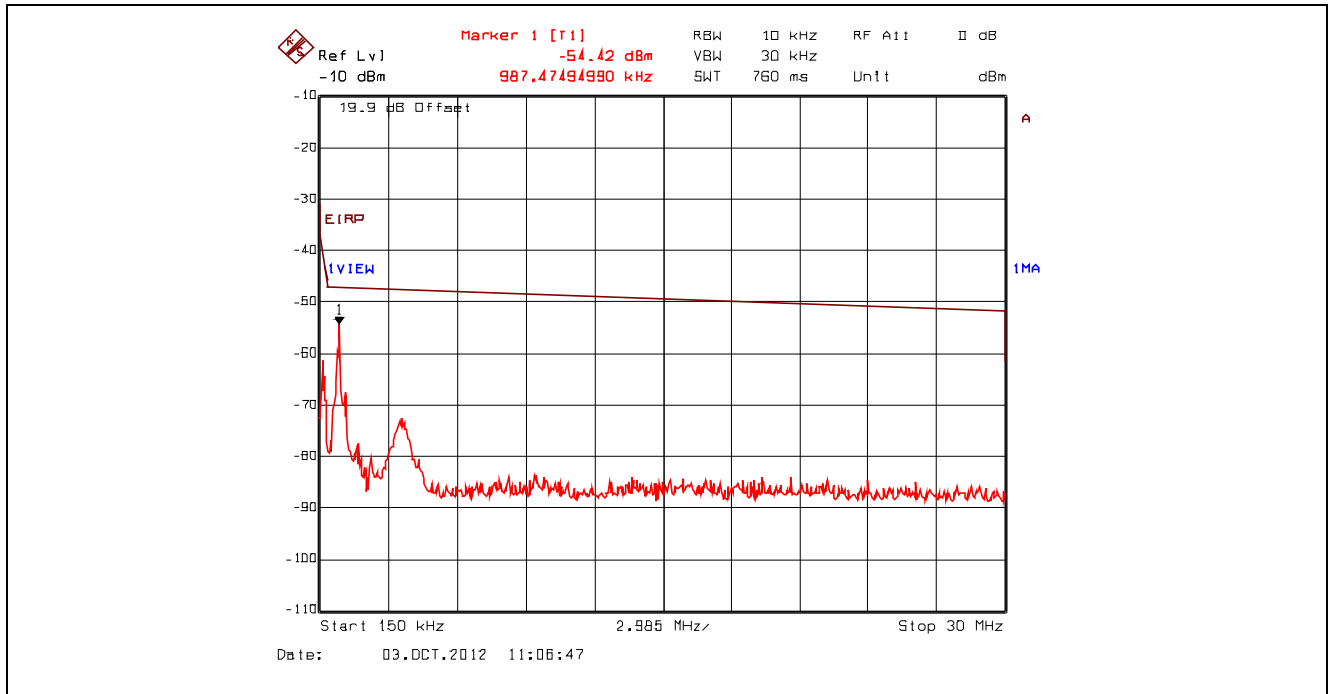

Plot 5.4.4.3.48. Conducted Spurious Emissions – Restricted Bands, 802.11g, 9 Mbps BPSK
 2462 MHz, 30 MHz - 1 GHz, Peak Detector with Band (Notch) Reject Filter

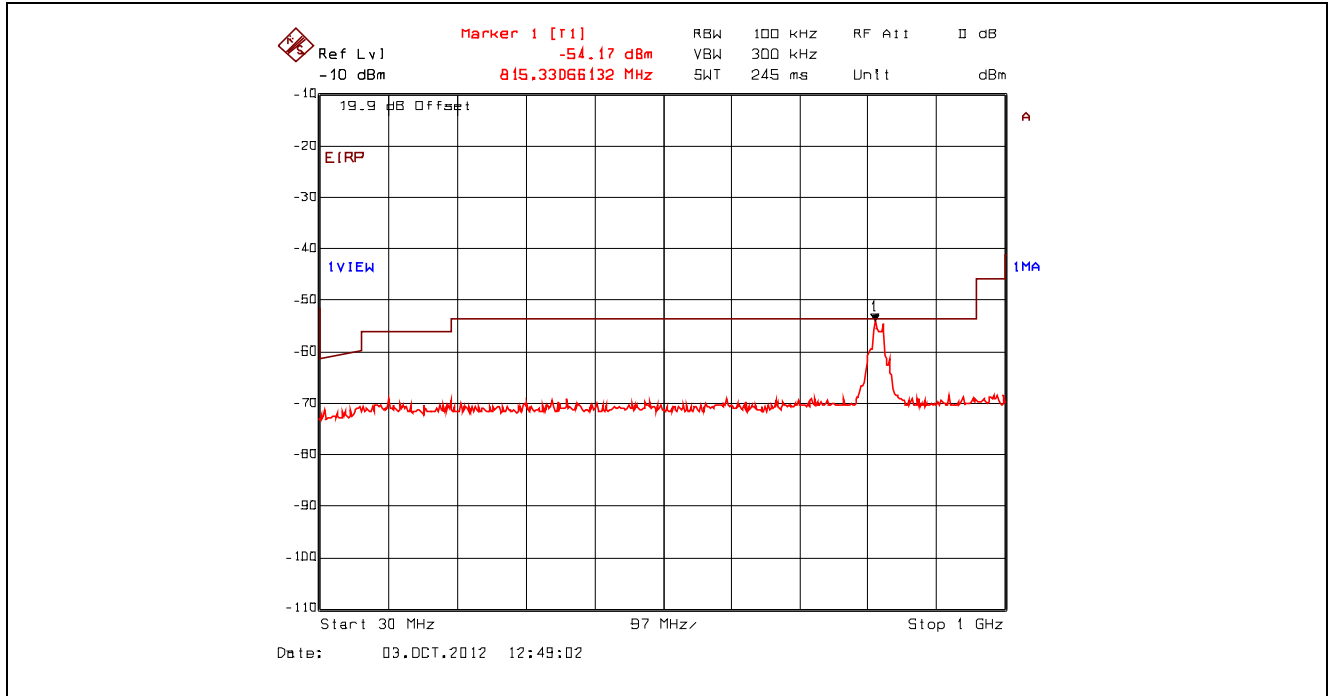

Plot 5.4.4.3.49. Conducted Spurious Emissions – Restricted Bands, 802.11g, 9 Mbps BPSK
 2462 MHz, QP Power at 818.76 MHz with Band (Notch) Reject Filter

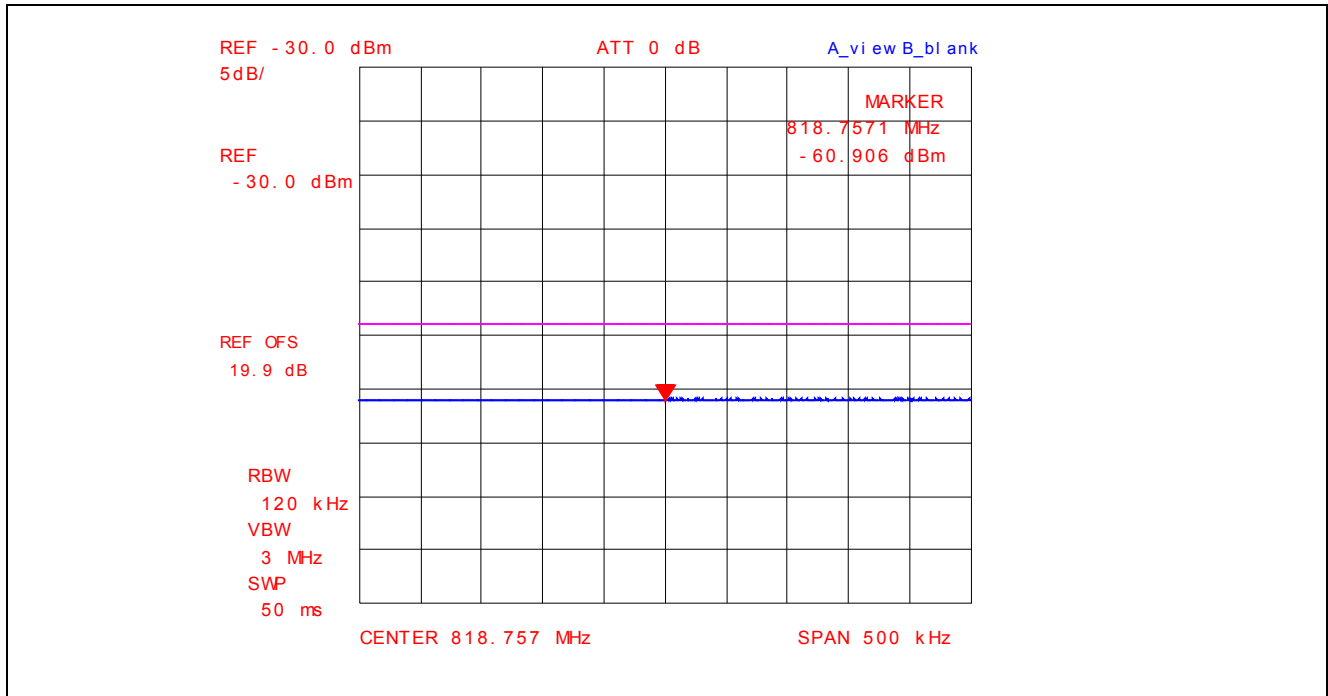

Plot 5.4.4.3.50. Conducted Spurious Emissions – Restricted Bands, 802.11g, 9 Mbps BPSK
 2462 MHz, 1 GHz - 4 GHz, Power Averaging with Band (Notch) Reject Filter

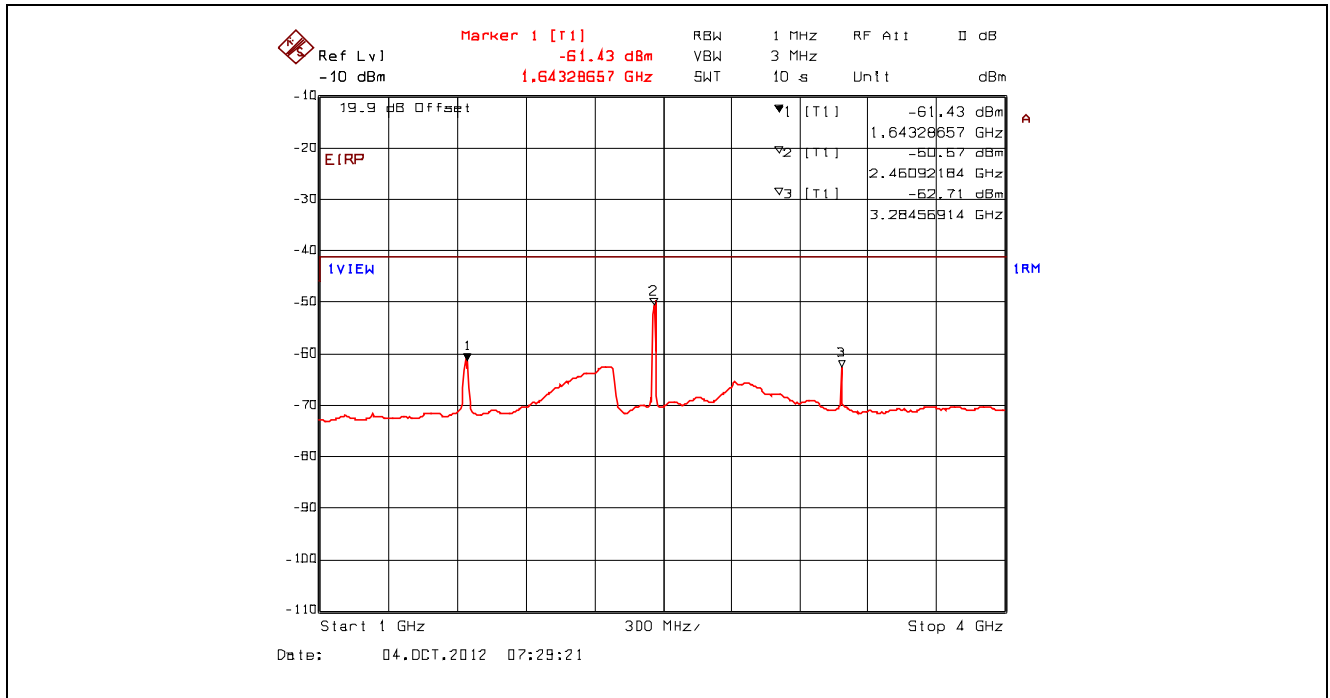

Plot 5.4.4.3.51. Conducted Spurious Emissions – Restricted Bands, 802.11g, 9 Mbps BPSK
 2462 MHz, 4 GHz - 25 GHz, Power Averaging with High Pass Filter

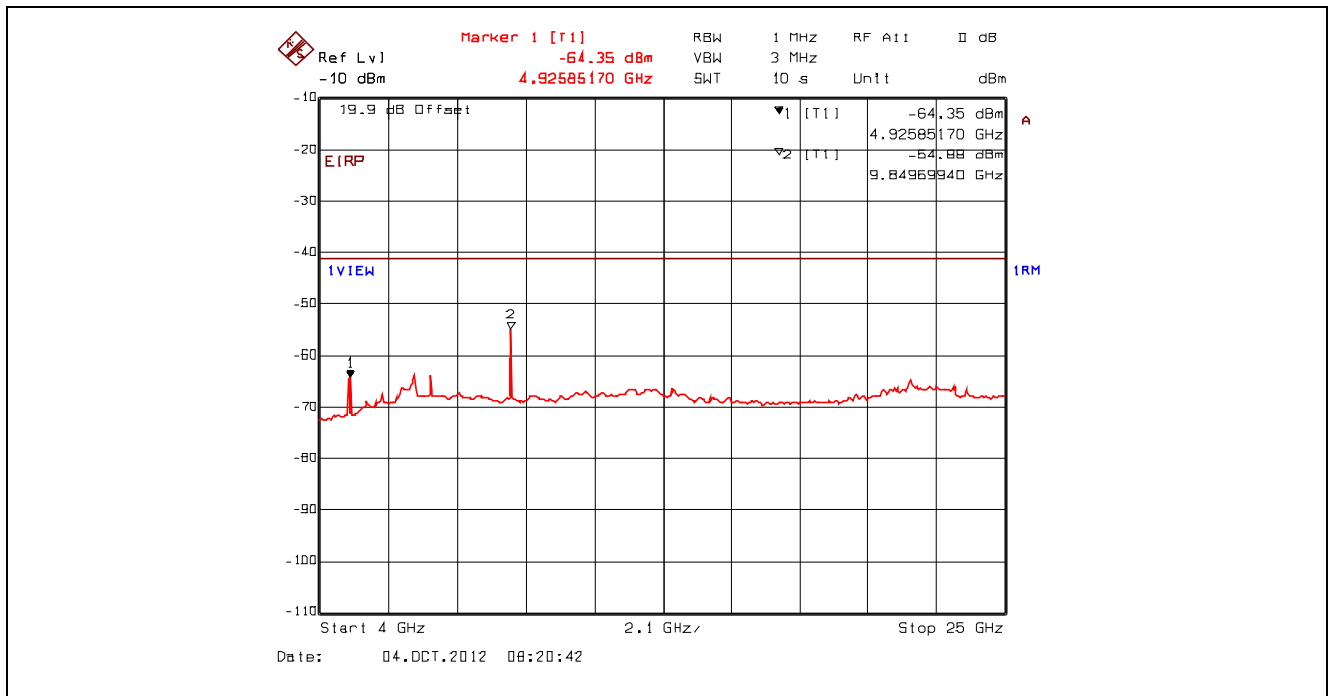

Plot 5.4.4.3.52. Conducted Spurious Emissions – Restricted Bands, 802.11g, 9 Mbps BPSK
2462 MHz, Peak Power at 1.64 GHz with Band (Notch) Reject Filter

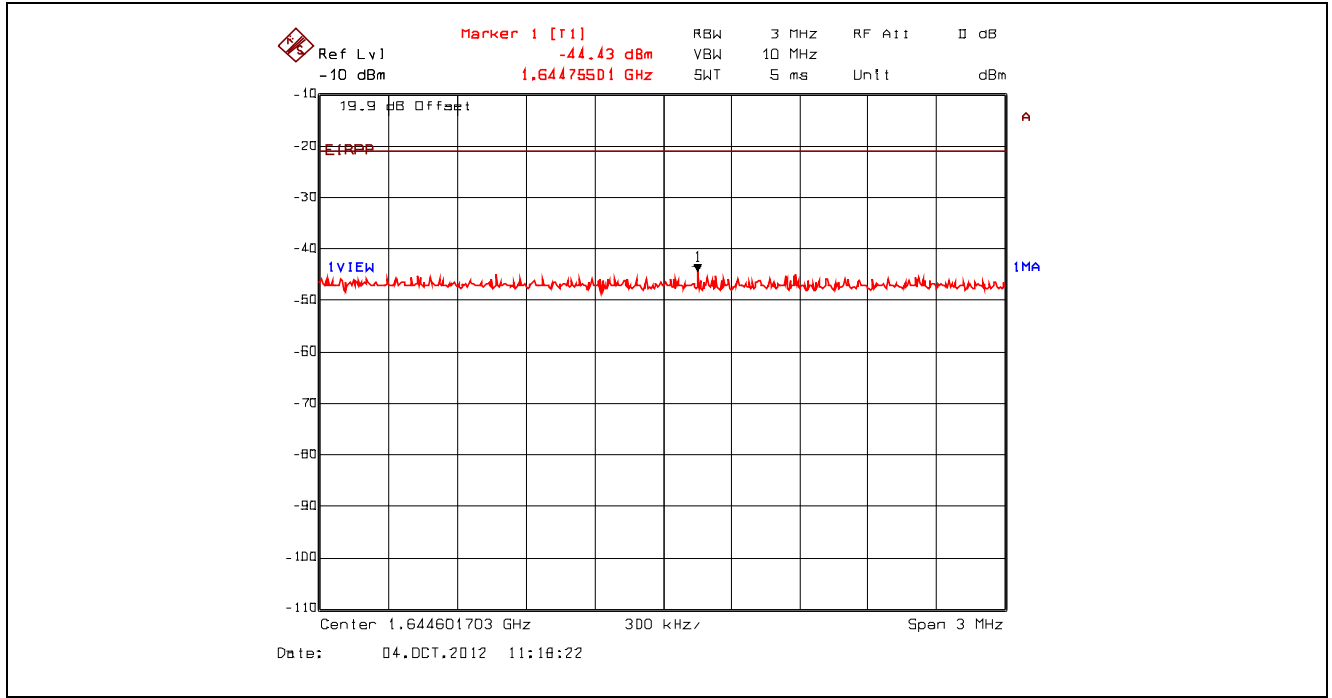

Plot 5.4.4.3.53. Conducted Spurious Emissions – Restricted Bands, 802.11g, 9 Mbps BPSK
2462 MHz, Peak Power at 3.28 GHz with Band (Notch) Reject Filter

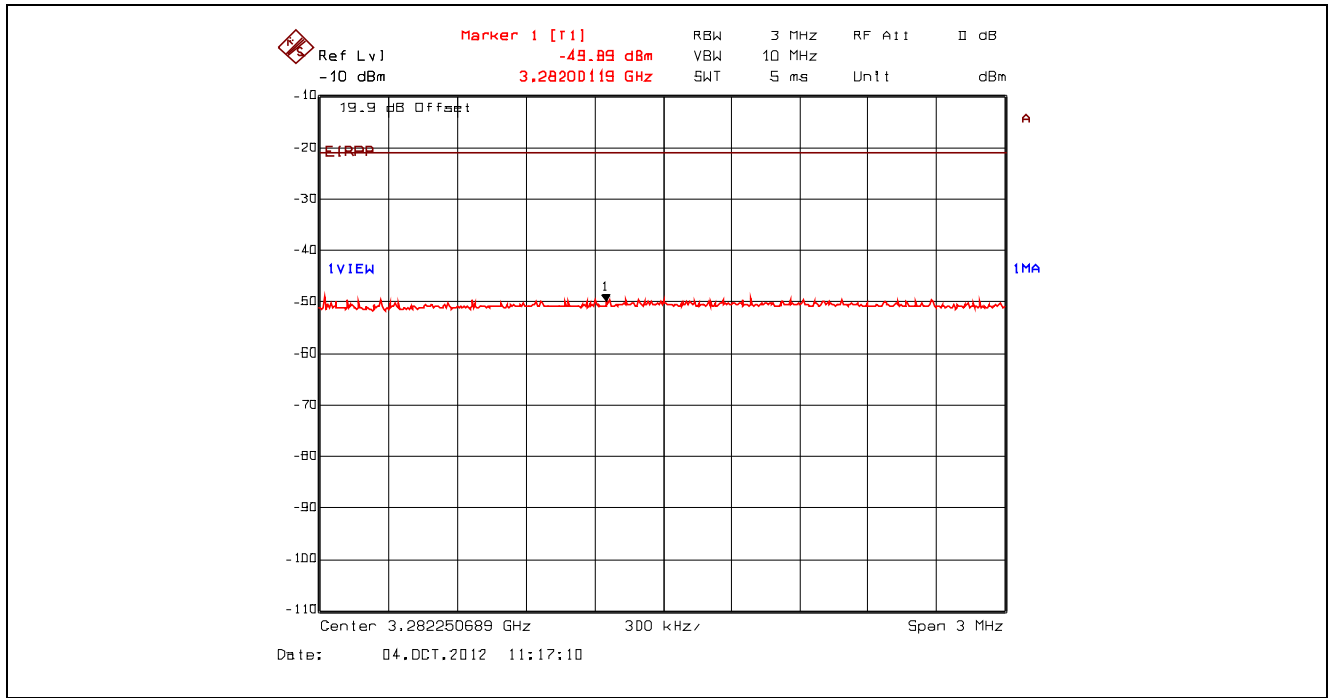

Plot 5.4.4.3.54. Conducted Spurious Emissions – Restricted Bands, 802.11g, 9 Mbps BPSK
2462 MHz, Peak Power at 4.93 GHz with High Pass Filter

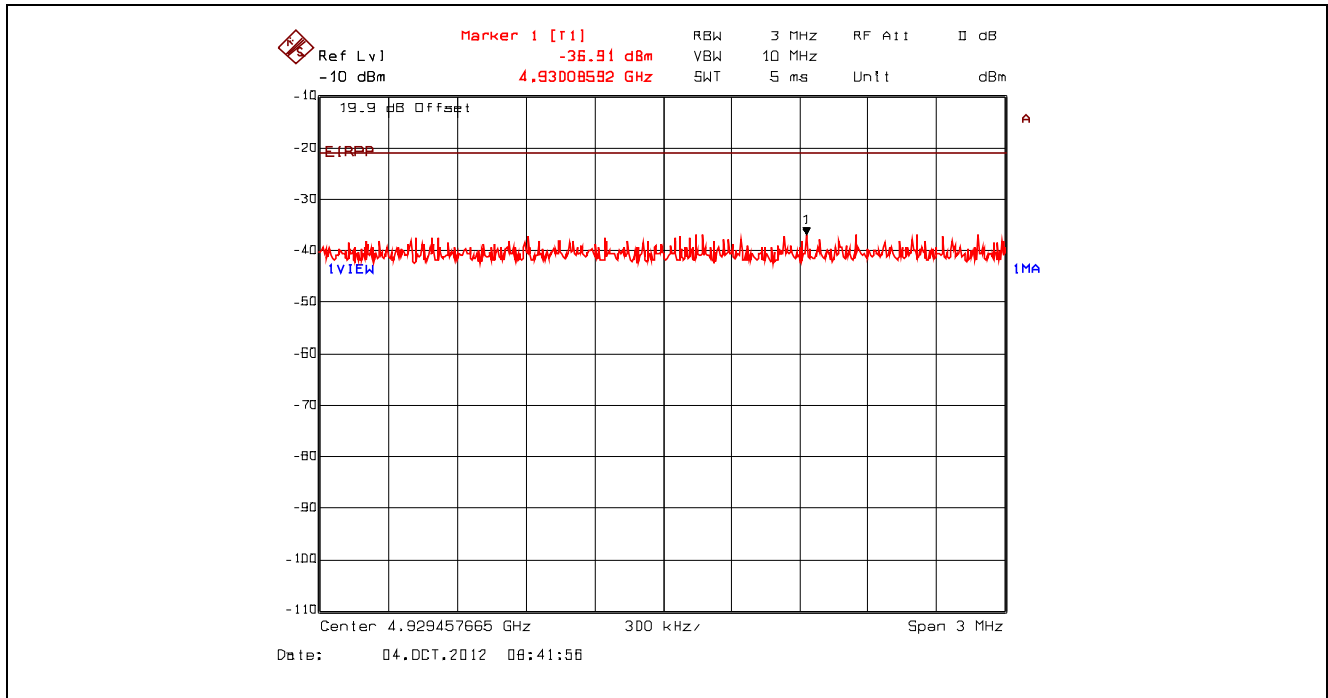

Plot 5.4.4.3.55. Conducted Spurious Emissions – Restricted Bands, 802.11g, 9 Mbps BPSK
2462 MHz, Peak Power at 9.85 GHz with High Pass Filter

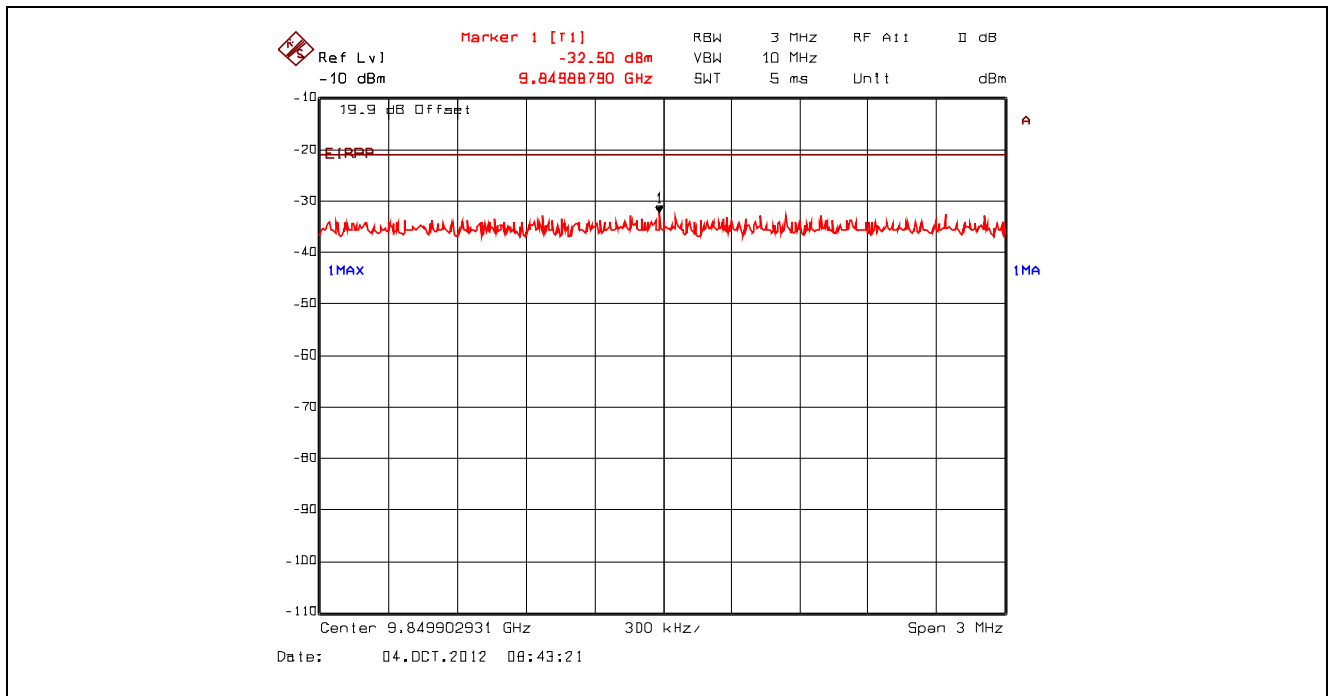

Plot 5.4.4.3.56. Conducted Spurious Emissions – Restricted Bands, 802.11n 800ns, 6.5 Mbps BPSK 1/2
 2412 MHz, 9 kHz - 150 kHz, Peak Detector with Band (Notch) Reject Filter

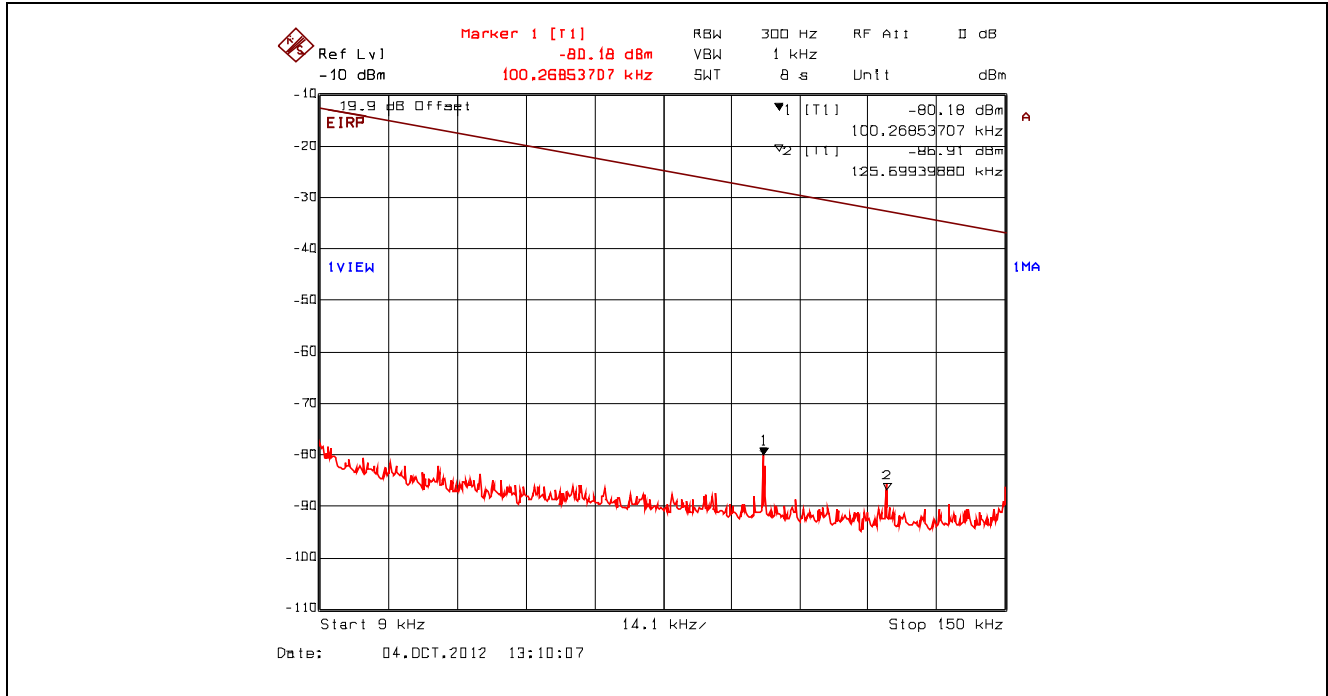

Plot 5.4.4.3.57. Conducted Spurious Emissions – Restricted Bands, 802.11n 800ns, 6.5 Mbps BPSK 1/2
 2412 MHz, 150 kHz - 30 MHz, Peak Detector with Band (Notch) Reject Filter

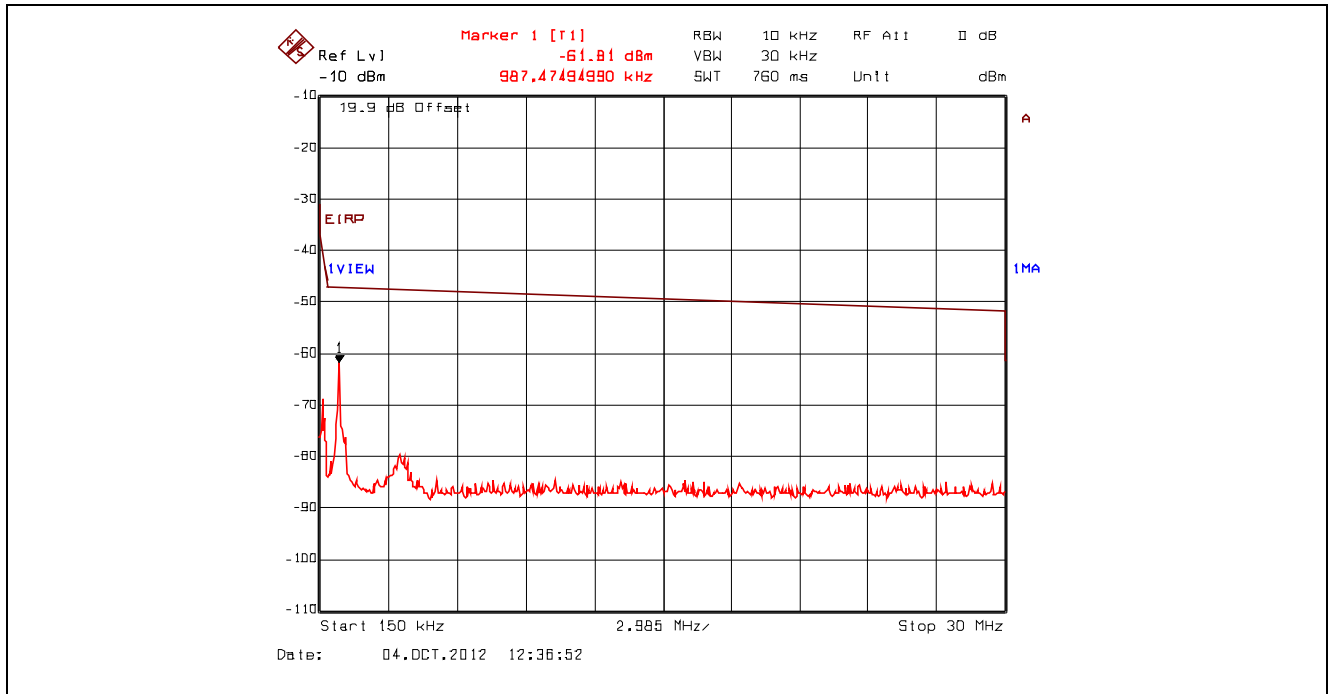

Plot 5.4.4.3.58. Conducted Spurious Emissions – Restricted Bands, 802.11n 800ns, 6.5 Mbps BPSK 1/2
 2412 MHz, 30 MHz - 1 GHz, Peak Detector with Band (Notch) Reject Filter

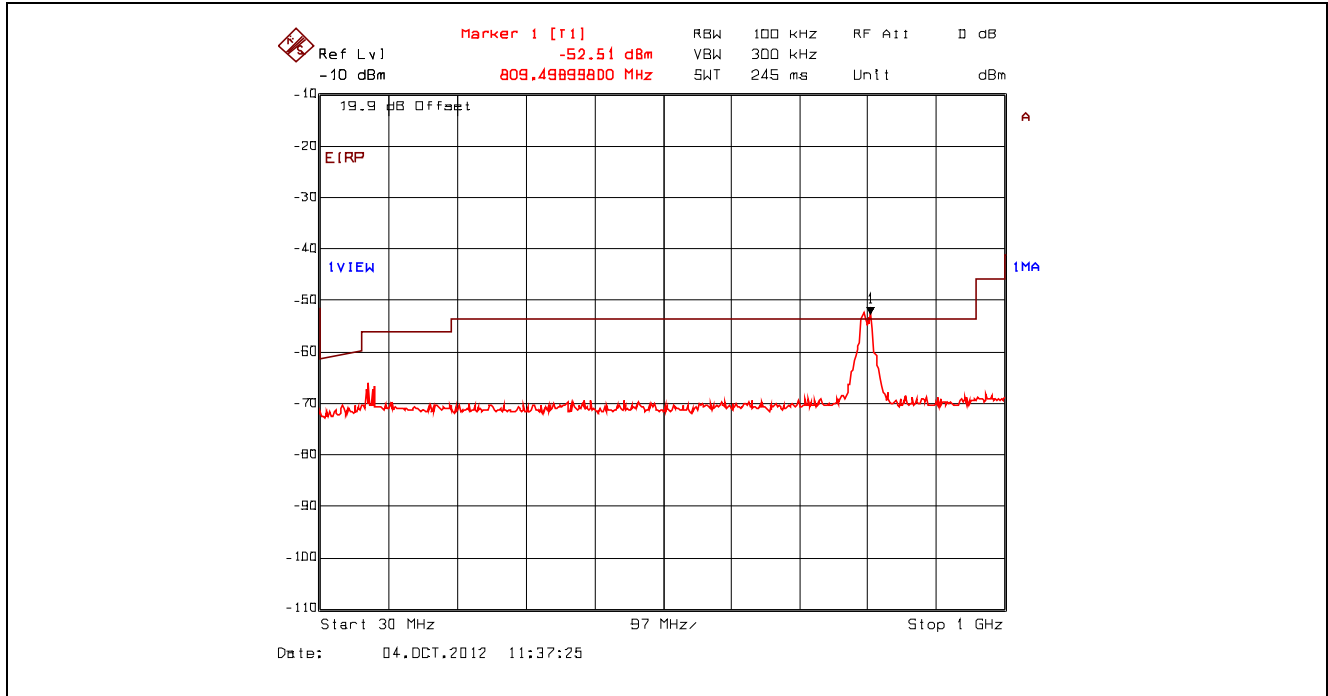

Plot 5.4.4.3.59. Conducted Spurious Emissions – Restricted Bands, 802.11n 800ns, 6.5 Mbps BPSK 1/2
 2412 MHz, QP Power at 810.12 MHz with Band (Notch) Reject Filter

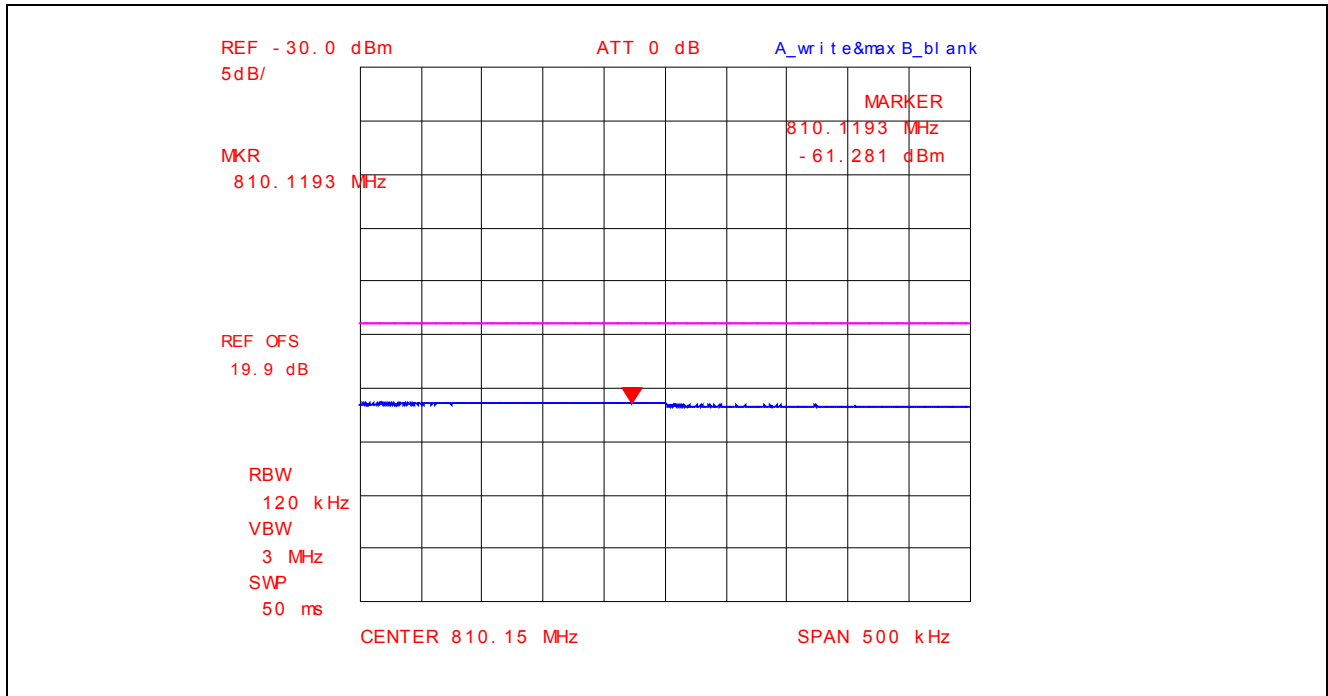

Plot 5.4.4.3.60. Conducted Spurious Emissions – Restricted Bands, 802.11n 800ns, 6.5 Mbps BPSK 1/2
 2412 MHz, 1 GHz - 4 GHz, Power Averaging with Band (Notch) Reject Filter

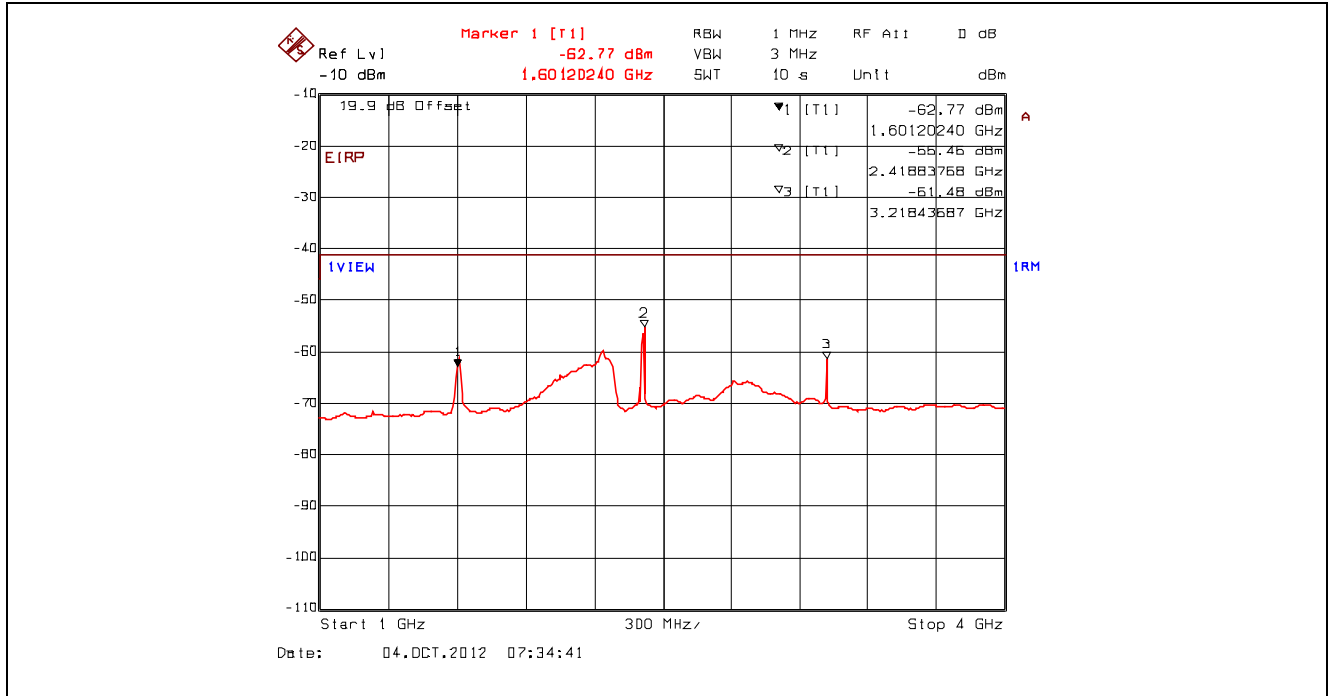

Plot 5.4.4.3.61. Conducted Spurious Emissions – Restricted Bands, 802.11n 800ns, 6.5 Mbps BPSK 1/2
 2412 MHz, 4 GHz - 25 GHz, Power Averaging with High Pass Filter

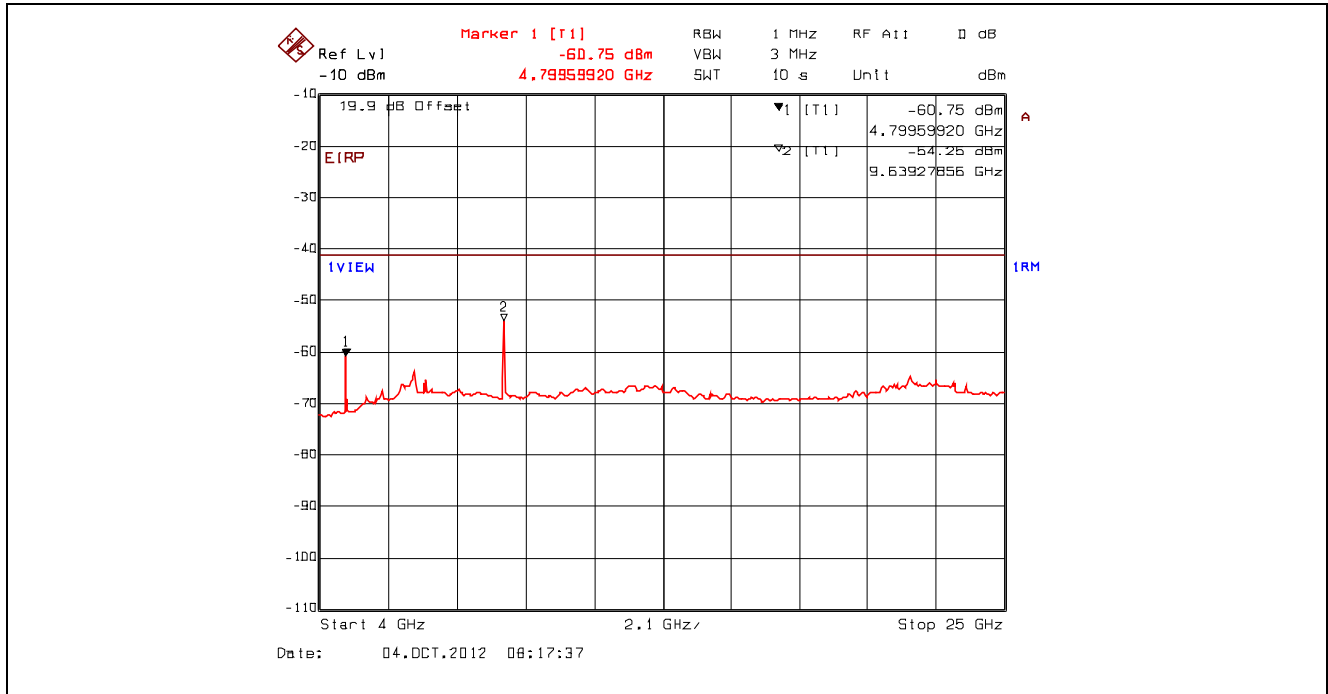

Plot 5.4.4.3.62. Conducted Spurious Emissions – Restricted Bands, 802.11n 800ns, 6.5 Mbps BPSK 1/2
2412 MHz, Peak Power at 1.61 GHz with Band (Notch) Reject Filter

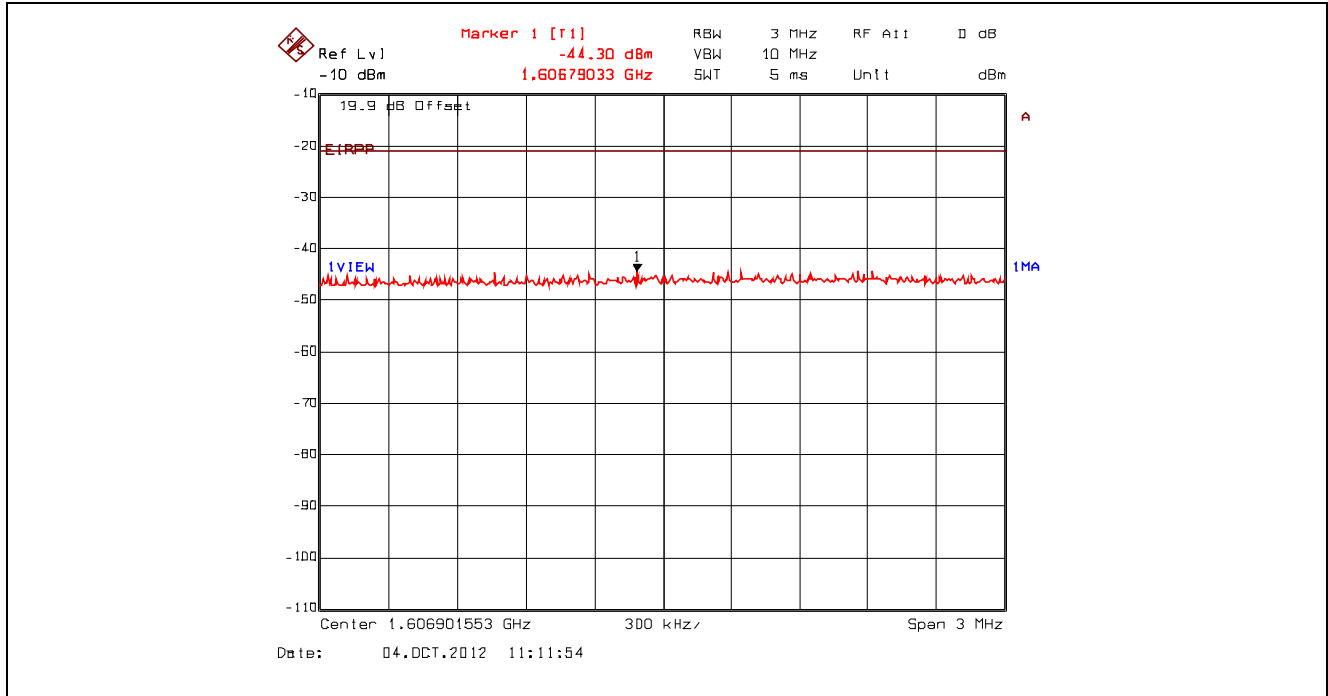

Plot 5.4.4.3.63. Conducted Spurious Emissions – Restricted Bands, 802.11n 800ns, 6.5 Mbps BPSK 1/2
2412 MHz, Peak Power at 3.22 GHz with Band (Notch) Reject Filter

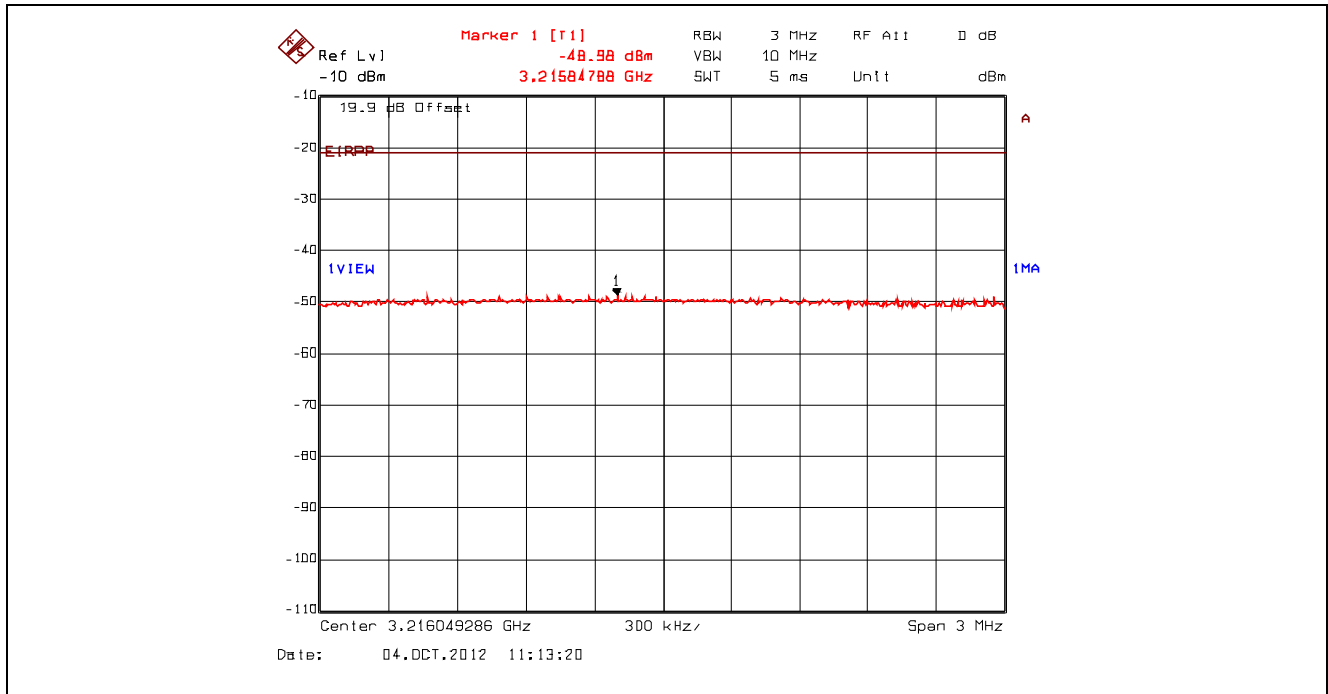

Plot 5.4.4.3.64. Conducted Spurious Emissions – Restricted Bands, 802.11n 800ns, 6.5 Mbps BPSK 1/2
2412 MHz, Peak Power at 4.82 GHz with High Pass Filter

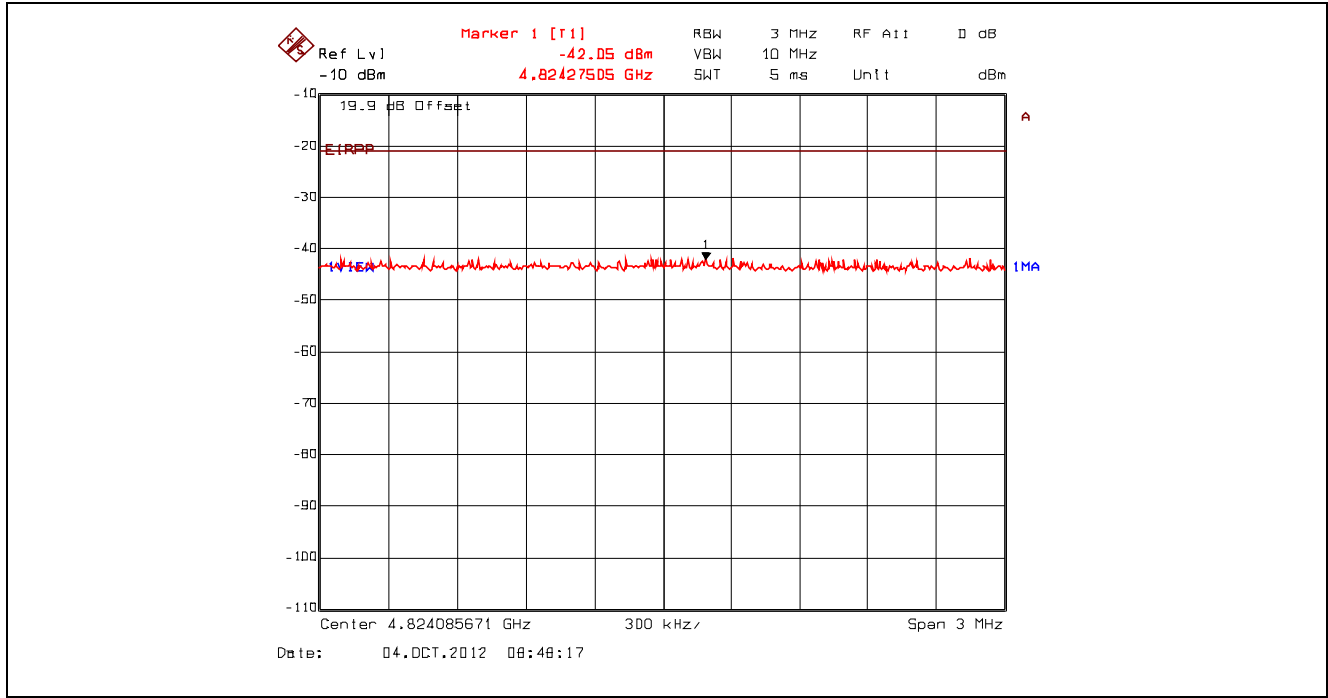

Plot 5.4.4.3.65. Conducted Spurious Emissions – Restricted Bands, 802.11n 800ns, 6.5 Mbps BPSK 1/2
2412 MHz, Peak Power at 9.63 GHz with High Pass Filter

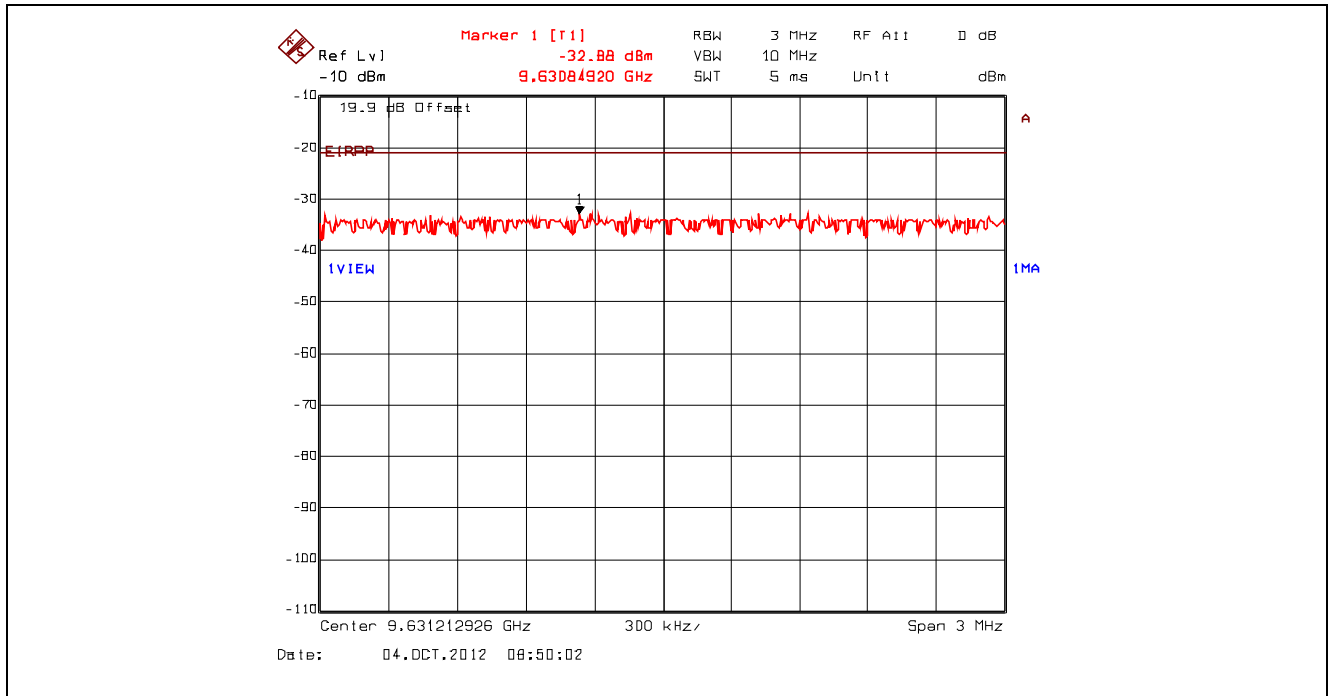

Plot 5.4.4.3.66. Conducted Spurious Emissions – Restricted Bands, 802.11n 800ns, 6.5 Mbps BPSK 1/2
 2442 MHz, 9 kHz - 150 kHz, Peak Detector with Band (Notch) Reject Filter

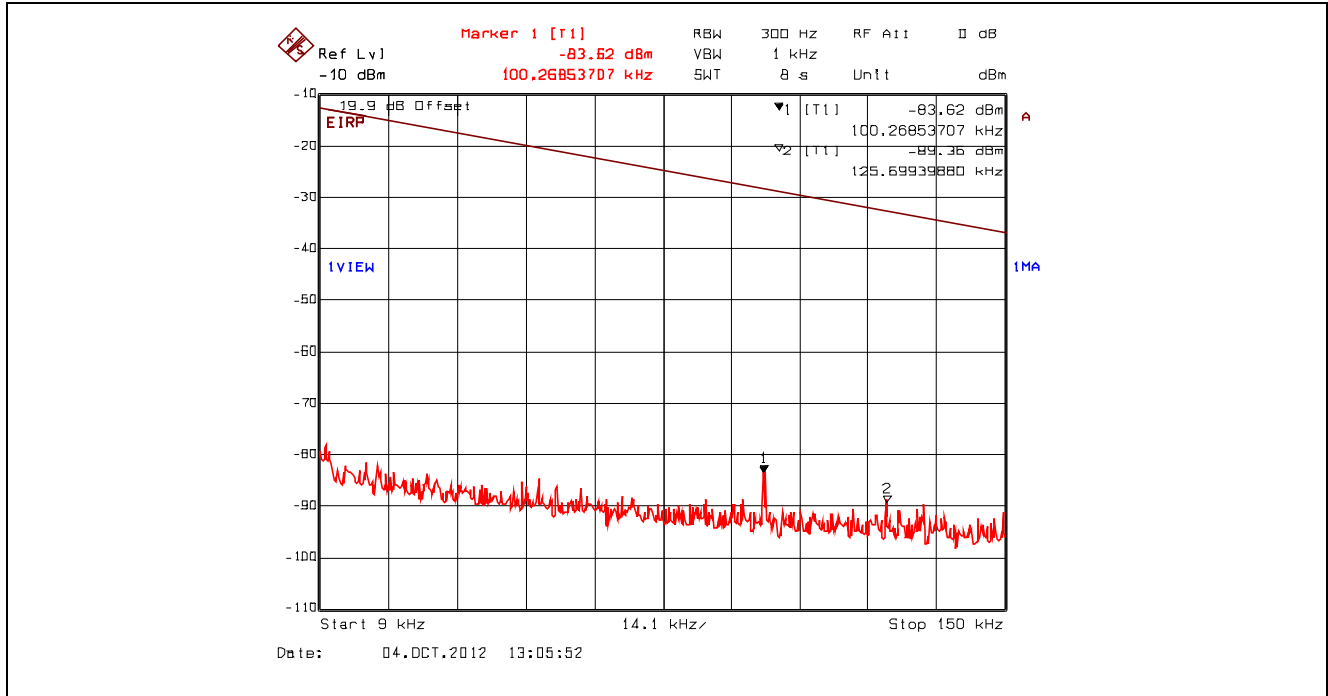

Plot 5.4.4.3.67. Conducted Spurious Emissions – Restricted Bands, 802.11n 800ns, 6.5 Mbps BPSK 1/2
 2442 MHz, 150 kHz - 30 MHz, Peak Detector with Band (Notch) Reject Filter

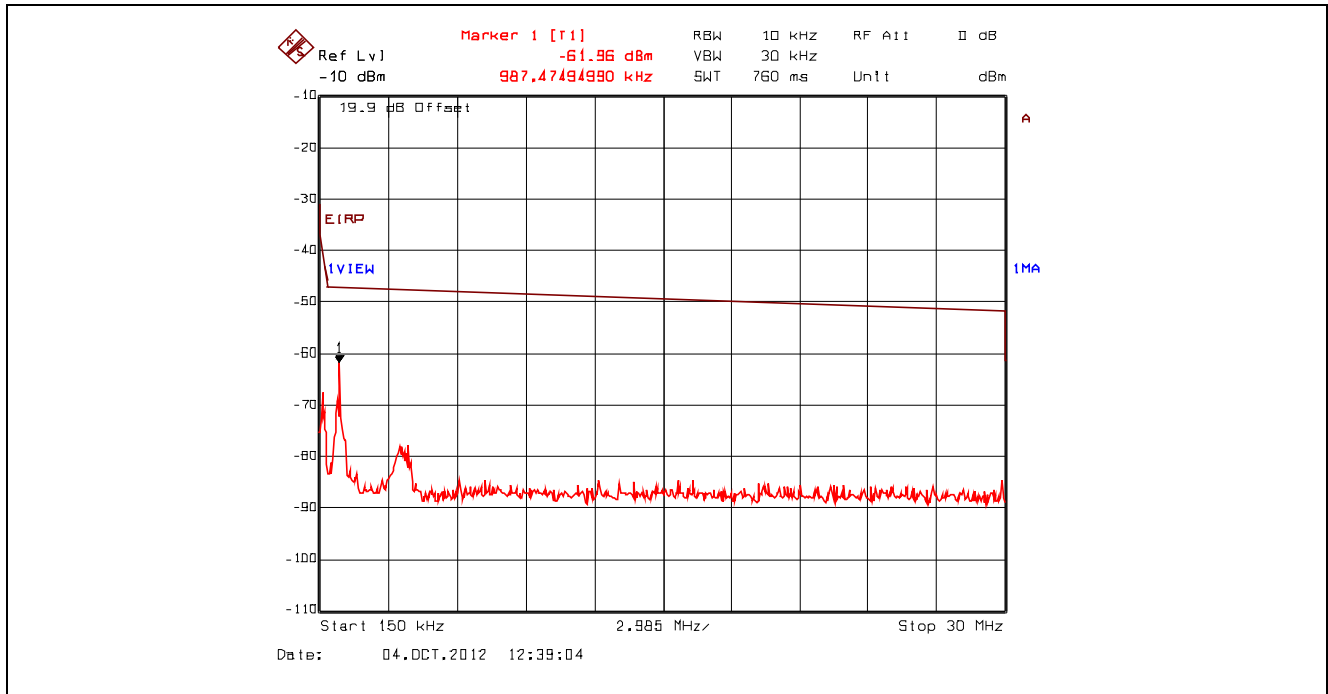

Plot 5.4.4.3.68. Conducted Spurious Emissions – Restricted Bands, 802.11n 800ns, 6.5 Mbps BPSK 1/2
 2442 MHz, 30 MHz - 1 GHz, Peak Detector with Band (Notch) Reject Filter

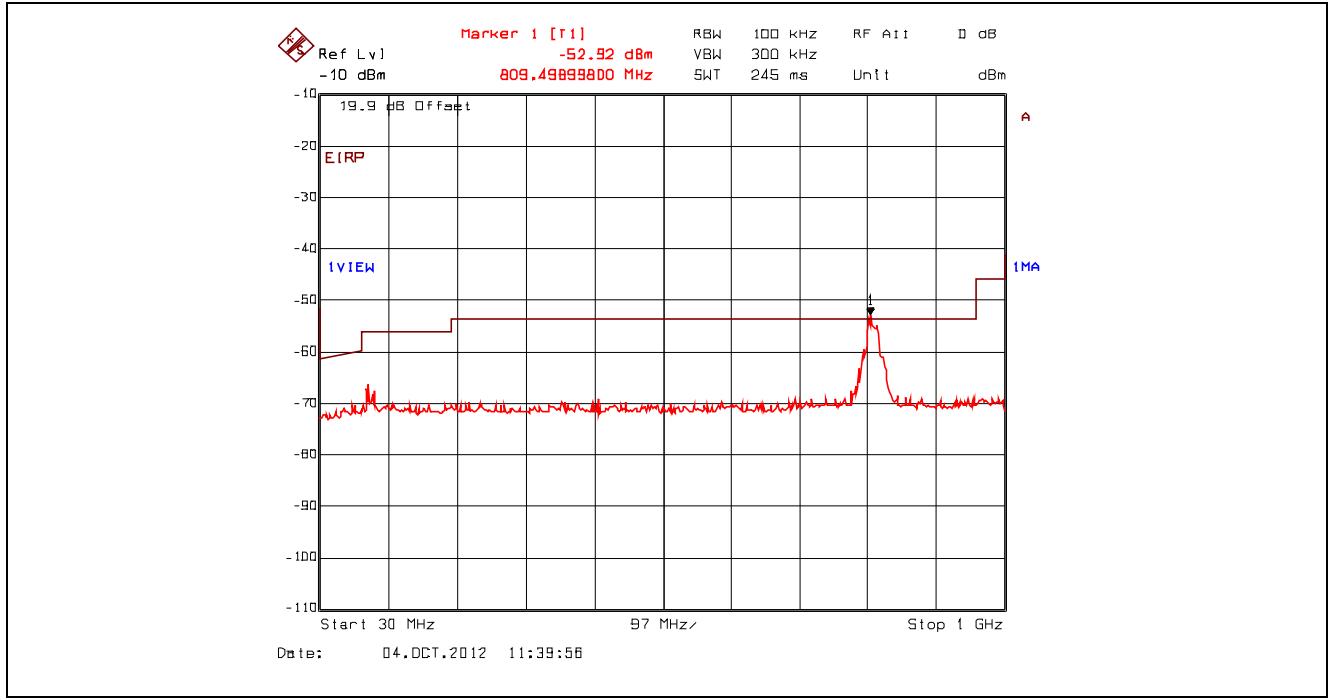

Plot 5.4.4.3.69. Conducted Spurious Emissions – Restricted Bands, 802.11n 800ns, 6.5 Mbps BPSK 1/2
 2442 MHz, QP Power at 810.12 MHz with Band (Notch) Reject Filter

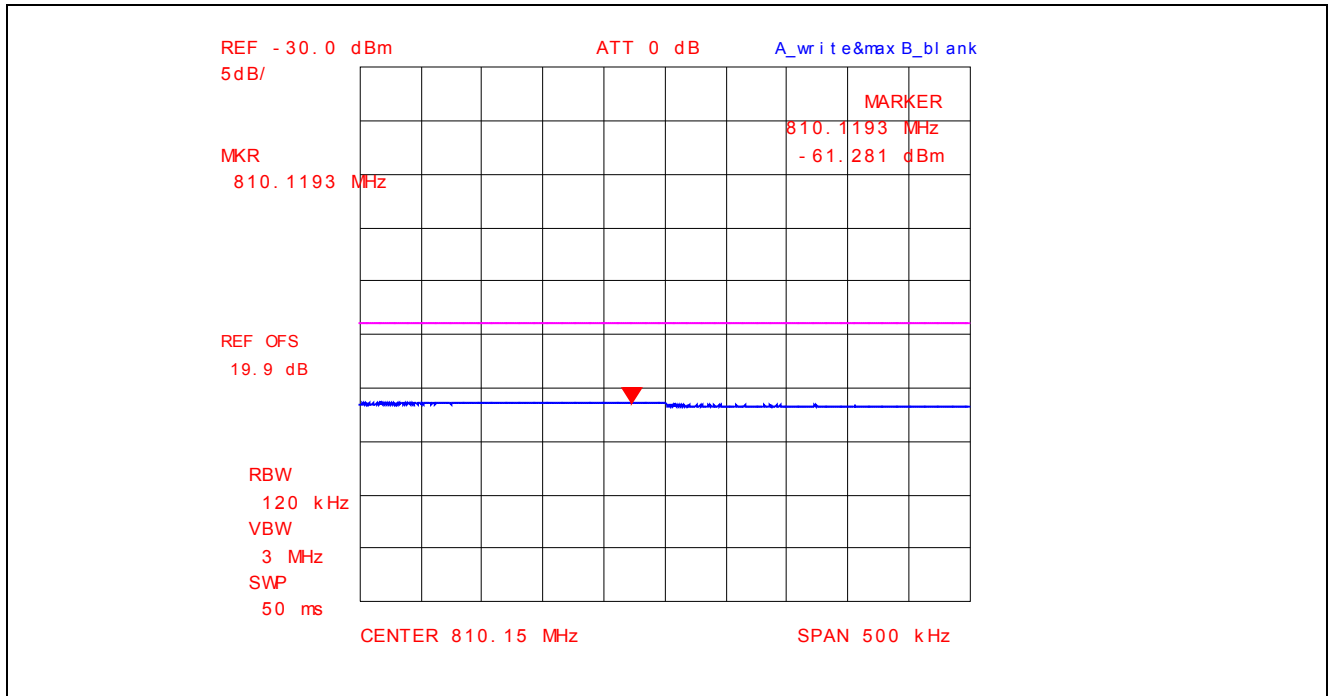

Plot 5.4.4.3.70. Conducted Spurious Emissions – Restricted Bands, 802.11n 800ns, 6.5 Mbps BPSK 1/2
 2442 MHz, 1 GHz - 4 GHz, Power Averaging with Band (Notch) Reject Filter

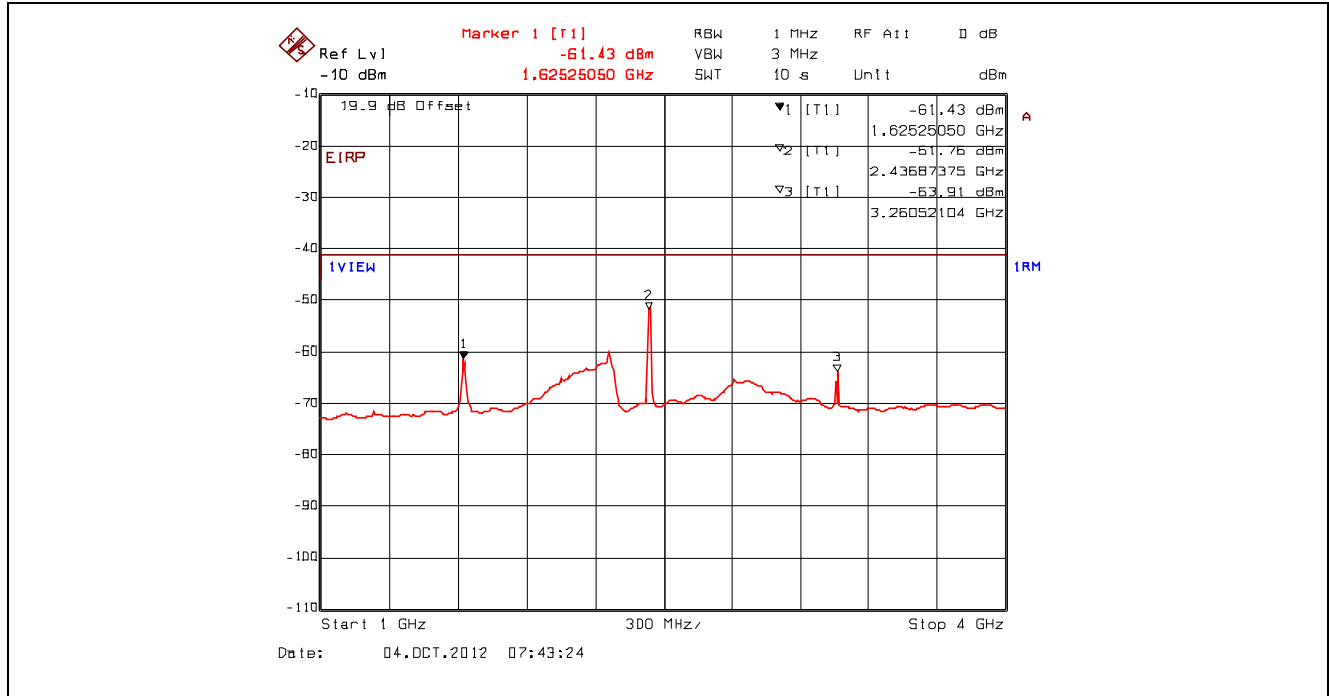

Plot 5.4.4.3.71. Conducted Spurious Emissions – Restricted Bands, 802.11n 800ns, 6.5 Mbps BPSK 1/2
 2442 MHz, 4 GHz - 25 GHz, Power Averaging with High Pass Filter

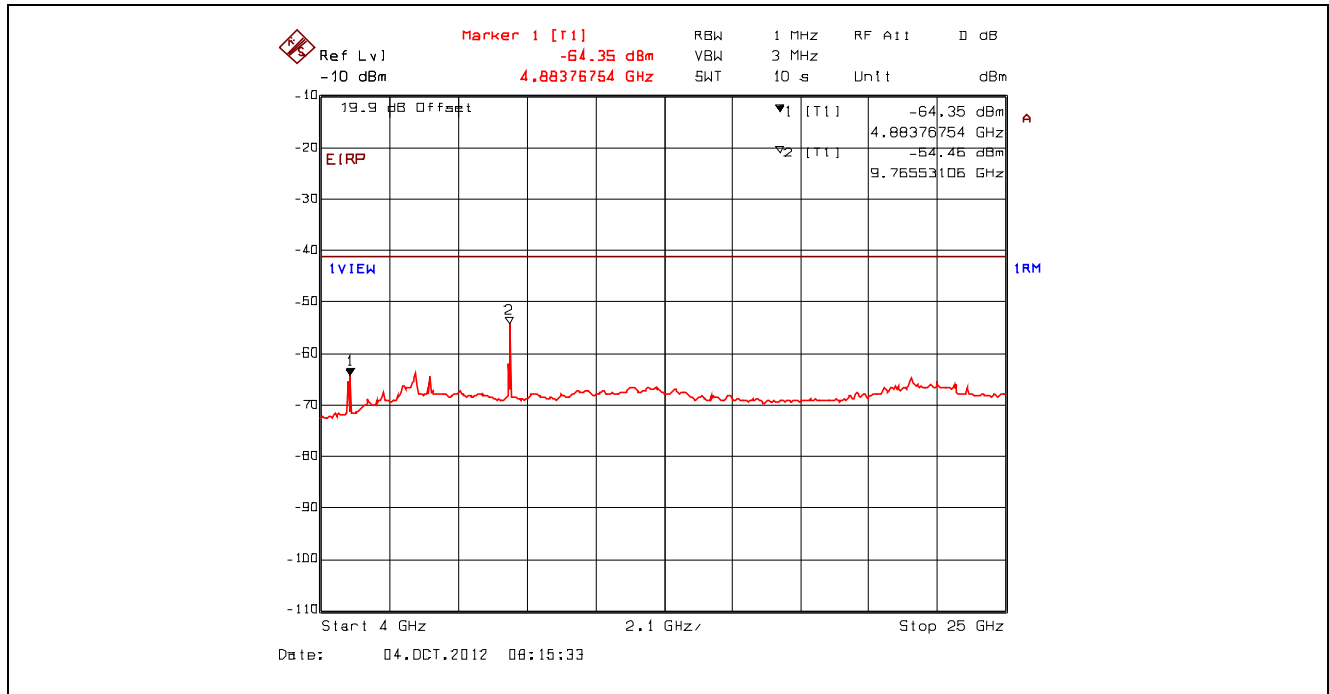

Plot 5.4.4.3.72. Conducted Spurious Emissions – Restricted Bands, 802.11n 800ns, 6.5 Mbps BPSK 1/2
 2442 MHz, Peak Power at 1.63 GHz with Band (Notch) Reject Filter

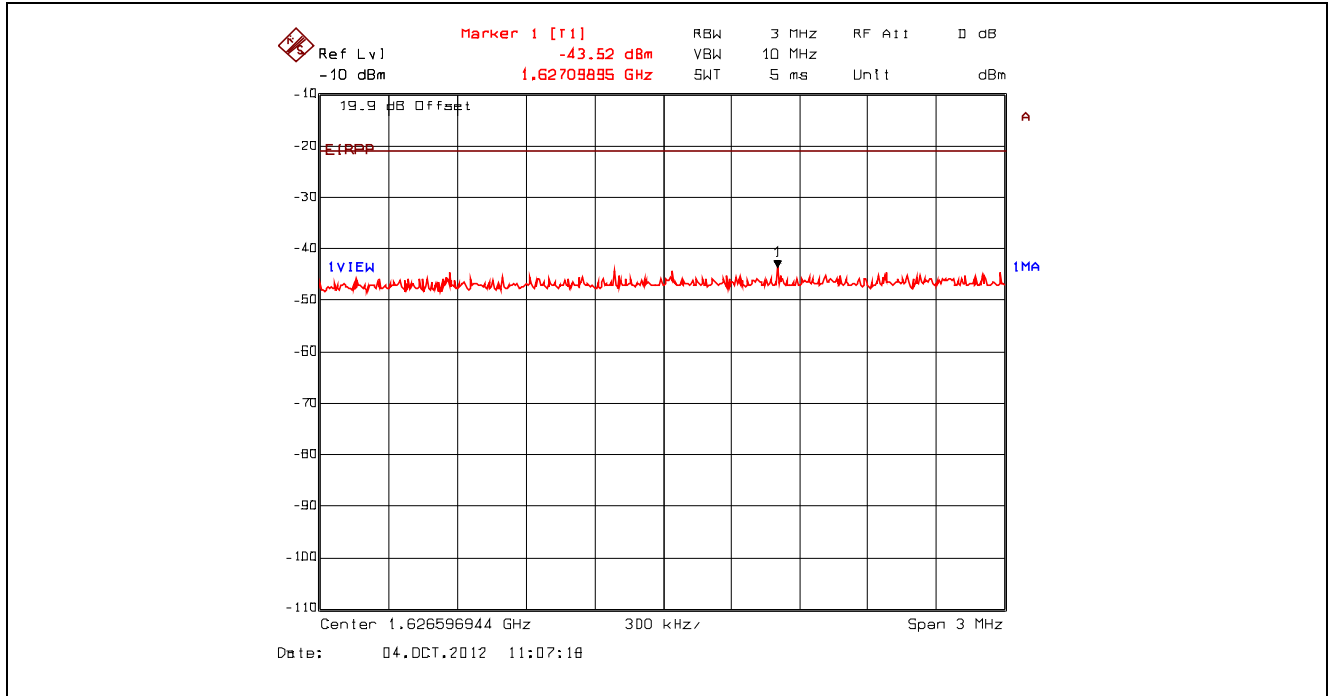

Plot 5.4.4.3.73. Conducted Spurious Emissions – Restricted Bands, 802.11n 800ns, 6.5 Mbps BPSK 1/2
 2442 MHz, Peak Power at 3.26 GHz with Band (Notch) Reject Filter

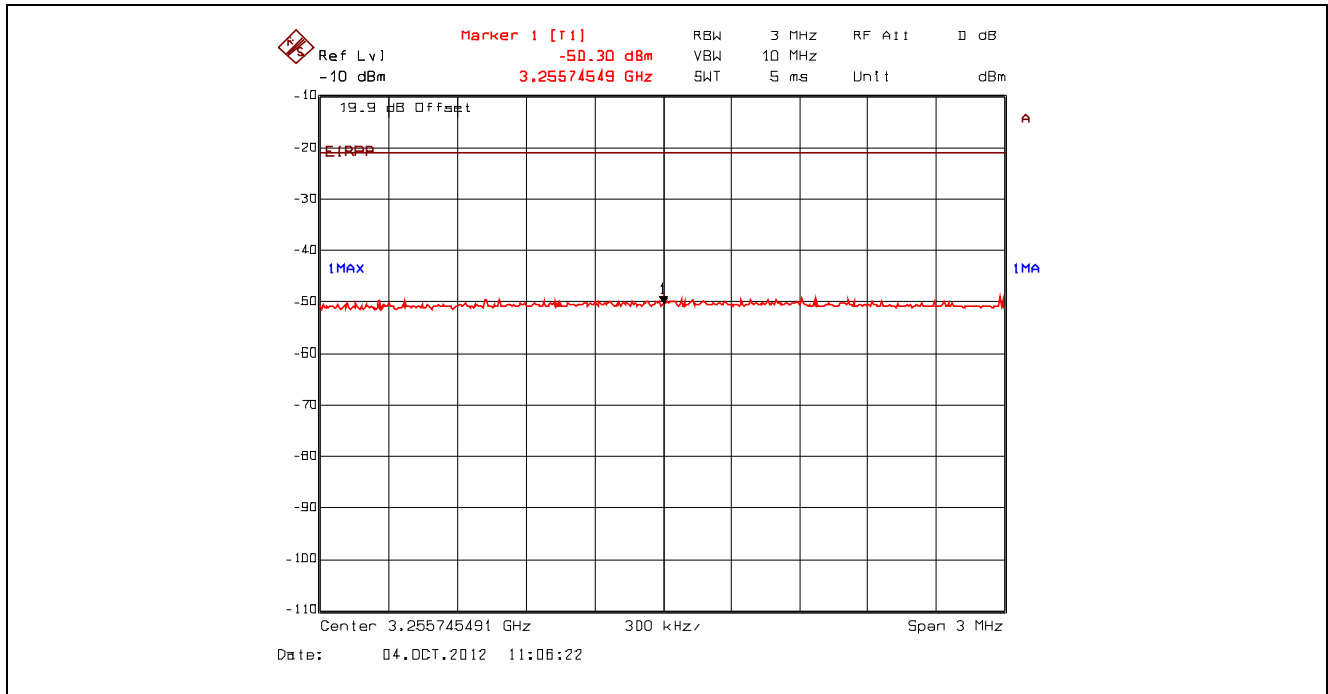

Plot 5.4.4.3.74. Conducted Spurious Emissions – Restricted Bands, 802.11n 800ns, 6.5 Mbps BPSK 1/2
2442 MHz, Peak Power at 4.89 GHz with High Pass Filter

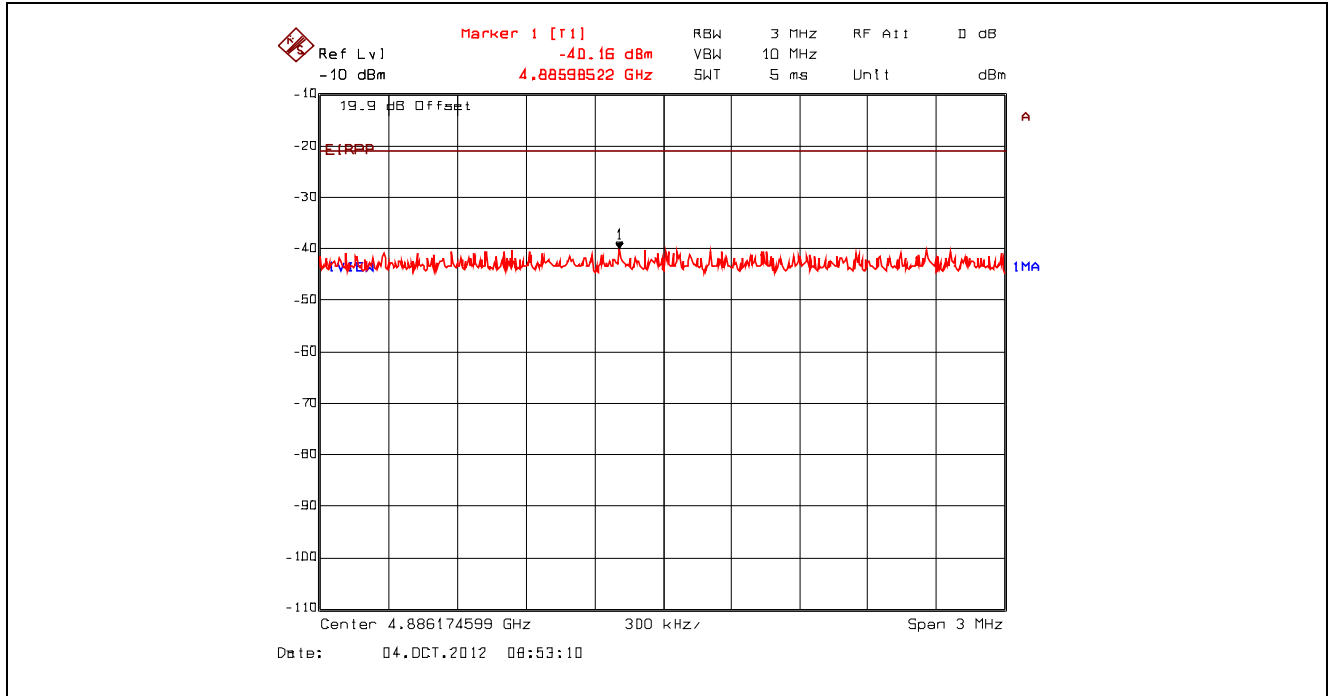

Plot 5.4.4.3.75. Conducted Spurious Emissions – Restricted Bands, 802.11n 800ns, 6.5 Mbps BPSK 1/2
2442 MHz, Peak Power at 9.76 GHz with High Pass Filter

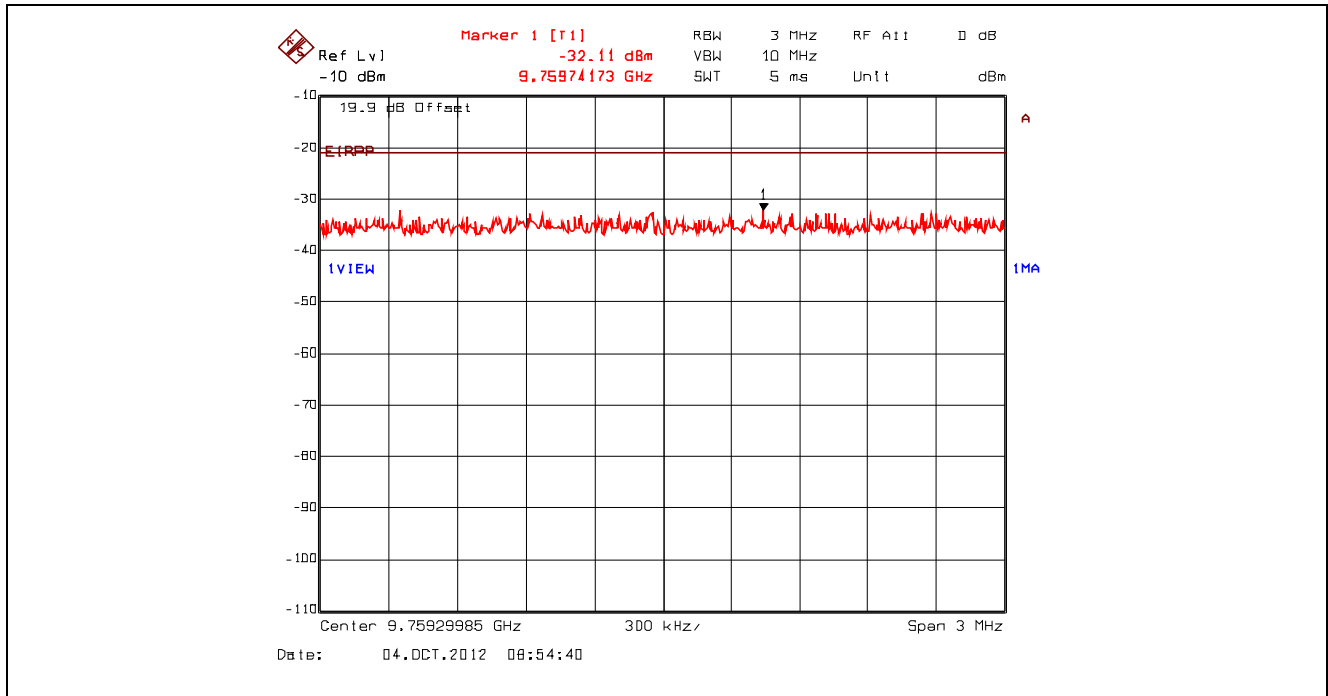

Plot 5.4.4.3.76. Conducted Spurious Emissions – Restricted Bands, 802.11n 800ns, 6.5 Mbps BPSK 1/2
 2462 MHz, 9 kHz - 150 kHz, Peak Detector with Band (Notch) Reject Filter

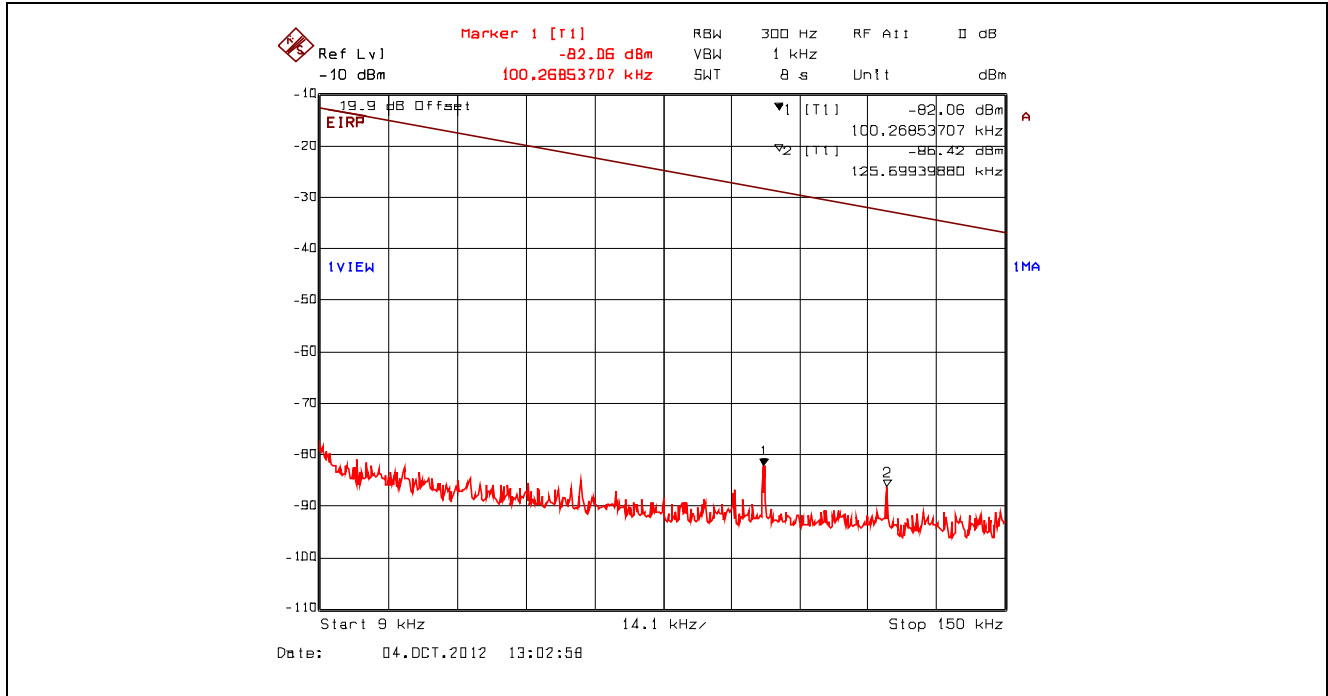

Plot 5.4.4.3.77. Conducted Spurious Emissions – Restricted Bands, 802.11n 800ns, 6.5 Mbps BPSK 1/2
 2462 MHz, 150 kHz - 30 MHz, Peak Detector with Band (Notch) Reject Filter

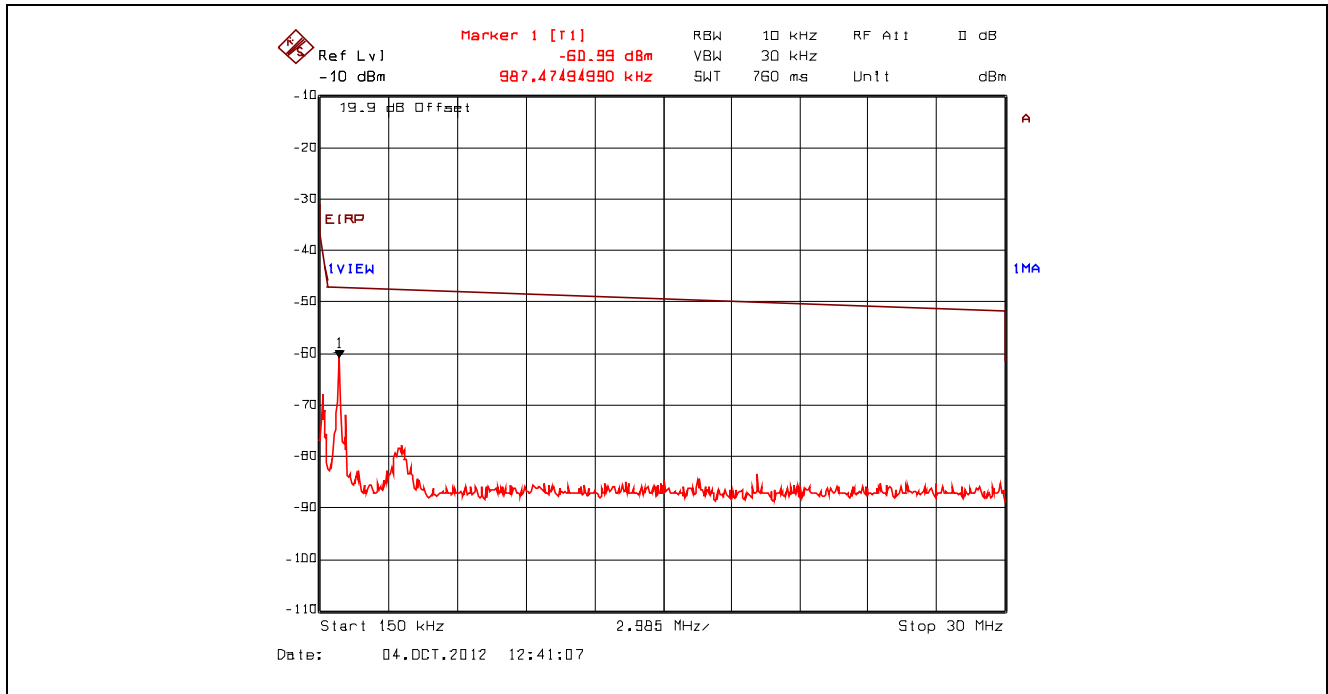

Plot 5.4.4.3.78. Conducted Spurious Emissions – Restricted Bands, 802.11n 800ns, 6.5 Mbps BPSK 1/2
 2462 MHz, 30 MHz - 1 GHz, Peak Detector with Band (Notch) Reject Filter

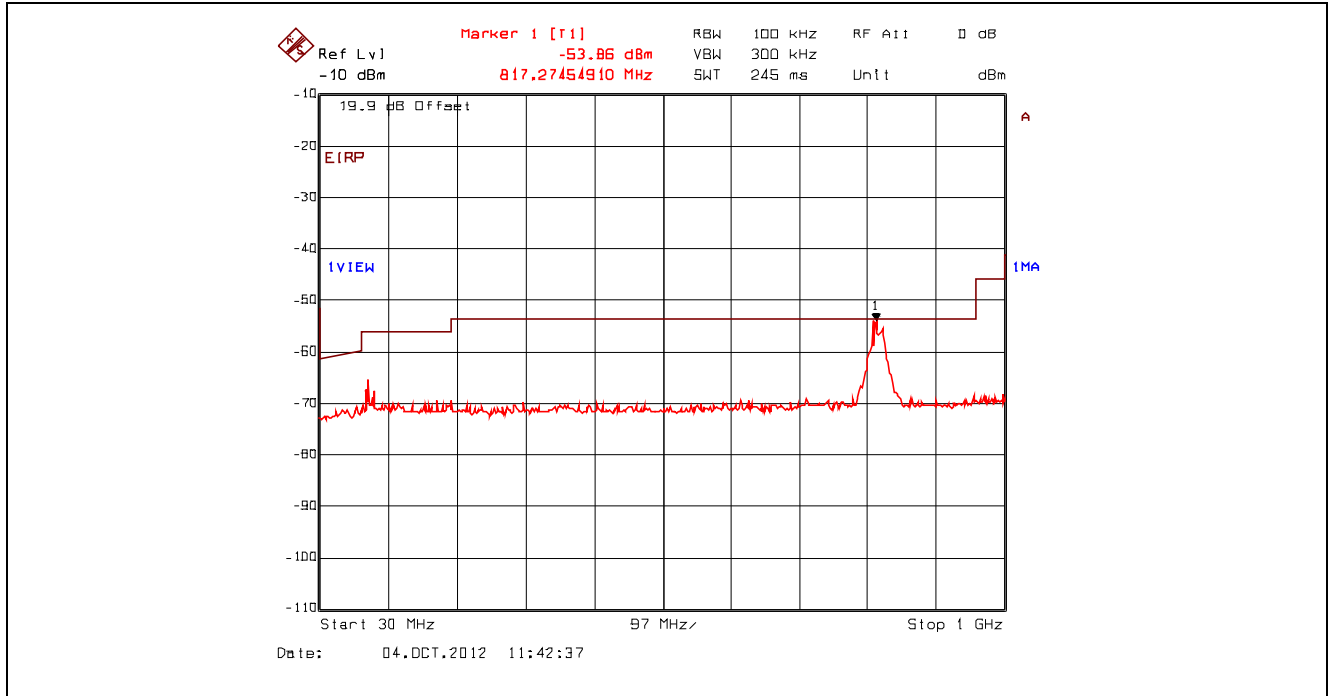

Plot 5.4.4.3.79. Conducted Spurious Emissions – Restricted Bands, 802.11n 800ns, 6.5 Mbps BPSK 1/2
 2462 MHz, QP Power at 821.55 MHz with Band (Notch) Reject Filter

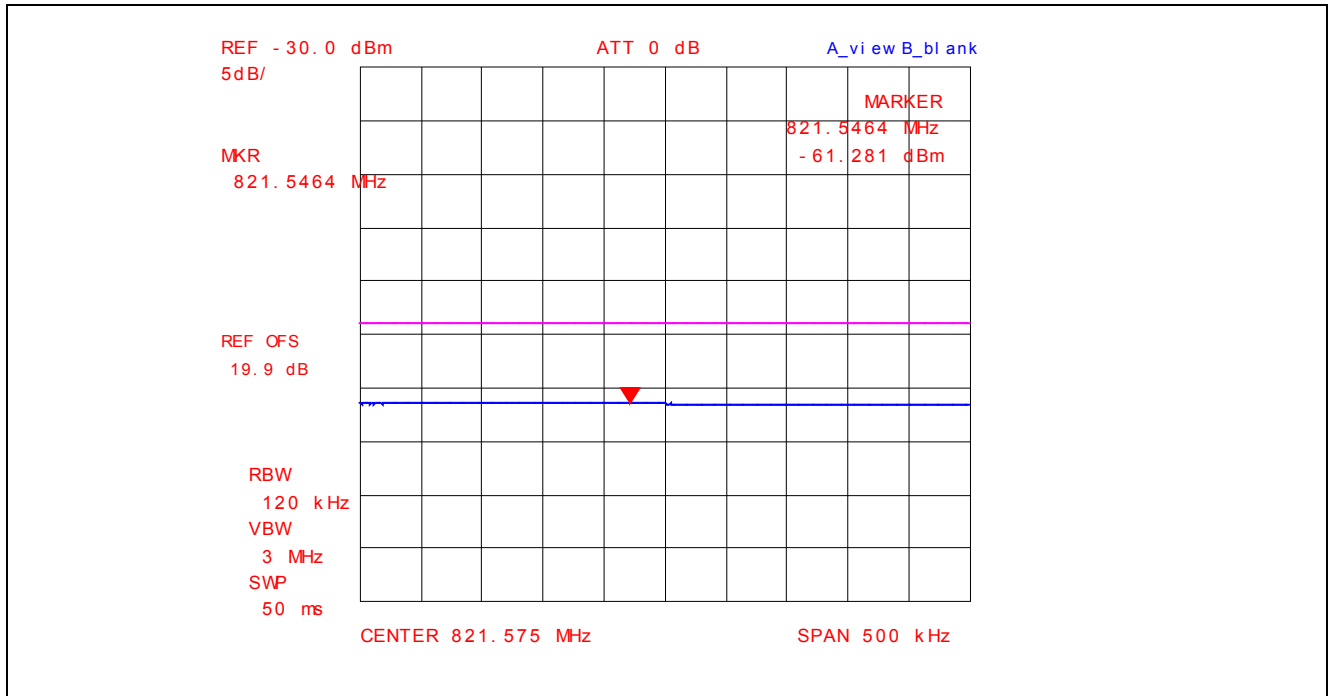

Plot 5.4.4.3.80. Conducted Spurious Emissions – Restricted Bands, 802.11n 800ns, 6.5 Mbps BPSK 1/2
 2462 MHz, 1 GHz - 4 GHz, Power Averaging with Band (Notch) Reject Filter

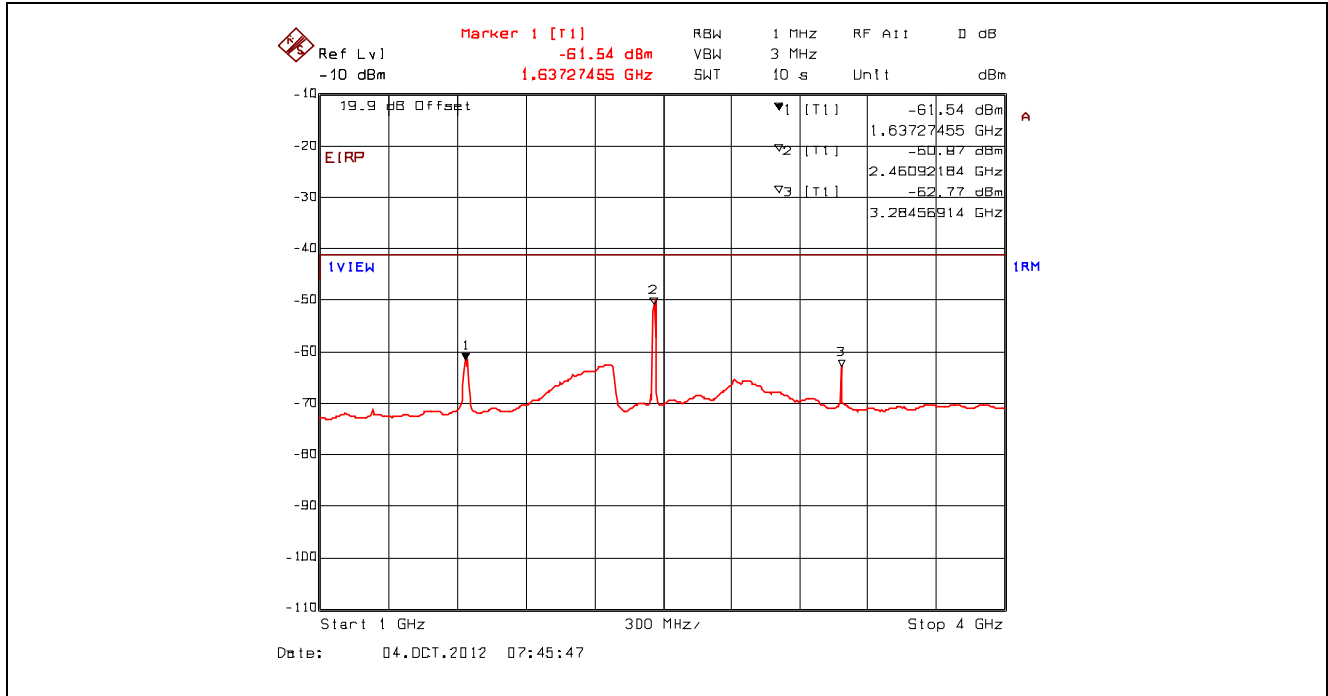

Plot 5.4.4.3.81. Conducted Spurious Emissions – Restricted Bands, 802.11n 800ns, 6.5 Mbps BPSK 1/2
 2462 MHz, 4 GHz - 25 GHz, Power Averaging with High Pass Filter

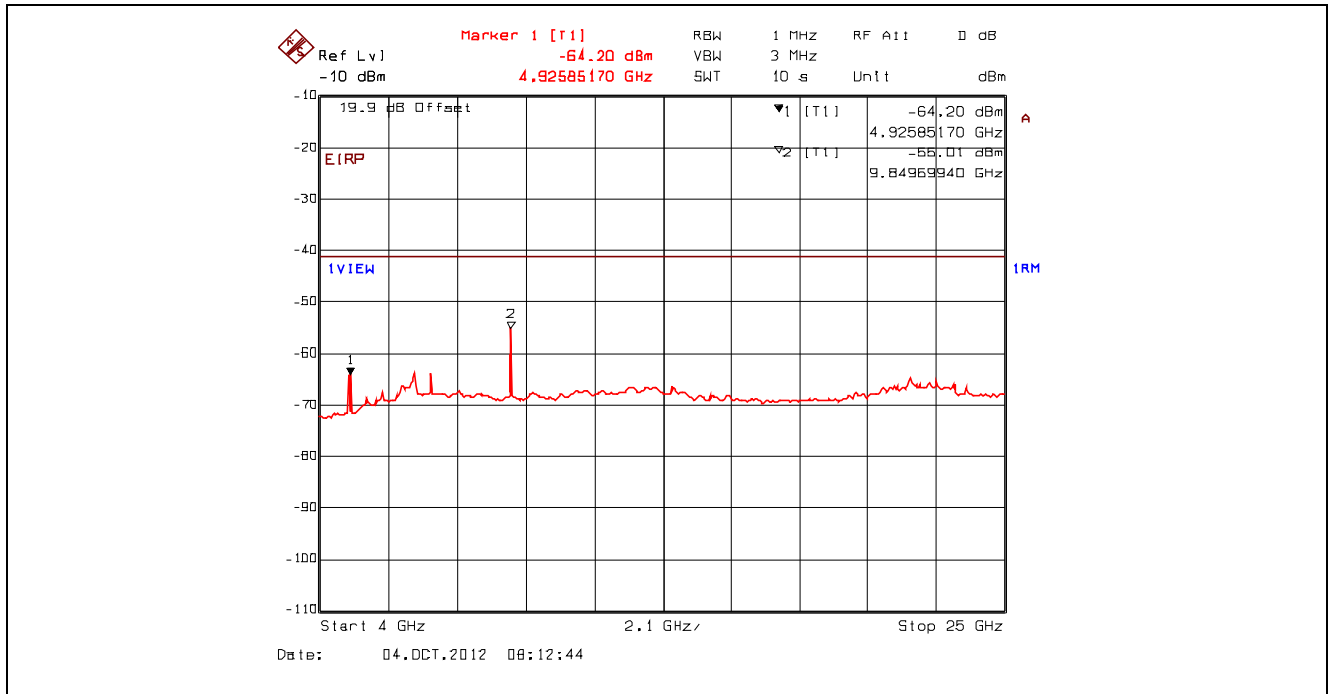

Plot 5.4.4.3.82. Conducted Spurious Emissions – Restricted Bands, 802.11n 800ns, 6.5 Mbps BPSK 1/2
 2462 MHz, Peak Power at 1.64 GHz with Band (Notch) Reject Filter

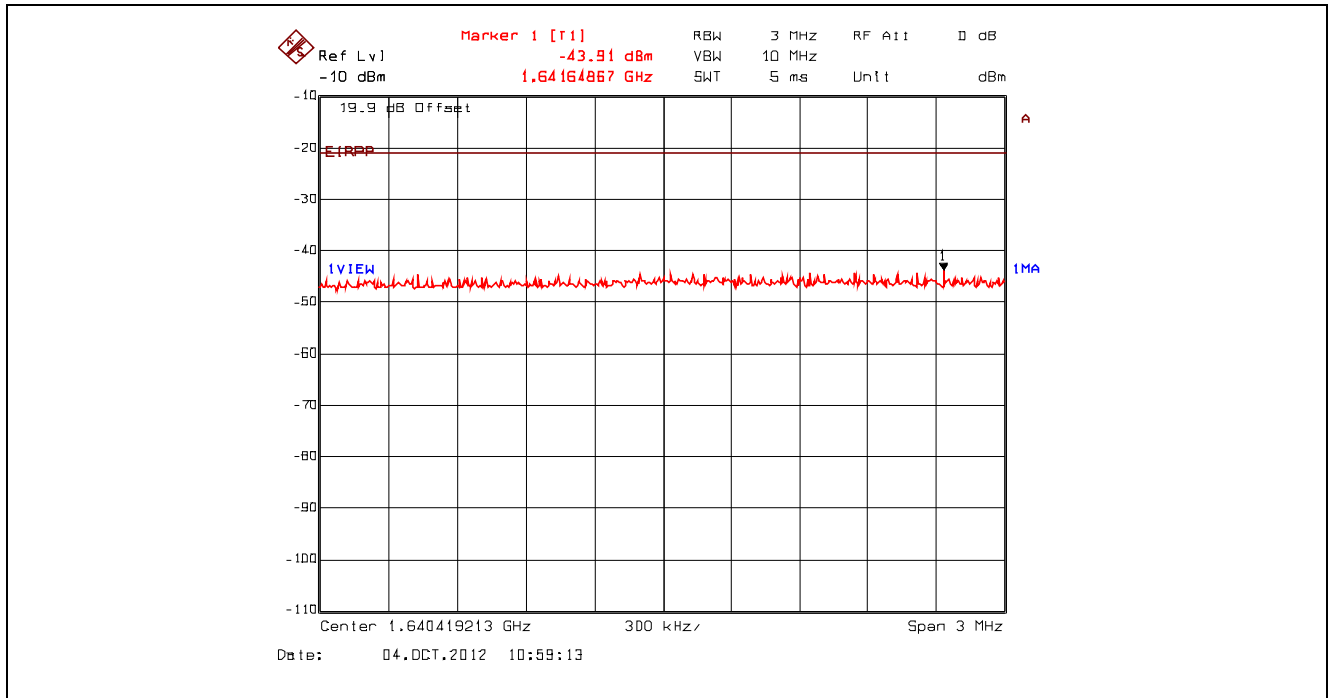

Plot 5.4.4.3.83. Conducted Spurious Emissions – Restricted Bands, 802.11n 800ns, 6.5 Mbps BPSK 1/2
 2462 MHz, Peak Power at 3.28 GHz with Band (Notch) Reject Filter

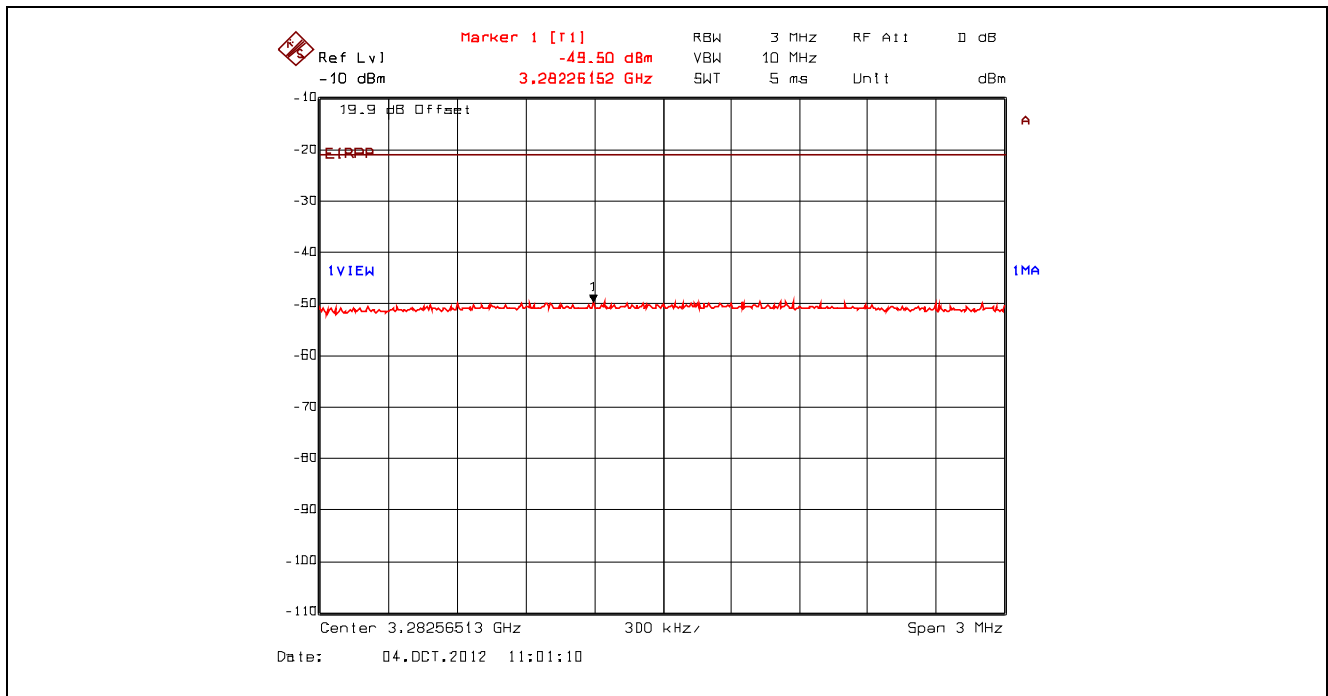

Plot 5.4.4.3.84. Conducted Spurious Emissions – Restricted Bands, 802.11n 800ns, 6.5 Mbps BPSK 1/2
2462 MHz, Peak Power at 4.92 GHz with High Pass Filter

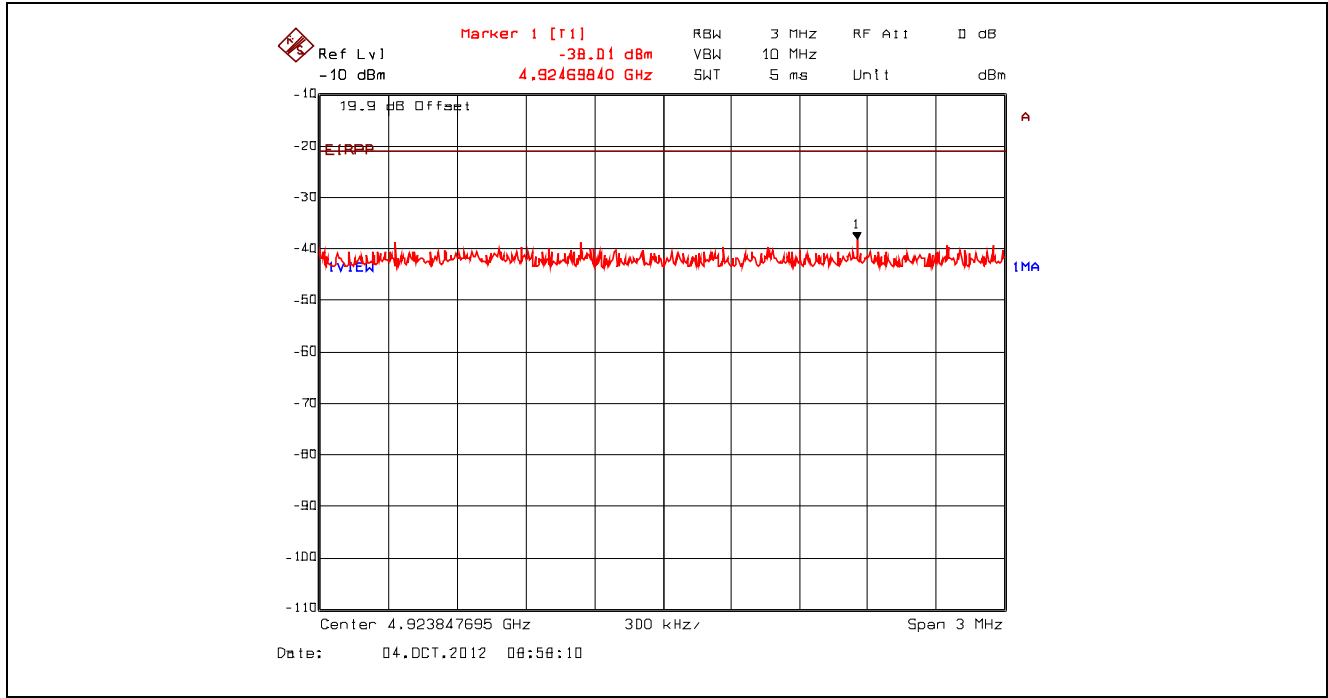

Plot 5.4.4.3.85. Conducted Spurious Emissions – Restricted Bands, 802.11n 800ns, 6.5 Mbps BPSK 1/2
2462 MHz, Peak Power at 9.86 GHz with High Pass Filter

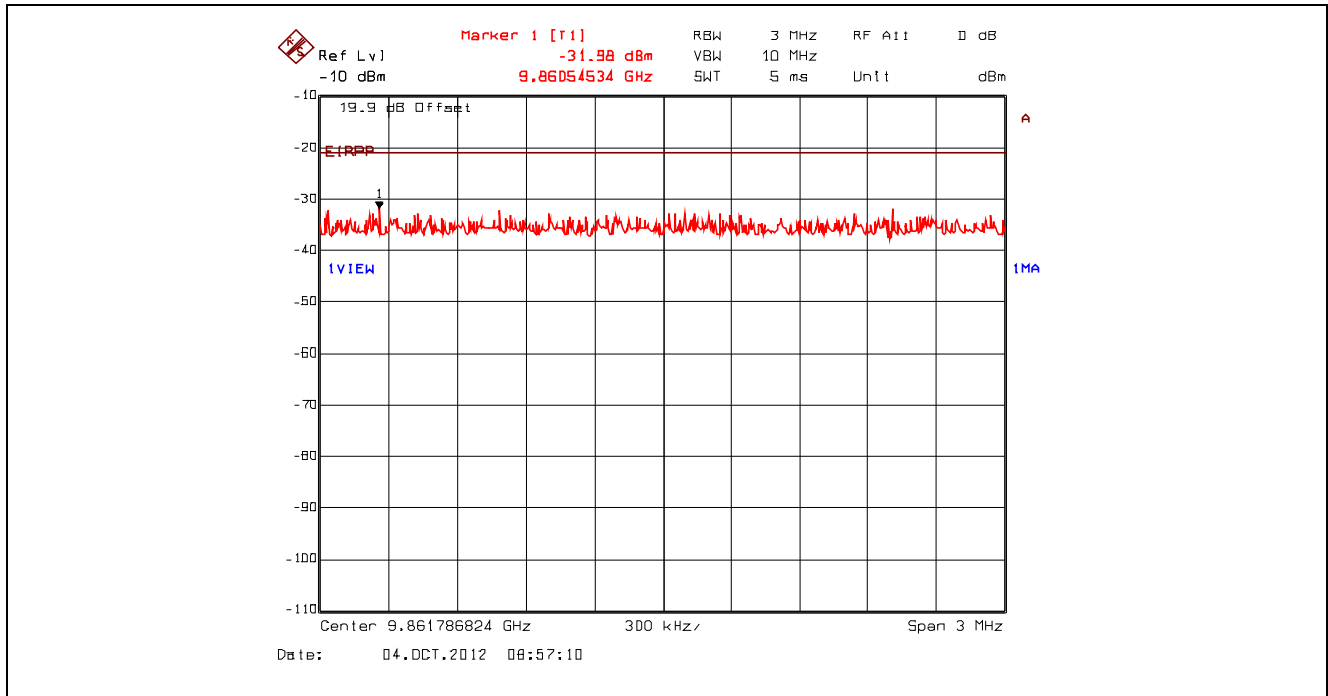

Plot 5.4.4.3.86. Conducted Spurious Emissions – Restricted Bands, 802.11n 400ns, 7.2 Mbps BPSK 1/2
 2412 MHz, 9 kHz - 150 kHz, Peak Detector with Band (Notch) Reject Filter

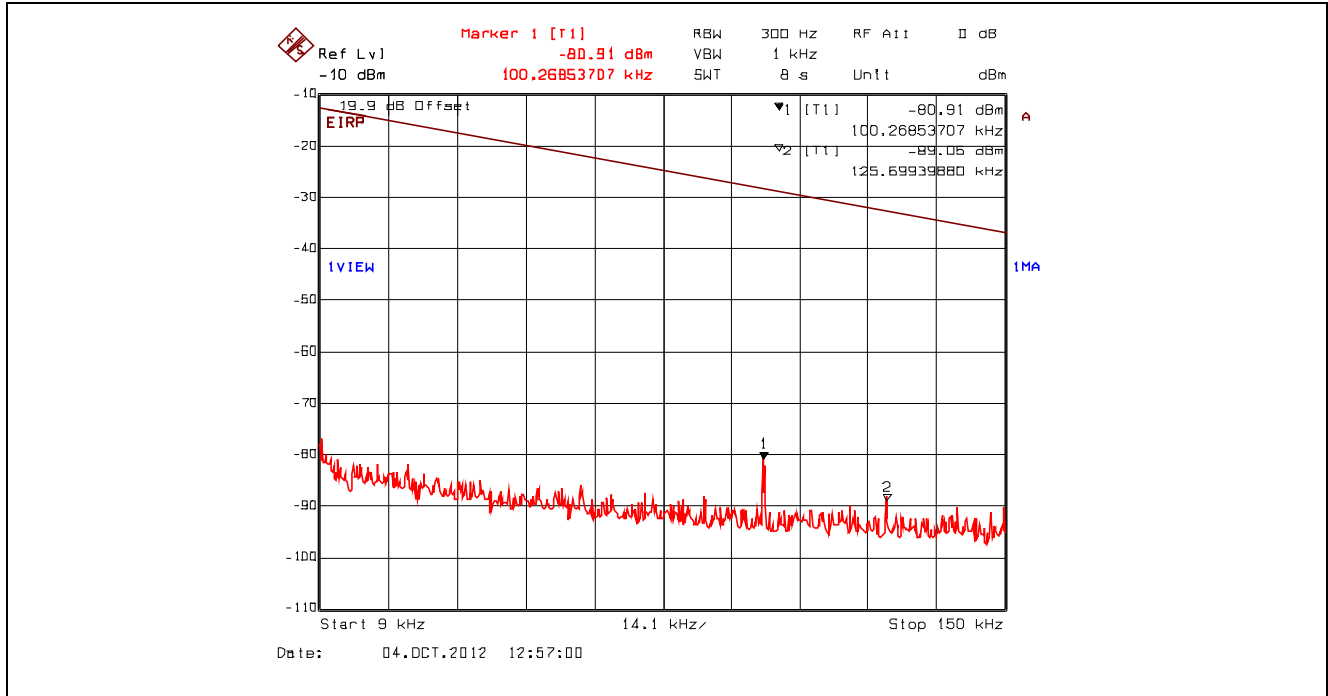

Plot 5.4.4.3.87. Conducted Spurious Emissions – Restricted Bands, 802.11n 400ns, 7.2 Mbps BPSK 1/2
 2412 MHz, 150 kHz - 30 MHz, Peak Detector with Band (Notch) Reject Filter

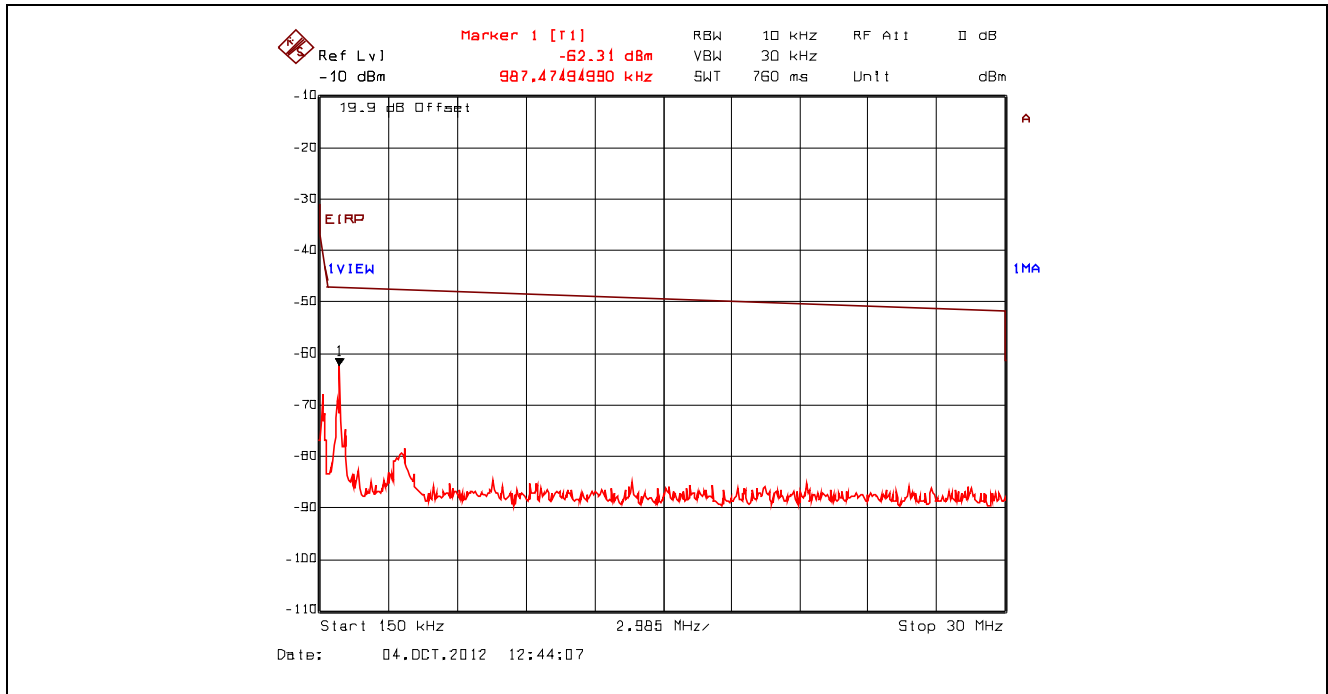

Plot 5.4.4.3.88. Conducted Spurious Emissions – Restricted Bands, 802.11n 400ns, 7.2 Mbps BPSK 1/2
 2412 MHz, 30 MHz - 1 GHz, Peak Detector with Band (Notch) Reject Filter

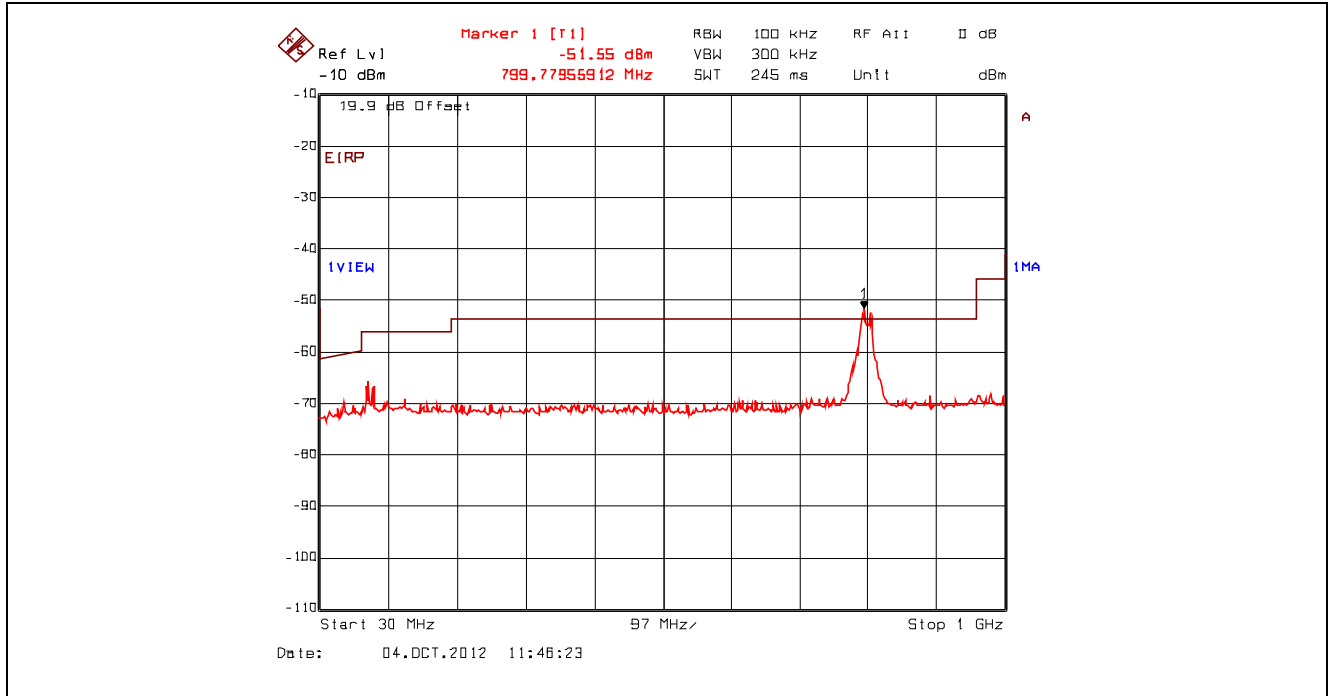

Plot 5.4.4.3.89. Conducted Spurious Emissions – Restricted Bands, 802.11n 400ns, 7.2 Mbps BPSK 1/2
 2412 MHz, QP Power at 799.01MHz with Band (Notch) Reject Filter

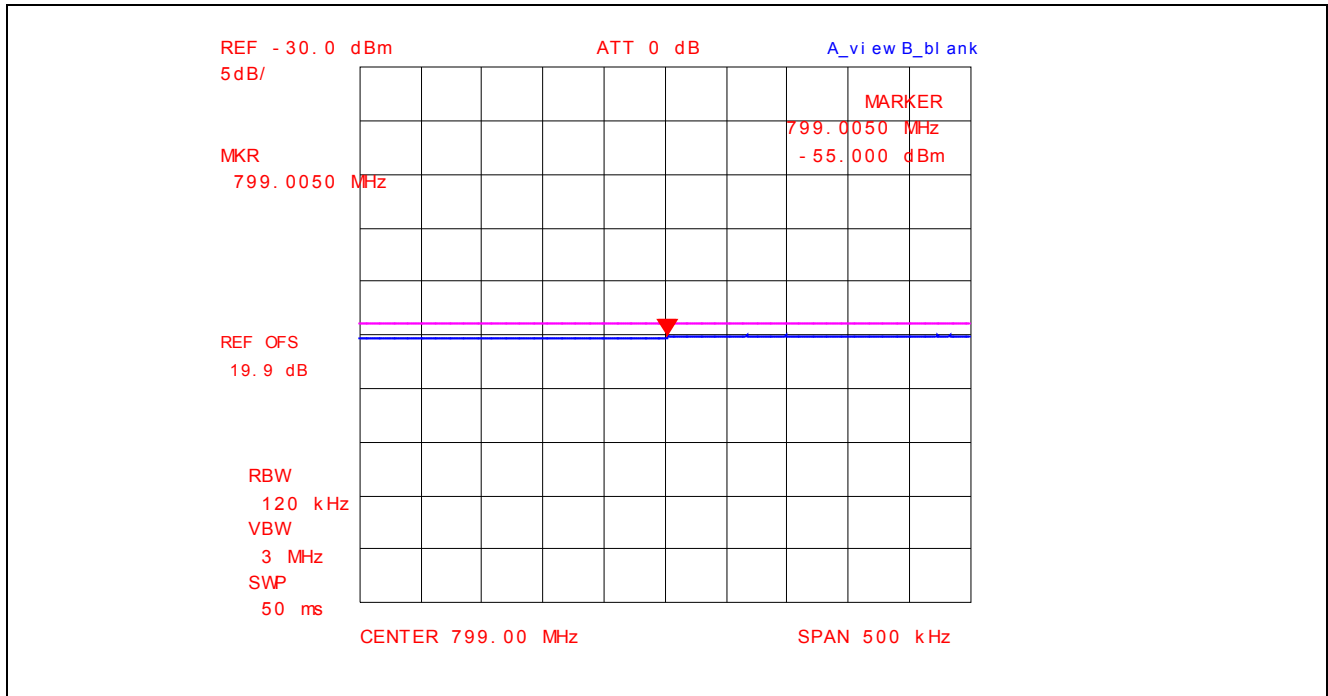

Plot 5.4.4.3.90. Conducted Spurious Emissions – Restricted Bands, 802.11n 400ns, 7.2 Mbps BPSK 1/2
 2412 MHz, 1 GHz - 4 GHz, Power Averaging with Band (Notch) Reject Filter

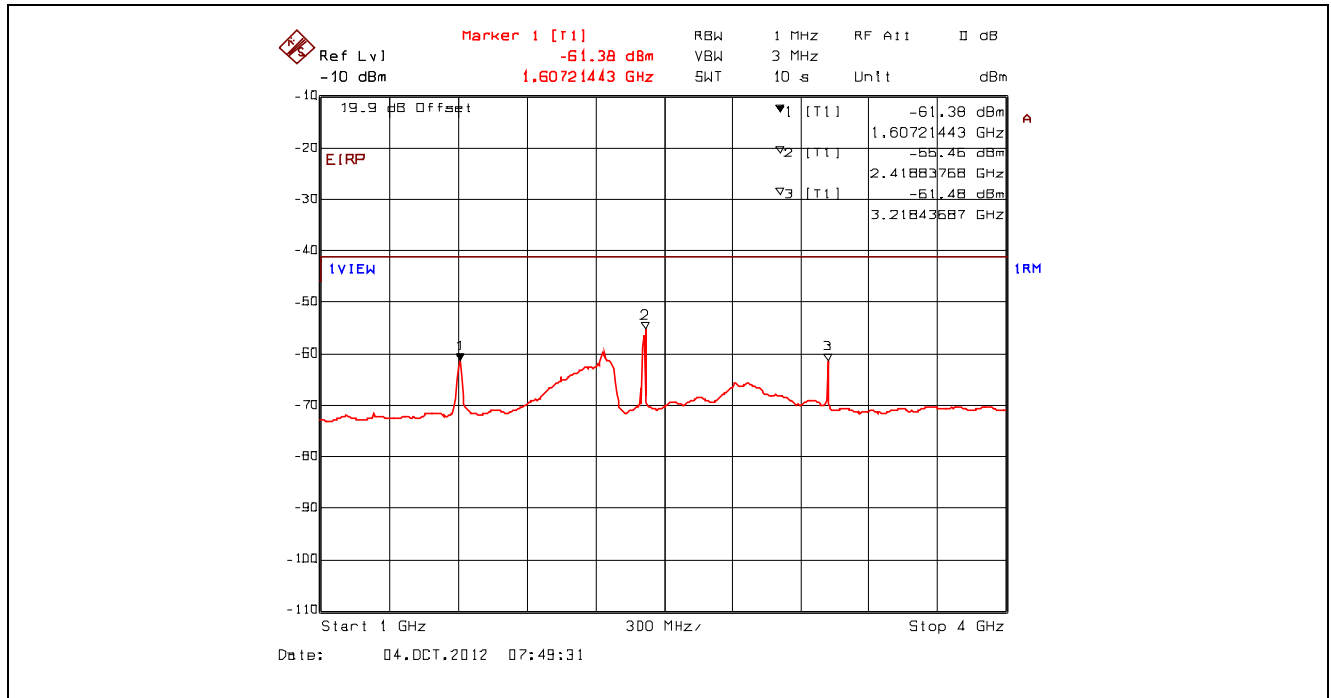

Plot 5.4.4.3.91. Conducted Spurious Emissions – Restricted Bands, 802.11n 400ns, 7.2 Mbps BPSK 1/2
 2412 MHz, 4 GHz - 25 GHz, Power Averaging with High Pass Filter

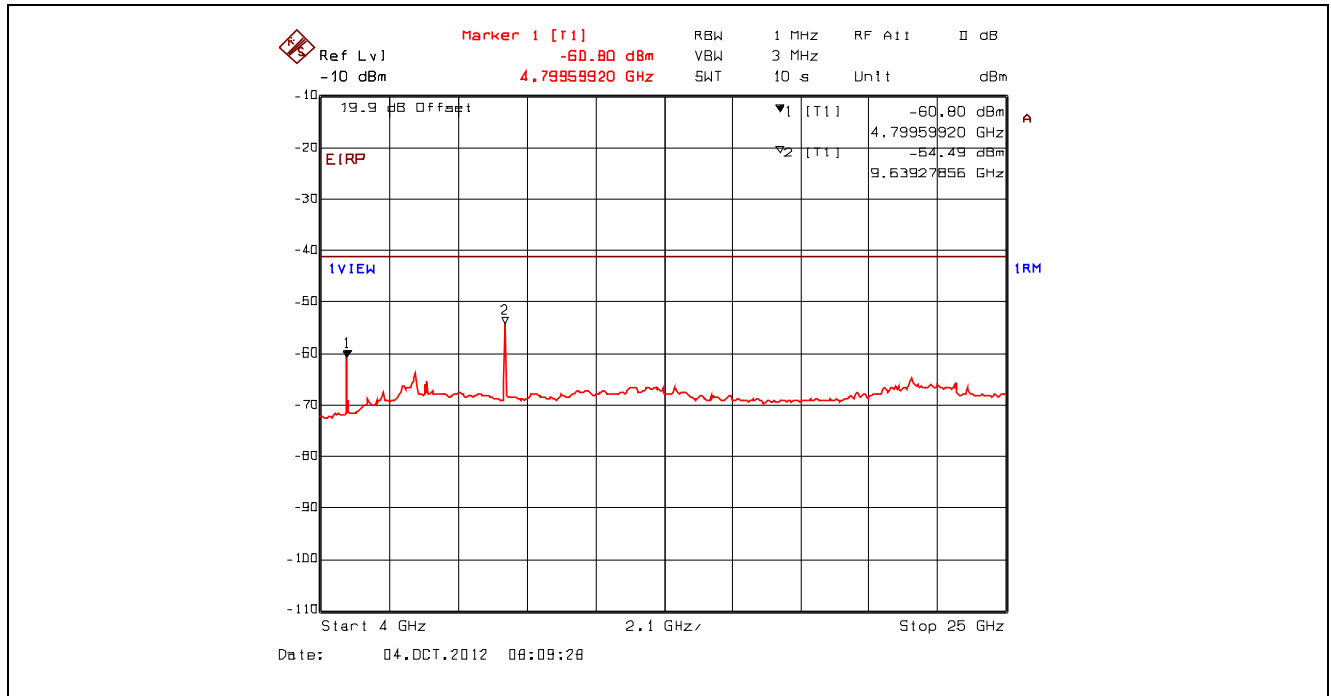

Plot 5.4.4.3.92. Conducted Spurious Emissions – Restricted Bands, 802.11n 400ns, 7.2 Mbps BPSK 1/2
2412 MHz, Peak Power at 1.61 GHz with Band (Notch) Reject Filter

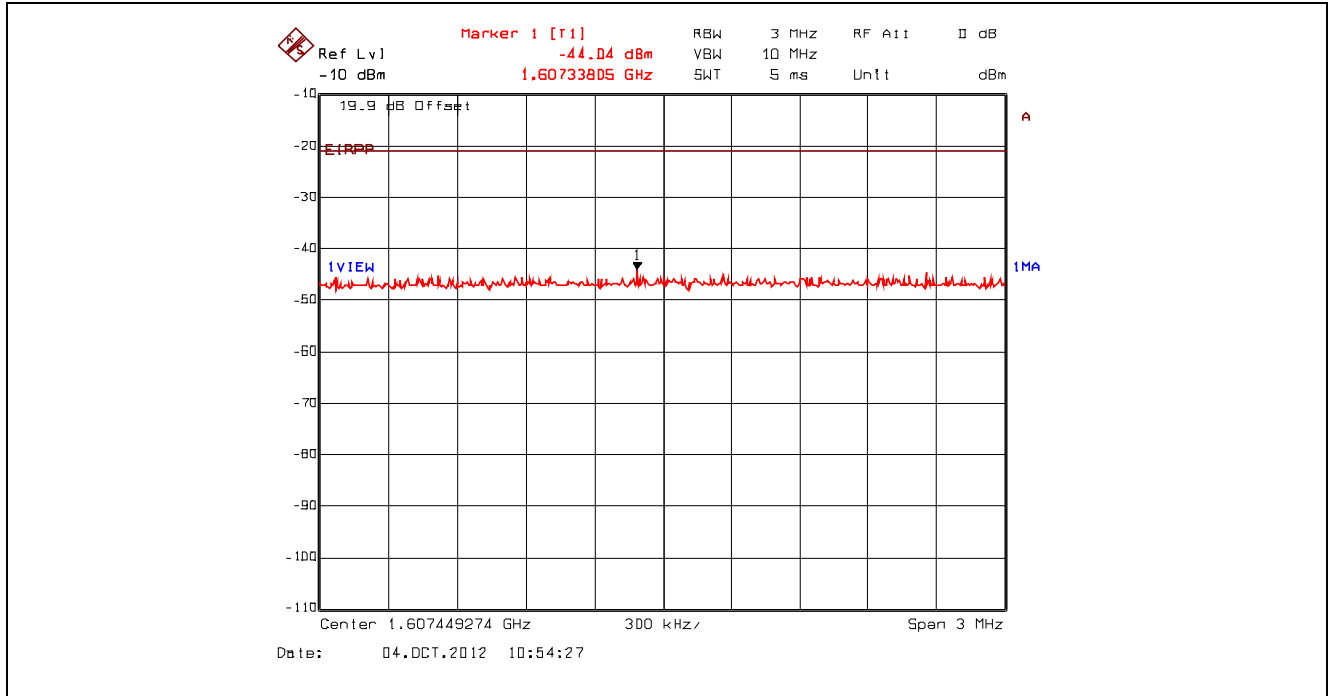

Plot 5.4.4.3.93. Conducted Spurious Emissions – Restricted Bands, 802.11n 400ns, 7.2 Mbps BPSK 1/2
2412 MHz, Peak Power at 3.22 GHz with Band (Notch) Reject Filter

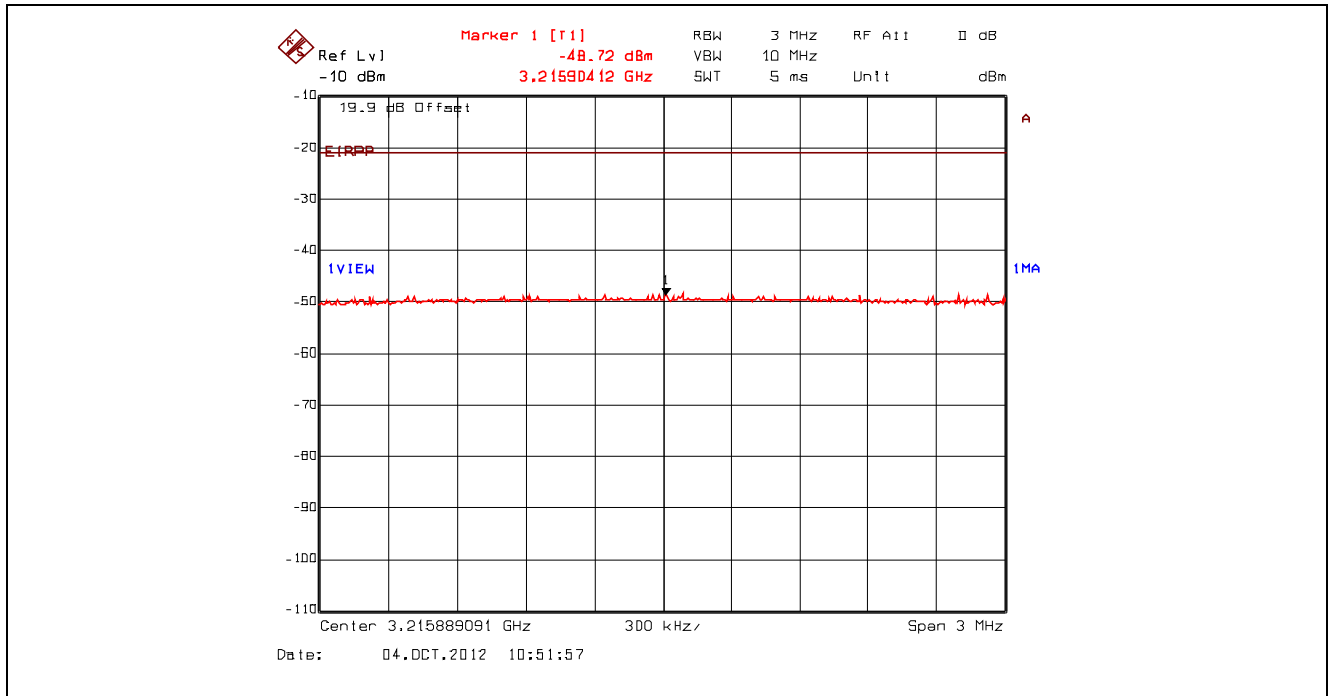

Plot 5.4.4.3.94. Conducted Spurious Emissions – Restricted Bands, 802.11n 400ns, 7.2 Mbps BPSK 1/2
2412 MHz, Peak Power at 4.83 GHz with High Pass Filter

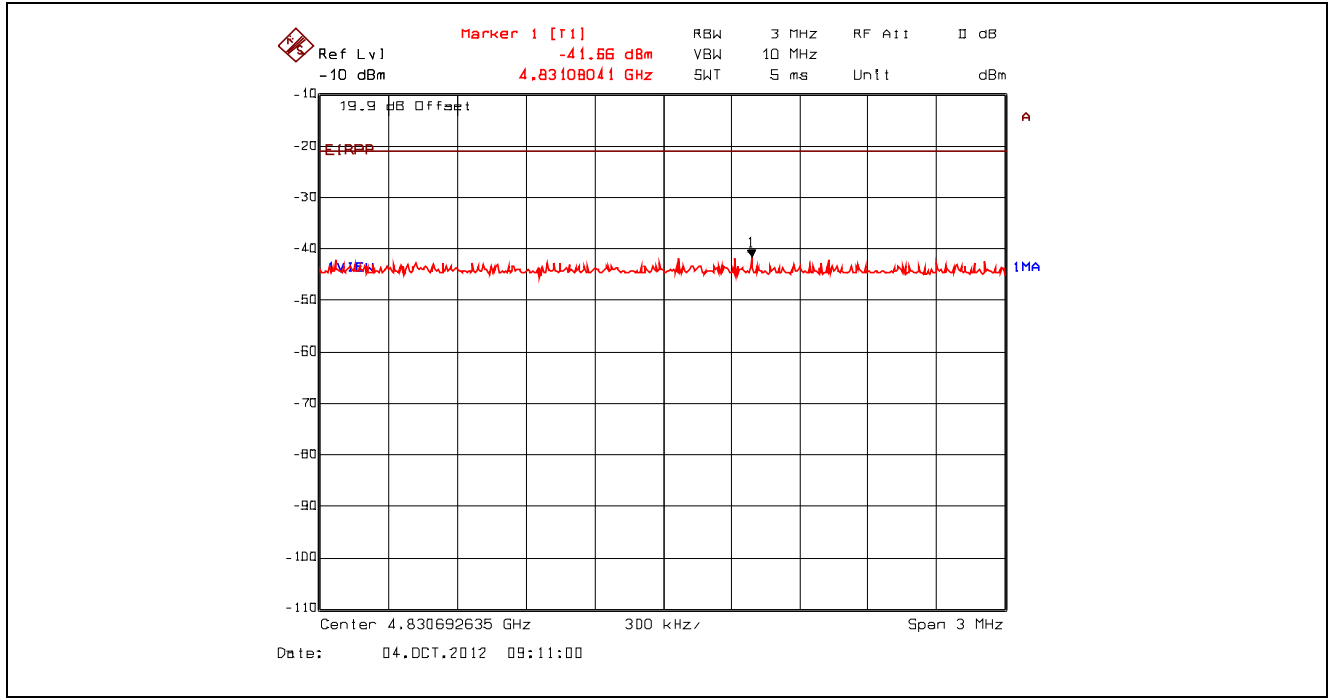

Plot 5.4.4.3.95. Conducted Spurious Emissions – Restricted Bands, 802.11n 400ns, 7.2 Mbps BPSK 1/2
2412 MHz, Peak Power at 9.64 GHz with High Pass Filter

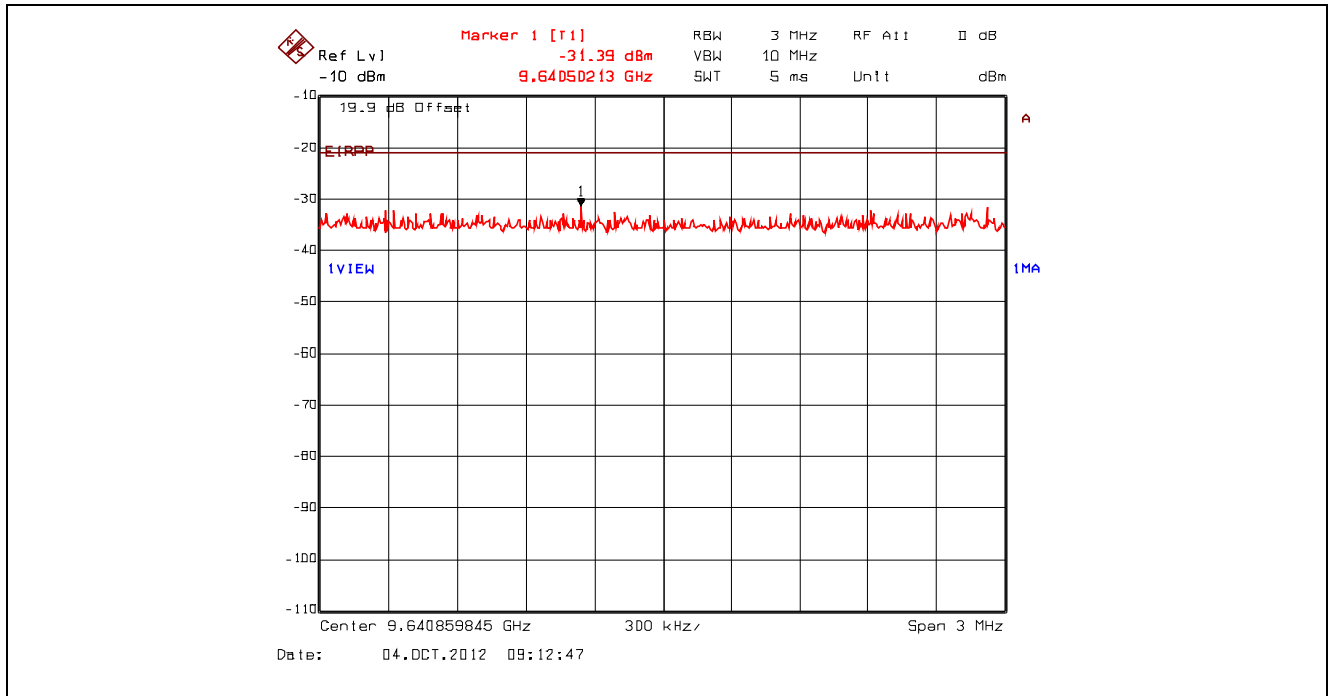

Plot 5.4.4.3.96. Conducted Spurious Emissions – Restricted Bands, 802.11n 400ns, 7.2 Mbps BPSK 1/2
 2442 MHz, 9 kHz - 150 kHz, Peak Detector with Band (Notch) Reject Filter

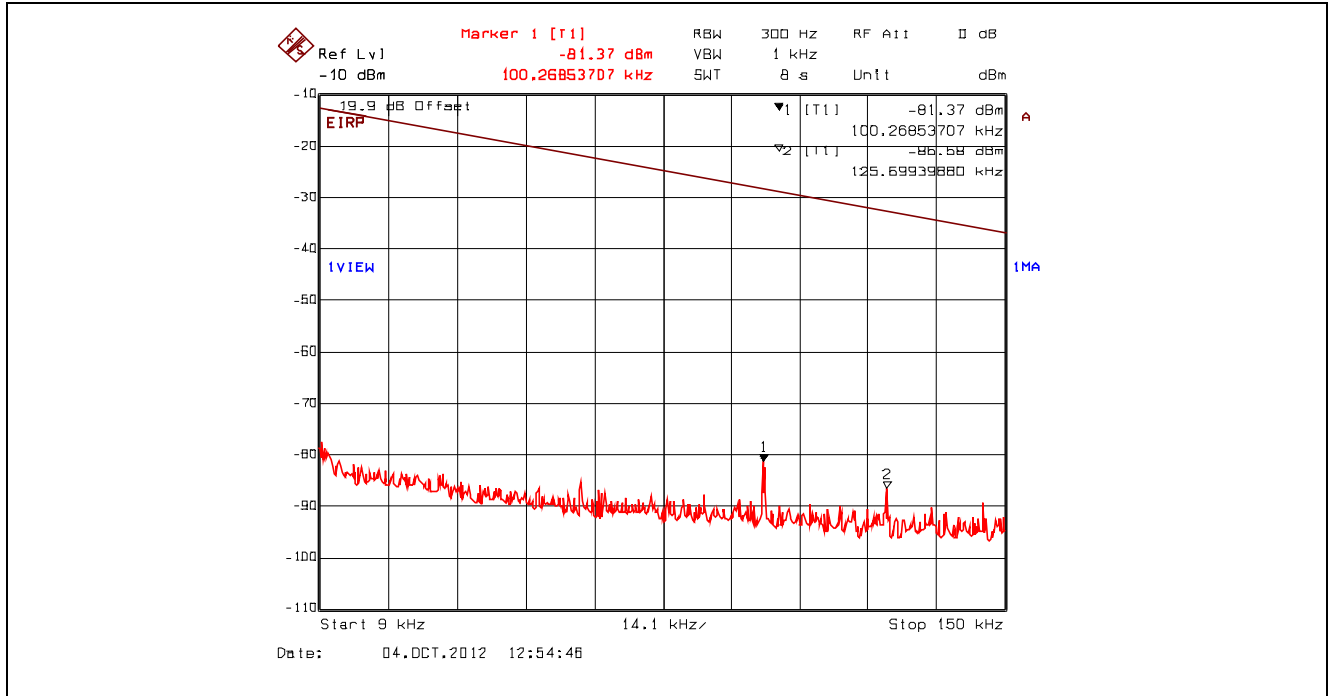

Plot 5.4.4.3.97. Conducted Spurious Emissions – Restricted Bands, 802.11n 400ns, 7.2 Mbps BPSK 1/2
 2442 MHz, 150 kHz - 30 MHz, Peak Detector with Band (Notch) Reject Filter

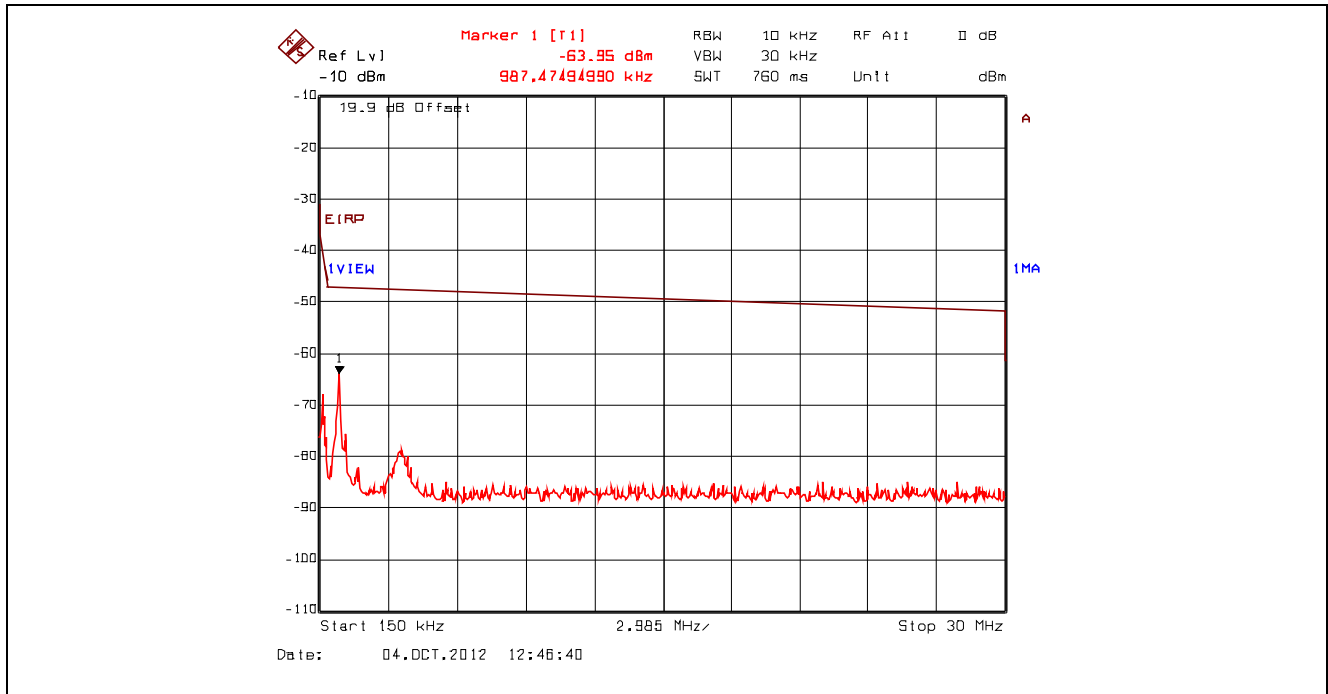

Plot 5.4.4.3.98. Conducted Spurious Emissions – Restricted Bands, 802.11n 400ns, 7.2 Mbps BPSK 1/2
 2442 MHz, 30 MHz - 1 GHz, Peak Detector with Band (Notch) Reject Filter

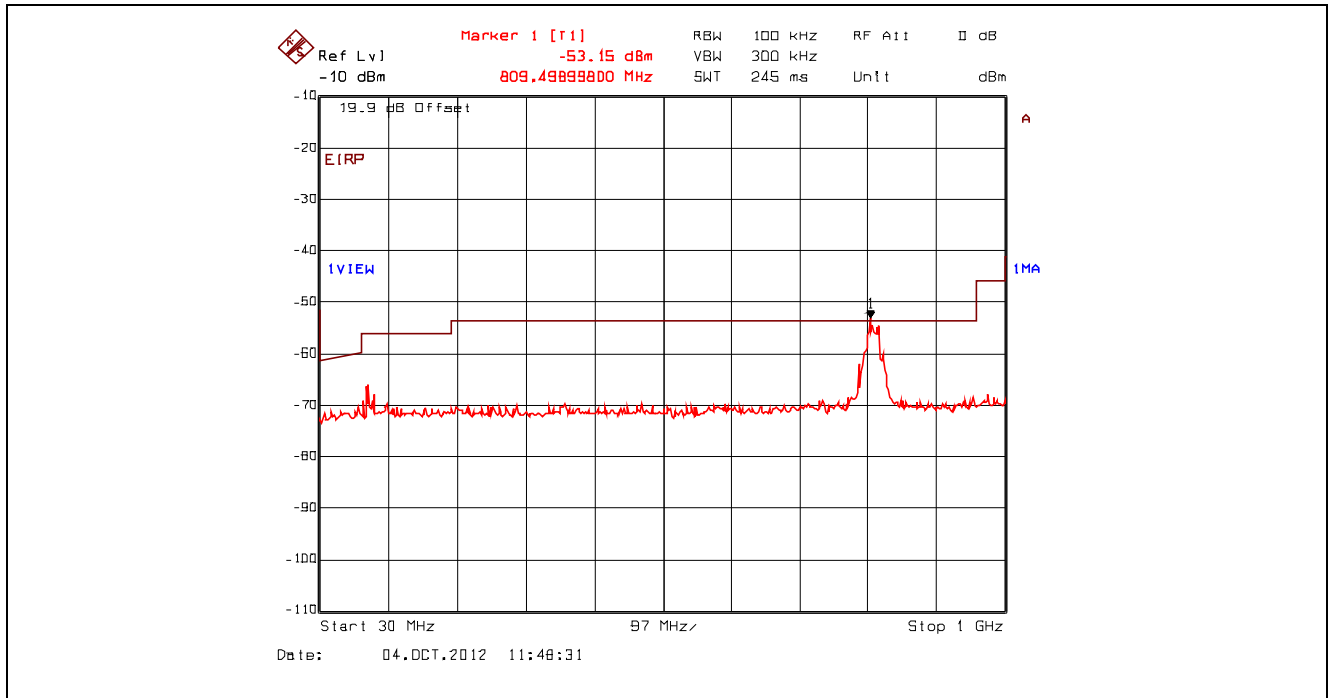

Plot 5.4.4.3.99. Conducted Spurious Emissions – Restricted Bands, 802.11n 400ns, 7.2 Mbps BPSK 1/2
 2442 MHz, QP Power at 808.98 MHz with Band (Notch) Reject Filter

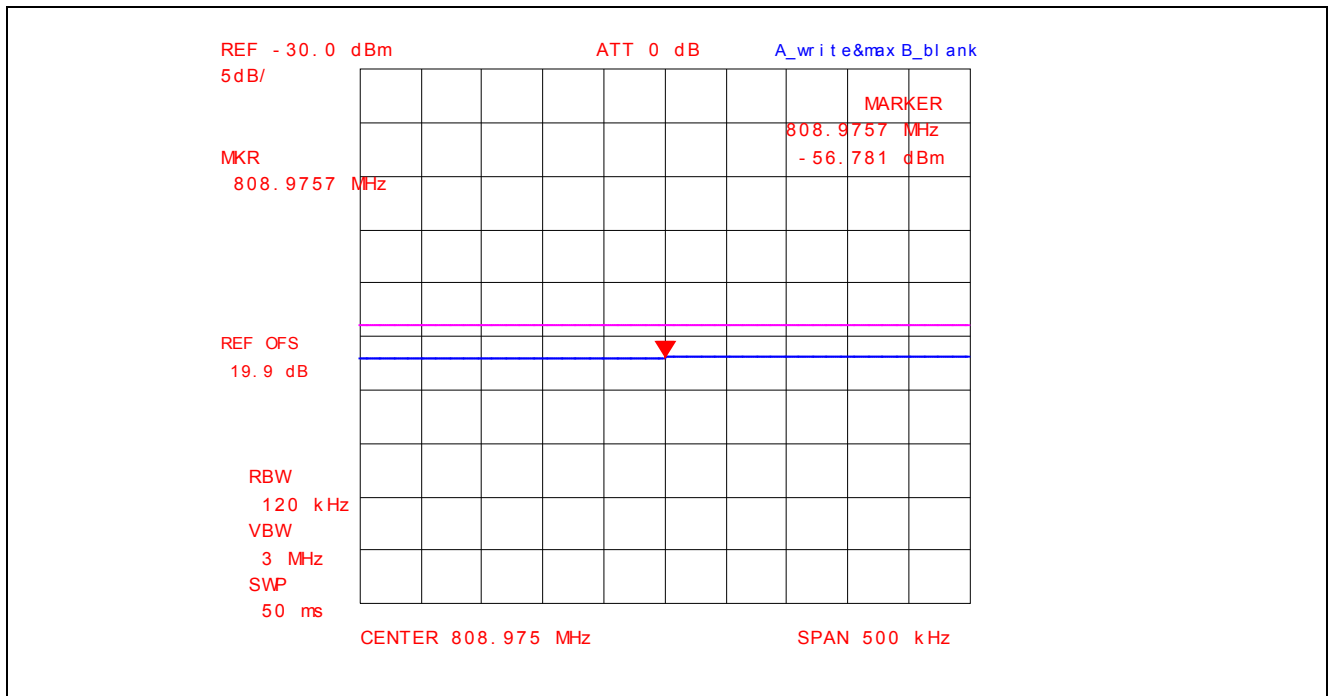

Plot 5.4.4.3.100. Conducted Spurious Emissions – Restricted Bands, 802.11n 400ns, 7.2 Mbps BPSK 1/2
 2442 MHz, 1 GHz - 4 GHz, Power Averaging with Band (Notch) Reject Filter

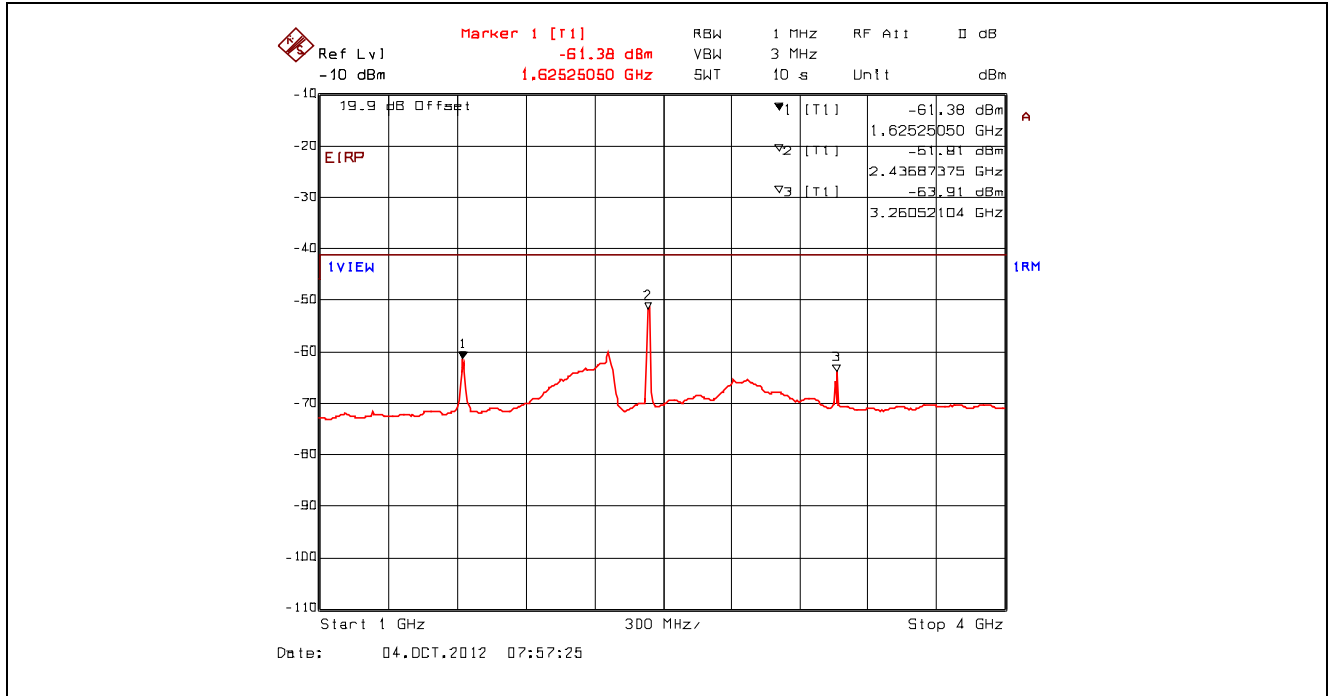

Plot 5.4.4.3.101. Conducted Spurious Emissions – Restricted Bands, 802.11n 400ns, 7.2 Mbps BPSK 1/2
 2442 MHz, 4 GHz - 25 GHz, Power Averaging with High Pass Filter

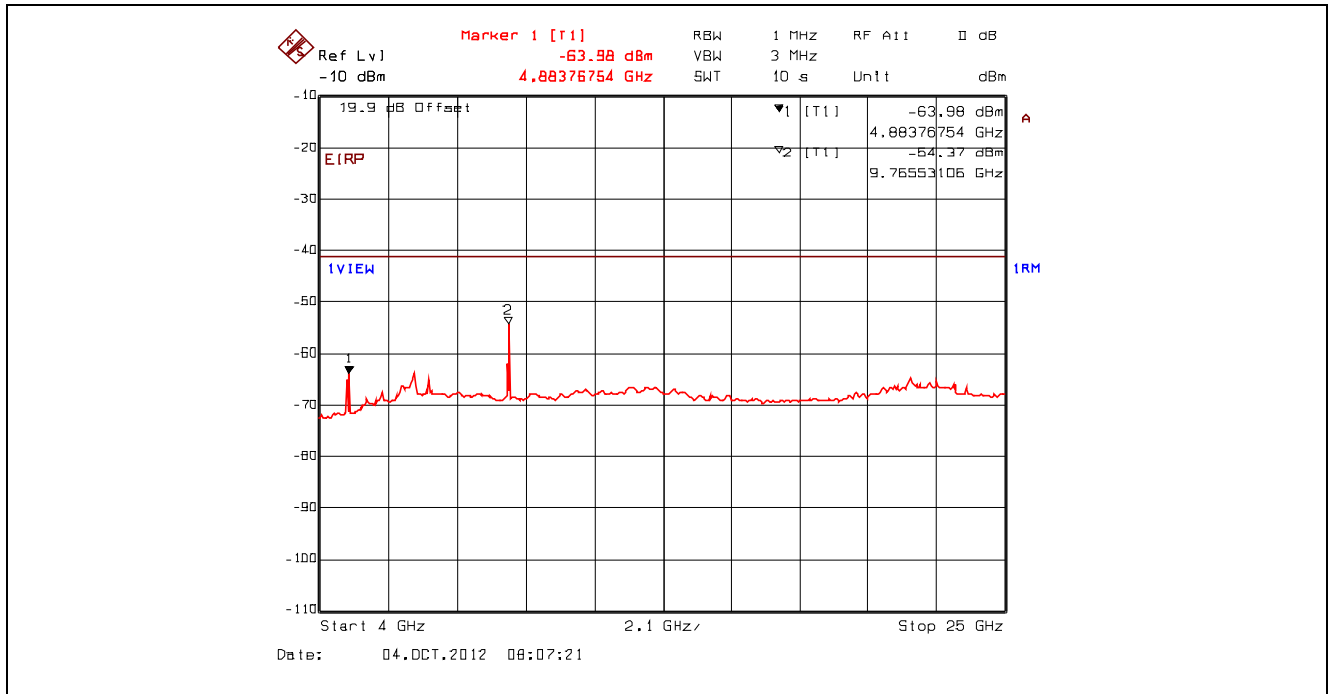

Plot 5.4.4.3.102. Conducted Spurious Emissions – Restricted Bands, 802.11n 400ns, 7.2 Mbps BPSK 1/2
2442 MHz, Peak Power at 1.63 GHz with Band (Notch) Reject Filter

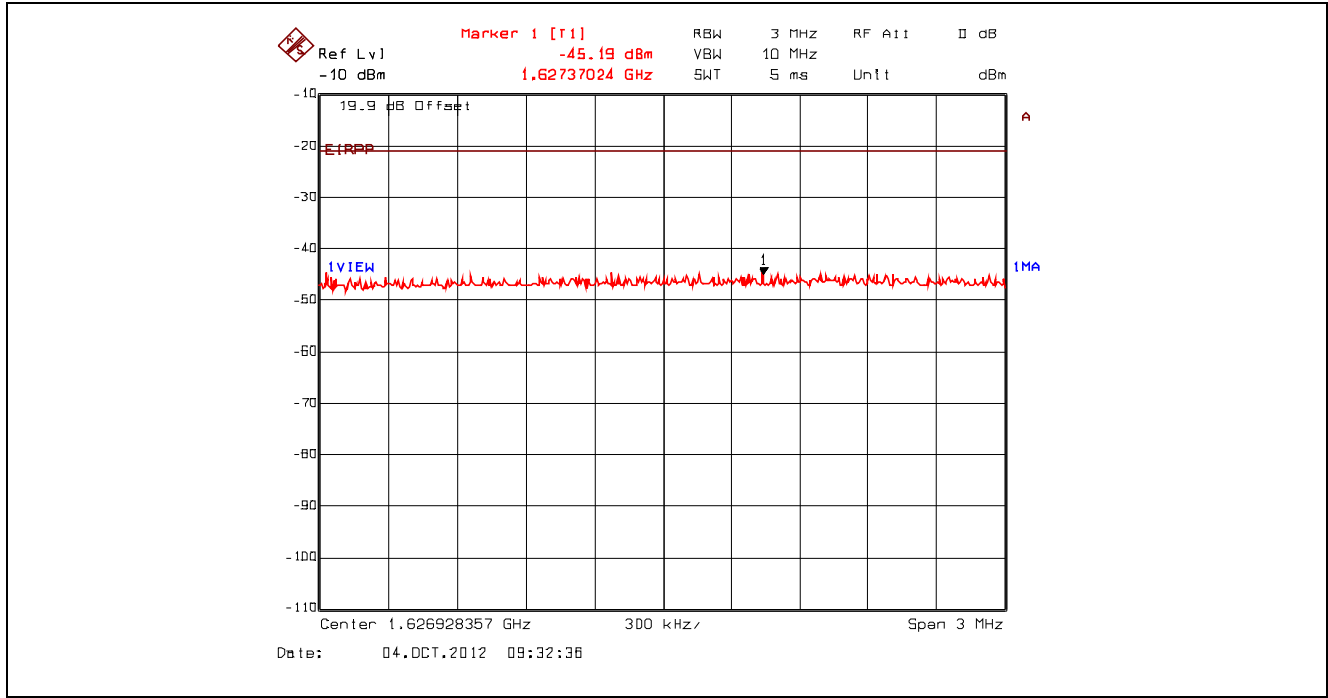

Plot 5.4.4.3.103. Conducted Spurious Emissions – Restricted Bands, 802.11n 400ns, 7.2 Mbps BPSK 1/2
2442 MHz, Peak Power at 3.26 GHz with Band (Notch) Reject Filter

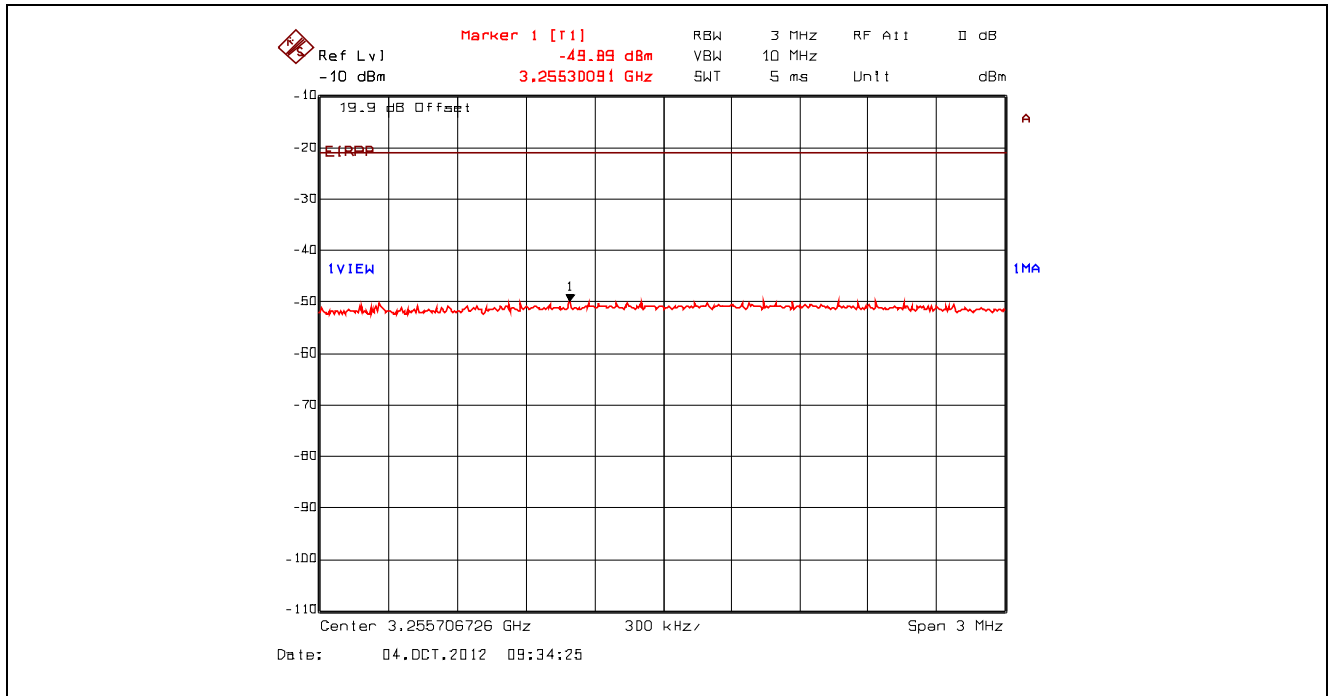

Plot 5.4.4.3.104. Conducted Spurious Emissions – Restricted Bands, 802.11n 400ns, 7.2 Mbps BPSK 1/2
2442 MHz, Peak Power at 4.88 GHz with High Pass Filter

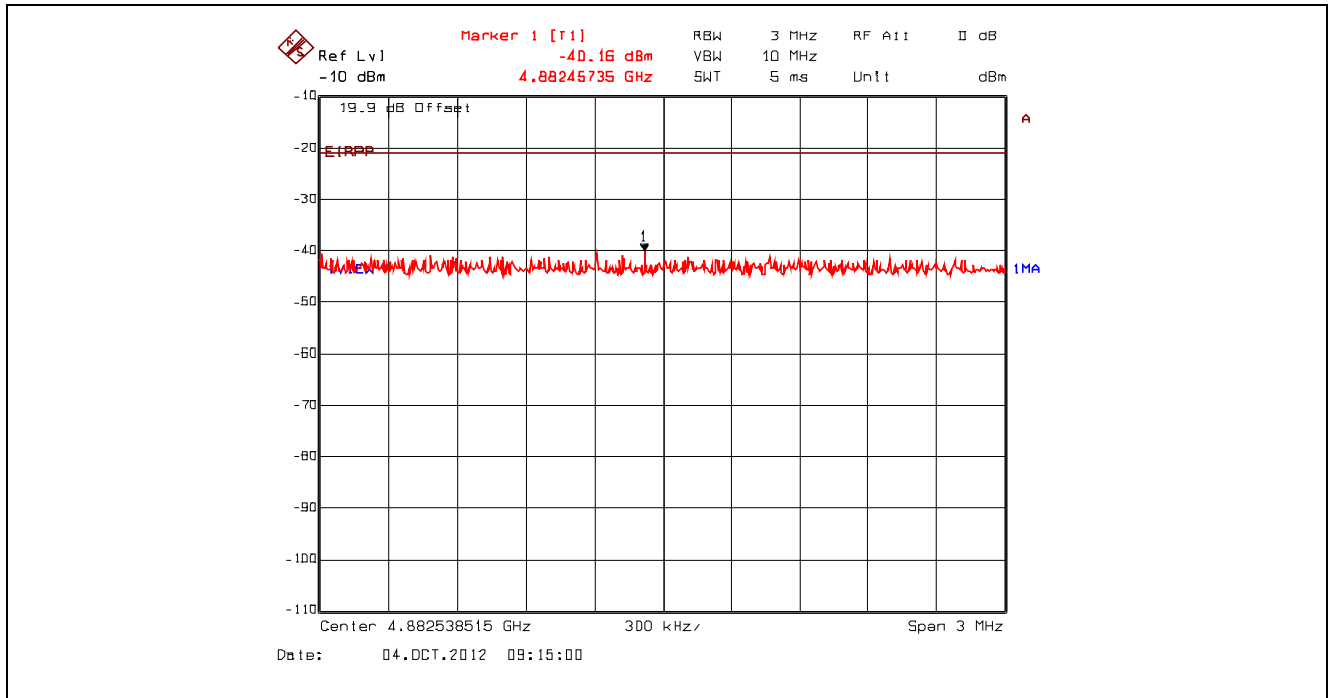

Plot 5.4.4.3.105. Conducted Spurious Emissions – Restricted Bands, 802.11n 400ns, 7.2 Mbps BPSK 1/2
2442 MHz, Peak Power at 9.78 GHz with High Pass Filter

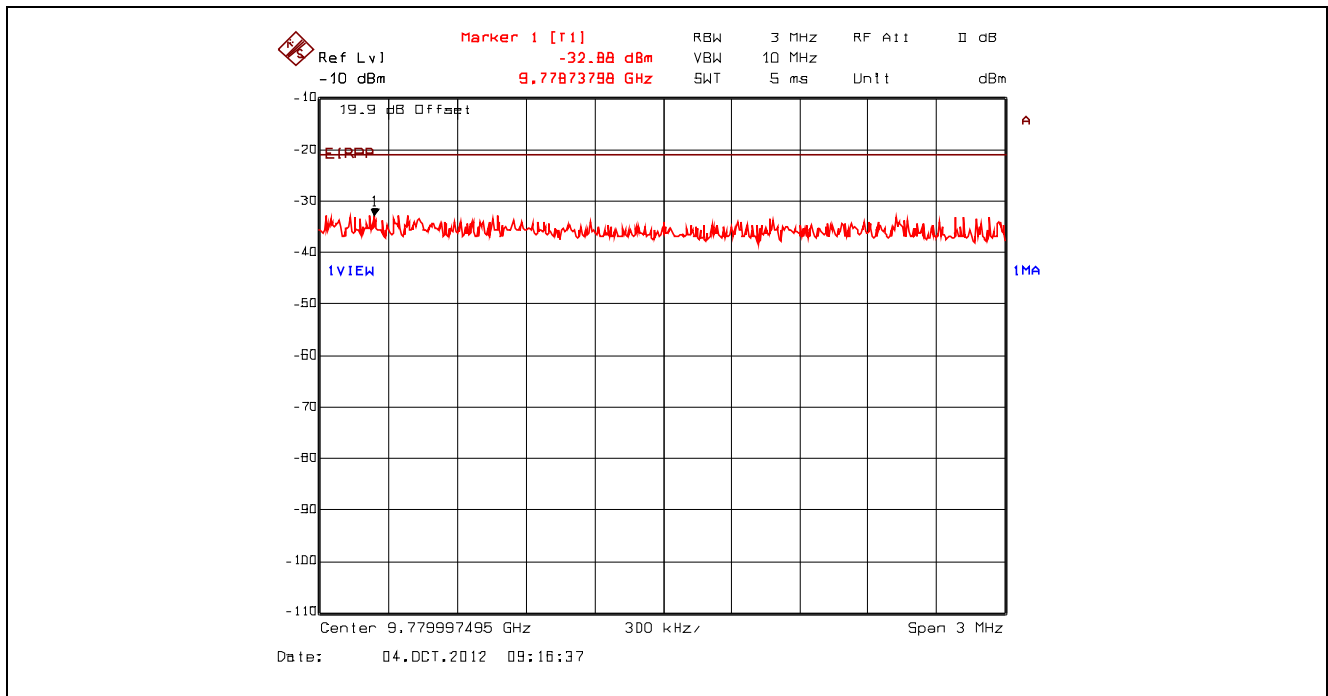

Plot 5.4.4.3.106. Conducted Spurious Emissions – Restricted Bands, 802.11n 400ns, 7.2 Mbps BPSK 1/2
 2462 MHz, 9 kHz - 150 kHz, Peak Detector with Band (Notch) Reject Filter

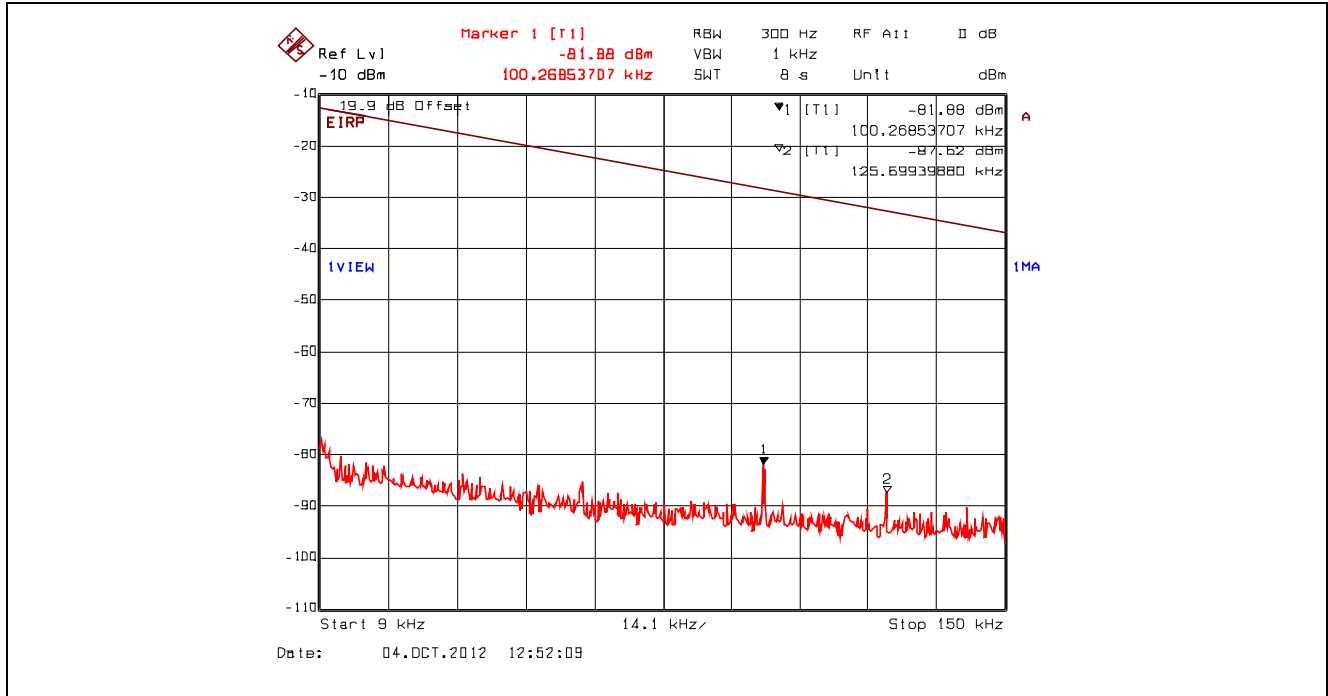

Plot 5.4.4.3.107. Conducted Spurious Emissions – Restricted Bands, 802.11n 400ns, 7.2 Mbps BPSK 1/2
 2462 MHz, 150 kHz - 30 MHz, Peak Detector with Band (Notch) Reject Filter

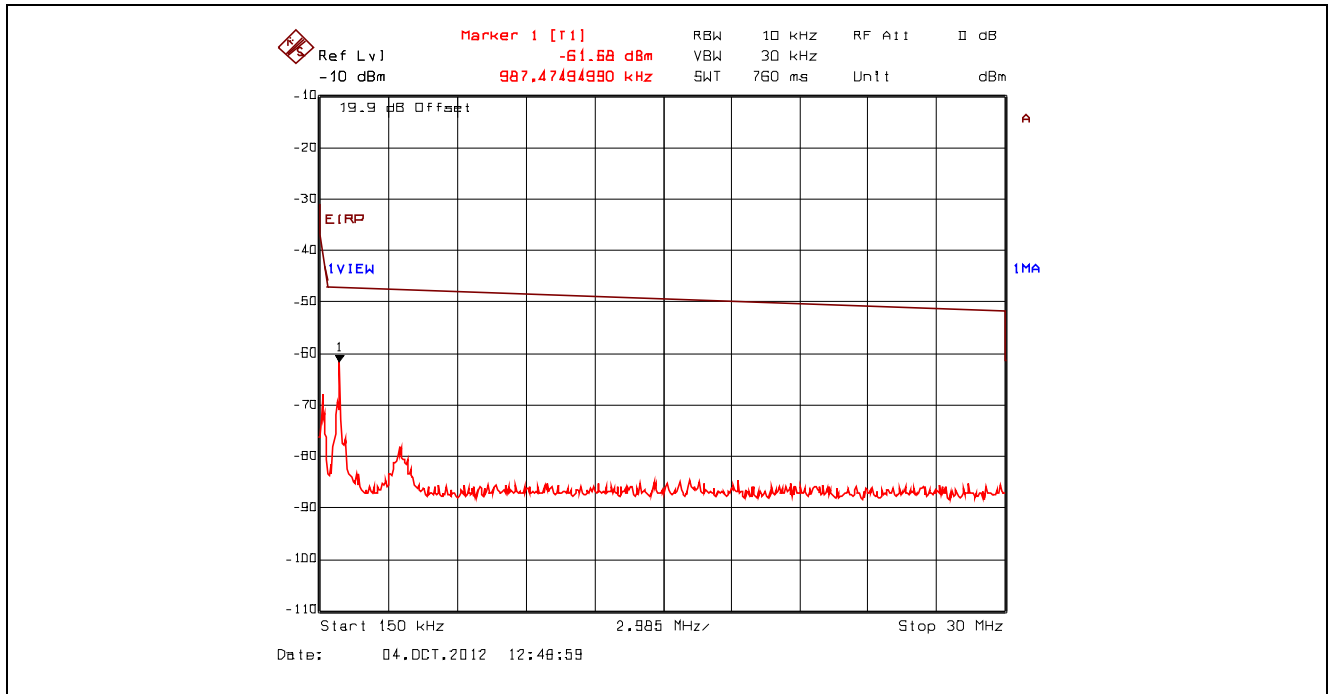

Plot 5.4.4.3.108. Conducted Spurious Emissions – Restricted Bands, 802.11n 400ns, 7.2 Mbps BPSK 1/2
 2462 MHz, 30 MHz - 1 GHz, Peak Detector with Band (Notch) Reject Filter

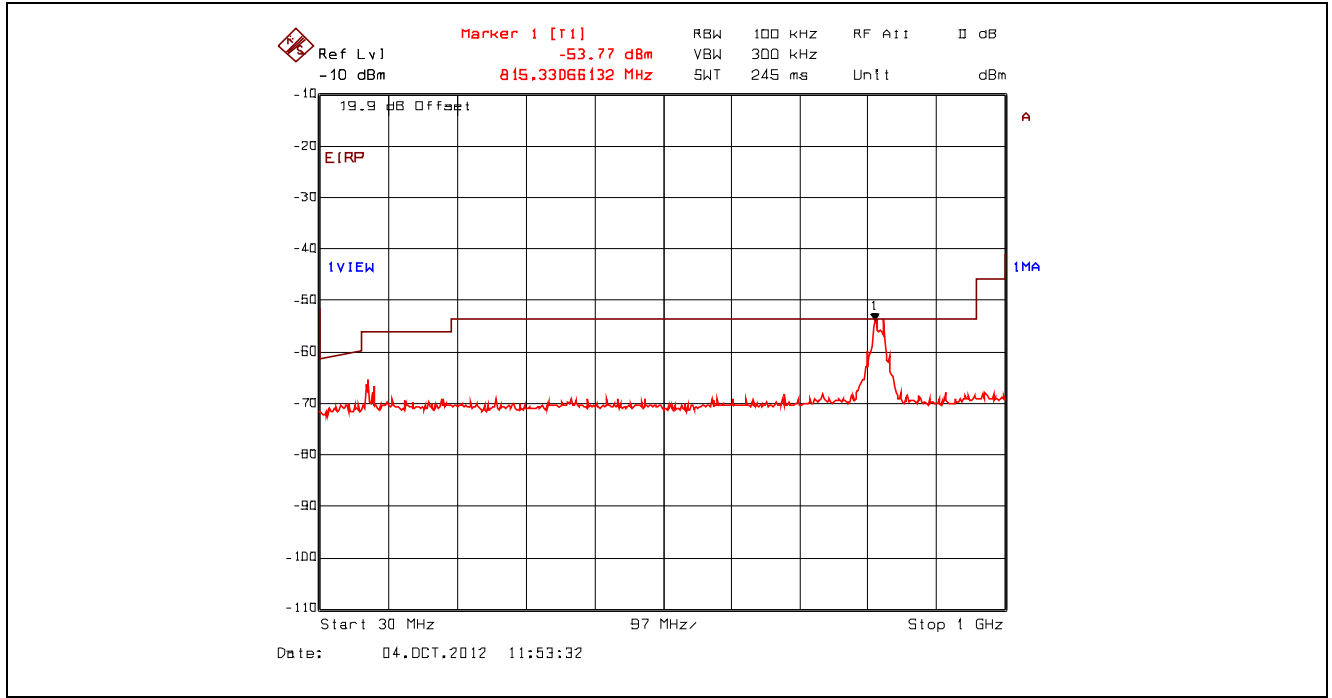

Plot 5.4.4.3.109. Conducted Spurious Emissions – Restricted Bands, 802.11n 400ns, 7.2 Mbps BPSK 1/2
 2462 MHz, QP Power at 811.91 MHz with Band (Notch) Reject Filter

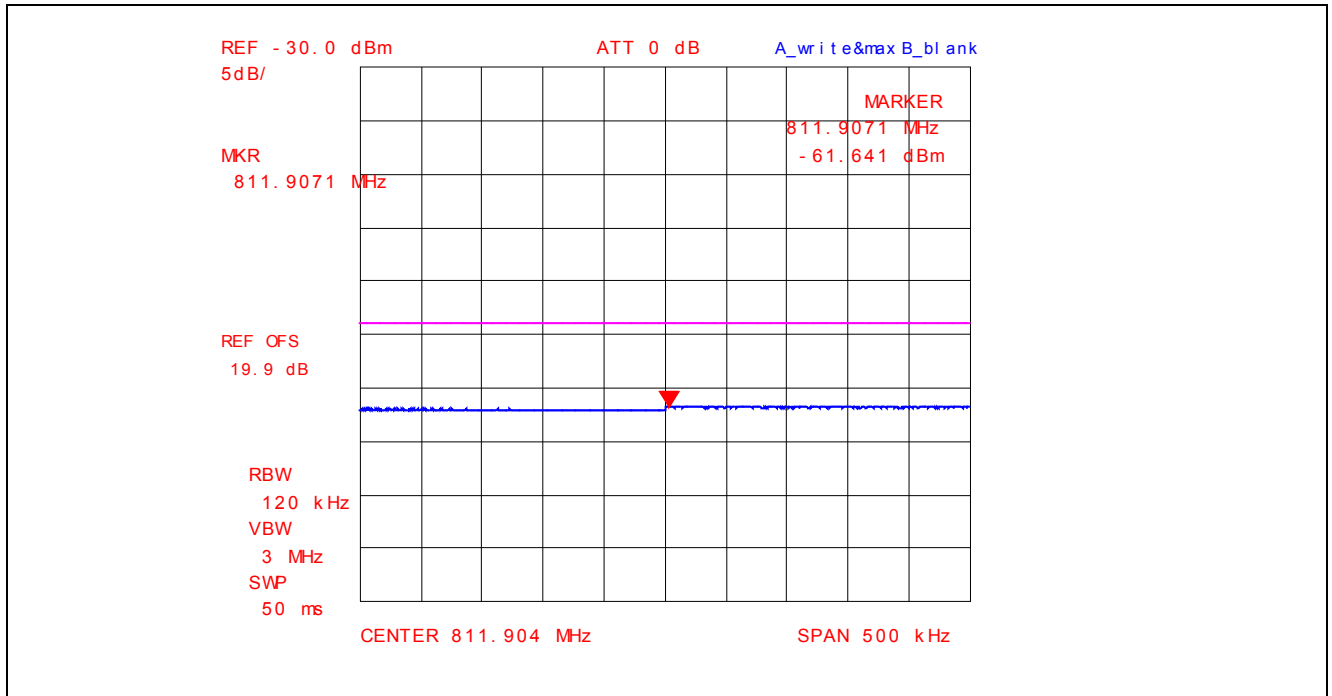

Plot 5.4.4.3.110. Conducted Spurious Emissions – Restricted Bands, 802.11n 400ns, 7.2 Mbps BPSK 1/2
 2462 MHz, 1 GHz - 4 GHz, Power Averaging with Band (Notch) Reject Filter

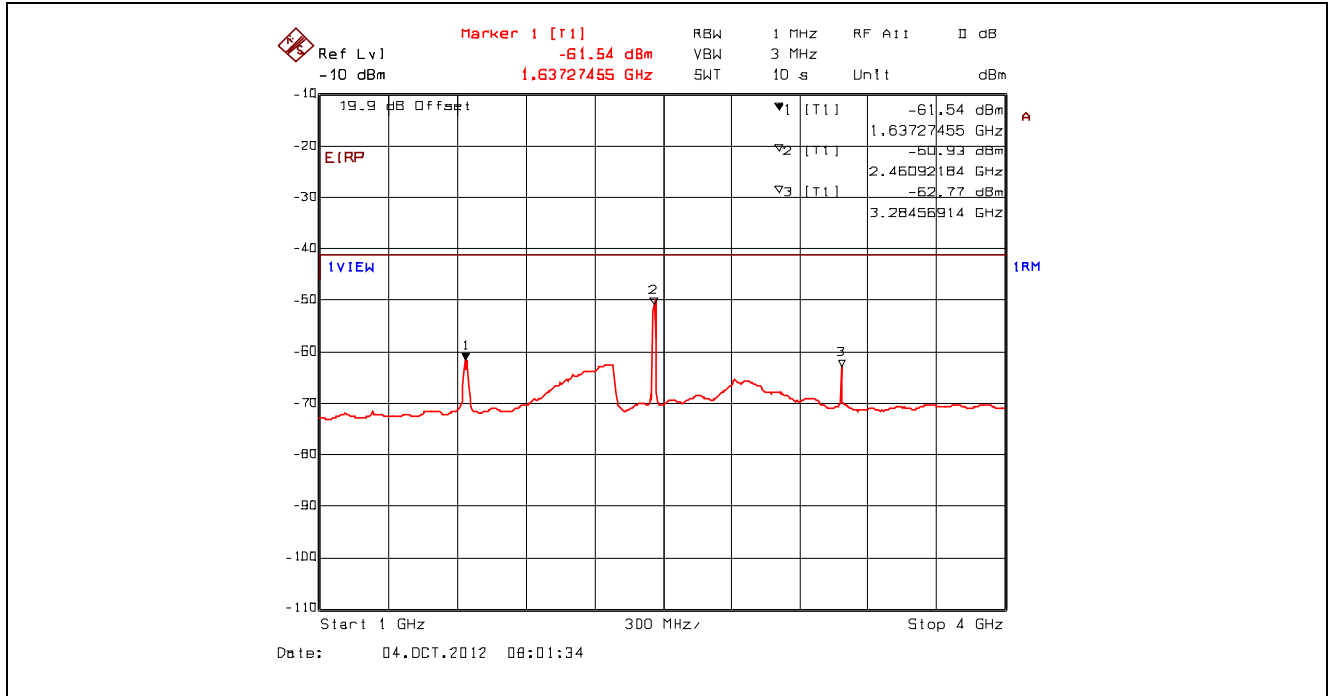

Plot 5.4.4.3.111. Conducted Spurious Emissions – Restricted Bands, 802.11n 400ns, 7.2 Mbps BPSK 1/2
 2462 MHz, 4 GHz - 25 GHz, Power Averaging with High Pass Filter

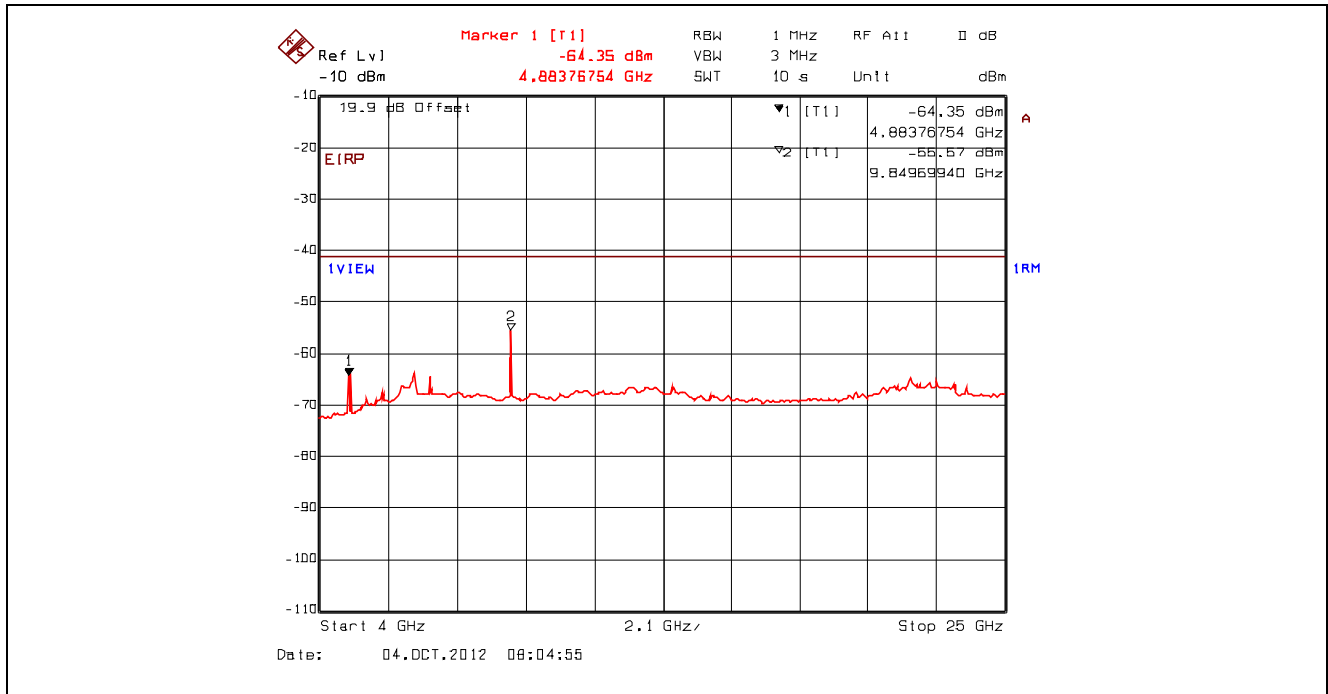

Plot 5.4.4.3.112. Conducted Spurious Emissions – Restricted Bands, 802.11n 400ns, 7.2 Mbps BPSK 1/2
 2462 MHz, Peak Power at 1.64 GHz with Band (Notch) Reject Filter

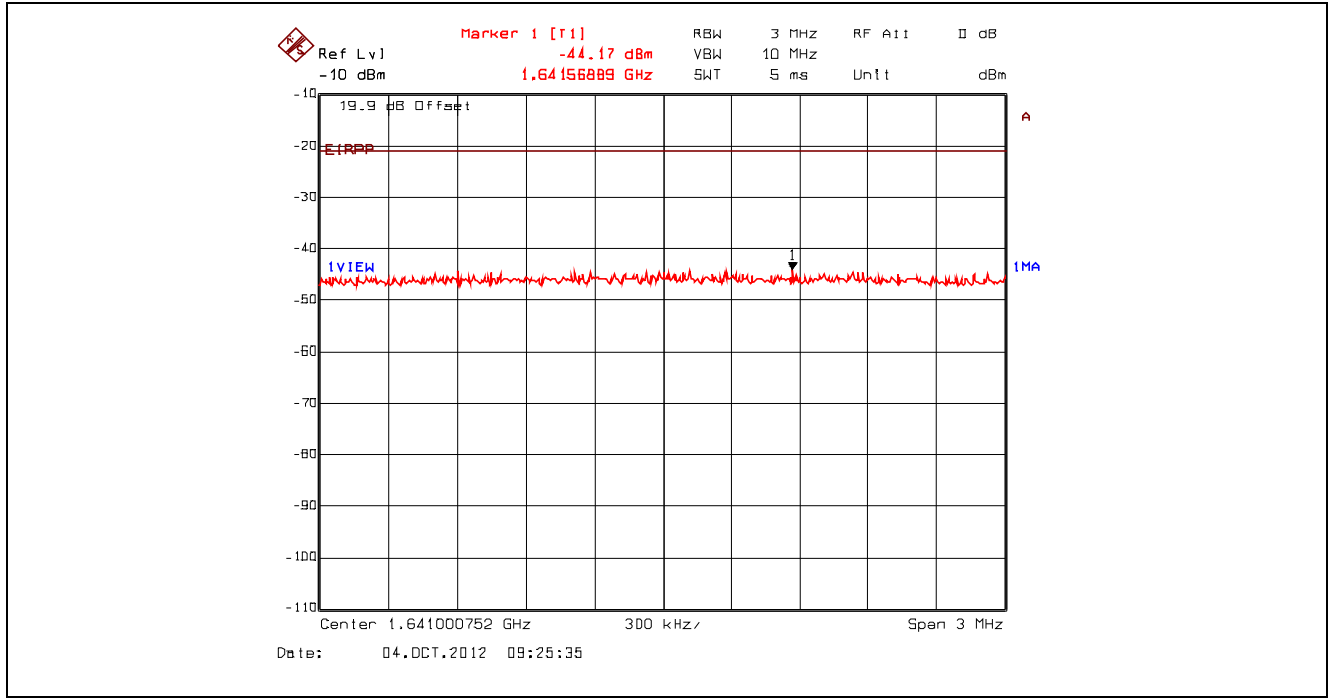

Plot 5.4.4.3.113. Conducted Spurious Emissions – Restricted Bands, 802.11n 400ns, 7.2 Mbps BPSK 1/2
 2462 MHz, Peak Power at 3.28 GHz with Band (Notch) Reject Filter

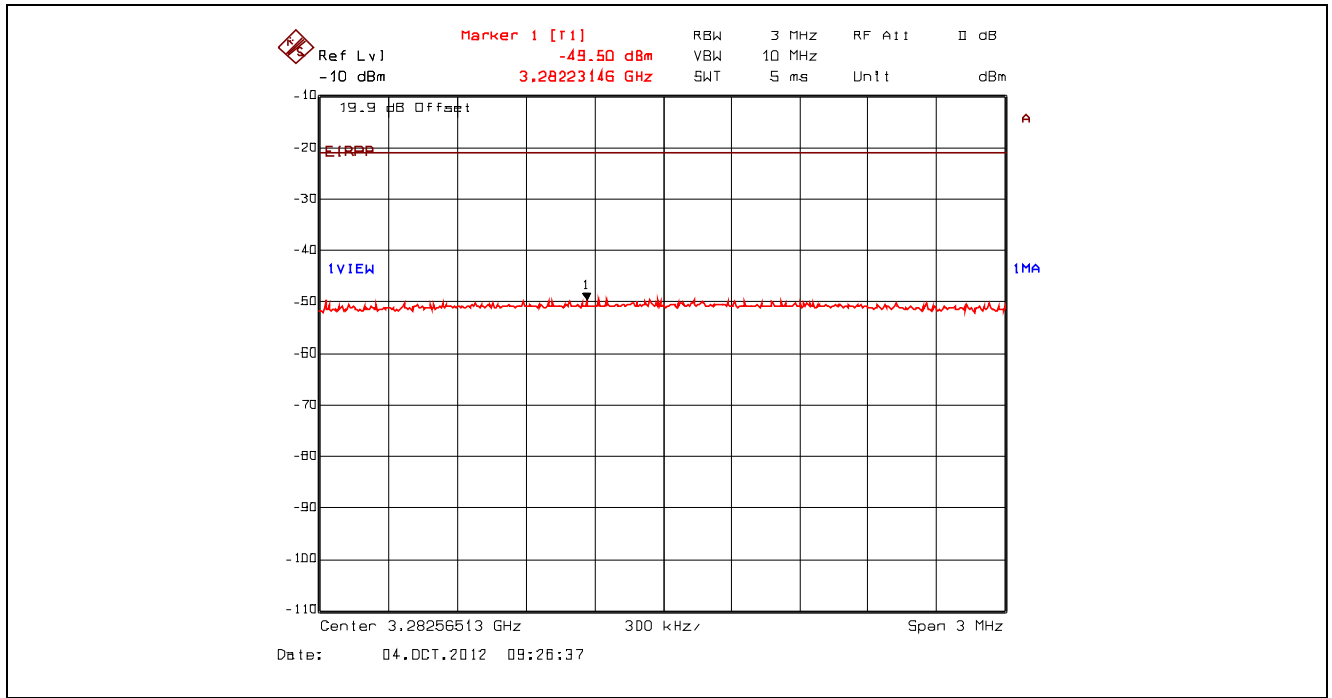

Plot 5.4.4.3.114. Conducted Spurious Emissions – Restricted Bands, 802.11n 400ns, 7.2 Mbps BPSK 1/2
 2462 MHz, Peak Power at 4.93 GHz with High Pass Filter

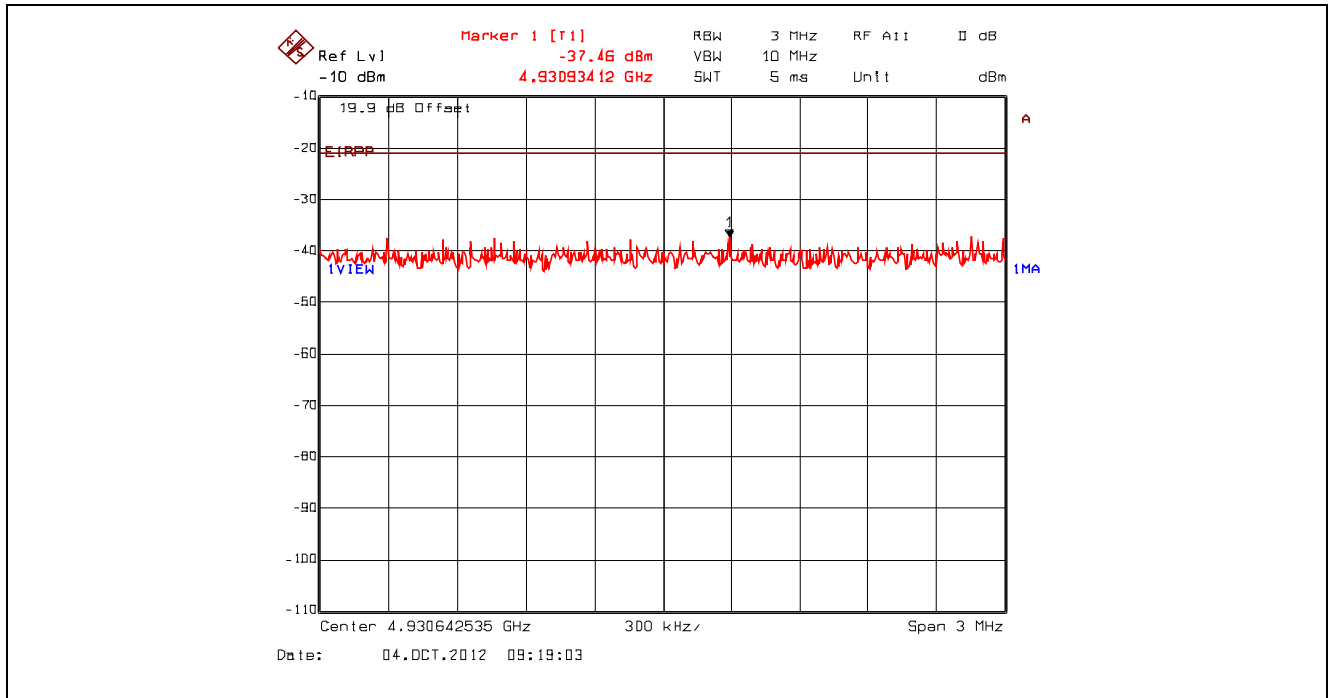

Plot 5.4.4.3.115. Conducted Spurious Emissions – Restricted Bands, 802.11n 400ns, 7.2 Mbps BPSK 1/2
 2462 MHz, Peak Power at 9.83 GHz with High Pass Filter

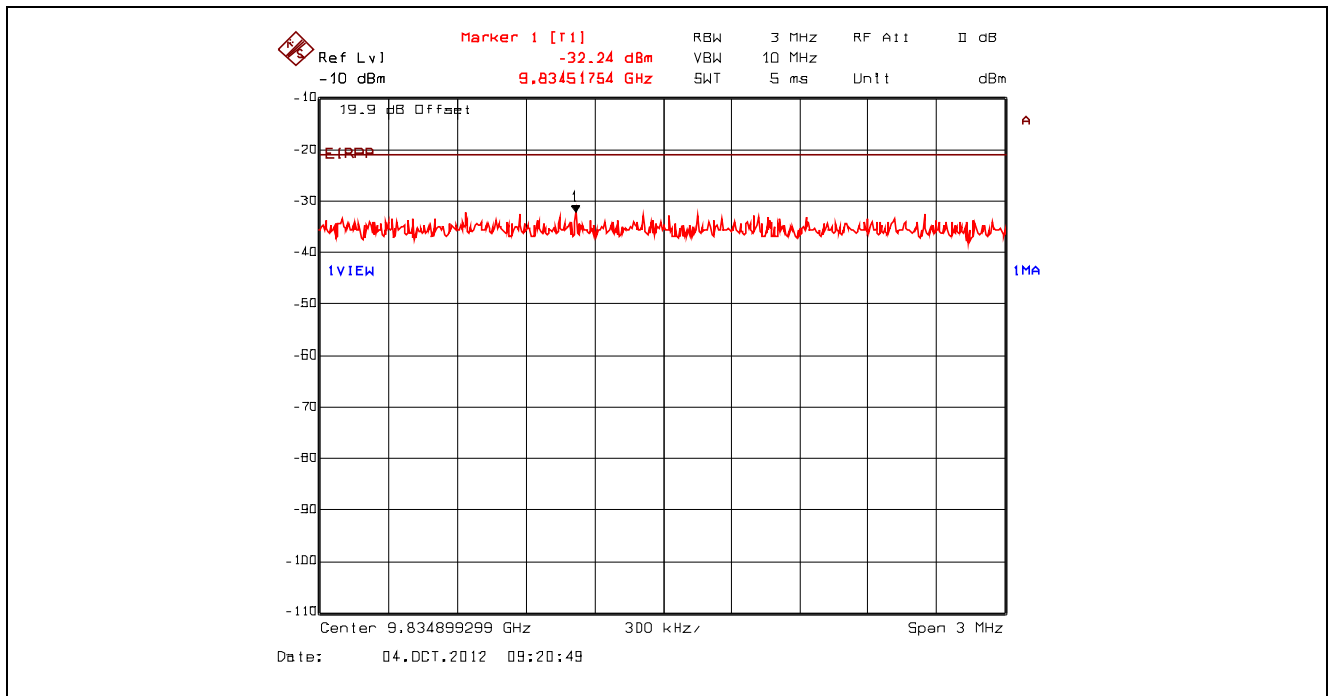

5.5. TRANSMITTER SPURIOUS RADIATED EMISSIONS AT 3 METERS [§§ 15.247(d), 15.209 & 15.205]

5.5.1. Limit(s)

§ 15.247 (d): In any 100 kHz bandwidth outside the frequency band in which the spread spectrum or digitally modulated intentional radiator is operating, the radio frequency power that is produced by the intentional radiator shall be at least 20 dB below that in the 100 kHz bandwidth within the band that contains the highest level of the desired power, based on either an RF conducted or a radiated measurement, provided the transmitter demonstrates compliance with the peak conducted power limits. If the transmitter complies with the conducted power limits based on the use of RMS averaging over a time interval, as permitted under paragraph (b)(3) of this section, the attenuation required under this paragraph shall be 30 dB instead of 20 dB. Attenuation below the general limits specified in Section 15.209(a) is not required. In addition, radiated emissions which fall in the restricted bands, as defined in Section 15.205(a), must also comply with the radiated emission limits specified in Section 15.209(a) (see Section 15.205(c)).

Section 15.205(a) - Restricted Bands of Operation

MHz	MHz	MHz	GHz
0.090–0.110	16.42–16.423	399.9–410	4.5–5.15
¹ 0.495–0.505	16.69475–16.69525	608–614	5.35–5.46
2.1735–2.1905	16.80425–16.80475	960–1240	7.25–7.75
4.125–4.128	25.5–25.67	1300–1427	8.025–8.5
4.17725–4.17775	37.5–38.25	1435–1626.5	9.0–9.2
4.20725–4.20775	73–74.6	1645.5–1646.5	9.3–9.5
6.215–6.218	74.8–75.2	1660–1710	10.6–12.7
6.26775–6.26825	108–121.94	1718.8–1722.2	13.25–13.4
6.31175–6.31225	123–138	2200–2300	14.47–14.5
8.291–8.294	149.9–150.05	2310–2390	15.35–16.2
8.362–8.366	156.52475–156.52525	2483.5–2500	17.7–21.4
8.37625–8.38675	156.7–156.9	2655–2900	22.01–23.12
8.41425–8.41475	162.0125–167.17	3260–3267	23.6–24.0
12.29–12.293	167.72–173.2	3332–3339	31.2–31.8
12.51975–12.52025	240–285	3345.8–3358	36.43–36.5
12.57675–12.57725	322–335.4	3600–4400	(²)
13.36–13.41			

¹ Until February 1, 1999, this restricted band shall be 0.490–0.510 MHz.
² Above 38.6

Section 15.209(a)
-- Field Strength Limits within Restricted Frequency Bands --

Frequency (MHz)	Field Strength (microvolts/meter)	Measurement Distance (meters)
0.009 - 0.490	2,400 / F (kHz)	300
0.490 - 1.705	24,000 / F (kHz)	30
1.705 - 30.0	30	30
30 - 88	100	3
88 - 216	150	3
216 - 960	200	3
Above 960	500	3

5.5.2. Method of Measurements

KDB Publication No. 558074 D01: Guidance for Performing Compliance Measurements on Digital Transmission Systems (DTS) Operating Under §15.247 and ANSI C63.10.

5.5.3. Test Arrangement

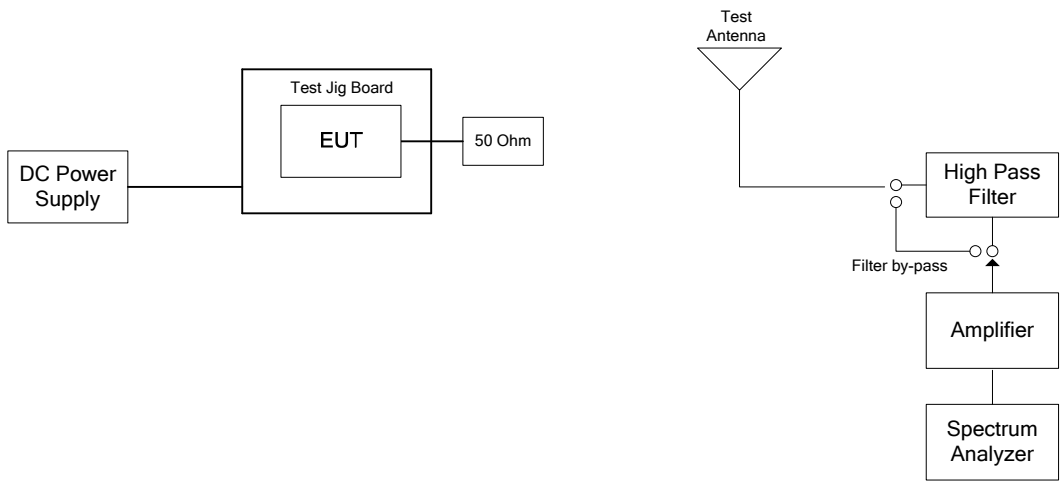

5.5.4. Test Data

Remark(s):

- All spurious emissions that are in excess of 20 dB below the specified limit shall be recorded.
- EUT shall be tested in three orthogonal positions.
- § 15.247 (d) spurious emission limit: $E = (EIRP - 20\log(d) + 104.8) - 20 = (EIRP - 20\log(3) + 104.8) - 20$
- Exploratory testing were conducted to determine the final test configurations, the following represent the worst-case.

5.5.4.1. 802.11b Mode, 1 Mbps DBPSK, High Power Setting 23

Fundamental Frequency:		2412 MHz					
Output Power:		36 dBm EIRP Max.					
Frequency Test Range		30 MHz – 25 GHz					
Frequency (MHz)	RF Peak Level (dBµV/m)	RF Avg Level (dBµV/m)	Antenna Plane (H/V)	Limit 15.209 (dBµV/m)	Limit 15.247 (dBµV/m)	Margin (dB)	Pass/Fail
30-25000	*	*	H/V	*	111.3	*	Pass

*All spurious emissions/harmonics are more than 20 dB below the applicable limit.

Fundamental Frequency:		2442 MHz					
Output Power:		36 dBm EIRP Max.					
Frequency Test Range		30 MHz – 25 GHz					
Frequency (MHz)	RF Peak Level (dBµV/m)	RF Avg Level (dBµV/m)	Antenna Plane (H/V)	Limit 15.209 (dBµV/m)	Limit 15.247 (dBµV/m)	Margin (dB)	Pass/Fail
30-25000	*	*	H/V	*	111.3	*	Pass

*All spurious emissions/harmonics are more than 20 dB below the applicable limit.

Fundamental Frequency:		2462 MHz					
Output Power:		36 dBm EIRP Max.					
Frequency Test Range:		30 MHz – 25 GHz					
Frequency (MHz)	RF Peak Level (dBµV/m)	RF Avg Level (dBµV/m)	Antenna Plane (H/V)	Limit 15.209 (dBµV/m)	Limit 15.247 (dBµV/m)	Margin (dB)	Pass/Fail
30-25000	*	*	H/V	*	111.3	*	Pass

*All spurious emissions/harmonics are more than 20 dB below the applicable limit.

5.5.4.2. 802.11g Mode, 9 Mbps BPSK, High Power Setting 23

Fundamental Frequency:		2412 MHz					
Output Power:		36 dBm EIRP Max.					
Frequency Test Range		30 MHz – 25 GHz					
Frequency (MHz)	RF Peak Level (dBµV/m)	RF Avg Level (dBµV/m)	Antenna Plane (H/V)	Limit 15.209 (dBµV/m)	Limit 15.247 (dBµV/m)	Margin (dB)	Pass/Fail
30-25000	*	*	H/V	*	111.3	*	Pass

*All spurious emissions/harmonics are more than 20 dB below the applicable limit.

Fundamental Frequency:		2442 MHz					
Output Power:		36 dBm EIRP Max.					
Frequency Test Range		30 MHz – 25 GHz					
Frequency (MHz)	RF Peak Level (dBµV/m)	RF Avg Level (dBµV/m)	Antenna Plane (H/V)	Limit 15.209 (dBµV/m)	Limit 15.247 (dBµV/m)	Margin (dB)	Pass/Fail
30-25000	*	*	H/V	*	111.3	*	Pass

*All spurious emissions/harmonics are more than 20 dB below the applicable limit.

Fundamental Frequency:		2462 MHz					
Output Power:		36 dBm EIRP Max.					
Frequency Test Range:		30 MHz – 25 GHz					
Frequency (MHz)	RF Peak Level (dBµV/m)	RF Avg Level (dBµV/m)	Antenna Plane (H/V)	Limit 15.209 (dBµV/m)	Limit 15.247 (dBµV/m)	Margin (dB)	Pass/Fail
30-25000	*	*	H/V	*	111.3	*	Pass

*All spurious emissions/harmonics are more than 20 dB below the applicable limit.

5.5.4.3. 802.11n 800ns Mode, 6.5Mbps BPSK 1/2, High Power Setting 23

Fundamental Frequency:		2412 MHz					
Output Power:		36 dBm EIRP Max.					
Frequency Test Range		30 MHz – 25 GHz					
Frequency (MHz)	RF Peak Level (dBµV/m)	RF Avg Level (dBµV/m)	Antenna Plane (H/V)	Limit 15.209 (dBµV/m)	Limit 15.247 (dBµV/m)	Margin (dB)	Pass/Fail
30-25000	*	*	H/V	*	111.3	*	Pass

*All spurious emissions/harmonics are more than 20 dB below the applicable limit.

Fundamental Frequency:		2442 MHz					
Output Power:		36 dBm EIRP Max.					
Frequency Test Range		30 MHz – 25 GHz					
Frequency (MHz)	RF Peak Level (dBµV/m)	RF Avg Level (dBµV/m)	Antenna Plane (H/V)	Limit 15.209 (dBµV/m)	Limit 15.247 (dBµV/m)	Margin (dB)	Pass/Fail
30-25000	*	*	H/V	*	111.3	*	Pass

*All spurious emissions/harmonics are more than 20 dB below the applicable limit.

Fundamental Frequency:		2462 MHz					
Output Power:		36 dBm EIRP Max.					
Frequency Test Range:		30 MHz – 25 GHz					
Frequency (MHz)	RF Peak Level (dBµV/m)	RF Avg Level (dBµV/m)	Antenna Plane (H/V)	Limit 15.209 (dBµV/m)	Limit 15.247 (dBµV/m)	Margin (dB)	Pass/Fail
30-25000	*	*	H/V	*	111.3	*	Pass

*All spurious emissions/harmonics are more than 20 dB below the applicable limit.

5.5.4.4. 802.11n 400ns Mode, 7.2 Mbps BPSK 1/2, High Power Setting 23

Fundamental Frequency:		2412 MHz					
Output Power:		36 dBm EIRP Max.					
Frequency Test Range		30 MHz – 25 GHz					
Frequency (MHz)	RF Peak Level (dBµV/m)	RF Avg Level (dBµV/m)	Antenna Plane (H/V)	Limit 15.209 (dBµV/m)	Limit 15.247 (dBµV/m)	Margin (dB)	Pass/Fail
30-25000	*	*	H/V	*	111.3	*	Pass

*All spurious emissions/harmonics are more than 20 dB below the applicable limit.

Fundamental Frequency:		2442 MHz					
Output Power:		36 dBm EIRP Max.					
Frequency Test Range		30 MHz – 25 GHz					
Frequency (MHz)	RF Peak Level (dBµV/m)	RF Avg Level (dBµV/m)	Antenna Plane (H/V)	Limit 15.209 (dBµV/m)	Limit 15.247 (dBµV/m)	Margin (dB)	Pass/Fail
30-25000	*	*	H/V	*	111.3	*	Pass

*All spurious emissions/harmonics are more than 20 dB below the applicable limit.

Fundamental Frequency:		2462 MHz					
Output Power:		36 dBm EIRP Max.					
Frequency Test Range:		30 MHz – 25 GHz					
Frequency (MHz)	RF Peak Level (dBµV/m)	RF Avg Level (dBµV/m)	Antenna Plane (H/V)	Limit 15.209 (dBµV/m)	Limit 15.247 (dBµV/m)	Margin (dB)	Pass/Fail
30-25000	*	*	H/V	*	111.3	*	Pass

*All spurious emissions/harmonics are more than 20 dB below the applicable limit.

5.6. POWER SPECTRAL DENSITY [§ 15.247(e)]

5.6.1. Limit(s)

For digitally modulated systems, the power spectral density conducted from the intentional radiator to the antenna shall not be greater than 8 dBm in any 3 kHz band during any time interval of continuous transmission.

5.6.2. Method of Measurements

KDB Publication No. 558074 D01 Section 5.3.1 Measurement Procedure PKPSD.

5.6.3. Test Arrangement

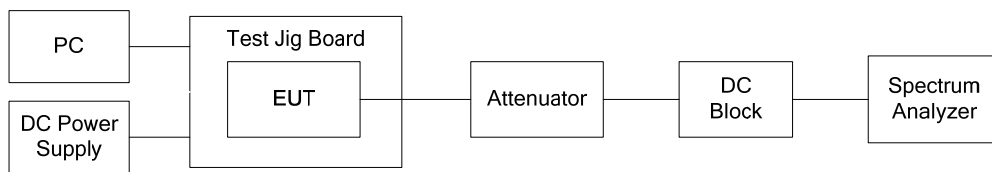

5.6.4. Test Data

Remark: Measurement method: Section 5.3.1 Measurement Procedure PKPSD

Operating Mode	Modulation	Frequency (MHz)	*PSD in 3 kHz BW (dBm)	Limit (dBm)	Margin (dB)
802.11b	1 Mbps DBPSK	2412	-4.68	8	-12.68
		2442	-4.97	8	-12.97
		2462	-5.48	8	-13.48
	2 Mbps DQPSK	2412	-5.03	8	-13.03
		2442	-4.98	8	-12.98
		2462	-5.39	8	-13.39
	11 Mbps CCK	2412	-4.78	8	-12.78
		2442	-4.82	8	-12.82
		2462	-5.52	8	-13.52

Operating Mode	Modulation	Frequency (MHz)	*PSD in 3 kHz BW (dBm)	Limit (dBm)	Margin (dB)
802.11g	9 Mbps BPSK	2412	-6.47	8	-14.47
		2442	-5.85	8	-13.85
		2462	-5.68	8	-13.68
	18 Mbps QPSK	2412	-6.02	8	-14.02
		2442	-5.65	8	-13.65
		2462	-5.64	8	-13.64
	36 Mbps 16-QAM	2412	-6.56	8	-14.56
		2442	-6.28	8	-14.28
		2462	-6.04	8	-14.04
	54 Mbps 64-QAM	2412	-6.55	8	-14.55
		2442	-6.09	8	-14.09
		2462	-6.04	8	-14.04
802.11n 800ns	6.5 Mbps BPSK 1/2	2412	-6.02	8	-14.02
		2442	-6.05	8	-14.05
		2462	-5.69	8	-13.69
	19.5 Mbps QPSK 3/4	2412	-6.02	8	-14.02
		2442	-5.65	8	-13.65
		2462	-5.70	8	-13.70
	39 Mbps 16-QAM 3/4	2412	-6.65	8	-14.65
		2442	-6.15	8	-14.15
		2462	-5.95	8	-13.95
	65 Mbps 64-QAM 5/6	2412	-6.51	8	-14.51
		2442	-6.06	8	-14.06
		2462	-5.89	8	-13.89
802.11n 400ns	7.2 Mbps BPSK1/2	2412	-6.52	8	-14.52
		2442	-5.83	8	-13.83
		2462	-5.64	8	-13.64
	21.7 Mbps QPSK 3/4	2412	-6.02	8	-14.02
		2442	-5.60	8	-13.6
		2462	-5.61	8	-13.61
	43.3 Mbps 16-QAM 3/4	2412	-6.55	8	-14.55
		2442	-6.01	8	-14.01
		2462	-5.97	8	-13.97
	72.2 Mbps 64-QAM 5/6	2412	-6.52	8	-14.52
		2442	-6.02	8	-14.02
		2462	-5.99	8	-13.99

*See the following plots for measurement details.

ULTRATECH GROUP OF LABS

3000 Bristol Circle, Oakville, Ontario, Canada L6H 6G4
 Tel. #: 905-829-1570, Fax. #: 905-829-8050, Email: vic@ultratech-labs.com, Website: <http://www.ultratech-labs.com>

File #: DIGI-064F15C247

October 26, 2012

All test results contained in this engineering test report are traceable to National Institute of Standards and Technology (NIST)

Plot 5.6.4.1. Power Spectral Density, 802.11b, 1 Mbps DBPSK, 2412 MHz, Setting 23
 Offset: Insertion Loss + BWCF = 20.63 dB + 10*log(3 kHz/ 100 kHz) = 5.43 dB

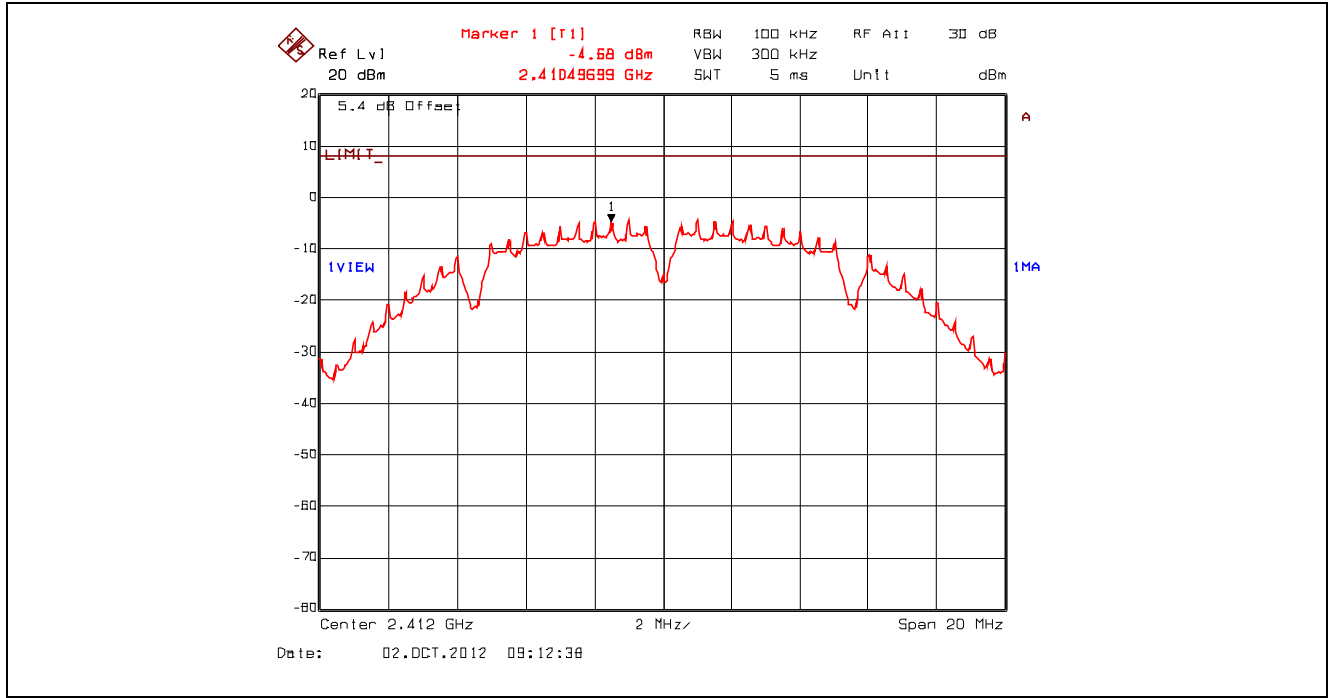

Plot 5.6.4.2. Power Spectral Density, 802.11b, 1 Mbps DBPSK, 2442 MHz, Setting 23
 Offset: Insertion Loss + BWCF = 20.63 dB + 10*log(3 kHz/ 100 kHz) = 5.43 dB

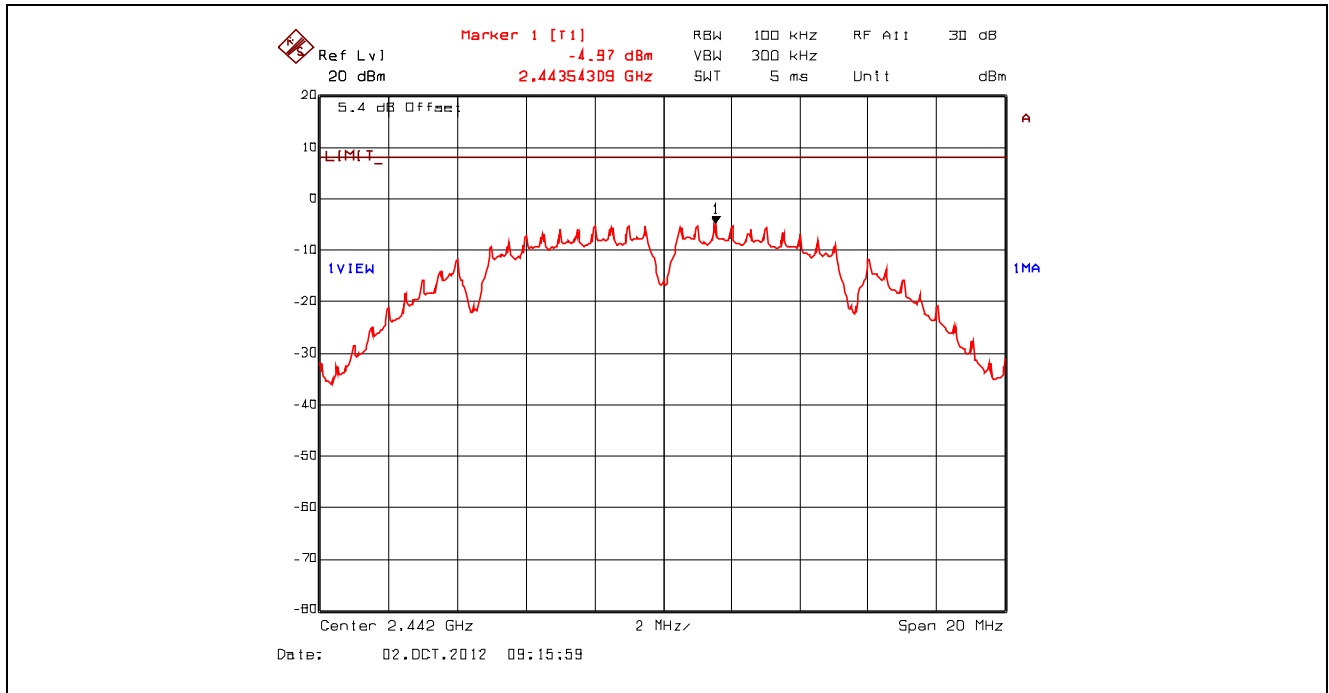

Plot 5.6.4.3. Power Spectral Density, 802.11b, 1 Mbps DBPSK, 2462 MHz, Setting 23
Offset: Insertion Loss + BWCF = 20.63 dB + $10 \cdot \log(3 \text{ kHz} / 100 \text{ kHz}) = 5.43 \text{ dB}$

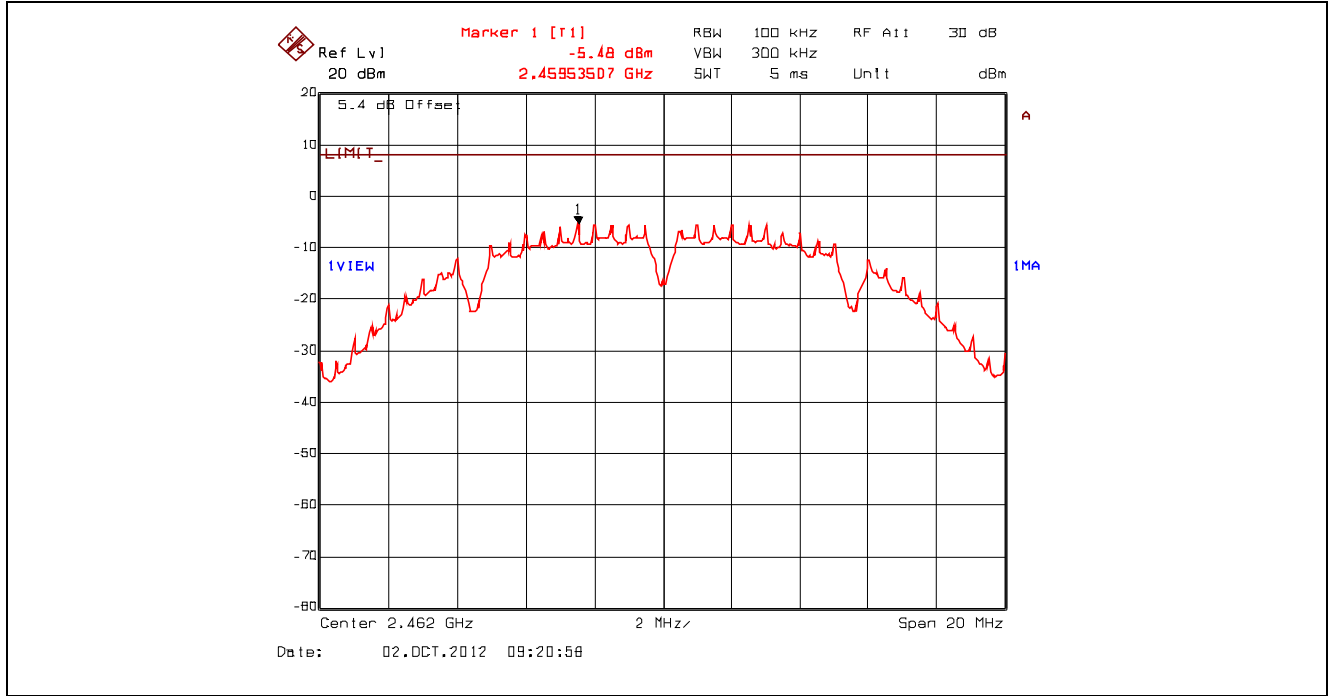

Plot 5.6.4.4. Power Spectral Density, 802.11b, 2 Mbps DQPSK, 2412 MHz, Setting 23
Offset: Insertion Loss + BWCF = 20.63 dB + $10 \cdot \log(3 \text{ kHz} / 100 \text{ kHz}) = 5.43 \text{ dB}$

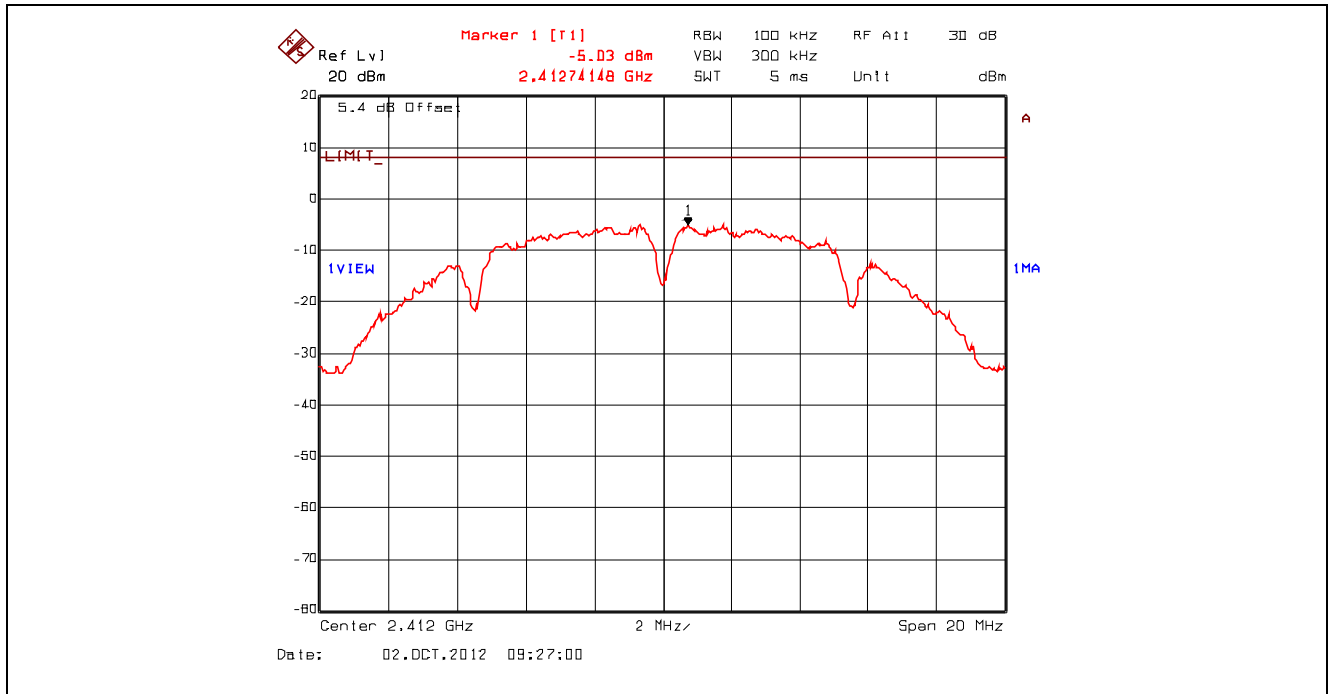

Plot 5.6.4.5. Power Spectral Density, 802.11b, 2 Mbps DQPSK, 2442 MHz, Setting 23
Offset: Insertion Loss + BWCF = 20.63 dB + 10*log(3 kHz/ 100 kHz) = 5.43 dB

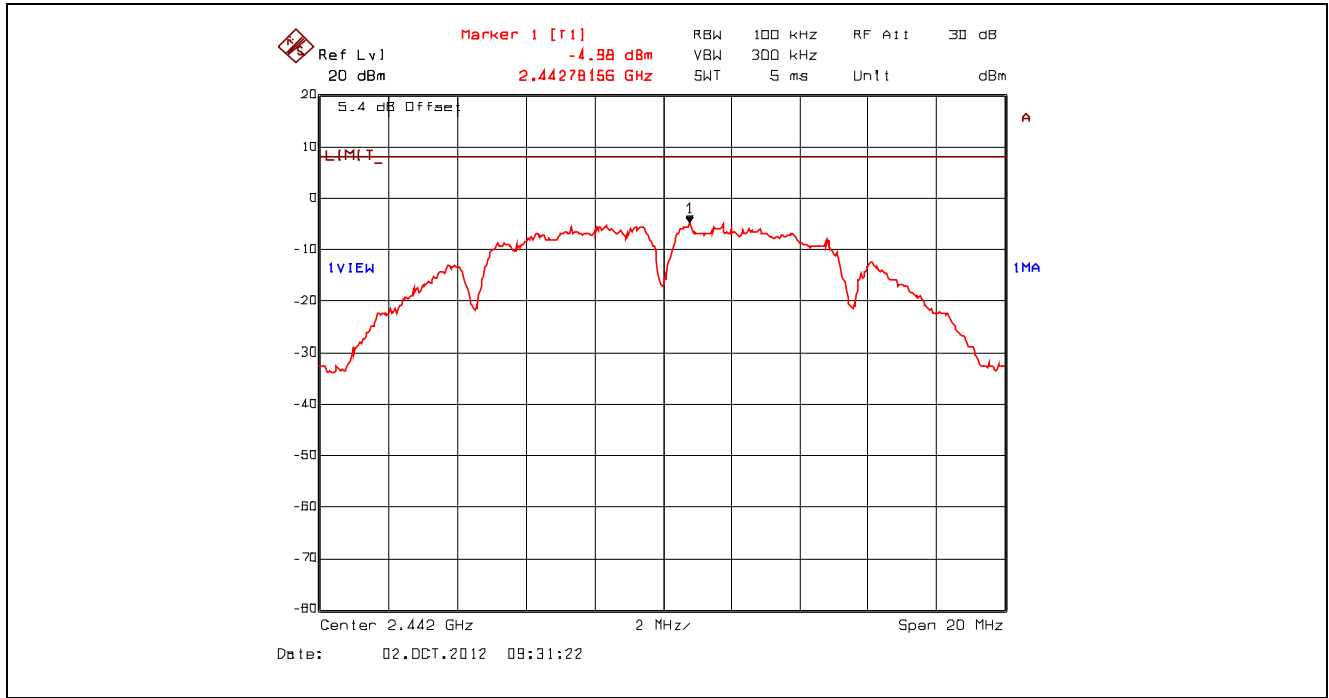

Plot 5.6.4.6. Power Spectral Density, 802.11b, 2 Mbps DQPSK, 2462 MHz, Setting 23
Offset: Insertion Loss + BWCF = 20.63 dB + 10*log(3 kHz/ 100 kHz) = 5.43 dB

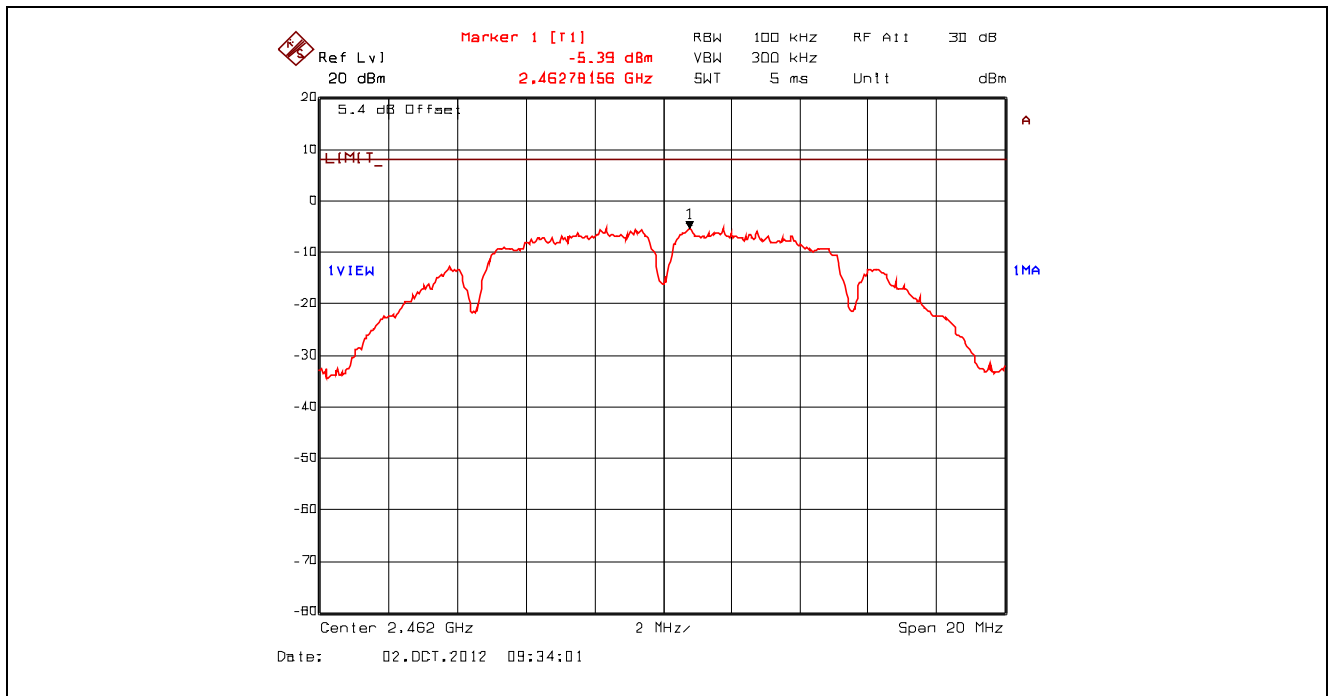

Plot 5.6.4.7. Power Spectral Density, 802.11b, 11 Mbps CCK, 2412 MHz, Setting 23
Offset: Insertion Loss + BWCF = 20.63 dB + $10 \cdot \log(3 \text{ kHz} / 100 \text{ kHz}) = 5.43 \text{ dB}$

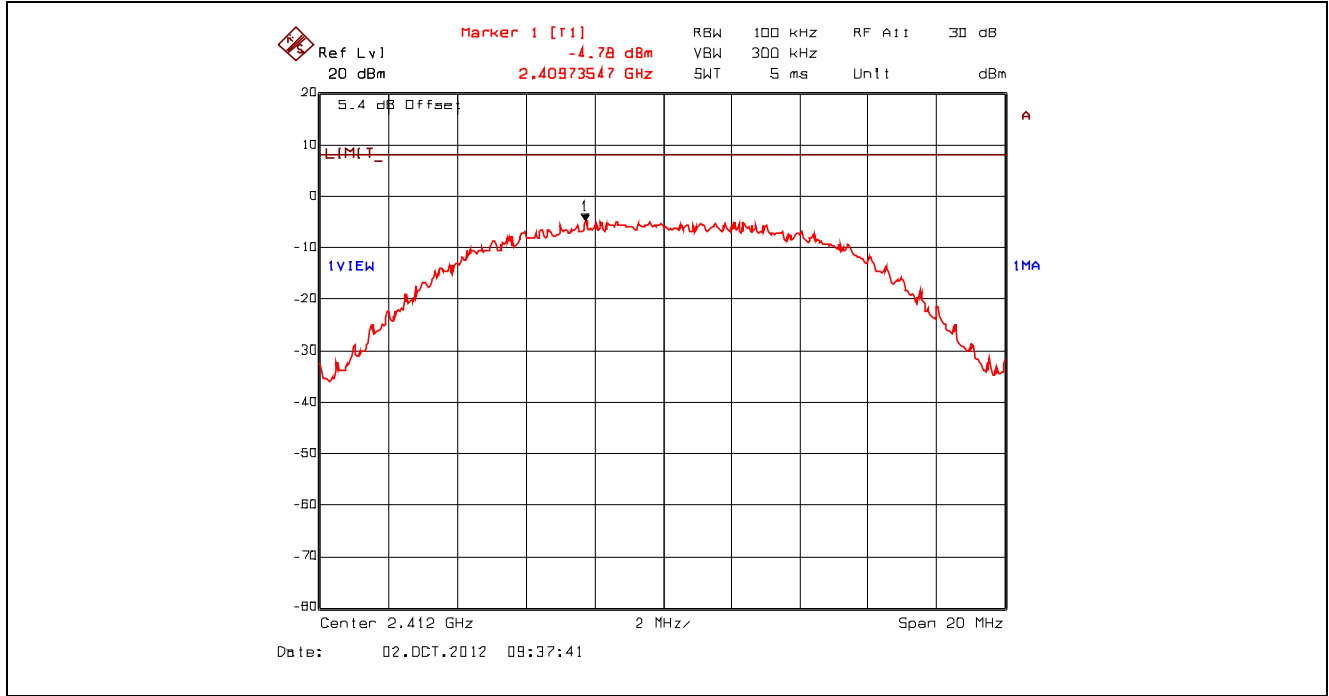

Plot 5.6.4.8. Power Spectral Density, 802.11b, 11 Mbps CCK, 2442 MHz, Setting 23
Offset: Insertion Loss + BWCF = 20.63 dB + $10 \cdot \log(3 \text{ kHz} / 100 \text{ kHz}) = 5.43 \text{ dB}$

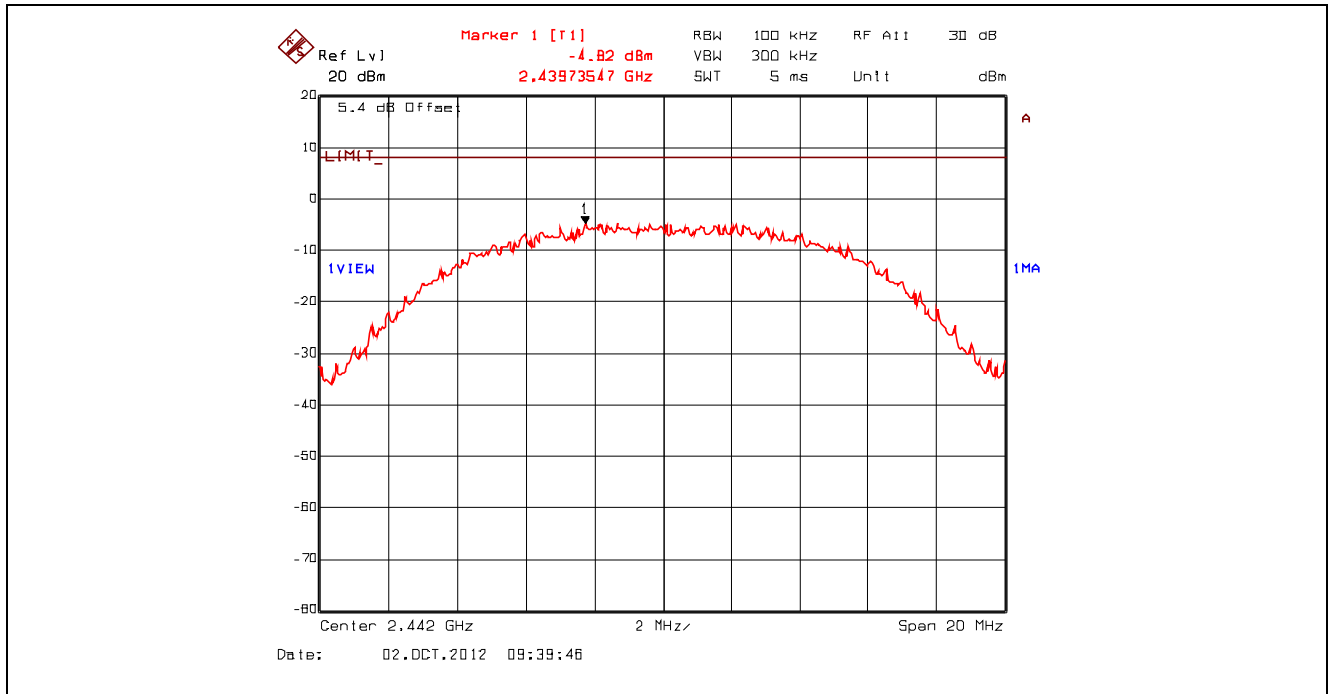

Plot 5.6.4.9. Power Spectral Density, 802.11b, 11 Mbps CCK, 2462 MHz, Setting 23
Offset: Insertion Loss + BWCF = 20.63 dB + 10*log(3 kHz/ 100 kHz) = 5.43 dB

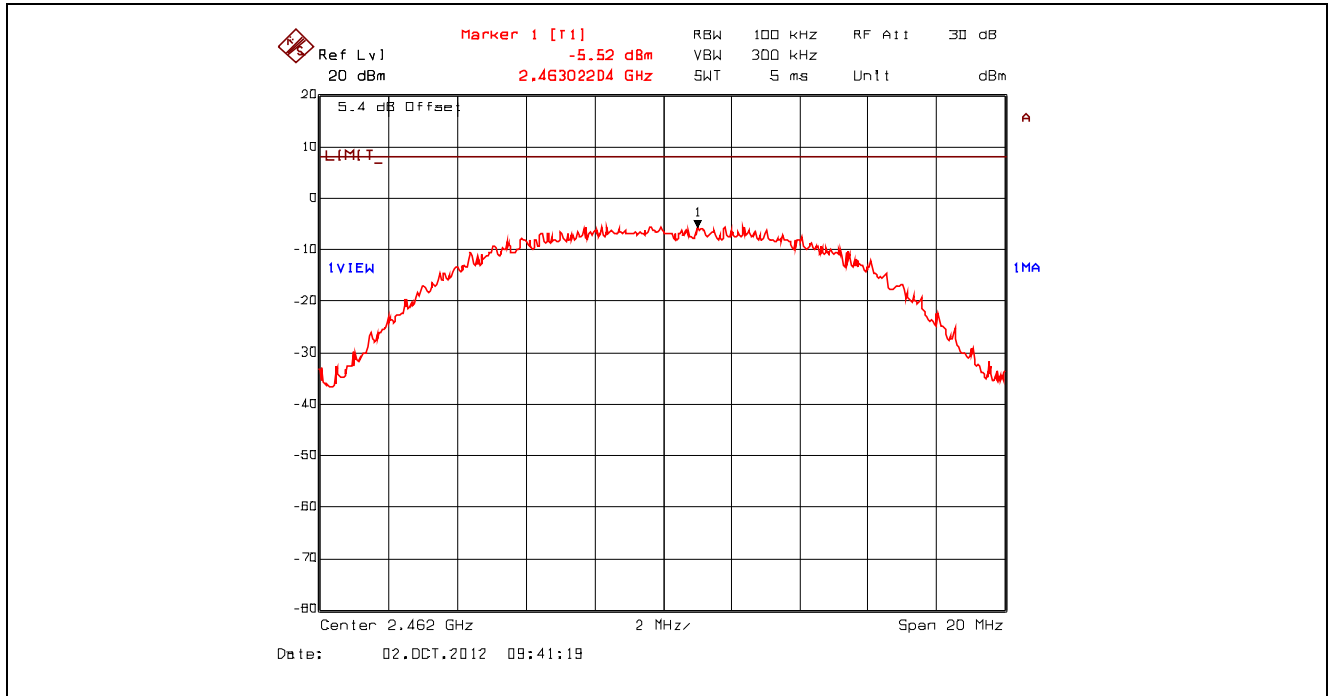

Plot 5.6.4.10. Power Spectral Density, 802.11g, 9 Mbps BPSK, 2412 MHz, Setting 23
Offset: Insertion Loss + BWCF = 20.63 dB + 10*log(3 kHz/ 100 kHz) = 5.43 dB

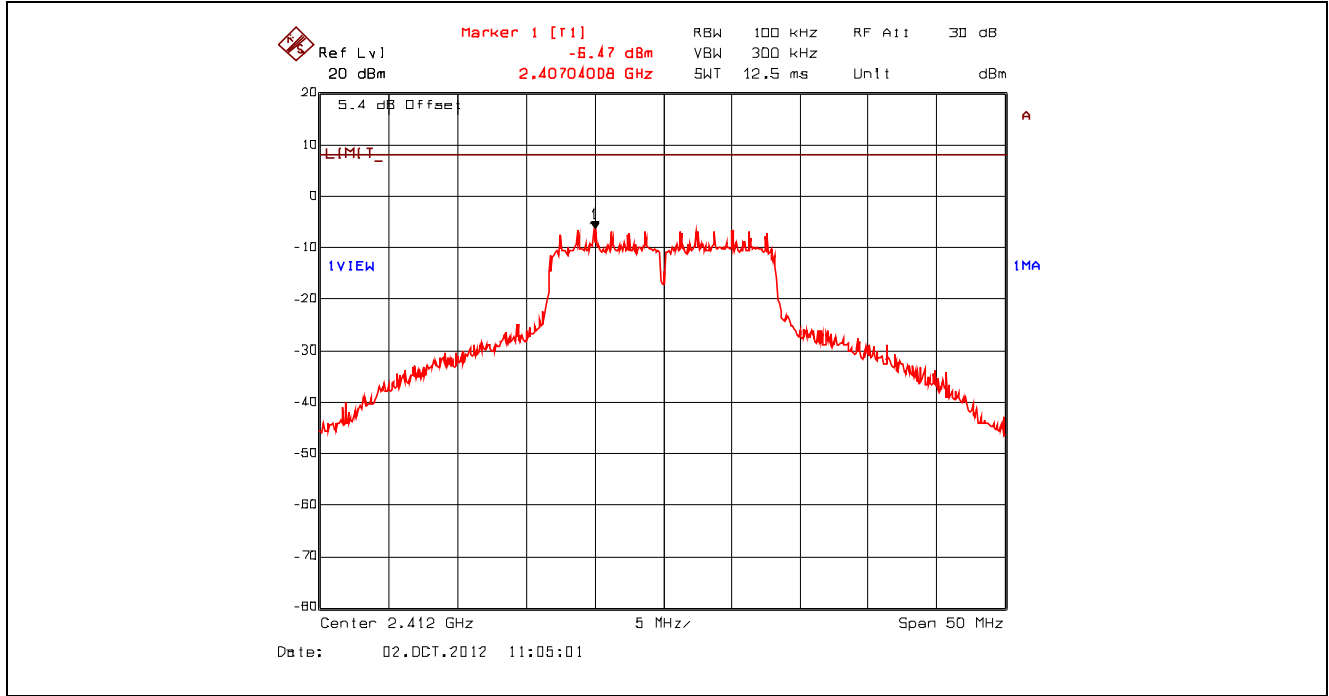

Plot 5.6.4.11. Power Spectral Density, 802.11g, 9 Mbps BPSK, 2442 MHz, Setting 23
Offset: Insertion Loss + BWCF = 20.63 dB + 10*log(3 kHz/ 100 kHz) = 5.43 dB

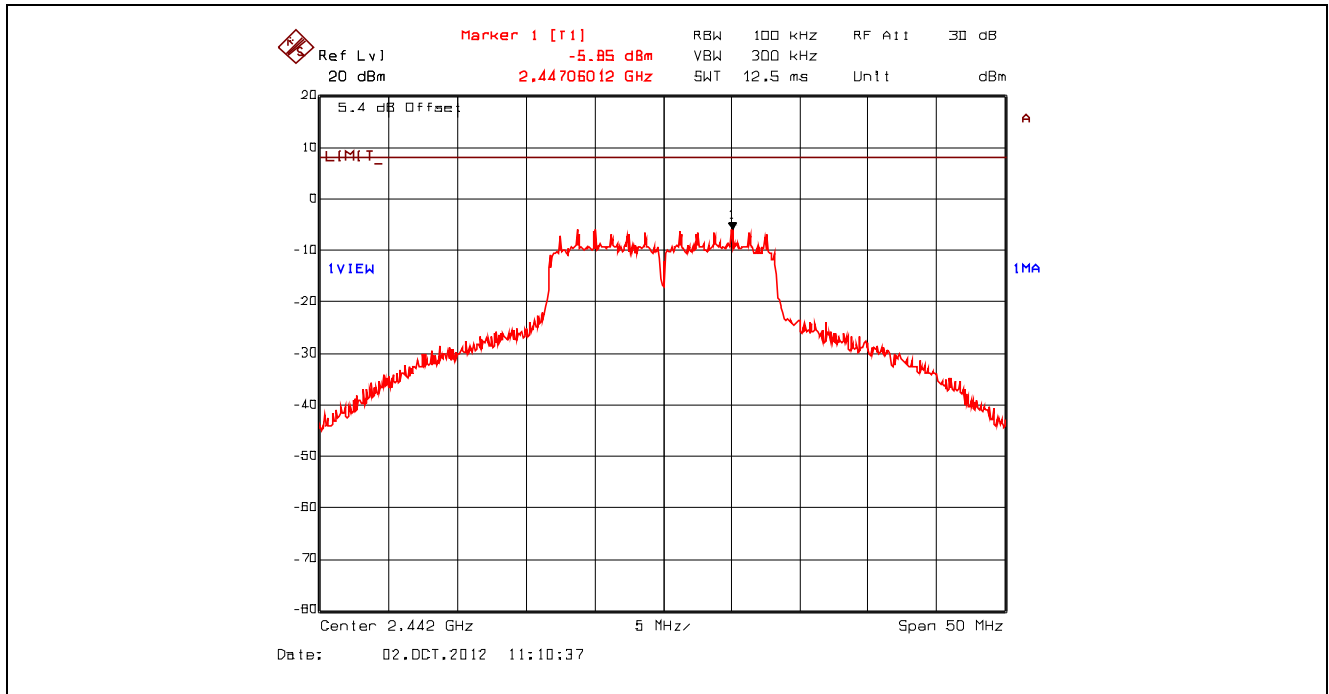

Plot 5.6.4.12. Power Spectral Density, 802.11g, 9 Mbps BPSK, 2462 MHz, Setting 23
 Offset: Insertion Loss + BWCF = 20.63 dB + 10*log(3 kHz/ 100 kHz) = 5.43 dB

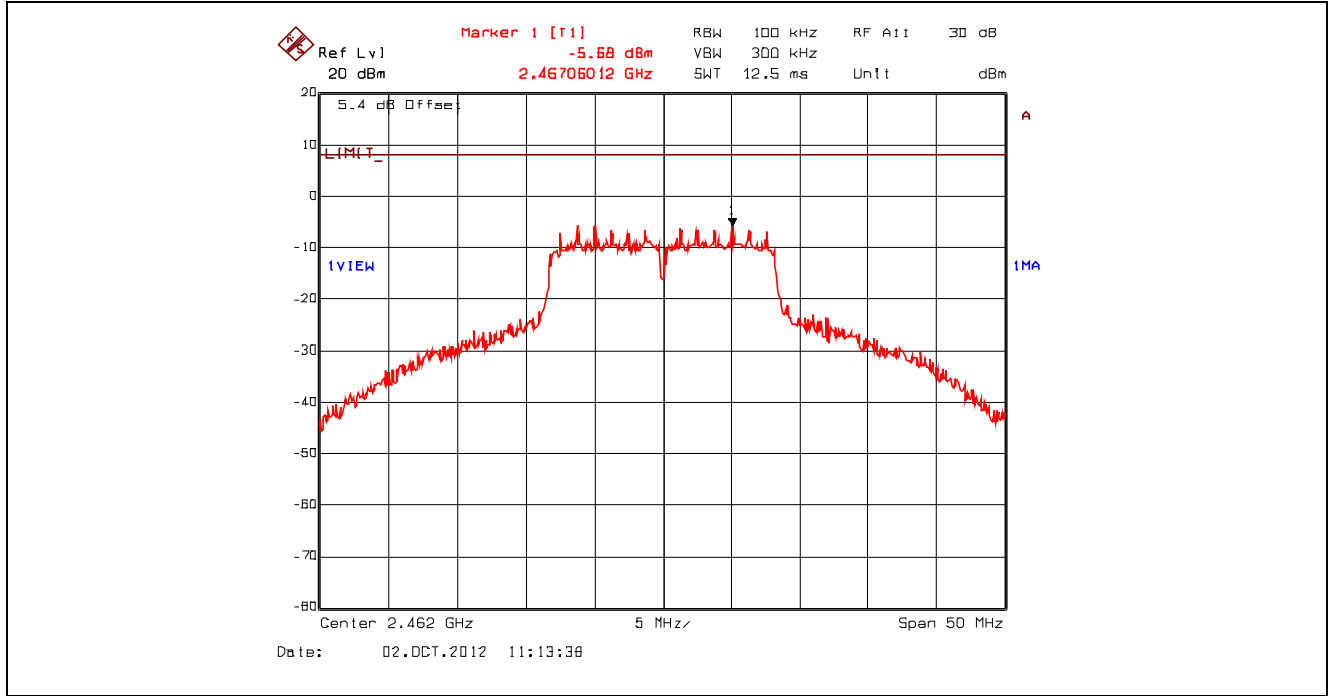

Plot 5.6.4.13. Power Spectral Density, 802.11g, 18 Mbps QPSK, 2412 MHz, Setting 23
 Offset: Insertion Loss + BWCF = 20.63 dB + 10*log(3 kHz/ 100 kHz) = 5.43 dB

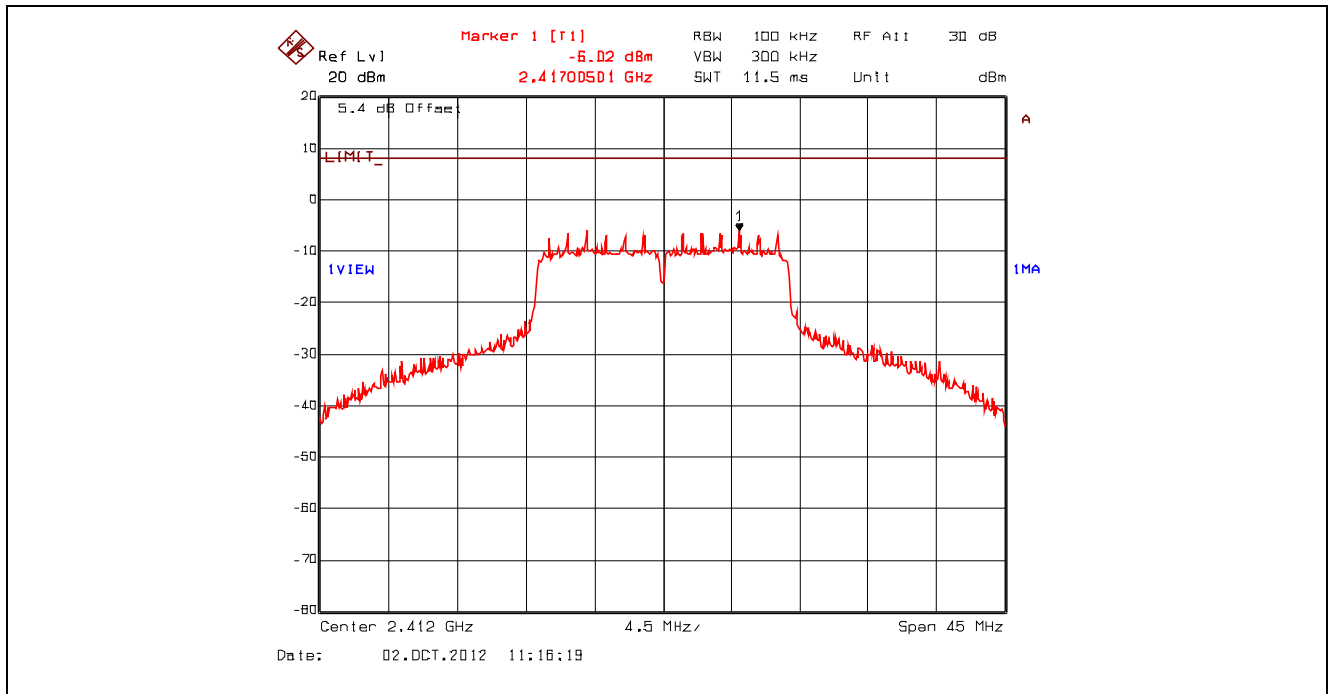

Plot 5.6.4.14. Power Spectral Density, 802.11g, 18 Mbps QPSK, 2442 MHz, Setting 23
 Offset: Insertion Loss + BWCF = 20.63 dB + 10*log(3 kHz/ 100 kHz) = 5.43 dB

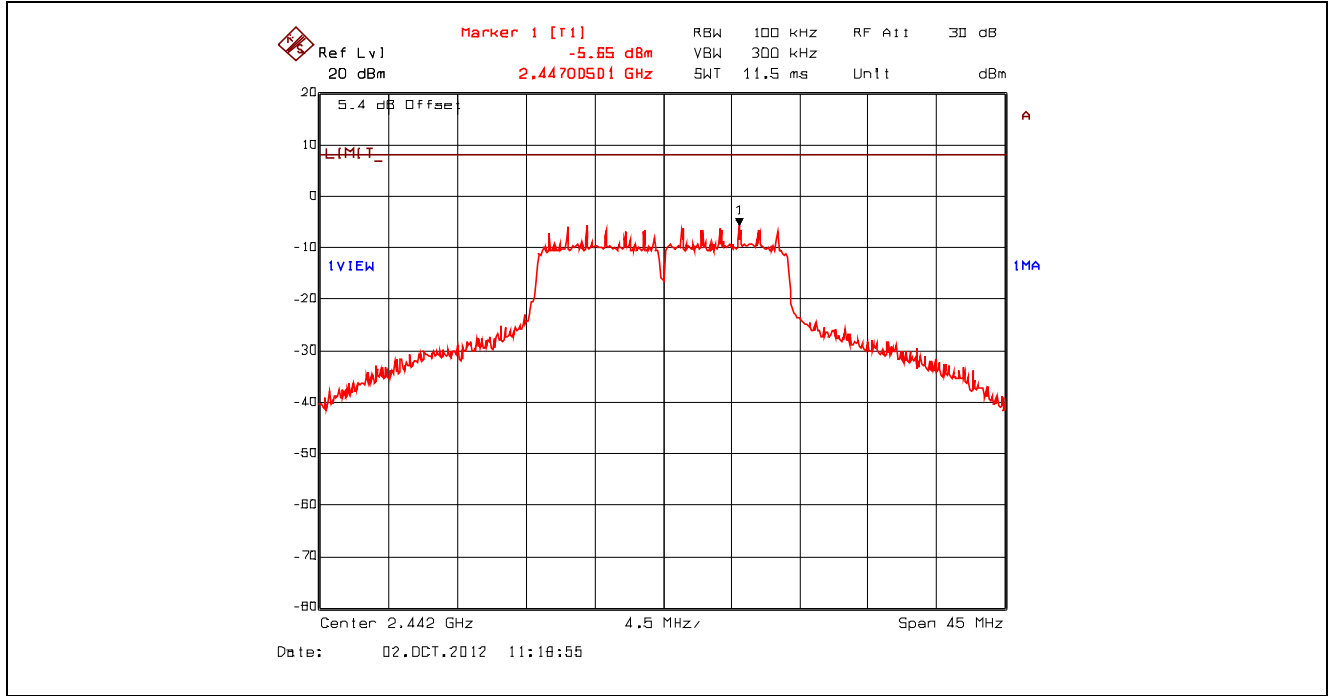

Plot 5.6.4.15. Power Spectral Density, 802.11g, 18 Mbps QPSK, 2462 MHz, Setting 23
 Offset: Insertion Loss + BWCF = 20.63 dB + 10*log(3 kHz/ 100 kHz) = 5.43 dB

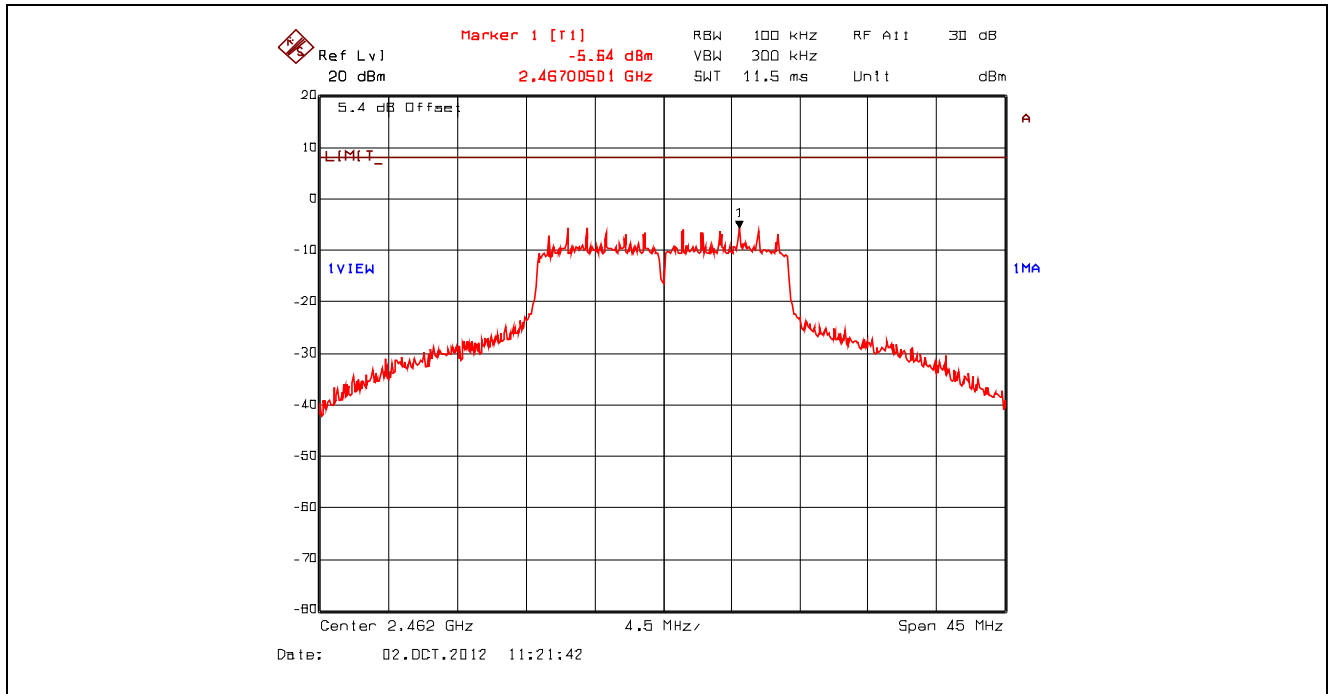

Plot 5.6.4.16. Power Spectral Density, 802.11g, 36 Mbps 16-QAM, 2412 MHz, Setting 23
 Offset: Insertion Loss + BWCF = 20.63 dB + 10*log(3 kHz/ 100 kHz) = 5.43 dB

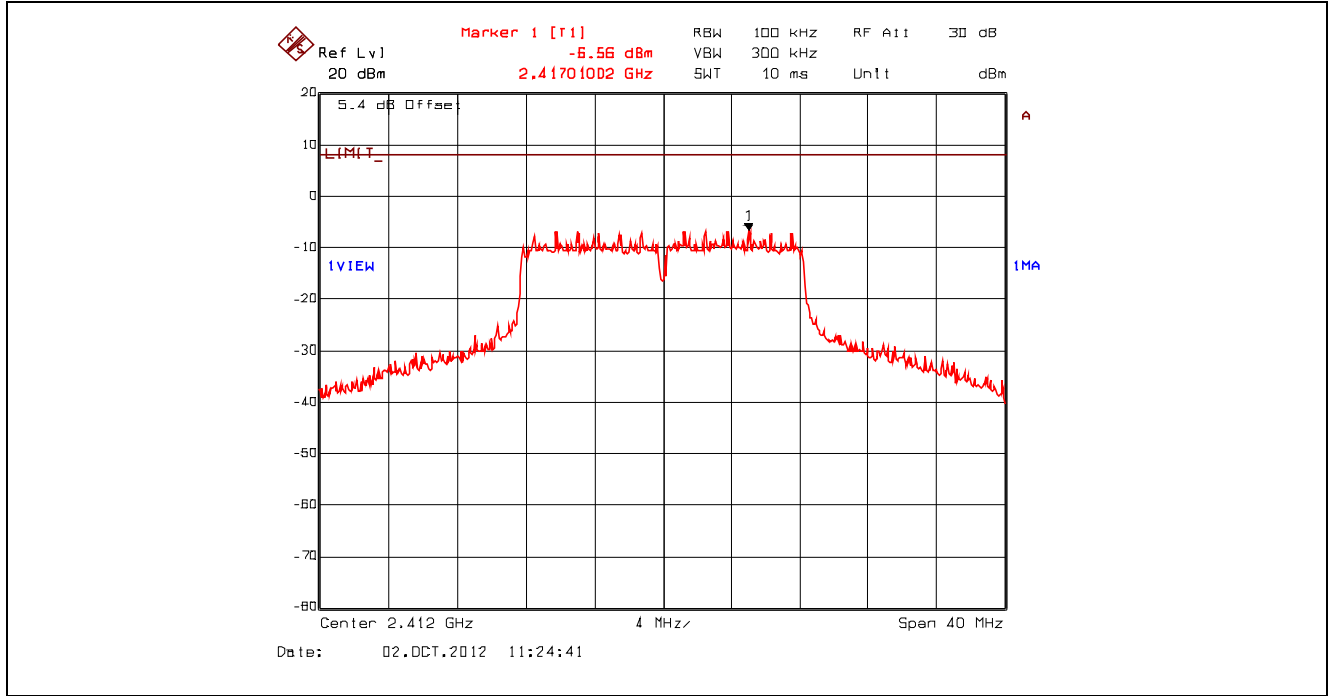

Plot 5.6.4.17. Power Spectral Density, 802.11g, 36 Mbps 16-QAM, 2442 MHz, Setting 23
 Offset: Insertion Loss + BWCF = 20.63 dB + 10*log(3 kHz/ 100 kHz) = 5.43 dB

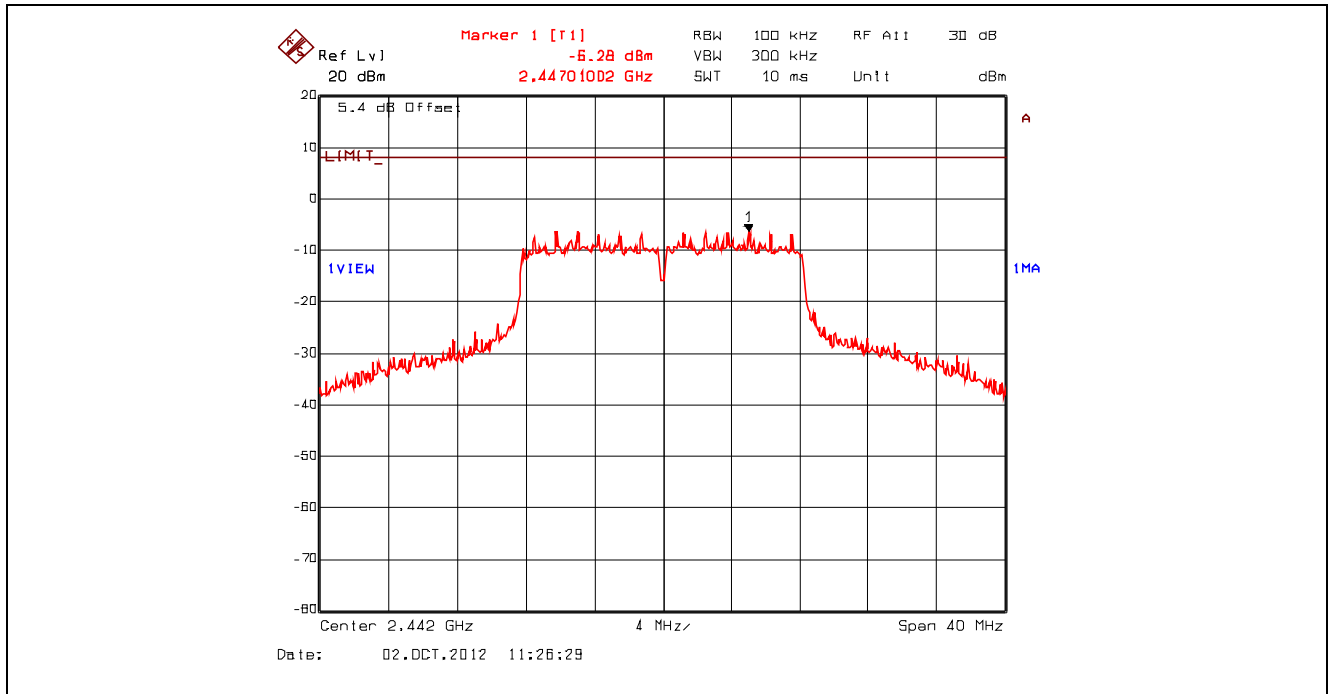

Plot 5.6.4.18. Power Spectral Density, 802.11g, 36 Mbps 16-QAM, 2462 MHz, Setting 23
 Offset: Insertion Loss + BWCF = 20.63 dB + 10*log(3 kHz/ 100 kHz) = 5.43 dB

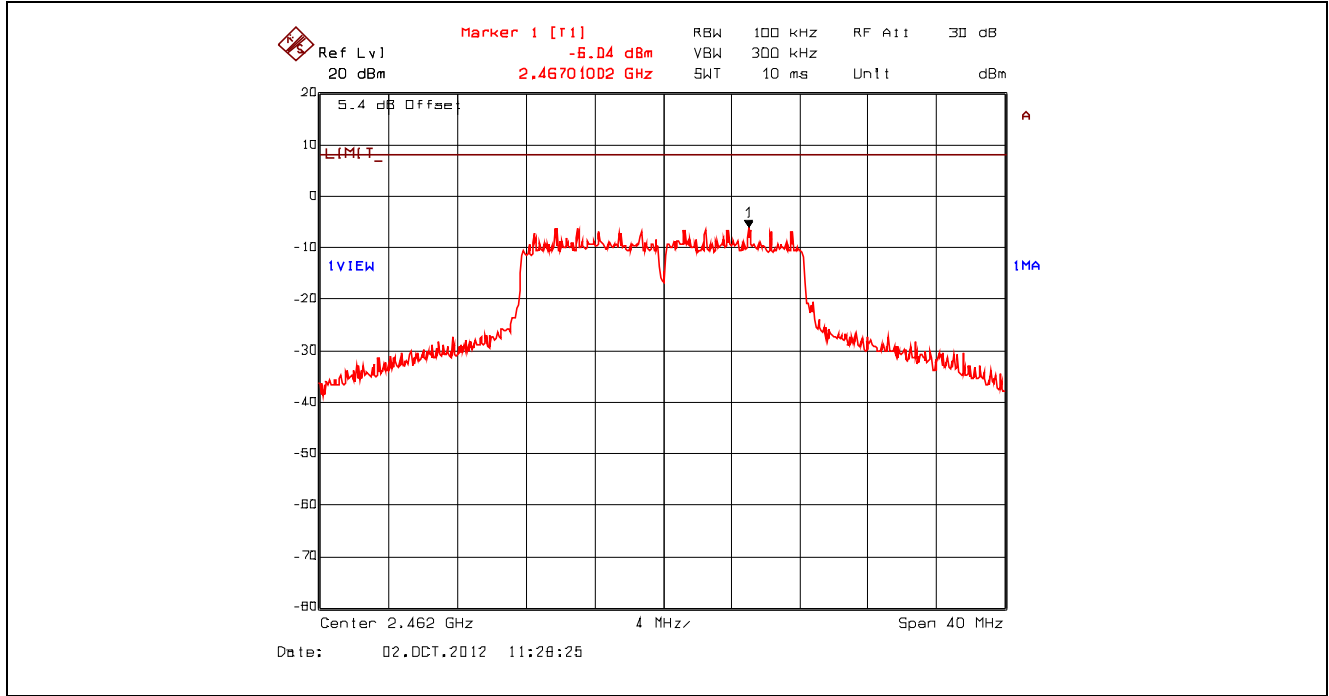

Plot 5.6.4.19. Power Spectral Density, 802.11g, 54 Mbps 64-QAM, 2412 MHz, Setting 23
 Offset: Insertion Loss + BWCF = 20.63 dB + 10*log(3 kHz/ 100 kHz) = 5.43 dB

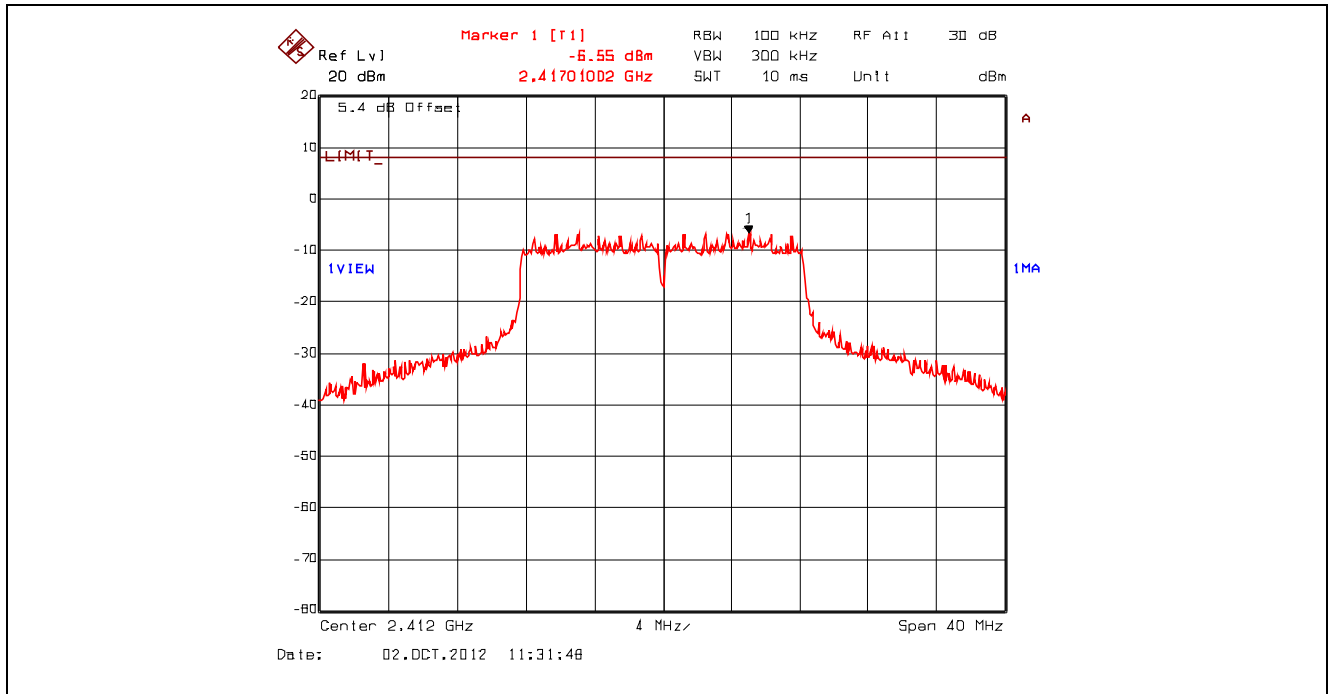

Plot 5.6.4.20. Power Spectral Density, 802.11g, 54 Mbps 64-QAM, 2442 MHz, Setting 23
 Offset: Insertion Loss + BWCF = 20.63 dB + 10*log(3 kHz/ 100 kHz) = 5.43 dB

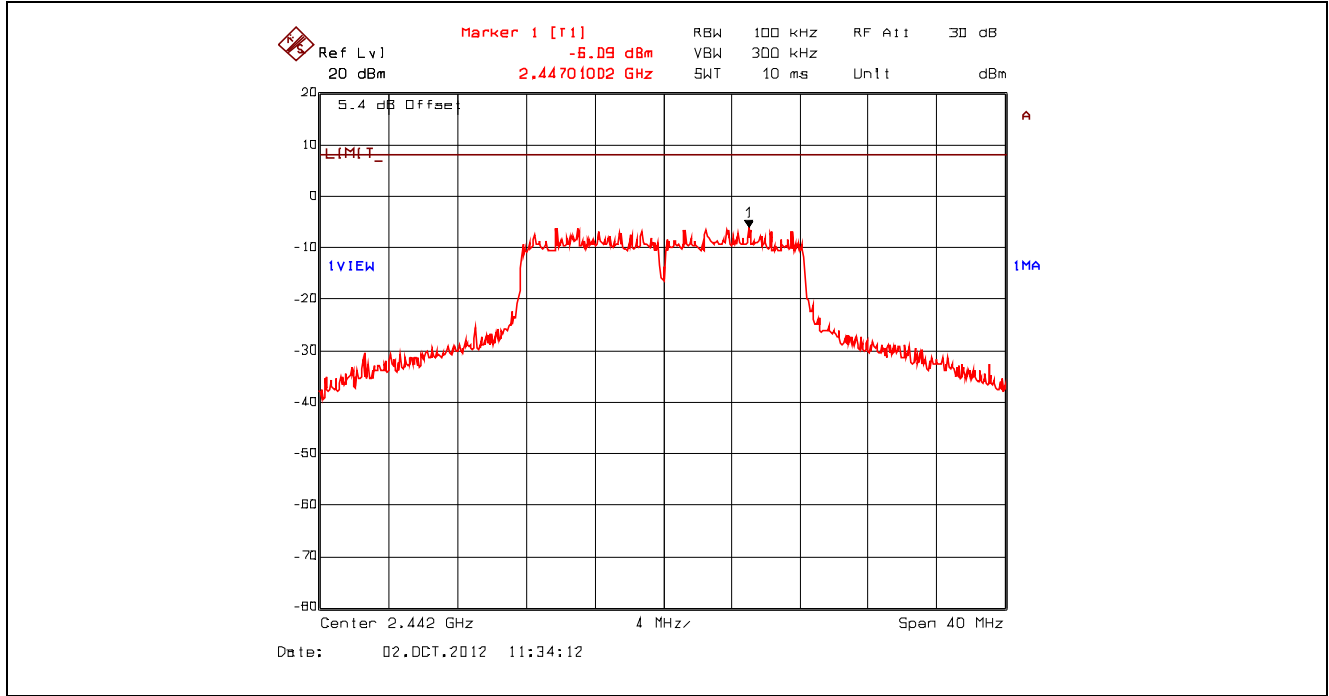

Plot 5.6.4.21. Power Spectral Density, 802.11g, 54 Mbps 64-QAM, 2462 MHz, Setting 23
 Offset: Insertion Loss + BWCF = 20.63 dB + 10*log(3 kHz/ 100 kHz) = 5.43 dB

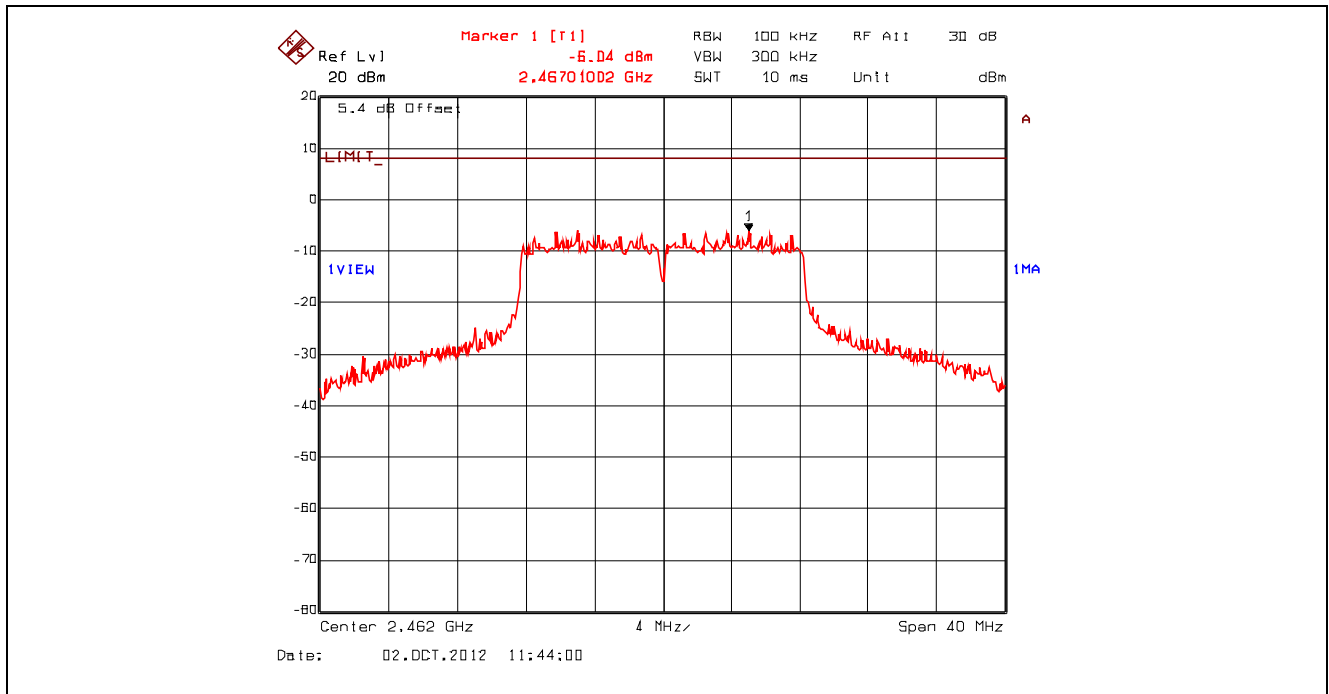

Plot 5.6.4.22. Power Spectral Density, 802.11n 800ns, 6.5 Mbps BPSK1/2, 2412 MHz, Setting 23
 Offset: Insertion Loss + BWCF = 20.63 dB + 10*log(3 kHz/ 100 kHz) = 5.43 dB

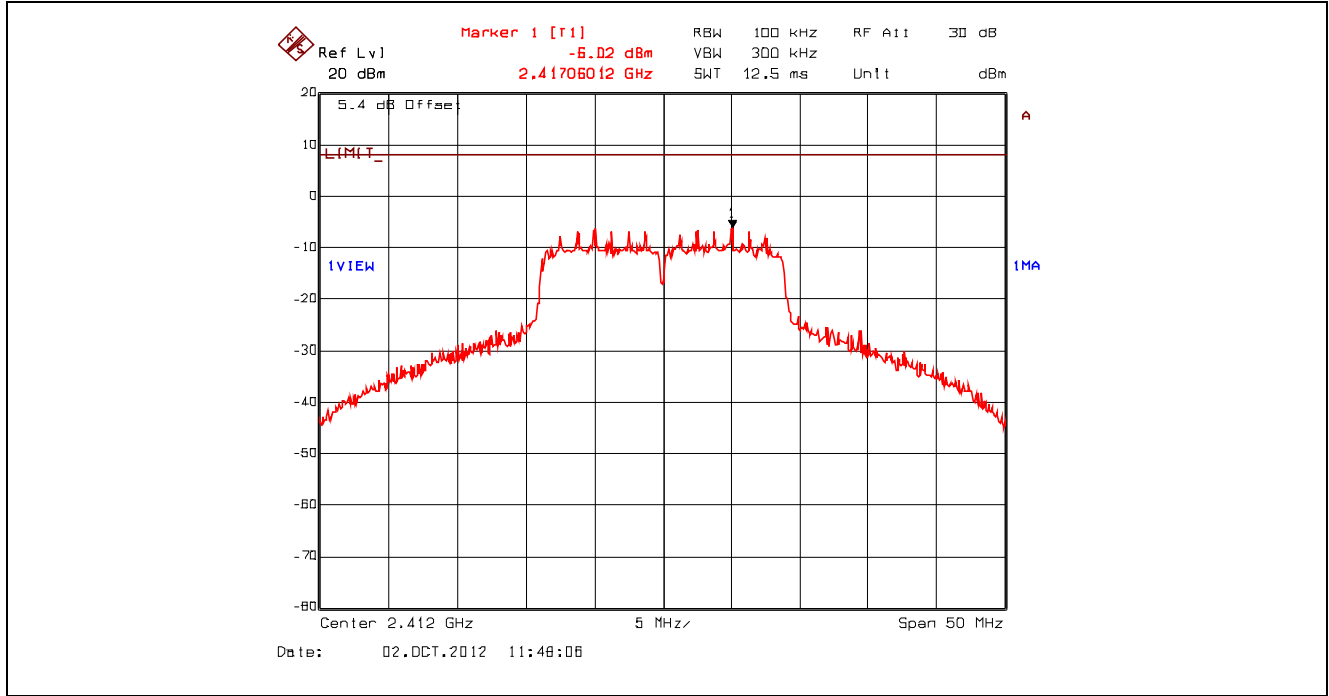

Plot 5.6.4.23. Power Spectral Density, 802.11n 800ns, 6.5 Mbps BPSK1/2, 2442 MHz, Setting 23
 Offset: Insertion Loss + BWCF = 20.63 dB + 10*log(3 kHz/ 100 kHz) = 5.43 dB

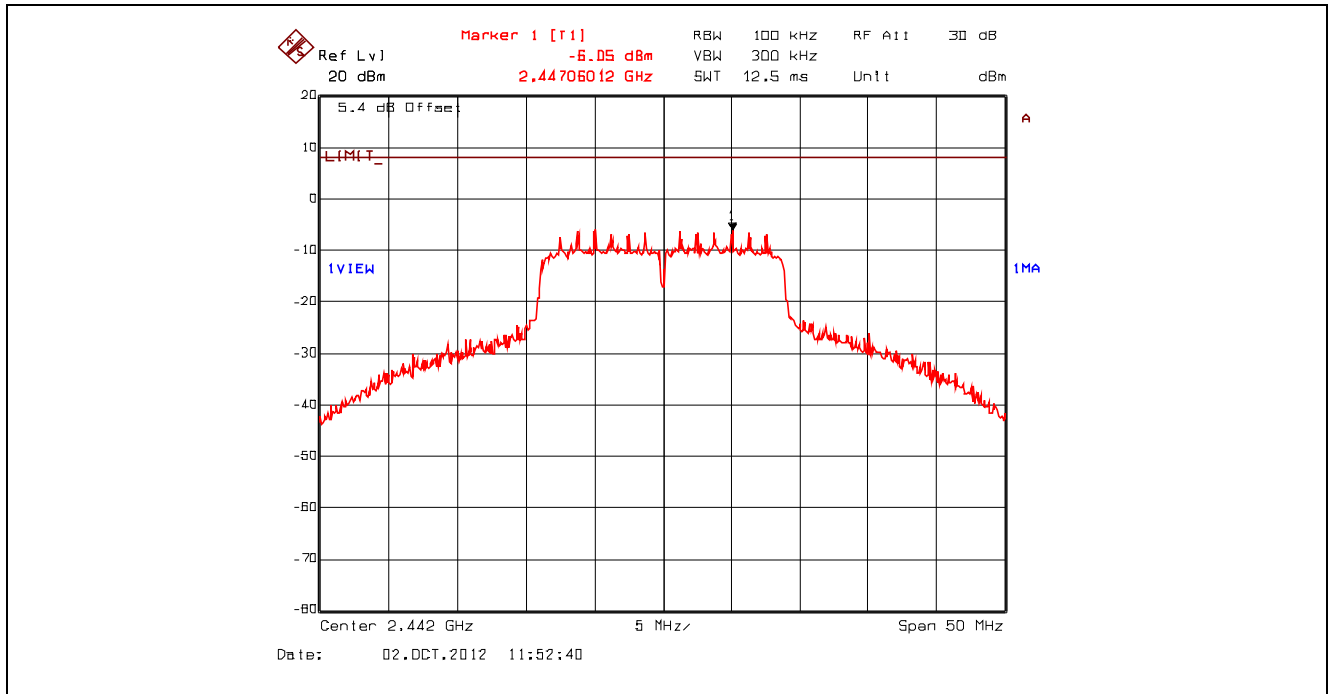

Plot 5.6.4.24. Power Spectral Density, 802.11n 800ns, 6.5 Mbps BPSK1/2, 2462 MHz, Setting 23
 Offset: Insertion Loss + BWCF = 20.63 dB + 10*log(3 kHz/ 100 kHz) = 5.43 dB

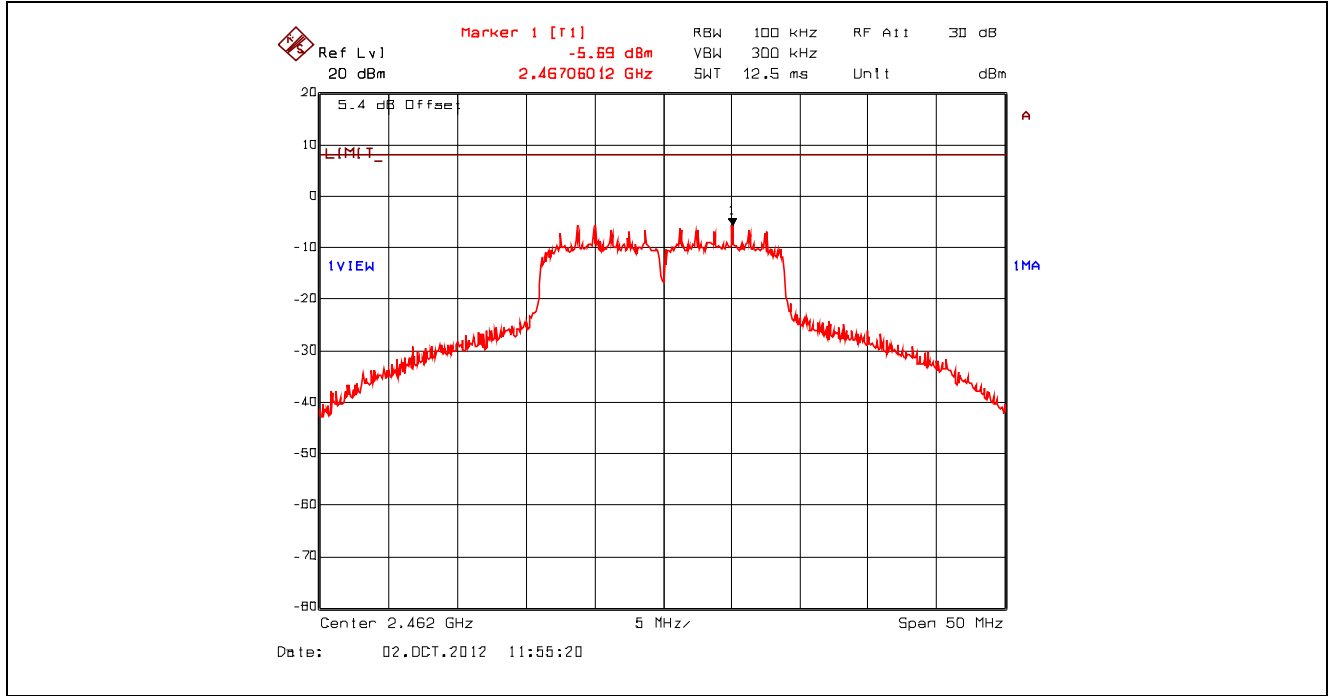

Plot 5.6.4.25. Power Spectral Density, 802.11n 800ns, 19.5 Mbps QPSK 3/4, 2412 MHz, Setting 23
 Offset: Insertion Loss + BWCF = 20.63 dB + 10*log(3 kHz/ 100 kHz) = 5.43 dB

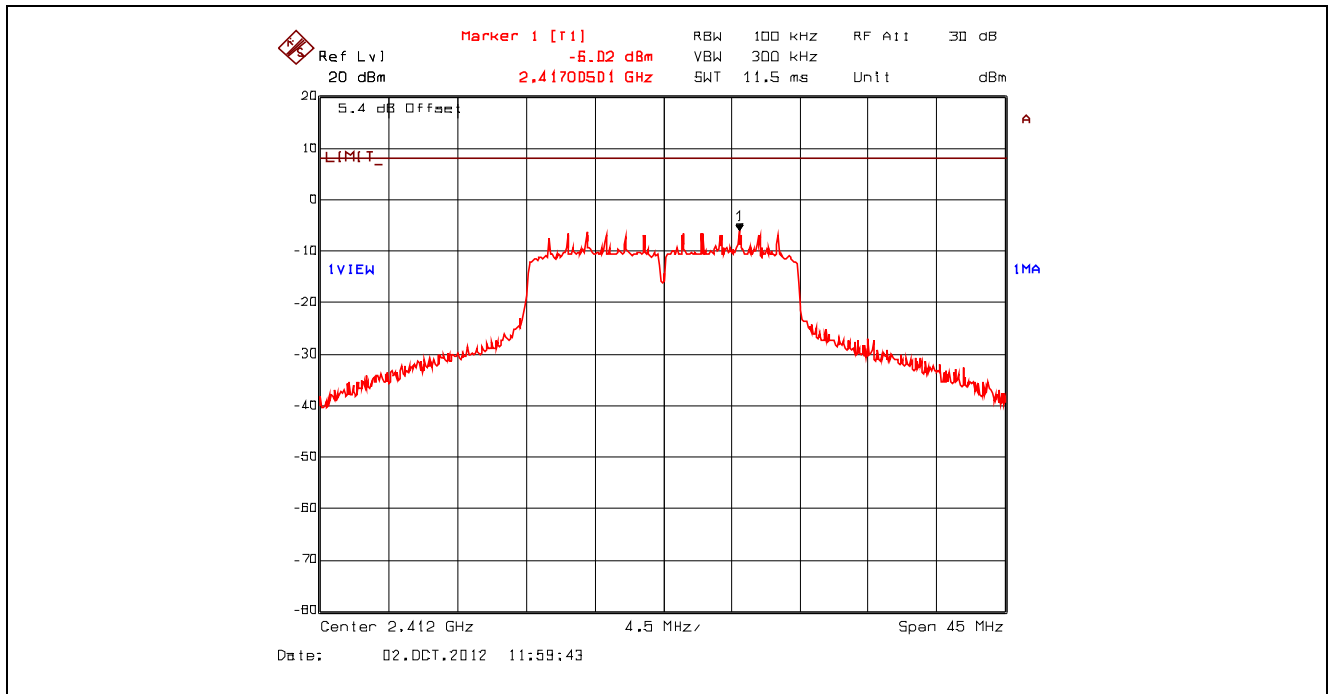

Plot 5.6.4.26. Power Spectral Density, 802.11n 800ns, 19.5 Mbps QPSK 3/4, 2442 MHz, Setting 23
 Offset: Insertion Loss + BWCF = 20.63 dB + 10*log(3 kHz/ 100 kHz) = 5.43 dB

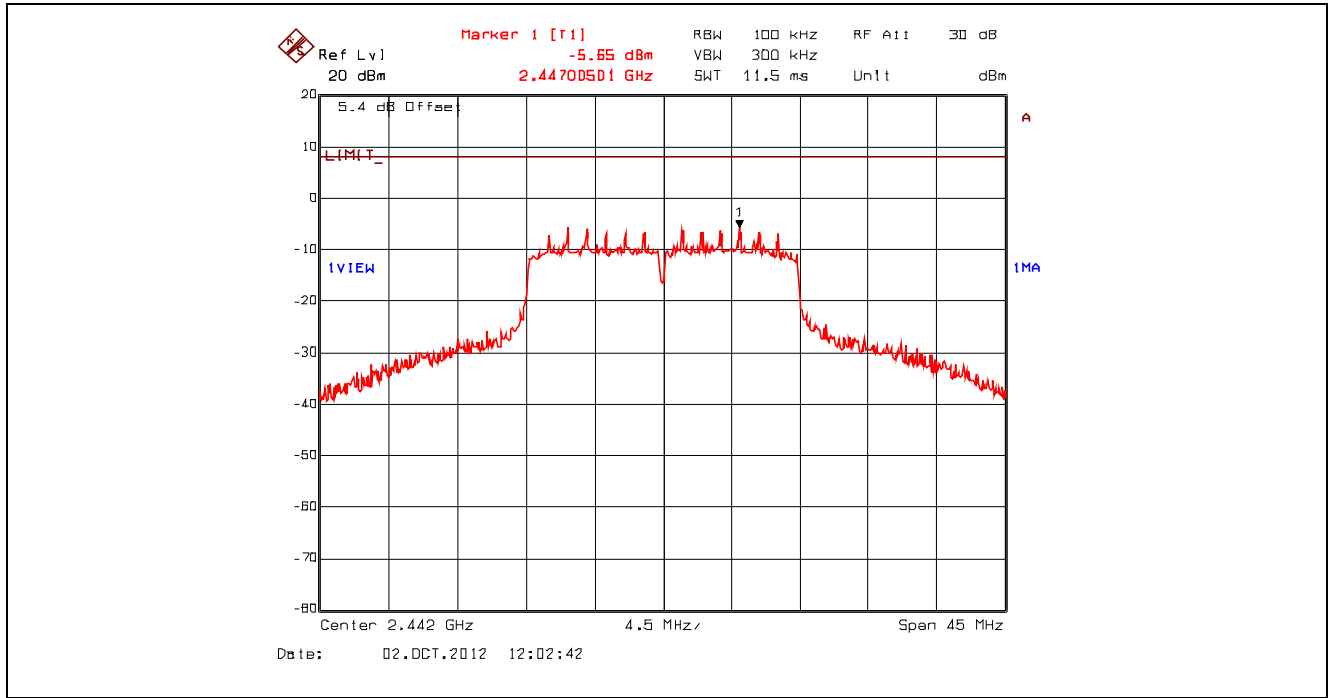

Plot 5.6.4.27. Power Spectral Density, 802.11n 800ns, 19.5 Mbps QPSK 3/4, 2462 MHz, Setting 23
 Offset: Insertion Loss + BWCF = 20.63 dB + 10*log(3 kHz/ 100 kHz) = 5.43 dB

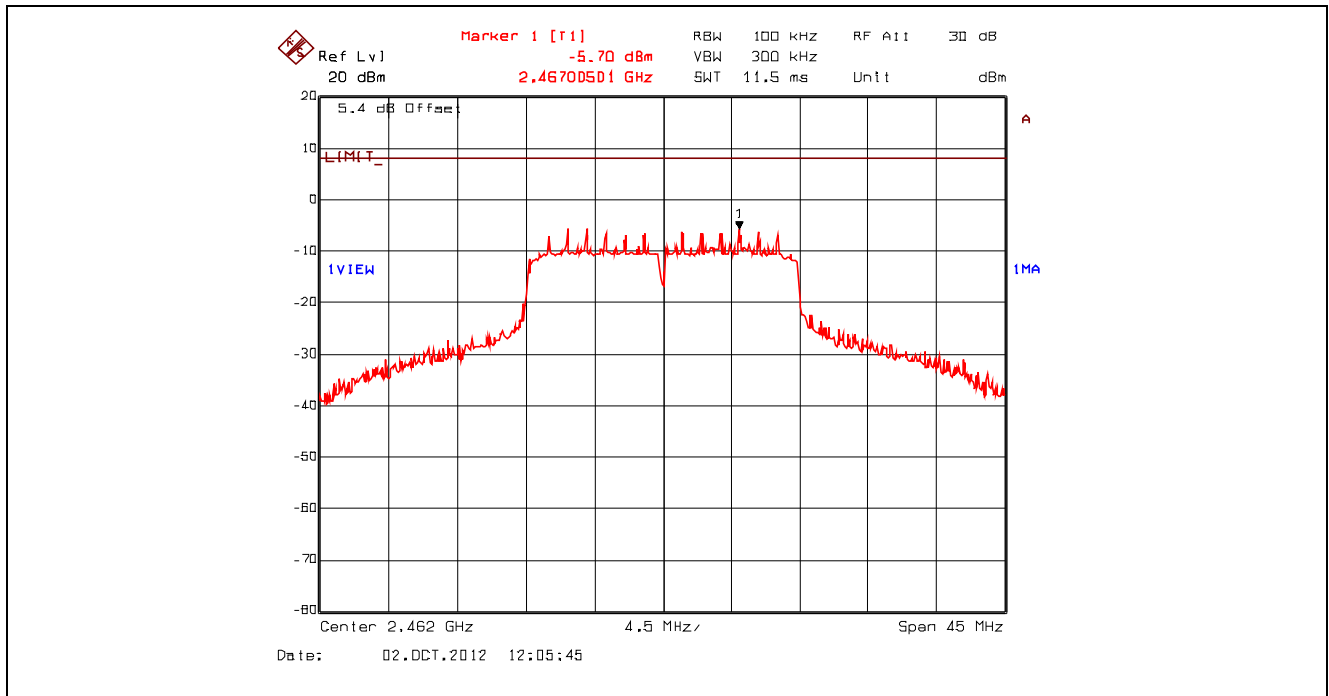

Plot 5.6.4.28. Power Spectral Density, 802.11n 800ns, 39 Mbps 16-QAM 3/4, 2412 MHz, Setting 23
Offset: Insertion Loss + BWCF = 20.63 dB + $10 \cdot \log(3 \text{ kHz} / 100 \text{ kHz}) = 5.43 \text{ dB}$

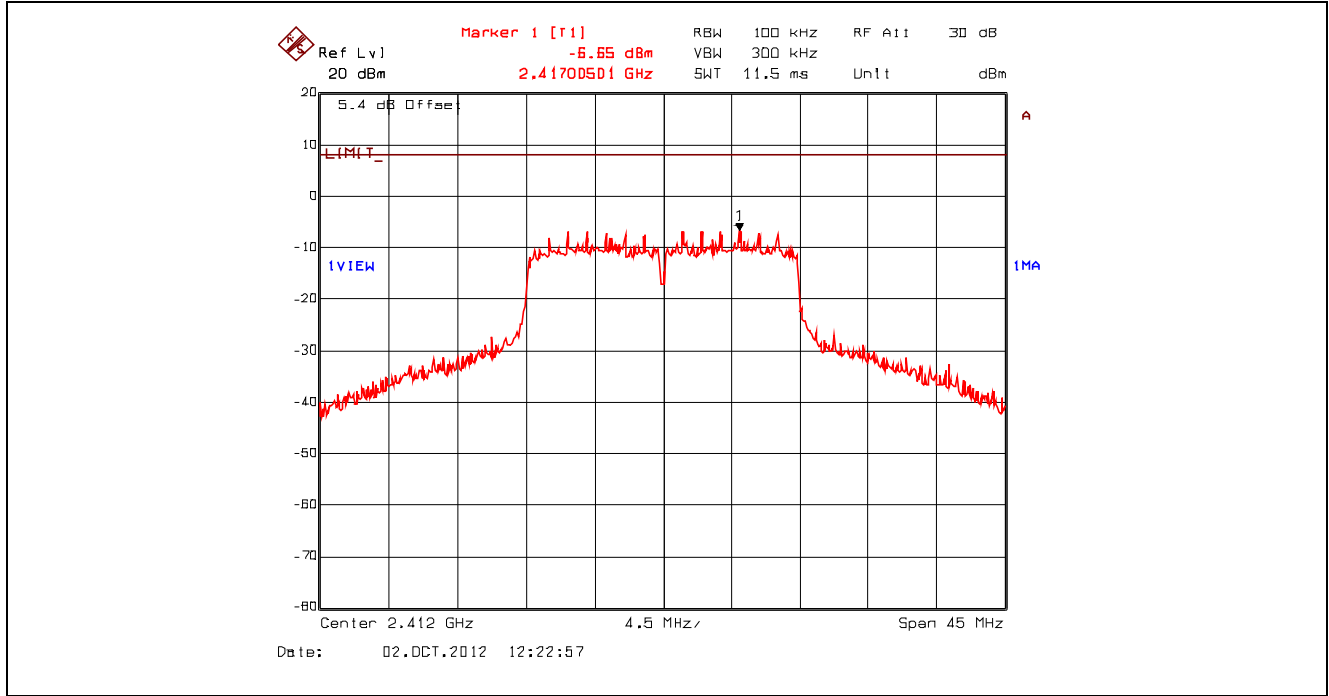

Plot 5.6.4.29. Power Spectral Density, 802.11n 800ns, 39 Mbps 16-QAM 3/4, 2442 MHz, Setting 23
Offset: Insertion Loss + BWCF = 20.63 dB + $10 \cdot \log(3 \text{ kHz} / 100 \text{ kHz}) = 5.43 \text{ dB}$

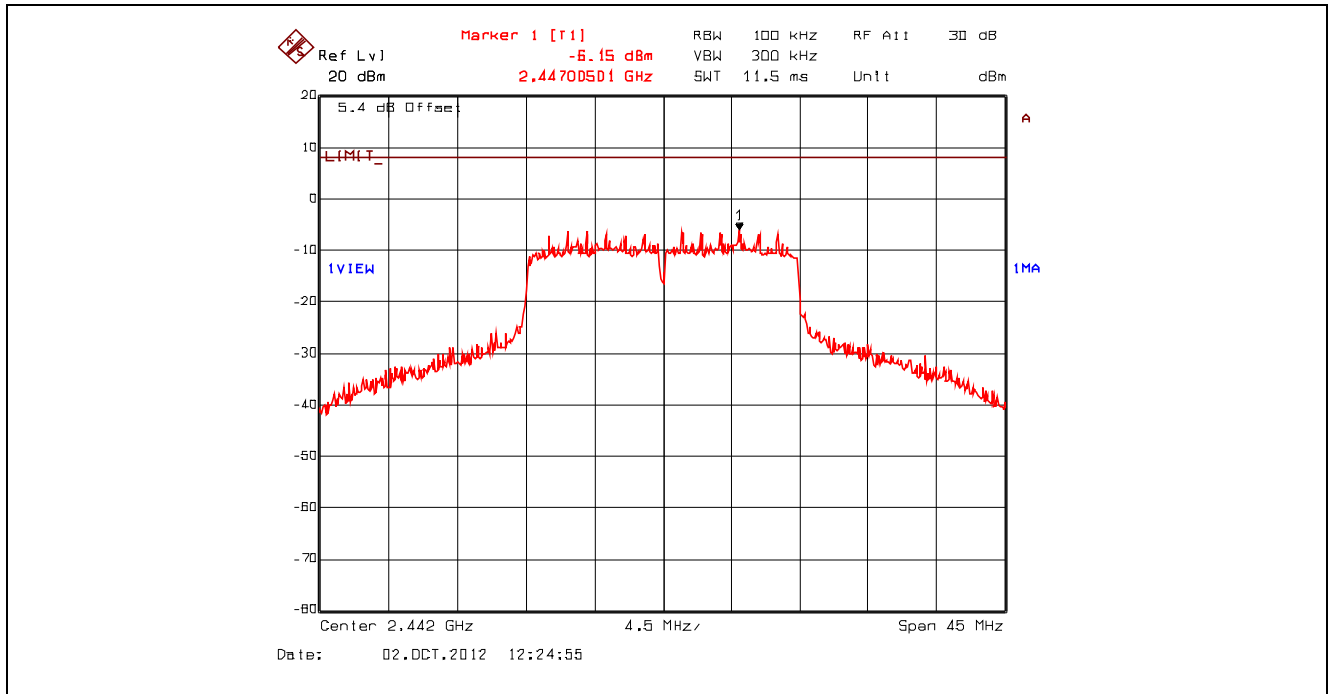

Plot 5.6.4.30. Power Spectral Density, 802.11n 800ns, 39 Mbps 16-QAM 3/4, 2462 MHz, Setting 23
 Offset: Insertion Loss + BWCF = 20.63 dB + $10 \cdot \log(3 \text{ kHz} / 100 \text{ kHz}) = 5.43 \text{ dB}$

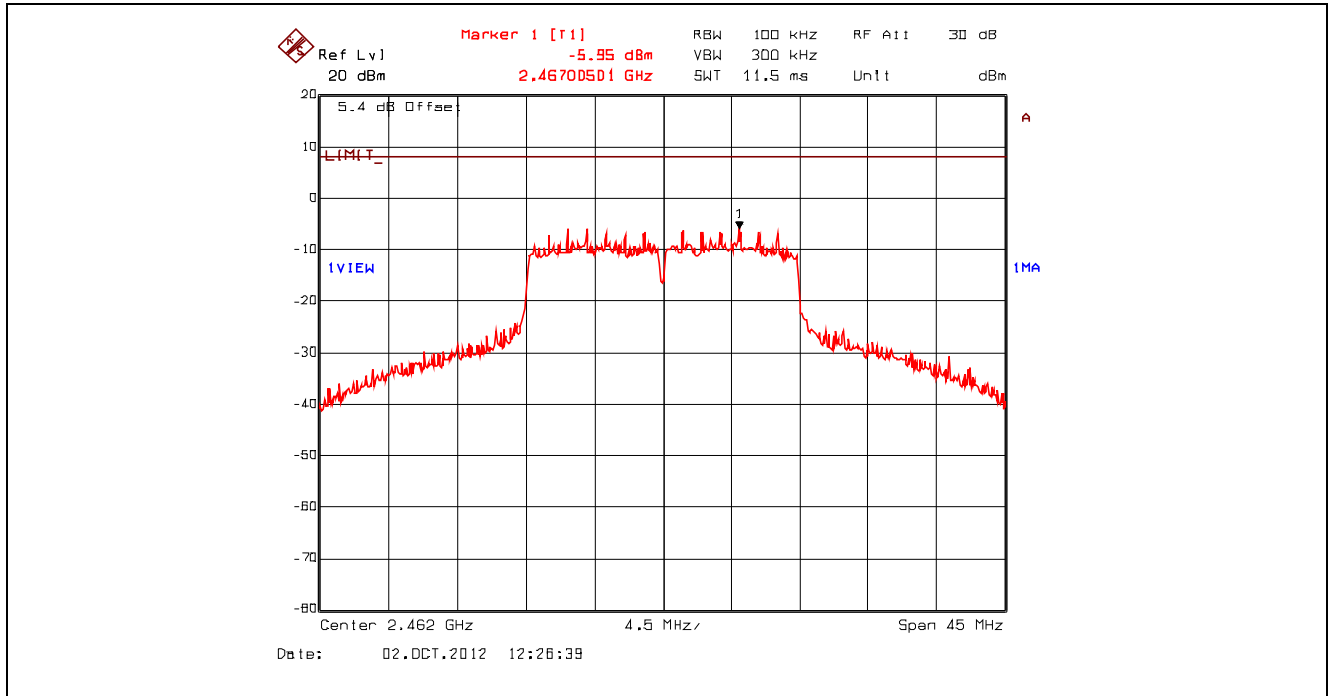

Plot 5.6.4.31. Power Spectral Density, 802.11n 800ns, 65 Mbps 64-QAM 5/6, 2412 MHz, Setting 23
 Offset: Insertion Loss + BWCF = 20.63 dB + $10 \cdot \log(3 \text{ kHz} / 100 \text{ kHz}) = 5.43 \text{ dB}$

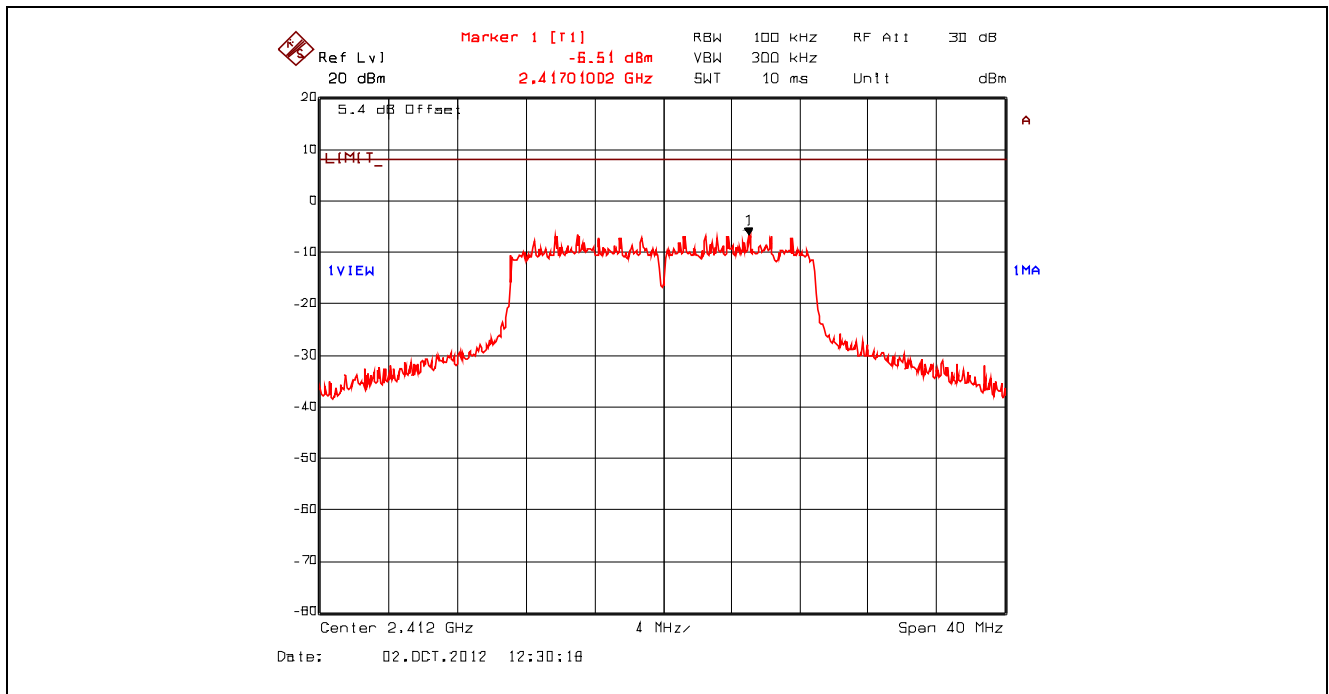

Plot 5.6.4.32. Power Spectral Density, 802.11n 800ns, 65 Mbps 64-QAM 5/6, 2442 MHz, Setting 23
Offset: Insertion Loss + BWCF = 20.63 dB + 10*log(3 kHz/ 100 kHz) = 5.43 dB

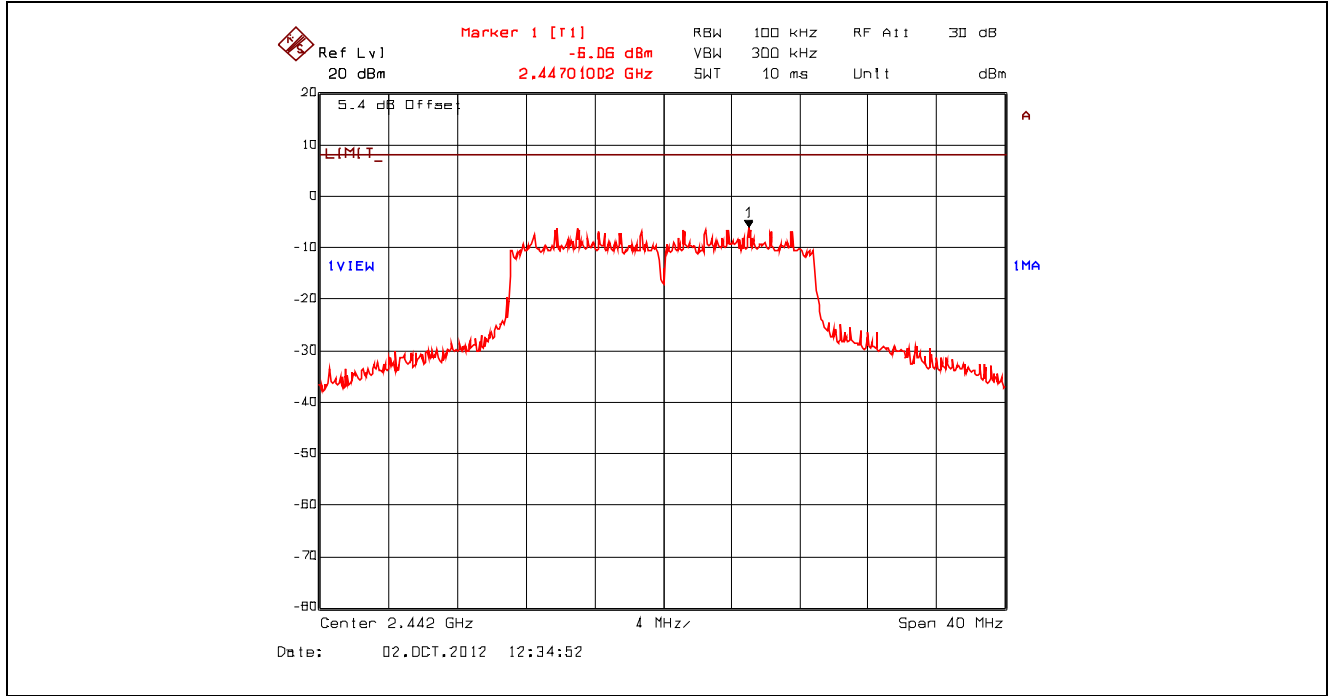

Plot 5.6.4.33. Power Spectral Density, 802.11n 800ns, 65 Mbps 64-QAM 5/6, 2462 MHz, Setting 23
Offset: Insertion Loss + BWCF = 20.63 dB + 10*log(3 kHz/ 100 kHz) = 5.43 dB

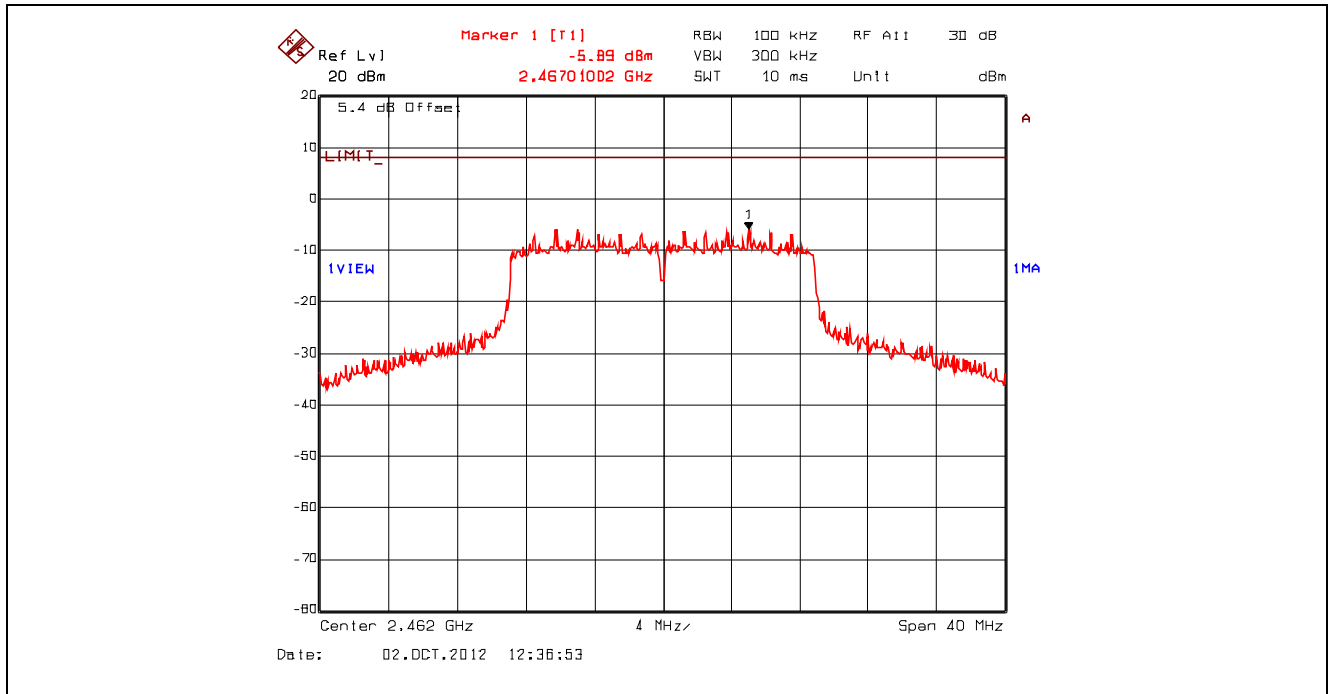

Plot 5.6.4.34. Power Spectral Density, 802.11n 400ns, 7.2 Mbps BPSK1/2, 2412 MHz, Setting 23
Offset: Insertion Loss + BWCF = 20.63 dB + 10*log(3 kHz/ 100 kHz) = 5.43 dB

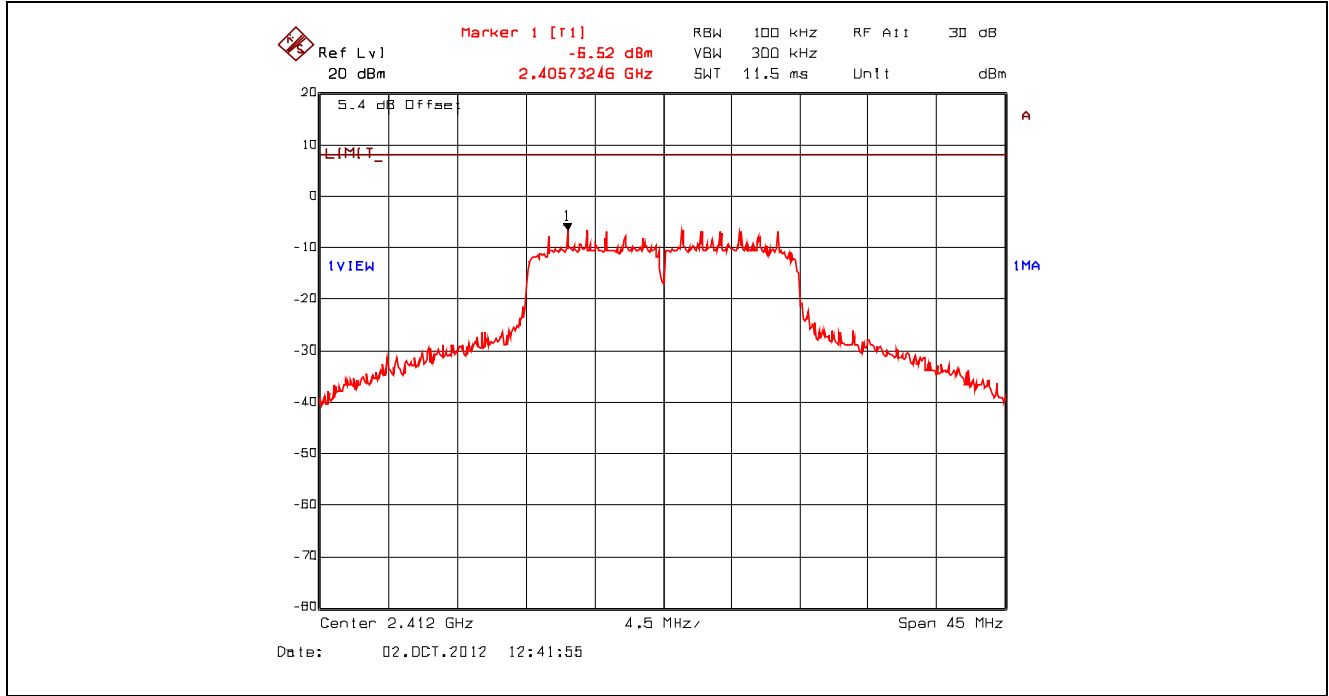

Plot 5.6.4.35. Power Spectral Density, 802.11n 400ns, 7.2 Mbps BPSK1/2, 2442 MHz, Setting 23
Offset: Insertion Loss + BWCF = 20.63 dB + 10*log(3 kHz/ 100 kHz) = 5.43 dB

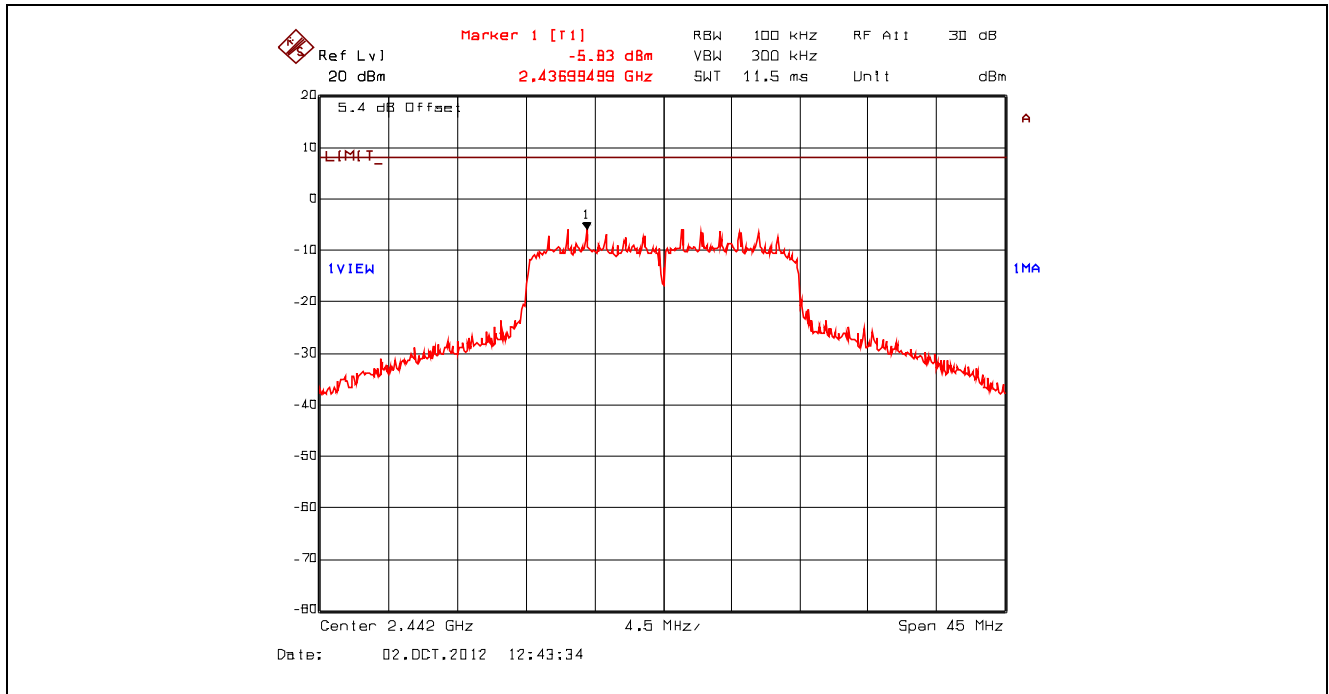

Plot 5.6.4.36. Power Spectral Density, 802.11n 400ns, 7.2 Mbps BPSK1/2, 2462 MHz, Setting 23
 Offset: Insertion Loss + BWCF = 20.63 dB + 10*log(3 kHz/ 100 kHz) = 5.43 dB

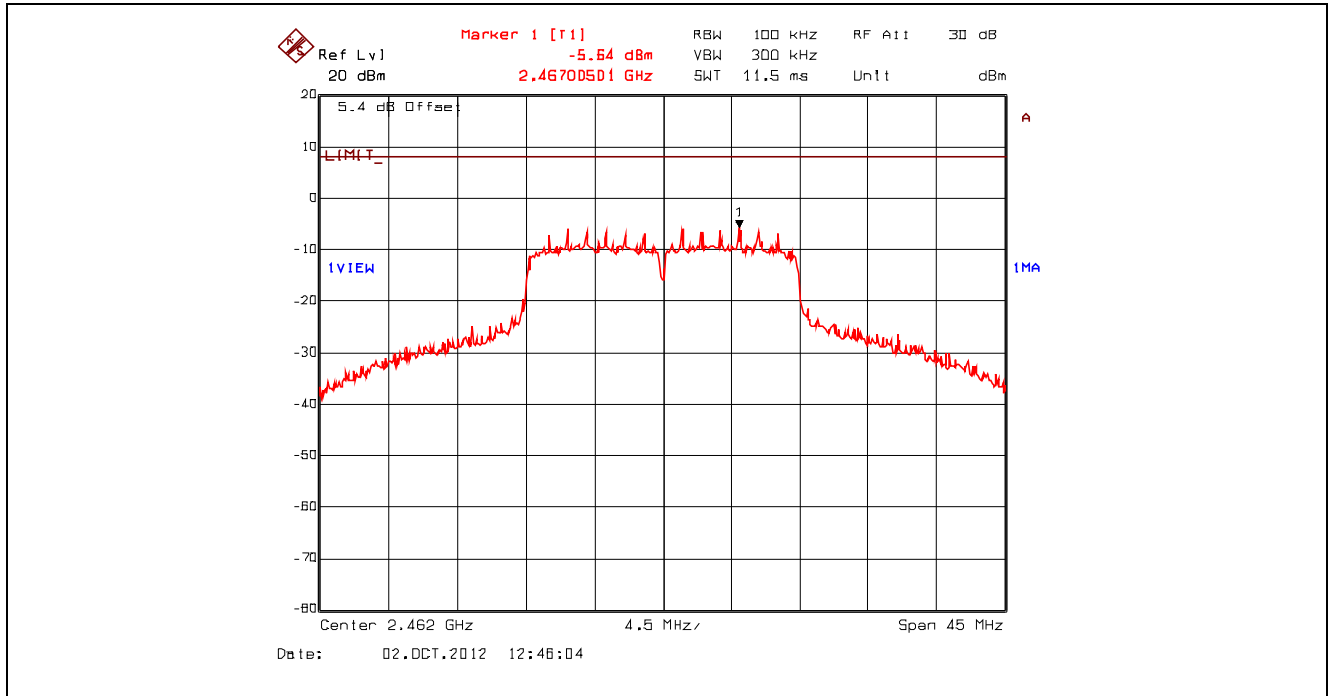

Plot 5.6.4.37. Power Spectral Density, 802.11n 400ns, 21.7 Mbps QPSK 3/4, 2412 MHz, Setting 23
 Offset: Insertion Loss + BWCF = 20.63 dB + 10*log(3 kHz/ 100 kHz) = 5.43 dB

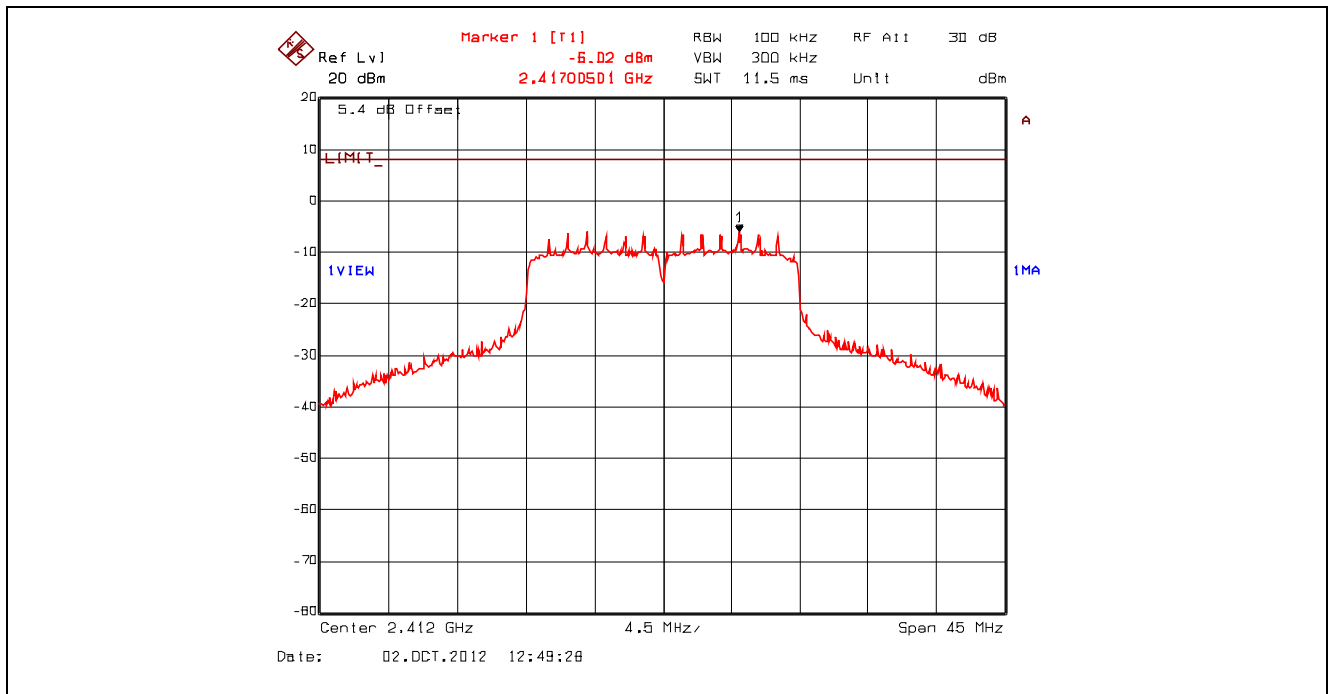

Plot 5.6.4.38. Power Spectral Density, 802.11n 400ns, 21.7 Mbps QPSK 3/4, 2442 MHz, Setting 23
Offset: Insertion Loss + BWCF = 20.63 dB + $10 \cdot \log(3 \text{ kHz} / 100 \text{ kHz}) = 5.43 \text{ dB}$

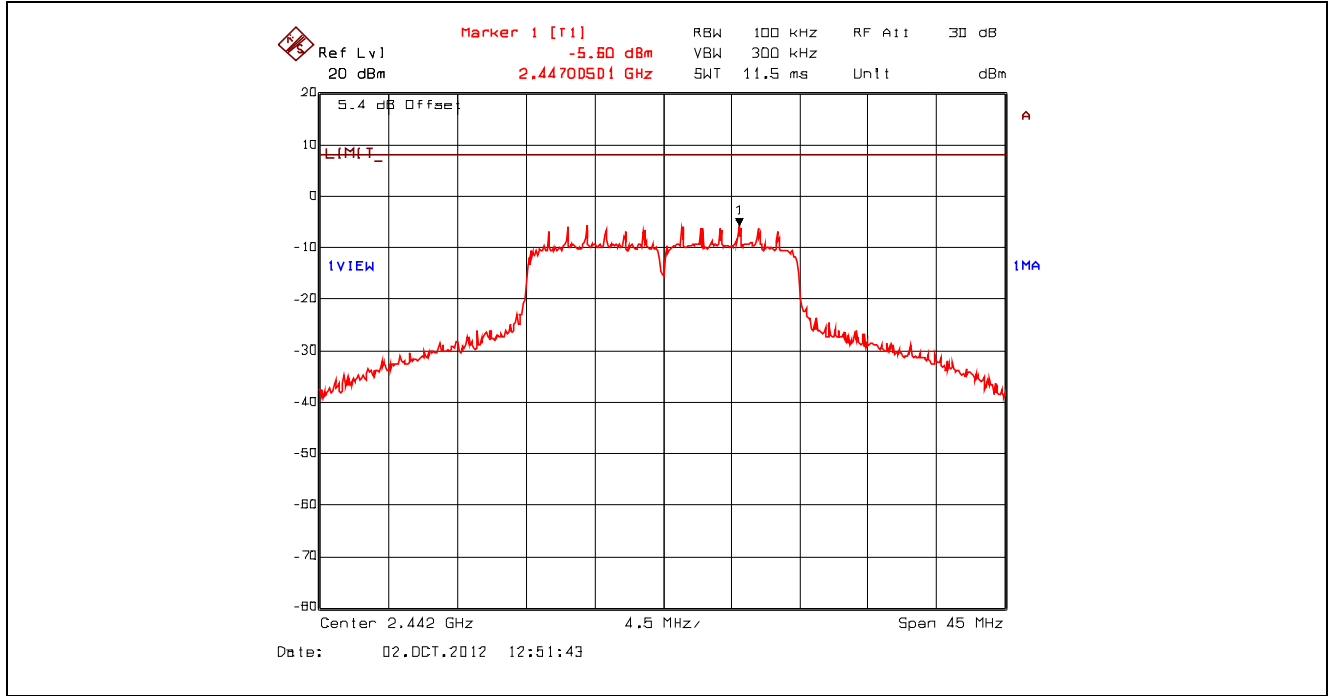

Plot 5.6.4.39. Power Spectral Density, 802.11n 400ns, 21.7 Mbps QPSK 3/4, 2462 MHz, Setting 23
Offset: Insertion Loss + BWCF = 20.63 dB + $10 \cdot \log(3 \text{ kHz} / 100 \text{ kHz}) = 5.43 \text{ dB}$

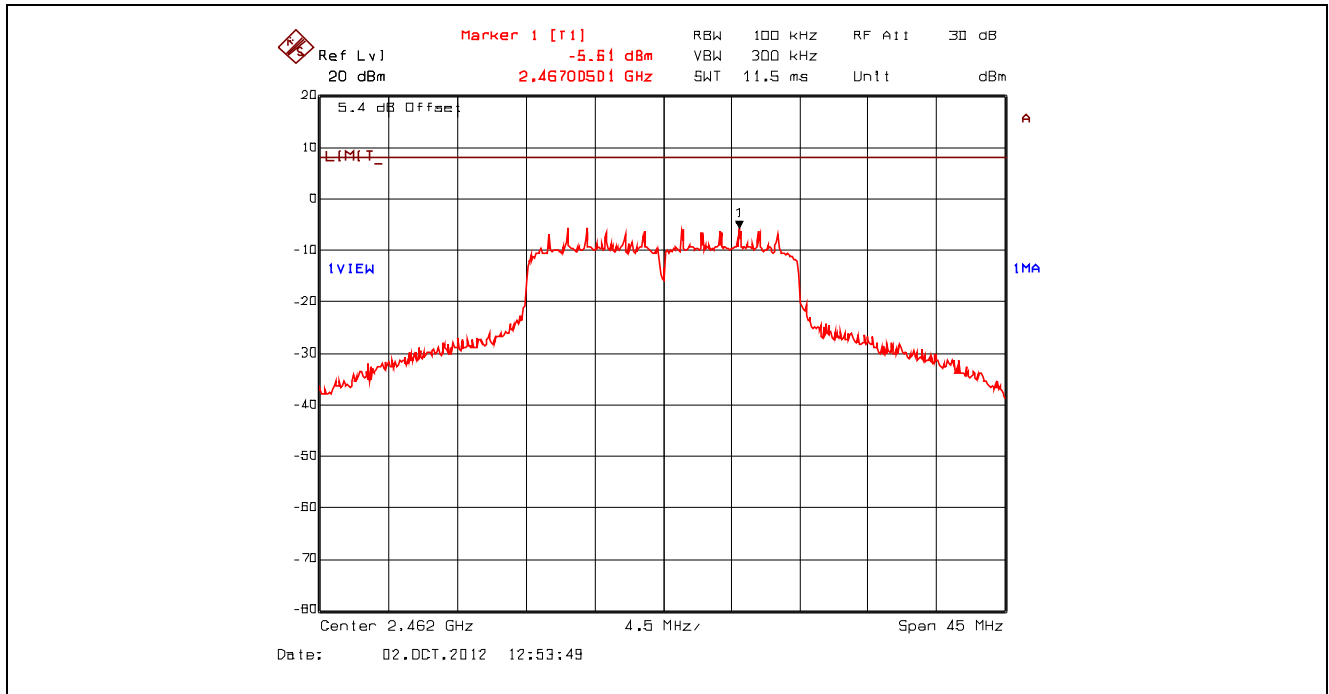

Plot 5.6.4.40. Power Spectral Density, 802.11n 400ns, 43.3 Mbps 16-QAM 3/4, 2412 MHz, Setting 23
 Offset: Insertion Loss + BWCF = 20.63 dB + 10*log(3 kHz/ 100 kHz) = 5.43 dB

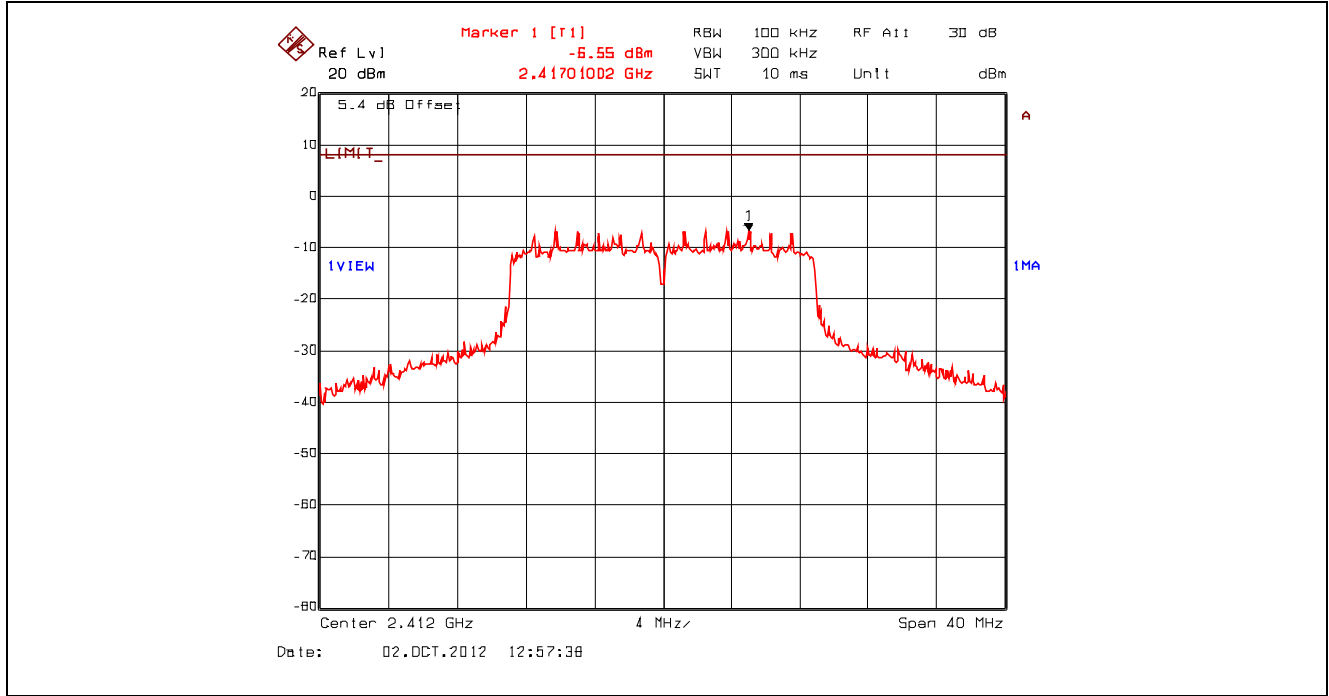

Plot 5.6.4.41. Power Spectral Density, 802.11n 400ns, 43.3 Mbps 16-QAM 3/4, 2442 MHz, Setting 23
 Offset: Insertion Loss + BWCF = 20.63 dB + 10*log(3 kHz/ 100 kHz) = 5.43 dB

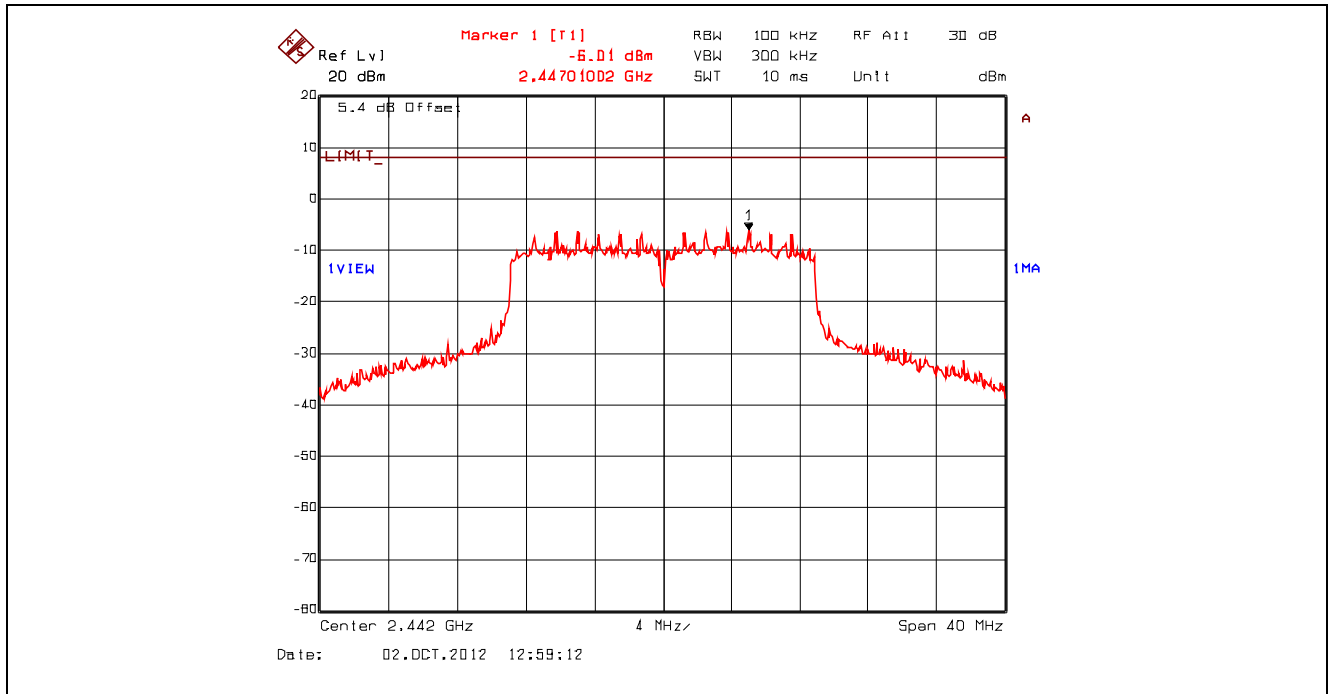

Plot 5.6.4.42. Power Spectral Density, 802.11n 400ns, 43.3 Mbps 16-QAM 3/4, 2462 MHz, Setting 23
 Offset: Insertion Loss + BWCF = 20.63 dB + 10*log(3 kHz/ 100 kHz) = 5.43 dB

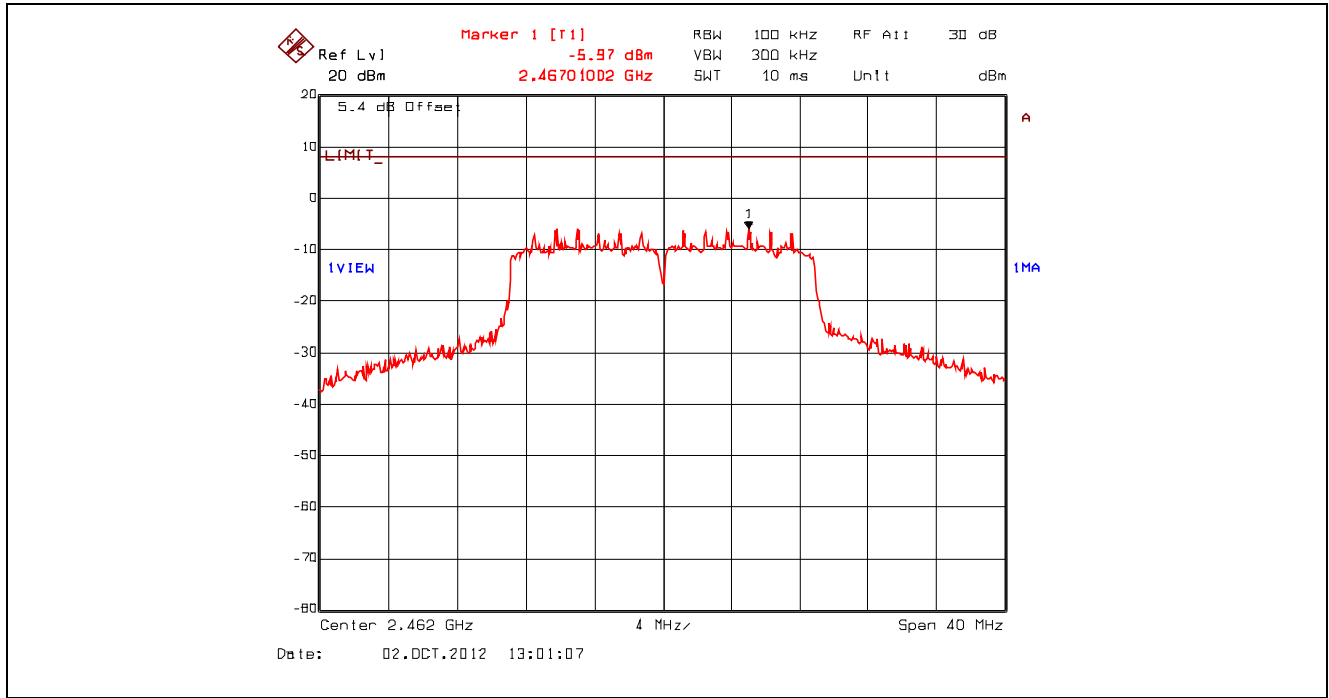

Plot 5.6.4.43. Power Spectral Density, 802.11n 400ns, 72.2 Mbps 64-QAM 5/6, 2412 MHz, Setting 23
 Offset: Insertion Loss + BWCF = 20.63 dB + 10*log(3 kHz/ 100 kHz) = 5.43 dB

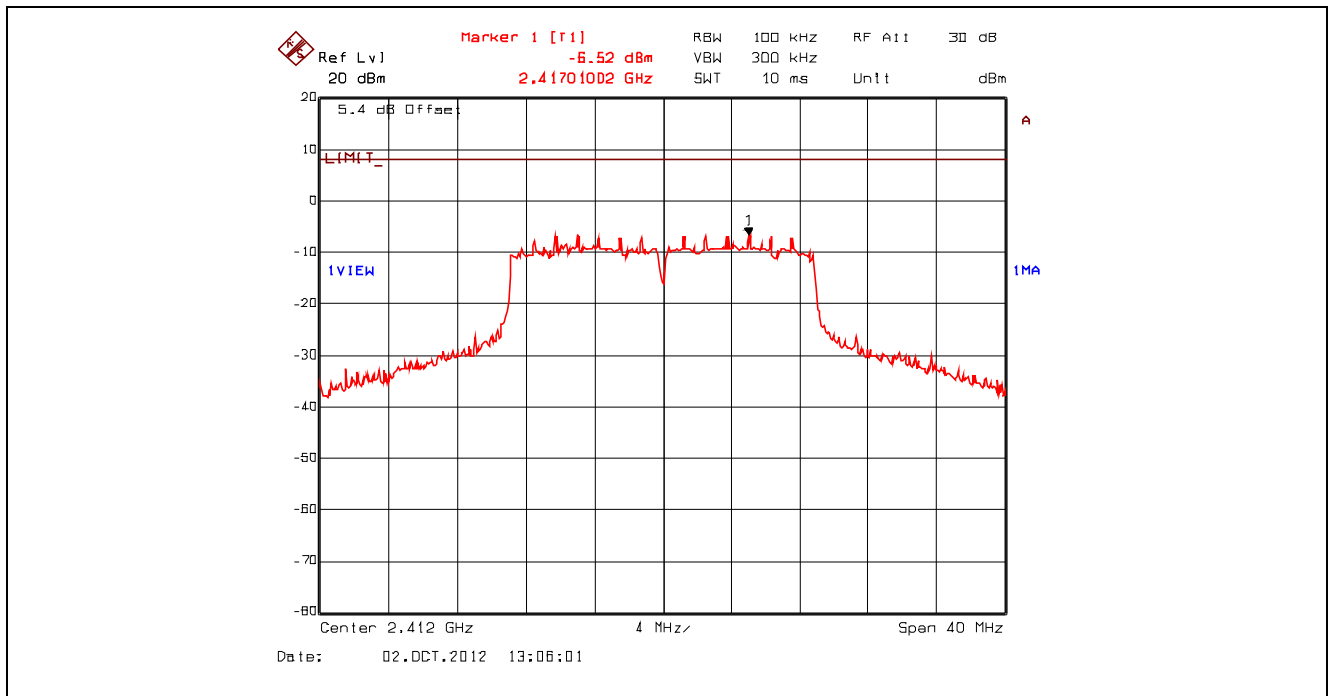

Plot 5.6.4.44. Power Spectral Density, 802.11n 400ns, 72.2 Mbps 64-QAM 5/6, 2442 MHz, Setting 23
 Offset: Insertion Loss + BWCF = 20.63 dB + 10*log(3 kHz/ 100 kHz) = 5.43 dB

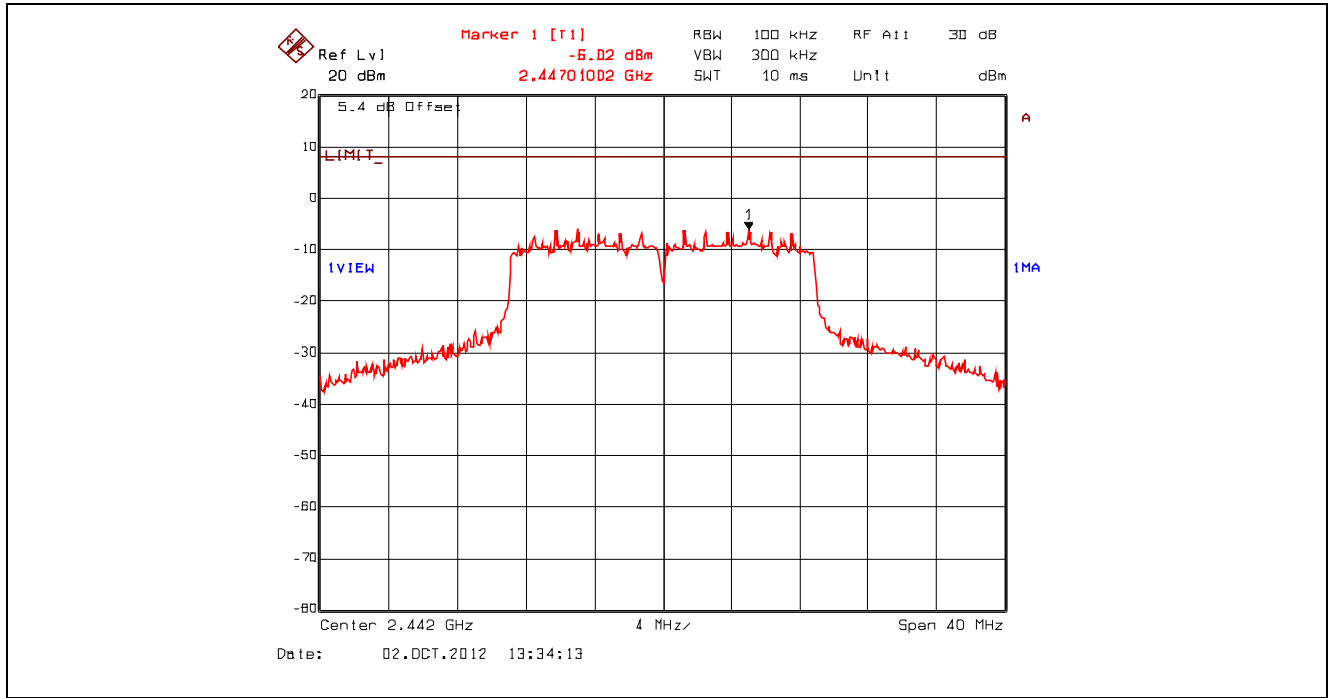

Plot 5.6.4.45. Power Spectral Density, 802.11n 400ns, 72.2 Mbps 64-QAM 5/6, 2462 MHz, Setting 23
 Offset: Insertion Loss + BWCF = 20.63 dB + 10*log(3 kHz/ 100 kHz) = 5.43 dB

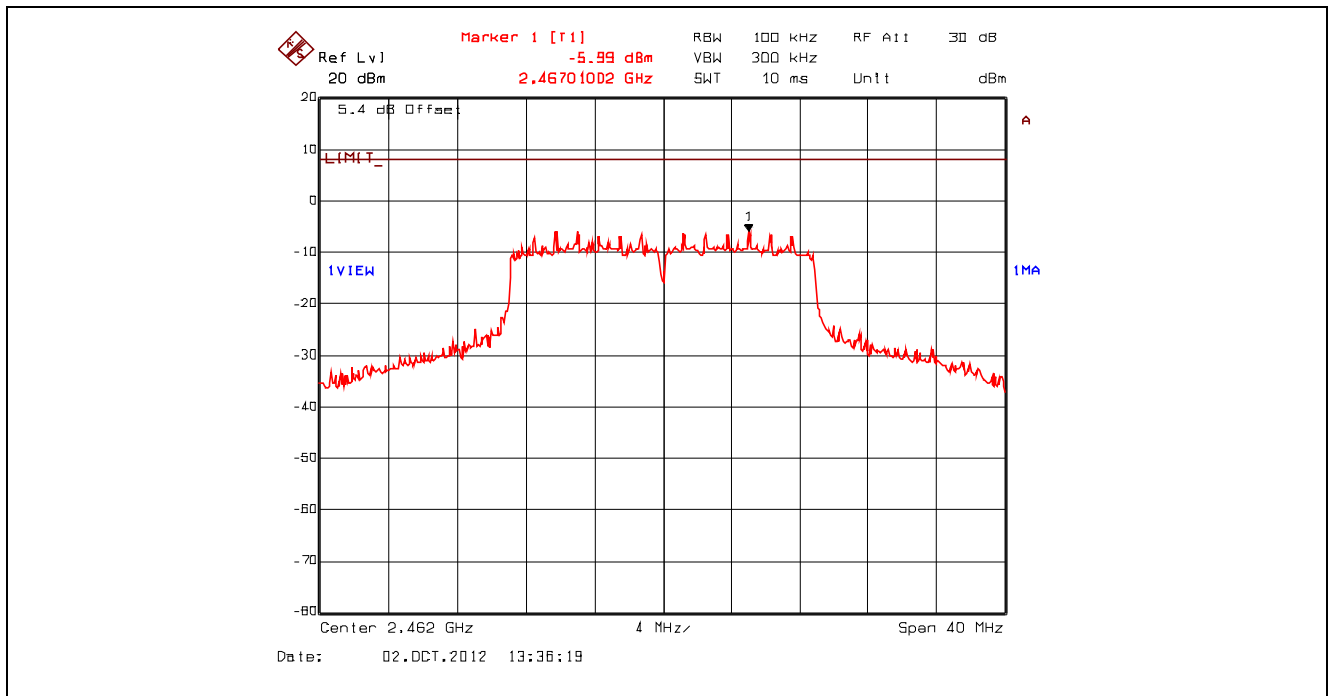

5.7. RF EXPOSURE REQUIRMENTS [§§ 15.247(e)(i), 1.1310 & 2.1091]

The criteria listed in the following table shall be used to evaluate the environmental impact of human exposure to radio-frequency (RF) radiation.

FCC 47 CFR § 1.1310:

TABLE 1—LIMITS FOR MAXIMUM PERMISSIBLE EXPOSURE (MPE)

Frequency range (MHz)	Electric field strength (V/m)	Magnetic field strength (A/m)	Power density (mW/cm ²)	Averaging time (minutes)
(A) Limits for Occupational/Controlled Exposures				
0.3–3.0	614	1.63	*(100)	6
3.0–30	1842/f	4.89/f	*(900/f ²)	6
30–300	61.4	0.163	1.0	6
300–1500	f/300	6
1500–100,000	5	6
(B) Limits for General Population/Uncontrolled Exposure				
0.3–1.34	614	1.63	*(100)	30
1.34–30	824/f	2.19/f	*(180/f ²)	30
30–300	27.5	0.073	0.2	30
300–1500	f/1500	30
1500–100,000	1.0	30

f = frequency in MHz

* = Plane-wave equivalent power density

NOTE 1 TO TABLE 1: Occupational/controlled limits apply in situations in which persons are exposed as a consequence of their employment provided those persons are fully aware of the potential for exposure and can exercise control over their exposure. Limits for occupational/controlled exposure also apply in situations when an individual is transient through a location where occupational/controlled limits apply provided he or she is made aware of the potential for exposure.

NOTE 2 TO TABLE 1: General population/uncontrolled exposures apply in situations in which the general public may be exposed, or in which persons that are exposed as a consequence of their employment may not be fully aware of the potential for exposure or can not exercise control over their exposure.

5.7.1. Method of Measurements

Refer to Sections 1.1310, 2.1091

In order to demonstrate compliance with MPE requirements (see Section 2.1091), the following information is typically needed:

- (1) Calculation that estimates the minimum separation distance (20 cm or more) between an antenna and persons required to satisfy power density limits defined for free space.
- (2) Antenna installation and device operating instructions for installers (professional/unskilled users), and the parties responsible for ensuring compliance with the RF exposure requirement
- (3) Any caution statements and/or warning labels that are necessary in order to comply with the exposure limits
- (4) Any other RF exposure related issues that may affect MPE compliance

Calculation Method of RF Safety Distance:

$$S = \frac{P \cdot G}{4 \cdot \pi \cdot r^2} = \frac{EIRP}{4 \cdot \pi \cdot r^2}$$

Where: P: power input to the antenna in mW
 EIRP: Equivalent (effective) isotropic radiated power
 S: power density mW/cm²
 G: numeric gain of antenna relative to isotropic radiator
 r: distance to centre of radiation in cm

5.7.2. RF Evaluation

Evaluation of RF Exposure Compliance Requirements	
RF Exposure Requirements	Compliance with FCC Rules
Minimum calculated separation distance between antenna and persons required: *17.8 cm	Manufacturer’ instruction for separation distance between antenna and persons required: 20 cm minimum
Antenna installation and device operating instructions for installers (professional/unskilled users), and the parties responsible for ensuring compliance with the RF exposure requirement	Antenna installation and device operating instructions shall be provided to installers to maintain and ensure compliance with RF exposure requirements.
Caution statements and/or warning labels that are necessary in order to comply with the exposure limits	Refer to user’s manual for RF exposure Information.
Any other RF exposure related issues that may affect MPE compliance	None.

*The minimum separation distance between the antenna and bodies of users are calculated using the following formula:

$$r = \sqrt{\frac{P \cdot G}{4 \cdot \pi \cdot S}} = \sqrt{\frac{EIRP}{4 \cdot \pi \cdot S}}$$

S = 1.0 mW/cm²

EIRP = 36 dBm = 10^(36/10) mW = 3981 mW (Worst Case)

$$\text{(Minimum Safe Distance, r)} = \sqrt{\frac{EIRP}{4 \cdot \pi \cdot S}} = \sqrt{\frac{3981}{4 \cdot \pi \cdot (1.0)}} \approx 17.8\text{cm}$$

EXHIBIT 6. TEST EQUIPMENT LIST

Test Instruments	Manufacturer	Model No.	Serial No.	Frequency Range	Cal. Due Date
Spectrum Analyzer	Agilent	E7401A	US40240432	9 kHz–1.5 GHz	01 May 2013
Attenuator	Pasternack	PE7010-20	-	DC–2 GHz	09 Jan 2013
High Pass Filter	Telemeter Electronics	MTA-HPF-150	2110465-007	-	17 Aug 2013
L.I.S.N	EMCO	3825/2	8907-1531	10 kHz -100 MHz	05 Apr 2013
Spectrum Analyzer	Rohde & Schwarz	FSEK20	834157	20Hz–40 GHz	30 July 2013
Attenuator	Pasternack	PE7024-20	-	DC–26.5 GHz	Cal on use
Attenuator	Pasternack	PE7024-10	-	DC–26.5 GHz	Cal on use
DC Block	Hewlett Packard	11742A	12460	0.045–26.5 GHz	Cal on use
High Pass Filter	K & L	11SH10-4000/T12000	4	Cut off 2400 MHz	Cal on use
Spectrum Analyzer	Advantest	R3271	15050203	100Hz–26.5 GHz	10 July 2013
Band Reject Filter	Micro-Tronics	BRM50701	105	Cut off 2.4-2.483 GHz	Cal on use
Spectrum Analyzer	Rohde & Schwarz	ESU40	100037	20 Hz – 40 GHz	19 Mar 2013
RF Amplifier	Hewlett Packard	84498	3008A00769	1 – 26.5 GHz	06 Aug 2013
RF Amplifier	AH System	PAM-0118	225	20 MHz – 18 GHz	16 Mar 2013
Biconi-Log Antenna	ETS Lindgren	3142B	1575	26 – 3000 MHz	04 May 2013
Horn Antenna	EMCO	3155	6570	1 – 18 GHz	02 Apr 2013
Horn Antenna	EMCO	3160-09	118385	18 – 26.5 GHz	30 July 2014

ULTRATECH GROUP OF LABS

3000 Bristol Circle, Oakville, Ontario, Canada L6H 6G4
 Tel. #: 905-829-1570, Fax. #: 905-829-8050, Email: vic@ultratech-labs.com, Website: <http://www.ultratech-labs.com>

File #: DIGI-064F15C247
 October 26, 2012

All test results contained in this engineering test report are traceable to National Institute of Standards and Technology (NIST)

EXHIBIT 7. MEASUREMENT UNCERTAINTY

The measurement uncertainties stated were calculated in accordance with the requirements of CISPR 16-4-2 @ IEC:2003 and JCGM 100:2008 (GUM 1995) – Guide to the Expression of Uncertainty in Measurement.

7.1. LINE CONDUCTED EMISSION MEASUREMENT UNCERTAINTY

	Line Conducted Emission Measurement Uncertainty (150 kHz – 30 MHz):	Measured	Limit
u_c	Combined standard uncertainty: $u_c(y) = \sqrt{\sum_{i=1}^m u_i^2(y)}$	± 1.57	± 1.8
U	Expanded uncertainty U: $U = 2u_c(y)$	± 3.14	± 3.6

7.2. RADIATED EMISSION MEASUREMENT UNCERTAINTY

	Radiated Emission Measurement Uncertainty @ 3m, Horizontal (30-1000 MHz):	Measured	Limit
u_c	Combined standard uncertainty: $u_c(y) = \sqrt{\sum_{i=1}^m u_i^2(y)}$	± 2.15	± 2.6
U	Expanded uncertainty U: $U = 2u_c(y)$	± 4.30	± 5.2

	Radiated Emission Measurement Uncertainty @ 3m, Vertical (30-1000 MHz):	Measured	Limit
u_c	Combined standard uncertainty: $u_c(y) = \sqrt{\sum_{i=1}^m u_i^2(y)}$	± 2.39	± 2.6
U	Expanded uncertainty U: $U = 2u_c(y)$	± 4.78	± 5.2

	Radiated Emission Measurement Uncertainty @ 3 m, Horizontal & Vertical (1 – 18 GHz):	Measured	Limit
u_c	Combined standard uncertainty: $u_c(y) = \sqrt{\sum_{i=1}^m u_i^2(y)}$	± 1.87	Under consideration
U	Expanded uncertainty U: $U = 2u_c(y)$	± 3.75	Under consideration