

# ENGINEERING TEST REPORT

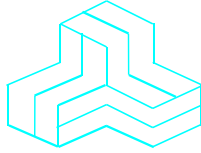

**XBee RR Pro**  
**Model: XBPRR**  
**FCC ID: MCQ-XBPRR**  
**Host Device: XBee USB Adapter Pro**

*Applicant:*  
**Digi International Inc**  
9350 Excelsior Blvd. Suite 700  
Hopkins, MN 55343

***In Accordance With***

**Federal Communications Commission (FCC) Part 15, Subpart C, Section 15.247**  
**Digital Modulation Systems (DTS) Operating in 2400 – 2483.5 MHz Band**  
**and**  
**ISED, RSS-247, Issue 2**  
**Digital Transmission Systems (DTSs), Frequency Hopping Systems (FHSs) and**  
**Licence-Exempt Local Area Network (LE-LAN) Devices**

**UltraTech's File No.: 23DIGI194\_FCC15C247Z**

This Test report is Issued under the Authority of  
Tri M. Luu  
Vice President of Engineering  
UltraTech Group of Labs

Date: January 11, 2023

Report Prepared by: Santhosh Fernandez

Tested by: Angus Au

Issued Date: January 11, 2023

Test Dates: September 23- December 1, 2022

- *The results in this Test Report apply only to the sample(s) tested, and the sample tested is randomly selected.*
- *This report must not be used by the client to claim product endorsement by any agency of the US Government.*
- *This test report shall not be reproduced, except in full, without a written approval from UltraTech*

## UltraTech

3000 Bristol Circle, Oakville, Ontario, Canada, L6H 6G4  
Tel.: (905) 829-1570 Fax.: (905) 829-8050  
Website: [www.ultratech-labs.com](http://www.ultratech-labs.com), Email: [vic@ultratech-labs.com](mailto:vic@ultratech-labs.com), Email: [tri@ultratech-labs.com](mailto:tri@ultratech-labs.com)



APEC TEL CA0001



1309



CA0001-2049



AT-1945



SL2-IN-E-1119R



Korea KCC-RRR  
CA0001

TABLE OF CONTENTS

**EXHIBIT 1. INTRODUCTION ..... 1**

1.1. SCOPE..... 1

1.2. RELATED SUBMITTAL(S)/GRANT(S)..... 1

1.3. NORMATIVE REFERENCES ..... 1

**EXHIBIT 2. PERFORMANCE ASSESSMENT ..... 2**

2.1. CLIENT INFORMATION ..... 2

2.2. EQUIPMENT UNDER TEST (EUT) INFORMATION..... 2

2.3. EUT’S TECHNICAL SPECIFICATIONS ..... 3

2.4. LIST OF EUT’S PORTS ..... 3

2.5. ANCILLARY EQUIPMENT ..... 4

**EXHIBIT 3. EUT OPERATING CONDITIONS AND CONFIGURATIONS DURING TESTS ..... 5**

3.1. CLIMATE TEST CONDITIONS ..... 5

3.2. OPERATIONAL TEST CONDITIONS & ARRANGEMENT FOR TESTS..... 5

**EXHIBIT 4. SUMMARY OF TEST RESULTS ..... 6**

4.1. LOCATION OF TESTS ..... 6

4.2. APPLICABILITY & SUMMARY OF EMC EMISSION TEST RESULTS ..... 6

4.3. MODIFICATIONS INCORPORATED IN THE EUT FOR COMPLIANCE PURPOSES..... 6

**EXHIBIT 5. TEST DATA..... 7**

5.1. PEAK CONDUCTED OUTPUT POWER - DTS [§ 15.247(B)(3)] [RSS-247, SECTION 5.4] ..... 7

5.1.1. *Limit(s)* ..... 7

5.1.2. *Method of Measurements*..... 7

5.1.3. *Test Data* ..... 7

5.2. TRANSMITTER SPURIOUS RADIATED EMISSIONS AT 3 METERS [§§ 15.247(D), 15.209 & 15.205] [RSS-247, SECTION 5.5] ..... 12

5.2.1. *Limit(s)* ..... 12

5.2.2. *Method of Measurements*..... 15

5.2.3. *Test Data* ..... 15

5.3. AC POWERLINE CONDUCTED EMISSIONS @ ISED CANADA ICES-003, ISSUE 7 ..... 23

5.3.1. *Limits* ..... 23

5.3.2. *Method of Measurements*..... 23

5.3.3. *Test Instruments*..... 23

5.3.4. *Test Results* ..... 24

5.4. RADIATED EMISSIONS FROM INFORMATION TECHNOLOGY EQUIPMENT (INCLUDING DIGITAL APPARATUS) ..... 26

5.4.1. *Limits* ..... 26

5.4.2. *Method of Measurements*..... 26

5.4.3. *Test Instruments*..... 26

5.4.4. *Test Results* ..... 27

**EXHIBIT 6. TEST EQUIPMENT LIST AND SETUP ..... 28**

6.1. FCC 15.247 (B) (3), RSS-247 5.4 (4) POP ..... 28

6.1.1. *Block Diagram*..... 28

6.1.2. *Test Equipment List* ..... 28

6.1.3. *Accessories for test* ..... 28

---

---

6.2.	FCC 15.247 (D), RSS-247 5.5 BAND-EDGE RADIATED EMISSIONS .....	29
6.2.1.	<i>Block Diagram</i> .....	29
6.3.	TEST EQUIPMENT LIST .....	29
6.3.1.	<i>Accessories for test</i> .....	29
6.4.	FCC 15.247 (D), RSS-247 5.5 TX RADIATED EMISSIONS .....	30
6.4.1.	<i>Block Diagram</i> .....	30
6.4.2.	<i>Test Equipment List</i> .....	30
6.4.3.	<i>Accessories for test</i> .....	30
6.5.	FCC 15.207 (A); ICES-003, POWER LINE CONDUCTED EMISSIONS .....	31
6.5.1.	<i>Block Diagram</i> .....	31
6.5.2.	<i>Test Equipment List</i> .....	31
6.5.3.	<i>Accessories for test</i> .....	31
6.6.	ICES-003, UNINTENTIONAL RADIATED EMISSIONS .....	32
6.6.1.	<i>Block Diagram</i> .....	32
6.6.2.	<i>Test Equipment List</i> .....	32
6.6.3.	<i>Accessories for test</i> .....	32
<b>EXHIBIT 7.</b>	<b>MEASUREMENT UNCERTAINTY.....</b>	<b>33</b>

**EXHIBIT 1. INTRODUCTION**

**1.1. SCOPE**

<b>Reference:</b>	FCC Part 15, Subpart C, Section 15.247
<b>Title:</b>	Code of Federal Regulations (CFR), Title 47 – Telecommunication, Part 15 – Radio Frequency Devices
<b>Purpose of Test:</b>	Equipment Certification for Digital Modulation Systems (DTS) Operating Under §15.247
<b>Test Procedures:</b>	<ul style="list-style-type: none"> <li>▪ ANSI C63.4</li> <li>▪ ANSI C63.10</li> <li>▪ FCC KDB Publication No. 558074 D01 15.247 Meas Guidance v05r02</li> </ul>
<b>Environmental Classification:</b>	<input checked="" type="checkbox"/> Commercial, industrial or business environment <input checked="" type="checkbox"/> Residential environment

**1.2. RELATED SUBMITTAL(S)/GRANT(S)**

None.

**1.3. NORMATIVE REFERENCES**

Publication	Year	Title
47 CFR Parts 0-19	2023	Code of Federal Regulations (CFR), Title 47 – Telecommunication
ANSI C63.4	2014	American National Standard for Methods of Measurement of Radio-Noise Emissions from Low-Voltage Electrical and Electronic Equipment in the Range of 9 KHz to 40 GHz
ANSI C63.10	2013	American National Standard of Procedures for Compliance Testing of Unlicensed Wireless Devices
FCC, KDB Publication No. 558074 D01 15.247 Meas Guidance v05r02	2019	Guidance For Compliance Measurements On Digital Transmission System, Frequency Hopping Spread Spectrum System, And Hybrid System Devices Operating Under Section 15.247 Of The FCC Rules
RSS-Gen, Issue 5	2018	General Requirements for Compliance of Radio Apparatus (with Amendment 1 (March 2019) Amendment 2 (February 2021))
RSS-247, Issue 2	2017	Digital Transmission Systems (DTSs), Frequency Hopping Systems (FHSs) and Licence-Exempt Local Area Network (LE-LAN) Devices
RSS-102, Issue 5	2015 Amendment 1 :2021	Radio Frequency (RF) Exposure Compliance of Radiocommunication Apparatus (All Frequency Bands)
ICES-003, Issue 7	2020	Information Technology Equipment (including Digital Apparatus)

**ULTRATECH GROUP OF LABS**

3000 Bristol Circle, Oakville, Ontario, Canada L6H 6G4  
 Tel. #: 905-829-1570, Fax. #: 905-829-8050, Email: [vic@ultratech-labs.com](mailto:vic@ultratech-labs.com), Website: <http://www.ultratech-labs.com>

File #: 23DIGI194\_FCC15C247Z  
 January 11, 2023

*All test results contained in this engineering test report are traceable to National Institute of Standards and Technology (NIST)*

## EXHIBIT 2. PERFORMANCE ASSESSMENT

### 2.1. CLIENT INFORMATION

Applicant	
<b>Name:</b>	Digi International Inc
<b>Address:</b>	9350 Excelsior Blvd. Suite 700 Hopkins, MN 55343 USA

Manufacturer	
<b>Name:</b>	Digi International Inc
<b>Address:</b>	10000 W 76th Street Eden Prairie, MN 55344 USA

### 2.2. EQUIPMENT UNDER TEST (EUT) INFORMATION

The following information (with the exception of the Date of Receipt) has been supplied by the applicant.

<b>Brand Name:</b>	Digi International Inc
<b>Product Name:</b>	XBee RR Pro
<b>Model Name or Number:</b>	XBPRR
<b>Host Device: HMN:</b>	XBee USB Adapter PRO
<b>PIN:</b>	50002142-01
<b>Serial Number:</b>	Test Sample
<b>Type of Equipment:</b>	Digital Transmission System (DTS)
<b>Input Power Supply Type:</b>	External DC Power Supply
<b>Primary User Functions of EUT:</b>	Digital Communications

#### ULTRATECH GROUP OF LABS

3000 Bristol Circle, Oakville, Ontario, Canada L6H 6G4

Tel. #: 905-829-1570, Fax. #: 905-829-8050, Email: [vic@ultratech-labs.com](mailto:vic@ultratech-labs.com), Website: <http://www.ultratech-labs.com>

File #: 23DIGI194\_FCC15C247Z

January 11, 2023

*All test results contained in this engineering test report are traceable to National Institute of Standards and Technology (NIST)*

### 2.3. EUT'S TECHNICAL SPECIFICATIONS

Transmitter	
<b>Equipment Type:</b>	Mobile Base station (fixed use)
<b>Intended Operating Environment:</b>	Commercial, industrial or business environment Residential environment
<b>Power Supply Requirement:</b>	1.71 to 3.8VDC (3.3V is nominal)
<b>RF Output Power Rating:</b>	-9.44 dBm to 19.35 dBm maximum peak conducted power
<b>Operating Frequency Range:</b>	2405 - 2480 MHz
<b>RF Output Impedance:</b>	50 $\Omega$
<b>Duty Cycle:</b>	Continuous
<b>Modulation Type:</b>	QPSK
<b>Antenna Connector Types:</b>	PCB Trace Dipole Antenna (0.87dBi manufacturer spec.)

### 2.4. LIST OF EUT'S PORTS

Port Number	EUT's Port Description	Number of Identical Ports	Connector Type	Cable Type (Shielded/Non-shielded)
1	USB	1	USB	Direct connection

## 2.5. ANCILLARY EQUIPMENT

The EUT was tested while connected to the following representative configuration of ancillary equipment necessary to exercise the ports during tests:

<b>Ancillary Equipment # 1</b>	
Description:	Test Jig
Brand name:	Digi International
Model Name or Number:	N/A
Serial Number:	N/A
Connected to EUT's Port:	Pin header

<b>Ancillary Equipment # 2</b>	
Description:	Laptop
Brand name:	HP
Model Name or Number:	EliteBook 820
Serial Number:	N/A
Connected to EUT's Port:	EUT Test Jig

**EXHIBIT 3. EUT OPERATING CONDITIONS AND CONFIGURATIONS DURING TESTS**

**3.1. CLIMATE TEST CONDITIONS**

The climate conditions of the test environment are as follows:

Temperature:	21 to 23 °C
Humidity:	45 to 58%
Pressure:	102 kPa
Power Input Source:	3.3 VDC nominal, 3.8 VDC Max.

**3.2. OPERATIONAL TEST CONDITIONS & ARRANGEMENT FOR TESTS**

<b>Operating Modes:</b>	The transmitter was operated in a continuous transmission mode with the carrier modulated as specified in the Test Data.
<b>Special Test Software:</b>	Test software provided by the Applicant to operate the EUT at each channel frequency continuously and in the range of typical modes of operation.
<b>Special Hardware Used:</b>	Test Jig
<b>Transmitter Test Antenna:</b>	The EUT is tested with the antenna fitted in a manner typical of normal intended use as described with the test results.

<b>Transmitter Test Signals</b>	
<b>Frequency Band(s):</b>	2405 - 2480 MHz
<b>Frequency(ies) Tested:</b>	2405 MHz, 2440 MHz, 2475 MHz, 2480 MHz
<b>RF Power Output:</b> (measured maximum peak conducted output power)	19.41 dBm
<b>Normal Test Modulation:</b>	QPSK
<b>Modulating Signal Source:</b>	Internal



**EXHIBIT 4. SUMMARY OF TEST RESULTS**

**4.1. LOCATION OF TESTS**

All of the measurements described in this report were performed at Ultratech Group of Labs located in the city of Oakville, Province of Ontario, Canada.

- AC Power Line Conducted Emissions were performed in UltraTech's shielded room, 24'(L) by 16'(W) by 8'(H).
- Radiated Emissions were performed at the Ultratech's 3-10 TDK Semi-Anechoic Chamber situated in the Town of Oakville, province of Ontario. This test site been calibrated in accordance with ANSI C63.4, and found to be in compliance with the requirements of Sec. 2.948 of the FCC Rules. The descriptions and site measurement data of the Oakville 3-10 TDK Semi-Anechoic Chamber has been filed with ANAB File No.: AT-1945.

**4.2. APPLICABILITY & SUMMARY OF EMC EMISSION TEST RESULTS**

FCC Section(s)	Test Requirements	Compliance (Yes/No)
15.203 RSS-Gen, Section 6.8	Antenna requirements	Yes*
15.207(a) RSS-Gen, Section 8.8	AC Power Line Conducted Emissions	Yes
15.247(a)(2) RSS-247, Section 5.2(a)	6 dB Bandwidth	N/A for this C2PC
15.247(b)(3) RSS-247, Section 5.4	Peak Conducted Output Power	Yes
15.247(d) RSS-247, Section 5.5	Band-Edge and RF Conducted Spurious Emissions at the Transmitter Antenna Terminal	--
15.247(d), 15.209 & 15.205 RSS-247, Section 5.5	Band-Edge and Transmitter Spurious Radiated Emissions	Yes
15.247(e) RSS-247, Section 5.2(b)	Power Spectral Density	N/A for this C2PC
15.247(i), 1.1307, 1.1310, 2.1091 RSS-Gen, Section 3.4 RSS-102	RF Exposure	Yes, Refer to SAR report
RSS-Gen, Section 8.8	AC Power Line Conducted Emissions	Yes
ICES-003, Issue 7	Information Technology Equipment (including Digital Apparatus)	Yes

\* The EUT complies with the requirement; it employs an integral antenna.

**4.3. MODIFICATIONS INCORPORATED IN THE EUT FOR COMPLIANCE PURPOSES**

None.

**EXHIBIT 5. TEST DATA**

**5.1. PEAK CONDUCTED OUTPUT POWER - DTS [§ 15.247(b)(3)] [RSS-247, SECTION 5.4]**

**5.1.1. Limit(s)**

§ 15.247(b)(3): For systems using digital modulation in the 902-928 MHz, 2400-2483.5 MHz, and 5725-5850 MHz bands: 1 Watt. As an alternative to a peak power measurement, compliance with the one Watt limit can be based on a measurement of the maximum conducted output power. Maximum Conducted Output Power is defined as the total transmit power delivered to all antennas and antenna elements averaged across all symbols in the signaling alphabet when the transmitter is operating at its maximum power control level. Power must be summed across all antennas and antenna elements. The average must not include any time intervals during which the transmitter is off or is transmitting at a reduced power level. If multiple modes of operation are possible (e.g., alternative modulation methods), the *maximum conducted output power* is the highest total transmit power occurring in any mode.

**RSS-247 Section 5.4(d):** For DTSs employing digital modulation techniques operating in the bands 902-928 MHz and 2400-2483.5 MHz, the maximum peak conducted output power shall not exceed 1W. The e.i.r.p. shall not exceed 4 W, except as provided in section 5.4(e).

**5.1.2. Method of Measurements**

FCC KDB 558074 D01 15.247 Meas Guidance V05r02, Section 8.3.1.1 RBW ≥ DTS bandwidth

**5.1.3. Test Data**

**Maximum Peak Conducted Output Power at Power Settings 20 dBm, 3 dBm and -10 dBm**

Modulation	Power Setting	Frequency (MHz)	Maximum Peak Conducted Output Power (dBm)	Peak Power Limit (dBm)
QPSK	20 dBm	2405	19.11	30
		2440	19.25	30
		2475	19.41	30
	3 dBm	2480	2.74	30
	-10 dBm	2405	-8.92	30
		2440	-8.84	30
		2475	-8.92	30
		2480	-8.79	30

Note: Power measured in this C2PC factoring the uncertainties of measurement is within the acceptable range of the original. Antenna gain for new antenna is 0.87dBi, < EIRP limit

Plot 5.1.3.1. Maximum Peak Conducted Output Power, QPSK Modulation, 20 dBm Power Setting, 2405 MHz

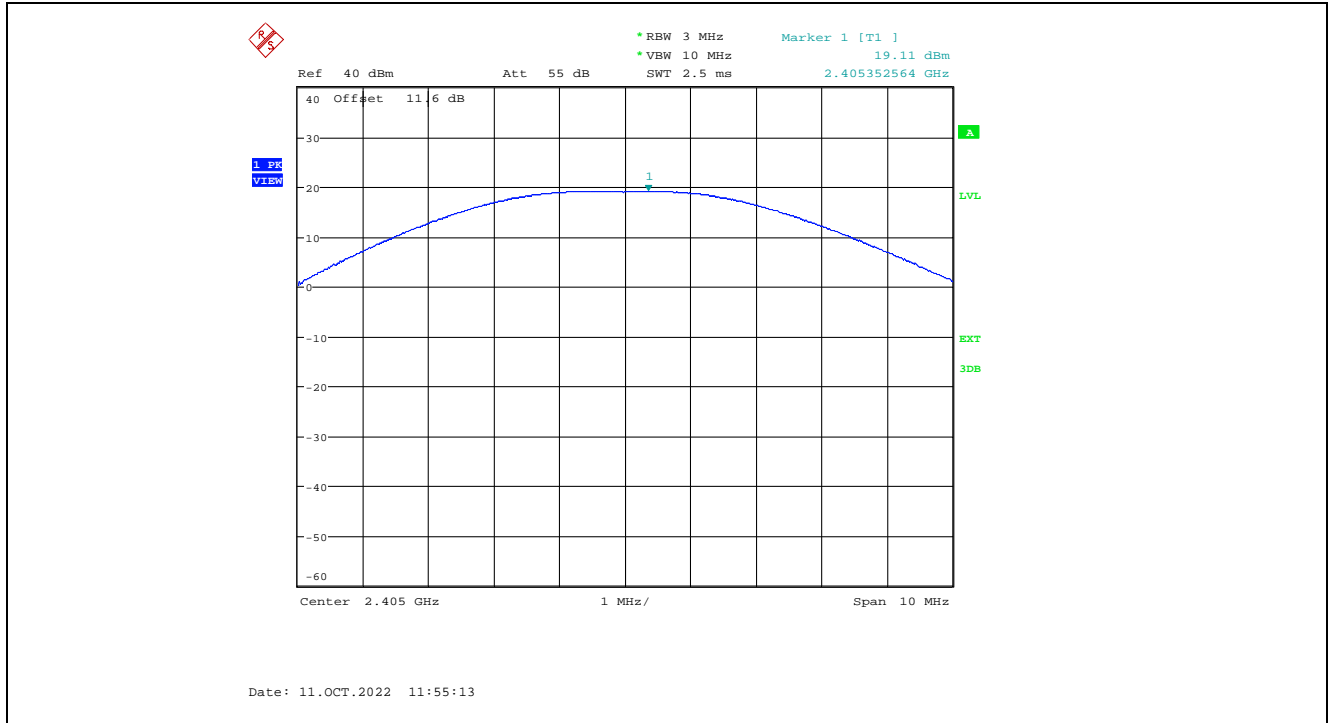

Plot 5.1.3.2. Maximum Peak Conducted Output Power, QPSK Modulation, 20 dBm Power Setting, 2440 MHz

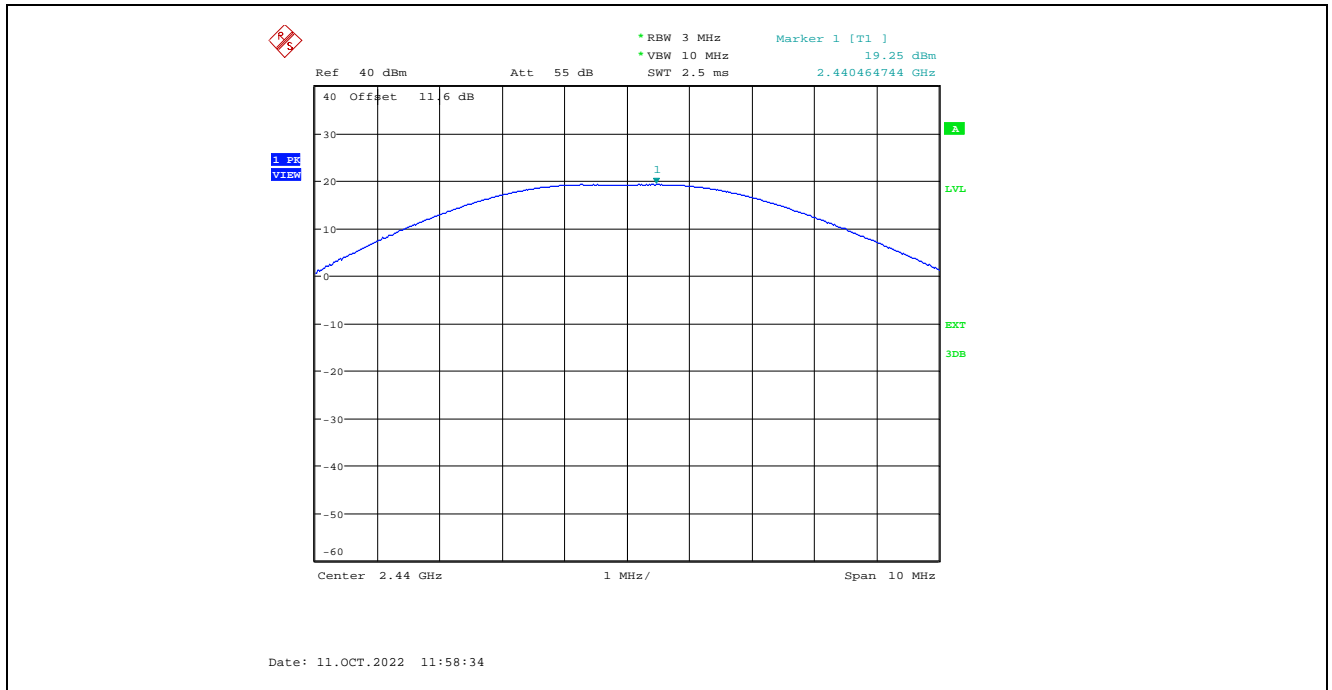

Plot 5.1.3.3. Maximum Peak Conducted Output Power, QPSK Modulation, 20 dBm Power Setting, 2475 MHz

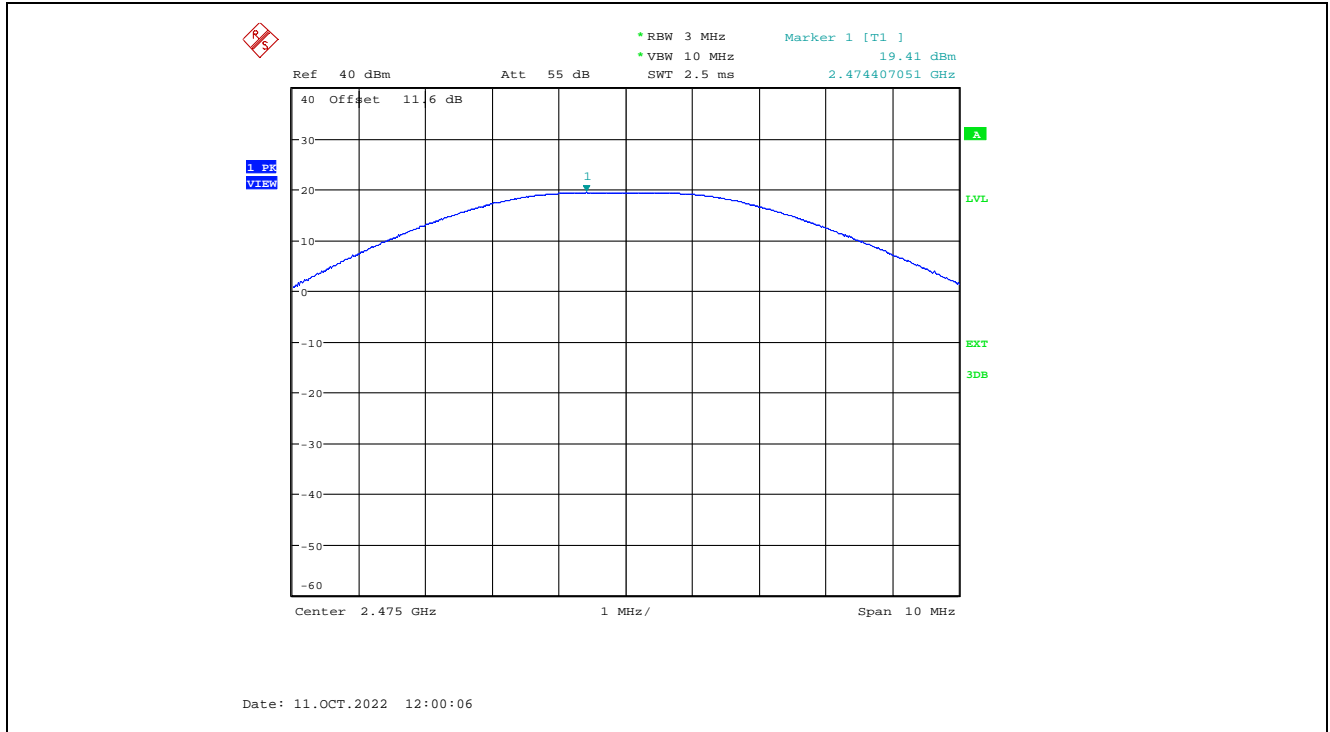

Plot 5.1.3.4. Maximum Peak Conducted Output Power, QPSK Modulation, 3 dBm Power Setting, 2480 MHz

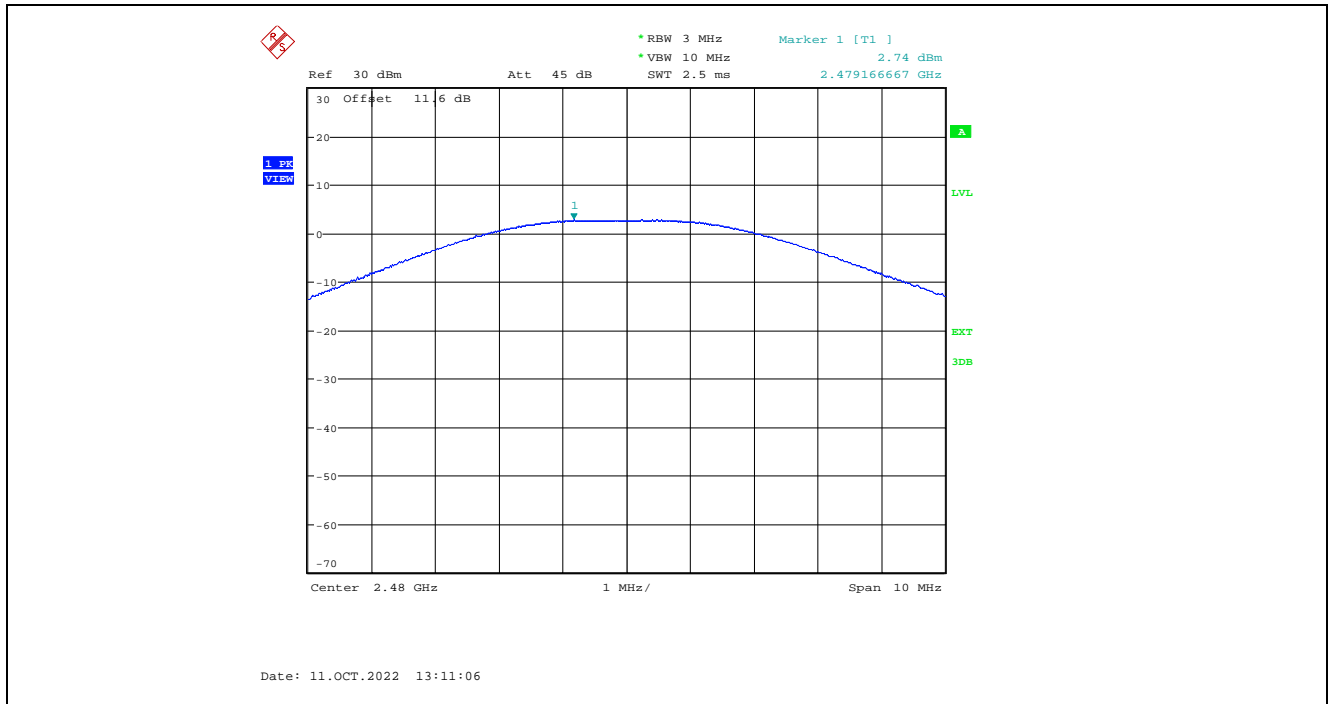

Plot 5.1.3.5. Maximum Peak Conducted Output Power, QPSK Modulation, -10 dBm Power Setting, 2405 MHz

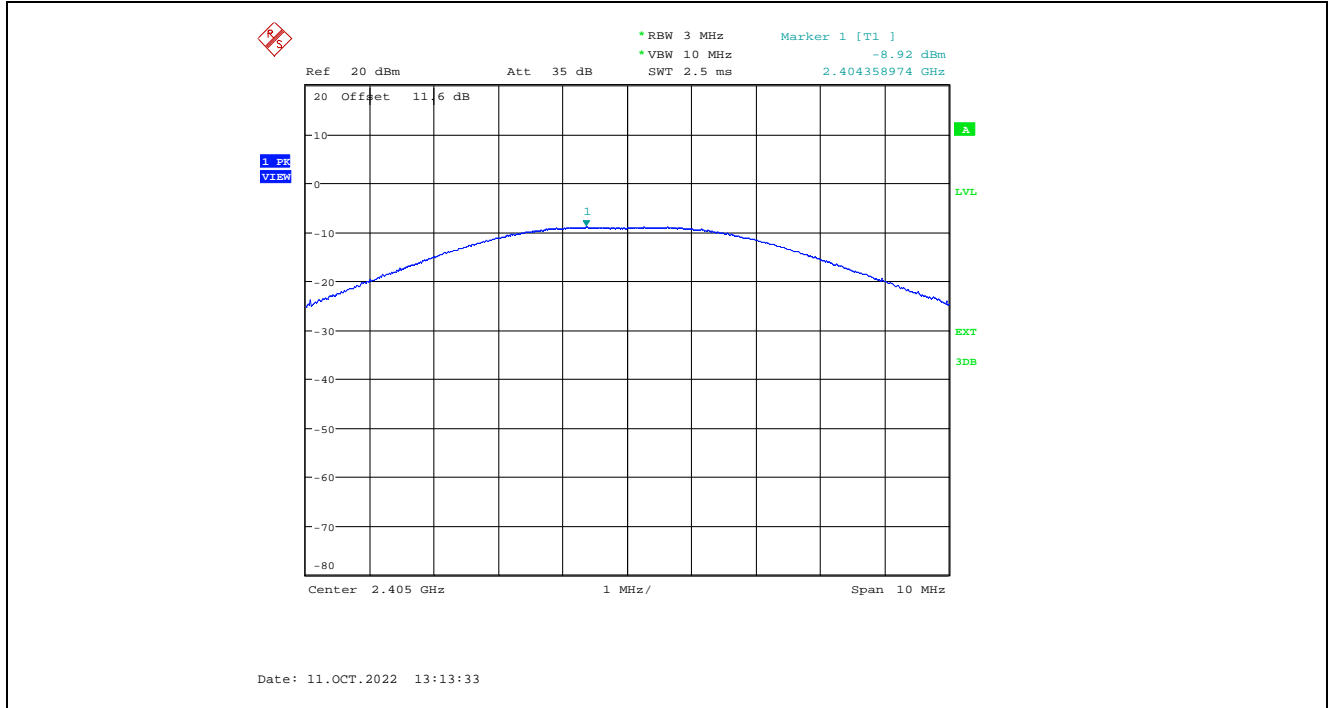

Plot 5.1.3.6. Maximum Peak Conducted Output Power, QPSK Modulation, -10 dBm Power Setting, 2440 MHz

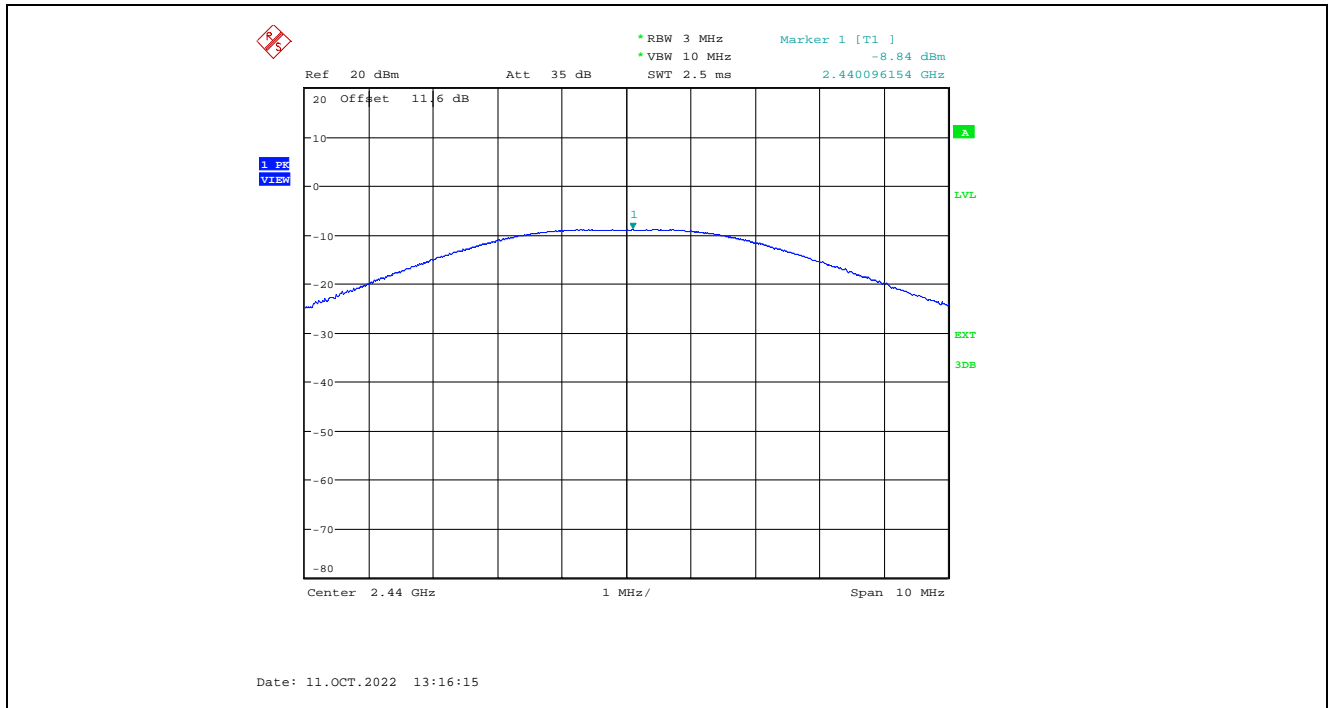

Plot 5.1.3.7. Maximum Peak Conducted Output Power, QPSK Modulation, -10 dBm Power Setting, 2475 MHz

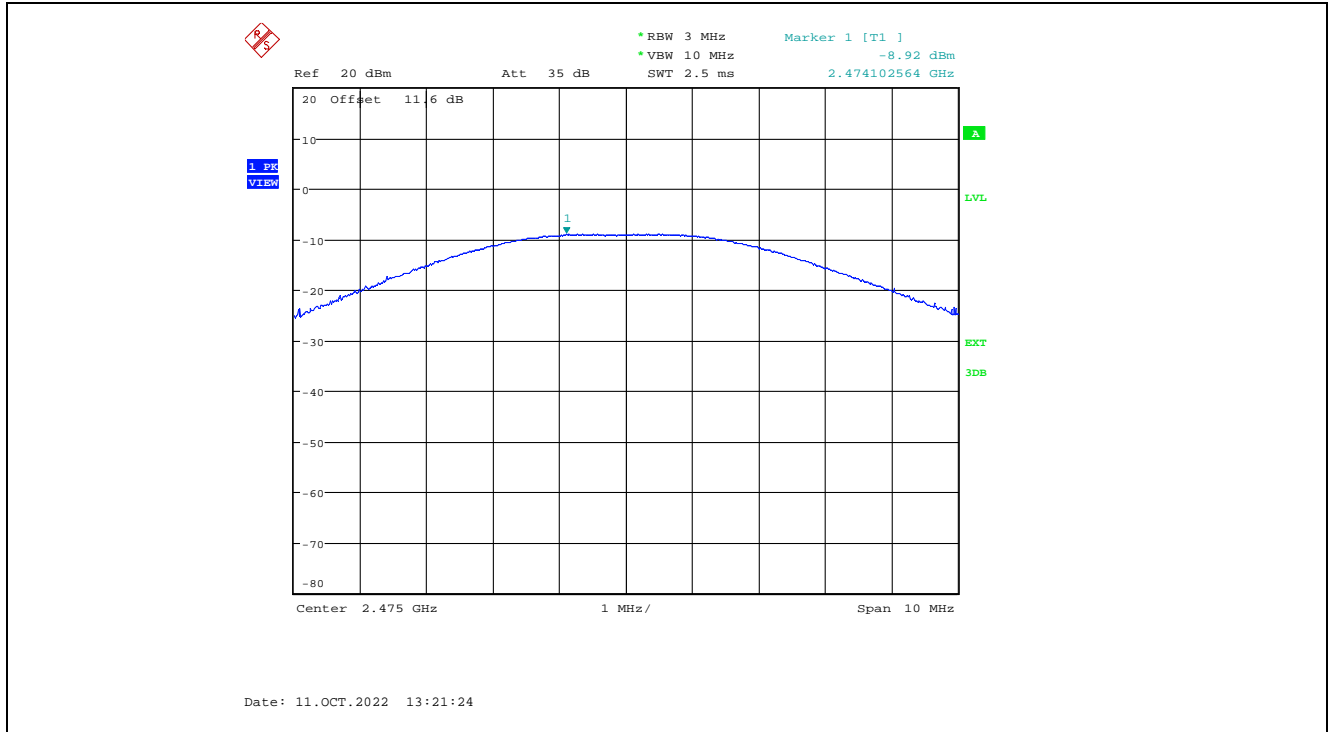

Plot 5.1.3.8. Maximum Peak Conducted Output Power, QPSK Modulation, -10 dBm Power Setting, 2480 MHz

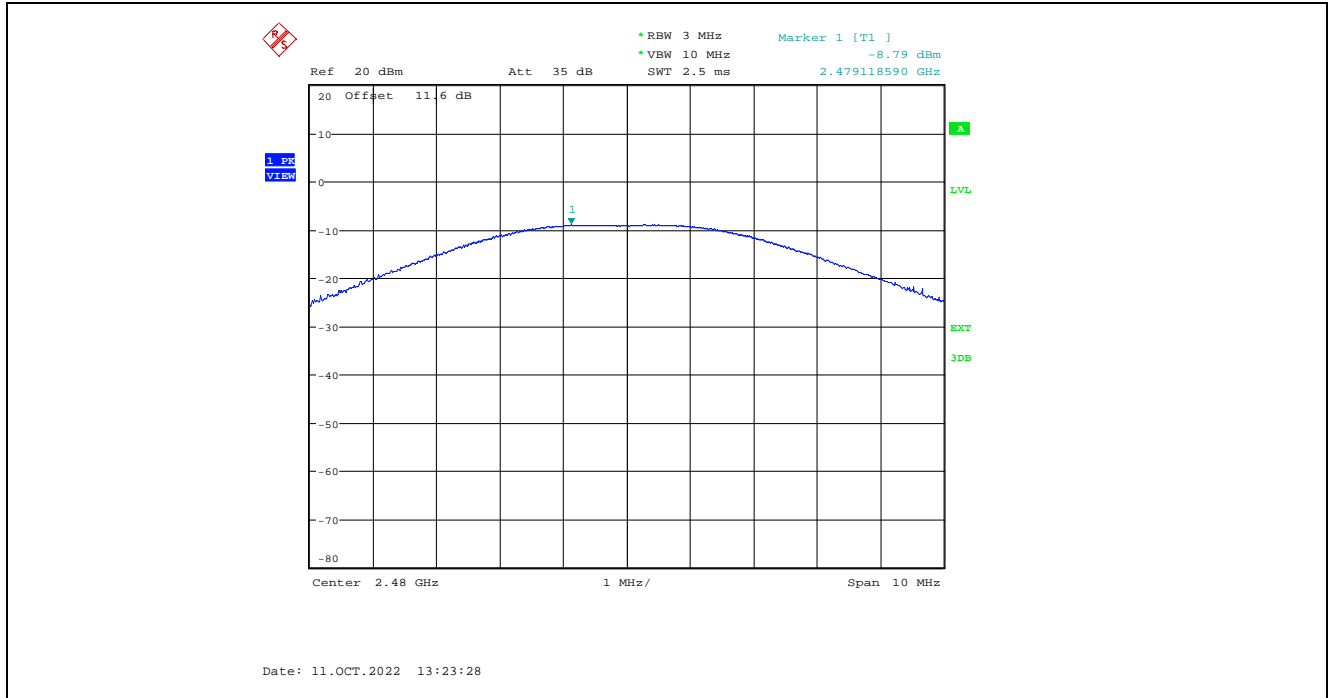

**5.2. TRANSMITTER SPURIOUS RADIATED EMISSIONS AT 3 METERS [§§ 15.247(d), 15.209 & 15.205] [RSS-247, SECTION 5.5]**

**5.2.1. Limit(s)**

**§ 15.247 (d):** In any 100 kHz bandwidth outside the frequency band in which the spread spectrum or digitally modulated intentional radiator is operating, the radio frequency power that is produced by the intentional radiator shall be at least 20 dB below that in the 100 kHz bandwidth within the band that contains the highest level of the desired power, based on either an RF conducted or a radiated measurement, provided the transmitter demonstrates compliance with the peak conducted power limits. If the transmitter complies with the conducted power limits based on the use of RMS averaging over a time interval, as permitted under paragraph (b)(3) of this section, the attenuation required under this paragraph shall be 30 dB instead of 20 dB. Attenuation below the general limits specified in Section 15.209(a) is not required. In addition, radiated emissions which fall in the restricted bands, as defined in Section 15.205(a), must also comply with the radiated emission limits specified in Section 15.209(a) (see Section 15.205(c)).

**Section 15.205(a) - Restricted Bands of Operation**

MHz	MHz	MHz	GHz
0.090–0.110 .....	16.42–16.423	399.9–410	4.5–5.15
10.495–0.505 .....	16.69475–16.69525	608–614	5.35–5.46
2.1735–2.1905 .....	16.80425–16.80475	960–1240	7.25–7.75
4.125–4.128 .....	25.5–25.67	1300–1427	8.025–8.5
4.17725–4.17775 .....	37.5–38.25	1435–1626.5	9.0–9.2
4.20725–4.20775 .....	73–74.6	1645.5–1646.5	9.3–9.5
6.215–6.218 .....	74.8–75.2	1660–1710	10.6–12.7
6.26775–6.26825 .....	108–121.94	1718.8–1722.2	13.25–13.4
6.31175–6.31225 .....	123–138	2200–2300	14.47–14.5
8.291–8.294 .....	149.9–150.05	2310–2390	15.35–16.2
8.362–8.366 .....	156.52475–156.52525	2483.5–2500	17.7–21.4
8.37625–8.38675 .....	156.7–156.9	2655–2900	22.01–23.12
8.41425–8.41475 .....	162.0125–167.17	3260–3267	23.6–24.0
12.29–12.293 .....	167.72–173.2	3332–3339	31.2–31.8
12.51975–12.52025 .....	240–285	3345.8–3358	36.43–36.5
12.57675–12.57725 .....	322–335.4	3600–4400	( <sup>2</sup> )
13.36–13.41.			

<sup>1</sup>Until February 1, 1999, this restricted band shall be 0.490–0.510 MHz.

<sup>2</sup>Above 38.6

**Section 15.209(a) - Field Strength Limits within Restricted Frequency Bands**

Frequency (MHz)	Field Strength (microvolts/meter)	Measurement Distance (meters)
0.009 - 0.490	2,400 / F (kHz)	300
0.490 - 1.705	24,000 / F (kHz)	30
1.705 - 30.0	30	30
30 – 88	100	3
88 – 216	150	3
216 – 960	200	3
Above 960	500	3

**ULTRATECH GROUP OF LABS**

3000 Bristol Circle, Oakville, Ontario, Canada L6H 6G4

Tel. #: 905-829-1570, Fax. #: 905-829-8050, Email: [vic@ultratech-labs.com](mailto:vic@ultratech-labs.com), Website: <http://www.ultratech-labs.com>

File #: 23DIGI194\_FCC15C247Z

January 11, 2023

*All test results contained in this engineering test report are traceable to National Institute of Standards and Technology (NIST)*

**RSS-247:Sec 5.5:** In any 100 kHz bandwidth outside the frequency band in which the spread spectrum or digitally modulated device is operating, the RF power that is produced shall be at least 20 dB below that in the 100 kHz bandwidth within the band that contains the highest level of the desired power, based on either an RF conducted or a radiated measurement, provided that the transmitter demonstrates compliance with the peak conducted power limits. If the transmitter complies with the conducted power limits based on the use of root-mean-square averaging over a time interval, as permitted under section 5.4(d), the attenuation required shall be 30 dB instead of 20 dB. Attenuation below the general field strength limits specified in RSS-Gen is not required.

**RSS-Gen, Section 8.10 Restricted Frequency Bands**

Restricted frequency bands, identified in table 7, are designated primarily for safety-of-life services (distress calling and certain aeronautical activities), certain satellite downlinks, radio astronomy and some government uses. Except where otherwise indicated, the following conditions related to the restricted frequency bands apply:

- (a) The transmit frequency, including fundamental components of modulation, of licence-exempt radio apparatus shall not fall within the restricted frequency bands listed in table 7 except for apparatus compliant with RSS-287, Emergency Position Indicating Radio Beacons (EPIRB), Emergency Locator Transmitters (ELT), Personal Locator Beacons (PLB), and Maritime Survivor Locator Devices (MSLD).
- (b) Unwanted emissions that fall into restricted frequency bands listed in table 7 shall comply with the limits specified in table 5 and table 6.
- (c) Unwanted emissions that do not fall within the restricted frequency bands listed in table 7 shall comply either with the limits specified in the applicable RSS or with those specified in table 5 and table 6

**RSS-Gen Table 5 - General field strength limits at frequencies above 30 MHz**

Frequency (MHz)	Field Strength (( $\mu$ V/m at 3 m)
30 - 88	100
88 - 216	150
216 - 960	200
Above 960	500

**RSS-Gen Table 6 – General field strength limits at frequencies below 30 MHz**

Frequency	Magnetic field strength (H-Field) ( $\mu$ A/m)	Measurement distance (m)
9 - 490 kHz <sup>1</sup>	6.37/F (F in kHz)	300
490 - 1705 kHz	63.7/F (F in kHz)	30
1.705 - 30 MHz	0.08	30

**Note 1:** The emission limits for the ranges 9-90 kHz and 110-490 kHz are based on measurements employing a linear average detector.



**RSS-Gen Table 7 – Restricted Frequency Bands\***

MHz	MHz	GHz
0.090 - 0.110	149.9 - 150.05	9.0 - 9.2
0.495 - 0.505	156.52475 - 156.52525	9.3 - 9.5
2.1735 - 2.1905	156.7 - 156.9	10.6 - 12.7
3.020 - 3.026	162.0125 - 167.17	13.25 - 13.4
4.125 - 4.128	167.72 - 173.2	14.47 - 14.5
4.17725 - 4.17775	240 - 285	15.35 - 16.2
4.20725 - 4.20775	322 - 335.4	17.7 - 21.4
5.677 - 5.683	399.9 - 410	22.01 - 23.12
6.215 - 6.218	608 - 614	23.6 - 24.0
6.26775 - 6.26825	960 - 1427	31.2 - 31.8
6.31175 - 6.31225	1435 - 1626.5	36.43 - 36.5
8.291 - 8.294	1645.5 - 1646.5	Above 38.6
8.362 - 8.366	1660 - 1710	
8.37625 - 8.38675	1718.8 - 1722.2	
8.41425 - 8.41475	2200 - 2300	
12.29 - 12.293	2310 - 2390	
12.51975 - 12.52025	2483.5 - 2500	
12.57675 - 12.57725	2655 - 2900	
13.36 - 13.41	3260 - 3267	
16.42 - 16.423	3332 - 3339	
16.69475 - 16.69525	3345.8 - 3358	
16.80425 - 16.80475	3500 - 4400	
25.5 - 25.67	4500 - 5150	
37.5 - 38.25	5350 - 5460	
73 - 74.6	7250 - 7750	
74.8 - 75.2	8025 - 8500	
108 - 138	--	

\* Certain frequency bands listed in table 7 and in bands above 38.6 GHz are designated for licence-exempt applications. These frequency bands and the requirements that apply to related devices are set out in the 200 and 300 series of RSSs.

**5.2.2. Method of Measurements**

KDB 558074 D01 DTS Meas Guidance v05r02 Sections 8.5 and 8.6 and ANSI C63.10.

**5.2.3. Test Data**

**Remark(s):**

- All spurious emissions that are in excess of 20 dB below the specified limit shall be recorded.
- EUT shall be tested in three orthogonal positions.
- The following test data represent the worst-case derived from exploratory tests.

**5.2.3.1. Spurious Radiated Emission**

Power Setting:		20 dBm					
Fundamental Frequency:		2405 MHz					
Test Frequency Range:		30 MHz – 25 GHz					
Frequency (MHz)	RF Peak Level (dBµV/m)	RF Avg Level (dBµV/m)	Antenna Plane (H/V)	Limit 15.209 (dBµV/m)	Limit 15.247 (dBµV/m)	Margin (dB)	Pass/Fail
2405.0	115.39	--	V	--	--	--	--
2405.0	110.18	--	H	--	--	--	--
4810.0	54.93	44.96	V	54.0	90.1	-9.04	Pass*
4810.0	55.73	43.89	H	54.0	90.1	-10.11	Pass*
All other spurious emissions and harmonics are more than 20 dB below the applicable limit.							

\*Field strength of emissions appearing within restricted frequency bands shall not exceed the limits in § 15.209.

Power Setting:		20 dBm					
Fundamental Frequency:		2440 MHz					
Test Frequency Range:		30 MHz – 25 GHz					
Frequency (MHz)	RF Peak Level (dBµV/m)	RF Avg Level (dBµV/m)	Antenna Plane (H/V)	Limit 15.209 (dBµV/m)	Limit 15.247 (dBµV/m)	Margin (dB)	Pass/Fail
2440.0	115.23	--	V	--	--	--	--
2440.0	110.55	--	H	--	--	--	--
4880.0	50.23	34.51	V	54.0	90.5	-19.49	Pass*
4880.0	52.47	40.81	H	54.0	90.5	-13.19	Pass*
7320.0	60.78	49.94	V	54.0	90.5	-4.06	Pass*
7320.0	63.21	51.95	H	54.0	90.5	-2.05	Pass*
All other spurious emissions and harmonics are more than 20 dB below the applicable limit.							

\*Field strength of emissions appearing within restricted frequency bands shall not exceed the limits in § 15.209.

**ULTRATECH GROUP OF LABS**

3000 Bristol Circle, Oakville, Ontario, Canada L6H 6G4  
 Tel. #: 905-829-1570, Fax. #: 905-829-8050, Email: [vic@ultratech-labs.com](mailto:vic@ultratech-labs.com), Website: <http://www.ultratech-labs.com>

File #: 23DIGI194\_FCC15C247Z  
 January 11, 2023

*All test results contained in this engineering test report are traceable to National Institute of Standards and Technology (NIST)*

Power Setting:		20 dBm					
Fundamental Frequency:		2475 MHz					
Test Frequency Range:		30 MHz – 25 GHz					
Frequency (MHz)	RF Peak Level (dBµV/m)	RF Avg Level (dBµV/m)	Antenna Plane (H/V)	Limit 15.209 (dBµV/m)	Limit 15.247 (dBµV/m)	Margin (dB)	Pass/Fail
2475.0	115.09	--	V	--	--	--	--
2475.0	111.67	--	H	--	--	--	--
4950.0	50.90	35.24	V	54.0	91.6	-18.76	Pass*
4950.0	51.00	38.80	H	54.0	91.6	-15.20	Pass*
7425.0	61.73	50.52	V	54.0	91.6	-3.48	Pass*
7425.0	63.91	53.07	H	54.0	91.6	-0.93	Pass*
All other spurious emissions and harmonics are more than 20 dB below the applicable limit.							

\*Field strength of emissions appearing within restricted frequency bands shall not exceed the limits in § 15.209.

Power Setting:		3 dBm					
Fundamental Frequency:		2480 MHz					
Test Frequency Range:		30 MHz – 25 GHz					
Frequency (MHz)	RF Peak Level (dBµV/m)	RF Avg Level (dBµV/m)	Antenna Plane (H/V)	Limit 15.209 (dBµV/m)	Limit 15.247 (dBµV/m)	Margin (dB)	Pass/Fail
2480.0	93.02	--	V	--	--	--	--
2480.0	96.04	--	H	--	--	--	--
4960.0	50.64	34.87	V	54.0	73.02	-19.13	Pass*
4960.0	50.64	38.42	H	54.0	73.02	-15.58	Pass*
7440.0	52.54	39.99	V	54.0	73.02	-14.01	Pass*
7440.0	52.46	40.03	H	54.0	73.02	-13.97	Pass*
All other spurious emissions and harmonics are more than 20 dB below the applicable limit.							

\*Field strength of emissions appearing within restricted frequency bands shall not exceed the limits in § 15.209.

### 5.2.3.2. Band-Edge RF Radiated Emission

#### 5.2.3.2.1. Band-Edge RF Radiated Emissions at 3 m, Vertical Polarization, Peak Low End of Frequency Band, 2405 MHz, 20 dBm Power Setting

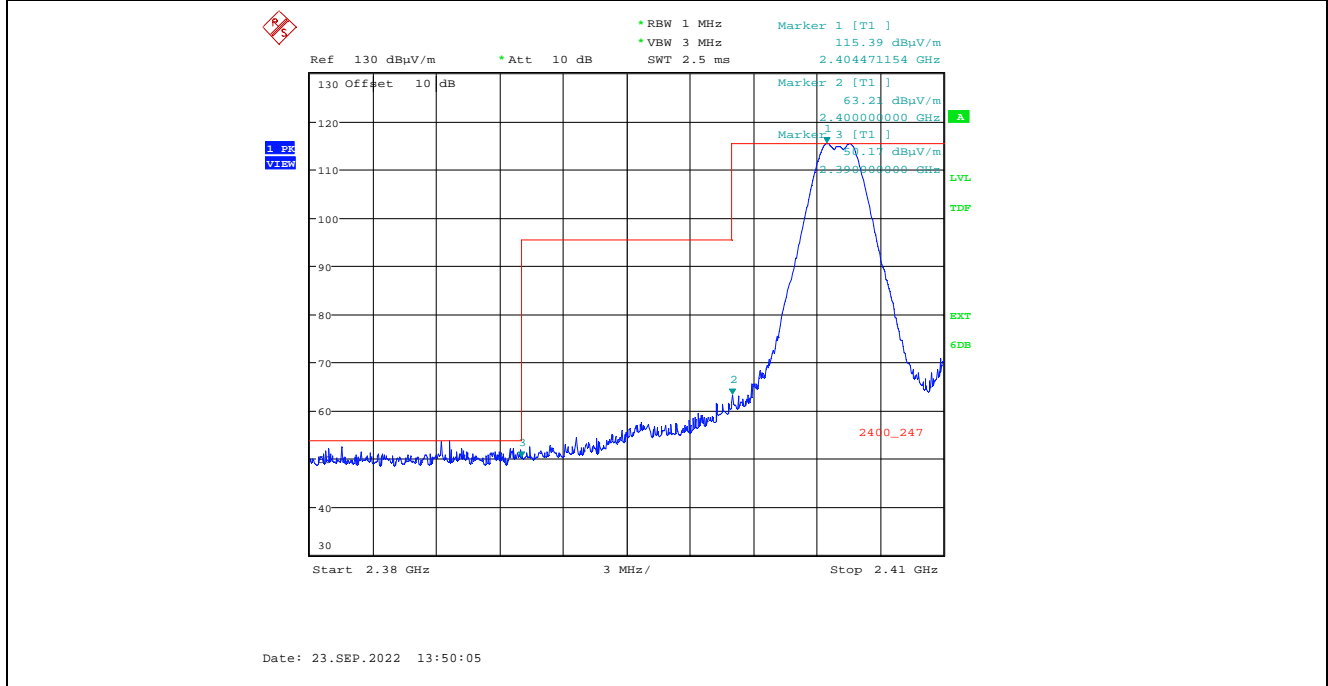

#### 5.2.3.2.2. Band-Edge RF Radiated Emissions at 3 m, Vertical Polarization, Average Low End of Frequency Band, 2405 MHz, 20 dBm Power Setting

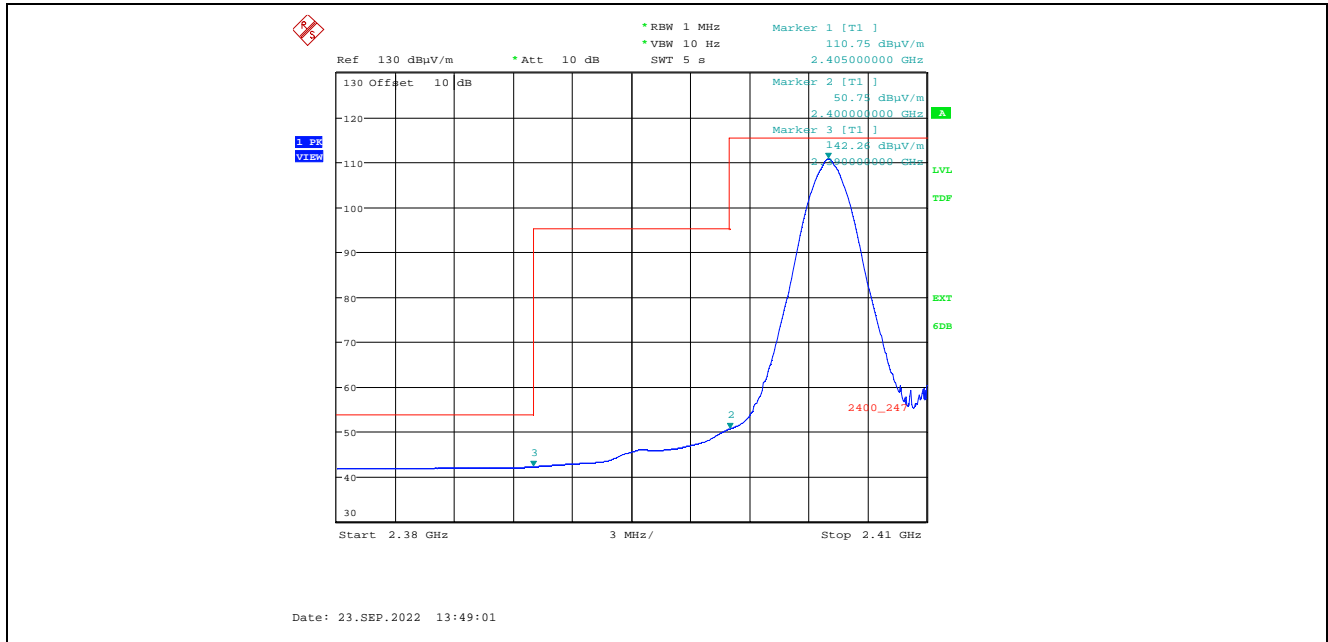

5.2.3.2.3. Band-Edge RF Radiated Emissions at 3 m, Horizontal Polarization, Peak  
Low End of Frequency Band, 2405 MHz, 20 dBm Power Setting

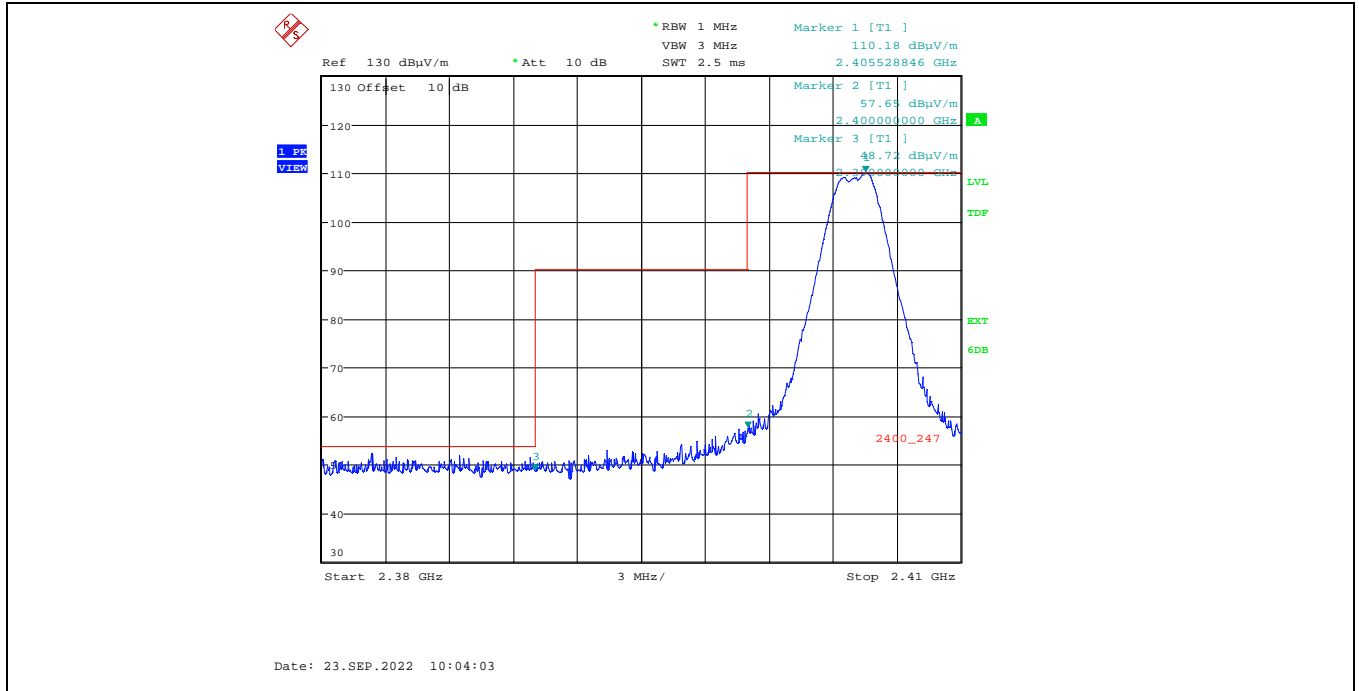

5.2.3.2.4. Band-Edge RF Radiated Emissions at 3 m, Horizontal Polarization, Average  
Low End of Frequency Band, 2405 MHz, 20 dBm Power Setting

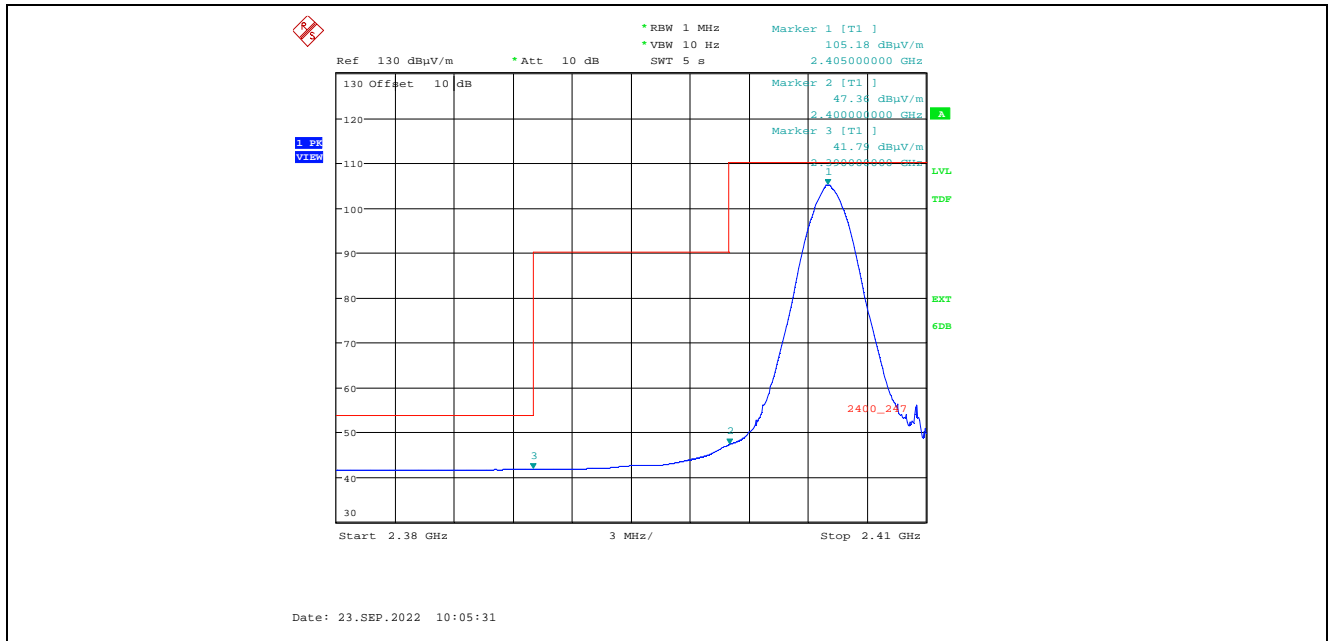

5.2.3.2.5. Band-Edge RF Radiated Emissions at 3 m, Vertical Polarization, Peak  
High End of Frequency Band, 2475 MHz, 20 dBm Power Setting

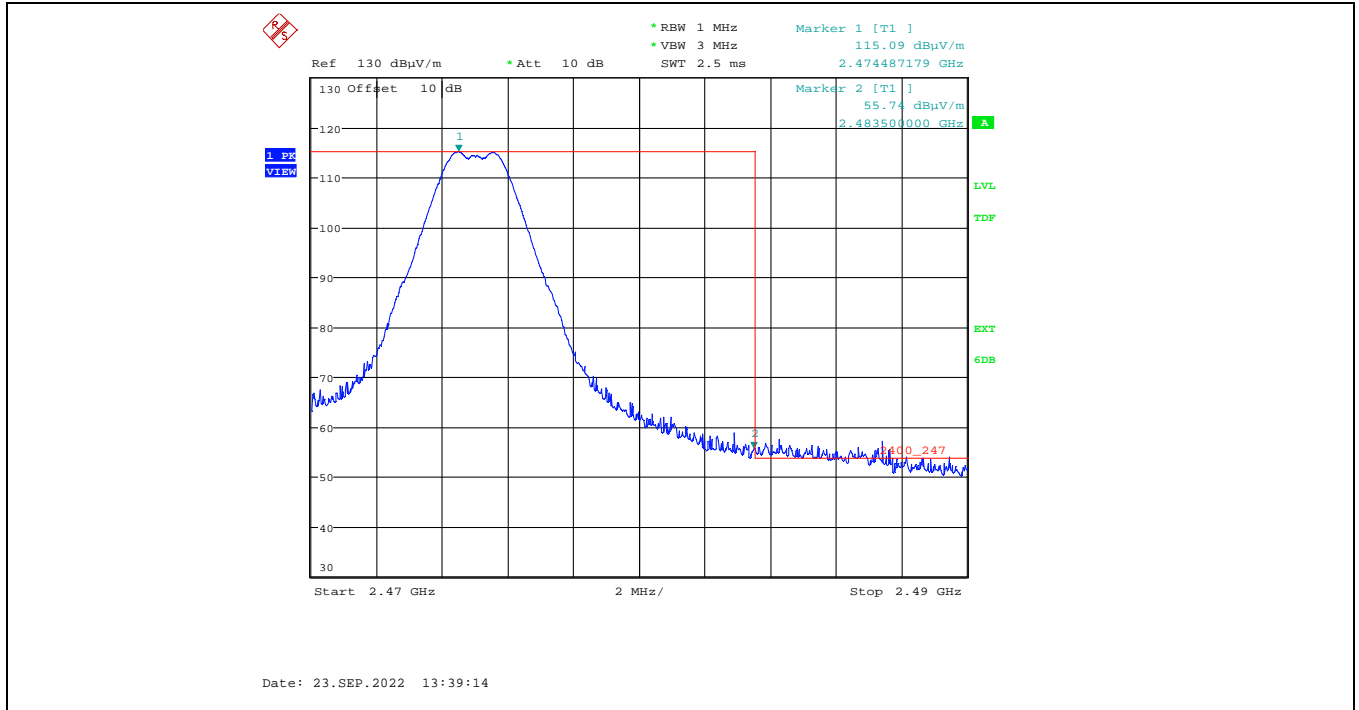

5.2.3.2.6. Band-Edge RF Radiated Emissions at 3 m, Vertical Polarization, Average  
High End of Frequency Band, 2475 MHz, 20 dBm Power Setting

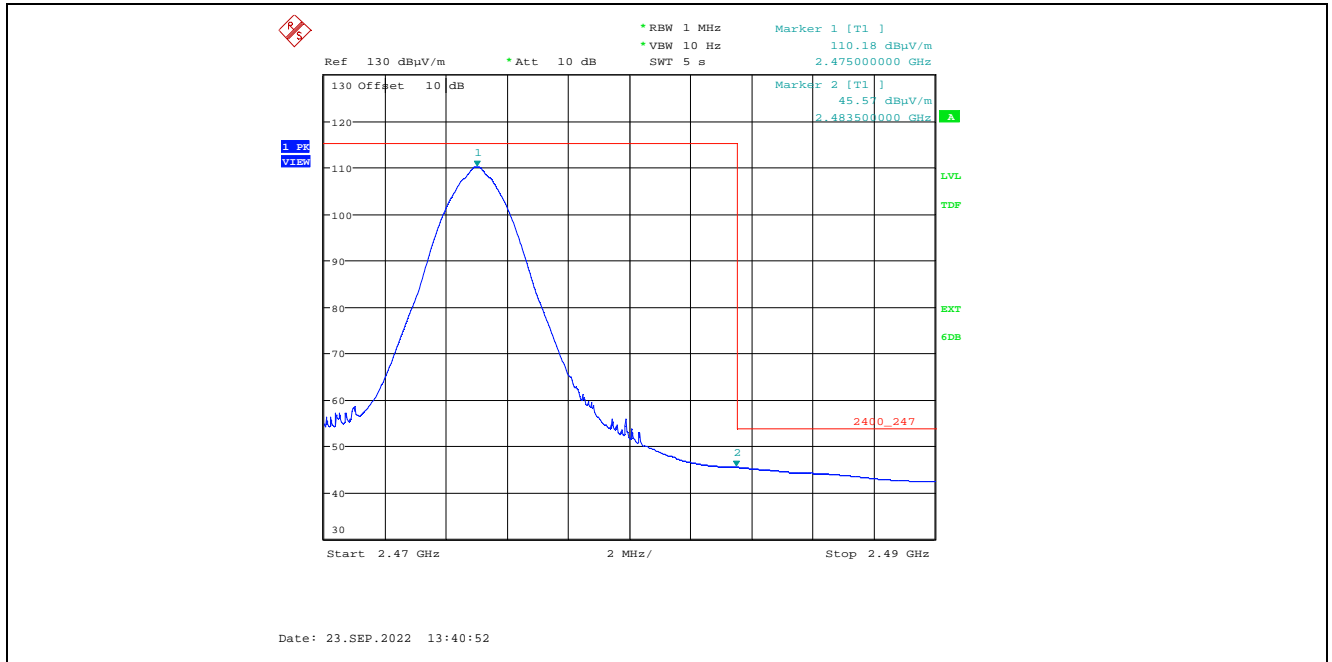

5.2.3.2.7. Band-Edge RF Radiated Emissions at 3 m, Horizontal Polarization, Peak  
 High End of Frequency Band, 2475 MHz, 20 dBm Power Setting

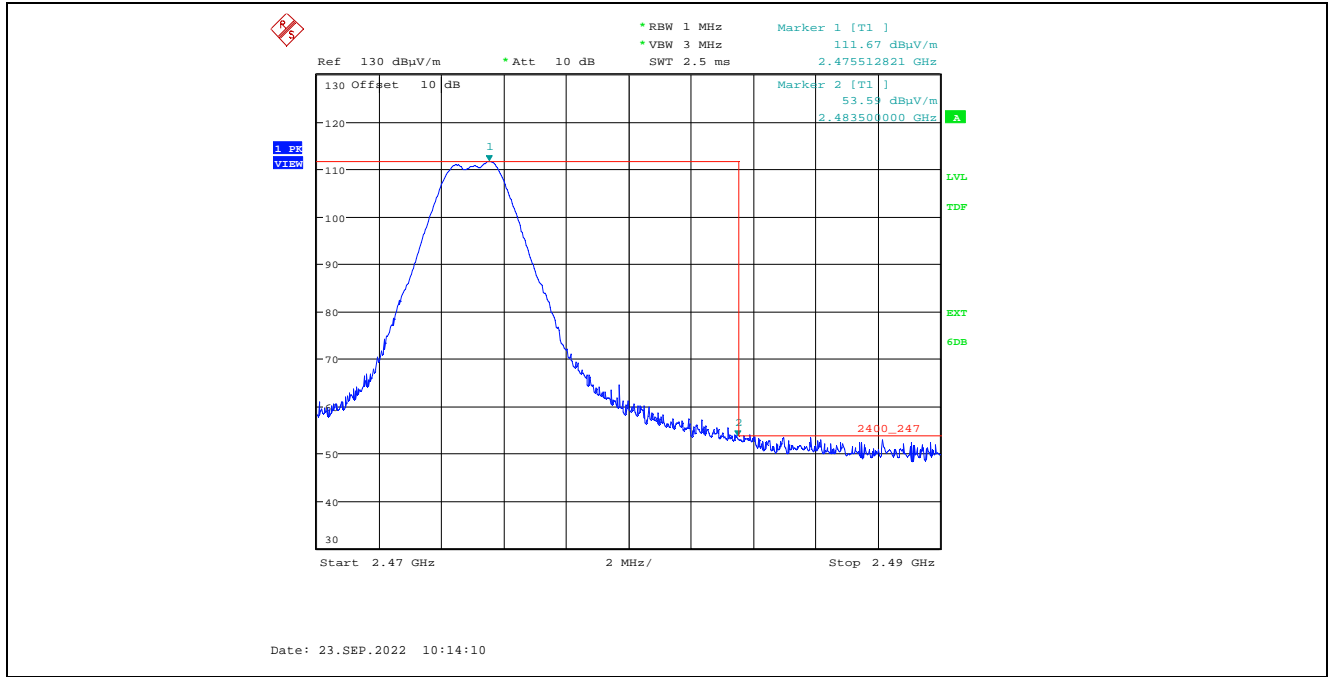

5.2.3.2.8. Band-Edge RF Radiated Emissions at 3 m, Horizontal Polarization, Average  
 High End of Frequency Band, 2475 MHz, 20 dBm Power Setting

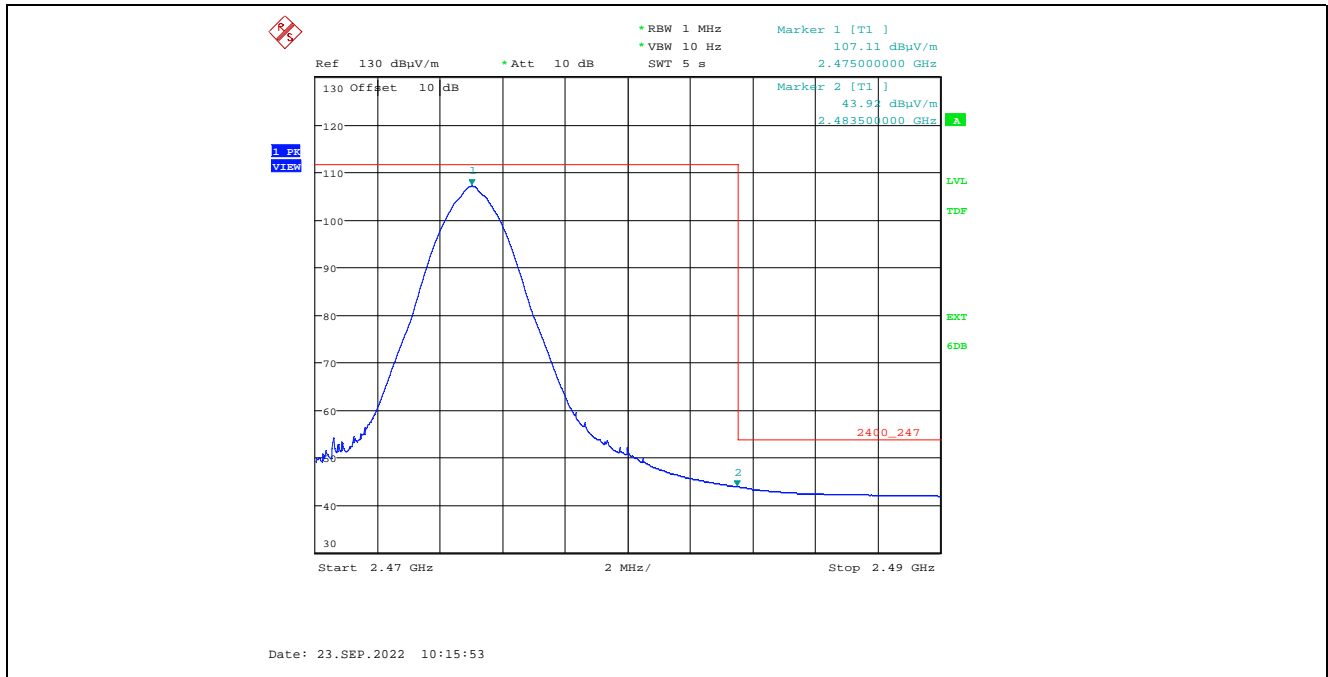

5.2.3.2.9. Band-Edge RF Radiated Emissions at 3 m, Vertical Polarization, Peak  
High End of Frequency Band, 2480 MHz, 3 dBm Power Setting

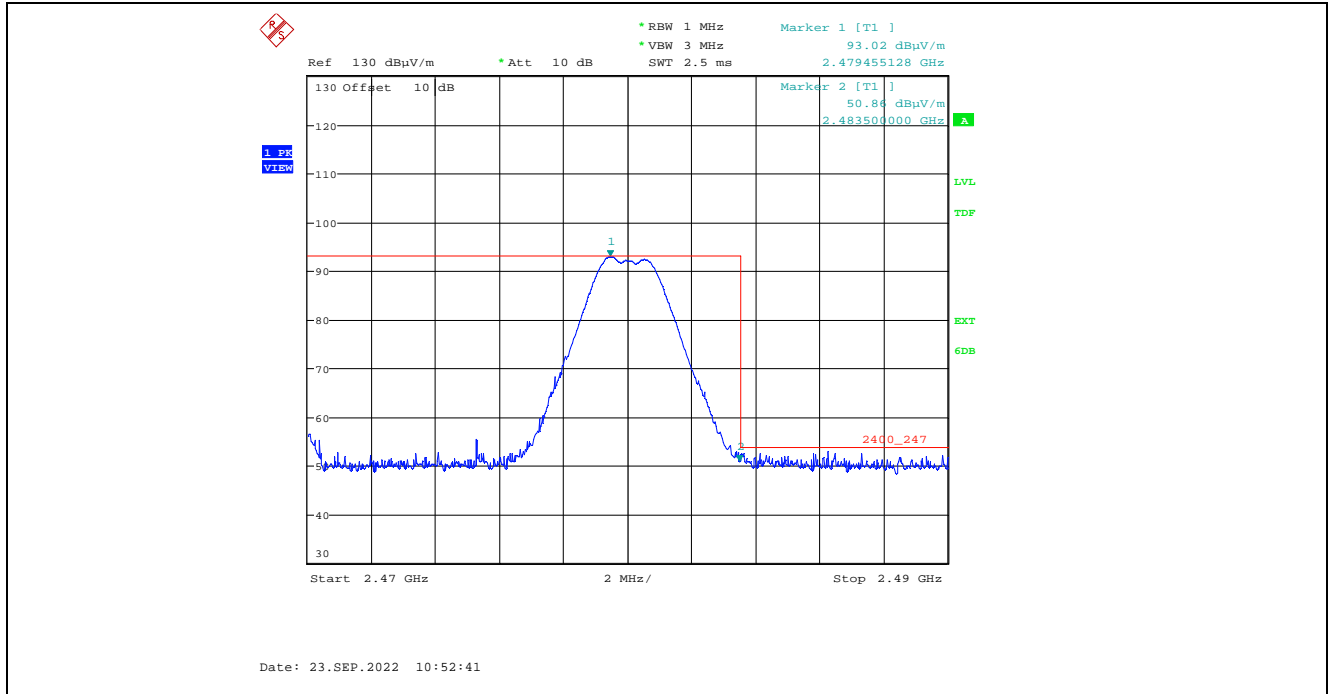

5.2.3.2.10. Band-Edge RF Radiated Emissions at 3 m, Vertical Polarization, Average  
High End of Frequency Band, 2480 MHz, 3 dBm Power Setting

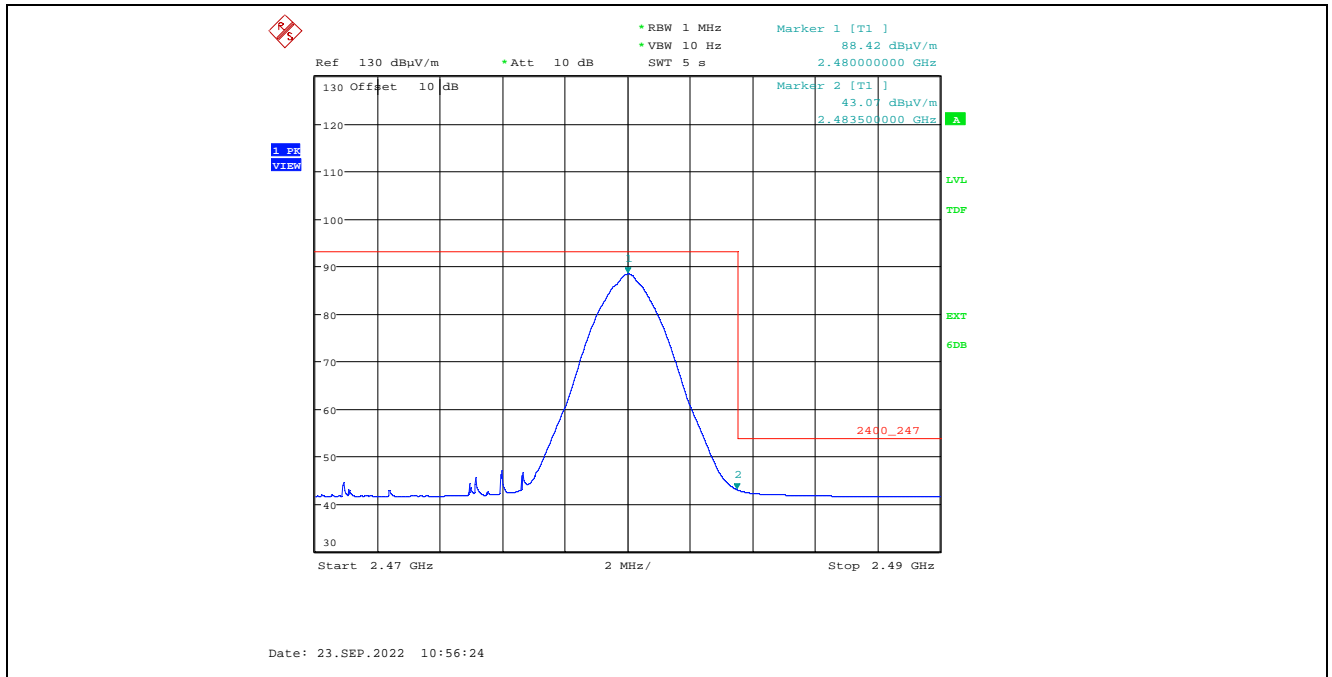



### 5.2.3.2.11. Band-Edge RF Radiated Emissions at 3 m, Horizontal Polarization, Peak High End of Frequency Band, 2480 MHz, 3 dBm Power Setting

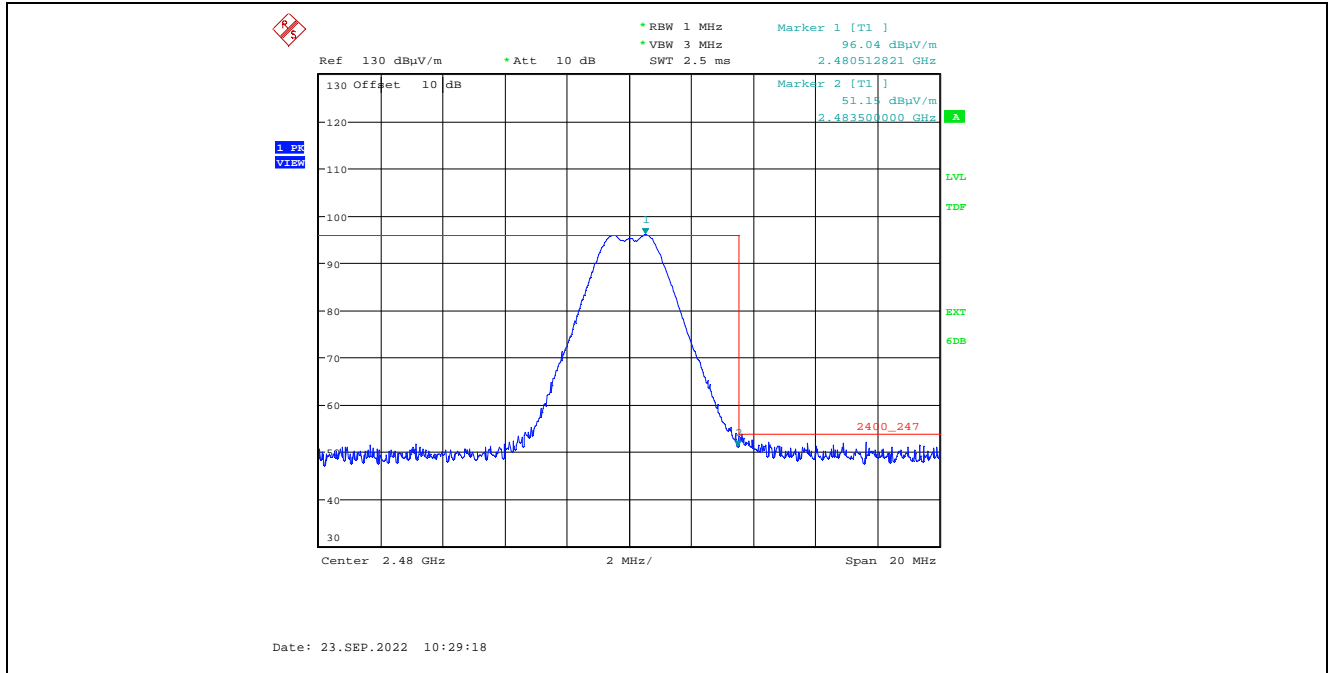

### 5.2.3.2.12. Band-Edge RF Radiated Emissions at 3 m, Horizontal Polarization, Average High End of Frequency Band, 2480 MHz, 3 dBm Power Setting

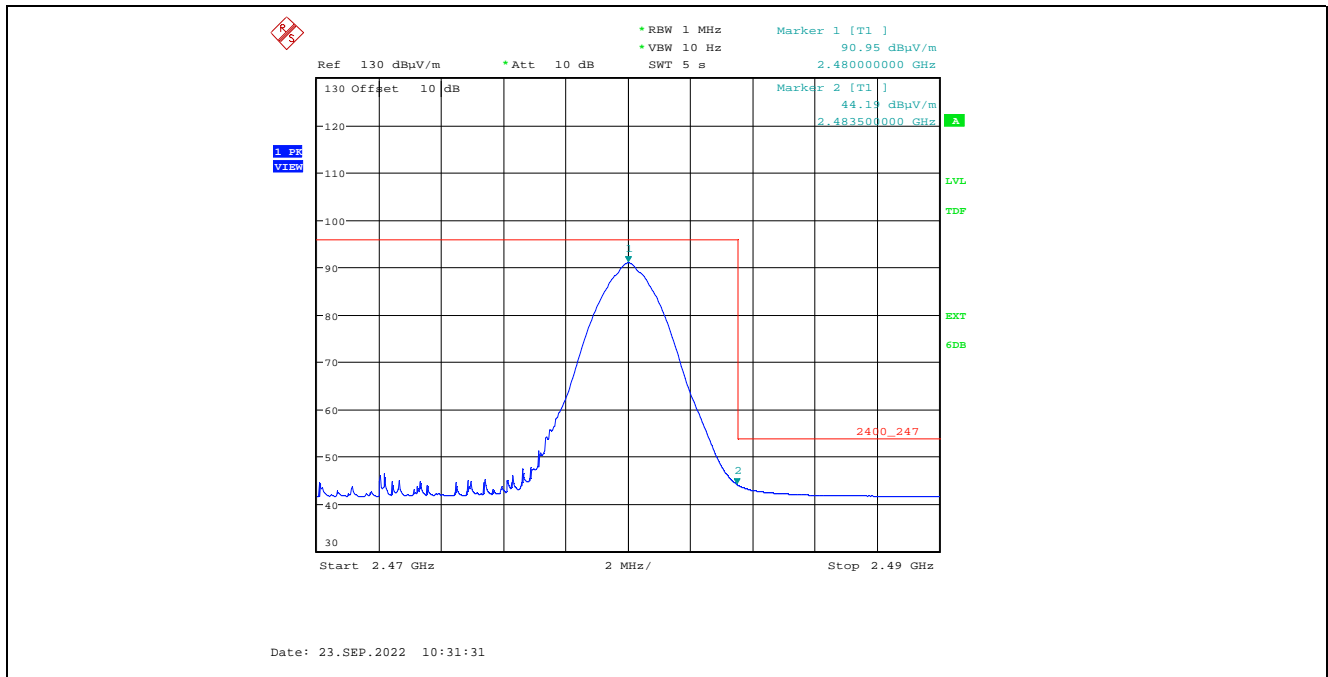

### 5.3. AC POWERLINE CONDUCTED Emissions @ ISED CANADA ICES-003, ISSUE 7

#### 5.3.1. Limits

The equipment shall meet the limits of the following table:

Limits – Class B		
Frequency (MHz)	Limit dB (µV)	
	Quasi-Peak	Average
0.15-0.5	66 to 56*	56 to 46*
0.5-5.0	56	46
5.0-30	60	50

\* Decreasing linearly with logarithm of frequency

#### 5.3.2. Method of Measurements

Refer to Ultratech Test Procedures ULTR-P001-2004 and ANSI C63.4 for method of measurements.

Calculation of Conducted Emission Voltage (dBµV):

This is calculated by adding the L.I.S.N factor, Cable loss factor, and Attenuator factor to the measured reading. The basic equation with a sample calculation is as follows:

$$\text{Voltage (dB}\mu\text{V)} = \text{RA} + \text{AF} + \text{CF} + \text{LF}$$

Where

RA	=	Receiver/Analyzer Reading in dBµV
AF	=	Attenuation Factor in dB
CF	=	Cable loss Factor in dB
LF	=	L.I.S.N Factor in dB

#### 5.3.3. Test Instruments

Refer to Exhibit 6 for Test Instruments & Measurement Uncertainty

**5.3.4. Test Results**

Description: Line Voltage: 120Vac  
 Setup Name: DC; Conducted  
 Customer Name: Digi International Inc  
 Project Number: DIGI-194Q  
 Operator Name: Angus  
 EUT Name: XBee3 USB with Module XBPRR

**Current Graph**

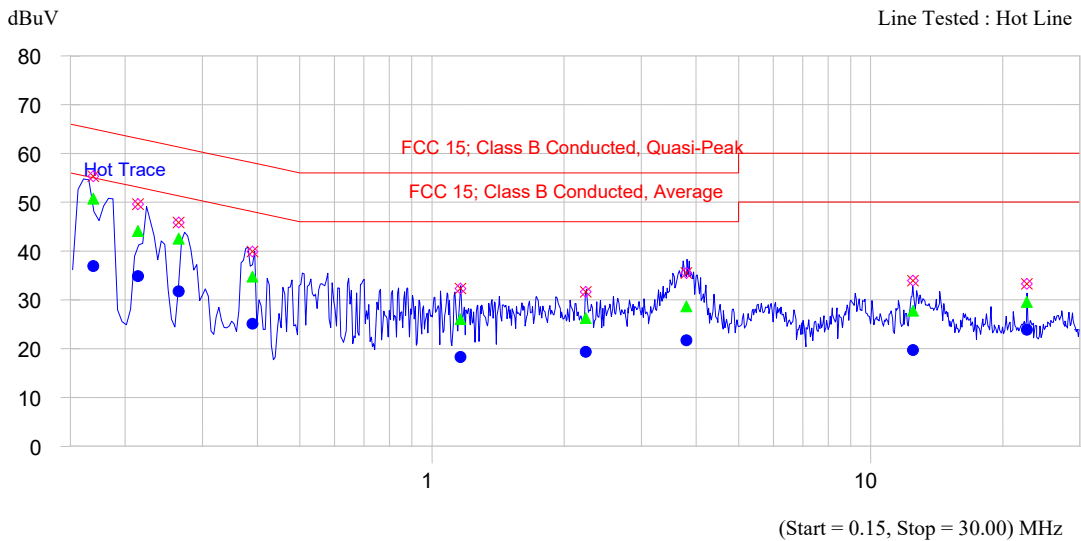

Frequency MHz	Peak dBuV	QP dBuV	Qp-Qp Limit dB	Avg dBuV	Avg-Avg Limit dB	Trace Name
0.169	55.3	50.7	-14.3	36.9	-18.1	Hot Trace
0.214	49.6	44.1	-18.9	34.9	-18.2	Hot Trace
0.265	45.8	42.5	-18.7	31.7	-19.5	Hot Trace
0.390	39.9	34.7	-23.3	25.1	-23.0	Hot Trace
1.162	32.3	26.0	-30.0	18.3	-27.7	Hot Trace
2.241	31.6	26.3	-29.7	19.4	-26.6	Hot Trace
3.805	35.5	28.7	-27.3	21.7	-24.3	Hot Trace
12.483	33.9	27.7	-32.3	19.7	-30.3	Hot Trace
22.703	33.3	29.6	-30.4	23.9	-26.1	Hot Trace

Description: Line Voltage: 120Vac  
 Setup Name: DC; Conducted  
 Customer Name: Digi International Inc  
 Project Number: DIGI-194Q  
 Operator Name: Angus  
 EUT Name: XBee3 USB with Module XBPRR

### Current Graph

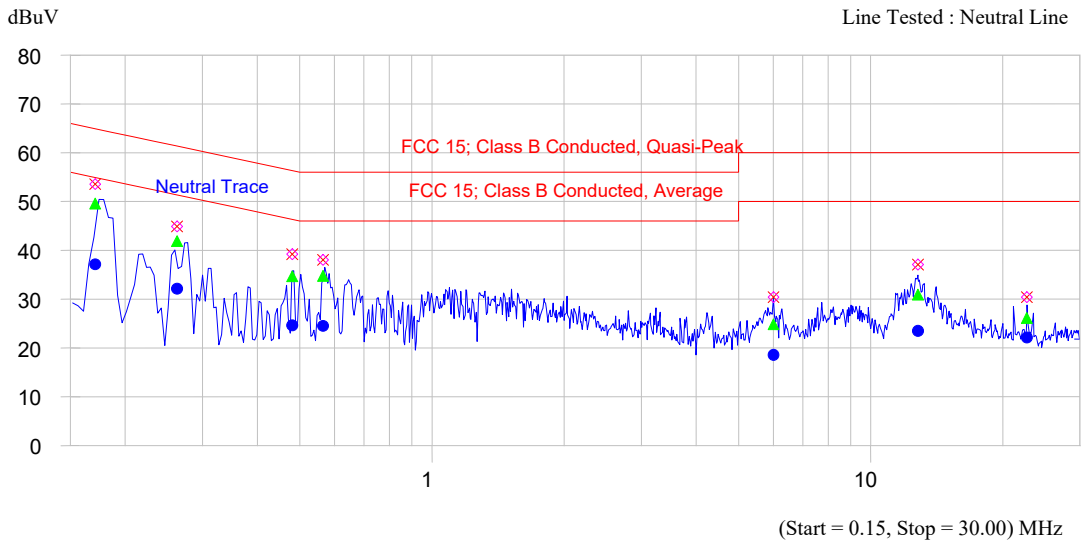

Frequency MHz	Peak dBuV	QP dBuV	Qp-Qp Limit dB	Avg dBuV	Avg-Avg Limit dB	Trace Name
0.171	53.6	49.6	-15.3	37.1	-17.8	Neutral Trace
0.263	44.9	41.9	-19.5	32.1	-19.2	Neutral Trace
0.481	39.2	34.7	-21.6	24.6	-21.7	Neutral Trace
0.565	38.0	34.7	-21.3	24.5	-21.5	Neutral Trace
6.004	30.4	24.8	-35.2	18.6	-31.4	Neutral Trace
12.813	37.1	30.9	-29.1	23.5	-26.5	Neutral Trace
22.696	30.4	26.1	-33.9	22.1	-27.9	Neutral Trace

**ULTRATECH GROUP OF LABS**

3000 Bristol Circle, Oakville, Ontario, Canada L6H 6G4  
 Tel. #: 905-829-1570, Fax. #: 905-829-8050, Email: [vic@ultratech-labs.com](mailto:vic@ultratech-labs.com), Website: <http://www.ultratech-labs.com>

File #: 23DIGI194\_FCC15C247Z  
 January 11, 2023

All test results contained in this engineering test report are traceable to National Institute of Standards and Technology (NIST)

**5.4. RADIATED Emissions from Information Technology Equipment (Including Digital Apparatus)**

**5.4.1. Limits**

The equipment shall meet the limits of the following table:

Test Frequency Range (MHz)	Class B Limits (dBµV/m)	EMI Detector Used	Measurement Distance (meters)
30 – 88	29.5	Quasi-Peak	10
88 – 216	33.0	Quasi-Peak	10
216 – 960	35.5	Quasi-Peak	10
960 -1000	43.5	Quasi-Peak	10
Above 1000	54.0 74.0	Average Peak	3

Note: The limits below 1 GHz has been extrapolated to 10m as per section 3.2.2 of the standard.

**5.4.2. Method of Measurements**

Refer to Ultratech Test Procedures ULTR-P001-2004 & ANSI C63.4 for method of measurements.

The spectrum shall be investigated from the lowest radio frequency signal generated or used in the device, without going below the lowest frequency for which a radiated emission limit is specified, up to the frequency shown in the following table:

Highest frequency generated or used in the device (MHz)	Upper frequency of measurement range (MHz)
Below 1.705	No radiated tests required
1.705 – 108	1000
108 – 500	2000
500 -1000	5000
Above 1000	5th harmonic of the highest frequency or 40 GHz, whichever is lower

Calculation of Field Strength:

The field strength is calculated by adding the calibrated antenna factor and cable factor, and subtracting the Amplifier gain (if any) from the measured reading. The basic equation with a sample calculation is as follows:

$$FS = RA + AF + CF - AG$$

- Where FS = Field Strength
- RA = Receiver/Analyzer Reading
- AF = Antenna Factor
- CF = Cable Attenuation Factor
- AG = Amplifier Gain

**5.4.3. Test Instruments**

Refer to Exhibit 6 for Test Instruments & Measurement Uncertainty

**5.4.4. Test Results**

The emissions were scanned from 30 MHz to 1 GHz at 10 Meters distance and all emissions within 20dB of the limits were recorded.

FREQUENCY (MHz)	RF LEVEL (dBuV/m)	DETECTOR USED (PEAK/QP)	ANTENNA PLANE (H/V)	LIMIT (dBuV/m)	MARGIN (dB)	PASS/ FAIL
115.49	20.2	PEAK	V	33.0	-12.8	PASS
193.22	25.1	PEAK	V	33.0	-7.9	PASS

The emissions were scanned from 1 GHz to 18 GHz at 3 Meters distance and all emissions within 20dB of the limits were recorded.

FREQUENCY (MHz)	RF LEVEL (dBuV/m)	DETECTOR USED (PEAK/QP)	ANTENNA PLANE (H/V)	LIMIT (dBuV/m)	MARGIN (dB)	PASS/ FAIL
1653.84	39.25	PEAK	V	54	-14.75	PASS
1653.84	42.68	PEAK	H	54	-11.32	PASS
1899.04	42.24	PEAK	V	54	-11.76	PASS
1899.04	44.68	PEAK	H	54	-9.32	PASS

**EXHIBIT 6. TEST EQUIPMENT LIST AND SETUP**

**6.1. FCC 15.247 (b) (3), RSS-247 5.4 (4) POP**

**6.1.1. Block Diagram**

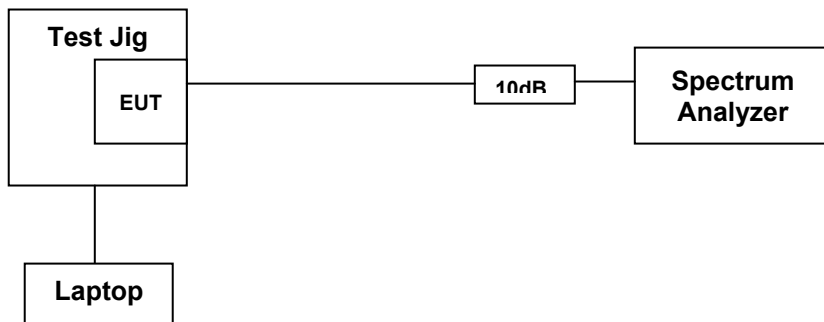

**6.1.2. Test Equipment List**

Test Instruments	Manufacturer	Model No.	Serial No.	Frequency Range	Calibration Due Date
Spectrum Analyzer	Rohde & Schwarz	FSU26	100398	20Hz–26.5 GHz	20 Sep 2023
Attenuator	Hewlett Packard	8493C	0461	DC–26.5 GHz	Cal before use

**6.1.3. Accessories for test**

Laptop: HP EliteBook 820  
 Test Software: Version 6.5.10

**6.2. FCC 15.247 (d), RSS-247 5.5 Band-Edge Radiated Emissions**

**6.2.1. Block Diagram**



**6.3. Test Equipment List**

Test Instruments	Manufacturer	Model No.	Serial No.	Frequency Range	Calibration Due Date
Spectrum Analyzer	Rohde & Schwarz	FSU26	100398	20Hz–26.5 GHz	20 Sep 2023
Attenuator	Hewlett Packard	8493C	0461	DC–26.5 GHz	Cal before use
Horn Antenna	ETS	3117	00119425	1-18GHz	20 Jan 2024
Preamp	Hewlett Packard	8449B	3008A00769	1GHz-26.5GHz	02 May 2023

**6.3.1. Accessories for test**

Laptop: HP EliteBook 820  
 Test Software: Version 6.5.10



**6.4. FCC 15.247 (d), RSS-247 5.5 Tx Radiated Emissions**

**6.4.1. Block Diagram**

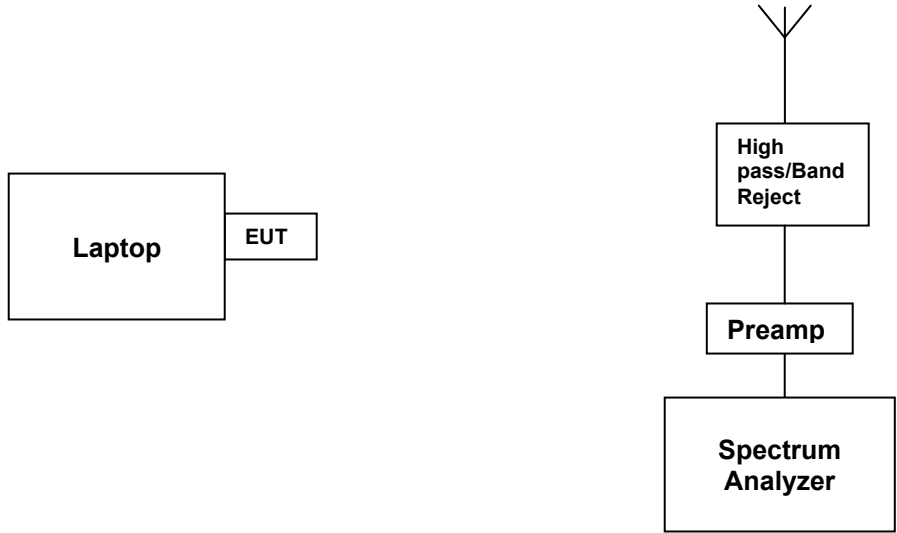

**6.4.2. Test Equipment List**

Test Instruments	Manufacturer	Model No.	Serial No.	Frequency Range	Calibration Due Date
Spectrum Analyzer	Rohde & Schwarz	FSU26	100398	20Hz–26.5 GHz	20 Sep 2023
EMI Receiver	Rohde & Schwarz	ESU40	100037	20Hz–40 GHz	26 Sep 2023
Biconilog Antenna	EMCO	3142C	00026873	26-2000MHz	16 Dec 2023
Horn Antenna	ETS	3115	9701-5061	1-18GHz	08 Aug 2024
Horn Antenna	ETS	3117	00119425	1-18GHz	20 Jan 2024
Horn Antenna	ETS	3160-09	00118385	18-26GHz	22 Jan 2023
Preamp	Com-Power	PAM-118A	551016	500MHz-18GHz	04 Mar 2023
Preamp	HP	8449B	3003A00769	1-26.5GHz	02 May 2023
Preamp	Com-Power	PAM-840A	18050002	18-40GHz	20 Oct 2023
Band Reject Filter	Microtronics	BRM50701	105	Cut off 2.170-3 GHz	Cal before use
High Pass Filter	K & L	11SH-10-4000/T 12000	4	Cut off 2.4GHz	Cal before use

**6.4.3. Accessories for test**

Laptop: HP EliteBook 820  
 Test Software: Version 6.5.10

**6.5. FCC 15.207 (a); ICES-003, Power line Conducted Emissions**

**6.5.1. Block Diagram**

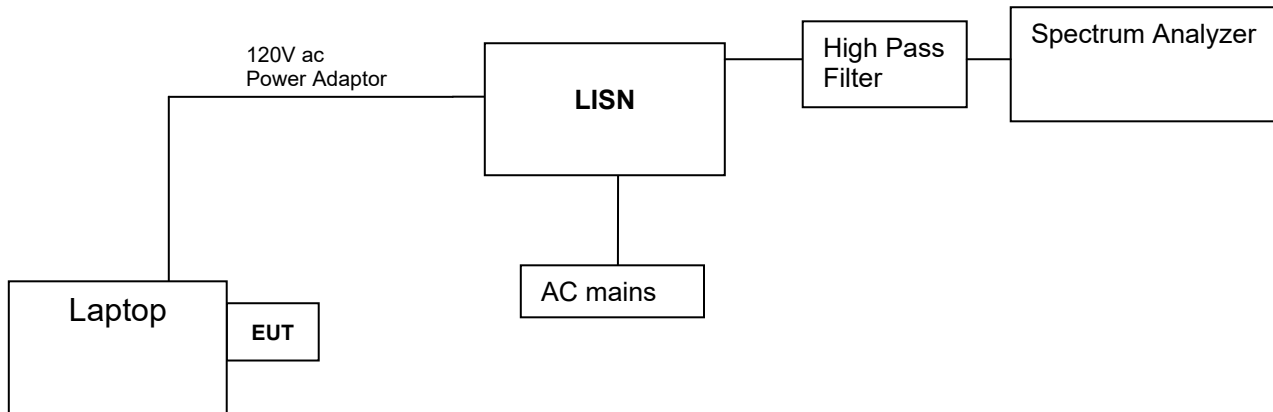

**6.5.2. Test Equipment List**

Test Instruments	Manufacturer	Model No.	Serial No.	Frequency Range	Calibration Due Date
Spectrum Analyzer	Agilent	E7401A	US40240432	9 kHz–22 GHz	Oct 26, 2023
High Pass filter	Rohde & Schwarz	EZ-25	100064	Cut off 150kHz	Aug 09, 2023
LISN Used	EMCO	3825-2	8907-1531	9 kHz–30 MHz	Feb 17, 2023
Laptop	HP EliteBook	820	-	-	-

**6.5.3. Accessories for test**

Laptop: HP EliteBook 820  
 Test Software: Version 6.5.10

**6.6. ICES-003, Unintentional Radiated Emissions**

**6.6.1. Block Diagram**

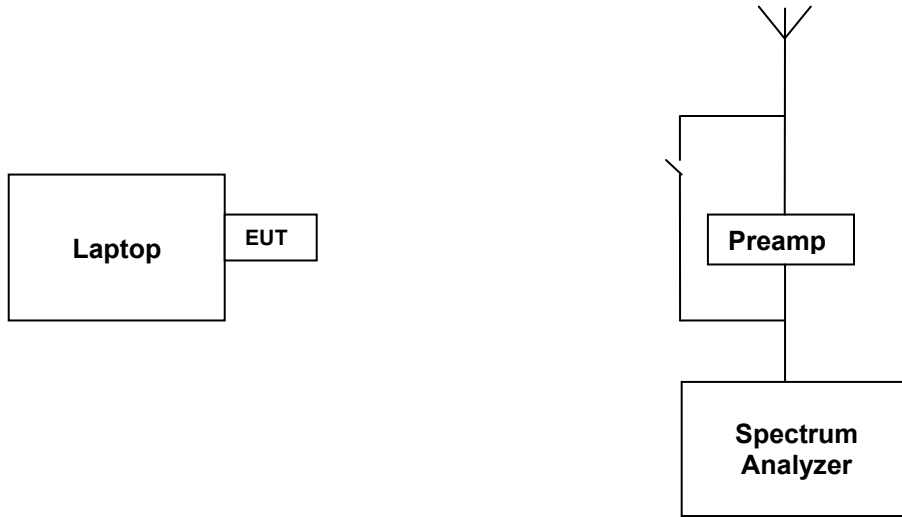

**6.6.2. Test Equipment List**

Test Instruments	Manufacturer	Model No.	Serial No.	Frequency Range	Calibration Due Date
Spectrum Analyzer	Rohde & Schwarz	FSU26	100398	20Hz–26.5 GHz	20 Sep 2023
EMI Receiver	Rohde & Schwarz	ESU40	100037	20Hz–40 GHz	26 Sep 2023
Biconilog Antenna	EMCO	3142C	00026873	26-2000MHz	16 Dec 2023
Horn Antenna	ETS	3115	9701-5061	1-18GHz	08 Aug 2024
Horn Antenna	ETS	3117	00119425	1-18GHz	20 Jan 2024
Preamp	Com-Power	PAM-118A	551016	500MHz-18GHz	04 Mar 2023
Preamp	HP	8449B	3003A00769	1-26.5GHz	02 May 2023
Band Reject Filter	Microtronics	BRM50701	105	Cut off 2.170-3 GHz	Cal before use
High Pass Filter	K & L	11SH-10-4000/T 12000	4	Cut off 2.4GHz	Cal before use

**6.6.3. Accessories for test**

Laptop: HP EliteBook 820  
 Test Software: Version 6.5.10

## EXHIBIT 7. MEASUREMENT UNCERTAINTY

The measurement uncertainties stated were calculated in accordance with the requirements of CISPR 16-4-2 @ IEC:2003 and JCGM 100:2008 (GUM 1995) – Guide to the Expression of Uncertainty in Measurement.

Test Description	Expanded Uncertainty, K=2 for 95% Confidence Level
Power Line Conducted Emissions	$\pm 2.62$
Conducted Output Power	$\pm 0.62$ dB
Power Spectral Density	$\pm 0.20$ Hz / $\pm 0.63$ dB
Occupied Bandwidth	$\pm 0.20$ Hz / $\pm 0.63$ dB
Transmitter Spurious Radiated Emissions	$\pm 4.20$ dB (30 MHz – 1 GHz)
	$\pm 2.70$ dB (1 – 18 GHz)

---

### ULTRATECH GROUP OF LABS

3000 Bristol Circle, Oakville, Ontario, Canada L6H 6G4

Tel. #: 905-829-1570, Fax. #: 905-829-8050, Email: [vic@ultratech-labs.com](mailto:vic@ultratech-labs.com), Website: <http://www.ultratech-labs.com>

File #: 23DIGI194\_FCC15C247Z

January 11, 2023

*All test results contained in this engineering test report are traceable to National Institute of Standards and Technology (NIST)*