

ENGINEERING TEST REPORT

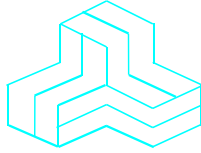

**XBee RR Pro
Model: XBPRR
FCC ID: MCQ-XBPRR**

Applicant:

Digi International Inc
9350 Excelsior Blvd. Suite 700
Hopkins, MN 55343

In Accordance With

**Federal Communications Commission (FCC)
Part 15, Subpart C, Section 15.247
Digital Modulation Systems (DTS) Operating in 2400 – 2483.5 MHz Band**

UltraTech's File No.: 22DIGI184_FCC15C247Z

This Test report is Issued under the Authority of
Tri M. Luu
Vice President of Engineering
UltraTech Group of Labs

Date: August 10, 2022

Report Prepared by: Santhosh Fernandez

Tested by: Nimisha Desai and Angus Au

Issued Date: August 10, 2022

Test Dates: June 21-July 4, 2022

- *The results in this Test Report apply only to the sample(s) tested, and the sample tested is randomly selected.*
- *This report must not be used by the client to claim product endorsement by any agency of the US Government.*
- *This test report shall not be reproduced, except in full, without a written approval from UltraTech*

UltraTech

3000 Bristol Circle, Oakville, Ontario, Canada, L6H 6G4
Tel.: (905) 829-1570 Fax.: (905) 829-8050

Website: www.ultratech-labs.com, Email: vic@ultratech-labs.com, Email: tri@ultratech-labs.com



APEC TEL CA0001



1309



CA0001-2049



AT-1945



SL2-IN-E-1119R



CA0001

TABLE OF CONTENTS

EXHIBIT 1. INTRODUCTION 1

1.1. SCOPE..... 1

1.2. RELATED SUBMITTAL(S)/GRANT(S)..... 1

1.3. NORMATIVE REFERENCES 1

EXHIBIT 2. PERFORMANCE ASSESSMENT 2

2.1. CLIENT INFORMATION 2

2.2. EQUIPMENT UNDER TEST (EUT) INFORMATION..... 2

2.3. EUT’S TECHNICAL SPECIFICATIONS 3

2.4. LIST OF EUT’S PORTS 3

2.5. ANCILLARY EQUIPMENT 4

EXHIBIT 3. EUT OPERATING CONDITIONS AND CONFIGURATIONS DURING TESTS 5

3.1. CLIMATE TEST CONDITIONS 5

3.2. OPERATIONAL TEST CONDITIONS & ARRANGEMENT FOR TESTS..... 5

EXHIBIT 4. SUMMARY OF TEST RESULTS 6

4.1. LOCATION OF TESTS 6

4.2. APPLICABILITY & SUMMARY OF EMC EMISSION TEST RESULTS 6

4.3. MODIFICATIONS INCORPORATED IN THE EUT FOR COMPLIANCE PURPOSES..... 6

EXHIBIT 5. TEST DATA..... 7

5.1. PEAK CONDUCTED OUTPUT POWER - DTS [§ 15.247(B)(3)] 7

5.1.1. *Limit(s)* 7

5.1.2. *Method of Measurements*..... 7

5.1.3. *Test Data* 7

5.2. TRANSMITTER SPURIOUS RADIATED EMISSIONS AT 3 METERS [§§ 15.247(D), 15.209 & 15.205]..... 12

5.2.1. *Limit(s)* 12

5.2.2. *Method of Measurements*..... 13

5.2.3. *Test Data* 13

EXHIBIT 6. TEST EQUIPMENT LIST AND SETUP 21

6.1. FCC 15.247 (B) (3), RSS-247 5.4 (4) POP 21

6.1.1. *Block Diagram*..... 21

6.1.2. *Test Equipment List* 21

6.1.3. *Accessories for test* 21

6.2. FCC 15.247 (D), RSS-247 5.5 BAND-EDGE RADIATED EMISSIONS 22

6.2.1. *Block Diagram*..... 22

6.2.2. *Test Equipment List* 22

6.2.3. *Accessories for test* 22

6.3. FCC 15.247 (D), RSS-247 5.5 TX RADIATED EMISSIONS 23

6.3.1. *Block Diagram*..... 23

6.3.2. *Test Equipment List* 24

6.3.3. *Accessories for test* 24

EXHIBIT 7. MEASUREMENT UNCERTAINTY..... 25

EXHIBIT 1. INTRODUCTION

1.1. SCOPE

Reference:	FCC Part 15, Subpart C, Section 15.247
Title:	Code of Federal Regulations (CFR), Title 47 – Telecommunication, Part 15 – Radio Frequency Devices
Purpose of Test:	Equipment Certification for Digital Modulation Systems (DTS) Operating Under §15.247
Test Procedures:	<ul style="list-style-type: none"> ▪ ANSI C63.4 ▪ ANSI C63.10 ▪ FCC KDB Publication No. 558074 D01 15.247 Meas Guidance v05r02
Environmental Classification:	<input checked="" type="checkbox"/> Commercial, industrial or business environment <input checked="" type="checkbox"/> Residential environment

1.2. RELATED SUBMITTAL(S)/GRANT(S)

None.

1.3. NORMATIVE REFERENCES

Publication	Year	Title
47 CFR Parts 0-19	2021	Code of Federal Regulations (CFR), Title 47 – Telecommunication
ANSI C63.4	2014	American National Standard for Methods of Measurement of Radio-Noise Emissions from Low-Voltage Electrical and Electronic Equipment in the Range of 9 KHz to 40 GHz
ANSI C63.10	2013	American National Standard of Procedures for Compliance Testing of Unlicensed Wireless Devices
FCC, KDB Publication No. 558074 D01 15.247 Meas Guidance v05r02	2019	GUIDANCE FOR COMPLIANCE MEASUREMENTS ON DIGITAL TRANSMISSION SYSTEM, FREQUENCY HOPPING SPREAD SPECTRUM SYSTEM, AND HYBRID SYSTEM DEVICES OPERATING UNDER SECTION 15.247 OF THE FCC RULES

EXHIBIT 2. PERFORMANCE ASSESSMENT

2.1. CLIENT INFORMATION

Applicant	
Name:	Digi International Inc
Address:	9350 Excelsior Blvd. Suite 700 Hopkins, MN 55343 USA

Manufacturer	
Name:	Digi International Inc
Address:	10000 W 76th Street Eden Prairie, MN 55344 USA

2.2. EQUIPMENT UNDER TEST (EUT) INFORMATION

The following information (with the exception of the Date of Receipt) has been supplied by the applicant.

Brand Name:	Digi International Inc
Product Name:	XBee RR Pro
Model Name or Number:	XBPRR
Serial Number:	Test Sample
Type of Equipment:	Digital Transmission System (DTS)
Input Power Supply Type:	External DC Power Supply
Primary User Functions of EUT:	Digital Communications

2.3. EUT’S TECHNICAL SPECIFICATIONS

Transmitter	
Equipment Type:	Mobile Base station (fixed use)
Intended Operating Environment:	Commercial, industrial or business environment Residential environment
Power Supply Requirement:	1.71 to 3.8VDC (3.3V is nominal)
RF Output Power Rating:	-9.44 dBm to 19.35 dBm maximum peak conducted power
Operating Frequency Range:	2405 - 2480 MHz
RF Output Impedance:	50 Ω
Duty Cycle:	Continuous
Modulation Type:	QPSK
Antenna Connector Types:	PCB mounted chip antenna (0dBi manufacturer spec.)

2.4. LIST OF EUT’S PORTS

Port Number	EUT’s Port Description	Number of Identical Ports	Connector Type	Cable Type (Shielded/Non-shielded)
1	UART, GPIO	1	Custom 34 pin interface	Direct connection

2.5. ANCILLARY EQUIPMENT

The EUT was tested while connected to the following representative configuration of ancillary equipment necessary to exercise the ports during tests:

Ancillary Equipment # 1	
Description:	Test Jig
Brand name:	Digi International
Model Name or Number:	N/A
Serial Number:	N/A
Connected to EUT's Port:	Pin header

Ancillary Equipment # 2	
Description:	Laptop
Brand name:	Lenovo
Model Name or Number:	0578
Serial Number:	N/A
Connected to EUT's Port:	EUT Test Jig

EXHIBIT 3. EUT OPERATING CONDITIONS AND CONFIGURATIONS DURING TESTS

3.1. CLIMATE TEST CONDITIONS

The climate conditions of the test environment are as follows:

Temperature:	21 to 23 °C
Humidity:	45 to 58%
Pressure:	102 kPa
Power Input Source:	3.3 VDC nominal, 3.8 VDC Max.

3.2. OPERATIONAL TEST CONDITIONS & ARRANGEMENT FOR TESTS

Operating Modes:	The transmitter was operated in a continuous transmission mode with the carrier modulated as specified in the Test Data.
Special Test Software:	Test software provided by the Applicant to operate the EUT at each channel frequency continuously and in the range of typical modes of operation.
Special Hardware Used:	Test Jig
Transmitter Test Antenna:	The EUT is tested with the antenna fitted in a manner typical of normal intended use as non-integral antenna equipment as described with the test results.

Transmitter Test Signals	
Frequency Band(s):	2405 - 2480 MHz
Frequency(ies) Tested:	2405 MHz, 2440 MHz, 2475 MHz, 2480 MHz
RF Power Output: (measured maximum peak conducted output power)	19.28 dBm
Normal Test Modulation:	QPSK
Modulating Signal Source:	Internal

EXHIBIT 4. SUMMARY OF TEST RESULTS

4.1. LOCATION OF TESTS

All of the measurements described in this report were performed at Ultratech Group of Labs located in the city of Oakville, Province of Ontario, Canada.

- AC Power Line Conducted Emissions were performed in UltraTech's shielded room, 24'(L) by 16'(W) by 8'(H).
- Radiated Emissions were performed at the Ultratech's 3-10 TDK Semi-Anechoic Chamber situated in the Town of Oakville, province of Ontario. This test site been calibrated in accordance with ANSI C63.4, and found to be in compliance with the requirements of Sec. 2.948 of the FCC Rules. The descriptions and site measurement data of the Oakville 3-10 TDK Semi-Anechoic Chamber has been filed with ANAB File No.: AT-1945.

4.2. APPLICABILITY & SUMMARY OF EMC EMISSION TEST RESULTS

FCC Section(s)	Test Requirements	Compliance (Yes/No)
15.203	Antenna requirements	Yes*
15.207(a)	AC Power Line Conducted Emissions	N/A for this C2PC
15.247(a)(2)	6 dB Bandwidth	N/A for this C2PC
15.247(b)(3)	Peak Conducted Output Power	Yes
15.247(d)	Band-Edge and RF Conducted Spurious Emissions at the Transmitter Antenna Terminal	--
15.247(d), 15.209 & 15.205	Band-Edge and Transmitter Spurious Radiated Emissions	Yes
15.247(e)	Power Spectral Density	N/A for this C2PC
15.247(i), 1.1307, 1.1310, 2.1091	RF Exposure	Yes, Addressed in original certification

* The EUT complies with the requirement; it employs a unique (non-standard) antenna connector or integral antenna.

4.3. MODIFICATIONS INCORPORATED IN THE EUT FOR COMPLIANCE PURPOSES

None.

EXHIBIT 5. TEST DATA

5.1. PEAK CONDUCTED OUTPUT POWER - DTS [§ 15.247(b)(3)]

5.1.1. Limit(s)

§ 15.247(b)(3): For systems using digital modulation in the 902-928 MHz, 2400-2483.5 MHz, and 5725-5850 MHz bands: 1 Watt. As an alternative to a peak power measurement, compliance with the one Watt limit can be based on a measurement of the maximum conducted output power. Maximum Conducted Output Power is defined as the total transmit power delivered to all antennas and antenna elements averaged across all symbols in the signaling alphabet when the transmitter is operating at its maximum power control level. Power must be summed across all antennas and antenna elements. The average must not include any time intervals during which the transmitter is off or is transmitting at a reduced power level. If multiple modes of operation are possible (e.g., alternative modulation methods), the *maximum conducted output power* is the highest total transmit power occurring in any mode.

5.1.2. Method of Measurements

FCC KDB 558074 D01 15.247 Meas Guidance V05r02, Section 8.3.1.1 RBW ≥ DTS bandwidth

5.1.3. Test Data

Maximum Peak Conducted Output Power at Power Settings 20 dBm, 3 dBm and -10 dBm

Modulation	Power Setting	Frequency (MHz)	Maximum Peak Conducted Output Power (dBm)	Peak Power Limit (dBm)
QPSK	20 dBm	2405	19.28	30
		2440	19.13	30
		2475	19.25	30
	3 dBm	2480	1.96	30
	-10 dBm	2405	-9.40	30
		2440	-9.46	30
		2475	-9.22	30
		2480	-9.22	30

Antenna gain for new antenna is 0dBi, EIRP <30dBm limit

Plot 5.1.3.1. Maximum Peak Conducted Output Power, QPSK Modulation, 20 dBm Power Setting, 2405 MHz

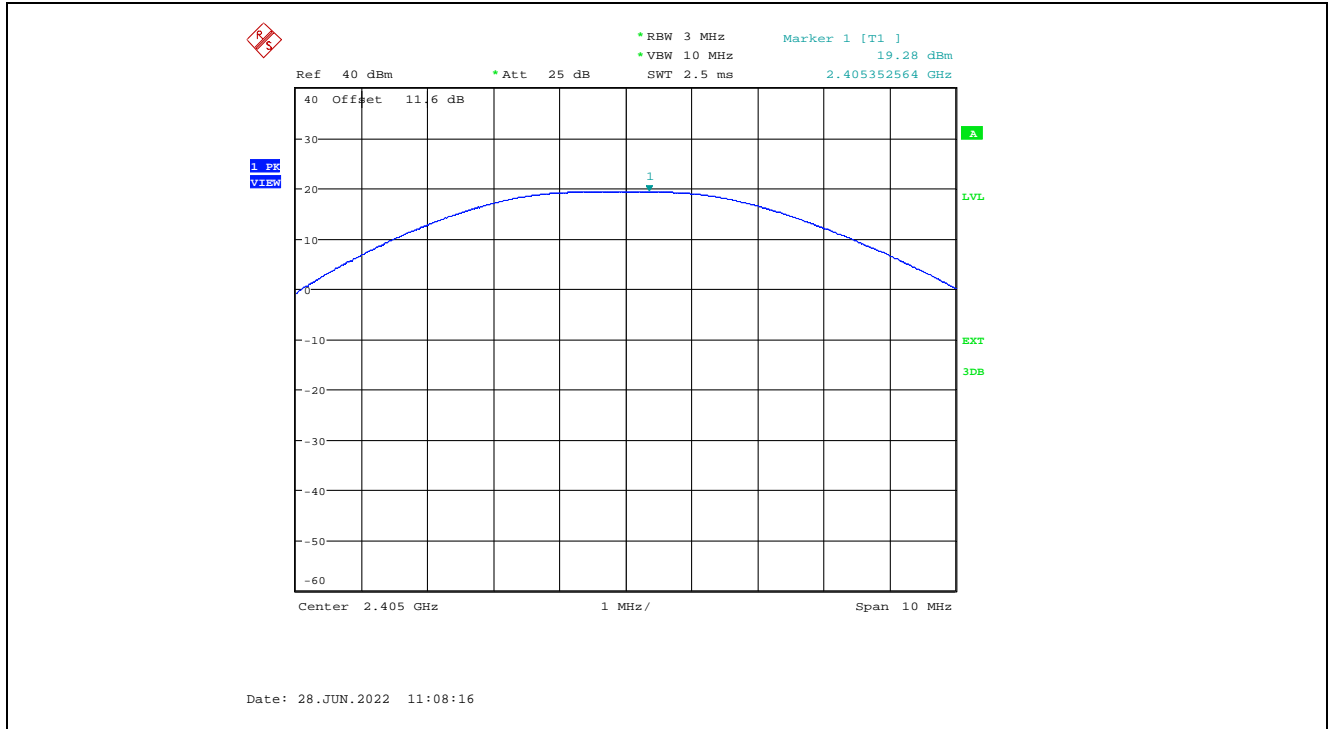

Plot 5.1.3.2. Maximum Peak Conducted Output Power, QPSK Modulation, 20 dBm Power Setting, 2440 MHz

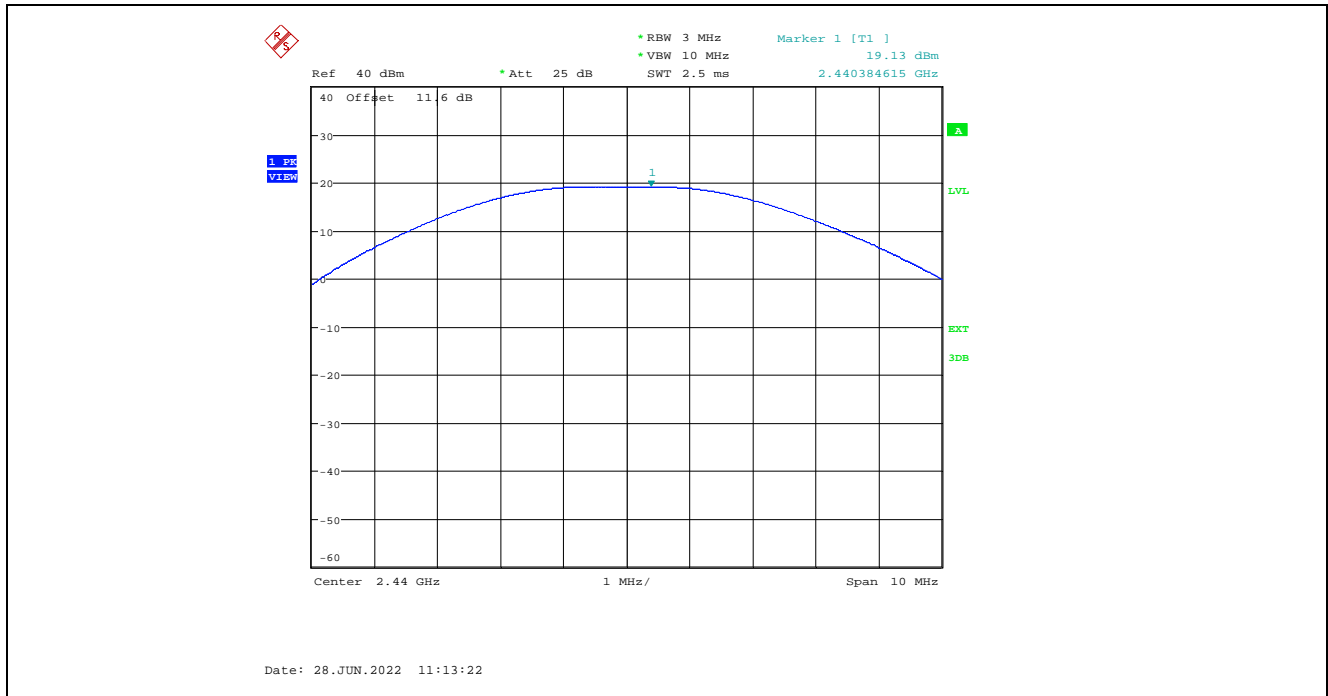

Plot 5.1.3.3. Maximum Peak Conducted Output Power, QPSK Modulation, 20 dBm Power Setting, 2475 MHz

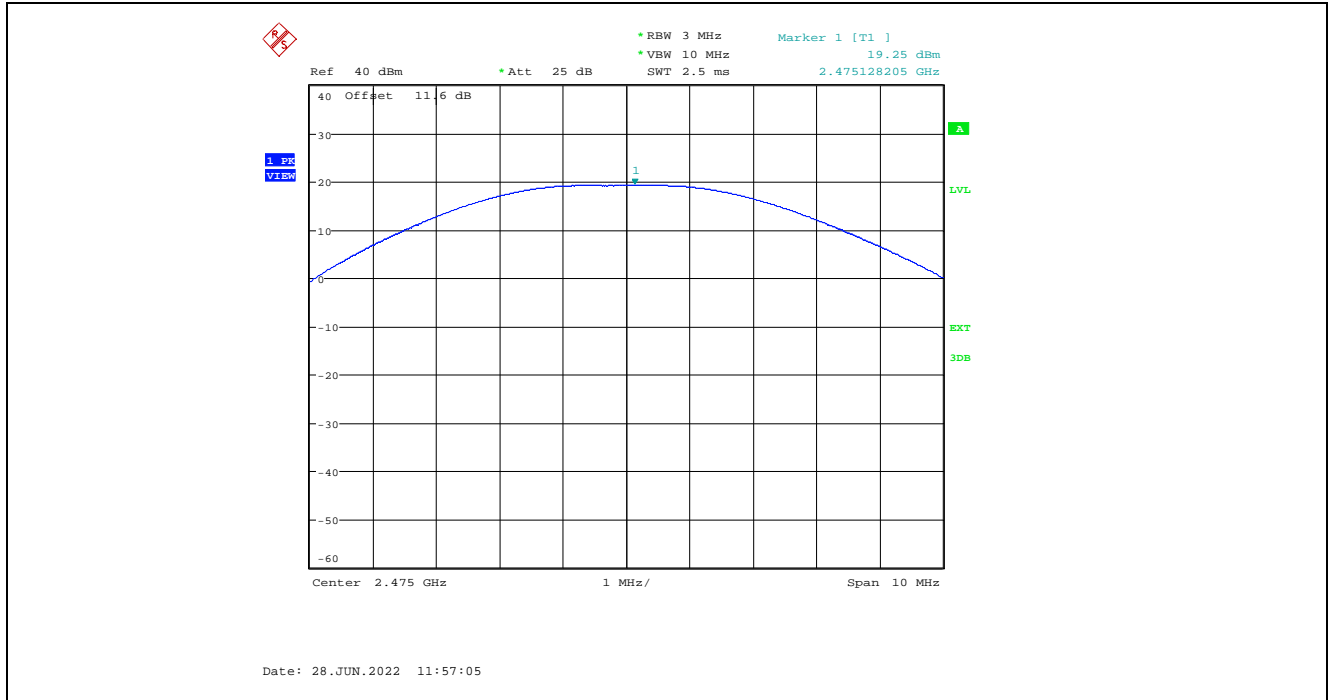

Plot 5.1.3.4. Maximum Peak Conducted Output Power, QPSK Modulation, 3 dBm Power Setting, 2480 MHz

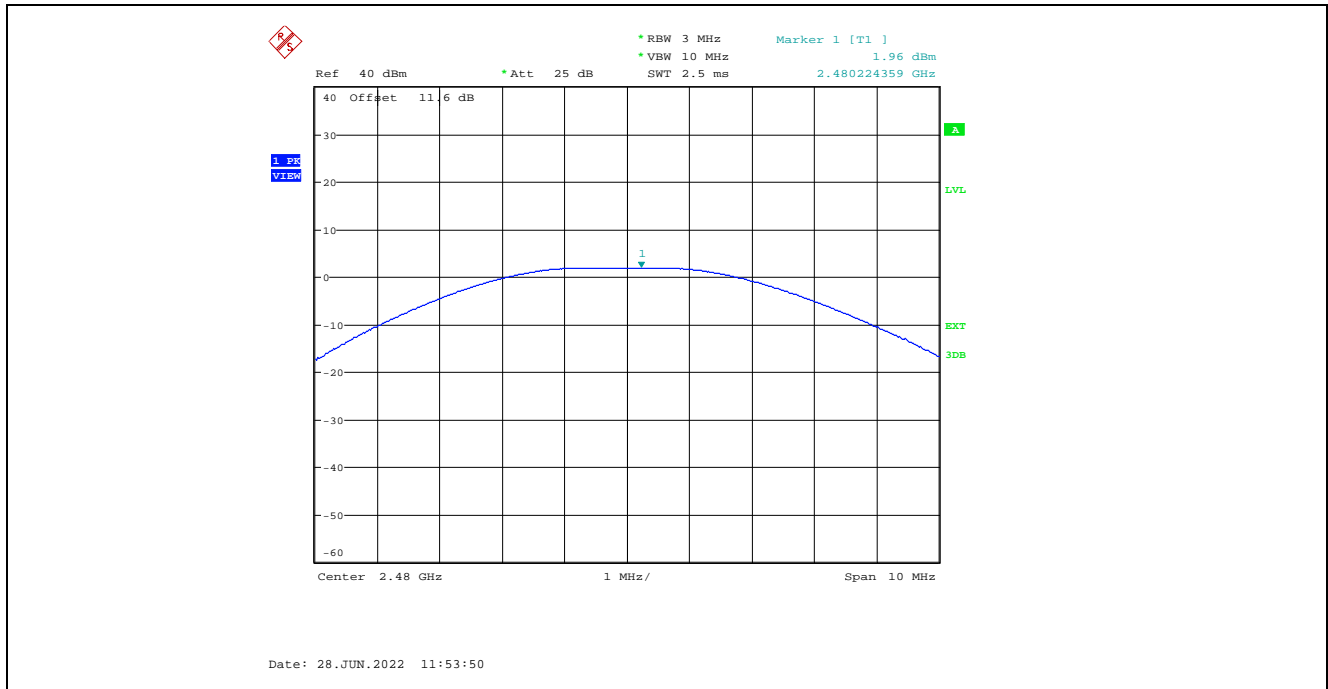

Plot 5.1.3.5. Maximum Peak Conducted Output Power, QPSK Modulation, -10 dBm Power Setting, 2405 MHz

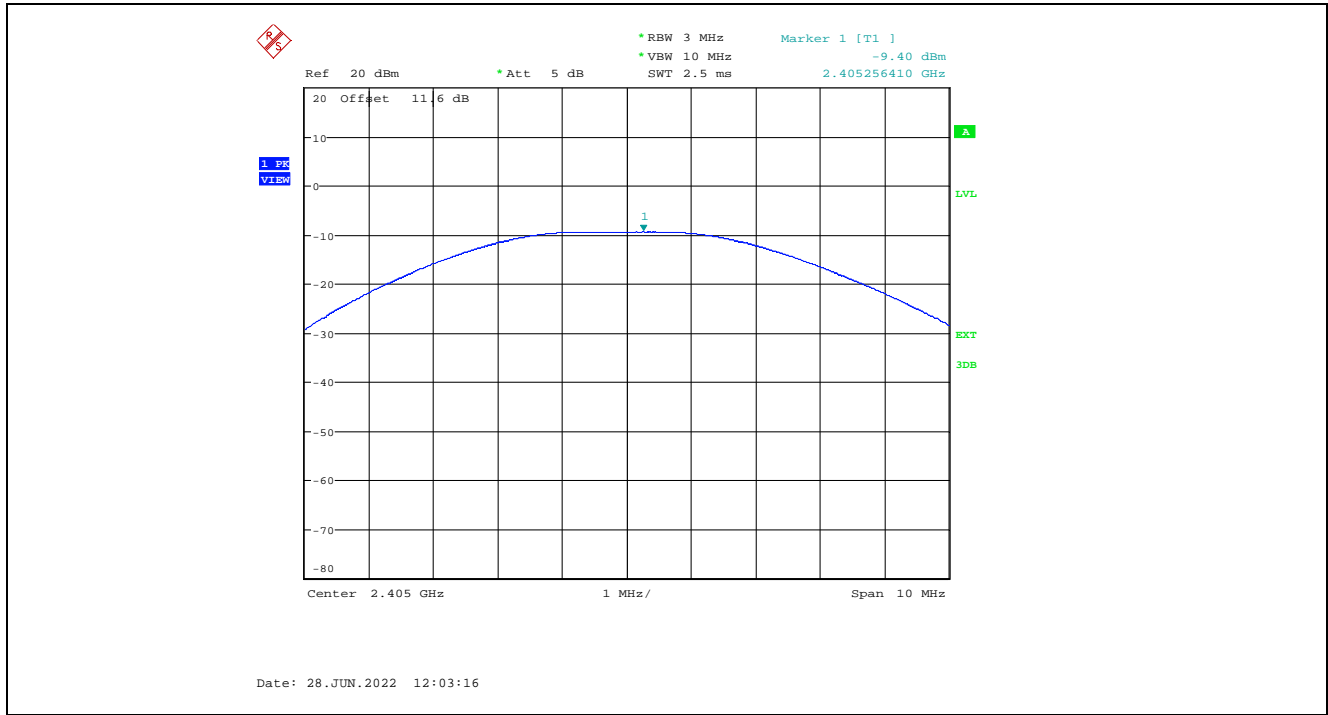

Plot 5.1.3.6. Maximum Peak Conducted Output Power, QPSK Modulation, -10 dBm Power Setting, 2440 MHz

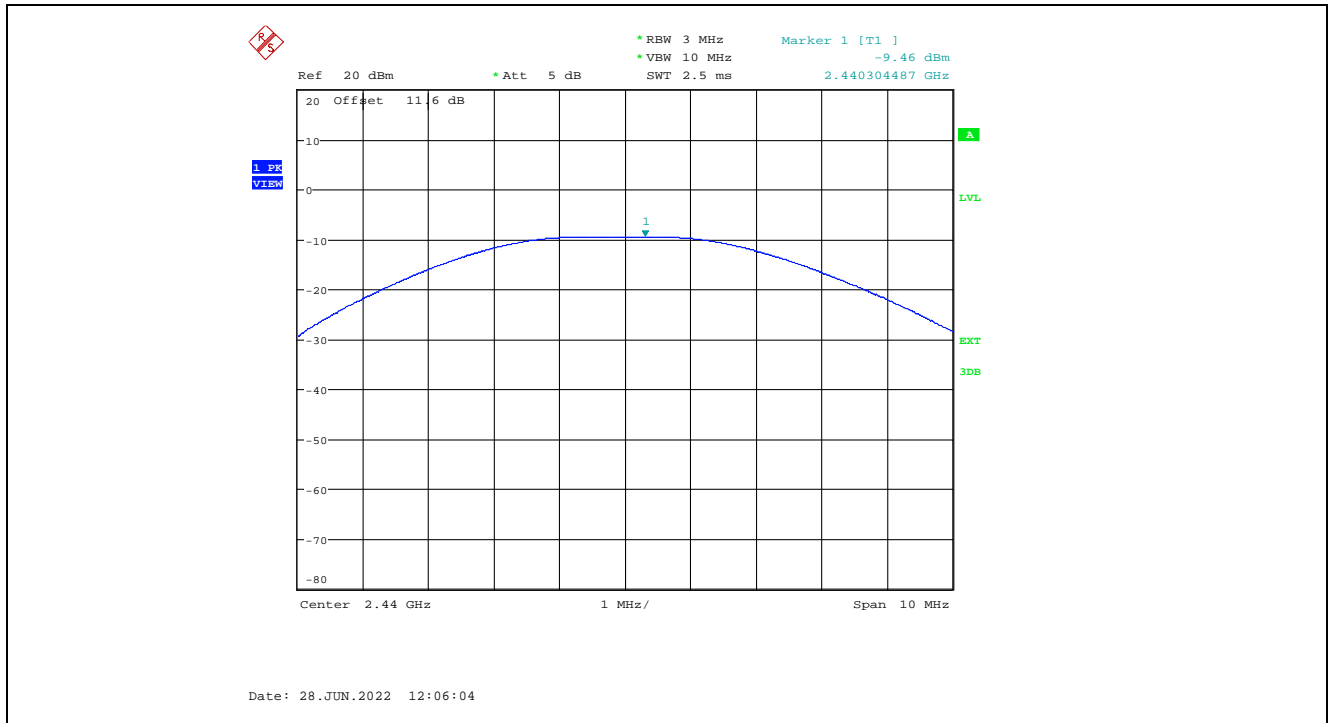

Plot 5.1.3.7. Maximum Peak Conducted Output Power, QPSK Modulation, -10 dBm Power Setting, 2475 MHz

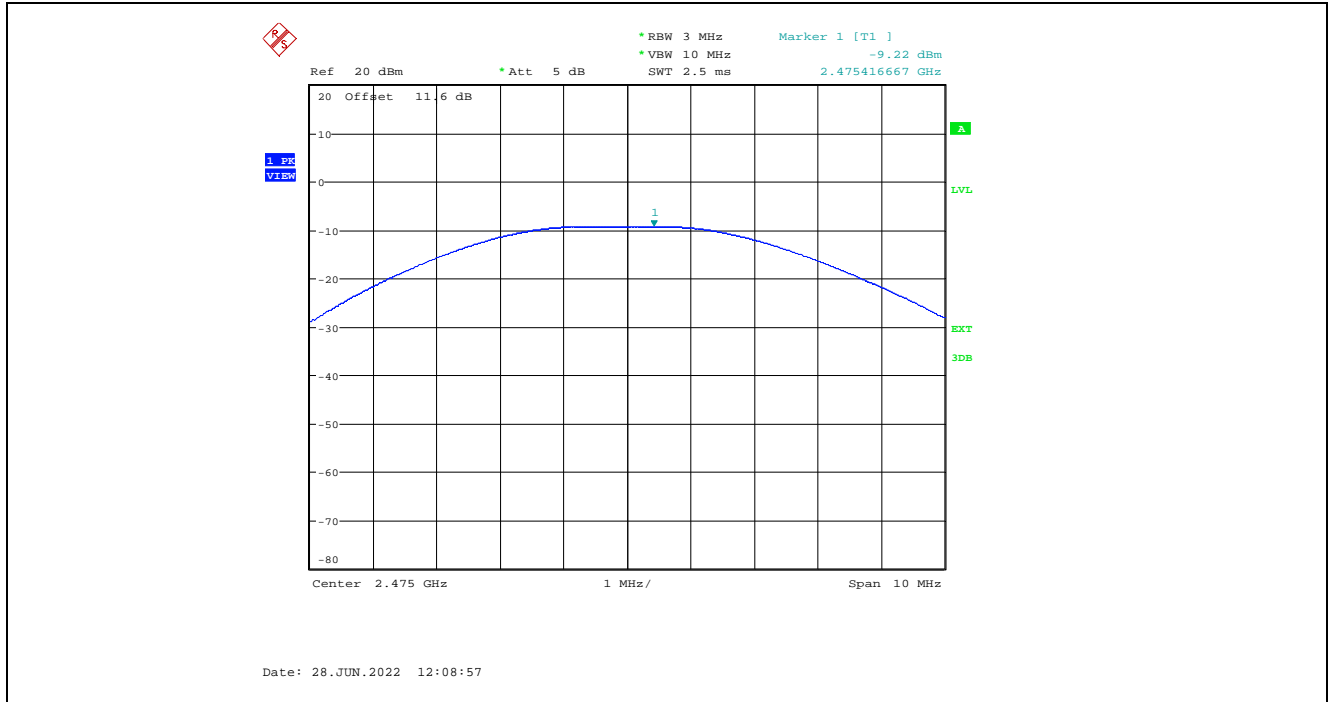

Plot 5.1.3.8. Maximum Peak Conducted Output Power, QPSK Modulation, -10 dBm Power Setting, 2480 MHz

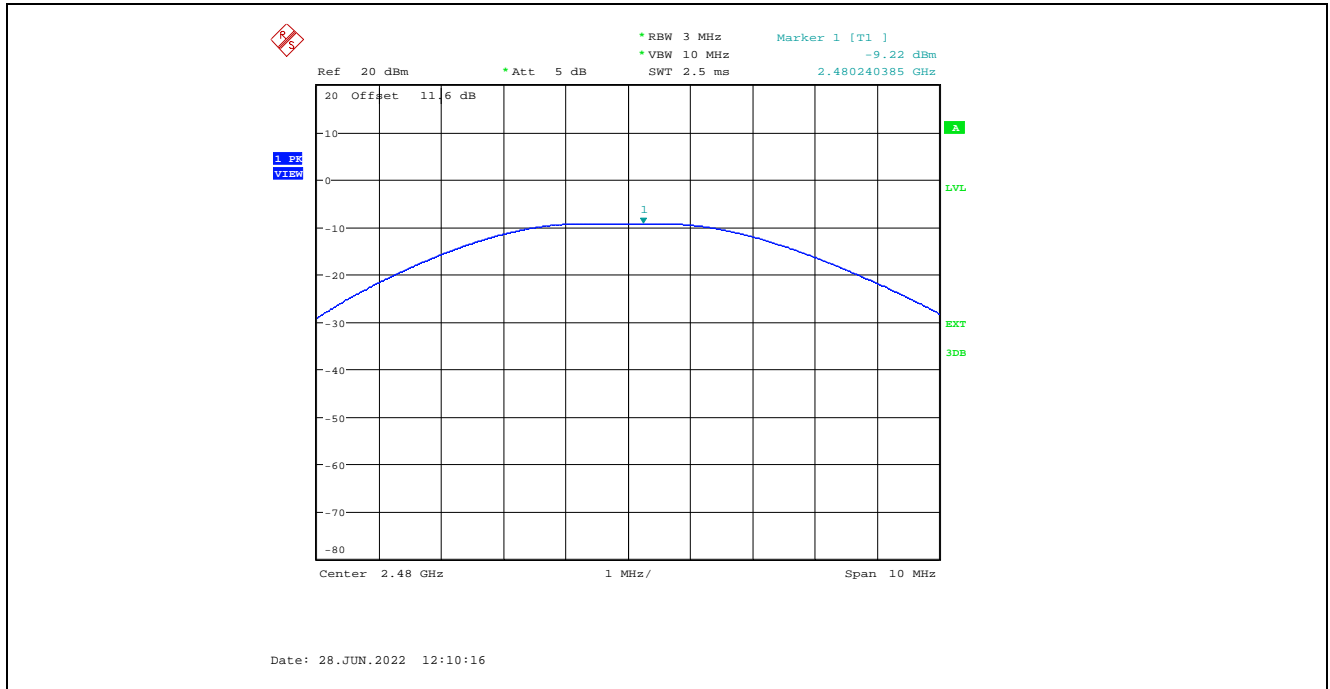

5.2. TRANSMITTER SPURIOUS RADIATED EMISSIONS AT 3 METERS [§§ 15.247(d), 15.209 & 15.205]

5.2.1. Limit(s)

§ 15.247 (d): In any 100 kHz bandwidth outside the frequency band in which the spread spectrum or digitally modulated intentional radiator is operating, the radio frequency power that is produced by the intentional radiator shall be at least 20 dB below that in the 100 kHz bandwidth within the band that contains the highest level of the desired power, based on either an RF conducted or a radiated measurement, provided the transmitter demonstrates compliance with the peak conducted power limits. If the transmitter complies with the conducted power limits based on the use of RMS averaging over a time interval, as permitted under paragraph (b)(3) of this section, the attenuation required under this paragraph shall be 30 dB instead of 20 dB. Attenuation below the general limits specified in Section 15.209(a) is not required. In addition, radiated emissions which fall in the restricted bands, as defined in Section 15.205(a), must also comply with the radiated emission limits specified in Section 15.209(a) (see Section 15.205(c)).

Section 15.205(a) - Restricted Bands of Operation

MHz	MHz	MHz	GHz
0.090–0.110	16.42–16.423	399.9–410	4.5–5.15
10.495–0.505	16.69475–16.69525	608–614	5.35–5.46
2.1735–2.1905	16.80425–16.80475	960–1240	7.25–7.75
4.125–4.128	25.5–25.67	1300–1427	8.025–8.5
4.17725–4.17775	37.5–38.25	1435–1626.5	9.0–9.2
4.20725–4.20775	73–74.6	1645.5–1646.5	9.3–9.5
6.215–6.218	74.8–75.2	1660–1710	10.6–12.7
6.26775–6.26825	108–121.94	1718.8–1722.2	13.25–13.4
6.31175–6.31225	123–138	2200–2300	14.47–14.5
8.291–8.294	149.9–150.05	2310–2390	15.35–16.2
8.362–8.366	156.52475–156.52525	2483.5–2500	17.7–21.4
8.37625–8.38675	156.7–156.9	2655–2900	22.01–23.12
8.41425–8.41475	162.0125–167.17	3260–3267	23.6–24.0
12.29–12.293	167.72–173.2	3332–3339	31.2–31.8
12.51975–12.52025	240–285	3345.8–3358	36.43–36.5
12.57675–12.57725	322–335.4	3600–4400	(²)
13.36–13.41.			

¹Until February 1, 1999, this restricted band shall be 0.490–0.510 MHz.

²Above 38.6

Section 15.209(a) - Field Strength Limits within Restricted Frequency Bands

Frequency (MHz)	Field Strength (microvolts/meter)	Measurement Distance (meters)
0.009 - 0.490	2,400 / F (kHz)	300
0.490 - 1.705	24,000 / F (kHz)	30
1.705 - 30.0	30	30
30 - 88	100	3
88 - 216	150	3
216 - 960	200	3
Above 960	500	3

5.2.2. Method of Measurements

KDB 558074 D01 DTS Meas Guidance v05r02 Sections 8.5 and 8.6 and ANSI C63.10.

5.2.3. Test Data

Remark(s):

- All spurious emissions that are in excess of 20 dB below the specified limit shall be recorded.
- EUT shall be tested in three orthogonal positions.
- The following test data represent the worst-case derived from exploratory tests.

5.2.3.1. EUT with 0 dBi Chip Antenna

5.2.3.1.1. Spurious Radiated Emission

Power Setting:		20 dBm					
Fundamental Frequency:		2405 MHz					
Test Frequency Range:		30 MHz – 25 GHz					
Frequency (MHz)	RF Peak Level (dBµV/m)	RF Avg Level (dBµV/m)	Antenna Plane (H/V)	Limit 15.209 (dBµV/m)	Limit 15.247 (dBµV/m)	Margin (dB)	Pass/Fail
2405.0	114.63	--	V	--	--	--	--
2405.0	114.82	--	H	--	--	--	--
4810.0	56.33	45.30	V	54.0	94.6	-8.70	Pass*
4810.0	54.33	41.43	H	54.0	94.6	-12.57	Pass*
All other spurious emissions and harmonics are more than 20 dB below the applicable limit.							

*Field strength of emissions appearing within restricted frequency bands shall not exceed the limits in § 15.209.

Power Setting:		20 dBm					
Fundamental Frequency:		2440 MHz					
Test Frequency Range:		30 MHz – 25 GHz					
Frequency (MHz)	RF Peak Level (dBµV/m)	RF Avg Level (dBµV/m)	Antenna Plane (H/V)	Limit 15.209 (dBµV/m)	Limit 15.247 (dBµV/m)	Margin (dB)	Pass/Fail
2440.0	113.31	--	V	--	--	--	--
2440.0	112.75	--	H	--	--	--	--
4880.0	55.50	44.41	V	54.0	92.7	-9.59	Pass*
4880.0	53.58	42.11	H	54.0	92.7	-11.89	Pass*
7320.0	58.73	46.03	V	54.0	92.7	-7.97	Pass*
7320.0	61.37	49.23	H	54.0	92.7	-4.77	Pass*
All other spurious emissions and harmonics are more than 20 dB below the applicable limit.							

*Field strength of emissions appearing within restricted frequency bands shall not exceed the limits in § 15.209.

Power Setting:		20 dBm					
Fundamental Frequency:		2475 MHz					
Test Frequency Range:		30 MHz – 25 GHz					
Frequency (MHz)	RF Peak Level (dBµV/m)	RF Avg Level (dBµV/m)	Antenna Plane (H/V)	Limit 15.209 (dBµV/m)	Limit 15.247 (dBµV/m)	Margin (dB)	Pass/Fail
2475.0	113.03	--	V	--	--	--	--
2475.0	111.70	--	H	--	--	--	--
4950.0	56.44	45.66	V	54.0	91.7	-8.34	Pass*
4950.0	54.08	42.59	H	54.0	91.7	-11.41	Pass*
7425.0	60.04	47.81	V	54.0	91.7	-6.19	Pass*
7425.0	60.72	48.57	H	54.0	91.7	-5.43	Pass*
All other spurious emissions and harmonics are more than 20 dB below the applicable limit.							

*Field strength of emissions appearing within restricted frequency bands shall not exceed the limits in § 15.209.

Power Setting:		3 dBm					
Fundamental Frequency:		2480 MHz					
Test Frequency Range:		30 MHz – 25 GHz					
Frequency (MHz)	RF Peak Level (dBµV/m)	RF Avg Level (dBµV/m)	Antenna Plane (H/V)	Limit 15.209 (dBµV/m)	Limit 15.247 (dBµV/m)	Margin (dB)	Pass/Fail
2480.0	94.37	--	V	--	--	--	--
2480.0	95.70	--	H	--	--	--	--
4960.0	51.48	39.56	V	54.0	74.3	-14.44	Pass*
4960.0	49.73	37.52	H	54.0	74.3	-16.48	Pass*
7440.0	52.72	41.35	V	54.0	74.3	-12.65	Pass*
7440.0	52.46	40.64	H	54.0	74.3	-13.36	Pass*
All other spurious emissions and harmonics are more than 20 dB below the applicable limit.							

*Field strength of emissions appearing within restricted frequency bands shall not exceed the limits in § 15.209.

5.2.3.1.2. Band-Edge RF Radiated Emission

Plot 5.2.3.1.2.1. Band-Edge RF Radiated Emissions at 3 m, Horizontal Polarization, Peak Low End of Frequency Band, 2405 MHz, 20 dBm Power Setting

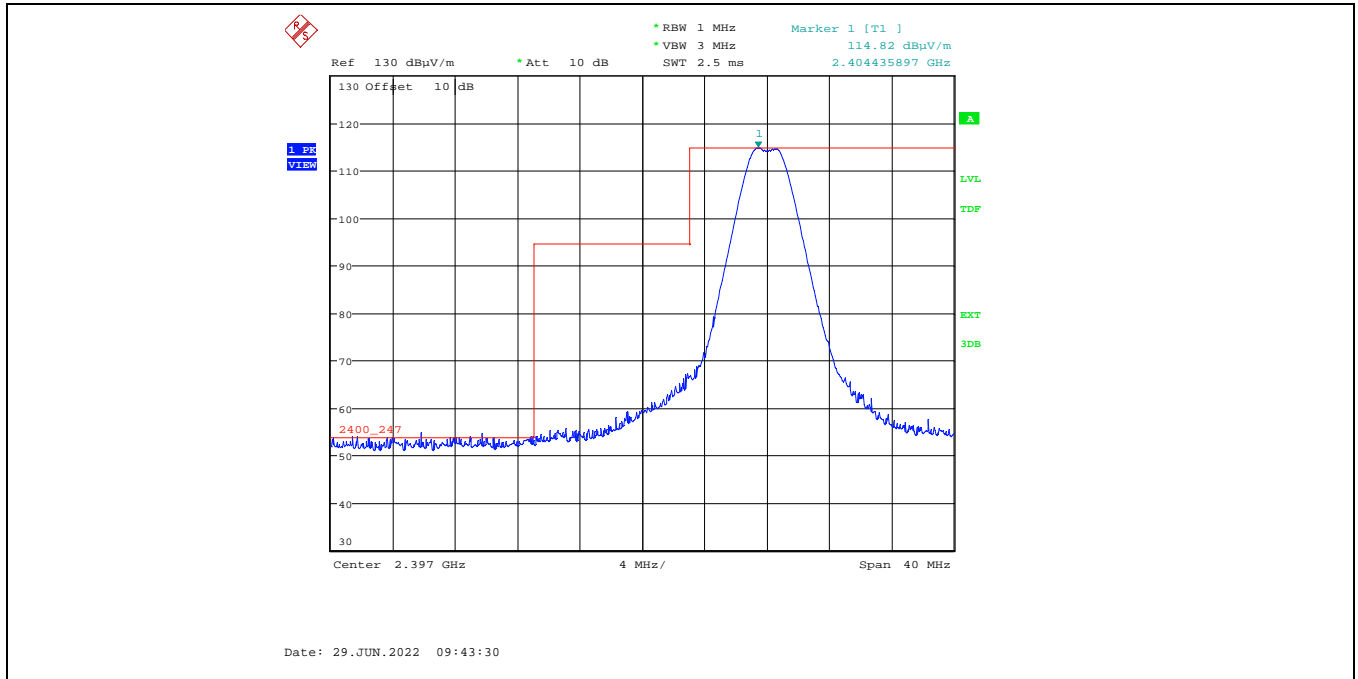

Plot 5.2.3.1.2.2. Band-Edge RF Radiated Emissions at 3 m, Horizontal Polarization, Average Low End of Frequency Band, 2405 MHz, 20 dBm Power Setting

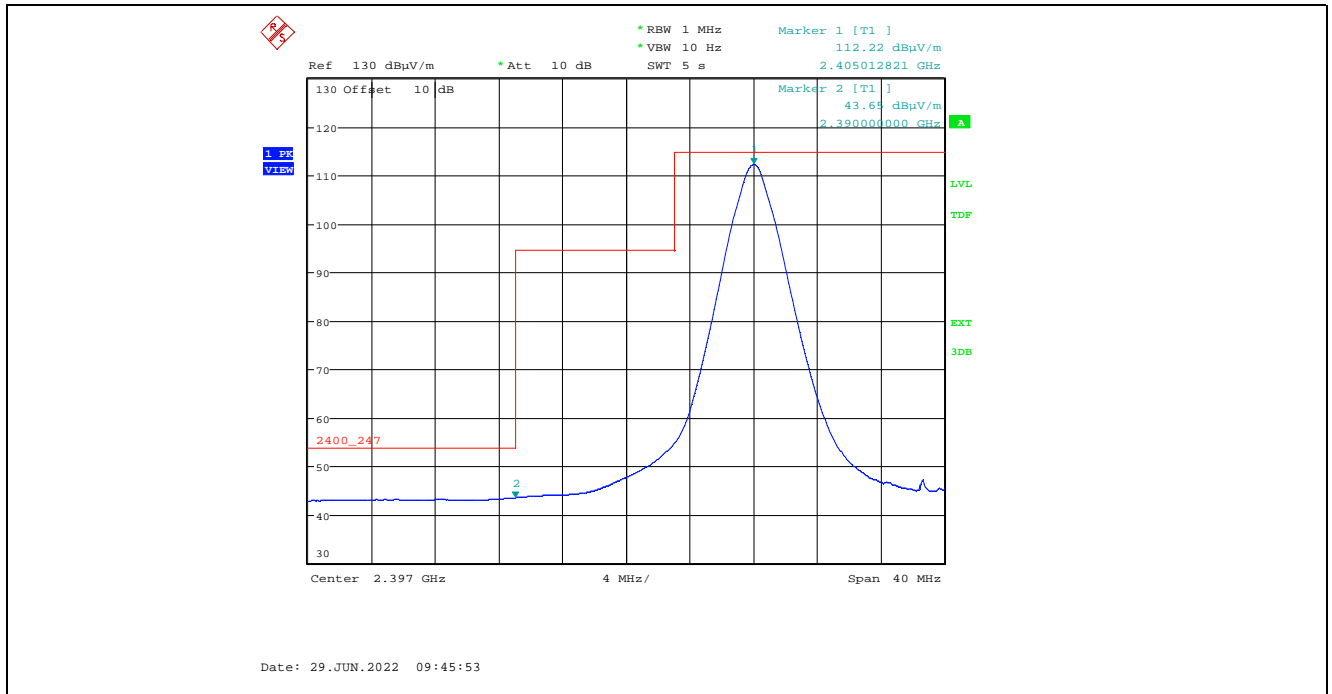

Plot 5.2.3.1.2.3. Band-Edge RF Radiated Emissions at 3 m, Vertical Polarization, Peak
Low End of Frequency Band, 2405 MHz, 20 dBm Power Setting

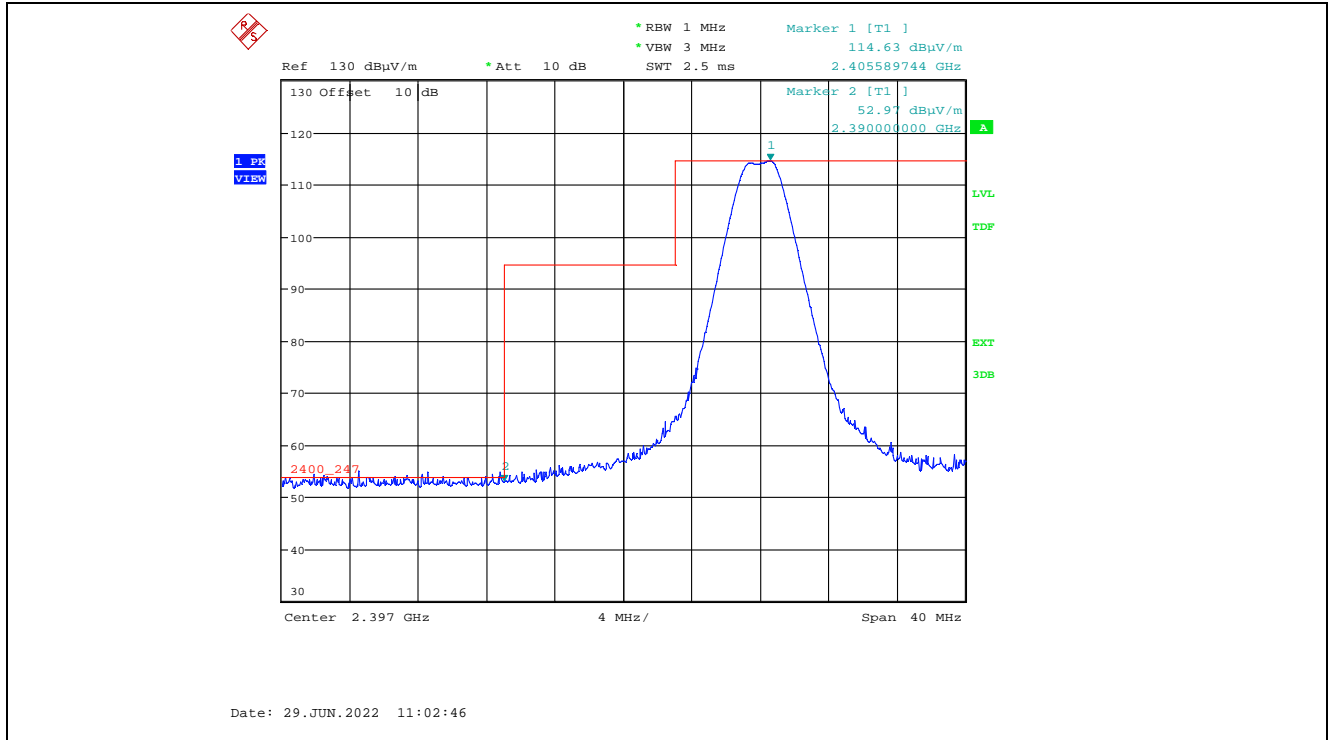

Plot 5.2.3.1.2.4. Band-Edge RF Radiated Emissions at 3 m, Vertical Polarization, Average
Low End of Frequency Band, 2405 MHz, 20 dBm Power Setting

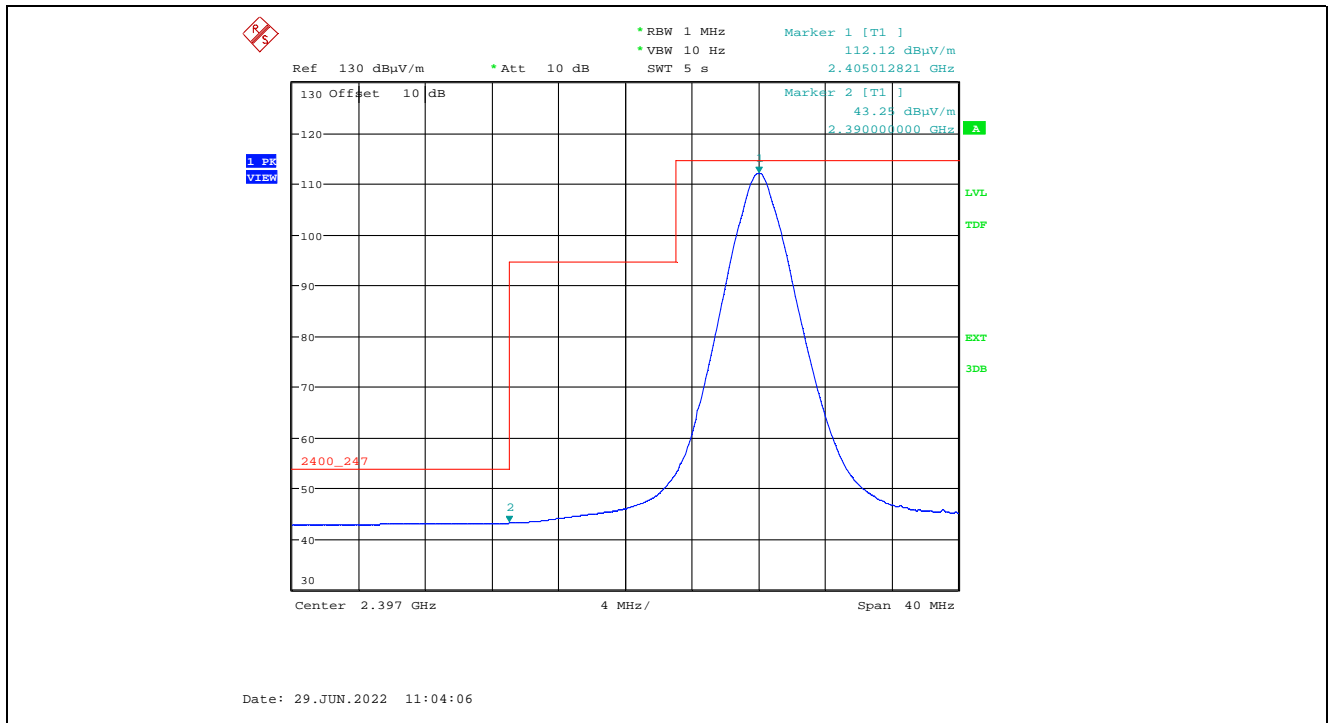

Plot 5.2.3.1.2.5. Band-Edge RF Radiated Emissions at 3 m, Horizontal Polarization, Peak
 High End of Frequency Band, 2475 MHz, 20 dBm Power Setting

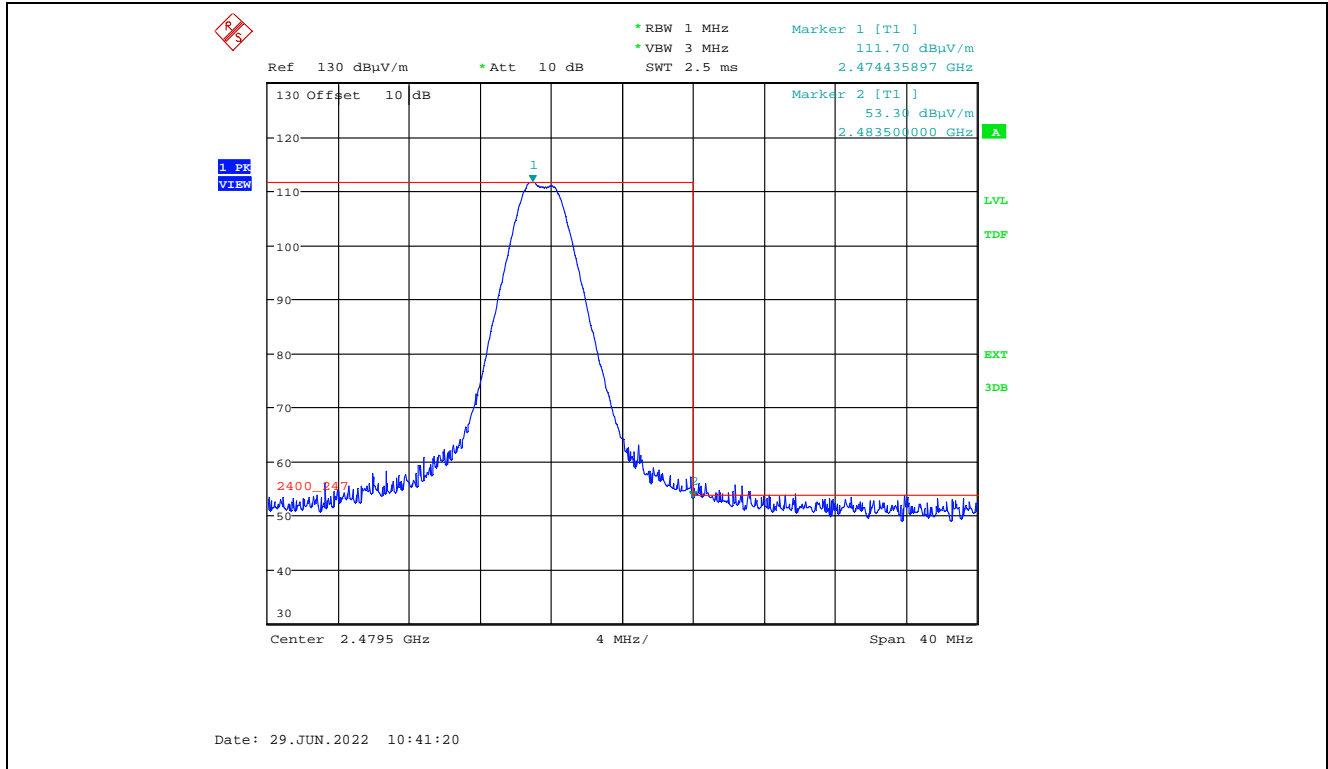

Plot 5.2.3.1.2.6. Band-Edge RF Radiated Emissions at 3 m, Horizontal Polarization, Average
 High End of Frequency Band, 2475 MHz, 20 dBm Power Setting

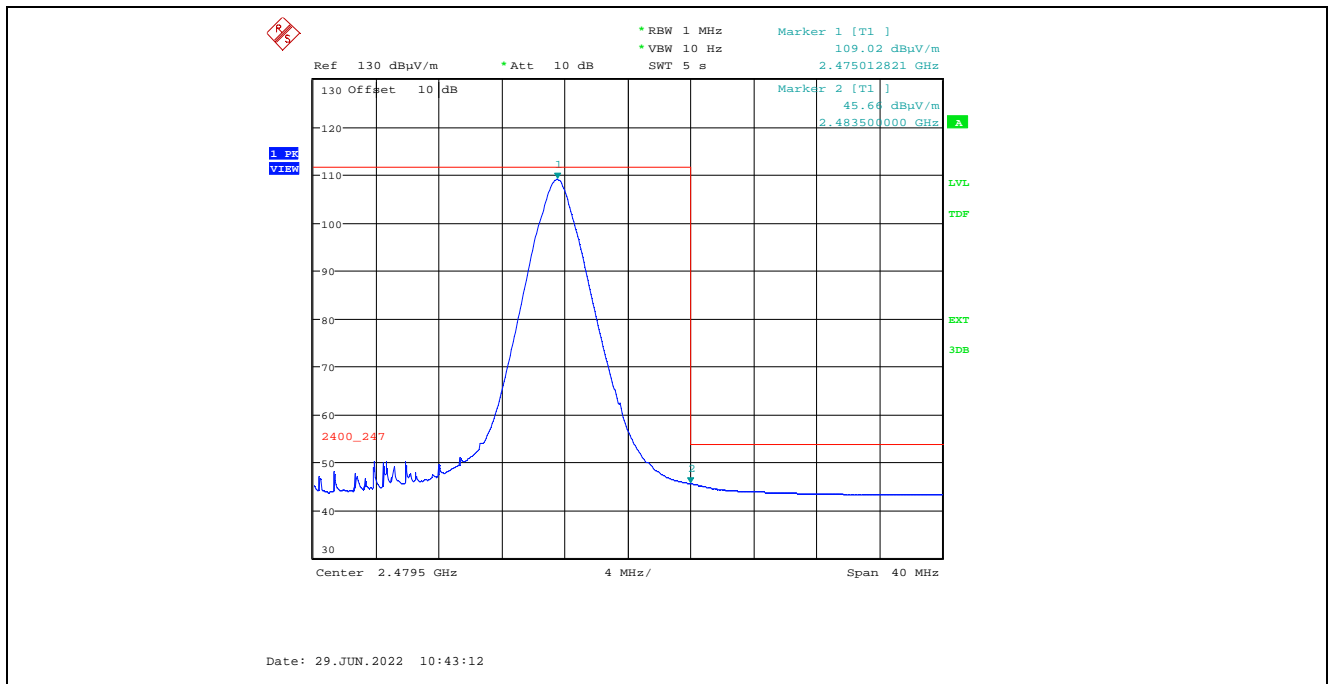

Plot 5.2.3.1.2.7. Band-Edge RF Radiated Emissions at 3 m, Vertical Polarization, Peak
 High End of Frequency Band, 2475 MHz, 20 dBm Power Setting

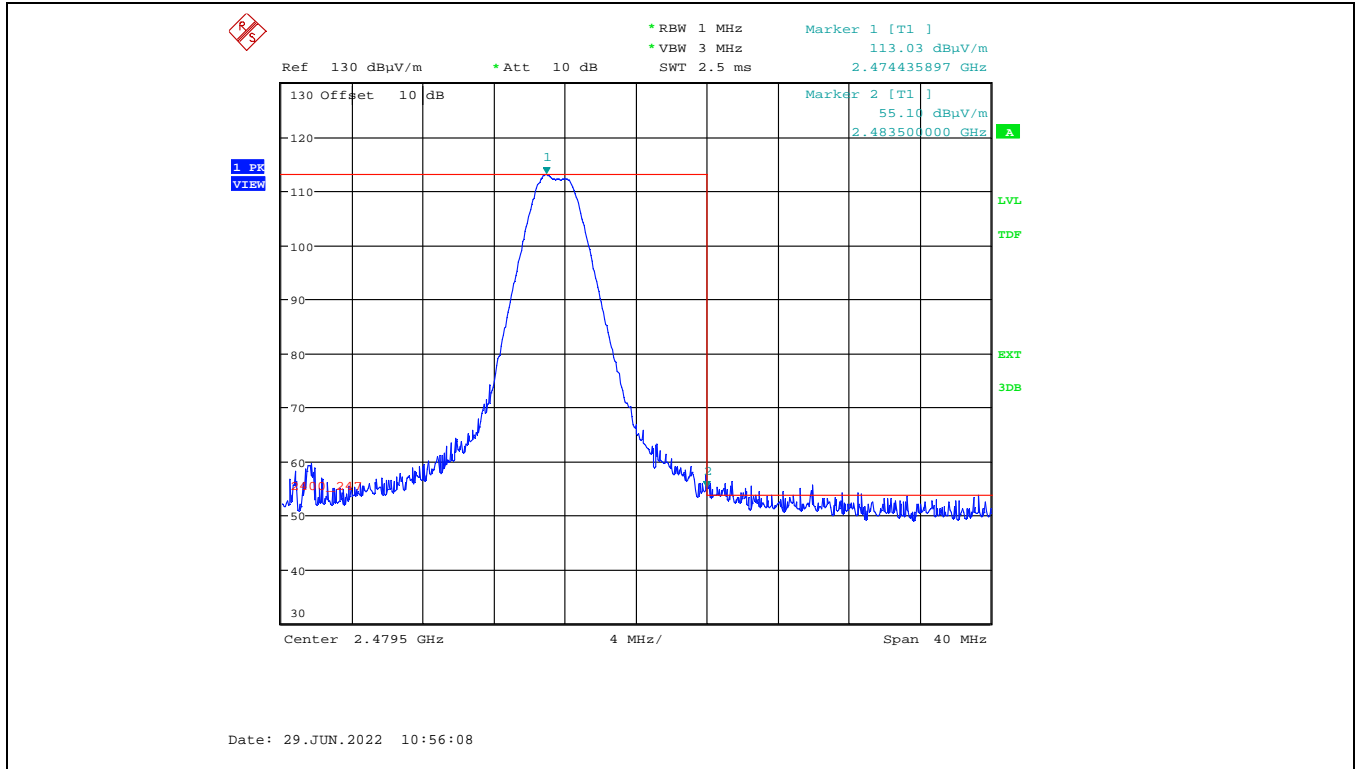

Plot 5.2.3.1.2.8. Band-Edge RF Radiated Emissions at 3 m, Vertical Polarization, Average
 High End of Frequency Band, 2475 MHz, 20 dBm Power Setting

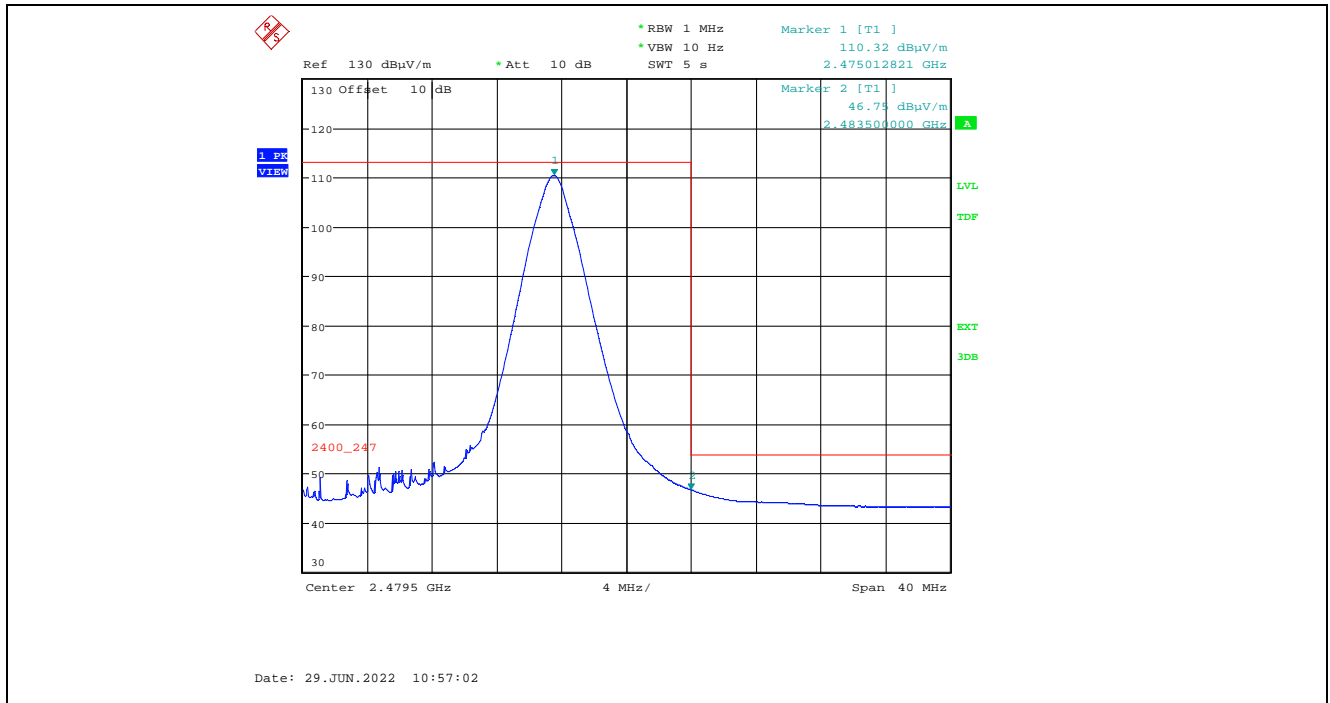

Plot 5.2.3.1.2.9. Band-Edge RF Radiated Emissions at 3 m, Horizontal Polarization, Peak
 High End of Frequency Band, 2480 MHz, 3 dBm Power Setting

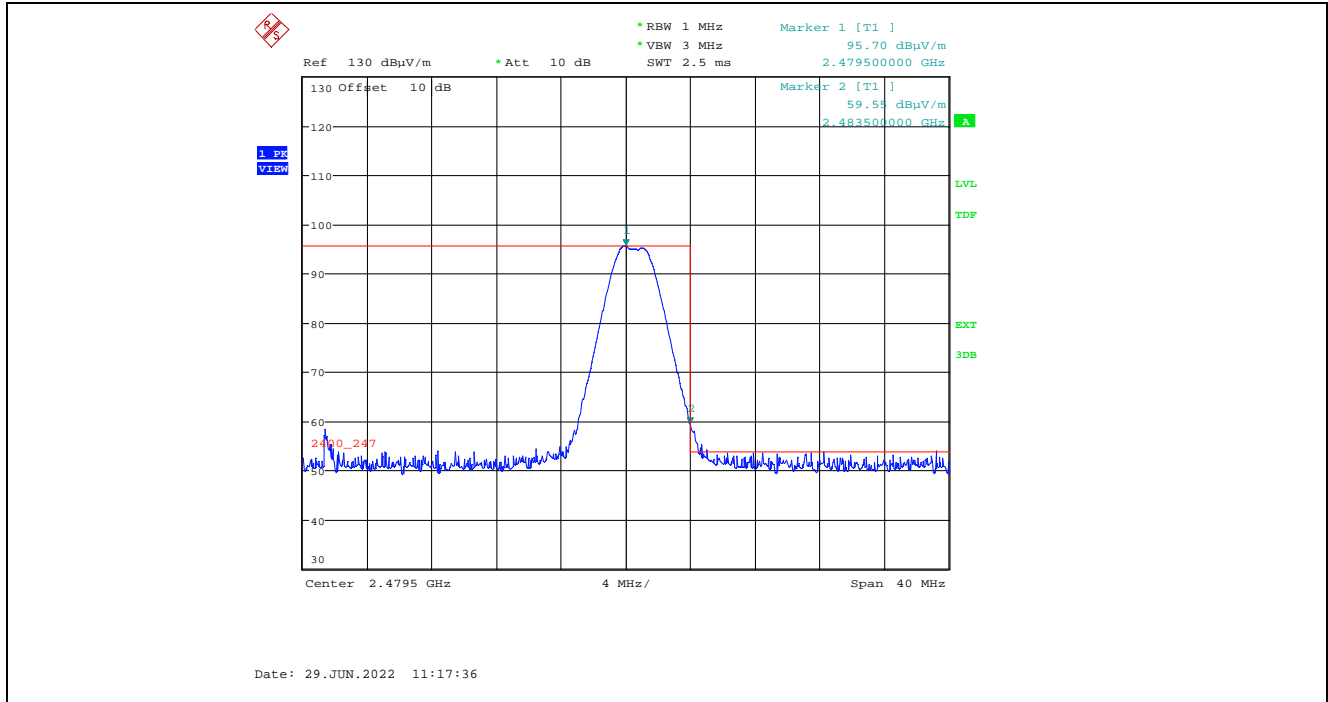

Plot 5.2.3.1.2.10. Band-Edge RF Radiated Emissions at 3 m, Horizontal Polarization, Average
 High End of Frequency Band, 2480 MHz, 3 dBm Power Setting

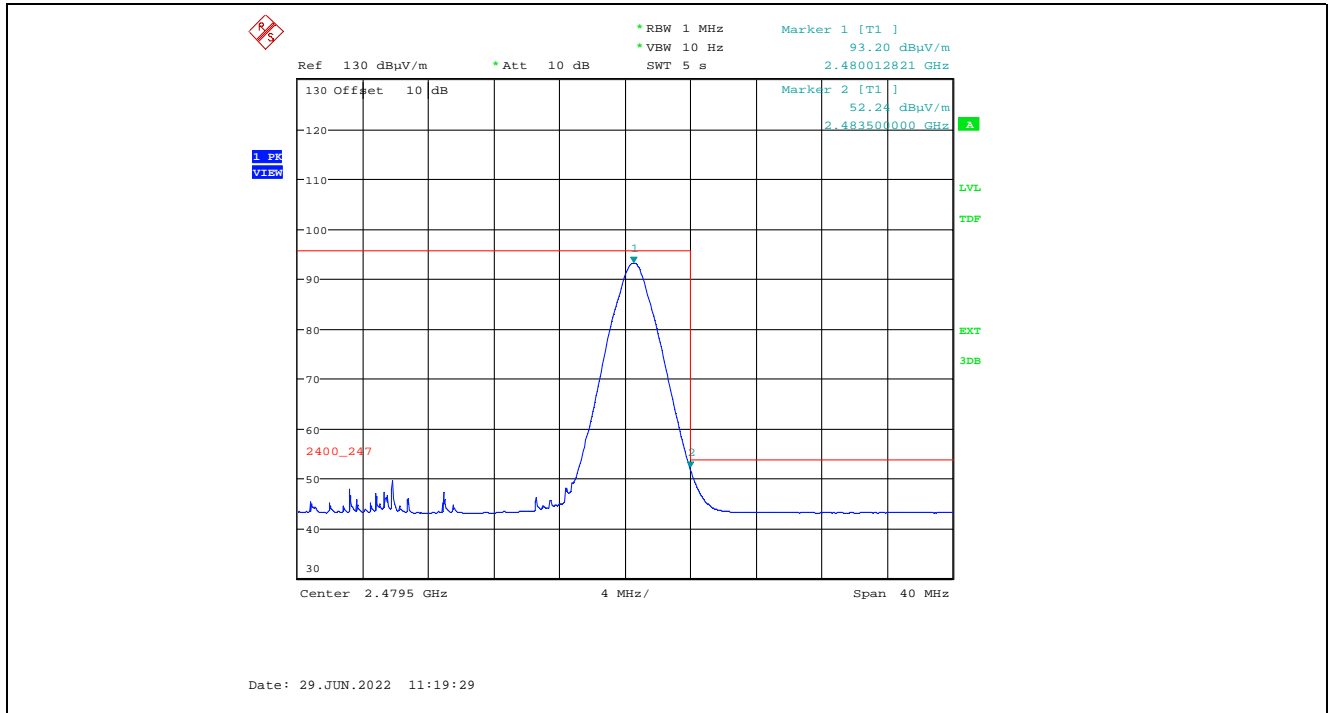

Plot 5.2.3.1.2.11. Band-Edge RF Radiated Emissions at 3 m, Vertical Polarization, Peak
 High End of Frequency Band, 2480 MHz, 3 dBm Power Setting

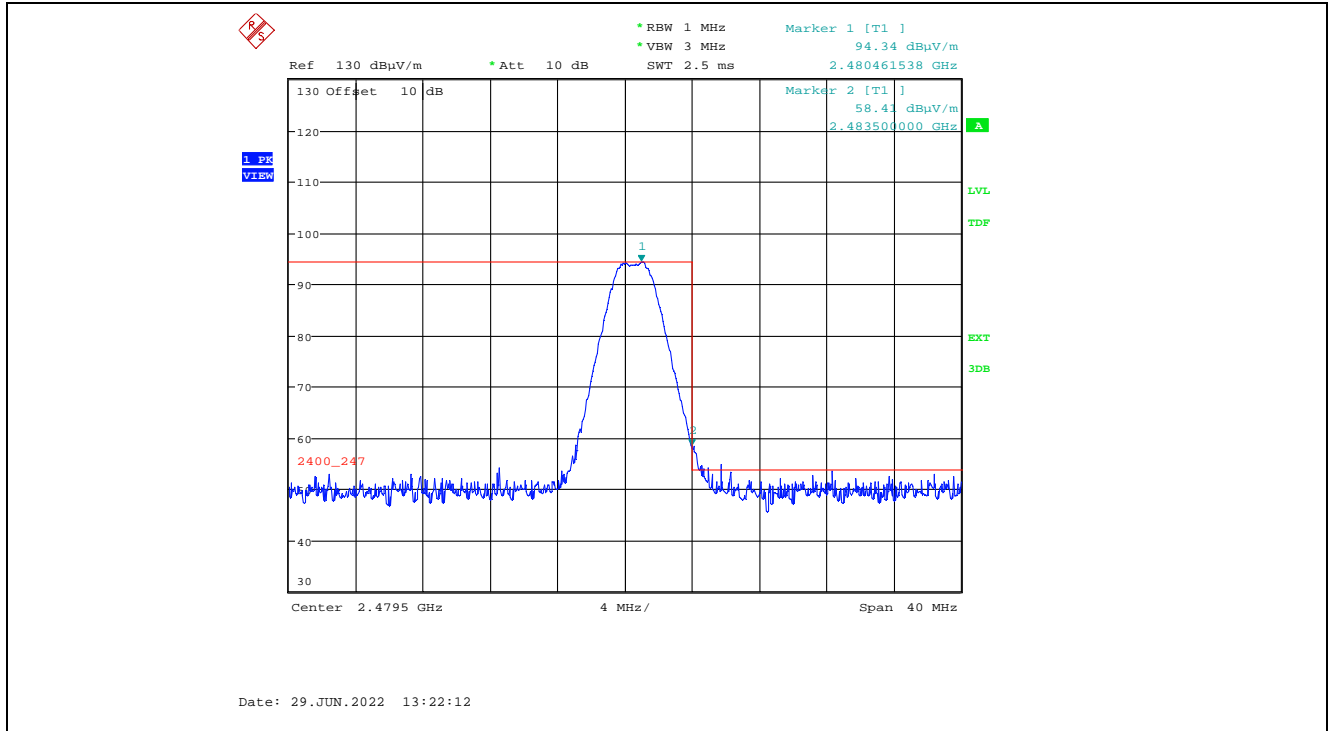

Plot 5.2.3.1.2.12. Band-Edge RF Radiated Emissions at 3 m, Vertical Polarization, Average
 High End of Frequency Band, 2480 MHz, 3 dBm Power Setting

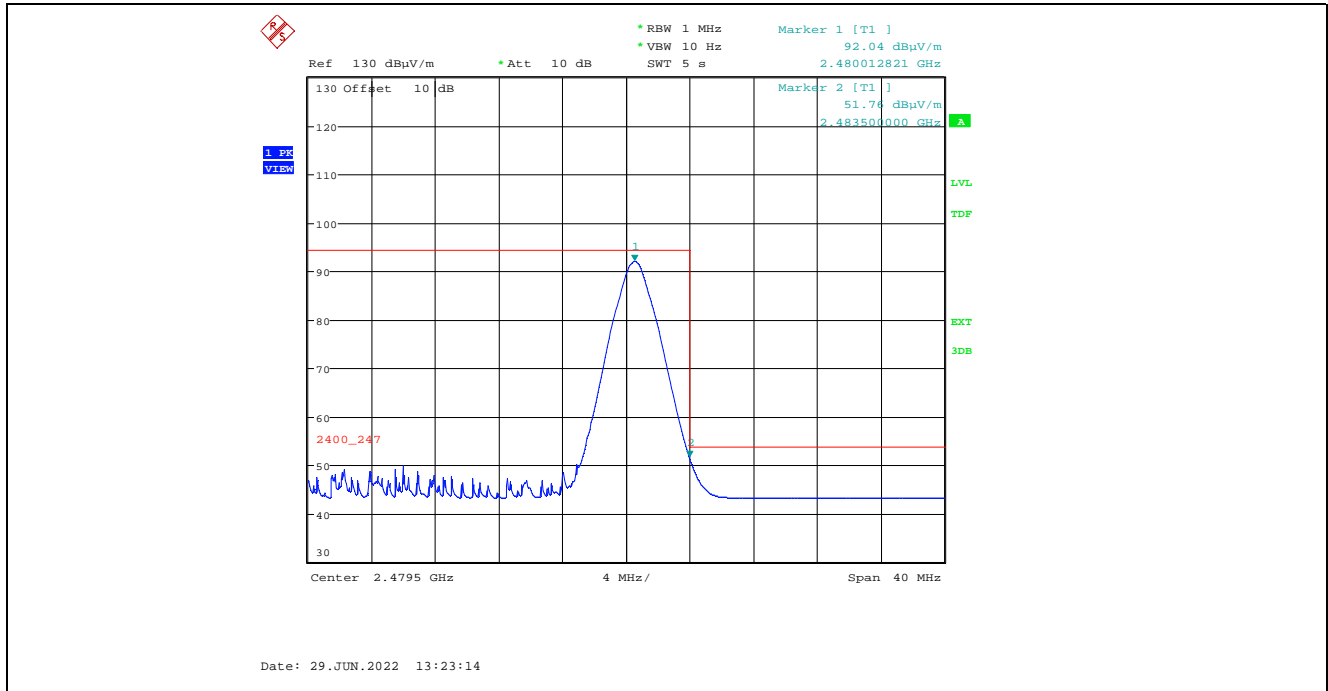
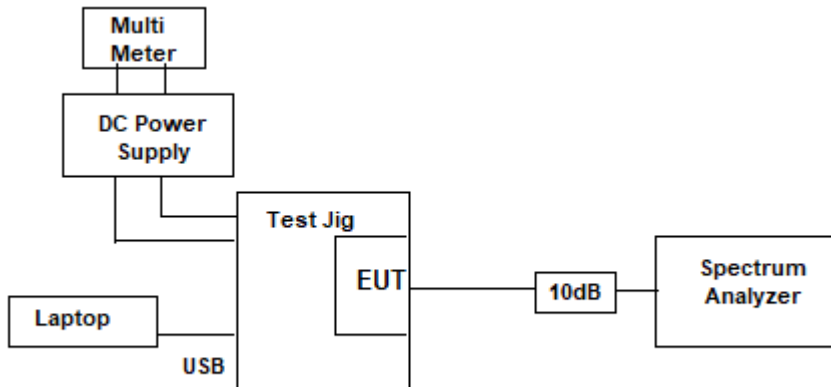

EXHIBIT 6. TEST EQUIPMENT LIST AND SETUP

6.1. FCC 15.247 (b) (3), RSS-247 5.4 (4) POP

6.1.1. Block Diagram



6.1.2. Test Equipment List

Test Instruments	Manufacturer	Model No.	Serial No.	Frequency Range	Calibration Due Date
Spectrum Analyzer	Rohde & Schwarz	FSU26	100398	20Hz–26.5 GHz	20 Sep 2023
Attenuator	Hewlett Packard	8493C	0461	DC–26.5 GHz	Cal before use
DC Power Supply	Tenma	72-6153	--	1-18 Vdc	--
Multi-meter	Fluke	8842A	4142058	20mV - 1kV	01 Oct 2022

6.1.3. Accessories for test

Laptop: Make: Lenovo, M/N: 0578
 Test Software: Version 6.5.9

6.2. FCC 15.247 (d), RSS-247 5.5 Band-Edge Radiated Emissions

6.2.1. Block Diagram

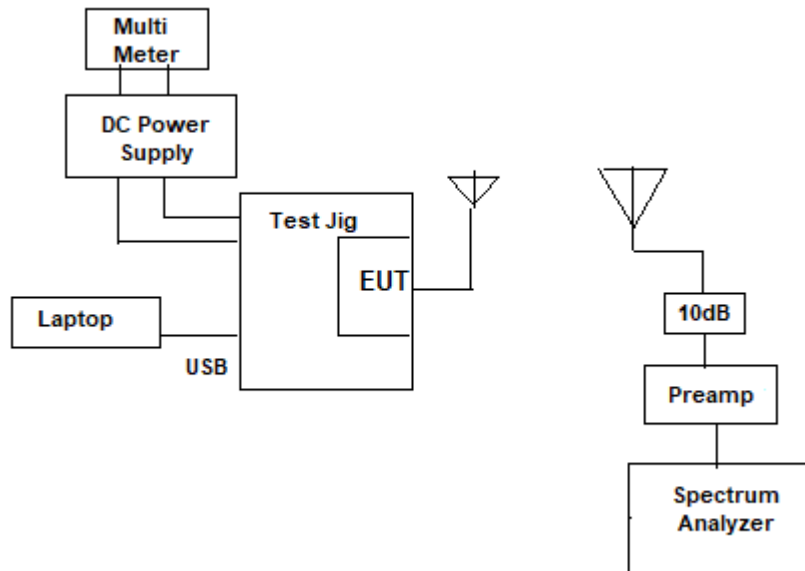

6.2.2. Test Equipment List

Test Instruments	Manufacturer	Model No.	Serial No.	Frequency Range	Calibration Due Date
Spectrum Analyzer	Rohde & Schwarz	FSU26	100398	20Hz–26.5 GHz	20 Sep 2023
Attenuator	Hewlett Packard	8493C	0461	DC–26.5 GHz	Cal before use
Horn Antenna	ETS	3117	00119425	1-18GHz	20 Jan 2024
Preamp	Com-Power	PAM-118A	551016	500MHz-18GHz	04 Mar 2023
DC Power Supply	Tenma	72-6153	--	1-18 Vdc	--
Multi-meter	Fluke	8842A	4142058	20mV - 1kV	01 Oct 2022

6.2.3. Accessories for test

Laptop: Make: Lenovo, M/N: 0578
 Test Software: Version 6.5.9

6.3. FCC 15.247 (d), RSS-247 5.5 Tx Radiated Emissions

6.3.1. Block Diagram

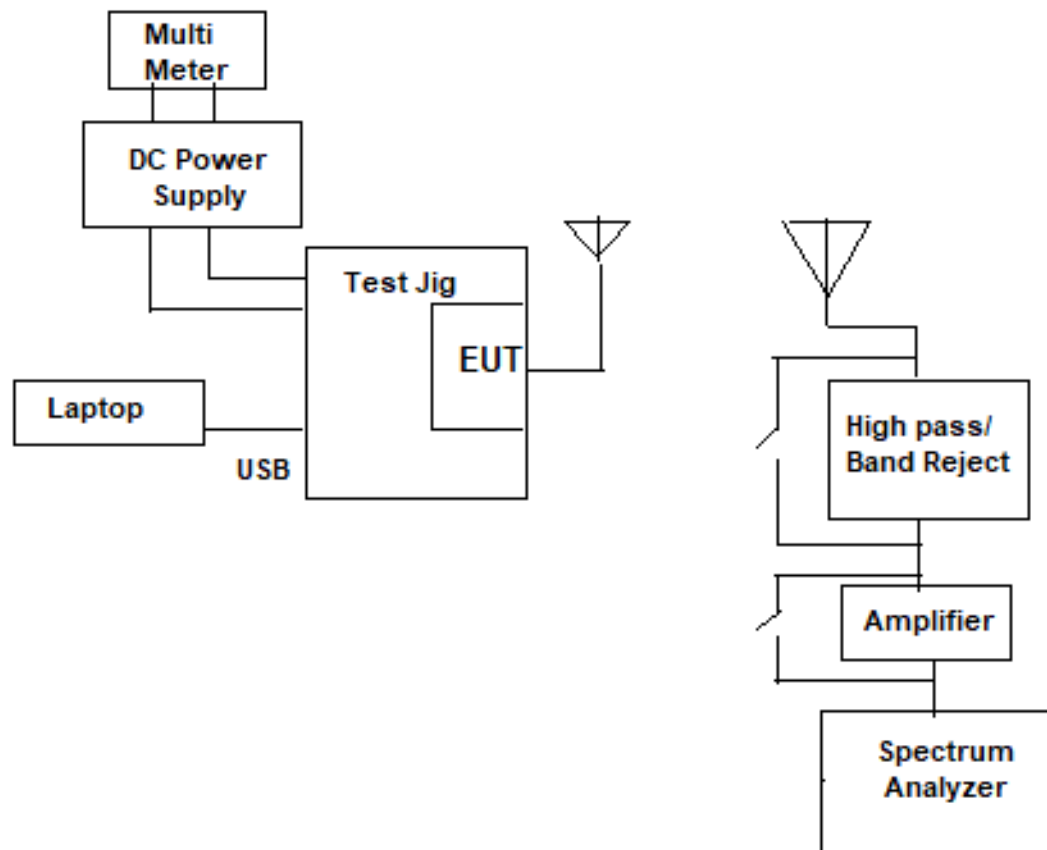

6.3.2. Test Equipment List

Test Instruments	Manufacturer	Model No.	Serial No.	Frequency Range	Calibration Due Date
Spectrum Analyzer	Rohde & Schwarz	FSU26	100398	20Hz–26.5 GHz	20 Sep 2023
EMI Receiver	Rohde & Schwarz	ESU40	100037	20Hz–40 GHz	01 Sep 2022
Biconilog Antenna	EMCO	3142C	00026873	26-2000MHz	16 Dec 2023
Horn Antenna	ETS	3115	5955	1-18GHz	12 Oct 2022
Horn Antenna	ETS	3117	00119425	1-18GHz	20 Jan 2024
Horn Antenna	ETS	3160-09	00118385	18-26GHz	22 Jan 2023
Preamp	Com-Power	PAM-118A	551016	500MHz-18GHz	04 Mar 2023
Preamp	Com-Power	PAM-840A	18050002	18-40GHz	28 Sep 2022
Band Reject Filter	Microtronics	BRM50701	105	Cut off 2.170-3 GHz	Cal before use
High Pass Filter	K & L	11SH-10-4000/T 12000	4	Cut off 2.4GHz	Cal before use
DC Power Supply	Tenma	72-6153	--	1-18 Vdc	--
Multi-meter	Fluke	8842A	4142058	20mV - 1kV	01 Oct 2022

6.3.3. Accessories for test

Laptop: Make: Lenovo, M/N: 0578
 Test Software: Version 6.5.9

EXHIBIT 7. MEASUREMENT UNCERTAINTY

The measurement uncertainties stated were calculated in accordance with the requirements of CISPR 16-4-2 @ IEC:2003 and JCGM 100:2008 (GUM 1995) – Guide to the Expression of Uncertainty in Measurement.

Test Description	Expanded Uncertainty, K=2 for 95% Confidence Level
Power Line Conducted Emissions	± 2.62
Conducted Output Power	± 0.62 dB
Power Spectral Density	± 0.20 Hz / ± 0.63 dB
Occupied Bandwidth	± 0.20 Hz / ± 0.63 dB
Transmitter Spurious Radiated Emissions	± 4.20 dB (30 MHz – 1 GHz)
	± 2.70 dB (1 – 18 GHz)