

# ENGINEERING TEST REPORT

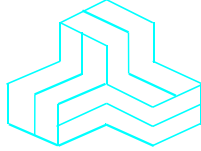

## **XBee PRO Series 2 OEM RF Module Model No.: XBEEPRO2**

**FCC ID: MCQ-XBEEPRO2**

*Applicant:*

**Digi International Inc.**  
11001 Bren Road East  
Minnetonka, MN 55343

*In Accordance With*

**Federal Communications Commission (FCC)  
Part 15, Subpart C, Section 15.247  
Digital Modulation Systems (DTS) Operating in 2400 – 2483.5 MHz Band**

**UltraTech's File No.: DIGI-003F15C247**

This Test report is Issued under the Authority  
of  
Tri M. Luu, Professional Engineer,  
Vice President of Engineering  
UltraTech Group of Labs



Date: November 6, 2007

Report Prepared by: Dan Huynh

Tested by: Mr. Hung Trinh, EMI/RFI Technician

Issued Date: November 6, 2007

Test Dates: September 28, 2007  
October 5 & 12, 2007  
November 5-6, 2007

*The results in this Test Report apply only to the sample(s) tested, and the sample tested is randomly selected.  
This report must not be used by the client to claim product endorsement by NVLAP or any agency of the US Government.*

## UltraTech

3000 Bristol Circle, Oakville, Ontario, Canada, L6H 6G4  
Tel.: (905) 829-1570 Fax.: (905) 829-8050  
Website: [www.ultratech-labs.com](http://www.ultratech-labs.com), Email: [vic@ultratech-labs.com](mailto:vic@ultratech-labs.com), Email: [tri@ultratech-labs.com](mailto:tri@ultratech-labs.com)



0685



31040/SIT



C-1376



46390-2049



200093-0



SL2-IN-E-1119R

## TABLE OF CONTENTS

<b>EXHIBIT 1.</b>	<b>SUBMITTAL CHECK LIST .....</b>	<b>1</b>
<b>EXHIBIT 2.</b>	<b>INTRODUCTION.....</b>	<b>2</b>
2.1.	SCOPE .....	2
2.2.	RELATED SUBMITTAL(S)/GRANT(S).....	2
2.3.	NORMATIVE REFERENCES .....	2
<b>EXHIBIT 3.</b>	<b>PERFORMANCE ASSESSMENT .....</b>	<b>3</b>
3.1.	CLIENT INFORMATION .....	3
3.2.	EQUIPMENT UNDER TEST (EUT) INFORMATION .....	3
3.3.	EUT’S TECHNICAL SPECIFICATIONS .....	4
3.4.	ASSOCIATED ANTENNA DESCRIPTION .....	4
3.5.	LIST OF EUT’S PORTS.....	4
3.6.	ANCILLARY EQUIPMENT .....	5
<b>EXHIBIT 4.</b>	<b>EUT OPERATING CONDITIONS AND CONFIGURATIONS DURING TESTS.....</b>	<b>6</b>
4.1.	CLIMATE TEST CONDITIONS .....	6
4.2.	OPERATIONAL TEST CONDITIONS & ARRANGEMENT FOR TESTS .....	6
<b>EXHIBIT 5.</b>	<b>SUMMARY OF TEST RESULTS.....</b>	<b>7</b>
5.1.	LOCATION OF TESTS .....	7
5.2.	APPLICABILITY & SUMMARY OF EMC EMISSION TEST RESULTS .....	7
5.3.	MODIFICATIONS INCORPORATED IN THE EUT FOR COMPLIANCE PURPOSES .....	7
<b>EXHIBIT 6.</b>	<b>MEASUREMENTS, EXAMINATIONS &amp; TEST DATA FOR EMC EMISSIONS .....</b>	<b>8</b>
6.1.	TEST PROCEDURES .....	8
6.2.	MEASUREMENT UNCERTAINTIES .....	8
6.3.	MEASUREMENT EQUIPMENT USED .....	8
6.4.	ESSENTIAL/PRIMARY FUNCTIONS AS DECLARED BY THE MANUFACTURER.....	8
6.5.	AC POWER LINE CONDUCTED EMISSIONS [§15.207(a)] .....	9
6.6.	OCCUPIED BANDWIDTH [§ 15.247(a)(2)] .....	13
6.7.	PEAK CONDUCTED OUTPUT POWER - DTS [§ 15.247(b)(3)] .....	20
6.8.	TRANSMITTER BAND-EDGE & SPURIOUS CONDUCTED EMISSIONS [§ 15.247(d)].....	22
6.9.	TRANSMITTER SPURIOUS RADIATED EMISSIONS AT 3 METERS [§§ 15.247(d), 15.209 & 15.205] .....	31
6.10.	POWER SPECTRAL DENSITY [§ 15.247(e)] .....	51
6.11.	RF EXPOSURE REQUIRMENTS [§§ 15.247(e)(i), 1.1310 & 2.1091].....	55
<b>EXHIBIT 7.</b>	<b>MEASUREMENT UNCERTAINTY.....</b>	<b>57</b>
7.1.	LINE CONDUCTED EMISSION MEASUREMENT UNCERTAINTY .....	57
7.2.	RADIATED EMISSION MEASUREMENT UNCERTAINTY .....	58

## EXHIBIT 1. SUBMITTAL CHECK LIST

Annex No.	Exhibit Type	Description of Contents	Quality Check (OK)
--	Test Report	<ul style="list-style-type: none"> <li>▪ Exhibit 1: Submittal check lists</li> <li>▪ Exhibit 2: Introduction</li> <li>▪ Exhibit 3: Performance Assessment</li> <li>▪ Exhibit 4: EUT Operation and Configuration during Tests</li> <li>▪ Exhibit 5: Summary of test Results</li> <li>▪ Exhibit 6: Measurement Data</li> <li>▪ Exhibit 7: Measurement Uncertainty</li> </ul>	OK
1	Test Setup Photos	<ul style="list-style-type: none"> <li>▪ Power Line Conducted Emissions Setup Photos</li> <li>▪ Radiated Emissions Setup Photos</li> </ul>	OK
2	External EUT Photos	External EUT Photos	OK
3	Internal EUT Photos	Internal EUT Photos	OK
4	Cover Letters	<ul style="list-style-type: none"> <li>▪ Letter from Ultratech for Certification Request</li> <li>▪ Letter from the Applicant to appoint Ultratech to act as an agent</li> <li>▪ Letter from the Applicant to request for Confidentiality Filing</li> <li>▪ Letter from the Applicant to request for Modular Approval</li> </ul>	OK
5	Attestation Statements	--	--
6	ID Label/Location Info	ID Label and Location of Label	OK
7	Block Diagrams	Block Diagram	OK
8	Schematic Diagrams	Schematics	OK
9	Parts List/Tune Up Info	Parts List	OK
10	Operational Description	Operation Description	OK
11	RF Exposure Info	MPE Evaluation, see section 6.11 in this Test Report for details.	OK
12	Users Manual	XBee™ Series 2/XBee™ Series 2 PRO OEM RF Modules	OK

### ULTRATECH GROUP OF LABS

3000 Bristol Circle, Oakville, Ontario, Canada L6H 6G4  
 Tel. #: 905-829-1570, Fax. #: 905-829-8050, Email: [vic@ultratech-labs.com](mailto:vic@ultratech-labs.com), Website: <http://www.ultratech-labs.com>

File #: DIGI-003F15C247  
 November 6, 2007

*All test results contained in this engineering test report are traceable to National Institute of Standards and Technology (NIST)*

## EXHIBIT 2. INTRODUCTION

### 2.1. SCOPE

<b>Reference:</b>	FCC Part 15, Subpart C, Section 15.247
<b>Title:</b>	Code of Federal Regulations (CFR), Title 47 – Telecommunication, Part 15
<b>Purpose of Test:</b>	Equipment Certification for Digital Modulation Systems (DTS) Transmitter Operating in the Frequency Band 2400-2483.5 MHz.
<b>Test Procedures:</b>	Both conducted and radiated emissions measurements were conducted in accordance with American National Standards Institute ANSI C63.4 - American National Standard for Methods of Measurement of Radio-Noise Emissions from Low-Voltage Electrical and Electronic Equipment in the Range of 9 kHz to 40 GHz.
<b>Environmental Classification:</b>	[ x ] Commercial, industrial or business environment [ ] Residential environment

### 2.2. RELATED SUBMITTAL(S)/GRANT(S)

None.

### 2.3. NORMATIVE REFERENCES

Publication	Year	Title
47 CFR Parts 0-19	2006	Code of Federal Regulations – Telecommunication
ANSI C63.4	2003	American National Standard for Methods of Measurement of Radio-Noise Emissions from Low-Voltage Electrical and Electronic Equipment in the Range of 9 kHz to 40 GHz
CISPR 22 & EN 55022	2006 2006	Information Technology Equipment - Radio Disturbance Characteristics – Limits and Methods of Measurement
CISPR 16-1-1	2003	Specification for radio disturbance and immunity measuring apparatus and methods. Part 1-1: Measuring Apparatus
CISPR 16-2-1	2003	Specification for radio disturbance and immunity measuring apparatus and methods. Part 2-1: Conducted disturbance measurement
KDB Publication No. 558074	2005	Guidance on Measurements for Digital Transmission Systems (47 CFR 15.247)
FCC Public Notice DA 00-1407	2000	Part 15 Unlicensed Modular Transmitter Approval

#### ULTRATECH GROUP OF LABS

3000 Bristol Circle, Oakville, Ontario, Canada L6H 6G4  
 Tel. #: 905-829-1570, Fax. #: 905-829-8050, Email: [vic@ultratech-labs.com](mailto:vic@ultratech-labs.com), Website: <http://www.ultratech-labs.com>

File #: DIGI-003F15C247  
 November 6, 2007

*All test results contained in this engineering test report are traceable to National Institute of Standards and Technology (NIST)*

## EXHIBIT 3. PERFORMANCE ASSESSMENT

### 3.1. CLIENT INFORMATION

APPLICANT	
<b>Name:</b>	Digi International Inc.
<b>Address:</b>	11001 Bren Road East Minnetonka, MN 55343 USA
<b>Contact Person:</b>	Mr. Paul Dahl Phone #: 801-765-9885 Fax #: 801-765-9895 Email Address: Paul.dahl@digi.com

MANUFACTURER	
<b>Name:</b>	Digi International Inc.
<b>Address:</b>	11001 Bren Road East Minnetonka, MN 55343 USA
<b>Contact Person:</b>	Mr. Paul Dahl Phone #: 801-765-9885 Fax #: 801-765-9895 Email Address: Paul.dahl@digi.com

### 3.2. EQUIPMENT UNDER TEST (EUT) INFORMATION

The following information (with the exception of the Date of Receipt) has been supplied by the applicant.

<b>Brand Name:</b>	Digi International Inc.
<b>Product Name:</b>	XBee PRO Series 2 OEM RF Module
<b>Model Name or Number:</b>	XBEEPRO2
<b>Serial Number:</b>	Test Sample
<b>Type of Equipment:</b>	Digital Modulation Transmitter
<b>Input Power Supply Type:</b>	3 – 3.4 Vdc TENMA DC Regulated Power Supply Model: 72-7295 S/N: 400300270
<b>Primary User Functions of EUT:</b>	Wireless modem

---

**ULTRATECH GROUP OF LABS**

3000 Bristol Circle, Oakville, Ontario, Canada L6H 6G4  
Tel. #: 905-829-1570, Fax. #: 905-829-8050, Email: [vic@ultratech-labs.com](mailto:vic@ultratech-labs.com), Website: <http://www.ultratech-labs.com>

File #: DIGI-003F15C247  
November 6, 2007

*All test results contained in this engineering test report are traceable to National Institute of Standards and Technology (NIST)*

### 3.3. EUT'S TECHNICAL SPECIFICATIONS

<b>TRANSMITTER</b>	
<b>Equipment Type:</b>	<ul style="list-style-type: none"> <li>• Mobile</li> <li>• Base Station (fixed use)</li> </ul>
<b>Intended Operating Environment:</b>	Commercial, industrial or business
<b>Power Supply Requirement:</b>	3.0 - 3.4 Vdc
<b>RF Output Power Rating:</b>	79 mW (+19 dBm) Peak
<b>Operating Frequency Range:</b>	2405 – 2470 MHz
<b>RF Output Impedance:</b>	50 Ohms
<b>Channel Spacing:</b>	5 MHz
<b>Duty Cycle:</b>	27%
<b>6 dB bandwidth:</b>	1.633 MHz
<b>Modulation Type:</b>	QPSK
<b>Oscillator Frequencies:</b>	4900 MHz
<b>Antenna Connector Type:</b>	<ul style="list-style-type: none"> <li>• Integral</li> <li>• Unique connector (RPSMA/U.FL/IPX)</li> </ul>

### 3.4. ASSOCIATED ANTENNA DESCRIPTION

The highest gain antenna from each type of antenna was selected for testing to represent the worst case. The following antennas were selected for testing in this filing:

1. Maxrad Yagi Antenna (P/N: A24-Y18NF; Max. Antenna Gain: 15 dBi)
2. D-Link Omni-directional Antenna (P/N: A24-F15NF; Max. Antenna Gain: 15 dBi)
3. ARC Panel Antenna (P/N: A24-P19NF; Max. Antenna Gain: 19 dBi)

### 3.5. LIST OF EUT'S PORTS

<b>Port Number</b>	<b>EUT's Port Description</b>	<b>Number of Identical Ports</b>	<b>Connector Type</b>	<b>Cable Type (Shielded/Non-shielded)</b>
1	RF IN/OUT Port	1	RPSMA/U.FL/IPX	Shielded
2	DC Supply & I/O Port	1	Pin Header	No cable, direct connection

### 3.6. ANCILLARY EQUIPMENT

The EUT was tested while connected to the following representative configuration of ancillary equipment necessary to exercise the ports during tests:

Ancillary Equipment # 1	
Description:	Test Jig Cable
Brand name:	Digi International
Model Name or Number:	N/A
Serial Number:	N/A
Connected to EUT's Port:	Module pin signals

## EXHIBIT 4. EUT OPERATING CONDITIONS AND CONFIGURATIONS DURING TESTS

### 4.1. CLIMATE TEST CONDITIONS

The climate conditions of the test environment are as follows:

Temperature:	21°C
Humidity:	51%
Pressure:	102 kPa
Power input source:	3.0 – 3.4 Vdc

### 4.2. OPERATIONAL TEST CONDITIONS & ARRANGEMENT FOR TESTS

<b>Operating Modes:</b>	Each of lowest, middle and highest channel frequencies transmits continuously for emissions measurements.
<b>Special Test Software:</b>	Special software and hardware by the Applicant to operate the EUT at each channel frequency continuously. For example, the transmitter will be operated at each of the lowest, middle and highest frequencies individually continuously during testing.
<b>Special Hardware Used:</b>	The RF Module could be tested outside of the enclosure using Digi International Test Jig Cable connected to EUT.
<b>Transmitter Test Antenna:</b>	The EUT is tested with the antenna fitted in a manner typical of normal intended use as integral / non-integral antenna equipment as described with the test results.

<b>Transmitter Test Signals</b>	
<b>Frequency Band(s):</b>	2405 – 2470 MHz
<b>Frequency(ies) Tested:</b> (Near lowest, near middle & near highest frequencies in the frequency range of operation.)	2405 MHz, 2440 MHz and 2470 MHz
<b>RF Power Output:</b> (measured maximum output power at antenna terminals)	19 dBm (79 mW) Peak
<b>Normal Test Modulation:</b>	QPSK
<b>Modulating Signal Source:</b>	Internal



## EXHIBIT 5. SUMMARY OF TEST RESULTS

### 5.1. LOCATION OF TESTS

All of the measurements described in this report were performed at Ultratech Group of Labs located in the city of Oakville, Province of Ontario, Canada.

- AC Power Line Conducted Emissions were performed in UltraTech's shielded room, 24'(L) by 16'(W) by 8'(H).
- Radiated Emissions were performed at the Ultratech's 3-10 TDK Semi-Anechoic Chamber situated in the Town of Oakville, province of Ontario. This test site been calibrated in accordance with ANSI C63.4, and found to be in compliance with the requirements of Sec. 2.948 of the FCC Rules. The descriptions and site measurement data of the Oakville 3-10 TDK Semi-Anechoic Chamber has been filed with FCC office (FCC File No.: 31040/SIT 1300B3) and Industry Canada office (Industry Canada Site No.: 2049A-2, Expiry Date: July 4, 2008).

### 5.2. APPLICABILITY & SUMMARY OF EMC EMISSION TEST RESULTS

FCC Section(s)	Test Requirements	Compliance (Yes/No)
15.203	Antenna requirements	Yes*
15.207(a)	AC Power Line Conducted Emissions	Yes
15.247(a)(2)	6 dB Bandwidth	Yes
15.247(b)(3)	Peak Conducted Output Power - DTS	Yes
15.247(d)	Band-Edge and RF Conducted Spurious Emissions at the Transmitter Antenna Terminal	Yes
15.247(d), 15.209 & 15.205	Transmitter Spurious Radiated Emissions	Yes
15.247(e)	Power Spectral Density	Yes
15.247(b)(5), (e)(i) 1.1307, 1.1310, 2.1091 & 2.1093	RF Exposure	Yes
The digital circuit portion of the EUT has been tested and verified to comply with FCC Part 15, Subpart B, Class B Digital Devices. The engineering test report is available upon request.		

\* The EUT complies with the requirement; it employs a unique (non-standard) antenna connector (RPSMA/U.FL/IPX), for all external antennas proposed for use with the EUT.

### 5.3. MODIFICATIONS INCORPORATED IN THE EUT FOR COMPLIANCE PURPOSES

None.

---

#### ULTRATECH GROUP OF LABS

3000 Bristol Circle, Oakville, Ontario, Canada L6H 6G4  
 Tel. #: 905-829-1570, Fax. #: 905-829-8050, Email: [vic@ultratech-labs.com](mailto:vic@ultratech-labs.com), Website: <http://www.ultratech-labs.com>

File #: DIGI-003F15C247  
 November 6, 2007

*All test results contained in this engineering test report are traceable to National Institute of Standards and Technology (NIST)*

---

---

## **EXHIBIT 6. MEASUREMENTS, EXAMINATIONS & TEST DATA FOR EMC EMISSIONS**

### **6.1. TEST PROCEDURES**

This section contains test results only. Details of test methods and procedures can be found in ANSI C63.4; FCC KDB Publication No. 558074: Guidance on Measurements for Digital Transmission Systems.

### **6.2. MEASUREMENT UNCERTAINTIES**

The measurement uncertainties stated were calculated in accordance with requirements of UKAS Document NIS 81 with a confidence level of 95%. Please refer to Exhibit 7 for Measurement Uncertainties.

### **6.3. MEASUREMENT EQUIPMENT USED**

The measurement equipment used complied with the requirements of the Standards referenced in the Methods & Procedures ANSI C63.4 and CISPR 16-1-1.

### **6.4. ESSENTIAL/PRIMARY FUNCTIONS AS DECLARED BY THE MANUFACTURER**

Wireless modem.

## 6.5. AC POWER LINE CONDUCTED EMISSIONS [§15.207(a)]

### 6.5.1. Limit(s)

The equipment shall meet the limits of the following table:

Frequency of emission (MHz)	Conducted Limits (dB $\mu$ V)		Measuring Bandwidth
	Quasi-peak	Average	
0.15–0.5 .....	66 to 56* .....	56 to 46*	RBW = 9 kHz VBW $\geq$ 9 kHz for QP VBW = 1 Hz for Average
0.5–5 .....	56 .....	46	
5–30 .....	60 .....	50	

\*Decreases linearly with the logarithm of the frequency

### 6.5.2. Method of Measurements

ANSI C63.4

### 6.5.3. Test Arrangement

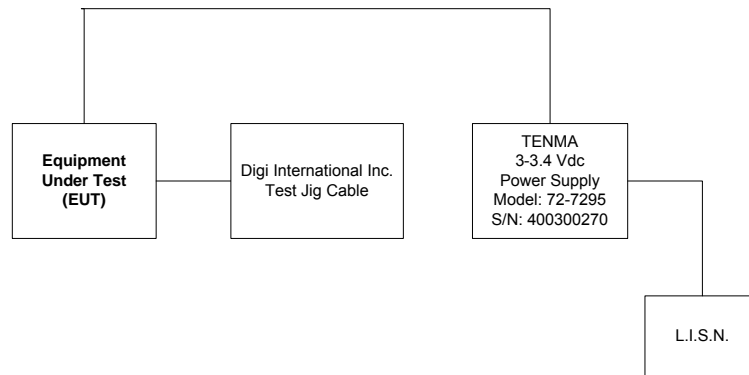

### 6.5.4. Test Equipment List

Test Instruments	Manufacturer	Model No.	Serial No.	Frequency Range
Spectrum Analyzer/ EMI Receiver	Hewlett Packard	HP 8593EM	3412A00103	9 kHz – 26.5 GHz
Transient Limiter	Hewlett Packard	11947A	310701998	9 kHz – 200 MHz 10 dB attenuation
L.I.S.N.	EMCO	3825/2	89071531	9 kHz – 200 MHz 50 Ohms / 50 $\mu$ H
24'(L) x 16'(W) x 8'(H) RF Shielded Chamber	Braden Shielding	...	...	...

**6.5.5. Test Data**

Frequency (MHz)	RF Level (dB $\mu$ V)	Receiver Detector (P/QP/AVG)	QP Limit (dB $\mu$ V)	AVG Limit (dB $\mu$ V)	Margin (dB)	Pass/ Fail	Line Tested
0.164650	34.8	QP	65.2	55.2	-30.4	Pass	Positive
0.164650	32.8	AVG	65.2	55.2	-22.4	Pass	Positive
0.164517	34.9	QP	65.2	55.2	-30.3	Pass	Negative
0.164517	32.8	AVG	65.2	55.2	-22.4	Pass	Negative

Note: See the following test data plots for details.

**Plot 6.5.5.1 Power Line Conducted Emissions**  
 Line Voltage: 3.4VDC  
 Line Tested: Positive

*hp*

Signal	Freq (MHz)	PK Amp	QP Amp	AV Amp	AV $\Delta$ L2
1	0.164650	37.5	34.8	32.8	-22.5

ACTV DET: PEAK  
 MEAS DET: PEAK QP AVG  
 MKR 160 kHz  
 36.30 dB $\mu$ V

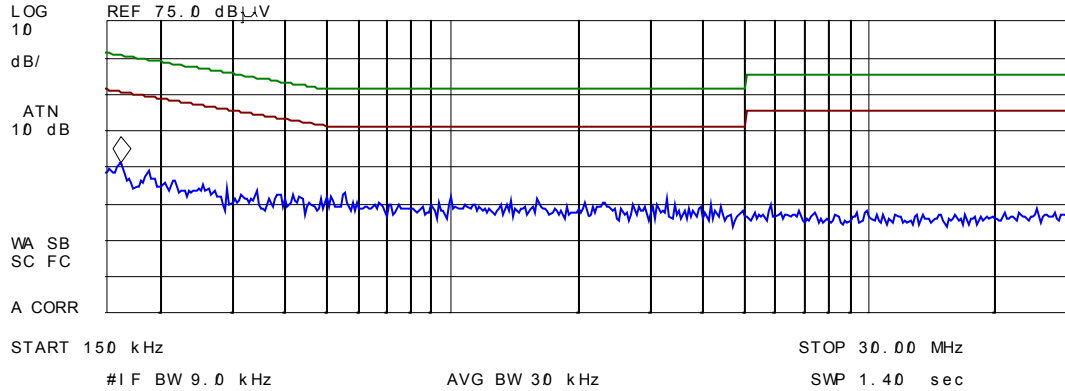

**Plot 6.5.5.2 Power Line Conducted Emissions**  
 Line Voltage: 3.4 VDC  
 Line Tested: Negative

*hp*

Signal	Freq (MHz)	PK Amp	QP Amp	AV Amp	AV $\Delta$ L2
1	0.164517	37.2	34.9	32.8	-22.5

ACTV DET: PEAK  
 MEAS DET: PEAK QP AVG  
 MKR 160 kHz  
 35.45 dB $\mu$ V

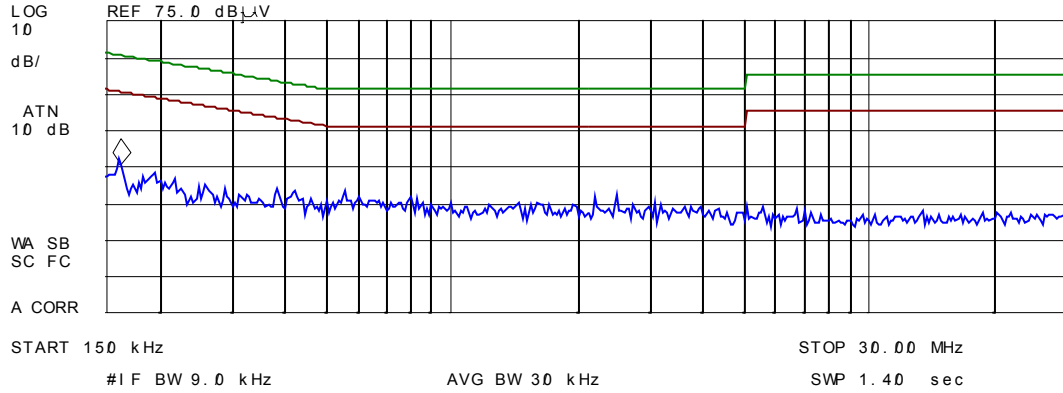

## 6.6. OCCUPIED BANDWIDTH [§ 15.247(a)(2)]

### 6.6.1. Limit(s)

For a Digital Modulation System, the minimum 6 dB bandwidth shall be at least 500 KHz.

### 6.6.2. Method of Measurements

KDB Publication No. 558074: Guidance on Measurements for Digital Transmission Systems (47 CFR 15.247)

### 6.6.3. Test Arrangement



### 6.6.4. Test Equipment List

Test Instruments	Manufacturer	Model No.	Serial No.	Frequency Range
Spectrum Analyzer	Rhode & Schwarz	FSEK 30	100077	20 Hz - 40 GHz

### 6.6.5. Test Data

Frequency (MHz)	6 dB Bandwidth (MHz)	99% Occupied Bandwidth (MHz)
2405	1.633	2.405
2440	1.623	2.445
2470	1.623	2.395

See the following plots for detailed measurements.

**Plot 6.6.5.1 6 dB Bandwidth**  
Frequency: 2405 MHz

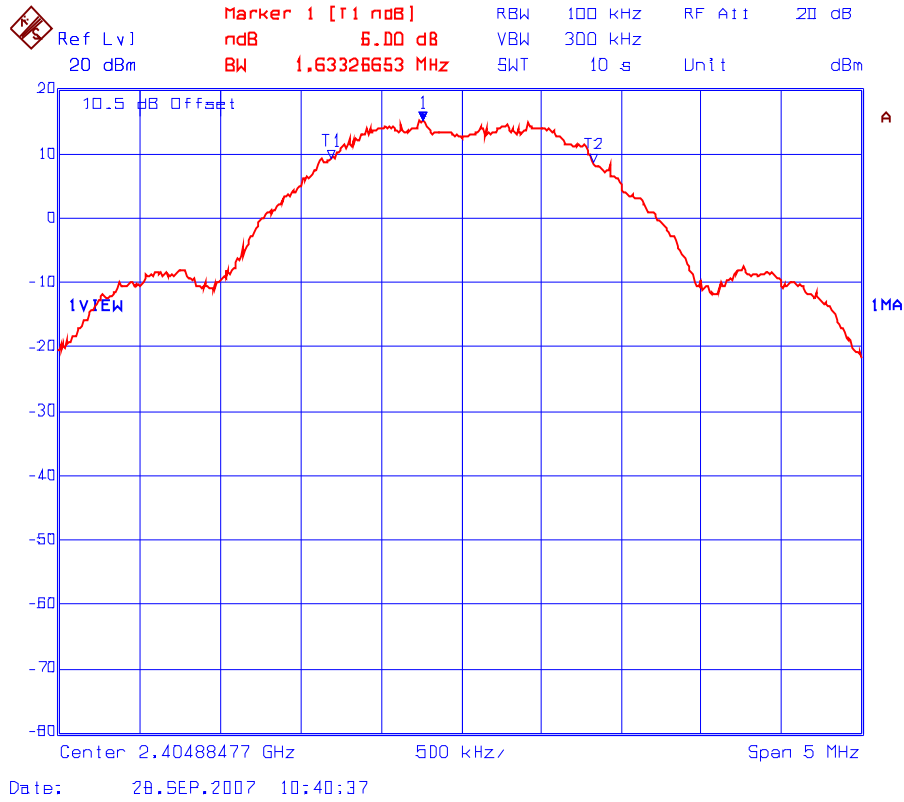



Plot 6.6.5.2 6 dB Bandwidth  
Frequency: 2440 MHz

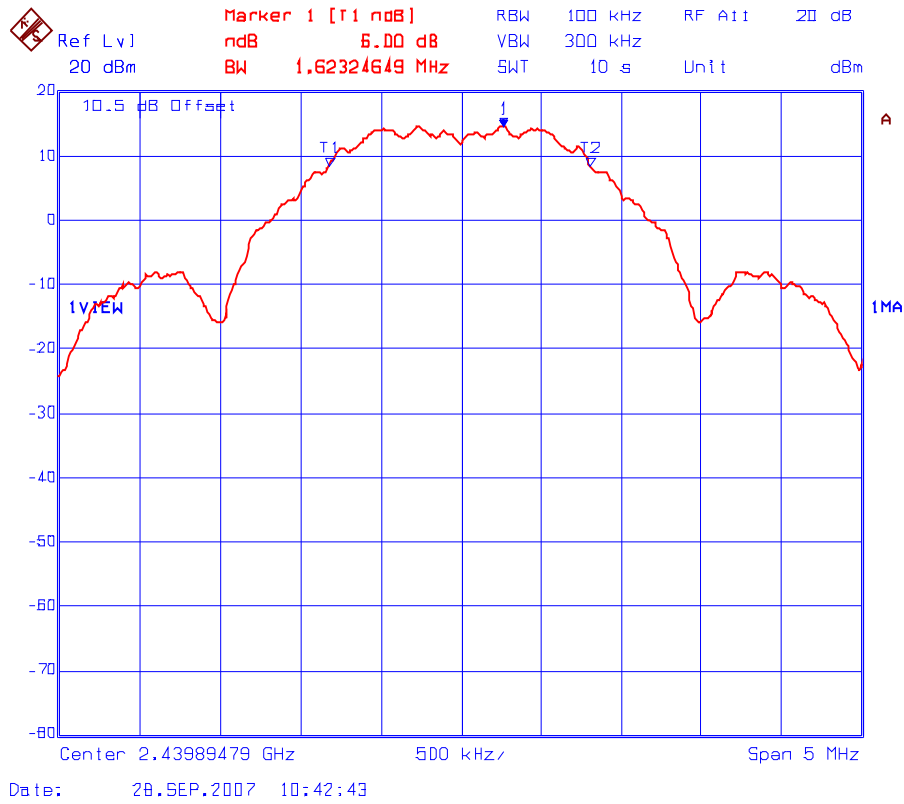

**ULTRATECH GROUP OF LABS**

3000 Bristol Circle, Oakville, Ontario, Canada L6H 6G4  
Tel. #: 905-829-1570, Fax. #: 905-829-8050, Email: [vic@ultratech-labs.com](mailto:vic@ultratech-labs.com), Website: <http://www.ultratech-labs.com>

File #: DIGI-003F15C247

November 6, 2007

All test results contained in this engineering test report are traceable to National Institute of Standards and Technology (NIST)

**Plot 6.6.5.3 6 dB Bandwidth**  
Frequency: 2470 MHz

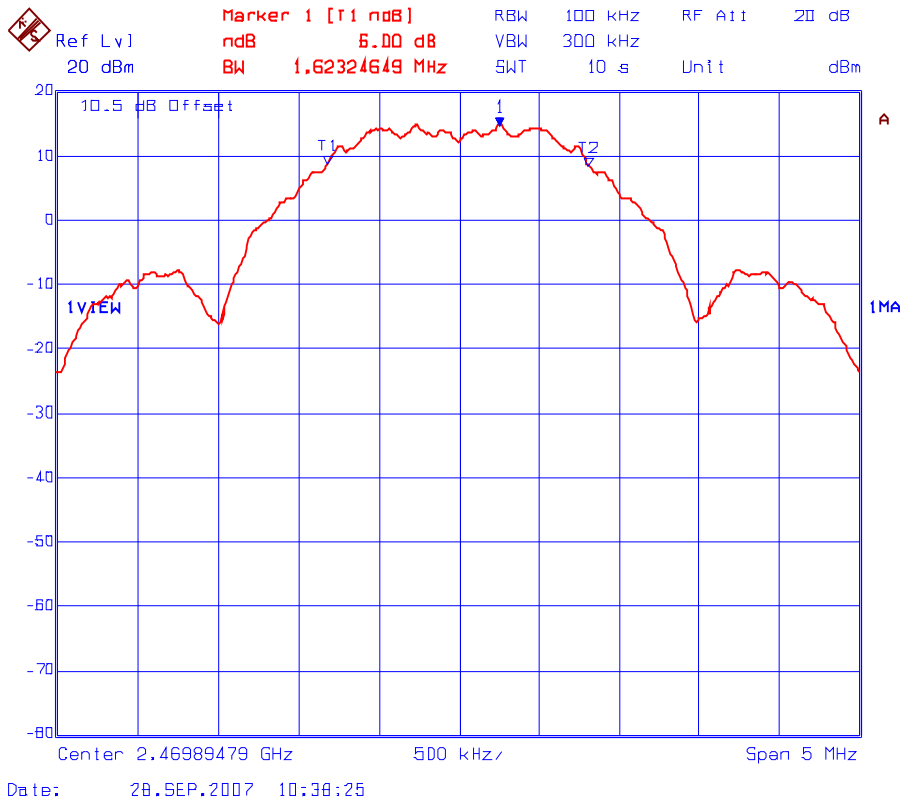

**Plot 6.6.5.4 99% Occupied Bandwidth  
 Frequency: 2405 MHz**

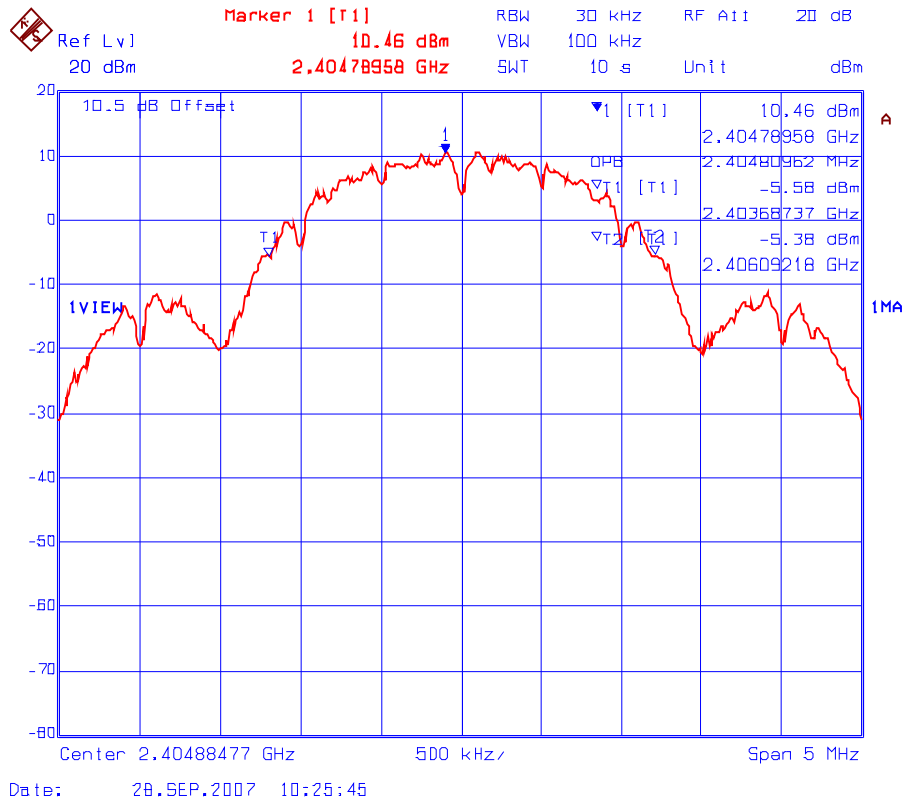

**Plot 6.6.5.5 99% Occupied Bandwidth  
 Frequency: 2440 MHz**

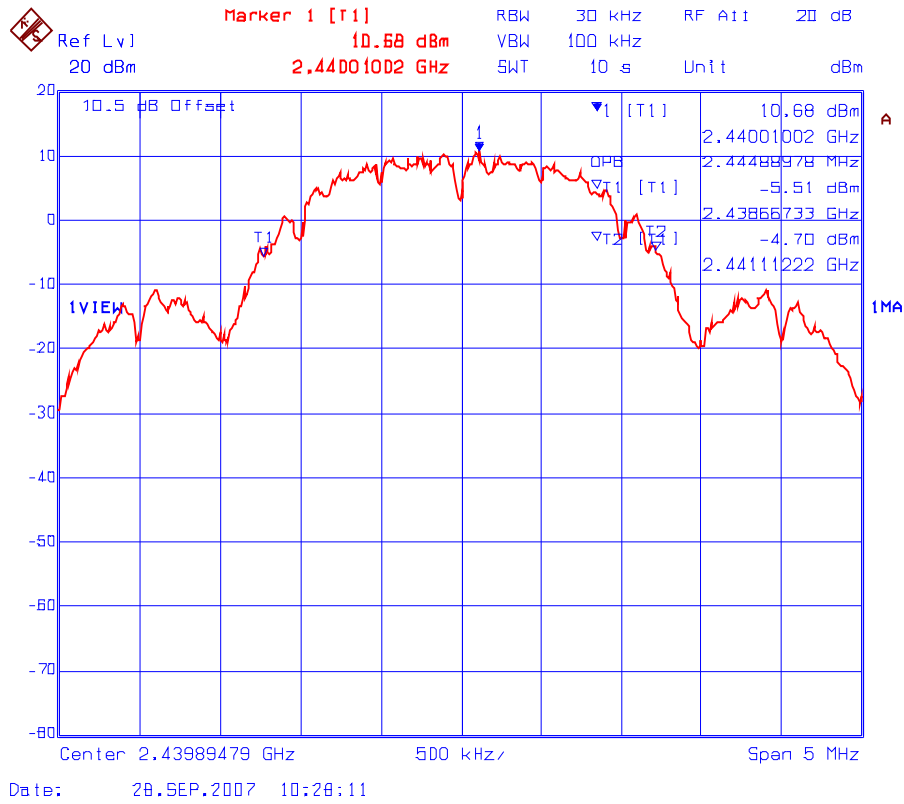

**Plot 6.6.5.6 99% Occupied Bandwidth  
 Frequency: 2470 MHz**

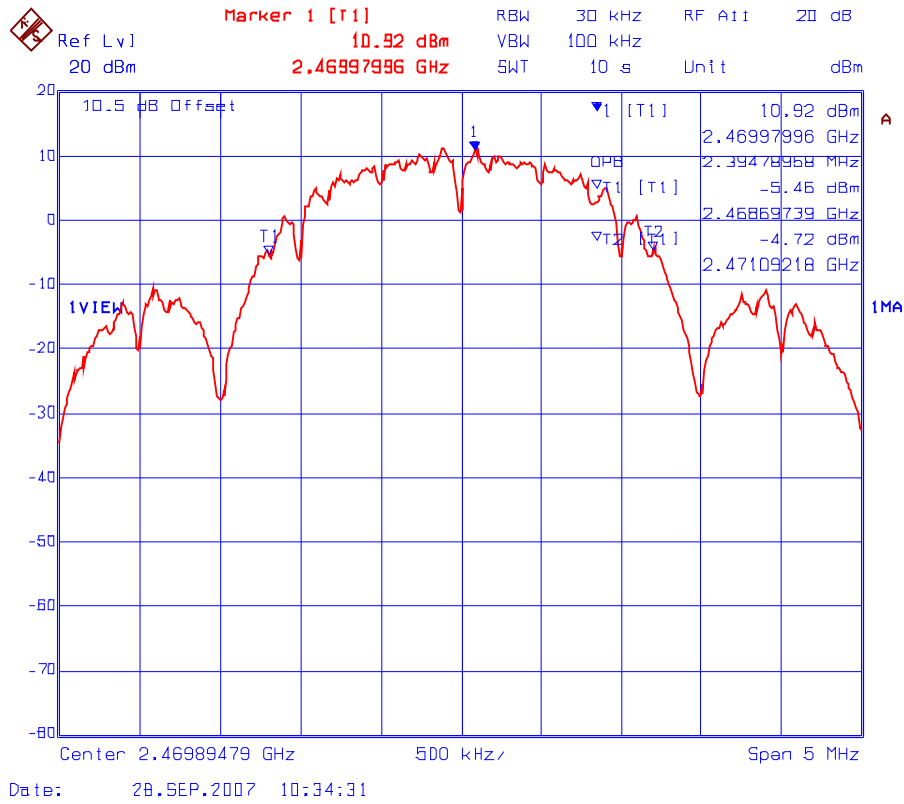

## 6.7. PEAK CONDUCTED OUTPUT POWER - DTS [§ 15.247(b)(3)]

### 6.7.1. Limit(s)

**§ 15.247(b)(3):** For systems using digital modulation in the 902-928 MHz, 2400-2483.5 MHz, and 5725-5850 MHz bands: 1 Watt. As an alternative to a peak power measurement, compliance with the one Watt limit can be based on a measurement of the maximum conducted output power. Maximum Conducted Output Power is defined as the total transmit power delivered to all antennas and antenna elements averaged across all symbols in the signaling alphabet when the transmitter is operating at its maximum power control level. Power must be summed across all antennas and antenna elements. The average must not include any time intervals during which the transmitter is off or is transmitting at a reduced power level. If multiple modes of operation are possible (e.g., alternative modulation methods), the *maximum conducted output power* is the highest total transmit power occurring in any mode.

**§15.247(b)(4):** The conducted output power limit specified in paragraph (b) of this section is based on the use of antennas with directional gains that do not exceed 6 dBi. Except as shown in paragraph (c) of this section, if transmitting antennas of directional gain greater than 6 dBi are used, the conducted output power from the intentional radiator shall be reduced below the stated values in paragraphs (b)(1), (b)(2), and (b)(3) of this section, as appropriate, by the amount in dB that the directional gain of the antenna exceeds 6 dBi.

### 6.7.2. Method of Measurements & Test Arrangement

KDB Publication No. 558074: Guidance on Measurements for Digital Transmission Systems (47 CFR 15.247)

### 6.7.3. Test Arrangement



### 6.7.4. Test Equipment List

Test Instruments	Manufacturer	Model No.	Serial No.	Frequency Range
Spectrum Analyzer	Rhode & Schwarz	FSEK 30	100077	20 Hz - 40 GHz

**6.7.5. Test Data**

Frequency (MHz)	Peak Conducted Power (dBm)	Peak EIRP <sup>(Note 1, 2)</sup> (dBm)	Peak Conducted Power Limit (dBm)	EIRP Limit (dBm)
High Power Setting, DC Voltage Input of 3.4 Vdc				
2405	18.61	35.13	30	36
2440	18.74	35.26	30	36
2470	18.99	35.51	30	36
High Power Setting, DC Voltage Input of 3.0 Vdc				
2405	18.25	34.77	30	36
2440	18.49	35.01	30	36
2470	18.74	35.26	30	36

Note 1: The Peak EIRP is calculated as the sum of Peak Conducted Power in dBm and antenna assembly gain of EUT in dBi (antenna gain – cable loss).

Note 2: The maximum antenna gain to be used with the EUT is 19 dBi with 2.48 dB cable loss.

## 6.8. TRANSMITTER BAND-EDGE & SPURIOUS CONDUCTED EMISSIONS [§ 15.247(d)]

### 6.8.1. Limit(s)

§ 15.247 (d): In any 100 kHz bandwidth outside the frequency band in which the spread spectrum or digitally modulated intentional radiator is operating, the radio frequency power that is produced by the intentional radiator shall be at least 20 dB below that in the 100 kHz bandwidth within the band that contains the highest level of the desired power, based on either an RF conducted or a radiated measurement, provided the transmitter demonstrates compliance with the peak conducted power limits. If the transmitter complies with the conducted power limits based on the use of RMS averaging over a time interval, as permitted under paragraph (b)(3) of this section, the attenuation required under this paragraph shall be 30 dB instead of 20 dB.

### 6.8.2. Method of Measurements

KDB Publication No. 558074: Guidance on Measurements for Digital Transmission Systems (47 CFR 15.247)

### 6.8.3. Test Arrangement

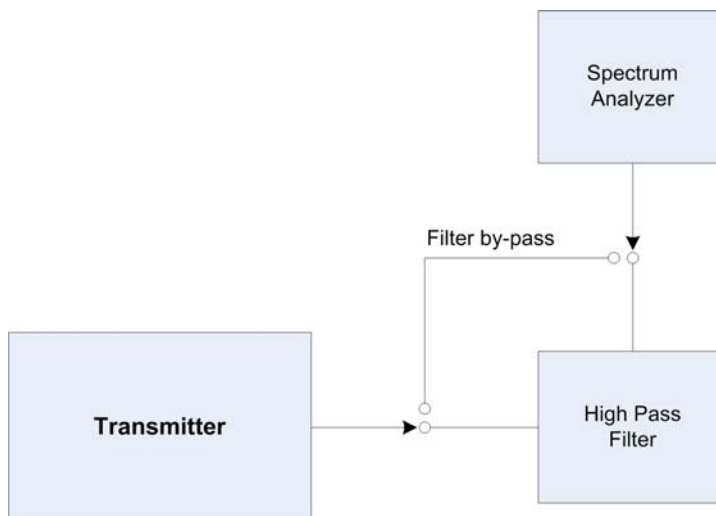

### 6.8.4. Test Equipment List

Test Instruments	Manufacturer	Model No.	Serial No.	Frequency Range
Spectrum Analyzer	Rhode & Schwarz	FSEK 30	100077	20 Hz - 40 GHz
High Pass Filter	K & L	11SH10-4000T12000	4	3dB cutoff at 4 GHz



### 6.8.5. Test Data

#### 6.8.5.1. Band-Edge RF Conducted Emissions

**Plot 6.8.5.1.1** Band-Edge RF Conducted Emissions  
Low End of Frequency Band

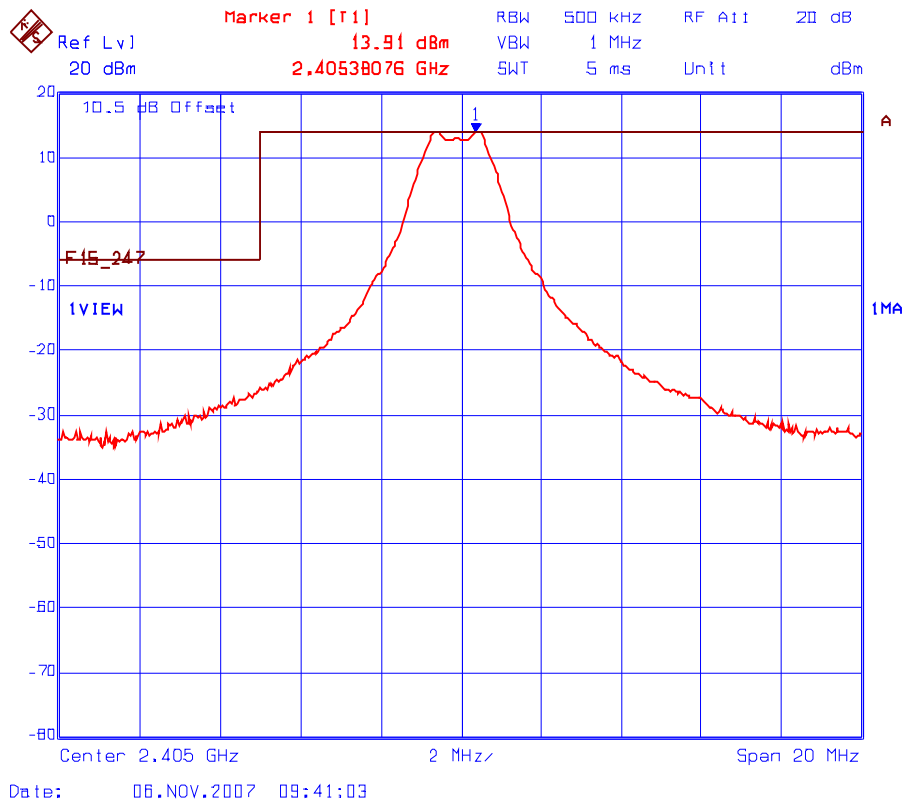

Plot 6.8.5.1.2 Band-Edge RF Conducted Emissions  
High End of Frequency Band

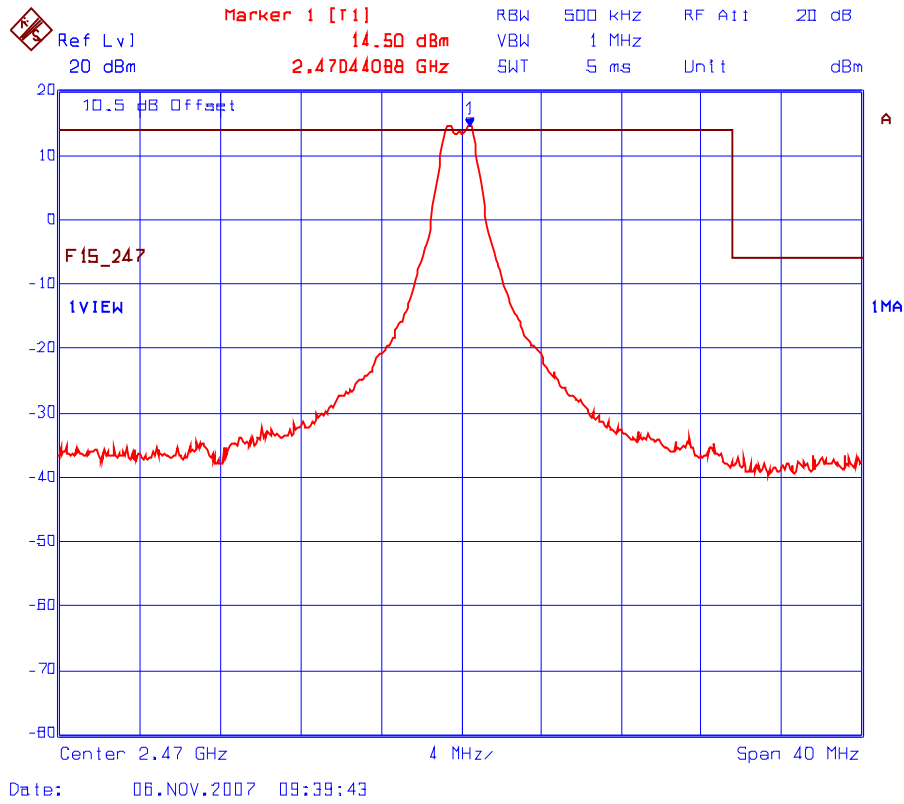

6.8.5.2. Spurious RF Conducted Emissions

Plot 6.8.5.2.1 Spurious RF Conducted Emissions  
Transmitter Frequency: 2405 MHz

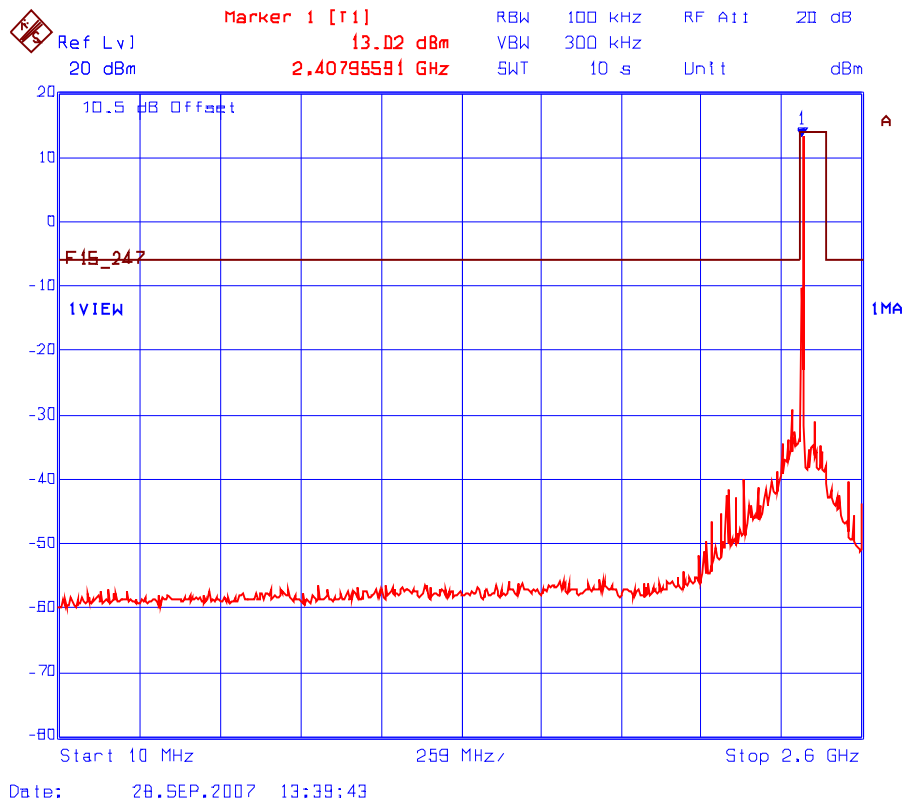

**Plot 6.8.5.2 Spurious RF Conducted Emissions**  
 Transmitter Frequency: 2405 MHz

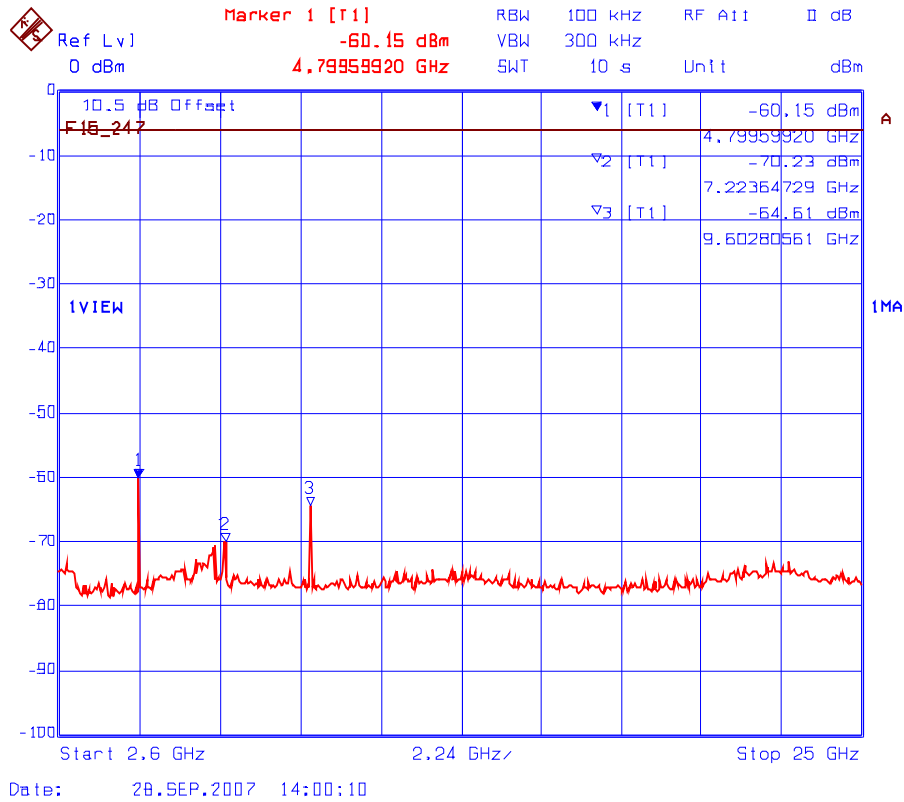

Plot 6.8.5.2.3 Spurious RF Conducted Emissions  
Transmitter Frequency: 2440 MHz

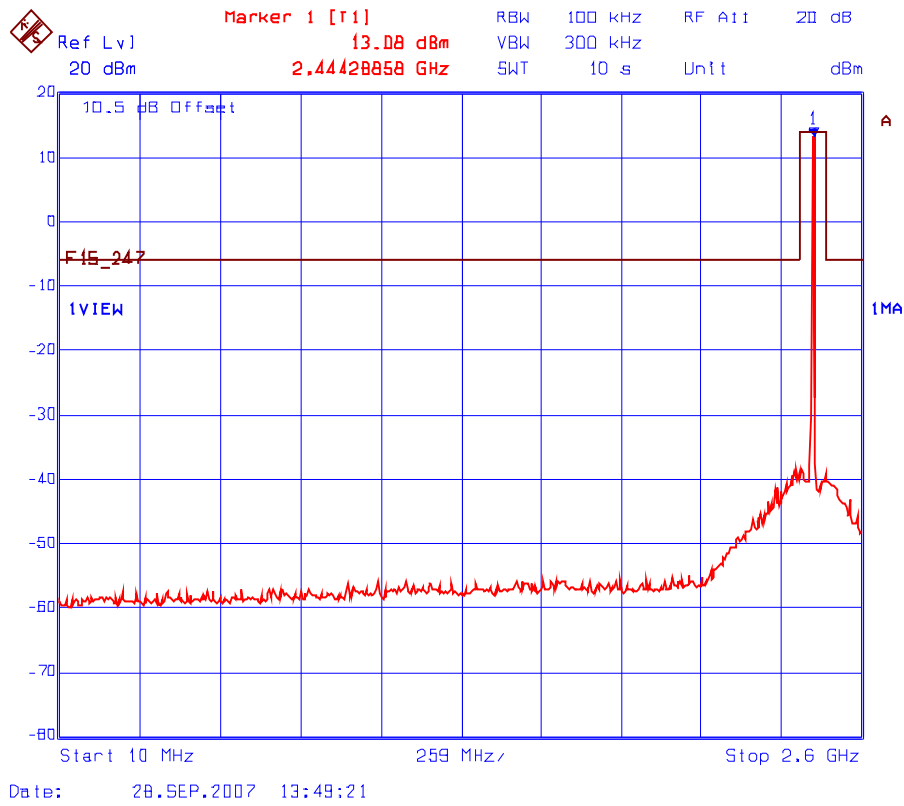

**Plot 6.8.5.2.4 Spurious RF Conducted Emissions**  
 Transmitter Frequency: 2440 MHz

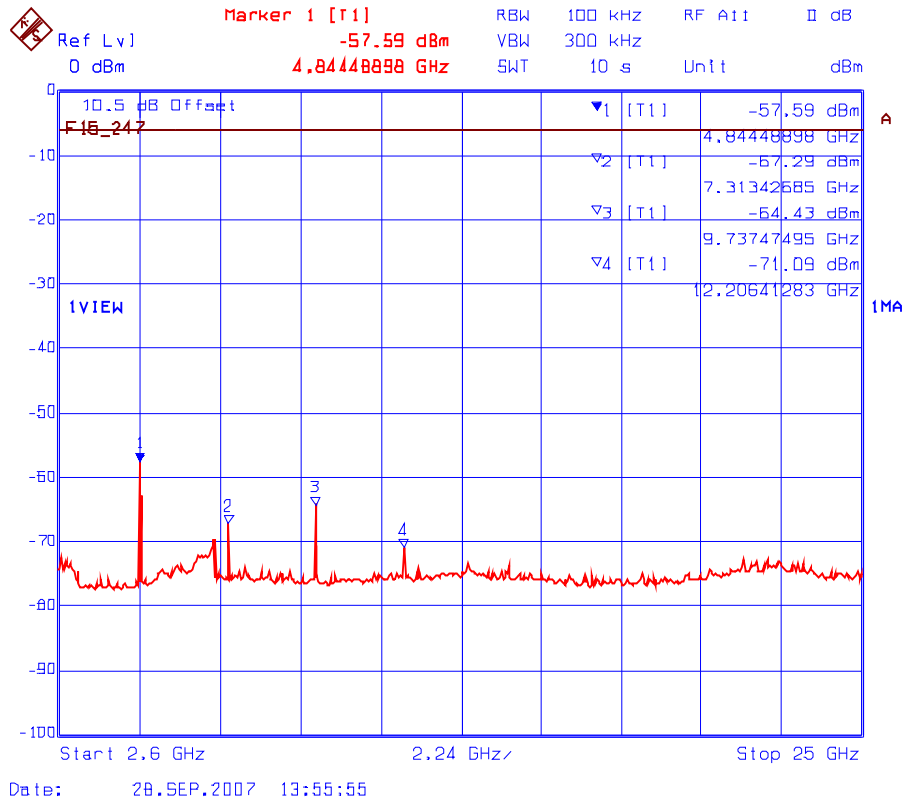

Plot 6.8.5.2.5 Spurious RF Conducted Emissions  
Transmitter Frequency: 2470 MHz

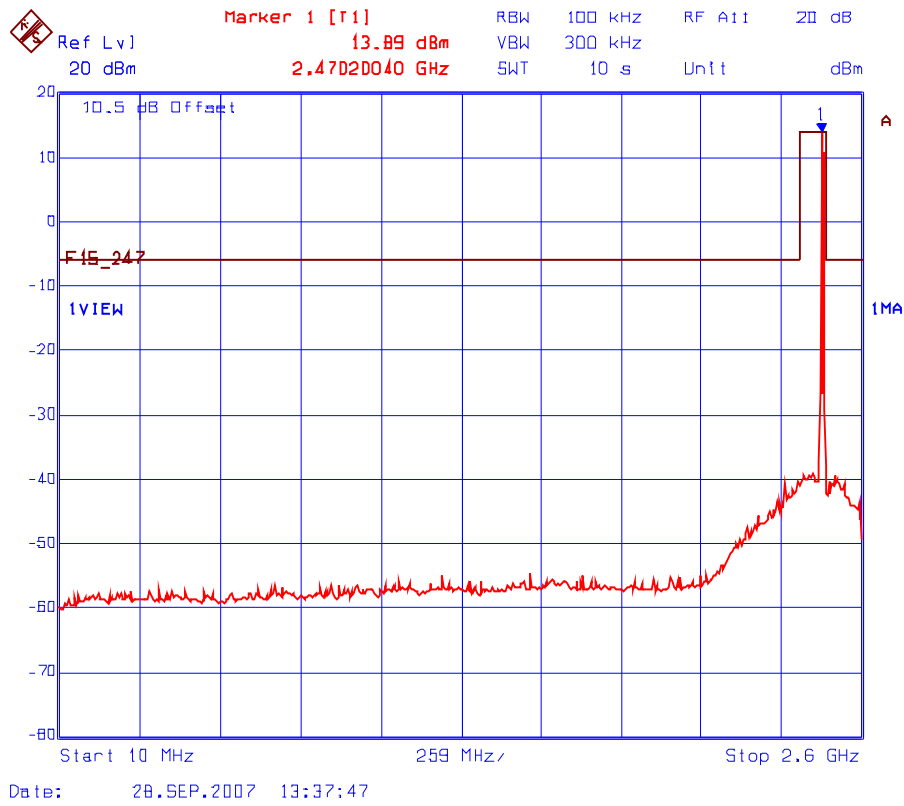

**Plot 6.8.5.2.6 Spurious RF Conducted Emissions**  
 Transmitter Frequency: 2470 MHz

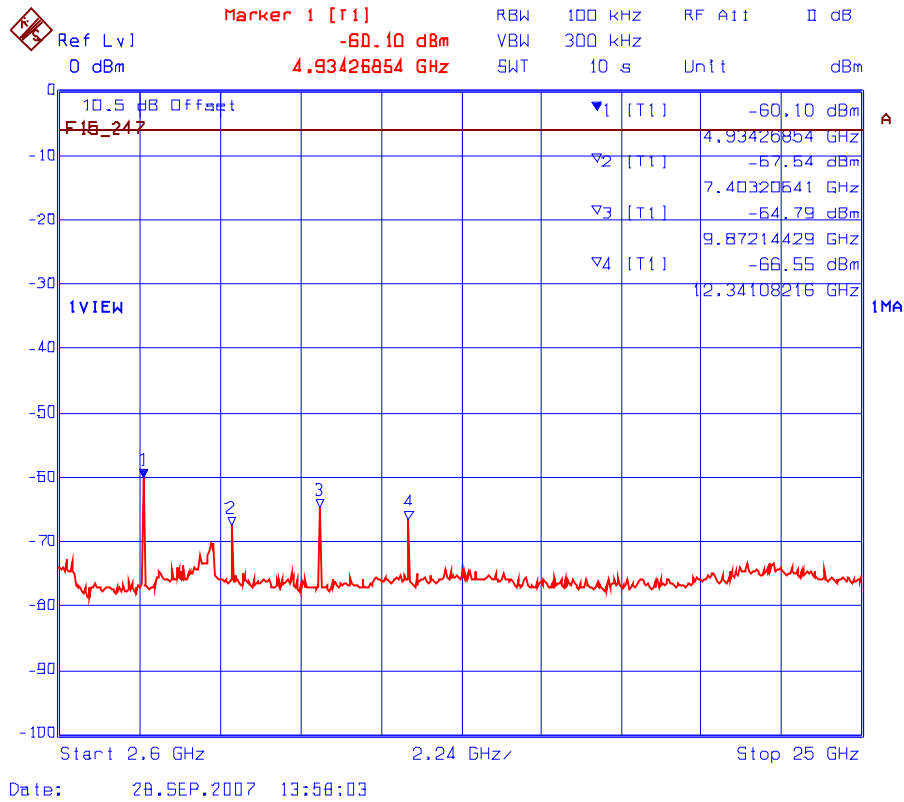



**6.9. TRANSMITTER SPURIOUS RADIATED EMISSIONS AT 3 METERS [§§ 15.247(d), 15.209 & 15.205]**

**6.9.1. Limit(s)**

§ 15.247 (d): In any 100 kHz bandwidth outside the frequency band in which the spread spectrum or digitally modulated intentional radiator is operating, the radio frequency power that is produced by the intentional radiator shall be at least 20 dB below that in the 100 kHz bandwidth within the band that contains the highest level of the desired power, based on either an RF conducted or a radiated measurement, provided the transmitter demonstrates compliance with the peak conducted power limits. If the transmitter complies with the conducted power limits based on the use of RMS averaging over a time interval, as permitted under paragraph (b)(3) of this section, the attenuation required under this paragraph shall be 30 dB instead of 20 dB. Attenuation below the general limits specified in Section 15.209(a) is not required. In addition, radiated emissions which fall in the restricted bands, as defined in Section 15.205(a), must also comply with the radiated emission limits specified in Section 15.209(a) (see Section 15.205(c)).

**Section 15.205(a) - Restricted Bands of Operation**

MHz	MHz	MHz	GHz
0.090–0.110 .....	16.42–16.423	399.9–410	4.5–5.15
<sup>1</sup> 0.495–0.505 .....	16.69475–16.69525	608–614	5.35–5.46
2.1735–2.1905 .....	16.80425–16.80475	960–1240	7.25–7.75
4.125–4.128 .....	25.5–25.67	1300–1427	8.025–8.5
4.17725–4.17775 .....	37.5–38.25	1435–1626.5	9.0–9.2
4.20725–4.20775 .....	73–74.6	1645.5–1646.5	9.3–9.5
6.215–6.218 .....	74.8–75.2	1660–1710	10.6–12.7
6.26775–6.26825 .....	108–121.94	1718.8–1722.2	13.25–13.4
6.31175–6.31225 .....	123–138	2200–2300	14.47–14.5
8.291–8.294 .....	149.9–150.05	2310–2390	15.35–16.2
8.362–8.366 .....	156.52475–156.52525	2483.5–2500	17.7–21.4
8.37625–8.38675 .....	156.7–156.9	2655–2900	22.01–23.12
8.41425–8.41475 .....	162.0125–167.17	3260–3267	23.6–24.0
12.29–12.293 .....	167.72–173.2	3332–3339	31.2–31.8
12.51975–12.52025 .....	240–285	3345.8–3358	36.43–36.5
12.57675–12.57725 .....	322–335.4	3600–4400	( <sup>2</sup> )
13.36–13.41 .....			

<sup>1</sup> Until February 1, 1999, this restricted band shall be 0.490–0.510 MHz.

<sup>2</sup> Above 38.6

**Section 15.209(a)**  
**-- Field Strength Limits within Restricted Frequency Bands --**

Frequency (MHz)	Field Strength (microvolts/meter)	Measurement Distance (meters)
0.009 - 0.490	2,400 / F (kHz)	300
0.490 - 1.705	24,000 / F (kHz)	30
1.705 - 30.0	30	30
30 – 88	100	3
88 – 216	150	3
216 – 960	200	3
Above 960	500	3

**6.9.2. Method of Measurements**

KDB Publication No. 558074: Guidance on Measurements for Digital Transmission Systems (47 CFR 15.247)

**6.9.3. Test Arrangement**

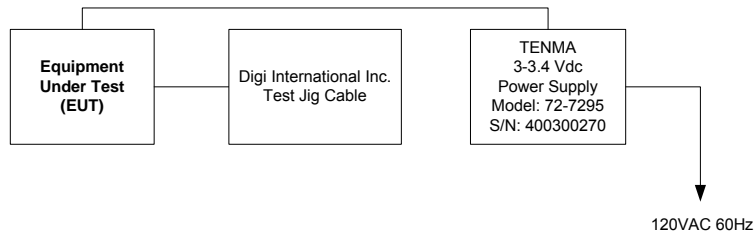

**6.9.4. Test Equipment List**

Test Instruments	Manufacturer	Model No.	Serial No.	Frequency Range
Spectrum Analyzer	Rhode & Schwarz	FSEK 30	100077	20 Hz - 40 GHz
Microwave Amplifier	Hewlett Packard	8449B	3008A00769	1 GHz to 26.5 GHz
Biconilog Antenna	EMCO	3143	1029	20 MHz to 2 GHz
Horn Antenna	EMCO	3155	9701-5061	1 GHz – 18 GHz
Horn Antenna	EMCO	3160-09	1007	18 GHz – 26.5 GHz

**6.9.5. Test Data**

**Remarks:**

- All spurious emissions that are in excess of 20 dB below the specified limit shall be recorded.
- EUT is tested in three orthogonal positions.
- The following test results are the worst-case measurements.
- A duty cycle correction factor of 27% (-11.37dB) shall be applied to a measurement made with an average detector.
- Band-edges compliance condition: EUT connected to antennas via antenna feedline must have a minimum cable loss as specified in the test configurations and the following table.

Antenna Type	Antenna Gain (dBi)	Minimum Required Cable Loss (dB)
Maxrad Yagi	15	0.5
DLink Omni-directional	15	0.5
ARC Panel	19	2.48

**6.9.5.1. EUT with Maxrad Yagi Antenna (15 dBi gain with minimum cable loss of 0.5 dB)**

Fundamental Frequency:		2405 MHz					
Frequency Test Range:		30 MHz – 25 GHz					
Frequency (MHz)	RF Peak Level (dBµV/m)	RF Avg Level (dBµV/m)	Antenna Plane (H/V)	Limit 15.209 (dBµV/m)	Limit 15.247 (dBµV/m)	Margin (dB)	Pass/Fail
2405	122.78	--	V	--	--	--	--
2405	121.70	--	H	--	--	--	--
All spurious emissions are more than 20 dB below the specified limit							

See the following test data plots for band-edge emissions.

**Plot 6.9.5.1.1(i) Band-Edge RF Radiated Emissions @ 3 m**  
 Low End of Frequency Band  
 Rx Antenna Orientation: Horizontal

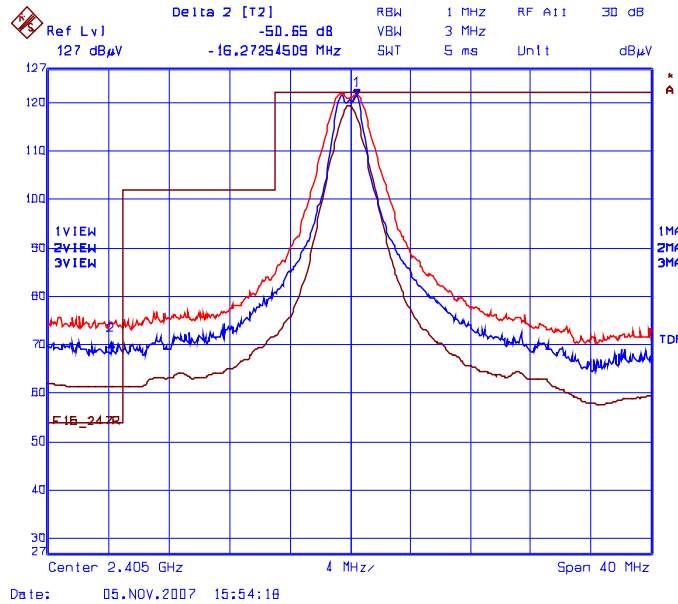

**Plot 6.9.5.1.1(ii) Band-Edge RF Radiated Emissions @ 3 m**  
 Low End of Frequency Band  
 Rx Antenna Orientation: Horizontal

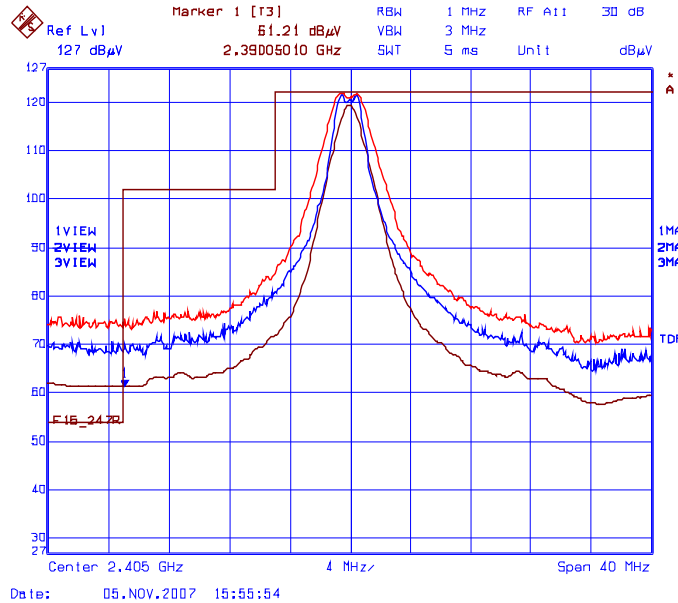

Trace 1: RBW = 1 MHz, VBW = 3 MHz  
 Trace 2: RBW = 500 kHz, VBW = 1 MHz, Delta (Peak to Band-Edge): 50.65 dB  
 Trace 3: RBW = 1 MHz, VBW = 10 Hz  
 Peak Band-Edge at 2390 MHz: Peak = 121.70 dBμV/m – 50.65 dB = 71.05 dBμV/m (limit 74dBuV/m)  
 Average: 61.21 dBμV/m – 11.37dB = 49.84 dBμV/m (limit 54 dBμV/m)

**Plot 6.9.5.1.2(i) Band-Edge RF Radiated Emissions @ 3 m**  
 Low End of Frequency Band  
 Rx Antenna Orientation: Vertical

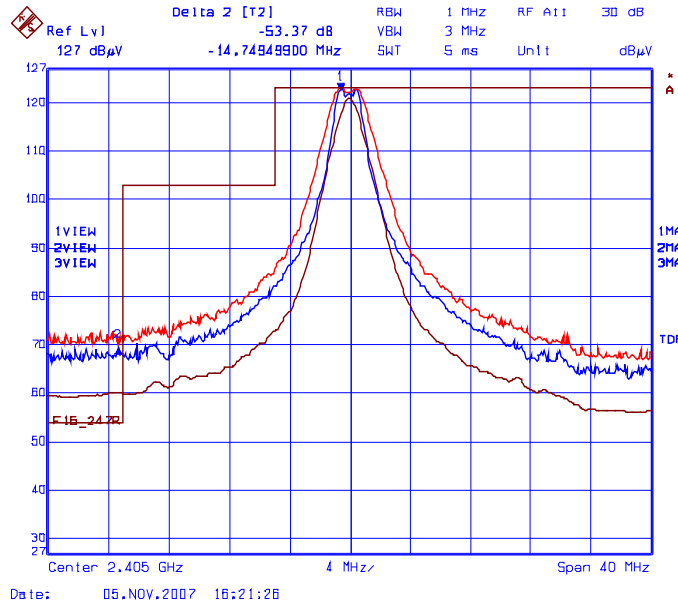

**Plot 6.9.5.1.2(ii) Band-Edge RF Radiated Emissions @ 3 m**  
 Low End of Frequency Band  
 Rx Antenna Orientation: Vertical

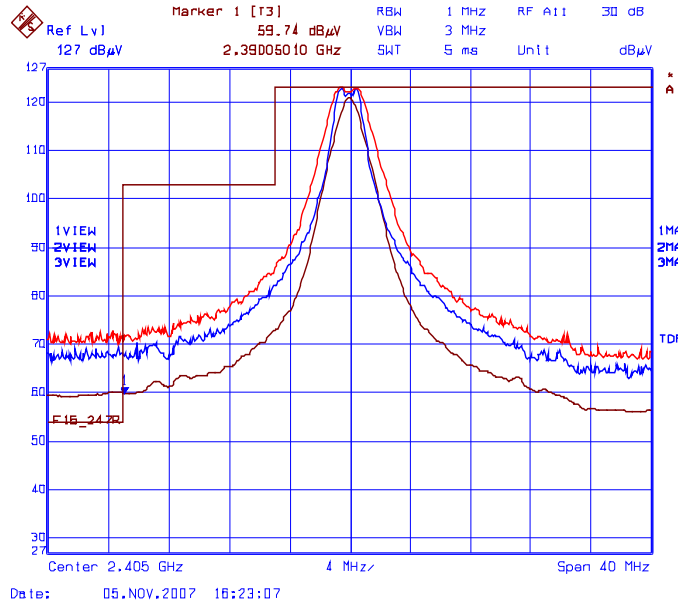

Trace 1: RBW = 1 MHz, VBW = 3 MHz  
 Trace 2: RBW = 500 kHz, VBW = 1 MHz, Delta (Peak to Band-Edge): 53.37 dB  
 Trace 3: RBW = 1 MHz, VBW = 10 Hz  
 Peak Band-Edge at 2390 MHz: Peak = 122.78 dBμV/m – 53.37 dB = 69.41 dBμV/m (limit 74 dBμV/m)  
 Average: 59.74 dBμV/m – 11.37 dB = 48.37 dBμV/m (limit 54 dBμV/m)

Fundamental Frequency: 2440 MHz							
Frequency Test Range: 30 MHz – 25 GHz							
Frequency (MHz)	RF Peak Level (dBµV/m)	RF Avg Level (dBµV/m)	Antenna Plane (H/V)	Limit 15.209 (dBµV/m)	Limit 15.247 (dBµV/m)	Margin (dB)	Pass/Fail
2440	123.09	--	V	--	--	--	--
2440	121.34	--	H	--	--	--	--
12200	58.34	36.00	V	54.00	103.09	-18.00	Pass*

\*Field strength of emissions appearing within restricted frequency bands shall not exceed the limits shown in § 15.209.

Fundamental Frequency: 2470 MHz							
Frequency Test Range: 30 MHz – 25 GHz							
Frequency (MHz)	RF Peak Level (dBµV/m)	RF Avg Level (dBµV/m)	Antenna Plane (H/V)	Limit 15.209 (dBµV/m)	Limit 15.247 (dBµV/m)	Margin (dB)	Pass/Fail
2470	123.24	--	V	--	--	--	--
2470	121.58	--	H	--	--	--	--
12350	58.41	35.27	V	54.0	103.2	-18.7	Pass*
12350	58.03	35.39	H	54.0	103.2	-18.6	Pass*

\*Field strength of emissions appearing within restricted frequency bands shall not exceed the limits shown in § 15.209.

See the following test data plots for band-edge emissions.

**Plot 6.9.5.1.3(i) Band-Edge RF Radiated Emissions @ 3 m**  
 Low End of Frequency Band  
 Rx Antenna Orientation: Horizontal

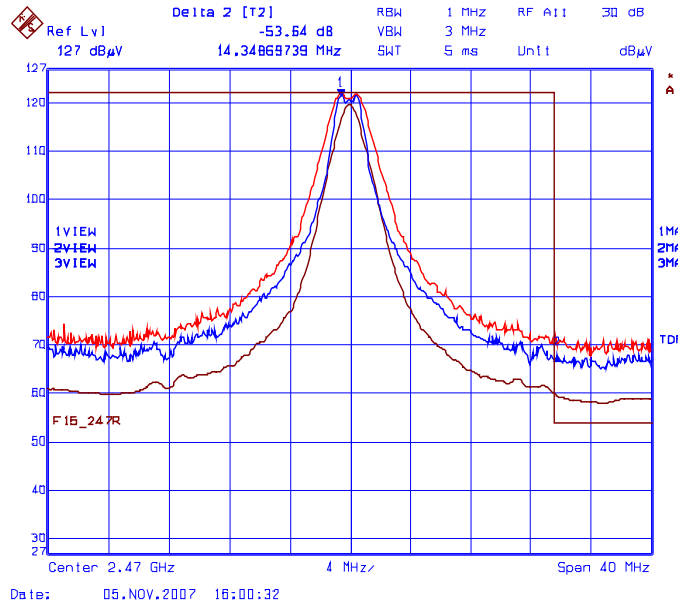

**Plot 6.9.5.1.3(ii) Band-Edge RF Radiated Emissions @ 3 m**  
 Low End of Frequency Band  
 Rx Antenna Orientation: Horizontal

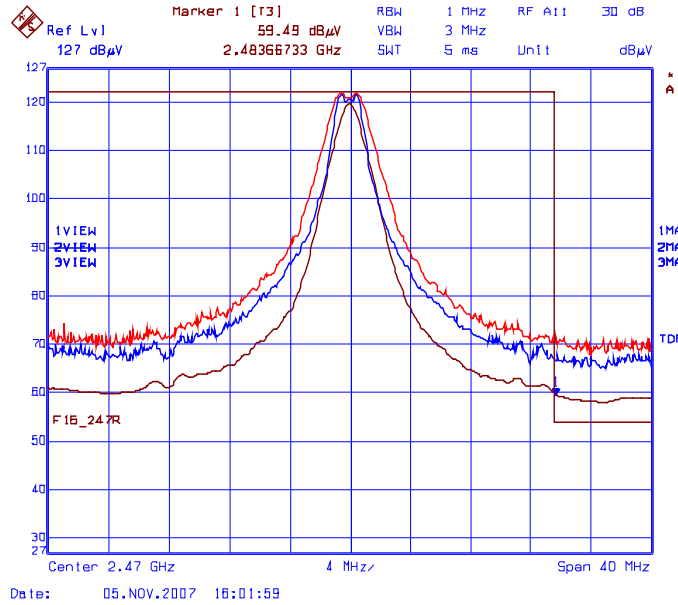

Trace 1: RBW = 1 MHz, VBW = 3 MHz

Trace 2: RBW = 500 kHz, VBW = 1 MHz, Delta (Peak to Band-Edge): 53.64 dB

Trace 3: RBW = 1 MHz, VBW = 10 Hz

Peak Band-Edge at 2483.5 MHz: Peak = 121.58 dBµV/m – 53.64 dB = 67.94 dBµV/m (limit 74 dBµV/m)

Average: 59.49 dBµV/m – 11.37 dB = 48.12 dBµV/m (limit 54 dBµV/m)

**Plot 6.9.5.1.4(i) Band-Edge RF Radiated Emissions @ 3 m**  
 Low End of Frequency Band  
 Rx Antenna Orientation: Vertical

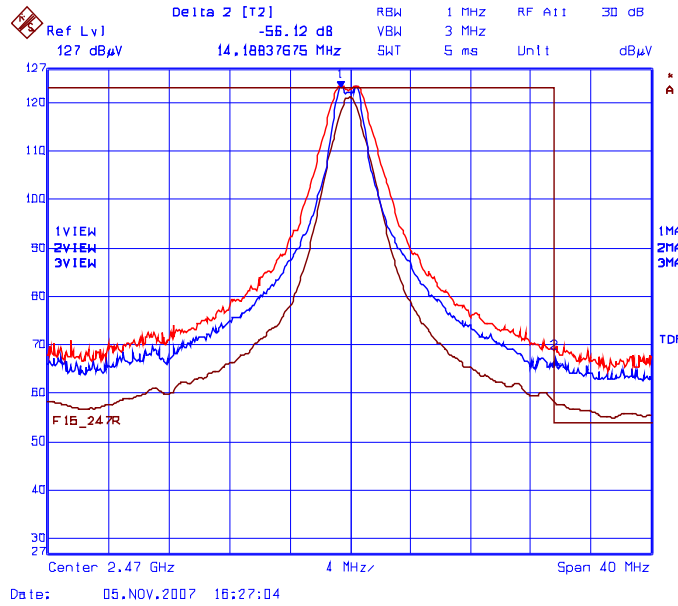

**Plot 6.9.5.1.4(ii) Band-Edge RF Radiated Emissions @ 3 m**  
 Low End of Frequency Band  
 Rx Antenna Orientation: Vertical

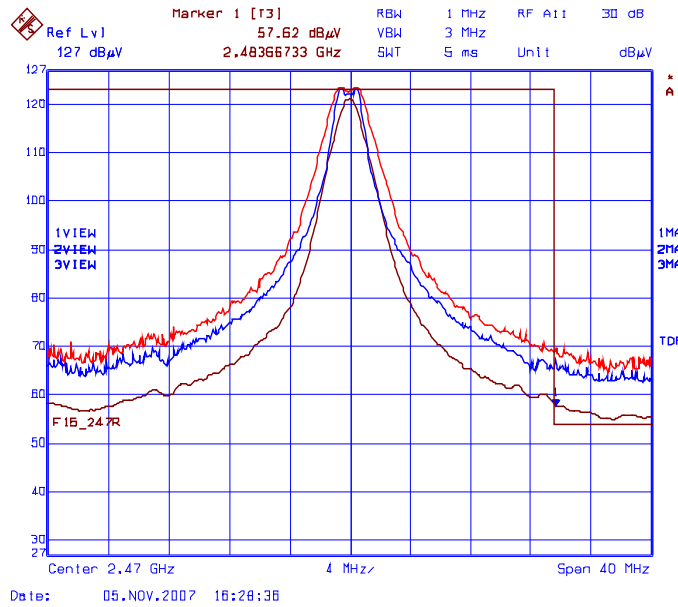

Trace 1: RBW = 1 MHz, VBW = 3 MHz  
 Trace 2: RBW = 500 kHz, VBW = 1 MHz, Delta (Peak to Band-Edge): 56.12 dB  
 Trace 3: RBW = 1 MHz, VBW = 10 Hz  
 Peak Band-Edge at 2483.5 MHz: Peak = 123.24 dBμV/m – 56.12dB = 67.12 dBμV/m (limit 74 dBμV/m)  
 Average: 57.62 dBμV/m – 11.37 dB = 46.25 dBμV/m (limit 54 dBμV/m)



**6.9.5.2. EUT with DLink Omni-directional Antenna (15 dBi gain with minimum cable loss of 0.5 dB)**

Fundamental Frequency: 2405 MHz							
Frequency Test Range: 30 MHz – 25 GHz							
<b>Frequency (MHz)</b>	<b>RF Peak Level (dBµV/m)</b>	<b>RF Avg Level (dBµV/m)</b>	<b>Antenna Plane (H/V)</b>	<b>Limit 15.209 (dBµV/m)</b>	<b>Limit 15.247 (dBµV/m)</b>	<b>Margin (dB)</b>	<b>Pass/Fail</b>
2405	119.94	--	V	--	--	--	--
2405	119.34	--	H	--	--	--	--
All spurious emissions are more than 20 dB below the specified limit							

See the following test data plots for band-edge emissions.

**Plot 6.9.5.2.1(i) Band-Edge RF Radiated Emissions @ 3 m**  
 Low End of Frequency Band  
 Rx Antenna Orientation: Horizontal

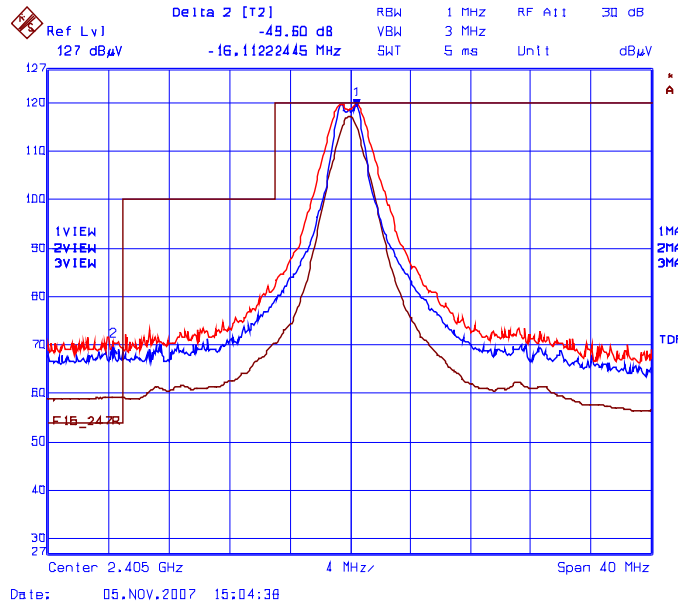

**Plot 6.9.5.2.1(ii) Band-Edge RF Radiated Emissions @ 3 m**  
 Low End of Frequency Band  
 Rx Antenna Orientation: Horizontal

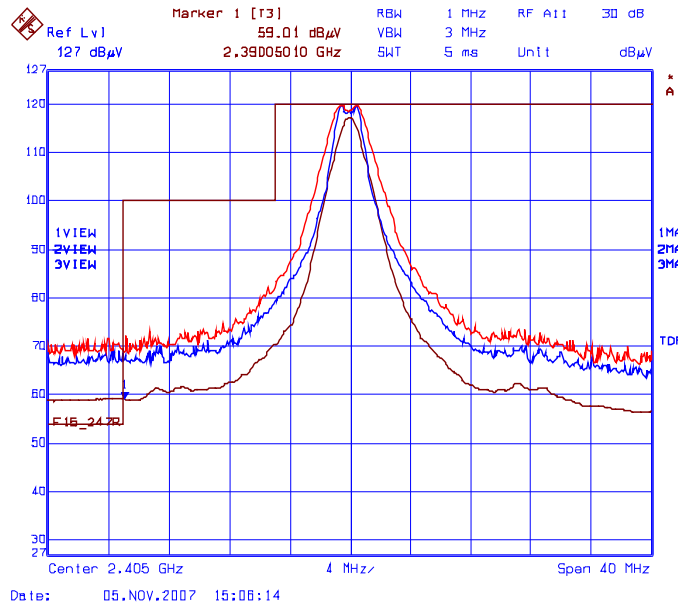

Trace 1: RBW = 1 MHz, VBW = 3 MHz  
 Trace 2: RBW = 500 kHz, VBW = 1 MHz, Delta (Peak to Band-Edge): 49.60 dB  
 Trace 3: RBW = 1 MHz, VBW = 10 Hz  
 Peak Band-Edge at 2390 MHz: Peak = 119.34 dBμV/m – 49.60 dB = 69.74 dBμV/m (limit 74 dBμV/m)  
 Average: 59.01 dBμV/m – 11.37 dB = 47.64 dBμV/m (limit 54 dBμV/m)

**Plot 6.9.5.2.2(i) Band-Edge RF Radiated Emissions @ 3 m**  
 Low End of Frequency Band  
 Rx Antenna Orientation: Vertical

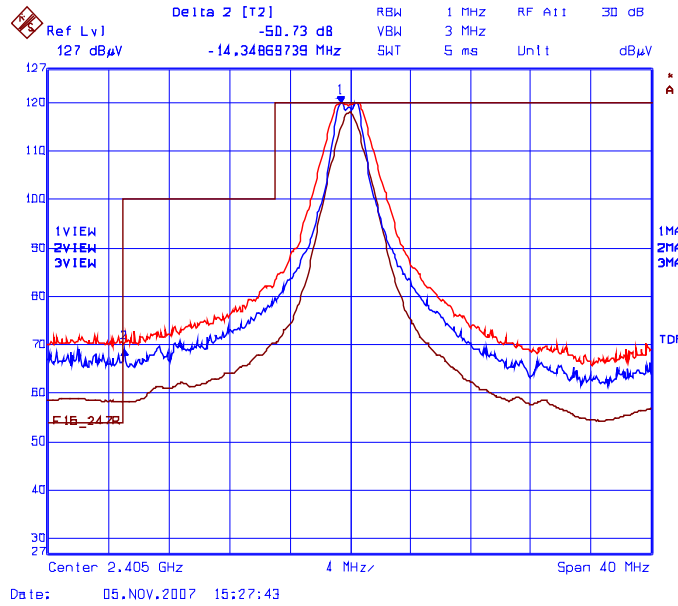

**Plot 6.9.5.2.2(ii) Band-Edge RF Radiated Emissions @ 3 m**  
 Low End of Frequency Band  
 Rx Antenna Orientation: Vertical

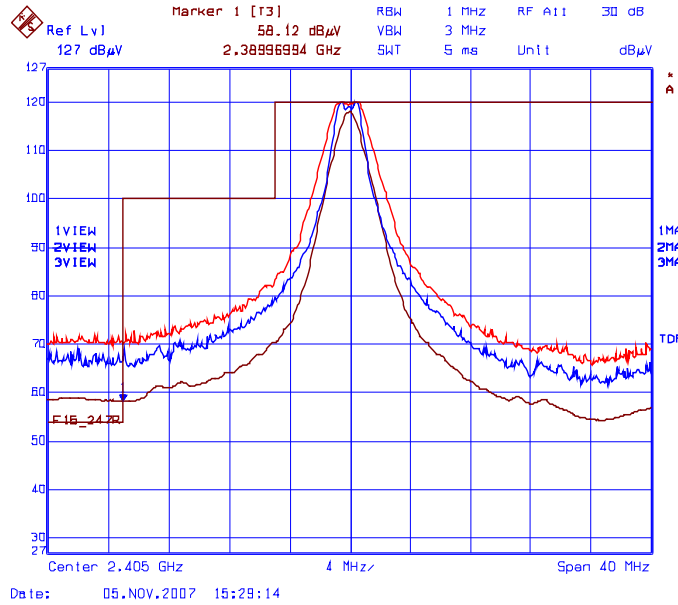

Trace 1: RBW = 1 MHz, VBW = 3 MHz  
 Trace 2: RBW = 500 kHz, VBW = 1 MHz, Delta (Peak to Band-Edge): 50.73 dB  
 Trace 3: RBW = 1 MHz, VBW = 10 Hz  
 Peak Band-Edge at 2390 MHz: Peak = 119.94 dBμV/m – 50.73 dB = 69.21 dBμV/m (limit 74 dBμV/m)  
 Average: 58.12 dBμV/m – 11.37 dB = 46.75 dBμV/m (limit 54 dBμV/m)

Fundamental Frequency: 2440 MHz							
Frequency Test Range: 30 MHz – 25 GHz							
Frequency (MHz)	RF Peak Level (dBµV/m)	RF Avg Level (dBµV/m)	Antenna Plane (H/V)	Limit 15.209 (dBµV/m)	Limit 15.247 (dBµV/m)	Margin (dB)	Pass/Fail
2440	119.45	--	V	--	--	--	--
2440	118.26	--	H	--	--	--	--
12200	58.16	34.82	V	54.00	99.45	-19.18	Pass*
12200	57.78	35.74	H	54.00	99.45	-18.26	Pass*

\*Field strength of emissions appearing within restricted frequency bands shall not exceed the limits shown in § 15.209.

Fundamental Frequency: 2470 MHz							
Frequency Test Range: 30 MHz – 25 GHz							
Frequency (MHz)	RF Peak Level (dBµV/m)	RF Avg Level (dBµV/m)	Antenna Plane (H/V)	Limit 15.209 (dBµV/m)	Limit 15.247 (dBµV/m)	Margin (dB)	Pass/Fail
2440	119.59	--	V	--	--	--	--
2440	117.81	--	H	--	--	--	--
12350	58.10	34.94	V	54.0	99.6	-19.1	Pass*
12350	60.15	37.21	H	54.0	99.6	-16.8	Pass*

\*Field strength of emissions appearing within restricted frequency bands shall not exceed the limits shown in § 15.209.

See the following test data plots for band-edge emissions.

**Plot 6.9.5.2.3(i) Band-Edge RF Radiated Emissions @ 3 m**  
 Low End of Frequency Band  
 Rx Antenna Orientation: Horizontal

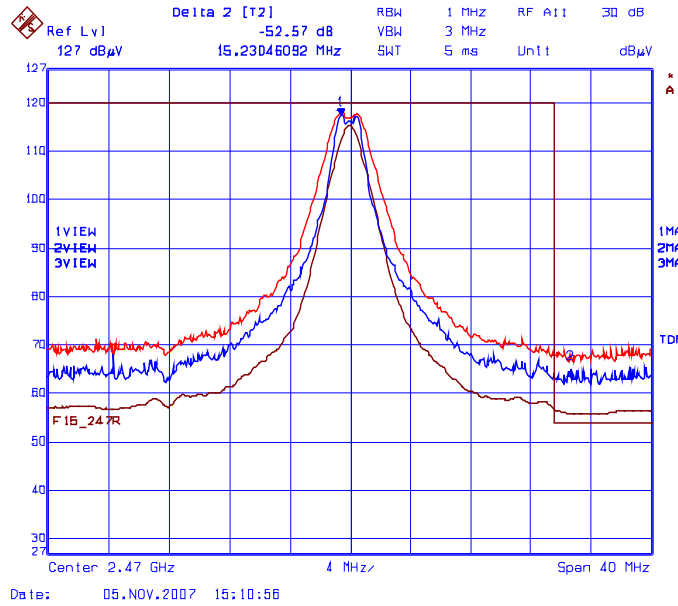

**Plot 6.9.5.2.3(ii) Band-Edge RF Radiated Emissions @ 3 m**  
 Low End of Frequency Band  
 Rx Antenna Orientation: Horizontal

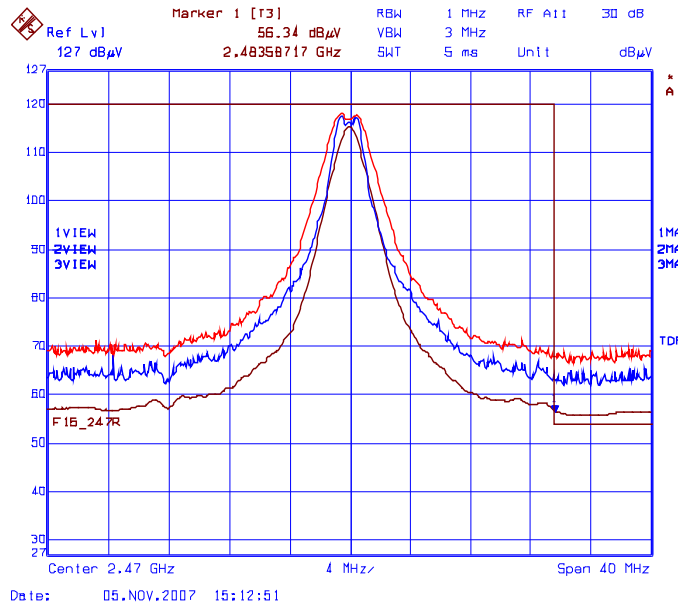

Trace 1: RBW = 1 MHz, VBW = 3 MHz

Trace 2: RBW = 500 kHz, VBW = 1 MHz, Delta (Peak to Band-Edge): 52.57 dB

Trace 3: RBW = 1 MHz, VBW = 10 Hz

Peak Band-Edge at 2438.5 MHz: Peak = 117.81 dBµV/m – 52.57dB = 65.24 dBµV/m (limit 74 dBµV/m)

Average: 56.34 dBµV/m – 11.37 dB = 44.97 dBµV/m (limit 54 dBµV/m)

**ULTRATECH GROUP OF LABS**

3000 Bristol Circle, Oakville, Ontario, Canada L6H 6G4

Tel. #: 905-829-1570, Fax. #: 905-829-8050, Email: [vic@ultratech-labs.com](mailto:vic@ultratech-labs.com), Website: <http://www.ultratech-labs.com>

File #: DIGI-003F15C247

November 6, 2007

All test results contained in this engineering test report are traceable to National Institute of Standards and Technology (NIST)

**Plot 6.9.5.2.4(i) Band-Edge RF Radiated Emissions @ 3 m**  
 Low End of Frequency Band  
 Rx Antenna Orientation: Vertical

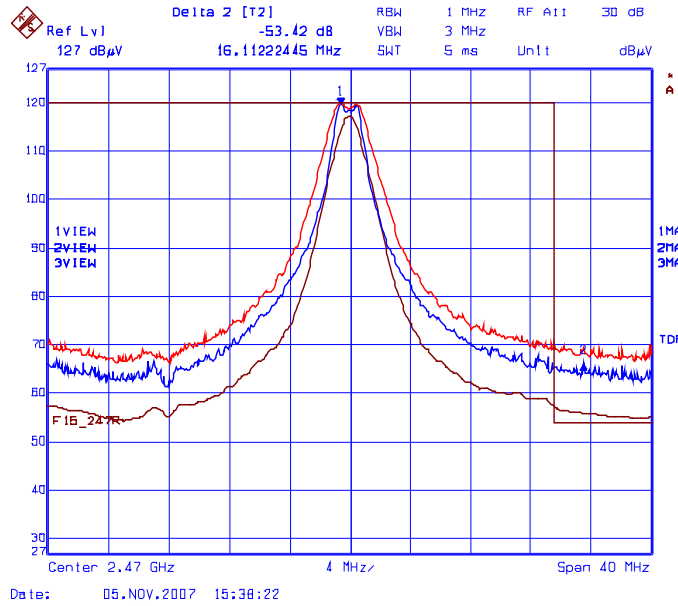

**Plot 6.9.5.2.4(ii) Band-Edge RF Radiated Emissions @ 3 m**  
 Low End of Frequency Band  
 Rx Antenna Orientation: Vertical

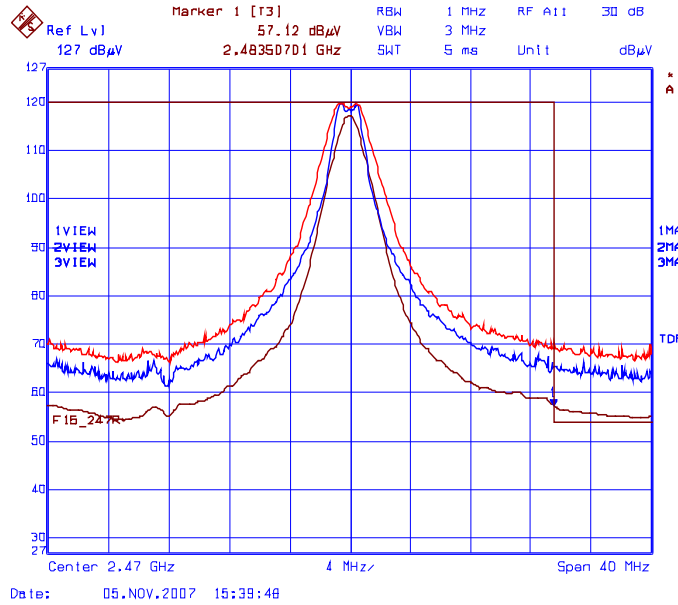

Trace 1: RBW = 1 MHz, VBW = 3 MHz

Trace 2: RBW = 500 kHz, VBW = 1 MHz, Delta (Peak to Band-Edge): 53.42 dB

Trace 3: RBW = 1 MHz, VBW = 10 Hz

Peak Band-Edge at 2438.5 MHz: Peak = 119.59 dBµV/m – 53.42 dB = 66.17 dBµV/m (limit 74 dBµV/m)

Average: 57.12 dBµV/m – 11.37 dB = 45.75 dBµV/m (limit 54 dBµV/m)

**ULTRATECH GROUP OF LABS**

3000 Bristol Circle, Oakville, Ontario, Canada L6H 6G4

Tel. #: 905-829-1570, Fax. #: 905-829-8050, Email: [vic@ultratech-labs.com](mailto:vic@ultratech-labs.com), Website: <http://www.ultratech-labs.com>

File #: DIGI-003F15C247

November 6, 2007

All test results contained in this engineering test report are traceable to National Institute of Standards and Technology (NIST)

**6.9.5.3. EUT with ARC Panel Antenna (19 dBi gain with minimum cable loss of 2.48 dB)**

Fundamental Frequency: 2405 MHz							
Frequency Test Range: 30 MHz – 25 GHz							
<b>Frequency (MHz)</b>	<b>RF Peak Level (dBµV/m)</b>	<b>RF Avg Level (dBµV/m)</b>	<b>Antenna Plane (H/V)</b>	<b>Limit 15.209 (dBµV/m)</b>	<b>Limit 15.247 (dBµV/m)</b>	<b>Margin (dB)</b>	<b>Pass/Fail</b>
2405	123.01	--	V	--	--	--	--
2405	123.22	--	H	--	--	--	--
All spurious emissions are more than 20 dB below the specified limit							

See the following test data plots for band-edge emissions.

**Plot 6.9.5.3.1(i) Band-Edge RF Radiated Emissions @ 3 m**  
 Low End of Frequency Band  
 Rx Antenna Orientation: Horizontal

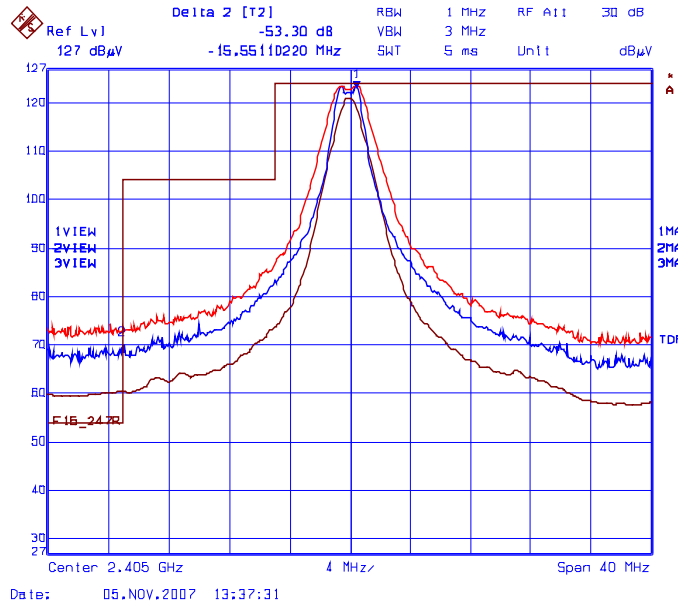

**Plot 6.9.5.3.1(ii) Band-Edge RF Radiated Emissions @ 3 m**  
 Low End of Frequency Band  
 Rx Antenna Orientation: Horizontal

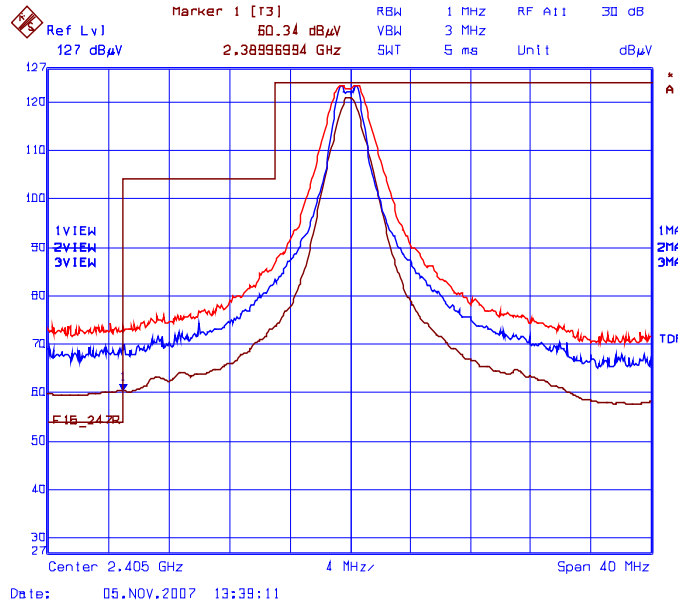

Trace 1: RBW = 1 MHz, VBW = 3 MHz  
 Trace 2: RBW = 500 kHz, VBW = 1 MHz, Delta (Peak to Band-Edge): 53.30 dB  
 Trace 3: RBW = 1 MHz, VBW = 10 Hz  
 Peak Band-Edge at 2390 MHz: Peak = 123.22 dBμV/m – 53.30 dB = 69.92 dBμV/m (limit 74 dBμV/m)  
 Average: 60.34 dBμV/m – 11.37 dB = 48.97 dBμV/m (limit 54 dBμV/m)



**Plot 6.9.5.3.2(i) Band-Edge RF Radiated Emissions @ 3 m**  
 Low End of Frequency Band  
 Rx Antenna Orientation: Vertical

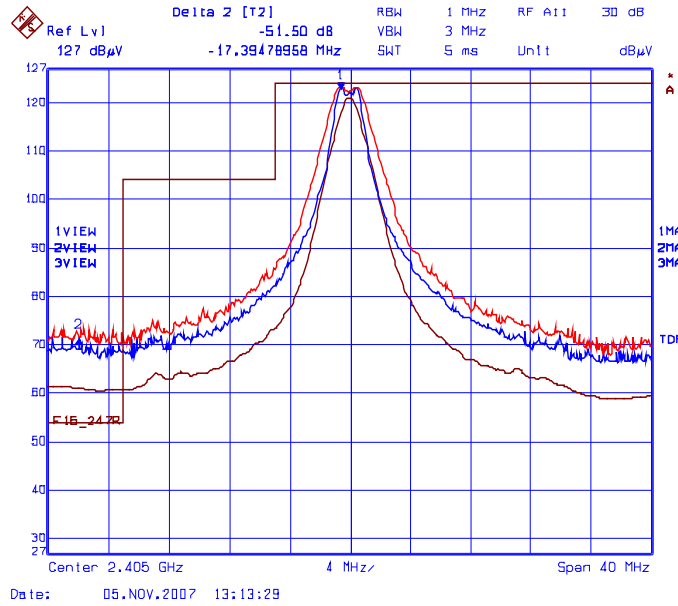

**Plot 6.9.5.3.2(ii) Band-Edge RF Radiated Emissions @ 3 m**  
 Low End of Frequency Band  
 Rx Antenna Orientation: Vertical

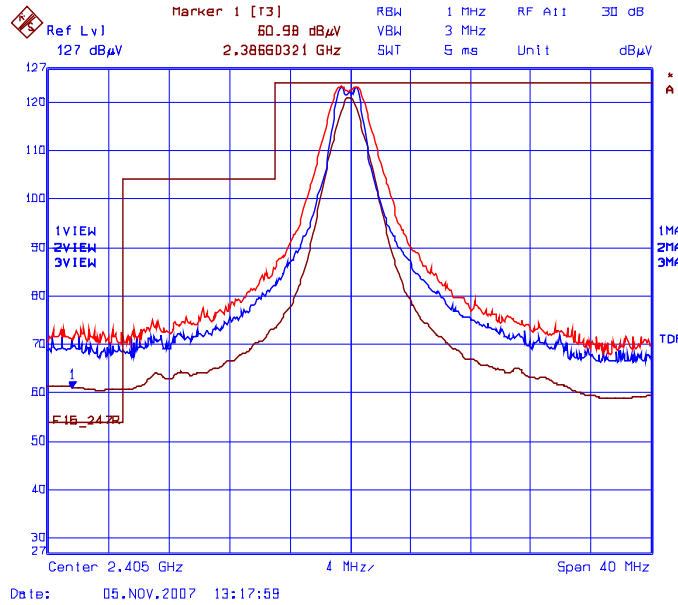

Trace 1: RBW = 1 MHz, VBW = 3 MHz  
 Trace 2: RBW = 500 kHz, VBW = 1 MHz, Delta (Peak to Band-Edge): 51.50 dB  
 Trace 3: RBW = 1 MHz, VBW = 10 Hz  
 Peak Band-Edge at 2390 MHz: Peak = 123.01dBuV/m – 51.50 dB = 71.51 dBμV/m (limit 74 dBμV/m)  
 Average: 60.98 dBμV/m – 11.37 dB = 49.61 dBμV/m (limit 54 dBμV/m)

Fundamental Frequency: 2440 MHz							
Frequency Test Range: 30 MHz – 25 GHz							
Frequency (MHz)	RF Peak Level (dBµV/m)	RF Avg Level (dBµV/m)	Antenna Plane (H/V)	Limit 15.209 (dBµV/m)	Limit 15.247 (dBµV/m)	Margin (dB)	Pass/Fail
2440	123.27	--	V	--	--	--	--
2440	123.55	--	H	--	--	--	--
12200	57.77	34.09	V	54.00	103.55	-19.91	Pass*
12200	58.89	34.89	H	54.00	103.55	-19.11	Pass*

\*Field strength of emissions appearing within restricted frequency bands shall not exceed the limits shown in § 15.209.

Fundamental Frequency: 2470 MHz							
Frequency Test Range: 30 MHz – 25 GHz							
Frequency (MHz)	RF Peak Level (dBµV/m)	RF Avg Level (dBµV/m)	Antenna Plane (H/V)	Limit 15.209 (dBµV/m)	Limit 15.247 (dBµV/m)	Margin (dB)	Pass/Fail
2470	123.56	--	V	--	--	--	--
2470	123.71	--	H	--	--	--	--
12350	59.09	36.25	V	54.0	103.7	-17.8	Pass*
12350	58.79	36.02	H	54.0	103.7	-18.0	Pass*

\*Field strength of emissions appearing within restricted frequency bands shall not exceed the limits shown in § 15.209.

See the following test data plots for band-edge emissions.

**Plot 6.9.5.3.3(i) Band-Edge RF Radiated Emissions @ 3 m**  
 Low End of Frequency Band  
 Rx Antenna Orientation: Horizontal

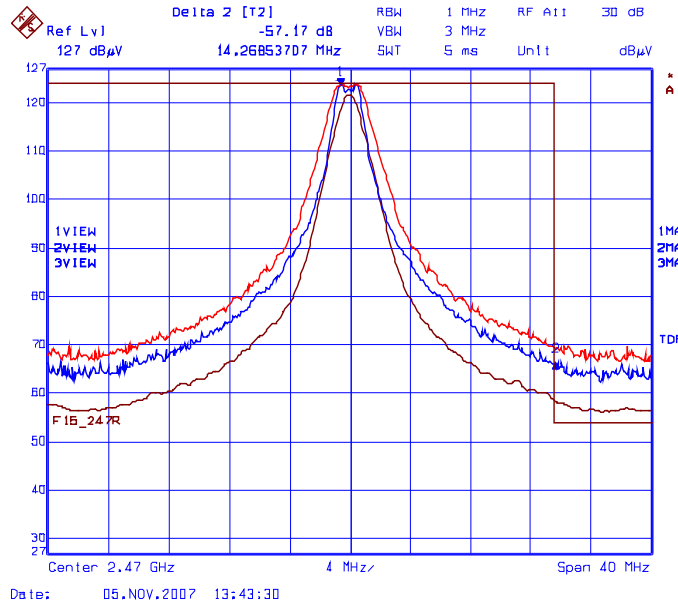

**Plot 6.9.5.3.3(ii) Band-Edge RF Radiated Emissions @ 3 m**  
 Low End of Frequency Band  
 Rx Antenna Orientation: Horizontal

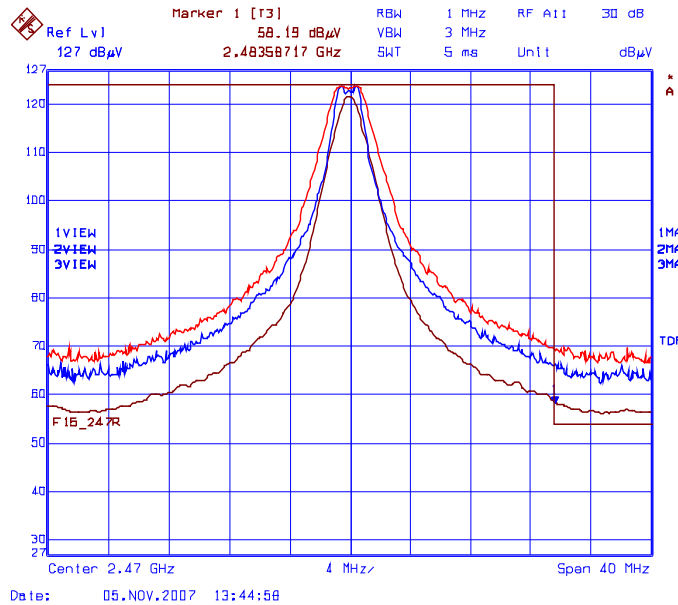

Trace 1: RBW = 1 MHz, VBW = 3 MHz  
 Trace 2: RBW = 500 kHz, VBW = 1 MHz, Delta (Peak to Band-Edge): 57.17 dB  
 Trace 3: RBW = 1 MHz, VBW = 10 Hz  
 Peak Band-Edge at 2483.5 MHz: Peak = 123.71 dBμV/m – 57.17 dB = 66.54 dBμV/m (limit 74 dBμV/m)  
 Average: 58.19 dBμV/m – 11.37 dB = 46.82 dBμV/m (limit 54 dBμV/m)

**Plot 6.9.5.3.4(i) Band-Edge RF Radiated Emissions @ 3 m**  
 Low End of Frequency Band  
 Rx Antenna Orientation: Vertical

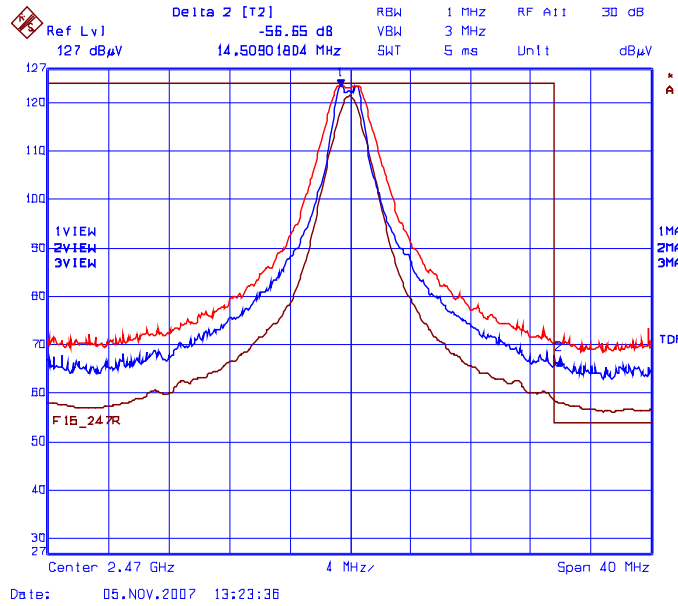

**Plot 6.9.5.3.4(ii) Band-Edge RF Radiated Emissions @ 3 m**  
 Low End of Frequency Band  
 Rx Antenna Orientation: Vertical

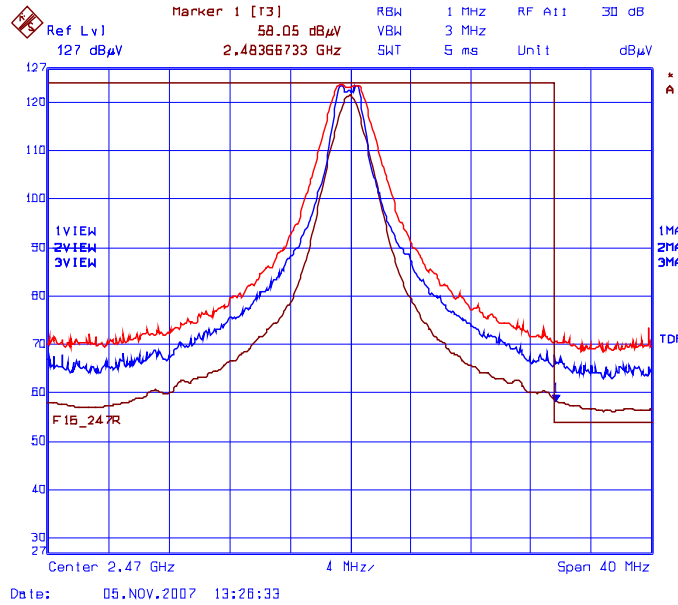

Trace 1: RBW = 1 MHz, VBW = 3 MHz  
 Trace 2: RBW = 500 kHz, VBW = 1 MHz, Delta (Peak to Band-Edge): 56.65 dB  
 Trace 3: RBW = 1 MHz, VBW = 10 Hz  
 Peak Band-Edge at 2483.5 MHz: Peak = 123.56 dBμV/m – 56.65dB = 66.91 dBμV/m (limit 74 dBμV/m)  
 Average: 58.05 dBμV/m – 11.37 dB = 46.68 dBμV/m (limit 54 dBμV/m)

## 6.10. POWER SPECTRAL DENSITY [§ 15.247(e)]

### 6.10.1. Limit(s)

For digitally modulated systems, the power spectral density conducted from the intentional radiator to the antenna shall not be greater than 8 dBm in any 3 kHz band during any time interval of continuous transmission.

### 6.10.2. Method of Measurements

KDB Publication No. 558074: Guidance on Measurements for Digital Transmission Systems (47 CFR 15.247), PSD Option 1 method.

### 6.10.3. Test Arrangement

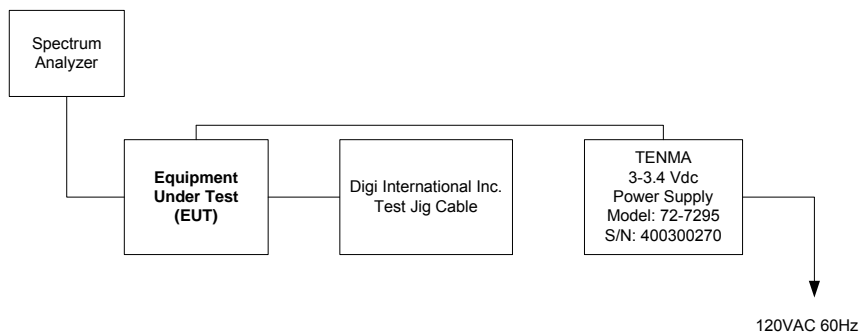

### 6.10.4. Test Equipment List

Test Instruments	Manufacturer	Model No.	Serial No.	Frequency Range
Spectrum Analyzer	Rhode & Schwarz	FSEK 30	100077	20 Hz - 40 GHz

### 6.10.5. Test Data

Remark: Measurement method: Power spectral density (PSD) Option 1.

Frequency (MHz)	*PSD in 3 kHz BW (dBm)	Limit (dBm)	Margin (dB)	Comments (Pass/Fail)
2405	2.70	8	-5.30	Pass
2440	2.88	8	-5.12	Pass
2470	3.35	8	-4.65	Pass

\*See the following plots for measurement details.

Plot 6.10.5.1 Power Spectral Density  
Frequency: 2405 MHz

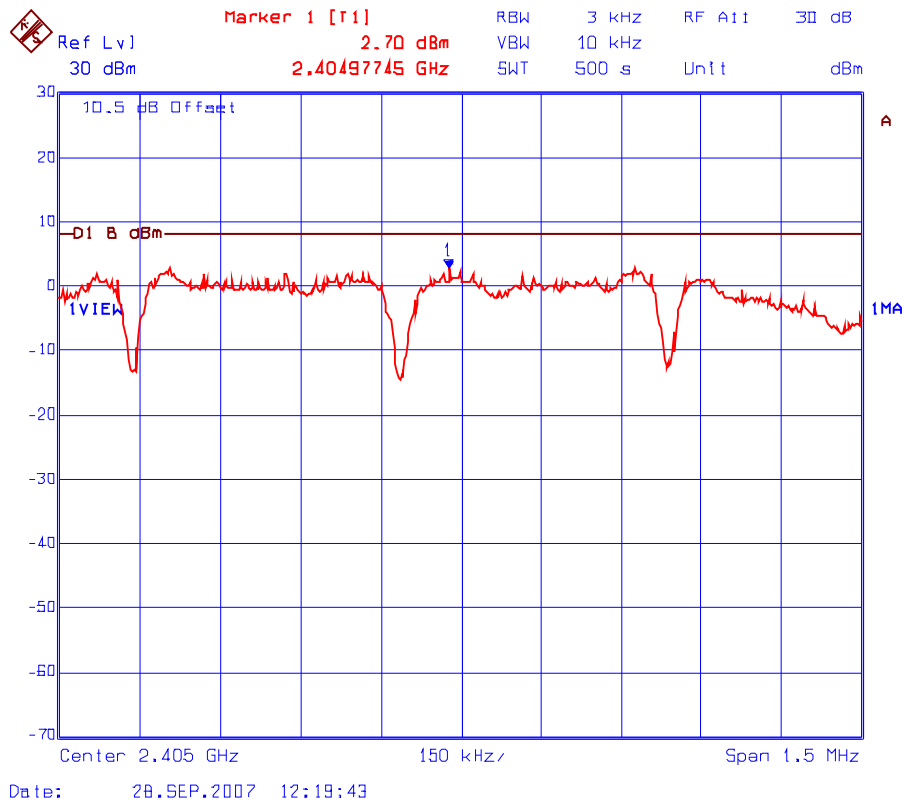

Plot 6.10.5.2 Power Spectral Density  
Frequency: 2440 MHz

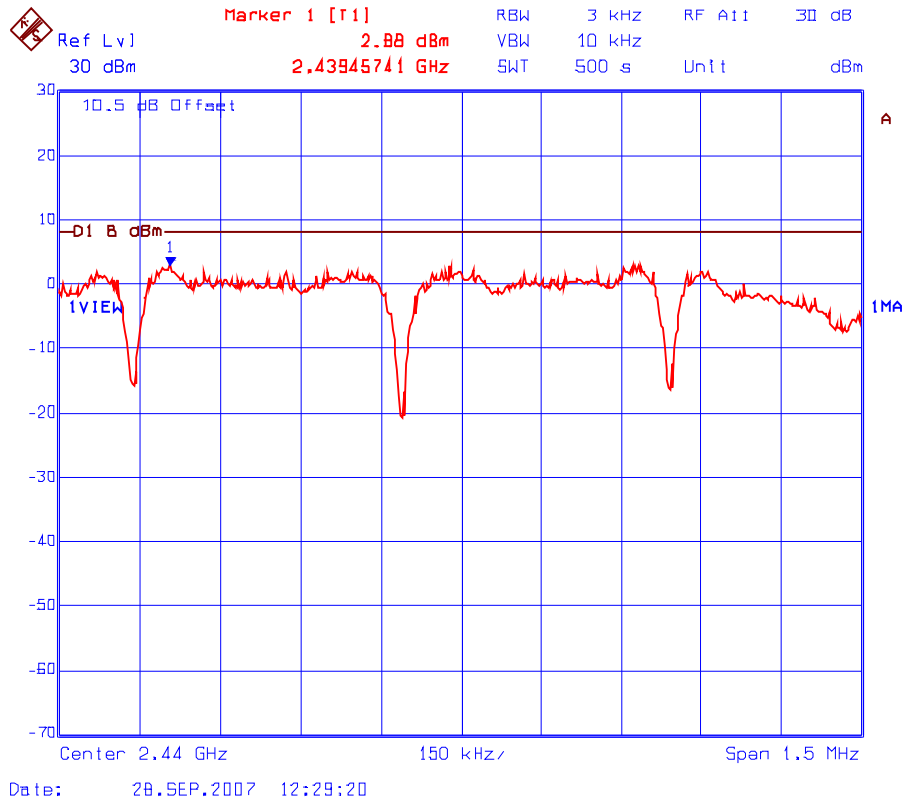

Plot 6.10.5.3 Power Spectral Density  
Frequency: 2470 MHz

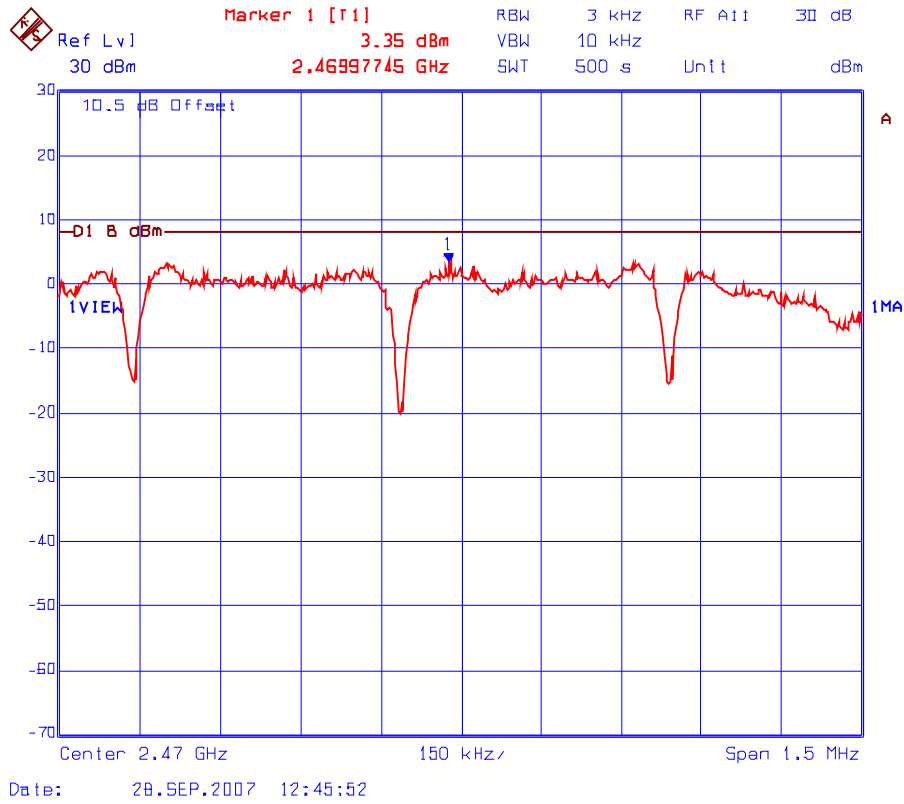



### 6.11. RF EXPOSURE REQUIRMENTS [§§ 15.247(e)(i), 1.1310 & 2.1091]

The criteria listed in the following table shall be used to evaluate the environmental impact of human exposure to radio-frequency (RF) radiation.

#### FCC 47 CFR § 1.1310:

TABLE 1—LIMITS FOR MAXIMUM PERMISSIBLE EXPOSURE (MPE)

Frequency range (MHz)	Electric field strength (V/m)	Magnetic field strength (A/m)	Power density (mW/cm <sup>2</sup> )	Averaging time (minutes)
<b>(A) Limits for Occupational/Controlled Exposures</b>				
0.3–3.0 .....	614	1.63	*(100)	6
3.0–30 .....	1842/f	4.89/f	*(900/f <sup>2</sup> )	6
30–300 .....	61.4	0.163	1.0	6
300–1500 .....	.....	.....	f/300	6
1500–100,000 .....	.....	.....	5	6
<b>(B) Limits for General Population/Uncontrolled Exposure</b>				
0.3–1.34 .....	614	1.63	*(100)	30
1.34–30 .....	824/f	2.19/f	*(180/f <sup>2</sup> )	30
30–300 .....	27.5	0.073	0.2	30
300–1500 .....	.....	.....	f/1500	30
1500–100,000 .....	.....	.....	1.0	30

f = frequency in MHz

\* = Plane-wave equivalent power density

NOTE 1 TO TABLE 1: Occupational/controlled limits apply in situations in which persons are exposed as a consequence of their employment provided those persons are fully aware of the potential for exposure and can exercise control over their exposure. Limits for occupational/controlled exposure also apply in situations when an individual is transient through a location where occupational/controlled limits apply provided he or she is made aware of the potential for exposure.

NOTE 2 TO TABLE 1: General population/uncontrolled exposures apply in situations in which the general public may be exposed, or in which persons that are exposed as a consequence of their employment may not be fully aware of the potential for exposure or can not exercise control over their exposure.

#### 6.11.1. Method of Measurements

Refer to Sections 1.1310, 2.1091

In order to demonstrate compliance with MPE requirements (see Section 2.1091), the following information is typically needed:

- (1) Calculation that estimates the minimum separation distance (20 cm or more) between an antenna and persons required to satisfy power density limits defined for free space.
- (2) Antenna installation and device operating instructions for installers (professional/unskilled users), and the parties responsible for ensuring compliance with the RF exposure requirement
- (3) Any caution statements and/or warning labels that are necessary in order to comply with the exposure limits
- (4) Any other RF exposure related issues that may affect MPE compliance

**Calculation Method of RF Safety Distance:**

$$S = PG/4\pi r^2 = EIRP/4\pi r^2$$

Where: P: power input to the antenna in mW  
 EIRP: Equivalent (effective) isotropic radiated power  
 S: power density mW/cm<sup>2</sup>  
 G: numeric gain of antenna relative to isotropic radiator  
 r: distance to centre of radiation in cm

$$r = \sqrt{EIRP/4\pi S}$$

**6.11.2. RF Evaluation**

Evaluation of RF Exposure Compliance Requirements	
RF Exposure Requirements	Compliance with FCC Rules
Minimum calculated separation distance between antenna and persons required: <b>*18 cm</b>	Manufacturer' instruction for separation distance between antenna and persons required: <b>20 cm.</b>
Antenna installation and device operating instructions for installers (professional/unskilled users), and the parties responsible for ensuring compliance with the RF exposure requirement	Antenna installation and device operating instructions shall be provided to installers to maintain and ensure compliance with RF exposure requirements.
Caution statements and/or warning labels that are necessary in order to comply with the exposure limits	Refer to User's Manual for RF Exposure Information.
Any other RF exposure related issues that may affect MPE compliance	None.

\*The minimum separation distance between the antenna and bodies of users are calculated using the following formula:

$$\text{RF EXPOSURE DISTANCE LIMITS: } r = (PG/4\pi S)^{1/2} = (EIRP/4\pi S)^{1/2}$$

$$S = 1.0 \text{ mW/cm}^2$$

$$EIRP = 36 \text{ dBm} = 10^{3.6} \text{ mW (assuming worst case)}$$

$$r = (EIRP/4\pi S)^{1/2} = (10^{3.6/10} / 4\pi(1.0))^{1/2} = 18 \text{ cm}$$

## EXHIBIT 7. MEASUREMENT UNCERTAINTY

The measurement uncertainties stated were calculated in accordance with the requirements of NIST Technical Note 1297 and NIS 81 (1994)

### 7.1. LINE CONDUCTED EMISSION MEASUREMENT UNCERTAINTY

CONTRIBUTION (Line Conducted)	PROBABILITY DISTRIBUTION	UNCERTAINTY (dB)	
		9-150 kHz	0.15-30 MHz
EMI Receiver specification	Rectangular	$\pm 1.5$	$\pm 1.5$
LISN coupling specification	Rectangular	$\pm 1.5$	$\pm 1.5$
Cable and Input Transient Limiter calibration	Normal (k=2)	$\pm 0.3$	$\pm 0.5$
Mismatch: Receiver VRC $\Gamma_1 = 0.03$ LISN VRC $\Gamma_R = 0.8(9 \text{ kHz}) 0.2 (30 \text{ MHz})$ Uncertainty limits $20\text{Log}(1 \pm \Gamma_1 \Gamma_R)$	U-Shaped	$\pm 0.2$	$\pm 0.3$
System repeatability	Std. deviation	$\pm 0.2$	$\pm 0.05$
Repeatability of EUT	--	--	--
Combined standard uncertainty	Normal	$\pm 1.25$	$\pm 1.30$
Expanded uncertainty U	Normal (k=2)	$\pm 2.50$	$\pm 2.60$

Sample Calculation for Measurement Accuracy in 450 kHz to 30 MHz Band:

$$u_c(y) = \sqrt{\sum_{i=1}^m u_i^2(y)} = \pm \sqrt{(1.5^2 + 1.5^2)/3 + (0.5/2)^2 + (0.05/2)^2 + 0.35^2} = \pm 1.30 \text{ dB}$$

$$U = 2u_c(y) = \pm 2.6 \text{ dB}$$

## 7.2. RADIATED EMISSION MEASUREMENT UNCERTAINTY

CONTRIBUTION (Radiated Emissions)	PROBABILITY DISTRIBUTION	UNCERTAINTY ( $\pm$ dB)	
		3 m	10 m
Antenna Factor Calibration	Normal (k=2)	$\pm 1.0$	$\pm 1.0$
Cable Loss Calibration	Normal (k=2)	$\pm 0.3$	$\pm 0.5$
EMI Receiver specification	Rectangular	$\pm 1.5$	$\pm 1.5$
Antenna Directivity	Rectangular	+0.5	+0.5
Antenna factor variation with height	Rectangular	$\pm 2.0$	$\pm 0.5$
Antenna phase center variation	Rectangular	0.0	$\pm 0.2$
Antenna factor frequency interpolation	Rectangular	$\pm 0.25$	$\pm 0.25$
Measurement distance variation	Rectangular	$\pm 0.6$	$\pm 0.4$
Site imperfections	Rectangular	$\pm 2.0$	$\pm 2.0$
Mismatch: Receiver VRC $\Gamma_1 = 0.2$ Antenna VRC $\Gamma_R = 0.67$ (Bi) 0.3 (Lp) Uncertainty limits $20\text{Log}(1+\Gamma_1\Gamma_R)$	U-Shaped	+1.1 -1.25	$\pm 0.5$
System repeatability	Std. Deviation	$\pm 0.5$	$\pm 0.5$
Repeatability of EUT		-	-
Combined standard uncertainty	Normal	+2.19 / -2.21	+1.74 / -1.72
Expanded uncertainty U	Normal (k=2)	+4.38 / -4.42	+3.48 / -3.44

Calculation for maximum uncertainty when 3m biconical antenna including a factor of k = 2 is used:

$$U = 2u_c(y) = 2x(+2.19) = +4.38 \text{ dB} \quad \text{And} \quad U = 2u_c(y) = 2x(-2.21) = -4.42 \text{ dB}$$