

ENGINEERING TEST REPORT

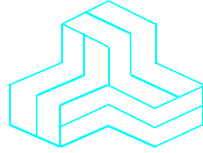

XBee3
Model: XBEE3
FCC ID: MCQ-XBEE3
Host Product: XBee 3 USB Adapter Pro

Applicant:

Digi International Inc
9350 Excelsior Blvd. Suite 700
Hopkins, MN 55343

In Accordance With

Federal Communications Commission (FCC)
Part 15, Subpart C, Section 15.247
Digital Modulation Systems (DTS) Operating in 2400 – 2483.5 MHz Band

UltraTech's File No.: 19DIGI160_FCC15C247Z

This Test report is Issued under the Authority of
Tri M. Luu
Vice President of Engineering
UltraTech Group of Labs

Date: December 17, 2019

Report Prepared by: Dan Huynh

Tested by: Hung Trinh

Issued Date: December 17, 2019

Test Dates: September 27 - November 27, 2019

- *The results in this Test Report apply only to the sample(s) tested, and the sample tested is randomly selected.*
- *This report must not be used by the client to claim product endorsement by any agency of the US Government.*
- *This test report shall not be reproduced, except in full, without a written approval from UltraTech*

UltraTech

3000 Bristol Circle, Oakville, Ontario, Canada L6H 6G4
Tel.: (905) 829-1570 Fax.: (905) 829-8050
Website: www.ultratech-labs.com, Email: vic@ultratech-labs.com, Email: tri@ultratech-labs.com



APEC TEL CA0001



1309



CA 0001/2049



AT-1945



SL2-IN-E-1119R



Korea KCC-RRA
CA2049

TABLE OF CONTENTS

EXHIBIT 1. INTRODUCTION..... 1

1.1. SCOPE 1

1.2. RELATED SUBMITTAL(S)/GRANT(S) 1

1.3. NORMATIVE REFERENCES 1

EXHIBIT 2. PERFORMANCE ASSESSMENT 2

2.1. CLIENT INFORMATION 2

2.2. EQUIPMENT UNDER TEST (EUT) INFORMATION 2

2.3. EUT'S TECHNICAL SPECIFICATIONS..... 3

2.4. ASSOCIATED ANTENNA DESCRIPTIONS 3

2.5. LIST OF EUT'S PORTS (XBee 3 USB Adapter Pro) 3

2.6. ANCILLARY EQUIPMENT 4

EXHIBIT 3. EUT OPERATING CONDITIONS AND CONFIGURATIONS DURING TESTS 5

3.1. CLIMATE TEST CONDITIONS 5

3.2. OPERATIONAL TEST CONDITIONS & ARRANGEMENT FOR TESTS..... 5

EXHIBIT 4. SUMMARY OF TEST RESULTS..... 6

4.1. LOCATION OF TESTS 6

4.2. APPLICABILITY & SUMMARY OF EMC EMISSION TEST RESULTS 6

4.3. MODIFICATIONS INCORPORATED IN THE EUT FOR COMPLIANCE PURPOSES 6

EXHIBIT 5. TEST DATA 7

5.1. PEAK CONDUCTED OUTPUT POWER - DTS [§ 15.247(b)(3)] 7

5.2. TRANSMITTER SPURIOUS RADIATED EMISSIONS AT 3 METERS [§§ 15.247(d), 15.209 & 15.205] 11

EXHIBIT 6. TEST EQUIPMENT LIST 21

EXHIBIT 7. MEASUREMENT UNCERTAINTY 22

7.1. RADIATED EMISSION MEASUREMENT UNCERTAINTY 22

EXHIBIT 1. INTRODUCTION

1.1. SCOPE

Reference:	FCC Part 15, Subpart C, Section 15.247
Title:	Code of Federal Regulations (CFR), Title 47 – Telecommunication, Part 15 – Radio Frequency Devices
Purpose of Test:	Class II Permissive Change: <ul style="list-style-type: none"> • The integration of the XBee3 module in XBee 3 USB Adapter Pro
Test Procedures:	<ul style="list-style-type: none"> ▪ ANSI C63.4 ▪ ANSI C63.10 ▪ FCC KDB Publication No. 558074 D01 15.247 Meas Guidance v05r02
Environmental Classification:	<input checked="" type="checkbox"/> Commercial, industrial or business environment <input type="checkbox"/> Residential environment

1.2. RELATED SUBMITTAL(S)/GRANT(S)

None.

1.3. NORMATIVE REFERENCES

Publication	Year	Title
47 CFR Parts 0-19	2019	Code of Federal Regulations (CFR), Title 47 – Telecommunication
ANSI C63.4	2014	American National Standard for Methods of Measurement of Radio-Noise Emissions from Low-Voltage Electrical and Electronic Equipment in the Range of 9 KHz to 40 GHz
ANSI C63.10	2013	American National Standard of Procedures for Compliance Testing of Unlicensed Wireless Devices
FCC, KDB Publication No. 558074 D01 15.247 Meas Guidance v05r02	2019	GUIDANCE FOR COMPLIANCE MEASUREMENTS ON DIGITAL TRANSMISSION SYSTEM, FREQUENCY HOPPING SPREAD SPECTRUM SYSTEM, AND HYBRID SYSTEM DEVICES OPERATING UNDER SECTION 15.247 OF THE FCC RULES

EXHIBIT 2. PERFORMANCE ASSESSMENT

2.1. CLIENT INFORMATION

Applicant	
Name:	Digi International Inc
Address:	9350 Excelsior Blvd. Suite 700 Hopkins, MN 55343 USA
Contact Person:	Scott Wilken Phone #:(952) 912-4965 Fax #: (952) 912-4952 Email Address: scott.wilken@digi.com

Manufacturer	
Name:	Digi International Inc
Address:	9350 Excelsior Blvd. Suite 700 Hopkins, MN 55343 USA
Contact Person:	Scott Wilken Phone #:(952) 912-4965 Fax #: (952) 912-4952 Email Address: scott.wilken@digi.com

2.2. EQUIPMENT UNDER TEST (EUT) INFORMATION

The following information (with the exception of the Date of Receipt) has been supplied by the applicant.

Brand Name:	Digi International Inc
Product Name:	XBee3
Model Name or Number:	XBEE3
Serial Number:	Test Sample
Type of Equipment:	Digital Transmission System (DTS)
Input Power Supply Type:	External DC Power Supply
Primary User Functions of EUT:	802.15.4 connectivity of embedded systems, BLE connectivity

2.3. EUT’S TECHNICAL SPECIFICATIONS

Transmitter	
Equipment Type:	Mobile Base station (fixed use)
Intended Operating Environment:	Commercial, industrial or business environment
Power Supply Requirement:	3.3V (nominal)
RF Output Power Rating:	19.44 dBm Maximum Peak (87.90 mW) for XBee 3 USB Adapter Pro
Operating Frequency Range:	2405 - 2480 MHz
RF Output Impedance:	50 Ω
Duty Cycle:	Continuous
Modulation Type:	QPSK
Antenna Connector Types:	Integral antenna

2.4. ASSOCIATED ANTENNA DESCRIPTIONS

Manufacturer	Antenna Type	P/N	Maximum Gain (dBi)
Digi International	PCB Trace Dipole Antenna	31000019-01	0.87

2.5. LIST OF EUT’S PORTS (XBee 3 USB Adapter Pro)

Port Number	EUT’s Port Description	Number of Identical Ports	Connector Type	Cable Type (Shielded/Non-shielded)
1	USB	1	USB	Direct connection (no cable)

2.6. ANCILLARY EQUIPMENT

The EUT was tested while connected to the following representative configuration of ancillary equipment necessary to exercise the ports during tests:

Ancillary Equipment # 1	
Description:	Test Jig
Brand name:	Digi International
Model Name or Number:	N/A
Serial Number:	N/A
Connected to EUT's Port:	Module pin signals

Ancillary Equipment # 2	
Description:	Laptop
Brand name:	Lenovo
Model Name or Number:	0578
Serial Number:	IS057882ULRBXKBG
Connected to EUT's Port:	XBee 3 USB Adapter Pro

EXHIBIT 3. EUT OPERATING CONDITIONS AND CONFIGURATIONS DURING TESTS

3.1. CLIMATE TEST CONDITIONS

The climate conditions of the test environment are as follows:

Temperature:	21 to 23 °C
Humidity:	45 to 58%
Pressure:	102 kPa
Power Input Source:	5 VDC from Laptop / 3.6 VDC from Test Jig

3.2. OPERATIONAL TEST CONDITIONS & ARRANGEMENT FOR TESTS

Operating Modes:	The transmitter was operated in a continuous transmission mode with the carrier modulated as specified in the Test Data.
Special Test Software:	Test software provided by the Applicant to operate the EUT at each channel frequency continuously and in the range of typical modes of operation.
Special Hardware Used:	Test Jig used for conducted power measurements
Transmitter Test Antenna:	The EUT is tested with the antenna fitted in a manner typical of normal intended use as integral as described with the test results.

Transmitter Test Signals	
Frequency Band(s):	2405 - 2480 MHz
Frequency(ies) Tested:	2405 MHz, 2440 MHz, 2475 MHz, 2480 MHz
RF Power Output: (measured maximum output power at antenna terminals)	19.44 dBm Maximum Peak (87.90 mW)
Normal Test Modulation:	QPSK
Modulating Signal Source:	Internal

EXHIBIT 4. SUMMARY OF TEST RESULTS

4.1. LOCATION OF TESTS

All of the measurements described in this report were performed at Ultratech Group of Labs located in the city of Oakville, Province of Ontario, Canada.

- AC Power Line Conducted Emissions were performed in UltraTech's shielded room, 24'(L) by 16'(W) by 8'(H).
- Radiated Emissions were performed at the Ultratech's 3-10 TDK Semi-Anechoic Chamber situated in the Town of Oakville, province of Ontario. This test site been calibrated in accordance with ANSI C63.4, and found to be in compliance with the requirements of Sec. 2.948 of the FCC Rules. The descriptions and site measurement data of the Oakville 3-10 TDK Semi-Anechoic Chamber has been filed with ANAB File No.: AT-1945.

4.2. APPLICABILITY & SUMMARY OF EMC EMISSION TEST RESULTS

FCC Section(s)	Test Requirements	Compliance (Yes/No)
15.203	Antenna requirements	Yes ¹
15.207(a)	AC Power Line Conducted Emissions	Yes
15.247(a)(2)	6 dB Bandwidth	N/A
15.247(b)(3)	Peak Conducted Output Power	Yes
15.247(d)	Band-Edge and RF Conducted Spurious Emissions at the Transmitter Antenna Terminal	N/A
15.247(d), 15.209 & 15.205	Transmitter Spurious Radiated Emissions	Yes
15.247(e)	Power Spectral Density	N/A
15.247(i), 1.1307, 1.1310, 2.1091, 2.1093	RF Exposure	Yes ²

¹ The EUT complies with the requirement; it employs an integral antenna.

² Compliant with SAR evaluation for 10-g extremity SAR at 0 mm from the flat phantom filled with body tissue simulating liquid. Refer to SAR report for details

4.3. MODIFICATIONS INCORPORATED IN THE EUT FOR COMPLIANCE PURPOSES

None.

EXHIBIT 5. TEST DATA

5.1. PEAK CONDUCTED OUTPUT POWER - DTS [§ 15.247(b)(3)]

5.1.1. Limit(s)

§ 15.247(b)(3): For systems using digital modulation in the 902-928 MHz, 2400-2483.5 MHz, and 5725-5850 MHz bands: 1 Watt. As an alternative to a peak power measurement, compliance with the one Watt limit can be based on a measurement of the maximum conducted output power. Maximum Conducted Output Power is defined as the total transmit power delivered to all antennas and antenna elements averaged across all symbols in the signaling alphabet when the transmitter is operating at its maximum power control level. Power must be summed across all antennas and antenna elements. The average must not include any time intervals during which the transmitter is off or is transmitting at a reduced power level. If multiple modes of operation are possible (e.g., alternative modulation methods), the *maximum conducted output power* is the highest total transmit power occurring in any mode.

§ 15.247(b)(4): The conducted output power limit specified in paragraph (b) of this section is based on the use of antennas with directional gains that do not exceed 6 dBi. Except as shown in paragraph (c) of this section, if transmitting antennas of directional gain greater than 6 dBi are used, the conducted output power from the intentional radiator shall be reduced below the stated values in paragraphs (b)(1), (b)(2), and (b)(3) of this section, as appropriate, by the amount in dB that the directional gain of the antenna exceeds 6 dBi.

5.1.2. Method of Measurements & Test Arrangement

KDB 558074 D01 15.247 Meas Guidance v05r02, Section 8.3.1.1 RBW ≥ DTS bandwidth

5.1.3. Test Arrangement

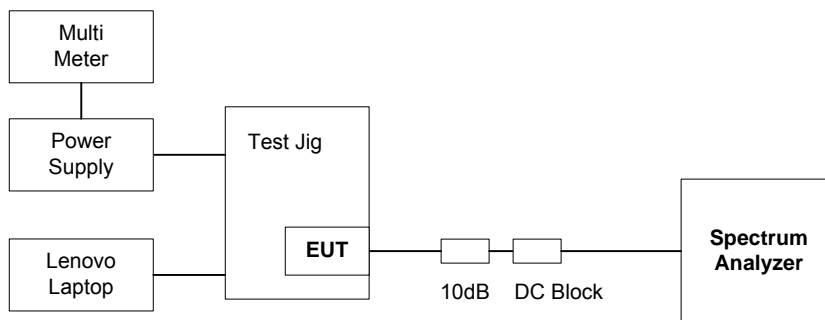

5.1.4. Test Data

Modulation	Power Setting	Channel	Frequency (MHz)	Maximum Peak Conducted Power (dBm)	Peak Power Limit (dBm)
QPSK	20	11	2405	19.44	30
		18	2440	19.37	30
		25	2475	19.41	30
	13	26	2480	13.28	30

Plot 5.1.4.1. Maximum Peak Conducted Output Power, QPSK Modulation, Power Setting 20, Ch 11, 2405 MHz

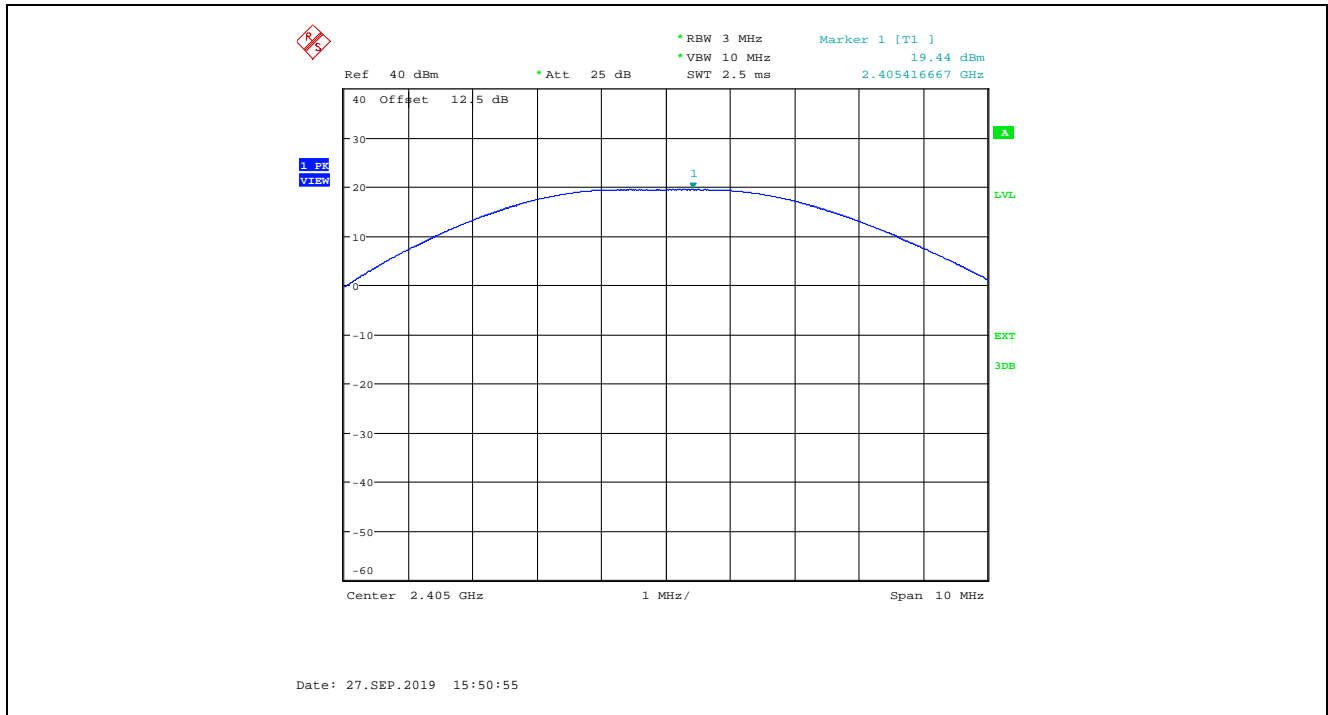

Plot 5.1.4.2. Maximum Peak Conducted Output Power, QPSK Modulation, Power Setting 20, Ch 18, 2440 MHz

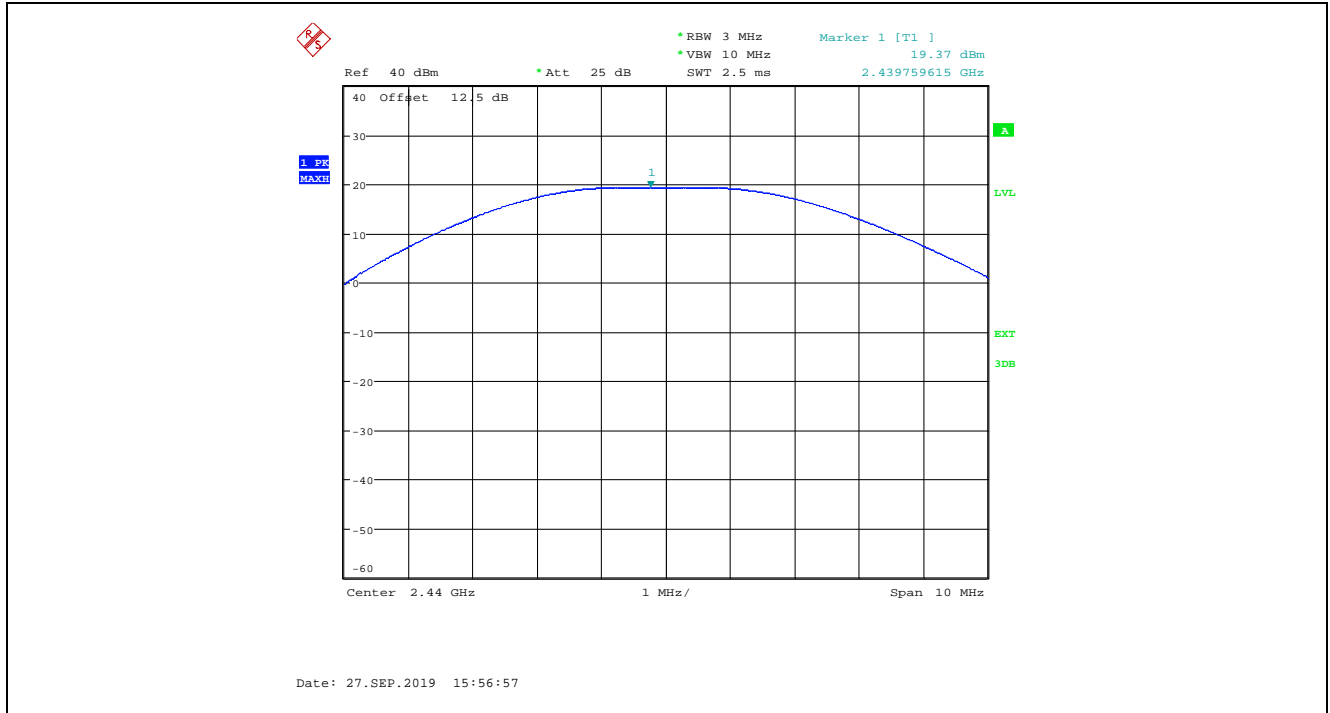

Plot 5.1.4.3. Maximum Peak Conducted Output Power, QPSK Modulation, Power Setting 20, Ch 25, 2475 MHz

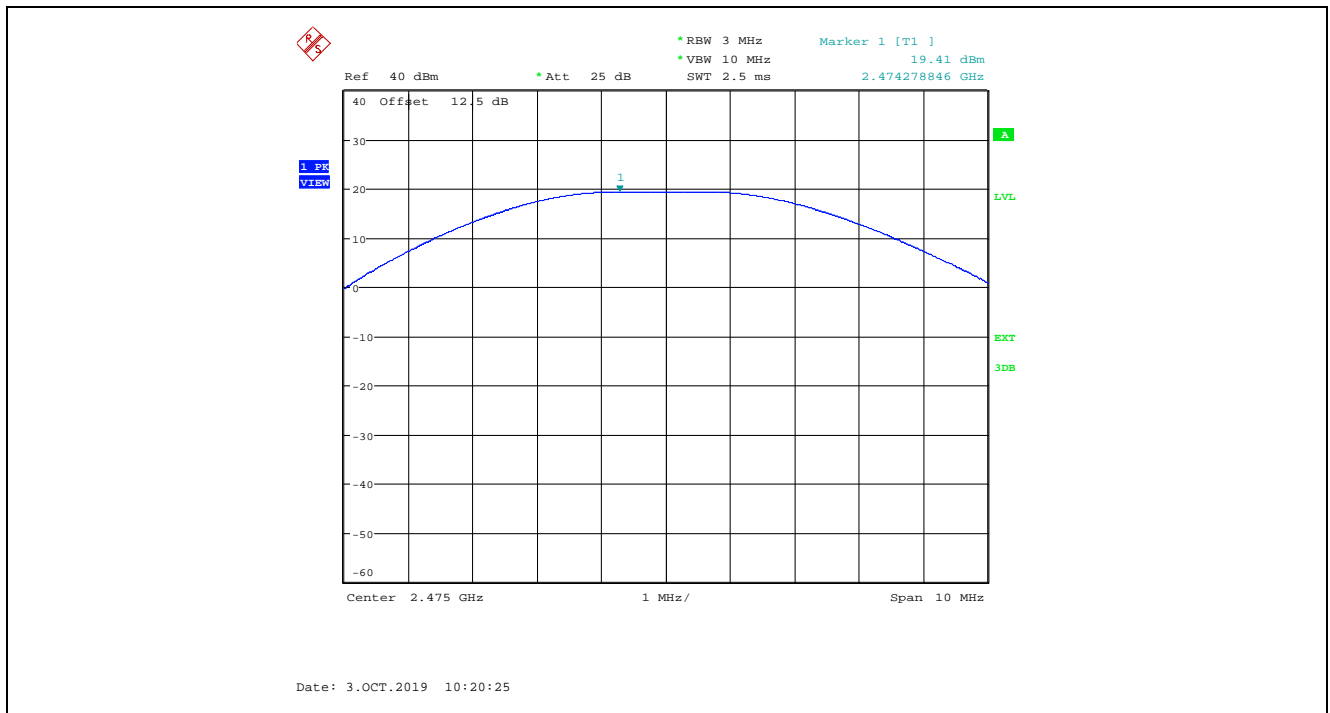

Plot 5.1.4.4. Maximum Peak Conducted Output Power, QPSK Modulation, Power Setting 13, Ch 26, 2480 MHz

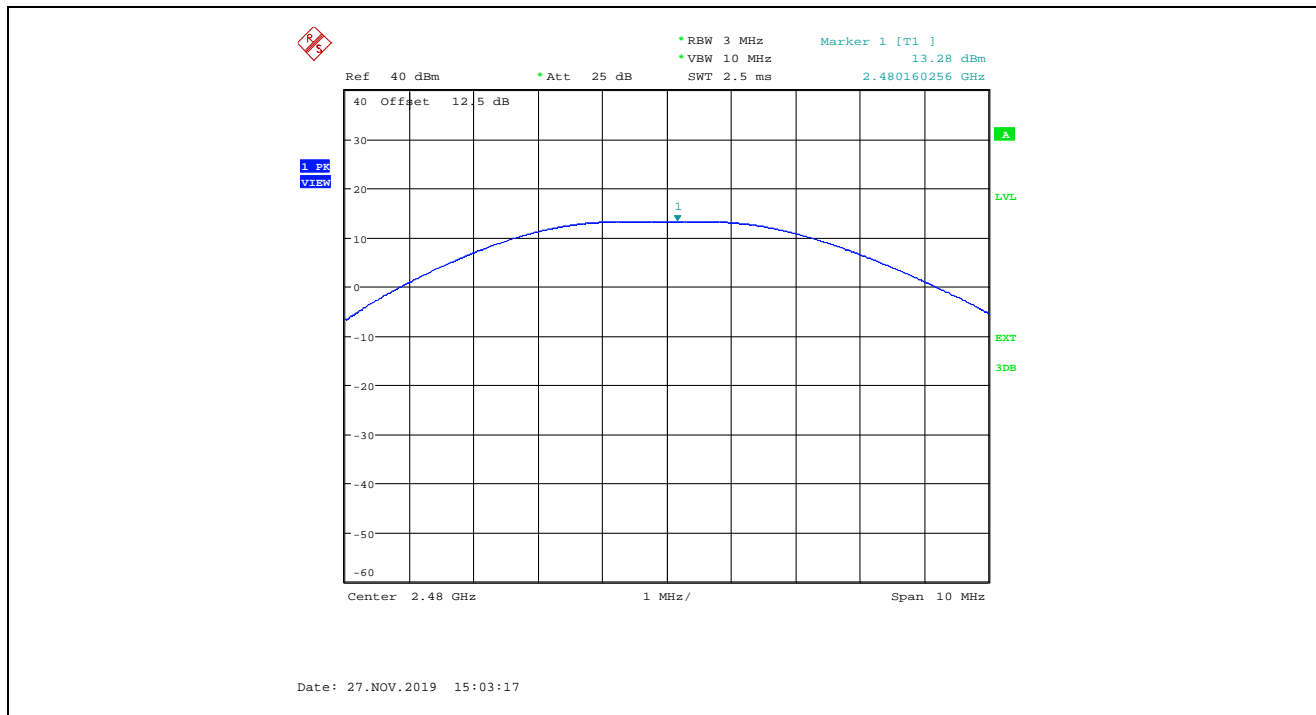

5.2. TRANSMITTER SPURIOUS RADIATED EMISSIONS AT 3 METERS [§§ 15.247(d), 15.209 & 15.205]

5.2.1. Limit(s)

§ 15.247 (d): In any 100 kHz bandwidth outside the frequency band in which the spread spectrum or digitally modulated intentional radiator is operating, the radio frequency power that is produced by the intentional radiator shall be at least 20 dB below that in the 100 kHz bandwidth within the band that contains the highest level of the desired power, based on either an RF conducted or a radiated measurement, provided the transmitter demonstrates compliance with the peak conducted power limits. If the transmitter complies with the conducted power limits based on the use of RMS averaging over a time interval, as permitted under paragraph (b)(3) of this section, the attenuation required under this paragraph shall be 30 dB instead of 20 dB. Attenuation below the general limits specified in Section 15.209(a) is not required. In addition, radiated emissions which fall in the restricted bands, as defined in Section 15.205(a), must also comply with the radiated emission limits specified in Section 15.209(a) (see Section 15.205(c)).

Section 15.205(a) - Restricted Bands of Operation

MHz	MHz	MHz	GHz
0.090–0.110	16.42–16.423	399.9–410	4.5–5.15
¹ 0.495–0.505	16.69475–16.69525	608–614	5.35–5.46
2.1735–2.1905	16.80425–16.80475	960–1240	7.25–7.75
4.125–4.128	25.5–25.67	1300–1427	8.025–8.5
4.17725–4.17775	37.5–38.25	1435–1626.5	9.0–9.2
4.20725–4.20775	73–74.6	1645.5–1646.5	9.3–9.5
6.215–6.218	74.8–75.2	1660–1710	10.6–12.7
6.26775–6.26825	108–121.94	1718.8–1722.2	13.25–13.4
6.31175–6.31225	123–138	2200–2300	14.47–14.5
8.291–8.294	149.9–150.05	2310–2390	15.35–16.2
8.362–8.366	156.52475–156.52525	2483.5–2500	17.7–21.4
8.37625–8.38675	156.7–156.9	2655–2900	22.01–23.12
8.41425–8.41475	162.0125–167.17	3260–3267	23.6–24.0
12.29–12.293	167.72–173.2	3332–3339	31.2–31.8
12.51975–12.52025	240–285	3345.8–3358	36.43–36.5
12.57675–12.57725	322–335.4	3600–4400	(²)
13.36–13.41.			

¹ Until February 1, 1999, this restricted band shall be 0.490–0.510 MHz.

² Above 38.6

Section 15.209(a) - Field Strength Limits within Restricted Frequency Bands

Frequency (MHz)	Field Strength (microvolts/meter)	Measurement Distance (meters)
0.009 - 0.490	2,400 / F (kHz)	300
0.490 - 1.705	24,000 / F (kHz)	30
1.705 - 30.0	30	30
30 – 88	100	3
88 – 216	150	3
216 – 960	200	3
Above 960	500	3

5.2.2. Method of Measurements

KDB 558074 D01 15.247 Meas Guidance v05r02, Sections 8.5, 8.6 and 8.7 / Subclauses 11.11, 11.12 and 11.13.of ANSI C63.10.

5.2.3. Test Arrangement

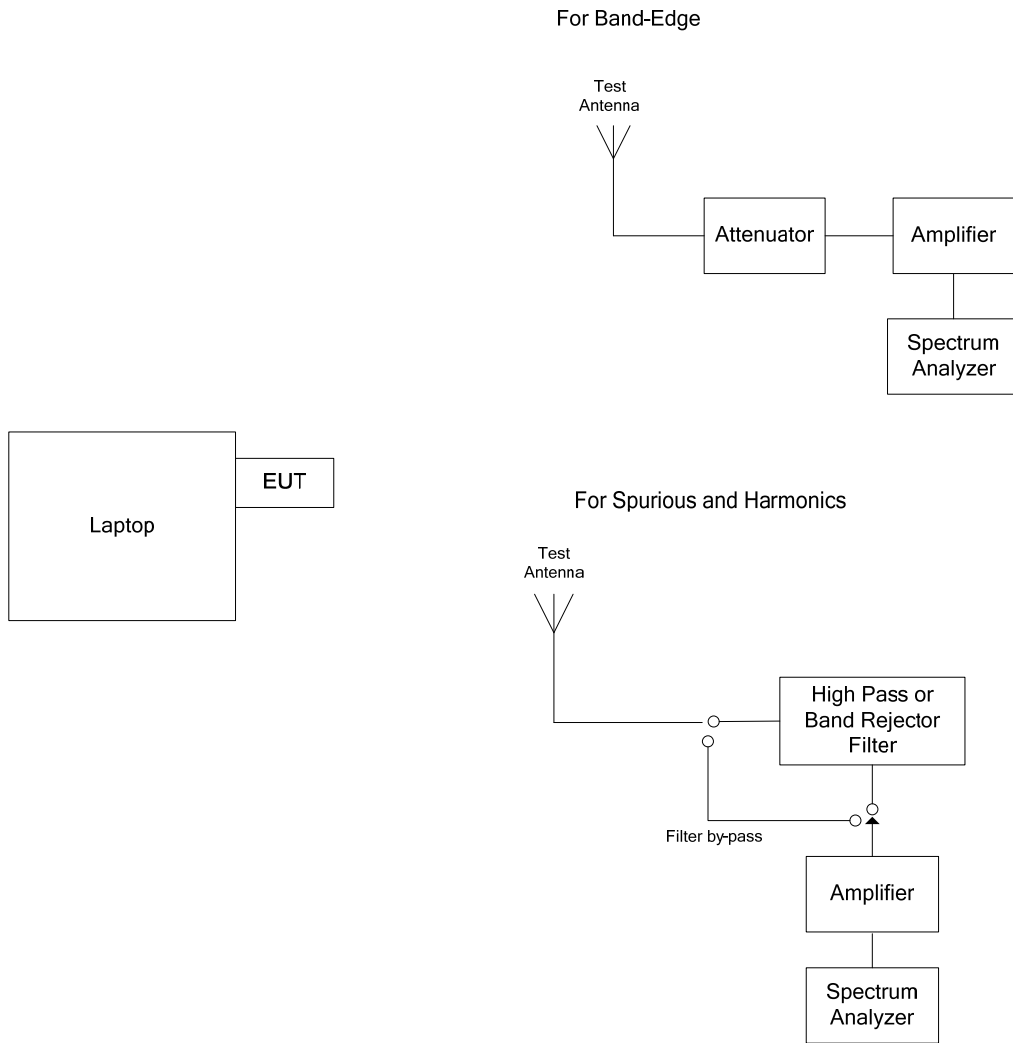

5.2.4. Test Data

Remark(s):

- All spurious emissions that are in excess of 20 dB below the specified limit shall be recorded.
- EUT shall be tested in three orthogonal positions.
- The following test data represent the worst-case derived from exploratory tests.

5.2.4.1. Spurious Radiated Emission

Fundamental Frequency:		2405 MHz					
Power Setting:		20					
Measured Conducted Power:		19.44 dBm					
Frequency Test Range:		30 MHz – 25 GHz					
Frequency (MHz)	RF Peak Level (dBµV/m)	RF Avg Level (dBµV/m)	Antenna Plane (H/V)	Limit 15.209 (dBµV/m)	Limit 15.247 (dBµV/m)	Margin (dB)	Pass/Fail
2405	107.79	--	V	--	--	--	--
2405	115.34	--	H	--	--	--	--
4810	49.21	35.89	V	54.0	95.3	-18.1	Pass*
4810	49.02	36.11	H	54.0	95.3	-17.9	Pass*
All other spurious emissions and harmonics are more than 20 dB below the applicable limit.							

Fundamental Frequency:		2440 MHz					
Power Setting:		20					
Measured Conducted Power:		19.37 dBm					
Frequency Test Range:		30 MHz – 25 GHz					
Frequency (MHz)	RF Peak Level (dBµV/m)	RF Avg Level (dBµV/m)	Antenna Plane (H/V)	Limit 15.209 (dBµV/m)	Limit 15.247 (dBµV/m)	Margin (dB)	Pass/Fail
2440	111.06	--	V	--	--	--	--
2440	115.28	--	H	--	--	--	--
4880	48.16	34.40	V	54.0	95.3	-19.6	Pass*
4880	48.62	34.68	H	54.0	95.3	-19.3	Pass*
7320	51.05	37.06	V	54.0	95.3	-16.9	Pass*
7320	52.23	37.43	H	54.0	95.3	-16.6	Pass*
All other spurious emissions and harmonics are more than 20 dB below the applicable limit.							

Fundamental Frequency:		2475 MHz					
Power Setting:		20					
Measured Conducted Power:		19.41 dBm					
Frequency Test Range:		30 MHz – 25 GHz					
Frequency (MHz)	RF Peak Level (dB μ V/m)	RF Avg Level (dB μ V/m)	Antenna Plane (H/V)	Limit 15.209 (dB μ V/m)	Limit 15.247 (dB μ V/m)	Margin (dB)	Pass/Fail
2475	109.18	--	V	--	--	--	--
2475	116.34	--	H	--	--	--	--
7425	50.15	36.47	V	54.0	96.3	-17.5	Pass*
7425	51.08	36.95	H	54.0	96.3	-17.1	Pass*
All other spurious emissions and harmonics are more than 20 dB below the applicable limit.							

Fundamental Frequency:		2480 MHz					
Power Setting:		13					
Measured Conducted Power:		13.28 dBm					
Frequency Test Range:		30 MHz – 25 GHz					
Frequency (MHz)	RF Peak Level (dB μ V/m)	RF Avg Level (dB μ V/m)	Antenna Plane (H/V)	Limit 15.209 (dB μ V/m)	Limit 15.247 (dB μ V/m)	Margin (dB)	Pass/Fail
2480	103.12	--	V	--	--	--	--
2480	110.10	--	H	--	--	--	--
7440	50.87	36.66	V	54.0	90.1	-17.3	Pass*
7440	51.24	36.64	H	54.0	90.1	-17.4	Pass*
All other spurious emissions and harmonics are more than 20 dB below the applicable limit.							

5.2.4.2. Band-Edge Radiated Emissions

Plot 5.2.4.2.1. Band-Edge Radiated Emissions, Lower Band-edge, Peak Detector
Rx Antenna in Vertical Polarization, QPSK Modulation, Power Setting 20, 2405 MHz

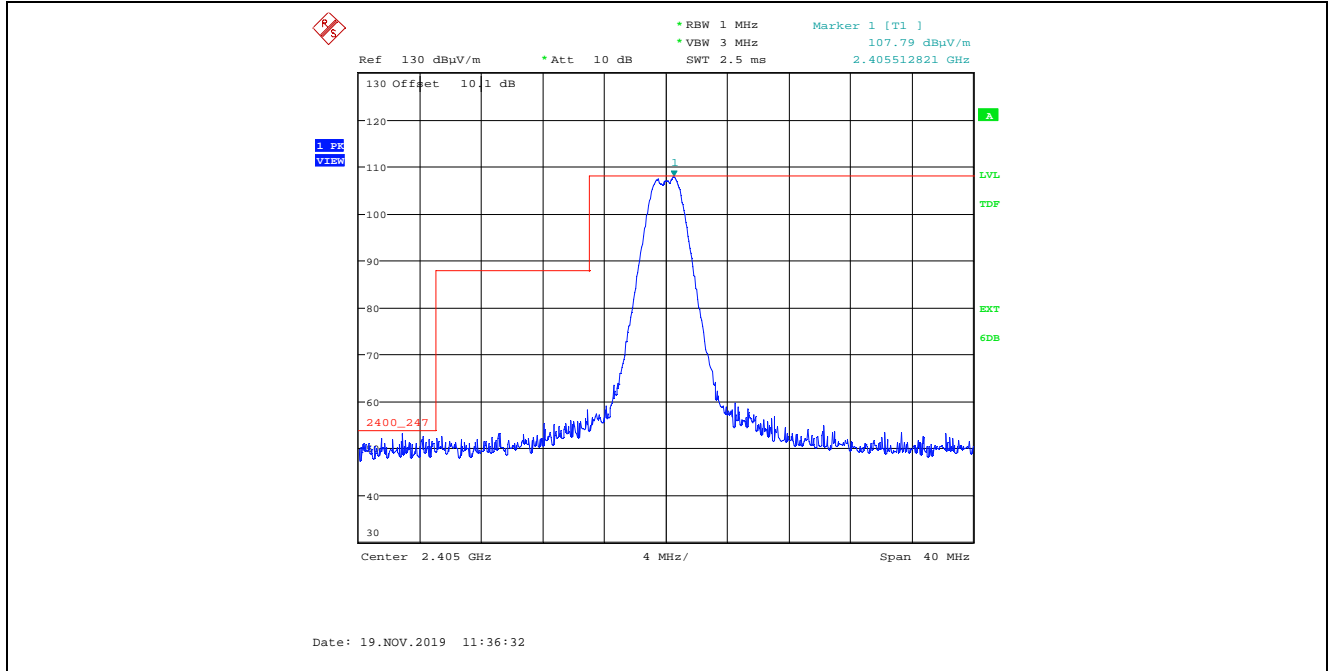

Plot 5.2.4.2.2. Band-Edge Radiated Emissions, Lower Band-edge, Average Detector
Rx Antenna in Vertical Polarization, QPSK Modulation, Power Setting 20, 2405 MHz

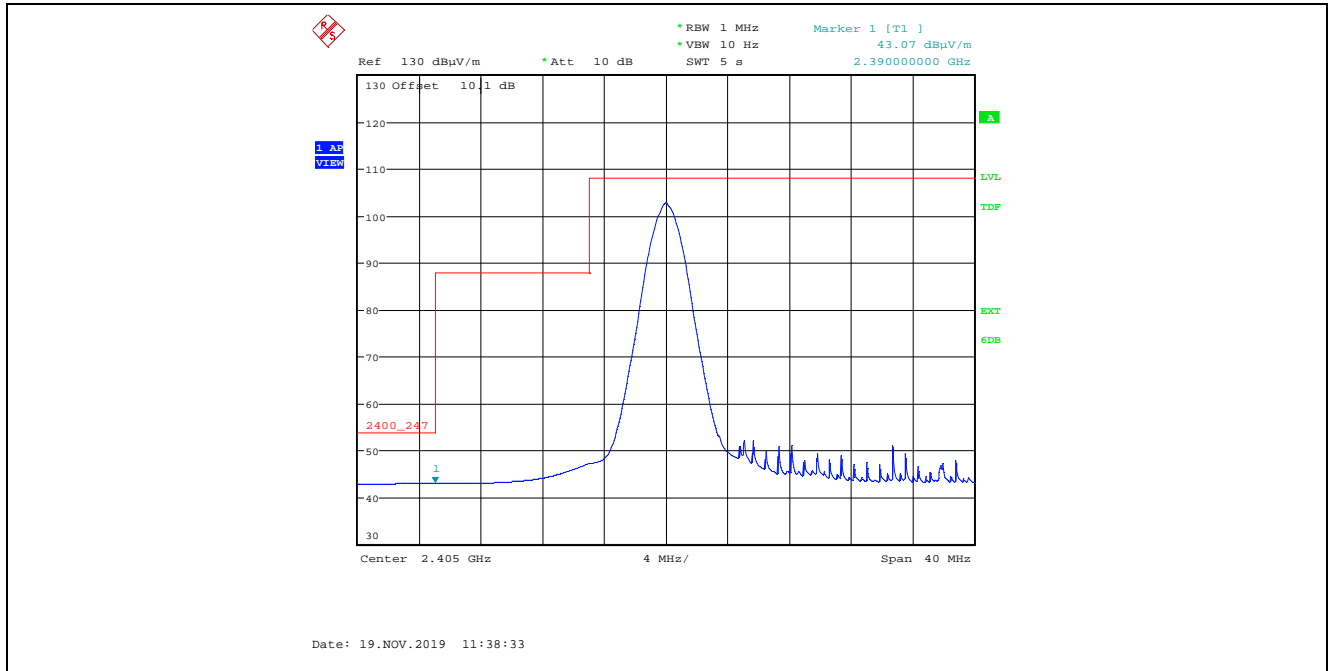

Plot 5.2.4.2.3. Band-Edge Radiated Emissions, Lower Band-edge, Peak Detector
Rx Antenna in Horizontal Polarization, QPSK Modulation, Power Setting 20, 2405 MHz

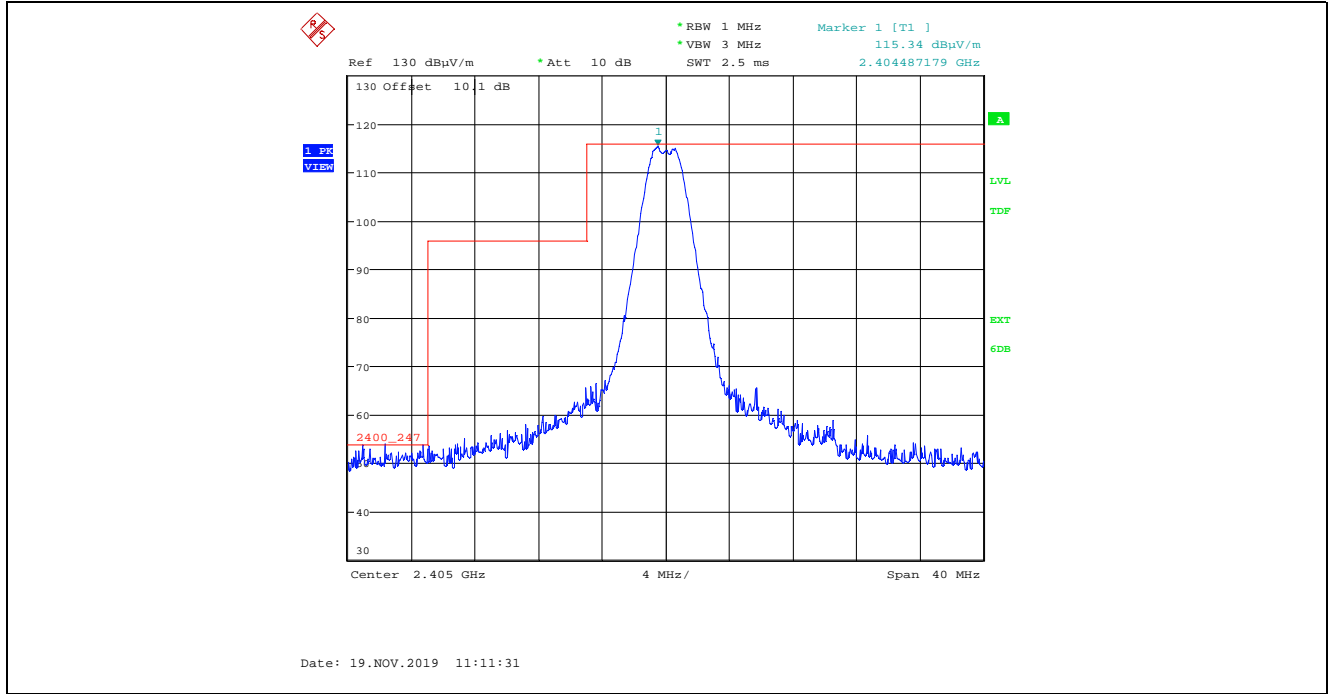

Plot 5.2.4.2.4. Band-Edge Radiated Emissions, Lower Band-edge, Average Detector
Rx Antenna in Horizontal Polarization, QPSK Modulation, Power Setting 20, 2405 MHz

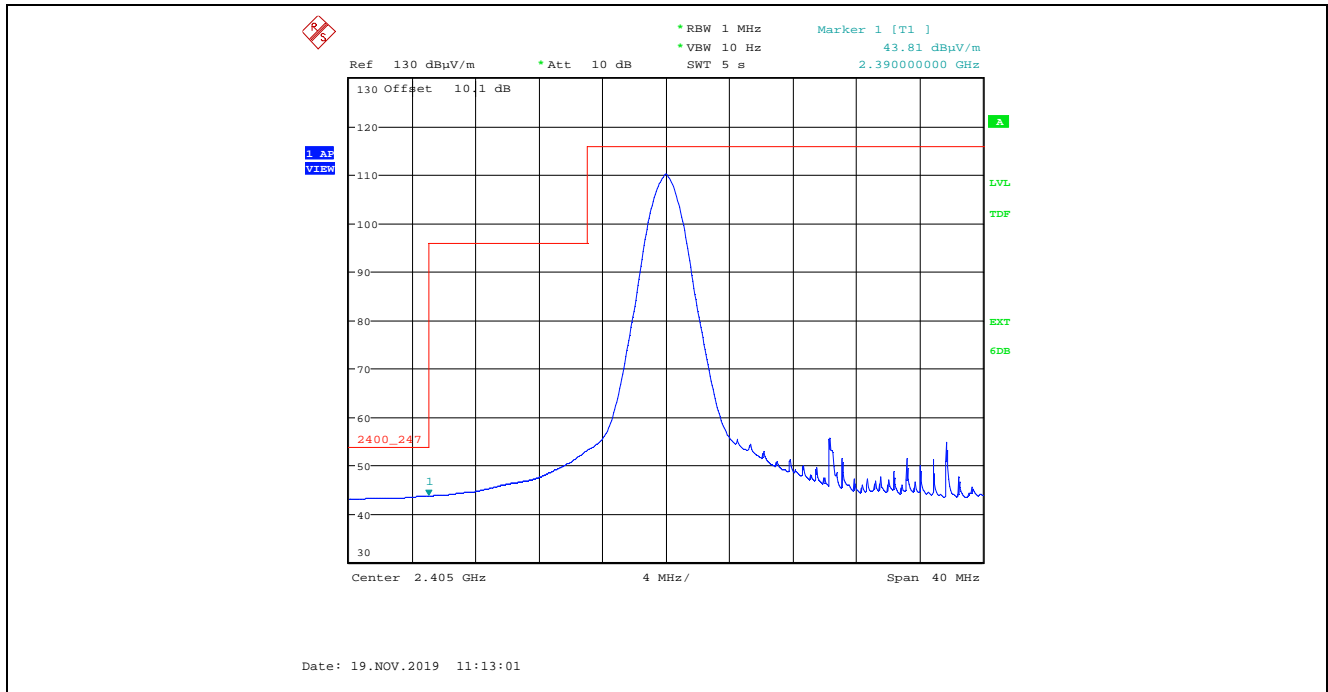

Plot 5.2.4.2.5. Band-Edge Radiated Emissions, Higher Band-edge, Peak Detector
 Rx Antenna in Vertical Polarization, QPSK Modulation, Power Setting 20, 2475 MHz

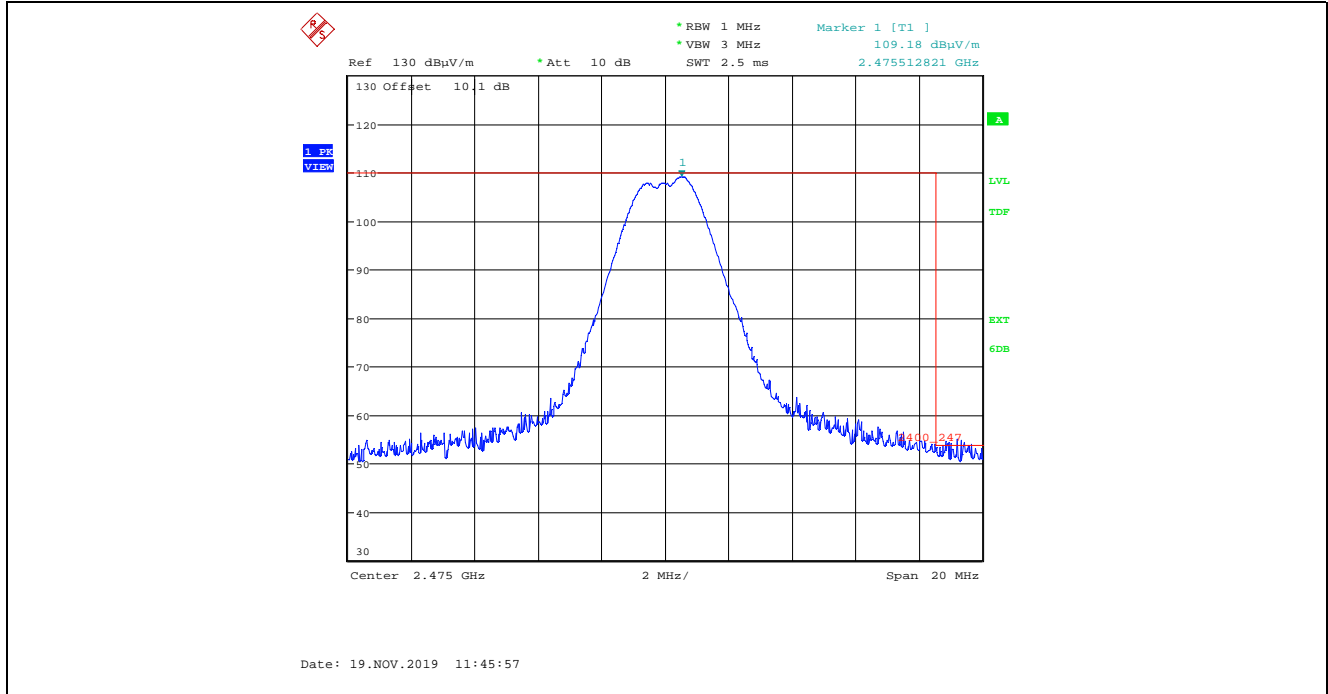

Plot 5.2.4.2.6. Band-Edge Radiated Emissions, Higher Band-edge, Average Detector
 Rx Antenna in Vertical Polarization, QPSK Modulation, Power Setting 20, 2475 MHz

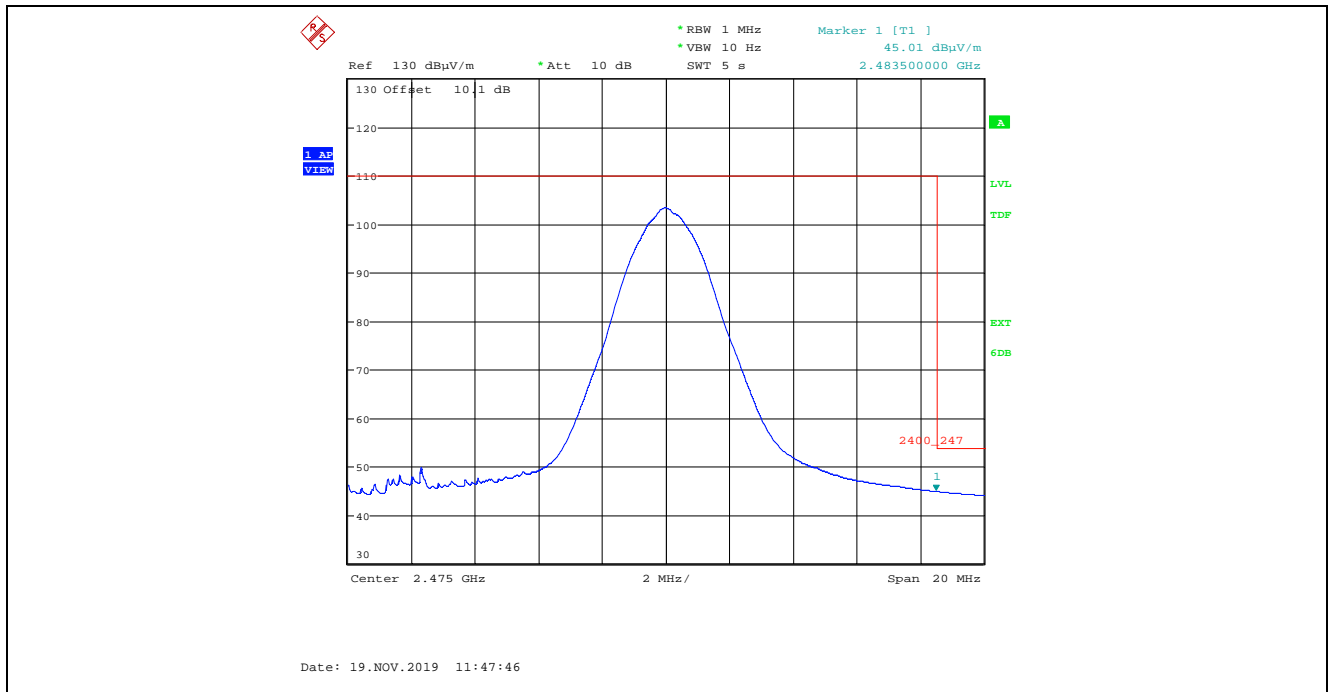

Plot 5.2.4.2.7. Band-Edge Radiated Emissions, Higher Band-edge, Peak Detector
 Rx Antenna in Horizontal Polarization, QPSK Modulation, Power Setting 20, 2475 MHz

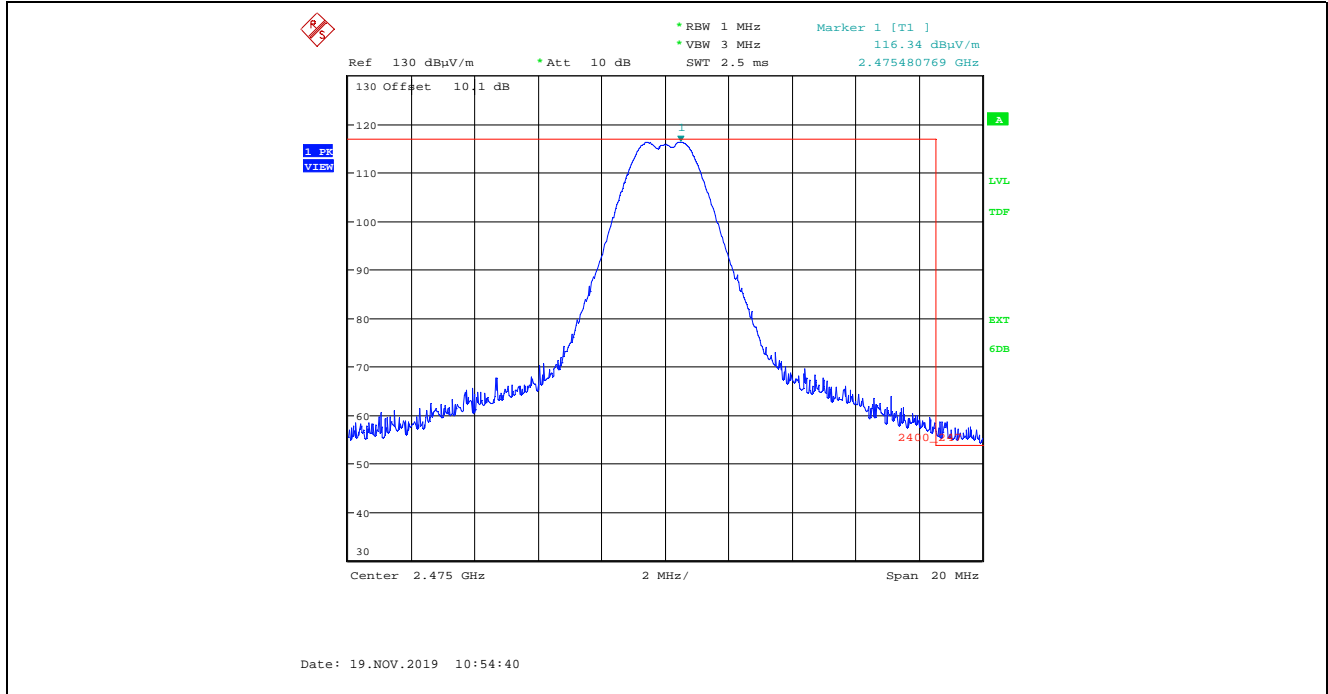

Plot 5.2.4.2.8. Band-Edge Radiated Emissions, Higher Band-edge, Average Detector
 Rx Antenna in Horizontal Polarization, QPSK Modulation, Power Setting 20, 2475 MHz

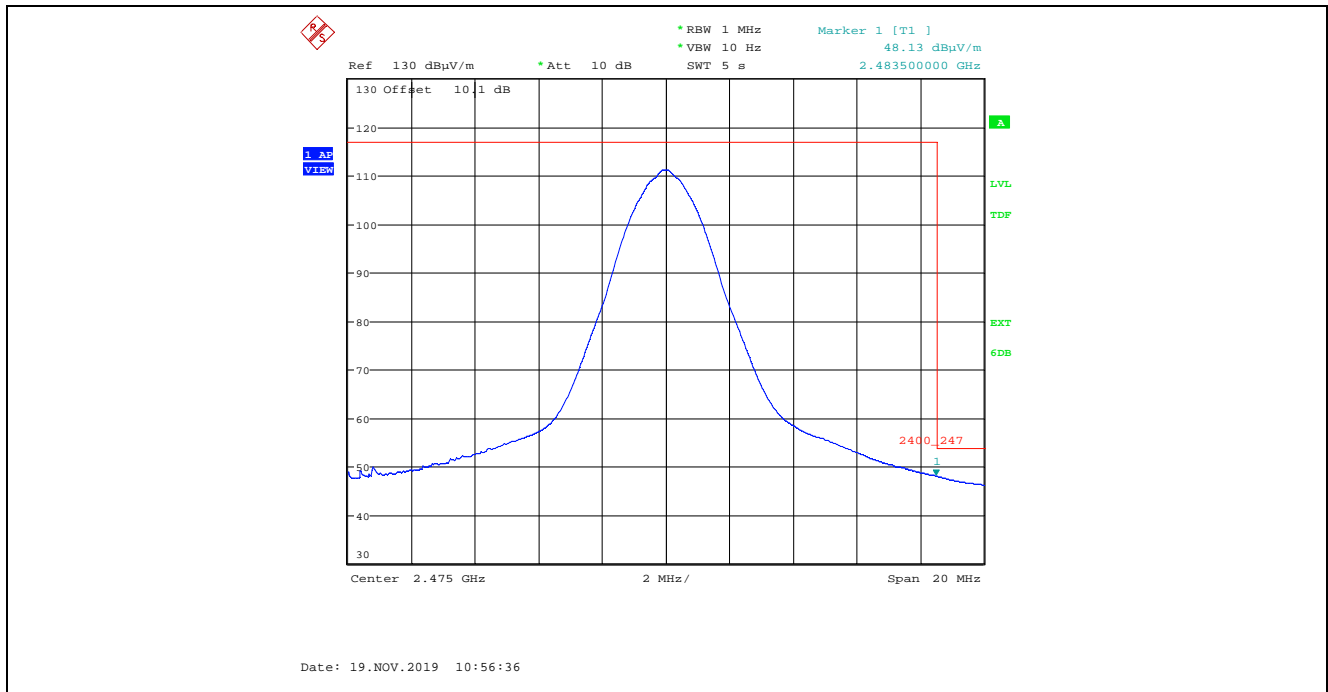

Plot 5.2.4.2.9. Band-Edge Radiated Emissions, Higher Band-edge, Peak Detector
 Rx Antenna in Vertical Polarization, QPSK Modulation, Power Setting 13, 2480 MHz

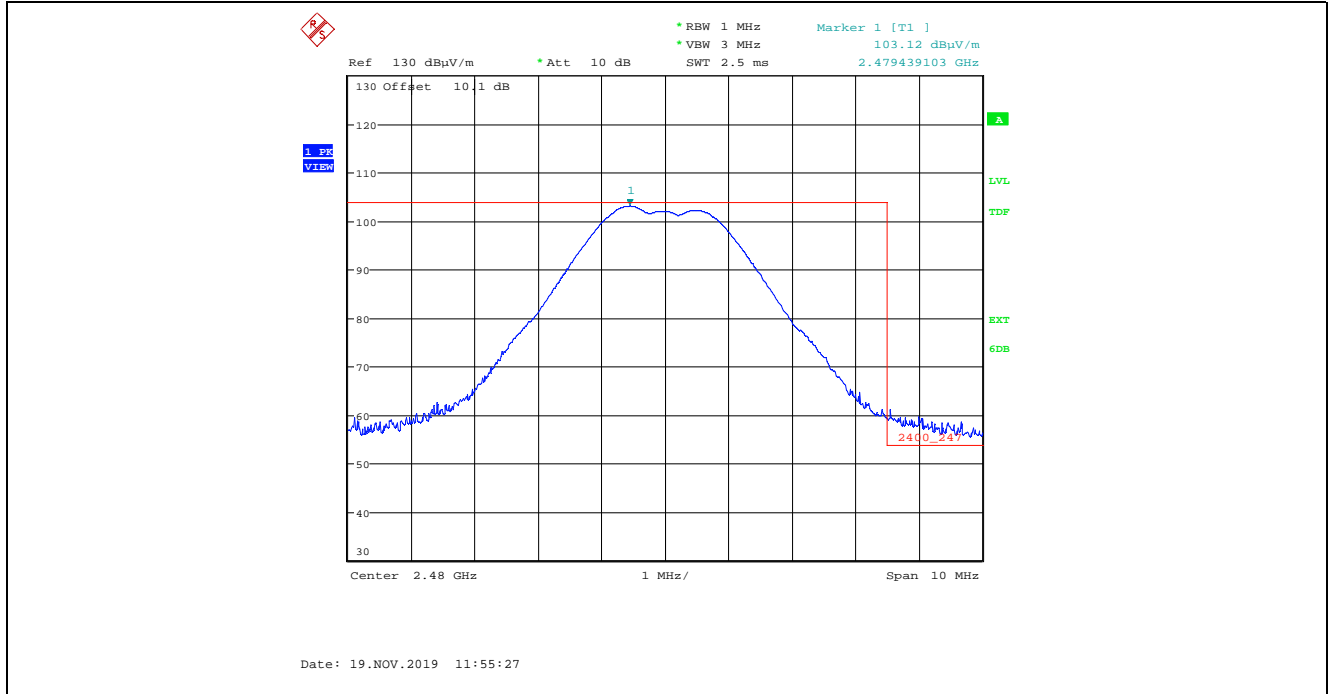

Plot 5.2.4.2.10. Band-Edge Radiated Emissions, Higher Band-edge, Average Detector
 Rx Antenna in Vertical Polarization, QPSK Modulation, Power Setting 13, 2480 MHz

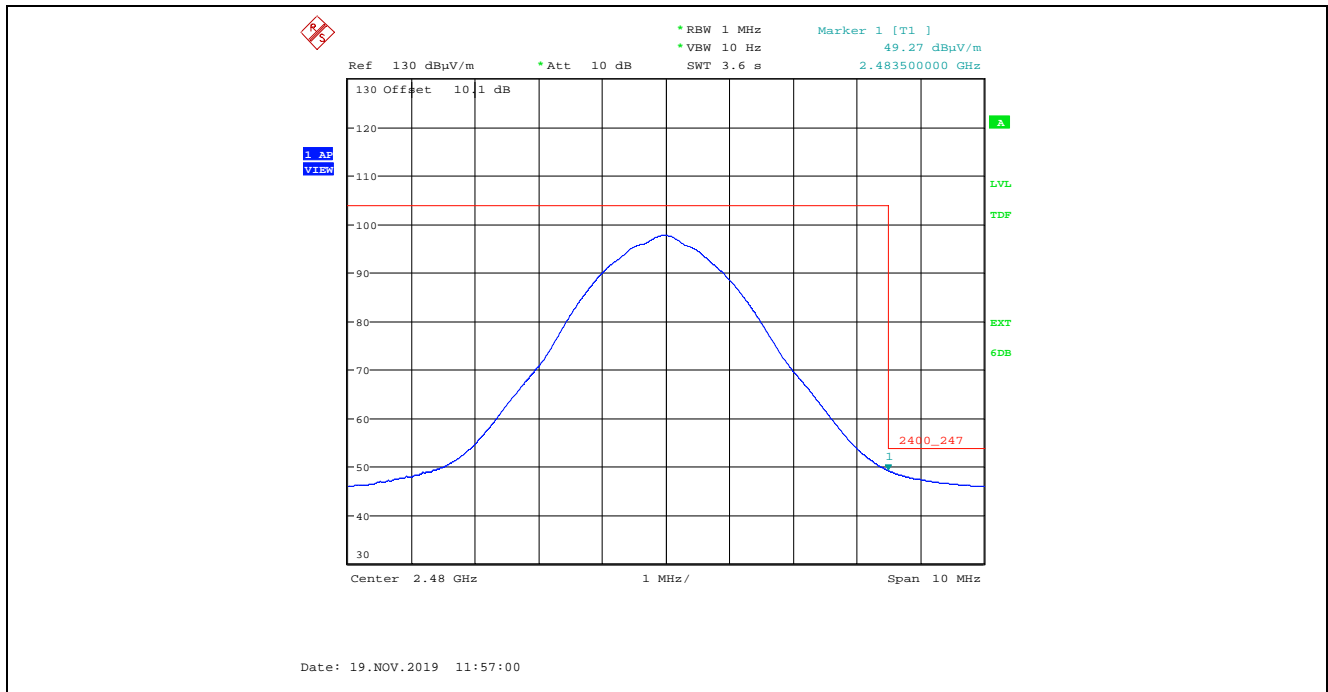

Plot 5.2.4.2.11. Band-Edge Radiated Emissions, Higher Band-edge, Peak Detector
 Rx Antenna in Horizontal Polarization, QPSK Modulation, Power Setting 13, 2480 MHz

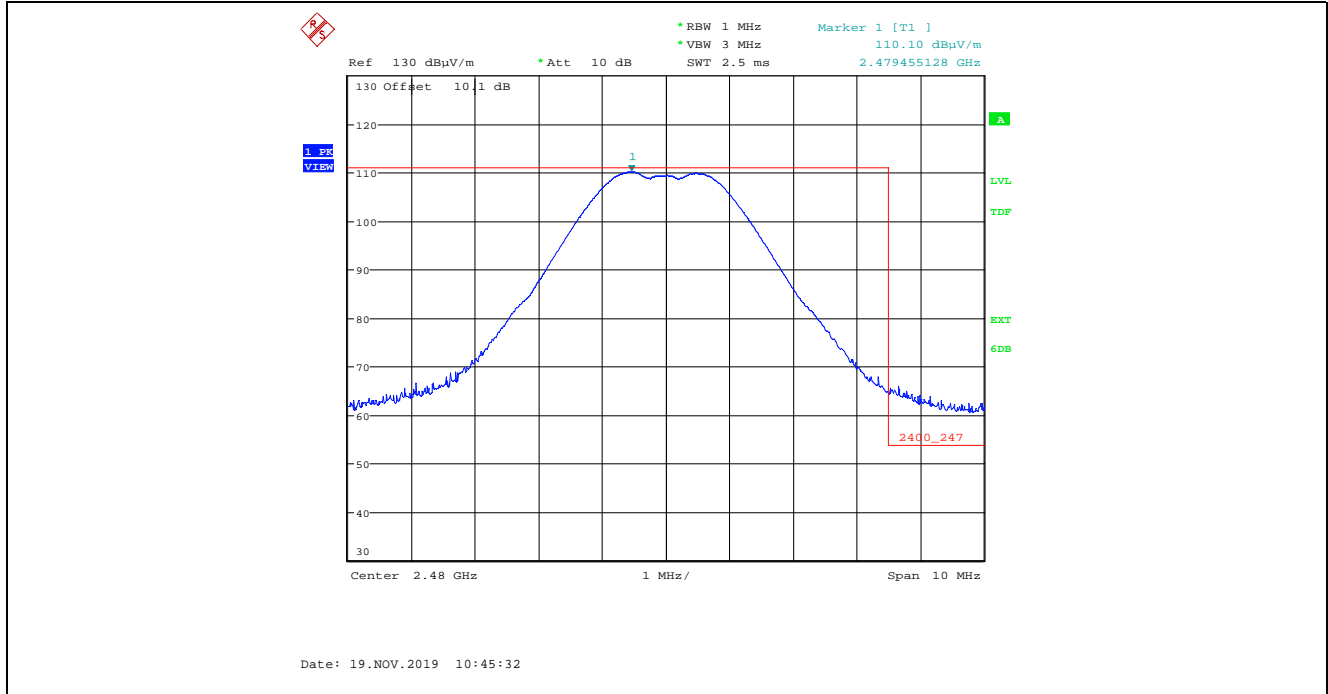

Plot 5.2.4.2.12. Band-Edge Radiated Emissions, Higher Band-edge, Average Detector
 Rx Antenna in Horizontal Polarization, QPSK Modulation, Power Setting 13, 2480 MHz

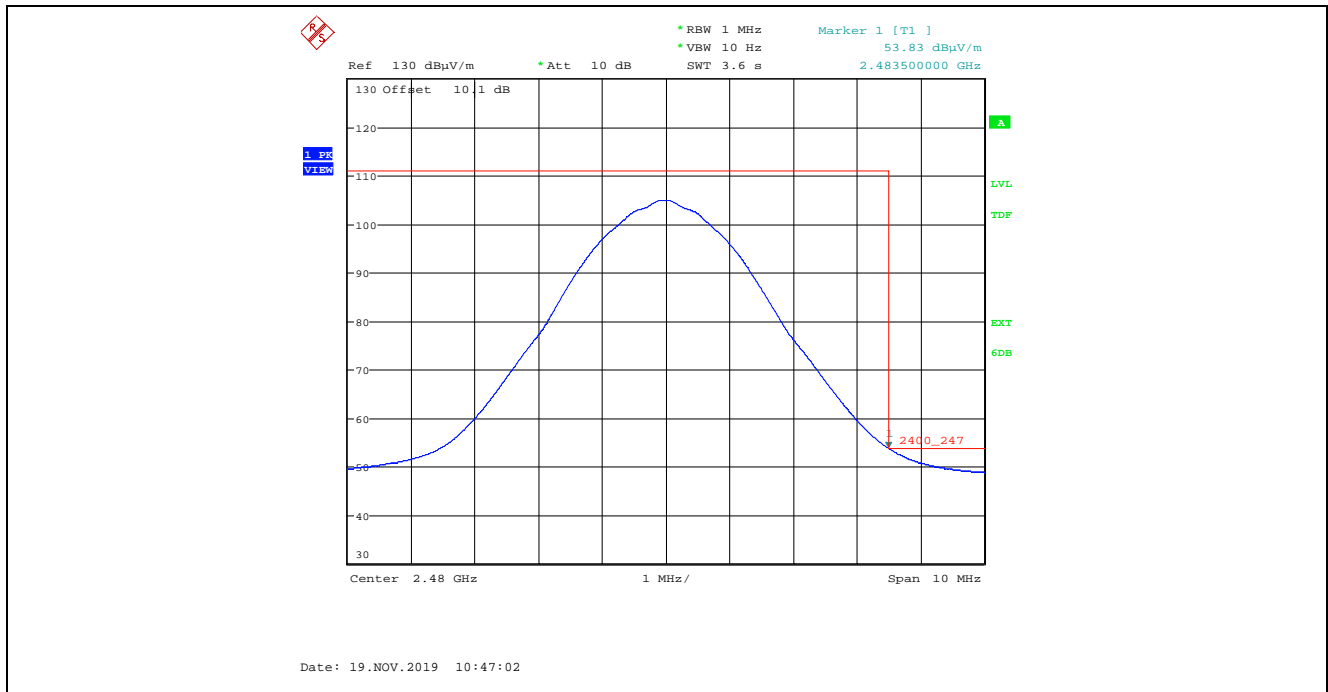

EXHIBIT 6. TEST EQUIPMENT LIST

Test Instruments	Manufacturer	Model No.	Serial No.	Frequency Range	Cal. Due Date
Spectrum Analyzer	Rohde & Schwarz	FSU26	200946	20Hz–26.5 GHz	25 Jul 2020
Attenuator	Hewlett Packard	8493C	0465	DC–26.5 GHz	See Note 1
DC Block	Hewlett Packard	11742A	12460	0.045 – 26.5 GHz	See Note 1
DC Power Supply	HQ Power	PS613U	NSN	0-30VDC	See Note 1
Multi-meter	Fluke	8842A	5021295	20mV - 1kV	05 Sep 2020
EMI Receiver	Rohde & Schwarz	ESU40	100037	20Hz–40 GHz	15 Mar 2020
RF Amplifier	Com-Power	PAM-0118A	551052	0.5 – 18 GHz	24 Jul 2020
RF Amplifier	Hewlett Packard	84498	3008A00769	1 – 26.5 GHz	15 May 2020
Biconilog	EMCO	3142B	1575	26-2000 MHz	10 May 2020
Horn Antenna	EMCO	3155	6570	1 – 18 GHz	11 Oct 2020
Horn Antenna	ETS-Lindgren	3160-09	001183858	18 – 26.5 GHz	27 Oct 2020
High Pass Filter	K & L	11SH10-4000/T12000	4	Cut off 2.4 GHz	See Note 1
Band Reject Filter	Micro-Tronics	BRM50701	105	Cut off 2.4-2.483 GHz	See Note 1
Note 1: Internal Verification/Calibration check					

EXHIBIT 7. MEASUREMENT UNCERTAINTY

The measurement uncertainties stated were calculated in accordance with the requirements of CISPR 16-4-2 @ IEC:2003 and JCGM 100:2008 (GUM 1995) – Guide to the Expression of Uncertainty in Measurement.

7.1. RADIATED EMISSION MEASUREMENT UNCERTAINTY

	Radiated Emission Measurement Uncertainty @ 3m, Horizontal (30-1000 MHz):	Measured (dB)	Limit (dB)
u_c	Combined standard uncertainty: $u_c(y) = \sqrt{\sum_{i=1}^m u_i^2(y)}$	± 2.39	± 2.6
U	Expanded uncertainty U: $U = 2u_c(y)$	± 4.79	± 5.2

	Radiated Emission Measurement Uncertainty @ 3m, Vertical (30-1000 MHz):	Measured (dB)	Limit (dB)
u_c	Combined standard uncertainty: $u_c(y) = \sqrt{\sum_{i=1}^m u_i^2(y)}$	± 2.39	± 2.6
U	Expanded uncertainty U: $U = 2u_c(y)$	± 4.78	± 5.2

	Radiated Emission Measurement Uncertainty @ 3 m, Horizontal & Vertical (1 – 18 GHz):	Measured (dB)	Limit (dB)
u_c	Combined standard uncertainty: $u_c(y) = \sqrt{\sum_{i=1}^m u_i^2(y)}$	± 1.87	Under consideration
U	Expanded uncertainty U: $U = 2u_c(y)$	± 3.75	Under consideration