

# ENGINEERING TEST REPORT

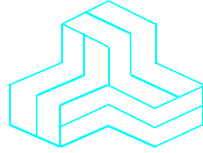

**XBee3  
Model: XBEE3  
FCC ID: MCQ-XBEE3**

*Applicant:*

**Digi International Inc**  
9350 Excelsior Blvd. Suite 700  
Hopkins, MN 55343

***In Accordance With***

**Federal Communications Commission (FCC)  
Part 15, Subpart C, Section 15.247  
Digital Modulation Systems (DTS) Operating in 2400 – 2483.5 MHz Band**

**UltraTech's File No.: 19DIGI159\_FCC15C247B**

This Test report is Issued under the Authority of  
Tri M. Luu  
Vice President of Engineering  
UltraTech Group of Labs

Date: December 16, 2019

Report Prepared by: Dan Huynh

Tested by: Hung Trinh

Issued Date: December 16, 2019

Test Dates:  
September 26, 27 & 30, 2019  
October 1, 2019

- *The results in this Test Report apply only to the sample(s) tested, and the sample tested is randomly selected.*
- *This report must not be used by the client to claim product endorsement by any agency of the US Government.*
- *This test report shall not be reproduced, except in full, without a written approval from UltraTech*

## UltraTech

3000 Bristol Circle, Oakville, Ontario, Canada L6H 6G4  
Tel.: (905) 829-1570 Fax.: (905) 829-8050  
Website: [www.ultratech-labs.com](http://www.ultratech-labs.com), Email: [vic@ultratech-labs.com](mailto:vic@ultratech-labs.com), Email: [tri@ultratech-labs.com](mailto:tri@ultratech-labs.com)



APEC TEL CA0001



1309



CA 0001/2049



AT-1945



SL2-IN-E-1119R



Korea KCC-RRR  
CA2049

**TABLE OF CONTENTS**

**EXHIBIT 1. INTRODUCTION..... 1**

1.1. SCOPE ..... 1

1.2. RELATED SUBMITTAL(S)/GRANT(S) ..... 1

1.3. NORMATIVE REFERENCES ..... 1

**EXHIBIT 2. PERFORMANCE ASSESSMENT ..... 2**

2.1. CLIENT INFORMATION ..... 2

2.2. EQUIPMENT UNDER TEST (EUT) INFORMATION ..... 2

2.3. EUT'S TECHNICAL SPECIFICATIONS..... 3

2.4. ASSOCIATED ANTENNA DESCRIPTIONS ..... 3

2.5. LIST OF EUT'S PORTS ..... 3

2.6. ANCILLARY EQUIPMENT ..... 3

**EXHIBIT 3. EUT OPERATING CONDITIONS AND CONFIGURATIONS DURING TESTS ..... 4**

3.1. CLIMATE TEST CONDITIONS ..... 4

3.2. OPERATIONAL TEST CONDITIONS & ARRANGEMENT FOR TESTS ..... 4

**EXHIBIT 4. SUMMARY OF TEST RESULTS..... 5**

4.1. LOCATION OF TESTS ..... 5

4.2. APPLICABILITY & SUMMARY OF EMC EMISSION TEST RESULTS ..... 5

4.3. MODIFICATIONS INCORPORATED IN THE EUT FOR COMPLIANCE PURPOSES ..... 5

**EXHIBIT 5. TEST DATA ..... 6**

5.1. PEAK CONDUCTED OUTPUT POWER - DTS [§ 15.247(b)(3)] ..... 6

5.2. TRANSMITTER SPURIOUS RADIATED EMISSIONS AT 3 METERS [§§ 15.247(d), 15.209 & 15.205] ..... 13

5.3. RF EXPOSURE REQUIRMENTS [§§ 15.247(i), 1.1310 & 2.1091] ..... 34

**EXHIBIT 6. TEST EQUIPMENT LIST ..... 36**

**EXHIBIT 7. MEASUREMENT UNCERTAINTY ..... 37**

7.1. RADIATED EMISSION MEASUREMENT UNCERTAINTY ..... 37

**EXHIBIT 1. INTRODUCTION**

**1.1. SCOPE**

<b>Reference:</b>	FCC Part 15, Subpart C, Section 15.247
<b>Title:</b>	Code of Federal Regulations (CFR), Title 47 – Telecommunication, Part 15 – Radio Frequency Devices
<b>Purpose of Test:</b>	Class II Permissive Change: <ul style="list-style-type: none"> <li>• Add additional antenna to the approved antennas list</li> </ul>
<b>Test Procedures:</b>	<ul style="list-style-type: none"> <li>▪ ANSI C63.4</li> <li>▪ ANSI C63.10</li> <li>▪ FCC KDB Publication No. 558074 D01 15.247 Meas Guidance v05r02</li> </ul>
<b>Environmental Classification:</b>	<input checked="" type="checkbox"/> Commercial, industrial or business environment <input type="checkbox"/> Residential environment

**1.2. RELATED SUBMITTAL(S)/GRANT(S)**

None.

**1.3. NORMATIVE REFERENCES**

Publication	Year	Title
47 CFR Parts 0-19	2019	Code of Federal Regulations (CFR), Title 47 – Telecommunication
ANSI C63.4	2014	American National Standard for Methods of Measurement of Radio-Noise Emissions from Low-Voltage Electrical and Electronic Equipment in the Range of 9 KHz to 40 GHz
ANSI C63.10	2013	American National Standard of Procedures for Compliance Testing of Unlicensed Wireless Devices
FCC, KDB Publication No. 558074 D01 15.247 Meas Guidance v05r02	2019	GUIDANCE FOR COMPLIANCE MEASUREMENTS ON DIGITAL TRANSMISSION SYSTEM, FREQUENCY HOPPING SPREAD SPECTRUM SYSTEM, AND HYBRID SYSTEM DEVICES OPERATING UNDER SECTION 15.247 OF THE FCC RULES

**EXHIBIT 2. PERFORMANCE ASSESSMENT**

**2.1. CLIENT INFORMATION**

<b>Applicant</b>	
<b>Name:</b>	Digi International Inc
<b>Address:</b>	9350 Excelsior Blvd. Suite 700 Hopkins, MN 55343 USA
<b>Contact Person:</b>	Scott Wilken Phone #:(952) 912-4965 Fax #: (952) 912-4952 Email Address: <a href="mailto:scott.wilken@digi.com">scott.wilken@digi.com</a>

<b>Manufacturer</b>	
<b>Name:</b>	Digi International Inc
<b>Address:</b>	9350 Excelsior Blvd. Suite 700 Hopkins, MN 55343 USA
<b>Contact Person:</b>	Scott Wilken Phone #:(952) 912-4965 Fax #: (952) 912-4952 Email Address: <a href="mailto:scott.wilken@digi.com">scott.wilken@digi.com</a>

**2.2. EQUIPMENT UNDER TEST (EUT) INFORMATION**

The following information (with the exception of the Date of Receipt) has been supplied by the applicant.

<b>Brand Name:</b>	Digi International Inc
<b>Product Name:</b>	XBee3
<b>Model Name or Number:</b>	XBEE3
<b>Serial Number:</b>	Test Sample
<b>Type of Equipment:</b>	Digital Transmission System (DTS)
<b>Input Power Supply Type:</b>	External DC Power Supply
<b>Primary User Functions of EUT:</b>	802.15.4 connectivity of embedded systems, BLE connectivity

**2.3. EUT’S TECHNICAL SPECIFICATIONS**

<b>Transmitter</b>	
<b>Equipment Type:</b>	Mobile Base station (fixed use)
<b>Intended Operating Environment:</b>	Commercial, industrial or business environment
<b>Power Supply Requirement:</b>	3.3V (nominal)
<b>RF Output Power Rating:</b>	+19.60 dBm maximum conducted power
<b>Operating Frequency Range:</b>	2402 - 2480 MHz (for 1 Mbps operating mode) 2404 - 2478 MHz (for 2 Mbps operating mode)
<b>RF Output Impedance:</b>	50 Ω
<b>Duty Cycle:</b>	Continuous
<b>Modulation Type:</b>	GFSK
<b>Antenna Connector Types:</b>	Integral antenna, U.FL, RF Pad

**2.4. ASSOCIATED ANTENNA DESCRIPTIONS**

<b>Manufacturer</b>	<b>Antenna Type</b>	<b>P/N</b>	<b>Maximum Gain (dBi)</b>
Taoglas	Patch	FXP74.07.0100A	4

**2.5. LIST OF EUT’S PORTS**

<b>Port Number</b>	<b>EUT’s Port Description</b>	<b>Number of Identical Ports</b>	<b>Connector Type</b>	<b>Cable Type (Shielded/Non-shielded)</b>
1	RF port	1	Integral antenna, U.FL or RF Pad	Shielded cable (N/A for integral antenna)
2	DC supply and I/O port	1	Castellated Pads	Direct connection (no cable)

**2.6. ANCILLARY EQUIPMENT**

The EUT was tested while connected to the following representative configuration of ancillary equipment necessary to exercise the ports during tests:

<b>Ancillary Equipment # 1</b>	
Description:	Test Jig
Brand name:	Digi International
Model Name or Number:	N/A
Serial Number:	N/A
Connected to EUT’s Port:	Module pin signals

**EXHIBIT 3. EUT OPERATING CONDITIONS AND CONFIGURATIONS DURING TESTS**

**3.1. CLIMATE TEST CONDITIONS**

The climate conditions of the test environment are as follows:

Temperature:	21 to 23 °C
Humidity:	45 to 58%
Pressure:	102 kPa
Power Input Source:	3.6 VDC from Test Jig

**3.2. OPERATIONAL TEST CONDITIONS & ARRANGEMENT FOR TESTS**

<b>Operating Modes:</b>	The transmitter was operated in a continuous transmission mode with the carrier modulated as specified in the Test Data.
<b>Special Test Software:</b>	Test software provided by the Applicant to operate the EUT at each channel frequency continuously and in the range of typical modes of operation.
<b>Special Hardware Used:</b>	Test Jig
<b>Transmitter Test Antenna:</b>	The EUT is tested with the antenna fitted in a manner typical of normal intended use as integral as described with the test results.

<b>Transmitter Test Signals</b>	
<b>Frequency Band(s):</b>	2402 - 2480 MHz (for 1 Mbps operating mode) 2404 - 2478 MHz (for 2 Mbps operating mode)
<b>Frequency(ies) Tested:</b>	1 Mbps operating mode: 2402 MHz, 2440 MHz, 2480 MHz  2 Mbps operating mode: 2404 MHz, 2440 MHz, 2470 MHz, 2472 MHz, 2474 MHz, 2476 MHz, 2478 MHz
<b>RF Power Output:</b> (measured maximum output power at antenna terminals)	19.60 dBm Maximum Peak (91.20 mW)
<b>Normal Test Modulation:</b>	GFSK
<b>Modulating Signal Source:</b>	Internal

**EXHIBIT 4. SUMMARY OF TEST RESULTS**

**4.1. LOCATION OF TESTS**

All of the measurements described in this report were performed at Ultratech Group of Labs located in the city of Oakville, Province of Ontario, Canada.

- AC Power Line Conducted Emissions were performed in UltraTech's shielded room, 24'(L) by 16'(W) by 8'(H).
- Radiated Emissions were performed at the Ultratech's 3-10 TDK Semi-Anechoic Chamber situated in the Town of Oakville, province of Ontario. This test site been calibrated in accordance with ANSI C63.4, and found to be in compliance with the requirements of Sec. 2.948 of the FCC Rules. The descriptions and site measurement data of the Oakville 3-10 TDK Semi-Anechoic Chamber has been filed with ANAB File No.: AT-1945.

**4.2. APPLICABILITY & SUMMARY OF EMC EMISSION TEST RESULTS**

FCC Section(s)	Test Requirements	Compliance (Yes/No)
15.203	Antenna requirements	Yes <sup>1</sup>
15.207(a)	AC Power Line Conducted Emissions	N/A
15.247(a)(2)	6 dB Bandwidth	N/A
15.247(b)(3)	Peak Conducted Output Power	Yes
15.247(d)	Band-Edge and RF Conducted Spurious Emissions at the Transmitter Antenna Terminal	N/A
15.247(d), 15.209 & 15.205	Transmitter Spurious Radiated Emissions	Yes
15.247(e)	Power Spectral Density	N/A
15.247(i), 1.1307, 1.1310, 2.1091, 2.1093	RF Exposure	Yes

<sup>1</sup> The EUT complies with the requirement; it employs an integral antenna.

**4.3. MODIFICATIONS INCORPORATED IN THE EUT FOR COMPLIANCE PURPOSES**

None.

## EXHIBIT 5. TEST DATA

### 5.1. PEAK CONDUCTED OUTPUT POWER - DTS [§ 15.247(b)(3)]

#### 5.1.1. Limit(s)

§ 15.247(b)(3): For systems using digital modulation in the 902-928 MHz, 2400-2483.5 MHz, and 5725-5850 MHz bands: 1 Watt. As an alternative to a peak power measurement, compliance with the one Watt limit can be based on a measurement of the maximum conducted output power. Maximum Conducted Output Power is defined as the total transmit power delivered to all antennas and antenna elements averaged across all symbols in the signaling alphabet when the transmitter is operating at its maximum power control level. Power must be summed across all antennas and antenna elements. The average must not include any time intervals during which the transmitter is off or is transmitting at a reduced power level. If multiple modes of operation are possible (e.g., alternative modulation methods), the *maximum conducted output power* is the highest total transmit power occurring in any mode.

§ 15.247(b)(4): The conducted output power limit specified in paragraph (b) of this section is based on the use of antennas with directional gains that do not exceed 6 dBi. Except as shown in paragraph (c) of this section, if transmitting antennas of directional gain greater than 6 dBi are used, the conducted output power from the intentional radiator shall be reduced below the stated values in paragraphs (b)(1), (b)(2), and (b)(3) of this section, as appropriate, by the amount in dB that the directional gain of the antenna exceeds 6 dBi.

#### 5.1.2. Method of Measurements & Test Arrangement

KDB 558074 D01 15.247 Meas Guidance v05r02, Section 8.3.1.1 RBW ≥ DTS bandwidth

#### 5.1.3. Test Arrangement

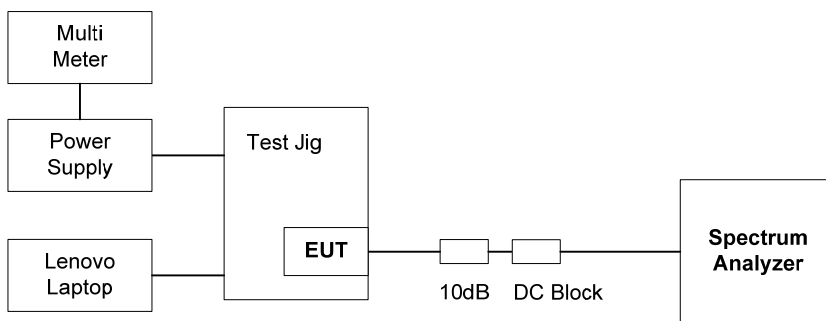



**5.1.4. Test Data**

Remarks:

- 1) The highest channel to test for BLE 2Mbps is 2478 MHz; 2480 MHz is an advertising channel operating only at 1Mbps.
- 2) The stack of Silicon Labs limits some channels output power internally, the approximate BLE output power reduction as shown in the following table.

**Approximate BLE Output Power Reductions from Maximum by EFR32 Stack**

Channel/Data Rate	1Mbit/s	2Mbit/s
2470MHz	None	None
2472MHz	None	1.5 dB
2474MHz	None	4 dB
2476MHz	1.5 dB	7 dB
2478MHz	4 dB	11 dB
2480MHz	None	None

**Maximum Peak Conducted Power at Power Setting 200**

Modulation	Power Setting	Data Rate (Mbps)	Channel	Frequency (MHz)	Maximum Peak Conducted Power (dBm)	Peak Power Limit (dBm)
GFSK	200	1	00	2402	19.60	30
			19	2440	19.41	30
			39	2480	19.48	30
		2	01	2404	19.54	30
			19	2440	19.45	30
			34	2470	19.44	30
			35	2472	18.71	30
			36	2474	15.81	30
			37	2476	12.73	30
			38	2478	8.34	30

Plot 5.1.4.1. Maximum Peak Conducted Output Power, GFSK Modulation, Power Setting 200, 1 Mbps, Ch 00, 2402 MHz

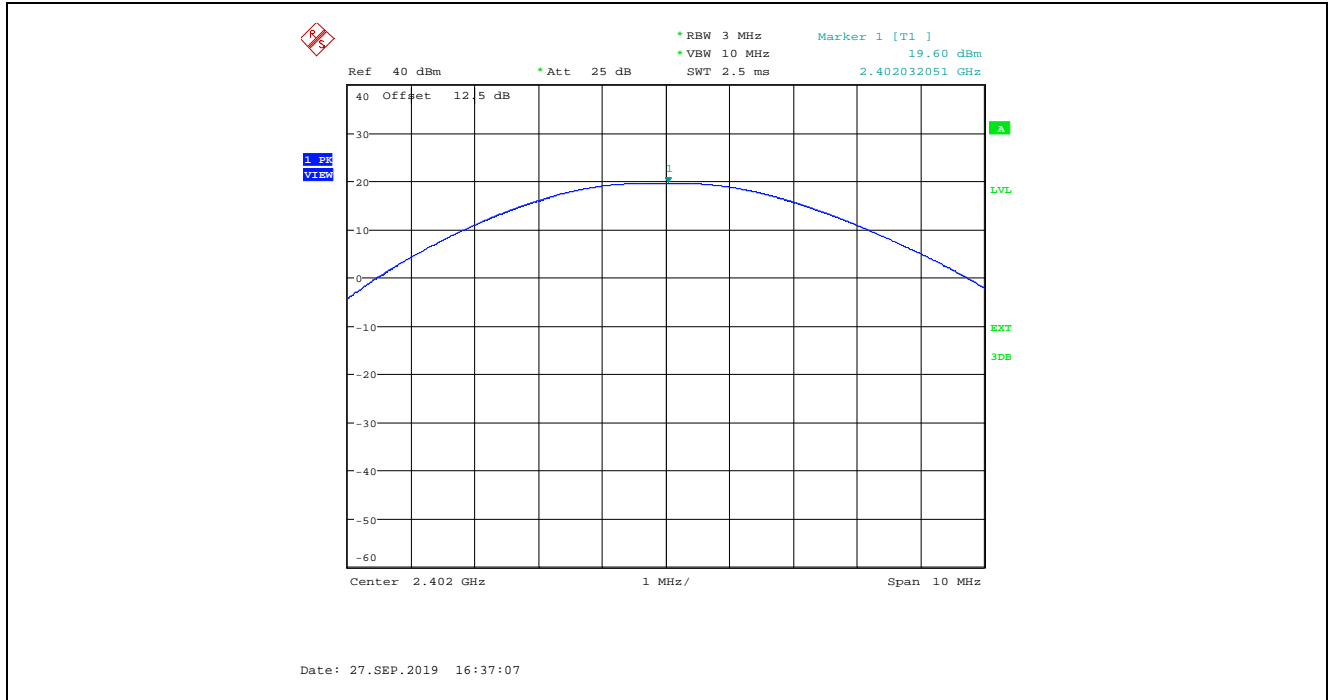

Plot 5.1.4.2. Maximum Peak Conducted Output Power, GFSK Modulation, Power Setting 200, 1 Mbps, Ch 19, 2440 MHz

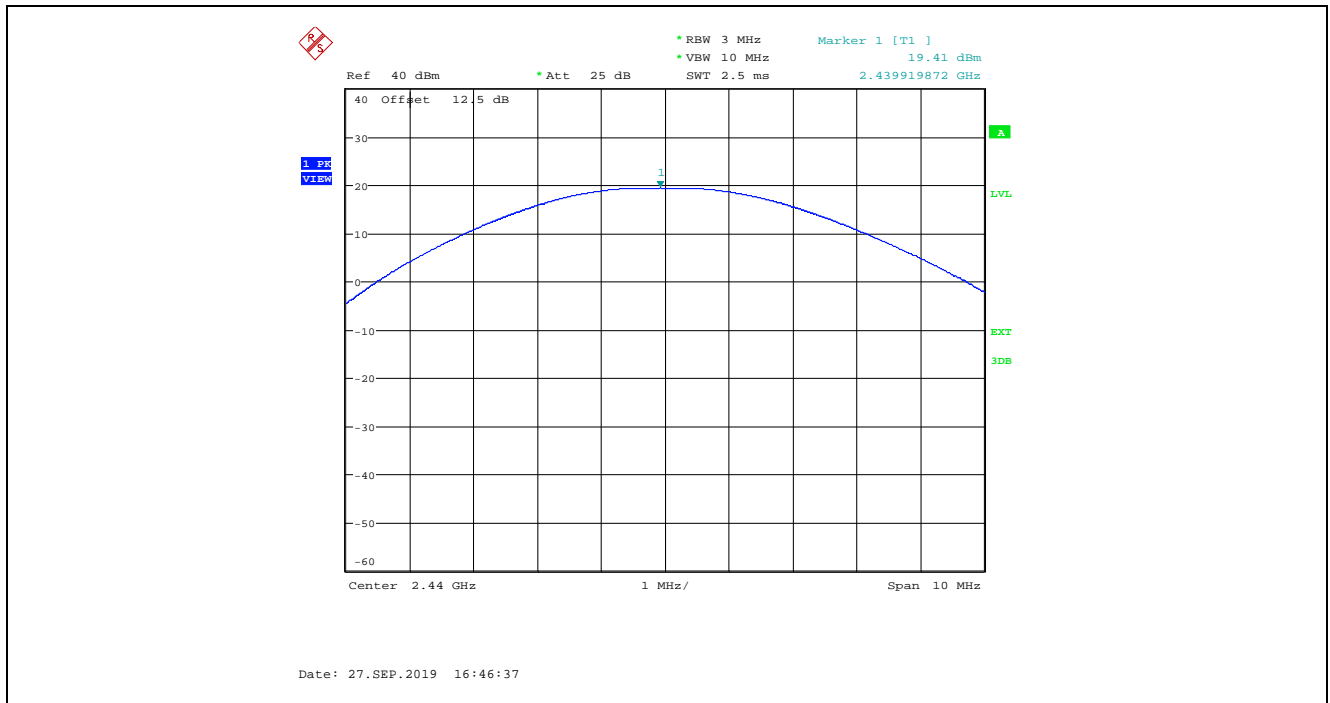

Plot 5.1.4.3. Maximum Peak Conducted Output Power, GFSK Modulation, Power Setting 200, 1 Mbps, Ch 39, 2480 MHz

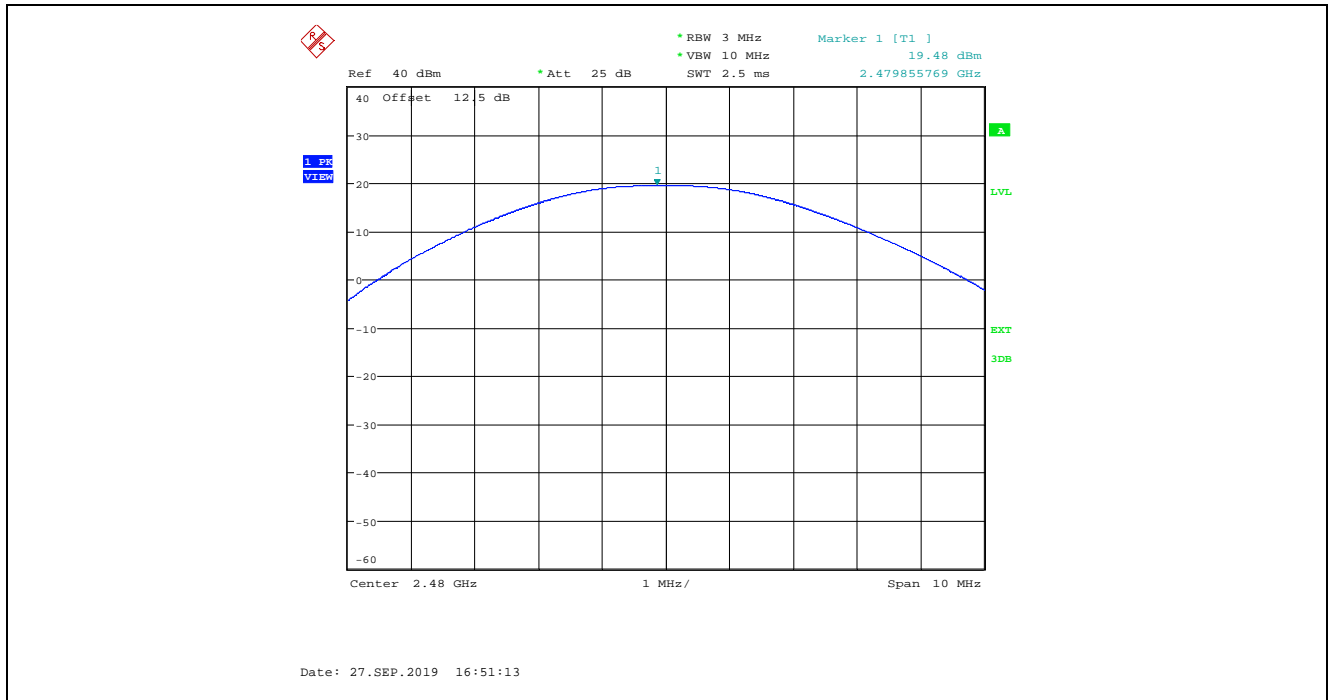

Plot 5.1.4.4. Maximum Peak Conducted Output Power, GFSK Modulation, Power Setting 200, 2 Mbps, Ch 01, 2404 MHz

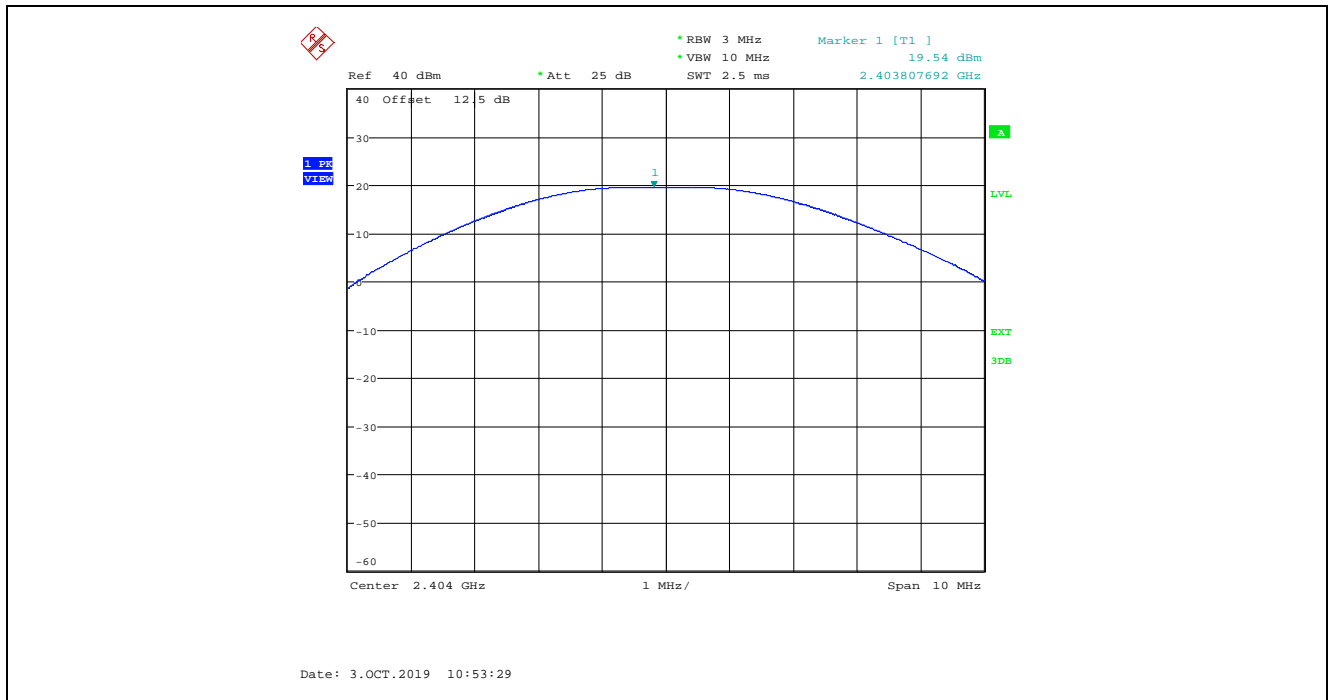

Plot 5.1.4.5. Maximum Peak Conducted Output Power, GFSK Modulation, Power Setting 200, 2 Mbps, Ch 19, 2440 MHz

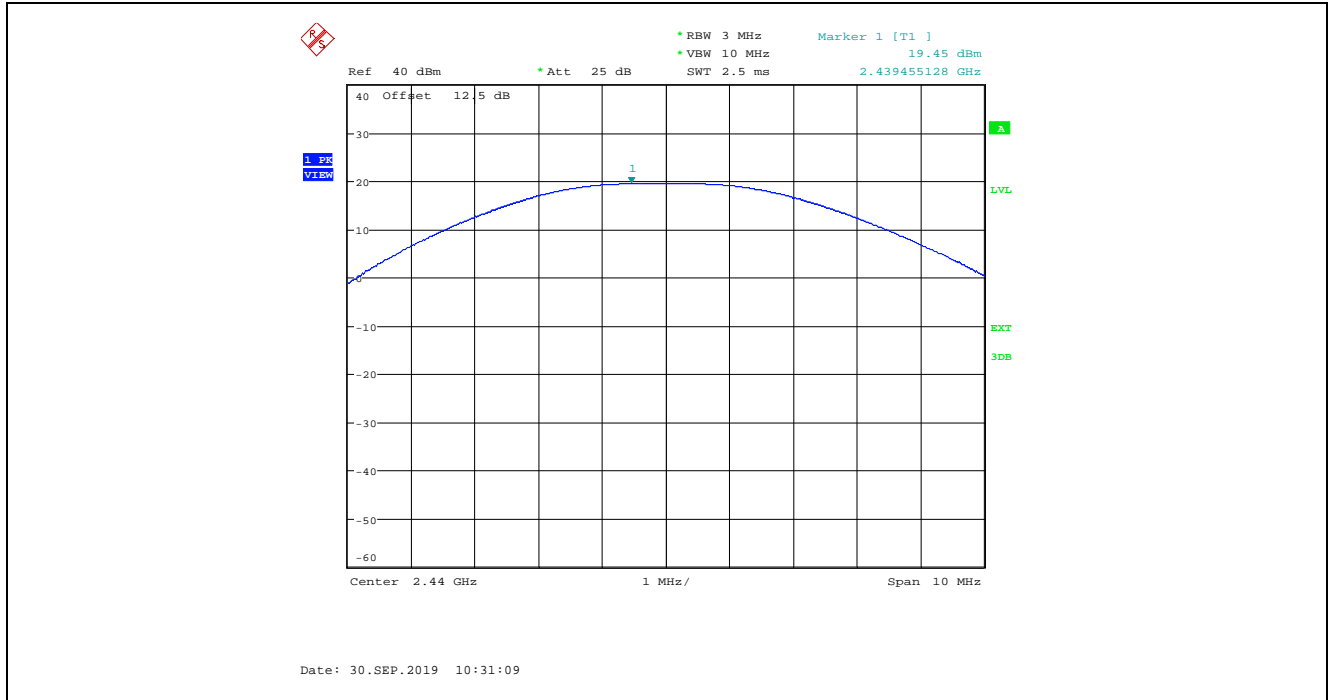

Plot 5.1.4.6. Maximum Peak Conducted Output Power, GFSK Modulation, Power Setting 200, 2 Mbps, Ch 34, 2470 MHz

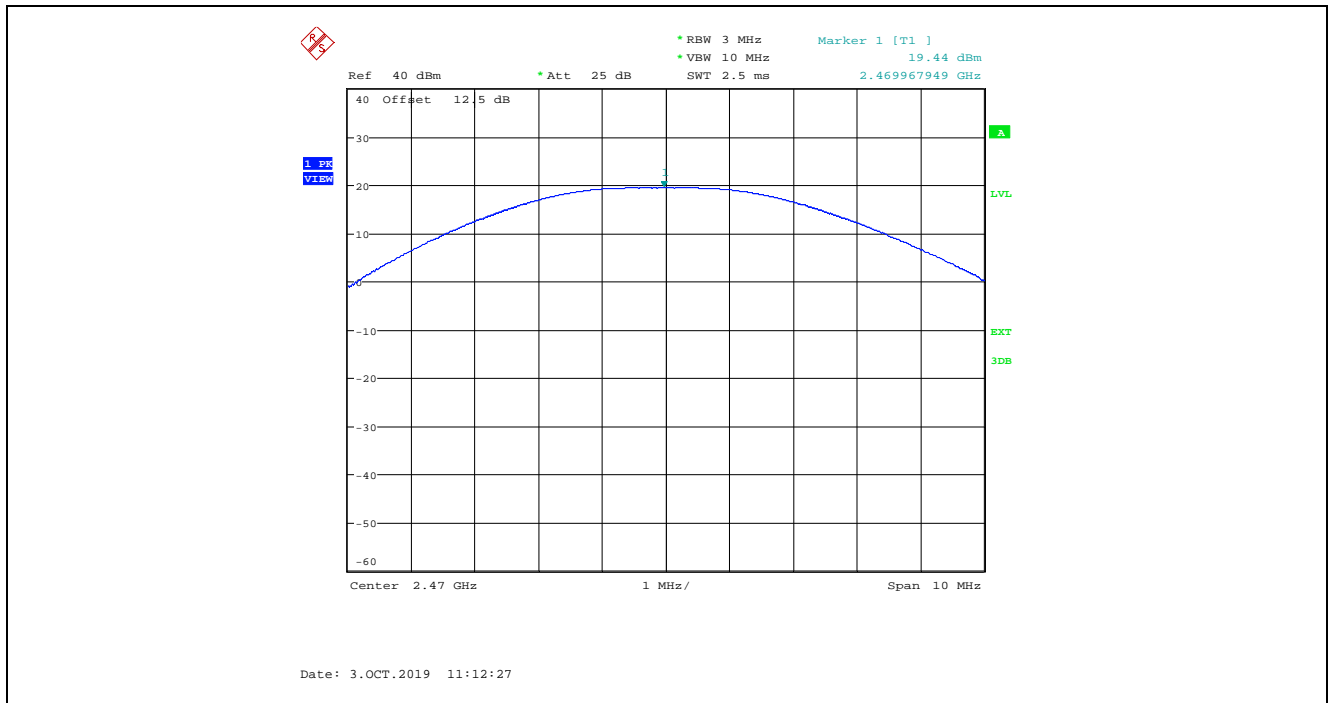

Plot 5.1.4.7. Maximum Peak Conducted Output Power, GFSK Modulation, Power Setting 200, 2 Mbps, Ch 35, 2472 MHz

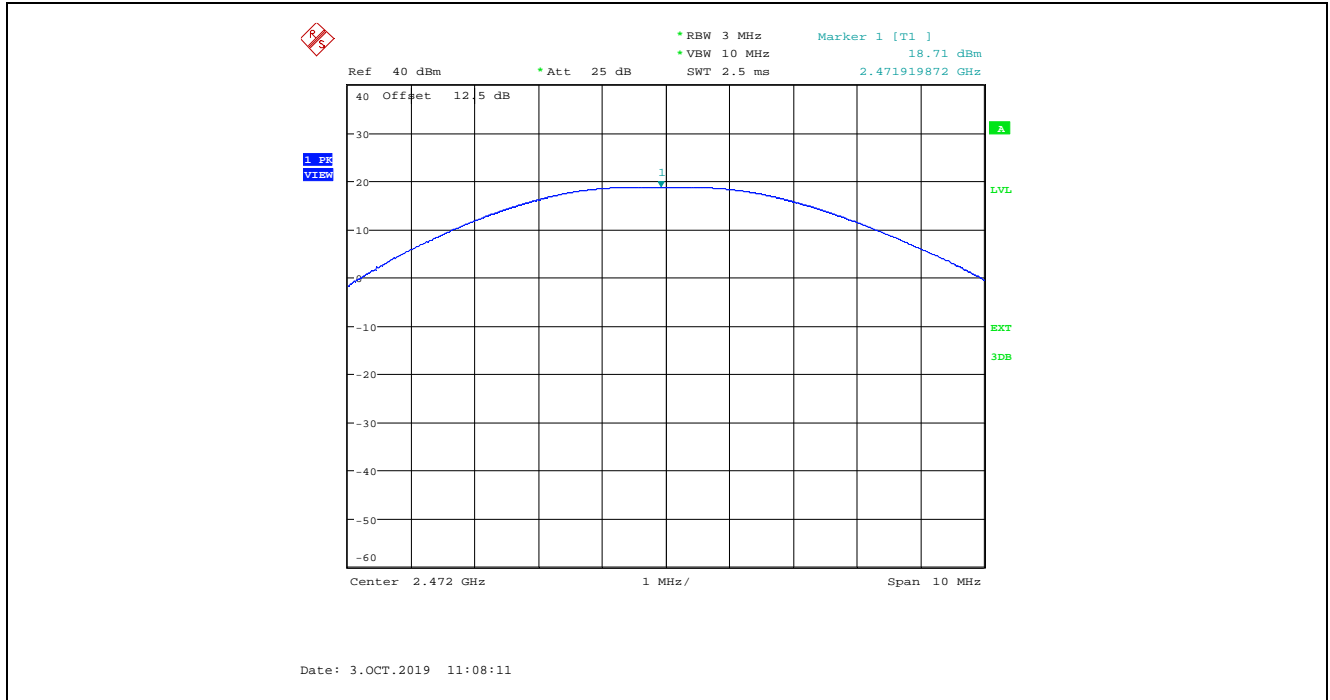

Plot 5.1.4.8. Maximum Peak Conducted Output Power, GFSK Modulation, Power Setting 200, 2 Mbps, Ch 36, 2474 MHz

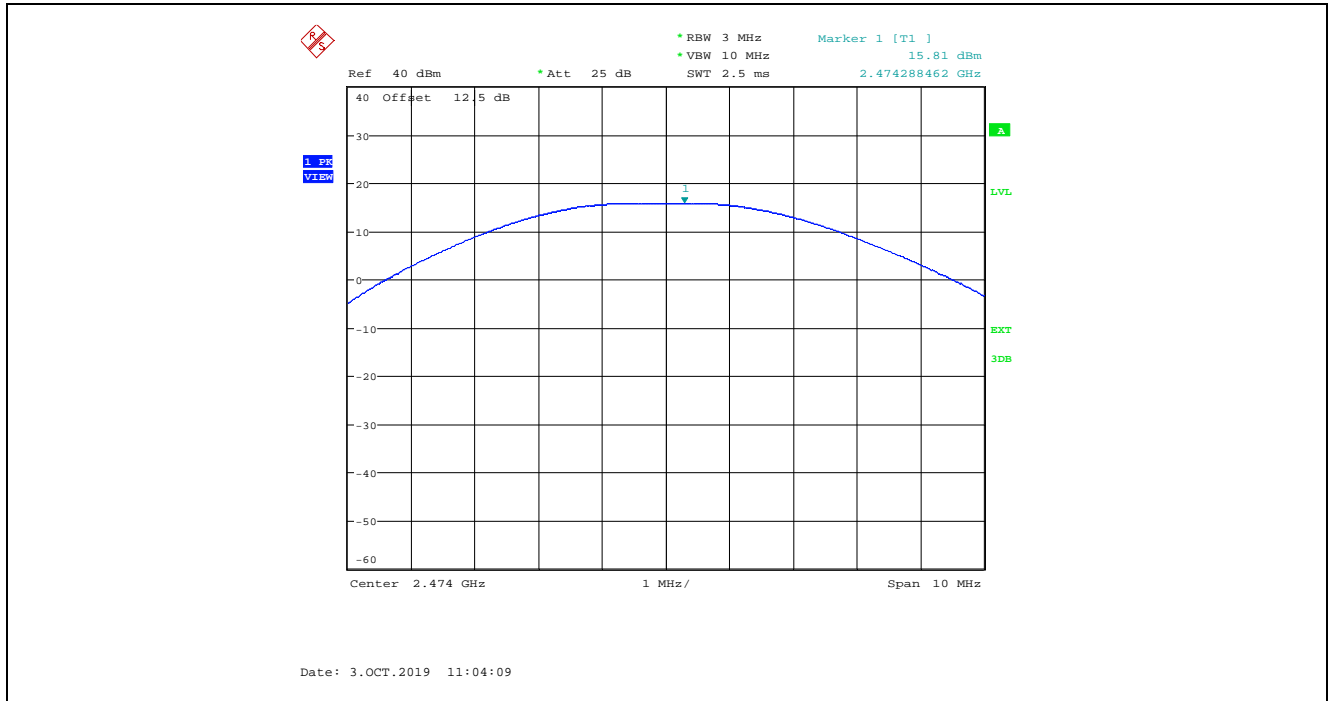

Plot 5.1.4.9. Maximum Peak Conducted Output Power, GFSK Modulation, Power Setting 200, 2 Mbps, Ch 37, 2476 MHz

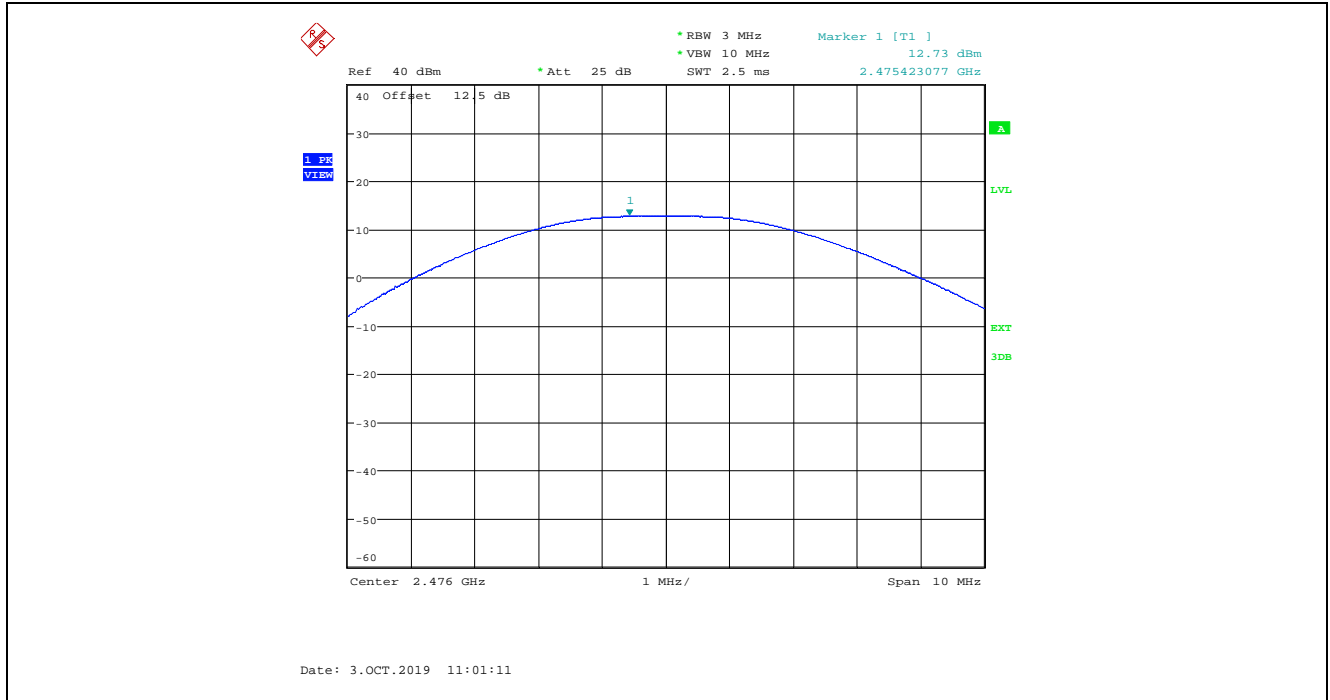

Plot 5.1.4.10. Maximum Peak Conducted Output Power, GFSK Modulation, Power Setting 200, 2 Mbps, Ch 38, 2478 MHz

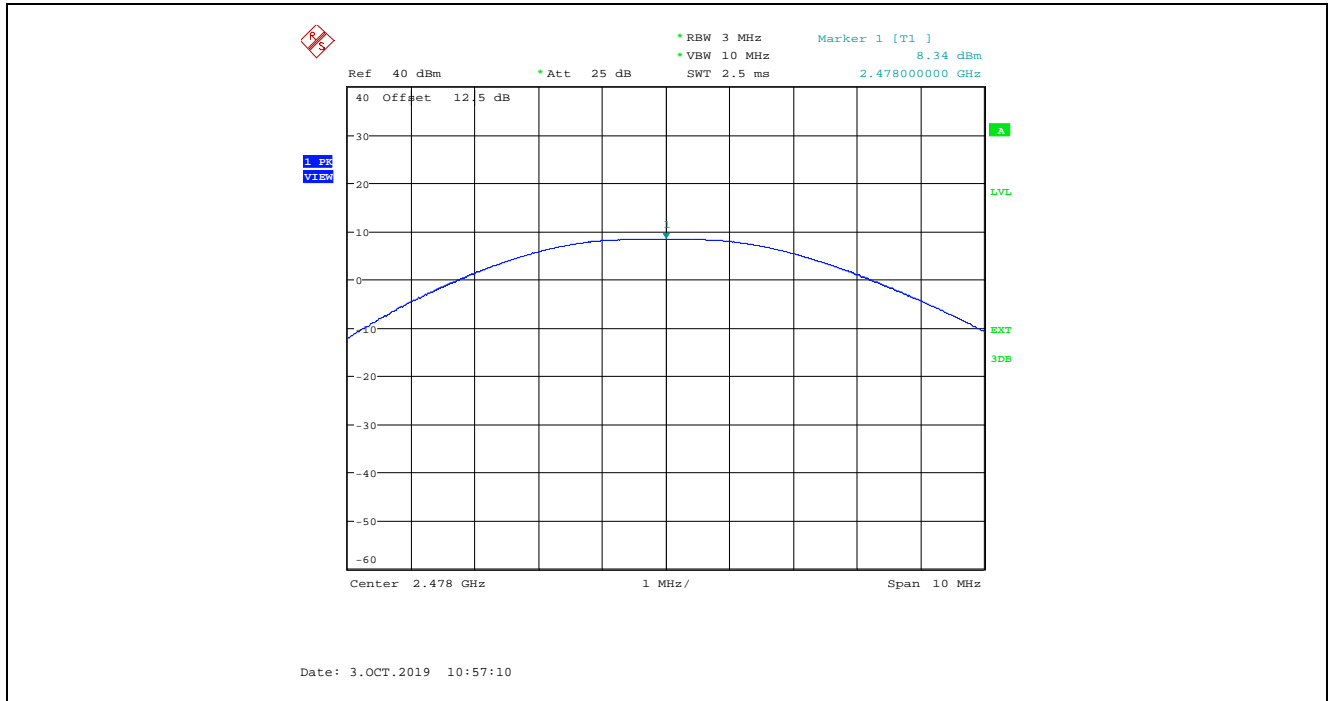

**5.2. TRANSMITTER SPURIOUS RADIATED EMISSIONS AT 3 METERS [§§ 15.247(d), 15.209 & 15.205]**

**5.2.1. Limit(s)**

**§ 15.247 (d):** In any 100 kHz bandwidth outside the frequency band in which the spread spectrum or digitally modulated intentional radiator is operating, the radio frequency power that is produced by the intentional radiator shall be at least 20 dB below that in the 100 kHz bandwidth within the band that contains the highest level of the desired power, based on either an RF conducted or a radiated measurement, provided the transmitter demonstrates compliance with the peak conducted power limits. If the transmitter complies with the conducted power limits based on the use of RMS averaging over a time interval, as permitted under paragraph (b)(3) of this section, the attenuation required under this paragraph shall be 30 dB instead of 20 dB. Attenuation below the general limits specified in Section 15.209(a) is not required. In addition, radiated emissions which fall in the restricted bands, as defined in Section 15.205(a), must also comply with the radiated emission limits specified in Section 15.209(a) (see Section 15.205(c)).

**Section 15.205(a) - Restricted Bands of Operation**

MHz	MHz	MHz	GHz
0.090–0.110 .....	16.42–16.423	399.9–410	4.5–5.15
<sup>1</sup> 0.495–0.505 .....	16.69475–16.69525	608–614	5.35–5.46
2.1735–2.1905 .....	16.80425–16.80475	960–1240	7.25–7.75
4.125–4.128 .....	25.5–25.67	1300–1427	8.025–8.5
4.17725–4.17775 .....	37.5–38.25	1435–1626.5	9.0–9.2
4.20725–4.20775 .....	73–74.6	1645.5–1646.5	9.3–9.5
6.215–6.218 .....	74.8–75.2	1660–1710	10.6–12.7
6.26775–6.26825 .....	108–121.94	1718.8–1722.2	13.25–13.4
6.31175–6.31225 .....	123–138	2200–2300	14.47–14.5
8.291–8.294 .....	149.9–150.05	2310–2390	15.35–16.2
8.362–8.366 .....	156.52475–156.52525	2483.5–2500	17.7–21.4
8.37625–8.38675 .....	156.7–156.9	2655–2900	22.01–23.12
8.41425–8.41475 .....	162.0125–167.17	3260–3267	23.6–24.0
12.29–12.293 .....	167.72–173.2	3332–3339	31.2–31.8
12.51975–12.52025 .....	240–285	3345.8–3358	36.43–36.5
12.57675–12.57725 .....	322–335.4	3600–4400	( <sup>2</sup> )
13.36–13.41.			

<sup>1</sup> Until February 1, 1999, this restricted band shall be 0.490–0.510 MHz.

<sup>2</sup> Above 38.6

**Section 15.209(a) - Field Strength Limits within Restricted Frequency Bands**

Frequency (MHz)	Field Strength (microvolts/meter)	Measurement Distance (meters)
0.009 - 0.490	2,400 / F (kHz)	300
0.490 - 1.705	24,000 / F (kHz)	30
1.705 - 30.0	30	30
30 – 88	100	3
88 – 216	150	3
216 – 960	200	3
Above 960	500	3

### 5.2.2. Method of Measurements

KDB 558074 D01 15.247 Meas Guidance v05r02, Sections 8.5, 8.6 and 8.7 (ANSI C63.10-2013 Clauses 11.11, 11.12 and 11.13)

### 5.2.3. Test Arrangement

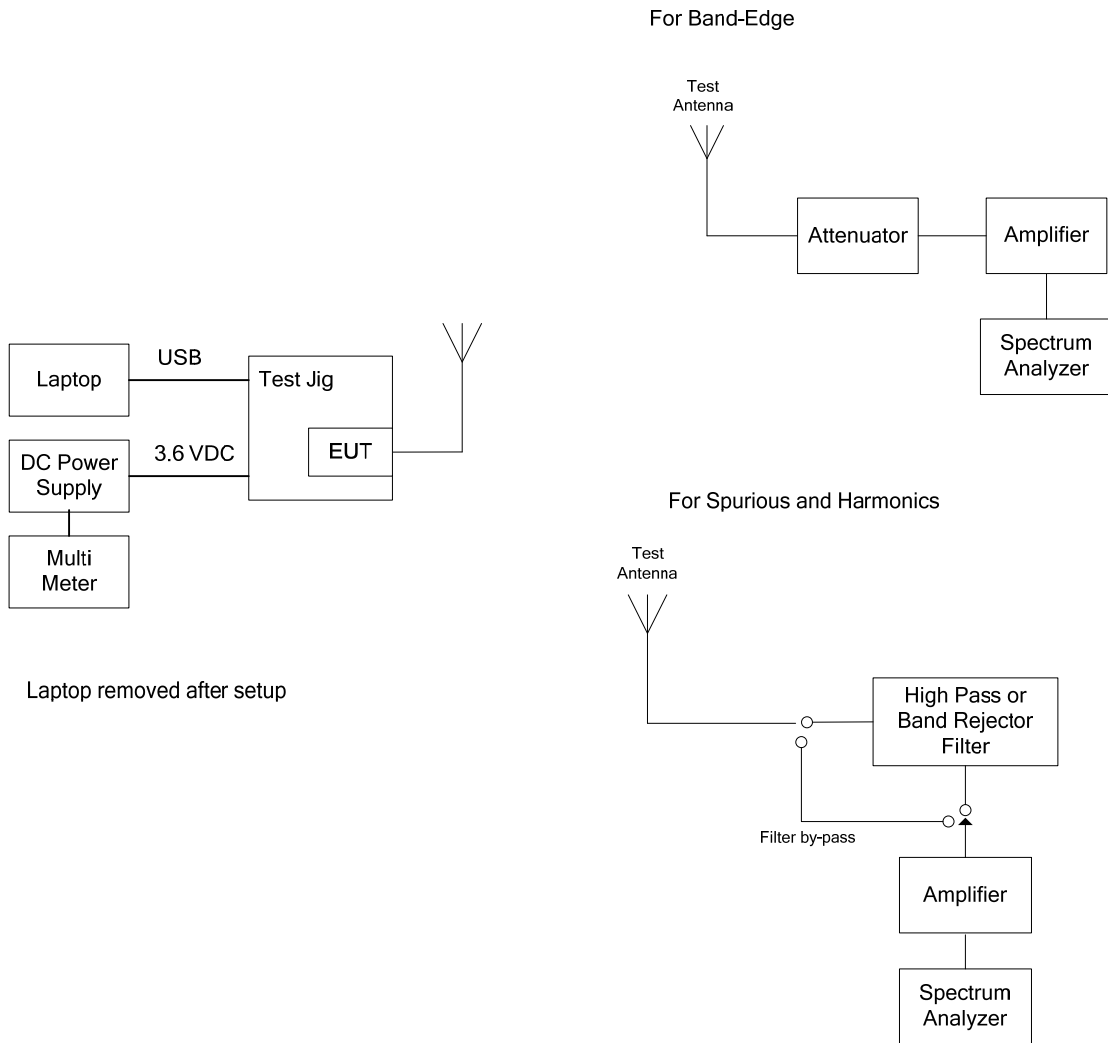



**5.2.4. Test Data**

**Remark(s):**

- All spurious emissions that are in excess of 20 dB below the specified limit shall be recorded.
- EUT shall be tested in three orthogonal positions.
- The following test data represent the worst-case derived from exploratory tests.

**5.2.4.1. Spurious Radiated Emission**

Fundamental Frequency:		2402 MHz					
Power Setting:		200					
Data Rate:		1 Mbps					
Frequency Test Range:		30 MHz – 25 GHz					
Frequency (MHz)	RF Peak Level (dBµV/m)	RF Avg Level (dBµV/m)	Antenna Plane (H/V)	Limit 15.209 (dBµV/m)	Limit 15.247 (dBµV/m)	Margin (dB)	Pass/Fail
2402	109.68	--	V	--	--	--	--
2402	113.15	--	H	--	--	--	--
4804	56.30	49.72	V	54.0	93.2	-4.3	Pass*
4804	58.70	52.31	H	54.0	93.2	-1.7	Pass*
All other spurious emissions and harmonics are more than 20 dB below the applicable limit.							

Fundamental Frequency:		2440 MHz					
Power Setting:		200					
Data Rate:		1 Mbps					
Frequency Test Range:		30 MHz – 25 GHz					
Frequency (MHz)	RF Peak Level (dBµV/m)	RF Avg Level (dBµV/m)	Antenna Plane (H/V)	Limit 15.209 (dBµV/m)	Limit 15.247 (dBµV/m)	Margin (dB)	Pass/Fail
2440	114.22	--	V	--	--	--	--
2440	114.78	--	H	--	--	--	--
4880	51.26	43.04	V	54.0	94.8	-11.0	Pass*
4880	53.17	44.64	H	54.0	94.8	-9.4	Pass*
7320	54.22	39.74	V	54.0	94.8	-14.3	Pass*
7320	51.92	38.27	H	54.0	94.8	-15.7	Pass*
All other spurious emissions and harmonics are more than 20 dB below the applicable limit.							

Fundamental Frequency:		2480 MHz					
Power Setting:		200					
Data Rate:		1 Mbps					
Frequency Test Range:		30 MHz – 25 GHz					
Frequency (MHz)	RF Peak Level (dBµV/m)	RF Avg Level (dBµV/m)	Antenna Plane (H/V)	Limit 15.209 (dBµV/m)	Limit 15.247 (dBµV/m)	Margin (dB)	Pass/Fail
2480	113.36	--	V	--	--	--	--
2480	113.75	--	H	--	--	--	--
4960	53.02	43.97	V	54.0	93.8	-10.0	Pass*
4960	52.45	44.69	H	54.0	93.8	-9.3	Pass*
7440	52.26	39.05	V	54.0	93.8	-15.0	Pass*
7440	51.80	38.84	H	54.0	93.8	-15.2	Pass*
All other spurious emissions and harmonics are more than 20 dB below the applicable limit.							

Fundamental Frequency:		2404 MHz					
Power Setting:		200					
Data Rate:		2 Mbps					
Frequency Test Range:		30 MHz – 25 GHz					
Frequency (MHz)	RF Peak Level (dBµV/m)	RF Avg Level (dBµV/m)	Antenna Plane (H/V)	Limit 15.209 (dBµV/m)	Limit 15.247 (dBµV/m)	Margin (dB)	Pass/Fail
2404	109.58	--	V	--	--	--	--
2404	113.01	--	H	--	--	--	--
4808	57.12	46.83	V	54.0	93.0	-7.2	Pass*
4808	57.15	46.85	H	54.0	93.0	-7.2	Pass*
All other spurious emissions and harmonics are more than 20 dB below the applicable limit.							

Fundamental Frequency:		2440 MHz					
Power Setting:		200					
Data Rate:		2 Mbps					
Frequency Test Range:		30 MHz – 25 GHz					
Frequency (MHz)	RF Peak Level (dBµV/m)	RF Avg Level (dBµV/m)	Antenna Plane (H/V)	Limit 15.209 (dBµV/m)	Limit 15.247 (dBµV/m)	Margin (dB)	Pass/Fail
2440	109.55	--	V	--	--	--	--
2440	114.97	--	H	--	--	--	--
4880	51.69	39.10	V	54.0	95.0	-14.9	Pass*
4880	52.15	40.00	H	54.0	95.0	-14.0	Pass*
All other spurious emissions and harmonics are more than 20 dB below the applicable limit.							

Fundamental Frequency:		2478 MHz					
Power Setting:		200					
Data Rate:		2 Mbps					
Frequency Test Range:		30 MHz – 25 GHz					
Frequency (MHz)	RF Peak Level (dBµV/m)	RF Avg Level (dBµV/m)	Antenna Plane (H/V)	Limit 15.209 (dBµV/m)	Limit 15.247 (dBµV/m)	Margin (dB)	Pass/Fail
2478	101.56	--	V	--	--	--	--
2478	100.61	--	H	--	--	--	--
4956	50.19	37.63	V	54.0	81.6	-16.4	Pass*
4956	48.99	35.67	H	54.0	81.6	-18.3	Pass*
All other spurious emissions and harmonics are more than 20 dB below the applicable limit.							

### 5.2.4.2. Band-Edge Radiated Emissions

**Plot 5.2.4.2.1.** Band-Edge Radiated Emissions, Lower Band- edge, Peak Detector  
Rx Antenna in Vertical Polarization, GFSK Modulation, 1 Mbps, Power Setting 200, Ch 00, 2402 MHz

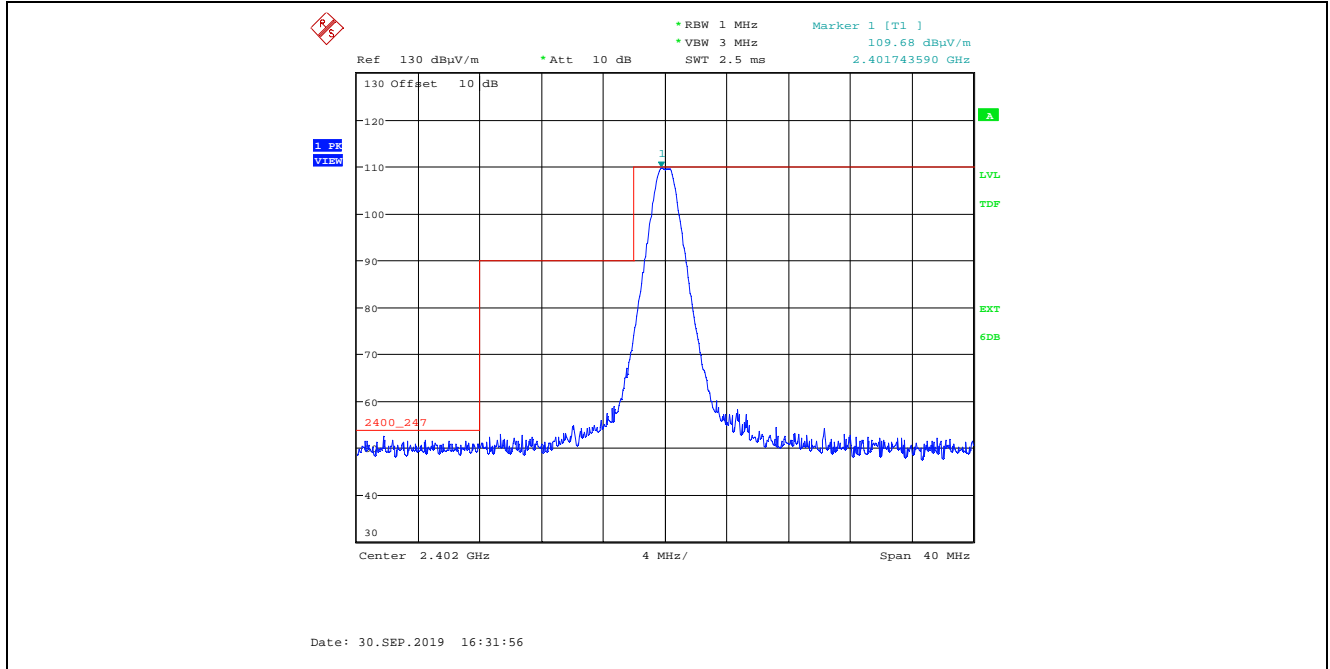

**Plot 5.2.4.2.2.** Band-Edge Radiated Emissions, Lower Band- edge, Average Detector  
Rx Antenna in Vertical Polarization, GFSK Modulation, 1 Mbps, Power Setting 200, Ch 00, 2402 MHz

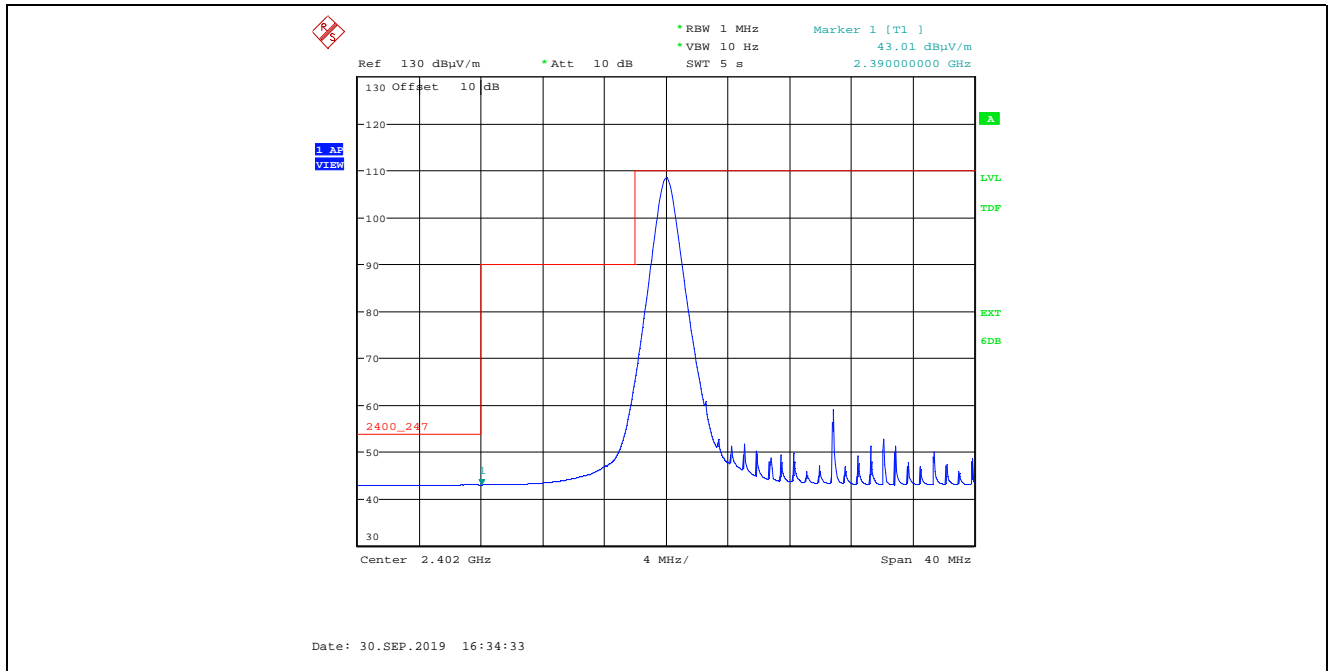

**Plot 5.2.4.2.3.** Band-Edge Radiated Emissions, Lower Band-edge, Peak Detector  
Rx Antenna in Horizontal Polarization, GFSK Modulation, 1 Mbps, Power Setting 200, Ch 00, 2402 MHz

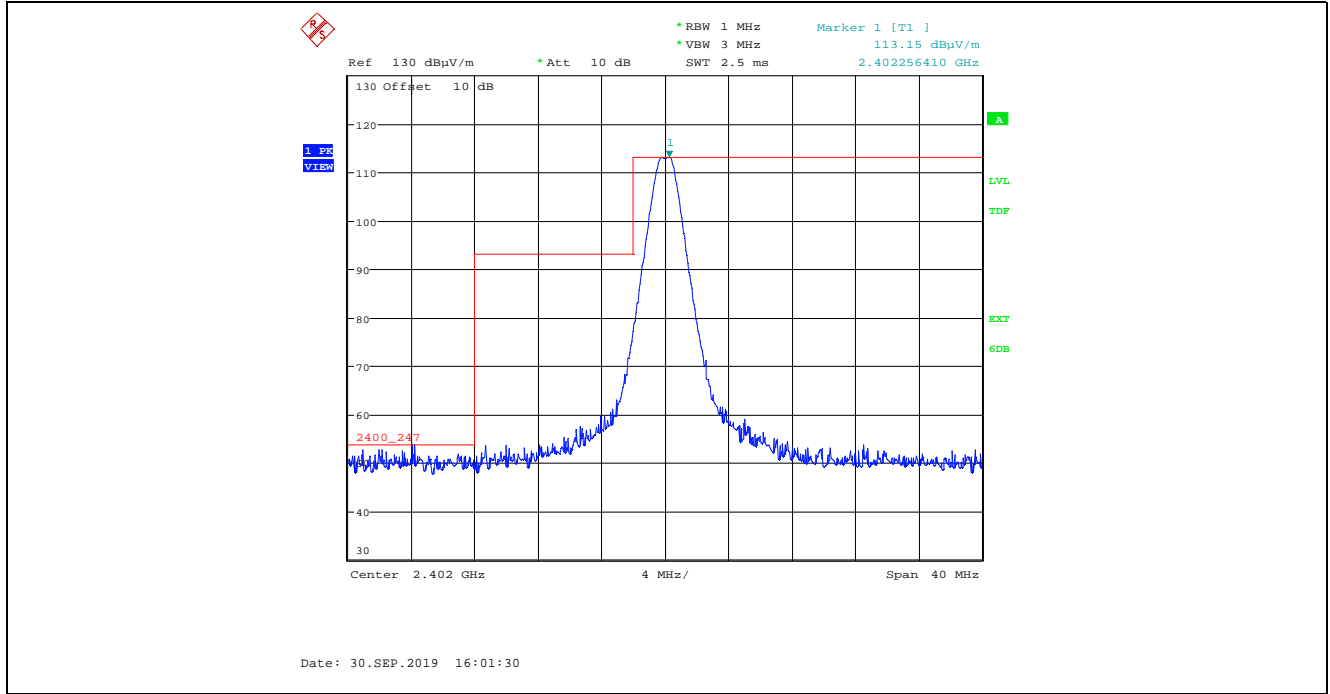

**Plot 5.2.4.2.4.** Band-Edge Radiated Emissions, Lower Band-edge, Average Detector  
Rx Antenna in Horizontal Polarization, GFSK Modulation, 1 Mbps, Power Setting 200, Ch 00, 2402 MHz

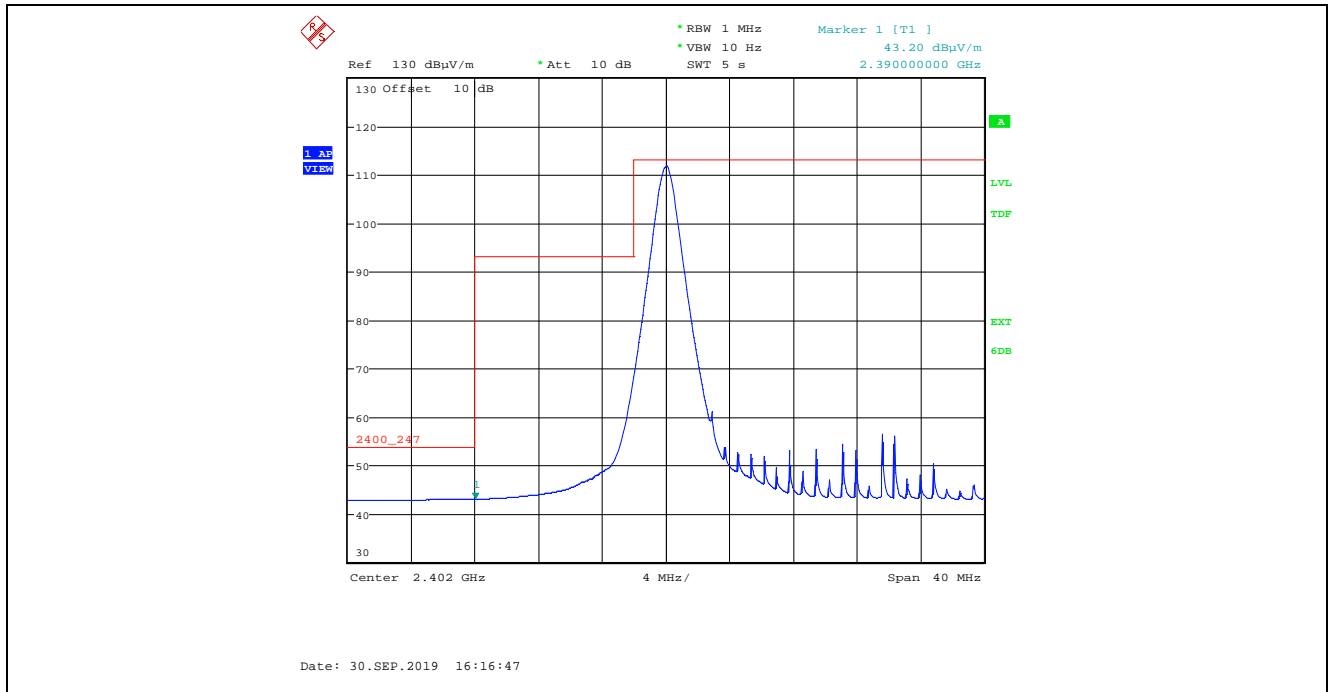

**Plot 5.2.4.2.5. Band-Edge Radiated Emissions, Higher Band-edge, Peak Detector**  
 Rx Antenna in Vertical Polarization, GFSK Modulation, 1 Mbps, Power Setting 200, Ch 39, 2480 MHz

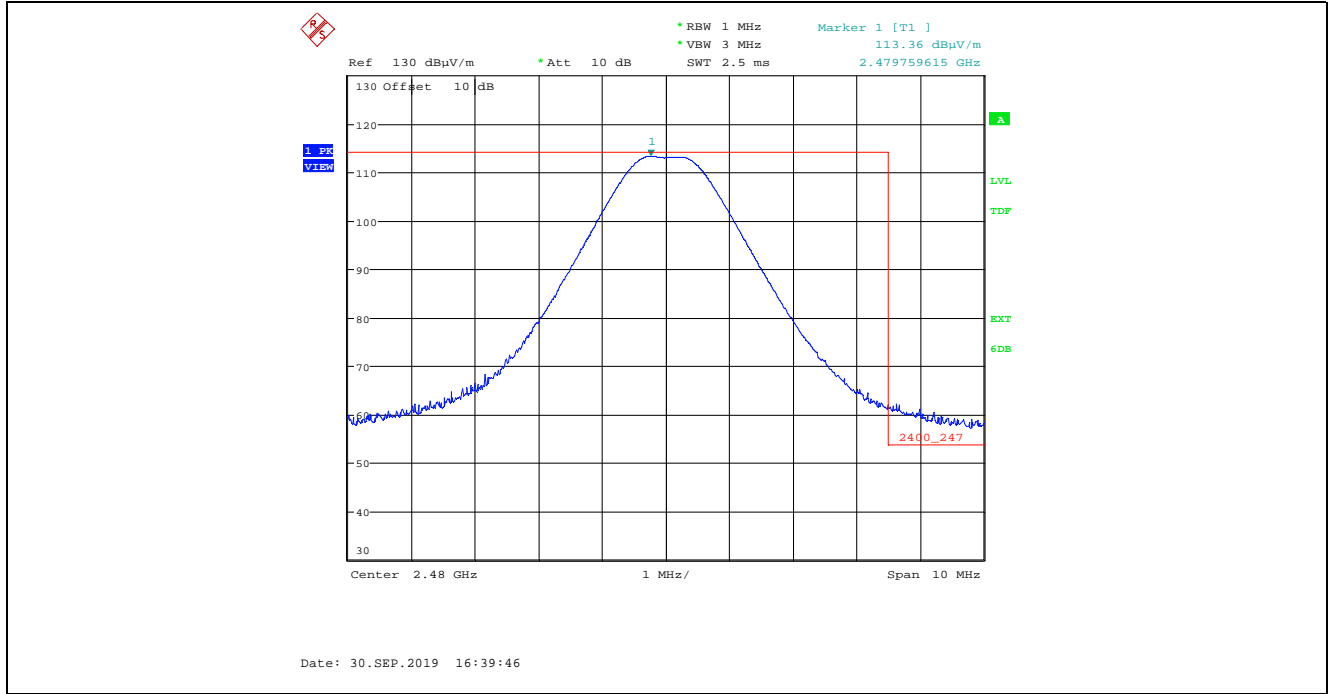

**Plot 5.2.4.2.6. Band-Edge Radiated Emissions, Higher Band-edge, Average Detector**  
 Rx Antenna in Vertical Polarization, GFSK Modulation, 1 Mbps, Power Setting 200, Ch 39, 2480 MHz

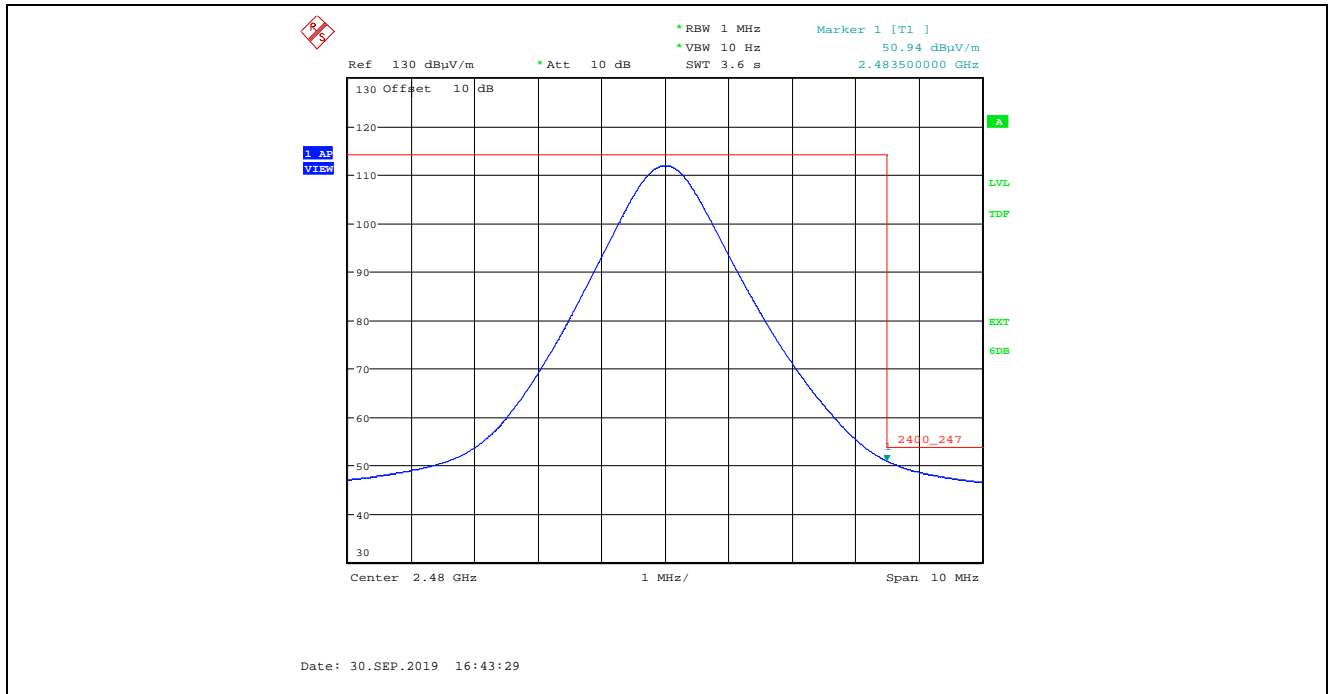

**Plot 5.2.4.2.7. Band-Edge Radiated Emissions, Higher Band-edge, Peak Detector**  
 Rx Antenna in Horizontal Polarization, GFSK Modulation, 1 Mbps, Power Setting 200, Ch 39, 2480 MHz

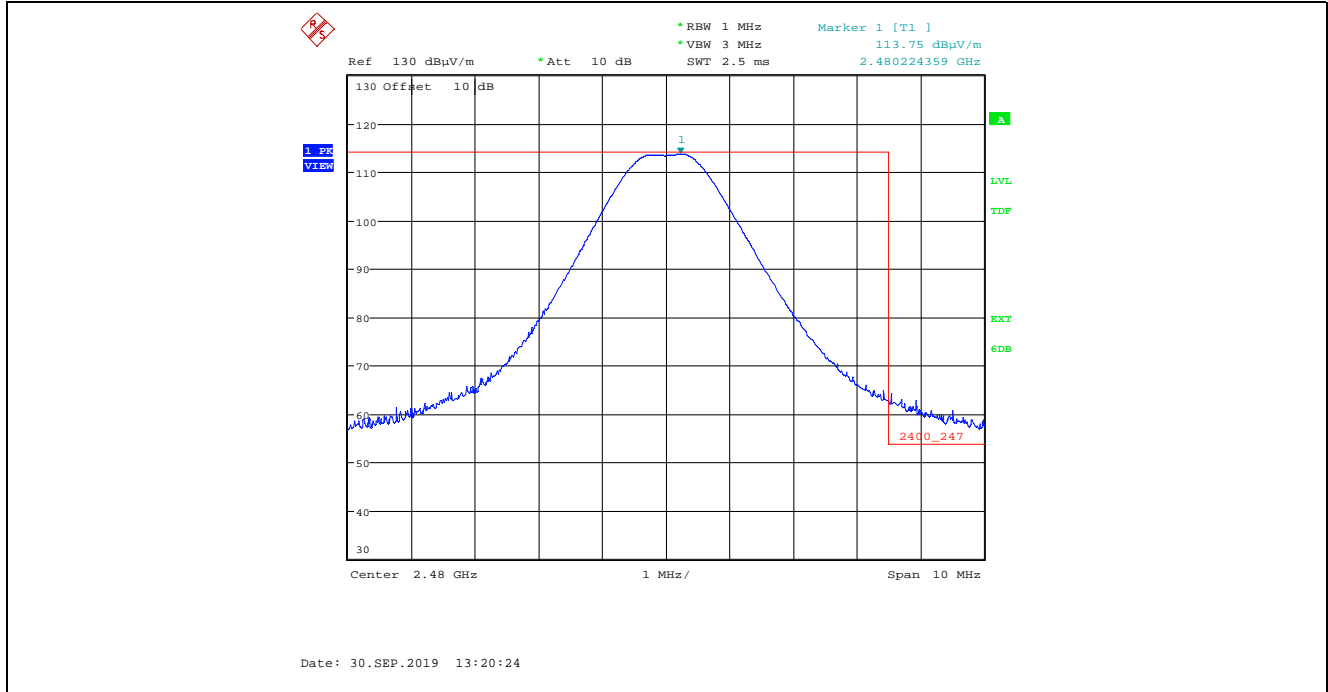

**Plot 5.2.4.2.8. Band-Edge Radiated Emissions, Higher Band-edge, Average Detector**  
 Rx Antenna in Horizontal Polarization, GFSK Modulation, 1 Mbps, Power Setting 200, Ch 39, 2480 MHz

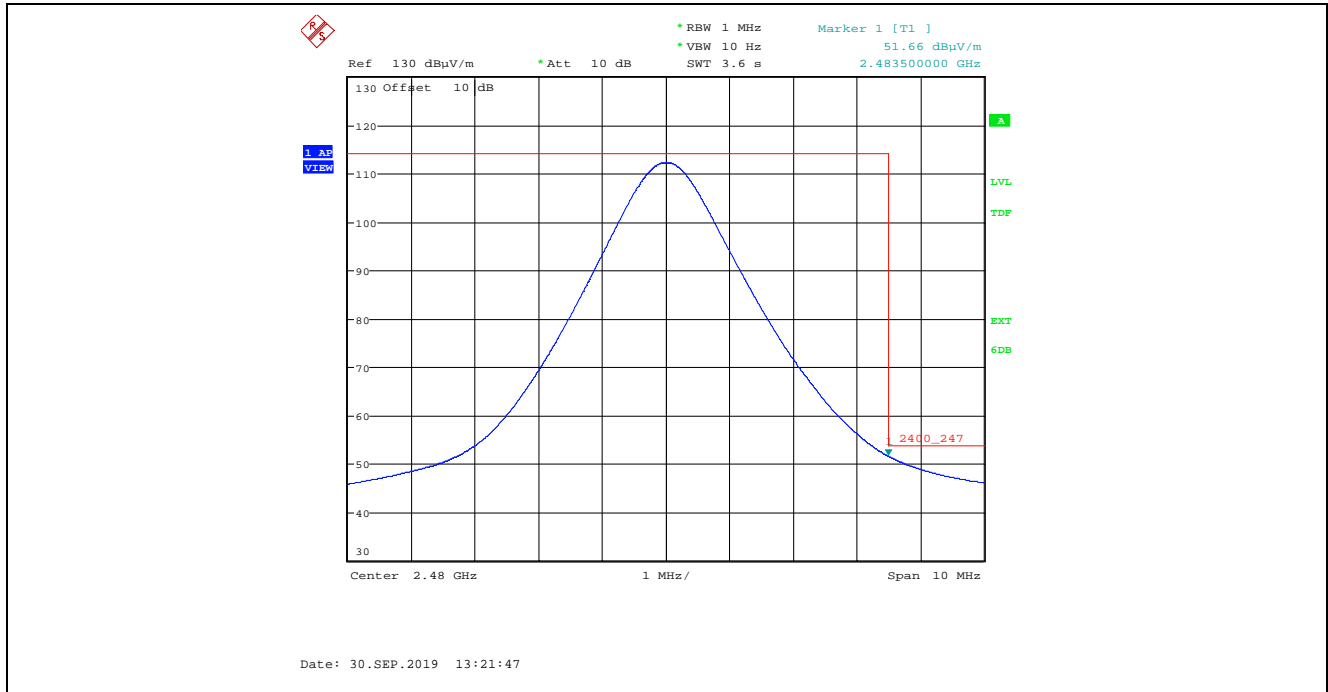

**Plot 5.2.4.2.9.** Band-Edge Radiated Emissions, Lower Band-edge, Peak Detector  
 Rx Antenna in Vertical Polarization, GFSK Modulation, 2 Mbps, Power Setting 200, Ch 01, 2404 MHz

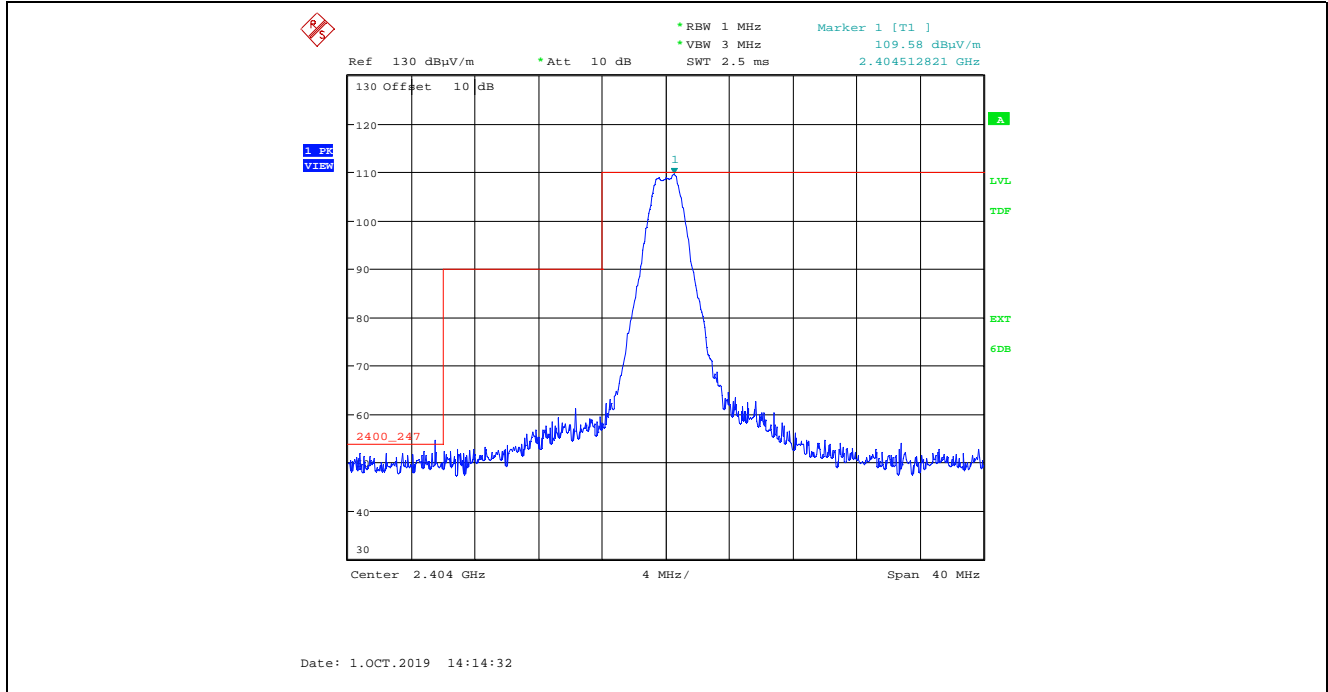

**Plot 5.2.4.2.10.** Band-Edge Radiated Emissions, Lower Band-edge, Average Detector  
 Rx Antenna in Vertical Polarization, GFSK Modulation, 2 Mbps, Power Setting 200, Ch 01, 2404 MHz

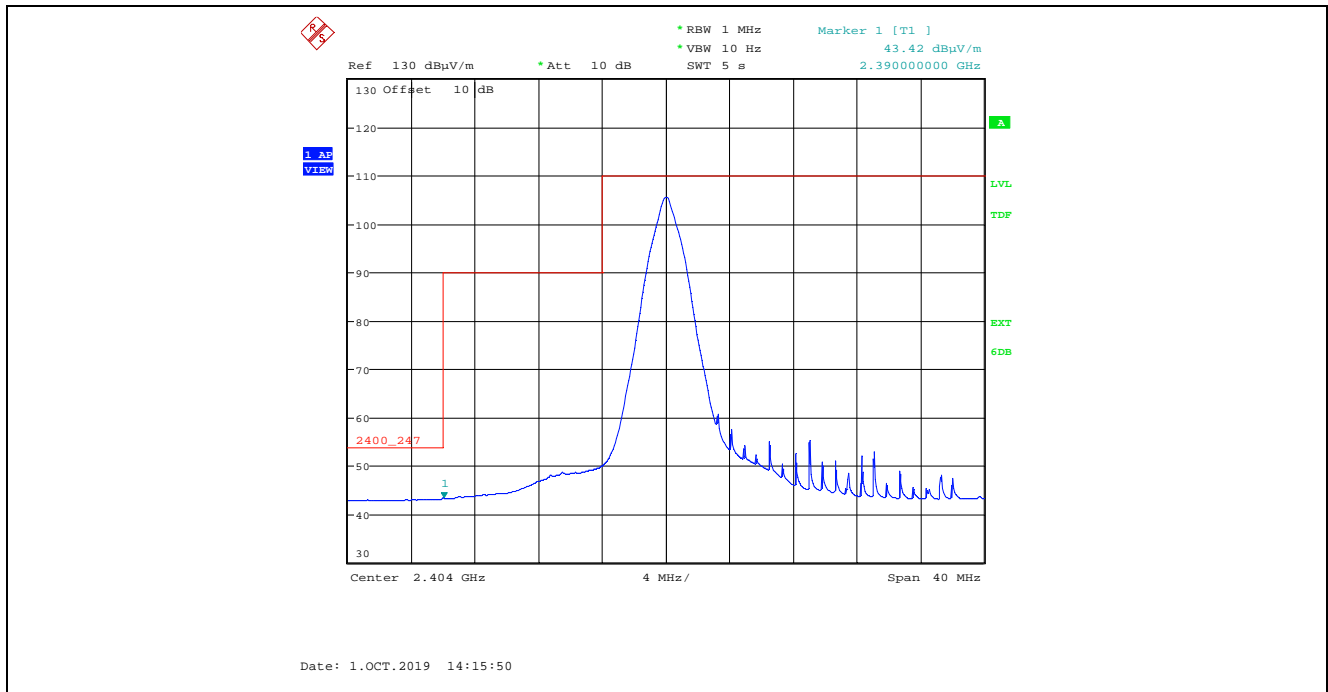



**Plot 5.2.4.2.11.** Band-Edge Radiated Emissions, Lower Band-edge, Peak Detector  
Rx Antenna in Horizontal Polarization, GFSK Modulation, 2 Mbps, Power Setting 200, Ch 01, 2404 MHz

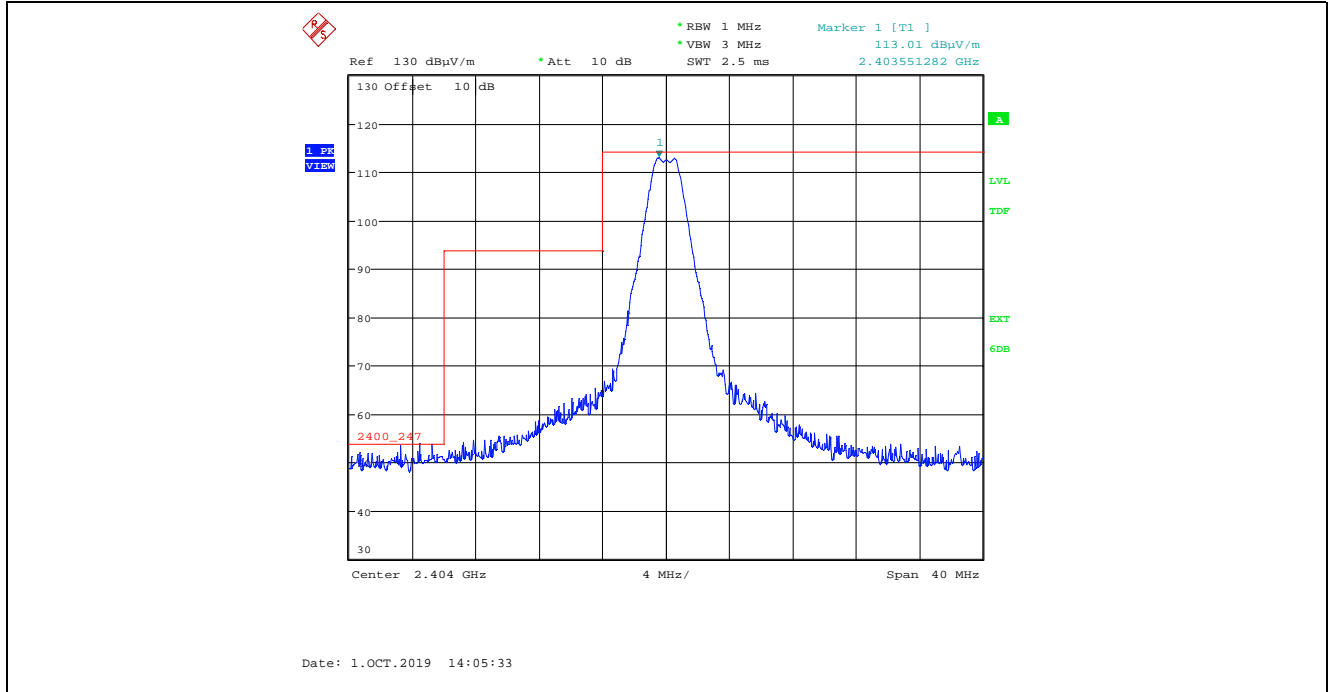

**Plot 5.2.4.2.12.** Band-Edge Radiated Emissions, Lower Band-edge, Average Detector  
Rx Antenna in Horizontal Polarization, GFSK Modulation, 2 Mbps, Power Setting 200, Ch 01, 2404 MHz

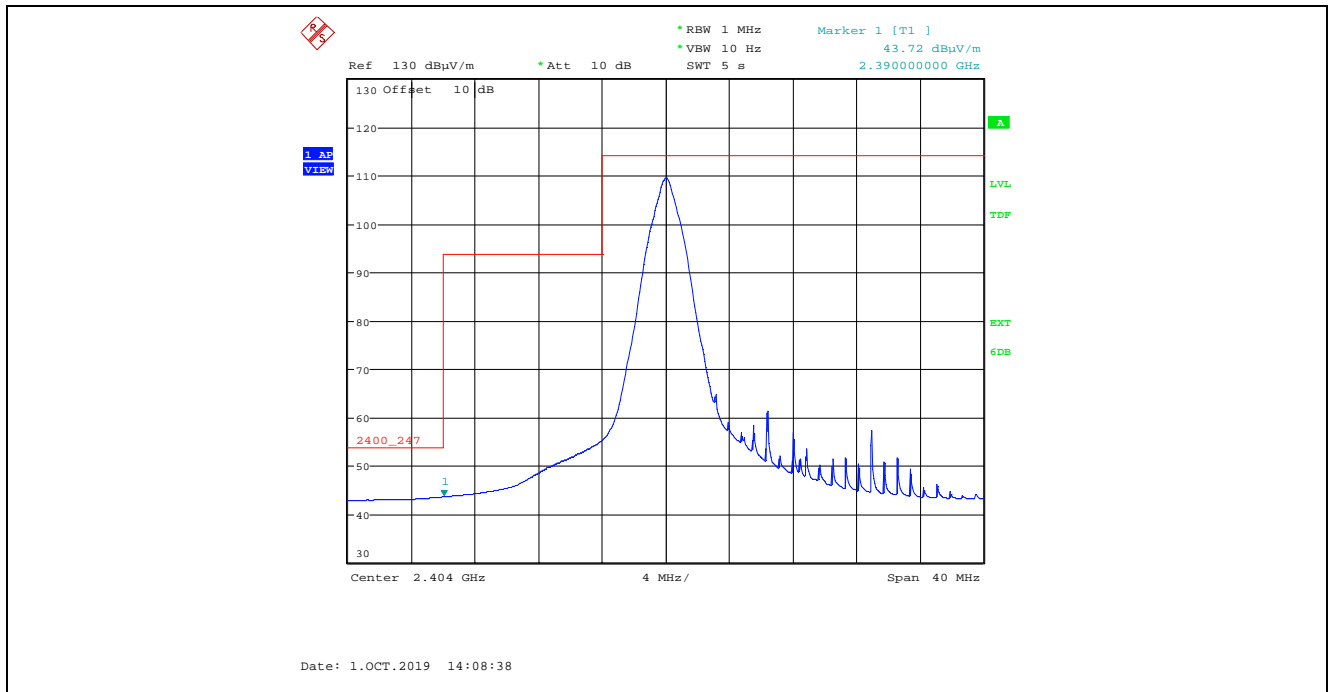

**Plot 5.2.4.2.13.** Band-Edge Radiated Emissions, Higher Band-edge, Peak Detector  
 Rx Antenna in Vertical Polarization, GFSK Modulation, 2 Mbps, Power Setting 200, Ch 34, 2470 MHz

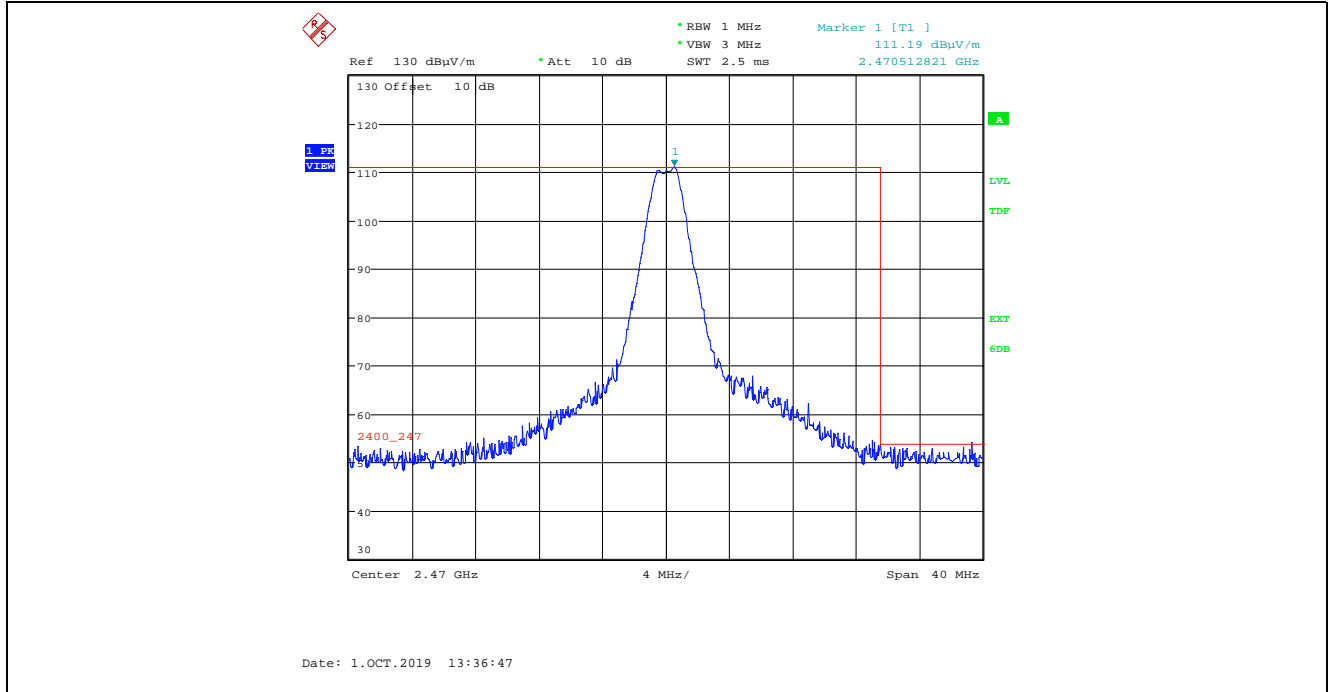

**Plot 5.2.4.2.14.** Band-Edge Radiated Emissions, Higher Band-edge, Average Detector  
 Rx Antenna in Vertical Polarization, GFSK Modulation, 2 Mbps, Power Setting 200, Ch 34, 2470 MHz

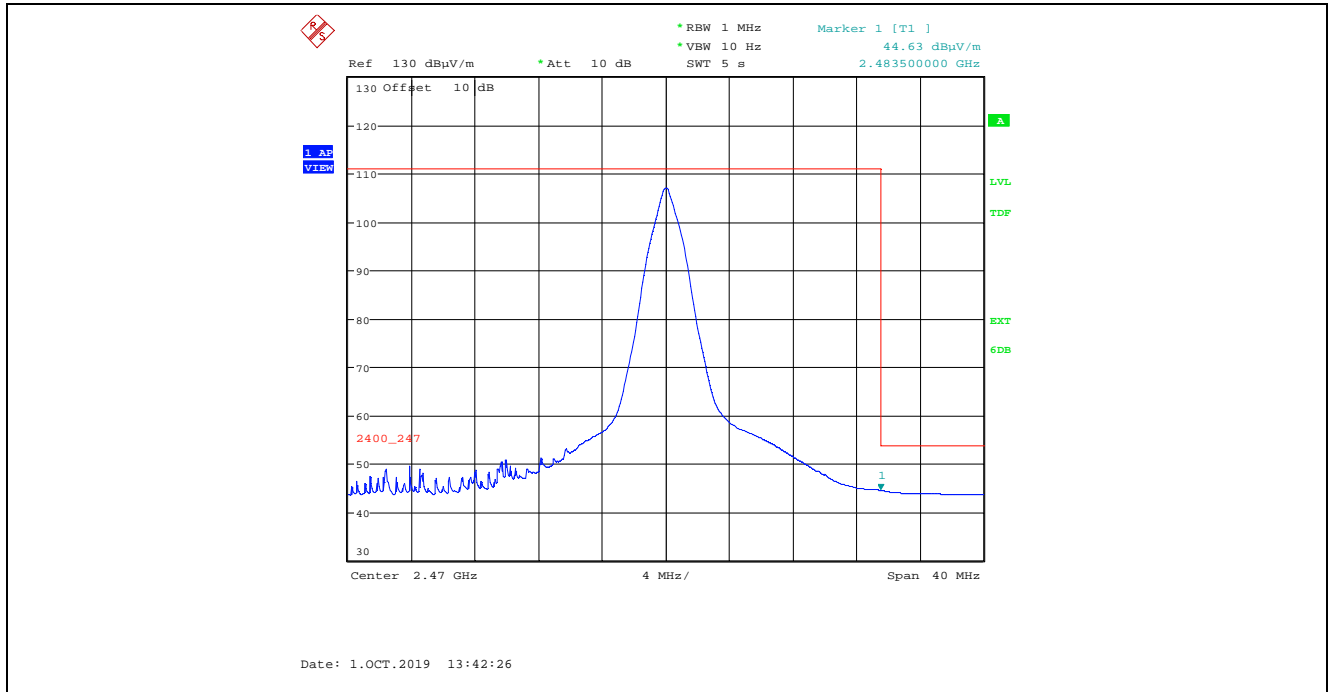

**Plot 5.2.4.2.15.** Band-Edge Radiated Emissions, Higher Band-edge, Peak Detector  
 Rx Antenna in Horizontal Polarization, GFSK Modulation, 2 Mbps, Power Setting 200, Ch 34, 2470 MHz

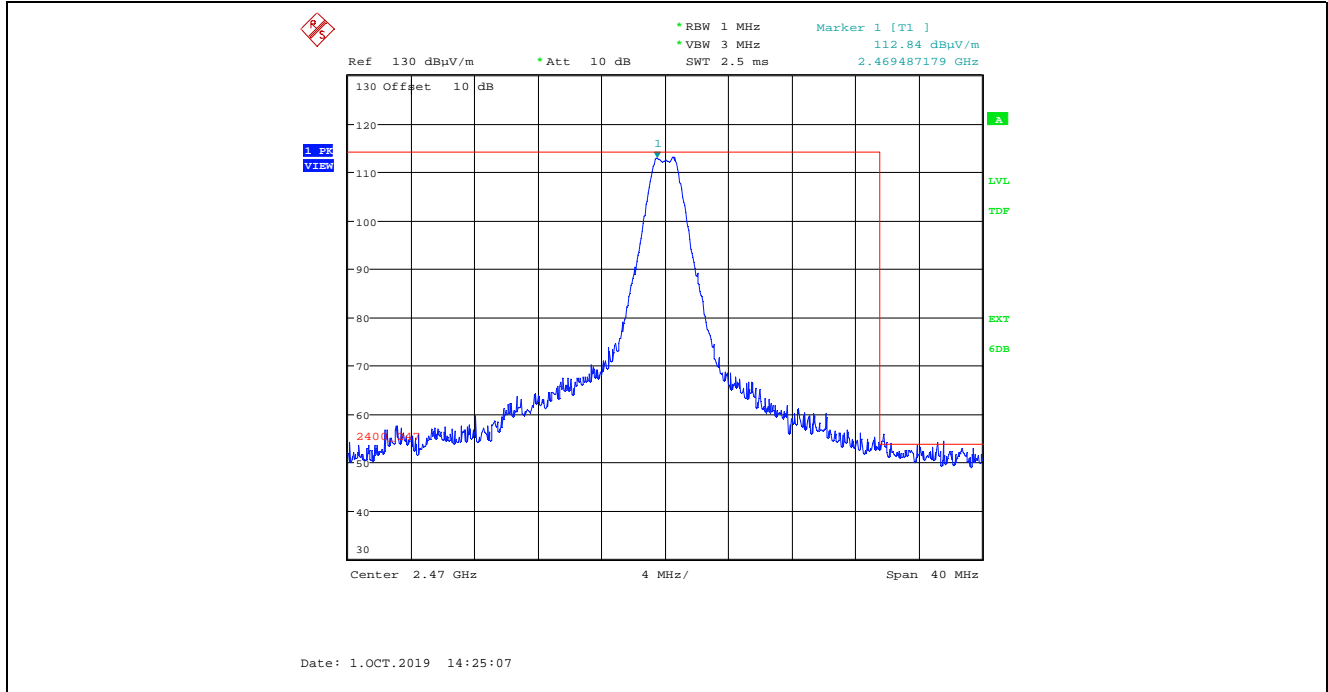

**Plot 5.2.4.2.16.** Band-Edge Radiated Emissions, Higher Band-edge, Average Detector  
 Rx Antenna in Horizontal Polarization, GFSK Modulation, 2 Mbps, Power Setting 200, Ch 34, 2470 MHz

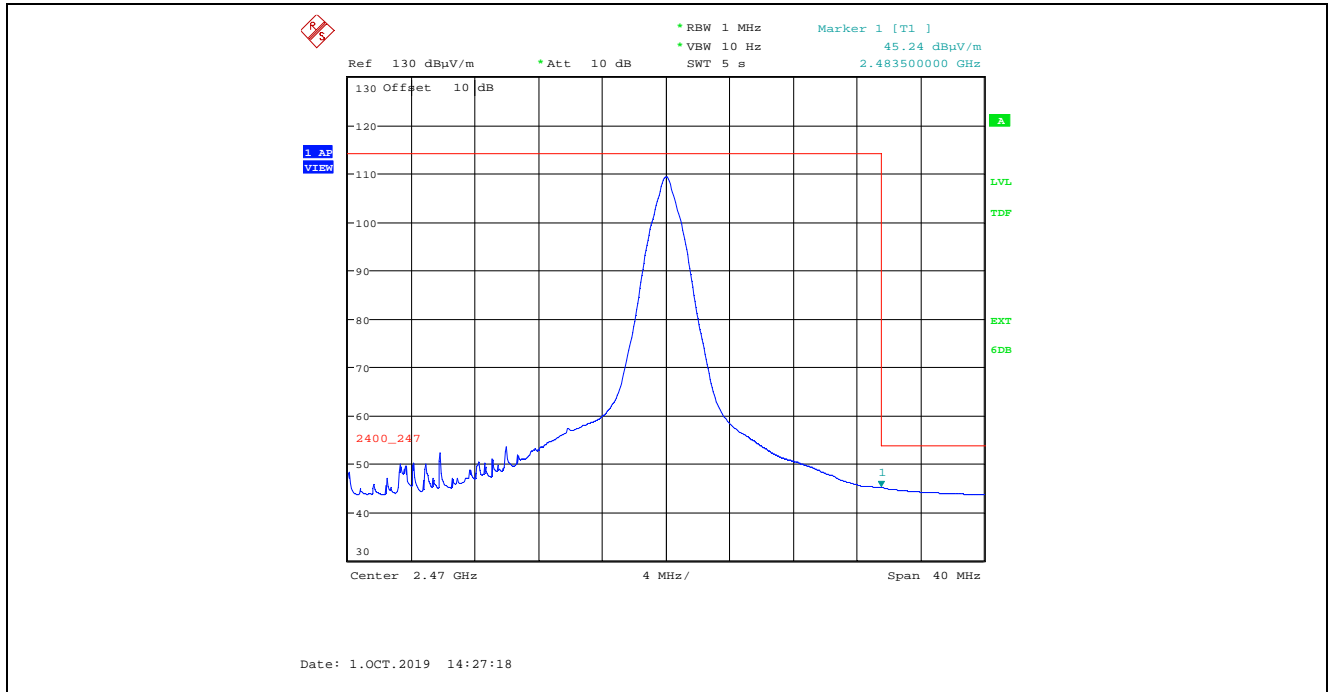

**Plot 5.2.4.2.17.** Band-Edge Radiated Emissions, Higher Band-edge, Peak Detector  
 Rx Antenna in Vertical Polarization, GFSK Modulation, 2 Mbps, Power Setting 200, Ch 35, 2472 MHz

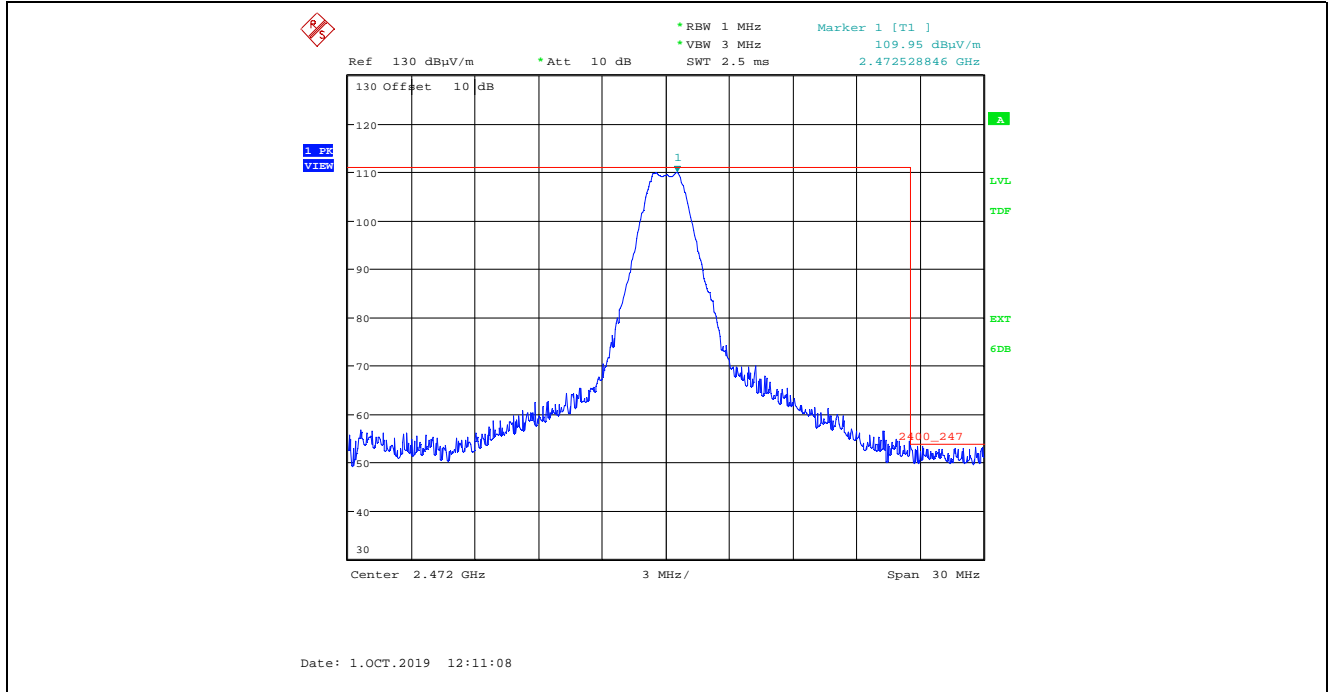

**Plot 5.2.4.2.18.** Band-Edge Radiated Emissions, Higher Band-edge, Average Detector  
 Rx Antenna in Vertical Polarization, GFSK Modulation, 2 Mbps, Power Setting 200, Ch 35, 2472 MHz

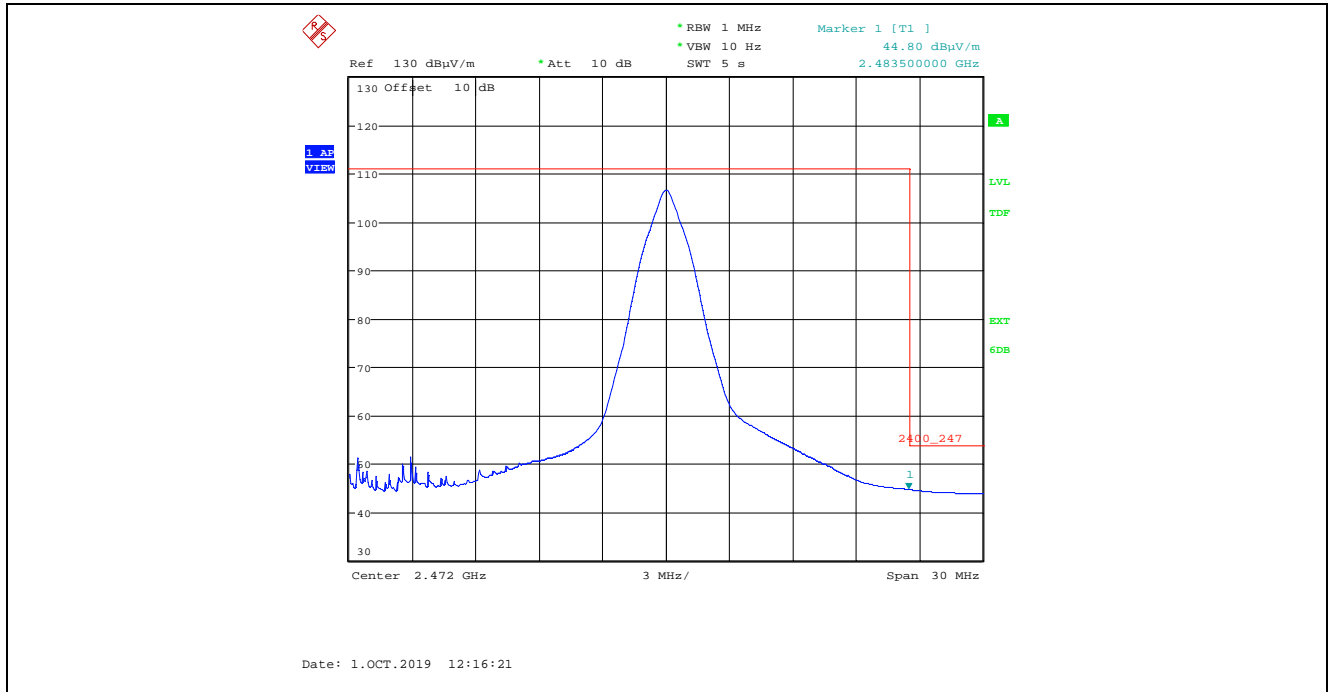

**Plot 5.2.4.2.19.** Band-Edge Radiated Emissions, Higher Band-edge, Peak Detector  
 Rx Antenna in Horizontal Polarization, GFSK Modulation, 2 Mbps, Power Setting 200, Ch 35, 2472 MHz

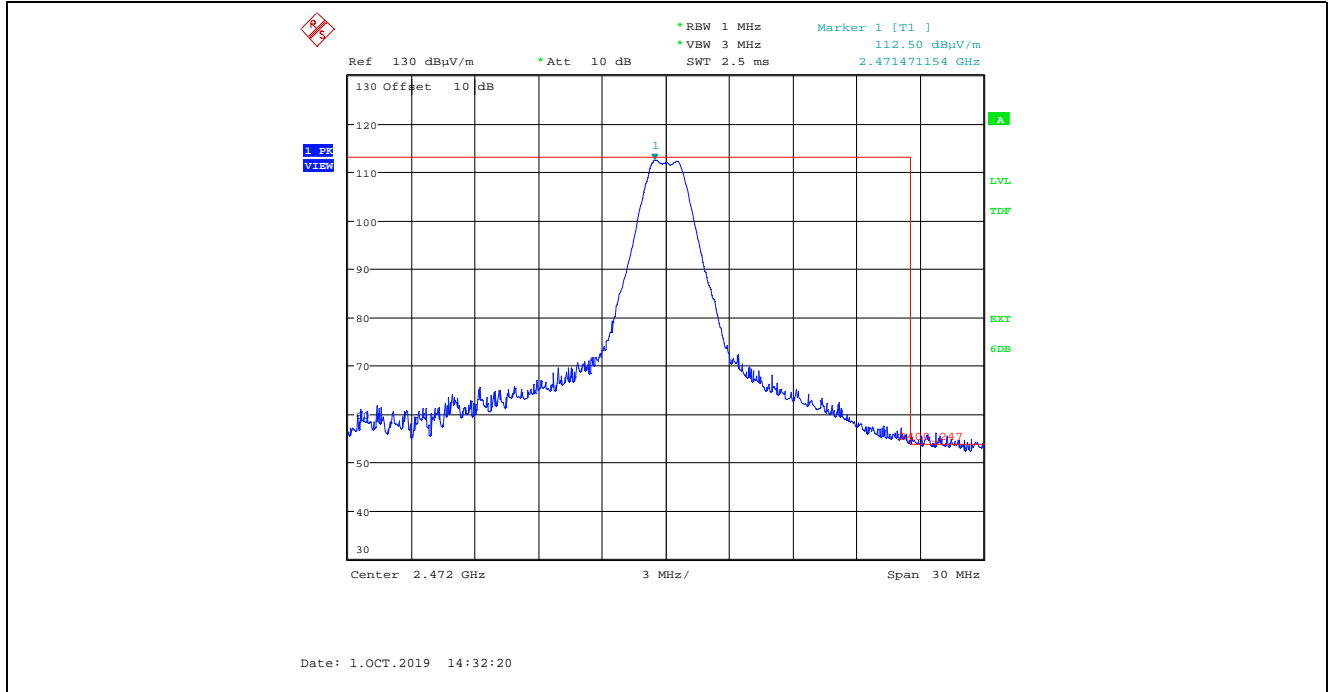

**Plot 5.2.4.2.20.** Band-Edge Radiated Emissions, Higher Band-edge, Average Detector  
 Rx Antenna in Horizontal Polarization, GFSK Modulation, 2 Mbps, Power Setting 200, Ch 35, 2472 MHz

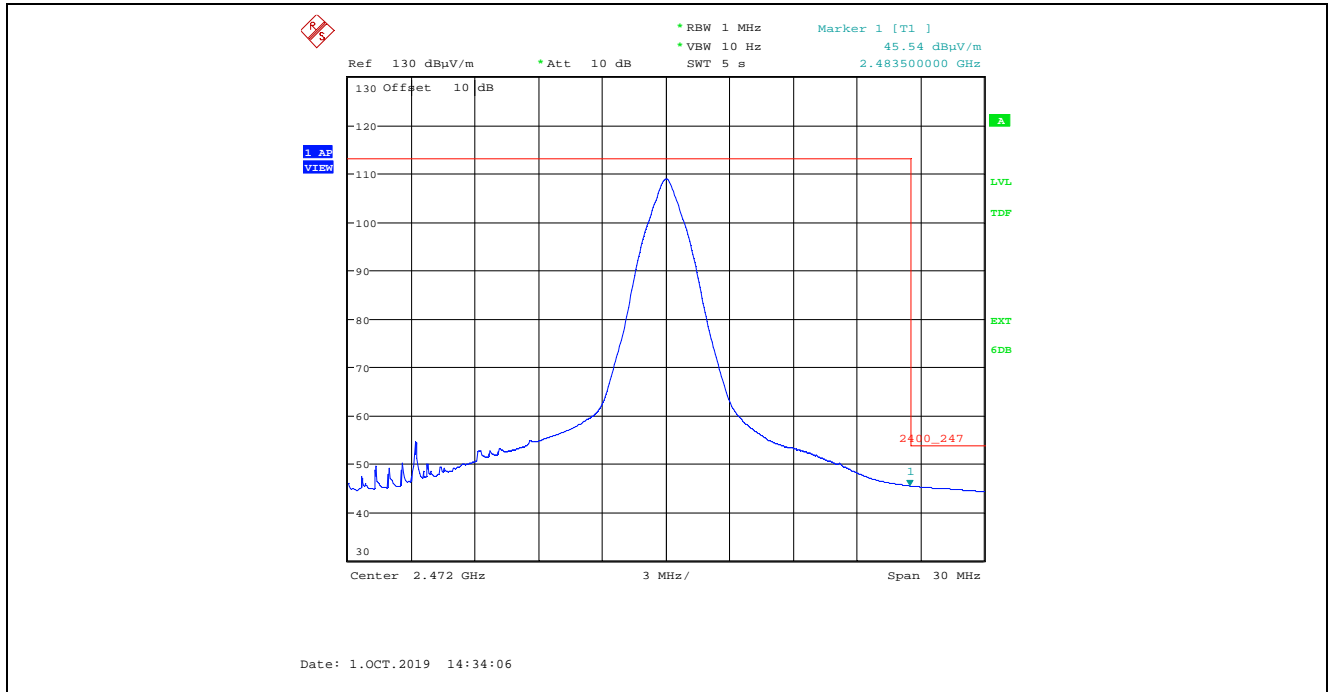

**Plot 5.2.4.2.21.** Band-Edge Radiated Emissions, Higher Band-edge, Peak Detector  
Rx Antenna in Vertical Polarization, GFSK Modulation, 2 Mbps, Power Setting 200, Ch 36, 2474 MHz

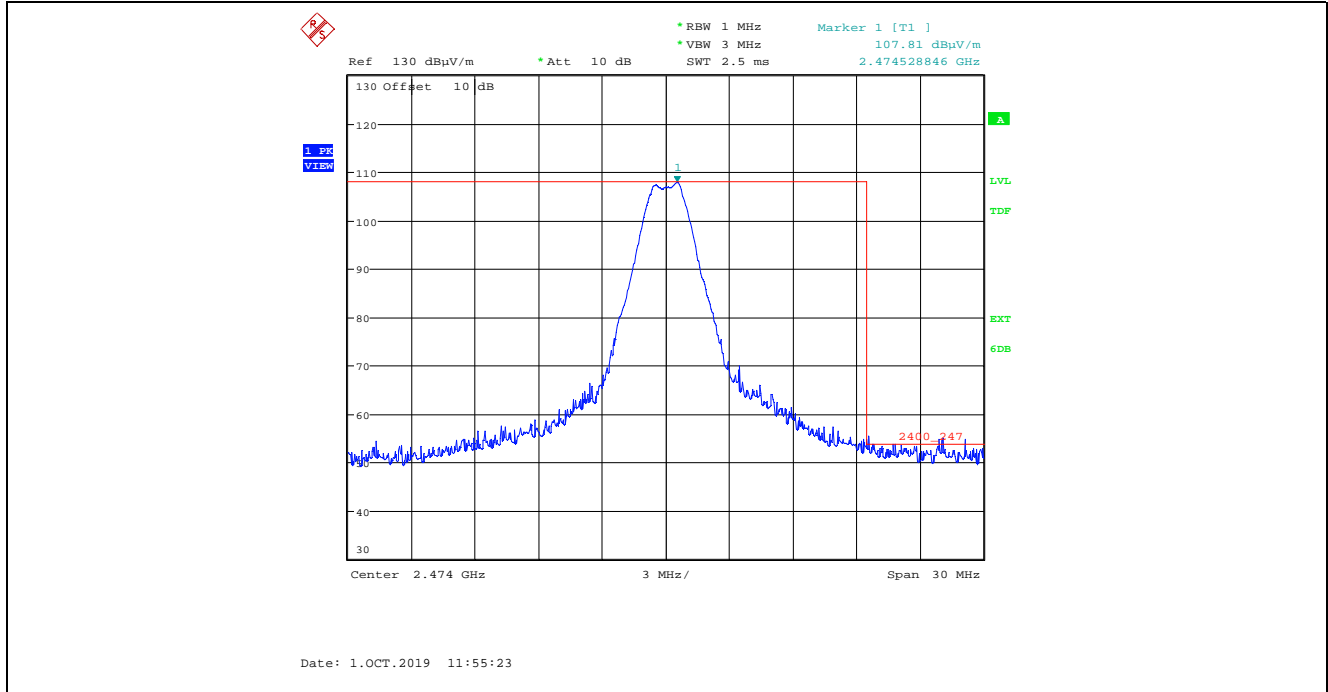

**Plot 5.2.4.2.22.** Band-Edge Radiated Emissions, Higher Band-edge, Average Detector  
Rx Antenna in Vertical Polarization, GFSK Modulation, 2 Mbps, Power Setting 200, Ch 36, 2474 MHz

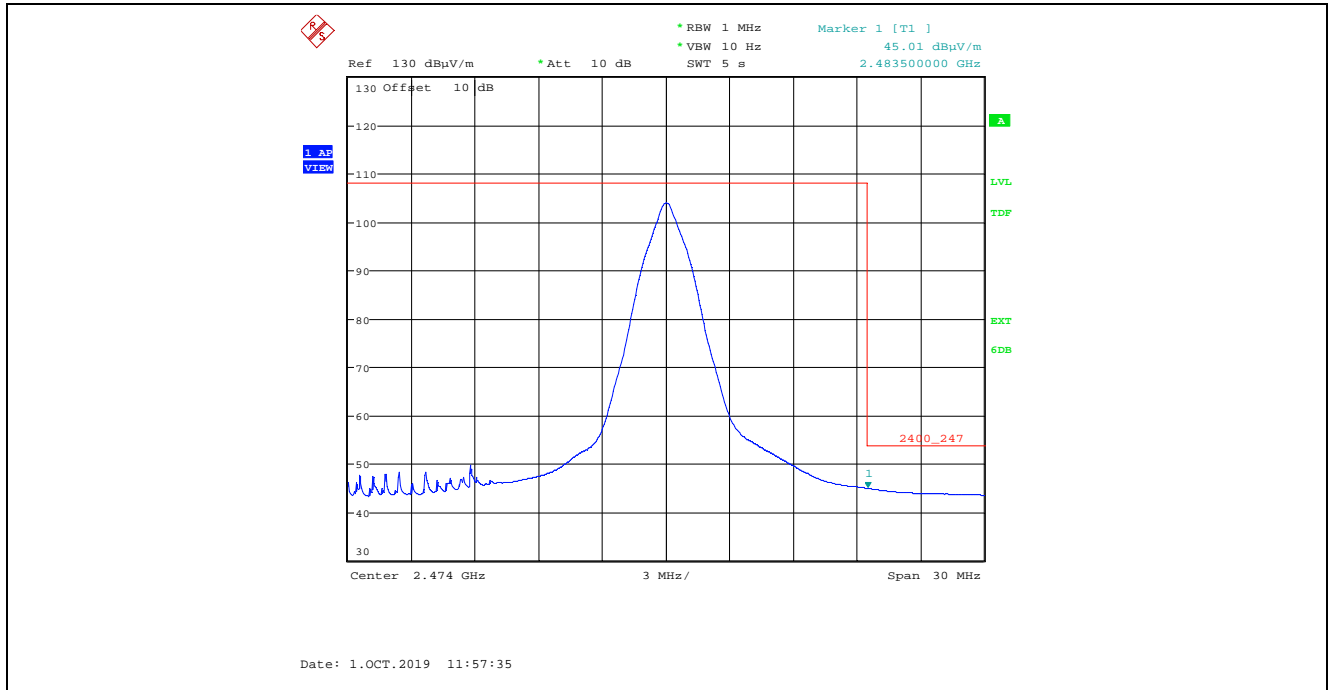

**Plot 5.2.4.2.23.** Band-Edge Radiated Emissions, Higher Band-edge, Peak Detector  
 Rx Antenna in Horizontal Polarization, GFSK Modulation, 2 Mbps, Power Setting 200, Ch 36, 2474 MHz

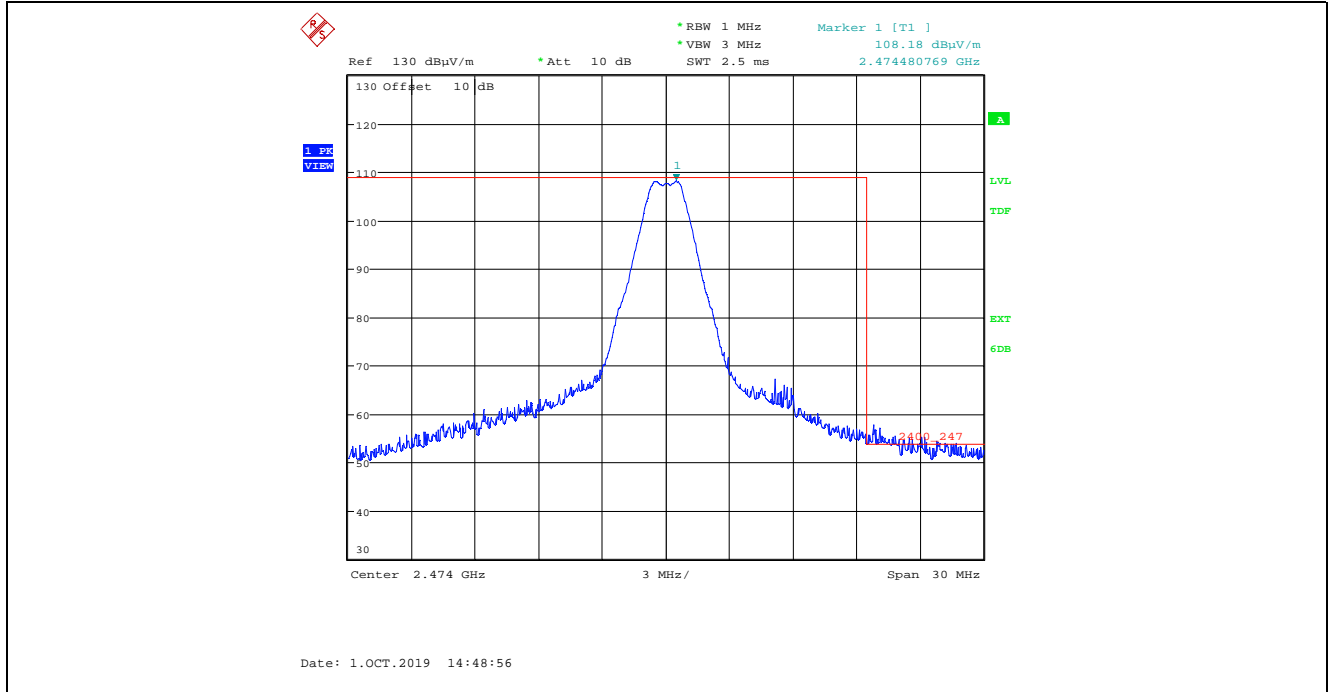

**Plot 5.2.4.2.24.** Band-Edge Radiated Emissions, Higher Band-edge, Average Detector  
 Rx Antenna in Horizontal Polarization, GFSK Modulation, 2 Mbps, Power Setting 200, Ch 36, 2474 MHz

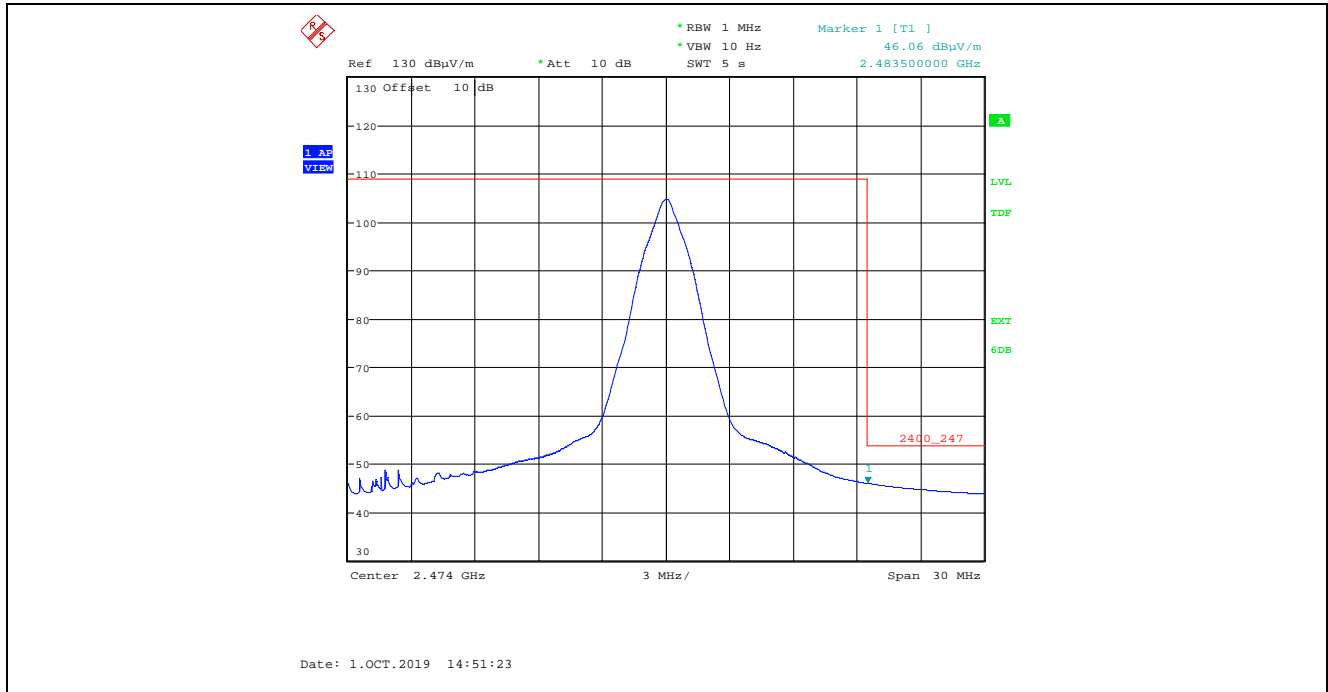

**Plot 5.2.4.2.25.** Band-Edge Radiated Emissions, Higher Band-edge, Peak Detector  
 Rx Antenna in Vertical Polarization, GFSK Modulation, 2 Mbps, Power Setting 200, Ch 37, 2476 MHz

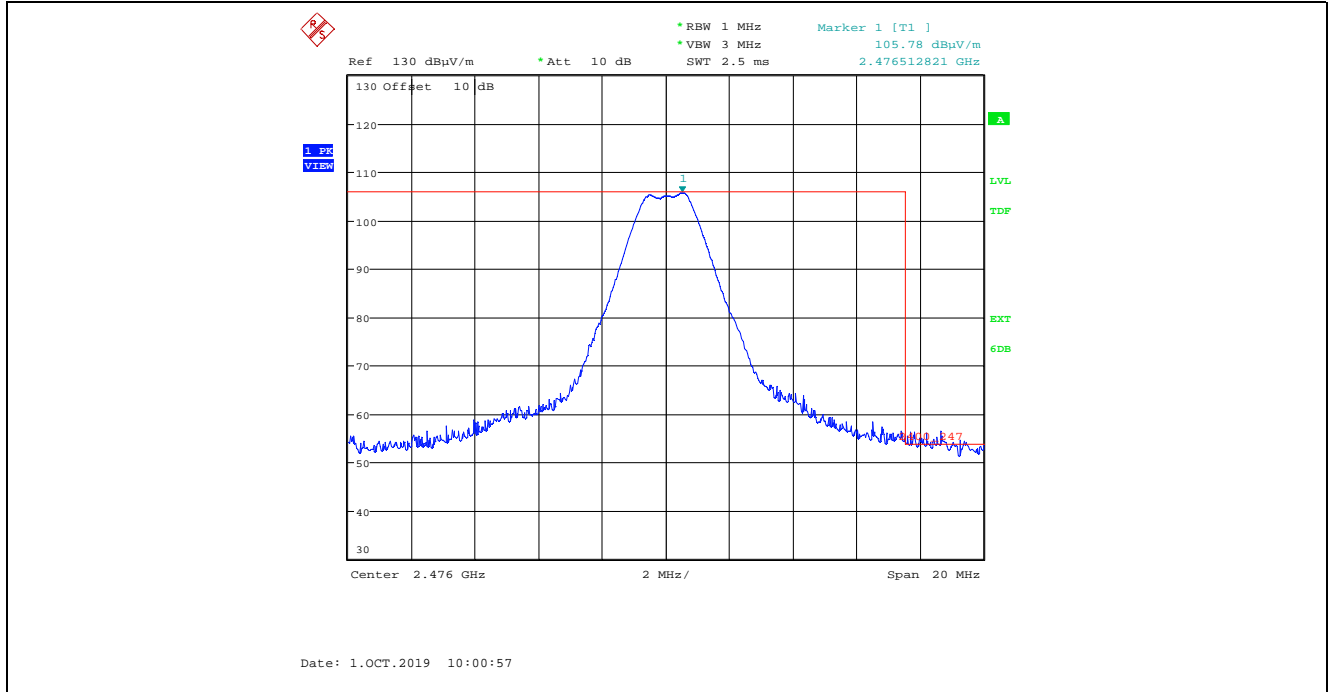

**Plot 5.2.4.2.26.** Band-Edge Radiated Emissions, Higher Band-edge, Average Detector  
 Rx Antenna in Vertical Polarization, GFSK Modulation, 2 Mbps, Power Setting 200, Ch 37, 2476 MHz

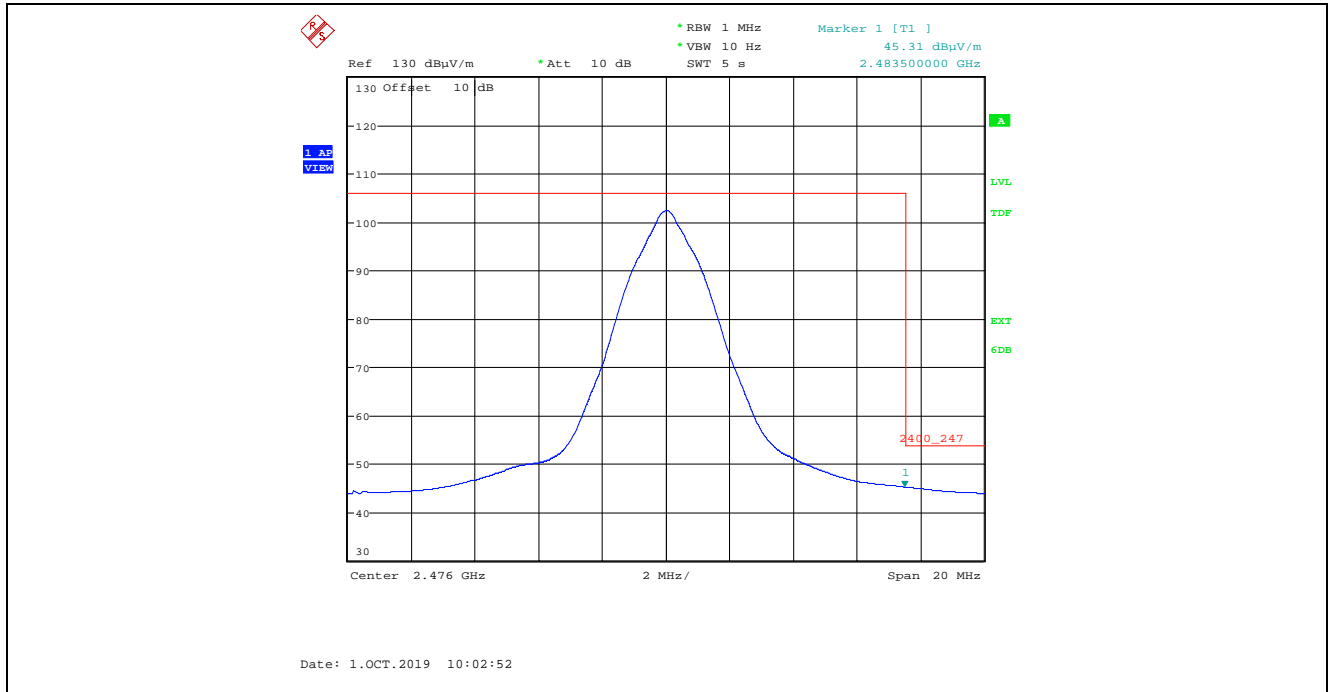



**Plot 5.2.4.2.27.** Band-Edge Radiated Emissions, Higher Band-edge, Peak Detector  
 Rx Antenna in Horizontal Polarization, GFSK Modulation, 2 Mbps, Power Setting 200, Ch 37, 2476 MHz

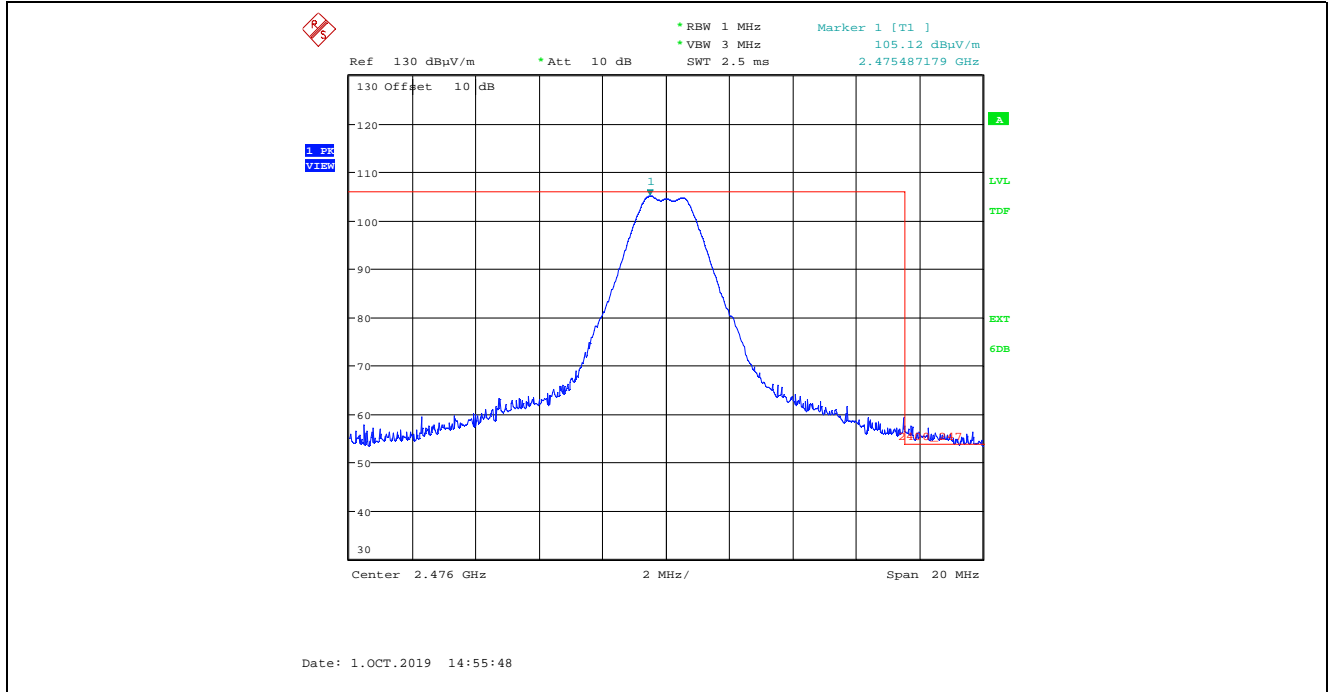

**Plot 5.2.4.2.28.** Band-Edge Radiated Emissions, Higher Band-edge, Average Detector  
 Rx Antenna in Horizontal Polarization, GFSK Modulation, 2 Mbps, Power Setting 200, Ch 37, 2476 MHz

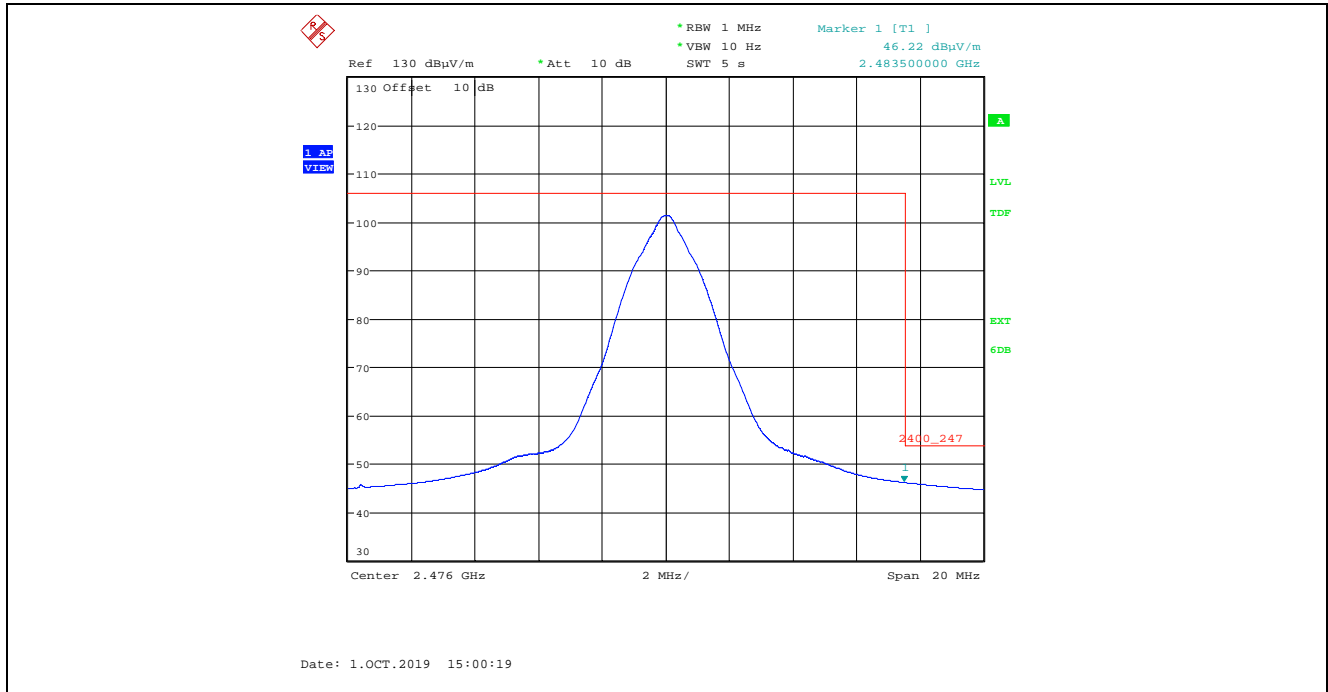

**Plot 5.2.4.2.29.** Band-Edge Radiated Emissions, Higher Band-edge, Peak Detector  
Rx Antenna in Vertical Polarization, GFSK Modulation, 2 Mbps, Power Setting 200, Ch 38, 2478 MHz

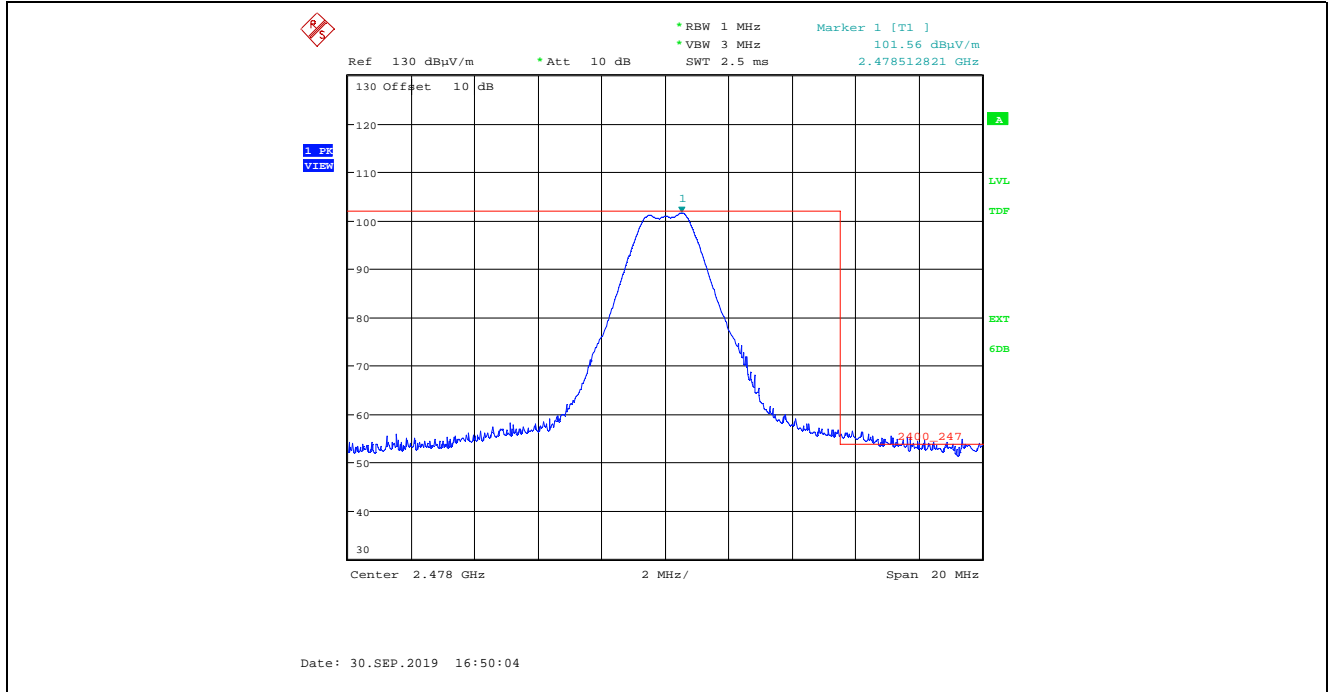

**Plot 5.2.4.2.30.** Band-Edge Radiated Emissions, Higher Band-edge, Average Detector  
Rx Antenna in Vertical Polarization, GFSK Modulation, 2 Mbps, Power Setting 200, Ch 38, 2478 MHz

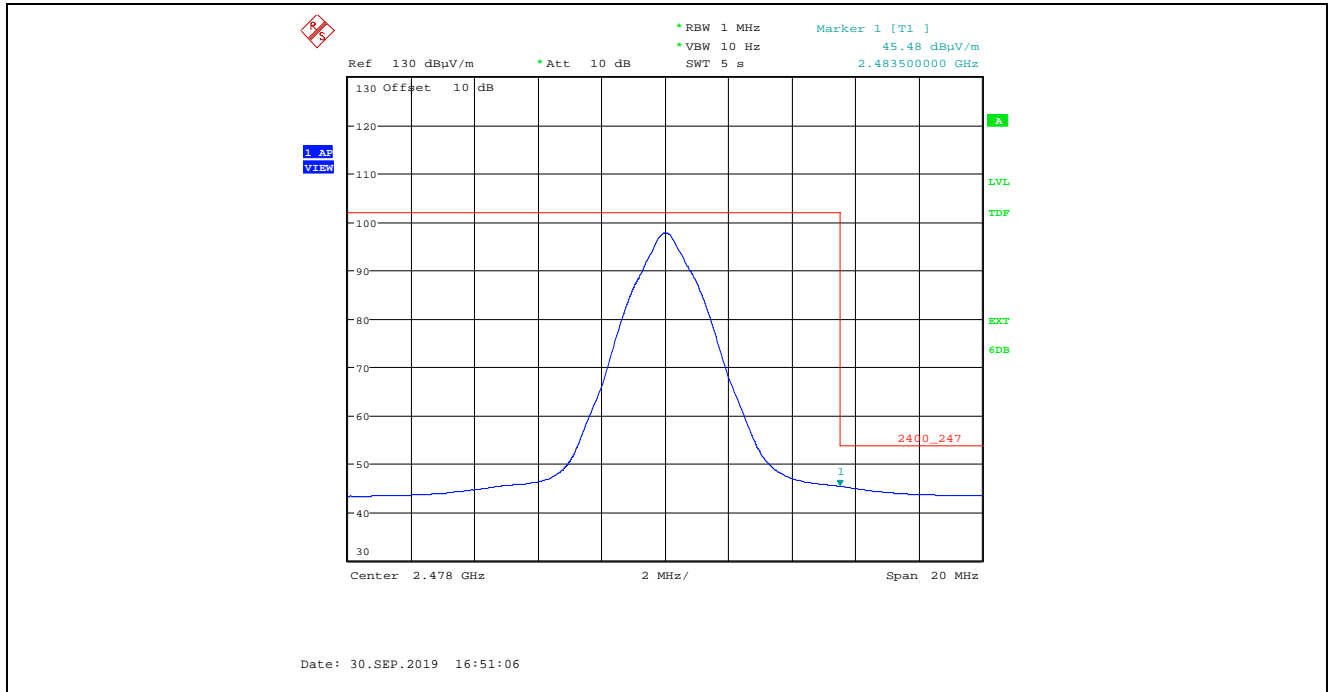

**Plot 5.2.4.2.31.** Band-Edge Radiated Emissions, Higher Band-edge, Peak Detector  
 Rx Antenna in Horizontal Polarization, GFSK Modulation, 2 Mbps, Power Setting 200, Ch 38, 2478 MHz

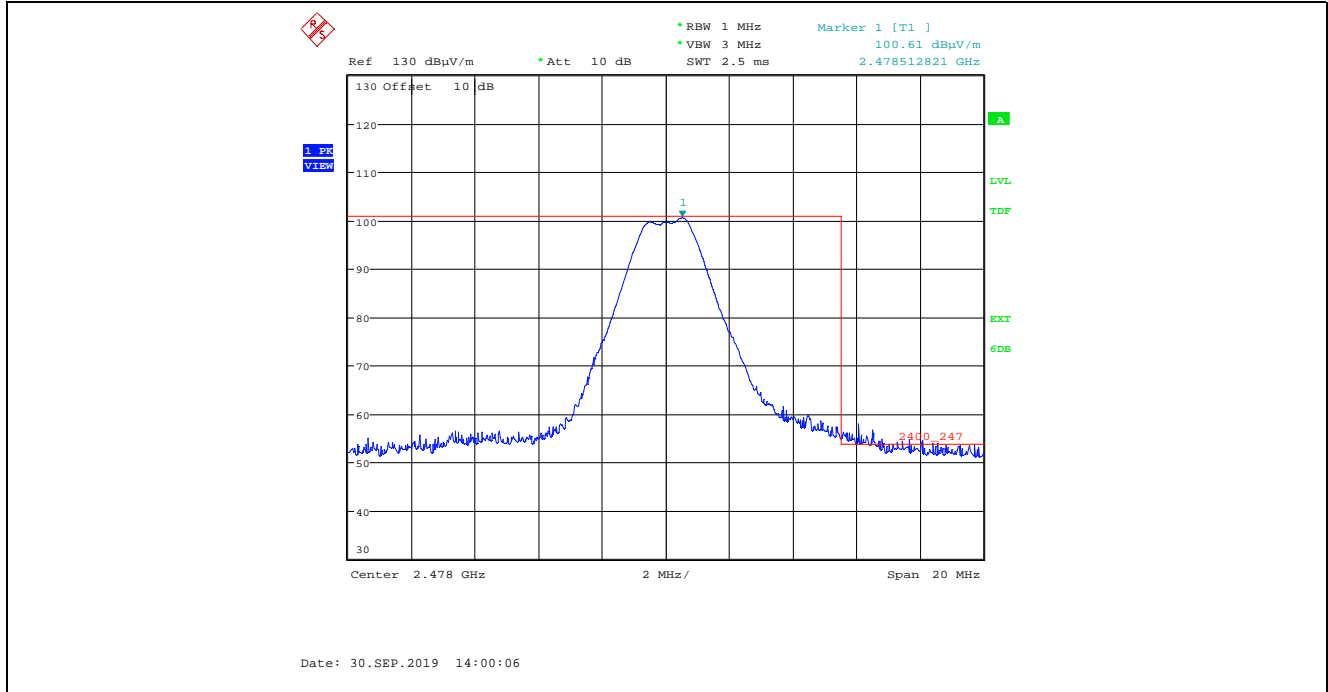

**Plot 5.2.4.2.32.** Band-Edge Radiated Emissions, Higher Band-edge, Average Detector  
 Rx Antenna in Horizontal Polarization, GFSK Modulation, 2 Mbps, Power Setting 200, Ch 38, 2478 MHz

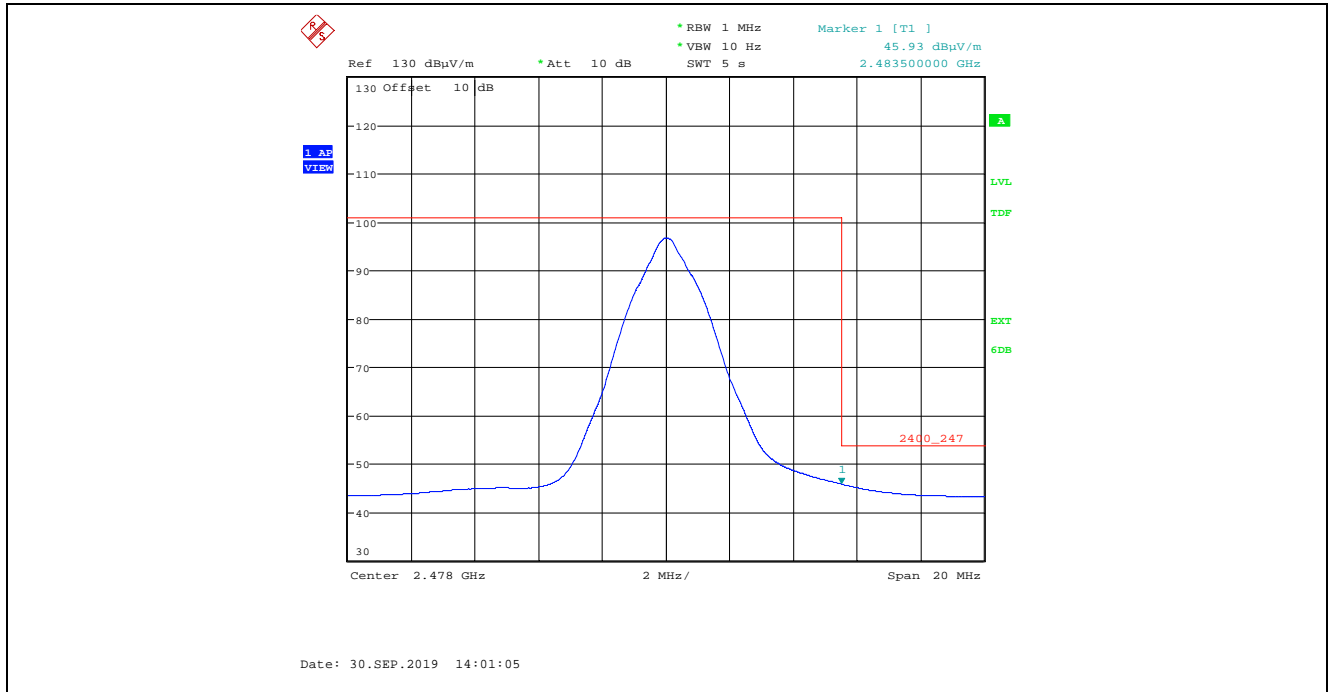

**5.3. RF EXPOSURE REQUIRMENTS [§§ 15.247(i), 1.1310 & 2.1091]**

**5.3.1. Limits**

§ 1.1310: The criteria listed in the following table shall be used to evaluate the environmental impact of human exposure to radio-frequency (RF) radiation as specified in 1.1307(b).

**Limits for Maximum Permissible Exposure (MPE)**

Frequency range (MHz)	Electric field strength (V/m)	Magnetic field strength (A/m)	Power density (mW/cm <sup>2</sup> )	Averaging time (minutes)
<b>(A) Limits for Occupational/Controlled Exposures</b>				
0.3-3.0	614	1.63	*(100)	6
3.0-30	1842/f	4.89/f	*(900/f <sup>2</sup> )	6
30-300	61.4	0.163	1.0	6
300-1500			f/300	6
1500-100,000			5	6
<b>(B) Limits for General Population/Uncontrolled Exposure</b>				
0.3-1.34	614	1.63	*(100)	30
1.34-30	824/f	2.19/f	*(180/f <sup>2</sup> )	30
30-300	27.5	0.073	0.2	30
300-1500			f/1500	30
1500-100,000			1.0	30

f = frequency in MHz

\* = Plane-wave equivalent power density

Note 1: Occupational/controlled limits apply in situations in which persons are exposed as a consequence of their employment provided those persons are fully aware of the potential for exposure and can exercise control over their exposure. Limits for occupational/controlled exposure also apply in situations when an individual is transient through a location where occupational/controlled limits apply provided he or she is made aware of the potential for exposure.

Note 2: General population/uncontrolled exposures apply in situations in which the general public may be exposed, or in which persons that are exposed as a consequence of their employment may not be fully aware of the potential for exposure or can not exercise control over their exposure.

### 5.3.2. Method of Measurements

#### Calculation Method of Power Density/RF Safety Distance:

$$S = \frac{PG}{4\pi \cdot r^2} = \frac{EIRP}{4\pi \cdot r^2}$$

Where,  
P: power input to the antenna in mW  
EIRP: Equivalent (effective) isotropic radiated power.  
S: power density mW/cm<sup>2</sup>  
G: numeric gain of antenna relative to isotropic radiator  
r: distance to centre of radiation in cm

### 5.3.3. RF Evaluation

Frequency (MHz)	EIRP (dBm)	EIRP (mW)	Evaluation Distance, r (cm)	Power Density, S (mW/cm <sup>2</sup> )	MPE Limit (mW/cm <sup>2</sup> )	Margin (mW/cm <sup>2</sup> )
2402	23.60	229.09	20	0.0456	1.0	-0.9544

**EXHIBIT 6. TEST EQUIPMENT LIST**

Test Instruments	Manufacturer	Model No.	Serial No.	Frequency Range	Cal. Due Date
Spectrum Analyzer	Rohde & Schwarz	FSU26	200946	20Hz–26.5 GHz	Jul 25, 2020
Attenuator	Hewlett Packard	8493C	0465	DC–26.5 GHz	See Note 1
DC Block	Hewlett Packard	11742A	12460	0.045 – 26.5 GHz	See Note 1
DC Power Supply	HQ Power	PS613U	NSN	0-30VDC	See Note 1
Multi-meter	Fluke	8842A	5021295	20mV - 1kV	Oct 23, 2019
EMI Receiver	Rohde & Schwarz	ESU40	100037	20Hz–40 GHz	Mar 15, 2020
RF Amplifier	Com-Power	PAM-0118A	551052	0.5 – 18 GHz	Jul 26, 2019
RF Amplifier	Hewlett Packard	84498	3008A00769	1 – 26.5 GHz	May 15, 2020
Biconilog Antenna	EMCO	3142B	1575	26-2000 MHz	May 10, 2020
Horn Antenna	EMCO	3155	6570	1 – 18 GHz	Oct 11, 2020
Horn Antenna	ETS-Lindgren	3160-09	001183858	18 – 26.5 GHz	Oct 27, 2020
High Pass Filter	K & L	11SH10-4000/T12000	4	Cut off 2.4 GHz	See Note 1
Band Reject Filter	Micro-Tronics	BRM50701	105	Cut off 2.4-2.483 GHz	See Note 1
Note 1: Internal Verification/Calibration check					

**EXHIBIT 7. MEASUREMENT UNCERTAINTY**

The measurement uncertainties stated were calculated in accordance with the requirements of CISPR 16-4-2 @ IEC:2003 and JCGM 100:2008 (GUM 1995) – Guide to the Expression of Uncertainty in Measurement.

**7.1. RADIATED EMISSION MEASUREMENT UNCERTAINTY**

	<b>Radiated Emission Measurement Uncertainty @ 3m, Horizontal (30-1000 MHz):</b>	<b>Measured (dB)</b>	<b>Limit (dB)</b>
<b>u<sub>c</sub></b>	<b>Combined standard uncertainty:</b> $u_c(y) = \sqrt{\sum_{i=1}^m u_i^2(y)}$	<b>± 2.39</b>	<b>± 2.6</b>
<b>U</b>	<b>Expanded uncertainty U:</b> $U = 2u_c(y)$	<b>± 4.79</b>	<b>± 5.2</b>

	<b>Radiated Emission Measurement Uncertainty @ 3m, Vertical (30-1000 MHz):</b>	<b>Measured (dB)</b>	<b>Limit (dB)</b>
<b>u<sub>c</sub></b>	<b>Combined standard uncertainty:</b> $u_c(y) = \sqrt{\sum_{i=1}^m u_i^2(y)}$	<b>± 2.39</b>	<b>± 2.6</b>
<b>U</b>	<b>Expanded uncertainty U:</b> $U = 2u_c(y)$	<b>± 4.78</b>	<b>± 5.2</b>

	<b>Radiated Emission Measurement Uncertainty @ 3 m, Horizontal &amp; Vertical (1 – 18 GHz):</b>	<b>Measured (dB)</b>	<b>Limit (dB)</b>
<b>u<sub>c</sub></b>	<b>Combined standard uncertainty:</b> $u_c(y) = \sqrt{\sum_{i=1}^m u_i^2(y)}$	<b>± 1.87</b>	<b>Under consideration</b>
<b>U</b>	<b>Expanded uncertainty U:</b> $U = 2u_c(y)$	<b>± 3.75</b>	<b>Under consideration</b>