

ENGINEERING TEST REPORT

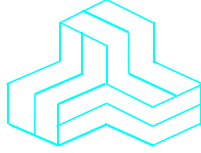

XBEE S2C TH
Model: S2CTH
FCC ID: MCQ-S2CTH

Applicant:

Digi International Inc.
11001 Bren Road East
Minnetonka, MN 55343

In Accordance With

Federal Communications Commission (FCC)
Part 15, Subpart C, Section 15.247
Digital Modulation Systems (DTS) Operating in 2400 – 2483.5 MHz Band

UltraTech's File No.: 16DIG112_FCC15C247

This Test report is Issued under the Authority of
Tri M. Luu
Vice President of Engineering
UltraTech Group of Labs

Date: April 08, 2016

Report Prepared by: Dharmajit Solanki

Tested by: Hung Trinh

Issued Date: April 08, 2016

Test Dates: March 16 - 30, 2016

- *The results in this Test Report apply only to the sample(s) tested, and the sample tested is randomly selected.*
- *This report must not be used by the client to claim product endorsement by NVLAP or any agency of the US Government.*

UltraTech

3000 Bristol Circle, Oakville, Ontario, Canada, L6H 6G4
Tel.: (905) 829-1570 Fax.: (905) 829-8050
Website: www.ultratech-labs.com, Email: vic@ultratech-labs.com, Email: tri@ultratech-labs.com



91038



1309



46390-2049



NVLAP LAB
CODE 200093-0



AT-1945



SL2-IN-E-
1119R



CA2049



TL363_B



TPTDP
DA1300

TABLE OF CONTENTS

EXHIBIT 1. INTRODUCTION	1
1.1. SCOPE.....	1
1.2. RELATED SUBMITTAL(S)/GRANT(S)	1
1.3. NORMATIVE REFERENCES	1
EXHIBIT 2. PERFORMANCE ASSESSMENT	2
2.1. CLIENT INFORMATION	2
2.2. EQUIPMENT UNDER TEST (EUT) INFORMATION	2
2.3. EUT'S TECHNICAL SPECIFICATIONS	3
2.4. ASSOCIATED ANTENNA DESCRIPTIONS.....	3
2.5. LIST OF EUT'S PORTS.....	3
2.6. ANCILLARY EQUIPMENT	4
EXHIBIT 3. EUT OPERATING CONDITIONS AND CONFIGURATIONS DURING TESTS	5
3.1. CLIMATE TEST CONDITIONS	5
3.2. OPERATIONAL TEST CONDITIONS & ARRANGEMENT FOR TESTS	5
EXHIBIT 4. SUMMARY OF TEST RESULTS	6
4.1. LOCATION OF TESTS.....	6
4.2. APPLICABILITY & SUMMARY OF EMC EMISSION TEST RESULTS	6
4.3. MODIFICATIONS INCORPORATED IN THE EUT FOR COMPLIANCE PURPOSES	6
EXHIBIT 5. TEST DATA	7
5.1. PEAK CONDUCTED OUTPUT POWER - DTS [§ 15.247(B)(3)].....	7
5.2. TRANSMITTER BAND-EDGE & SPURIOUS RADIATED EMISSIONS AT 3 METERS [§§ 15.247(D), 15.209 & 15.205]	9
5.3. RF EXPOSURE REQUIREMENTS [§§ 15.247(E)(I), 1.1310 & 2.1091]	57
EXHIBIT 6. TEST EQUIPMENT LIST	59
EXHIBIT 7. MEASUREMENT UNCERTAINTY	60
7.1. RADIATED EMISSION MEASUREMENT UNCERTAINTY	60

EXHIBIT 1. INTRODUCTION

1.1. SCOPE

Reference:	FCC Part 15, Subpart C, Section 15.247
Title:	Code of Federal Regulations (CFR), Title 47 – Telecommunication, Part 15 – Radio Frequency Devices
Purpose of Test:	Class II Permissive Change to add a new firmware option which uses an RF Duty Cycle of up to 66%
Test Procedures:	<ul style="list-style-type: none"> ▪ ANSI C63.4 ▪ ANSI C63.10 ▪ FCC KDB Publication No. 558074 D01 DTS Meas Guidance v03r04
Environmental Classification:	<input checked="" type="checkbox"/> Commercial, industrial or business environment <input checked="" type="checkbox"/> Residential environment

1.2. RELATED SUBMITTAL(S)/GRANT(S)

None

1.3. NORMATIVE REFERENCES

Publication	Year	Title
47 CFR Parts 0-19	2016	Code of Federal Regulations (CFR), Title 47 – Telecommunication
ANSI C63.4	2014	American National Standard for Methods of Measurement of Radio-Noise Emissions from Low-Voltage Electrical and Electronic Equipment in the Range of 9 KHz to 40 GHz
ANSI C63.10	2013	American National Standard of Procedures for Compliance Testing of Unlicensed Wireless Devices
CISPR 22 & EN 55022	2008-09, Edition 6.0 2006	Information Technology Equipment - Radio Disturbance Characteristics - Limits and Methods of Measurement
CISPR 16-1-1 +A1 +A2	2006 2006 2007	Specification for radio disturbance and immunity measuring apparatus and methods. Part 1-1: Measuring Apparatus
CISPR 16-1-2 +A1 +A2	2003 2004 2006	Specification for radio disturbance and immunity measuring apparatus and methods. Part 1-2: Conducted disturbances
FCC, KDB Publication No. 558074 D01 DTS Meas Guidance v03r04	2016	Guidance for Performing Compliance Measurements on Digital Transmission Systems (DTS) Operating Under §15.247

EXHIBIT 2. PERFORMANCE ASSESSMENT

2.1. CLIENT INFORMATION

Applicant	
Name:	Digi International Inc.
Address:	11001 Bren Road East Minnetonka, MN 55343 USA
Contact Person:	Paul Dahl Phone #: 801-765-9885 Fax #: 801-765-9895 Email Address: paul.dahl@digi.com

Manufacturer	
Name:	Digi International Inc.
Address:	10000 W 76th St. Eden Prairie, MN 55344 USA
Contact Person:	John Nyland Phone #: 952-912-4721 Fax #: n/a Email Address: john.nyland@digi.com

2.2. EQUIPMENT UNDER TEST (EUT) INFORMATION

The following information (with the exception of the Date of Receipt) has been supplied by the applicant.

Brand Name:	Digi International Inc.
Product Name:	XBEE S2C TH
Model Name or Number:	S2CTH
Serial Number:	Test Sample
Type of Equipment:	Digital Transmission System (DTS)
Input Power Supply Type:	External DC Power Supply
Primary User Functions of EUT:	802.15.212 connectivity of embedded systems Zigbee

2.3. EUT’S TECHNICAL SPECIFICATIONS

Transmitter	
Equipment Type:	<ul style="list-style-type: none"> • Mobile • Base Station (fixed use)
Intended Operating Environment:	<ul style="list-style-type: none"> ▪ Commercial, industrial or business environment ▪ Residential environment
Power Supply Requirement:	2.1 - 3.6 VDC
RF Output Power Rating:	+7.31 dBm (5.38mW) Peak (2405-2475 MHz) -5.09 dBm (0.31mW) Peak (2480 MHz)
Operating Frequency Range:	2405 – 2480 MHz
RF Output Impedance:	50 Ω
Channel Spacing:	5 MHz
Duty Cycle:	66% (see operational description exhibit for details)
Modulation Type:	QPSK
Oscillator Frequency(ies):	24 MHz
Antenna Connector Types:	Integral antenna, RPSMA or U.FL

2.4. ASSOCIATED ANTENNA DESCRIPTIONS

Antenna Type	Maximum Gain Allowed (dBi)	Required minimum Basic Assembly & Cable Loss for Antenna (dB)
Monopole (Integrated Whip) antenna	1.5	0.00
Dipole	2.1	0.00
Omni-Directional	15.0	0.42
Yagi	15.0	0.42
Flat Panel	19.0	0.42

2.5. LIST OF EUT’S PORTS

Port Number	EUT’s Port Description	Number of Identical Ports	Connector Type	Cable Type (Shielded/Non-shielded)
1	RF port	1	Integral antenna, RPSMA or U.FL	Shielded cable (N/A for integral antenna)
2	DC supply and I/O port	1	Pin header	Direct connection (no cable)

2.6. ANCILLARY EQUIPMENT

The EUT was tested while connected to the following representative configuration of ancillary equipment necessary to exercise the ports during tests:

Ancillary Equipment # 1	
Description:	Test Jig
Brand name:	Digi International
Model Name or Number:	N/A
Serial Number:	N/A
Connected to EUT's Port:	Module pins

Ancillary Equipment # 2	
Description:	Laptop
Brand name:	IBM
Model Name or Number:	1161-260
Serial Number:	AAA-FV8WK
Connected to EUT's Port:	Test Jig

EXHIBIT 3. EUT OPERATING CONDITIONS AND CONFIGURATIONS DURING TESTS

3.1. CLIMATE TEST CONDITIONS

The climate conditions of the test environment are as follows:

Temperature:	21 to 23 °C
Humidity:	45 to 58%
Pressure:	102 kPa
Power Input Source:	3.6 VDC

3.2. OPERATIONAL TEST CONDITIONS & ARRANGEMENT FOR TESTS

Operating Modes:	The transmitter was operated in a continuous transmission mode with the carrier modulated as specified in the Test Data.
Special Test Software:	Special software provided by the Applicant to operate the EUT at each channel frequency continuously and in the range of typical modes of operation.
Special Hardware Used:	Test Jig
Transmitter Test Antenna:	The EUT tested with the antennas used with RPSMA connector for testing as shown in the test data.

Transmitter Test Signals	
Frequency Band(s):	2405 – 2480 MHz
Frequency(ies) Tested:	2405, 2475 and 2480 MHz
RF Power Output: (measured maximum output power at antenna terminals)	+7.31 dBm (5.38mW) Peak (2405-2475MHz) -5.09 dBm (0.31mW) Peak (2480MHz)
Normal Test Modulation:	QPSK
Modulating Signal Source:	Internal

EXHIBIT 4. SUMMARY OF TEST RESULTS

4.1. LOCATION OF TESTS

All of the measurements described in this report were performed at Ultratech Group of Labs located in the city of Oakville, Province of Ontario, Canada.

- AC Power Line Conducted Emissions were performed in UltraTech's shielded room, 24'(L) by 16'(W) by 8'(H).
- Radiated Emissions were performed at the Ultratech's 3-10 TDK Semi-Anechoic Chamber situated in the Town of Oakville, province of Ontario. This test site been calibrated in accordance with ANSI C63.4, and found to be in compliance with the requirements of Sec. 2.948 of the FCC Rules. The descriptions and site measurement data of the Oakville 3-10 TDK Semi-Anechoic Chamber has been filed with FCC office (FCC File No.: 91038) and Industry Canada office (Industry Canada File No.: 2049A-3). Expiry Date: 2017-04-02.

4.2. APPLICABILITY & SUMMARY OF EMC EMISSION TEST RESULTS

FCC Section(s)	Test Requirements	Compliance (Yes/No)
15.203	Antenna requirements	Yes*
15.207(a)	AC Power Line Conducted Emissions	N/A**
15.247(a)(2)	6 dB Bandwidth	N/A**
15.247(b)(3)	Peak Conducted Output Power - DTS	Yes
15.247(d)	Band-Edge and RF Conducted Spurious Emissions at the Transmitter Antenna Terminal	N/A**
15.247(d), 15.209 & 15.205	Transmitter Band-Edge and Spurious Radiated Emissions	Yes
15.247(e)	Power Spectral Density	N/A**
15.247(i), 1.1307, 1.1310, 2.1091	RF Exposure	Yes

* The EUT complies with the requirement; it employs a unique (non-standard) antenna connector or integral antenna.

** These tests would not affect due to this C2PC change of increasing the Duty cycle to 66%.

4.3. MODIFICATIONS INCORPORATED IN THE EUT FOR COMPLIANCE PURPOSES

None

EXHIBIT 5. TEST DATA

5.1. PEAK CONDUCTED OUTPUT POWER - DTS [§ 15.247(b)(3)]

5.1.1. Limit(s)

§ 15.247(b)(3): For systems using digital modulation in the 902-928 MHz, 2400-2483.5 MHz, and 5725-5850 MHz bands: 1 Watt. As an alternative to a peak power measurement, compliance with the one Watt limit can be based on a measurement of the maximum conducted output power. Maximum Conducted Output Power is defined as the total transmit power delivered to all antennas and antenna elements averaged across all symbols in the signaling alphabet when the transmitter is operating at its maximum power control level. Power must be summed across all antennas and antenna elements. The average must not include any time intervals during which the transmitter is off or is transmitting at a reduced power level. If multiple modes of operation are possible (e.g., alternative modulation methods), the *maximum conducted output power* is the highest total transmit power occurring in any mode.

§ 15.247(c)(1)(i) Systems operating in the 2400-2483.5 MHz band that are used exclusively for fixed, point-to-point operations may employ transmitting antennas with directional gain greater than 6 dBi provided the maximum conducted output power of the intentional radiator is reduced by 1 dB for every 3 dB that the directional gain of the antenna exceeds 6 dBi.

5.1.2. Method of Measurements & Test Arrangement

KDB Publication No. 558074 D01 DTS Meas Guidance V03r04, Section 9.1.1 RBW ≥ DTS bandwidth

5.1.3. Test Arrangement

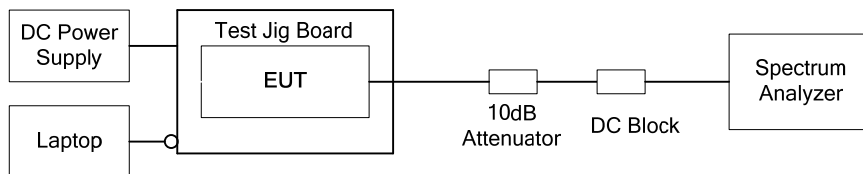

5.1.4. Test Data

Operating Mode	Modulation	Channel Number	Frequency (MHz)	Peak Conducted Power (dBm)	Peak Conducted Power Limit (dBm)	Margin (dBm)
Power Setting 8 Mode 1	QPSK	11	2405	7.31	30	-22.69
		18	2440	7.08	30	-22.92
		25	2475	7.20	30	-22.80
Power Setting -4 Mode 1	QPSK	26	2480	-5.09	30	-35.09

Note: The EIRP shall not exceed 36 dBm for all proposed antennas.

The following are the antennas having Gains more than 6 dBi: Net gain shall be determined after subtracting the *Basic Assembly Cable Loss (The high gain antennas with N connector needs a 91cm SMA to N cable having loss of 0.42dB). There is additional cable loss for Channels 25 & 26 as shown in the Band-Edge test data at highest gain of these antennas.

Omni Direction D-Link Antenna 15 dBi gain:

Channel Number	Frequency (MHz)	Modulation	Peak Power (dBm)	Power Setting	Basic Cable Loss* (dB)	EIRP (dBm)	EIRP Limit (dBm)	Margin (dB)
11	2405	QPSK	7.31	8 Mode 1	0.42	21.89	36.00	-14.11
18	2440	QPSK	7.08	8 Mode 1	0.42	21.66	36.00	-14.34
25	2475	QPSK	7.20	8 Mode 1	0.42	21.78	36.00	-14.22
26	2480	QPSK	-5.09	-4 Mode 1	6.42	3.49	36.00	-32.51

Maxrad Yagi Antenna 15 dBi gain:

Channel Number	Frequency (MHz)	Modulation	Peak Power (dBm)	Power Setting	Basic Cable Loss* (dB)	EIRP (dBm)	EIRP Limit (dBm)	Margin (dB)
11	2405	QPSK	7.31	8 Mode 1	0.42	21.89	36.00	-14.11
18	2440	QPSK	7.08	8 Mode 1	0.42	21.66	36.00	-14.34
25	2475	QPSK	7.20	8 Mode 1	5.42	16.78	36.00	-19.22
26	2480	QPSK	-5.09	-4 Mode 1	10.92	-1.01	36.00	-37.01

Arc Wireless Solution Panel Antenna 19 dBi gain

Channel Number	Frequency (MHz)	Modulation	Peak Power (dBm)	Power Setting	Basic Cable Loss* (dB)	EIRP (dBm)	EIRP Limit (dBm)	Margin (dB)
11	2405	QPSK	7.31	8 Mode 1	0.42	25.89	36.00	-14.11
18	2440	QPSK	7.08	8 Mode 1	0.42	25.66	36.00	-14.34
25	2475	QPSK	7.20	8 Mode 1	9.42	16.78	36.00	-19.22
26	2480	QPSK	-5.09	-4 Mode 1	15.42	-1.51	36.00	-37.51

5.2. TRANSMITTER BAND-EDGE & SPURIOUS RADIATED EMISSIONS AT 3 METERS [§§ 15.247(d), 15.209 & 15.205]

5.2.1. Limit(s)

§ 15.247 (d): In any 100 kHz bandwidth outside the frequency band in which the spread spectrum or digitally modulated intentional radiator is operating, the radio frequency power that is produced by the intentional radiator shall be at least 20 dB below that in the 100 kHz bandwidth within the band that contains the highest level of the desired power, based on either an RF conducted or a radiated measurement, provided the transmitter demonstrates compliance with the peak conducted power limits. If the transmitter complies with the conducted power limits based on the use of RMS averaging over a time interval, as permitted under paragraph (b)(3) of this section, the attenuation required under this paragraph shall be 30 dB instead of 20 dB. Attenuation below the general limits specified in Section 15.209(a) is not required. In addition, radiated emissions which fall in the restricted bands, as defined in Section 15.205(a), must also comply with the radiated emission limits specified in Section 15.209(a) (see Section 15.205(c)).

Section 15.205(a) - Restricted Bands of Operation

MHz	MHz	MHz	GHz
0.090–0.110	16.42–16.423	399.9–410	4.5–5.15
¹ 0.495–0.505	16.69475–16.69525	608–614	5.35–5.46
2.1735–2.1905	16.80425–16.80475	960–1240	7.25–7.75
4.125–4.128	25.5–25.67	1300–1427	8.025–8.5
4.17725–4.17775	37.5–38.25	1435–1626.5	9.0–9.2
4.20725–4.20775	73–74.6	1645.5–1646.5	9.3–9.5
6.215–6.218	74.8–75.2	1660–1710	10.6–12.7
6.26775–6.26825	108–121.94	1718.8–1722.2	13.25–13.4
6.31175–6.31225	123–138	2200–2300	14.47–14.5
8.291–8.294	149.9–150.05	2310–2390	15.35–16.2
8.362–8.366	156.52475–156.52525	2483.5–2500	17.7–21.4
8.37625–8.38675	156.7–156.9	2655–2900	22.01–23.12
8.41425–8.41475	162.0125–167.17	3260–3267	23.6–24.0
12.29–12.293	167.72–173.2	3332–3339	31.2–31.8
12.51975–12.52025	240–285	3345.8–3358	36.43–36.5
12.57675–12.57725	322–335.4	3600–4400	(²)
13.36–13.41			

¹ Until February 1, 1999, this restricted band shall be 0.490–0.510 MHz.
² Above 38.6

**Section 15.209(a)
 -- Field Strength Limits within Restricted Frequency Bands --**

Frequency (MHz)	Field Strength (microvolts/meter)	Measurement Distance (meters)
0.009 - 0.490	2,400 / F (kHz)	300
0.490 - 1.705	24,000 / F (kHz)	30
1.705 - 30.0	30	30
30 - 88	100	3
88 - 216	150	3
216 - 960	200	3
Above 960	500	3

5.2.2. Method of Measurements

ANSI C63.10 and ANSI 63.4 procedures.

5.2.3. Test Arrangement

Band-Edge Radiated Set-up Diagram

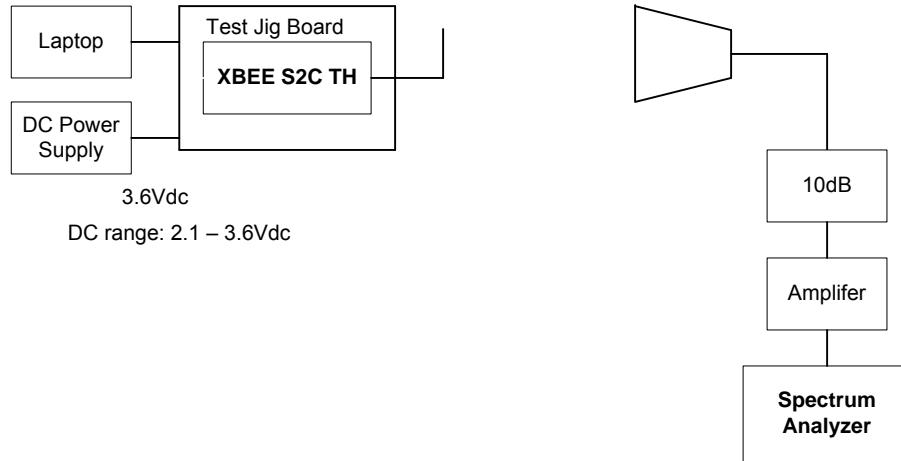

Tx Radiated Set-up Diagram

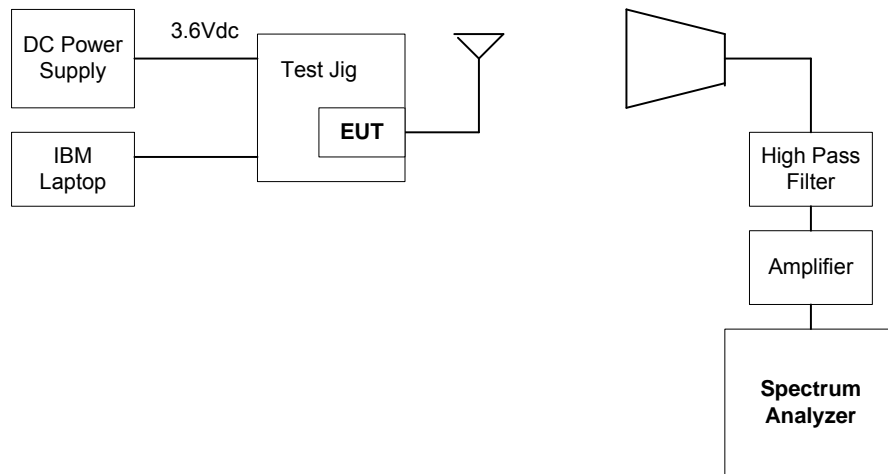

5.2.4. Test Data

Remark(s):

- All spurious emissions that are in excess of 20 dB below the specified limit shall be recorded.
- EUT shall be tested in three orthogonal positions.
- The following test results are the worst-case measurements, derived from exploratory tests.
- A duty cycle factor of -3.61dB (66%) were applied to the measured average values.

5.2.4.1. EUT with 1.5 dBi Monopole (Integrated Whip) Antenna

5.2.4.1.1. Spurious Radiated Emissions

Fundamental Frequency:		2405 MHz					
Power Setting and Operating Mode:		Power 8 Mode 1, QPSK Modulation					
Frequency Test Range:		30 MHz - 25 GHz					
Frequency (MHz)	RF Peak Level (dBµV/m)	RF Avg Level (dBµV/m)	Antenna Plane (H/V)	Limit 15.209 (dBµV/m)	Limit 15.247 (dBµV/m)	Margin (dB)	Pass/Fail
2405	105.86	--	V	--	--	--	--
2405	105.07	--	H	--	--	--	--
4810	53.00	41.66	V	54.0	85.9	-12.3	Pass
4810	52.59	41.09	H	54.0	85.9	-12.9	Pass
All other spurious emissions and harmonics are more than 20 dB below the applicable limit.							

*Field strength of emissions appearing within restricted frequency bands shall not exceed the limits in § 15.209.

Fundamental Frequency:		2440 MHz					
Power Setting and Operating Mode:		Power 8 Mode 1, QPSK Modulation					
Frequency Test Range:		30 MHz - 25 GHz					
Frequency (MHz)	RF Peak Level (dBµV/m)	RF Avg Level (dBµV/m)	Antenna Plane (H/V)	Limit 15.209 (dBµV/m)	Limit 15.247 (dBµV/m)	Margin (dB)	Pass/Fail
2440	105.27	--	V	--	--	--	--
2440	106.55	--	H	--	--	--	--
4880	53.31	41.26	V	54.0	86.6	-12.7	Pass*
4880	54.10	42.93	H	54.0	86.6	-11.1	Pass*
7320	54.38	42.99	V	54.0	86.6	-11.0	Pass*
7320	56.97	45.74	H	54.0	86.6	-8.3	Pass*
All other spurious emissions and harmonics are more than 20 dB below the applicable limit.							

*Field strength of emissions appearing within restricted frequency bands shall not exceed the limits in § 15.209.

Fundamental Frequency:		2475 MHz					
Power Setting and Operating Mode:		Power 8 Mode 1, QPSK Modulation					
Frequency Test Range:		30 MHz - 25 GHz					
Frequency (MHz)	RF Peak Level (dBµV/m)	RF Avg Level (dBµV/m)	Antenna Plane (H/V)	Limit 15.209 (dBµV/m)	Limit 15.247 (dBµV/m)	Margin (dB)	Pass/Fail
2475	105.76	--	V	--	--	--	--
2475	107.00	--	H	--	--	--	--
4950	52.68	41.55	V	54.0	87.0	-12.4	Pass*
4950	55.83	45.20	H	54.0	87.0	-8.8	Pass*
7425	55.94	43.11	V	54.0	87.0	-10.9	Pass*
7425	57.46	45.70	H	54.0	87.0	-8.3	Pass*
All other spurious emissions and harmonics are more than 20 dB below the applicable limit.							

*Field strength of emissions appearing within restricted frequency bands shall not exceed the limits in § 15.209.

5.2.4.1.2. Band-Edge RF Radiated Emissions

Plot 5.2.4.1.2.1. Band-Edge RF Radiated Emissions at 3 m, Horizontal Polarization
 Low End of Frequency Band, Ch11- 2405 MHz, QPSK Modulation, Power 8 Mode 1

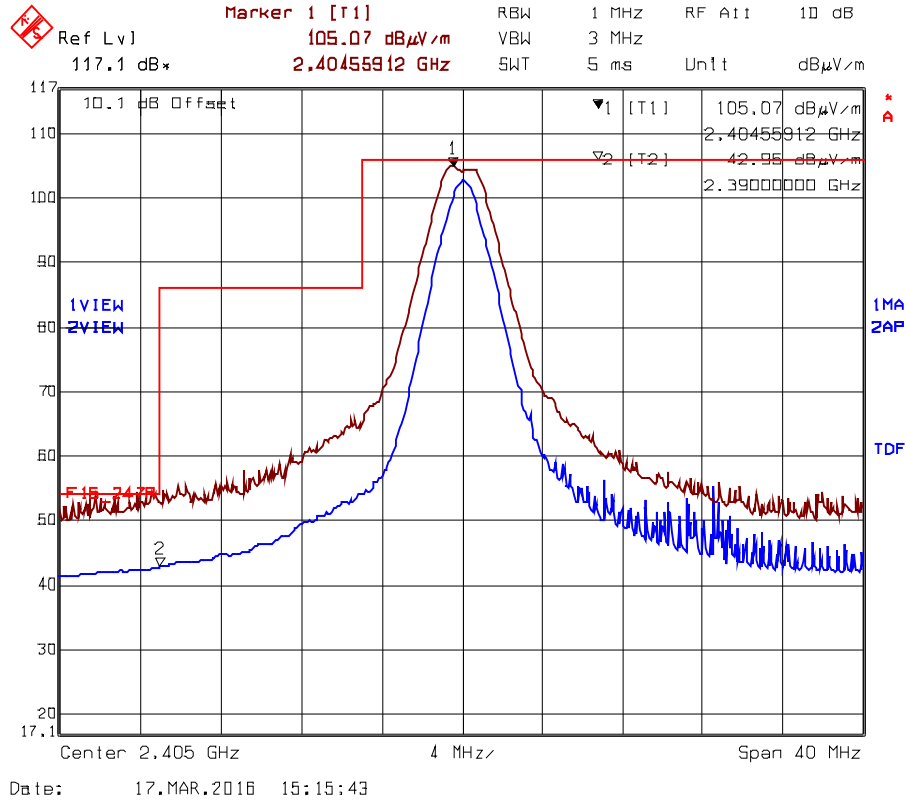

Trace 1: RBW = 1 MHz, VBW = 3 MHz, Trace 2: RBW = 1 MHz, VBW = 10 Hz
 Average level at 2390 MHz is 42.95dBµV/m, 100% Duty Cycle can be applied from channel 11 to 25

Plot 5.2.4.1.2.2. Band-Edge RF Radiated Emissions at 3 m, Vertical Polarization
 Low End of Frequency Band, Ch11- 2405 MHz, QPSK Modulation, Power 8 Mode 1

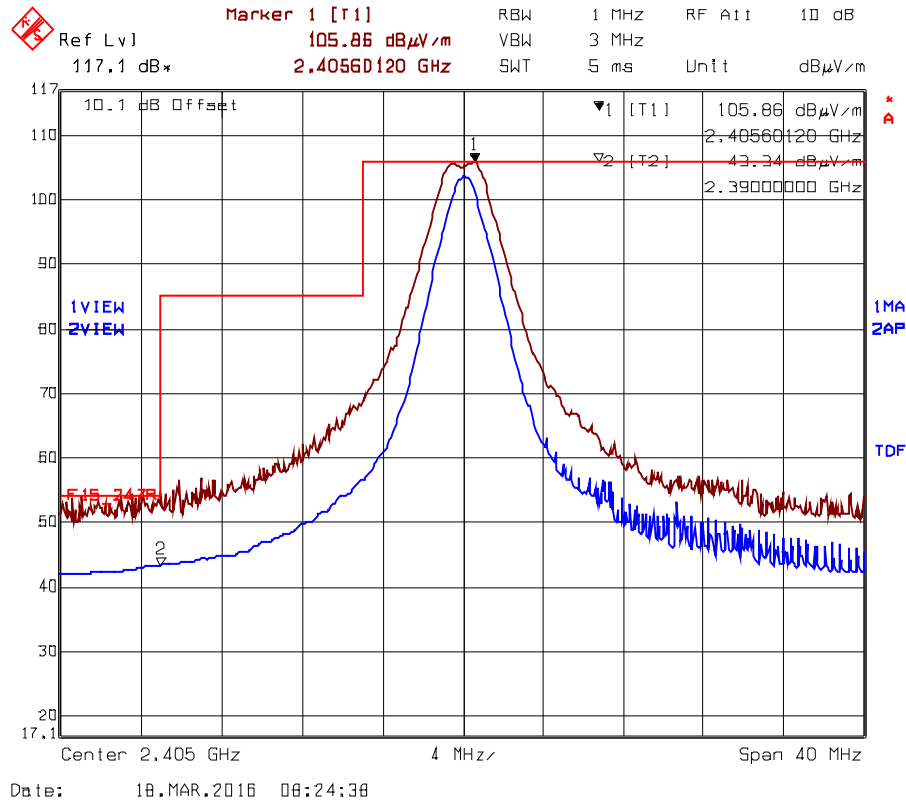

Trace 1: RBW = 1 MHz, VBW = 3 MHz, Trace 2: RBW = 1 MHz, VBW = 10 Hz
 Average level at 2390 MHz is 43.34dBμV/m, 100% Duty Cycle can be applied from channel 11 to 25

Plot 5.2.4.1.2.3. Band-Edge RF Radiated Emissions at 3 m, Horizontal Polarization
 High End of Frequency Band, Ch25- 2475 MHz, QPSK Modulation, Power 8 Mode 1

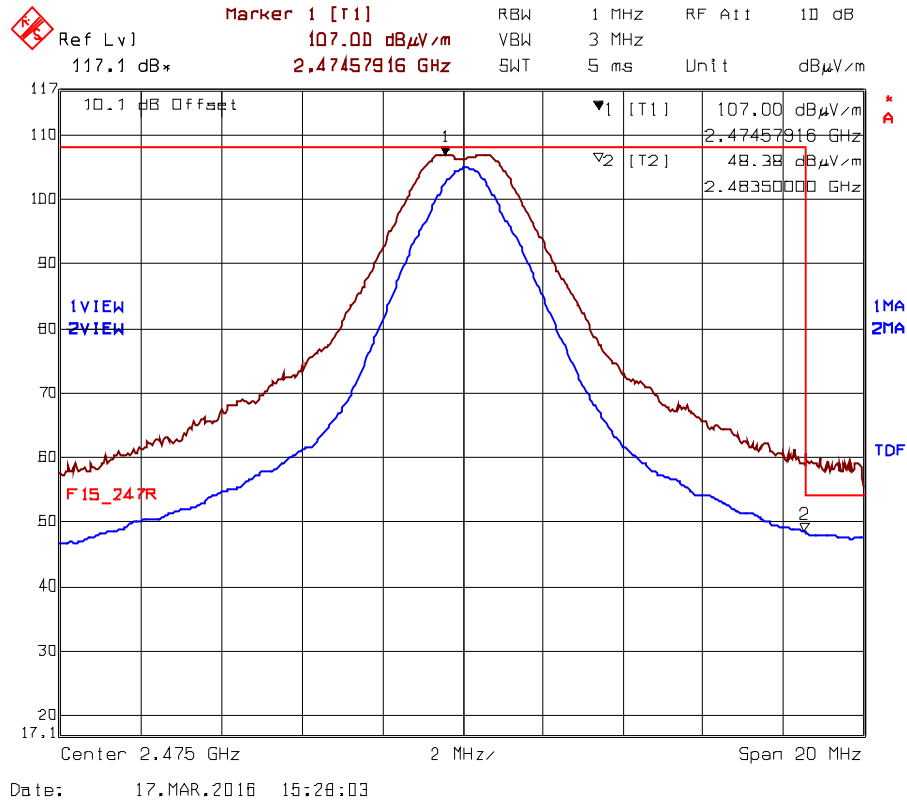

Trace 1: RBW = 1 MHz, VBW = 3 MHz, Trace 2: RBW = 1 MHz, VBW = 10 Hz
 Average level at 2483.5 MHz is 48.38dBμV/m, 100% Duty Cycle can be applied from channel 11 to 25

Plot 5.2.4.1.2.4. Band-Edge RF Radiated Emissions at 3 m, Vertical Polarization
 High End of Frequency Band, Ch25- 2475 MHz, QPSK Modulation, Power 8 Mode 1

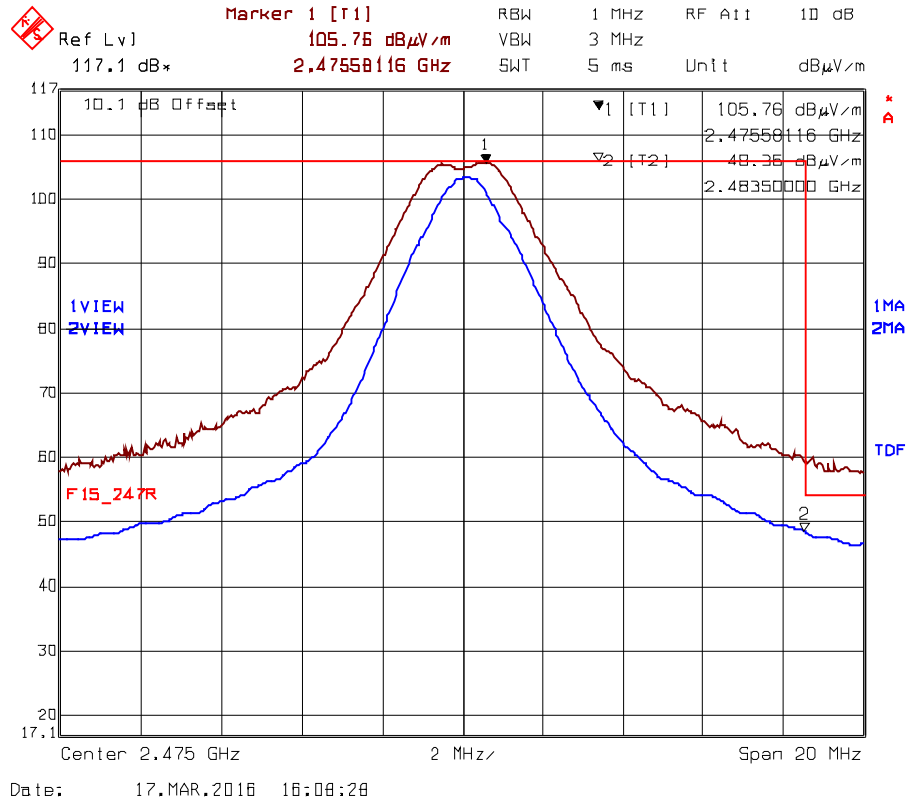

Trace 1: RBW = 1 MHz, VBW = 3 MHz, Trace 2: RBW = 1 MHz, VBW = 10 Hz
 Average level at 2483.5 MHz is 48.38dBμV/m, 100% Duty Cycle can be applied from channel 11 to 25

Plot 5.2.4.1.2.5. Band-Edge RF Radiated Emissions at 3 m, Horizontal Polarization
 Highest End of Frequency Band, Ch26- 2480 MHz, QPSK Modulation, Power -4 Mode 1 @ 66% Duty Cycle

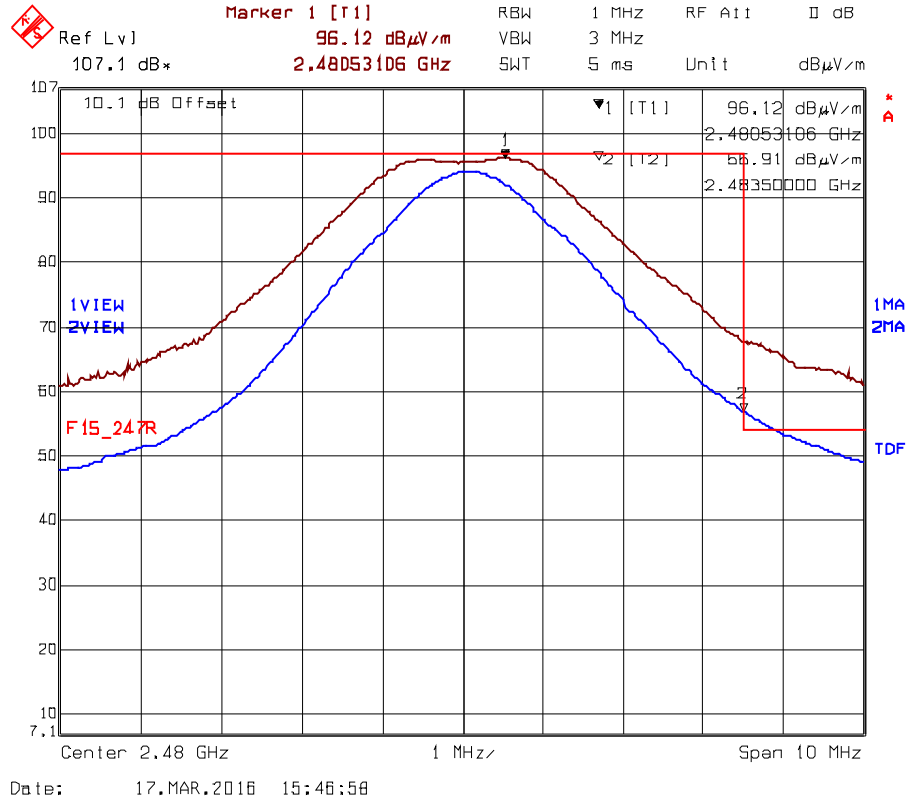

Trace 1: RBW= 1 MHz, VBW= 3 MHz, Trace 2: RBW= 1 MHz, VBW= 10 Hz
 Average level at 2483.5 MHz is 53.30dBμV/m (56.91-3.61), Duty cycle is 66% ($20 \cdot \log(0.66) = 3.61\text{dB}$)

Plot 5.2.4.1.2.6. Band-Edge RF Radiated Emissions at 3 m, Vertical Polarization
 Highest End of Frequency Band, Ch26- 2480 MHz, QPSK Modulation, Power -4 Mode 1 @ 66% Duty Cycle

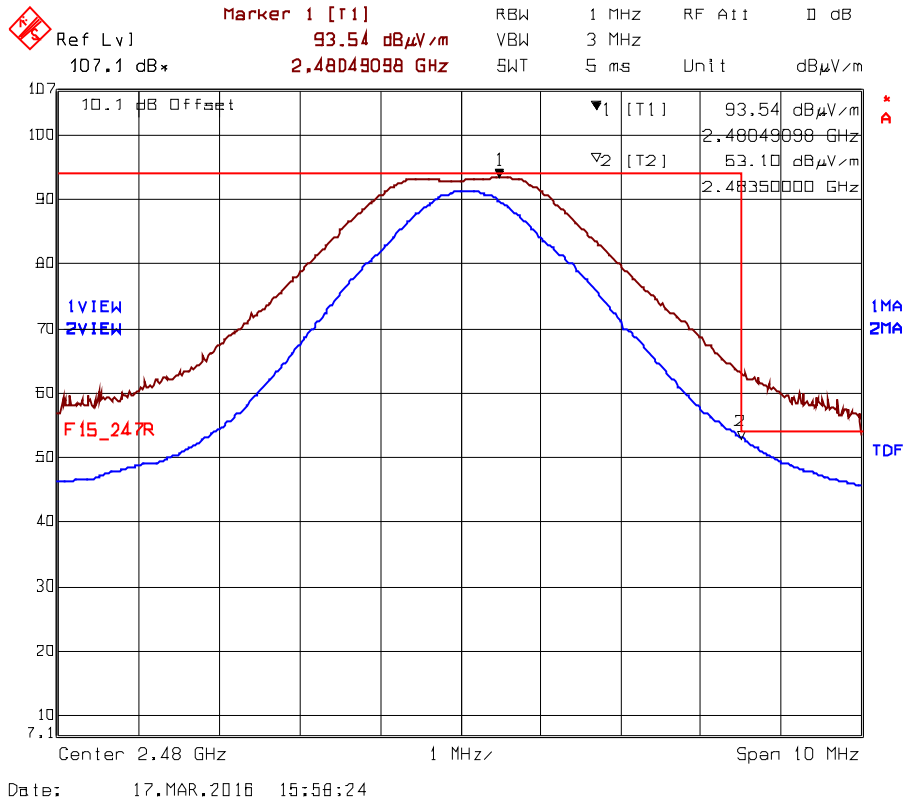

Trace 1: RBW= 1 MHz, VBW= 3 MHz, Trace 2: RBW= 1 MHz, VBW= 10 Hz
 Average level at 2483.5 MHz is 49.49dBμV/m (53.10-3.61), Duty cycle is 66% ($20 \cdot \log(0.66) = 3.61\text{dB}$)

5.2.4.2. EUT with 2.1 dBi Dipole Antenna with 0.0dB Assembly Cable loss

5.2.4.2.1. Spurious Radiated Emissions

Fundamental Frequency:		2405 MHz					
Power Setting and Operating Mode:		Power 8 Mode 1, QPSK Modulation					
Frequency Test Range:		30 MHz - 25 GHz					
Frequency (MHz)	RF Peak Level (dBµV/m)	RF Avg Level (dBµV/m)	Antenna Plane (H/V)	Limit 15.209 (dBµV/m)	Limit 15.247 (dBµV/m)	Margin (dB)	Pass/Fail
2405	109.10	--	V	--	--	--	--
2405	111.47	--	H	--	--	--	--
4810	56.29	46.11	V	54.0	91.5	-7.9	Pass
4810	57.60	47.01	H	54.0	91.5	-7.0	Pass
All other spurious emissions and harmonics are more than 20 dB below the applicable limit.							

*Field strength of emissions appearing within restricted frequency bands shall not exceed the limits in § 15.209.

Fundamental Frequency:		2440 MHz					
Power Setting and Operating Mode:		Power 8 Mode 1, QPSK Modulation					
Frequency Test Range:		30 MHz - 25 GHz					
Frequency (MHz)	RF Peak Level (dBµV/m)	RF Avg Level (dBµV/m)	Antenna Plane (H/V)	Limit 15.209 (dBµV/m)	Limit 15.247 (dBµV/m)	Margin (dB)	Pass/Fail
2440	109.17	--	V	--	--	--	--
2440	111.25	--	H	--	--	--	--
4880	59.74	49.33	V	54.0	91.3	-4.7	Pass*
4880	59.30	49.11	H	54.0	91.3	-4.9	Pass*
7320	54.49	42.82	V	54.0	91.3	-11.2	Pass*
7320	57.90	46.21	H	54.0	91.3	-7.8	Pass*
All other spurious emissions and harmonics are more than 20 dB below the applicable limit.							

*Field strength of emissions appearing within restricted frequency bands shall not exceed the limits in § 15.209.

Fundamental Frequency:		2475 MHz					
Power Setting and Operating Mode:		Power 8 Mode 1, QPSK Modulation					
Frequency Test Range:		30 MHz - 25 GHz					
Frequency (MHz)	RF Peak Level (dBµV/m)	RF Avg Level (dBµV/m)	Antenna Plane (H/V)	Limit 15.209 (dBµV/m)	Limit 15.247 (dBµV/m)	Margin (dB)	Pass/Fail
2475	109.10	--	V	--	--	--	--
2475	111.36	--	H	--	--	--	--
4950	58.77	48.64	V	54.0	91.4	-5.4	Pass*
4950	57.73	46.40	H	54.0	91.4	-7.6	Pass*
7425	55.54	43.60	V	54.0	91.4	-10.4	Pass*
7425	59.95	48.92	H	54.0	91.4	-5.1	Pass*
All other spurious emissions and harmonics are more than 20 dB below the applicable limit.							

*Field strength of emissions appearing within restricted frequency bands shall not exceed the limits in § 15.209.

5.2.4.2.2. Band-Edge RF Radiated Emissions

Plot 5.2.4.2.2.1. Band-Edge RF Radiated Emissions at 3 m, Horizontal Polarization
 Low End of Frequency Band, Ch11- 2405 MHz, QPSK Modulation, Power 8 Mode 1

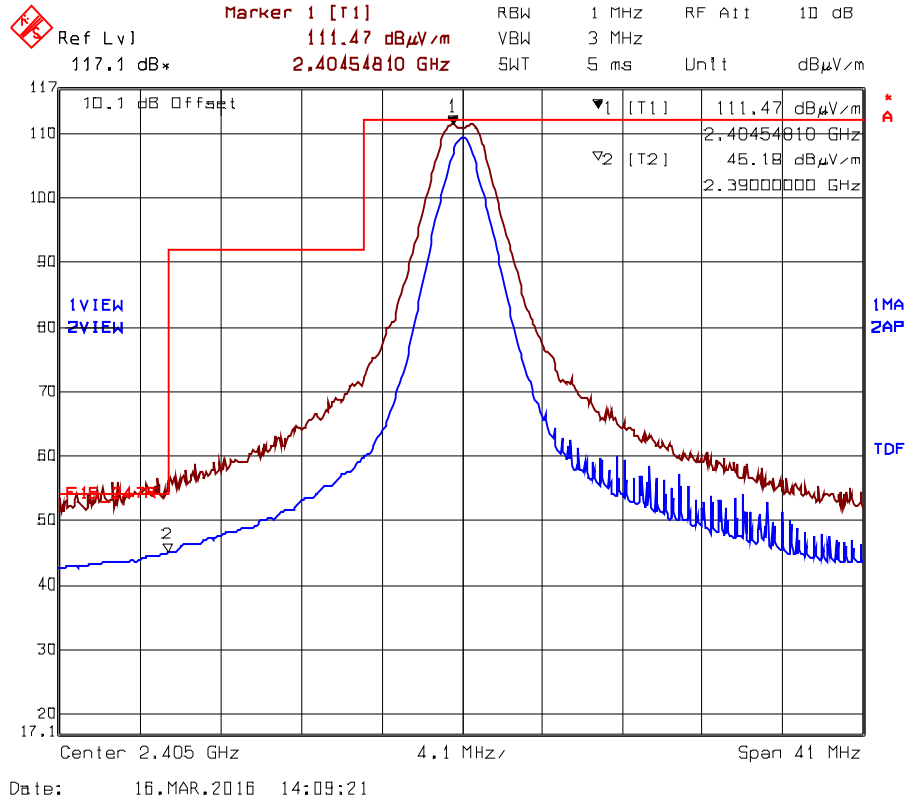

Trace 1: RBW = 1 MHz, VBW = 3 MHz, Trace 2: RBW = 1 MHz, VBW = 10 Hz
 Average level at 2390 MHz is 45.18dBµV/m, 100% Duty Cycle can be applied from channel 11 to 25

Plot 5.2.4.2.2.2. Band-Edge RF Radiated Emissions at 3 m, Vertical Polarization
 Low End of Frequency Band, Ch11- 2405 MHz, QPSK Modulation, Power 8 Mode 1

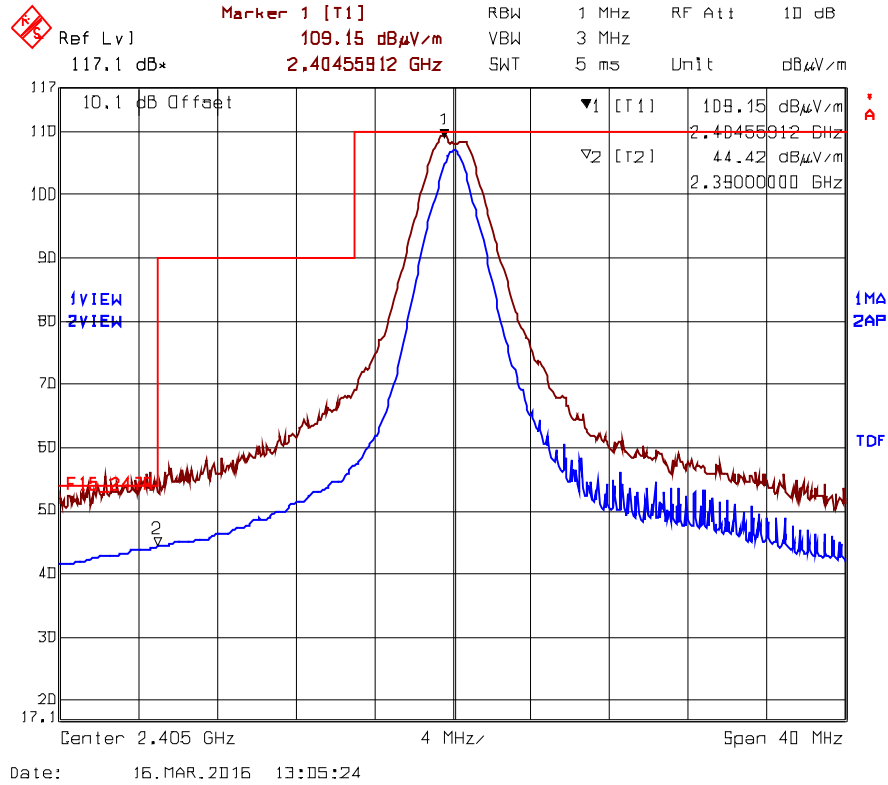

Trace 1: RBW = 1 MHz, VBW = 3 MHz, Trace 2: RBW = 1 MHz, VBW = 10 Hz
 Average level at 2390 MHz is 44.42dBμV/m, 100% Duty Cycle can be applied from channel 11 to 25

Plot 5.2.4.2.3. Band-Edge RF Radiated Emissions at 3 m, Horizontal Polarization
 High End of Frequency Band, Ch25- 2475 MHz, QPSK Modulation, Power 8 Mode 1

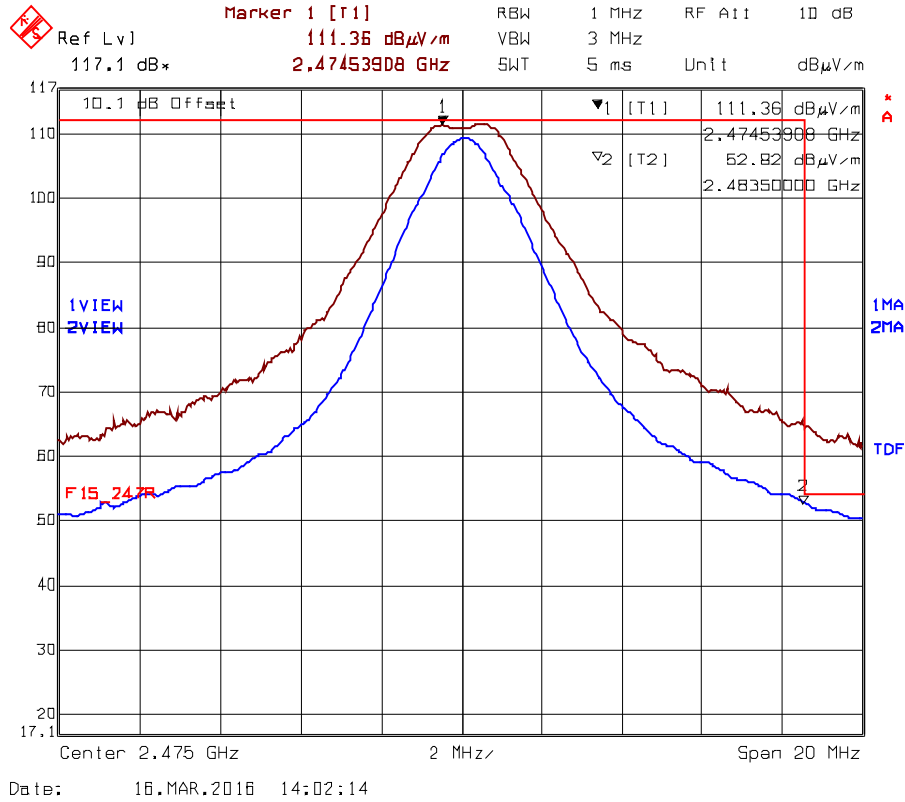

Trace 1: RBW = 1 MHz, VBW = 3 MHz, Trace 2: RBW = 1 MHz, VBW = 10 Hz
 Average level at 2483.5 MHz is 52.82dBµV/m, 100% Duty Cycle can be applied from channel 11 to 25

Plot 5.2.4.2.4. Band-Edge RF Radiated Emissions at 3 m, Vertical Polarization
 High End of Frequency Band, Ch25- 2475 MHz, QPSK Modulation, Power 8 Mode 1

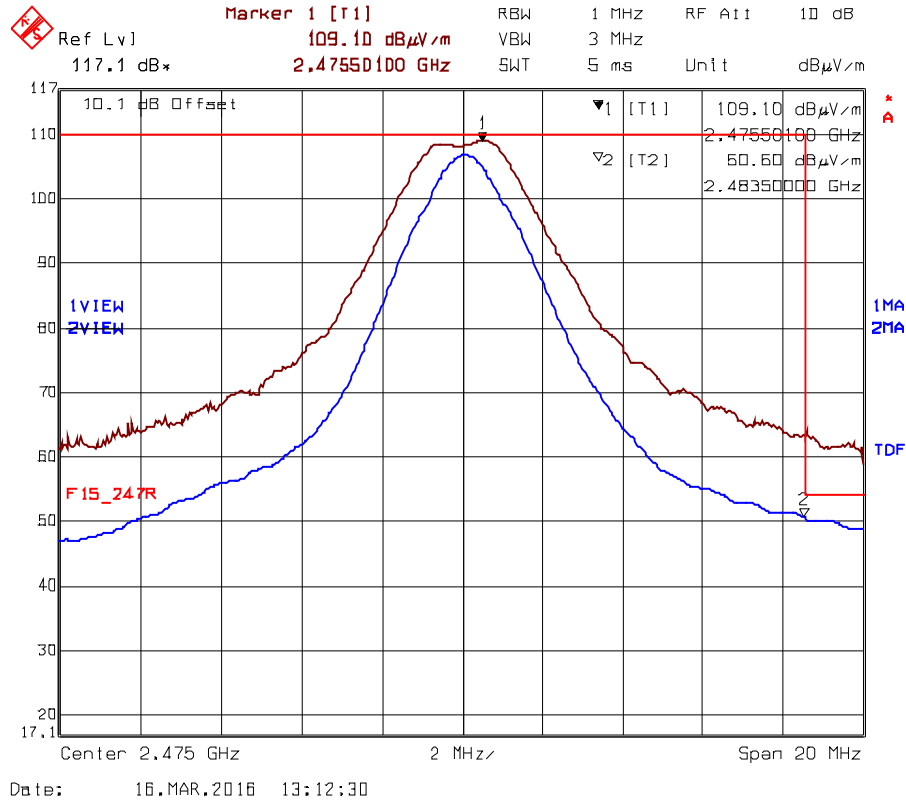

Trace 1: RBW = 1 MHz, VBW = 3 MHz, Trace 2: RBW = 1 MHz, VBW = 10 Hz
 Average level at 2483.5 MHz is 50.60dBµV/m, 100% Duty Cycle can be applied from channel 11 to 25

Plot 5.2.4.2.5. Band-Edge RF Radiated Emissions at 3 m, Horizontal Polarization
 Highest End of Frequency Band, Ch26- 2480 MHz, QPSK Modulation, Power -4 Mode 1 @ 66% Duty Cycle

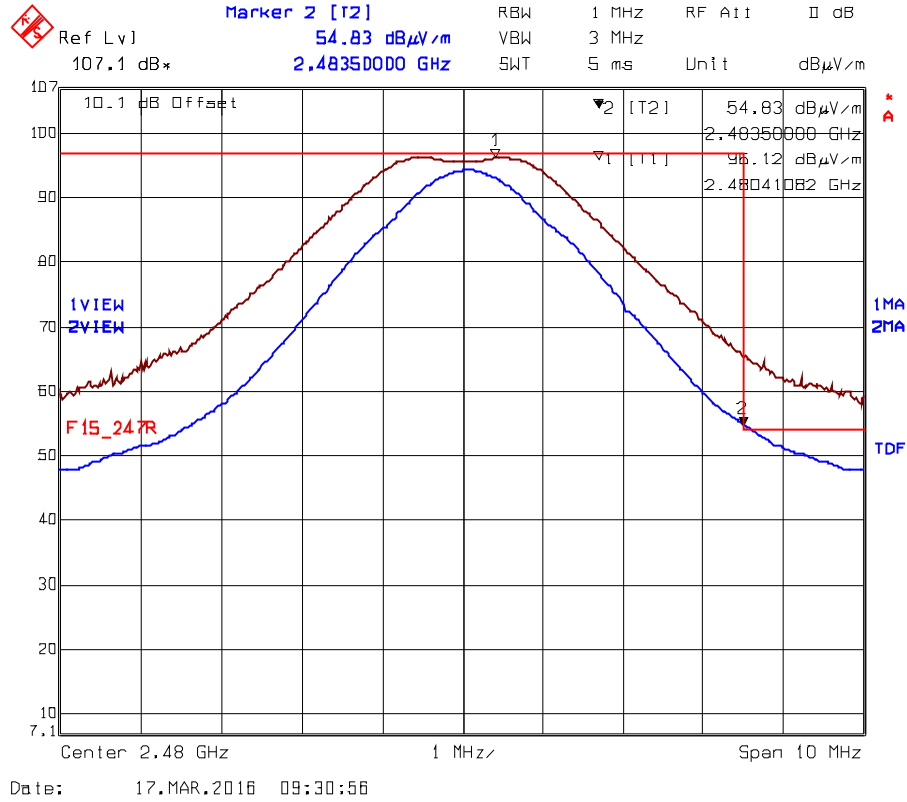

Trace 1: RBW= 1 MHz, VBW= 3 MHz, Trace 2: RBW= 1 MHz, VBW= 10 Hz
 Average level at 2483.5 MHz is 51.22dBμV/m (54.83-3.61), Duty cycle is 66% ($20 \cdot \log(0.66) = 3.61\text{dB}$)

Plot 5.2.4.2.2.6. Band-Edge RF Radiated Emissions at 3 m, Vertical Polarization
 Highest End of Frequency Band, Ch26- 2480 MHz, QPSK Modulation, Power -4 Mode 1 @ 66% Duty Cycle

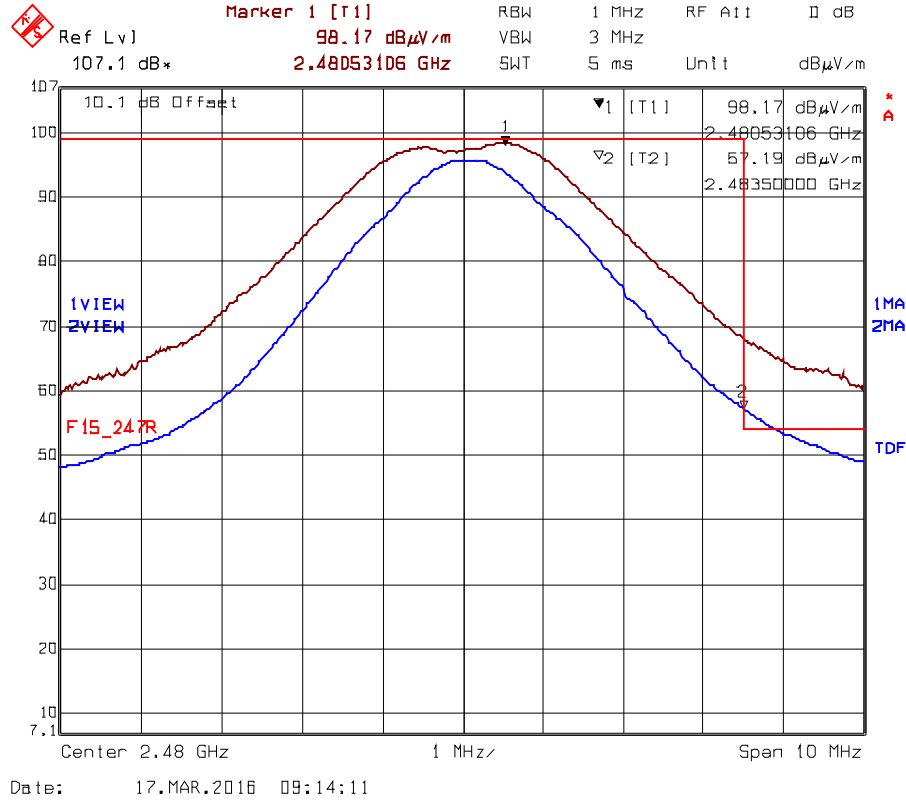

Trace 1: RBW= 1 MHz, VBW= 3 MHz, Trace 2: RBW= 1 MHz, VBW= 10 Hz
 Average level at 2483.5 MHz is 53.58dBμV/m (57.19-3.61), Duty cycle is 66% ($20 \cdot \log(0.66) = 3.61\text{dB}$)

5.2.4.3. EUT with 15 dBi Omni-directional Antenna with 0.42dB Basic Assembly Cable Loss

5.2.4.3.1. Spurious Radiated Emissions

Fundamental Frequency:		2405 MHz					
Power Setting and Operating Mode:		Power 8 Mode 1, QPSK Modulation					
Frequency Test Range:		30 MHz - 25 GHz					
Frequency (MHz)	RF Peak Level (dBµV/m)	RF Avg Level (dBµV/m)	Antenna Plane (H/V)	Limit 15.209 (dBµV/m)	Limit 15.247 (dBµV/m)	Margin (dB)	Pass/Fail
2405	113.84	--	V	--	--	--	--
2405	112.12	--	H	--	--	--	--
4810	57.15	47.30	V	54.0	93.8	-6.7	Pass
4810	57.78	48.32	H	54.0	93.8	-5.7	Pass
All other spurious emissions and harmonics are more than 20 dB below the applicable limit.							

*Field strength of emissions appearing within restricted frequency bands shall not exceed the limits in § 15.209.

Fundamental Frequency:		2440 MHz					
Power Setting and Operating Mode:		Power 8 Mode 1, QPSK Modulation					
Frequency Test Range:		30 MHz - 25 GHz					
Frequency (MHz)	RF Peak Level (dBµV/m)	RF Avg Level (dBµV/m)	Antenna Plane (H/V)	Limit 15.209 (dBµV/m)	Limit 15.247 (dBµV/m)	Margin (dB)	Pass/Fail
2440	113.59	--	V	--	--	--	--
2440	111.57	--	H	--	--	--	--
4880	56.41	45.59	V	54.0	93.6	-8.4	Pass*
4880	53.42	42.92	H	54.0	93.6	-11.1	Pass*
7320	54.89	43.37	V	54.0	93.6	-10.6	Pass*
7320	54.32	42.09	H	54.0	93.6	-11.9	Pass*
All other spurious emissions and harmonics are more than 20 dB below the applicable limit.							

*Field strength of emissions appearing within restricted frequency bands shall not exceed the limits in § 15.209.

Fundamental Frequency:		2475 MHz					
Power Setting and Operating Mode:		Power 8 Mode 1, QPSK Modulation					
Frequency Test Range:		30 MHz - 25 GHz					
Frequency (MHz)	RF Peak Level (dBµV/m)	RF Avg Level (dBµV/m)	Antenna Plane (H/V)	Limit 15.209 (dBµV/m)	Limit 15.247 (dBµV/m)	Margin (dB)	Pass/Fail
2475	113.47	--	V	--	--	--	--
2475	110.69	--	H	--	--	--	--
4950	58.68	47.87	V	54.0	93.5	-6.1	Pass*
4950	57.03	45.34	H	54.0	93.5	-8.7	Pass*
7425	56.43	42.21	V	54.0	93.5	-11.8	Pass*
7425	53.27	41.47	H	54.0	93.5	-12.5	Pass*
All other spurious emissions and harmonics are more than 20 dB below the applicable limit.							

*Field strength of emissions appearing within restricted frequency bands shall not exceed the limits in § 15.209.

5.2.4.3.2. Band-Edge RF Radiated Emissions

Plot 5.2.4.3.2.1. Band-Edge RF Radiated Emissions at 3 m, Horizontal Polarization
 Low End of Frequency Band, Ch11- 2405 MHz, QPSK Modulation, Power 8 Mode 1

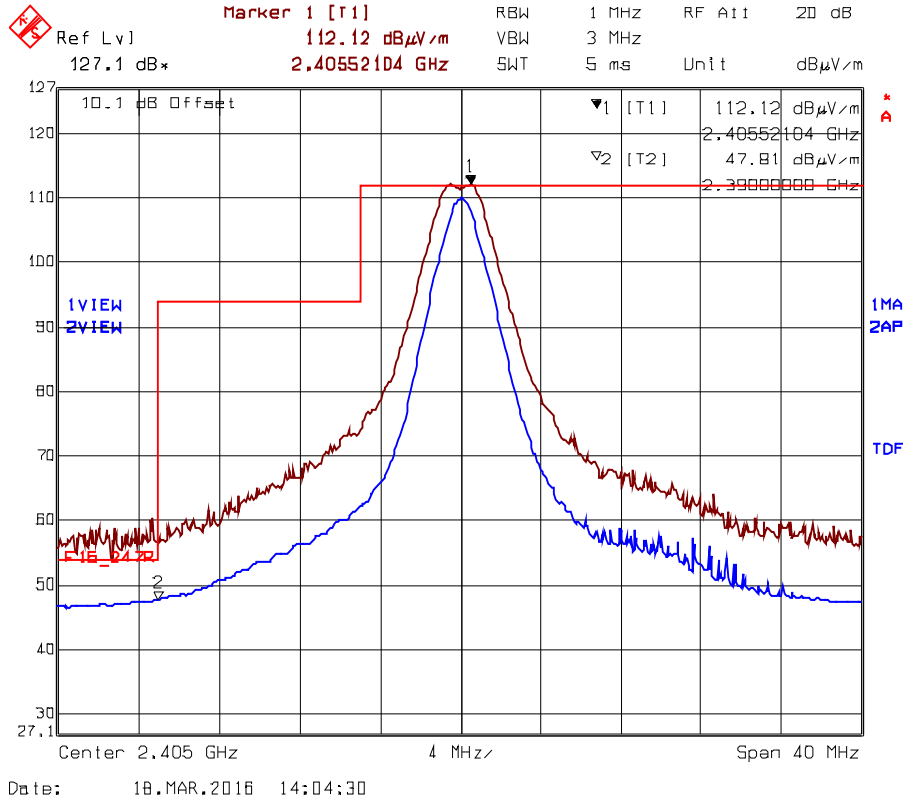

Trace 1: RBW = 1 MHz, VBW = 3 MHz, Trace 2: RBW = 1 MHz, VBW = 10 Hz
 Average level at 2390 MHz is 47.81dBμV/m, 100% Duty Cycle can be applied from channel 11 to 24

Plot 5.2.4.3.2.2. Band-Edge RF Radiated Emissions at 3 m, Vertical Polarization
 Low End of Frequency Band, Ch11- 2405 MHz, QPSK Modulation, Power 8 Mode 1

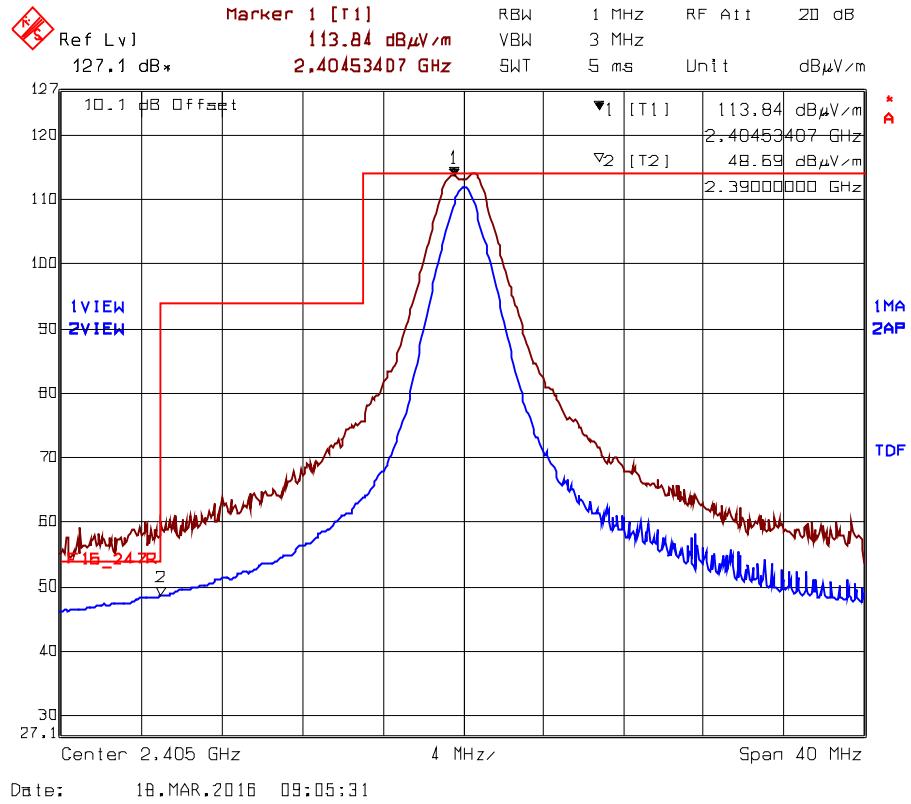

Trace 1: RBW = 1 MHz, VBW = 3 MHz, Trace 2: RBW = 1 MHz, VBW = 10 Hz
 Average level at 2390 MHz is 48.69dBμV/m, 100% Duty Cycle can be applied from channel 11 to 24

Plot 5.2.4.3.2.3. Band-Edge RF Radiated Emissions at 3 m, Horizontal Polarization
 High End of Frequency Band, Ch24- 2470 MHz, QPSK Modulation, Power 8 Mode 1

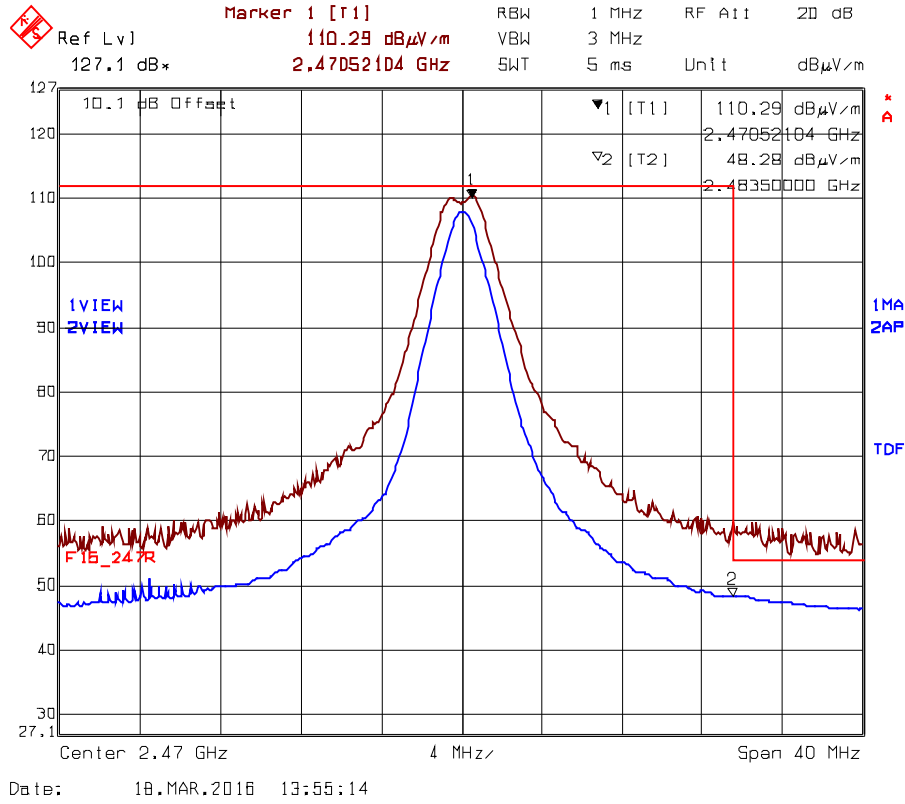

Trace 1: RBW = 1 MHz, VBW = 3 MHz, Trace 2: RBW = 1 MHz, VBW = 10 Hz
 Average level at 2483.5 MHz is 48.28dBμV/m, 100% Duty Cycle can be applied from channel 11 to 24

Plot 5.2.4.3.2.4. Band-Edge RF Radiated Emissions at 3 m, Vertical Polarization
 High End of Frequency Band, Ch24- 2470 MHz, QPSK Modulation, Power 8 Mode 1

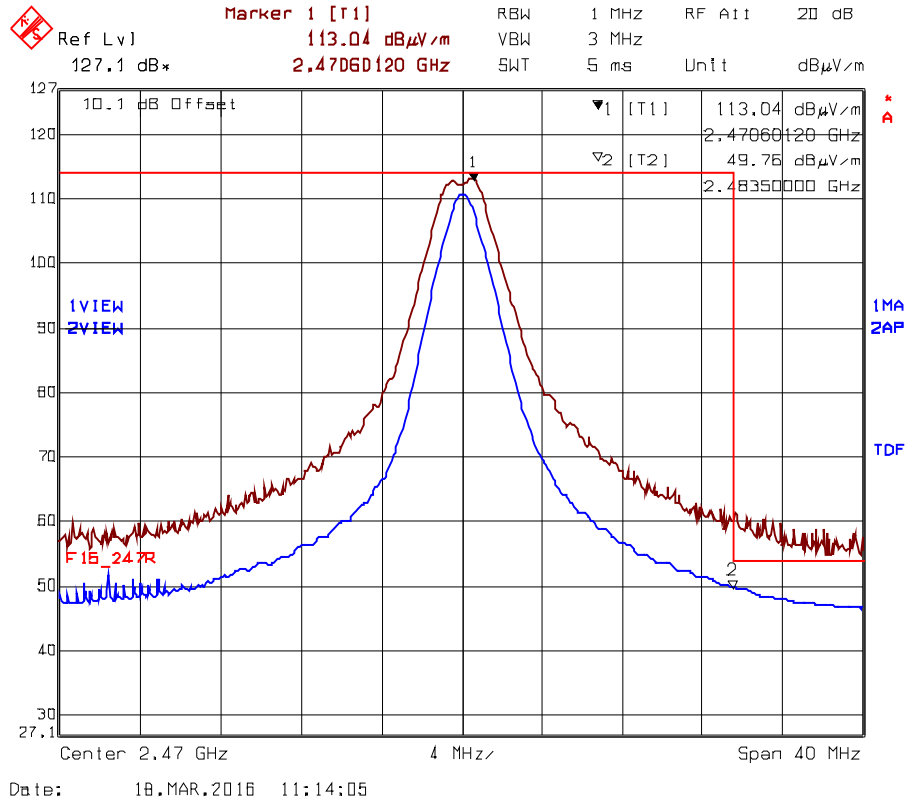

Trace 1: RBW = 1 MHz, VBW = 3 MHz, Trace 2: RBW = 1 MHz, VBW = 10 Hz
 Average level at 2483.5 MHz is 49.76dBμV/m, 100% Duty Cycle can be applied from channel 11 to 24

EUT with 15dBi Omni-Directional Antenna @ 66% Duty Cycle requires 0.42dB Assembly Cable loss

Plot 5.2.4.3.2.5. Band-Edge RF Radiated Emissions at 3 m, Horizontal Polarization
 High End of Frequency Band, Ch25- 2475 MHz, QPSK Modulation, Power 8 Mode 1 @ 66% Duty Cycle

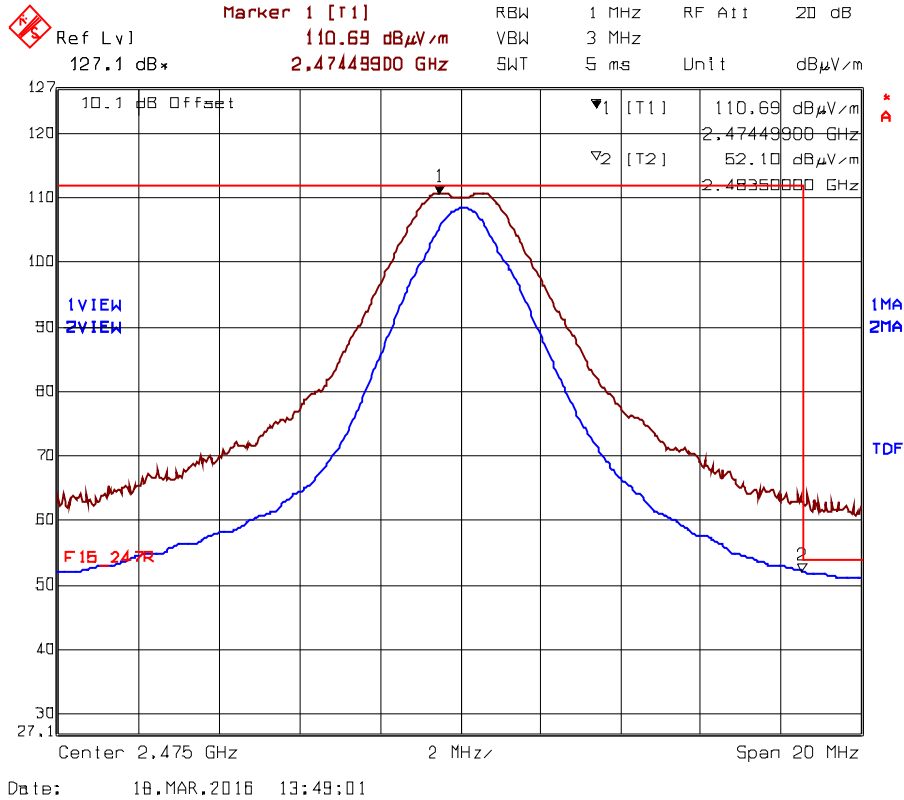

Trace 1: RBW = 1 MHz, VBW = 3 MHz, Trace 2: RBW = 1 MHz, VBW = 10 Hz
 Average level at 2483.5 MHz is 48.49dBµV/m (52.10 - 3.61), Duty cycle is 66% ($20 \cdot \log(0.66) = 3.61\text{dB}$)

Plot 5.2.4.3.2.6. Band-Edge RF Radiated Emissions at 3 m, Vertical Polarization
 High End of Frequency Band, Ch25- 2475 MHz, QPSK Modulation, Power 8 Mode 1@ 66% Duty Cycle

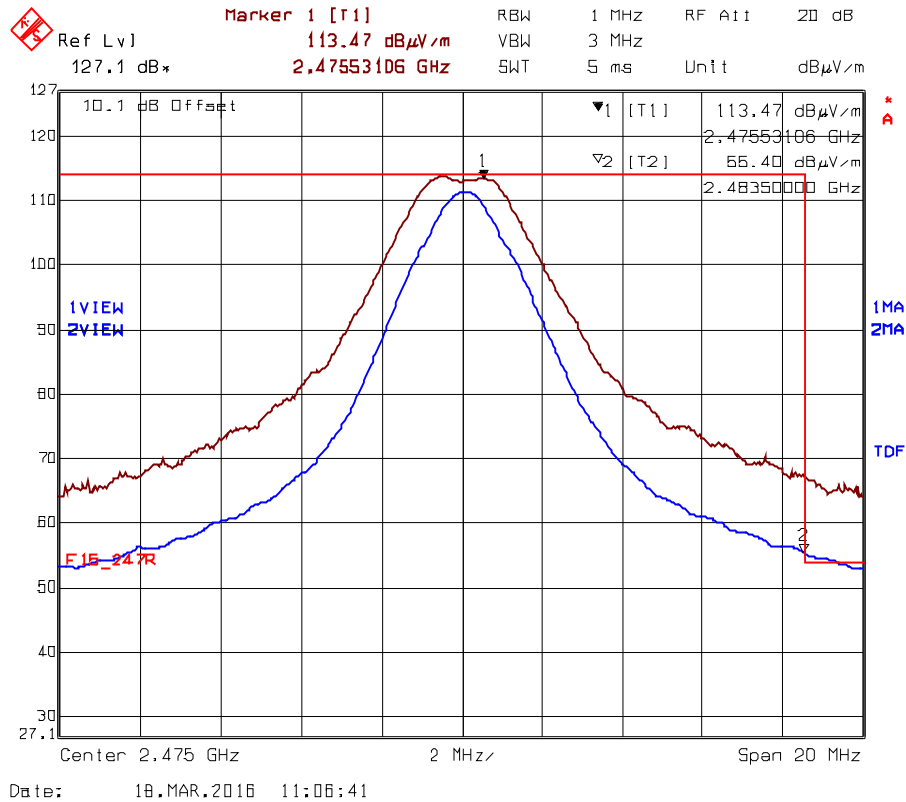

Trace 1: RBW = 1 MHz, VBW = 3 MHz, Trace 2: RBW = 1 MHz, VBW = 10 Hz
 Average level at 2483.5 MHz is 51.79dBμV/m (55.40-3.61), Duty cycle is 66% ($20 \cdot \log(0.66) = 3.61\text{dB}$)

EUT with 15dBi Omni-Directional Antenna @ 66% Duty Cycle requires total 6.42dB Assembly Cable loss

Plot 5.2.4.3.2.7. Band-Edge RF Radiated Emissions at 3 m, Horizontal Polarization
 Highest End of Frequency Band, Ch26- 2480 MHz, QPSK Modulation, Power -4 Mode 1 @ 66% Duty Cycle

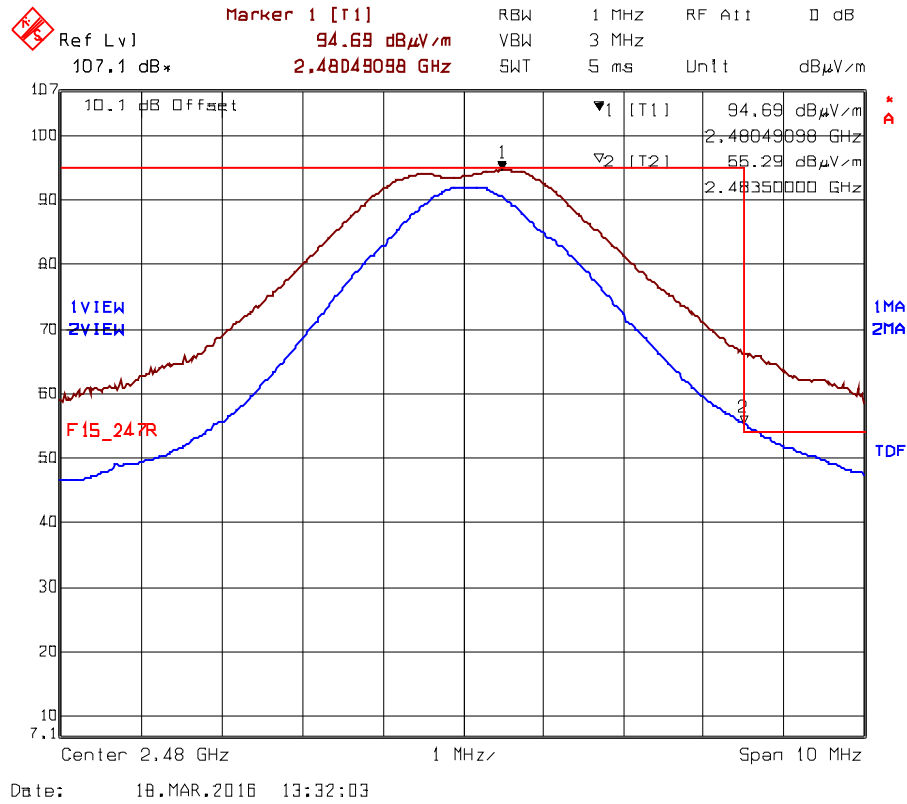

Trace 1: RBW= 1 MHz, VBW= 3 MHz, Trace 2: RBW= 1 MHz, VBW= 10 Hz
 Average level at 2483.5 MHz is 51.68dBµV/m (55.29-3.61), Duty cycle is 66% ($20 \cdot \log(0.66) = 3.61\text{dB}$)

Plot 5.2.4.3.2.8. Band-Edge RF Radiated Emissions at 3 m, Vertical Polarization
 Highest End of Frequency Band, Ch26- 2480 MHz, QPSK Modulation, Power -4 Mode 1 @ 66% Duty Cycle

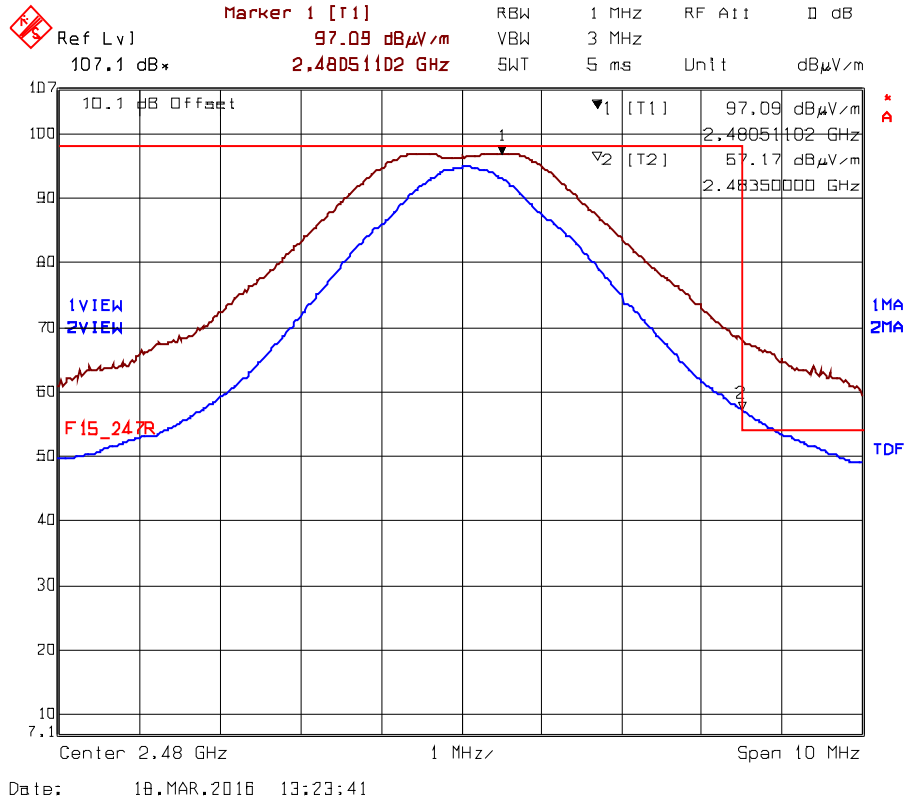

Trace 1: RBW= 1 MHz, VBW= 3 MHz, Trace 2: RBW= 1 MHz, VBW= 10 Hz
 Average level at 2483.5 MHz is 53.56dBμV/m (57.17-3.61), Duty cycle is 66% ($20 \cdot \log(0.66) = 3.61\text{dB}$)

5.2.4.4. EUT with 15.0 dBi Yagi Antenna with 0.42dB Basic Assembly Cable Loss

5.2.4.4.1. Spurious Radiated Emissions

Fundamental Frequency:		2405 MHz					
Power Setting and Operating Mode:		Power 8 Mode 1, QPSK Modulation					
Frequency Test Range:		30 MHz - 25 GHz					
Frequency (MHz)	RF Peak Level (dBµV/m)	RF Avg Level (dBµV/m)	Antenna Plane (H/V)	Limit 15.209 (dBµV/m)	Limit 15.247 (dBµV/m)	Margin (dB)	Pass/Fail
2405	118.62	--	V	--	--	--	--
2405	118.30	--	H	--	--	--	--
4810	58.32	47.95	V	54.0	98.6	-6.0	Pass
4810	55.58	44.41	H	54.0	98.6	-9.6	Pass
All other spurious emissions and harmonics are more than 20 dB below the applicable limit.							

*Field strength of emissions appearing within restricted frequency bands shall not exceed the limits in § 15.209.

Fundamental Frequency:		2440 MHz					
Power Setting and Operating Mode:		Power 8 Mode 1, QPSK Modulation					
Frequency Test Range:		30 MHz - 25 GHz					
Frequency (MHz)	RF Peak Level (dBµV/m)	RF Avg Level (dBµV/m)	Antenna Plane (H/V)	Limit 15.209 (dBµV/m)	Limit 15.247 (dBµV/m)	Margin (dB)	Pass/Fail
2440	118.25	--	V	--	--	--	--
2440	118.17	--	H	--	--	--	--
4880	58.86	47.51	V	54.0	98.3	-6.5	Pass*
4880	55.73	44.64	H	54.0	98.3	-9.4	Pass*
7320	53.88	41.68	V	54.0	98.3	-12.3	Pass*
7320	57.32	46.00	H	54.0	98.3	-8.0	Pass*
All other spurious emissions and harmonics are more than 20 dB below the applicable limit.							

*Field strength of emissions appearing within restricted frequency bands shall not exceed the limits in § 15.209.

Fundamental Frequency:		2475 MHz					
Power Setting and Operating Mode:		Power 8 Mode 1, QPSK Modulation					
Frequency Test Range:		30 MHz - 25 GHz					
Frequency (MHz)	RF Peak Level (dBµV/m)	RF Avg Level (dBµV/m)	Antenna Plane (H/V)	Limit 15.209 (dBµV/m)	Limit 15.247 (dBµV/m)	Margin (dB)	Pass/Fail
2475	114.29	--	V	--	--	--	--
2475	114.04	--	H	--	--	--	--
4950	58.77	48.67	V	54.0	94.3	-5.3	Pass*
4950	55.70	42.98	H	54.0	94.3	-11.0	Pass*
7425	54.65	42.20	V	54.0	94.3	-11.8	Pass*
7425	59.66	48.23	H	54.0	94.3	-5.8	Pass*
All other spurious emissions and harmonics are more than 20 dB below the applicable limit.							

*Field strength of emissions appearing within restricted frequency bands shall not exceed the limits in § 15.209.

5.2.4.4.2. Band-Edge RF Radiated Emissions

Plot 5.2.4.4.2.1. Band-Edge RF Radiated Emissions at 3 m, Horizontal Polarization
 Low End of Frequency Band, Ch11- 2405 MHz, QPSK Modulation, Power 8 Mode 1

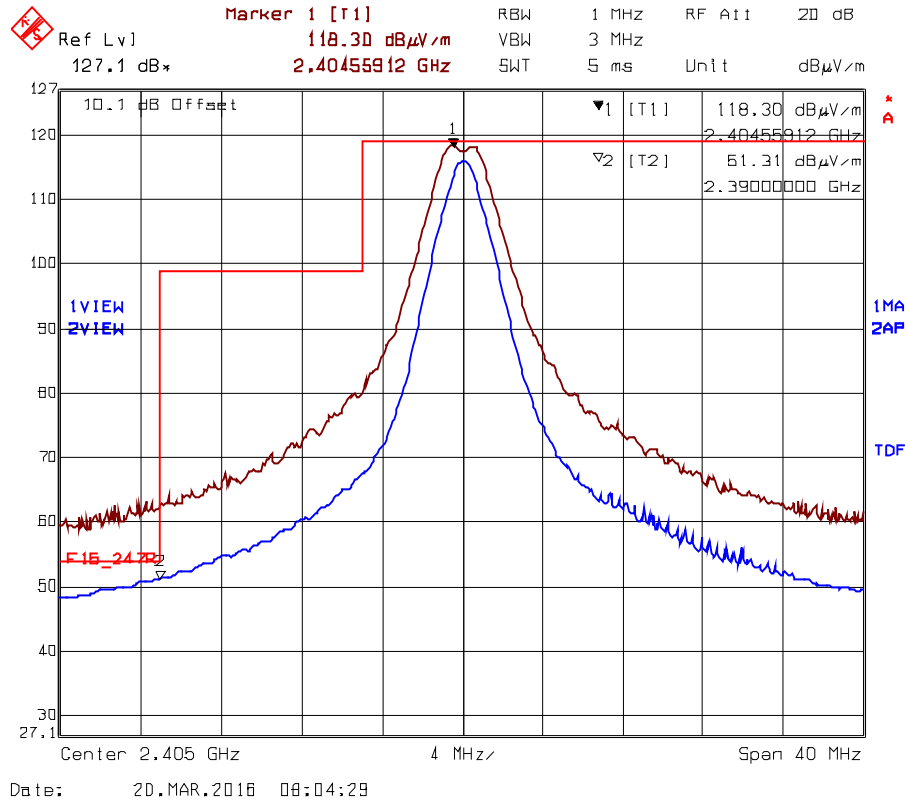

Trace 1: RBW = 1 MHz, VBW = 3 MHz, Trace 2: RBW = 1 MHz, VBW = 10 Hz
 Average level at 2390 MHz is 51.31dBμV/m, 100% Duty Cycle can be applied from channel 11 to 24

Plot 5.2.4.4.2.2. Band-Edge RF Radiated Emissions at 3 m, Vertical Polarization
 Low End of Frequency Band, Ch11- 2405 MHz, QPSK Modulation, Power 8 Mode 1

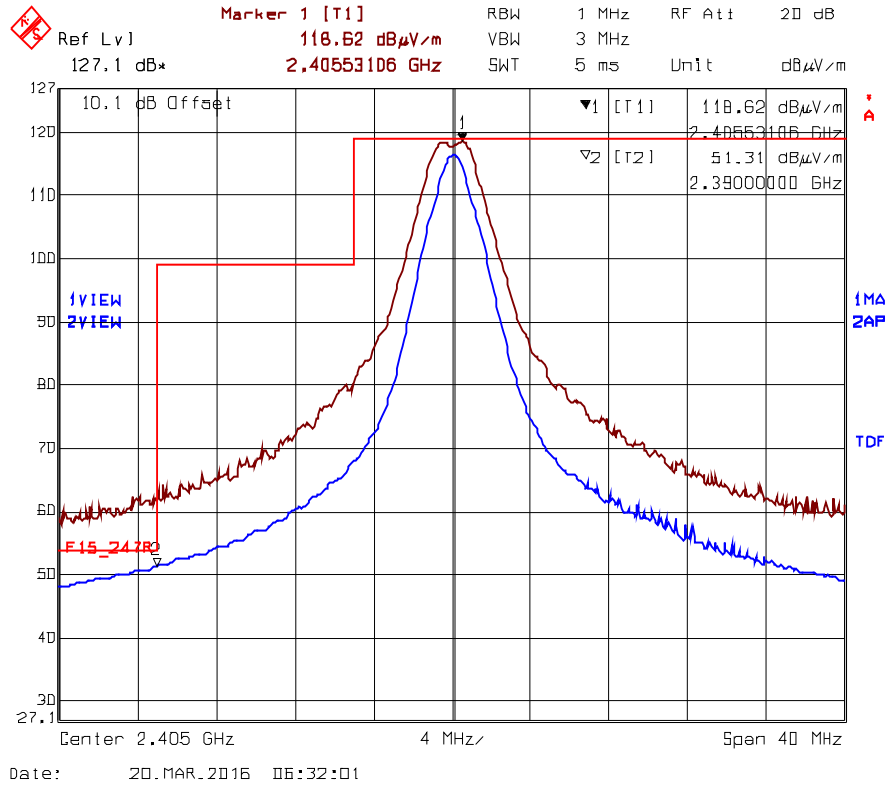

Trace 1: RBW = 1 MHz, VBW = 3 MHz, Trace 2: RBW = 1 MHz, VBW = 10 Hz
 Average level at 2390 MHz is 51.31dBμV/m, 100% Duty Cycle can be applied from channel 11 to 24

Plot 5.2.4.4.2.3. Band-Edge RF Radiated Emissions at 3 m, Horizontal Polarization
 High End of Frequency Band, Ch24- 2470 MHz, QPSK Modulation, Power 8 Mode 1

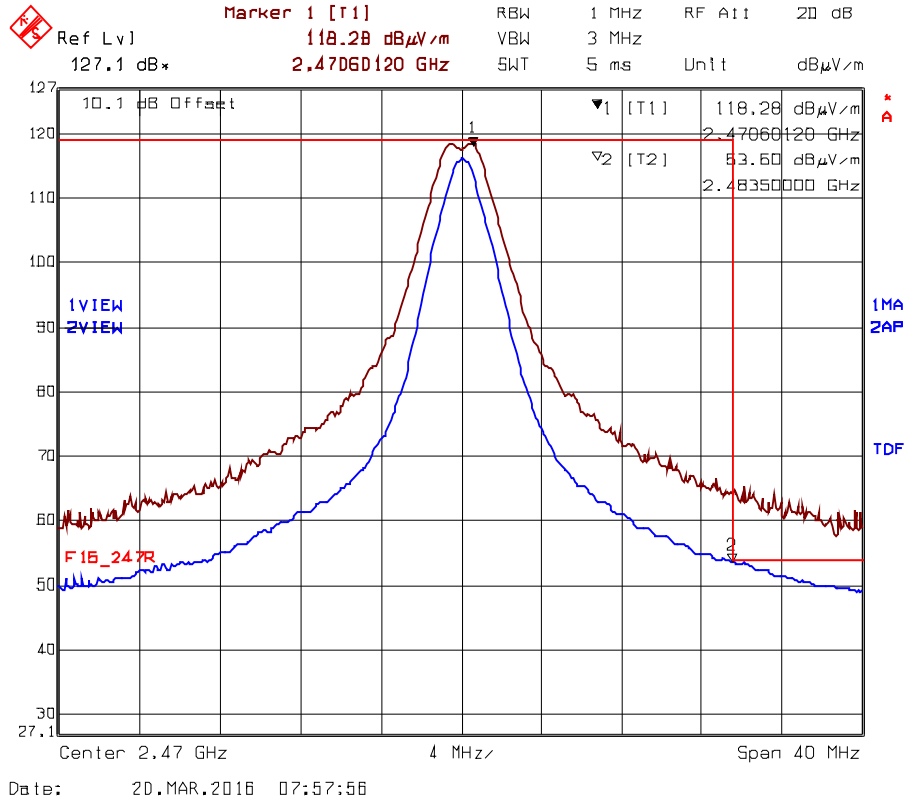

Trace 1: RBW = 1 MHz, VBW = 3 MHz, Trace 2: RBW = 1 MHz, VBW = 10 Hz
 Average level at 2483.5 MHz is 53.60dBμV/m, 100% Duty Cycle can be applied from channel 11 to 24

Plot 5.2.4.4.2.4. Band-Edge RF Radiated Emissions at 3 m, Vertical Polarization
 High End of Frequency Band, Ch24- 2470 MHz, QPSK Modulation, Power 8 Mode 1

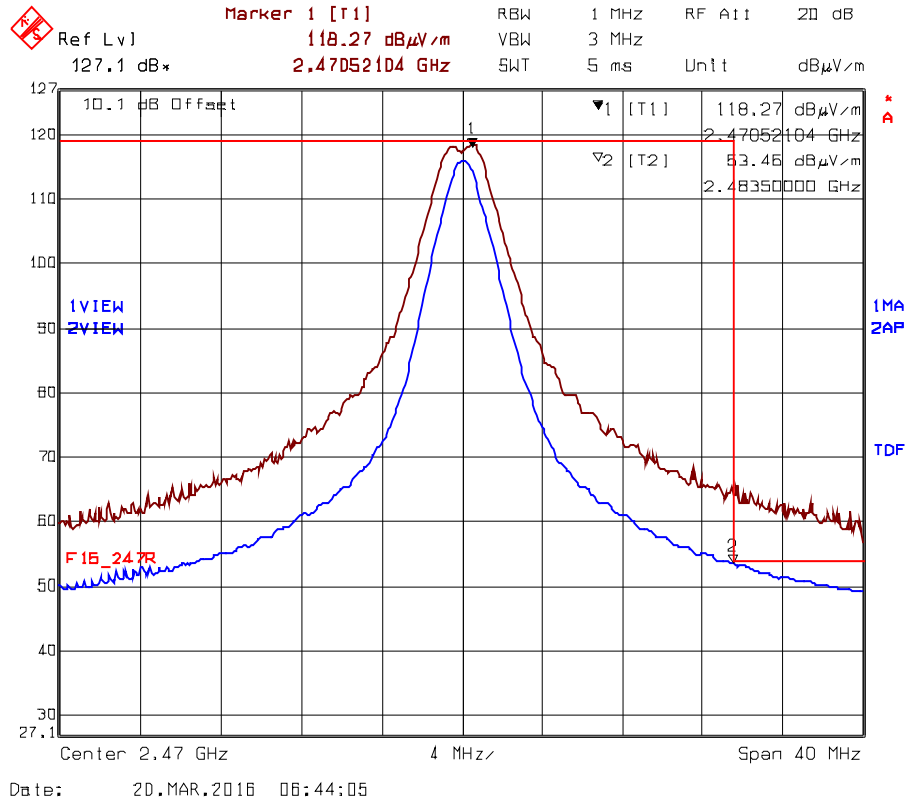

Trace 1: RBW = 1 MHz, VBW = 3 MHz, Trace 2: RBW = 1 MHz, VBW = 10 Hz
 Average level at 2483.5 MHz is 53.46dBμV/m, 100% Duty Cycle can be applied from channel 11 to 24

EUT with 15dBi Yagi Antenna @ 66% Duty Cycle requires total 5.42dB Assembly Cable loss

Plot 5.2.4.4.2.5. Band-Edge RF Radiated Emissions at 3 m, Horizontal Polarization
 Higher End of Frequency Band, Ch25- 2475 MHz, QPSK Modulation, Power 8 Mode 1 @ 66% Duty Cycle

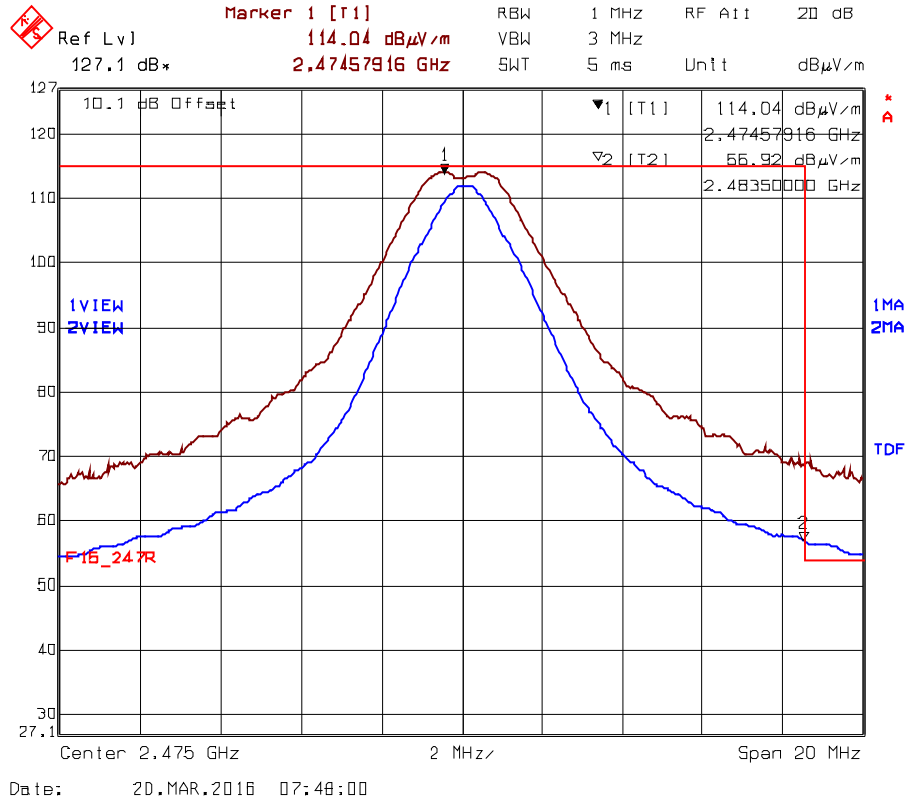

Trace 1: RBW= 1 MHz, VBW= 3 MHz, Trace 2: RBW= 1 MHz, VBW= 10 Hz
 Average level at 2483.5 MHz is 53.36dBµV/m (56.97-3.61), Duty cycle is 66% ($20 \cdot \log(0.66) = 3.61\text{dB}$)

Plot 5.2.4.4.2.6. Band-Edge RF Radiated Emissions at 3 m, Vertical Polarization
Higher End of Frequency Band, Ch25- 2475 MHz, QPSK Modulation, Power 8 Mode 1 @ 66% Duty Cycle

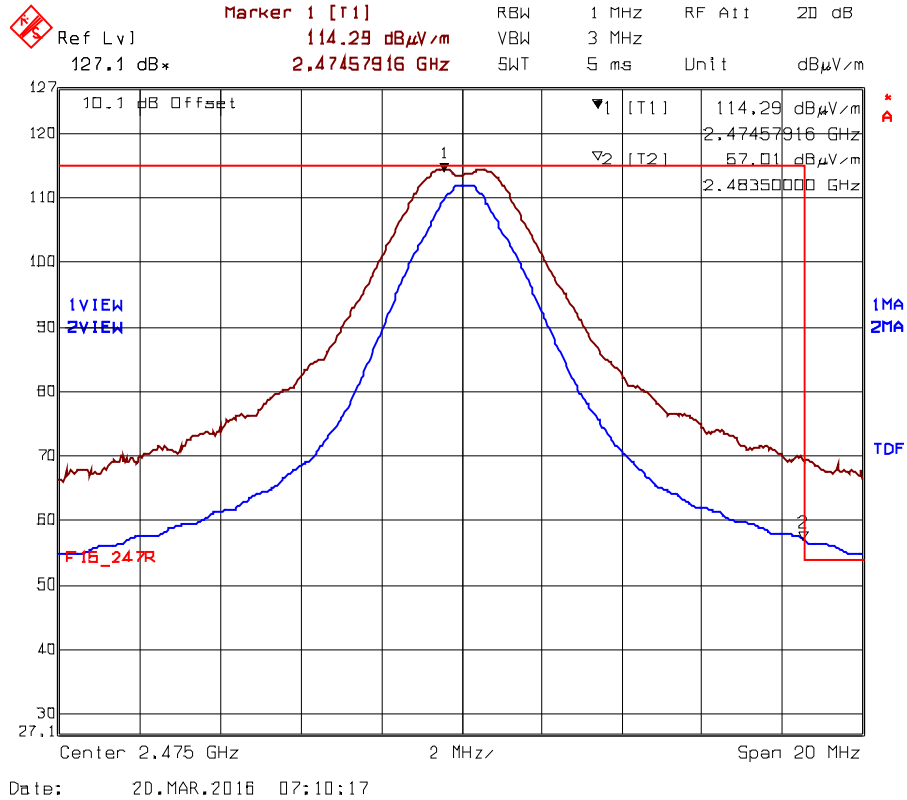

Trace 1: RBW= 1 MHz, VBW= 3 MHz, Trace 2: RBW= 1 MHz, VBW= 10 Hz
Average level at 2483.5 MHz is 53.40dBμV/m (57.01-3.61), Duty cycle is 66% ($20 \cdot \log(0.66) = 3.61\text{dB}$)

EUT with 15dBi Yagi Antenna @ 66% Duty Cycle requires total 10.92dB Assembly Cable loss

Plot 5.2.4.4.2.7. Band-Edge RF Radiated Emissions at 3 m, Horizontal Polarization
 Highest End of Frequency Band, Ch26- 2480 MHz, QPSK Modulation, Power -4 Mode 1 @ 66% Duty Cycle

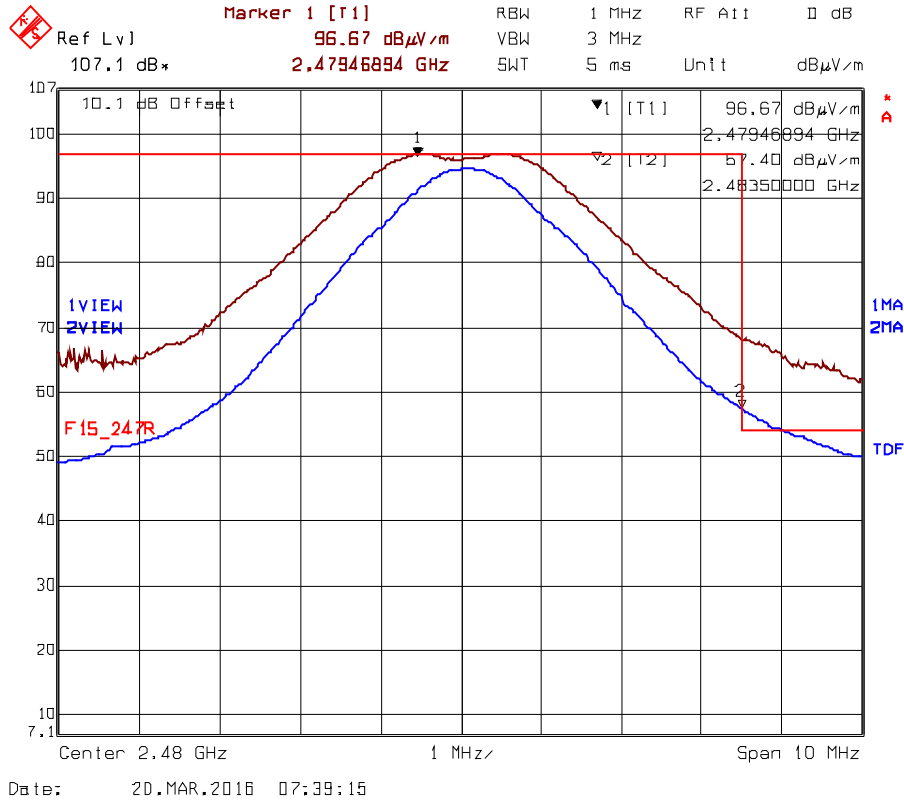

Trace 1: RBW= 1 MHz, VBW= 3 MHz, Trace 2: RBW= 1 MHz, VBW= 10 Hz
 Average level at 2483.5 MHz is 53.79dBμV/m (57.40-3.61), Duty cycle is 66% ($20 \cdot \log(0.66) = 3.61\text{dB}$)

Plot 5.2.4.4.2.8. Band-Edge RF Radiated Emissions at 3 m, Vertical Polarization
 Highest End of Frequency Band, Ch26- 2480 MHz, QPSK Modulation, Power -4 Mode 1 @ 66% Duty Cycle

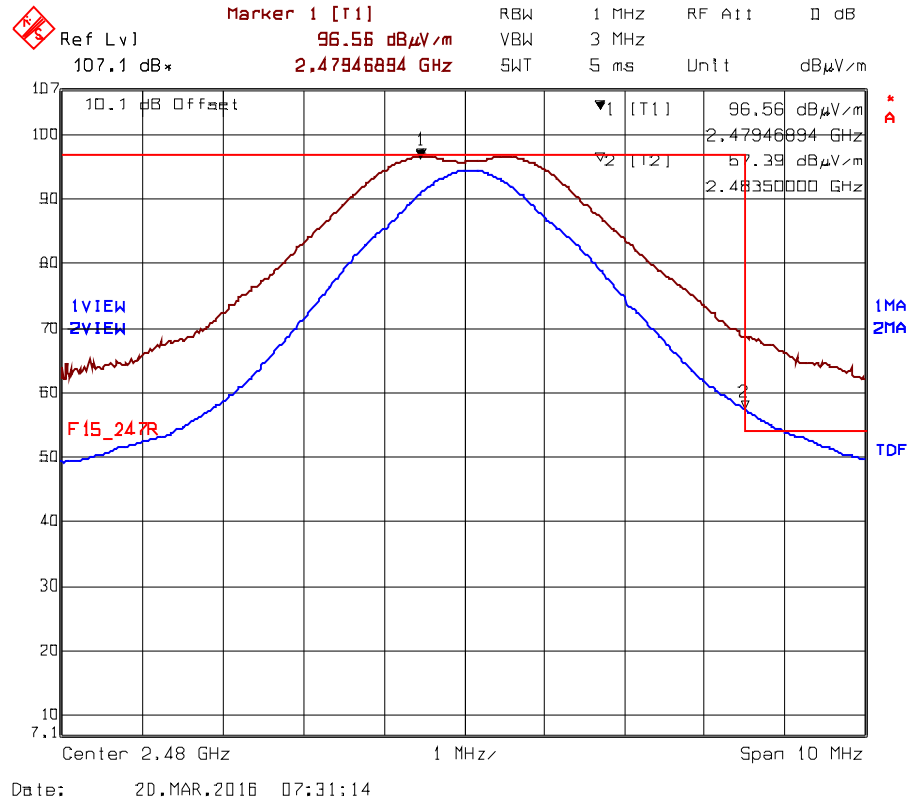

Trace 1: RBW= 1 MHz, VBW= 3 MHz, Trace 2: RBW= 1 MHz, VBW= 10 Hz
 Average level at 2483.5 MHz is 53.78dBμV/m (57.39-3.61), Duty cycle is 66% ($20 \cdot \log(0.66) = 3.61\text{dB}$)

5.2.4.5. EUT with 19.0 dBi Flat Panel Antenna with 0.42dB Basic Assembly Cable Loss

5.2.4.5.1. Spurious Radiated Emissions

Fundamental Frequency:		2405 MHz					
Power Setting and Operating Mode:		Power 8 Mode 1, QPSK Modulation					
Frequency Test Range:		30 MHz - 25 GHz					
Frequency (MHz)	RF Peak Level (dBµV/m)	RF Avg Level (dBµV/m)	Antenna Plane (H/V)	Limit 15.209 (dBµV/m)	Limit 15.247 (dBµV/m)	Margin (dB)	Pass/Fail
2405	122.93	--	V	--	--	--	--
2405	122.62	--	H	--	--	--	--
4810	55.36	44.42	V	54.0	102.9	-9.6	Pass
4810	54.99	44.84	H	54.0	102.9	-9.2	Pass
All other spurious emissions and harmonics are more than 20 dB below the applicable limit.							

*Field strength of emissions appearing within restricted frequency bands shall not exceed the limits in § 15.209.

Fundamental Frequency:		2440 MHz					
Power Setting and Operating Mode:		Power 8 Mode 1, QPSK Modulation					
Frequency Test Range:		30 MHz - 25 GHz					
Frequency (MHz)	RF Peak Level (dBµV/m)	RF Avg Level (dBµV/m)	Antenna Plane (H/V)	Limit 15.209 (dBµV/m)	Limit 15.247 (dBµV/m)	Margin (dB)	Pass/Fail
2440	122.88	--	V	--	--	--	--
2440	122.95	--	H	--	--	--	--
4880	55.88	46.44	V	54.0	103.0	-7.6	Pass*
4880	57.36	46.86	H	54.0	103.0	-7.1	Pass*
7320	55.85	44.51	V	54.0	103.0	-9.5	Pass*
7320	56.23	45.14	H	54.0	103.0	-8.9	Pass*
All other spurious emissions and harmonics are more than 20 dB below the applicable limit.							

*Field strength of emissions appearing within restricted frequency bands shall not exceed the limits in § 15.209.

Fundamental Frequency:		2475 MHz					
Power Setting and Operating Mode:		Power 8 Mode 1, QPSK Modulation					
Frequency Test Range:		30 MHz - 25 GHz					
Frequency (MHz)	RF Peak Level (dBµV/m)	RF Avg Level (dBµV/m)	Antenna Plane (H/V)	Limit 15.209 (dBµV/m)	Limit 15.247 (dBµV/m)	Margin (dB)	Pass/Fail
2475	114.29	--	V	--	--	--	--
2475	114.54	--	H	--	--	--	--
4950	55.42	45.22	V	54.0	94.5	-8.8	Pass*
4950	55.36	45.39	H	54.0	94.5	-8.6	Pass*
7425	55.86	44.16	V	54.0	94.5	-9.8	Pass*
7425	57.25	46.25	H	54.0	94.5	-7.7	Pass*
All other spurious emissions and harmonics are more than 20 dB below the applicable limit.							

*Field strength of emissions appearing within restricted frequency bands shall not exceed the limits in § 15.209.

5.2.4.5.2. Band-Edge RF Radiated Emissions

EUT with 19dBi Flat-Panel Antenna @ 66% Duty Cycle for Ch11, 2405 MHz

Plot 5.2.4.5.2.1. Band-Edge RF Radiated Emissions at 3 m, Horizontal Polarization
 Low End of Frequency Band, Ch11- 2405 MHz, QPSK Modulation, Power 8 Mode 1 @ 66% Duty Cycle

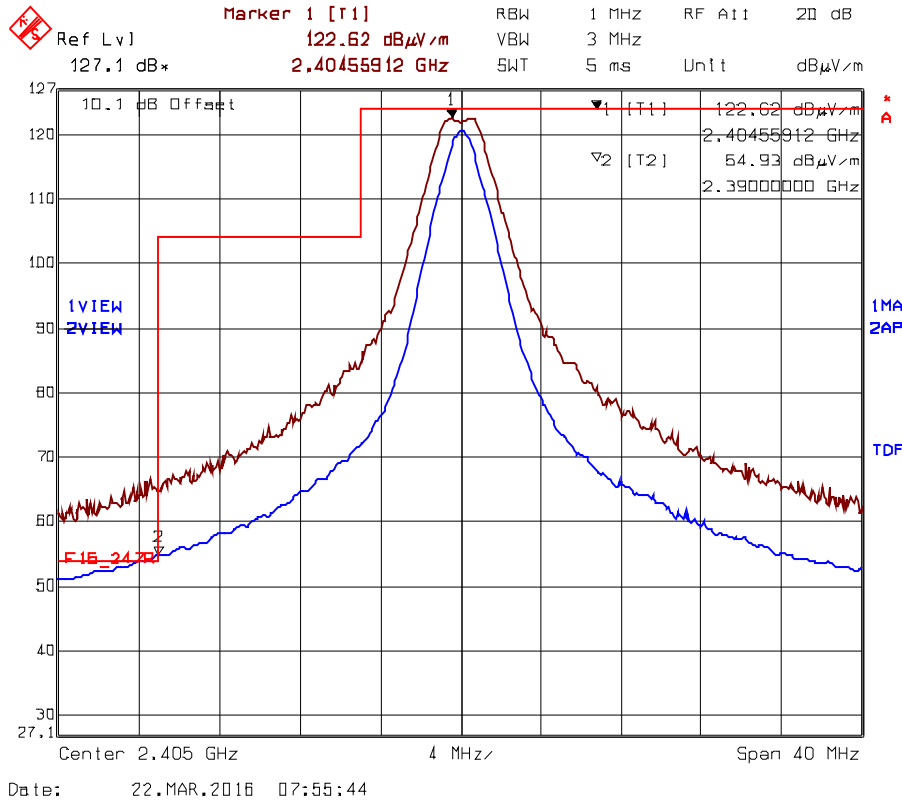

Trace 1: RBW = 1 MHz, VBW = 3 MHz, Trace 2: RBW = 1 MHz, VBW = 10 Hz
 Average level at 2390 MHz is 51.32dBμV/m (54.93-3.61), Duty cycle is 66% ($20 \cdot \log(0.66) = 3.61\text{dB}$)

Plot 5.2.4.5.2.2. Band-Edge RF Radiated Emissions at 3 m, Vertical Polarization
 Low End of Frequency Band, Ch11- 2405 MHz, QPSK Modulation, Power 8 Mode 1 @ 66% Duty Cycle

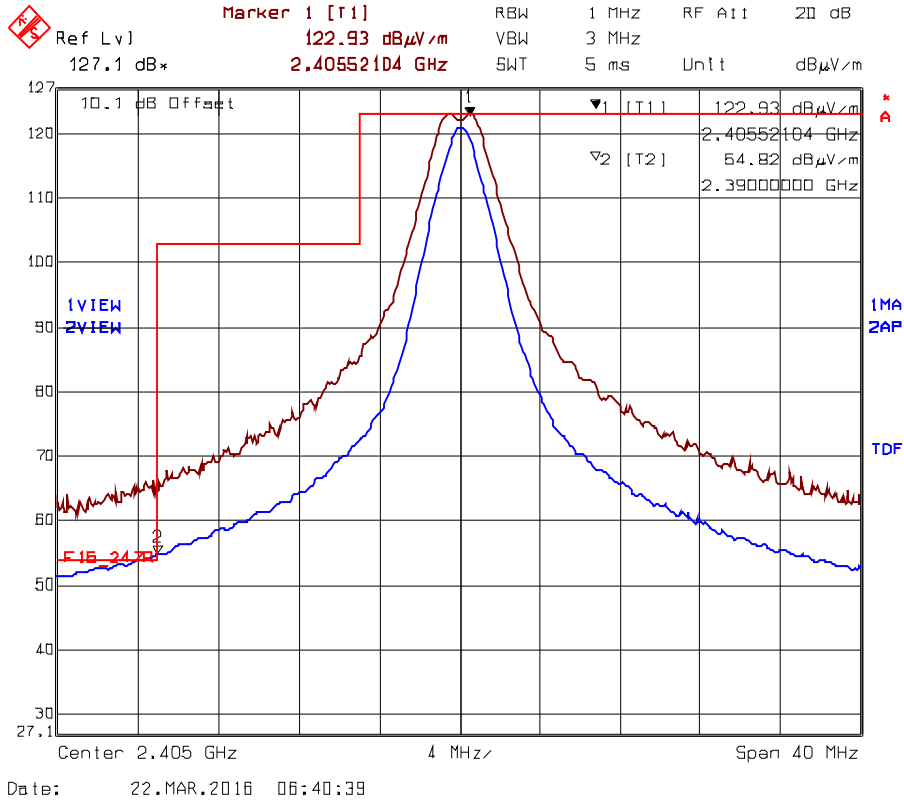

Trace 1: RBW = 1 MHz, VBW = 3 MHz, Trace 2: RBW = 1 MHz, VBW = 10 Hz
 Average level at 2390 MHz is 51.21dBµV/m (54.82-3.61), Duty cycle is 66% (20*log(0.66)= 3.61dB)

EUT with 19dBi Flat-Panel Antenna @ 66% Duty Cycle for Ch24, 2470 MHz

Plot 5.2.4.5.2.3. Band-Edge RF Radiated Emissions at 3 m, Horizontal Polarization
 High End of Frequency Band, Ch24- 2470 MHz, QPSK Modulation, Power 8 Mode 1 @ 66% Duty Cycle

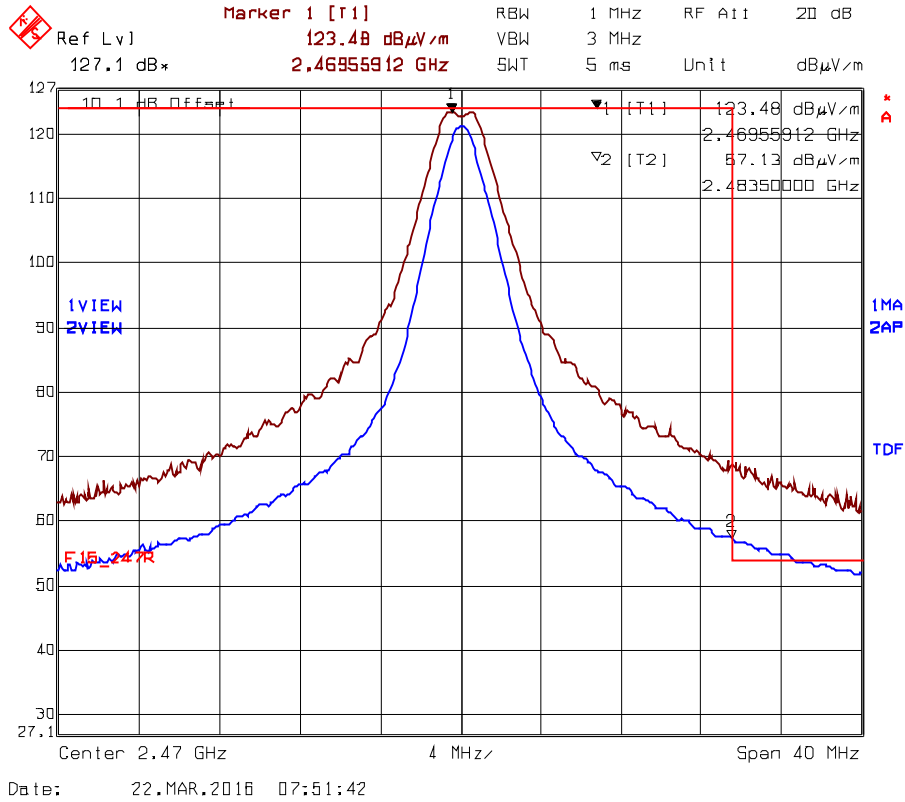

Trace 1: RBW = 1 MHz, VBW = 3 MHz, Trace 2: RBW = 1 MHz, VBW = 10 Hz
 Average level at 2483.5 MHz is 53.52dBμV/m (57.13-3.61), Duty cycle is 66% ($20 \cdot \log(0.66) = 3.61\text{dB}$)

Plot 5.2.4.5.2.4. Band-Edge RF Radiated Emissions at 3 m, Vertical Polarization
 High End of Frequency Band, Ch24- 2470 MHz, QPSK Modulation, Power 8 Mode 1 @ 66% Duty Cycle

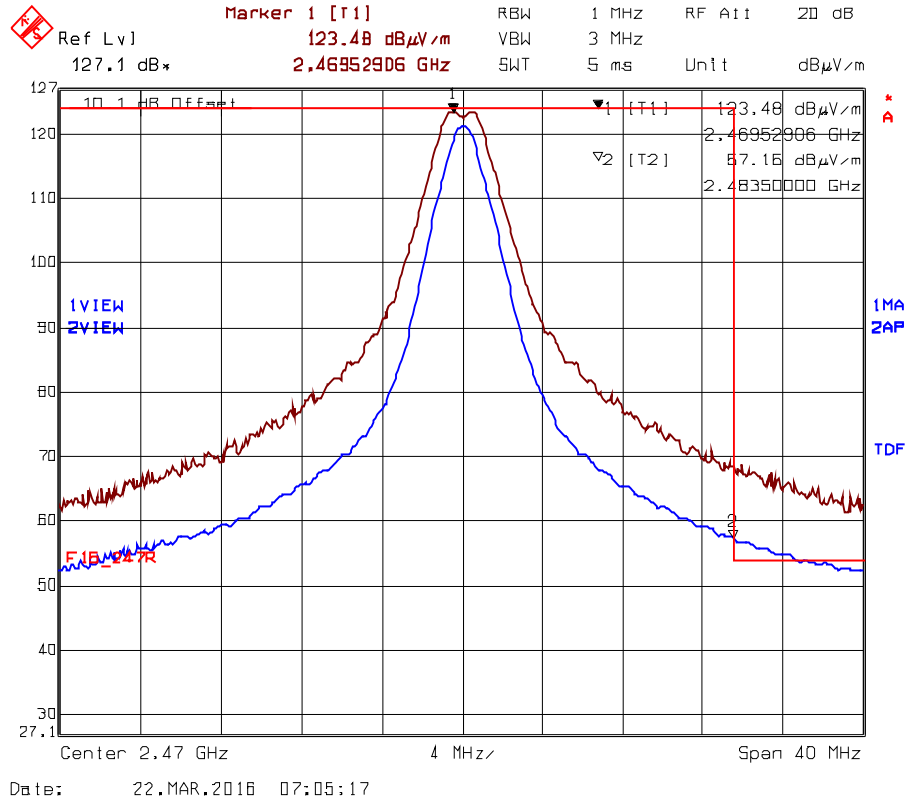

Trace 1: RBW = 1 MHz, VBW = 3 MHz, Trace 2: RBW = 1 MHz, VBW = 10 Hz
 Average level at 2483.5 MHz is 53.55dBμV/m (57.16-3.61), Duty cycle is 66% (20*log(0.66)= 3.61dB)

EUT with 15dBi Flat-Panel Antenna @ 66% Duty Cycle requires 9.42dB Assembly Cable loss

Plot 5.2.4.5.2.5. Band-Edge RF Radiated Emissions at 3 m, Horizontal Polarization
 Higher End of Frequency Band, Ch25- 2475 MHz, QPSK Modulation, Power 8 Mode 1 @ 66% Duty Cycle

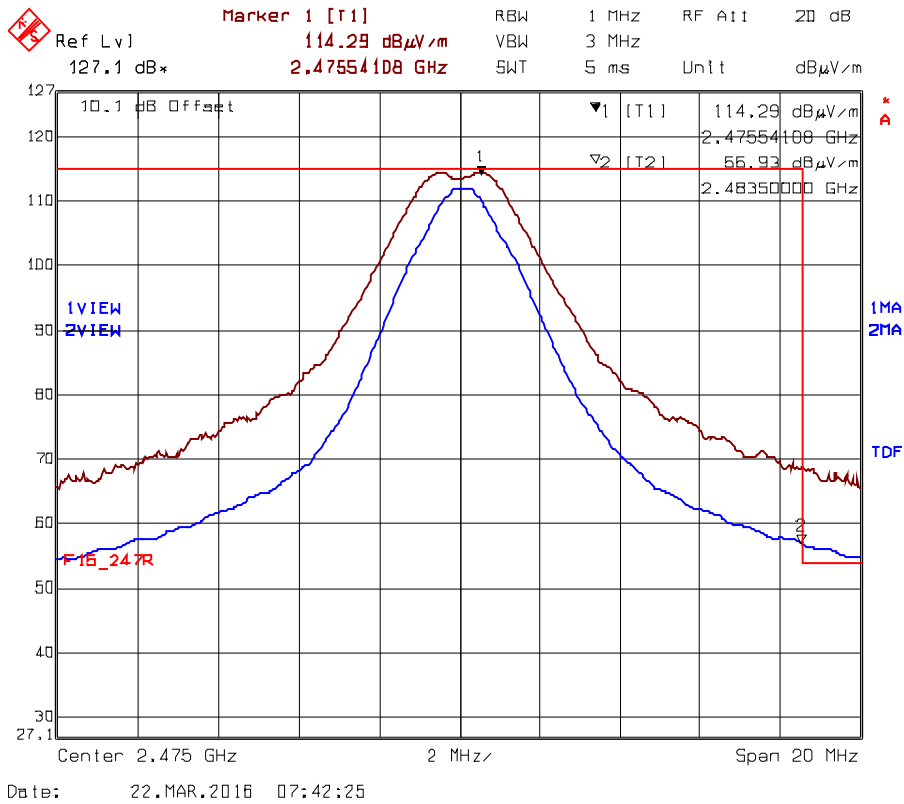

Trace 1: RBW= 1 MHz, VBW= 3 MHz, Trace 2: RBW= 1 MHz, VBW= 10 Hz
 Average level at 2483.5 MHz is 53.32dBµV/m (56.93-3.61), Duty cycle is 66% ($20 \cdot \log(0.66) = 3.61\text{dB}$)

Plot 5.2.4.5.2.6. Band-Edge RF Radiated Emissions at 3 m, Vertical Polarization
 Higher End of Frequency Band, Ch25- 2475 MHz, QPSK Modulation, Power 8 Mode 1 @ 66% Duty Cycle

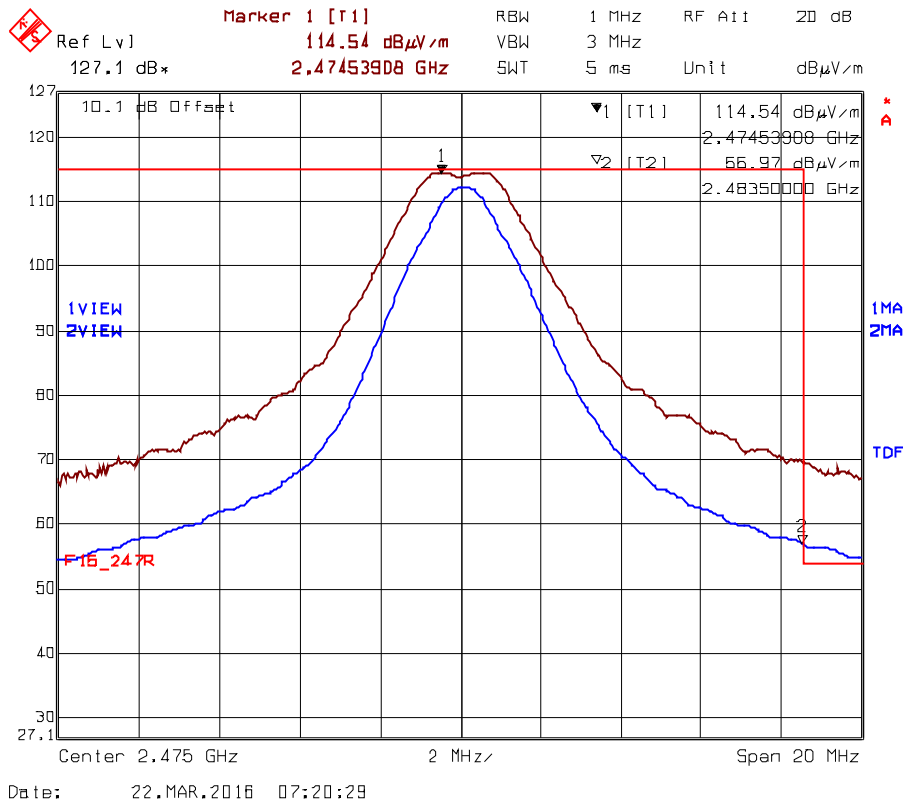

Trace 1: RBW= 1 MHz, VBW= 3 MHz, Trace 2: RBW= 1 MHz, VBW= 10 Hz
 Average level at 2483.5 MHz is 53.36dBµV/m (56.97-3.61), Duty cycle is 66% ($20 \cdot \log(0.66) = 3.61\text{dB}$)

EUT with 19dBi Flat-Panel Antenna @ 66% Duty Cycle requires total 15.42dB Assembly Cable loss

Plot 5.2.4.5.2.7. Band-Edge RF Radiated Emissions at 3 m, Horizontal Polarization
 Highest End of Frequency Band, Ch26- 2480 MHz, QPSK Modulation, Power -4 Mode 1 @ 66% Duty Cycle

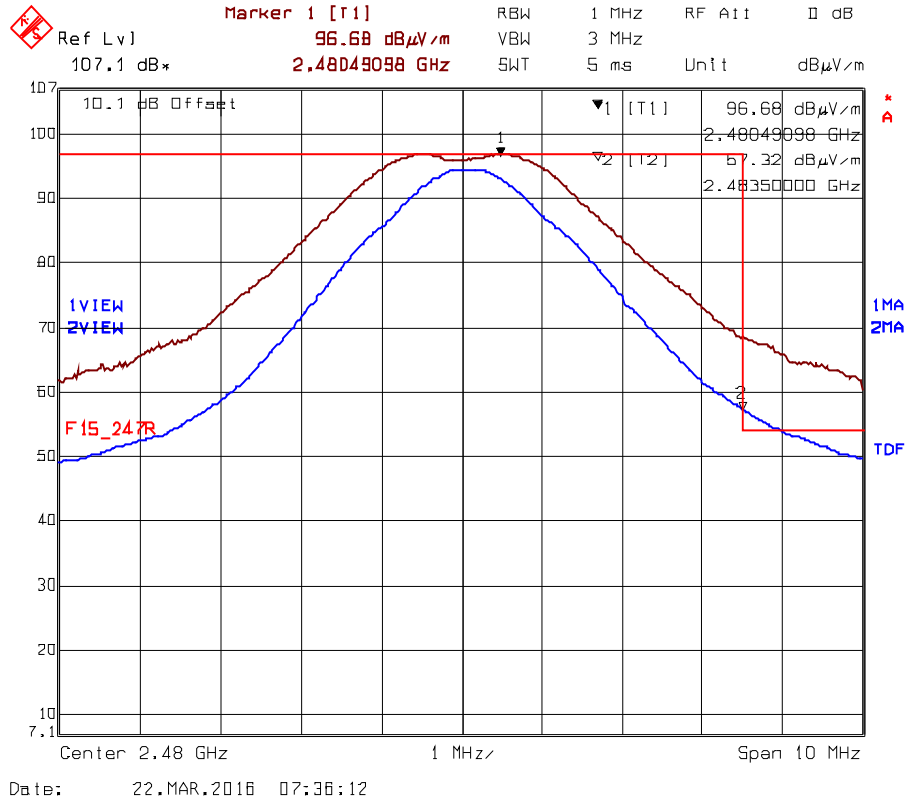

Trace 1: RBW= 1 MHz, VBW= 3 MHz, Trace 2: RBW= 1 MHz, VBW= 10 Hz
 Average level at 2483.5 MHz is 53.71dBμV/m (57.32-3.61), Duty cycle is 66% ($20 \cdot \log(0.66) = 3.61\text{dB}$)

Plot 5.2.4.5.2.8. Band-Edge RF Radiated Emissions at 3 m, Vertical Polarization
 Highest End of Frequency Band, Ch26- 2480 MHz, QPSK Modulation, Power -4 Mode 1 @ 66% Duty Cycle

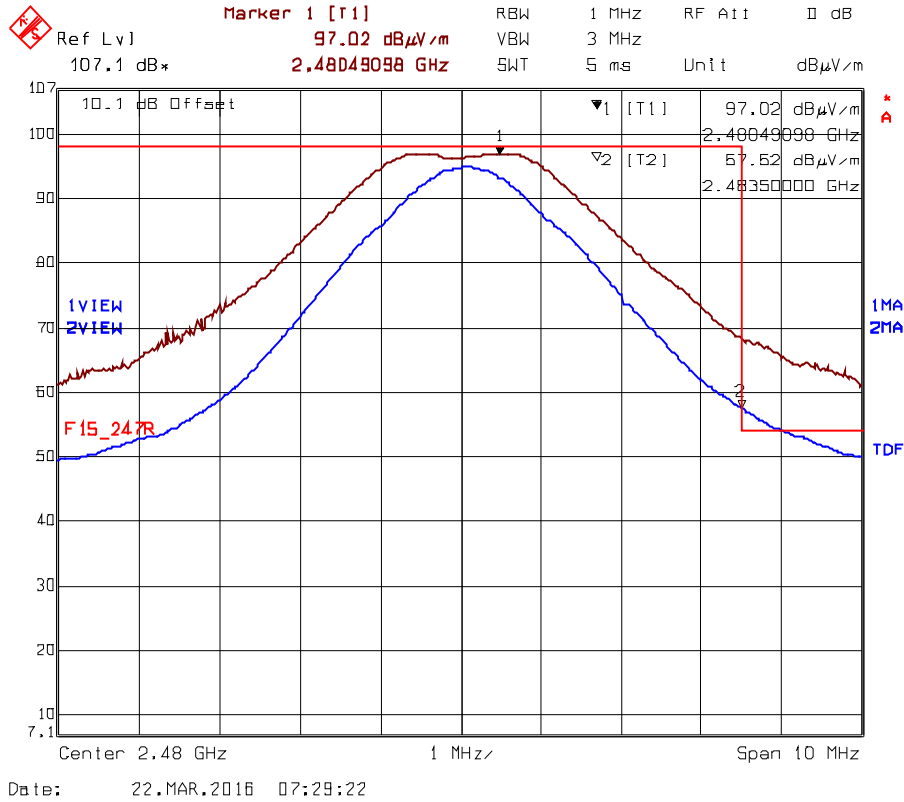

Trace 1: RBW= 1 MHz, VBW= 3 MHz, Trace 2: RBW= 1 MHz, VBW= 10 Hz
 Average level at 2483.5 MHz is 53.91dBμV/m (57.52-3.61), Duty cycle is 66% ($20 \cdot \log(0.66) = 3.61\text{dB}$)

5.3. RF EXPOSURE REQUIRMENTS [§§ 15.247(e)(i), 1.1310 & 2.1091]

The criteria listed in the following table shall be used to evaluate the environmental impact of human exposure to radio-frequency (RF) radiation.

FCC 47 CFR § 1.1310:

TABLE 1—LIMITS FOR MAXIMUM PERMISSIBLE EXPOSURE (MPE)

Frequency range (MHz)	Electric field strength (V/m)	Magnetic field strength (A/m)	Power density (mW/cm ²)	Averaging time (minutes)
(A) Limits for Occupational/Controlled Exposures				
0.3–3.0	614	1.63	*(100)	6
3.0–30	1842/f	4.89/f	*(900/f ²)	6
30–300	61.4	0.163	1.0	6
300–1500	f/300	6
1500–100,000	5	6
(B) Limits for General Population/Uncontrolled Exposure				
0.3–1.34	614	1.63	*(100)	30
1.34–30	824/f	2.19/f	*(180/f ²)	30
30–300	27.5	0.073	0.2	30
300–1500	f/1500	30
1500–100,000	1.0	30

f = frequency in MHz

* = Plane-wave equivalent power density

NOTE 1 TO TABLE 1: Occupational/controlled limits apply in situations in which persons are exposed as a consequence of their employment provided those persons are fully aware of the potential for exposure and can exercise control over their exposure. Limits for occupational/controlled exposure also apply in situations when an individual is transient through a location where occupational/controlled limits apply provided he or she is made aware of the potential for exposure.

NOTE 2 TO TABLE 1: General population/uncontrolled exposures apply in situations in which the general public may be exposed, or in which persons that are exposed as a consequence of their employment may not be fully aware of the potential for exposure or can not exercise control over their exposure.

5.3.1. Method of Measurements

Refer to Sections 1.1310, 2.1091

In order to demonstrate compliance with MPE requirements (see Section 2.1091), the following information is typically needed:

- (1) Calculation that estimates the minimum separation distance (20 cm or more) between an antenna and persons required to satisfy power density limits defined for free space.
- (2) Antenna installation and device operating instructions for installers (professional/unskilled users), and the parties responsible for ensuring compliance with the RF exposure requirement
- (3) Any caution statements and/or warning labels that are necessary in order to comply with the exposure limits
- (4) Any other RF exposure related issues that may affect MPE compliance

Calculation Method of RF Safety Distance:

$$S = \frac{P \cdot G}{4 \cdot \pi \cdot r^2} = \frac{EIRP}{4 \cdot \pi \cdot r^2}$$

Where: P: power input to the antenna in mW
 EIRP: Equivalent (effective) isotropic radiated power
 S: power density mW/cm²
 G: numeric gain of antenna relative to isotropic radiator
 r: distance to centre of radiation in cm

$$r = \sqrt{\frac{P \cdot G}{4 \cdot \pi \cdot S}} = \sqrt{\frac{EIRP}{4 \cdot \pi \cdot S}}$$

5.3.2. RF Evaluation

Evaluation of RF Exposure Compliance Requirements	
RF Exposure Requirements	Compliance with FCC Rules
Minimum calculated separation distance between antenna and persons required: *5.62 cm	Manufacturer' instruction for separation distance between antenna and persons required: 20 cm
Antenna installation and device operating instructions for installers (professional/unskilled users), and the parties responsible for ensuring compliance with the RF exposure requirement	Antenna installation and device operating instructions shall be provided to installers to maintain and ensure compliance with RF exposure requirements.
Caution statements and/or warning labels that are necessary in order to comply with the exposure limits	Refer to user's manual for RF exposure Information.
Any other RF exposure related issues that may affect MPE compliance	None

*The minimum separation distance between the antenna and bodies of users are calculated using the following formula:

$$r = \sqrt{\frac{P \cdot G}{4 \cdot \pi \cdot S}} = \sqrt{\frac{EIRP}{4 \cdot \pi \cdot S}}$$

S = 1.0 mW/cm²

EIRP = 26 dBm = 10^(26/10) mW = 398.1 mW (Worst Case)

$$\text{(Minimum Safe Distance, r)} = \sqrt{\frac{EIRP}{4 \cdot \pi \cdot S}} = \sqrt{\frac{398.1}{4 \cdot \pi \cdot (1.0)}} \approx 5.62\text{cm}$$

EXHIBIT 6. TEST EQUIPMENT LIST

Test Instruments	Manufacturer	Model No.	Serial No.	Frequency Range	Cal. Due Date
Signal Generator	Hewlett Packard	8648C	3443U00391	0.1 – 3200 MHz	02 Feb 2017
Spectrum Analyzer	Rohde & Schwarz	FSEK30	100077	20Hz–40 GHz	21 Nov 2016
RF Amplifier	Hewlett Packard	84498	3008A00769	1 – 26.5 GHz	20 Aug 2016
Band Reject Filter	Micro-Tronics	BRM50701	105	Cut off 2.4-2.483 GHz	Cal on use
DC Block	Hewlett Packard	11742A	12460	0.045–26.5 GHz	Cal on use
DC Power Supply	Xantrex	HPD 60-5SX	63903	0.1 – 60 Vdc	Cal on use
High Pass Filter	K & L	11SH10- 4000/T12000	4	Cut off 2400 MHz	Cal on use
EMI Receiver	Rohde & Schwarz	ESU40	100037	20Hz–40 GHz	08 May 2017
RF Amplifier	Com-Power	PAM-0118A	551052	0.5 – 18 GHz	13 Jul 2016
Biconi-Log Antenna	EMCO	3142C	26873	0.026 – 3 GHz	14 Apr 2016
Horn Antenna	Emco	3155	6570	1 – 18 GHz	11 Sep 2016
Horn Antenna	Emco	3160-09	118385	18 – 26.5 GHz	04 Aug 2016
Attenuator	Pasternack	7024-10	3	DC–26.5 GHz	Cal on use
Attenuator	Pasternack	7024-20	6	DC–26.5 GHz	Cal on use

ULTRATECH GROUP OF LABS

3000 Bristol Circle, Oakville, Ontario, Canada L6H 6G4
 Tel. #: 905-829-1570, Fax. #: 905-829-8050, Email: vic@ultratech-labs.com, Website: <http://www.ultratech-labs.com>

File #: 16DIG112_FCC15C247
 April 08, 2016

All test results contained in this engineering test report are traceable to National Institute of Standards and Technology (NIST)

EXHIBIT 7. MEASUREMENT UNCERTAINTY

The measurement uncertainties stated were calculated in accordance with the requirements of CISPR 16-4-2 @ IEC:2003 and JCGM 100:2008 (GUM 1995) – Guide to the Expression of Uncertainty in Measurement.

7.1. RADIATED EMISSION MEASUREMENT UNCERTAINTY

	Radiated Emission Measurement Uncertainty @ 3m, Horizontal (30-1000 MHz):	Measured (dB)	Limit (dB)
u_c	Combined standard uncertainty: $u_c(y) = \sqrt{\sum_{i=1}^m u_i^2(y)}$	± 2.39	± 2.6
U	Expanded uncertainty U: $U = 2u_c(y)$	± 4.79	± 5.2

	Radiated Emission Measurement Uncertainty @ 3m, Vertical (30-1000 MHz):	Measured (dB)	Limit (dB)
u_c	Combined standard uncertainty: $u_c(y) = \sqrt{\sum_{i=1}^m u_i^2(y)}$	± 2.39	± 2.6
U	Expanded uncertainty U: $U = 2u_c(y)$	± 4.78	± 5.2

	Radiated Emission Measurement Uncertainty @ 3 m, Horizontal & Vertical (1 – 18 GHz):	Measured (dB)	Limit (dB)
u_c	Combined standard uncertainty: $u_c(y) = \sqrt{\sum_{i=1}^m u_i^2(y)}$	± 1.87	Under consideration
U	Expanded uncertainty U: $U = 2u_c(y)$	± 3.75	Under consideration