

Global EMC Inc. Labs

EMC & RF Test Report

As per

FCC Part 15 Subpart C:2015

&

RSS 247:2015

Unlicensed Intentional Radiators

on the

Digi Bluenica HoneyBee



Raymond Lee Au, B.Eng
Project Engineer
Global EMC Inc.
11 Gordon Collins Dr.
Gormley, ON
L0H 1G0, Canada
Ph: (905) 883-8189

Testing produced for



See Appendix A for full customer & EUT details.



Client	Digi International	
Product	Digi Bluenica HoneyBee	
Standard(s)	FCC Part 15 Subpart C 15:2015 / RSS-247:2015	

Table of Contents

Table of Contents 2

Report Scope 3

Summary 4

Test Results Summary 5

Notes, Justifications, or Deviations 6

Applicable Standards, Specifications and Methods 7

Sample calculation(s) 8

Document Revision Status 8

Definitions and Acronyms 9

Testing Facility 10

Calibrations and Accreditations 10

Testing Environmental Conditions and Dates 11

Detailed Test Results Section 12

6 dB Bandwidth of Digitally Modulated Systems 13

Maximum Peak Radiated Power - Digital Modulation 22

Antenna Spurious Conducted Emissions (-20 dBc Requirement) 31

Power Spectral Density - Digital Modulation 37

Radiated Emissions – 15.247, 15.209 45

Appendix A – EUT Summary 73

Appendix B – EUT and Test Setup Photographs 74

Client	Digi International	
Product	Digi Bluenica HoneyBee	
Standard(s)	FCC Part 15 Subpart C 15:2015 / RSS-247:2015	

Report Scope

This report addresses the EMC testing and test results of the Digi Bluenica HoneyBee. This unit is herein referred to as EUT (Equipment Under Test). Testing is performed at Global EMC Labs.

The EUT was tested for compliance against the following standards:

FCC Part 15 Subpart C:2015
RSS 247:2015

Test procedures, results, justifications, and engineering considerations, if any, follow later in this report.

The results contained in this report relate only to the item(s) tested.

This report does not imply product endorsement by A2LA or any other accreditation agency, any government, or Global EMC Inc.

Opinions/interpretations expressed in this report, if any, are outside the scope of Global EMC Inc accreditation. Any opinions expressed do not necessarily reflect the opinions of Global EMC Inc, unless otherwise stated.

Client	Digi International	
Product	Digi Bluenica HoneyBee	
Standard(s)	FCC Part 15 Subpart C 15:2015 / RSS-247:2015	

Summary

The results contained in this report relate only to the item(s) tested.

EUT FCC Certification #, FCC ID:	MCQ-HBTEMPV01
EUT Industry Canada Certification #, IC:	1846A-HBTEMPV01
EUT Passed all tests performed.	Yes (see test results summary)
Tests conducted by	Raymond Lee Au

Client	Digi International	
Product	Digi Bluenica HoneyBee	
Standard(s)	FCC Part 15 Subpart C 15:2015 / RSS-247:2015	

Test Results Summary

Standard/Method	Description	Class/Limit	Result
FCC 15.203	Antenna Requirement	Unique	Pass
FCC 15.205 RSS-Gen 8.10 (Table 6)	Restricted Bands for intentional operation	QuasiPeak Average	Pass
FCC 15.209 RSS-Gen 8.9 (Table 4 & 5)	Spurious Radiated emissions	QuasiPeak Average	Pass
FCC 15.247(a)2 RSS-247 5.2(1)	6 dB Bandwidth	> 500 kHz	Pass
FCC 15.247(b)3 RSS-247 5.4(4)	Max output power	< 1 Watt	Pass
FCC 15.247(b)(4)	Antenna Gain	< 6 dBi	Pass
FCC 15.247(d) RSS-247 5.5	Antenna spurious conducted	< 20 dBc	Pass
FCC 15.247(e) RSS-247 5.2(2)	Power Spectral Density	< 8 dBm (3 kHz BW)	Pass
FCC 15.247(i) IC Safety code 6	RF Energy Levels	Per requirements	Pass
Overall Result			PASS

See the following *Notes, Justifications, or Deviations* section for important information regarding these tests.

All tests were performed by Raymond Lee Au.

If the product as tested or otherwise complies with the specification, the EUT is deemed to comply with the requirement and is deemed a 'PASS' grade. If not 'FAIL' grade will be issued. Note that 'PASS' / 'FAIL' grade is independent of any measurement uncertainties.

Client	Digi International	
Product	Digi Bluenica HoneyBee	
Standard(s)	FCC Part 15 Subpart C 15:2015 / RSS-247:2015	

Notes, Justifications, or Deviations

The following are justifications for tests not performed, deviations from the above listed specifications, and notes regarding the product or the testing.

The EUT is an environmental temperature sensor with BLE (2.402 – 2.480 MHz) capabilities.

For the antenna requirement specified in FCC 15.203, the antenna used is a PCB trace antenna which will be sealed within the unit’s enclosure. It is not replaceable by the end user.

For the Restricted Bands of operation, the transmitter is designed to operate between 2.402 GHz and 2.480 GHz.

The EUT is not a hybrid system; FCC 15.247 (f) does not apply.

The EUT is designed with a mounting tab to be hung in an upright position. Therefore, the EUT is tested in this orientation.

The antenna gain for the 15.247 transmitter is 0 dBi.

The EUT operates using a long life lithium CR2477 button cell battery sealed within the unit. It is not rechargeable or replicable by the end user. It does not have the means to plug into mains power, nor does it have any connectors or cables.

See separate RF Exposure Exhibit for this unit regarding the permissible RF exposure levels.

There are 2 models included in this family. They are the “HBtemp,” and the “HCtemp.” These models have identical hardware and identical firmware. The only difference between them is the branding of the product (and therefore, the label). Otherwise, they are the same. See separate label exhibit for samples of both labels.

Testing of the 15.247 transmitter is performed according to procedures documented in FCC KDB Publication No. 558074 - Guidance on Measurements for Digital Transmission Systems (47 CFR 15.247).

Client	Digi International	
Product	Digi Bluenica HoneyBee	
Standard(s)	FCC Part 15 Subpart C 15:2015 / RSS-247:2015	

Applicable Standards, Specifications and Methods

- ANSI C63.4:2009 - Methods of Measurement of Radio-Noise Emissions from Low-Voltage Electrical and Electronic Equipment in the Range of 9 kHz to 40 GHz
- ANSI C63.4:2014 - American National Standard for Methods of Measurement of Radio-Noise Emissions from Low-Voltage Electrical and Electronic Equipment in the Range of 9 kHz to 40 GHz
- ANSI C63.10:2009 - American national standard for testing unlicensed wireless devices
- ANSI C63.10:2013 - American National Standard of Procedures for Compliance Testing of Unlicensed Wireless Devices
- CFR 47 FCC 15:2015 - Code of Federal Regulations – Radio Frequency Devices
- CISPR 22:2008 - Information technology equipment – Radio disturbance characteristics – Limits and methods of measurement
- FCC KDB 558074 - FCC KDB 558074 Digital Transmission Systems, measurements and procedures
- ICES-003:2012 - Digital Apparatus - Spectrum Management and Telecommunications Policy Interference-Causing Equipment Standard
- ISO 17025:2005 - General Requirements for the competence of testing and calibration laboratories
- RSS-Gen:2014 - General Requirements and Information for the Certification of Radio Apparatus
- RSS 210:2010 - Issue 8: Spectrum Management and Telecommunications Policy. Radio Standards Specification Low Power Licence-Exempt Radiocommunication Devices
- RSS 247:2015 - Digital Transmission Systems (DTSs), Frequency Hopping Systems (FHSs) and Licence-Exempt Local Area Network (LE-LAN) Devices

Client	Digi International	
Product	Digi Bluenica HoneyBee	
Standard(s)	FCC Part 15 Subpart C 15:2015 / RSS-247:2015	

Sample calculation(s)

Margin = limit – (received signal + antenna factor + cable loss – pre-amp gain)

Margin = 50.5dBuV/m – (50dBuV + 10dB + 2.5dB – 20dB)

Margin = 8 dB

Document Revision Status

Release 1 - December 7, 2015
Initial release.

Client	Digi International	
Product	Digi Bluenica HoneyBee	
Standard(s)	FCC Part 15 Subpart C 15:2015 / RSS-247:2015	

Definitions and Acronyms

The following definitions and acronyms are applicable in this report.
See also ANSI C63.14.

AE – Auxillary Equipment.

BW – Bandwidth. Unless otherwise stated, this is refers to the 6 dB bandwidth.

EMC – Electro-Magnetic Compatibility

EMI – Electro-Magnetic Immunity

EUT – Equipment Under Test

ITE – Information Technology Equipment with a primary function(s) of entry, storage, display, retrieval, transmission, processing, switching, or control, of data.

LISN – Line impedance stabilization network

NCR – No Calibration Required

RF – Radio Frequency

Client	Digi International	
Product	Digi Bluenica HoneyBee	
Standard(s)	FCC Part 15 Subpart C 15:2015 / RSS-247:2015	

Testing Facility

Testing for EMC on the EUT was carried out at Global EMC labs in Toronto, Ontario, Canada. The testing lab consists of a 3m semi-anechoic chamber calibrated to be able to allow measurements on an EUT with a maximum width or length of up to 2m and height up to 3m. The chamber is equipped with a turn table that is capable of testing devices up to 3300lb in weight. This facility is capable of testing products that are rated for 120 Vac and 240Vac single phase, or 208 Vac 3 phase input. DC capability is also available. The chamber is equipped with an antenna mast that controls polarization and height from the control room adjoining the shielded chamber. Radiated emissions measurements are performed using a Bilog, and Horn antenna where applicable. Conducted emissions, unless otherwise stated, are performed using a LISN.

Calibrations and Accreditations

The measurement site used is registered with Federal Communications Commission (FCC) and Industry Canada (IC). This site is calibrated for Normalized Site Attenuation (NSA) using test procedures outlined in ANSI C63.4 “Methods of Measurement of Radio-Noise Emissions from Low-Voltage Electrical and Electronic Equipment in the Range of 9 kHz to 40 GHz”. The semi-anechoic chamber is lined with ferrite tiles and absorption cones to minimize any undesired reflections. All measuring equipment is calibrated on an annual or bi-annual basis as listed for each respective test.

Client	Digi International	
Product	Digi Bluenica HoneyBee	
Standard(s)	FCC Part 15 Subpart C 15:2015 / RSS-247:2015	

Testing Environmental Conditions and Dates

Following were the environmental conditions in the facility during time of testing –

Date	Test	Init.	Temperature (°C)	Humidity (%)	Pressure (kPa)
Nov. 2, 2015	Restricted Band Edges	RA	20-25°C	30-45%	100 -103kPa
Nov. 5, 2015	Spurious Radiated Emissions	RA	20-25°C	30-45%	100 -103kPa
Nov. 11, 2015	Bandwidth	RA	20-25°C	30-45%	100 -103kPa
Nov. 2, 2015	Max Output Power	RA	20-25°C	30-45%	100 -103kPa
Nov.10, 2015	Antenna Spurious Conducted	RA	20-25°C	30-45%	100 -103kPa
Nov. 11, 2015	Spectral Density	RA	20-25°C	30-45%	100 -103kPa

Client	Digi International	
Product	Digi Bluenica HoneyBee	
Standard(s)	FCC Part 15 Subpart C 15:2015 / RSS-247:2015	

Detailed Test Results Section

Client	Digi International	
Product	Digi Bluenica HoneyBee	
Standard(s)	FCC Part 15 Subpart C 15:2015 / RSS-247:2015	

6 dB Bandwidth of Digitally Modulated Systems

Purpose

The purpose of this test is to ensure that the bandwidth occupied exceeds a stated minimum. This helps ensure the utilization of the frequency allocation is sufficiently wide. This also helps prevent corruption of data by ensuring adequate data separation to distinguish the reception of the intended information.

Limits

The Limit is as specified in FCC Part 15.247(a)2 and RSS-247 5.2.

Systems using digital modulation techniques may operate in the 902 - 928 MHz, 2400 - 2483.5 MHz, and 5725 - 5850 MHz bands. The minimum 6 dB bandwidth shall be at least 500 kHz.

Results

The EUT passed. The minimum 6 dB BW measured was 664 kHz.

Client	Digi International	
Product	Digi Bluenica HoneyBee	
Standard(s)	FCC Part 15 Subpart C 15:2015 / RSS-247:2015	

Graph(s)

The graphs below show the 6dB bandwidth during the operation of the device. This is measured by a max hold on the spectrum analyzer and the highest resolution bandwidth that is sufficiently low to exhibit the 6 dB bandwidth of a channel during operation of the EUT. This measurement is a peak measurement. Max hold is performed for a duration of not less than 1 minute. Worst case results obtained are shown.

High Channel (2.480 GHz)
 6 dB BW = 664 kHz
 Vertical Antenna Polarity

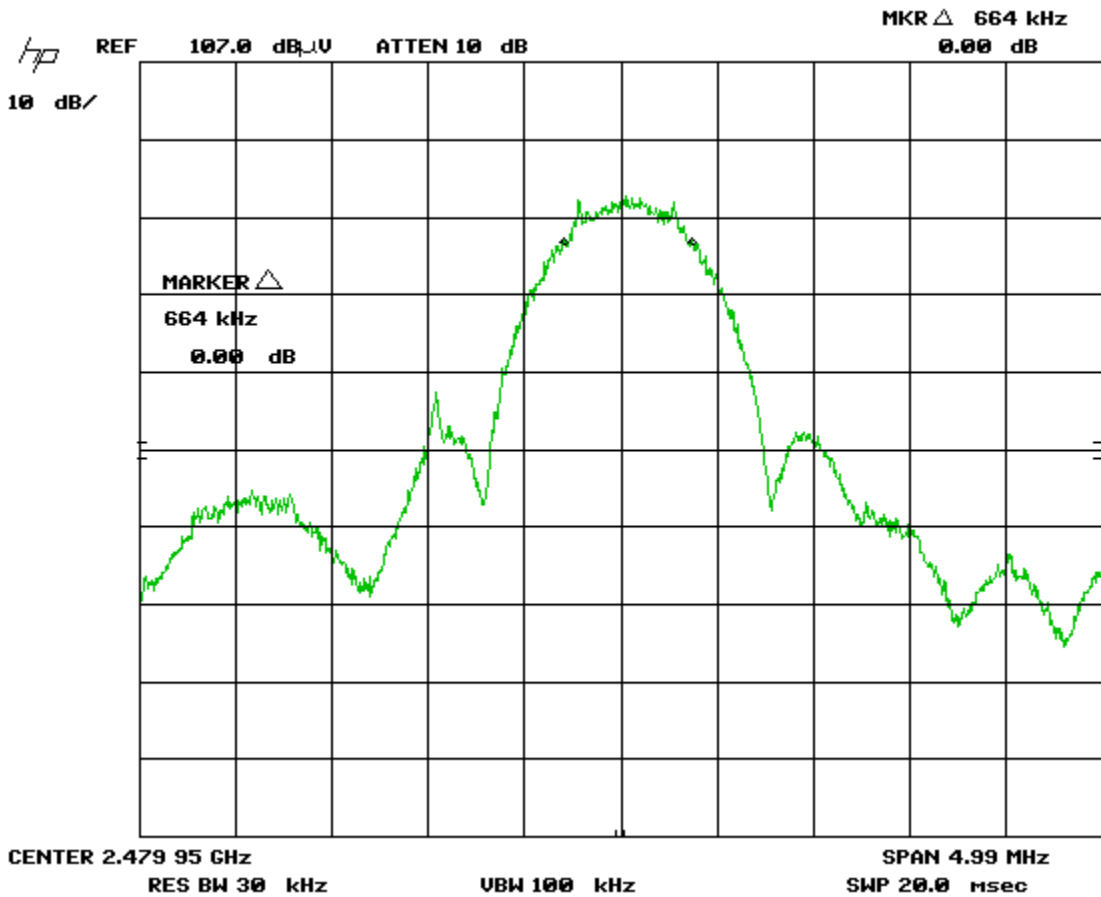

Client	Digi International	
Product	Digi Bluenica HoneyBee	
Standard(s)	FCC Part 15 Subpart C 15:2015 / RSS-247:2015	

High Channel (2.480 GHz)
6 dB BW = 699 kHz
Horizontal Antenna Polarity

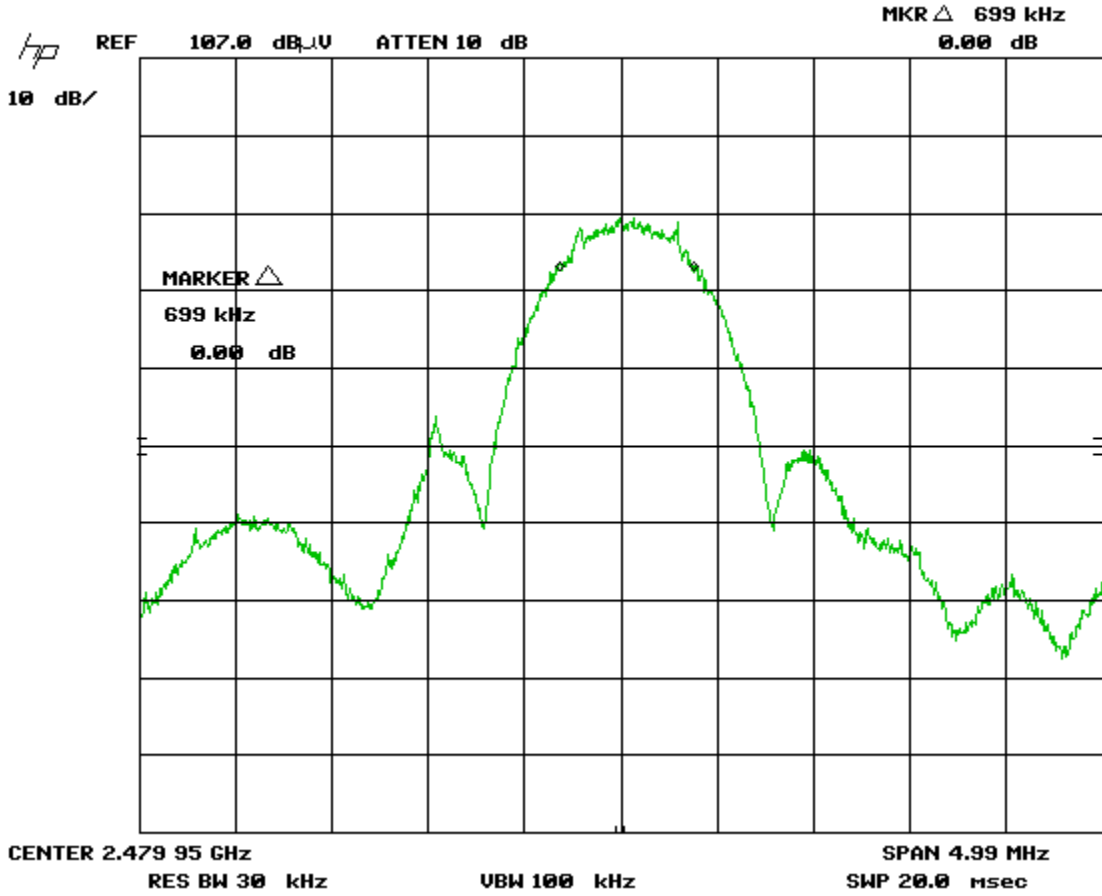

Client	Digi International	
Product	Digi Bluenica HoneyBee	
Standard(s)	FCC Part 15 Subpart C 15:2015 / RSS-247:2015	

Middle Channel (2.446 GHz)
6 dB BW = 698 kHz
Vertical Antenna Polarity

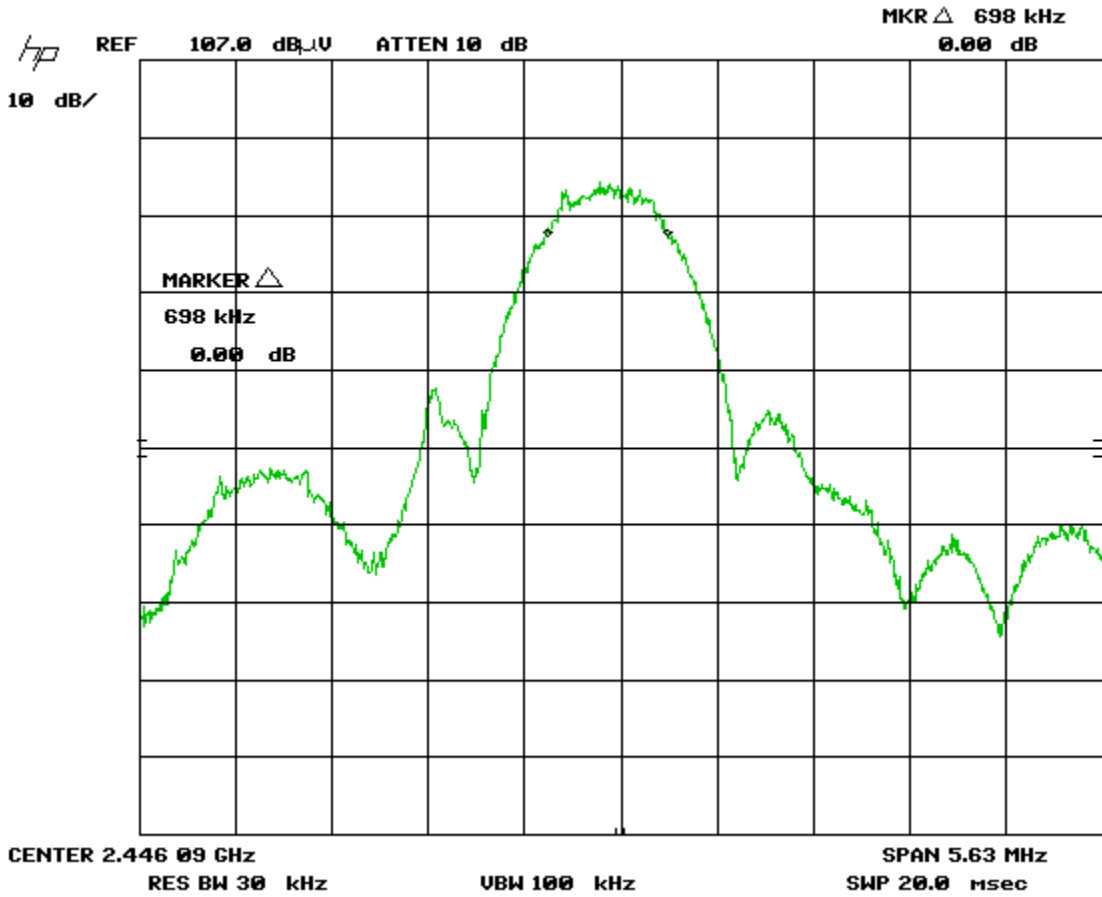

Client	Digi International	
Product	Digi Bluenica HoneyBee	
Standard(s)	FCC Part 15 Subpart C 15:2015 / RSS-247:2015	

Middle Channel (2.446 GHz)
6 dB BW = 732 kHz
Horizontal Antenna Polarity

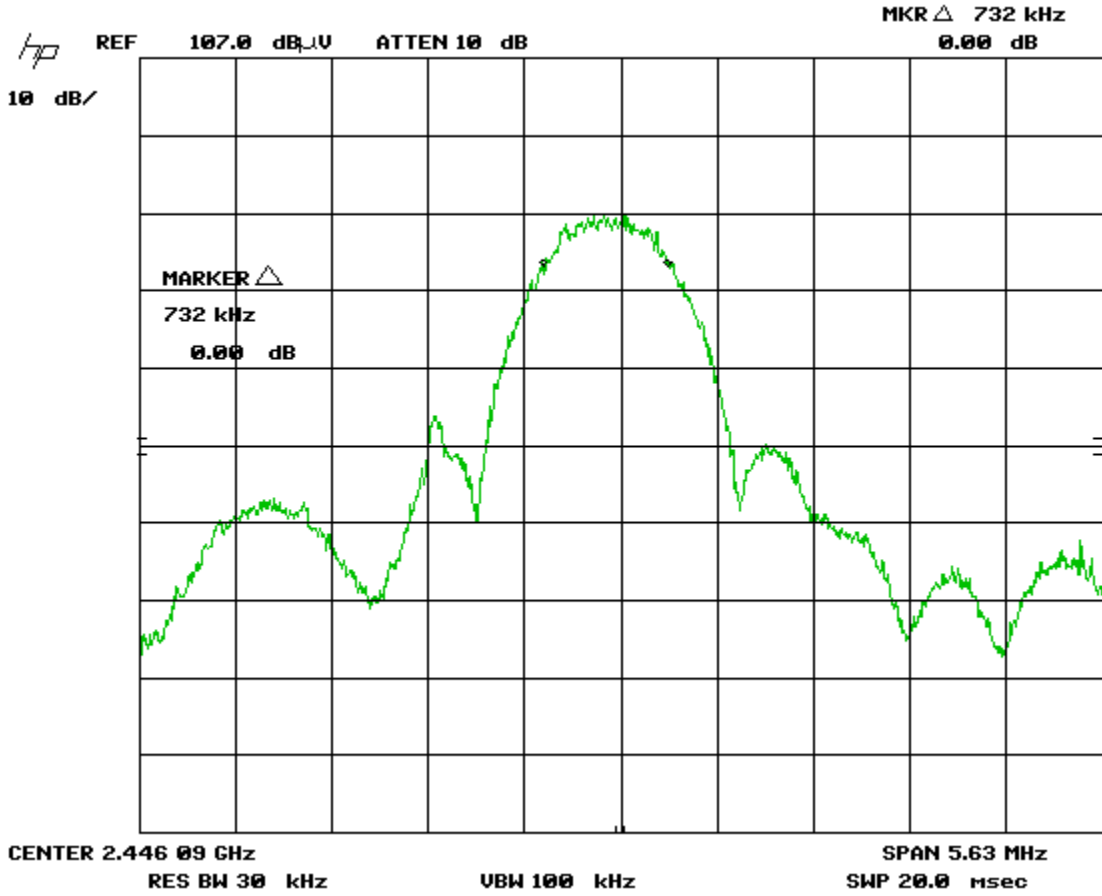

Client	Digi International	
Product	Digi Bluenica HoneyBee	
Standard(s)	FCC Part 15 Subpart C 15:2015 / RSS-247:2015	

Low Channel (2.402 GHz)
6 dB BW = 722 kHz
Vertical Antenna Polarity

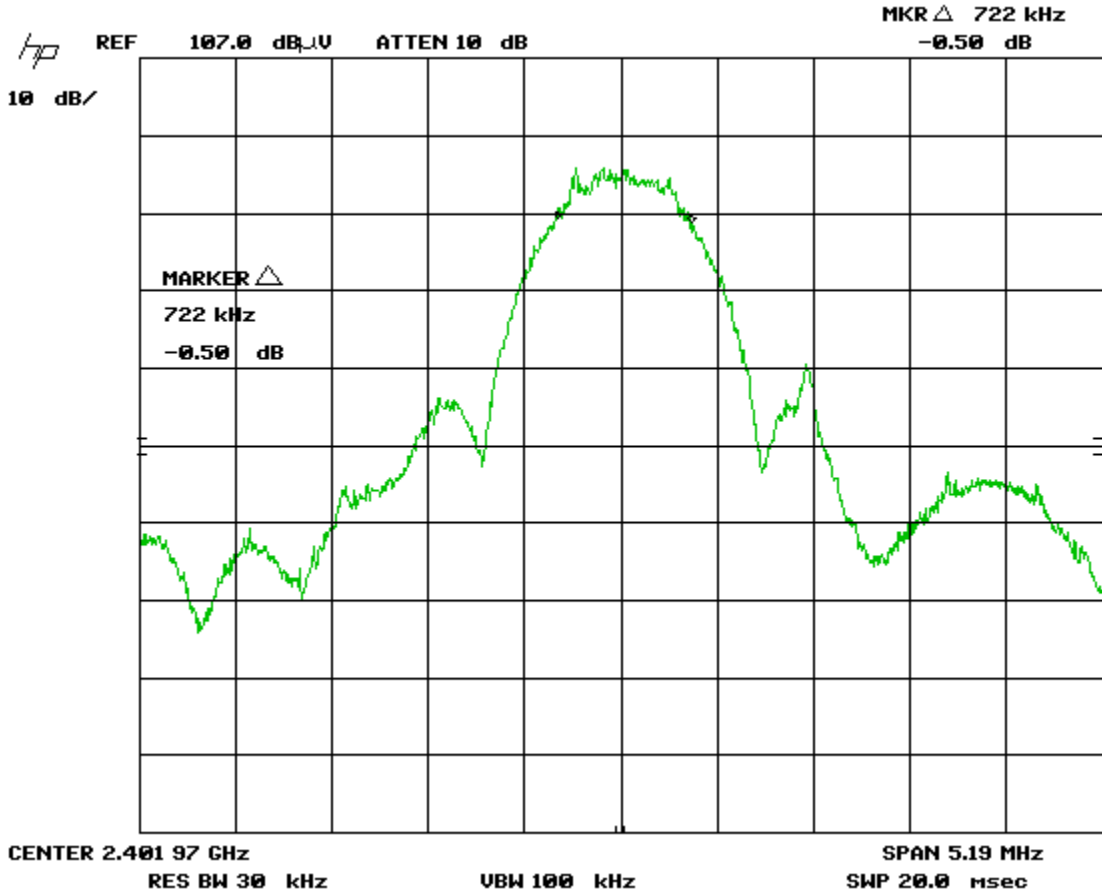

Client	Digi International	
Product	Digi Bluenica HoneyBee	
Standard(s)	FCC Part 15 Subpart C 15:2015 / RSS-247:2015	

Low Channel (2.402 GHz)
6 dB BW = 722 kHz
Horizontal Antenna Polarity

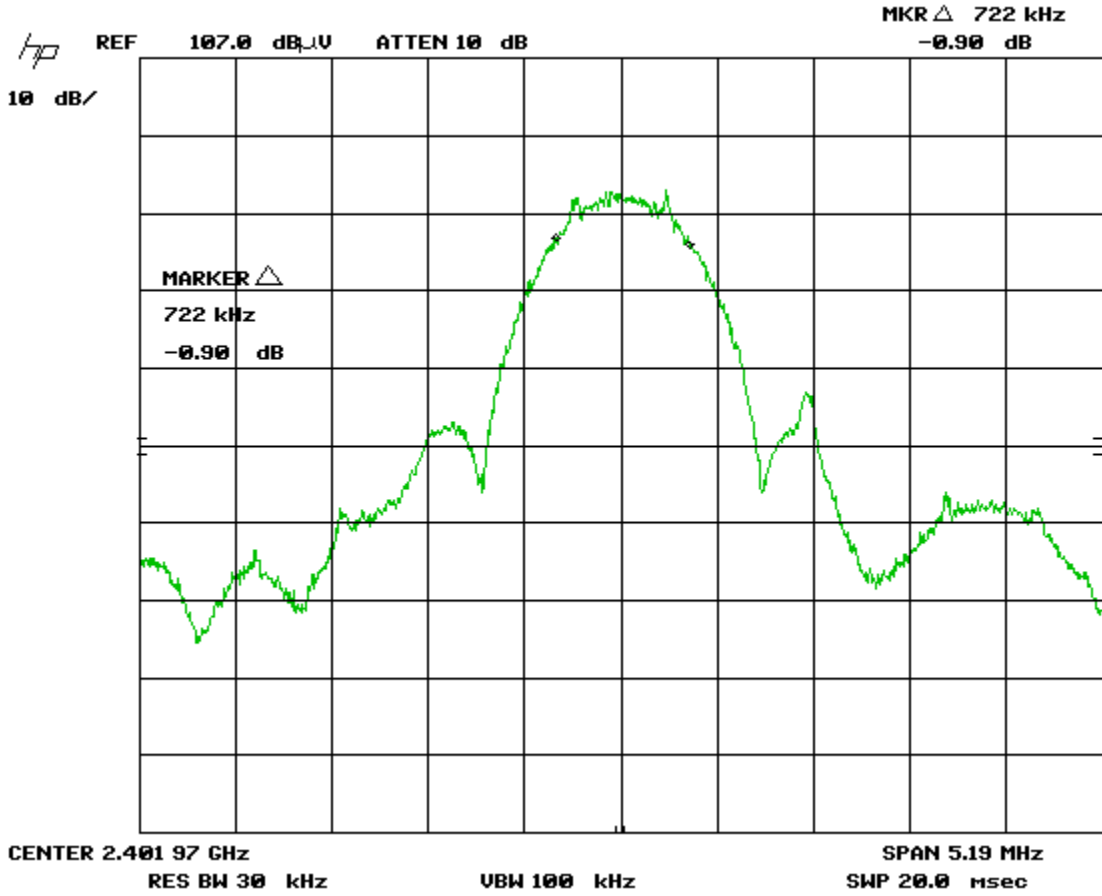

Client	Digi International	
Product	Digi Bluenica HoneyBee	
Standard(s)	FCC Part 15 Subpart C 15:2015 / RSS-247:2015	

For information purposes, maximum 20 dB bandwidth is 1.287 MHz.

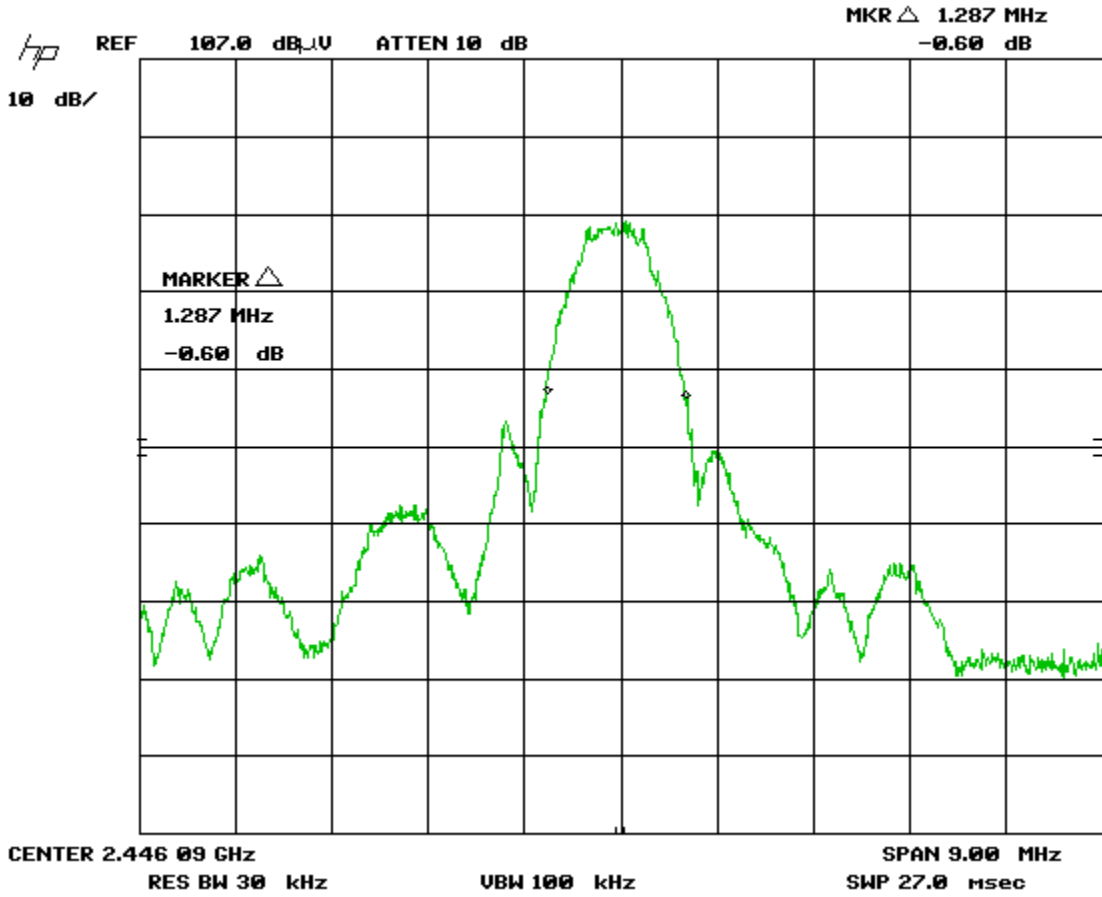

Note: See ‘Appendix B – EUT & Test Setup Photographs’ for photos showing the test set-up.

Client	Digi International	
Product	Digi Bluenica HoneyBee	
Standard(s)	FCC Part 15 Subpart C 15:2015 / RSS-247:2015	

Test Equipment List

Equipment	Model No.	Manufacturer	Last calibration date	Next calibration due date	Asset #
Spectrum Analyzer	8566B	HP	May 21, 2014	May 21, 2016	GEMC 193
Quasi-Peak Adapter	85650A	HP	May 22, 2014	May 22, 2016	GEMC 194
Horn Antenna	WBH218HN	Q-par	Jan. 23, 2014	Jan. 23, 2016	GEMC 6375
Pre-amp 1-26GHz	HP 8449B	HP	Sept. 9, 2014	Sept. 9, 2016	GEMC 6351
RF Cable 7m	LMR-400-7M-50OHM-MN-MN	LexTec	NCR	NCR	GEMC 28
RF Cable 1m	LMR-400-1M-50OHM-MN-MN	LexTec	NCR	NCR	GEMC 29

This report module is based on GEMC template "FCC – Power Line Conducted Emissions Class B_Rev1"

Client	Digi International	
Product	Digi Bluenica HoneyBee	
Standard(s)	FCC Part 15 Subpart C 15:2015 / RSS-247:2015	

Maximum Peak Radiated Power - Digital Modulation

Purpose

The purpose of this test is to ensure that the maximum power output does not exceed the limits specified. This ensures that if the end-user replaces the antenna, that the maximum power does not exceed an amount which may create an excessive power level.

Limits

The limits are defined in FCC Part 15.247(b) and RSS-247 5.4(4).
For systems using digital modulation in the 902-928 MHz, 2400-2483.5 MHz, and 5725-5850 MHz bands, the peak limit is 1 watt (or 30 dBm = 125.2 dB μ V at 3m distance).

Results

The EUT passed. The peak radiated power output at 3 meters is 97.9 dB μ V/m (2.7 dBm, or 1.9 mW).

Client	Digi International	
Product	Digi Bluenica HoneyBee	
Standard(s)	FCC Part 15 Subpart C 15:2015 / RSS-247:2015	

Table(s)

The table below shows the measured peak power output of the device. Peak measurements were made during transmit operation of the EUT with continuous modulated data (>98%). Worst case plots are shown.

Maximum Peak Radiated Power

Test Frequency (MHz)	Channel	Detection mode	Antenna polarity (Horz/Vert)	Raw signal (dB μ V)	Antenna factor (dB)	Cable loss + Pre-selector (dB)	Pre-Amp Gain (dB)	Received signal at 3m (dB μ V/m)	Output Power (dBm)	Result
2.402	Low	Peak	Vert	99.3	28.3	4.1	33.8	97.9	2.7	Pass
2.402	Low	Peak	Horz	97.5	28.3	4.1	33.8	96.1	0.9	Pass
2.446	Middle	Peak	Vert	98.0	28.6	4.1	33.8	96.9	1.7	Pass
2.446	Middle	Peak	Horz	95.9	28.6	4.1	33.8	94.8	-0.4	Pass
2.48	High	Peak	Vert	96.9	28.9	4.1	33.8	96.1	0.9	Pass
2.48	High	Peak	Horz	92.9	28.9	4.1	33.8	92.1	-3.1	Pass

Client	Digi International	
Product	Digi Bluenica HoneyBee	
Standard(s)	FCC Part 15 Subpart C 15:2015 / RSS-247:2015	

Low Channel
Vertical Antenna Polarity

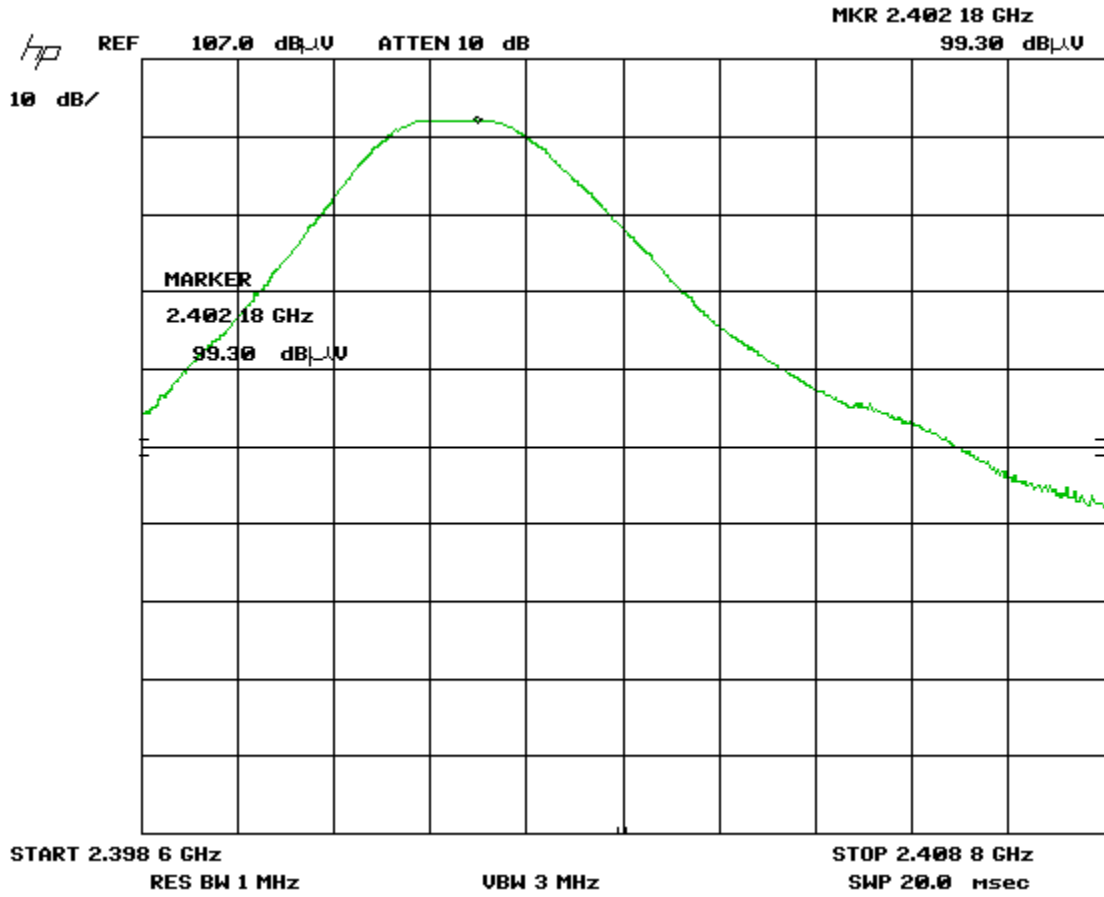

Client	Digi International	
Product	Digi Bluenica HoneyBee	
Standard(s)	FCC Part 15 Subpart C 15:2015 / RSS-247:2015	

Low Channel
Horizontal Antenna Polarity

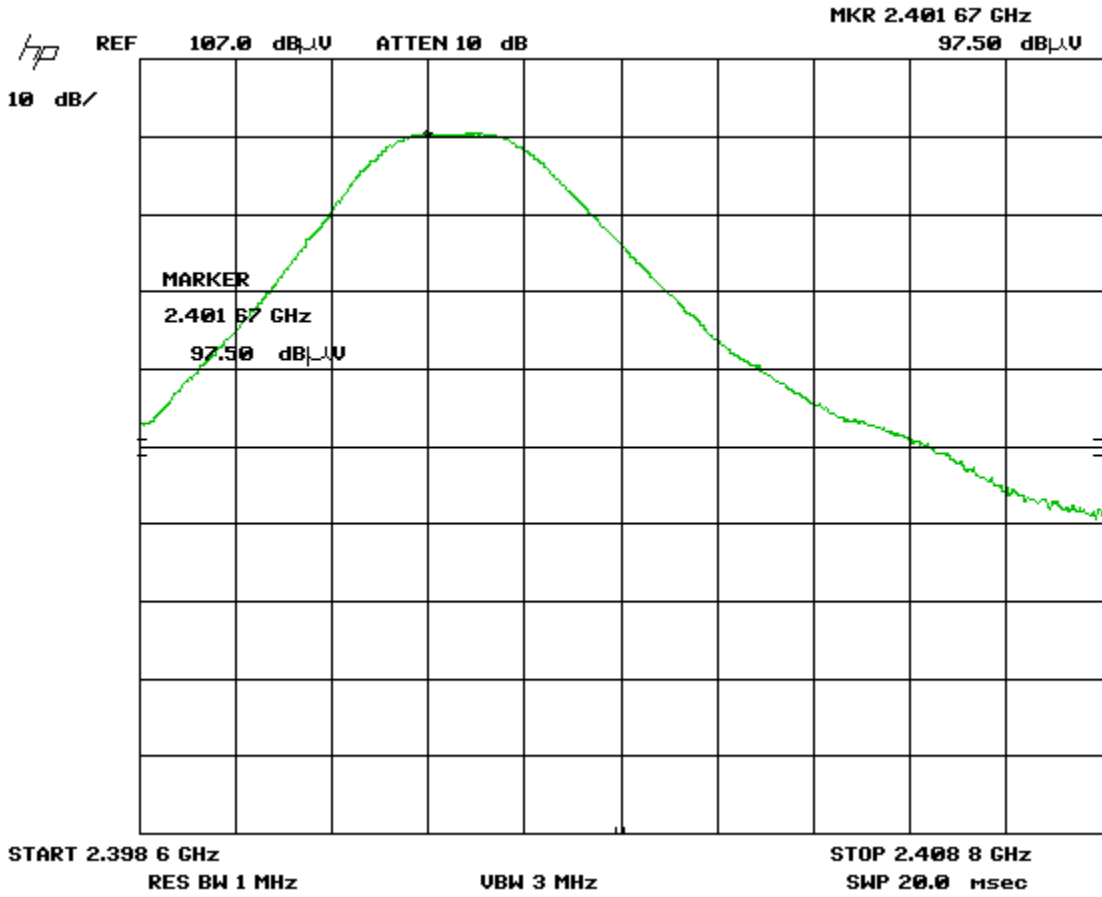

Client	Digi International	
Product	Digi Bluenica HoneyBee	
Standard(s)	FCC Part 15 Subpart C 15:2015 / RSS-247:2015	

Middle Channel
Vertical Antenna Polarity

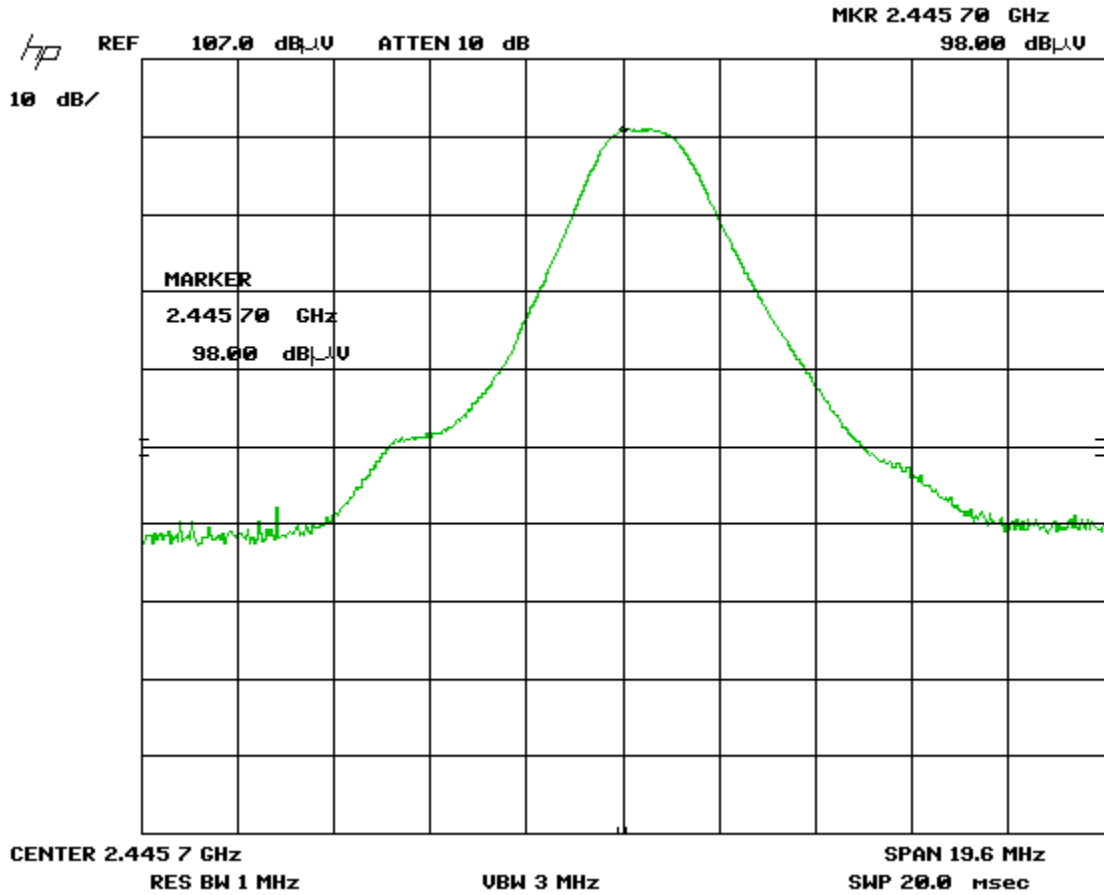

Client	Digi International	
Product	Digi Bluenica HoneyBee	
Standard(s)	FCC Part 15 Subpart C 15:2015 / RSS-247:2015	

Middle Channel
Horizontal Antenna Polarity

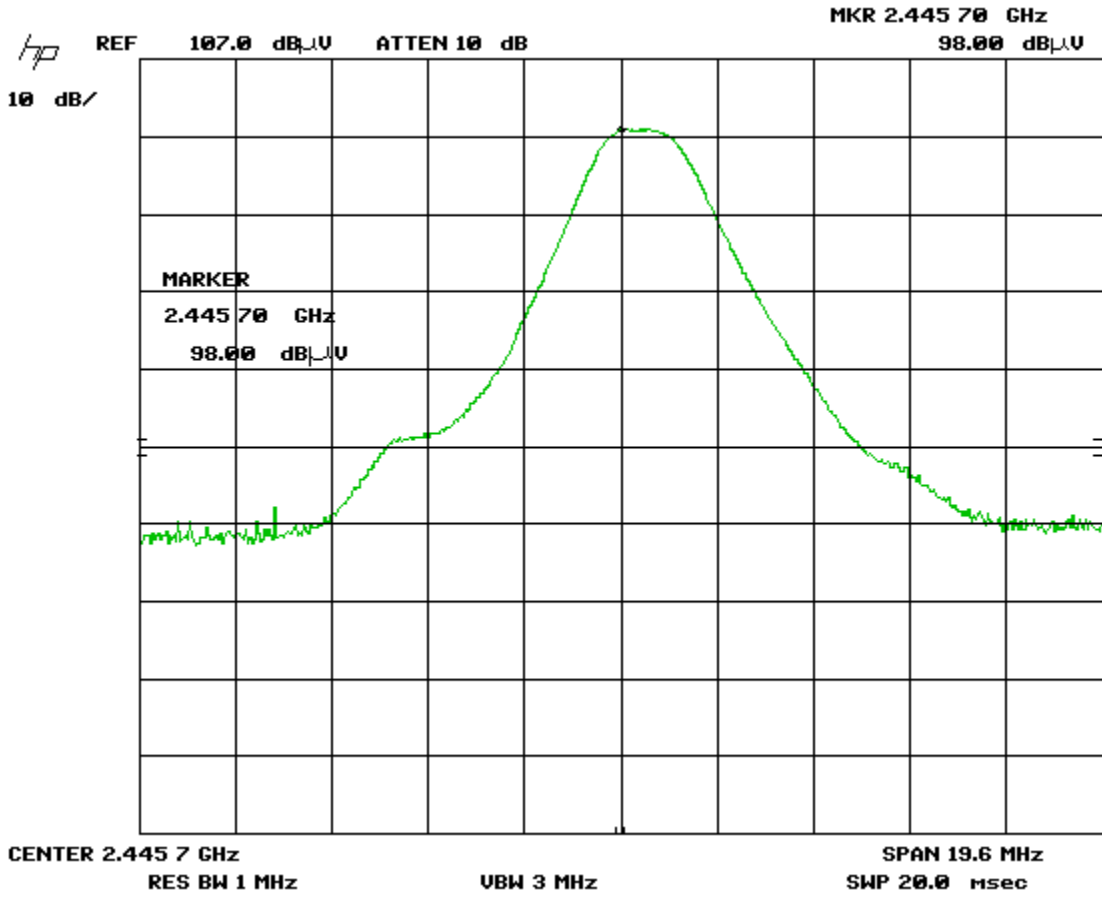

Client	Digi International	
Product	Digi Bluenica HoneyBee	
Standard(s)	FCC Part 15 Subpart C 15:2015 / RSS-247:2015	

High Channel
Vertical Antenna Polarity

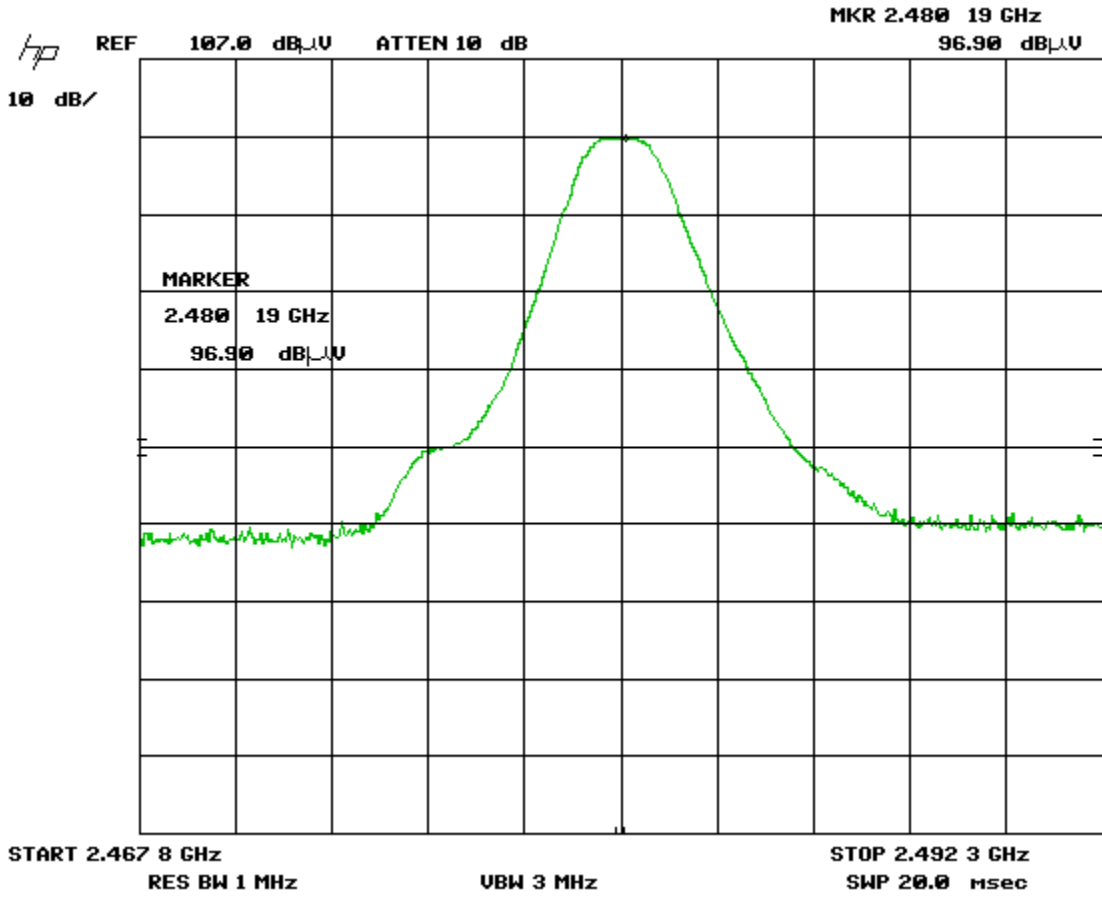

Client	Digi International	
Product	Digi Bluenica HoneyBee	
Standard(s)	FCC Part 15 Subpart C 15:2015 / RSS-247:2015	

High Channel
Horizontal Antenna Polarity

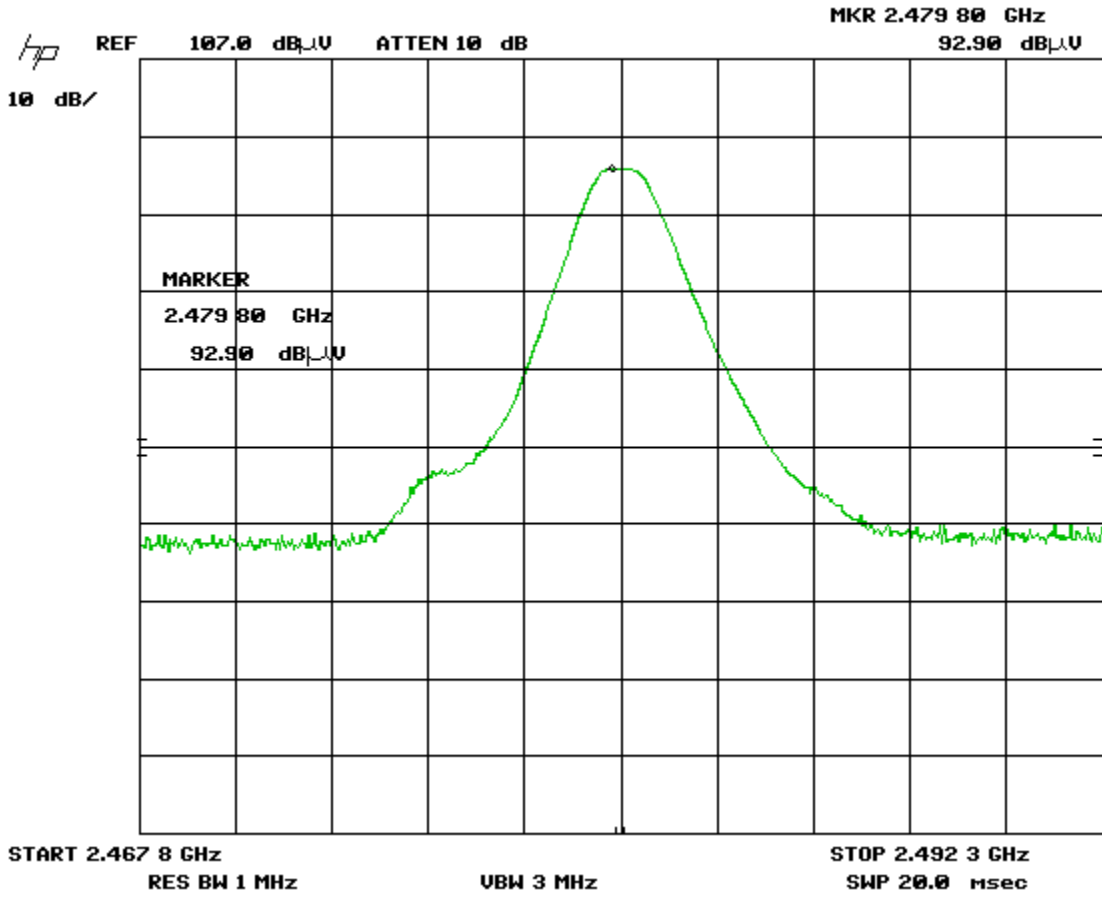

Note: See 'Appendix B – EUT & Test Setup Photographs' for photos showing the test set-up.

Client	Digi International	
Product	Digi Bluenica HoneyBee	
Standard(s)	FCC Part 15 Subpart C 15:2015 / RSS-247:2015	

Test Equipment List

Equipment	Model No.	Manufacturer	Last calibration date	Next calibration due date	Asset #
Spectrum Analyzer	8566B	HP	Oct 9, 2014	Oct 9, 2016	GEMC 193
Quasi-Peak Adapter	85650A	HP	May 22, 2014	May 22, 2016	GEMC 194
Horn Antenna	WBH218HN	Q-par	Jan. 23, 2014	Jan. 23, 2016	GEMC 6375
Pre-amp	HP 8449B	HP	Sept. 9, 2014	Sept. 9, 2016	GEMC 6351
Power Head	PH 2000	AR	Jan. 22, 2015	Jan. 22, 2017	GEMC 15
Power meter	PM 2002	AR	Jan. 21, 2015	Jan. 21, 2017	GEMC 16
RF Cable 7m	LMR-400-7M-50OHM-MN-MN	LexTec	NCR	NCR	GEMC 28
RF Cable 1m	LMR-400-1M-50OHM-MN-MN	LexTec	NCR	NCR	GEMC 29

This report module is based on GEMC template "FCC – Power Line Conducted Emissions Class B_Rev1"

Client	Digi International	
Product	Digi Bluenica HoneyBee	
Standard(s)	FCC Part 15 Subpart C 15:2015 / RSS-247:2015	

Antenna Spurious Conducted Emissions (-20 dBc Requirement)

Purpose

The purpose of this test is to ensure that the maximum power conducted to the radiating element at frequencies outside of the authorized spectrum does not exceed the limits specified. This ensures that the only the intended signal is delivered to the radiating element.

Limits

The limits are defined in FCC Part 15.247(d) and RSS-247 5.5. In any 100 kHz band, the peak spurious harmonics emissions must be at least 20 dB below the fundamental. Spurious Conducted emissions are to be evaluated up to the 10th harmonic. This -20 dBc requirement also applies at the ‘band edge’ or 2.4 GHz and 2.4835 GHz.

Results

The EUT passes. Low, middle and high bands were measured. The worst case is presented as a graph for the spectrum. The -20 dBc requirement is also shown for the lower band edge at 2.4 GHz while transmitting in the low channel, and for the high band edge at 2.4835 GHz while transmitting in the high channel.

Client	Digi International	
Product	Digi Bluenica HoneyBee	
Standard(s)	FCC Part 15 Subpart C 15:2015 / RSS-247:2015	

Graph(s)

1 MHz – 2.5 GHz

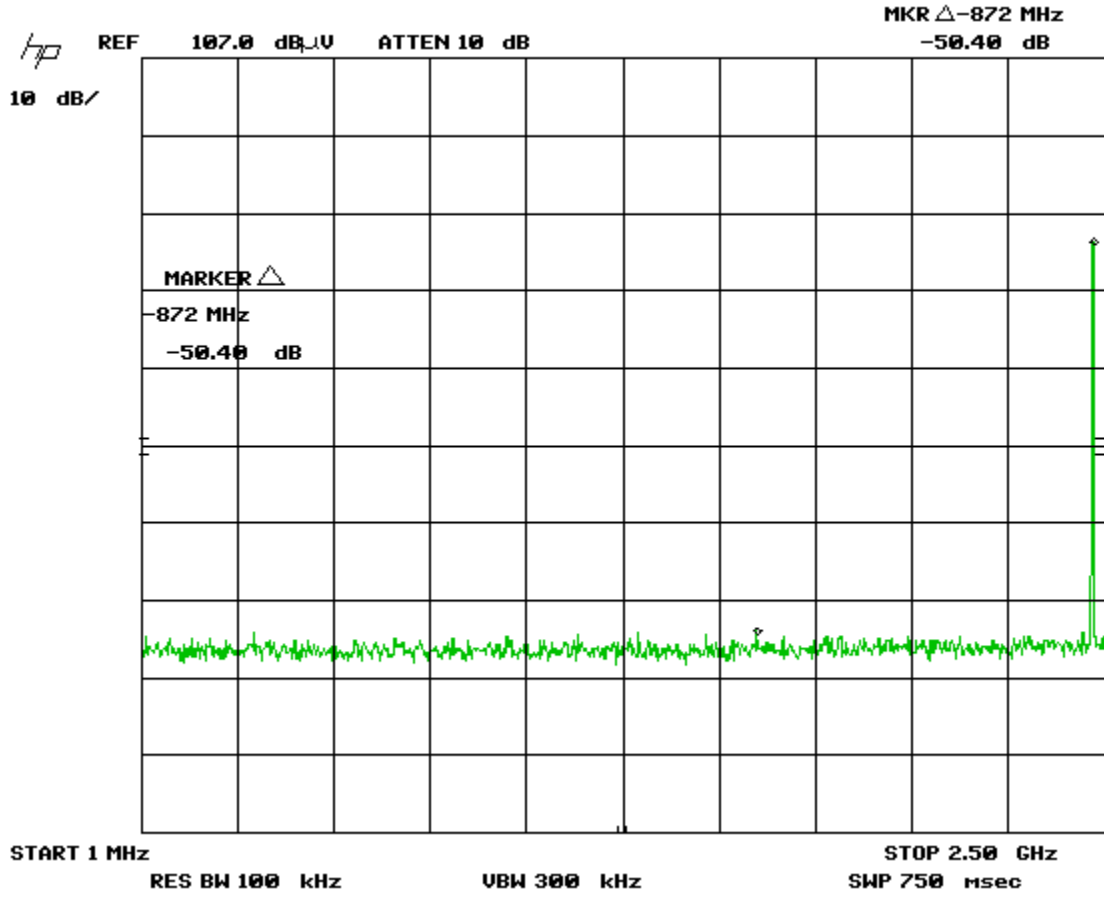

Client	Digi International	
Product	Digi Bluenica HoneyBee	
Standard(s)	FCC Part 15 Subpart C 15:2015 / RSS-247:2015	

2.4 GHz – 24 GHz

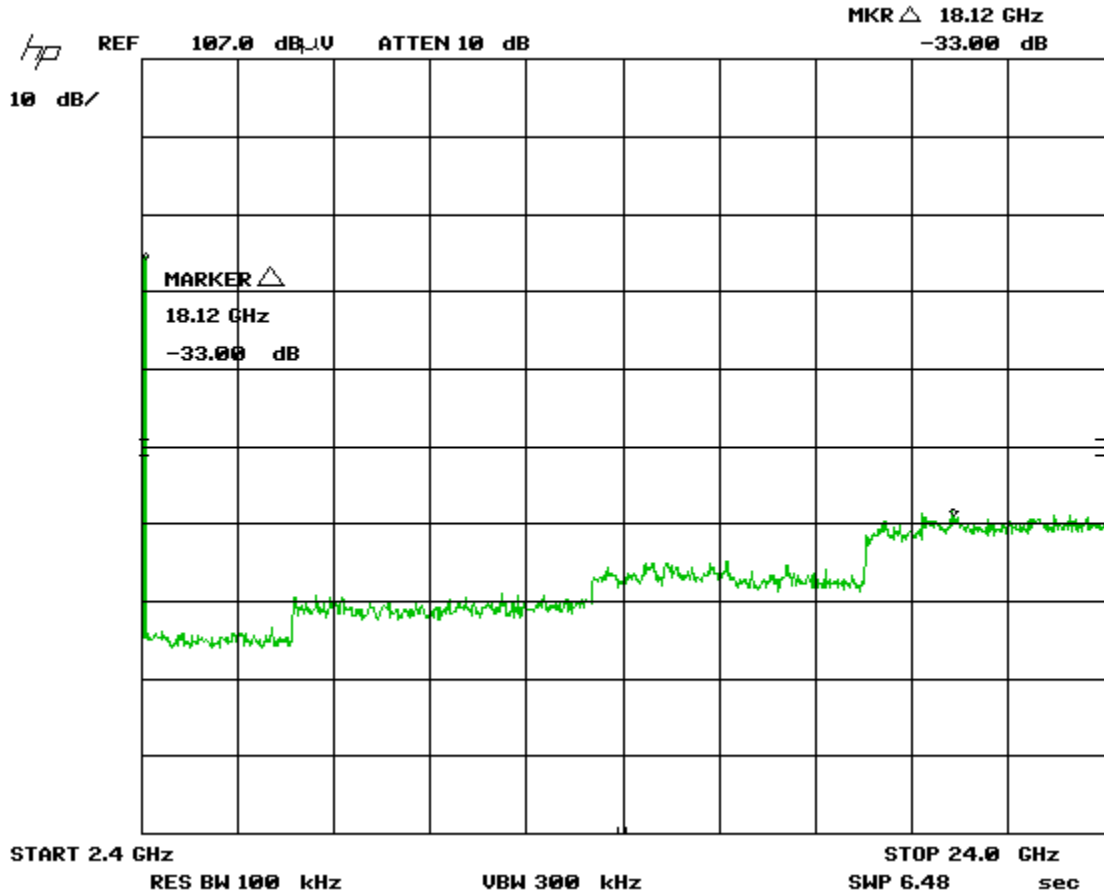

Client	Digi International	
Product	Digi Bluenica HoneyBee	
Standard(s)	FCC Part 15 Subpart C 15:2015 / RSS-247:2015	

2.4 GHz
EUT transmitting at Low Channel
-20 dBc requirement is met at low band edge

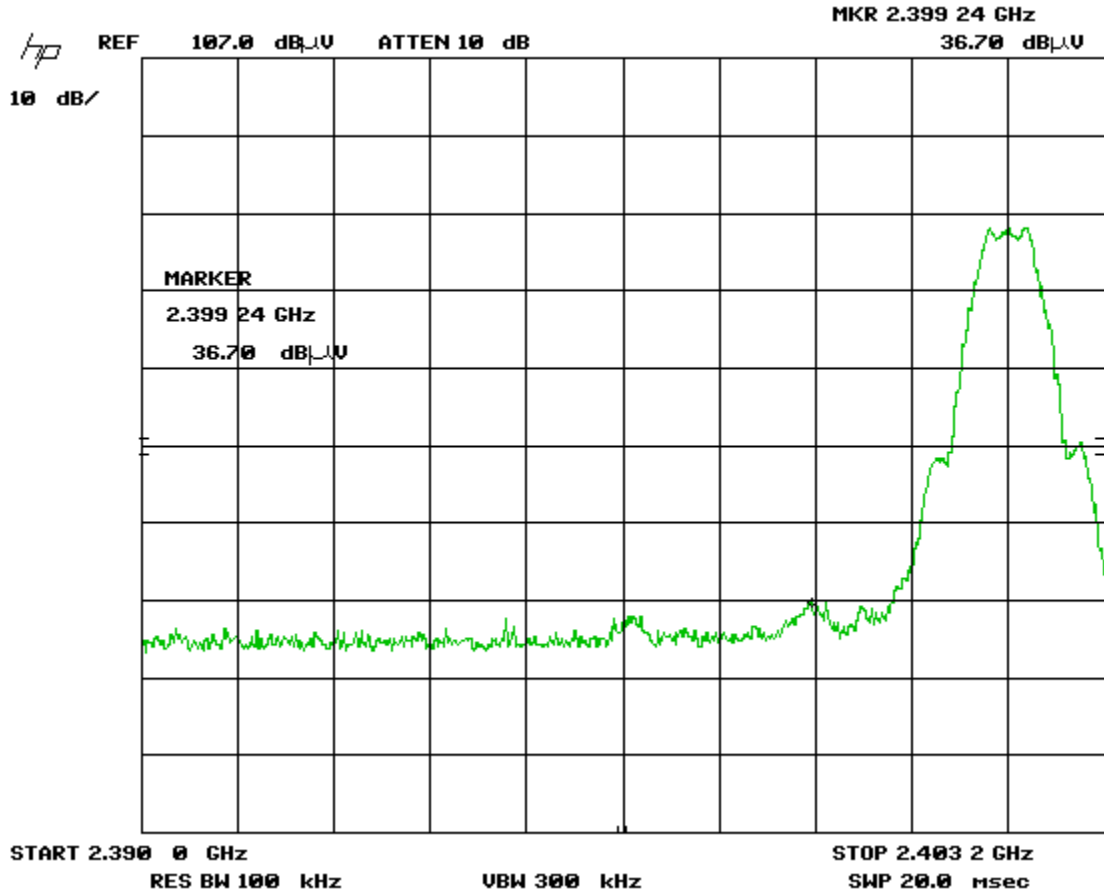

Client	Digi International	
Product	Digi Bluenica HoneyBee	
Standard(s)	FCC Part 15 Subpart C 15:2015 / RSS-247:2015	

2.4835 GHz
EUT transmitting at High Channel
-20 dBc requirement is met at high band edge

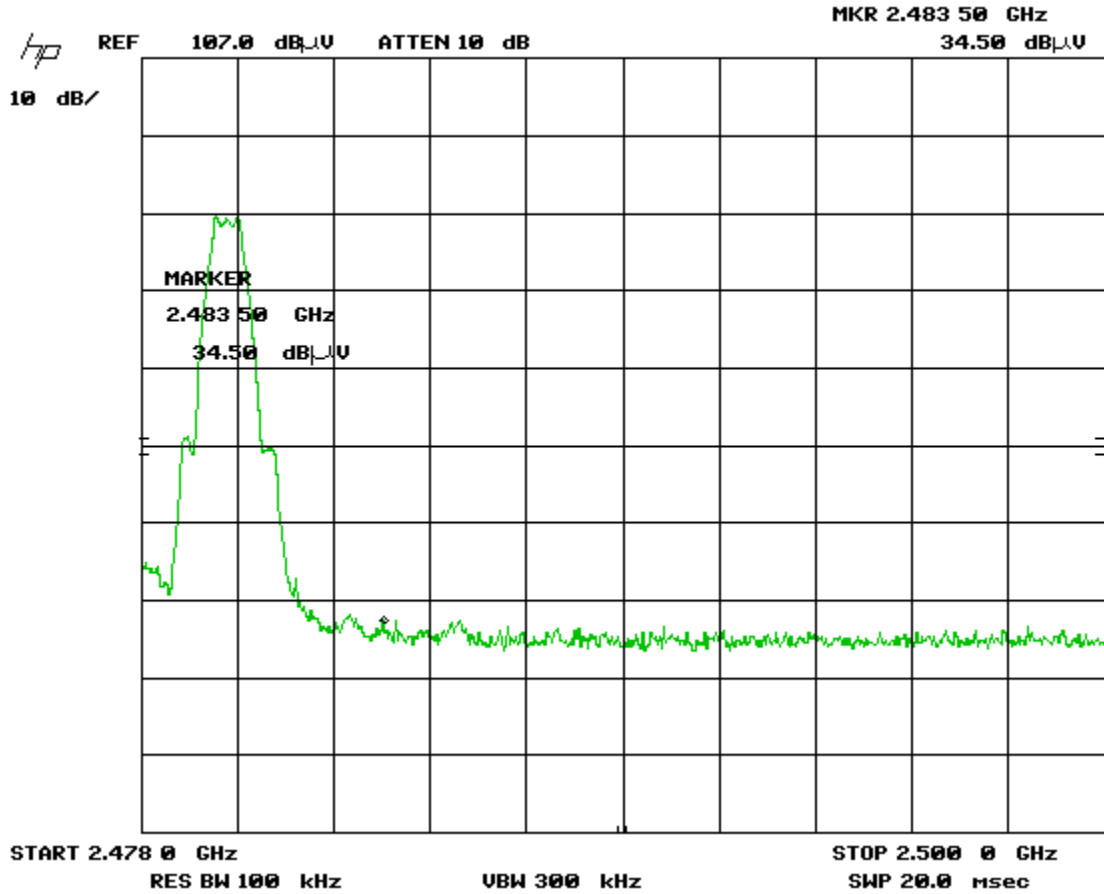

Client	Digi International	
Product	Digi Bluenica HoneyBee	
Standard(s)	FCC Part 15 Subpart C 15:2015 / RSS-247:2015	

Test Equipment List

Equipment	Model No.	Manufacturer	Last calibration date	Next calibration due date	Asset #
Spectrum Analyzer	8566B	HP	May 21, 2014	May 21, 2016	GEMC 193
Quasi-Peak Adapter	85650A	HP	May 22, 2014	May 22, 2016	GEMC 194

This report module is based on GEMC template "FCC – Power Line Conducted Emissions Class B_Rev1"

Client	Digi International	
Product	Digi Bluenica HoneyBee	
Standard(s)	FCC Part 15 Subpart C 15:2015 / RSS-247:2015	

Power Spectral Density - Digital Modulation

Purpose

The purpose of this test is to ensure that the maximum power spectral density to the radiating element does not exceed the limits specified. This ensures that the modulation is significantly wide enough, or low enough in power that it will allow for co-operation of other wireless devices operating within this frequency allocation.

Limits

The limits are defined in FCC Part 15.247(e) and RSS-247 5.2(2).

For digitally modulated systems, the power spectral density conducted from the intentional radiator to the antenna shall not be greater than 8 dBm (103.2dB μ V/m at 3m distance) in any 3 kHz band during any time interval of continuous transmission.

The method is given in Section 10.2 of FCC KDB 558074: June 5, 2014 (peak PSD).

Results

The EUT passed. Low, middle, and high channel was tested. Peak measurements were made for each with a 3 kHz resolution bandwidth, during transmit operation of the EUT with continuous modulated data (>98%). The power spectral density is < 8dBm.

Maximum Power Spectral Density

Test Frequency (MHz)	Detection mode	Antenna polarity (Horz/Vert)	Raw signal (dB μ V)	Antenna factor (dB)	Cable loss + Pre-selector (dB)	Pre-Amp Gain (dB)	Received signal (dB μ V/m)	Emission limit at 3m (dB μ V/m)	Margin (dB μ V)	Result
2.402	Peak	Vert	84.1	28.3	4.1	33.8	82.7	103.20	20.5	Pass
2.402	Peak	Horz	81.5	28.3	4.1	33.8	80.1	103.20	23.1	Pass
2.446	Peak	Vert	82.9	28.6	4.1	33.8	81.8	103.20	21.4	Pass
2.446	Peak	Horz	79.2	28.6	4.1	33.8	78.1	103.20	25.1	Pass
2.48	Peak	Vert	82.1	28.9	4.1	33.8	81.3	103.20	21.9	Pass
2.48	Peak	Horz	77.5	28.9	4.1	33.8	76.7	103.20	26.5	Pass

Client	Digi International	
Product	Digi Bluenica HoneyBee	
Standard(s)	FCC Part 15 Subpart C 15:2015 / RSS-247:2015	

Graph(s)

The graphs shown below show the power spectral density of the device during the operation of the EUT. Low, middle, and high channels were investigated and presented.

Note: See ‘Appendix B – EUT & Test Setup Photographs’ for photos showing the test set-up.

Low Channel
Vertical Antenna Polarity

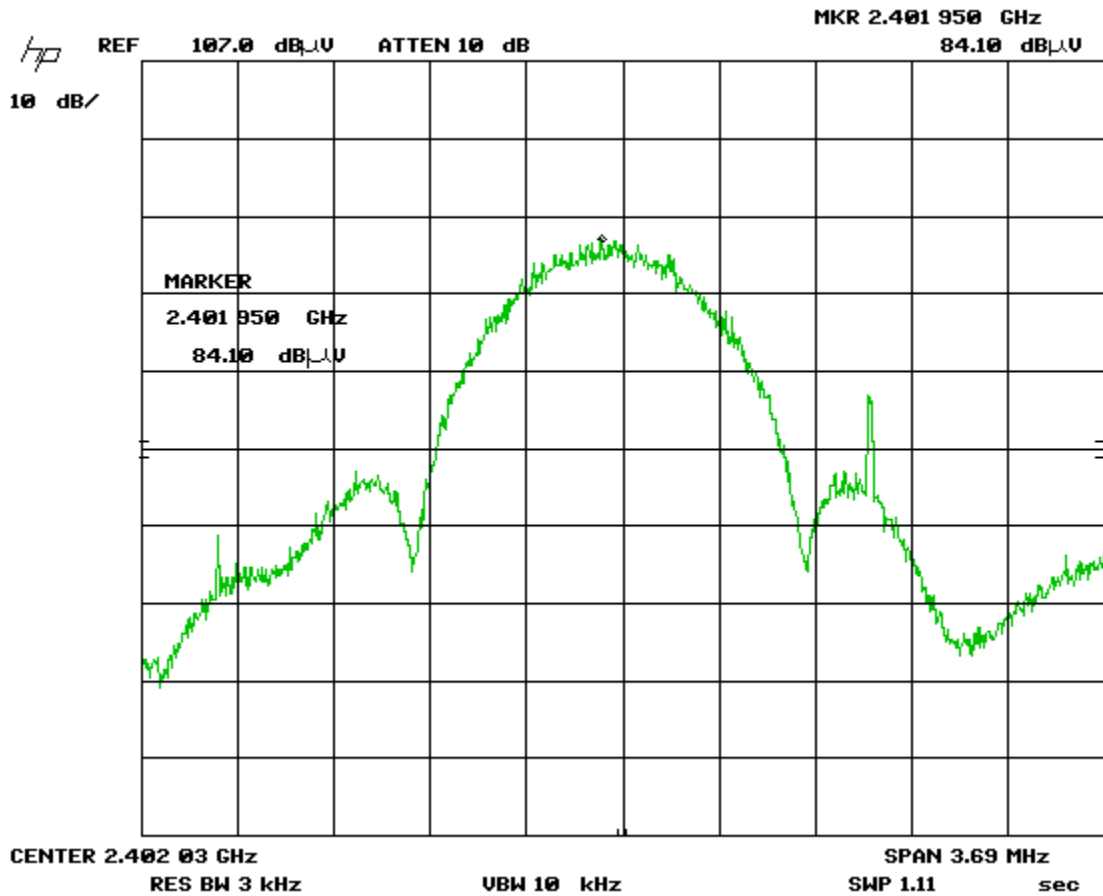

Client	Digi International	
Product	Digi Bluenica HoneyBee	
Standard(s)	FCC Part 15 Subpart C 15:2015 / RSS-247:2015	

Low Channel
Horizontal Antenna Polarity

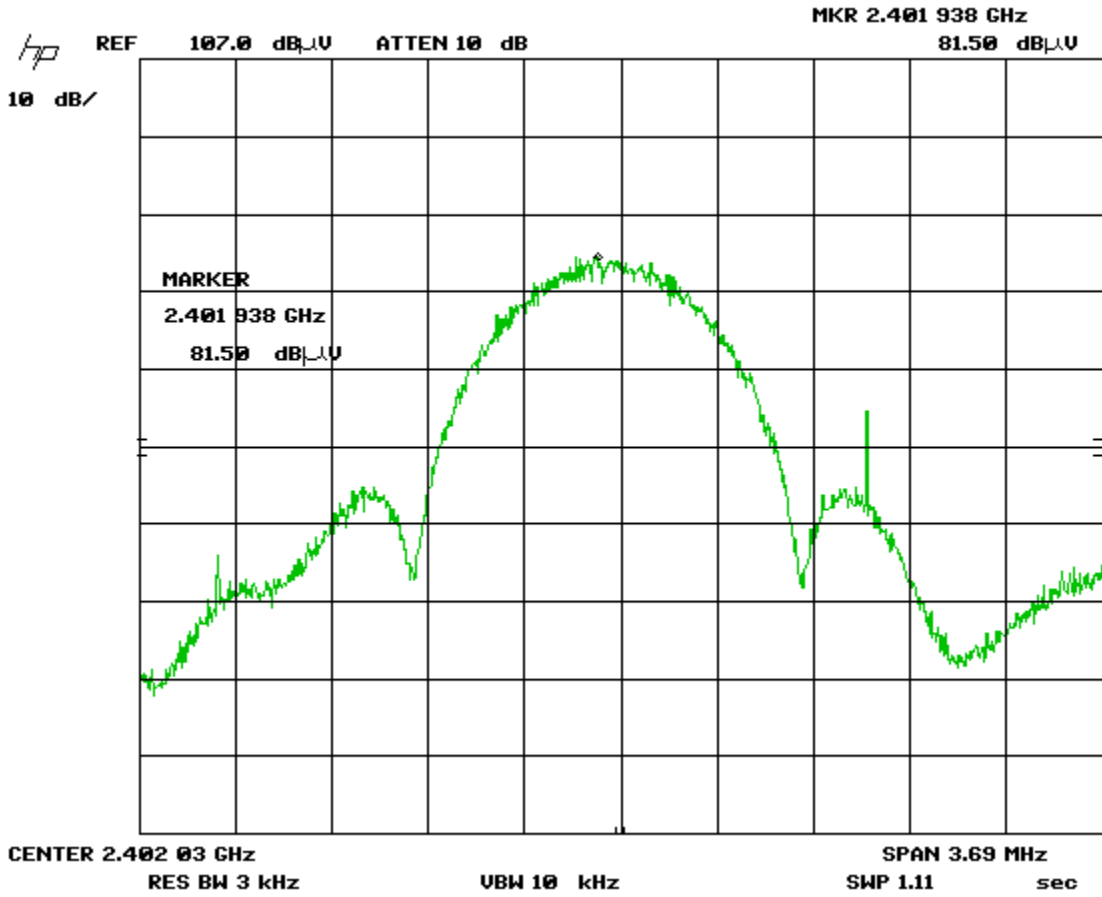

Client	Digi International	
Product	Digi Bluenica HoneyBee	
Standard(s)	FCC Part 15 Subpart C 15:2015 / RSS-247:2015	

Middle Channel
Vertical Antenna Polarity

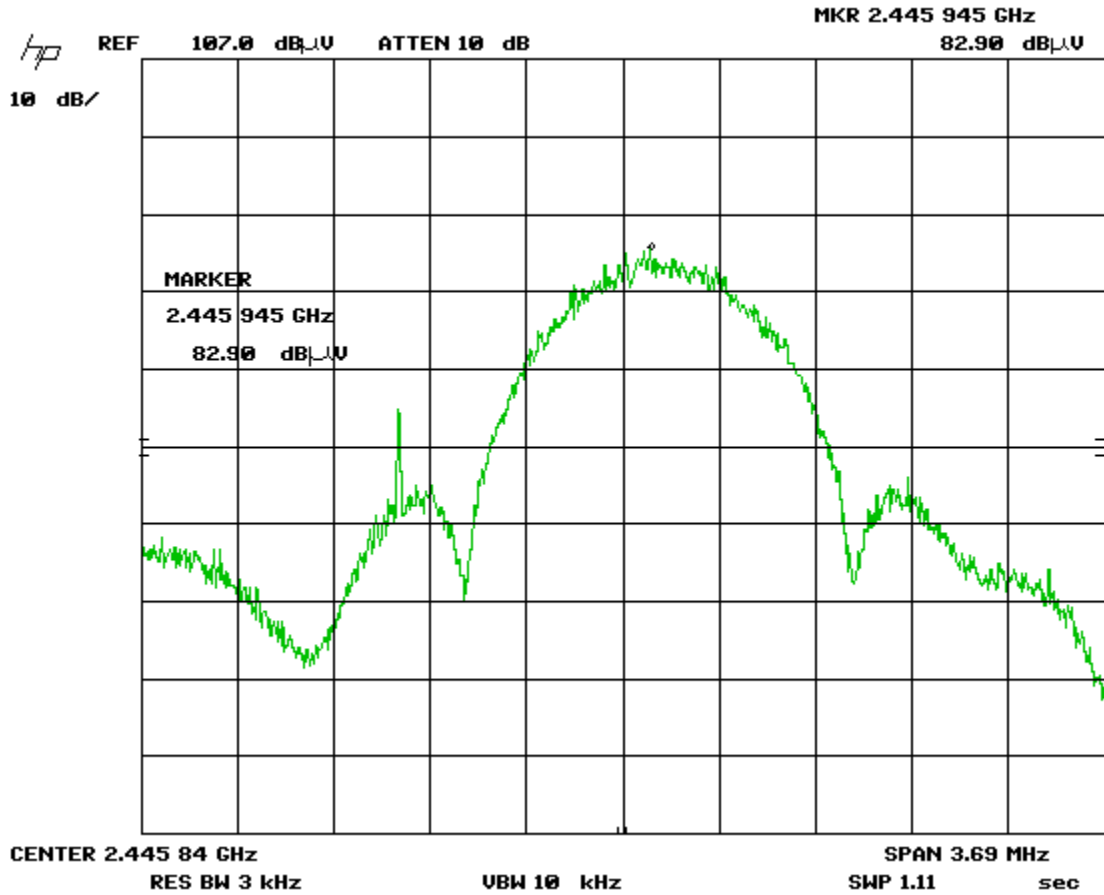

Client	Digi International	
Product	Digi Bluenica HoneyBee	
Standard(s)	FCC Part 15 Subpart C 15:2015 / RSS-247:2015	

Middle Channel
Horizontal Antenna Polarity

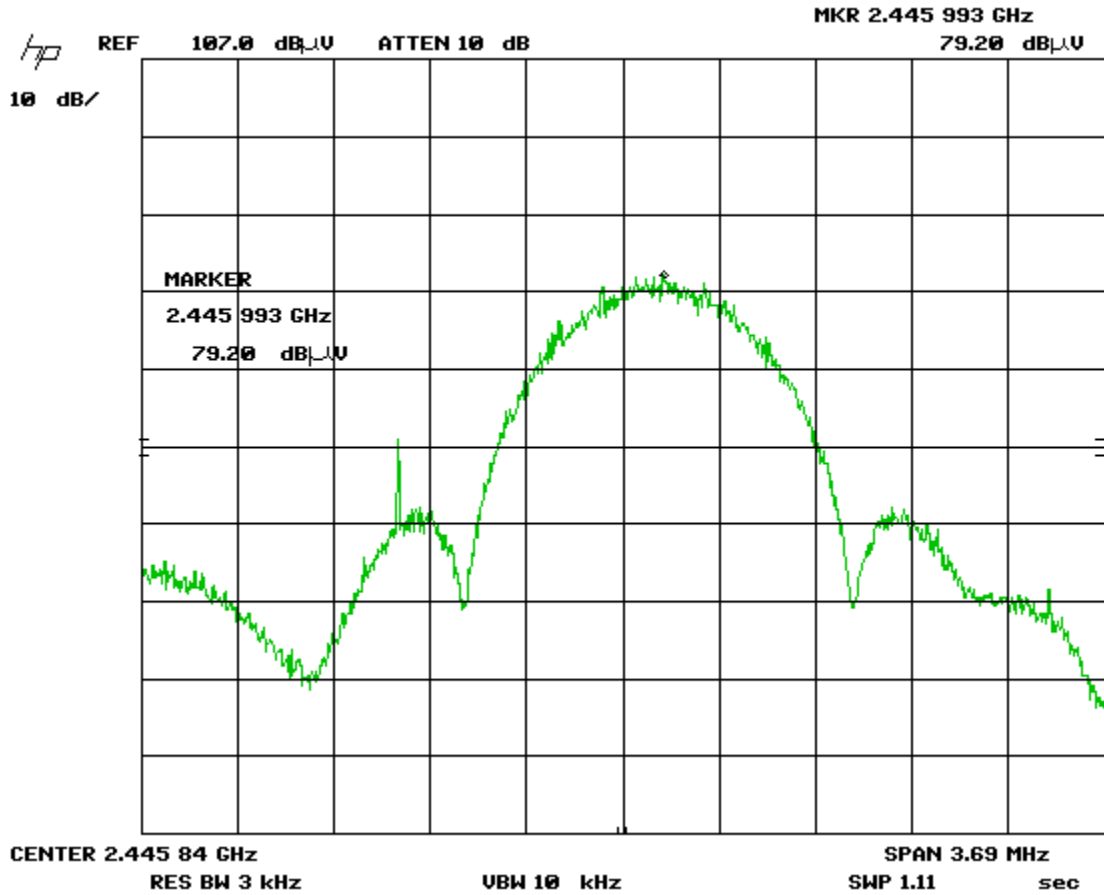

Client	Digi International	
Product	Digi Bluenica HoneyBee	
Standard(s)	FCC Part 15 Subpart C 15:2015 / RSS-247:2015	

High Channel
Vertical Antenna Polarity

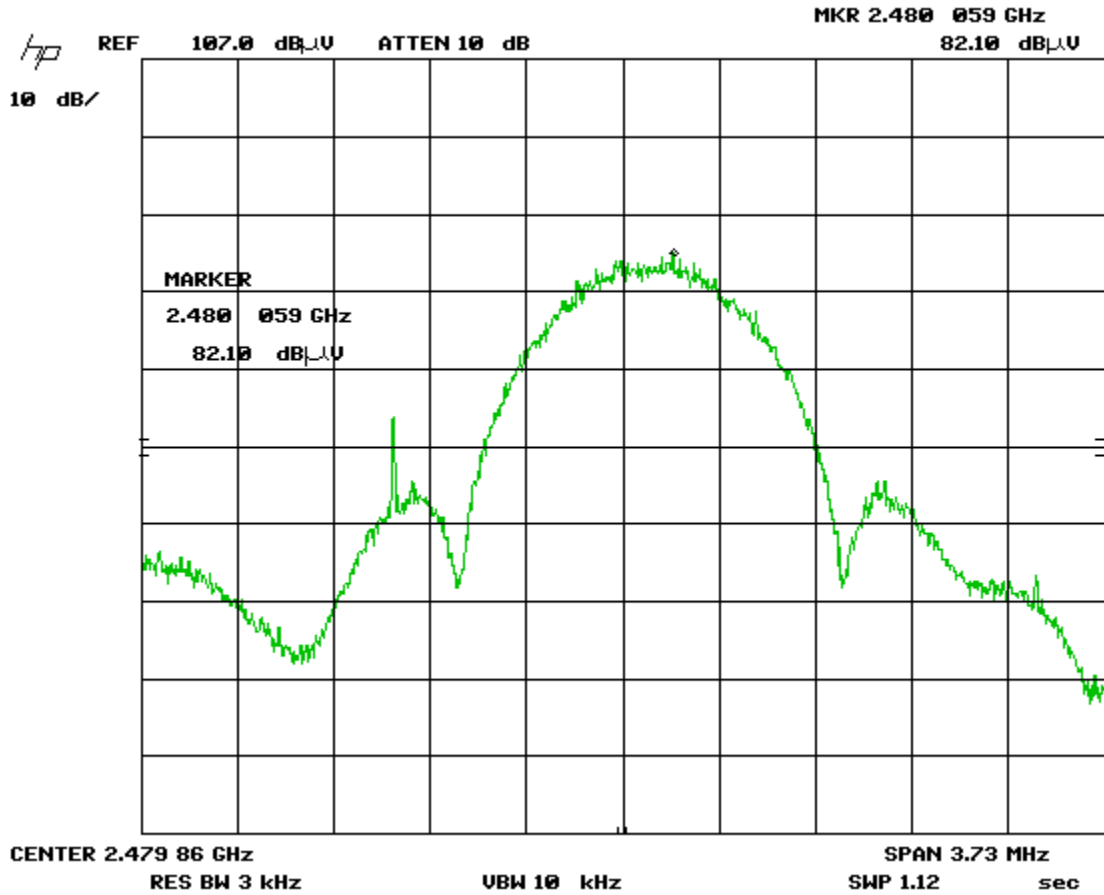

Client	Digi International	
Product	Digi Bluenica HoneyBee	
Standard(s)	FCC Part 15 Subpart C 15:2015 / RSS-247:2015	

High Channel
Horizontal Antenna Polarity

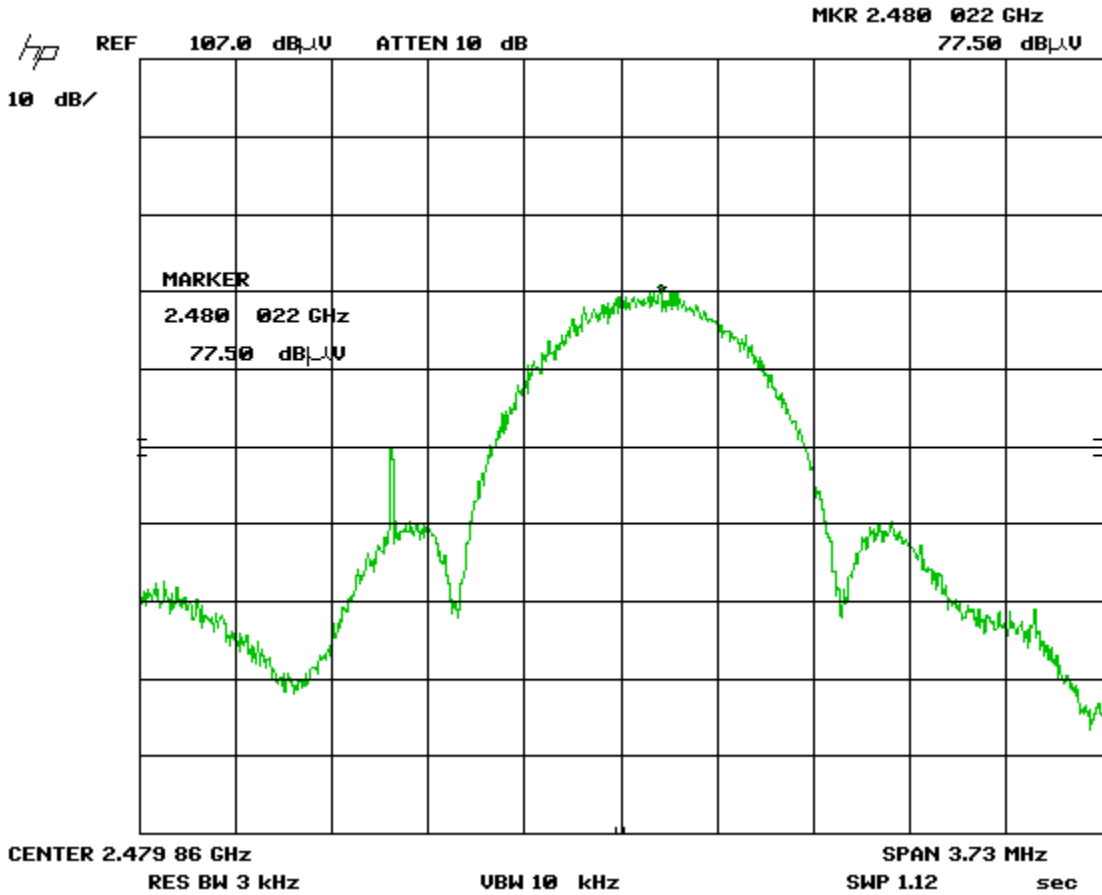

Client	Digi International	
Product	Digi Bluenica HoneyBee	
Standard(s)	FCC Part 15 Subpart C 15:2015 / RSS-247:2015	

Test Equipment List

Equipment	Model No.	Manufacturer	Last calibration date	Next calibration due date	Asset #
Spectrum Analyzer	8566B	HP	Oct 9, 2014	Oct 9, 2016	GEMC 193
Quasi-Peak Adapter	85650A	HP	May 22, 2014	May 22, 2016	GEMC 194
Horn Antenna	WBH218HN	Q-par	Jan. 23, 2014	Jan. 23, 2016	GEMC 6375
Pre-amp	HP 8449B	HP	Sept. 9, 2014	Sept. 9, 2016	GEMC 6351
RF Cable 7m	LMR-400-7M-50OHM-MN-MN	LexTec	NCR	NCR	GEMC 28
RF Cable 1m	LMR-400-1M-50OHM-MN-MN	LexTec	NCR	NCR	GEMC 29

This report module is based on GEMC template "FCC – Power Line Conducted Emissions Class B_Rev1"

Client	Digi International	
Product	Digi Bluenica HoneyBee	
Standard(s)	FCC Part 15 Subpart C 15:2015 / RSS-247:2015	

Radiated Emissions – 15.247, 15.209

Purpose

The purpose of this test is to ensure that the RF energy unintentionally emitted from the EUT does not exceed the limits listed below as defined in the applicable test standard, as measured from a receiving antenna. This helps protect broadcast radio services such as television, FM radio, pagers, cellular telephones, emergency services, and so on, from unwanted interference.

Limit(s) and Method

The method is as defined in ANSI C63.4:2009.

The limits are as defined in FCC Part 15, Section 15.209 and RSS-Gen 8.9 (Table 4 & 5):

The limits, as defined in FCC 15.247(d) for unintentional radiated emissions apply for those emissions that fall in the restricted bands, as defined in FCC Section 15.205(a). These emissions must comply with the radiated emission limits specified in Section 15.209(a).

0.009 MHz – 0.490 MHz, 2400/F(kHz) uV/m at 300 m¹
0.490 MHz – 1.705 MHz, 24000/F(kHz) uV/m at 30 m¹
1.705 MHz – 30 MHz, 30 uV/m at 30 m¹
30 MHz – 88 MHz, 100 uV/m (40.0 dBuV/m¹) at 3 m
88 MHz – 216 MHz, 150 uV/m (43.5 dBuV/m¹) at 3 m
216 MHz – 960 MHz, 200 uV/m (46.0 dBuV/m¹) at 3 m
Above 960 MHz, 500 uV/m (54.0 dBuV/m¹) at 3 m
Above 1000 MHz, 500 uV/m (54 dBuV/m²) at 3m
Above 1000 MHz, 500 uV/m (74 dBuV/m³) at 3m

¹Limit is with Quasi Peak detector with bandwidths as defined in CISPR-16-1-1.

²Limit is with 1 MHz measurement bandwidth and using an Average detector.

³Limit is with 1 MHz measurement bandwidth and using a Peak detector.

Client	Digi International	
Product	Digi Bluenica HoneyBee	
Standard(s)	FCC Part 15 Subpart C 15:2015 / RSS-247:2015	

Typical Radiated Emissions Setup

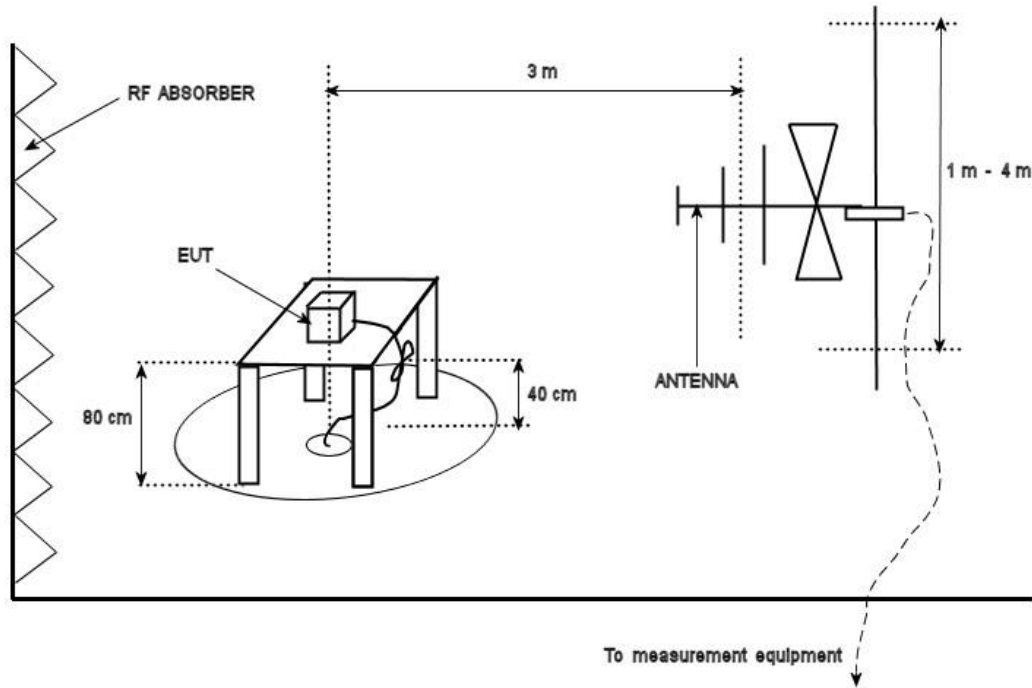

Measurement Uncertainty

The expanded measurement uncertainty is calculated in accordance with CISPR 16-4-2 and is +/-4.4 dB with a 'k=2' coverage factor and a 95% confidence level.

Preliminary Graphs

Note the graphs shown below are for graphical illustration only. For final measurements with the appropriate detector, please refer to the final measurement table where applicable. The graphs shown below are maximized peak measurement graphs, measured with a resolution bandwidth greater than or equal to, the final required detector and over a full 0-360° rotation. This peaking process is done as a worst case measurement. This process enables the detection of frequencies of concern for final measurement, and provides considerable time savings.

In accordance with FCC Part 15, Subpart A, Section 15.33, the device was scanned to the 10th harmonic.

Client	Digi International	
Product	Digi Bluenica HoneyBee	
Standard(s)	FCC Part 15 Subpart C 15:2015 / RSS-247:2015	

Devices tested may be scanned at alternate test distances, and in accordance with FCC Part 15, Subpart A, Section 15.31, an extrapolation factor of 20 dB/decade was used above 30 MHz and 40 dB/decade below 30 MHz. For example for 1 meter measurements, an extrapolation factor 9.5 dB from 20 Log (1m/3m) is applied.

See final measurement section for all measurements.

Low, middle, and high channels were scanned. Worst case is presented.

The BLE transmitter is active and constantly transmitting modulated data at maximum power during testing.

Plots and measurements are made at a 3 meter distance.

Client	Digi International	
Product	Digi Bluenica HoneyBee	
Standard(s)	FCC Part 15 Subpart C 15:2015 / RSS-247:2015	

Peak Emissions Graph
9 kHz to 150 kHz

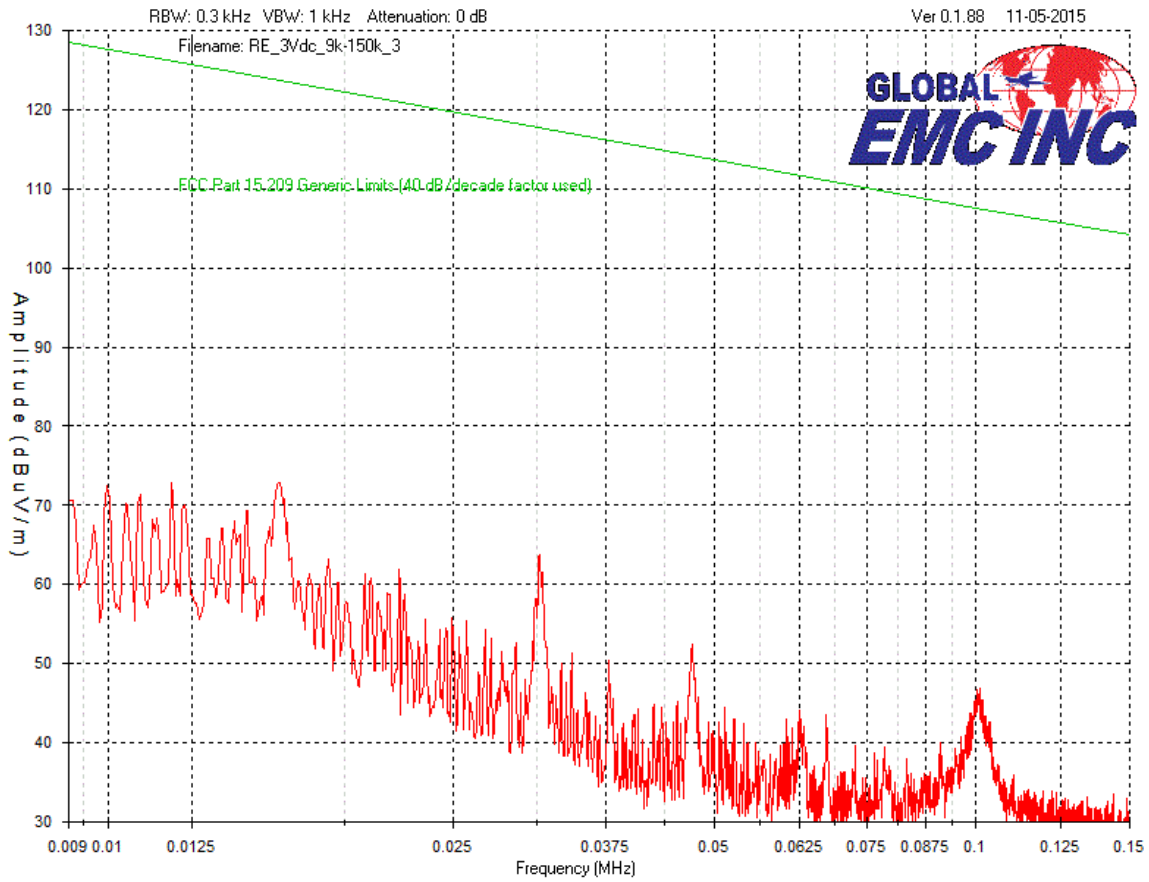

Client	Digi International	
Product	Digi Bluenica HoneyBee	
Standard(s)	FCC Part 15 Subpart C 15:2015 / RSS-247:2015	

Peak Emissions Graph
150 kHz to 30 MHz

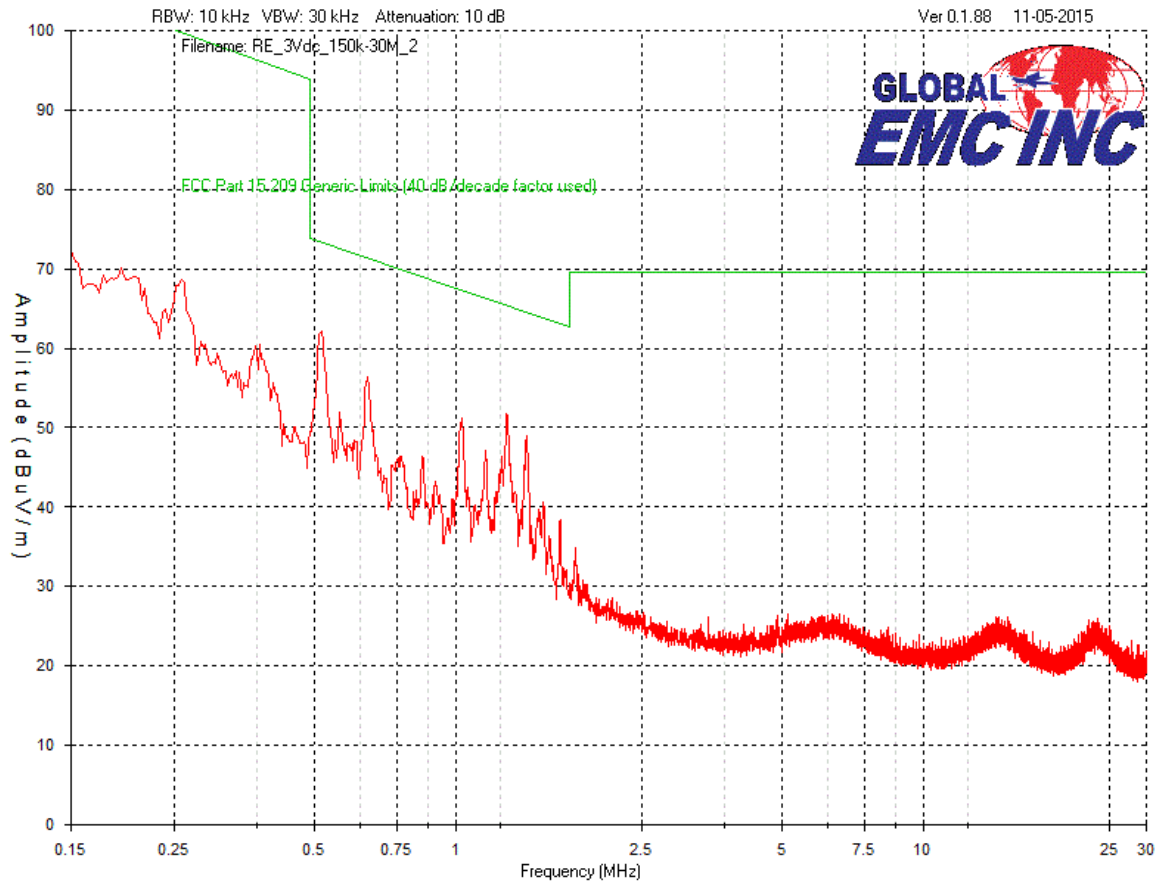

Client	Digi International	
Product	Digi Bluenica HoneyBee	
Standard(s)	FCC Part 15 Subpart C 15:2015 / RSS-247:2015	

Peak Emissions Graph
Vertical Antenna Polarity
30 MHz to 1 GHz

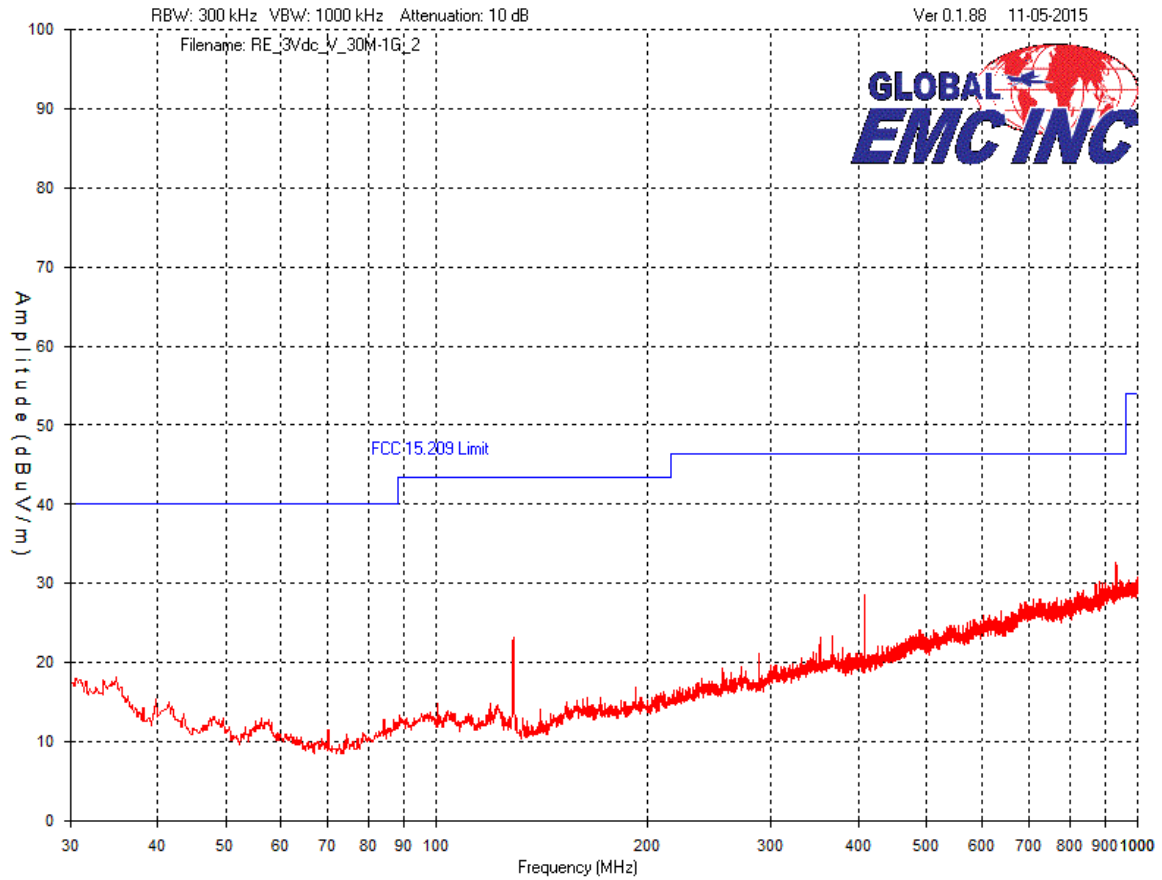

Client	Digi International	
Product	Digi Bluenica HoneyBee	
Standard(s)	FCC Part 15 Subpart C 15:2015 / RSS-247:2015	

Peak Emissions Graph
Horizontal Antenna Polarity
30 MHz to 1 GHz

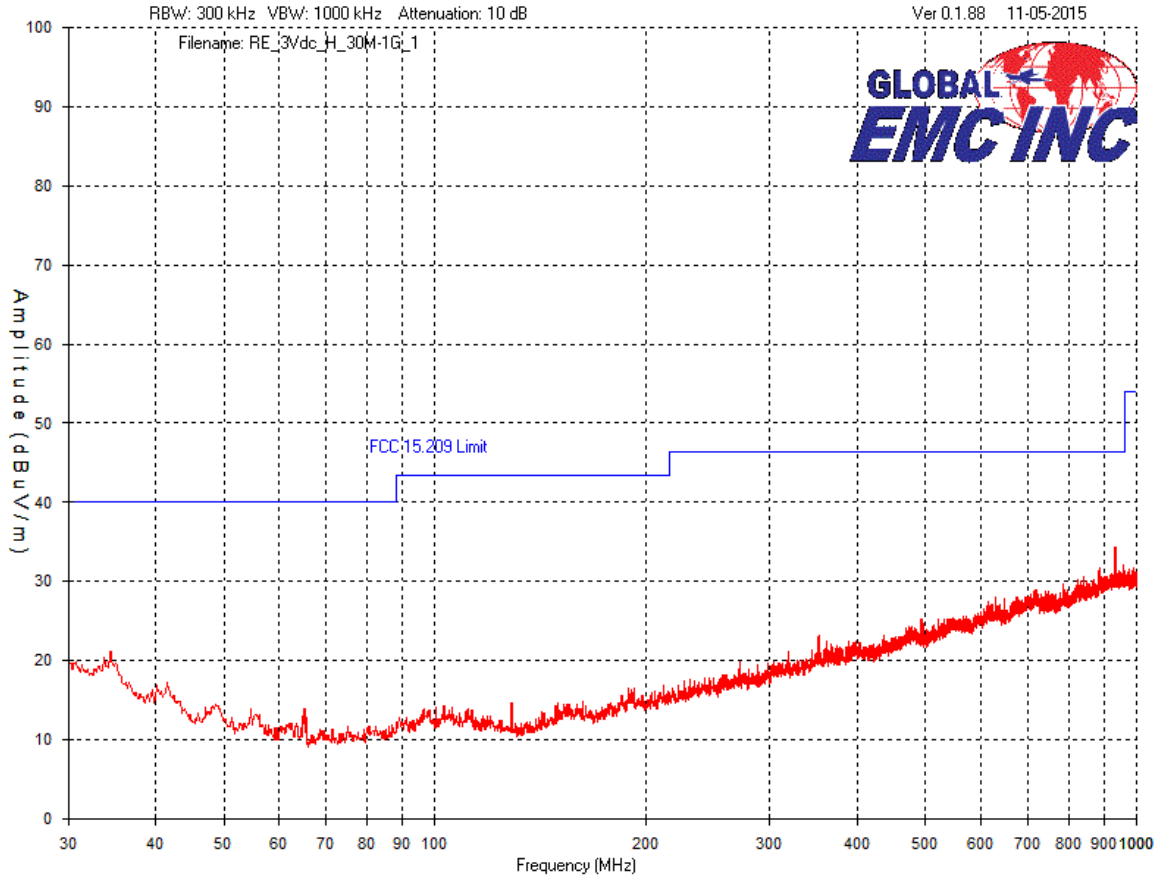

Client	Digi International	
Product	Digi Bluenica HoneyBee	
Standard(s)	FCC Part 15 Subpart C 15:2015 / RSS-247:2015	

Peak Emissions Graph
Vertical Antenna Polarity
1 GHz to 2 GHz

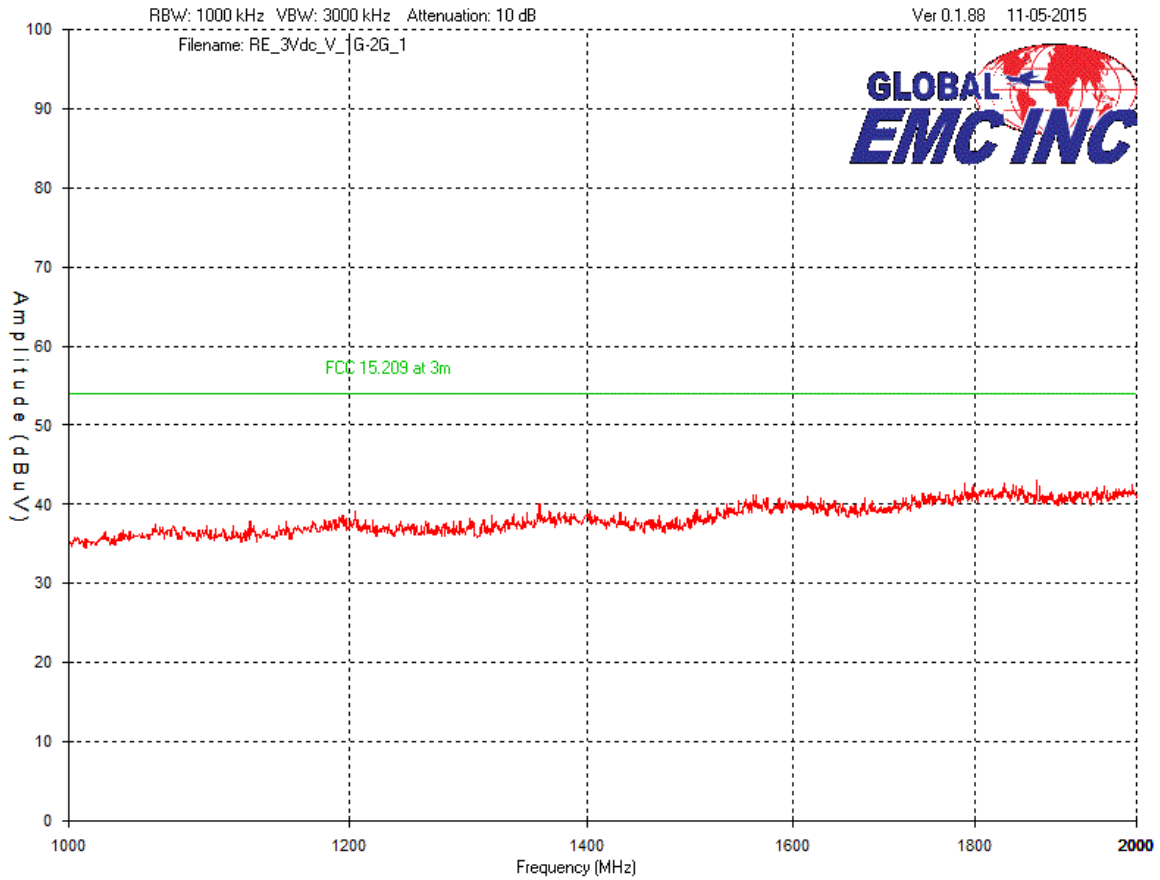

Client	Digi International	
Product	Digi Bluenica HoneyBee	
Standard(s)	FCC Part 15 Subpart C 15:2015 / RSS-247:2015	

Peak Emissions Graph
Horizontal Antenna Polarity
1 GHz to 2 GHz

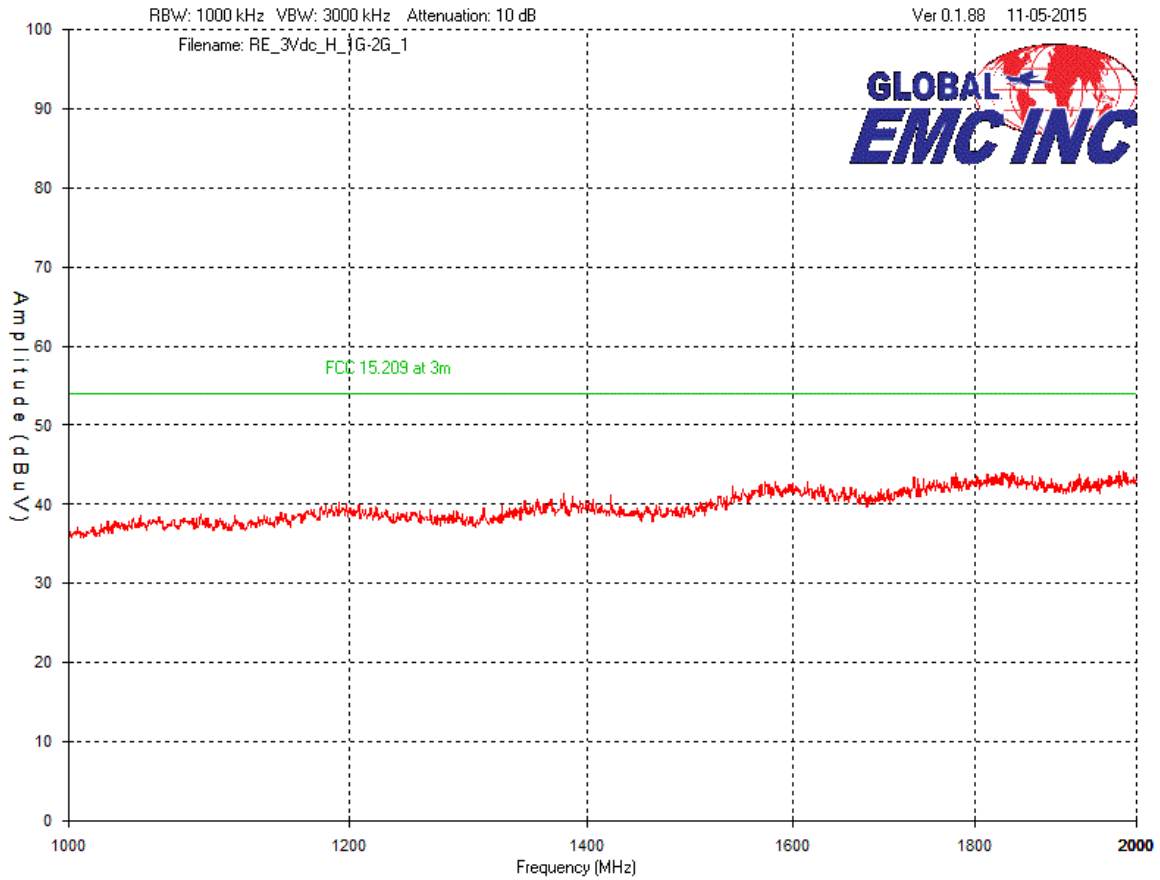

Client	Digi International	
Product	Digi Bluenica HoneyBee	
Standard(s)	FCC Part 15 Subpart C 15:2015 / RSS-247:2015	

Peak Emissions Graph
 Vertical Antenna Polarity
 2 GHz to 10 GHz

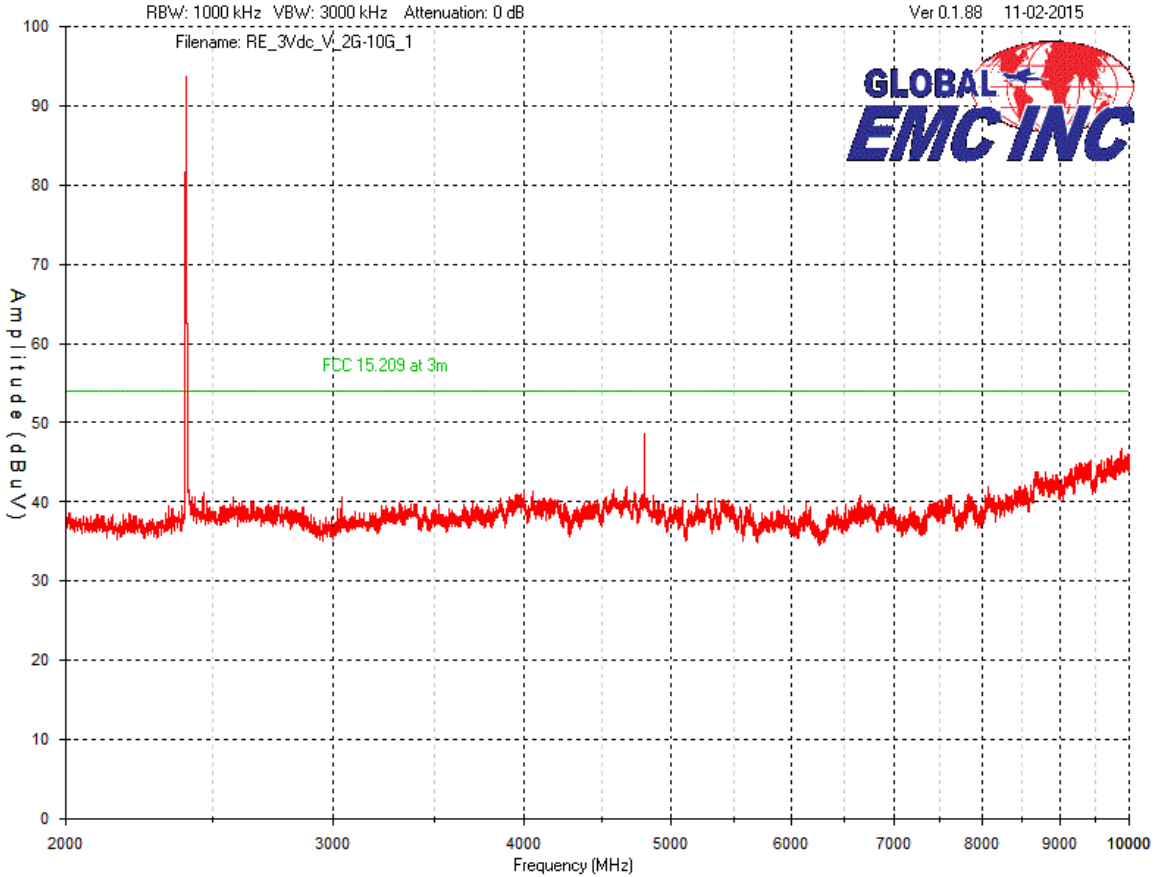

Note: Peak between 2000 MHz and 3000 MHz is the intentional transmission of the BLE at 2.4 GHz.

Client	Digi International	
Product	Digi Bluenica HoneyBee	
Standard(s)	FCC Part 15 Subpart C 15:2015 / RSS-247:2015	

Peak Emissions Graph
Horizontal Antenna Polarity
2 GHz to 10 GHz

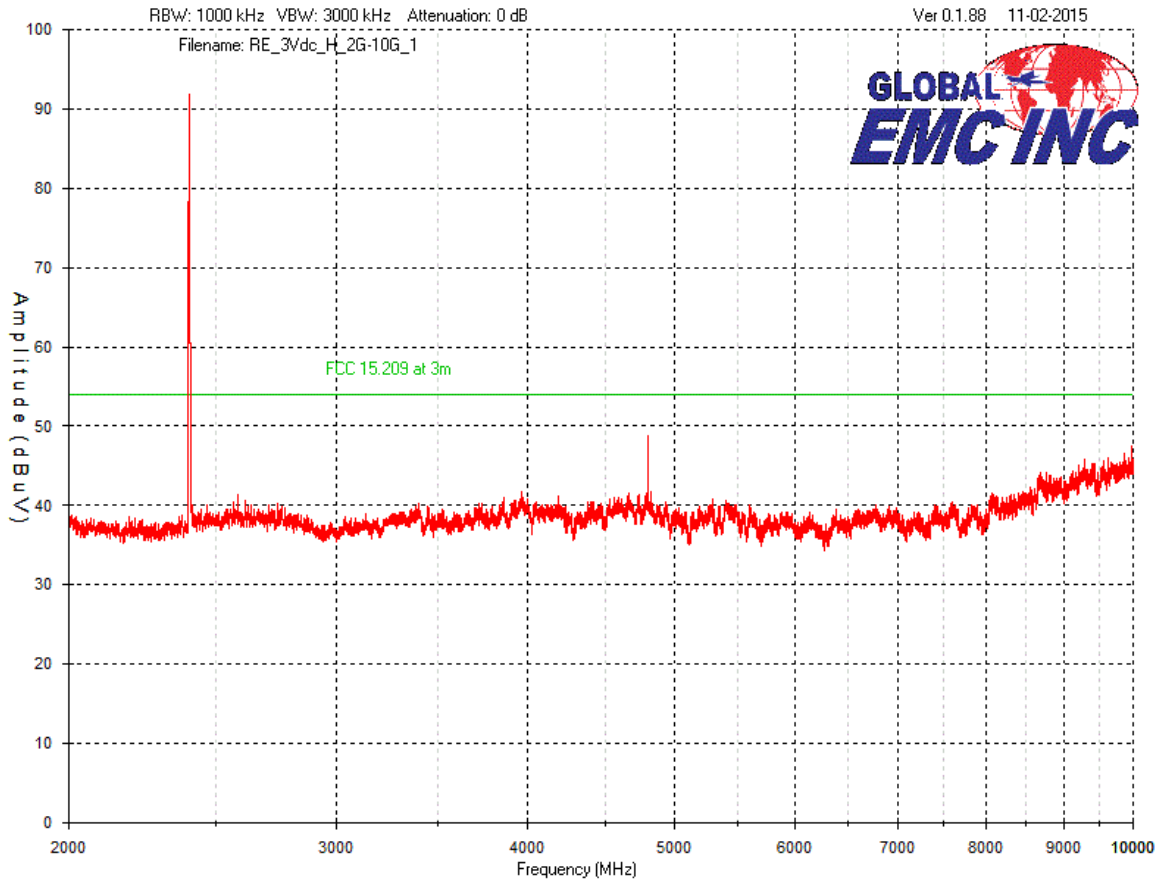

Note: Peak between 2000 MHz and 3000 MHz is the intentional transmission of the BLE at 2.4 GHz.

Client	Digi International	
Product	Digi Bluenica HoneyBee	
Standard(s)	FCC Part 15 Subpart C 15:2015 / RSS-247:2015	

Peak Emissions Graph
 Vertical Antenna Polarity
 10 GHz to 14 GHz

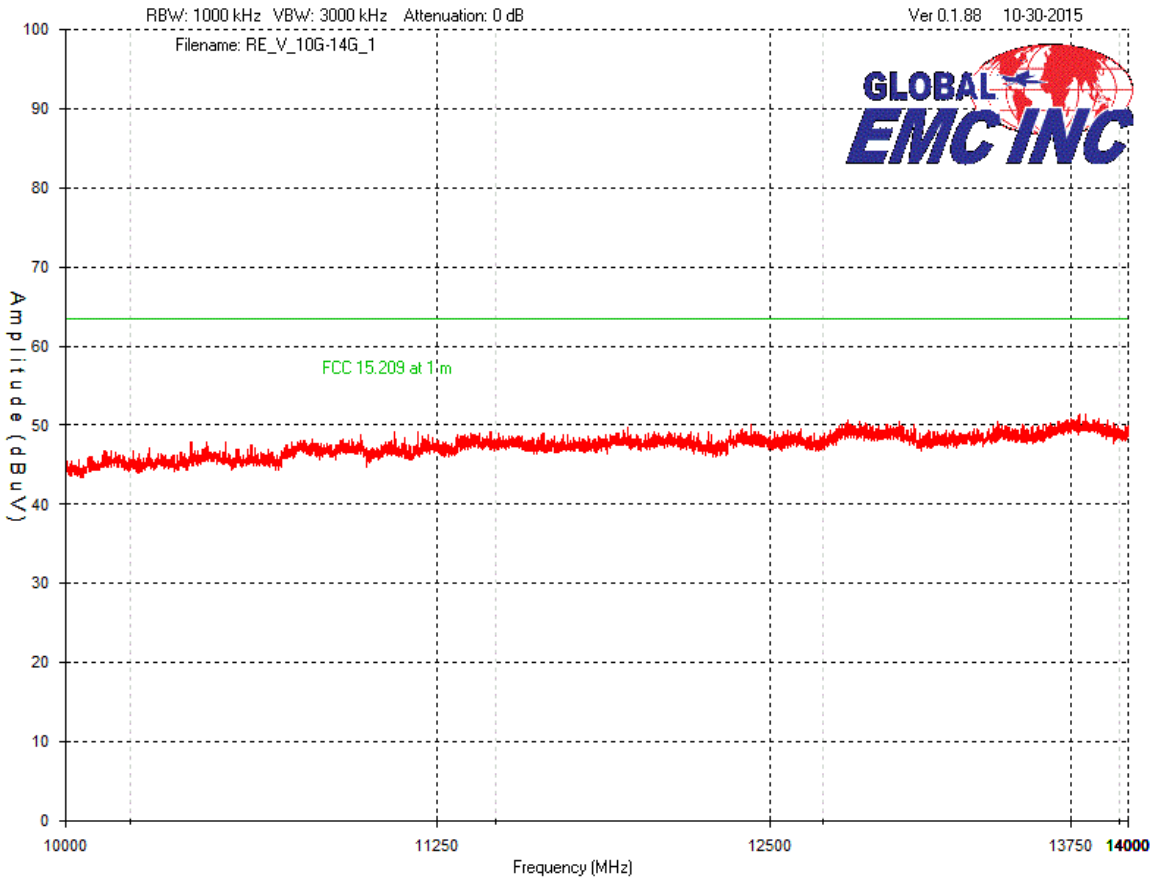

Client	Digi International	
Product	Digi Bluenica HoneyBee	
Standard(s)	FCC Part 15 Subpart C 15:2015 / RSS-247:2015	

Peak Emissions Graph
Horizontal Antenna Polarity
10 GHz to 14 GHz

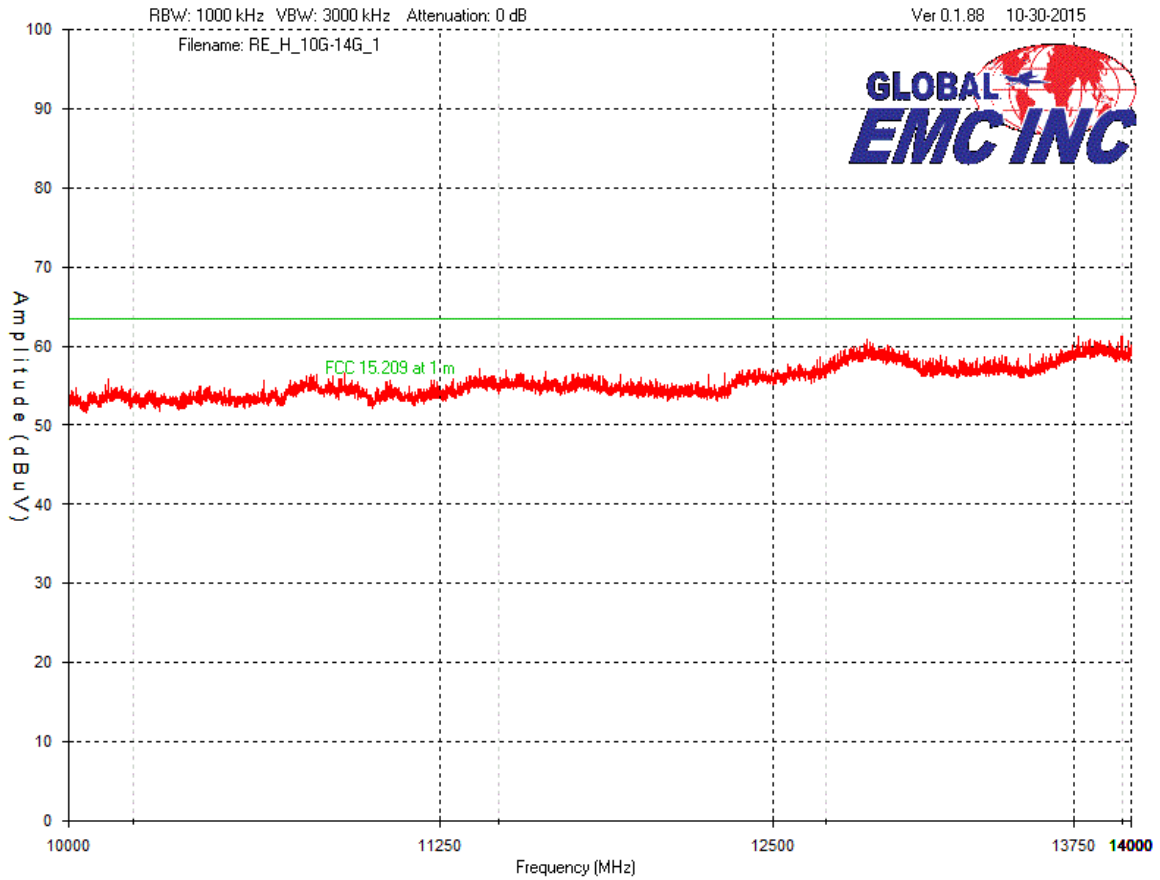

Client	Digi International	
Product	Digi Bluenica HoneyBee	
Standard(s)	FCC Part 15 Subpart C 15:2015 / RSS-247:2015	

Peak Emissions Graph
 Vertical Antenna Polarity
 14 GHz to 18 GHz

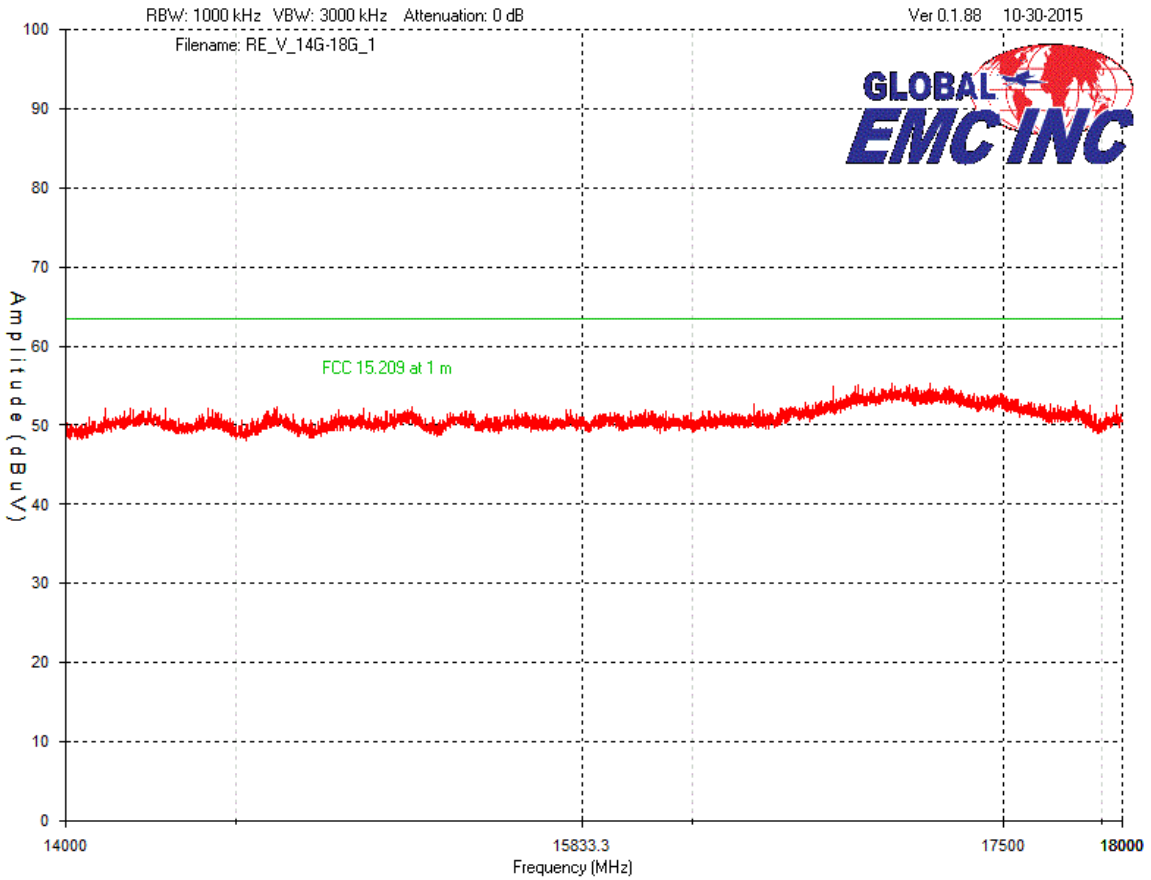

Client	Digi International	
Product	Digi Bluenica HoneyBee	
Standard(s)	FCC Part 15 Subpart C 15:2015 / RSS-247:2015	

Peak Emissions Graph
Horizontal Antenna Polarity
14 GHz to 18 GHz

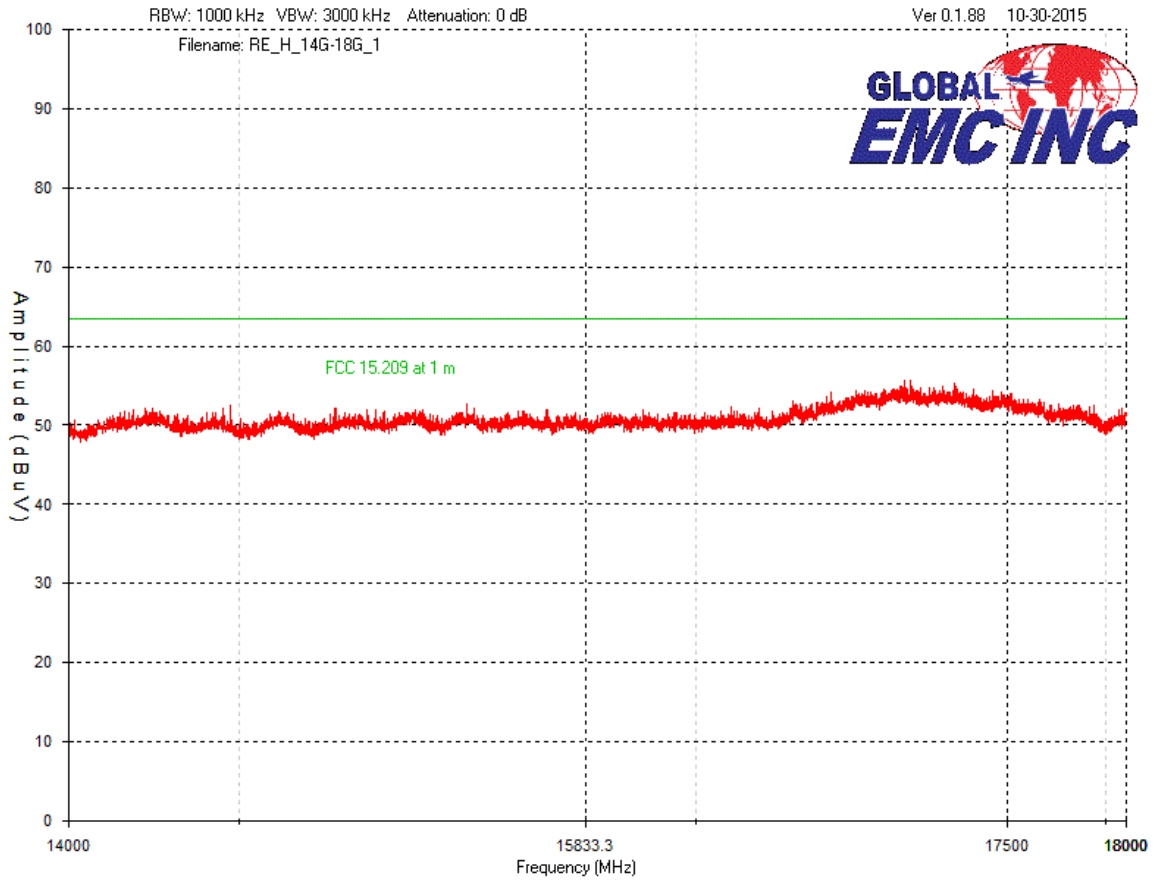

Client	Digi International	
Product	Digi Bluenica HoneyBee	
Standard(s)	FCC Part 15 Subpart C 15:2015 / RSS-247:2015	

Peak Emissions Graph
Vertical Antenna Polarity
18 GHz to 26.5 GHz

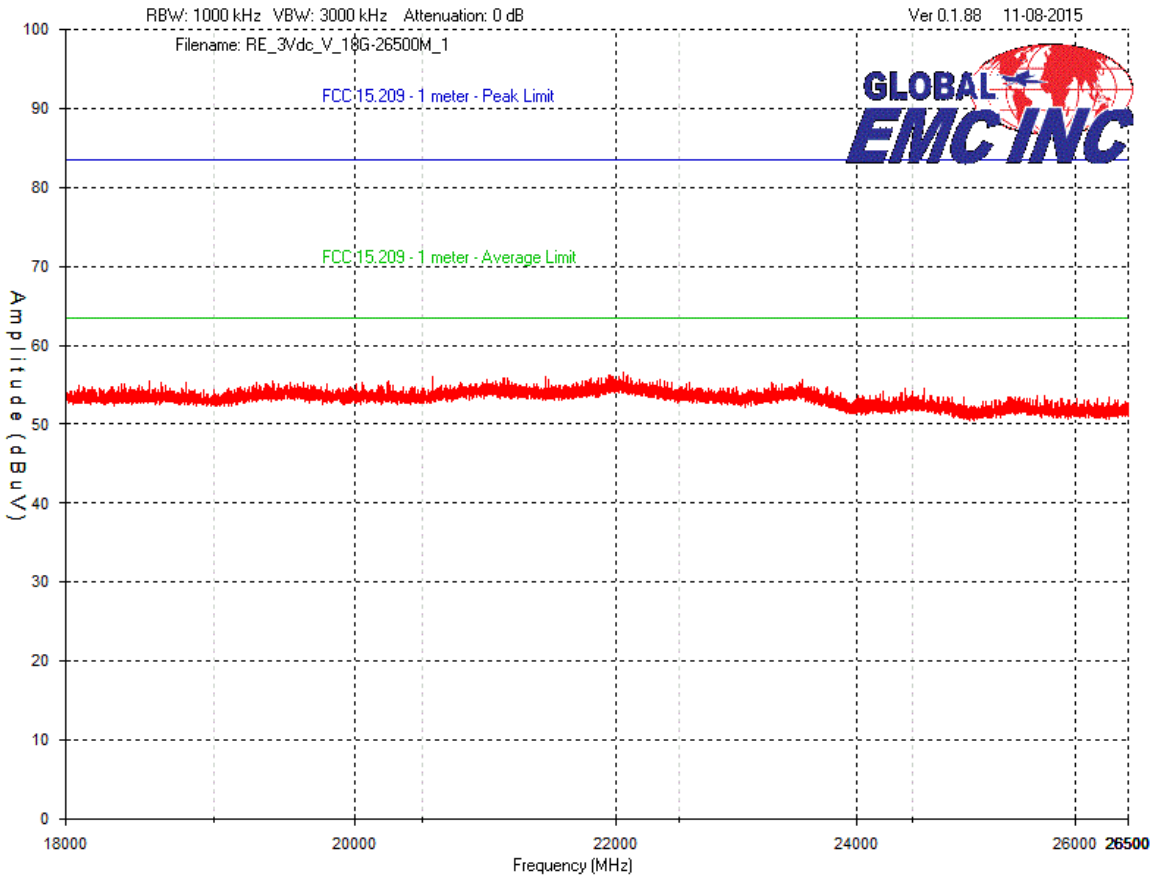

Client	Digi International	
Product	Digi Bluenica HoneyBee	
Standard(s)	FCC Part 15 Subpart C 15:2015 / RSS-247:2015	

Peak Emissions Graph
Horizontal Antenna Polarity
18 GHz to 26.5 GHz

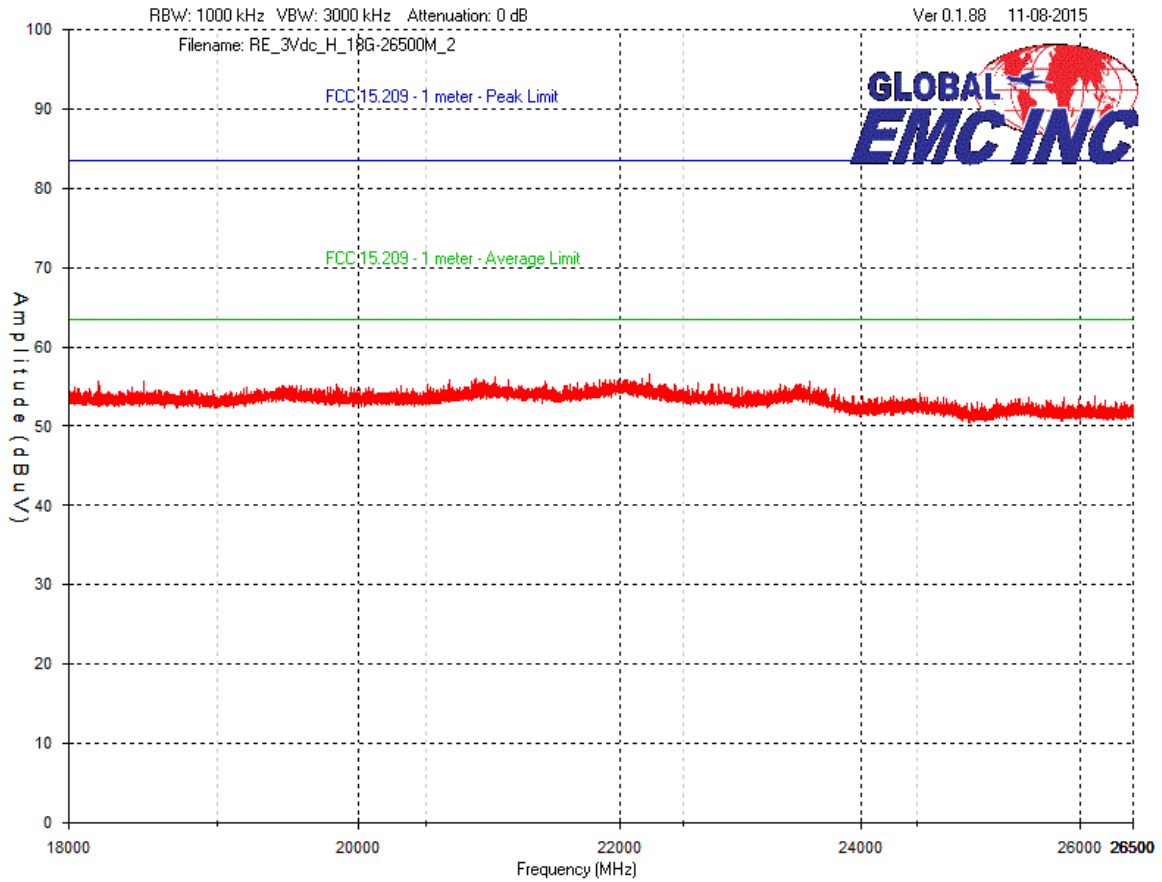

Client	Digi International	
Product	Digi Bluenica HoneyBee	
Standard(s)	FCC Part 15 Subpart C 15:2015 / RSS-247:2015	

Restricted Band Edges Emissions Graph (Peak)
 At 2.390 GHz, Horizontal Antenna Polarity
 Low Channel1 (2402 MHz)

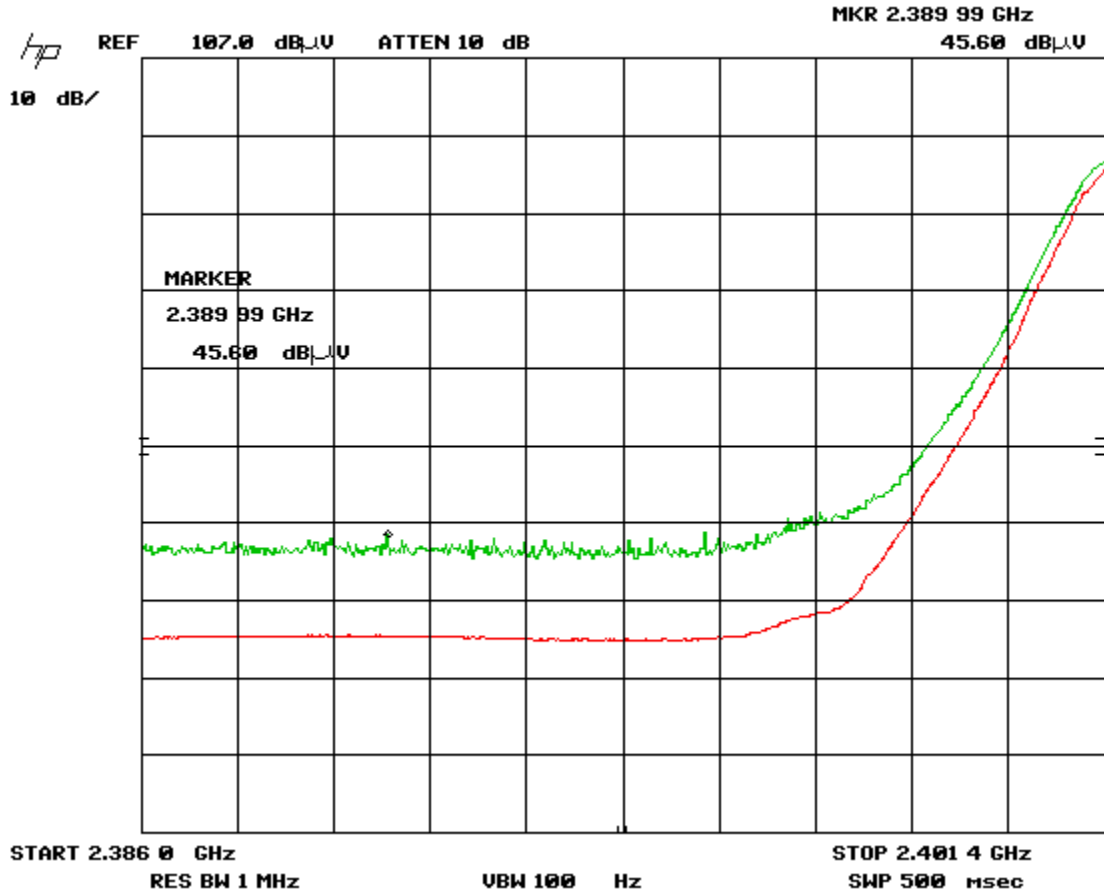

Client	Digi International	
Product	Digi Bluenica HoneyBee	
Standard(s)	FCC Part 15 Subpart C 15:2015 / RSS-247:2015	

Restricted Band Edges Emissions Graph (Average)
 At 2.390 GHz, Horizontal Antenna Polarity
 Low Channel1 (2402 MHz)

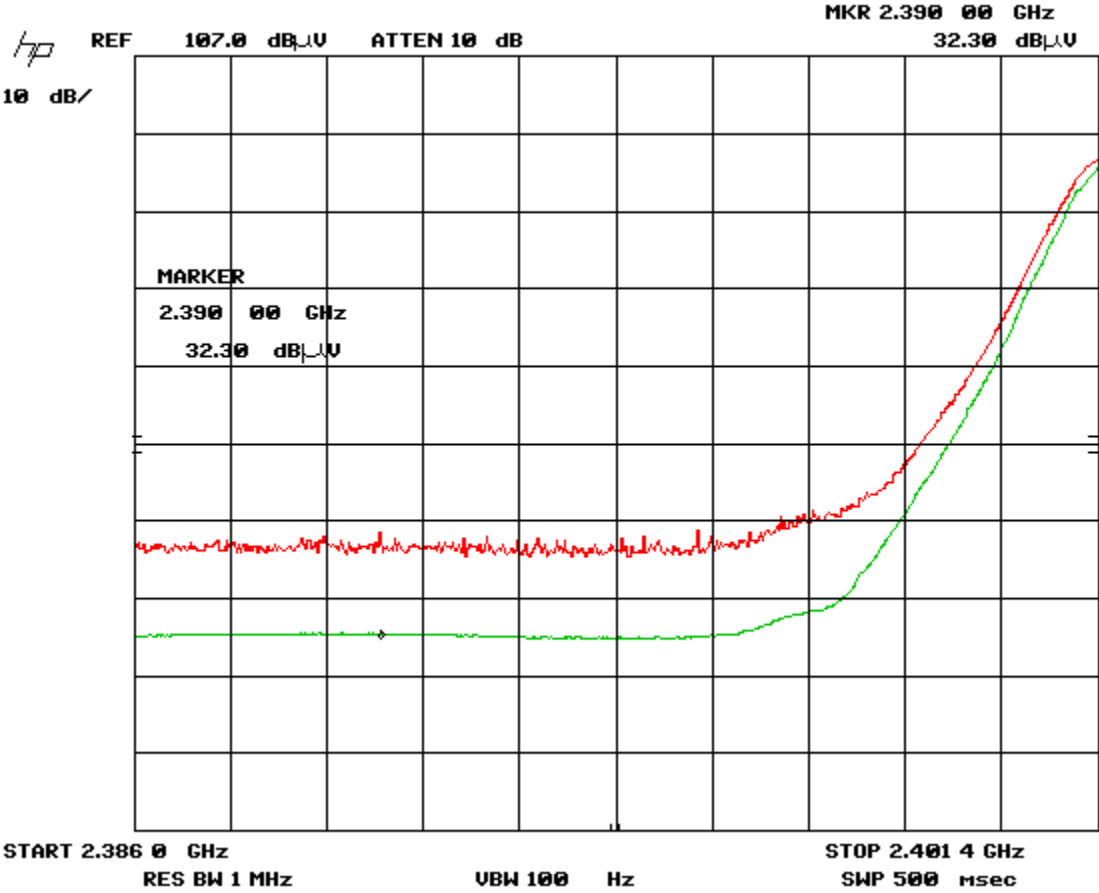

Client	Digi International	
Product	Digi Bluenica HoneyBee	
Standard(s)	FCC Part 15 Subpart C 15:2015 / RSS-247:2015	

Restricted Band Edges Emissions Graph (Peak)
 At 2.390 GHz, Vertical Antenna Polarity
 Low Channel1 (2402 MHz)

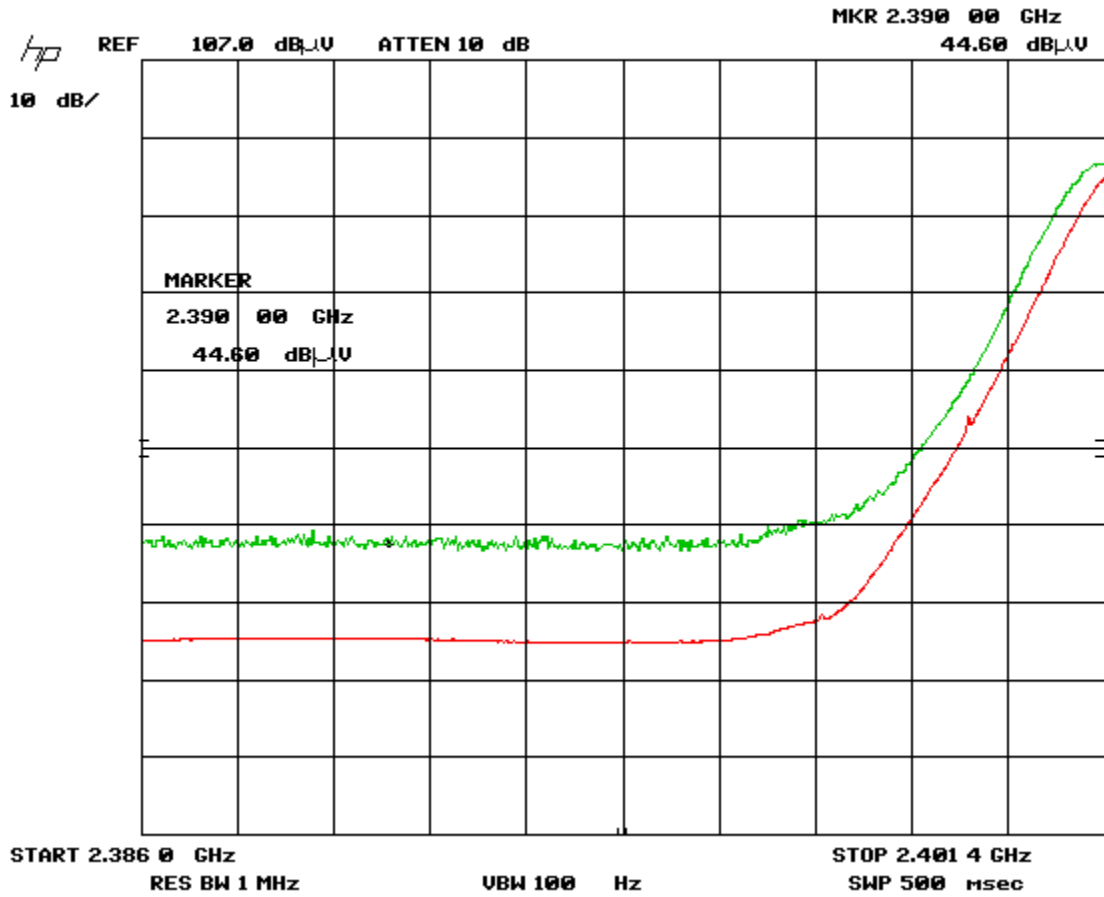

Client	Digi International	
Product	Digi Bluenica HoneyBee	
Standard(s)	FCC Part 15 Subpart C 15:2015 / RSS-247:2015	

Restricted Band Edges Emissions Graph (Average)
 At 2.390 GHz, Vertical Antenna Polarity
 Low Channel1 (2402 MHz)

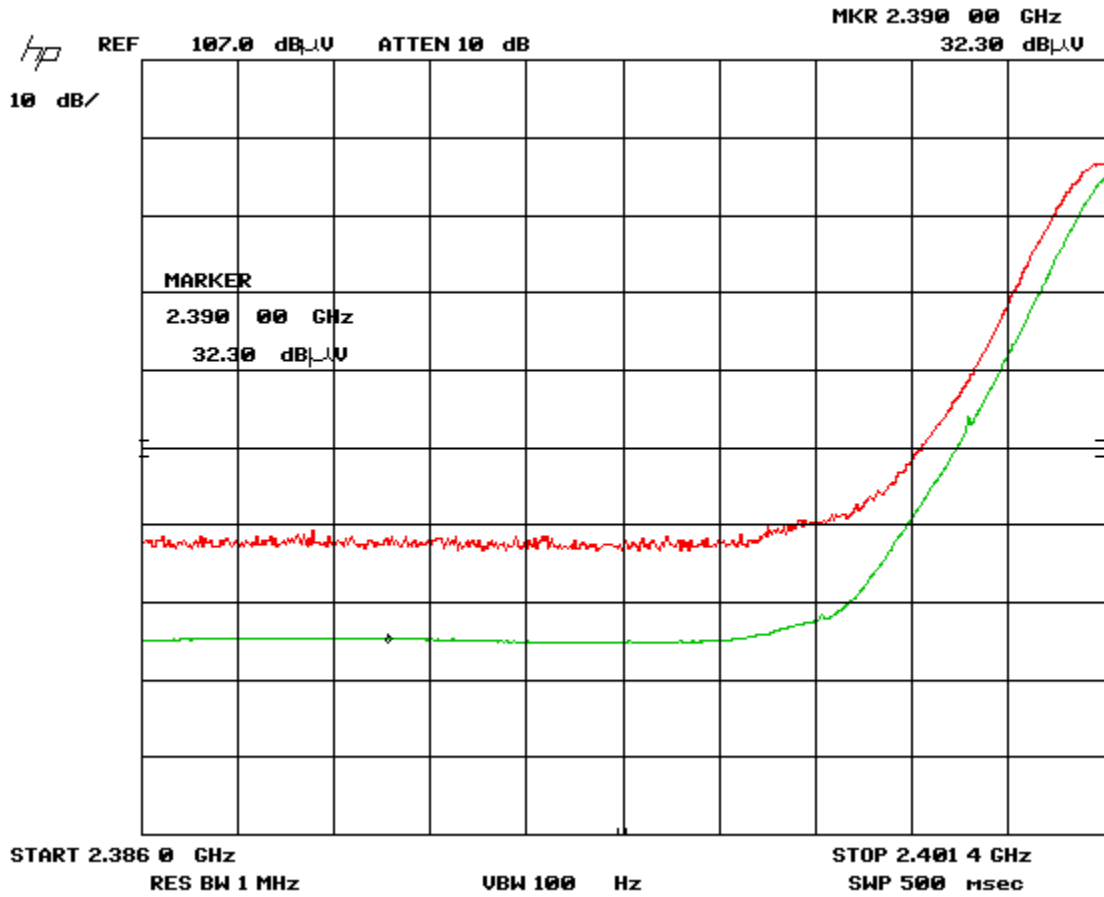

Client	Digi International	
Product	Digi Bluenica HoneyBee	
Standard(s)	FCC Part 15 Subpart C 15:2015 / RSS-247:2015	

Restricted Band Edges Emissions Graph (Peak)
 At 2.4835 GHz, Horizontal Antenna Polarity
 High Channel1 (2480 MHz)

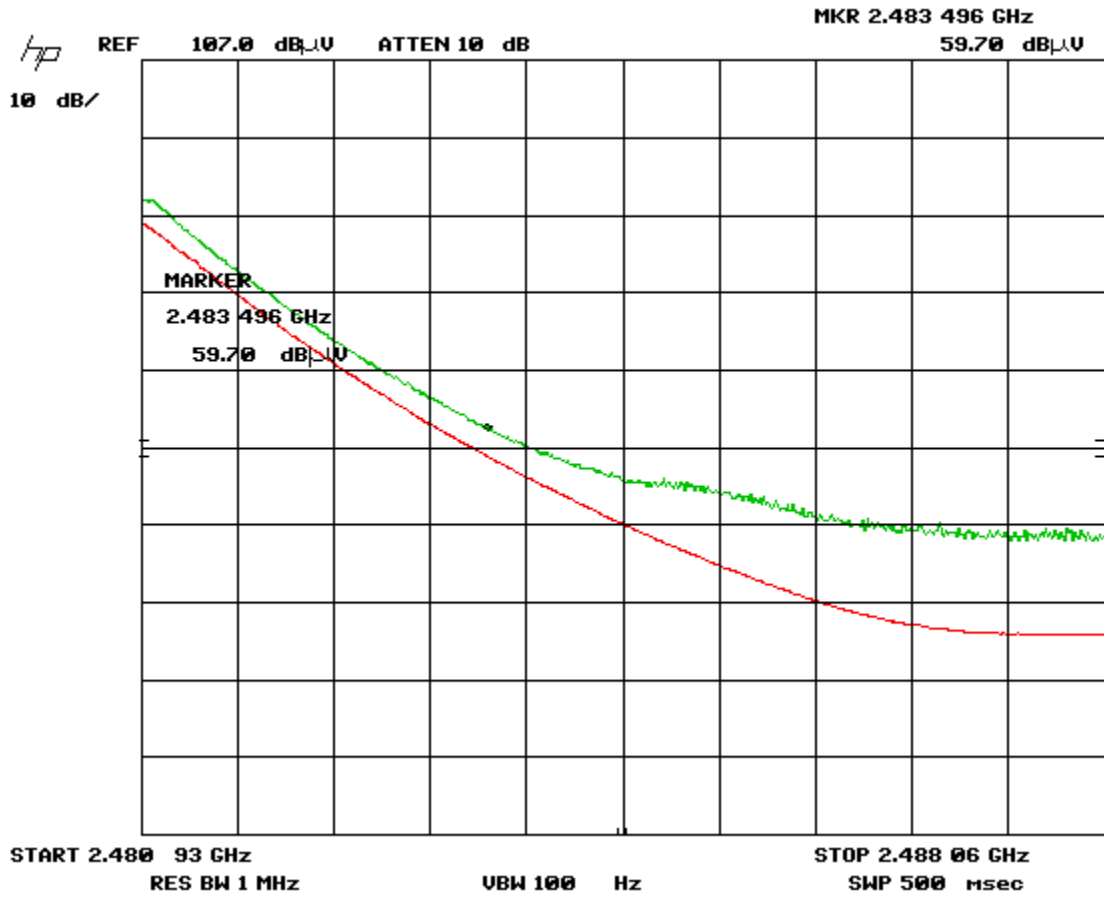

Client	Digi International	
Product	Digi Bluenica HoneyBee	
Standard(s)	FCC Part 15 Subpart C 15:2015 / RSS-247:2015	

Restricted Band Edges Emissions Graph (Average)
 At 2.4835 GHz, Horizontal Antenna Polarity
 High Channel1 (2480 MHz)

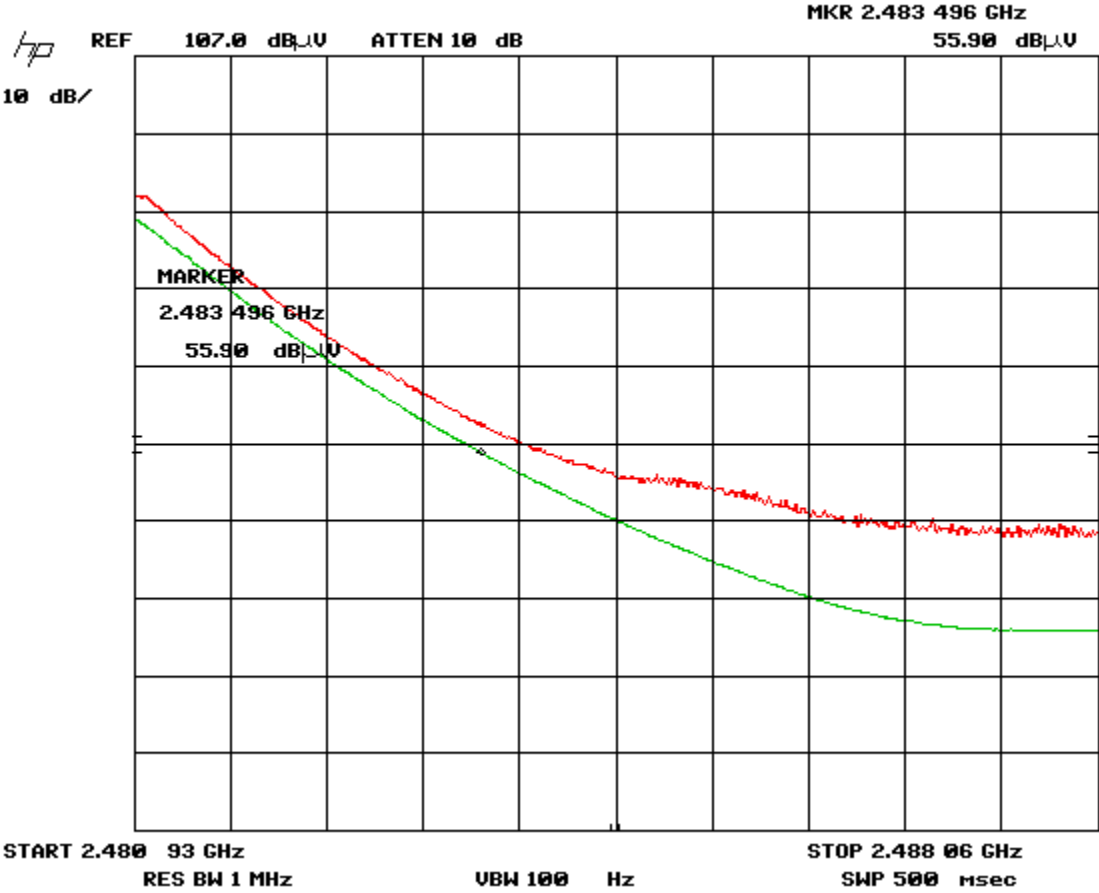

Client	Digi International	
Product	Digi Bluenica HoneyBee	
Standard(s)	FCC Part 15 Subpart C 15:2015 / RSS-247:2015	

Restricted Band Edges Emissions Graph (Peak)
 At 2.4835 GHz, Vertical Antenna Polarity
 High Channel 1

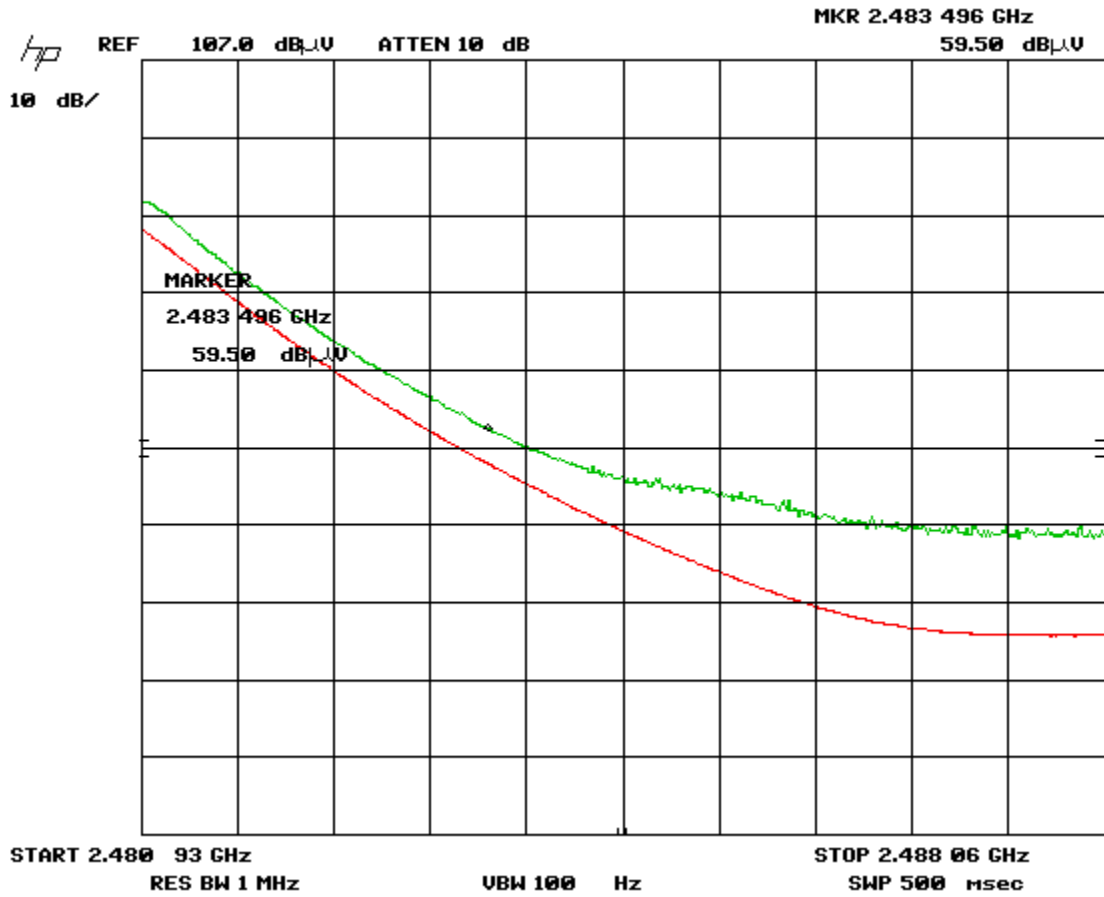

Client	Digi International	
Product	Digi Bluenica HoneyBee	
Standard(s)	FCC Part 15 Subpart C 15:2015 / RSS-247:2015	

Restricted Band Edges Emissions Graph (Average)
 At 2.4835 GHz, Vertical Antenna Polarity
 High Channel1 (2480 MHz)

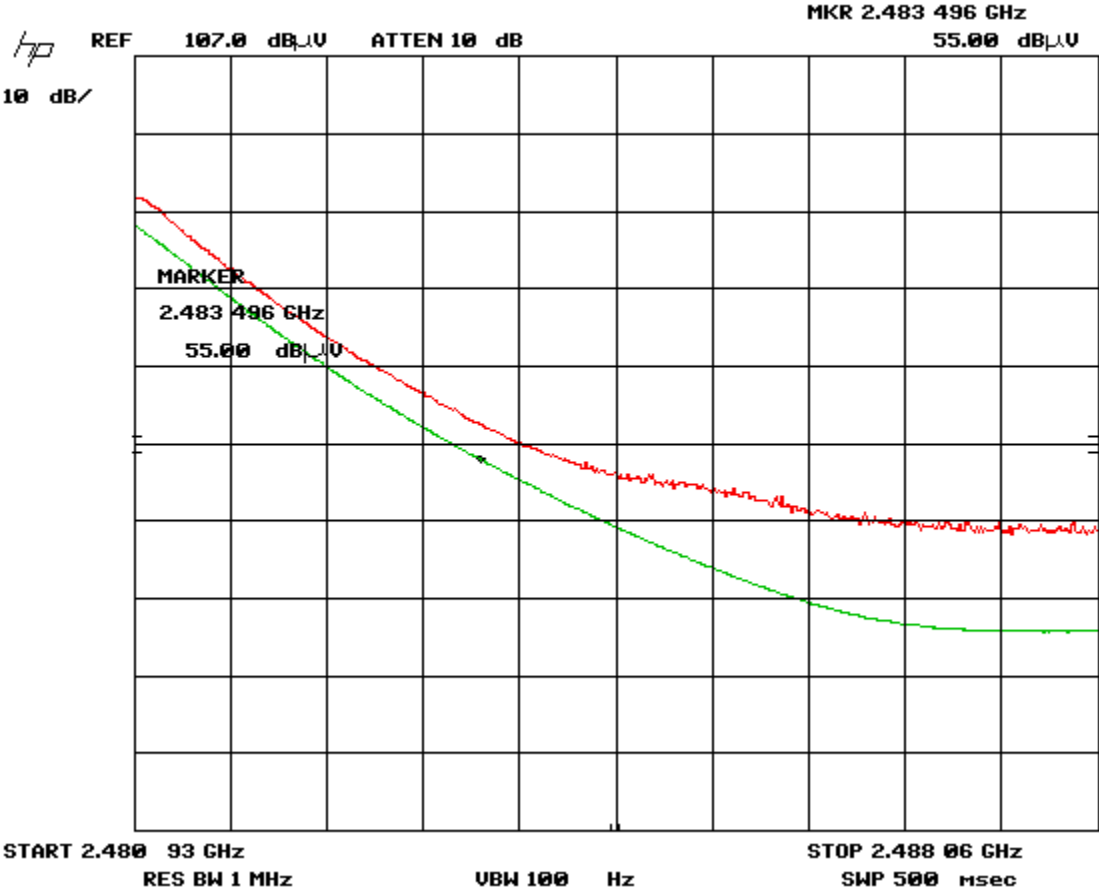

Client	Digi International	
Product	Digi Bluenica HoneyBee	
Standard(s)	FCC Part 15 Subpart C 15:2015 / RSS-247:2015	

Final Measurements

Radiated Emissions
Spurious emissions
3m measurement distance

Test Frequency (MHz)	Detection mode	Raw signal (dB μ V)	Cable loss + Pre-selector (dB)	Current to Voltage Factor (dB)	Antenna factor (dB)	Pre-Amp Gain (dB)	Received signal (dB μ V/m)	Emission limit (dB μ V/m)	Margin (dB μ V)	Result
0.0158	Peak	46.6	0.1	51.5	7.7	-33.1	72.8	123.6	50.8	Pass
0.0118	Peak	45.9	0.1	51.5	8.3	-33	72.8	126.2	53.4	Pass
0.0314	Peak	39.5	0.1	51.5	5.8	-33.2	63.7	117.7	54	Pass
0.518	Peak	42.6	0.1	51.5	1.1	-33.2	62.1	73.3	11.2	Pass
1.29	Peak	39.4	0.1	51.5	-6.1	-33.2	51.7	65.4	13.7	Pass
0.651	Peak	38.7	0.1	51.5	-0.8	-33.2	56.3	71.3	15	Pass
Vertical Antenna Polarity										
931.4	Peak	39.3	2.3	---	22.7	-31.7	32.6	46.4	13.8	Pass
408.2	Peak	45.6	1.5	---	15.4	-33.9	28.6	46.4	17.8	Pass
128.6	Peak	47.7	0.9	---	7.9	-33.3	23.2	43.5	20.3	Pass
4805	Peak	50.5	5.8	---	27.6	-35.3	48.6	54	5.4	Pass
Horizontal Polarity										
931.6	Peak	39.8	2.3	---	23.9	-31.7	34.3	46.4	12.1	Pass
34.5	Peak	38.6	0.5	---	15.2	-33.1	21.2	40	18.8	Pass
30.0	Peak	34.7	0.5	---	17.9	-33.1	20	40	20	Pass
4805.3	Peak	50.7	5.8	---	27.6	-35.3	48.8	54	5.2	Pass

Client	Digi International	
Product	Digi Bluenica HoneyBee	
Standard(s)	FCC Part 15 Subpart C 15:2015 / RSS-247:2015	

Radiated Emissions
Spurious emissions at restricted band edges
3m measurement distance

Test Frequency (MHz)	Detection mode	Raw signal (dBμV)	Antenna factor (dB)	Cable loss + Pre-selector (dB)	Pre-Amp Gain (dB)	Received signal (dBμV/m)	Emission limit (dBμV/m)	Margin (dBμV)	Result
Horizontal Antenna Polarity									
2390	Peak	45.6	26.1	4.0	33.8	41.9	73.90	32.0	Pass
2390	Avg.	32.3	26.1	4.0	33.8	41.9	53.90	12.0	Pass
2483.5	Peak	59.7	26.1	4.1	33.8	56.1	73.90	17.8	Pass
2483.5	Avg.	55.9	26.1	4.1	33.8	52.3	53.90	1.6	Pass
Vertical Antenna Polarity									
2390	Peak	44.6	26.1	4.0	33.8	40.9	73.90	33.0	Pass
2390	Avg.	32.3	26.1	4.0	33.8	28.6	53.90	25.3	Pass
2483.5	Peak	59.5	26.1	4.1	33.8	55.9	73.90	18.0	Pass
2483.5	Avg.	55.0	26.1	4.1	33.8	51.4	53.90	2.5	Pass

Notes.

All harmonics are under the limits defined in FCC 15.209.

Peak = Peak measurement

QP = Quasi-Peak measurement

Avg. = Average measurement

Where peak values are under the quasi-peak and/or average limit, the emission passes the corresponding limit, and no measurement with the respective detector is required.

Client	Digi International	
Product	Digi Bluenica HoneyBee	
Standard(s)	FCC Part 15 Subpart C 15:2015 / RSS-247:2015	

Test Equipment List

Equipment	Model No.	Manufacturer	Last calibration date	Next calibration due date	Asset #
Spectrum Analyzer	8566B	HP	May 21, 2014	May 21, 2016	GEMC 193
Quasi-Peak Adapter	85650A	HP	May 22, 2014	May 22, 2016	GEMC 194
Loop Antenna 30Hz – 1MHz	EM 6871	Electro-Metrics	Feb. 3, 2015	Feb. 3, 2017	GEMC 70
Loop Antenna 100kHz – 30MHz	EM 6872	Electro-Metrics	Feb. 3, 2015	Feb. 3, 2017	GEMC 71
BiLog Antenna	3142-C	ETS	Feb. 10, 2015	Feb. 10, 2017	GEMC 137
Horn Antenna	WBH218HN	Q-par	Jan. 23, 2014	Jan. 23, 2016	GEMC 6375
Horn Antenna	6878/24	Q-par	Sept 10, 2014	Sept 10, 2016	GEMC 6365
Horn Antenna	SAS-572	A.H. Systems	Sept. 9, 2014	Sept. 9, 2016	GEMC 6371
18.0-26.5 GHz Harmonic Mixer	11970K	HP	Jan 28, 2014	Jan 28, 2016	GEMC 158
Preamp 9kHz - 1 GHz	CPA9231A	Chase	Sept. 9, 2014	Sept. 9, 2016	GEMC 6403
Pre-amp 1-26GHz	HP 8449B	HP	Sept. 9, 2014	Sept. 9, 2016	GEMC 6351
RF Cable 7m	LMR-400-7M- 50OHM-MN- MN	LexTec	NCR	NCR	GEMC 28
RF Cable 1m	LMR-400-1M- 50OHM-MN- MN	LexTec	NCR	NCR	GEMC 29

This report module is based on GEMC template "FCC - 15.209 - Radiated Emissions_Rev1.doc"

Client	Digi International	
Product	Digi Bluenica HoneyBee	
Standard(s)	FCC Part 15 Subpart C 15:2015 / RSS-247:2015	

Appendix A – EUT Summary

For further details for filing purposes, refer to filing package.

General EUT Description

Client / Manufacturer Details	
Organization / Address	Digi International 11001 Bren Rd E Minnetonka, MN 55343 USA
Contact	Michael Mothershed
Phone	952-912-3059
Email	Michael.Mothershed@digi.com
EUT (Equipment Under Test) Details	
EUT Name	Digi Bluenica HoneyBee
EUT Model	HBtemp HCtemp
Software version	2.53.123
Equipment category	ITE
EUT is powered using	Non-rechargeable, LiMnO ₂ , not user replaceable
Transmits RF energy?	BLE @ 2.4GHz
Basic EUT functionality description	The HBtemp broadcasts local temperature data using BLE on channels 37, 38, and 39. Duty cycle is extremely low allowing for a 2-year battery life.
Frequency of all clocks present in EUT	32MHz
I/O cables & connectors	None
Peripherals required to exercise EUT	None
Dimensions of product	L: 94mm W: 59mm H: 35mm

Note the EUT is considered to have been received the date of the commencement of the first test, unless otherwise stated. For a close-up picture of the EUT, see ‘Appendix B – EUT & Test Setup Photographs’.

Client	Digi International	
Product	Digi Bluenica HoneyBee	
Standard(s)	FCC Part 15 Subpart C 15:2015 / RSS-247:2015	

Appendix B – EUT and Test Setup Photographs

Note: These photos are for information purposes only.
 Also refer to .PDF files that are separate from this test report.

Client	Digi International	
Product	Digi Bluenica HoneyBee	
Standard(s)	FCC Part 15 Subpart C 15:2015 / RSS-247:2015	

EUT – External view 1

Note: Preliminary label shown. Not final version.



Client	Digi International	
Product	Digi Bluenica HoneyBee	
Standard(s)	FCC Part 15 Subpart C 15:2015 / RSS-247:2015	

EUT – External view 2

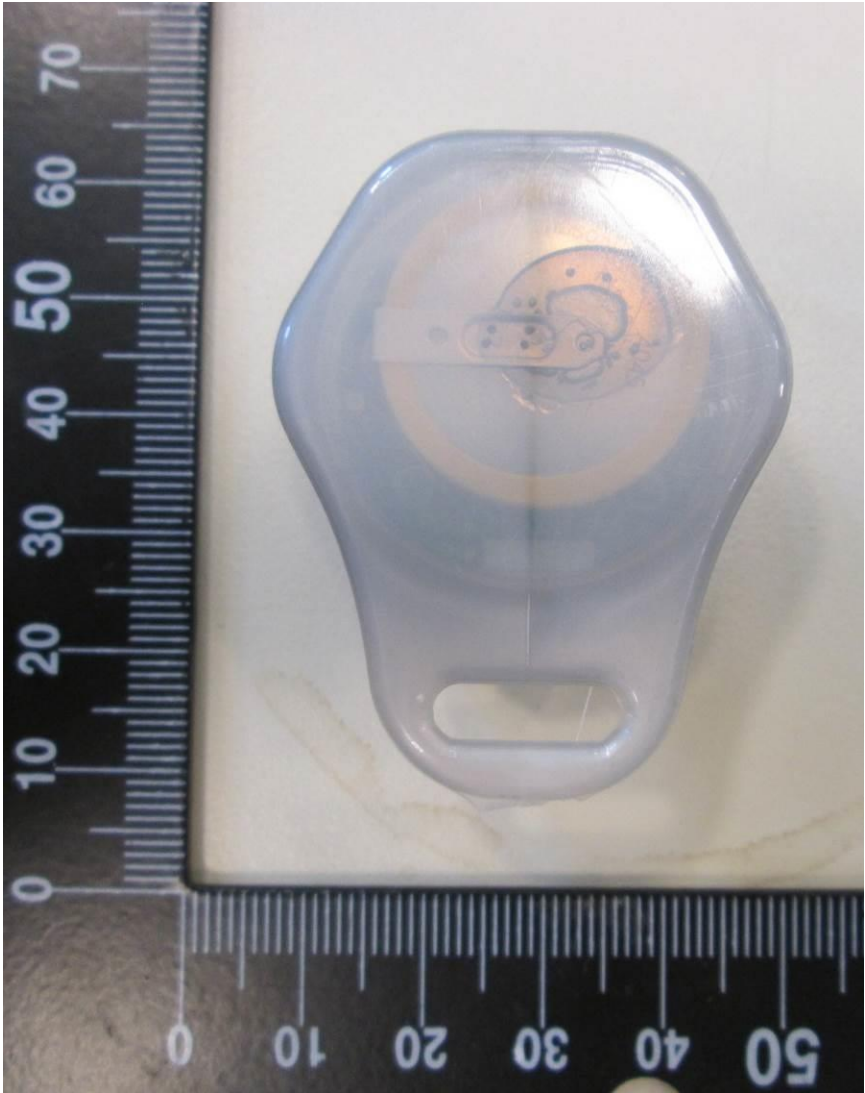

Client	Digi International	
Product	Digi Bluenica HoneyBee	
Standard(s)	FCC Part 15 Subpart C 15:2015 / RSS-247:2015	

EUT – External view 3



Client	Digi International	
Product	Digi Bluenica HoneyBee	
Standard(s)	FCC Part 15 Subpart C 15:2015 / RSS-247:2015	

EUT – Internal view 1
Enclosure Cover removed
Cover will be permanently welded to enclosure in production product.

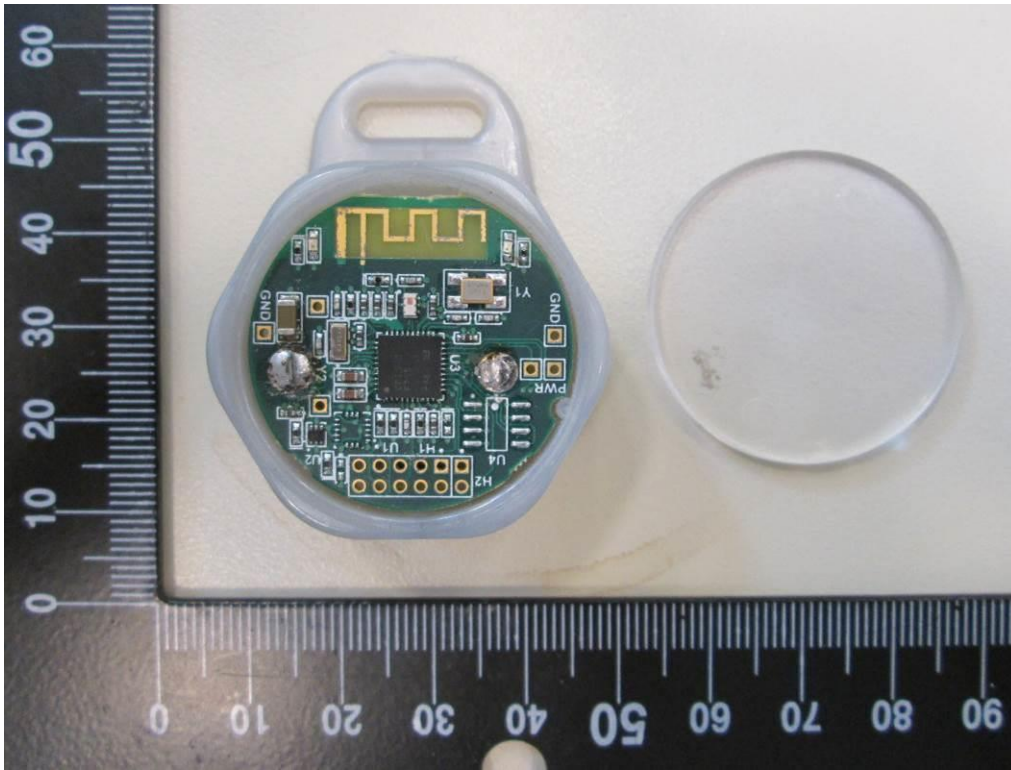

Client	Digi International	
Product	Digi Bluenica HoneyBee	
Standard(s)	FCC Part 15 Subpart C 15:2015 / RSS-247:2015	

EUT – Internal view 2
PCB removed from enclosure

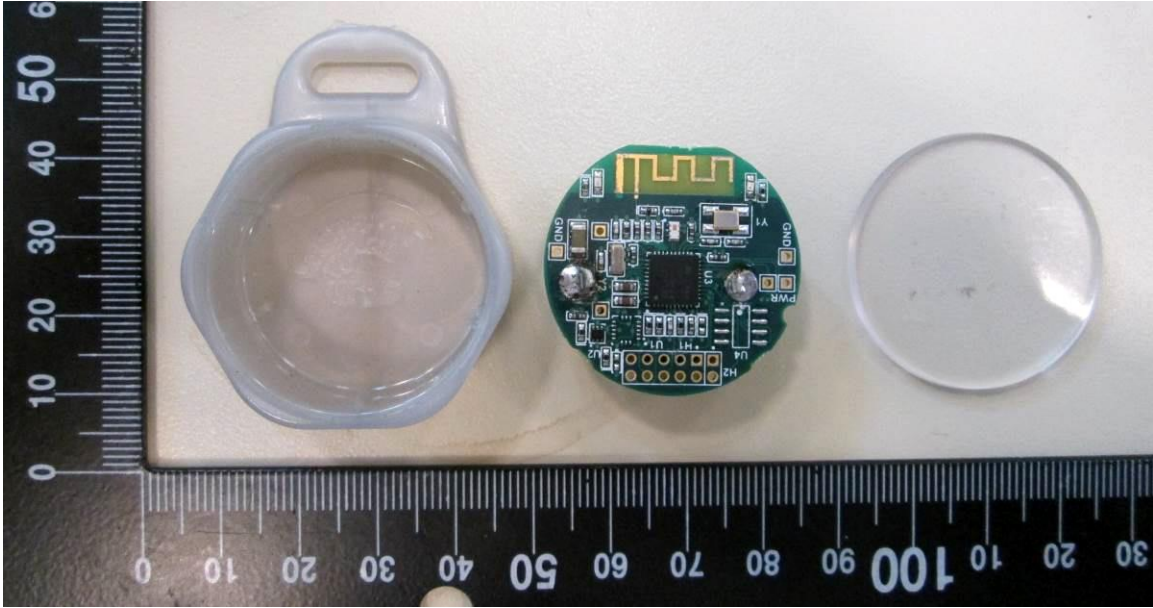

Client	Digi International	
Product	Digi Bluenica HoneyBee	
Standard(s)	FCC Part 15 Subpart C 15:2015 / RSS-247:2015	

EUT – Internal view 3
PCB, side 1

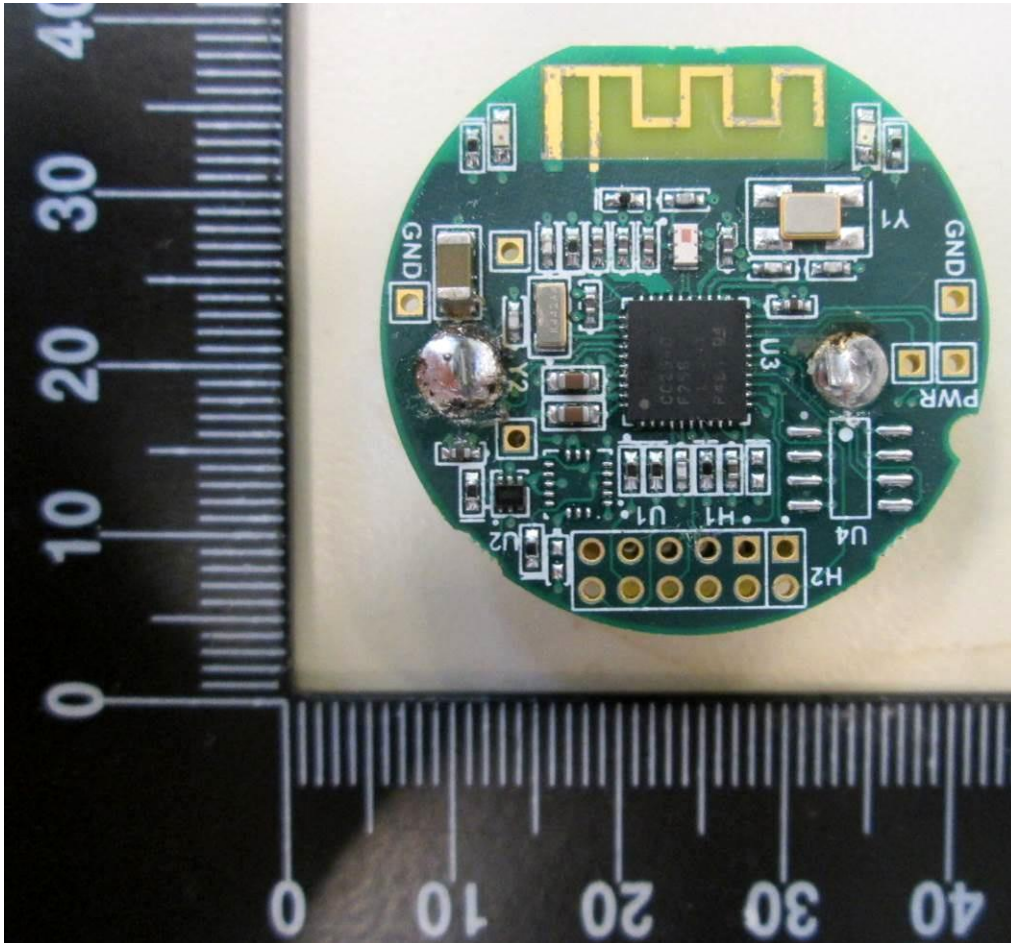

Client	Digi International	
Product	Digi Bluenica HoneyBee	
Standard(s)	FCC Part 15 Subpart C 15:2015 / RSS-247:2015	

EUT – Internal view 4
PCB, side 2

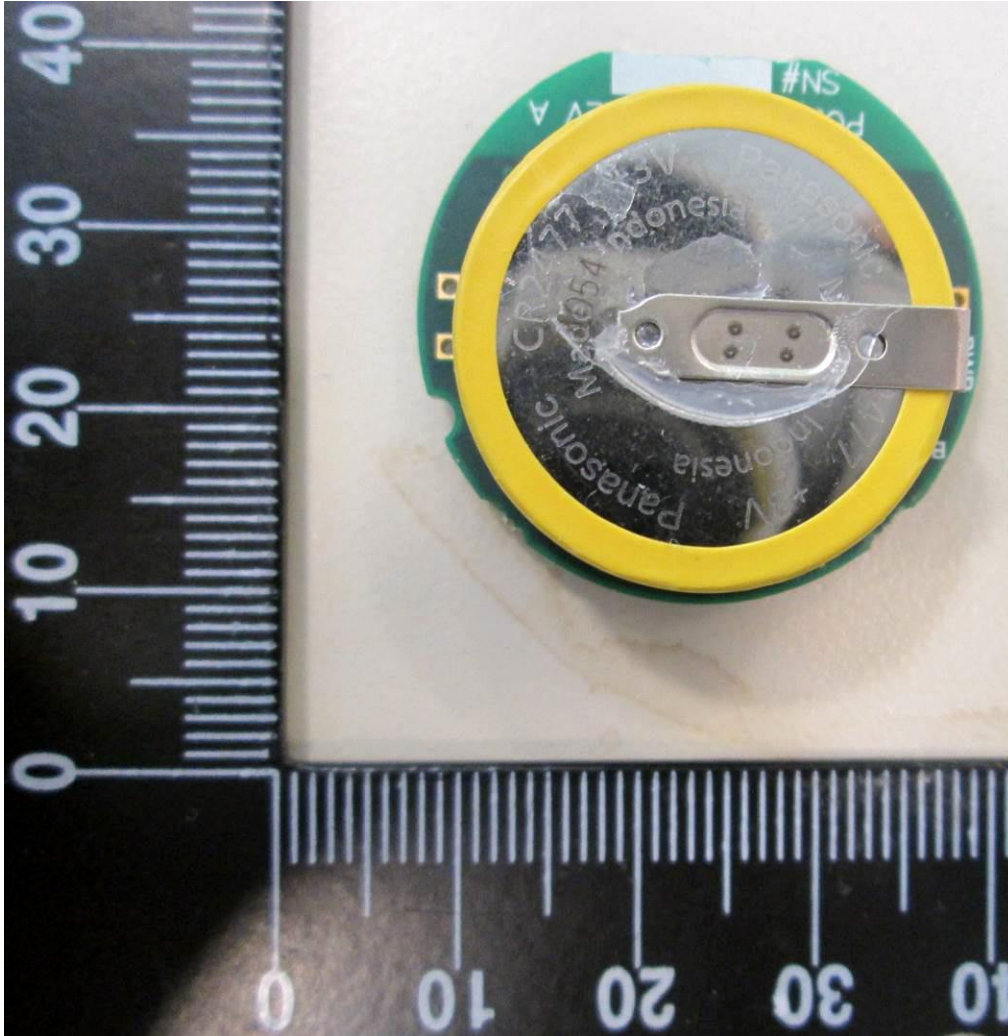

Client	Digi International	
Product	Digi Bluenica HoneyBee	
Standard(s)	FCC Part 15 Subpart C 15:2015 / RSS-247:2015	

EUT – Internal view 5
 PCB, side 2, showing underside of battery

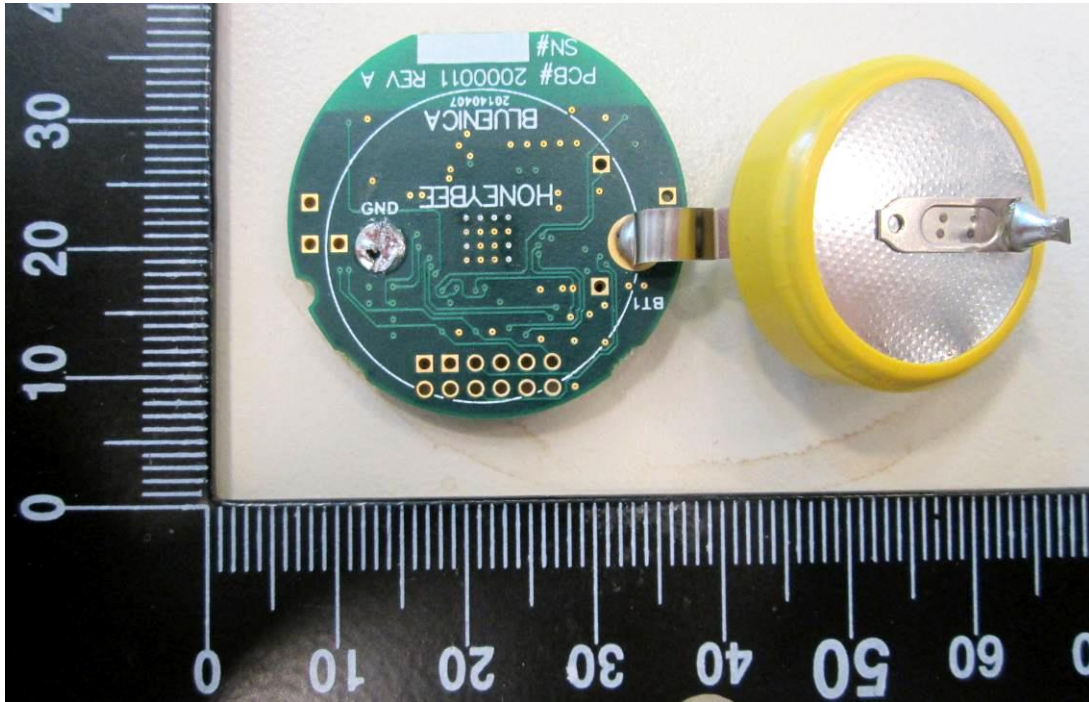

Client	Digi International	
Product	Digi Bluenica HoneyBee	
Standard(s)	FCC Part 15 Subpart C 15:2015 / RSS-247:2015	

Radiated Emissions Photo 1



Client	Digi International	
Product	Digi Bluenica HoneyBee	
Standard(s)	FCC Part 15 Subpart C 15:2015 / RSS-247:2015	

Radiated Emissions Photo 2



Client	Digi International	
Product	Digi Bluenica HoneyBee	
Standard(s)	FCC Part 15 Subpart C 15:2015 / RSS-247:2015	

Radiated Emissions Photo 3



Client	Digi International	
Product	Digi Bluenica HoneyBee	
Standard(s)	FCC Part 15 Subpart C 15:2015 / RSS-247:2015	

Radiated Emissions Photo 4

