

DFS MEASUREMENT REPORT

FCC 15.407 WLAN 802.11a/n/ac/ax

FCC ID: MCQ-EX50W
Applicant: Digi International Inc
Application Type: Certification
Product: 5G NR/LTE Router
Model No.: Digi EX40, Digi EX50
Brand Name: DIGI
FCC Classification: Unlicensed National Information Infrastructure (NII)
Type of Device: Master Device
FCC Rule Part(s): Part 15 Subpart E - 15.407 Section (h)(2)
KDB 905462 D02v02, KDB 905462 D04v01
Test Date: July 16 ~ 19, 2021

Reviewed By:

Kevin Guo

Approved By:

Robin Wu



The test results relate only to the samples tested.

This equipment has been shown to be capable of compliance with the applicable technical standards as indicated in the measurement report and was tested in accordance with the measurement procedures specified in KDB 905462 D02v02. Test results reported herein relate only to the item(s) tested.

The test report shall not be reproduced except in full without the written approval of MRT Technology (Suzhou) Co., Ltd.

Revision History

Report No.	Version	Description	Issue Date	Note
2106RSU041-U3	Rev. 01	Initial Report	11-16-2021	Valid

CONTENTS

Description	Page
1. General Information	5
1.1. Applicant	5
1.2. Manufacturer	5
1.3. Testing Facility	5
1.4. Product Information	6
1.5. Radio Specification	7
1.6. Working Frequencies	7
1.7. Antenna Details	8
1.8. Test Channel	8
1.9. Test Mode	8
2. DFS Detection Thresholds and Radar Test Waveforms	9
2.1. Applicability	9
2.2. DFS Devices Requirements	10
2.3. DFS Detection Threshold Values	11
2.4. Parameters of DFS Test Signals	12
2.5. Conducted Test Setup	15
3. Test Equipment Calibration Date	16
4. Test Result	17
4.1. Summary	17
4.2. Radar Waveform Calibration	18
4.2.1. Calibration Setup	18
4.2.2. Calibration Procedure	18
4.2.3. Calibration Result	19
4.2.4. Channel Loading Test Result	21
4.3. NII Detection Bandwidth Measurement	23
4.3.1. Test Limit	23
4.3.2. Test Procedure	23
4.3.3. Test Result	25
4.4. Initial Channel Availability Check Time Measurement	28
4.4.1. Test Limit	28
4.4.2. Test Procedure	28
4.4.3. Test Result	29
4.5. Radar Burst at the Beginning of the Channel Availability Check Time Measurement	30
4.5.1. Test Limit	30
4.5.2. Test Procedure	30
4.5.3. Test Result	31
4.6. Radar Burst at the End of the Channel Availability Check Time Measurement	32

4.6.1. Test Limit	32
4.6.2. Test Procedure	32
4.6.3. Test Result.....	33
4.7. In-Service Monitoring for Channel Move Time, Channel Closing Transmission Time and Non-Occupancy Period Measurement.....	34
4.7.1. Test Limit	34
4.7.2. Test Procedure Used	34
4.7.3. Test Result.....	35
4.8. Statistical Performance Check Measurement.....	37
4.8.1. Test Limit	37
4.8.2. Test Procedure	37
4.8.3. Test Result.....	38
5. Conclusion	119
Appendix A - Test Setup Photograph	120
Appendix B - EUT Photograph.....	121

1.4. Product Information

Product Name	5G NR/LTE Router
Model No.	Digi EX40, Digi EX50
Brand Name	DIGI
Wi-Fi Specification	802.11a/b/g/n/ac/ax
Antenna Specification	Refer to section 1.7
EUT Identification No	20210622Sample#16
Power Supply	AC/DC Adapter or POE Adapter
Accessory	
Adapter	Model No.: DA-50F19 Input: 100-240V, 50/60Hz, 1.2A Output: 19.0V, 2.63A, 49.97W
Remark: 1. This report reused the test data from another authorized device (FCC ID: MCQ-WPQ618, Original Grant Date: 2021/11/15). And add some verified data according to KDB 484596 D01v01 and the difference (refer to as below table 1) between the FCC IDs. 2. Different models differ in the configuration of different authorized modules, Digi EX40 will be configured an LTE module, Digi EX50 will be configured a 5G NR module. 3. The information of EUT was provided by the manufacturer, and the accuracy of the information shall be the responsibility of the manufacturer.	

Table 1			
Diff	Original	New	Remark
1	Without Enclosure, Only the PCBA	With an Enclosure, and add an authorized module	Just add an enclosure, PCBA and Antennas are the same.
Conclusion: According to the difference as above, it has no effect on DFS test, so no verified data in this report.			

1.5. Radio Specification

Frequency Range:	For 802.11a/n-HT20/ac-VHT20/ax-HE20: 5260~5320MHz, 5500~5720MHz For 802.11n-HT40/ac-VHT40/ax-HE40: 5270~5310MHz, 5510~5710MHz For 802.11ac-VHT80/ax-HE80: 5290MHz, 5530MHz, 5610MHz, 5690MHz
Type of Modulation:	802.11a/n/ac: OFDM 802.11ax: OFDMA
Data Rate:	802.11a: 6/9/12/18/24/36/48/54Mbps 802.11n: up to 300Mbps 802.11ac: up to 866.6Mbps 802.11ax: up to 1201Mbps
Power-on cycle:	Requires 45.79 seconds to complete its power-on cycle
Uniform Spreading (For DFS Frequency Band)	For the 5250-5350MHz, 5470-5725 MHz bands, the Master device provides, on aggregate, uniform loading of the spectrum across all devices by selecting an operating channel among the available channels using a random algorithm.

Note: For other features of this EUT, test report will be issued separately.

1.6. Working Frequencies

802.11a/n-HT20/ac-VHT20/ax-HE20

Channel	Frequency	Channel	Frequency	Channel	Frequency
52	5260 MHz	56	5280 MHz	60	5300 MHz
64	5320 MHz	100	5500 MHz	104	5520 MHz
108	5540 MHz	112	5560 MHz	116	5580 MHz
120	5600 MHz	124	5620 MHz	128	5640 MHz
132	5660 MHz	136	5680 MHz	140	5700 MHz
144	5720 MHz	--	--	--	--

802.11n-HT40/ac-VHT40/ax-HE40

Channel	Frequency	Channel	Frequency	Channel	Frequency
54	5270 MHz	62	5310 MHz	102	5510 MHz
110	5550 MHz	118	5590 MHz	126	5630 MHz
134	5670 MHz	142	5710 MHz	--	--

802.11ac-VHT80/ax-HE80

Channel	Frequency	Channel	Frequency	Channel	Frequency
58	5290 MHz	106	5530 MHz	122	5610 MHz
138	5690 MHz	--	--	--	--

1.7. Antenna Details

Antenna Type	Frequency Band (MHz)	T _x Paths	Antenna Gain (dBi)	CDD Directional Gain (dBi)	
				For Power	For PSD
Omni Antenna	2412 ~ 2462	2	8.00	8.00	11.01
	5150 ~ 5850	2	5.00	5.00	8.01

Note: The EUT supports Cyclic Delay Diversity (CDD) mode, and CDD signals are correlated.

If all antennas have the same gain, G_{ANT} , Directional gain = G_{ANT} + Array Gain, where Array Gain is as follows.

- For power spectral density (PSD) measurements on all devices,
Array Gain = $10 \log (N_{ANT} / N_{SS})$ dB;
- For power measurements on IEEE 802.11 devices,
Array Gain = 0 dB for $N_{ANT} \leq 4$;

1.8. Test Channel

Test Mode	Test Channel	Test Frequency
802.11ax-HE20	100	5500 MHz
802.11ax-HE40	102	5510 MHz
802.11ax-HE80	106	5530 MHz

1.9. Test Mode

Test Mode	Mode 1: Operating under Master mode.
-----------	--------------------------------------

2. DFS Detection Thresholds and Radar Test Waveforms

2.1. Applicability

The following table from FCC KDB 905462 D02 NII DFS Compliance Procedures New Rules v02 lists the applicable requirements for the DFS testing.

Requirement	Operational Mode		
	Master	Client Without Radar Detection	Client With Radar Detection
Non-Occupancy Period	Yes	Not required	Yes
DFS Detection Threshold	Yes	Not required	Yes
Channel Availability Check Time	Yes	Not required	Not required
U-NII Detection Bandwidth	Yes	Not required	Yes

Table 3-1: Applicability of DFS Requirements Prior to Use of a Channel

Requirement	Operational Mode	
	Master Device or Client With Radar Detection	Client Without Radar Detection
DFS Detection Threshold	Yes	Not required
Channel Closing Transmission Time	Yes	Yes
Channel Move Time	Yes	Yes
U-NII Detection Bandwidth	Yes	Not required

Additional requirements for devices with multiple bandwidth modes	Master Device or Client with Radar Detection	Client Without Radar Detection
U-NII Detection Bandwidth and Statistical Performance Check	All BW modes must be tested	Not required
Channel Move Time and Channel Closing Transmission Time	Test using widest BW mode available	Test using the widest BW mode available for the link
All other tests	Any single BW mode	Not required

Note: Frequencies selected for statistical performance check should include several frequencies within the radar detection bandwidth and frequencies near the edge of the radar detection bandwidth. For 802.11 devices it is suggested to select frequencies in each of the bonded 20 MHz channels and the channel center frequency.

Table 3-2: Applicability of DFS Requirements during normal operation

2.2. DFS Devices Requirements

Per FCC KDB 905462 D02 NII DFS Compliance Procedures New Rules v02 the following are the requirements for Master Devices:

- (a) The Master Device will use DFS in order to detect Radar Waveforms with received signal strength above the DFS Detection Threshold in the 5250 ~ 5350 MHz and 5470 ~ 5725 MHz bands. DFS is not required in the 5150 ~ 5250 MHz or 5725 ~ 5825 MHz bands.
- (b) Before initiating a network on a Channel, the Master Device will perform a Channel Availability Check for a specified time duration (Channel Availability Check Time) to ensure that there is no radar system operating on the Channel, using DFS described under subsection a) above.
- (c) The Master Device initiates a U-NII network by transmitting control signals that will enable other U-NII devices to Associate with the Master Device.
- (d) During normal operation, the Master Device will monitor the Channel (In-Service Monitoring) to ensure that there is no radar system operating on the Channel, using DFS described under a).
- (e) If the Master Device has detected a Radar Waveform during In-Service Monitoring as described under d), the Operating Channel of the U-NII network is no longer an Available Channel. The Master Device will instruct all associated Client Device(s) to stop transmitting on this Channel within the Channel Move Time. The transmissions during the Channel Move Time will be limited to the Channel Closing Transmission Time.
- (f) Once the Master Device has detected a Radar Waveform it will not utilize the Channel for the duration of the Non-Occupancy Period.
- (g) If the Master Device delegates the In-Service Monitoring to a Client Device, then the combination will be tested to the requirements described under d) through f) above.

Channel Move Time and Channel Closing Transmission Time requirements are listed in the following table.

Parameter	Value
Non-occupancy period	Minimum 30 minutes
Channel Availability Check Time	60 seconds
Channel Move Time	10 seconds See Note 1.
Channel Closing Transmission Time	200 milliseconds + an aggregate of 60 milliseconds over remaining 10 second period. See Notes 1 and 2.
U-NII Detection Bandwidth	Minimum 100% of the U-NII 99% transmission power bandwidth. See Note 3.

Note 1: Channel Move Time and the Channel Closing Transmission Time should be performed with Radar Type 0. The measurement timing begins at the end of the Radar Type 0 burst.

Note 2: The Channel Closing Transmission Time is comprised of 200 milliseconds starting at the beginning of the Channel Move Time plus any additional intermittent control signals required to facilitate a Channel move (an aggregate of 60 milliseconds) during the remainder of the 10 second period. The aggregate duration of control signals will not count quiet periods in between transmissions.

Note 3: During the U-NII Detection Bandwidth detection test, radar type 0 should be used. For each frequency step the minimum percentage of detection is 90 percent. Measurements are performed with no data traffic.

Table 3-3: DFS Response Requirements

2.3. DFS Detection Threshold Values

The DFS detection thresholds are defined for Master devices and Client Devices with In-service monitoring. These detection thresholds are listed in the following table.

Maximum Transmit Power	Value (See Notes 1, 2, and 3)
EIRP ≥ 200 milliwatt	-64 dBm
EIRP < 200 milliwatt and power spectral density < 10 dBm/MHz	-62 dBm
EIRP < 200 milliwatt that do not meet the power spectral density requirement	-64 dBm

Note 1: This is the level at the input of the receiver assuming a 0 dBi receive antenna.

Note 2: Throughout these test procedures an additional 1 dB has been added to the amplitude of the test transmission waveforms to account for variations in measurement equipment. This will ensure that the test signal is at or above the detection threshold level to trigger a DFS response.

Note3: EIRP is based on the highest antenna gain. For MIMO devices refer to KDB Publication 662911 D01.

Table 3-4: Detection Thresholds for Master Devices and Client Devices with Radar Detection

2.4. Parameters of DFS Test Signals

This section provides the parameters for required test waveforms, minimum percentage of successful detections, and the minimum number of trials that must be used for determining DFS conformance. Step intervals of 0.1 microsecond for Pulse Width, 1 microsecond for PRI, 1 MHz for chirp width and 1 for the number of pulses will be utilized for the random determination of specific test waveforms.

Short Pulse Radar Test Waveforms

Radar Type	Pulse Width (μsec)	PRI (μsec)	Number of Pulses	Minimum Percentage of Successful Detection	Minimum Number of Trials
0	1	1428	18	See Note 1	See Note 1
1	1	Test A: 15 unique PRI values randomly selected from the list of 23 PRI values in Table 3-6	$\text{Roundup} \left\{ \left(\frac{1}{360} \right) \cdot \left(\frac{19 \cdot 10^6}{\text{PRI}_{\mu\text{sec}}} \right) \right\}$	60%	30
		Test B: 15 unique PRI values randomly selected within the range of 518-3066 μsec, with a minimum increment of 1 μsec, excluding PRI values selected in Test A			
2	1-5	150-230	23-29	60%	30
3	6-10	200-500	16-18	60%	30
4	11-20	200-500	12-16	60%	30
Aggregate (Radar Types 1-4)				80%	120
Note: Short Pulse Radar Type 0 should be used for the detection bandwidth test, channel move time, and channel closing time tests.					

Table 3-5: Parameters for Short Pulse Radar Waveforms

A minimum of 30 unique waveforms are required for each of the Short Pulse Radar Types 2 through 4. If more than 30 waveforms are used for Short Pulse Radar Types 2 through 4, then each additional waveform must also be unique and not repeated from the previous waveforms.

Pulse Repetition Frequency Number	Pulse Repetition Frequency (Pulses Per Second)	Pulse Repetition Interval (Microseconds)
1	1930.5	518
2	1858.7	538
3	1792.1	558
4	1730.1	578
5	1672.2	598
6	1618.1	618
7	1567.4	638
8	1519.8	658
9	1474.9	678
10	1432.7	698
11	1392.8	718
12	1355	738
13	1319.3	758
14	1285.3	778
15	1253.1	798
16	1222.5	818
17	1193.3	838
18	1165.6	858
19	1139	878
20	1113.6	898
21	1089.3	918
22	1066.1	938
23	326.2	3066

Table 3-6: Pulse Repetition Intervals Values for Test A

Long Pulse Radar Test Waveform

Radar Type	Pulse Width (μsec)	Chirp Width (MHz)	PRI (μsec)	Number of Pulses per Burst	Number of Bursts	Minimum Percentage of Successful Detection	Minimum Number of Trials
5	50 - 100	5 - 20	1000 - 2000	1 - 3	8 - 20	80%	30

Table 3-7: Parameters for Long Pulse Radar Waveforms

The parameters for this waveform are randomly chosen. Thirty unique waveforms are required for the Long Pulse Radar Type waveforms. If more than 30 waveforms are used for the Long Pulse Radar Type waveforms, then each additional waveform must also be unique and not repeated from the previous waveforms.

Frequency Hopping Radar Test Waveform

Radar Type	Pulse Width (μsec)	PRI (μsec)	Pulses Per Hop	Hopping Rate (kHz)	Hopping Sequence Length (msec)	Minimum Percentage of Successful Detection	Minimum Number of Trials
6	1	333	9	0.333	300	70%	30

Table 3-8: Parameters for Frequency Hopping Radar Waveforms

For the Frequency Hopping Radar Type, the same Burst parameters are used for each waveform. The hopping sequence is different for each waveform and a 100-length segment is selected from the hopping sequence defined by the following algorithm:

The first frequency in a hopping sequence is selected randomly from the group of 475 integer frequencies from 5250 – 5724MHz. Next, the frequency that was just chosen is removed from the group and a frequency is randomly selected from the remaining 474 frequencies in the group. This process continues until all 475 frequencies are chosen for the set. For selection of a random frequency, the frequencies remaining within the group are always treated as equally likely.

2.5. Conducted Test Setup

The FCC KDB 905462 D02 NII DFS Compliance Procedures New Rules v02 describes a radiated test setup and a conducted test setup. The conducted test setup was used for this testing. Figure 3-1 shows the typical test setup.

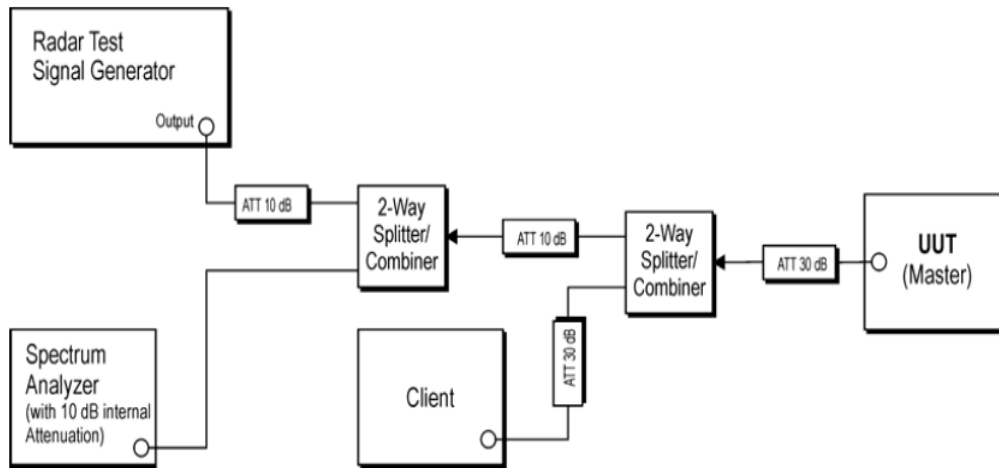

Figure 3-1: Conducted Test Setup where UUT is a Master and Radar Test Waveforms are injected into the Masters

3. Test Equipment Calibration Date

Dynamic Frequency Selection (DFS) (WZ-SR4)

Instrument	Manufacturer	Type No.	Asset No.	Cali. Interval	Cali. Due Date
EXA Signal Analyzer	KEYSIGHT	N9010B	MRTSUE06457	1 year	2022/06/24
EXA Signal Analyzer	Agilent	N9020A	MRTSUE06106	1 year	2022/04/13
Signal Analyzer	R&S	FSV40	MRTSUE06218	1 year	2022/04/13
ESG Vector Signal Generator	Agilent	E4438C	MRTSUE06026	1 year	2021/10/22
Power divider	Marvelous Microwave Inc.	MVE8576	MRTSUE06259	1 year	2021/10/29
Power divider	Woken Technology Inc.	2-8GB	MRTSUE06261	1 year	2021/10/29
Power divider	Woken Technology Inc.	2-8GB	MRTSUE06262	1 year	2021/10/29
Power divider	Weinschel	6179	MRTSUE06567	1 year	2021/10/29
MXG Vector Signal Generator	KEYSIGHT	N5182B	MRTSUE06451	1 year	2022/06/24
Signal Analyzer	R&S	FSV40	MRTSUE06218	1 year	2022/04/13
Vector Signal Generator	R&S	SMBV100A	MRTSUE06279	1 year	2022/04/13
Thermohygrometer	Testo	608-H1	MRTSUE06222	1 year	2021/10/25

Client Information

Instrument	Manufacturer	Type No.	Certification Number
Wi-Fi Module	Intel	AX200NGW	FCC ID: PD9AX200NG

Software	Version	Manufacturer	Function
Pulse Building	N/A	Agilent	Radar Signal Generation Software
DFS Tool	V 6.9.2	Agilent	DFS Test Software
R&S Pulse Sequencer DFS	V 2.0	R&S	DFS Test Software
DFS Tool	V2.2.0.0	Keysight	DFS Test Software

4. Test Result

4.1. Summary

Parameter	Limit	Test Result	Reference
NII Detection Bandwidth Measurement	Refer Table 3-3	Pass	Section 5.3
Initial Channel Availability Check Time	Refer Table 3-3	Pass	Section 5.4
Radar Burst at the Beginning of the Channel Availability Check Time	Refer Table 3-3	Pass	Section 5.5
Radar Burst at the End of the Channel Availability Check Time	Refer Table 3-3	Pass	Section 5.6
In-Service Monitoring for Channel Move Time, Channel Closing Transmission Time	Refer Table 3-3	Pass	Section 5.7
Non-Occupancy Period	Refer Table 3-3	Pass	Section 5.7
Statistical Performance Check	Refer Table 3-3	Pass	Section 5.8

4.2. Radar Waveform Calibration

4.2.1. Calibration Setup

The conducted test setup was used for this calibration testing. Figure 3-2 shows the typical test setup.

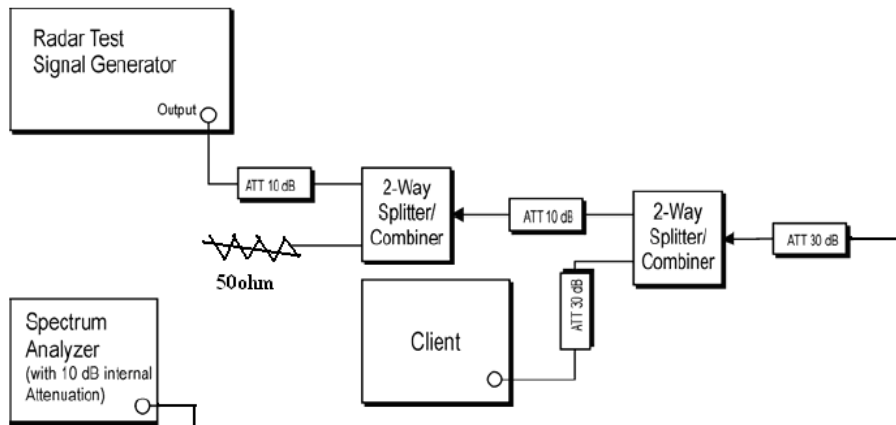

Figure 3-2: Conducted Test Setup

4.2.2. Calibration Procedure

The Interference Radar Detection Threshold Level is $(-64\text{dBm}) + (0) [\text{dBi}] + 1 \text{ dB} = -63 \text{ dBm}$ that had been taken into account the output power range and antenna gain. The above equipment setup was used to calibrate the conducted Radar Waveform. A vector signal generator was utilized to establish the test signal level for each radar type. During this process there were replace 50ohm terminal form Master and Client device and no transmissions by either the Master or Client Device. The spectrum analyzer was switched to the zero span (Time Domain) at the frequency of the Radar Waveform generator. Peak detection was used. The spectrum analyzer resolution bandwidth (RBW) and video bandwidth (VBW) were set to at least 3MHz. The vector signal generator amplitude was set so that the power level measured at the spectrum analyzer was $(-64\text{dBm}) + (0) [\text{dBi}] + 1 \text{ dB} = -63\text{dBm}$. Capture the spectrum analyzer plots on short pulse radar types, long pulse radar type and hopping radar waveform.

4.2.3. Calibration Result

Product	5G NR/LTE Router	Temperature	25°C
Test Engineer	Jake Lan	Relative Humidity	60%
Test Site	WZ-SR4	Test Date	2021/07/16~2021/07/19
Test Item	Radar Waveform Calibration		

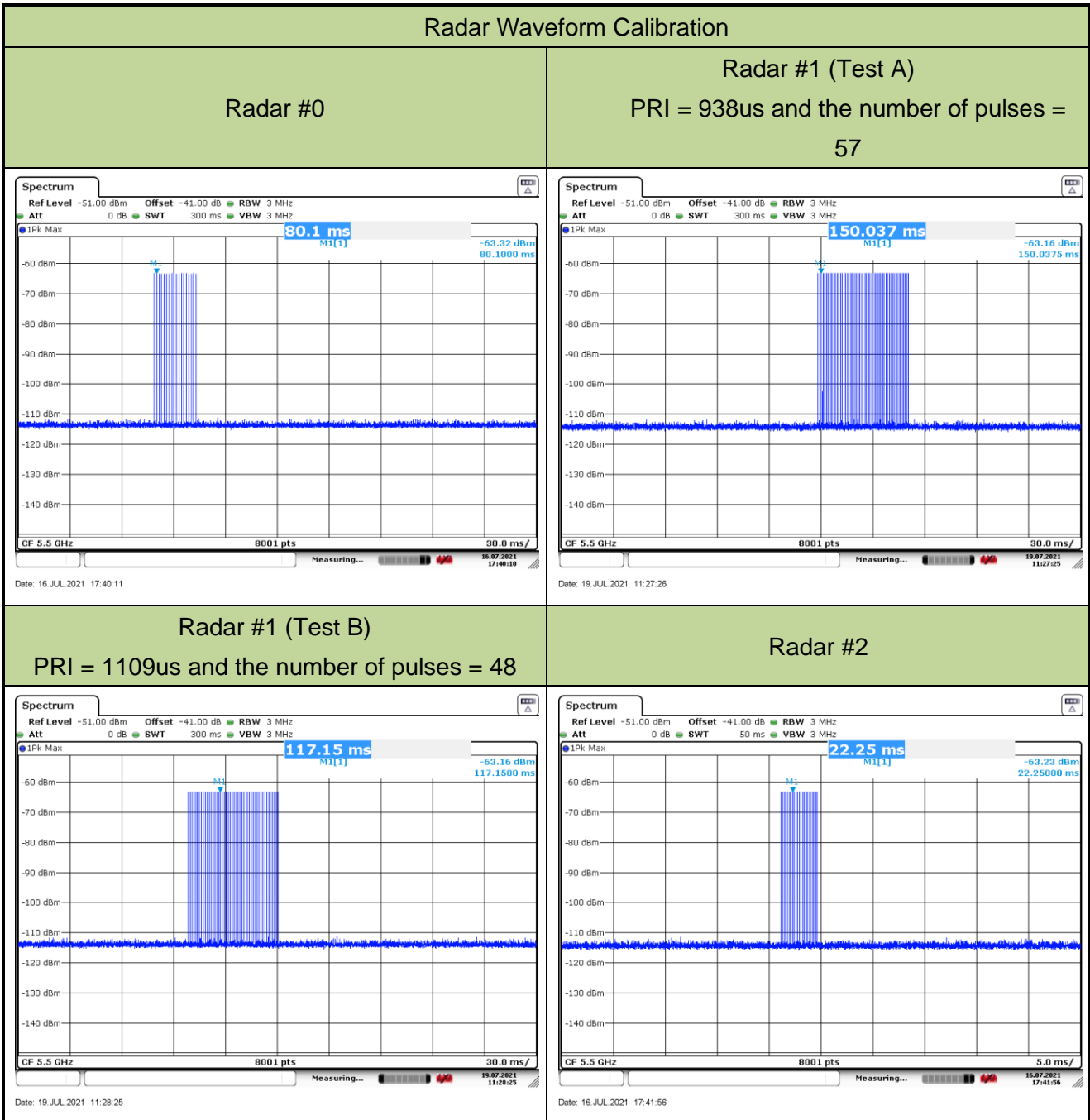

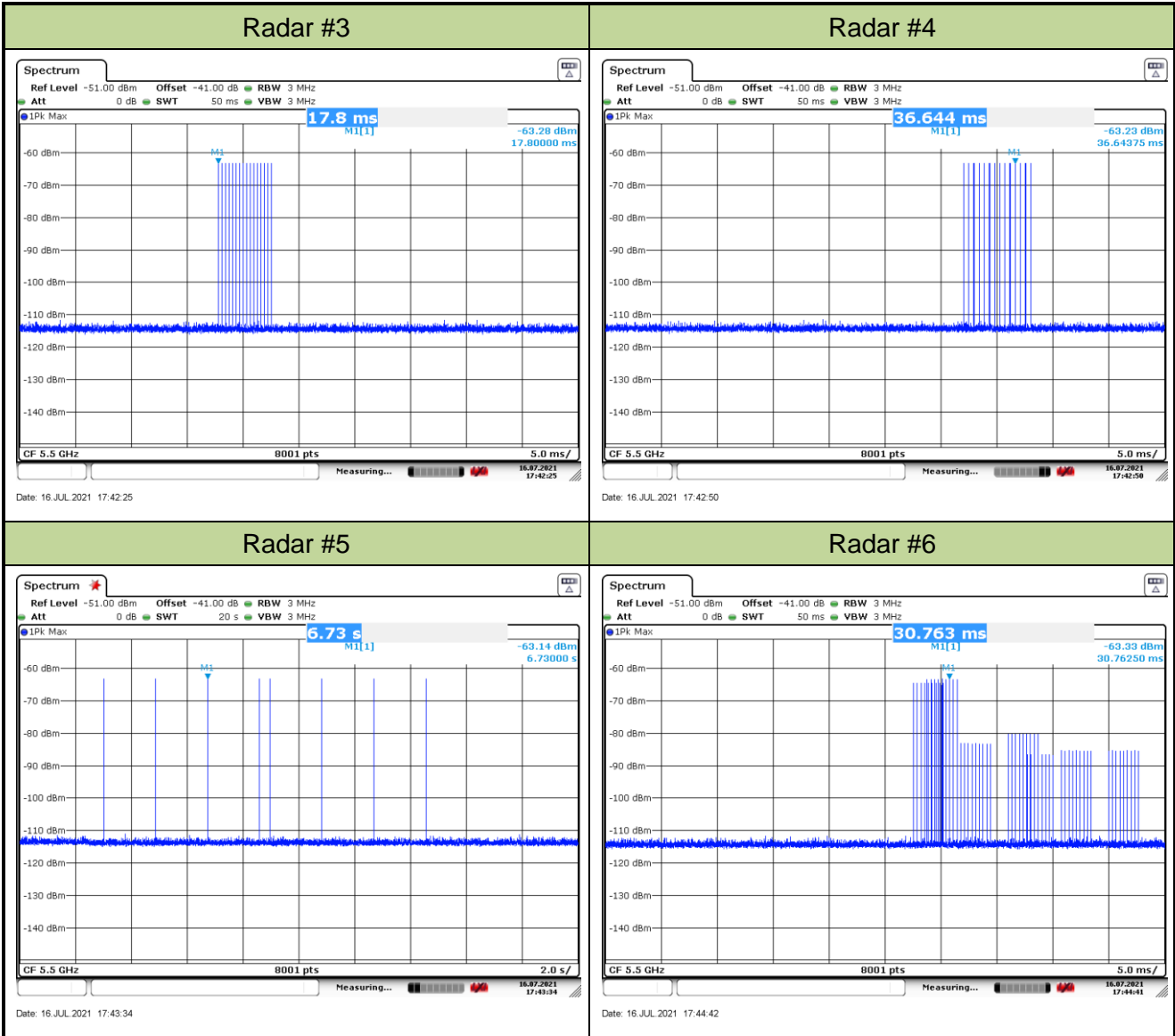

4.2.4. Channel Loading Test Result

Product	5G NR/LTE Router	Temperature	25°C
Test Engineer	Jake Lan	Relative Humidity	62%
Test Site	WZ-SR4	Test Date	2021/07/16~2021/07/19
Test Item	Channel Loading		

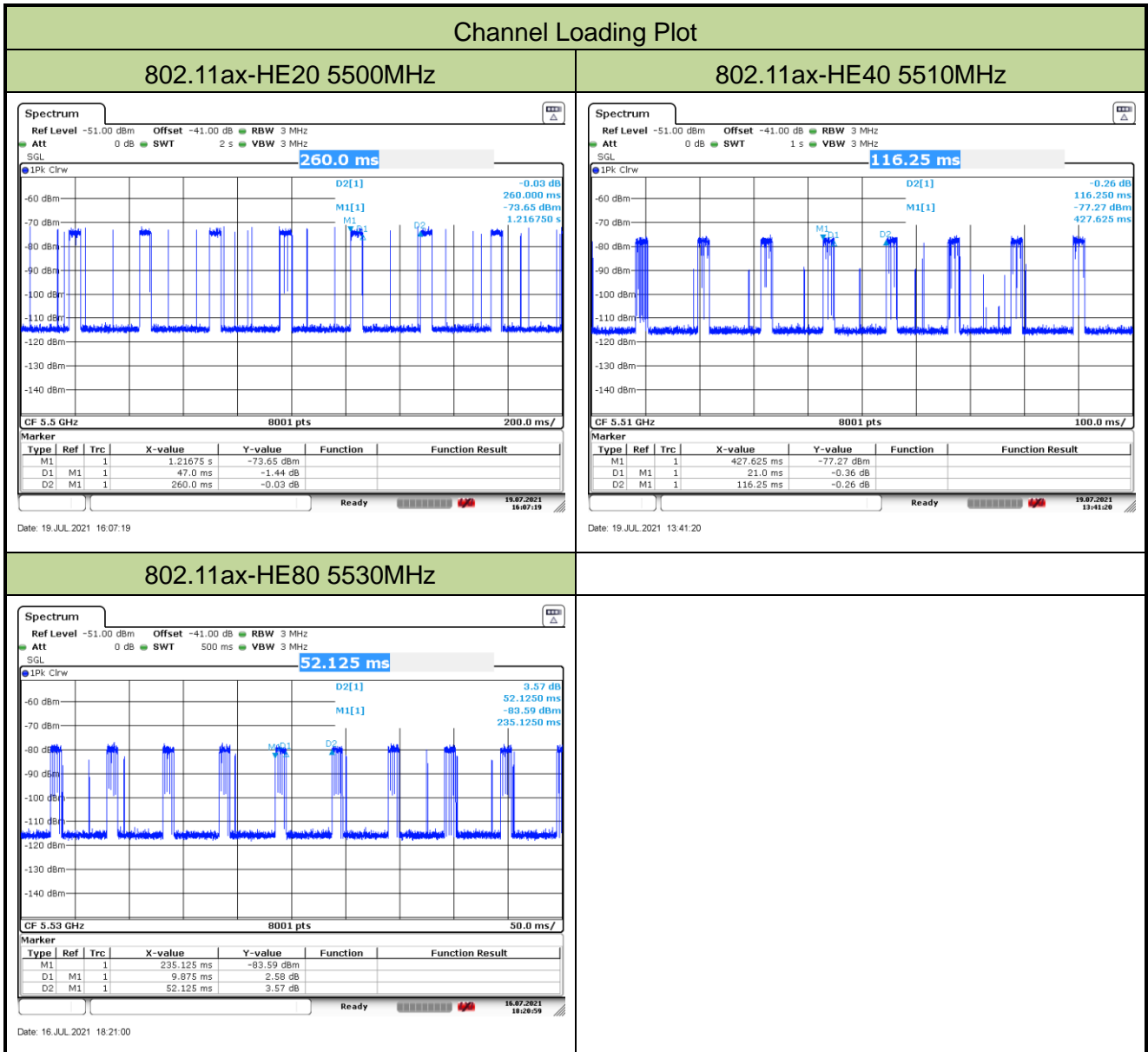

Test Mode	Test Frequency	Packet ratio	Requirement ratio	Test Result
802.11ax-HE20	5500 MHz	18.08%	≥ 17%	Pass
802.11ax-HE40	5510 MHz	18.06%	≥ 17%	Pass
802.11ax-HE80	5530 MHz	18.94%	≥ 17%	Pass

Note: System testing was performed with the designated iperf test file. This file is used by IP and Frame based systems for loading the test channel during the In-service compliance testing of the U-NII device. Packet ratio = Time On / (Time On + Off Time).

4.3. NII Detection Bandwidth Measurement

4.3.1. Test Limit

Minimum 100% of the NII 99% transmission power bandwidth. During the U-NII Detection Bandwidth detection test, each frequency step the minimum percentage of detection is 90 percent. Measurements are performed with no data traffic.

4.3.2. Test Procedure

1. Adjust the equipment to produce a single Burst of any one of the Short Pulse Radar Types 0-4 in Table 3-5 at the center frequency of the EUT Operating Channel at the specified DFS Detection Threshold level.
2. The generating equipment is configured as shown in the Conducted Test Setup above section 3.5.
3. The EUT is set up as a stand-alone device (no associated Client or Master, as appropriate) and no traffic. Frame based systems will be set to a talk/listen ratio reflecting the worst case (maximum) that is user configurable during this test.
4. Generate a single radar Burst, and note the response of the EUT. Repeat for a minimum of 10 trials. The EUT must detect the Radar Waveform using the specified U-NII Detection Bandwidth criterion shown in Table 3-5. In cases where the channel bandwidth may exceed past the DFS band edge on specific channels (i.e., 802.11ac or wideband frame based systems) select a channel that has the entire emission bandwidth within the DFS band. If this is not possible, test the detection BW to the DFS band edge.
5. Starting at the center frequency of the UUT operating Channel, increase the radar frequency in 5 MHz steps, repeating the above test sequence, until the detection rate falls below the U-NII Detection Bandwidth criterion specified in Table 3-3. Repeat this measurement in 1MHz steps at frequencies 5 MHz below where the detection rate begins to fall. Record the highest frequency (denote as FH) at which detection is greater than or equal to the U-NII Detection Bandwidth criterion. Recording the detection rate at frequencies above FH is not required to demonstrate compliance.
6. Starting at the center frequency of the EUT operating Channel, decrease the radar frequency in 1 MHz steps, repeating the above item 4 test sequence, until the detection rate falls below the U-NII Detection Bandwidth criterion. Record the lowest frequency (denote as FL) at which detection is greater than or equal to the U-NII Detection Bandwidth criterion. Recording the detection rate at frequencies below FL is not required to demonstrate compliance.

7. The U-NII Detection Bandwidth is calculated as follows: $\text{U-NII Detection Bandwidth} = \text{FH} - \text{FL}$
8. The U-NII Detection Bandwidth must be at least 100% of the EUT transmitter 99% power, otherwise, the EUT does not comply with DFS requirements.

4.3.3. Test Result

Product	5G NR/LTE Router	Temperature	25°C
Test Engineer	Jake Lan	Relative Humidity	64%
Test Site	WZ-SR4	Test Date	2021/07/19
Test Item	Detection Bandwidth (802.11ax-HE20 mode - 5500MHz)		

Radar Frequency (MHz)	DFS Detection Trials (1=Detection, 0= No Detection)										Detection Rate (%)
	1	2	3	4	5	6	7	8	9	10	
5490	0	0	0	0	0	0	0	0	0	0	0%
5490.4 FL	1	1	1	1	1	1	1	1	1	1	100%
5091	1	1	1	1	1	1	1	1	1	1	100%
5492	1	1	1	1	1	1	1	1	1	1	100%
5493	1	1	1	1	1	1	1	1	1	1	100%
5494	1	1	1	1	1	1	1	1	1	1	100%
5495	1	1	1	1	1	1	1	1	1	1	100%
5500	1	1	1	1	1	1	1	1	1	1	100%
5505	1	1	1	1	1	1	1	1	1	1	100%
5506	1	1	1	1	1	1	1	1	1	1	100%
5507	1	1	1	1	1	1	1	1	1	1	100%
5508	1	1	1	1	1	1	1	1	1	1	100%
5509	1	1	1	1	1	1	1	1	1	1	100%
5509.6 FH	1	1	1	1	1	1	1	1	1	1	100%
5510	0	0	0	0	0	0	0	0	0	0	0%

Note 1: All NII channels for this device have identical Channel bandwidths. Therefore, all DFS testing was done at 5500MHz. The 99% channel bandwidth is 18.95MHz. (See the 99% BW section of the RF report for further measurement details).

Note 2: Detection Bandwidth = FH - FL = 5509.6MHz – 5490.4MHz = 19.2MHz.

Note 3: NII Detection Bandwidth Min. Limit (MHz): 19.05MHz x 100% = 18.95MHz.

Product	5G NR/LTE Router	Temperature	25°C
Test Engineer	Jake Lan	Relative Humidity	64%
Test Site	WZ-SR4	Test Date	2021/07/19
Test Item	Detection Bandwidth (802.11ax-HE40 mode - 5510MHz)		

Radar Frequency (MHz)	DFS Detection Trials (1=Detection, 0= No Detection)										Detection Rate (%)
	1	2	3	4	5	6	7	8	9	10	
5490	0	0	0	0	0	0	0	0	0	0	0%
5491 FL	1	1	1	1	1	1	1	1	1	1	100%
5492	1	1	1	1	1	1	1	1	1	1	100%
5493	1	1	1	1	1	1	1	1	1	1	100%
5494	1	1	1	1	1	1	1	1	1	1	100%
5495	1	1	1	1	1	1	1	1	1	1	100%
5500	1	1	1	1	1	1	1	1	1	1	100%
5505	1	1	1	1	1	1	1	1	1	1	100%
5510	1	1	1	1	1	1	1	1	1	1	100%
5515	1	1	1	1	1	1	1	1	1	1	100%
5520	1	1	1	1	1	1	1	1	1	1	100%
5525	1	1	1	1	1	1	1	1	1	1	100%
5526	1	1	1	1	1	1	1	1	1	1	100%
5527	1	1	1	1	1	1	1	1	1	1	100%
5528	1	1	1	1	1	1	1	1	1	1	100%
5529 FH	1	1	1	1	1	1	1	1	1	1	100%
5530	0	0	0	0	0	0	0	0	0	0	0%

Note 1: All NII channels for this device have identical Channel bandwidths. Therefore, all DFS testing was done at 5510MHz. The 99% channel bandwidth is 37.74MHz. (See the 99% BW section of the RF report for further measurement details).

Note 2: Detection Bandwidth = FH - FL = 5529MHz - 5491MHz = 38MHz.

Note 3: NII Detection Bandwidth Min. Limit (MHz): 37.74MHz x 100% = 37.74MHz.

Product	5G NR/LTE Router	Temperature	25°C
Test Engineer	Jake Lan	Relative Humidity	64%
Test Site	WZ-SR4	Test Date	2021/07/19
Test Item	Detection Bandwidth (802.11ax-HE80 mode - 5530MHz)		

Radar Frequency (MHz)	DFS Detection Trials (1=Detection, 0= No Detection)										Detection Rate (%)
	1	2	3	4	5	6	7	8	9	10	
5490	0	0	0	0	0	0	0	0	0	0	0%
5491 FL	1	1	1	1	1	1	1	1	1	1	100%
5492	1	1	1	1	1	1	1	1	1	1	100%
5493	1	1	1	1	1	1	1	1	1	1	100%
5494	1	1	1	1	1	1	1	1	1	1	100%
5495	1	1	1	1	1	1	1	1	1	1	100%
5500	1	1	1	1	1	1	1	1	1	1	100%
5505	1	1	1	1	1	1	1	1	1	1	100%
5510	1	1	1	1	1	1	1	1	1	1	100%
5515	1	1	1	1	1	1	1	1	1	1	100%
5520	1	1	1	1	1	1	1	1	1	1	100%
5525	1	1	1	1	1	1	1	1	1	1	100%
5530	1	1	1	1	1	1	1	1	1	1	100%
5535	1	1	1	1	1	1	1	1	1	1	100%
5540	1	1	1	1	1	1	1	1	1	1	100%
5545	1	1	1	1	1	1	1	1	1	1	100%
5550	1	1	1	1	1	1	1	1	1	1	100%
5555	1	1	1	1	1	1	1	1	1	1	100%
5560	1	1	1	1	1	1	1	1	1	1	100%
5565	1	1	1	1	1	1	1	1	1	1	100%
5566	1	1	1	1	1	1	1	1	1	1	100%
5567	1	1	1	1	1	1	1	1	1	1	100%
5568	1	1	1	1	1	1	1	1	1	1	100%
5569 FH	1	1	1	1	1	1	1	1	1	1	100%
5570	0	0	0	0	0	0	0	0	0	0	0%

Note 1: All NII channels for this device have identical Channel bandwidths. Therefore, all DFS testing was done at 5530MHz. The 99% channel bandwidth is 77.05MHz. (See the 99% BW section of the RF report for further measurement details).

Note 2: Detection Bandwidth = FH - FL = 5569MHz - 5491MHz = 78MHz.

Note 3: NII Detection Bandwidth Min. Limit (MHz): 77.05MHz x 100% = 77.05MHz.

4.4. Initial Channel Availability Check Time Measurement

4.4.1. Test Limit

The EUT shall perform a Channel Availability Check to ensure that there is no radar operating on the channel. After power-up sequence, receive at least 1 minute on the intended operating frequency.

4.4.2. Test Procedure

1. The U-NII devices will be powered on and be instructed to operate on the appropriate U-NII Channel that must incorporate DFS functions. At the same time the EUT is powered on, the spectrum analyzer will be set to zero span mode with a 3 MHz RBW and 3 MHz VBW on the Channel occupied by the radar (Chr) with a 2.5 minute sweep time. The spectrum analyzer's sweep will be started at the same time power is applied to the U-NII device.
2. The EUT should not transmit any beacon or data transmissions until at least 1 minute after the completion of the power-on cycle.
3. Confirm that the EUT initiates transmission on the channel. Measurement system showing its nominal noise floor is marker1.

4.4.3. Test Result

Product	5G NR/LTE Router	Temperature	27°C
Test Engineer	Jake Lan	Relative Humidity	65%
Test Site	WZ-SR4	Test Date	2021/07/16
Test Item	Initial Channel Availability Check Time (802.11ax-HE20 mode - 5500MHz)		

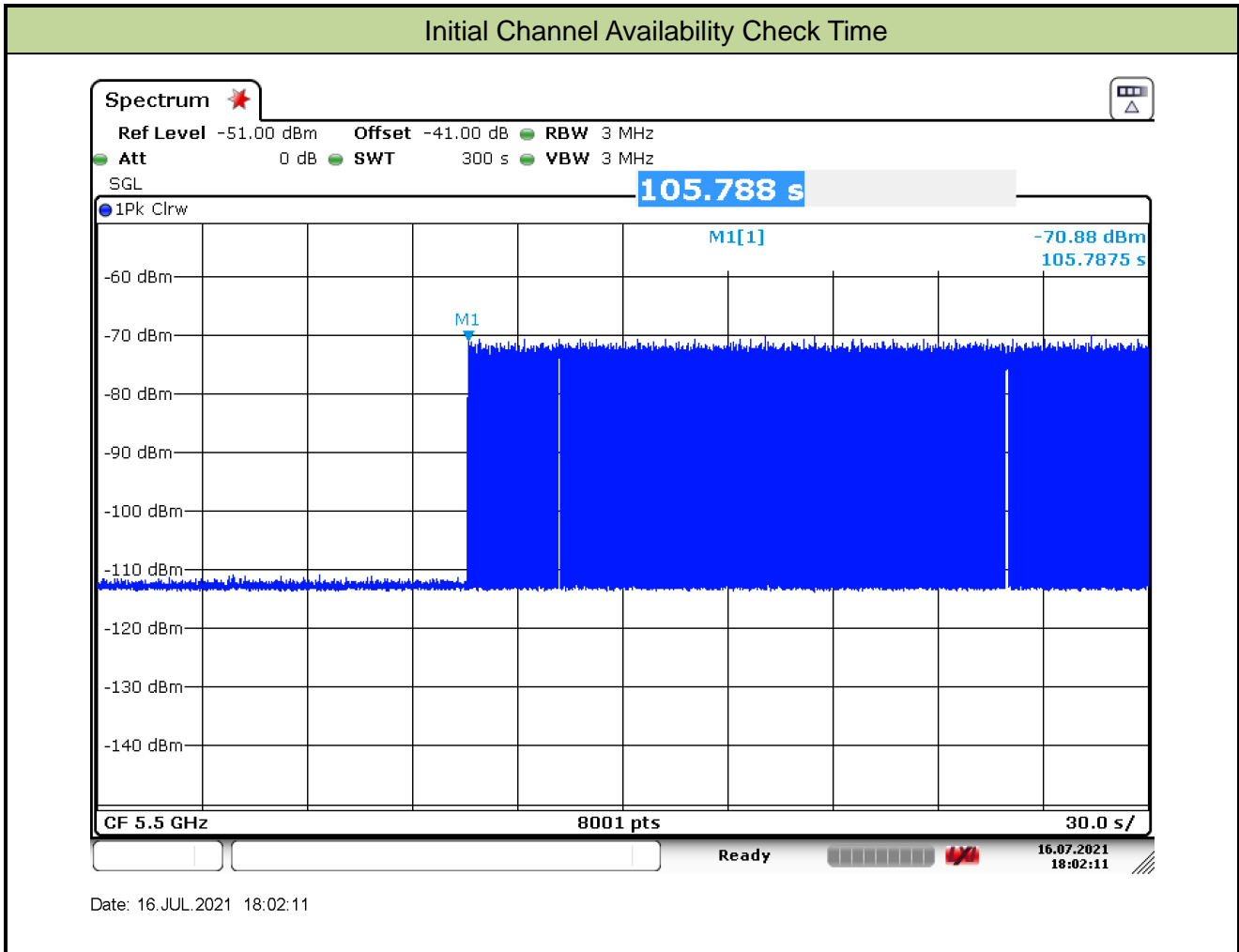

Note: The EUT does not transmit any beacon or data transmissions until at least 1 minute after the completion of the power-on cycle (45.79 sec). Initial beacons/data transmissions are indicated by marker 1 (105.79 sec).

4.5. Radar Burst at the Beginning of the Channel Availability Check Time Measurement

4.5.1. Test Limit

In beginning of the Channel Availability Check (CAC) Time, radar is detected on this channel, select another intended channel and perform a CAC on that channel.

4.5.2. Test Procedure

1. The steps below define the procedure to verify successful radar detection on the selected Channel during a period equal to the Channel Availability Check Time and avoidance of operation on that Channel when a radar Burst with a level equal to the DFS Detection Threshold + 1 dB occurs at the beginning of the Channel Availability Check Time.
2. The EUT is in completion power-up cycle (from T0 to T1). T1 denotes the instant when the EUT has completed its power-up sequence. The Channel Availability Check Time commences at instant T1 and will end no sooner than T1 + 60 seconds. A single Burst of one of Short Pulse Radar Types 0-4 at DFS Detection Threshold + 1 dB will commence within a 6 second window starting at T1.
3. Visual indication on the EUT of successful detection of the radar Burst will be recorded and reported. Observation of emissions will continue for 2.5 minutes after the radar Burst has been generated. Verify that during the 2.5 minutes measurement window no EUT transmissions occurred.

4.5.3. Test Result

Product	5G NR/LTE Router	Temperature	27°C
Test Engineer	Jake Lan	Relative Humidity	65%
Test Site	WZ-SR4	Test Date	2021/07/16
Test Item	Beginning of the Channel Availability Check Time (802.11ax-HE20 mode - 5500MHz)		

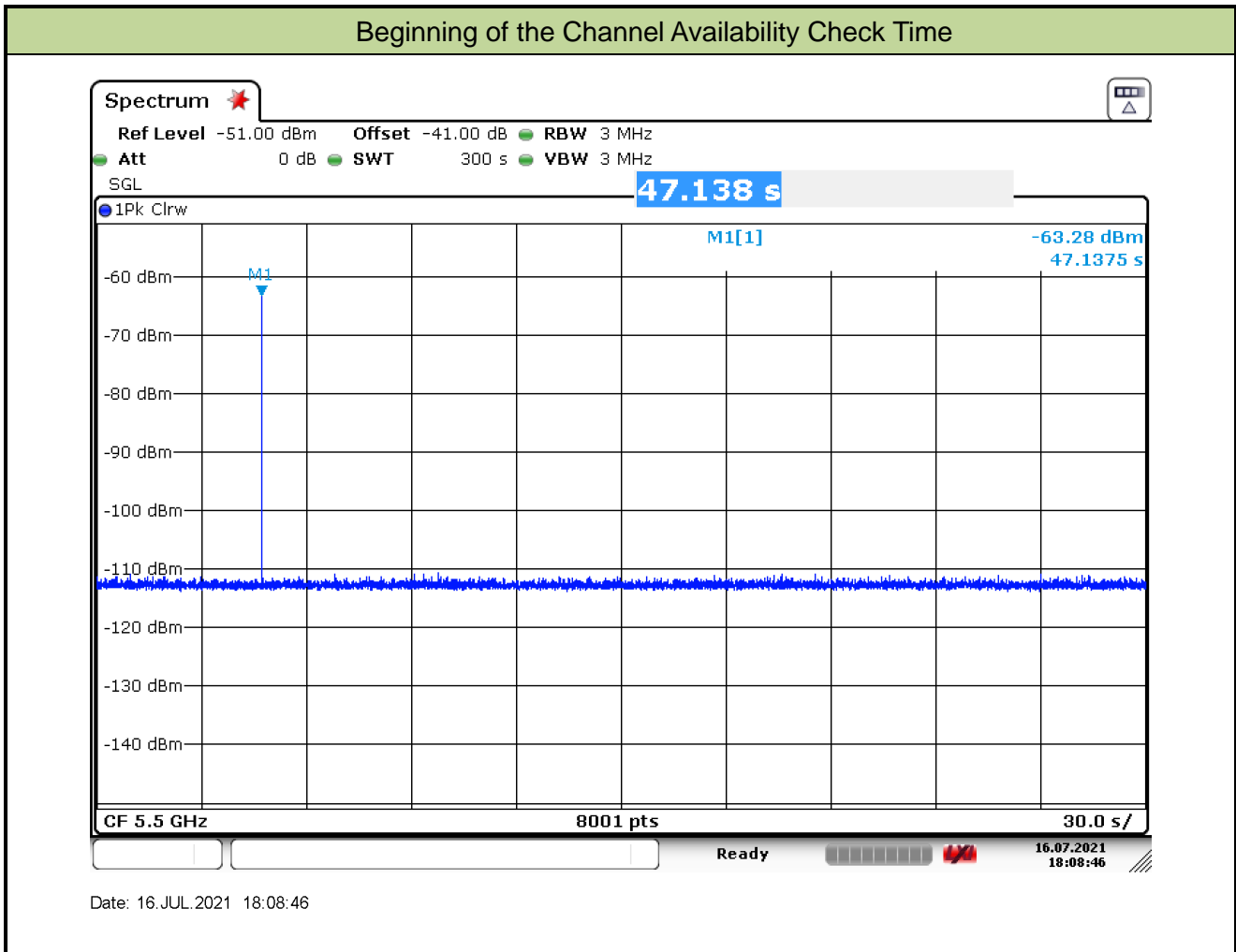

4.6. Radar Burst at the End of the Channel Availability Check Time Measurement

4.6.1. Test Limit

In the end of Channel Availability Check (CAC) Time, radar is detected on this channel, select another intended channel and perform a CAC on that channel.

4.6.2. Test Procedure

1. The steps below define the procedure to verify successful radar detection on the selected Channel during a period equal to the Channel Availability Check Time and avoidance of operation on that Channel when a radar Burst with a level equal to the DFS Detection Threshold + 1 dB occurs at the beginning of the Channel Availability Check Time.
2. The EUT is powered on at T0. T1 denotes the instant when the EUT has completed its power-up sequence. The Channel Availability Check Time commences at instant T1 and will end no sooner than T1 + 60 seconds. A single Burst of one of Short Pulse Radar Types 0-4 at DFS Detection Threshold + 1 dB will commence within a 6 second window starting at T1+ 54 seconds.
3. Visual indication on the EUT of successful detection of the radar Burst will be recorded and reported. Observation of emissions will continue for 2.5 minutes after the radar Burst has been generated. Verify that during the 2.5 minutes measurement window no EUT transmissions occurred.

4.6.3. Test Result

Product	5G NR/LTE Router	Temperature	27°C
Test Engineer	Jake Lan	Relative Humidity	65%
Test Site	WZ-SR4	Test Date	2021/07/16
Test Item	End of the Channel Availability Check Time (802.11ax-HE20 mode - 5500MHz)		

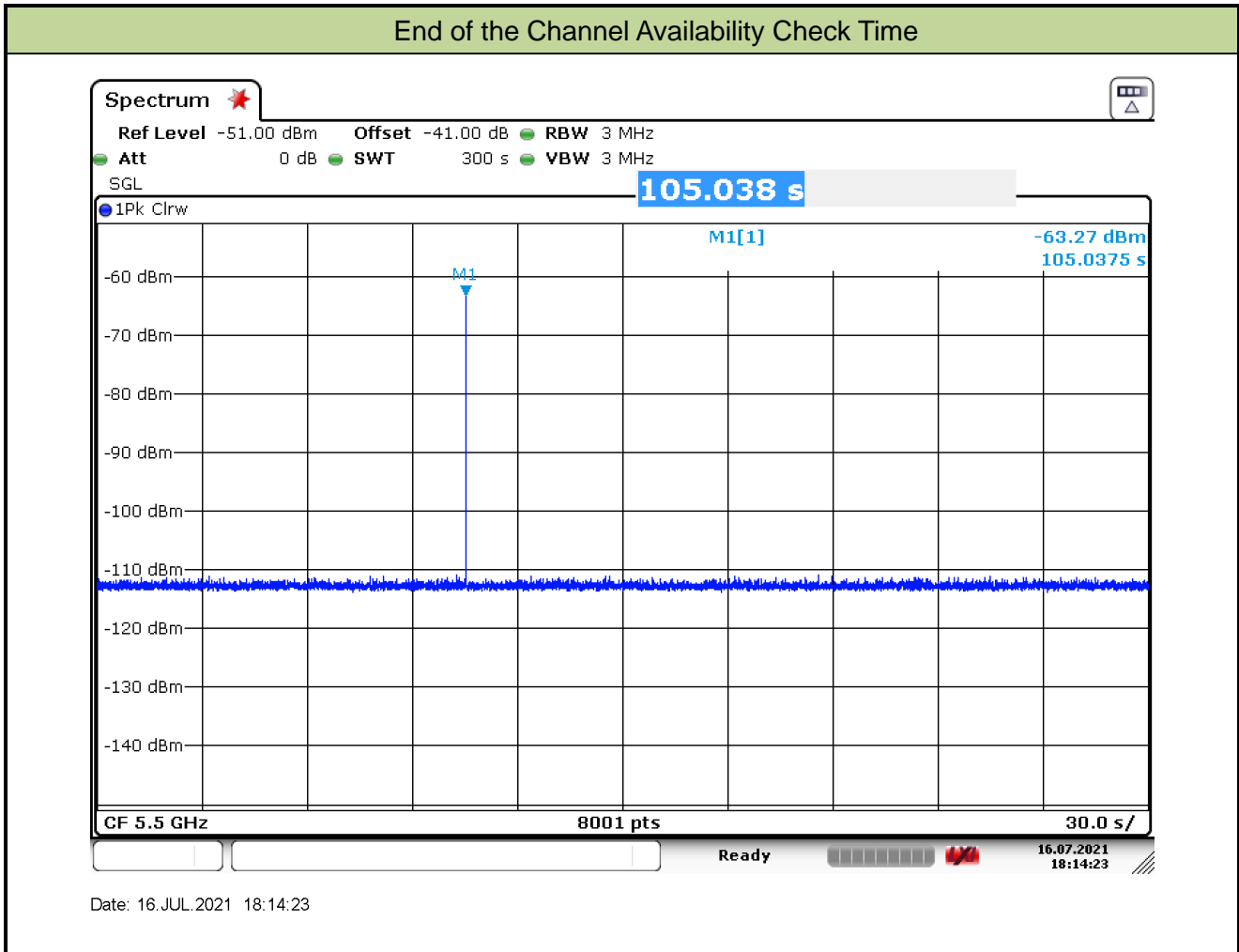

4.7. In-Service Monitoring for Channel Move Time, Channel Closing Transmission Time and Non-Occupancy Period Measurement

4.7.1. Test Limit

The EUT has In-Service Monitoring function to continuously monitor the radar signals. If the radar is detected, must leave the channel (Shutdown). The Channel Move Time to cease all transmissions on the current channel upon detection of a Radar Waveform above the DFS Detection Threshold within 10 sec. The total duration of Channel Closing Transmission Time is 260ms, consisting of data signals and the aggregate of control signals, by a U-NII device during the Channel Move Time. The Non-Occupancy Period time is 30 minute during which a Channel will not be utilized after a Radar Waveform is detected on that Channel.

4.7.2. Test Procedure Used

1. The test should be performed with Radar Type 0. The measurement timing begins at the end of the Radar Type 0.
2. When the radar burst with a level equal to the DFS Detection Threshold + 1dB is generated on the Operating Channel of the U-NII device. A U-NII device operating as a Master Device will associate with the Client Device at Channel. Stream the MPEG test file from the Master Device to the Client Device on the selected Channel for the entire period of the test. At time T0 the Radar Waveform generator sends a Burst of pulses for each of the radar types at Detection Threshold + 1dB.
3. Observe the transmissions of the EUT at the end of the radar Burst on the Operating Channel. Measure and record the transmissions from the EUT during the observation time (Channel Move Time).
4. Measurement of the aggregate duration of the Channel Closing Transmission Time method. With the spectrum analyzer set to zero span tuned to the center frequency of the EUT operating channel at the radar simulated frequency, peak detection, and max hold, the dwell time per bin is given by: $Dwell (1.5ms) = S (12 \text{ sec}) / B (8000)$; where Dwell is the dwell time per spectrum analyzer sampling bin, S is the sweep time and B is the number of spectrum analyzer sampling bins. An upper bound of the aggregate duration of the intermittent control signals of Channel Closing Transmission Time is calculated by: $C = N \times Dwell$; where C is the Closing Time, N is the number of spectrum analyzer sampling bins showing a U-NII transmission and Dwell is the dwell time per bin.
5. Measure the EUT for more than 30 minutes following the channel close/move time to verify that the EUT does not resume any transmissions on this Channel.

4.7.3. Test Result

Product	5G NR/LTE Router	Temperature	27°C
Test Engineer	Jake Lan	Relative Humidity	65%
Test Site	WZ-SR4	Test Date	2021/07/16
Test Item	Channel Move Time and Channel Closing Transmission Time (802.11ax-HE80 mode - 5530MHz)		

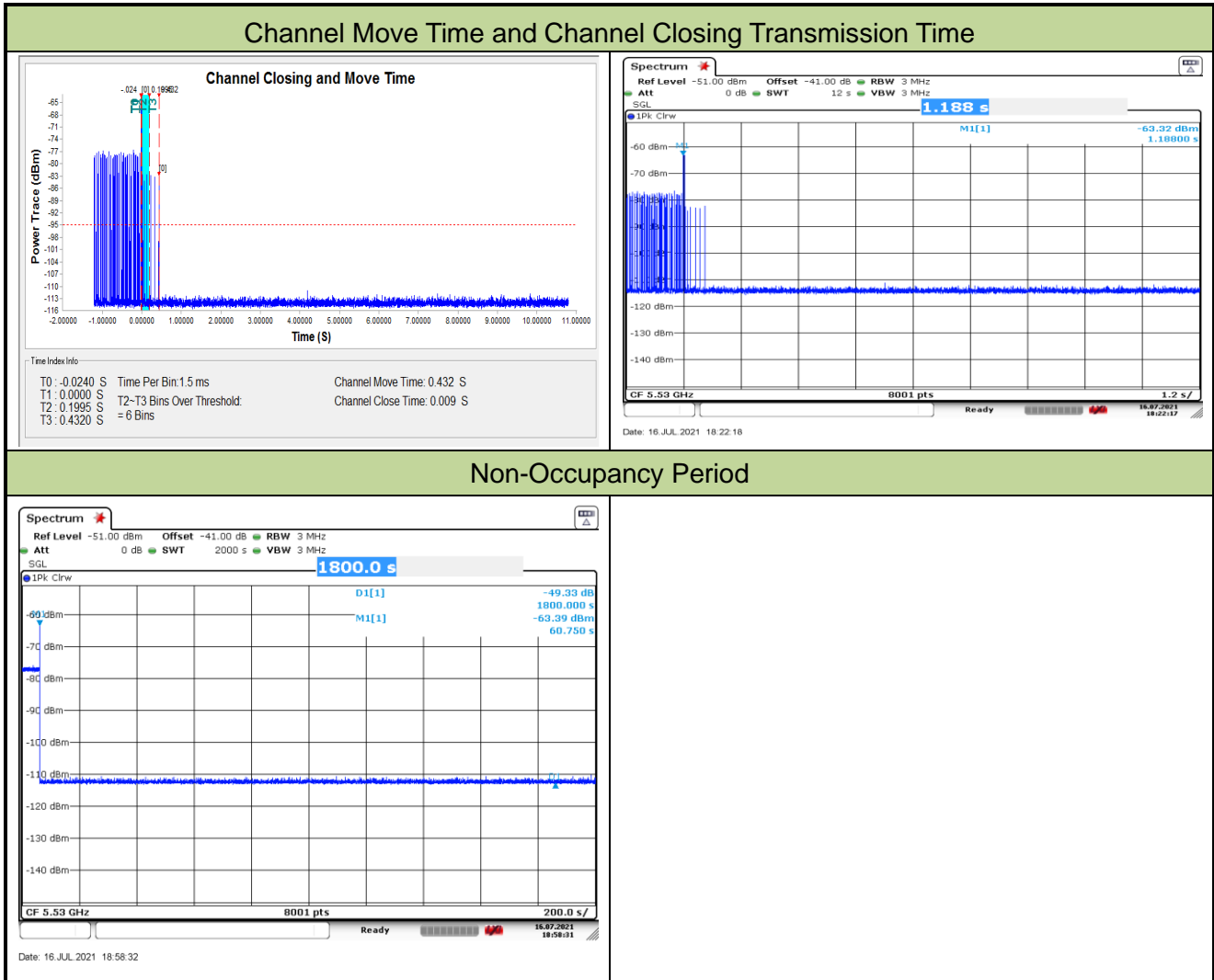

Parameter	Test Result	Limit
Channel Move Time (s)	0.432s	<10s
Channel Closing Transmission Time (ms) (Note)	0.009s	< 60ms
Non-Occupancy Period (min)	≥ 30min	≥ 30 min

Note: The Channel Closing Transmission Time is comprised of 200 milliseconds starting at the beginning of the Channel Move Time plus any additional intermittent control signals required to facilitate a Channel move (an aggregate of 60 milliseconds) during the remainder of the 10 seconds period. The aggregate duration of control signals will not count quiet periods in between transmissions.

4.8. Statistical Performance Check Measurement

4.8.1. Test Limit

The minimum percentage of successful detection requirements found in below table when a radar burst with a level equal to the DFS Detection Threshold + 1dB is generated on the Operating Channel of the U-NII device (In- Service Monitoring).

Radar Type	Minimum Number of Trails	Detection Probability
0	30	Pd > 60%
1	30(15 of test A and 15 of test B)	Pd > 60%
2	30	Pd > 60%
3	30	Pd > 60%
4	30	Pd > 60%
Aggregate (Radar Types 1-4)	120	Pd > 80%
5	30	Pd > 80%
6	30	Pd > 70%

Note: The percentage of successful detection is calculated by:
 $(\text{Total Waveform Detections} / \text{Total Waveform Trails}) * 100 = \text{Probability of Detection Radar Waveform}$
 In addition an aggregate minimum percentage of successful detection across all Short Pulse Radar Types 1-4 is required and is calculated as follows: $(Pd1 + Pd2 + Pd3 + Pd4) / 4$.

4.8.2. Test Procedure

1. Stream the MPEG test file from the Master Device to the Client Device on the test Channel for the entire period of the test.
2. At time T0 the Radar Waveform generator sends the individual waveform for each of the Radar Types 1-6, at levels equal to the DFS Detection Threshold + 1dB, on the Operating Channel.
3. Observe the transmissions of the EUT at the end of the Burst on the Operating Channel for duration greater than 10 seconds for Short Pulse Radar Types 0 to ensure detection occurs.
4. Observe the transmissions of the EUT at the end of the Burst on the Operating Channel for duration greater than 22 seconds for Long Pulse Radar Type 5 to ensure detection occurs.
5. The device can utilize a test mode to demonstrate when detection occurs to prevent the need to reset the device between trial runs.
6. The Minimum number of trails, minimum percentage of successful detection and the average minimum percentage of successful detection are found in below table.

4.8.3. Test Result

Product	5G NR/LTE Router	Temperature	27°C
Test Engineer	Jake Lan	Relative Humidity	65%
Test Site	WZ-SR4	Test Date	2021/07/19
Test Item	Radar Statistical Performance Check (802.11ax-HE20 – 5500MHz)		

Radar Type 1-4 - Radar Statistical Performance

Trial	Frequency (MHz)	1 detect ,0 no detect			
		Radar Type 1	Radar Type 2	Radar Type 3	Radar Type 4
0	5490.4	1	1	0	1
1	5500	1	1	1	1
2	5492	1	1	1	1
3	5508	1	1	1	1
4	5493	1	1	1	1
5	5502	1	1	1	1
6	5494	1	0	0	1
7	5509	1	1	1	1
8	5496	1	0	1	1
9	5504	0	0	0	1
10	5497	0	1	1	1
11	5505	1	1	1	1
12	5498	1	0	1	1
13	5506	0	1	1	1
14	5500	0	1	1	1
15	5491	1	1	1	1
16	5501	1	1	1	1
17	5496	1	1	1	0
18	5502	1	1	1	1
19	5503	1	1	1	1
20	5494	0	1	1	1
21	5504	1	0	1	1
22	5492	0	1	1	1
23	5506	1	1	1	1
24	5498	1	1	1	1
25	5507	0	1	1	0
26	5495	1	1	1	1
27	5508	0	1	1	1

28	5499	1	0	1	1
29	5509.6	1	0	1	0
Probability:		73.3%	76.7%	90.0%	90.0%
Aggregate (Radar Types 1-4):		82.5% (>80%)			

Radar Type 1 - Radar Waveform

	Trial Id	Radar Type	Pulse Width (us)	PRI (us)	Number of Pulses	Waveform Length (us)
Download	0	Type 1	1.0	698.0	76	53048.0
Download	1	Type 1	1.0	618.0	86	53148.0
Download	2	Type 1	1.0	598.0	89	53222.0
Download	3	Type 1	1.0	898.0	59	52982.0
Download	4	Type 1	1.0	798.0	67	53466.0
Download	5	Type 1	1.0	538.0	99	53262.0
Download	6	Type 1	1.0	678.0	78	52884.0
Download	7	Type 1	1.0	558.0	95	53010.0
Download	8	Type 1	1.0	518.0	102	52836.0
Download	9	Type 1	1.0	578.0	92	53176.0
Download	10	Type 1	1.0	718.0	74	53132.0
Download	11	Type 1	1.0	918.0	58	53244.0
Download	12	Type 1	1.0	738.0	72	53136.0
Download	13	Type 1	1.0	878.0	61	53558.0
Download	14	Type 1	1.0	3066.0	18	55188.0
Download	15	Type 1	1.0	1506.0	36	54216.0
Download	16	Type 1	1.0	2284.0	24	54816.0
Download	17	Type 1	1.0	2578.0	21	54138.0
Download	18	Type 1	1.0	2395.0	23	55085.0
Download	19	Type 1	1.0	746.0	71	52966.0
Download	20	Type 1	1.0	901.0	59	53159.0
Download	21	Type 1	1.0	1992.0	27	53784.0
Download	22	Type 1	1.0	1095.0	49	53655.0
Download	23	Type 1	1.0	1769.0	30	53070.0
Download	24	Type 1	1.0	1124.0	47	52828.0
Download	25	Type 1	1.0	2846.0	19	54074.0
Download	26	Type 1	1.0	1465.0	37	54205.0
Download	27	Type 1	1.0	2096.0	26	54496.0
Download	28	Type 1	1.0	1313.0	41	53833.0
Download	29	Type 1	1.0	2482.0	22	54604.0

Radar Type 2 - Radar Waveform

	Trial Id	Radar Type	Pulse Width (us)	PRI (us)	Number of Pulses	Waveform Length (us)
Download	0	Type 2	4.0	154.0	28	4312.0
Download	1	Type 2	4.2	220.0	28	6160.0
Download	2	Type 2	3.6	225.0	27	6075.0
Download	3	Type 2	1.4	190.0	23	4370.0
Download	4	Type 2	4.8	161.0	29	4669.0
Download	5	Type 2	2.7	192.0	25	4800.0
Download	6	Type 2	1.6	212.0	24	5088.0
Download	7	Type 2	2.0	172.0	24	4128.0
Download	8	Type 2	1.3	194.0	23	4462.0
Download	9	Type 2	2.5	156.0	25	3900.0
Download	10	Type 2	4.2	197.0	28	5516.0
Download	11	Type 2	1.0	230.0	23	5290.0
Download	12	Type 2	4.1	218.0	28	6104.0
Download	13	Type 2	2.8	179.0	26	4654.0
Download	14	Type 2	3.0	196.0	26	5096.0
Download	15	Type 2	4.1	200.0	28	5600.0
Download	16	Type 2	3.3	207.0	27	5589.0
Download	17	Type 2	1.5	215.0	23	4945.0
Download	18	Type 2	3.1	219.0	26	5694.0
Download	19	Type 2	4.8	221.0	29	6409.0
Download	20	Type 2	3.7	181.0	27	4887.0
Download	21	Type 2	1.1	166.0	23	3818.0
Download	22	Type 2	1.8	182.0	24	4368.0
Download	23	Type 2	2.7	171.0	25	4275.0
Download	24	Type 2	4.2	193.0	28	5404.0
Download	25	Type 2	3.7	223.0	27	6021.0
Download	26	Type 2	1.4	152.0	23	3496.0
Download	27	Type 2	2.6	162.0	25	4050.0
Download	28	Type 2	2.0	227.0	24	5448.0
Download	29	Type 2	4.6	155.0	29	4495.0

Radar Type 3 - Radar Waveform

	Trial Id	Radar Type	Pulse Width (us)	PRI (us)	Number of Pulses	Waveform Length (us)
Download	0	Type 3	9.0	465.0	18	8370.0
Download	1	Type 3	9.2	408.0	18	7344.0
Download	2	Type 3	8.6	308.0	17	5236.0
Download	3	Type 3	6.4	436.0	16	6976.0
Download	4	Type 3	9.8	433.0	18	7794.0
Download	5	Type 3	7.7	283.0	17	4811.0
Download	6	Type 3	6.6	348.0	16	5568.0
Download	7	Type 3	7.0	282.0	16	4512.0
Download	8	Type 3	6.3	486.0	16	7776.0
Download	9	Type 3	7.5	381.0	17	6477.0
Download	10	Type 3	9.2	429.0	18	7722.0
Download	11	Type 3	6.0	342.0	16	5472.0
Download	12	Type 3	9.1	473.0	18	8514.0
Download	13	Type 3	7.8	441.0	17	7497.0
Download	14	Type 3	8.0	205.0	17	3485.0
Download	15	Type 3	9.1	203.0	18	3654.0
Download	16	Type 3	8.3	442.0	17	7514.0
Download	17	Type 3	6.5	301.0	16	4816.0
Download	18	Type 3	8.1	444.0	17	7548.0
Download	19	Type 3	9.8	260.0	18	4680.0
Download	20	Type 3	8.7	330.0	18	5940.0
Download	21	Type 3	6.1	462.0	16	7392.0
Download	22	Type 3	6.8	343.0	16	5488.0
Download	23	Type 3	7.7	346.0	17	5882.0
Download	24	Type 3	9.2	500.0	18	9000.0
Download	25	Type 3	8.7	292.0	18	5256.0
Download	26	Type 3	6.4	475.0	16	7600.0
Download	27	Type 3	7.6	356.0	17	6052.0
Download	28	Type 3	7.0	277.0	16	4432.0
Download	29	Type 3	9.6	320.0	18	5760.0

Radar Type 4 - Radar Waveform

	Trial Id	Radar Type	Pulse Width (us)	PRI (us)	Number of Pulses	Waveform Length (us)
Download	0	Type 4	17.8	465.0	15	6975.0
Download	1	Type 4	18.1	408.0	15	6120.0
Download	2	Type 4	16.9	308.0	15	4620.0
Download	3	Type 4	11.9	436.0	12	5232.0
Download	4	Type 4	19.4	433.0	16	6928.0
Download	5	Type 4	14.8	283.0	14	3962.0
Download	6	Type 4	12.3	348.0	12	4176.0
Download	7	Type 4	13.4	282.0	13	3666.0
Download	8	Type 4	11.7	486.0	12	5832.0
Download	9	Type 4	14.3	381.0	13	4953.0
Download	10	Type 4	18.2	429.0	15	6435.0
Download	11	Type 4	11.1	342.0	12	4104.0
Download	12	Type 4	17.9	473.0	15	7095.0
Download	13	Type 4	15.0	441.0	14	6174.0
Download	14	Type 4	15.4	205.0	14	2870.0
Download	15	Type 4	18.0	203.0	15	3045.0
Download	16	Type 4	16.2	442.0	14	6188.0
Download	17	Type 4	12.1	301.0	12	3612.0
Download	18	Type 4	15.7	444.0	14	6216.0
Download	19	Type 4	19.5	260.0	16	4160.0
Download	20	Type 4	17.1	330.0	15	4950.0
Download	21	Type 4	11.2	462.0	12	5544.0
Download	22	Type 4	12.8	343.0	13	4459.0
Download	23	Type 4	14.8	346.0	14	4844.0
Download	24	Type 4	18.1	500.0	15	7500.0
Download	25	Type 4	17.2	292.0	15	4380.0
Download	26	Type 4	11.9	475.0	12	5700.0
Download	27	Type 4	14.6	356.0	13	4628.0
Download	28	Type 4	13.4	277.0	13	3601.0
Download	29	Type 4	19.1	320.0	16	5120.0

Radar Type 5 - Radar Statistical Performance

Trail #	Test Freq. (MHz)	1=Detection 0=No Detection	Trail #	Test Freq. (MHz)	1=Detection 0=No Detection
0	5500	1	15	5497.2	1
1	5500	1	16	5496	1
2	5500	1	17	5493.2	1
3	5500	1	18	5495.6	1
4	5500	1	19	5498.4	1
5	5500	1	20	5503.6	1
6	5500	1	21	5507.6	1
7	5500	1	22	5506.4	1
8	5500	1	23	5505.2	1
9	5500	1	24	5502.8	1
10	5497.2	1	25	5503.6	1
11	5492.4	1	26	5507.2	1
12	5497.2	1	27	5505.2	1
13	5495.2	0	28	5506	1
14	5495.2	0	29	5502	1
Detection Percentage (%)					93.3%

Type 5 Radar Waveform_0

Burst Offset (us)	Pulse Width (us)	Chirp Width (MHz)	Number of Pulses per Burst	PRI-1 (us)	PRI-2 (us)	PRI-3 (us)
695606.0	87.5	16	3	1895.0	1094.0	1750.0
164505.0	89.3	16	3	1424.0	1887.0	1453.0
335515.0	82.8	16	2	1122.0	1616.0	-
507127.0	55.1	16	1	1242.0	-	-
674891.0	96.5	16	3	1987.0	1407.0	1104.0
143872.0	71.1	16	2	1787.0	1470.0	-
315128.0	57.3	16	1	1355.0	-	-
486086.0	63.3	16	1	1227.0	-	-
656814.0	54.1	16	1	1413.0	-	-
122831.0	68.5	16	2	1582.0	1941.0	-
292477.0	90.0	16	3	1981.0	1381.0	1836.0
464816.0	51.0	16	1	1560.0	-	-
632078.0	88.4	16	3	1874.0	1991.0	1638.0
101917.0	72.2	16	2	1585.0	1486.0	-
272422.0	74.6	16	2	1415.0	1518.0	-
442012.0	88.6	16	3	1011.0	1648.0	1698.0
612672.0	78.7	16	2	1980.0	1783.0	-

Type 5 Radar Waveform_1

Burst Offset (us)	Pulse Width (us)	Chirp Width (MHz)	Number of Pulses per Burst	PRI-1 (us)	PRI-2 (us)	PRI-3 (us)
76565.0	56.3	17	1	1666.0	-	-
237403.0	76.0	17	2	1637.0	1274.0	-
397685.0	97.1	17	3	1241.0	1311.0	1525.0
557183.0	83.8	17	3	1923.0	1643.0	1936.0
56736.0	51.2	17	1	1221.0	-	-
217970.0	60.2	17	1	1702.0	-	-
378741.0	71.2	17	2	1115.0	1471.0	-
538704.0	89.3	17	3	1068.0	1780.0	1088.0
36675.0	84.1	17	3	1903.0	1059.0	1536.0
198274.0	54.9	17	1	1134.0	-	-
358298.0	69.9	17	2	1805.0	1898.0	-
520565.0	63.4	17	1	1817.0	-	-
16899.0	94.8	17	3	1792.0	1403.0	1080.0
178302.0	59.5	17	1	1469.0	-	-
338122.0	92.4	17	3	1649.0	1711.0	1069.0
499381.0	75.4	17	2	1745.0	1827.0	-
662153.0	57.0	17	1	1613.0	-	-
157681.0	86.0	17	3	1749.0	1198.0	1667.0

Type 5 Radar Waveform_2

Burst Offset (us)	Pulse Width (us)	Chirp Width (MHz)	Number of Pulses per Burst	PRI-1 (us)	PRI-2 (us)	PRI-3 (us)
358301.0	93.3	15	3	1740.0	1323.0	1564.0
541440.0	59.1	15	1	1360.0	-	-
722441.0	54.7	15	1	1948.0	-	-
155397.0	83.4	15	3	1231.0	1055.0	1670.0
337608.0	66.3	15	1	1136.0	-	-
516376.0	89.6	15	3	1604.0	1946.0	1703.0
698685.0	87.2	15	3	1233.0	1048.0	1172.0
133283.0	81.7	15	2	1247.0	1735.0	-
315245.0	62.7	15	1	1114.0	-	-
495489.0	77.2	15	2	1741.0	1459.0	-
678196.0	50.7	15	1	1451.0	-	-
111023.0	69.1	15	2	1161.0	1445.0	-
291934.0	69.1	15	2	1986.0	1527.0	-
472651.0	95.6	15	3	1185.0	1118.0	1731.0
653921.0	68.5	15	2	1877.0	1757.0	-
88769.0	57.3	15	1	1977.0	-	-

Type 5 Radar Waveform_3

Burst Offset (us)	Pulse Width (us)	Chirp Width (MHz)	Number of Pulses per Burst	PRI-1 (us)	PRI-2 (us)	PRI-3 (us)
480435.0	78.4	6	2	1872.0	1366.0	-
804165.0	51.5	6	1	1350.0	-	-
1125537.0	74.7	6	2	1833.0	1497.0	-
118017.0	88.8	6	3	1429.0	1441.0	1400.0
440166.0	86.2	6	3	1656.0	1801.0	1389.0
763750.0	79.0	6	2	1019.0	1416.0	-
1087583.0	61.5	6	1	1151.0	-	-
78504.0	65.8	6	1	1021.0	-	-
401389.0	62.4	6	1	1826.0	-	-

Type 5 Radar Waveform_4

Burst Offset (us)	Pulse Width (us)	Chirp Width (MHz)	Number of Pulses per Burst	PRI-1 (us)	PRI-2 (us)	PRI-3 (us)
325532.0	66.1	19	1	1580.0	-	-
468586.0	87.4	19	3	1131.0	1888.0	1208.0
17318.0	99.9	19	3	1289.0	1162.0	1372.0
162575.0	59.3	19	1	1376.0	-	-
307737.0	58.9	19	1	1421.0	-	-
451340.0	97.6	19	3	1046.0	1190.0	1261.0
595688.0	75.6	19	2	1849.0	1971.0	-
144399.0	81.3	19	2	1120.0	1463.0	-
288585.0	86.3	19	3	1677.0	1071.0	1294.0
433727.0	81.4	19	2	1900.0	1312.0	-
579236.0	79.4	19	2	1362.0	1056.0	-
126606.0	74.0	19	2	1218.0	1111.0	-
271650.0	72.9	19	2	1034.0	1097.0	-
417330.0	59.7	19	1	1158.0	-	-
562200.0	57.5	19	1	1550.0	-	-
108441.0	96.7	19	3	1626.0	1342.0	1061.0
253399.0	69.5	19	2	1671.0	1378.0	-
397473.0	97.5	19	3	1306.0	1020.0	1781.0
541400.0	94.1	19	3	1906.0	1461.0	1395.0
90670.0	88.5	19	3	1205.0	1420.0	1188.0

Type 5 Radar Waveform_5

Burst Offset (us)	Pulse Width (us)	Chirp Width (MHz)	Number of Pulses per Burst	PRI-1 (us)	PRI-2 (us)	PRI-3 (us)
363648.0	65.0	11	1	1549.0	-	-
585014.0	85.9	11	3	1943.0	1806.0	1149.0
808842.0	74.4	11	2	1762.0	1839.0	-
112208.0	94.9	11	3	1599.0	1814.0	1494.0
335249.0	87.5	11	3	1053.0	1316.0	1563.0
559280.0	81.2	11	2	1012.0	1093.0	-
779909.0	90.8	11	3	1966.0	1476.0	1882.0
85050.0	50.6	11	1	1964.0	-	-
308285.0	68.3	11	2	1402.0	1052.0	-
530626.0	99.8	11	3	1299.0	1018.0	1763.0
755221.0	64.2	11	1	1996.0	-	-
57346.0	97.7	11	3	1655.0	1410.0	1891.0
280334.0	88.9	11	3	1030.0	1346.0	1546.0

Type 5 Radar Waveform_6

Burst Offset (us)	Pulse Width (us)	Chirp Width (MHz)	Number of Pulses per Burst	PRI-1 (us)	PRI-2 (us)	PRI-3 (us)
728498.0	71.0	7	2	1009.0	1790.0	-
1051992.0	50.2	7	1	1789.0	-	-
43387.0	52.1	7	1	1854.0	-	-
365529.0	87.3	7	3	1262.0	1822.0	1618.0
688923.0	72.3	7	2	1315.0	1148.0	-
1012272.0	53.8	7	1	1712.0	-	-
3605.0	79.6	7	2	1769.0	1813.0	-
326227.0	75.2	7	2	1427.0	1684.0	-
647965.0	87.8	7	3	1540.0	1840.0	1541.0

Type 5 Radar Waveform_7

Burst Offset (us)	Pulse Width (us)	Chirp Width (MHz)	Number of Pulses per Burst	PRI-1 (us)	PRI-2 (us)	PRI-3 (us)
795158.0	82.9	9	2	1005.0	1103.0	-
1059335.0	64.2	9	1	1997.0	-	-
233929.0	89.2	9	3	1818.0	1089.0	1820.0
498433.0	83.3	9	2	1298.0	1092.0	-
762706.0	55.5	9	1	2000.0	-	-
1024210.0	91.9	9	3	1668.0	1802.0	1278.0
201826.0	67.2	9	2	1176.0	1689.0	-
464726.0	92.2	9	3	1390.0	1821.0	1955.0
730287.0	66.6	9	1	1835.0	-	-
993656.0	81.6	9	2	1436.0	1237.0	-
169315.0	67.4	9	2	1679.0	1224.0	-

Type 5 Radar Waveform_8

Burst Offset (us)	Pulse Width (us)	Chirp Width (MHz)	Number of Pulses per Burst	PRI-1 (us)	PRI-2 (us)	PRI-3 (us)
529661.0	77.4	6	2	1681.0	1351.0	-
851148.0	97.5	6	3	1979.0	1058.0	1794.0
1174248.0	80.3	6	2	1908.0	1909.0	-
167507.0	63.0	6	1	1217.0	-	-
490399.0	55.0	6	1	1730.0	-	-
812050.0	71.9	6	2	1975.0	1890.0	-
1135344.0	77.8	6	2	1354.0	1508.0	-
127704.0	56.7	6	1	1295.0	-	-
450047.0	75.0	6	2	1455.0	1961.0	-

Type 5 Radar Waveform_9

Burst Offset (us)	Pulse Width (us)	Chirp Width (MHz)	Number of Pulses per Burst	PRI-1 (us)	PRI-2 (us)	PRI-3 (us)
580021.0	63.0	10	1	1571.0	-	-
820585.0	86.5	10	3	1119.0	1125.0	1254.0
65801.0	67.2	10	2	1348.0	1621.0	-
307773.0	81.7	10	2	1121.0	1329.0	-
548708.0	85.1	10	3	1022.0	1863.0	1383.0
792428.0	51.8	10	1	1465.0	-	-
36060.0	59.5	10	1	1736.0	-	-
278156.0	55.3	10	1	1787.0	-	-
520609.0	59.4	10	1	1105.0	-	-
760183.0	97.2	10	3	1349.0	1853.0	1425.0
6219.0	93.7	10	3	1530.0	1718.0	1386.0
248481.0	64.5	10	1	1201.0	-	-

Type 5 Radar Waveform_10

Burst Offset (us)	Pulse Width (us)	Chirp Width (MHz)	Number of Pulses per Burst	PRI-1 (us)	PRI-2 (us)	PRI-3 (us)
326652.0	63.3	17	1	1809.0	-	-
487339.0	77.2	17	2	1352.0	1223.0	-
649901.0	52.9	17	1	1040.0	-	-
145505.0	60.2	17	1	1972.0	-	-
306904.0	55.7	17	1	1561.0	-	-
468149.0	54.1	17	1	1652.0	-	-
627725.0	75.7	17	2	1598.0	1862.0	-
125181.0	99.0	17	3	1944.0	1493.0	1003.0
285611.0	83.4	17	3	1083.0	1922.0	1856.0
447284.0	76.2	17	2	1361.0	1772.0	-
608350.0	83.1	17	2	1275.0	1708.0	-
105738.0	82.6	17	2	1212.0	1091.0	-
266792.0	80.3	17	2	1405.0	1084.0	-
428753.0	61.4	17	1	1128.0	-	-
588731.0	73.6	17	2	1565.0	1183.0	-
85793.0	69.9	17	2	1764.0	1291.0	-
246187.0	89.1	17	3	1332.0	1462.0	1748.0
408145.0	82.2	17	2	1175.0	1135.0	-

Type 5 Radar Waveform_11

Burst Offset (us)	Pulse Width (us)	Chirp Width (MHz)	Number of Pulses per Burst	PRI-1 (us)	PRI-2 (us)	PRI-3 (us)
1284122.0	50.4	5	1	1393.0	-	-
148793.0	76.1	5	2	1498.0	1707.0	-
511972.0	72.8	5	2	1537.0	1202.0	-
875727.0	50.2	5	1	1675.0	-	-
1237527.0	74.8	5	2	1753.0	1846.0	-
104006.0	96.4	5	3	1556.0	1534.0	1139.0
466667.0	97.0	5	3	1196.0	1864.0	1523.0
830841.0	57.4	5	1	1901.0	-	-

Type 5 Radar Waveform_12

Burst Offset (us)	Pulse Width (us)	Chirp Width (MHz)	Number of Pulses per Burst	PRI-1 (us)	PRI-2 (us)	PRI-3 (us)
559399.0	98.3	17	3	1569.0	1106.0	1440.0
27935.0	53.6	17	1	1507.0	-	-
198239.0	82.4	17	2	1457.0	1927.0	-
369508.0	61.9	17	1	1686.0	-	-
539056.0	82.7	17	2	1591.0	1714.0	-
6872.0	69.4	17	2	1700.0	1918.0	-
176877.0	88.0	17	3	1337.0	1747.0	1788.0
348435.0	52.9	17	1	1758.0	-	-
519502.0	64.1	17	1	1358.0	-	-
689193.0	70.2	17	2	1235.0	1326.0	-
156347.0	77.3	17	2	1593.0	1426.0	-
327292.0	52.8	17	1	1989.0	-	-
496484.0	99.3	17	3	1266.0	1062.0	1816.0
667998.0	67.7	17	2	1432.0	1322.0	-
135604.0	52.1	17	1	1697.0	-	-
306676.0	57.8	17	1	1041.0	-	-
475077.0	91.6	17	3	1782.0	1866.0	1150.0

Type 5 Radar Waveform_13

Burst Offset (us)	Pulse Width (us)	Chirp Width (MHz)	Number of Pulses per Burst	PRI-1 (us)	PRI-2 (us)	PRI-3 (us)
844259.0	86.8	12	3	1673.0	1963.0	1930.0
149980.0	53.4	12	1	1219.0	-	-
372357.0	84.6	12	3	1353.0	1693.0	1140.0
597095.0	51.4	12	1	1288.0	-	-
818553.0	73.6	12	2	1828.0	1824.0	-
122228.0	78.2	12	2	1167.0	1650.0	-
345078.0	89.6	12	3	1165.0	1025.0	1538.0
569672.0	66.2	12	1	1102.0	-	-
791720.0	77.2	12	2	1344.0	1570.0	-
94577.0	96.8	12	3	1127.0	1597.0	1635.0
318083.0	67.5	12	2	1082.0	1287.0	-
540382.0	91.7	12	3	1886.0	1060.0	1126.0
765798.0	63.0	12	1	1027.0	-	-

Type 5 Radar Waveform_14

Burst Offset (us)	Pulse Width (us)	Chirp Width (MHz)	Number of Pulses per Burst	PRI-1 (us)	PRI-2 (us)	PRI-3 (us)
62514.0	52.3	12	1	1610.0	-	-
269956.0	56.5	12	1	1775.0	-	-
477816.0	63.2	12	1	1047.0	-	-
682475.0	98.4	12	3	1974.0	1398.0	1385.0
36981.0	55.9	12	1	1014.0	-	-
244048.0	72.0	12	2	1701.0	1314.0	-
452073.0	66.6	12	1	1364.0	-	-
658443.0	71.5	12	2	1074.0	1825.0	-
11359.0	93.5	12	3	1334.0	1339.0	1779.0
218895.0	63.6	12	1	1592.0	-	-
424712.0	94.7	12	3	1317.0	1905.0	1744.0
632778.0	77.3	12	2	1623.0	1472.0	-
838079.0	97.4	12	3	1680.0	1659.0	1619.0
193414.0	53.3	12	1	1250.0	-	-

Type 5 Radar Waveform_15

Burst Offset (us)	Pulse Width (us)	Chirp Width (MHz)	Number of Pulses per Burst	PRI-1 (us)	PRI-2 (us)	PRI-3 (us)
309863.0	92.6	17	3	1951.0	1728.0	1608.0
471103.0	86.3	17	3	1228.0	1490.0	1396.0
632056.0	83.0	17	2	1871.0	1967.0	-
130066.0	82.7	17	2	1766.0	1653.0	-
290956.0	73.9	17	2	1605.0	1742.0	-
453079.0	65.0	17	1	1516.0	-	-
614685.0	58.6	17	1	1207.0	-	-
110261.0	88.1	17	3	1081.0	1028.0	1256.0
270890.0	93.0	17	3	1036.0	1430.0	1492.0
433519.0	62.3	17	1	1039.0	-	-
594852.0	55.9	17	1	1154.0	-	-
90510.0	74.6	17	2	1076.0	1811.0	-
251345.0	75.4	17	2	1551.0	1739.0	-
411484.0	92.8	17	3	1552.0	1628.0	1319.0
571584.0	95.7	17	3	1831.0	1409.0	1834.0
70862.0	55.5	17	1	1184.0	-	-
231720.0	72.7	17	2	1573.0	1164.0	-
392729.0	70.4	17	2	1645.0	1117.0	-

Type 5 Radar Waveform_16

Burst Offset (us)	Pulse Width (us)	Chirp Width (MHz)	Number of Pulses per Burst	PRI-1 (us)	PRI-2 (us)	PRI-3 (us)
665915.0	61.2	14	1	1614.0	-	-
61198.0	51.0	14	1	1147.0	-	-
254150.0	67.9	14	2	1933.0	1705.0	-
447435.0	70.8	14	2	1678.0	1706.0	-
639319.0	89.6	14	3	1969.0	1483.0	1575.0
37296.0	50.9	14	1	1938.0	-	-
230839.0	61.8	14	1	1978.0	-	-
423916.0	80.1	14	2	1620.0	1240.0	-
615186.0	91.3	14	3	1873.0	1962.0	1688.0
13434.0	70.0	14	2	1945.0	1200.0	-
206249.0	93.4	14	3	1304.0	1761.0	1807.0
396804.0	89.8	14	3	1642.0	1869.0	1914.0
592308.0	90.0	14	3	1129.0	1998.0	1246.0
785871.0	74.1	14	2	1992.0	1773.0	-
183070.0	76.3	14	2	1271.0	1095.0	-

Type 5 Radar Waveform_17

Burst Offset (us)	Pulse Width (us)	Chirp Width (MHz)	Number of Pulses per Burst	PRI-1 (us)	PRI-2 (us)	PRI-3 (us)
627774.0	74.8	7	2	1479.0	1958.0	-
949564.0	97.0	7	3	1146.0	1847.0	1496.0
1273772.0	80.0	7	2	1357.0	1124.0	-
265350.0	94.3	7	3	1166.0	1502.0	1529.0
588960.0	64.0	7	1	1365.0	-	-
909777.0	93.7	7	3	1588.0	1539.0	1491.0
1233393.0	76.7	7	2	1947.0	1204.0	-
226065.0	54.4	7	1	1715.0	-	-
549046.0	64.3	7	1	1663.0	-	-

Type 5 Radar Waveform_18

Burst Offset (us)	Pulse Width (us)	Chirp Width (MHz)	Number of Pulses per Burst	PRI-1 (us)	PRI-2 (us)	PRI-3 (us)
560248.0	63.6	13	1	1581.0	-	-
767895.0	50.8	13	1	1418.0	-	-
119252.0	92.4	13	3	1860.0	1615.0	1213.0
326636.0	81.3	13	2	1239.0	1785.0	-
532669.0	96.6	13	3	1716.0	1216.0	1880.0
741346.0	73.8	13	2	1373.0	1180.0	-
93986.0	75.9	13	2	1145.0	1725.0	-
300616.0	87.9	13	3	1558.0	1439.0	1454.0
507076.0	90.9	13	3	1949.0	1475.0	1607.0
715650.0	74.2	13	2	1481.0	1269.0	-
68536.0	66.0	13	1	1984.0	-	-
275040.0	96.3	13	3	1554.0	1260.0	1956.0
482345.0	85.5	13	3	1032.0	1302.0	1414.0
689847.0	71.8	13	2	1257.0	1838.0	-

Type 5 Radar Waveform_19

Burst Offset (us)	Pulse Width (us)	Chirp Width (MHz)	Number of Pulses per Burst	PRI-1 (us)	PRI-2 (us)	PRI-3 (us)
29927.0	96.7	20	3	1743.0	1665.0	1263.0
174804.0	82.0	20	2	1937.0	1057.0	-
319350.0	70.9	20	2	2000.0	1456.0	-
463158.0	93.9	20	3	1428.0	1935.0	1215.0
12164.0	73.7	20	2	1942.0	1676.0	-
156602.0	88.7	20	3	1138.0	1369.0	1884.0
300978.0	94.8	20	3	1477.0	1433.0	1634.0
447574.0	53.1	20	1	1631.0	-	-
591693.0	72.4	20	2	1544.0	1101.0	-
139285.0	81.8	20	2	1203.0	1143.0	-
283592.0	98.4	20	3	1248.0	1382.0	1067.0
429508.0	50.5	20	1	1896.0	-	-
572872.0	95.9	20	3	1195.0	1189.0	1276.0
121694.0	65.7	20	1	1050.0	-	-
266764.0	61.3	20	1	1484.0	-	-
411619.0	58.7	20	1	1926.0	-	-
554961.0	76.8	20	2	1861.0	1902.0	-
103152.0	84.6	20	3	1915.0	1374.0	1505.0
247959.0	96.7	20	3	1510.0	1174.0	1024.0
394149.0	53.5	20	1	1324.0	-	-

Type 5 Radar Waveform_20

Burst Offset (us)	Pulse Width (us)	Chirp Width (MHz)	Number of Pulses per Burst	PRI-1 (us)	PRI-2 (us)	PRI-3 (us)
674284.0	57.1	15	1	1542.0	-	-
106884.0	88.8	15	3	1844.0	1646.0	1307.0
288907.0	58.5	15	1	1460.0	-	-
469853.0	80.6	15	2	1001.0	1412.0	-
649151.0	83.6	15	3	1318.0	1528.0	1881.0
84916.0	67.5	15	2	1171.0	1037.0	-
265252.0	94.2	15	3	1892.0	1282.0	1919.0
448008.0	55.4	15	1	1596.0	-	-
627398.0	99.0	15	3	1133.0	1137.0	1848.0
62638.0	65.7	15	1	1468.0	-	-
244189.0	58.1	15	1	1442.0	-	-
425106.0	80.0	15	2	1524.0	1029.0	-
605549.0	89.4	15	3	1368.0	1153.0	1063.0
40220.0	75.1	15	2	1272.0	1243.0	-
221451.0	83.3	15	2	1258.0	1449.0	-
403371.0	62.2	15	1	1450.0	-	-

Type 5 Radar Waveform_21

Burst Offset (us)	Pulse Width (us)	Chirp Width (MHz)	Number of Pulses per Burst	PRI-1 (us)	PRI-2 (us)	PRI-3 (us)
1167987.0	93.1	5	3	1627.0	1917.0	1722.0
35794.0	99.8	5	3	1982.0	1107.0	1244.0
399428.0	52.9	5	1	1004.0	-	-
762567.0	65.7	5	1	1819.0	-	-
1124629.0	69.6	5	2	1704.0	1837.0	-
1489617.0	60.5	5	1	1478.0	-	-
354190.0	78.5	5	2	1640.0	1292.0	-
718078.0	60.6	5	1	1259.0	-	-

Type 5 Radar Waveform_22

Burst Offset (us)	Pulse Width (us)	Chirp Width (MHz)	Number of Pulses per Burst	PRI-1 (us)	PRI-2 (us)	PRI-3 (us)
863762.0	82.9	8	2	1110.0	1968.0	-
1152909.0	96.0	8	3	1636.0	1488.0	1141.0
247495.0	77.9	8	2	1480.0	1245.0	-
538596.0	60.1	8	1	1113.0	-	-
828110.0	76.6	8	2	1042.0	1883.0	-
1117974.0	82.2	8	2	1843.0	1579.0	-
211384.0	97.5	8	3	1515.0	1852.0	1297.0
501898.0	81.5	8	2	1572.0	1644.0	-
790724.0	99.7	8	3	1726.0	1669.0	1983.0
1082088.0	82.0	8	2	1611.0	1965.0	-

Type 5 Radar Waveform_23

Burst Offset (us)	Pulse Width (us)	Chirp Width (MHz)	Number of Pulses per Burst	PRI-1 (us)	PRI-2 (us)	PRI-3 (us)
135457.0	64.7	11	1	1391.0	-	-
358948.0	57.9	11	1	1512.0	-	-
581931.0	73.5	11	2	1186.0	1157.0	-
803167.0	90.4	11	3	1545.0	1181.0	1985.0
107956.0	60.3	11	1	1100.0	-	-
331582.0	56.2	11	1	1051.0	-	-
553168.0	94.5	11	3	1347.0	1815.0	1268.0
775437.0	89.4	11	3	1499.0	1960.0	1600.0
80356.0	54.2	11	1	1755.0	-	-
303883.0	56.6	11	1	1520.0	-	-
526158.0	73.7	11	2	1912.0	1760.0	-
749580.0	68.4	11	2	1768.0	1367.0	-
52843.0	61.2	11	1	1553.0	-	-

Type 5 Radar Waveform_24

Burst Offset (us)	Pulse Width (us)	Chirp Width (MHz)	Number of Pulses per Burst	PRI-1 (us)	PRI-2 (us)	PRI-3 (us)
198801.0	70.7	17	2	1842.0	1879.0	-
360116.0	82.4	17	2	1562.0	1182.0	-
519459.0	99.2	17	3	1187.0	1798.0	1899.0
18263.0	65.6	17	1	1812.0	-	-
179192.0	77.0	17	2	1624.0	1371.0	-
339915.0	81.6	17	2	1682.0	1778.0	-
501097.0	80.9	17	2	1079.0	1939.0	-
660159.0	84.0	17	3	1192.0	1920.0	1804.0
158995.0	96.7	17	3	1759.0	1193.0	1586.0
321142.0	60.2	17	1	1305.0	-	-
480219.0	98.0	17	3	1647.0	1197.0	1625.0
640868.0	97.7	17	3	1377.0	1867.0	1178.0
139104.0	87.6	17	3	1503.0	1583.0	1973.0
299773.0	89.6	17	3	1672.0	1234.0	1695.0
460736.0	84.0	17	3	1078.0	1746.0	1214.0
622322.0	78.8	17	2	1823.0	1279.0	-
119779.0	66.7	17	2	1509.0	1112.0	-
280806.0	68.3	17	2	1064.0	1617.0	-

Type 5 Radar Waveform_25

Burst Offset (us)	Pulse Width (us)	Chirp Width (MHz)	Number of Pulses per Burst	PRI-1 (us)	PRI-2 (us)	PRI-3 (us)
497391.0	76.6	15	2	1333.0	1206.0	-
677997.0	80.4	15	2	1487.0	1797.0	-
112623.0	57.3	15	1	1694.0	-	-
294267.0	60.4	15	1	1296.0	-	-
474856.0	75.4	15	2	1691.0	1170.0	-
653644.0	88.8	15	3	1931.0	1751.0	1932.0
90319.0	52.7	15	1	1267.0	-	-
270462.0	89.5	15	3	1934.0	1452.0	1870.0
451746.0	96.8	15	3	1630.0	1010.0	1526.0
633072.0	71.3	15	2	1858.0	1791.0	-
67817.0	80.3	15	2	1423.0	1321.0	-
249583.0	56.3	15	1	1144.0	-	-
430492.0	71.8	15	2	1072.0	1309.0	-
610879.0	86.9	15	3	1015.0	1375.0	1132.0
45549.0	64.4	15	1	1830.0	-	-
226271.0	84.7	15	3	1727.0	1191.0	1327.0

Type 5 Radar Waveform_26

Burst Offset (us)	Pulse Width (us)	Chirp Width (MHz)	Number of Pulses per Burst	PRI-1 (us)	PRI-2 (us)	PRI-3 (us)
727098.0	57.2	6	1	1513.0	-	-
1048773.0	77.8	6	2	1397.0	1808.0	-
41267.0	77.5	6	2	1308.0	1086.0	-
364379.0	66.6	6	1	1232.0	-	-
686831.0	70.5	6	2	1408.0	1035.0	-
1007723.0	100.0	6	3	1380.0	1845.0	1710.0
1506.0	68.7	6	2	1363.0	1280.0	-
323796.0	98.0	6	3	1810.0	1142.0	1511.0
646925.0	68.1	6	2	1388.0	1356.0	-

Type 5 Radar Waveform_27

Burst Offset (us)	Pulse Width (us)	Chirp Width (MHz)	Number of Pulses per Burst	PRI-1 (us)	PRI-2 (us)	PRI-3 (us)
669252.0	97.7	11	3	1404.0	1916.0	1370.0
893363.0	75.6	11	2	1770.0	1506.0	-
196391.0	92.7	11	3	1869.0	1419.0	1169.0
419884.0	72.7	11	2	1859.0	1065.0	-
642713.0	66.7	11	2	1685.0	1721.0	-
867478.0	60.5	11	1	1584.0	-	-
169501.0	60.5	11	1	1448.0	-	-
392189.0	87.5	11	3	1156.0	1225.0	1026.0
614509.0	88.4	11	3	1474.0	1434.0	1589.0
837673.0	97.1	11	3	1054.0	1950.0	1077.0
141467.0	88.1	11	3	1754.0	1016.0	1928.0
365506.0	53.8	11	1	1411.0	-	-
589158.0	60.2	11	1	1226.0	-	-

Type 5 Radar Waveform_28

Burst Offset (us)	Pulse Width (us)	Chirp Width (MHz)	Number of Pulses per Burst	PRI-1 (us)	PRI-2 (us)	PRI-3 (us)
960354.0	57.0	9	1	1622.0	-	-
135226.0	60.4	9	1	1832.0	-	-
399471.0	62.8	9	1	1535.0	-	-
661887.0	87.5	9	3	1897.0	1199.0	1379.0
925174.0	84.9	9	3	1384.0	1868.0	1467.0
102697.0	59.6	9	1	1765.0	-	-
366959.0	53.7	9	1	1438.0	-	-
629147.0	90.3	9	3	1658.0	1514.0	1793.0
892917.0	88.4	9	3	1683.0	1007.0	1795.0
70208.0	61.0	9	1	1013.0	-	-
333917.0	83.3	9	2	1277.0	1771.0	-

Type 5 Radar Waveform_29

Burst Offset (us)	Pulse Width (us)	Chirp Width (MHz)	Number of Pulses per Burst	PRI-1 (us)	PRI-2 (us)	PRI-3 (us)
346120.0	52.8	19	1	1674.0	-	-
498210.0	82.3	19	2	1270.0	1265.0	-
21753.0	56.1	19	1	1829.0	-	-
174716.0	51.3	19	1	1006.0	-	-
327552.0	50.1	19	1	1194.0	-	-
477875.0	97.9	19	3	1651.0	1330.0	1578.0
2934.0	76.7	19	2	1587.0	1447.0	-
155867.0	61.6	19	1	1049.0	-	-
308330.0	59.4	19	1	1990.0	-	-
459305.0	92.4	19	3	1595.0	1713.0	1031.0
612717.0	77.7	19	2	1533.0	1486.0	-
137016.0	63.1	19	1	1116.0	-	-
289566.0	60.1	19	1	1893.0	-	-
441960.0	66.8	19	2	1073.0	1281.0	-
593966.0	80.0	19	2	1555.0	1435.0	-
118078.0	60.7	19	1	1664.0	-	-
270334.0	69.7	19	2	1709.0	1160.0	-
422826.0	68.8	19	2	1519.0	1336.0	-
574336.0	83.5	19	3	1038.0	1109.0	1774.0

Radar Type 6 - Radar Statistical Performance

Trail #	1=Detection 0=No Detection	Trail #	1=Detection 0=No Detection
0	1	15	1
1	1	16	1
2	1	17	1
3	1	18	1
4	1	19	1
5	1	20	1
6	1	21	1
7	1	22	1
8	1	23	1
9	1	24	1
10	1	25	1
11	1	26	1
12	1	27	1
13	1	28	1
14	1	29	0
Detection Percentage (%)		96.7%	

Type 6 Radar Waveform_0					
Frequency List (MHz)	0	1	2	3	4
0	5441	5609	5691	5365	5253
5	5463	5605	5465	5703	5593
10	5398	5449	5594	5579	5471
15	5279	5490	5633	5555	5521
20	5392	5336	5302	5534	5542
25	5639	5719	5352	5291	5535
30	5454	5250	5257	5258	5690
35	5558	5341	5472	5409	5432
40	5567	5722	5515	5692	5362
45	5400	5635	5469	5528	5266
50	5715	5553	5299	5523	5653
55	5436	5549	5708	5460	5284
60	5324	5486	5495	5442	5500
65	5668	5506	5446	5496	5411
70	5333	5459	5307	5591	5402
75	5269	5575	5624	5666	5539
80	5547	5354	5438	5260	5526
85	5489	5252	5630	5648	5296
90	5493	5563	5367	5597	5684
95	5457	5476	5370	5282	5677

Type 6 Radar Waveform_1

Frequency List (MHz)	0	1	2	3	4
0	5696	5373	5627	5526	5473
5	5505	5540	5391	5341	5427
10	5284	5490	5314	5600	5462
15	5406	5593	5678	5272	5432
20	5558	5374	5507	5333	5588
25	5447	5456	5325	5674	5343
30	5682	5472	5354	5271	5612
35	5625	5386	5723	5515	5487
40	5609	5621	5342	5483	5693
45	5522	5318	5617	5416	5604
50	5388	5346	5583	5366	5390
55	5264	5430	5334	5413	5489
60	5431	5327	5268	5446	5394
65	5455	5482	5328	5303	5611
70	5531	5293	5594	5629	5720
75	5534	5496	5311	5585	5528
80	5606	5451	5613	5690	5552
85	5457	5630	5708	5681	5639
90	5449	5266	5306	5532	5603
95	5339	5488	5387	5337	5661

Type 6 Radar Waveform_2

Frequency List (MHz)	0	1	2	3	4
0	5379	5612	5563	5687	5315
5	5644	5552	5615	5554	5645
10	5358	5548	5531	5509	5621
15	5550	5533	5696	5626	5464
20	5440	5724	5383	5480	5650
25	5657	5262	5716	5707	5639
30	5367	5276	5493	5362	5408
35	5400	5300	5562	5598	5443
40	5630	5606	5453	5322	5566
45	5654	5575	5680	5592	5655
50	5477	5547	5430	5344	5454
55	5305	5542	5376	5634	5666
60	5392	5692	5404	5421	5538
65	5573	5414	5603	5597	5478
70	5599	5465	5431	5253	5561
75	5394	5313	5411	5671	5398
80	5604	5403	5514	5601	5697
85	5609	5428	5302	5448	5675
90	5299	5576	5714	5640	5399
95	5283	5618	5637	5587	5537

Type 6 Radar Waveform_3

Frequency List (MHz)	0	1	2	3	4
0	5634	5376	5499	5373	5535
5	5686	5574	5690	5717	5377
10	5289	5337	5572	5607	5642
15	5638	5563	5324	5671	5656
20	5448	5318	5256	5472	5453
25	5584	5389	5378	5286	5296
30	5283	5693	5596	5427	5519
35	5474	5301	5553	5311	5401
40	5303	5381	5395	5603	5382
45	5302	5649	5712	5628	5470
50	5369	5293	5706	5566	5370
55	5374	5267	5298	5644	5543
60	5276	5344	5321	5492	5435
65	5418	5353	5457	5465	5692
70	5297	5362	5697	5327	5575
75	5452	5454	5299	5490	5538
80	5650	5446	5678	5451	5508
85	5533	5253	5493	5357	5287
90	5387	5615	5689	5481	5518
95	5447	5251	5423	5659	5551

Type 6 Radar Waveform_4

Frequency List (MHz)	0	1	2	3	4
0	5414	5615	5435	5534	5377
5	5253	5499	5290	5308	5584
10	5598	5601	5613	5327	5663
15	5251	5690	5427	5716	5373
20	5456	5484	5294	5464	5426
25	5375	5390	5330	5422	5582
30	5553	5545	5293	5674	5544
35	5572	5706	5700	5337	5386
40	5319	5635	5600	5311	5660
45	5257	5295	5681	5357	5623
50	5469	5282	5277	5668	5696
55	5455	5252	5359	5362	5625
60	5325	5509	5363	5395	5318
65	5381	5302	5396	5580	5260
70	5495	5369	5348	5651	5551
75	5411	5306	5574	5442	5471
80	5315	5684	5431	5610	5351
85	5703	5436	5667	5694	5685
90	5437	5408	5535	5619	5552
95	5718	5626	5502	5710	5321

Type 6 Radar Waveform_5

Frequency List (MHz)	0	1	2	3	4
0	5669	5379	5371	5695	5597
5	5295	5521	5365	5471	5413
10	5529	5390	5654	5522	5684
15	5339	5342	5433	5286	5565
20	5367	5553	5710	5399	5263
25	5568	5687	5494	5364	5464
30	5510	5285	5445	5492	5338
35	5635	5368	5481	5614	5651
40	5469	5257	5400	5618	5640
45	5340	5353	5259	5622	5499
50	5645	5333	5366	5491	5546
55	5681	5452	5559	5596	5357
60	5674	5308	5702	5716	5327
65	5442	5251	5432	5412	5530
70	5676	5538	5334	5325	5500
75	5527	5370	5275	5694	5488
80	5567	5319	5299	5426	5348
85	5520	5509	5279	5305	5362
90	5717	5724	5660	5623	5352
95	5552	5557	5282	5416	5487

Type 6 Radar Waveform_6

Frequency List (MHz)	0	1	2	3	4
0	5352	5618	5307	5381	5342
5	5434	5446	5440	5634	5620
10	5363	5276	5695	5717	5705
15	5330	5469	5536	5709	5282
20	5375	5719	5651	5545	5372
25	5529	5517	5415	5398	5506
30	5457	5467	5500	5694	5312
35	5477	5348	5261	5625	5490
40	5649	5573	5543	5691	5547
45	5423	5314	5690	5509	5346
50	5384	5455	5692	5487	5259
55	5635	5642	5378	5567	5486
60	5364	5253	5534	5542	5370
65	5643	5675	5468	5622	5422
70	5479	5610	5417	5328	5252
75	5503	5329	5339	5631	5433
80	5344	5332	5463	5489	5345
85	5715	5351	5497	5270	5413
90	5556	5637	5407	5255	5597
95	5505	5461	5569	5612	5300

Type 6 Radar Waveform_7

Frequency List (MHz)	0	1	2	3	4
0	5607	5382	5718	5445	5659
5	5476	5468	5515	5322	5352
10	5294	5540	5358	5437	5251
15	5418	5596	5639	5279	5474
20	5383	5313	5592	5634	5345
25	5417	5369	5618	5324	5432
30	5548	5346	5424	5715	5371
35	5519	5439	5532	5312	5539
40	5329	5257	5511	5308	5688
45	5379	5600	5506	5372	5268
50	5299	5522	5435	5544	5431
55	5447	5589	5357	5672	5538
60	5615	5529	5673	5366	5465
65	5316	5466	5624	5407	5454
70	5692	5282	5304	5403	5428
75	5576	5479	5288	5591	5362
80	5442	5724	5530	5552	5342
85	5717	5290	5302	5689	5613
90	5367	5707	5360	5572	5261
95	5631	5473	5586	5667	5284

Type 6 Radar Waveform_8

Frequency List (MHz)	0	1	2	3	4
0	5387	5621	5654	5606	5404
5	5518	5490	5590	5485	5656
10	5700	5329	5399	5535	5272
15	5506	5626	5267	5324	5288
20	5294	5479	5630	5318	5683
25	5346	5428	5466	5687	5332
30	5381	5358	5620	5330	5658
35	5530	5328	5562	5453	5265
40	5340	5449	5548	5685	5308
45	5580	5589	5430	5321	5661
50	5505	5698	5486	5255	5338
55	5278	5635	5543	5547	5394
60	5412	5269	5694	5715	5295
65	5291	5262	5667	5573	5443
70	5664	5584	5560	5376	5389
75	5431	5425	5722	5463	5482
80	5345	5492	5276	5552	5712
85	5339	5607	5309	5578	5418
90	5480	5655	5364	5568	5647
95	5582	5268	5388	5360	5591

Type 6 Radar Waveform_9

Frequency List (MHz)	0	1	2	3	4
0	5642	5385	5590	5292	5721
5	5560	5415	5665	5551	5388
10	5534	5593	5440	5255	5293
15	5594	5278	5370	5369	5480
20	5302	5548	5571	5715	5291
25	5645	5452	5532	5500	5254
30	5696	5338	5573	5297	5625
35	5322	5621	5599	5464	5579
40	5423	5387	5313	5682	5615
45	5672	5391	5374	5451	5381
50	5399	5537	5344	5636	5697
55	5348	5497	5262	5688	5383
60	5398	5384	5660	5602	5592
65	5683	5490	5522	5479	5496
70	5379	5363	5545	5472	5531
75	5274	5334	5681	5432	5488
80	5473	5528	5565	5286	5300
85	5336	5350	5620	5449	5325
90	5501	5446	5372	5253	5378
95	5427	5529	5717	5349	5339

Type 6 Radar Waveform_10

Frequency List (MHz)	0	1	2	3	4
0	5422	5624	5526	5453	5466
5	5699	5437	5265	5714	5595
10	5465	5382	5481	5450	5314
15	5585	5405	5376	5317	5672
20	5310	5512	5707	5264	5459
25	5497	5655	5258	5534	5296
30	5295	5313	5546	5348	5364
35	5712	5492	5393	5378	5418
40	5603	5325	5456	5679	5544
45	5540	5280	5449	5427	5338
50	5257	5575	5588	5433	5362
55	5536	5354	5452	5507	5430
60	5549	5605	5434	5515	5251
65	5691	5471	5706	5649	5617
70	5458	5501	5640	5304	5722
75	5454	5305	5675	5542	5547
80	5363	5711	5642	5523	5388
85	5288	5693	5411	5423	5673
90	5592	5539	5703	5259	5357
95	5333	5281	5696	5322	5650

Type 6 Radar Waveform_11

Frequency List (MHz)	0	1	2	3	4
0	5580	5388	5462	5614	5308
5	5266	5362	5340	5402	5424
10	5396	5268	5522	5645	5335
15	5673	5532	5479	5389	5696
20	5550	5321	5712	5250	5446
25	5383	5568	5435	5571	5252
30	5528	5698	5643	5503	5328
35	5288	5292	5257	5686	5263
40	5298	5473	5423	5363	5507
45	5480	5603	5608	5276	5639
50	5660	5488	5627	5642	5326
55	5325	5559	5714	5341	5672
60	5514	5420	5454	5538	5541
65	5347	5311	5444	5537	5350
70	5286	5599	5273	5367	5677
75	5557	5310	5323	5523	5708
80	5426	5705	5348	5313	5279
85	5377	5274	5282	5382	5573
90	5671	5337	5412	5317	5654
95	5675	5425	5373	5688	5531

Type 6 Radar Waveform_12

Frequency List (MHz)	0	1	2	3	4
0	5360	5724	5398	5300	5528
5	5308	5384	5415	5565	5631
10	5705	5532	5563	5365	5356
15	5286	5562	5582	5407	5581
20	5704	5474	5491	5313	5685
25	5613	5298	5586	5466	5602
30	5477	5460	5684	5646	5472
35	5366	5642	5516	5559	5321
40	5303	5571	5294	5676	5461
45	5295	5305	5403	5446	5468
50	5436	5490	5387	5452	5690
55	5708	5483	5335	5340	5262
60	5260	5523	5674	5688	5404
65	5592	5670	5618	5715	5369
70	5393	5273	5336	5625	5383
75	5430	5637	5558	5620	5390
80	5723	5416	5334	5323	5579
85	5557	5426	5644	5311	5505
90	5622	5428	5522	5594	5447
95	5388	5510	5456	5349	5467

Type 6 Radar Waveform_13

Frequency List (MHz)	0	1	2	3	4
0	5815	5488	5334	5461	5370
5	5350	5309	5490	5631	5363
10	5836	5321	5604	5463	5377
15	5374	5689	5685	5355	5298
20	5712	5640	5432	5402	5658
25	5404	5722	5314	5570	5519
30	5349	5641	5386	5624	5661
35	5306	5607	5452	5474	5692
40	5507	5614	5292	5709	5383
45	5529	5526	5489	5280	5263
50	5628	5266	5322	5279	5528
55	5691	5450	5342	5645	5569
60	5537	5502	5565	5538	5318
65	5429	5580	5703	5428	5455
70	5513	5523	5616	5517	5589
75	5510	5391	5397	5433	5360
80	5467	5649	5702	5277	5329
85	5486	5371	5600	5587	5382
90	5295	5414	5612	5491	5544
95	5338	5458	5407	5522	5536

Type 6 Radar Waveform_14

Frequency List (MHz)	0	1	2	3	4
0	5395	5252	5270	5622	5590
5	5489	5331	5565	5319	5667
10	5567	5585	5645	5658	5398
15	5365	5341	5313	5400	5490
20	5623	5709	5470	5394	5631
25	5292	5574	5420	5296	5670
30	5335	5598	5601	5481	5348
35	5698	5723	5724	5606	5346
40	5557	5455	5369	5289	5541
45	5363	5612	5584	5542	5642
50	5614	5707	5317	5411	5604
55	5716	5640	5636	5616	5471
60	5259	5482	5334	5391	5607
65	5264	5267	5465	5315	5498
70	5706	5624	5499	5265	5372
75	5592	5476	5558	5630	5437
80	5378	5266	5543	5712	5699
85	5569	5328	5433	5302	5497
90	5578	5424	5577	5366	5418
95	5589	5576	5374	5516	5429

Type 6 Radar Waveform_15

Frequency List (MHz)	0	1	2	3	4
0	5553	5491	5681	5686	5432
5	5531	5256	5640	5482	5399
10	5401	5374	5308	5378	5419
15	5453	5468	5319	5445	5682
20	5631	5400	5411	5483	5604
25	5558	5426	5623	5704	5700
30	5699	5555	5341	5550	5679
35	5487	5314	5519	5402	5617
40	5660	5393	5609	5286	5470
45	5343	5695	5545	5595	5408
50	5368	5500	5330	5429	5599
55	5355	5358	5587	5600	5424
60	5524	5641	5465	5691	5404
65	5622	5293	5412	5696	5485
70	5268	5568	5435	5430	5275
75	5580	5359	5518	5556	5397
80	5698	5289	5707	5267	5297
85	5509	5420	5387	5694	5467
90	5503	5515	5480	5579	5441
95	5632	5447	5362	5409	5671

Type 6 Radar Waveform_16

Frequency List (MHz)	0	1	2	3	4
0	5333	5255	5617	5372	5652
5	5573	5278	5715	5645	5606
10	5332	5260	5349	5440	5541
15	5595	5422	5490	5496	5639
20	5469	5352	5475	5577	5446
25	5375	5351	5504	5263	5267
30	5685	5512	5459	5324	5499
35	5626	5405	5315	5555	5531
40	5723	5331	5374	5380	5399
45	5323	5303	5603	5648	5319
50	5269	5584	5419	5589	5628
55	5392	5553	5545	5461	5632
60	5473	5615	5288	5262	5357
65	5660	5690	5390	5471	5368
70	5448	5544	5394	5395	5340
75	5295	5666	5653	5387	5460
80	5596	5484	5610	5604	5341
85	5467	5630	5509	5549	5362
90	5688	5458	5687	5431	5716
95	5279	5465	5607	5291	5506

Type 6 Radar Waveform_17

Frequency List (MHz)	0	1	2	3	4
0	5588	5494	5553	5533	5712
5	5678	5315	5711	5338	5641
10	5524	5390	5293	5461	5629
15	5625	5525	5438	5688	5550
20	5635	5564	5702	5554	5608
25	5297	5406	5574	5469	5674
30	5476	5697	5668	5593	5683
35	5330	5445	5435	5428	5269
40	5517	5377	5706	5681	5386
45	5661	5701	5584	5620	5285
50	5470	5300	5451	5336	5507
55	5260	5471	5432	5286	5279
60	5414	5402	5441	5542	5489
65	5686	5379	5664	5455	5493
70	5462	5371	5520	5353	5271
75	5418	5294	5547	5679	5434
80	5551	5523	5513	5426	5320
85	5321	5253	5392	5715	5450
90	5322	5612	5486	5622	5572
95	5267	5415	5614	5258	5568

Type 6 Radar Waveform_18

Frequency List (MHz)	0	1	2	3	4
0	5368	5258	5489	5694	5714
5	5279	5700	5390	5399	5642
10	5572	5313	5431	5391	5482
15	5620	5277	5628	5483	5405
20	5558	5704	5331	5556	5523
25	5600	5651	5282	5334	5448
30	5463	5426	5414	5250	5517
35	5332	5684	5479	5456	5274
40	5511	5682	5374	5635	5661
45	5469	5622	5657	5471	5496
50	5461	5521	5389	5658	5421
55	5450	5290	5403	5415	5444
60	5359	5709	5364	5488	5312
65	5347	5296	5631	5540	5621
70	5715	5538	5437	5324	5314
75	5690	5683	5590	5513	5365
80	5380	5416	5596	5346	5648
85	5487	5618	5520	5504	5589
90	5322	5512	5712	5574	5625
95	5384	5272	5460	5477	5363

Type 6 Radar Waveform_19

Frequency List (MHz)	0	1	2	3	4
0	5526	5497	5425	5380	5556
5	5321	5625	5465	5562	5374
10	5503	5577	5472	5586	5708
15	5404	5256	5528	5597	5566
20	5395	5272	5645	5496	5488
25	5388	5438	5365	5490	5449
30	5383	5629	5402	5715	5471
35	5300	5275	5636	5370	5588
40	5594	5620	5522	5371	5467
45	5641	5552	5680	5710	5261
50	5637	5572	5478	5475	5602
55	5609	5415	5543	5487	5544
60	5401	5541	5665	5434	5513
65	5584	5451	5706	5617	5574
70	5703	5474	5373	5375	5271
75	5587	5658	5483	5479	5424
80	5307	5691	5416	5682	5343
85	5608	5561	5397	5468	5652
90	5624	5457	5289	5443	5606
95	5377	5480	5410	5677	5348

Type 6 Radar Waveform_20

Frequency List (MHz)	0	1	2	3	4
0	5306	5261	5361	5541	5301
5	5363	5647	5540	5250	5581
10	5337	5366	5513	5524	5321
15	5531	5262	5573	5314	5477
20	5464	5688	5637	5469	5279
25	5355	5591	5542	5399	5532
30	5338	5340	5272	5651	5535
35	5610	5391	5643	5411	5284
40	5427	5677	5558	5287	5368
45	5396	5621	5635	5263	5288
50	5623	5626	5567	5298	5449
55	5322	5369	5258	5723	5673
60	5299	5346	5373	5491	5336
65	5533	5390	5441	5412	5280
70	5397	5512	5697	5351	5705
75	5556	5303	5256	5437	5252
80	5471	5334	5487	5416	5403
85	5325	5429	5509	5666	5342
90	5630	5646	5552	5432	5308
95	5305	5546	5574	5696	5389

Type 6 Radar Waveform_21

Frequency List (MHz)	0	1	2	3	4
0	5561	5500	5297	5702	5618
5	5502	5572	5615	5316	5410
10	5268	5252	5554	5501	5545
15	5409	5658	5365	5521	5506
20	5485	5630	5251	5442	5642
25	5304	5319	5646	5336	5671
30	5487	5328	5355	5652	5482
35	5439	5564	5673	5266	5382
40	5399	5430	5462	5325	5601
45	5718	5699	5341	5413	5514
50	5674	5278	5596	5393	5510
55	5323	5448	5600	5694	5705
60	5464	5291	5680	5414	5423
65	5537	5426	5273	5558	5469
70	5595	5577	5546	5327	5664
75	5525	5326	5672	5342	5506
80	5547	5635	5397	5484	5606
85	5463	5366	5420	5394	5402
90	5282	5486	5507	5636	5428
95	5528	5262	5681	5455	5408

Type 6 Radar Waveform_22

Frequency List (MHz)	0	1	2	3	4
0	5341	5264	5708	5291	5363
5	5544	5594	5690	5479	5617
10	5674	5516	5595	5696	5566
15	5400	5688	5468	5698	5493
20	5321	5667	5718	5415	5433
25	5631	5522	5275	5370	5713
30	5254	5702	5577	5553	5316
35	5573	5710	5717	5684	5677
40	5465	5337	5670	5459	5632
45	5581	5326	5282	5394	5300
50	5378	5250	5367	5419	5715
55	5655	5638	5322	5665	5359
60	5629	5711	5609	5369	5263
65	5431	5365	5483	5574	5361
70	5541	5580	5395	5303	5623
75	5397	5446	5340	5323	5285
80	5657	5289	5324	5557	5481
85	5697	5305	5426	5612	5262
90	5356	5672	5462	5313	5673
95	5279	5542	5529	5676	5434

Type 6 Radar Waveform_23

Frequency List (MHz)	0	1	2	3	4
0	5596	5503	5644	5452	5680
5	5586	5519	5290	5642	5349
10	5508	5305	5258	5319	5587
15	5488	5340	5571	5611	5512
20	5404	5390	5608	5332	5388
25	5321	5580	5250	5476	5280
30	5577	5686	5442	5254	5373
35	5455	5286	5506	5492	5598
40	5516	5548	5275	5435	5456
45	5561	5409	5447	5565	5632
50	5391	5301	5620	5659	5411
55	5609	5353	5616	5636	5278
60	5441	5638	5315	5380	5401
65	5466	5639	5710	5567	5719
70	5279	5582	5366	5566	5386
75	5304	5537	5670	5545	5478
80	5521	5697	5389	5707	5702
85	5407	5681	5504	5362	5270
90	5496	5685	5296	5597	5513
95	5574	5316	5614	5287	5382

Type 6 Radar Waveform_24

Frequency List (MHz)	0	1	2	3	4
0	5279	5267	5580	5613	5425
5	5628	5541	5365	5330	5653
10	5439	5569	5299	5514	5608
15	5576	5467	5674	5559	5704
20	5412	5556	5646	5324	5361
25	5587	5432	5356	5438	5419
30	5466	5546	5560	5503	5571
35	5594	5377	5399	5645	5512
40	5355	5253	5688	5578	5453
45	5393	5444	5492	5301	5403
50	5452	5508	5567	5352	5545
55	5443	5506	5502	5563	5543
60	5435	5510	5617	5484	5698
65	5273	5464	5358	5287	5329
70	5437	5525	5261	5442	5307
75	5650	5683	5471	5255	5713
80	5686	5529	5285	5692	5305
85	5326	5555	5475	5338	5600
90	5561	5449	5424	5570	5454
95	5702	5527	5276	5433	5455

Type 6 Radar Waveform_25

Frequency List (MHz)	0	1	2	3	4
0	5534	5506	5516	5299	5267
5	5292	5466	5440	5396	5385
10	5370	5358	5340	5709	5629
15	5664	5594	5680	5604	5421
20	5420	5625	5587	5413	5334
25	5475	5284	5559	5684	5472
30	5461	5452	5503	5300	5655
35	5391	5636	5468	5670	5323
40	5523	5669	5336	5626	5343
45	5450	5322	5424	5575	5359
50	5456	5717	5384	5268	5403
55	5256	5266	5690	5517	5258
60	5254	5481	5271	5649	5643
65	5580	5290	5304	5585	5278
70	5376	5357	5531	5623	5476
75	5308	5320	5609	5682	5331
80	5672	5469	5415	5582	5719
85	5375	5533	5412	5616	5535
90	5702	5425	5595	5282	5467
95	5337	5428	5427	5707	5578

Type 6 Radar Waveform_26

Frequency List (MHz)	0	1	2	3	4
0	5314	5270	5452	5460	5487
5	5334	5488	5515	5559	5592
10	5679	5622	5381	5429	5650
15	5655	5721	5308	5649	5613
20	5331	5316	5528	5405	5307
25	5363	5708	5287	5313	5506
30	5503	5341	5589	5300	5466
35	5573	5437	5605	5419	5564
40	5583	5544	5251	5404	5658
45	5417	5509	5604	5260	5444
50	5454	5345	5297	5403	5471
55	5448	5451	5400	5339	5588
60	5688	5250	5311	5702	5412
65	5567	5423	5426	5548	5644
70	5585	5362	5554	5354	5718
75	5344	5428	5408	5431	5372
80	5253	5342	5472	5711	5366
85	5475	5720	5285	5385	5694
90	5440	5562	5268	5631	5543
95	5359	5619	5459	5306	5507

Type 6 Radar Waveform_27

Frequency List (MHz)	0	1	2	3	4
0	5569	5509	5388	5621	5329
5	5376	5413	5590	5722	5421
10	5610	5508	5422	5624	5671
15	5268	5276	5411	5694	5330
20	5339	5385	5566	5494	5280
25	5629	5560	5490	5514	5540
30	5642	5327	5417	5255	5678
35	5409	5439	5650	5359	5251
40	5351	5444	5502	5348	5541
45	5558	5384	5266	5378	5562
50	5394	5620	5505	5434	5290
55	5716	5591	5425	5270	5423
60	5432	5504	5630	5341	5293
65	5609	5651	5448	5399	5693
70	5704	5717	5608	5314	5493
75	5561	5321	5523	5474	5386
80	5325	5498	5538	5619	5475
85	5369	5406	5659	5435	5428
90	5368	5723	5443	5450	5391
95	5438	5479	5549	5461	5342

Type 6 Radar Waveform_28

Frequency List (MHz)	0	1	2	3	4
0	5252	5370	5324	5307	5549
5	5418	5435	5665	5410	5628
10	5444	5297	5463	5722	5692
15	5356	5403	5514	5642	5522
20	5347	5551	5507	5486	5253
25	5517	5509	5693	5618	5574
30	5684	5691	5374	5373	5355
35	5704	5481	5363	5630	5404
40	5362	5283	5682	5440	5491
45	5538	5487	5364	5349	5436
50	5615	5281	5390	5321	5556
55	5523	5588	5563	5304	5379
60	5256	5564	5561	5669	5575
65	5648	5340	5714	5335	5600
70	5387	5609	5585	5314	5414
75	5720	5537	5280	5395	5594
80	5432	5306	5275	5400	5639
85	5557	5366	5265	5309	5501
90	5398	5711	5371	5496	5263
95	5397	5375	5361	5658	5478

Type 6 Radar Waveform_29

Frequency List (MHz)	0	1	2	3	4
0	5507	5609	5260	5371	5391
5	5557	5360	5265	5573	5375
10	5561	5504	5442	5713	5444
15	5530	5617	5687	5714	5258
20	5620	5448	5575	5701	5308
25	5361	5324	5722	5608	5251
30	5580	5331	5588	5604	5427
35	5454	5426	5654	5276	5597
40	5290	5281	5256	5535	5319
45	5344	5432	5494	5668	5546
50	5266	5497	5607	5612	5411
55	5492	5333	5446	5383	5268
60	5690	5359	5520	5480	5263
65	5660	5536	5549	5423	5441
70	5380	5310	5483	5677	5417
75	5569	5513	5364	5287	5527
80	5661	5656	5328	5717	5363
85	5460	5309	5440	5458	5715
90	5676	5325	5647	5461	5305
95	5403	5409	5621	5670	5495

Product	5G NR/LTE Router	Temperature	27°C
Test Engineer	Jake Lan	Relative Humidity	65%
Test Site	WZ-SR4	Test Date	2021/07/19
Test Item	Radar Statistical Performance Check (802.11ax-HE40 mode – 5510MHz)		

Radar Type 1-4 - Radar Statistical Performance

Trial	Frequency (MHz)	1 detect ,0 no detect			
		Radar Type 1	Radar Type 2	Radar Type 3	Radar Type 4
0	5491	1	1	1	1
1	5526	1	1	1	1
2	5494	0	1	0	0
3	5495	1	1	1	1
4	5514	1	0	1	1
5	5498	1	1	1	1
6	5519	1	0	1	0
7	5500	1	1	0	1
8	5515	1	1	1	1
9	5503	1	0	0	1
10	5523	1	1	1	1
11	5505	1	0	1	0
12	5527	1	1	1	1
13	5508	1	1	1	1
14	5492	1	1	1	1
15	5510	1	1	1	1
16	5499	1	1	0	1
17	5513	1	1	1	1
18	5496	1	1	1	1
19	5507	1	1	1	1
20	5517	1	1	1	1
21	5518	1	1	1	1
22	5501	1	1	1	0
23	5520	1	1	1	1
24	5522	1	1	1	1
25	5511	1	1	0	0
26	5524	1	0	1	1
27	5504	1	1	1	1
28	5509	1	0	1	1
29	5529	1	1	1	1

Probability:	96.7%	80.0%	83.3%	83.3%
Aggregate (Radar Types 1-4):	85.8%(>80%)			

Radar Type 1 - Radar Waveform

	Trial Id	Radar Type	Pulse Width (us)	PRI (us)	Number of Pulses	Waveform Length (us)
Download	0	Type 1	1.0	678.0	78	52884.0
Download	1	Type 1	1.0	598.0	89	53222.0
Download	2	Type 1	1.0	718.0	74	53132.0
Download	3	Type 1	1.0	778.0	68	52904.0
Download	4	Type 1	1.0	698.0	76	53048.0
Download	5	Type 1	1.0	918.0	58	53244.0
Download	6	Type 1	1.0	898.0	59	52982.0
Download	7	Type 1	1.0	658.0	81	53298.0
Download	8	Type 1	1.0	858.0	62	53196.0
Download	9	Type 1	1.0	938.0	57	53466.0
Download	10	Type 1	1.0	518.0	102	52836.0
Download	11	Type 1	1.0	538.0	99	53262.0
Download	12	Type 1	1.0	838.0	63	52794.0
Download	13	Type 1	1.0	618.0	86	53148.0
Download	14	Type 1	1.0	738.0	72	53136.0
Download	15	Type 1	1.0	543.0	98	53214.0
Download	16	Type 1	1.0	1844.0	29	53476.0
Download	17	Type 1	1.0	664.0	80	53120.0
Download	18	Type 1	1.0	2569.0	21	53949.0
Download	19	Type 1	1.0	732.0	73	53436.0
Download	20	Type 1	1.0	1542.0	35	53970.0
Download	21	Type 1	1.0	554.0	96	53184.0
Download	22	Type 1	1.0	2594.0	21	54474.0
Download	23	Type 1	1.0	949.0	56	53144.0
Download	24	Type 1	1.0	2537.0	21	53277.0
Download	25	Type 1	1.0	630.0	84	52920.0
Download	26	Type 1	1.0	1088.0	49	53312.0
Download	27	Type 1	1.0	909.0	59	53631.0
Download	28	Type 1	1.0	1207.0	44	53108.0
Download	29	Type 1	1.0	2706.0	20	54120.0

Radar Type 2 - Radar Waveform

	Trial Id	Radar Type	Pulse Width (us)	PRI (us)	Number of Pulses	Waveform Length (us)
Download	0	Type 2	2.3	171.0	25	4275.0
Download	1	Type 2	4.2	201.0	28	5628.0
Download	2	Type 2	2.4	180.0	25	4500.0
Download	3	Type 2	1.0	214.0	23	4922.0
Download	4	Type 2	4.0	220.0	28	6160.0
Download	5	Type 2	4.9	218.0	29	6322.0
Download	6	Type 2	1.2	228.0	23	5244.0
Download	7	Type 2	3.7	168.0	27	4536.0
Download	8	Type 2	4.4	183.0	28	5124.0
Download	9	Type 2	2.8	174.0	26	4524.0
Download	10	Type 2	1.7	169.0	24	4056.0
Download	11	Type 2	3.1	160.0	26	4160.0
Download	12	Type 2	2.8	198.0	26	5148.0
Download	13	Type 2	4.1	179.0	28	5012.0
Download	14	Type 2	2.2	150.0	25	3750.0
Download	15	Type 2	2.6	175.0	25	4375.0
Download	16	Type 2	1.4	172.0	23	3956.0
Download	17	Type 2	5.0	209.0	29	6061.0
Download	18	Type 2	1.6	202.0	24	4848.0
Download	19	Type 2	4.6	196.0	29	5684.0
Download	20	Type 2	4.3	217.0	28	6076.0
Download	21	Type 2	4.4	199.0	28	5572.0
Download	22	Type 2	2.1	158.0	24	3792.0
Download	23	Type 2	3.6	164.0	27	4428.0
Download	24	Type 2	1.1	192.0	23	4416.0
Download	25	Type 2	2.6	177.0	25	4425.0
Download	26	Type 2	3.4	221.0	27	5967.0
Download	27	Type 2	3.8	153.0	27	4131.0
Download	28	Type 2	3.7	229.0	27	6183.0
Download	29	Type 2	4.8	165.0	29	4785.0

Radar Type 3 - Radar Waveform

	Trial Id	Radar Type	Pulse Width (us)	PRI (us)	Number of Pulses	Waveform Length (us)
Download	0	Type 3	7.3	312.0	16	4992.0
Download	1	Type 3	9.2	356.0	18	6408.0
Download	2	Type 3	7.4	369.0	17	6273.0
Download	3	Type 3	6.0	259.0	16	4144.0
Download	4	Type 3	9.0	342.0	18	6156.0
Download	5	Type 3	9.9	488.0	18	8784.0
Download	6	Type 3	6.2	398.0	16	6368.0
Download	7	Type 3	8.7	323.0	18	5814.0
Download	8	Type 3	9.4	207.0	18	3726.0
Download	9	Type 3	7.8	397.0	17	6749.0
Download	10	Type 3	6.7	425.0	16	6800.0
Download	11	Type 3	8.1	390.0	17	6630.0
Download	12	Type 3	7.8	244.0	17	4148.0
Download	13	Type 3	9.1	413.0	18	7434.0
Download	14	Type 3	7.2	206.0	16	3296.0
Download	15	Type 3	7.6	366.0	17	6222.0
Download	16	Type 3	6.4	437.0	16	6992.0
Download	17	Type 3	10.0	477.0	18	8586.0
Download	18	Type 3	6.6	434.0	16	6944.0
Download	19	Type 3	9.6	451.0	18	8118.0
Download	20	Type 3	9.3	262.0	18	4716.0
Download	21	Type 3	9.4	224.0	18	4032.0
Download	22	Type 3	7.1	358.0	16	5728.0
Download	23	Type 3	8.6	237.0	17	4029.0
Download	24	Type 3	6.1	325.0	16	5200.0
Download	25	Type 3	7.6	239.0	17	4063.0
Download	26	Type 3	8.4	333.0	17	5661.0
Download	27	Type 3	8.8	235.0	18	4230.0
Download	28	Type 3	8.7	367.0	18	6606.0
Download	29	Type 3	9.8	272.0	18	4896.0

Radar Type 4 - Radar Waveform

	Trial Id	Radar Type	Pulse Width (us)	PRI (us)	Number of Pulses	Waveform Length (us)
Download	0	Type 4	13.9	312.0	13	4056.0
Download	1	Type 4	18.1	356.0	15	5340.0
Download	2	Type 4	14.3	369.0	13	4797.0
Download	3	Type 4	11.2	259.0	12	3108.0
Download	4	Type 4	17.7	342.0	15	5130.0
Download	5	Type 4	19.6	488.0	16	7808.0
Download	6	Type 4	11.5	398.0	12	4776.0
Download	7	Type 4	17.1	323.0	15	4845.0
Download	8	Type 4	18.6	207.0	16	3312.0
Download	9	Type 4	15.0	397.0	14	5558.0
Download	10	Type 4	12.7	425.0	12	5100.0
Download	11	Type 4	15.6	390.0	14	5460.0
Download	12	Type 4	15.0	244.0	14	3416.0
Download	13	Type 4	18.0	413.0	15	6195.0
Download	14	Type 4	13.8	206.0	13	2678.0
Download	15	Type 4	14.7	366.0	14	5124.0
Download	16	Type 4	11.9	437.0	12	5244.0
Download	17	Type 4	19.9	477.0	16	7632.0
Download	18	Type 4	12.4	434.0	12	5208.0
Download	19	Type 4	19.0	451.0	16	7216.0
Download	20	Type 4	18.5	262.0	16	4192.0
Download	21	Type 4	18.5	224.0	16	3584.0
Download	22	Type 4	13.5	358.0	13	4654.0
Download	23	Type 4	16.8	237.0	15	3555.0
Download	24	Type 4	11.3	325.0	12	3900.0
Download	25	Type 4	14.7	239.0	14	3346.0
Download	26	Type 4	16.3	333.0	14	4662.0
Download	27	Type 4	17.2	235.0	15	3525.0
Download	28	Type 4	17.1	367.0	15	5505.0
Download	29	Type 4	19.4	272.0	16	4352.0

Radar Type 5 - Radar Statistical Performance

Trail #	Test Freq. (MHz)	1=Detection 0=No Detection	Trail #	Test Freq. (MHz)	1=Detection 0=No Detection
0	5510	1	15	5495.4	1
1	5510	1	16	5493.4	1
2	5510	1	17	5499	1
3	5510	1	18	5493.8	1
4	5510	1	19	5498.6	1
5	5510	1	20	5521.8	1
6	5510	1	21	5521.8	1
7	5510	1	22	5525.4	1
8	5510	1	23	5523	1
9	5510	1	24	5527	1
10	5494.2	1	25	5524.6	1
11	5496.2	1	26	5523.4	1
12	5495.8	1	27	5523	1
13	5497.8	1	28	5523	1
14	5495	1	29	5521.4	1
Detection Percentage (%)					100.0%

Type 5 Radar Waveform_0

Burst Offset (us)	Pulse Width (us)	Chirp Width (MHz)	Number of Pulses per Burst	PRI-1 (us)	PRI-2 (us)	PRI-3 (us)
566459.0	66.2	10	1	1736.0	-	-
806450.0	89.1	10	3	1090.0	1303.0	1961.0
52346.0	68.2	10	2	1262.0	1818.0	-
294567.0	51.1	10	1	1600.0	-	-
535305.0	87.3	10	3	1507.0	1495.0	1213.0
776481.0	97.8	10	3	1217.0	1724.0	1702.0
22590.0	53.2	10	1	1899.0	-	-
263819.0	83.6	10	3	1390.0	1700.0	1987.0
505365.0	91.8	10	3	1397.0	1500.0	1695.0
748240.0	72.3	10	2	1244.0	1406.0	-
991077.0	59.7	10	1	1694.0	-	-
234639.0	75.6	10	2	1161.0	1607.0	-

Type 5 Radar Waveform_1

Burst Offset (us)	Pulse Width (us)	Chirp Width (MHz)	Number of Pulses per Burst	PRI-1 (us)	PRI-2 (us)	PRI-3 (us)
316824.0	72.3	17	2	1739.0	1869.0	-
477019.0	88.8	17	3	1551.0	1405.0	1510.0
640390.0	65.8	17	1	1593.0	-	-
136355.0	70.4	17	2	1855.0	1013.0	-
297790.0	55.2	17	1	1879.0	-	-
456931.0	99.2	17	3	1770.0	1690.0	1448.0
620981.0	57.9	17	1	1100.0	-	-
116087.0	94.2	17	3	1501.0	1944.0	1916.0
276825.0	91.4	17	3	1745.0	1192.0	1585.0
437713.0	91.5	17	3	1414.0	1348.0	1311.0
600818.0	64.2	17	1	1410.0	-	-
96674.0	82.2	17	2	1116.0	1890.0	-
258078.0	51.7	17	1	1859.0	-	-
418178.0	70.4	17	2	1958.0	1703.0	-
580362.0	79.5	17	2	1062.0	1014.0	-
76696.0	84.3	17	3	1396.0	1395.0	1525.0
237232.0	83.9	17	3	1951.0	1302.0	1355.0
397881.0	96.7	17	3	1238.0	1622.0	1617.0

Type 5 Radar Waveform_2

Burst Offset (us)	Pulse Width (us)	Chirp Width (MHz)	Number of Pulses per Burst	PRI-1 (us)	PRI-2 (us)	PRI-3 (us)
841731.0	53.0	10	1	1964.0	-	-
85762.0	60.8	10	1	1825.0	-	-
327026.0	87.7	10	3	1129.0	1955.0	1252.0
569248.0	72.0	10	2	1138.0	1898.0	-
812040.0	56.9	10	1	1811.0	-	-
55877.0	78.4	10	2	1781.0	1214.0	-
297946.0	68.3	10	2	1109.0	1000.0	-
539517.0	69.2	10	2	1512.0	1428.0	-
781372.0	82.9	10	2	1459.0	1435.0	-
26131.0	66.5	10	1	1517.0	-	-
267346.0	94.0	10	3	1653.0	1953.0	1438.0
510573.0	50.3	10	1	1292.0	-	-

Type 5 Radar Waveform_3

Burst Offset (us)	Pulse Width (us)	Chirp Width (MHz)	Number of Pulses per Burst	PRI-1 (us)	PRI-2 (us)	PRI-3 (us)
1129663.0	62.4	5	1	1306.0	-	-
1492702.0	55.2	5	1	1748.0	-	-
357086.0	96.2	5	3	1978.0	1246.0	1614.0
721247.0	66.2	5	1	1643.0	-	-
1084962.0	60.8	5	1	1207.0	-	-
1447442.0	79.1	5	2	1216.0	1050.0	-
312776.0	67.1	5	2	1639.0	1488.0	-
676534.0	60.5	5	1	1534.0	-	-

Type 5 Radar Waveform_4

Burst Offset (us)	Pulse Width (us)	Chirp Width (MHz)	Number of Pulses per Burst	PRI-1 (us)	PRI-2 (us)	PRI-3 (us)
487775.0	77.5	16	2	1416.0	1638.0	-
659244.0	57.7	16	1	1974.0	-	-
125969.0	81.1	16	2	1313.0	1145.0	-
296321.0	76.1	16	2	1283.0	1768.0	-
466872.0	76.9	16	2	1624.0	1289.0	-
638018.0	74.7	16	2	1095.0	1097.0	-
104824.0	74.9	16	2	1492.0	1840.0	-
275027.0	86.0	16	3	1587.0	1212.0	1011.0
444185.0	99.4	16	3	1962.0	1946.0	1663.0
616646.0	66.8	16	2	1199.0	1392.0	-
83834.0	68.2	16	2	1922.0	1420.0	-
254395.0	69.0	16	2	1860.0	1007.0	-
424078.0	99.7	16	3	1146.0	1203.0	1875.0
594744.0	95.1	16	3	1193.0	1178.0	1272.0
62804.0	69.3	16	2	1881.0	1934.0	-
232680.0	99.0	16	3	1577.0	1513.0	1923.0
403433.0	88.0	16	3	1350.0	1067.0	1256.0

Type 5 Radar Waveform_5

Burst Offset (us)	Pulse Width (us)	Chirp Width (MHz)	Number of Pulses per Burst	PRI-1 (us)	PRI-2 (us)	PRI-3 (us)
488667.0	50.2	20	1	1913.0	-	-
35540.0	81.9	20	2	1756.0	1747.0	-
180085.0	87.5	20	3	1056.0	1231.0	1628.0
325955.0	52.0	20	1	1528.0	-	-
468731.0	86.0	20	3	1843.0	1006.0	1692.0
17777.0	66.3	20	1	1582.0	-	-
162076.0	91.5	20	3	1393.0	1865.0	1396.0
308118.0	50.1	20	1	1445.0	-	-
451584.0	91.1	20	3	1222.0	1157.0	1314.0
596143.0	79.1	20	2	1850.0	1908.0	-
144945.0	59.0	20	1	1954.0	-	-
288734.0	86.0	20	3	1343.0	1660.0	1541.0
433030.0	85.5	20	3	1741.0	1294.0	1675.0
580225.0	59.6	20	1	1804.0	-	-
127199.0	50.3	20	1	1387.0	-	-
271520.0	67.1	20	2	1917.0	1365.0	-
416499.0	73.3	20	2	1247.0	1667.0	-
561126.0	69.2	20	2	1590.0	1519.0	-
108797.0	95.3	20	3	1442.0	1352.0	1437.0
254135.0	79.7	20	2	1184.0	1058.0	-

Type 5 Radar Waveform_6

Burst Offset (us)	Pulse Width (us)	Chirp Width (MHz)	Number of Pulses per Burst	PRI-1 (us)	PRI-2 (us)	PRI-3 (us)
1000549.0	61.6	6	1	1452.0	-	-
1361433.0	95.1	6	3	1113.0	1468.0	1684.0
228761.0	82.2	6	2	1220.0	1074.0	-
592459.0	53.4	6	1	1139.0	-	-
954502.0	82.4	6	2	1538.0	1918.0	-
1317363.0	69.9	6	2	1966.0	1601.0	-
184159.0	66.0	6	1	1151.0	-	-
546518.0	98.4	6	3	1520.0	1443.0	1359.0

Type 5 Radar Waveform_7

Burst Offset (us)	Pulse Width (us)	Chirp Width (MHz)	Number of Pulses per Burst	PRI-1 (us)	PRI-2 (us)	PRI-3 (us)
454299.0	75.0	15	2	1230.0	1481.0	-
636928.0	50.6	15	1	1080.0	-	-
69400.0	67.3	15	2	1977.0	1726.0	-
249995.0	85.9	15	3	1584.0	1772.0	1556.0
431067.0	97.3	15	3	1975.0	1021.0	1285.0
613102.0	78.3	15	2	1423.0	1427.0	-
47241.0	60.5	15	1	1547.0	-	-
228029.0	97.3	15	3	1073.0	1310.0	1572.0
409636.0	79.7	15	2	1029.0	1707.0	-
592169.0	58.5	15	1	1094.0	-	-
24787.0	91.5	15	3	1479.0	1751.0	1171.0
205620.0	91.5	15	3	1291.0	1764.0	1338.0
388205.0	89.7	15	3	1666.0	1870.0	1336.0
568263.0	75.9	15	2	1475.0	1634.0	-
2513.0	85.8	15	3	1386.0	1709.0	1232.0
183229.0	95.7	15	3	1718.0	1568.0	1580.0

Type 5 Radar Waveform_8

Burst Offset (us)	Pulse Width (us)	Chirp Width (MHz)	Number of Pulses per Burst	PRI-1 (us)	PRI-2 (us)	PRI-3 (us)
324685.0	65.9	18	1	1919.0	-	-
486505.0	50.0	18	1	1101.0	-	-
647909.0	63.8	18	1	1118.0	-	-
143747.0	57.2	18	1	1253.0	-	-
304517.0	67.8	18	2	1539.0	1054.0	-
466460.0	51.8	18	1	1331.0	-	-
625953.0	76.4	18	2	1533.0	1782.0	-
123440.0	75.9	18	2	1900.0	1654.0	-
284538.0	74.0	18	2	1063.0	1856.0	-
445423.0	69.2	18	2	1266.0	1794.0	-
606399.0	76.3	18	2	1357.0	1670.0	-
103976.0	55.1	18	1	1340.0	-	-
264154.0	99.7	18	3	1205.0	1166.0	1940.0
424640.0	84.1	18	3	1463.0	1380.0	1711.0
587151.0	69.7	18	2	1003.0	1370.0	-
84072.0	66.1	18	1	1558.0	-	-
245581.0	50.2	18	1	1019.0	-	-
404796.0	93.2	18	3	1456.0	1412.0	1787.0

Type 5 Radar Waveform_9

Burst Offset (us)	Pulse Width (us)	Chirp Width (MHz)	Number of Pulses per Burst	PRI-1 (us)	PRI-2 (us)	PRI-3 (us)
785082.0	75.1	12	2	1871.0	1904.0	-
88748.0	90.5	12	3	1099.0	1125.0	1466.0
312356.0	61.7	12	1	1838.0	-	-
535113.0	73.1	12	2	1661.0	1334.0	-
756136.0	88.7	12	3	1646.0	1932.0	1996.0
61448.0	57.1	12	1	1204.0	-	-
284095.0	99.1	12	3	1527.0	1309.0	1394.0
508280.0	53.1	12	1	1810.0	-	-
729316.0	87.5	12	3	1762.0	1549.0	1521.0
33885.0	64.8	12	1	1816.0	-	-
257045.0	77.8	12	2	1332.0	1467.0	-
480837.0	53.7	12	1	1658.0	-	-
701855.0	90.1	12	3	1795.0	1921.0	1153.0

Type 5 Radar Waveform_10

Burst Offset (us)	Pulse Width (us)	Chirp Width (MHz)	Number of Pulses per Burst	PRI-1 (us)	PRI-2 (us)	PRI-3 (us)
8257.0	85.7	8	3	1608.0	1288.0	1561.0
299006.0	59.2	8	1	1281.0	-	-
588143.0	86.5	8	3	1884.0	1033.0	1597.0
878235.0	87.6	8	3	1259.0	1482.0	1569.0
1169583.0	82.3	8	2	1554.0	1369.0	-
263196.0	56.0	8	1	1278.0	-	-
553818.0	58.8	8	1	1505.0	-	-
843817.0	80.5	8	2	1356.0	1106.0	-
1133578.0	73.1	8	2	1545.0	1635.0	-
227021.0	74.3	8	2	1362.0	1833.0	-

Type 5 Radar Waveform_11

Burst Offset (us)	Pulse Width (us)	Chirp Width (MHz)	Number of Pulses per Burst	PRI-1 (us)	PRI-2 (us)	PRI-3 (us)
368635.0	91.5	13	3	1678.0	1493.0	1087.0
577207.0	61.9	13	1	1708.0	-	-
783193.0	78.1	13	2	1645.0	1680.0	-
136681.0	52.0	13	1	1897.0	-	-
344089.0	55.4	13	1	1937.0	-	-
549698.0	97.7	13	3	1902.0	1320.0	1515.0
756265.0	95.6	13	3	1248.0	1815.0	1863.0
110934.0	88.8	13	3	1031.0	1179.0	1206.0
317968.0	75.4	13	2	1573.0	1901.0	-
524518.0	91.3	13	3	1175.0	1504.0	1594.0
731711.0	96.6	13	3	1260.0	1329.0	1282.0
85629.0	50.8	13	1	1417.0	-	-
291991.0	95.4	13	3	1650.0	1347.0	1861.0
499363.0	84.0	13	3	1049.0	1662.0	1008.0

Type 5 Radar Waveform_12

Burst Offset (us)	Pulse Width (us)	Chirp Width (MHz)	Number of Pulses per Burst	PRI-1 (us)	PRI-2 (us)	PRI-3 (us)
760565.0	92.9	12	3	1102.0	1409.0	1632.0
64706.0	61.3	12	1	1235.0	-	-
288127.0	56.6	12	1	1726.0	-	-
511744.0	58.1	12	1	1439.0	-	-
735333.0	64.7	12	1	1360.0	-	-
37137.0	64.4	12	1	1968.0	-	-
260604.0	61.5	12	1	1722.0	-	-
482970.0	98.1	12	3	1433.0	1308.0	1060.0
706457.0	70.3	12	2	1878.0	1227.0	-
9609.0	79.2	12	2	1187.0	1743.0	-
232508.0	90.6	12	3	1321.0	1586.0	1075.0
454755.0	95.9	12	3	1777.0	1730.0	1812.0
679898.0	63.1	12	1	1853.0	-	-

Type 5 Radar Waveform_13

Burst Offset (us)	Pulse Width (us)	Chirp Width (MHz)	Number of Pulses per Burst	PRI-1 (us)	PRI-2 (us)	PRI-3 (us)
649992.0	96.6	17	3	1699.0	1053.0	1043.0
147579.0	87.4	17	3	1676.0	1571.0	1930.0
309938.0	60.1	17	1	1039.0	-	-
468714.0	91.5	17	3	1734.0	1824.0	1237.0
632012.0	62.6	17	1	1877.0	-	-
128516.0	51.9	17	1	1560.0	-	-
289992.0	66.2	17	1	1177.0	-	-
450545.0	70.2	17	2	1088.0	1341.0	-
612341.0	61.1	17	1	1672.0	-	-
108704.0	60.6	17	1	1208.0	-	-
269996.0	55.1	17	1	1462.0	-	-
429042.0	93.7	17	3	1774.0	1723.0	1491.0
592928.0	55.5	17	1	1163.0	-	-
68354.0	91.9	17	3	1591.0	1926.0	1209.0
249617.0	76.1	17	2	1174.0	1633.0	-
411310.0	52.3	17	1	1698.0	-	-
572720.0	62.5	17	1	1542.0	-	-
68654.0	93.6	17	3	1066.0	1750.0	1186.0

Type 5 Radar Waveform_14

Burst Offset (us)	Pulse Width (us)	Chirp Width (MHz)	Number of Pulses per Burst	PRI-1 (us)	PRI-2 (us)	PRI-3 (us)
344561.0	84.9	10	3	1821.0	1188.0	1537.0
587914.0	63.9	10	1	1277.0	-	-
829730.0	52.4	10	1	1765.0	-	-
73414.0	94.8	10	3	1280.0	1404.0	1583.0
315266.0	71.0	10	2	1155.0	1988.0	-
556700.0	99.4	10	3	1543.0	1018.0	1182.0
800268.0	50.7	10	1	1317.0	-	-
43807.0	65.7	10	1	1077.0	-	-
286062.0	58.7	10	1	1132.0	-	-
528139.0	62.7	10	1	1471.0	-	-
767403.0	93.4	10	3	1801.0	1729.0	1714.0
13914.0	91.7	10	3	1588.0	1885.0	1251.0

Type 5 Radar Waveform_15

Burst Offset (us)	Pulse Width (us)	Chirp Width (MHz)	Number of Pulses per Burst	PRI-1 (us)	PRI-2 (us)	PRI-3 (us)
235671.0	99.0	11	3	1228.0	1649.0	1446.0
460080.0	61.4	11	1	1152.0	-	-
683772.0	59.5	11	1	1023.0	-	-
904356.0	84.5	11	3	1032.0	1526.0	1557.0
208048.0	99.1	11	3	1965.0	1137.0	1997.0
432467.0	51.3	11	1	1305.0	-	-
655790.0	65.3	11	1	1636.0	-	-
876084.0	99.9	11	3	1191.0	1887.0	1895.0
180692.0	83.9	11	3	1874.0	1122.0	1755.0
404048.0	98.9	11	3	1103.0	1128.0	1079.0
626850.0	79.2	11	2	1880.0	1827.0	-
851698.0	63.8	11	1	1682.0	-	-
153506.0	81.7	11	2	1701.0	1565.0	-

Type 5 Radar Waveform_16

Burst Offset (us)	Pulse Width (us)	Chirp Width (MHz)	Number of Pulses per Burst	PRI-1 (us)	PRI-2 (us)	PRI-3 (us)
545104.0	50.6	6	1	1927.0	-	-
868513.0	51.5	6	1	1160.0	-	-
1191167.0	64.4	6	1	1651.0	-	-
182462.0	59.2	6	1	1630.0	-	-
505027.0	72.6	6	2	1015.0	1710.0	-
827148.0	85.5	6	3	1413.0	1210.0	1055.0
1148896.0	95.7	6	3	1009.0	1668.0	1852.0
142656.0	57.7	6	1	1837.0	-	-
464516.0	85.7	6	3	1819.0	1799.0	1279.0

Type 5 Radar Waveform_17

Burst Offset (us)	Pulse Width (us)	Chirp Width (MHz)	Number of Pulses per Burst	PRI-1 (us)	PRI-2 (us)	PRI-3 (us)
354348.0	55.7	20	1	1644.0	-	-
497772.0	82.0	20	2	1848.0	1828.0	-
46226.0	60.6	20	1	1732.0	-	-
191439.0	51.8	20	1	1374.0	-	-
336559.0	66.4	20	1	1490.0	-	-
481629.0	60.7	20	1	1599.0	-	-
28210.0	90.8	20	3	1814.0	1112.0	1822.0
172549.0	97.0	20	3	1842.0	1945.0	1059.0
317198.0	93.3	20	3	1854.0	1353.0	1065.0
464036.0	53.4	20	1	1233.0	-	-
10462.0	76.8	20	2	1242.0	1532.0	-
155296.0	69.5	20	2	1401.0	1418.0	-
300628.0	61.7	20	1	1830.0	-	-
443516.0	93.8	20	3	1889.0	1758.0	1119.0
587643.0	84.2	20	3	1131.0	1933.0	1941.0
137417.0	71.0	20	2	1083.0	1905.0	-
281462.0	92.8	20	3	1061.0	1605.0	1906.0
427162.0	74.8	20	2	1105.0	1664.0	-
570426.0	87.1	20	3	1623.0	1453.0	1346.0
119790.0	62.7	20	1	1947.0	-	-

Type 5 Radar Waveform_18

Burst Offset (us)	Pulse Width (us)	Chirp Width (MHz)	Number of Pulses per Burst	PRI-1 (us)	PRI-2 (us)	PRI-3 (us)
530844.0	59.6	7	1	1249.0	-	-
819087.0	86.0	7	3	1267.0	1706.0	1912.0
1109701.0	84.7	7	3	1089.0	1318.0	1659.0
203797.0	88.7	7	3	1020.0	1399.0	1766.0
494889.0	63.0	7	1	1595.0	-	-
784827.0	70.4	7	2	1223.0	1460.0	-
1073449.0	97.9	7	3	1086.0	1759.0	1803.0
167978.0	86.3	7	3	1665.0	1618.0	1576.0
459289.0	56.5	7	1	1069.0	-	-
747520.0	86.2	7	3	1907.0	1265.0	1970.0

Type 5 Radar Waveform_19

Burst Offset (us)	Pulse Width (us)	Chirp Width (MHz)	Number of Pulses per Burst	PRI-1 (us)	PRI-2 (us)	PRI-3 (us)
545823.0	77.3	19	2	1200.0	1656.0	-
69322.0	97.8	19	3	1820.0	1976.0	1440.0
221442.0	83.9	19	3	1619.0	1518.0	1499.0
375362.0	63.2	19	1	1502.0	-	-
528331.0	55.6	19	1	1316.0	-	-
50799.0	77.5	19	2	1149.0	1754.0	-
203126.0	73.8	19	2	1983.0	1373.0	-
355443.0	97.3	19	3	1048.0	1255.0	1136.0
506148.0	85.0	19	3	1839.0	1733.0	1894.0
32086.0	54.5	19	1	1550.0	-	-
185049.0	59.1	19	1	1002.0	-	-
335726.0	87.0	19	3	1705.0	1888.0	1621.0
490566.0	55.6	19	1	1455.0	-	-
13233.0	75.8	19	2	1536.0	1508.0	-
165383.0	87.1	19	3	1431.0	1027.0	1685.0
318654.0	62.1	19	1	1973.0	-	-
469303.0	89.0	19	3	1993.0	1579.0	1140.0
624721.0	57.7	19	1	1299.0	-	-
146944.0	80.3	19	2	1805.0	1030.0	-

Type 5 Radar Waveform_20

Burst Offset (us)	Pulse Width (us)	Chirp Width (MHz)	Number of Pulses per Burst	PRI-1 (us)	PRI-2 (us)	PRI-3 (us)
315513.0	88.2	18	3	1307.0	1744.0	1111.0
477111.0	79.8	18	2	1016.0	1867.0	-
639008.0	60.7	18	1	1938.0	-	-
135493.0	58.6	18	1	1952.0	-	-
295354.0	95.1	18	3	1368.0	1980.0	1637.0
456729.0	76.0	18	2	1971.0	1713.0	-
617705.0	69.8	18	2	1696.0	1792.0	-
115161.0	97.4	18	3	1421.0	1315.0	1942.0
276446.0	72.0	18	2	1377.0	1544.0	-
436689.0	88.8	18	3	1603.0	1224.0	1211.0
597858.0	96.1	18	3	1363.0	1022.0	1142.0
95905.0	62.9	18	1	1070.0	-	-
257259.0	54.4	18	1	1261.0	-	-
416896.0	90.4	18	3	1322.0	1342.0	1371.0
579916.0	57.0	18	1	1383.0	-	-
75874.0	76.1	18	2	1036.0	1312.0	-
236787.0	79.1	18	2	1752.0	1173.0	-
397013.0	85.7	18	3	1760.0	1162.0	1258.0

Type 5 Radar Waveform_21

Burst Offset (us)	Pulse Width (us)	Chirp Width (MHz)	Number of Pulses per Burst	PRI-1 (us)	PRI-2 (us)	PRI-3 (us)
557777.0	98.5	18	3	1202.0	1800.0	1071.0
55796.0	88.2	18	3	1689.0	1998.0	1411.0
217448.0	56.6	18	1	1426.0	-	-
377523.0	97.3	18	3	1275.0	1333.0	1042.0
537963.0	95.6	18	3	1434.0	1082.0	1581.0
36087.0	89.9	18	3	1271.0	1494.0	1324.0
196886.0	82.6	18	2	1753.0	1990.0	-
358766.0	53.6	18	1	1704.0	-	-
519599.0	72.7	18	2	1148.0	1121.0	-
16342.0	80.3	18	2	1047.0	1044.0	-
177607.0	58.9	18	1	1775.0	-	-
338861.0	51.6	18	1	1783.0	-	-
500348.0	50.9	18	1	1474.0	-	-
659469.0	81.4	18	2	1785.0	1910.0	-
157024.0	90.1	18	3	1719.0	1613.0	1480.0
318966.0	55.9	18	1	1849.0	-	-
479617.0	68.3	18	2	1181.0	1483.0	-
642227.0	56.4	18	1	1038.0	-	-

Type 5 Radar Waveform_22

Burst Offset (us)	Pulse Width (us)	Chirp Width (MHz)	Number of Pulses per Burst	PRI-1 (us)	PRI-2 (us)	PRI-3 (us)
225834.0	66.6	9	1	1886.0	-	-
488709.0	89.1	9	3	1516.0	1592.0	1553.0
751896.0	88.9	9	3	1943.0	1969.0	1127.0
1015242.0	87.3	9	3	1788.0	1503.0	1761.0
192757.0	85.9	9	3	1982.0	1354.0	1611.0
457089.0	80.2	9	2	1389.0	1293.0	-
721964.0	51.7	9	1	1254.0	-	-
985629.0	58.5	9	1	1929.0	-	-
160455.0	88.9	9	3	1159.0	1604.0	1234.0
423866.0	91.7	9	3	1736.0	1721.0	1051.0
689358.0	54.6	9	1	1339.0	-	-

Type 5 Radar Waveform_23

Burst Offset (us)	Pulse Width (us)	Chirp Width (MHz)	Number of Pulses per Burst	PRI-1 (us)	PRI-2 (us)	PRI-3 (us)
652470.0	96.6	15	3	1640.0	1378.0	1489.0
87793.0	98.6	15	3	1304.0	1154.0	1959.0
268566.0	99.7	15	3	1835.0	1196.0	1535.0
451485.0	57.9	15	1	1037.0	-	-
631856.0	76.4	15	2	1170.0	1376.0	-
65467.0	90.5	15	3	1925.0	1789.0	1300.0
247078.0	69.6	15	2	1091.0	1110.0	-
427719.0	73.6	15	2	1786.0	1679.0	-
608091.0	90.9	15	3	1834.0	1025.0	1447.0
43219.0	84.2	15	3	1832.0	1361.0	1669.0
224700.0	70.9	15	2	1325.0	1004.0	-
405307.0	76.1	15	2	1986.0	1681.0	-
585612.0	91.4	15	3	1424.0	1514.0	1626.0
21043.0	53.2	15	1	1882.0	-	-
201913.0	89.5	15	3	1552.0	1093.0	1351.0
382650.0	88.4	15	3	1688.0	1381.0	1301.0

Type 5 Radar Waveform_24

Burst Offset (us)	Pulse Width (us)	Chirp Width (MHz)	Number of Pulses per Burst	PRI-1 (us)	PRI-2 (us)	PRI-3 (us)
1130800.0	70.4	5	2	1872.0	1809.0	-
1492684.0	87.8	5	3	1540.0	1891.0	1273.0
360726.0	64.6	5	1	1873.0	-	-
723474.0	72.8	5	2	1780.0	1323.0	-
1085467.0	98.6	5	3	1496.0	1180.0	1876.0
1449900.0	72.0	5	2	1144.0	1612.0	-
316078.0	50.6	5	1	1364.0	-	-
679326.0	59.5	5	1	1846.0	-	-

Type 5 Radar Waveform_25

Burst Offset (us)	Pulse Width (us)	Chirp Width (MHz)	Number of Pulses per Burst	PRI-1 (us)	PRI-2 (us)	PRI-3 (us)
639284.0	90.0	11	3	1240.0	1298.0	1992.0
862075.0	96.9	11	3	1763.0	1627.0	1124.0
166903.0	61.2	11	1	1141.0	-	-
390351.0	52.2	11	1	1498.0	-	-
612287.0	76.5	11	2	1928.0	1935.0	-
834536.0	95.5	11	3	1384.0	1831.0	1407.0
138849.0	87.1	11	3	1349.0	1564.0	1616.0
362777.0	50.9	11	1	1606.0	-	-
584535.0	90.9	11	3	1862.0	1115.0	1344.0
806774.0	99.1	11	3	1989.0	1478.0	1523.0
111615.0	76.2	11	2	1164.0	1657.0	-
334717.0	81.7	11	2	1609.0	1457.0	-
558815.0	59.2	11	1	1472.0	-	-

Type 5 Radar Waveform_26

Burst Offset (us)	Pulse Width (us)	Chirp Width (MHz)	Number of Pulses per Burst	PRI-1 (us)	PRI-2 (us)	PRI-3 (us)
675509.0	93.7	14	3	1269.0	1236.0	1731.0
72865.0	74.5	14	2	1444.0	1464.0	-
265648.0	91.0	14	3	1727.0	1076.0	1712.0
459500.0	70.5	14	2	1486.0	1429.0	-
653289.0	82.3	14	2	1295.0	1046.0	-
49065.0	77.4	14	2	1693.0	1010.0	-
242114.0	72.2	14	2	2000.0	1757.0	-
434347.0	95.8	14	3	1903.0	1555.0	1911.0
630075.0	63.0	14	1	1562.0	-	-
25195.0	97.5	14	3	1156.0	1687.0	1477.0
218223.0	84.0	14	3	1784.0	1114.0	1239.0
411435.0	96.4	14	3	1297.0	1470.0	1001.0
604046.0	91.8	14	3	1406.0	1221.0	1797.0
1427.0	81.4	14	2	1647.0	1197.0	-
194865.0	70.7	14	2	1005.0	1419.0	-

Type 5 Radar Waveform_27

Burst Offset (us)	Pulse Width (us)	Chirp Width (MHz)	Number of Pulses per Burst	PRI-1 (us)	PRI-2 (us)	PRI-3 (us)
363745.0	74.3	15	2	1092.0	1773.0	-
544517.0	68.8	15	2	1771.0	1686.0	-
727770.0	56.1	15	1	1201.0	-	-
160146.0	74.5	15	2	1868.0	1345.0	-
340601.0	98.0	15	3	1328.0	1960.0	1379.0
521405.0	90.2	15	3	1143.0	1673.0	1798.0
703653.0	68.0	15	2	1920.0	1135.0	-
138012.0	79.6	15	2	1034.0	1226.0	-
318729.0	79.3	15	2	1948.0	1796.0	-
500610.0	67.3	15	2	1012.0	1402.0	-
679219.0	97.2	15	3	1746.0	1956.0	1677.0
115310.0	95.5	15	3	1531.0	1981.0	1104.0
295983.0	97.2	15	3	1290.0	1963.0	1629.0
477928.0	69.9	15	2	1045.0	1914.0	-
658520.0	85.2	15	3	1546.0	1028.0	1052.0
93050.0	92.4	15	3	1270.0	1767.0	1511.0

Type 5 Radar Waveform_28

Burst Offset (us)	Pulse Width (us)	Chirp Width (MHz)	Number of Pulses per Burst	PRI-1 (us)	PRI-2 (us)	PRI-3 (us)
274188.0	77.1	15	2	1991.0	1825.0	-
456233.0	57.7	15	1	1939.0	-	-
636471.0	79.2	15	2	1683.0	1852.0	-
70898.0	76.7	15	2	1857.0	1458.0	-
252708.0	63.2	15	1	1194.0	-	-
433451.0	73.7	15	2	1296.0	1391.0	-
615338.0	52.3	15	1	1909.0	-	-
48738.0	66.2	15	1	1057.0	-	-
229220.0	94.7	15	3	1026.0	1808.0	1995.0
410605.0	78.4	15	2	1790.0	1844.0	-
593081.0	63.7	15	1	1793.0	-	-
26317.0	77.0	15	2	1172.0	1225.0	-
208827.0	99.4	15	3	1864.0	1589.0	1847.0
388486.0	77.2	15	2	1924.0	1366.0	-
570964.0	55.9	15	1	1485.0	-	-
3972.0	84.8	15	3	1802.0	1084.0	1450.0

Type 5 Radar Waveform_29

Burst Offset (us)	Pulse Width (us)	Chirp Width (MHz)	Number of Pulses per Burst	PRI-1 (us)	PRI-2 (us)	PRI-3 (us)
148221.0	64.0	19	1	1994.0	-	-
293623.0	66.3	19	1	1245.0	-	-
437778.0	76.6	19	2	1506.0	1189.0	-
582161.0	72.1	19	2	1915.0	1274.0	-
129855.0	93.0	19	3	1218.0	1473.0	1602.0
275654.0	51.7	19	1	1422.0	-	-
417816.0	83.8	19	3	1979.0	1778.0	1950.0
564514.0	69.1	19	2	1400.0	1596.0	-
112352.0	75.7	19	2	1615.0	1117.0	-
256457.0	95.0	19	3	1972.0	1264.0	1241.0
403057.0	61.7	19	1	1257.0	-	-
547727.0	53.1	19	1	1851.0	-	-
94321.0	85.2	19	3	1449.0	1185.0	1287.0
239085.0	82.0	19	2	1776.0	1655.0	-
384344.0	75.1	19	2	1461.0	1081.0	-
528564.0	75.8	19	2	1327.0	1985.0	-
76585.0	77.9	19	2	1642.0	1720.0	-
221899.0	55.0	19	1	1717.0	-	-
367272.0	58.9	19	1	1276.0	-	-
508876.0	88.6	19	3	1806.0	1725.0	1957.0

Radar Type 6 - Radar Statistical Performance

Trail #	1=Detection 0=No Detection	Trail #	1=Detection 0=No Detection
0	1	15	1
1	1	16	1
2	1	17	1
3	1	18	1
4	1	19	1
5	1	20	1
6	1	21	1
7	0	22	1
8	1	23	1
9	1	24	1
10	1	25	1
11	1	26	1
12	1	27	1
13	1	28	1
14	1	29	1
Detection Percentage (%)		96.7%	

Type 6 Radar Waveform_0					
Frequency List (MHz)	0	1	2	3	4
0	5617	5348	5273	5490	5650
5	5557	5674	5554	5390	5645
10	5304	5678	5453	5607	5699
15	5478	5415	5413	5530	5559
20	5539	5620	5664	5351	5272
25	5660	5491	5315	5350	5313
30	5687	5635	5681	5310	5392
35	5531	5685	5365	5445	5648
40	5425	5633	5256	5513	5446
45	5621	5663	5357	5305	5420
50	5655	5642	5549	5595	5719
55	5586	5290	5679	5439	5293
60	5497	5644	5294	5609	5550
65	5396	5344	5697	5375	5378
70	5345	5484	5464	5377	5340
75	5355	5517	5327	5603	5582
80	5572	5705	5707	5437	5371
85	5568	5541	5688	5363	5624
90	5314	5716	5570	5577	5255
95	5606	5428	5481	5520	5454

Type 6 Radar Waveform_1

Frequency List (MHz)	0	1	2	3	4
0	5397	5587	5684	5651	5395
5	5659	5579	5274	5620	5597
10	5576	5568	5719	5648	5628
15	5312	5605	5421	5458	5722
20	5470	5608	5658	5445	5637
25	5714	5599	5388	5595	5349
30	5489	5299	5644	5375	5455
35	5508	5531	5622	5327	5363
40	5279	5625	5586	5630	5660
45	5493	5529	5679	5716	5656
50	5596	5706	5514	5276	5264
55	5503	5310	5538	5404	5618
60	5624	5271	5691	5443	5370
65	5506	5708	5441	5345	5693
70	5468	5330	5322	5699	5354
75	5304	5453	5584	5263	5358
80	5495	5465	5298	5394	5666
85	5292	5646	5400	5563	5670
90	5257	5478	5291	5316	5300
95	5409	5423	5258	5561	5488

Type 6 Radar Waveform_2

Frequency List (MHz)	0	1	2	3	4
0	5652	5351	5620	5337	5712
5	5701	5504	5349	5308	5426
10	5507	5357	5285	5271	5649
15	5400	5257	5524	5503	5439
20	5478	5299	5599	5534	5707
25	5505	5548	5494	5699	5286
30	5531	5663	5601	5590	5607
35	5328	5670	5713	5598	5613
40	5668	5708	5333	5724	5492
45	5473	5612	5262	5294	5509
50	5435	5297	5282	5603	5574
55	5433	5452	5457	5500	5375
60	5272	5569	5578	5517	5389
65	5552	5269	5651	5615	5496
70	5637	5316	5325	5451	5263
75	5422	5704	5309	5339	5554
80	5558	5254	5576	5487	5608
85	5488	5363	5658	5538	5686
90	5251	5489	5396	5322	5334
95	5291	5532	5275	5680	5545

Type 6 Radar Waveform_3

Frequency List (MHz)	0	1	2	3	4
0	5432	5590	5556	5498	5457
5	5268	5526	5424	5471	5633
10	5341	5718	5326	5466	5670
15	5391	5384	5627	5548	5631
20	5486	5368	5540	5680	5393
25	5400	5697	5425	5320	5573
30	5552	5558	5708	5381	5623
35	5712	5426	5491	5291	5679
40	5502	5316	5462	5721	5421
45	5356	5695	5698	5250	5396
50	5311	5473	5333	5314	5300
55	5280	5640	5411	5690	5554
60	5346	5401	5310	5514	5410
65	5440	5394	5501	5305	5483
70	5507	5299	5709	5399	5684
75	5294	5349	5452	5524	5588
80	5335	5722	5414	5682	5511
85	5330	5423	5375	5503	5262
90	5402	5309	5561	5328	5271
95	5648	5544	5292	5260	5626

Type 6 Radar Waveform_4

Frequency List (MHz)	0	1	2	3	4
0	5590	5354	5492	5659	5299
5	5407	5548	5499	5634	5365
10	5272	5507	5464	5661	5691
15	5479	5511	5255	5496	5348
20	5397	5534	5481	5615	5653
25	5349	5425	5529	5712	5538
30	5515	5448	5533	5346	5376
35	5517	5287	5444	5593	5341
40	5399	5400	5716	5718	5350
45	5336	5303	5281	5662	5649
50	5384	5403	5596	5699	5353
55	5405	5373	5695	5530	5475
60	5556	5339	5266	5378	5595
65	5450	5719	5693	5302	5577
70	5306	5385	5428	5624	5660
75	5656	5263	5372	5498	5398
80	5301	5601	5591	5411	5477
85	5570	5414	5269	5366	5470
90	5371	5650	5251	5334	5305
95	5433	5406	5315	5610	5419

Type 6 Radar Waveform_5

Frequency List (MHz)	0	1	2	3	4
0	5370	5593	5428	5345	5519
5	5449	5473	5574	5700	5669
10	5581	5296	5505	5381	5712
15	5567	5541	5358	5540	5405
20	5603	5607	5626	5547	5676
25	5628	5633	5388	5279	5427
30	5472	5663	5307	5641	5515
35	5608	5558	5694	5507	5277
40	5579	5338	5481	5715	5657
45	5316	5386	5339	5356	5548
50	5538	5350	5435	5492	5421
55	5546	5319	5498	5667	5666
60	5659	5640	5501	5646	5324
65	5418	5399	5280	5525	5380
70	5475	5371	5528	5636	5615
75	5610	5379	5553	5711	5372
80	5478	5470	5414	5586	5446
85	5662	5336	5645	5423	5327
90	5416	5340	5717	5315	5287
95	5594	5317	5420	5630	5429

Type 6 Radar Waveform_6

Frequency List (MHz)	0	1	2	3	4
0	5625	5357	5364	5506	5361
5	5491	5495	5649	5368	5401
10	5512	5560	5546	5576	5258
15	5655	5668	5586	5257	5413
20	5294	5460	5696	5599	5338
25	5528	5356	5262	5422	5321
30	5316	5429	5403	5459	5557
35	5699	5451	5372	5518	5591
40	5662	5276	5721	5712	5296
45	5469	5300	5409	5317	5526
50	5486	5581	5719	5490	5254
55	5273	5668	5389	5637	5691
60	5330	5446	5478	5367	5619
65	5348	5694	5260	5464	5561
70	5547	5454	5531	5700	5612
75	5574	5579	5687	5360	5708
80	5346	5628	5642	5467	5414
85	5428	5379	5679	5671	5525
90	5443	5575	5299	5440	5425
95	5675	5690	5664	5474	5438

Type 6 Radar Waveform_7

Frequency List (MHz)	0	1	2	3	4
0	5405	5596	5300	5667	5581
5	5533	5420	5724	5551	5608
10	5443	5349	5587	5674	5279
15	5646	5320	5467	5534	5546
20	5324	5363	5401	5688	5572
25	5701	5477	5462	5366	5456
30	5460	5302	5386	5521	5708
35	5659	5696	5315	5722	5525
40	5432	5430	5270	5592	5486
45	5331	5418	5276	5552	5358
50	5700	5668	5702	5537	5292
55	5445	5337	5345	5403	5683
60	5495	5391	5310	5316	5313
65	5442	5297	5255	5567	5356
70	5364	5716	5440	5549	5588
75	5451	5257	5355	5341	5485
80	5359	5409	5288	5464	5609
85	5695	5367	5469	5474	5644
90	5650	5444	5271	5449	5457
95	5408	5480	5643	5577	5636

Type 6 Radar Waveform_8

Frequency List (MHz)	0	1	2	3	4
0	5563	5360	5711	5256	5423
5	5672	5442	5324	5714	5437
10	5277	5710	5628	5394	5300
15	5259	5447	5570	5579	5263
20	5332	5529	5439	5302	5545
25	5589	5329	5665	5567	5490
30	5502	5666	5343	5261	5385
35	5382	5503	5518	5346	5269
40	5353	5530	5629	5328	5347
45	5635	5416	5515	5544	5403
50	5588	5381	5266	5281	5533
55	5559	5593	5482	5474	5660
60	5433	5617	5643	5721	5291
65	5626	5642	5313	5426	5634
70	5398	5467	5492	5420	5280
75	5498	5322	5262	5469	5495
80	5351	5461	5695	5684	5432
85	5512	5701	5692	5543	5436
90	5455	5722	5339	5535	5486
95	5525	5680	5456	5608	5316

Type 6 Radar Waveform_9

Frequency List (MHz)	0	1	2	3	4
0	5343	5599	5647	5417	5643
5	5714	5367	5399	5402	5644
10	5683	5499	5669	5589	5321
15	5347	5574	5673	5624	5455
20	5340	5695	5380	5294	5518
25	5278	5393	5671	5524	5544
30	5652	5300	5476	5634	5677
35	5594	5314	5453	5357	5583
40	5533	5468	5394	5325	5276
45	5711	5718	5377	5471	5323
50	5579	5639	5470	5566	5603
55	5721	5513	5308	5350	5378
60	5546	5540	5680	5466	5670
65	5705	5609	5421	5445	5482
70	5412	5637	5722	5443	5451
75	5389	5400	5303	5514	5446
80	5562	5414	5458	5621	5598
85	5623	5492	5286	5477	5655
90	5465	5363	5601	5461	5281
95	5529	5588	5493	5724	5384

Type 6 Radar Waveform_10

Frequency List (MHz)	0	1	2	3	4
0	5598	5363	5583	5578	5485
5	5281	5389	5474	5468	5376
10	5614	5288	5710	5309	5342
15	5435	5604	5301	5669	5647
20	5251	5289	5321	5383	5491
25	5268	5605	5596	5300	5558
30	5683	5541	5257	5691	5311
35	5497	5685	5682	5606	5271
40	5519	5616	5406	5634	5322
45	5594	5326	5524	5642	5674
50	5280	5690	5559	5547	5434
55	5467	5498	5518	5424	5515
60	5323	5378	5366	5723	5667
65	5619	5266	5344	5313	5554
70	5495	5262	5571	5419	5410
75	5261	5520	5687	5284	5291
80	5592	5702	5574	5455	5341
85	5501	5465	5478	5345	5706
90	5561	5564	5693	5481	5638
95	5548	5708	5379	5386	5411

Type 6 Radar Waveform_11

Frequency List (MHz)	0	1	2	3	4
0	5378	5602	5519	5264	5705
5	5323	5314	5549	5631	5583
10	5448	5552	5276	5407	5363
15	5426	5256	5307	5617	5364
20	5259	5455	5359	5375	5464
25	5534	5457	5324	5404	5592
30	5250	5430	5689	5334	5560
35	5695	5680	5301	5478	5381
40	5660	5358	5699	5344	5399
45	5319	5512	5574	5409	5493
50	5577	5529	5550	5456	5266
55	5270	5590	5394	5622	5421
60	5688	5337	5395	5386	5268
65	5685	5289	5669	5490	5568
70	5302	5651	5429	5723	5481
75	5265	5369	5640	5258	5543
80	5702	5483	5415	5637	5355
85	5536	5501	5515	5670	5310
90	5389	5570	5252	5650	5603
95	5692	5277	5365	5514	5672

Type 6 Radar Waveform_12

Frequency List (MHz)	0	1	2	3	4
0	5536	5463	5455	5425	5547
5	5462	5336	5624	5319	5412
10	5379	5341	5414	5602	5384
15	5514	5383	5410	5662	5556
20	5267	5524	5300	5464	5437
25	5422	5406	5430	5605	5626
30	5292	5416	5549	5712	5515
35	5344	5392	5274	5534	5574
40	5672	5404	5282	5542	5316
45	5554	5492	5454	5630	5426
50	5632	5317	5359	5413	5338
55	5335	5375	5306	5631	5269
60	5418	5370	5310	5517	5590
65	5615	5691	5716	5386	5475
70	5707	5320	5467	5365	5647
75	5371	5328	5577	5285	5401
80	5721	5698	5337	5264	5579
85	5700	5352	5256	5478	5290
90	5653	5711	5637	5621	5576
95	5664	5623	5284	5639	5658

Type 6 Radar Waveform_13

Frequency List (MHz)	0	1	2	3	4
0	5316	5702	5391	5586	5292
5	5504	5261	5699	5482	5619
10	5310	5605	5455	5322	5405
15	5602	5510	5513	5707	5273
20	5653	5690	5716	5456	5410
25	5688	5258	5633	5709	5660
30	5334	5305	5506	5289	5486
35	5713	5386	5580	5642	5687
40	5585	5511	5487	5695	5307
45	5534	5575	5512	5683	5681
50	5680	5711	5368	5448	5523
55	5329	5496	5353	5715	5547
60	5535	5255	5446	5416	5658
65	5417	5466	5277	5693	5270
70	5489	5453	5347	5287	5546
75	5308	5447	5324	5475	5350
80	5520	5646	5288	5349	5548
85	5404	5563	5538	5618	5665
90	5399	5311	5582	5698	5505
95	5393	5278	5282	5701	5720

Type 6 Radar Waveform_14

Frequency List (MHz)	0	1	2	3	4
0	5571	5466	5327	5272	5609
5	5546	5263	5299	5548	5351
10	5619	5491	5496	5517	5426
15	5690	5637	5616	5277	5465
20	5661	5284	5279	5545	5383
25	5576	5682	5361	5338	5694
30	5473	5669	5463	5504	5638
35	5533	5525	5671	5438	5462
40	5499	5447	5570	5633	5547
45	5407	5677	5514	5658	5261
50	5471	5556	5412	5419	5537
55	5534	5604	5614	5686	5647
60	5676	5700	5675	5278	5339
65	5715	5415	5691	5428	5540
70	5313	5561	5536	5468	5345
75	5701	5721	5418	5590	5305
80	5252	5460	5301	5335	5446
85	5346	5266	5307	5405	5501
90	5674	5486	5716	5597	5476
95	5588	5635	5290	5295	5293

Type 6 Radar Waveform_15

Frequency List (MHz)	0	1	2	3	4
0	5351	5705	5263	5336	5354
5	5588	5683	5374	5711	5655
10	5550	5280	5537	5712	5447
15	5681	5667	5719	5700	5279
20	5669	5450	5695	5356	5464
25	5534	5564	5442	5253	5515
30	5420	5622	5412	5256	5664
35	5287	5709	5615	5413	5266
40	5653	5474	5690	5404	5509
45	5494	5363	5531	5314	5358
50	5432	5470	5626	5260	5451
55	5327	5401	5466	5657	5330
60	5390	5717	5585	5640	5441
65	5364	5252	5591	5633	5522
70	5471	5572	5677	5680	5387
75	5548	5636	5504	5473	5654
80	5499	5511	5343	5463	5685
85	5344	5294	5670	5431	5320
90	5641	5691	5647	5514	5312
95	5348	5347	5562	5611	5604

Type 6 Radar Waveform_16

Frequency List (MHz)	0	1	2	3	4
0	5606	5469	5674	5497	5671
5	5252	5705	5449	5399	5387
10	5384	5544	5578	5335	5468
15	5294	5319	5250	5270	5471
20	5580	5519	5636	5626	5329
25	5255	5386	5292	5643	5287
30	5557	5377	5362	5564	5551
35	5328	5378	5505	5293	5424
40	5600	5358	5412	5455	5401
45	5438	5446	5589	5623	5308
50	5289	5521	5337	5558	5395
55	5515	5666	5591	5285	5531
60	5459	5555	5662	5417	5563
65	5496	5264	5313	5288	5470
70	5702	5297	5327	5508	5474
75	5421	5653	5639	5259	5668
80	5304	5267	5281	5583	5435
85	5663	5574	5718	5658	5685
90	5661	5524	5486	5721	5679
95	5615	5331	5697	5432	5403

Type 6 Radar Waveform_17

Frequency List (MHz)	0	1	2	3	4
0	5289	5708	5610	5658	5416
5	5294	5630	5524	5562	5594
10	5315	5333	5619	5530	5489
15	5382	5446	5353	5663	5588
20	5685	5577	5618	5302	5335
25	5398	5272	5321	5696	5334
30	5338	5371	5370	5469	5543
35	5439	5441	5350	5695	5270
40	5357	5529	5647	5323	5510
45	5465	5572	5426	5381	5717
50	5703	5620	5306	5482	5502
55	5491	5720	5607	5724	5389
60	5539	5262	5702	5575	5399
65	5494	5574	5629	5598	5691
70	5447	5723	5436	5693	5255
75	5259	5715	5378	5503	5487
80	5581	5284	5675	5355	5496
85	5640	5314	5635	5443	5458
90	5712	5423	5657	5319	5421
95	5328	5516	5402	5590	5534

Type 6 Radar Waveform_18

Frequency List (MHz)	0	1	2	3	4
0	5544	5472	5546	5344	5636
5	5336	5652	5599	5628	5423
10	5721	5597	5660	5250	5510
15	5470	5573	5456	5263	5380
20	5596	5376	5615	5707	5275
25	5409	5662	5601	5355	5419
30	5291	5317	5587	5589	5509
35	5560	5669	5696	5252	5278
40	5524	5268	5460	5492	5674
45	5337	5612	5608	5300	5438
50	5641	5623	5515	5679	5661
55	5416	5574	5496	5301	5473
60	5620	5410	5552	5653	5690
65	5485	5686	5512	5389	5378
70	5568	5577	5594	5605	5557
75	5672	5493	5704	5688	5706
80	5322	5712	5670	5491	5442
85	5547	5298	5627	5629	5603
90	5633	5709	5671	5269	5513
95	5396	5610	5402	5285	5352

Type 6 Radar Waveform_19

Frequency List (MHz)	0	1	2	3	4
0	5324	5711	5482	5505	5478
5	5475	5577	5674	5316	5630
10	5555	5483	5701	5445	5531
15	5461	5700	5559	5308	5572
20	5507	5556	5699	5723	5297
25	5611	5329	5480	5389	5305
30	5435	5264	5648	5273	5465
35	5374	5263	5689	5704	5603
40	5489	5317	5695	5666	5429
45	5662	5314	5342	5604	5405
50	5508	5528	5589	5595	5444
55	5274	5575	5594	5485	5613
60	5431	5635	5677	5344	5659
65	5656	5640	5563	5443	5484
70	5516	5544	5456	5636	5685
75	5341	5253	5583	5385	5709
80	5390	5491	5284	5510	5490
85	5592	5680	5376	5356	5351
90	5715	5281	5477	5568	5380
95	5388	5550	5412	5370	5262

Type 6 Radar Waveform_20

Frequency List (MHz)	0	1	2	3	4
0	5579	5475	5418	5666	5698
5	5517	5599	5652	5479	5362
10	5486	5272	5364	5640	5552
15	5549	5255	5662	5353	5289
20	5515	5611	5497	5313	5696
25	5563	5463	5532	5681	5326
30	5444	5294	5680	5650	5513
35	5587	5690	5358	5624	5528
40	5312	5639	5368	5435	5297
45	5303	5724	5482	5452	5665
50	5518	5250	5315	5703	5695
55	5304	5317	5318	5403	5265
60	5539	5439	5474	5584	5713
65	5554	5551	5459	5334	5670
70	5460	5576	5682	5717	5451
75	5509	5448	5706	5585	5394
80	5570	5634	5651	5516	5343
85	5645	5338	5390	5494	5623
90	5406	5263	5491	5273	5507
95	5582	5257	5613	5458	5462

Type 6 Radar Waveform_21

Frequency List (MHz)	0	1	2	3	4
0	5262	5714	5354	5352	5540
5	5559	5524	5252	5642	5666
10	5417	5536	5405	5263	5573
15	5637	5382	5668	5398	5481
20	5523	5680	5535	5305	5669
25	5451	5315	5260	5310	5360
30	5486	5658	5390	5665	5407
35	5455	5629	5302	5566	5367
40	5395	5577	5608	5483	5364
45	5277	5386	5307	5339	5444
50	5694	5301	5404	5526	5299
55	5408	5494	5611	5289	5532
60	5430	5484	5624	5265	5420
65	5513	5533	5274	5346	5640
70	5406	5632	5519	5436	5434
75	5385	5696	5350	5647	5464
80	5290	5606	5297	5328	5685
85	5397	5374	5681	5349	5582
90	5598	5499	5511	5678	5445
95	5304	5620	5594	5568	5602

Type 6 Radar Waveform_22

Frequency List (MHz)	0	1	2	3	4
0	5517	5478	5290	5513	5285
5	5601	5546	5327	5708	5398
10	5251	5325	5446	5458	5594
15	5250	5509	5296	5346	5673
20	5434	5371	5476	5394	5642
25	5339	5264	5463	5414	5528
30	5547	5605	5439	5493	5425
35	5455	5577	5681	5418	5373
40	5460	5671	5635	5469	5268
45	5491	5604	5320	5395	5352
50	5349	5718	5596	5293	5684
55	5430	5260	5661	5595	5429
60	5456	5663	5366	5714	5482
65	5688	5713	5443	5575	5618
70	5308	5368	5412	5393	5354
75	5719	5396	5628	5271	5574
80	5503	5603	5597	5297	5382
85	5593	5397	5639	5645	5669
90	5274	5355	5616	5511	5625
95	5258	5677	5599	5697	5291

Type 6 Radar Waveform_23

Frequency List (MHz)	0	1	2	3	4
0	5297	5717	5701	5577	5602
5	5265	5471	5402	5396	5605
10	5657	5589	5487	5653	5615
15	5716	5636	5399	5391	5442
20	5440	5417	5483	5591	5569
25	5518	5428	5667	5533	5551
30	5723	5425	5632	5637	5696
35	5705	5491	5617	5658	5356
40	5516	5574	5600	5552	5326
45	5544	5671	5571	5403	5582
50	5550	5565	5309	5722	5724
55	5706	5693	5285	5385	5489
60	5409	5537	5431	5508	5721
65	5647	5604	5311	5692	5388
70	5352	5364	5539	5426	5587
75	5327	5259	5317	5675	5321
80	5556	5690	5418	5392	5439
85	5361	5553	5620	5642	5313
90	5413	5672	5481	5325	5695
95	5268	5423	5610	5334	5584

Type 6 Radar Waveform_24

Frequency List (MHz)	0	1	2	3	4
0	5552	5481	5637	5263	5347
5	5307	5493	5477	5559	5434
10	5491	5475	5528	5373	5636
15	5329	5288	5502	5436	5679
20	5450	5606	5455	5588	5540
25	5297	5719	5462	5709	5422
30	5508	5463	5365	5720	5674
35	5350	5589	5383	5405	5456
40	5266	5294	5281	5571	5529
45	5595	5635	5384	5597	5272
50	5454	5293	5509	5497	5676
55	5446	5580	5416	5692	5412
60	5355	5380	5663	5638	5303
65	5524	5590	5411	5444	5364
70	5311	5670	5484	5585	5687
75	5678	5697	5583	5356	5419
80	5512	5578	5616	5306	5601
85	5644	5666	5604	5464	5587
90	5622	5254	5659	5368	5494
95	5570	5460	5428	5309	5315

Type 6 Radar Waveform_25

Frequency List (MHz)	0	1	2	3	4
0	5332	5720	5573	5424	5664
5	5349	5418	5552	5722	5641
10	5422	5264	5569	5568	5657
15	5417	5318	5605	5481	5396
20	5361	5675	5564	5561	5284
25	5392	5500	5348	5496	5276
30	5311	5465	5678	5517	5443
35	5338	5441	5385	5536	5416
40	5295	5707	5521	5575	5718
45	5345	5650	5643	5326	5448
50	5505	5382	5671	5356	5685
55	5630	5304	5265	5551	5476
60	5615	5524	5713	5301	5329
65	5699	5470	5670	5327	5413
70	5673	5414	5293	5270	5542
75	5604	5253	5668	5455	5364
80	5423	5482	5594	5578	5480
85	5579	5401	5469	5695	5342
90	5410	5294	5504	5266	5676
95	5478	5468	5531	5507	5692

Type 6 Radar Waveform_26

Frequency List (MHz)	0	1	2	3	4
0	5490	5484	5509	5585	5409
5	5391	5440	5627	5313	5373
10	5353	5528	5610	5666	5678
15	5505	5445	5611	5429	5588
20	5369	5366	5337	5556	5534
25	5647	5719	5703	5452	5530
30	5318	5297	5422	5418	5291
35	5263	5477	5532	5656	5311
40	5330	5609	5432	5645	5664
45	5565	5290	5555	5326	5403
50	5433	5677	5624	5471	5494
55	5300	5301	5584	5397	5559
60	5522	5605	5305	5306	5356
65	5539	5722	5287	5278	5260
70	5680	5465	5508	5485	5659
75	5514	5617	5694	5704	5511
80	5396	5649	5707	5345	5620
85	5587	5545	5591	5427	5481
90	5419	5639	5593	5434	5590
95	5705	5459	5476	5558	5289

Type 6 Radar Waveform_27

Frequency List (MHz)	0	1	2	3	4
0	5270	5723	5445	5271	5251
5	5530	5365	5702	5476	5580
10	5682	5317	5651	5386	5699
15	5496	5572	5714	5474	5305
20	5377	5435	5375	5645	5507
25	5438	5668	5431	5556	5564
30	5457	5661	5379	5536	5443
35	5461	5519	5623	5549	5464
40	5719	5448	5612	5583	5429
45	5562	5597	5535	5409	5281
50	5320	5553	5325	5607	5560
55	5695	5622	5489	5538	5587
60	5493	5259	5470	5348	5285
65	5462	5290	5488	5674	5512
70	5357	5311	5654	5517	5466
75	5670	5663	5480	5272	5442
80	5630	5484	5455	5401	5276
85	5608	5491	5384	5261	5602
90	5688	5302	5700	5363	5428
95	5624	5482	5592	5646	5332

Type 6 Radar Waveform_28

Frequency List (MHz)	0	1	2	3	4
0	5525	5584	5381	5432	5471
5	5572	5387	5302	5639	5409
10	5593	5581	5314	5720	5699
15	5342	5519	5497	5288	5601
20	5316	5637	5480	5326	5520
25	5537	5660	5598	5499	5647
30	5336	5276	5692	5281	5658
35	5714	5345	5617	5255	5384
40	5695	5521	5669	5656	5526
45	5515	5492	5422	5712	5585
50	5332	5501	5649	5518	5566
55	5677	5575	5367	5291	5635
60	5293	5592	5711	5311	5273
65	5710	5344	5627	5589	5251
70	5631	5315	5646	5352	5392
75	5611	5565	5657	5440	5488
80	5439	5675	5662	5405	5267
85	5654	5626	5529	5431	5496
90	5349	5588	5527	5268	5723
95	5378	5297	5530	5604	5502

Type 6 Radar Waveform_29

Frequency List (MHz)	0	1	2	3	4
0	5305	5348	5317	5593	5313
5	5614	5312	5377	5327	5616
10	5524	5467	5355	5301	5266
15	5672	5254	5445	5689	5296
20	5292	5257	5251	5453	5469
25	5265	5386	5632	5541	5536
30	5293	5491	5369	5479	5322
35	5330	5392	5644	5698	5303
40	5459	5434	5653	5455	5398
45	5575	5480	5290	5472	5683
50	5677	5709	5360	5341	5413
55	5390	5446	5492	5394	5338
60	5420	5325	5713	5424	5589
65	5657	5512	5697	5271	5554
70	5422	5714	5620	5542	5622
75	5484	5321	5631	5592	5416
80	5578	5438	5507	5356	5485
85	5634	5287	5517	5625	5597
90	5610	5705	5384	5591	5563
95	5605	5366	5643	5511	5636

Product	5G NR/LTE Router	Temperature	27°C
Test Engineer	Jake Lan	Relative Humidity	65%
Test Site	WZ-SR4	Test Date	2021/07/19
Test Item	Radar Statistical Performance Check (802.11ax-HE80 mode – 5530MHz)		

Radar Type 1-4 - Radar Statistical Performance

Trial	Frequency (MHz)	1 detect ,0 no detect			
		Radar Type 1	Radar Type 2	Radar Type 3	Radar Type 4
0	5491	0	1	1	1
1	5539	1	1	1	1
2	5496	1	1	0	1
3	5545	1	1	1	0
4	5502	1	1	1	1
5	5550	1	0	1	1
6	5507	1	1	1	1
7	5556	1	1	1	1
8	5494	1	1	1	1
9	5515	1	1	1	1
10	5523	1	1	1	1
11	5521	1	1	1	1
12	5561	1	1	1	0
13	5526	1	1	0	1
14	5518	1	1	1	1
15	5531	1	1	1	0
16	5499	1	1	1	0
17	5537	1	1	1	1
18	5534	1	0	1	1
19	5542	1	1	0	1
20	5504	1	0	1	0
21	5547	1	1	1	0
22	5530	1	1	1	0
23	5553	1	0	0	1
24	5566	1	1	1	0
25	5558	1	1	1	1
26	5510	1	1	1	0
27	5564	1	1	1	1
28	5513	1	1	1	1
29	5569	1	1	0	1

Probability:	96.7%	86.7%	83.3%	70.0%
Aggregate (Radar Types 1-4):	84.2% (>80%)			

Radar Type 1 - Radar Waveform

	Trial Id	Radar Type	Pulse Width (us)	PRI (us)	Number of Pulses	Waveform Length (us)
Download	0	Type 1	1.0	638.0	83	52954.0
Download	1	Type 1	1.0	898.0	59	52982.0
Download	2	Type 1	1.0	938.0	57	53466.0
Download	3	Type 1	1.0	598.0	89	53222.0
Download	4	Type 1	1.0	698.0	76	53048.0
Download	5	Type 1	1.0	878.0	61	53558.0
Download	6	Type 1	1.0	758.0	70	53060.0
Download	7	Type 1	1.0	538.0	99	53262.0
Download	8	Type 1	1.0	3066.0	18	55188.0
Download	9	Type 1	1.0	918.0	58	53244.0
Download	10	Type 1	1.0	578.0	92	53176.0
Download	11	Type 1	1.0	818.0	65	53170.0
Download	12	Type 1	1.0	518.0	102	52836.0
Download	13	Type 1	1.0	838.0	63	52794.0
Download	14	Type 1	1.0	858.0	62	53196.0
Download	15	Type 1	1.0	2289.0	24	54936.0
Download	16	Type 1	1.0	1067.0	50	53350.0
Download	17	Type 1	1.0	2878.0	19	54682.0
Download	18	Type 1	1.0	1516.0	35	53060.0
Download	19	Type 1	1.0	2132.0	25	53300.0
Download	20	Type 1	1.0	2387.0	23	54901.0
Download	21	Type 1	1.0	2566.0	21	53886.0
Download	22	Type 1	1.0	1607.0	33	53031.0
Download	23	Type 1	1.0	1109.0	48	53232.0
Download	24	Type 1	1.0	2600.0	21	54600.0
Download	25	Type 1	1.0	2298.0	23	52854.0
Download	26	Type 1	1.0	1438.0	37	53206.0
Download	27	Type 1	1.0	2846.0	19	54074.0
Download	28	Type 1	1.0	886.0	60	53160.0
Download	29	Type 1	1.0	585.0	91	53235.0

Radar Type 2 - Radar Waveform

	Trial Id	Radar Type	Pulse Width (us)	PRI (us)	Number of Pulses	Waveform Length (us)
Download	0	Type 2	1.2	165.0	23	3795.0
Download	1	Type 2	1.3	196.0	23	4508.0
Download	2	Type 2	4.6	222.0	29	6438.0
Download	3	Type 2	2.0	220.0	24	5280.0
Download	4	Type 2	4.4	209.0	28	5852.0
Download	5	Type 2	3.1	153.0	26	3978.0
Download	6	Type 2	2.9	203.0	26	5278.0
Download	7	Type 2	1.0	158.0	23	3634.0
Download	8	Type 2	4.4	230.0	28	6440.0
Download	9	Type 2	2.3	152.0	25	3800.0
Download	10	Type 2	2.4	155.0	25	3875.0
Download	11	Type 2	4.1	199.0	28	5572.0
Download	12	Type 2	2.5	206.0	25	5150.0
Download	13	Type 2	4.5	162.0	29	4698.0
Download	14	Type 2	1.4	226.0	23	5198.0
Download	15	Type 2	3.7	177.0	27	4779.0
Download	16	Type 2	4.2	192.0	28	5376.0
Download	17	Type 2	4.5	224.0	29	6496.0
Download	18	Type 2	2.9	188.0	26	4888.0
Download	19	Type 2	3.7	160.0	27	4320.0
Download	20	Type 2	1.5	184.0	23	4232.0
Download	21	Type 2	4.5	227.0	28	6356.0
Download	22	Type 2	3.8	207.0	27	5589.0
Download	23	Type 2	5.0	150.0	29	4350.0
Download	24	Type 2	4.2	176.0	28	4928.0
Download	25	Type 2	1.0	169.0	23	3887.0
Download	26	Type 2	3.3	213.0	27	5751.0
Download	27	Type 2	5.0	181.0	29	5249.0
Download	28	Type 2	3.2	197.0	26	5122.0
Download	29	Type 2	1.2	166.0	23	4278.0

Radar Type 3 - Radar Waveform

	Trial Id	Radar Type	Pulse Width (us)	PRI (us)	Number of Pulses	Waveform Length (us)
Download	0	Type 3	6.2	384.0	16	6144.0
Download	1	Type 3	6.3	237.0	16	3792.0
Download	2	Type 3	9.6	450.0	18	8100.0
Download	3	Type 3	7.0	201.0	16	3216.0
Download	4	Type 3	9.4	374.0	18	6732.0
Download	5	Type 3	8.1	465.0	17	7905.0
Download	6	Type 3	7.9	272.0	17	4624.0
Download	7	Type 3	6.0	263.0	16	4208.0
Download	8	Type 3	9.4	303.0	18	5454.0
Download	9	Type 3	7.3	399.0	17	6783.0
Download	10	Type 3	7.4	492.0	17	8364.0
Download	11	Type 3	9.1	285.0	18	5130.0
Download	12	Type 3	7.5	380.0	17	6460.0
Download	13	Type 3	9.5	388.0	18	6984.0
Download	14	Type 3	6.4	241.0	16	3856.0
Download	15	Type 3	8.7	333.0	18	5994.0
Download	16	Type 3	9.2	352.0	18	6336.0
Download	17	Type 3	9.5	400.0	18	7200.0
Download	18	Type 3	7.9	213.0	17	3621.0
Download	19	Type 3	8.7	341.0	18	6138.0
Download	20	Type 3	6.5	395.0	16	6320.0
Download	21	Type 3	9.5	457.0	18	8226.0
Download	22	Type 3	8.8	375.0	18	6750.0
Download	23	Type 3	10.0	257.0	18	4626.0
Download	24	Type 3	9.2	245.0	18	4410.0
Download	25	Type 3	6.0	487.0	16	7792.0
Download	26	Type 3	8.3	464.0	17	7888.0
Download	27	Type 3	10.0	358.0	18	6444.0
Download	28	Type 3	8.2	308.0	17	5236.0
Download	29	Type 3	6.2	442.0	16	7072.0

Radar Type 4 - Radar Waveform

	Trial Id	Radar Type	Pulse Width (us)	PRI (us)	Number of Pulses	Waveform Length (us)
Download	0	Type 4	11.6	384.0	12	4608.0
Download	1	Type 4	11.7	237.0	12	2844.0
Download	2	Type 4	19.1	450.0	16	7200.0
Download	3	Type 4	13.3	201.0	13	2613.0
Download	4	Type 4	18.5	374.0	16	5984.0
Download	5	Type 4	15.7	465.0	14	6510.0
Download	6	Type 4	15.2	272.0	14	3808.0
Download	7	Type 4	11.0	263.0	12	3156.0
Download	8	Type 4	18.6	303.0	16	4848.0
Download	9	Type 4	14.0	399.0	13	5187.0
Download	10	Type 4	14.1	492.0	13	6396.0
Download	11	Type 4	17.9	285.0	15	4275.0
Download	12	Type 4	14.3	380.0	13	4940.0
Download	13	Type 4	18.9	388.0	16	6208.0
Download	14	Type 4	11.9	241.0	12	2892.0
Download	15	Type 4	17.1	333.0	15	4995.0
Download	16	Type 4	18.2	352.0	16	5632.0
Download	17	Type 4	18.9	400.0	16	6400.0
Download	18	Type 4	15.2	213.0	14	2982.0
Download	19	Type 4	17.2	341.0	15	5115.0
Download	20	Type 4	12.1	395.0	12	4740.0
Download	21	Type 4	18.7	457.0	16	7312.0
Download	22	Type 4	17.2	375.0	15	5625.0
Download	23	Type 4	20.0	257.0	16	4112.0
Download	24	Type 4	18.1	245.0	15	3675.0
Download	25	Type 4	11.0	487.0	12	5844.0
Download	26	Type 4	16.3	464.0	14	6496.0
Download	27	Type 4	19.8	358.0	16	5728.0
Download	28	Type 4	16.0	308.0	14	4312.0
Download	29	Type 4	11.6	442.0	12	5304.0

Radar Type 5 - Radar Statistical Performance

Trail #	Test Freq. (MHz)	1=Detection 0=No Detection	Trail #	Test Freq. (MHz)	1=Detection 0=No Detection
0	5530	1	15	5497	1
1	5530	1	16	5497.8	1
2	5530	1	17	5498.2	1
3	5530	1	18	5495.8	1
4	5530	1	19	5497	1
5	5530	1	20	5566.6	1
6	5530	1	21	5561.8	1
7	5530	1	22	5562.6	1
8	5530	1	23	5561	1
9	5530	1	24	5562.2	1
10	5495	1	25	5567	1
11	5497.8	1	26	5563.4	1
12	5495	1	27	5561	1
13	5498.6	1	28	5563.8	1
14	5493.4	1	29	5566.6	1
Detection Percentage (%)					100.0%

Type 5 Radar Waveform_0						
Burst Offset (us)	Pulse Width (us)	Chirp Width (MHz)	Number of Pulses per Burst	PRI-1 (us)	PRI-2 (us)	PRI-3 (us)
469353.0	53.5	6	1	1546.0	-	-
832782.0	53.9	6	1	1535.0	-	-
1193487.0	94.9	6	3	1456.0	1517.0	1968.0
61166.0	62.8	6	1	1543.0	-	-
423612.0	91.6	6	3	1602.0	1791.0	1599.0
787573.0	76.1	6	2	1113.0	1266.0	-
1149970.0	73.6	6	2	1619.0	1830.0	-
16400.0	50.1	6	1	1596.0	-	-

Type 5 Radar Waveform_1

Burst Offset (us)	Pulse Width (us)	Chirp Width (MHz)	Number of Pulses per Burst	PRI-1 (us)	PRI-2 (us)	PRI-3 (us)
336783.0	91.8	6	3	1201.0	1991.0	1486.0
659864.0	66.9	6	2	1654.0	1329.0	-
982508.0	67.2	6	2	1863.0	1131.0	-
1303532.0	88.1	6	3	1181.0	1823.0	1647.0
297440.0	68.5	6	2	1287.0	1825.0	-
619403.0	93.8	6	3	1342.0	1290.0	1892.0
943685.0	55.4	6	1	1696.0	-	-
1264292.0	83.6	6	3	1194.0	1770.0	1210.0
257406.0	90.1	6	3	1088.0	1986.0	1558.0

Type 5 Radar Waveform_2

Burst Offset (us)	Pulse Width (us)	Chirp Width (MHz)	Number of Pulses per Burst	PRI-1 (us)	PRI-2 (us)	PRI-3 (us)
273567.0	93.5	19	3	1434.0	1568.0	1503.0
426845.0	73.3	19	2	1335.0	1412.0	-
577752.0	84.1	19	3	1086.0	1567.0	1836.0
103232.0	56.2	19	1	1551.0	-	-
254366.0	92.9	19	3	1722.0	1974.0	1960.0
406691.0	84.5	19	3	1931.0	1009.0	1916.0
559583.0	99.8	19	3	1508.0	1309.0	1038.0
83979.0	89.5	19	3	1187.0	1618.0	1967.0
237397.0	50.4	19	1	1062.0	-	-
389349.0	79.1	19	2	1483.0	1143.0	-
540558.0	98.9	19	3	1454.0	1565.0	1152.0
65352.0	77.9	19	2	1905.0	1921.0	-
218321.0	53.3	19	1	1751.0	-	-
371276.0	65.6	19	1	1409.0	-	-
520705.0	97.1	19	3	1995.0	1612.0	1898.0
46625.0	74.6	19	2	1557.0	1920.0	-
199301.0	81.3	19	2	1151.0	1247.0	-
352427.0	55.7	19	1	1451.0	-	-
505375.0	66.4	19	1	1298.0	-	-

Type 5 Radar Waveform_3

Burst Offset (us)	Pulse Width (us)	Chirp Width (MHz)	Number of Pulses per Burst	PRI-1 (us)	PRI-2 (us)	PRI-3 (us)
48262.0	75.2	9	2	1616.0	1240.0	-
312654.0	65.2	9	1	1096.0	-	-
576097.0	77.8	9	2	1104.0	1637.0	-
838827.0	98.0	9	3	1361.0	1883.0	1033.0
15749.0	67.3	9	2	1941.0	1461.0	-
279588.0	76.7	9	2	1172.0	1903.0	-
543226.0	67.3	9	2	1621.0	1846.0	-
806143.0	88.7	9	3	1625.0	1338.0	1613.0
1071129.0	76.0	9	2	1100.0	1936.0	-
246943.0	72.2	9	2	1917.0	1802.0	-
510540.0	86.9	9	3	1313.0	1232.0	1348.0

Type 5 Radar Waveform_4

Burst Offset (us)	Pulse Width (us)	Chirp Width (MHz)	Number of Pulses per Burst	PRI-1 (us)	PRI-2 (us)	PRI-3 (us)
472030.0	95.6	18	3	1286.0	1249.0	1357.0
633475.0	73.8	18	2	1315.0	1842.0	-
131037.0	70.1	18	2	1142.0	1255.0	-
292327.0	59.2	18	1	1980.0	-	-
451627.0	96.3	18	3	1918.0	1039.0	1819.0
614050.0	73.2	18	2	1457.0	1271.0	-
111406.0	65.6	18	1	1123.0	-	-
272776.0	61.8	18	1	1233.0	-	-
434162.0	60.7	18	1	1237.0	-	-
594566.0	69.5	18	2	1092.0	1244.0	-
91083.0	95.2	18	3	1305.0	1185.0	1835.0
252165.0	73.4	18	2	1793.0	1366.0	-
411989.0	91.1	18	3	1604.0	1364.0	1954.0
573388.0	97.0	18	3	1325.0	1296.0	1254.0
71501.0	74.7	18	2	1125.0	1289.0	-
232395.0	72.2	18	2	1328.0	1682.0	-
392160.0	88.5	18	3	1786.0	1837.0	1399.0
555501.0	51.2	18	1	1585.0	-	-

Type 5 Radar Waveform_5

Burst Offset (us)	Pulse Width (us)	Chirp Width (MHz)	Number of Pulses per Burst	PRI-1 (us)	PRI-2 (us)	PRI-3 (us)
66434.0	70.1	13	2	1012.0	1868.0	-
274011.0	63.5	13	1	1659.0	-	-
479999.0	87.2	13	3	1422.0	1574.0	1317.0
686895.0	88.0	13	3	1045.0	1684.0	1512.0
40886.0	89.1	13	3	1076.0	1140.0	1234.0
248493.0	58.4	13	1	1522.0	-	-
455230.0	74.9	13	2	1416.0	1566.0	-
663191.0	65.7	13	1	1951.0	-	-
15390.0	75.3	13	2	1238.0	1780.0	-
222492.0	66.8	13	2	1556.0	1655.0	-
429475.0	79.5	13	2	1672.0	1783.0	-
636880.0	75.6	13	2	1129.0	1844.0	-
842896.0	95.8	13	3	1339.0	1651.0	1144.0
196975.0	73.7	13	2	1907.0	1333.0	-

Type 5 Radar Waveform_6

Burst Offset (us)	Pulse Width (us)	Chirp Width (MHz)	Number of Pulses per Burst	PRI-1 (us)	PRI-2 (us)	PRI-3 (us)
404036.0	67.2	12	2	1880.0	1439.0	-
612397.0	63.6	12	1	1528.0	-	-
817362.0	83.6	12	3	1666.0	1219.0	1302.0
171380.0	75.1	12	2	1961.0	1701.0	-
379153.0	57.7	12	1	1909.0	-	-
584623.0	94.1	12	3	1643.0	1178.0	1934.0
793441.0	69.4	12	2	1347.0	1160.0	-
146027.0	73.9	12	2	1370.0	1450.0	-
353732.0	58.9	12	1	1600.0	-	-
560784.0	69.5	12	2	1063.0	1213.0	-
765074.0	95.1	12	3	1989.0	1760.0	1913.0
120285.0	97.0	12	3	1536.0	1769.0	1074.0
327547.0	80.1	12	2	1424.0	1809.0	-
533211.0	91.9	12	3	1732.0	1797.0	1996.0

Type 5 Radar Waveform_7

Burst Offset (us)	Pulse Width (us)	Chirp Width (MHz)	Number of Pulses per Burst	PRI-1 (us)	PRI-2 (us)	PRI-3 (us)
1299117.0	86.7	5	3	1003.0	1902.0	1532.0
166619.0	51.0	5	1	1332.0	-	-
528964.0	92.6	5	3	1649.0	1139.0	1739.0
893258.0	54.4	5	1	1851.0	-	-
1255638.0	78.8	5	2	1035.0	1971.0	-
121648.0	87.4	5	3	1380.0	1307.0	1099.0
485165.0	55.8	5	1	1817.0	-	-
848857.0	58.7	5	1	1226.0	-	-

Type 5 Radar Waveform_8

Burst Offset (us)	Pulse Width (us)	Chirp Width (MHz)	Number of Pulses per Burst	PRI-1 (us)	PRI-2 (us)	PRI-3 (us)
535213.0	99.7	18	3	1541.0	1908.0	1561.0
34196.0	57.5	18	1	1768.0	-	-
194598.0	84.8	18	3	1445.0	1627.0	1610.0
358901.0	61.7	18	1	1418.0	-	-
516317.0	84.4	18	3	1007.0	1431.0	1455.0
14307.0	80.5	18	2	1552.0	1419.0	-
174779.0	98.0	18	3	1367.0	1673.0	1803.0
335267.0	98.8	18	3	1321.0	1904.0	1669.0
497654.0	82.3	18	2	1101.0	1274.0	-
655510.0	85.1	18	3	1984.0	1940.0	1734.0
155349.0	73.7	18	2	1392.0	1992.0	-
316378.0	71.4	18	2	1927.0	1117.0	-
478287.0	56.1	18	1	1710.0	-	-
638051.0	77.5	18	2	1571.0	1708.0	-
135950.0	63.4	18	1	1350.0	-	-
296045.0	99.7	18	3	1134.0	1340.0	1707.0
458603.0	64.5	18	1	1448.0	-	-
616289.0	94.4	18	3	1657.0	1723.0	1985.0

Type 5 Radar Waveform_9

Burst Offset (us)	Pulse Width (us)	Chirp Width (MHz)	Number of Pulses per Burst	PRI-1 (us)	PRI-2 (us)	PRI-3 (us)
173899.0	81.8	10	2	1500.0	1738.0	-
414754.0	96.3	10	3	1518.0	1962.0	1895.0
658710.0	54.5	10	1	1239.0	-	-
899870.0	67.7	10	2	1401.0	1025.0	-
143880.0	92.9	10	3	1440.0	1887.0	1579.0
385315.0	92.1	10	3	1713.0	1488.0	1464.0
627481.0	78.4	10	2	1704.0	1746.0	-
869111.0	83.0	10	2	1540.0	1983.0	-
114344.0	79.0	10	2	1966.0	1270.0	-
356168.0	74.3	10	2	1221.0	1799.0	-
597873.0	74.3	10	2	1633.0	1544.0	-
839479.0	75.0	10	2	1484.0	1876.0	-

Type 5 Radar Waveform_10

Burst Offset (us)	Pulse Width (us)	Chirp Width (MHz)	Number of Pulses per Burst	PRI-1 (us)	PRI-2 (us)	PRI-3 (us)
84534.0	96.8	10	3	1388.0	1199.0	1032.0
326877.0	58.4	10	1	1513.0	-	-
568317.0	67.8	10	2	1516.0	1268.0	-
811245.0	58.5	10	1	1465.0	-	-
54872.0	63.9	10	1	1715.0	-	-
296550.0	76.1	10	2	1559.0	1629.0	-
537919.0	90.3	10	3	1472.0	1206.0	1230.0
780032.0	96.0	10	3	1093.0	1030.0	1109.0
25048.0	59.6	10	1	1757.0	-	-
266496.0	88.9	10	3	1807.0	1334.0	1075.0
508759.0	75.9	10	2	1479.0	1258.0	-
751744.0	60.1	10	1	1253.0	-	-

Type 5 Radar Waveform_11

Burst Offset (us)	Pulse Width (us)	Chirp Width (MHz)	Number of Pulses per Burst	PRI-1 (us)	PRI-2 (us)	PRI-3 (us)
698553.0	87.2	17	3	1433.0	1481.0	1060.0
167458.0	60.0	17	1	1539.0	-	-
337422.0	73.2	17	2	1717.0	1614.0	-
509133.0	58.6	17	1	1505.0	-	-
677077.0	85.8	17	3	1714.0	1761.0	1024.0
146437.0	59.2	17	1	1437.0	-	-
316051.0	87.6	17	3	1698.0	1058.0	1425.0
486103.0	92.9	17	3	1363.0	1607.0	1403.0
656355.0	90.0	17	3	1688.0	1494.0	1069.0
124792.0	84.5	17	3	1124.0	1808.0	1875.0
296285.0	55.5	17	1	1336.0	-	-
467172.0	59.6	17	1	1318.0	-	-
638150.0	54.2	17	1	1208.0	-	-
104132.0	82.0	17	2	1871.0	1020.0	-
275304.0	64.6	17	1	1165.0	-	-
444281.0	92.7	17	3	1111.0	1414.0	1703.0
614276.0	83.4	17	3	1771.0	1587.0	1073.0

Type 5 Radar Waveform_12

Burst Offset (us)	Pulse Width (us)	Chirp Width (MHz)	Number of Pulses per Burst	PRI-1 (us)	PRI-2 (us)	PRI-3 (us)
118124.0	51.4	10	1	1085.0	-	-
360307.0	51.5	10	1	1320.0	-	-
601719.0	73.6	10	2	1529.0	1116.0	-
843156.0	74.5	10	2	1906.0	1275.0	-
88250.0	57.3	10	1	1449.0	-	-
329531.0	88.4	10	3	1396.0	1223.0	1545.0
572649.0	65.2	10	1	1381.0	-	-
815026.0	53.5	10	1	1159.0	-	-
58225.0	97.6	10	3	1699.0	1943.0	1119.0
300510.0	63.5	10	1	1743.0	-	-
541406.0	87.4	10	3	1189.0	1343.0	1442.0
784629.0	59.4	10	1	1869.0	-	-

Type 5 Radar Waveform_13

Burst Offset (us)	Pulse Width (us)	Chirp Width (MHz)	Number of Pulses per Burst	PRI-1 (us)	PRI-2 (us)	PRI-3 (us)
17995.0	68.5	19	2	1603.0	1427.0	-
170001.0	84.7	19	3	1692.0	1222.0	1726.0
322206.0	92.9	19	3	1979.0	1169.0	1195.0
474994.0	70.3	19	2	1821.0	1645.0	-
626450.0	94.4	19	3	1575.0	1376.0	1397.0
151879.0	80.6	19	2	1098.0	1026.0	-
303979.0	82.9	19	2	1661.0	1626.0	-
456190.0	68.9	19	2	1747.0	1774.0	-
609422.0	89.7	19	2	1534.0	1049.0	-
132386.0	97.2	19	3	1993.0	1469.0	1919.0
285570.0	89.7	19	2	1054.0	1438.0	-
437099.0	86.7	19	3	1192.0	1718.0	1081.0
590733.0	81.4	19	2	1174.0	1301.0	-
113813.0	85.1	19	3	1671.0	1511.0	1459.0
267157.0	62.2	19	1	1594.0	-	-
419883.0	52.8	19	1	1693.0	-	-
573270.0	58.2	19	1	1011.0	-	-
95510.0	54.3	19	1	1832.0	-	-
247602.0	82.0	19	2	1970.0	1489.0	-

Type 5 Radar Waveform_14

Burst Offset (us)	Pulse Width (us)	Chirp Width (MHz)	Number of Pulses per Burst	PRI-1 (us)	PRI-2 (us)	PRI-3 (us)
848068.0	61.4	6	1	1415.0	-	-
1168655.0	97.6	6	3	1396.0	1784.0	1016.0
162157.0	62.6	6	1	1877.0	-	-
485390.0	58.2	6	1	1017.0	-	-
806308.0	87.4	6	3	1854.0	1360.0	1446.0
1130876.0	52.3	6	1	1926.0	-	-
122176.0	85.7	6	3	1499.0	1044.0	1553.0
444951.0	79.8	6	2	1037.0	1884.0	-
767642.0	71.6	6	2	1526.0	1354.0	-

Type 5 Radar Waveform_15

Burst Offset (us)	Pulse Width (us)	Chirp Width (MHz)	Number of Pulses per Burst	PRI-1 (us)	PRI-2 (us)	PRI-3 (us)
813759.0	57.9	15	1	1085.0	-	-
46420.0	55.1	15	1	1781.0	-	-
227092.0	88.2	15	3	1408.0	1132.0	1849.0
408211.0	95.8	15	3	1463.0	1359.0	1047.0
591381.0	50.2	15	1	1070.0	-	-
23987.0	83.5	15	3	1265.0	1533.0	1470.0
205179.0	71.4	15	2	1576.0	1498.0	-
385620.0	99.9	15	3	1378.0	1805.0	1267.0
568794.0	62.6	15	1	1351.0	-	-
1708.0	89.3	15	3	1548.0	1667.0	1620.0
183133.0	59.9	15	1	1978.0	-	-
384575.0	51.3	15	1	1930.0	-	-
545448.0	81.7	15	2	1615.0	1079.0	-
725744.0	73.8	15	2	1737.0	1933.0	-
160892.0	63.6	15	1	1487.0	-	-
342602.0	54.2	15	1	1112.0	-	-

Type 5 Radar Waveform_16

Burst Offset (us)	Pulse Width (us)	Chirp Width (MHz)	Number of Pulses per Burst	PRI-1 (us)	PRI-2 (us)	PRI-3 (us)
465042.0	81.8	17	2	1135.0	1197.0	-
624829.0	87.0	17	3	1149.0	1031.0	1569.0
122571.0	93.2	17	3	1283.0	1288.0	1816.0
283425.0	72.3	17	2	1949.0	1900.0	-
444495.0	76.1	17	2	1720.0	1658.0	-
607534.0	62.4	17	1	1000.0	-	-
102774.0	95.4	17	3	1915.0	1353.0	1200.0
262995.0	93.3	17	3	1963.0	1700.0	1766.0
424813.0	81.6	17	2	1785.0	1385.0	-
586398.0	75.9	17	2	1407.0	1008.0	-
83321.0	61.8	17	1	1834.0	-	-
244510.0	55.9	17	1	1981.0	-	-
405274.0	76.5	17	2	1090.0	1617.0	-
567353.0	55.5	17	1	1478.0	-	-
63314.0	68.0	17	2	1677.0	1686.0	-
224878.0	58.6	17	1	1314.0	-	-
386324.0	50.7	17	1	1182.0	-	-
547871.0	61.3	17	1	1004.0	-	-

Type 5 Radar Waveform_17

Burst Offset (us)	Pulse Width (us)	Chirp Width (MHz)	Number of Pulses per Burst	PRI-1 (us)	PRI-2 (us)	PRI-3 (us)
41339.0	60.9	18	1	1193.0	-	-
194216.0	64.6	18	1	1231.0	-	-
346993.0	58.9	18	1	1417.0	-	-
498951.0	74.0	18	2	1515.0	1006.0	-
22386.0	86.4	18	3	1858.0	1198.0	1514.0
174359.0	97.9	18	3	1894.0	1729.0	1295.0
327939.0	63.6	18	1	1855.0	-	-
480867.0	62.4	18	1	1593.0	-	-
3656.0	90.2	18	3	1089.0	1563.0	1764.0
155988.0	68.9	18	2	1831.0	1675.0	-
308224.0	94.4	18	3	1156.0	1150.0	1386.0
461220.0	60.6	18	2	1706.0	1013.0	-
613745.0	79.7	18	2	1072.0	1641.0	-
137503.0	73.7	18	2	1205.0	1028.0	-
289252.0	99.0	18	3	1591.0	1214.0	1352.0
443577.0	53.9	18	1	1094.0	-	-
596229.0	55.5	18	1	1369.0	-	-
118746.0	65.3	18	1	1998.0	-	-
270303.0	92.6	18	3	1611.0	1452.0	1572.0

Type 5 Radar Waveform_18

Burst Offset (us)	Pulse Width (us)	Chirp Width (MHz)	Number of Pulses per Burst	PRI-1 (us)	PRI-2 (us)	PRI-3 (us)
576462.0	57.5	12	1	1444.0	-	-
780484.0	95.6	12	3	1833.0	1623.0	1822.0
135272.0	95.6	12	3	1687.0	1736.0	1542.0
343525.0	59.8	12	1	1046.0	-	-
548615.0	95.0	12	3	1345.0	1888.0	1758.0
758248.0	64.1	12	1	1653.0	-	-
110051.0	74.4	12	2	1279.0	1848.0	-
317119.0	71.6	12	2	1577.0	1705.0	-
525523.0	65.5	12	1	1138.0	-	-
731726.0	73.4	12	2	1027.0	1752.0	-
84719.0	57.1	12	1	1292.0	-	-
291515.0	71.3	12	2	1972.0	1590.0	-
499566.0	51.2	12	1	1796.0	-	-
707643.0	50.5	12	1	1036.0	-	-

Type 5 Radar Waveform_19

Burst Offset (us)	Pulse Width (us)	Chirp Width (MHz)	Number of Pulses per Burst	PRI-1 (us)	PRI-2 (us)	PRI-3 (us)
51624.0	70.4	15	2	1246.0	1820.0	-
233376.0	62.9	15	1	1148.0	-	-
413477.0	99.1	15	3	1589.0	1245.0	1056.0
593884.0	95.4	15	3	1050.0	1724.0	1804.0
29375.0	57.8	15	1	1389.0	-	-
210823.0	50.5	15	1	1794.0	-	-
390719.0	95.3	15	3	1866.0	1608.0	1310.0
574162.0	58.6	15	1	1256.0	-	-
7009.0	63.6	15	1	1639.0	-	-
188105.0	72.3	15	2	1355.0	1891.0	-
369712.0	76.4	15	2	1041.0	1202.0	-
549482.0	98.9	15	3	1982.0	1002.0	1410.0
732682.0	50.9	15	1	1977.0	-	-
165293.0	96.3	15	3	1787.0	1886.0	1840.0
346217.0	88.1	15	3	1242.0	1490.0	2000.0
529193.0	56.9	15	1	1586.0	-	-

Type 5 Radar Waveform_20

Burst Offset (us)	Pulse Width (us)	Chirp Width (MHz)	Number of Pulses per Burst	PRI-1 (us)	PRI-2 (us)	PRI-3 (us)
1263698.0	72.5	6	2	1485.0	1103.0	-
255391.0	100.0	6	3	1429.0	1681.0	1087.0
578801.0	52.6	6	1	1775.0	-	-
902161.0	66.1	6	1	1163.0	-	-
1222801.0	93.3	6	3	1095.0	1476.0	1259.0
216081.0	65.7	6	1	1753.0	-	-
539063.0	65.4	6	1	1674.0	-	-
862389.0	54.7	6	1	1122.0	-	-
1185552.0	64.0	6	1	1055.0	-	-

Type 5 Radar Waveform_21

Burst Offset (us)	Pulse Width (us)	Chirp Width (MHz)	Number of Pulses per Burst	PRI-1 (us)	PRI-2 (us)	PRI-3 (us)
83358.0	59.9	18	1	1987.0	-	-
236101.0	62.0	18	1	1861.0	-	-
388330.0	76.3	18	2	1262.0	1405.0	-
539332.0	98.2	18	3	1423.0	1697.0	1324.0
64246.0	89.1	18	3	1471.0	1646.0	1829.0
216749.0	83.0	18	2	1853.0	1573.0	-
368556.0	97.7	18	3	1250.0	1284.0	1810.0
521231.0	93.2	18	3	1260.0	1029.0	1391.0
45696.0	80.0	18	2	1491.0	1106.0	-
198450.0	59.2	18	1	1944.0	-	-
351229.0	60.8	18	1	1814.0	-	-
501315.0	99.9	18	3	1748.0	1527.0	1852.0
26938.0	58.6	18	1	1838.0	-	-
178854.0	97.8	18	3	1377.0	1725.0	1598.0
332576.0	64.7	18	1	1509.0	-	-
483033.0	97.4	18	3	1241.0	1436.0	1889.0
8099.0	99.0	18	3	1064.0	1496.0	1276.0
160480.0	81.9	18	2	1634.0	1680.0	-
313167.0	73.3	18	2	1468.0	1218.0	-

Type 5 Radar Waveform_22

Burst Offset (us)	Pulse Width (us)	Chirp Width (MHz)	Number of Pulses per Burst	PRI-1 (us)	PRI-2 (us)	PRI-3 (us)
551720.0	83.4	16	3	1795.0	1346.0	1792.0
731885.0	96.1	16	3	1994.0	1712.0	1773.0
168744.0	83.1	16	1	1885.0	-	-
349536.0	78.2	16	2	1924.0	1349.0	-
530419.0	83.5	16	3	1146.0	1161.0	1278.0
713866.0	58.5	16	1	1048.0	-	-
146495.0	50.8	16	1	1372.0	-	-
327834.0	57.2	16	1	1890.0	-	-
508288.0	68.6	16	2	1911.0	1428.0	-
688214.0	85.2	16	3	1034.0	1642.0	1922.0
124126.0	57.3	16	1	1400.0	-	-
305551.0	54.6	16	1	1727.0	-	-
485259.0	97.6	16	3	1772.0	1519.0	1158.0
665681.0	94.4	16	3	1859.0	1170.0	1865.0
101476.0	81.3	16	2	1716.0	1789.0	-
281928.0	97.9	16	3	1745.0	1371.0	1965.0

Type 5 Radar Waveform_23

Burst Offset (us)	Pulse Width (us)	Chirp Width (MHz)	Number of Pulses per Burst	PRI-1 (us)	PRI-2 (us)	PRI-3 (us)
370323.0	88.6	20	3	1127.0	1497.0	1042.0
515968.0	69.0	20	2	1447.0	1043.0	-
63462.0	60.4	20	1	1650.0	-	-
207888.0	74.6	20	2	1691.0	1947.0	-
352233.0	89.3	20	3	1531.0	1171.0	1430.0
497517.0	78.7	20	2	1432.0	1779.0	-
45592.0	55.7	20	1	1581.0	-	-
190464.0	71.0	20	2	1294.0	1115.0	-
334392.0	87.0	20	3	1217.0	1322.0	1664.0
480180.0	77.3	20	2	1273.0	1326.0	-
27704.0	57.1	20	1	1827.0	-	-
172987.0	63.8	20	1	1108.0	-	-
317831.0	52.1	20	1	1873.0	-	-
460672.0	88.0	20	3	1878.0	1068.0	1800.0
9809.0	68.8	20	2	1379.0	1958.0	-
154429.0	94.3	20	3	1356.0	1248.0	1077.0
298905.0	83.9	20	3	1480.0	1368.0	1133.0
442503.0	92.1	20	3	1460.0	1850.0	1955.0
589188.0	71.4	20	2	1330.0	1458.0	-
136788.0	67.9	20	2	1668.0	1257.0	-

Type 5 Radar Waveform_24

Burst Offset (us)	Pulse Width (us)	Chirp Width (MHz)	Number of Pulses per Burst	PRI-1 (us)	PRI-2 (us)	PRI-3 (us)
312240.0	96.8	17	3	1588.0	1636.0	1395.0
472895.0	83.9	17	3	1652.0	1261.0	1584.0
632889.0	92.8	17	3	1870.0	1762.0	1495.0
131732.0	89.6	17	3	1554.0	2000.0	1879.0
292625.0	88.2	17	3	1118.0	1402.0	1730.0
453691.0	75.8	17	2	1679.0	1973.0	-
615771.0	79.1	17	2	1128.0	1145.0	-
112615.0	58.0	17	1	1676.0	-	-
273159.0	72.7	17	2	1945.0	1520.0	-
435486.0	54.5	17	1	1204.0	-	-
596334.0	63.3	17	1	1815.0	-	-
92738.0	55.5	17	1	1754.0	-	-
253800.0	77.3	17	2	1225.0	1053.0	-
413748.0	100.0	17	3	1605.0	1263.0	1311.0
575371.0	76.1	17	2	1583.0	1501.0	-
72705.0	78.4	17	2	1413.0	1881.0	-
232818.0	88.5	17	3	1549.0	1957.0	1990.0
395593.0	57.2	17	1	1426.0	-	-

Type 5 Radar Waveform_25

Burst Offset (us)	Pulse Width (us)	Chirp Width (MHz)	Number of Pulses per Burst	PRI-1 (us)	PRI-2 (us)	PRI-3 (us)
1251436.0	84.1	5	3	1755.0	1695.0	1750.0
119452.0	54.6	5	1	1683.0	-	-
482018.0	90.4	5	3	1524.0	1052.0	1662.0
844775.0	92.2	5	3	1303.0	1215.0	1742.0
1207361.0	91.2	5	3	1946.0	1453.0	1082.0
74712.0	56.2	5	1	1272.0	-	-
438213.0	51.4	5	1	1227.0	-	-
800210.0	87.0	5	3	1341.0	1186.0	1510.0

Type 5 Radar Waveform_26

Burst Offset (us)	Pulse Width (us)	Chirp Width (MHz)	Number of Pulses per Burst	PRI-1 (us)	PRI-2 (us)	PRI-3 (us)
620810.0	55.0	14	1	1474.0	-	-
15936.0	80.6	14	2	1059.0	1188.0	-
209587.0	66.3	14	1	1597.0	-	-
403428.0	63.0	14	1	1196.0	-	-
596075.0	70.8	14	2	1630.0	1021.0	-
790594.0	55.4	14	1	1502.0	-	-
185553.0	72.9	14	2	1005.0	1375.0	-
379541.0	63.3	14	1	1243.0	-	-
573380.0	51.1	14	1	1083.0	-	-
766600.0	54.7	14	1	1648.0	-	-
161626.0	76.2	14	2	1019.0	1847.0	-
355038.0	70.9	14	2	1319.0	1362.0	-
546836.0	86.4	14	3	1932.0	1631.0	1411.0
743240.0	63.4	14	1	1120.0	-	-
137534.0	99.7	14	3	1601.0	1183.0	1690.0

Type 5 Radar Waveform_27

Burst Offset (us)	Pulse Width (us)	Chirp Width (MHz)	Number of Pulses per Burst	PRI-1 (us)	PRI-2 (us)	PRI-3 (us)
247675.0	97.7	20	3	1390.0	1224.0	1177.0
391912.0	98.3	20	3	1121.0	1252.0	1969.0
537399.0	82.4	20	2	1741.0	1466.0	-
85535.0	64.0	20	1	1893.0	-	-
230656.0	51.5	20	1	1735.0	-	-
374124.0	86.5	20	3	1190.0	1950.0	1191.0
520758.0	52.2	20	1	1843.0	-	-
67697.0	61.8	20	1	1635.0	-	-
211889.0	90.5	20	3	1180.0	1788.0	1281.0
357826.0	55.8	20	1	1824.0	-	-
501910.0	76.6	20	2	1337.0	1670.0	-
49797.0	58.0	20	1	1923.0	-	-
194586.0	66.7	20	2	1374.0	1358.0	-
338981.0	77.6	20	2	1609.0	1935.0	-
485577.0	54.6	20	1	1155.0	-	-
31748.0	92.7	20	3	1776.0	1624.0	1925.0
176526.0	86.5	20	3	1084.0	1203.0	1179.0
321108.0	88.2	20	3	1001.0	1061.0	1582.0
467592.0	51.2	20	1	1277.0	-	-
14040.0	70.8	20	2	1323.0	1555.0	-

Type 5 Radar Waveform_28

Burst Offset (us)	Pulse Width (us)	Chirp Width (MHz)	Number of Pulses per Burst	PRI-1 (us)	PRI-2 (us)	PRI-3 (us)
211744.0	98.5	13	3	1091.0	1507.0	1506.0
403981.0	91.7	13	3	1975.0	1776.0	1910.0
599876.0	59.6	13	1	1344.0	-	-
790394.0	83.8	13	3	1756.0	1097.0	1694.0
188669.0	57.8	13	1	1130.0	-	-
381369.0	82.6	13	2	1564.0	1763.0	-
576188.0	64.0	13	1	1107.0	-	-
767018.0	98.9	13	3	1592.0	1537.0	1014.0
164350.0	71.4	13	2	1731.0	1595.0	-
358366.0	52.1	13	1	1550.0	-	-
551412.0	67.6	13	2	1211.0	1212.0	-
744497.0	70.9	13	2	1749.0	1051.0	-
140745.0	70.6	13	2	1057.0	1164.0	-
334367.0	55.0	13	1	1899.0	-	-
525690.0	92.8	13	3	1901.0	1475.0	1912.0

Type 5 Radar Waveform_29

Burst Offset (us)	Pulse Width (us)	Chirp Width (MHz)	Number of Pulses per Burst	PRI-1 (us)	PRI-2 (us)	PRI-3 (us)
1352261.0	93.9	6	3	1660.0	1327.0	1175.0
219555.0	58.7	6	1	1806.0	-	-
582020.0	92.3	6	3	1176.0	1306.0	1622.0
944326.0	99.9	6	3	1665.0	1384.0	1841.0
1309575.0	50.4	6	1	1872.0	-	-
174853.0	52.7	6	1	1331.0	-	-
537635.0	68.8	6	2	1394.0	1867.0	-
900518.0	75.9	6	2	1606.0	1860.0	-

Radar Type 6 - Radar Statistical Performance

Trail #	1=Detection 0=No Detection	Trail #	1=Detection 0=No Detection
0	1	15	1
1	1	16	1
2	1	17	1
3	1	18	1
4	1	19	1
5	1	20	1
6	1	21	1
7	1	22	1
8	1	23	1
9	1	24	1
10	1	25	1
11	1	26	1
12	1	27	1
13	1	28	1
14	1	29	1
Detection Percentage (%)		100.0%	

Type 6 Radar Waveform_0					
Frequency List (MHz)	0	1	2	3	4
0	5439	5374	5597	5671	5400
5	5460	5574	5369	5542	5433
10	5276	5704	5694	5297	5602
15	5267	5477	5294	5320	5386
20	5421	5424	5289	5281	5454
25	5309	5657	5399	5375	5382
30	5462	5308	5664	5446	5607
35	5332	5388	5387	5322	5633
40	5269	5674	5381	5412	5463
45	5655	5254	5429	5691	5437
50	5362	5432	5663	5564	5341
55	5625	5522	5670	5301	5636
60	5646	5377	5576	5342	5660
65	5339	5632	5285	5314	5610
70	5405	5384	5719	5541	5467
75	5445	5690	5300	5496	5431
80	5491	5393	5482	5622	5623
85	5470	5612	5662	5720	5262
90	5278	5420	5649	5304	5288
95	5430	5347	5334	5402	5621

Type 6 Radar Waveform_1

Frequency List (MHz)	0	1	2	3	4
0	5694	5613	5533	5357	5620
5	5502	5596	5444	5608	5640
10	5682	5493	5260	5395	5623
15	5355	5507	5300	5365	5578
20	5429	5705	5273	5427	5672
25	5509	5505	5479	5631	5424
30	5351	5265	5404	5695	5471
35	5658	5535	5711	5472	5352
40	5612	5621	5317	5719	5346
45	5713	5307	5567	5563	5488
50	5546	5255	5510	5277	5295
55	5718	5341	5312	5324	5466
60	5581	5478	5678	5522	5543
65	5609	5375	5464	5555	5592
70	5391	5440	5474	5360	5413
75	5587	5588	5671	5552	5606
80	5641	5494	5422	5686	5549
85	5710	5542	5717	5396	5290
90	5564	5368	5646	5447	5354
95	5279	5577	5262	5318	5531

Type 6 Radar Waveform_2

Frequency List (MHz)	0	1	2	3	4
0	5474	5469	5518	5462	5641
5	5521	5519	5296	5516	5282
10	5301	5590	5644	5346	5634
15	5403	5313	5295	5437	5659
20	5646	5362	5400	5560	5458
25	5708	5583	5665	5563	5715
30	5697	5522	5372	5625	5513
35	5667	5551	5688	5722	5311
40	5532	5453	5289	5314	5648
45	5326	5348	5674	5360	5581
50	5443	5264	5539	5637	5553
55	5454	5465	5724	5433	5538
60	5283	5356	5631	5623	5407
65	5601	5468	5366	5558	5447
70	5395	5376	5323	5336	5362
75	5707	5652	5329	5619	5683
80	5330	5557	5419	5406	5452
85	5649	5505	5434	5375	5426
90	5547	5488	5254	5394	5463
95	5632	5721	5691	5510	5478

Type 6 Radar Waveform_3

Frequency List (MHz)	0	1	2	3	4
0	5254	5713	5405	5679	5682
5	5683	5543	5594	5459	5676
10	5447	5546	5439	5310	5665
15	5434	5286	5506	5358	5487
20	5348	5253	5684	5354	5373
25	5351	5436	5309	5699	5605
30	5701	5654	5262	5621	5445
35	5652	5283	5347	5463	5636
40	5722	5615	5391	5529	5408
45	5577	5306	5431	5257	5413
50	5371	5697	5440	5590	5251
55	5279	5301	5653	5581	5623
60	5357	5632	5485	5321	5568
65	5714	5427	5511	5567	5507
70	5350	5717	5673	5448	5460
75	5550	5312	5596	5255	5302
80	5633	5464	5397	5620	5416
85	5698	5452	5491	5565	5340
90	5360	5320	5308	5419	5400
95	5617	5686	5475	5313	5687

Type 6 Radar Waveform_4

Frequency List (MHz)	0	1	2	3	4
0	5509	5477	5341	5365	5524
5	5250	5468	5669	5622	5408
10	5378	5432	5480	5505	5686
15	5522	5413	5609	5403	5679
20	5356	5419	5625	5443	5346
25	5714	5259	5639	5258	5647
30	5590	5611	5298	5643	5316
35	5374	5618	5616	5550	5561
40	5698	5329	5294	5405	5409
45	5286	5514	5315	5466	5573
50	5641	5340	5577	5720	5269
55	5535	5338	5651	5603	5614
60	5486	5513	5546	5253	5457
65	5293	5456	5289	5716	5379
70	5617	5446	5399	5666	5555
75	5375	5445	5261	5364	5305
80	5418	5355	5333	5528	5721
85	5683	5431	5568	5506	5584
90	5406	5471	5427	5267	5311
95	5487	5371	5281	5571	5328

Type 6 Radar Waveform_5

Frequency List (MHz)	0	1	2	3	4
0	5667	5716	5277	5526	5269
5	5292	5490	5688	5712	5687
10	5696	5521	5700	5707	5610
15	5540	5448	5396	5364	5488
20	5566	5435	5319	5505	5586
25	5367	5517	5311	5479	5568
30	5692	5547	5463	5455	5465
35	5414	5294	5561	5400	5403
40	5267	5534	5402	5338	5266
45	5597	5276	5519	5523	5449
50	5317	5429	5567	5457	5489
55	5528	5470	5574	5268	5651
60	5456	5378	5591	5502	5325
65	5548	5404	5657	5689	5432
70	5646	5723	5642	5514	5495
75	5491	5595	5513	5377	5501
80	5250	5368	5410	5613	5258
85	5272	5588	5438	5648	5385
90	5341	5326	5274	5509	5353
95	5596	5444	5322	5295	5350

Type 6 Radar Waveform_6

Frequency List (MHz)	0	1	2	3	4
0	5447	5480	5688	5590	5586
5	5431	5415	5344	5376	5444
10	5618	5485	5562	5323	5253
15	5601	5570	5718	5396	5685
20	5275	5654	5604	5524	5292
25	5393	5438	5473	5621	5326
30	5353	5465	5525	5335	5699
35	5283	5497	5556	5307	5475
40	5714	5486	5680	5677	5399
45	5645	5721	5334	5410	5703
50	5493	5268	5615	5698	5511
55	5443	5667	5545	5397	5500
60	5477	5349	5317	5451	5361
65	5674	5460	5383	5515	5649
70	5572	5539	5634	5576	5290
75	5487	5282	5414	5310	5333
80	5258	5589	5551	5533	5516
85	5436	5439	5622	5613	5705
90	5461	5377	5279	5707	5299
95	5664	5277	5429	5636	5546

Type 6 Radar Waveform_7

Frequency List (MHz)	0	1	2	3	4
0	5702	5719	5624	5276	5331
5	5473	5437	5419	5539	5651
10	5549	5274	5603	5518	5689
15	5697	5346	5441	5402	5283
20	5723	5545	5516	5265	5659
25	5387	5676	5347	5360	5395
30	5354	5482	5550	5481	5636
35	5647	5578	5389	5650	5569
40	5618	5442	5396	5574	5604
45	5288	5392	5528	5675	5579
50	5669	5319	5704	5424	5358
55	5397	5433	5486	5429	5445
60	5614	5303	5615	5400	5300
65	5590	5566	5263	5455	5501
70	5324	5594	5432	5508	5638
75	5680	5557	5542	5500	5538
80	5591	5307	5431	5611	5250
85	5390	5362	5344	5521	5559
90	5495	5339	5478	5278	5686
95	5497	5284	5586	5312	5573

Type 6 Radar Waveform_8

Frequency List (MHz)	0	1	2	3	4
0	5482	5483	5560	5437	5648
5	5515	5362	5494	5702	5480
10	5383	5538	5644	5713	5295
15	5302	5349	5449	5486	5594
20	5291	5414	5605	5547	5714
25	5404	5451	5394	5534	5718
30	5439	5290	5625	5301	5300
35	5360	5374	5375	5400	5489
40	5652	5556	5682	5490	5503
45	5584	5371	5450	5581	5562
50	5455	5370	5318	5722	5546
55	5351	5526	5305	5390	5558
60	5293	5446	5701	5338	5341
65	5336	5325	5361	5541	5624
70	5487	5277	5570	5391	5380
75	5283	5348	5319	5610	5645
80	5654	5304	5345	5539	5574
85	5442	5441	5542	5294	5527
90	5593	5377	5592	5344	5651
95	5568	5317	5379	5323	5307

Type 6 Radar Waveform_9

Frequency List (MHz)	0	1	2	3	4
0	5640	5722	5496	5598	5393
5	5557	5384	5569	5390	5687
10	5314	5327	5685	5433	5316
15	5476	5552	5531	5311	5677
20	5580	5524	5597	5686	5435
25	5663	5607	5555	5428	5576
30	5704	5396	5505	5399	5499
35	5342	5451	5267	5528	5328
40	5357	5494	5447	5487	5335
45	5564	5454	5411	5634	5352
50	5331	5546	5421	5407	5545
55	5624	5259	5305	5716	5502
60	5361	5458	5278	5527	5284
65	5639	5298	5372	5632	5253
70	5696	5473	5377	5497	5350
75	5349	5403	5394	5616	5474
80	5720	5575	5334	5717	5301
85	5540	5539	5537	5395	5383
90	5362	5459	5630	5530	5637
95	5460	5609	5542	5549	5547

Type 6 Radar Waveform_10

Frequency List (MHz)	0	1	2	3	4
0	5420	5486	5432	5284	5710
5	5696	5309	5644	5456	5419
10	5623	5688	5251	5628	5337
15	5381	5603	5655	5479	5503
20	5685	5649	5465	5686	5659
25	5701	5515	5335	5462	5618
30	5593	5353	5551	5319	5481
35	5542	5538	5303	5703	5642
40	5440	5590	5484	5264	5544
45	5537	5469	5687	5714	5585
50	5722	5472	5368	5568	5350
55	5259	5431	5321	5332	5341
60	5377	5450	5327	5365	5311
65	5367	5523	5525	5293	5556
70	5380	5346	5425	5597	5258
75	5356	5498	5305	5298	5260
80	5442	5529	5254	5657	5446
85	5534	5560	5624	5636	5564
90	5519	5569	5626	5409	5447
95	5429	5287	5713	5272	5675

Type 6 Radar Waveform_11

Frequency List (MHz)	0	1	2	3	4
0	5675	5250	5368	5445	5455
5	5263	5331	5719	5619	5723
10	5554	5477	5389	5251	5358
15	5469	5633	5661	5524	5695
20	5693	5340	5406	5678	5632
25	5589	5367	5441	5385	5496
30	5282	5579	5310	5363	5325
35	5517	5620	5334	5456	5714
40	5481	5523	5273	5355	5571
45	5527	5265	5504	5461	5423
50	5682	5569	5415	5538	5688
55	5621	5615	5681	5470	5313
60	5322	5514	5276	5566	5671
65	5347	5674	5318	5328	5462
70	5542	5383	5670	5401	5268
75	5665	5643	5680	5578	5503
80	5612	5565	5465	5673	5345
85	5468	5657	5349	5622	5400
90	5307	5283	5314	5642	5501
95	5304	5581	5652	5393	5408

Type 6 Radar Waveform_12

Frequency List (MHz)	0	1	2	3	4
0	5455	5489	5304	5606	5675
5	5305	5256	5319	5307	5485
10	5266	5430	5446	5379	5557
15	5285	5289	5589	5412	5604
20	5409	5444	5292	5605	5380
25	5316	5644	5530	5324	5468
30	5267	5578	5477	5337	5284
35	5724	5609	5628	5417	5686
40	5595	5478	5500	5504	5703
45	5488	5696	5294	5599	5574
50	5296	5392	5359	5251	5642
55	5336	5434	5652	5346	5577
60	5694	5389	5620	5286	5685
65	5534	5528	5483	5422	5377
70	5702	5634	5666	5559	5280
75	5490	5254	5670	5650	5345
80	5310	5541	5354	5555	5479
85	5648	5535	5661	5690	5282
90	5707	5718	5290	5493	5662
95	5665	5524	5651	5448	5611

Type 6 Radar Waveform_13

Frequency List (MHz)	0	1	2	3	4
0	5710	5253	5715	5670	5517
5	5347	5278	5394	5470	5662
10	5319	5530	5471	5641	5400
15	5645	5412	5392	5614	5604
20	5612	5575	5385	5284	5578
25	5268	5643	5372	5593	5564
30	5366	5357	5699	5318	5251
35	5632	5326	5437	5498	5384
40	5542	5256	5311	5624	5263
45	5572	5429	5484	5546	5274
50	5656	5688	5300	5625	5690
55	5681	5439	5596	5526	5631
60	5623	5309	5653	5500	5640
65	5590	5569	5322	5716	5480
70	5409	5703	5514	5486	5271
75	5353	5661	5506	5540	5532
80	5491	5418	5591	5667	5467
85	5723	5724	5680	5258	5455
90	5405	5328	5301	5644	5654
95	5446	5324	5299	5287	5458

Type 6 Radar Waveform_14

Frequency List (MHz)	0	1	2	3	4
0	5393	5492	5651	5356	5262
5	5486	5678	5469	5536	5491
10	5250	5319	5512	5361	5421
15	5636	5539	5495	5562	5418
20	5620	5644	5326	5373	5551
25	5534	5592	5575	5697	5596
30	5505	5343	5656	5436	5403
35	5355	5465	5528	5294	5537
40	5553	5570	5394	5503	5569
45	5261	5367	5604	5327	5446
50	5467	5476	5676	5474	5513
55	5625	5627	5550	5716	5450
60	5497	5285	5333	5254	5485
65	5683	5413	5518	5358	5451
70	5372	5590	5300	5597	5586
75	5595	5329	5475	5431	5440
80	5521	5309	5601	5527	5582
85	5276	5664	5662	5626	5566
90	5643	5353	5323	5359	5576
95	5596	5334	5282	5506	5326

Type 6 Radar Waveform_15

Frequency List (MHz)	0	1	2	3	4
0	5648	5256	5587	5517	5579
5	5528	5700	5544	5699	5698
10	5656	5680	5553	5556	5442
15	5724	5666	5598	5607	5610
20	5531	5335	5267	5365	5524
25	5422	5444	5303	5423	5632
30	5547	5707	5613	5651	5652
35	5650	5604	5619	5565	5690
40	5467	5409	5477	5500	5268
45	5566	5665	5347	5380	5333
50	5343	5252	5660	5714	5472
55	5340	5407	5334	5269	5468
60	5414	5498	5674	5317	5627
65	5629	5614	5297	5283	5642
70	5393	5469	5583	5589	5305
75	5551	5502	5464	5711	5308
80	5649	5339	5661	5382	5626
85	5408	5606	5545	5288	5410
90	5349	5319	5499	5540	5685
95	5445	5397	5426	5509	5605

Type 6 Radar Waveform_16

Frequency List (MHz)	0	1	2	3	4
0	5428	5495	5523	5678	5324
5	5570	5625	5619	5387	5430
10	5490	5469	5594	5654	5463
15	5337	5696	5604	5652	5327
20	5539	5404	5305	5454	5497
25	5310	5296	5409	5527	5666
30	5589	5596	5391	5426	5373
35	5646	5710	5458	5465	5381
40	5345	5657	5438	5508	5563
45	5560	5623	5433	5598	5694
50	5353	5303	5274	5537	5416
55	5528	5361	5524	5466	5439
60	5543	5663	5721	5550	5575
65	5437	5333	5493	5534	5671
70	5541	5569	5689	5659	5538
75	5316	5574	5629	5483	5716
80	5724	5564	5338	5402	5658
85	5577	5529	5347	5640	5631
90	5364	5597	5614	5664	5294
95	5477	5470	5554	5350	5452

Type 6 Radar Waveform_17

Frequency List (MHz)	0	1	2	3	4
0	5683	5356	5459	5364	5641
5	5612	5647	5694	5550	5637
10	5421	5258	5635	5374	5484
15	5425	5348	5707	5600	5519
20	5547	5570	5721	5446	5470
25	5576	5720	5631	5700	5582
30	5527	5606	5578	5668	5310
35	5326	5254	5618	5392	5659
40	5265	5279	5651	5560	5426
45	5307	5643	5681	5486	5485
50	5473	5529	5354	5363	5360
55	5263	5619	5315	5714	5285
60	5410	5672	5353	5661	5553
65	5376	5638	5365	5272	5325
70	5329	5474	5710	5652	5692
75	5520	5497	5663	5297	5464
80	5493	5359	5345	5502	5465
85	5558	5394	5432	5664	5629
90	5357	5596	5415	5273	5337
95	5300	5511	5352	5566	5507

Type 6 Radar Waveform_18

Frequency List (MHz)	0	1	2	3	4
0	5366	5595	5395	5525	5386
5	5276	5572	5294	5616	5466
10	5352	5522	5676	5569	5505
15	5416	5475	5335	5645	5711
20	5458	5639	5662	5535	5443
25	5464	5340	5260	5637	5295
30	5471	5484	5724	5391	5449
35	5514	5296	5306	5496	5348
40	5692	5654	5355	5267	5251
45	5642	5442	5275	5349	5705
50	5405	5452	5658	5682	5332
55	5269	5429	5579	5264	5704
60	5518	5606	5385	5299	5564
65	5461	5314	5308	5599	5277
70	5307	5638	5317	5369	5611
75	5456	5632	5339	5343	5542
80	5270	5372	5601	5666	5625
85	5555	5589	5432	5506	5689
90	5549	5521	5519	5448	5612
95	5675	5481	5562	5678	5445

Type 6 Radar Waveform_19

Frequency List (MHz)	0	1	2	3	4
0	5621	5359	5331	5686	5703
5	5318	5594	5369	5304	5673
10	5661	5311	5339	5289	5526
15	5504	5602	5438	5690	5428
20	5466	5330	5700	5527	5416
25	5255	5521	5543	5364	5671
30	5337	5457	5441	5464	5588
35	5605	5321	5546	5695	5431
40	5630	5656	5651	5662	5267
45	5334	5495	5637	5309	5456
50	5638	5384	5529	5520	5698
55	5619	5398	5358	5683	5551
60	5692	5600	5510	5263	5344
65	5367	5491	5458	5379	5624
70	5320	5693	5587	5415	5459
75	5486	5523	5522	5482	5382
80	5258	5688	5552	5335	5445
85	5652	5644	5332	5420	5294
90	5355	5684	5409	5494	5687
95	5498	5617	5556	5327	5264

Type 6 Radar Waveform_20

Frequency List (MHz)	0	1	2	3	4
0	5401	5598	5267	5372	5448
5	5360	5519	5444	5467	5405
10	5592	5672	5380	5484	5547
15	5254	5541	5260	5620	5474
20	5496	5641	5616	5389	5618
25	5373	5271	5565	5705	5379
30	5346	5398	5679	5278	5506
35	5630	5696	5689	5699	5706
40	5651	5611	5568	5421	5648
45	5591	5625	5417	5283	5548
50	5427	5576	5485	5507	5252
55	5682	5473	5708	5652	5334
60	5595	5701	5487	5621	5426
65	5553	5388	5687	5577	5286
70	5261	5610	5323	5542	5563
75	5374	5579	5629	5504	5677
80	5638	5422	5276	5549	5713
85	5287	5712	5361	5297	5650
90	5415	5419	5376	5321	5515
95	5575	5540	5571	5306	5367

Type 6 Radar Waveform_21

Frequency List (MHz)	0	1	2	3	4
0	5656	5362	5678	5436	5290
5	5402	5541	5519	5630	5709
10	5426	5461	5421	5582	5568
15	5680	5284	5547	5683	5434
20	5385	5565	5608	5409	5700
25	5377	5669	5264	5518	5710
30	5355	5419	5430	5704	5294
35	5312	5485	5620	5587	5694
40	5506	5564	5645	5423	5605
45	5597	5719	5601	5314	5661
50	5558	5341	5505	5320	5606
55	5524	5414	5672	5616	5538
60	5453	5349	5499	5686	5636
65	5319	5653	5539	5693	5333
70	5442	5602	5675	5454	5586
75	5339	5546	5699	5713	5701
80	5456	5640	5425	5315	5373
85	5629	5469	5663	5470	5429
90	5276	5537	5722	5381	5334
95	5658	5488	5410	5487	5662

Type 6 Radar Waveform_22

Frequency List (MHz)	0	1	2	3	4
0	5339	5601	5614	5597	5510
5	5541	5466	5594	5696	5441
10	5357	5250	5462	5302	5589
15	5671	5411	5650	5253	5626
20	5393	5256	5620	5697	5335
25	5297	5649	5580	5298	5560
30	5312	5537	5679	5524	5433
35	5403	5281	5627	5534	5426
40	5444	5329	5642	5352	5585
45	5680	5654	5579	5706	5362
50	5609	5430	5328	5264	5617
55	5708	5546	5270	5703	5483
60	5285	5445	5412	5258	5619
65	5448	5342	5314	5618	5418
70	5292	5722	5343	5715	5675
75	5275	5499	5446	5516	5616
80	5543	5260	5648	5605	5379
85	5563	5668	5704	5427	5487
90	5518	5442	5646	5685	5367
95	5573	5371	5615	5711	5550

Type 6 Radar Waveform_23

Frequency List (MHz)	0	1	2	3	4
0	5594	5365	5550	5283	5352
5	5583	5488	5669	5384	5648
10	5288	5514	5503	5497	5610
15	5284	5538	5278	5298	5343
20	5401	5325	5561	5689	5308
25	5660	5501	5402	5332	5602
30	5585	5269	5277	5356	5722
35	5475	5494	5649	5305	5545
40	5265	5482	5382	5569	5261
45	5281	5565	5360	5707	5466
50	5582	5616	5529	5586	5700
55	5430	5517	5399	5393	5428
60	5592	5476	5391	5710	5534
65	5294	5451	5718	5620	5386
70	5665	5526	5467	5394	5251
75	5367	5389	5447	5483	5350
80	5456	5342	5562	5443	5711
85	5519	5385	5698	5473	5336
90	5530	5424	5303	5551	5663
95	5589	5524	5676	5653	5396

Type 6 Radar Waveform_24

Frequency List (MHz)	0	1	2	3	4
0	5374	5604	5486	5444	5572
5	5625	5413	5269	5547	5477
10	5597	5303	5544	5692	5631
15	5372	5665	5381	5343	5535
20	5312	5491	5502	5281	5451
25	5450	5511	5603	5366	5266
30	5474	5492	5605	5542	5614
35	5682	5445	5458	5459	5579
40	5565	5320	5712	5258	5588
45	5545	5371	5321	5663	5256
50	5714	5711	5705	5352	5530
55	5468	5522	5724	5488	5431
60	5558	5373	5424	5399	5434
65	5436	5483	5330	5661	5610
70	5326	5555	5651	5529	5316
75	5370	5685	5630	5487	5532
80	5428	5260	5363	5506	5440
85	5519	5324	5283	5460	5438
90	5384	5589	5559	5536	5660
95	5680	5573	5638	5503	5304

Type 6 Radar Waveform_25

Frequency List (MHz)	0	1	2	3	4
0	5629	5368	5422	5605	5414
5	5289	5435	5344	5710	5684
10	5528	5664	5585	5412	5652
15	5460	5317	5484	5291	5252
20	5320	5560	5540	5295	5254
25	5339	5302	5714	5707	5400
30	5308	5561	5282	5265	5278
35	5298	5716	5708	5373	5515
40	5648	5636	5477	5255	5517
45	5525	5454	5379	5618	5712
50	5415	5287	5319	5650	5377
55	5601	5543	5459	5723	5353
60	5700	5380	5259	5432	5269
65	5493	5405	5604	5627	5346
70	5547	5599	5607	5578	5409
75	5473	5670	5310	5437	5626
80	5641	5721	5306	5338	5260
85	5724	5542	5395	5672	5697
90	5375	5654	5536	5482	5407
95	5559	5602	5600	5283	5606

Type 6 Radar Waveform_26

Frequency List (MHz)	0	1	2	3	4
0	5409	5607	5358	5291	5634
5	5331	5457	5419	5301	5416
10	5459	5453	5626	5510	5673
15	5451	5347	5490	5336	5444
20	5328	5251	5481	5384	5702
25	5605	5629	5345	5434	5350
30	5349	5518	5531	5560	5417
35	5389	5512	5386	5354	5256
40	5574	5717	5252	5505	5537
45	5437	5294	5408	5588	5591
50	5338	5473	5321	5314	5376
55	5427	5362	5333	5689	5413
60	5360	5660	5623	5326	5460
65	5381	5305	5325	5297	5407
70	5720	5632	5392	5322	5506
75	5471	5630	5721	5390	5667
80	5486	5274	5359	5373	5346
85	5483	5306	5272	5271	5508
90	5414	5548	5429	5327	5430
95	5638	5364	5566	5654	5339

Type 6 Radar Waveform_27

Frequency List (MHz)	0	1	2	3	4
0	5567	5371	5294	5452	5476
5	5373	5382	5494	5464	5720
10	5293	5717	5289	5705	5694
15	5539	5474	5593	5381	5636
20	5336	5320	5422	5376	5675
25	5493	5578	5548	5440	5468
30	5489	5713	5475	5565	5683
35	5283	5459	5480	5405	5298
40	5668	5436	5512	5482	5724
45	5278	5388	5620	5398	5347
50	5295	5292	5389	5497	5296
55	5643	5502	5708	5617	5559
60	5304	5343	5305	5492	5449
65	5369	5661	5330	5341	5535
70	5685	5393	5706	5257	5716
75	5676	5465	5275	5444	5596
80	5530	5426	5334	5638	5325
85	5269	5614	5281	5427	5579
90	5554	5366	5684	5415	5353
95	5485	5622	5429	5613	5386

Type 6 Radar Waveform_28

Frequency List (MHz)	0	1	2	3	4
0	5347	5610	5705	5516	5696
5	5415	5404	5569	5627	5452
10	5699	5506	5330	5425	5715
15	5601	5329	5353	5722	5486
20	5363	5465	5648	5284	5430
25	5276	5641	5502	5531	5432
30	5305	5457	5578	5598	5571
35	5676	5314	5687	5507	5519
40	5450	5625	5721	5682	5368
45	5703	5456	5400	5560	5340
50	5468	5440	5683	5497	5587
55	5690	5662	5332	5378	5275
60	5472	5268	5324	5315	5484
65	5279	5260	5367	5362	5488
70	5692	5260	5565	5652	5424
75	5312	5395	5435	5449	5706
80	5311	5590	5499	5331	5358
85	5264	5707	5656	5579	5394
90	5529	5269	5657	5469	5427
95	5370	5540	5327	5700	5716

Type 6 Radar Waveform_29

Frequency List (MHz)	0	1	2	3	4
0	5602	5374	5641	5677	5538
5	5554	5329	5644	5315	5659
10	5630	5295	5371	5620	5261
15	5715	5253	5324	5642	5255
20	5555	5401	5457	5621	5647
25	5379	5479	5270	5536	5573
30	5588	5389	5520	5609	5398
35	5262	5284	5472	5467	5698
40	5346	5388	5390	5340	5514
45	5348	5311	5453	5447	5594
50	5491	5297	5320	5434	5403
55	5616	5425	5672	5721	5504
60	5433	5292	5631	5673	5685
65	5703	5316	5577	5254	5291
70	5634	5300	5263	5414	5628
75	5383	5261	5515	5578	5430
80	5473	5719	5567	5279	5328
85	5553	5678	5276	5302	5445
90	5663	5337	5351	5387	5595
95	5687	5700	5679	5344	5307

5. Conclusion

The data collected relate only the item(s) tested and show that the device is in compliance with FCC Rules.

————— The End —————

Appendix A - Test Setup Photograph

Refer to "2106RSU041-UT" file.

Appendix B - EUT Photograph

Refer to "2106RSU041-UE" file.