

CETECOM ICT Services is now

**CTC** | **advanced**  
member of RWTÜV group

## TEST REPORT

Test report no.: 1-3116/16-01-20



### Testing laboratory

**CTC advanced GmbH**

Untertuerkheimer Strasse 6 – 10  
66117 Saarbruecken / Germany

Phone: + 49 681 5 98 - 0

Fax: + 49 681 5 98 - 9075

Internet: <http://www.ctcadvanced.com>

e-mail: [mail@ctcadvanced.com](mailto:mail@ctcadvanced.com)

**Accredited Testing Laboratory:**

The testing laboratory (area of testing) is accredited according to DIN EN ISO/IEC 17025 (2005) by the Deutsche Akkreditierungsstelle GmbH (DAkkS)

The accreditation is valid for the scope of testing procedures as stated in the accreditation certificate with the registration number: D-PL-12076-01-01

### Applicant

**Digi International Inc**

11001 Bren Road East  
MN 55343 Minnetonka / United States

Phone: +1-952-912-4248

Fax: -/-

Contact: Scott McCall

e-mail: [Scott.mccall@digi.com](mailto:Scott.mccall@digi.com)

Phone: +1-952-912-4248

### Manufacturer

**Digi International Inc**

11001 Bren Road East  
MN 55343 Minnetonka / United States

### Test standard/s

- |                   |   |
|-------------------|---|
| 47 CFR Part 15    | Title 47 of the Code of Federal Regulations; Chapter I; Part 15 - Radio frequency devices   |
| RSS - 247 Issue 2 | Digital Transmission Systems (DTSs), Frequency Hopping Systems (FHSs) and Licence - Exempt Local Area Network (LE-LAN) Devices                            |
| RSS - Gen Issue 4 | Spectrum Management and Telecommunications Radio Standards Specifications - General Requirements and Information for the Certification of Radio Apparatus |

For further applied test standards please refer to section 4 of this test report.

### Test Item

**Kind of test item:** Embedded ARM Module

**Model name:** ConnectCore 6UL

**FCC ID:** MCQ-CCIMX6UL

**IC:** 1846A-CCIMX6UL

**Frequency:** UNII bands: 5150 MHz to 5250 MHz; 5250 MHz to 5350 MHz; 5470 MHz to 5600 MHz, 5650 MHz to 5725 MHz and 5725 MHz to 5850 MHz

**Technology tested:** WLAN (OFDMA-; n HT20- & n HT40-mode ; ac HT20- & ac HT40 & ac HT80-mode)

**Antenna:** 3 different external antennas

**Power supply:** 5.0 V DC by C-24000120(RVB) power supply

**Temperature range:** -40°C to +85°C



This test report is electronically signed and valid without handwriting signature. For verification of the electronic signatures, the public keys can be requested at the testing laboratory.

### Test report authorized:

Andreas Luckenbill  
Lab Manager  
Radio Communications & EMC

### Test performed:

Mihail Dorongovskij  
Testing Manager  
Radio Communications & EMC

## 1 Table of contents

1	Table of contents.....	2
2	General information .....	3
2.1	Notes and disclaimer .....	3
2.2	Application details .....	3
3	Test laboratories sub-contracted .....	3
4	Test standard/s and references.....	4
5	Test environment .....	5
6	Test item .....	5
6.1	General description.....	5
6.2	Additional information .....	5
7	Description of the test setup .....	6
7.1	Shielded semi anechoic chamber .....	7
7.2	Shielded fully anechoic chamber .....	8
7.3	Radiated measurements > 18 GHz .....	9
7.4	Conducted measurements with peak power meter & spectrum analyzer.....	10
7.5	AC conducted .....	11
8	Sequence of testing .....	12
8.1	Sequence of testing radiated spurious 9 kHz to 30 MHz .....	12
8.2	Sequence of testing radiated spurious 30 MHz to 1 GHz .....	13
8.3	Sequence of testing radiated spurious 1 GHz to 18 GHz .....	14
8.4	Sequence of testing radiated spurious above 18 GHz .....	15
9	Measurement uncertainty.....	16
10	Summary of measurement results.....	17
11	Additional comments .....	18
12	Measurement results .....	19
12.1	Identify worst case data rate.....	19
12.2	Gain .....	20
12.3	Duty cycle .....	21
12.4	Maximum output power .....	22
12.5	Power spectral density .....	22
12.6	Minimum emission bandwidth for the band 5.725-5.85 GHz .....	22
12.7	Spectrum bandwidth – 26 dB bandwidth .....	22
12.8	Occupied bandwidth – 99% emission bandwidth .....	22
12.9	Band edge compliance radiated .....	23
12.10	TX spurious emissions radiated .....	34
12.11	RX spurious emissions radiated.....	35
12.12	Spurious emissions radiated < 30 MHz.....	42
12.13	Spurious emissions conducted < 30 MHz .....	67
Annex A	Document history .....	70
Annex B	Further information .....	70
Annex C	Accreditation Certificate .....	71

## 2 General information

### 2.1 Notes and disclaimer

The test results of this test report relate exclusively to the test item specified in this test report. CTC advanced GmbH does not assume responsibility for any conclusions and generalizations drawn from the test results with regard to other specimens or samples of the type of the equipment represented by the test item.

The test report may only be reproduced or published in full. Reproduction or publication of extracts from the report requires the prior written approval of CTC advanced GmbH.

The testing service provided by CTC advanced GmbH has been rendered under the current "General Terms and Conditions for CTC advanced GmbH".

CTC advanced GmbH will not be liable for any loss or damage resulting from false, inaccurate, inappropriate or incomplete product information provided by the customer.

Under no circumstances does the CTC advanced GmbH test report include any endorsement or warranty regarding the functionality, quality or performance of any other product or service provided.

Under no circumstances does the CTC advanced GmbH test report include or imply any product or service warranties from CTC advanced GmbH, including, without limitation, any implied warranties of merchantability, fitness for purpose, or non-infringement, all of which are expressly disclaimed by CTC advanced GmbH.

All rights and remedies regarding vendor's products and services for which CTC advanced GmbH has prepared this test report shall be provided by the party offering such products or services and not by CTC advanced GmbH. In no case this test report can be considered as a Letter of Approval.

This test report is electronically signed and valid without handwritten signature. For verification of the electronic signatures, the public keys can be requested at the testing laboratory.

### 2.2 Application details

Date of receipt of order:	2017-01-16
Date of receipt of test item:	2017-01-16
Start of test:	2017-01-28
End of test:	2017-04-06
Person(s) present during the test:	-/-

## 3 Test laboratories sub-contracted

None

#### 4 Test standard/s and references

Test standard	Date	Description
47 CFR Part 15		Title 47 of the Code of Federal Regulations; Chapter I; Part 15 - Radio frequency devices
RSS - 247 Issue 2	February 2017	Digital Transmission Systems (DTSs), Frequency Hopping Systems (FHSs) and Licence - Exempt Local Area Network (LE-LAN) Devices
RSS - Gen Issue 4	November 2014	Spectrum Management and Telecommunications Radio Standards Specifications - General Requirements and Information for the Certification of Radio Apparatus

Guidance	Version	Description
UNII: KDB 789033 D02	v01r04	Guidelines for Compliance Testing of Unlicensed National Information Infrastructure (U-NII) Devices - Part 15, Subpart E
ANSI C63.4-2014	-/-	American national standard for methods of measurement of radio-noise emissions from low-voltage electrical and electronic equipment in the range of 9 kHz to 40 GHz
ANSI C63.10-2013	-/-	American national standard of procedures for compliance testing of unlicensed wireless devices

## 5 Test environment

Temperature	:	T <sub>nom</sub> T <sub>max</sub> T <sub>min</sub>	+22 °C during room temperature tests No tests under extreme conditions required. No tests under extreme conditions required.
Relative humidity content	:		55 %
Barometric pressure	:		1021 hpa
Power supply	:	V <sub>nom</sub> V <sub>max</sub> V <sub>min</sub>	5.0 V DC by C-24000120(RVB) power supply No tests under extreme conditions required. No tests under extreme conditions required.

## 6 Test item

### 6.1 General description

Kind of test item	:	Embedded ARM Module
Type identification	:	ConnectCore 6UL
HMN	:	-/-
PMN	:	CC IMX6UL
HVIN	:	55001944-xx
FVIN	:	82004060
S/N serial number	:	Rad. UL-SBC3-020 Cond. UL-SBC3-020
HW hardware status	:	55001944-01 rev 1P
SW software status	:	82004060 rev 1P
Frequency band	:	UNII bands 5150 MHz to 5250 MHz; 5250 MHz to 5350 MHz; 5470 MHz to 5600 MHz; 5650 MHz to 5725 MHz; 5725 MHz to 5850 MHz (lowest channel 5180 MHz; highest channel 5825 MHz)
Type of radio transmission	:	OFDM
Use of frequency spectrum	:	
Type of modulation	:	BPSK, QPSK, 16 – QAM, 64 – QAM; 256 – QAM
Number of channels	:	20 MHz channels: 24 40 MHz channels: 11 80 MHz channels: 5
Antenna	:	1 external dipole antenna and 2 external PCB antennas
Power supply	:	5.0 V DC by C-24000120(RVB) power supply
Temperature range	:	-40°C to +85°C

### 6.2 Additional information

The content of the following annexes is defined in the QA. It may be that not all of the listed annexes are necessary for this report, thus some values in between may be missing.

Test setup- and EUT-photos are included in test report:

- 1-3116/16-01-01\_AnnexA
- 1-3116/16-01-01\_AnnexB
- 1-3116/16-01-01\_AnnexD

## 7 Description of the test setup

Typically, the calibrations of the test apparatus are commissioned to and performed by an accredited calibration laboratory. The calibration intervals are determined in accordance with the DIN EN ISO/IEC 17025. In addition to the external calibrations, the laboratory executes comparison measurements with other calibrated test systems or effective verifications. Weekly chamber inspections and range calibrations are performed. Where possible, RF generating and signaling equipment as well as measuring receivers and analyzers are connected to an external high-precision 10 MHz reference (GPS-based or rubidium frequency standard).

In order to simplify the identification of the equipment used at some special tests, some items of test equipment and ancillaries can be provided with an identifier or number in the equipment list below (Lab/Item).

**Agenda:** Kind of Calibration

k	calibration / calibrated	EK	limited calibration
ne	not required (k, ev, izw, zw not required)	zw	cyclical maintenance (external cyclical maintenance)
ev	periodic self verification	izw	internal cyclical maintenance
Ve	long-term stability recognized	g	blocked for accredited testing
vkl!	Attention: extended calibration interval		
NK!	Attention: not calibrated	*)	next calibration ordered / currently in progress

## 7.1 Shielded semi anechoic chamber

The radiated measurements are performed in vertical and horizontal plane in the frequency range from 9 kHz to 1 GHz in semi-anechoic chambers. The EUT is positioned on a non-conductive support with a height of 0.80 m above a conductive ground plane that covers the whole chamber. The receiving antennas are conform to specifications ANSI C63. These antennas can be moved over the height range between 1.0 m and 4.0 m in order to search for maximum field strength emitted from EUT. The measurement distances between EUT and receiving antennas are indicated in the test setups for the various frequency ranges. For each measurement, the EUT is rotated in all three axes until the maximum field strength is received. The wanted and unwanted emissions are received by spectrum analyzers where the detector modes and resolution bandwidths over various frequency ranges are set according to requirement ANSI C63.

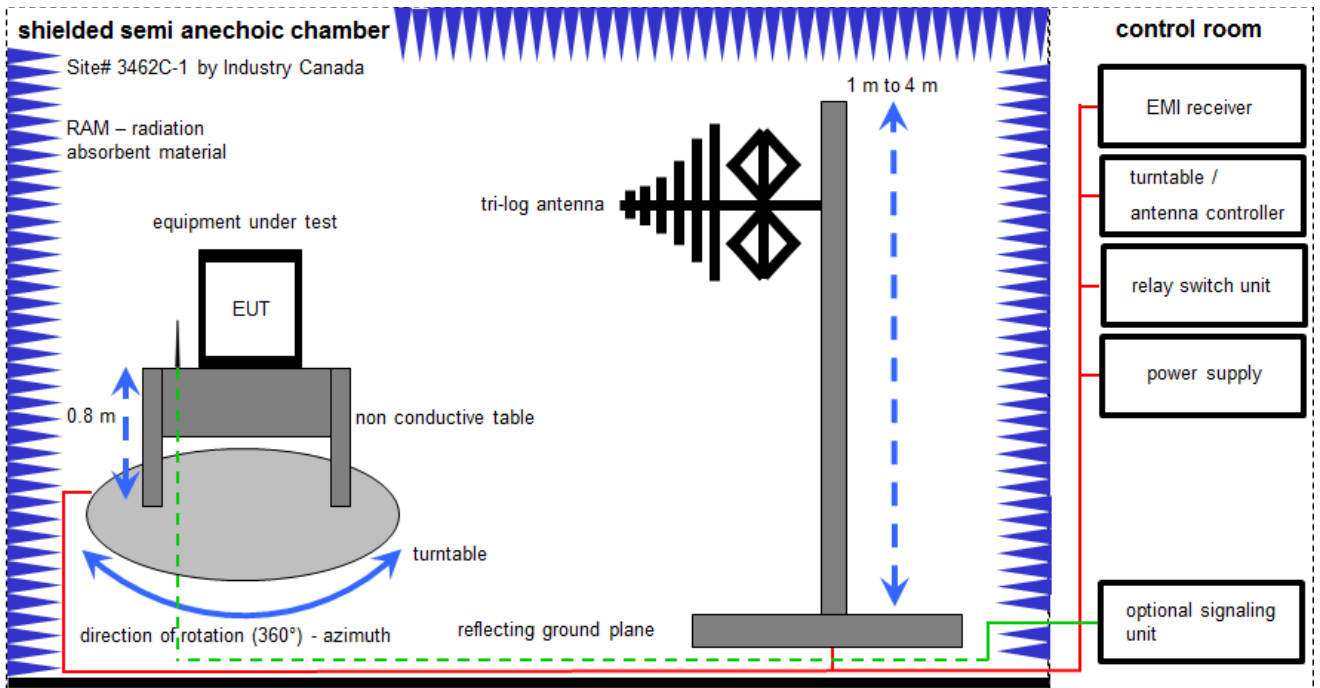

Measurement distance: tri-log antenna 10 meter

$$FS = UR + CL + AF$$

(FS-field strength; UR-voltage at the receiver; CL-loss of the cable; AF-antenna factor)

Example calculation:

$$FS [dB\mu V/m] = 12.35 [dB\mu V/m] + 1.90 [dB] + 16.80 [dB/m] = 31.05 [dB\mu V/m] (35.69 \mu V/m)$$

### Equipment table:

No.	Lab / Item	Equipment	Type	Manufacturer	Serial No.	INV. No.	Kind of Calibration	Last Calibration	Next Calibration
1	A	Switch-Unit	3488A	HP	2719A14505	300000368	ev	-/-	-/-
2	A	Meßkabine 1	HF-Absorberhalle	MWB AG 300023	101042	300000551	ne	-/-	-/-
3	A	EMI Test Receiver	ESCI 3	R&S	100083	300003312	k	08.03.2016	08.03.2017
4	A	Analyzer-Reference-System (Harmonics and Flicker)	ARS 16/1	SPS	A3509 07/0 0205	300003314	Ve	02.02.2016	02.02.2018
5	A	Antenna Tower	Model 2175	ETS-Lindgren	64762	300003745	izw	-/-	-/-
6	A	Positioning Controller	Model 2090	ETS-Lindgren	64672	300003746	izw	-/-	-/-
7	A	Turntable Interface-Box	Model 105637	ETS-Lindgren	44583	300003747	izw	-/-	-/-
8	A	TRILOG Broadband Test-Antenna 30 MHz - 3 GHz	VULB9163	Schwarzbeck	295	300003787	k	25.04.2016	25.04.2018

## 7.2 Shielded fully anechoic chamber

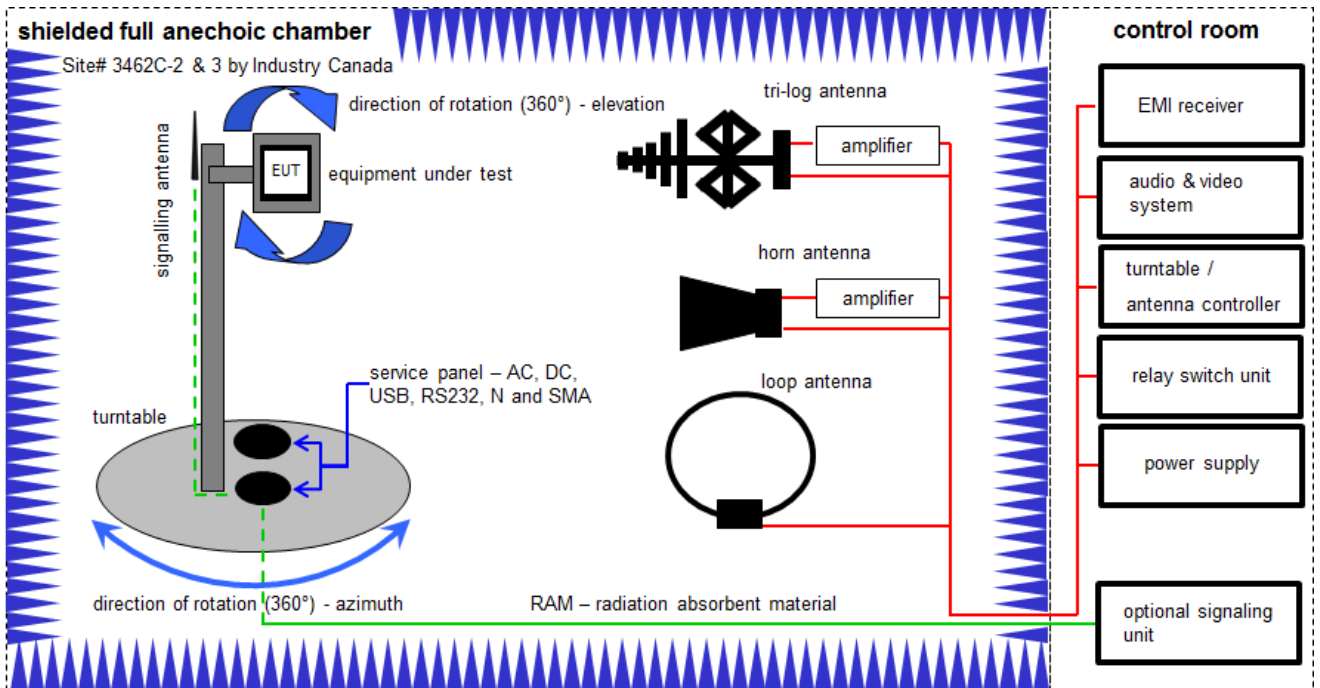

Measurement distance: tri-log antenna and horn antenna 3 meter; loop antenna 3 meter

$$FS = UR + CA + AF$$

(FS-field strength; UR-voltage at the receiver; CA-loss of the signal path; AF-antenna factor)

Example calculation:

$$FS [dB\mu V/m] = 40.0 [dB\mu V/m] + (-35.8) [dB] + 32.9 [dB/m] = 37.1 [dB\mu V/m] (71.61 \mu V/m)$$

### Equipment table:

No.	Lab / Item	Equipment	Type	Manufacturer	Serial No.	INV. No.	Kind of Calibration	Last Calibration	Next Calibration
1	C	Active Loop Antenna 10 kHz to 30 MHz	6502	EMCO	2210	300001015	k	20.05.2015	20.05.2017
2	A	Double-Ridged Waveguide Horn Antenna 1-18.0GHz	3115	EMCO	9709-5290	300000212	k	13.08.2015	13.08.2017
3	A	Highpass Filter	WHK1.1/15G-10SS	Wainwright	37	400000148	ne	-/-	-/-
4	A	Highpass Filter	WHKX7.0/18G-8SS	Wainwright	18	300003789	ne	-/-	-/-
5	A	Band Reject Filter	WRCG2400/2483-2375/2505-50/10SS	Wainwright	26	300003792	ne	-/-	-/-
6	B	TRILOG Broadband Test-Antenna 30 MHz - 3 GHz	VULB9163	Schwarzbeck	318	300003696	k	22.04.2014	22.04.2017
7	A, B	Broadband Amplifier 0.5-18 GHz	CBLU5184540	CERNEX	22051	300004483	ev	-/-	-/-
8	A, B, C	4U RF Switch Platform	L4491A	Agilent Technologies	MY50000032	300004510	ne	-/-	-/-
9	A, B, C	Messrechner und Monitor	Intel Core i3 3220/3,3 GHz, Prozessor	Huber & Suhner	2V2403033A54 21	300004591	ne	-/-	-/-
10	A, B, C	NEXIO EMV-Software	BAT EMC V3.16.0.49	EMCO	Batch no. 14844	300004682	ne	-/-	-/-
11	A, B, C	Anechoic chamber	ESH3-Z5	IDK	893045/004	300003726	ne	-/-	-/-
12	A, B, C	EMI Test Receiver 9kHz-26,5GHz	ESR26	R&S	101376	300005063	vIKI!	13.09.2016	13.03.2018



### 7.3 Radiated measurements > 18 GHz

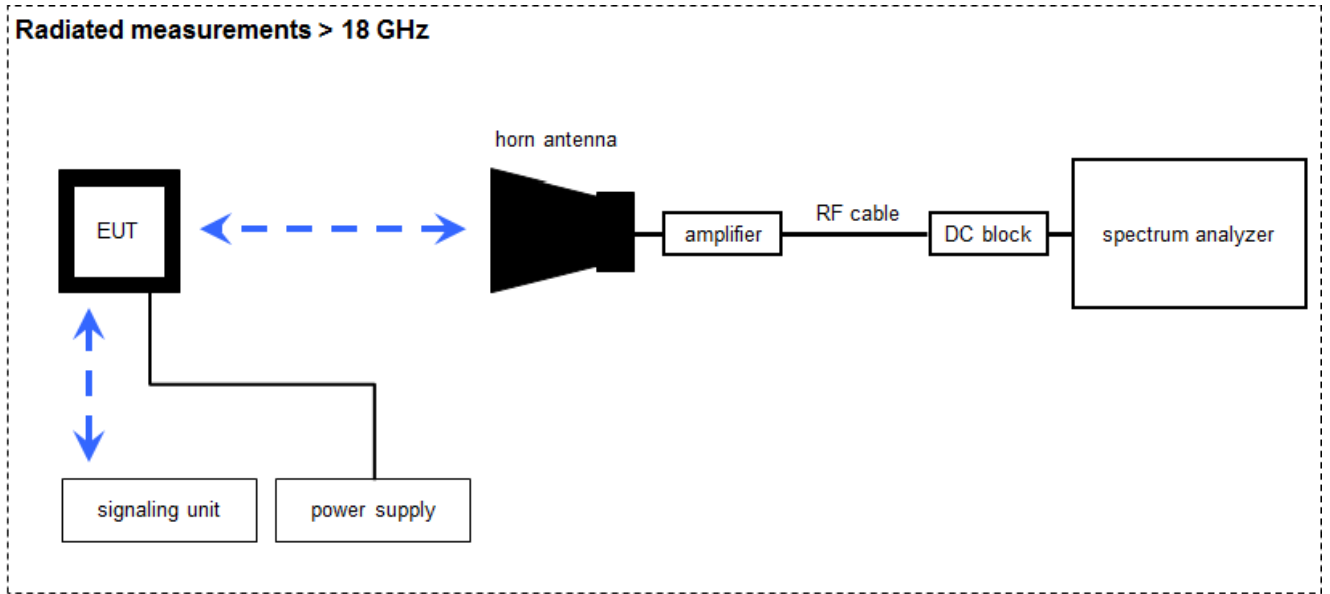

Measurement distance: horn antenna 50 cm

$$FS = U_R + CA + AF$$

(FS-field strength;  $U_R$ -voltage at the receiver; CA-loss signal path & distance correction; AF-antenna factor)

Example calculation:

$$FS \text{ [dB}\mu\text{V/m]} = 40.0 \text{ [dB}\mu\text{V/m]} + (-60.1) \text{ [dB]} + 36.74 \text{ [dB/m]} = 16.64 \text{ [dB}\mu\text{V/m]} \text{ (6.79 } \mu\text{V/m)}$$

#### Equipment table:

No.	Lab / Item	Equipment	Type	Manufacturer	Serial No.	INV. No.	Kind of Calibration	Last Calibration	Next Calibration
1	A	Std. Gain Horn Antenna 18.0 to 26.5 GHz	638	Narda	-/-	300000486	k	10.09.2015	10.09.2017
2	A	Signal Analyzer 40 GHz	FSV40	R&S	101042	300004517	k	27.01.2017	26.01.2018
3	A	Amplifier 2-40 GHz	JS32-02004000-57-5P	MITEQ	1777200	300004541	ev	-/-	-/-
4	A	RF-Cable	ST18/SMAm/SMAm/48	Huber & Suhner	Batch no. 600918	400001182	ev	-/-	-/-
5	A	RF-Cable	ST18/SMAm/SMAm/48	Huber & Suhner	Batch no. 127377	400001183	ev	-/-	-/-
6	A	DC-Blocker 0.1-40 GHz	8141A	Inmet	-/-	400001185	ev	-/-	-/-

## 7.4 Conducted measurements with peak power meter & spectrum analyzer

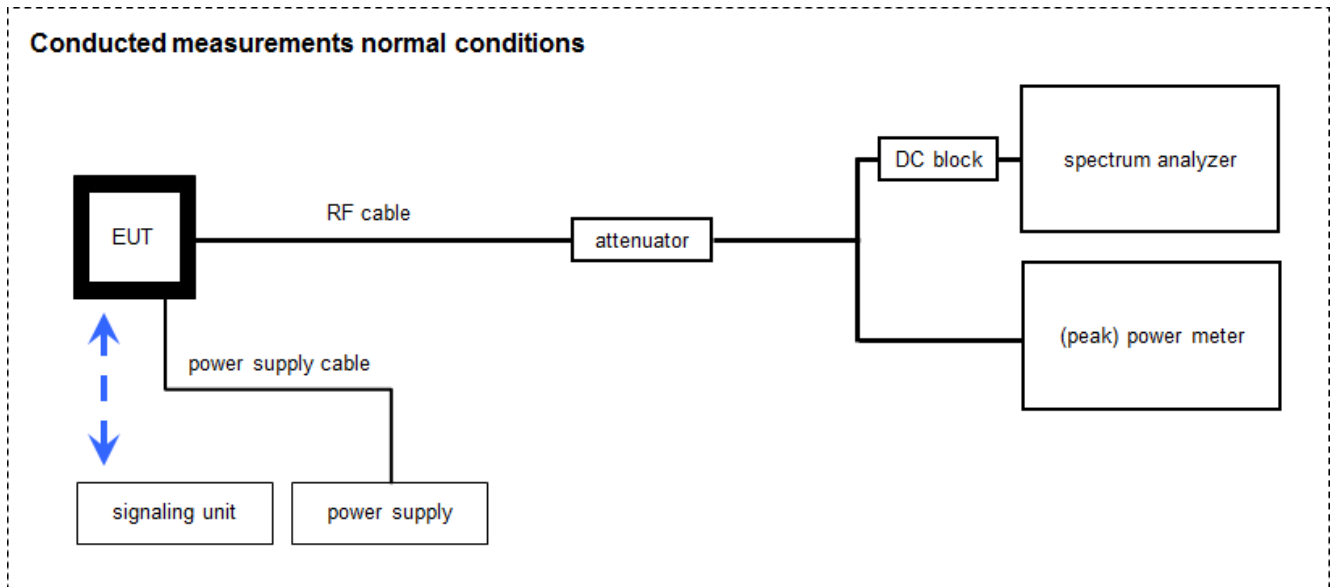

OP = AV + CA  
 (OP-output power; AV-analyzer value; CA-loss signal path)

Example calculation:

OP [dBm] = 6.0 [dBm] + 11.7 [dB] = 17.7 [dBm] (58.88 mW)

Equipment table:

No.	Lab / Item	Equipment	Type	Manufacturer	Serial No.	INV. No.	Kind of Calibration	Last Calibration	Next Calibration
1	A, B	Switch / Control Unit	3488A	HP	2719A15013	300000151	ne	-/-	-/-
2	A, B	PC-WLAN Tester	Intel Core i3 3220/3,3 GHz, Prozessor	R&S	2V2403033A45 23	300004589	ne	-/-	-/-
3	A, B	Teststand	Teststand Custom Sequence Editor	National Instruments GmbH	2V2403033A45 23	300004590	ne	-/-	-/-
4	A	Wideband Power Sensor, 50 MHz to 18 GHz	NRP-Z81	R&S	102585	300004863	k	27.01.2017	26.01.2019
5	A, B	PowerSplitter/Combiner 150-6000MHz N-Type	ZB3PD-63-N+	Mini-Circuits	100010	400000451	ev	-/-	-/-
6	A, B	RF-Cable	ST18/SMAm/SMAm/60	Huber & Suhner	Batch no. 606844	400001181	ev	-/-	-/-
7	A, B	Coax Attenuator 10 dB 2W 0-40 GHz	MCL BW-K10-2W44+	Mini Circuits	Batch no. 606844	400001186	ev	-/-	-/-
8	B	DC-Blocker 0.1-40 GHz	8141A	Inmet	Batch no. 127377	400001185	ev	-/-	-/-
9	B	Signal Analyzer 40 GHz	FSV40	R&S	101042	300004517	k	27.01.2017	26.01.2018

**7.5 AC conducted**

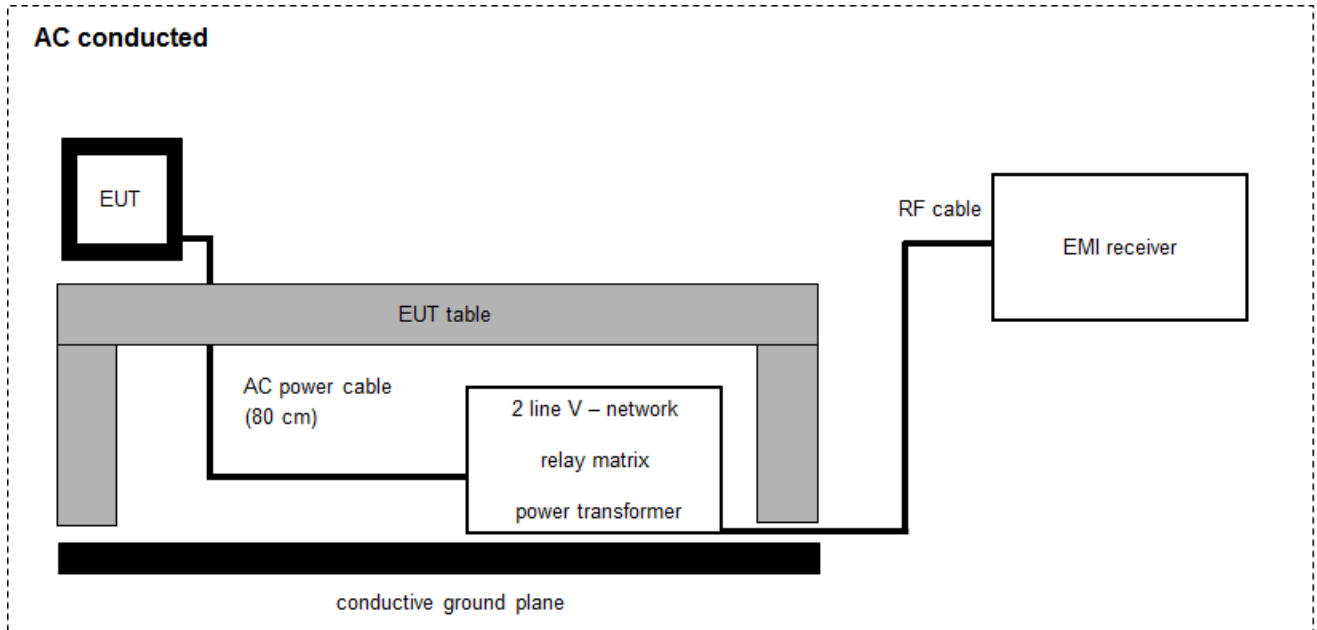

$FS = UR + CF + VC$

(FS-field strength; UR-voltage at the receiver; CR-loss of the cable and filter; VC-correction factor of the ISN)

Example calculation:

$FS [dB\mu V/m] = 37.62 [dB\mu V/m] + 9.90 [dB] + 0.23 [dB] = 47.75 [dB\mu V/m] (244.06 \mu V/m)$

**Equipment table:**

No.	Lab / Item	Equipment	Type	Manufacturer	Serial No.	INV. No.	Kind of Calibration	Last Calibration	Next Calibration
1	A	Two-line V-Network (LISN) 9 kHz to 30 MHz	ESH3-Z5	R&S	893045/004	300000584	k	31.01.2017	30.01.2018
2	A	RF-Filter-section	85420E	HP	3427A00162	300002214	k	27.11.2006	-/-
3	A	EM-Injection Clamp	FCC-203i	emv	232	300000626	ev	18.05.2001	-/-
4	A	AC-Spannungsquelle variabel	MV2616-V	EM-Test	0397-12	300003259	k	11.12.2015	11.12.2017
5	A	Hochpass 150 kHz	EZ-25	R&S	100010	300003798	ev	08.04.2008	-/-
6	A	MXE EMI Receiver 20 Hz to 26,5 GHz	N9038A	Agilent Technologies	MY51210197	300004405	k	16.08.2016	16.08.2017

## 8 Sequence of testing

### 8.1 Sequence of testing radiated spurious 9 kHz to 30 MHz

#### Setup

- The equipment is set up to simulate normal operation mode as described in the user manual or defined by the manufacturer.
- If the EUT is a tabletop system, a 2-axis positioner with 1.5 m height is used.
- If the EUT is a floor standing device, it is placed directly on the turn table.
- Auxiliary equipment and cables are positioned to simulate normal operation conditions as described in ANSI C 63.4.
- The AC power port of the EUT (if available) is connected to a power outlet below the turntable.
- Measurement distance is 3 m (see ANSI C 63.4) – see test details.
- EUT is set into operation.

#### Premeasurement

- The turntable rotates from 0° to 315° using 45° steps.
- The antenna height is 1.5 m.
- At each turntable position the analyzer sweeps with positive-peak detector to find the maximum of all emissions.

#### Final measurement

- Identified emissions during the premeasurement are maximized by the software by rotating the turntable from 0° to 360°. In case of the 2-axis positioner is used the elevation axis is also rotated from 0° to 360°.
- The final measurement is done in the position (turntable and elevation) causing the highest emissions with quasi-peak (as described in ANSI C 63.4).
- Final levels, frequency, measuring time, bandwidth, turntable position, correction factor, margin to the limit and limit will be recorded. A plot with the graph of the premeasurement and the limit is stored.

## 8.2 Sequence of testing radiated spurious 30 MHz to 1 GHz

### Setup

- The equipment is set up to simulate normal operation mode as described in the user manual or defined by the manufacturer.
- If the EUT is a tabletop system, a table with 0.8 m height is used, which is placed on the ground plane.
- If the EUT is a floor standing device, it is placed on the ground plane with insulation between both.
- Auxiliary equipment and cables are positioned to simulate normal operation conditions as described in ANSI C 63.4.
- The AC power port of the EUT (if available) is connected to a power outlet below the turntable.
- Measurement distance is 10 m or 3 m (see ANSI C 63.4) – see test details.
- EUT is set into operation.

### Premeasurement

- The turntable rotates from 0° to 315° using 45° steps.
- The antenna is polarized vertical and horizontal.
- The antenna height changes from 1 m to 3 m.
- At each turntable position, antenna polarization and height the analyzer sweeps three times in peak to find the maximum of all emissions.

### Final measurement

- The final measurement is performed for at least six highest peaks according to the requirements of the ANSI C63.4.
- Based on antenna and turntable positions at which the peak values are measured the software maximize the peaks by changing turntable position  $\pm 45^\circ$  and antenna height between 1 and 4 m.
- The final measurement is done with quasi-peak detector (as described in ANSI C 63.4).
- Final levels, frequency, measuring time, bandwidth, antenna height, antenna polarization, turntable angle, correction factor, margin to the limit and limit are recorded. A plot with the graph of the premeasurement with marked maximum final results and the limit is stored.

### 8.3 Sequence of testing radiated spurious 1 GHz to 18 GHz

#### Setup

- The equipment is set up to simulate normal operation mode as described in the user manual or defined by the manufacturer.
- If the EUT is a tabletop system, a 2-axis positioner with 1.5 m height is used.
- If the EUT is a floor standing device, it is placed directly on the turn table.
- Auxiliary equipment and cables are positioned to simulate normal operation conditions as described in ANSI C 63.4.
- The AC power port of the EUT (if available) is connected to a power outlet below the turntable.
- Measurement distance is 3 m (see ANSI C 63.4) – see test details.
- EUT is set into operation.

#### Premeasurement

- The turntable rotates from 0° to 315° using 45° steps.
- The antenna is polarized vertical and horizontal.
- The antenna height is 1.5 m.
- At each turntable position and antenna polarization the analyzer sweeps with positive peak detector to find the maximum of all emissions.

#### Final measurement

- The final measurement is performed for at least six highest peaks according to the requirements of the ANSI C63.4.
- Based on antenna and turntable positions at which the peak values are measured the software maximizes the peaks by rotating the turntable from 0° to 360°. This measurement is repeated for different EUT-table positions (0° to 150° in 30°-steps) and for both antenna polarizations.
- The final measurement is done in the position (turntable, EUT-table and antenna polarization) causing the highest emissions with Peak and RMS detector (as described in ANSI C 63.4).
- Final levels, frequency, measuring time, bandwidth, turntable position, EUT-table position, antenna polarization, correction factor, margin to the limit and limit are recorded. A plot with the graph of the premeasurement with marked maximum final results and the limit is stored.

## 8.4 Sequence of testing radiated spurious above 18 GHz

### Setup

- The equipment is set up to simulate normal operation mode as described in the user manual or defined by the manufacturer.
- Auxiliary equipment and cables are positioned to simulate normal operation conditions as described in ANSI C 63.4.
- The AC power port of the EUT (if available) is connected to a power outlet.
- The measurement distance is as appropriate (e.g. 0.5 m).
- The EUT is set into operation.

### Premeasurement

- The test antenna is handheld and moved carefully over the EUT to cover the EUT's whole sphere and different polarizations of the antenna.

### Final measurement

- The final measurement is performed at the position and antenna orientation causing the highest emissions with Peak and RMS detector (as described in ANSI C 63.4).
- Final levels, frequency, measuring time, bandwidth, correction factor, margin to the limit and limit are recorded. A plot with the graph of the premeasurement and the limit is stored.

## 9 Measurement uncertainty

Measurement uncertainty	
Test case	Uncertainty
Antenna gain	± 3 dB
Power spectral density	± 1.5 dB
Spectrum bandwidth	± 100 kHz (depends on the used RBW)
Occupied bandwidth	± 100 kHz (depends on the used RBW)
Maximum output power	± 1.5 dB
Minimum emissions bandwidth	± 100 kHz (depends on the used RBW)
Spurious emissions conducted	± 3 dB
Spurious emissions radiated below 30 MHz	± 3 dB
Spurious emissions radiated 30 MHz to 1 GHz	± 3 dB
Spurious emissions radiated 1 GHz to 12.75 GHz	± 3.7 dB
Spurious emissions radiated above 12.75 GHz	± 4.5 dB
Spurious emissions conducted below 30 MHz (AC conducted)	± 2.6 dB



**10 Summary of measurement results**

<input type="checkbox"/>	No deviations from the technical specifications were ascertained
<input type="checkbox"/>	There were deviations from the technical specifications ascertained
<input checked="" type="checkbox"/>	This test report is only a partial test report. The content and verdict of the performed test cases are listed below.

TC Identifier	Description	Verdict	Date	Remark
RF-Testing	CFR Part 15 RSS 247, Issue 2	see table	2017-05-09	-/-

Test specification clause	Test case	Temperature conditions	Power source voltages	C	NC	NA	NP	Remark
-/-	Output power verification (conducted)	Nominal	Nominal	-/-				-/-
-/-	Antenna gain	Nominal	Nominal	-/-				Declared
U-NII Part 15	Duty cycle	Nominal	Nominal	-/-				-/-
§15.407(a) RSS - 247 (6.2.1) (1) RSS - 247 (6.2.2) (1) RSS - 247 (6.2.3) (1) RSS - 247 (6.2.4) (1)	Maximum output power (conducted & radiated)	Nominal	Nominal	<input checked="" type="checkbox"/>	<input type="checkbox"/>	<input type="checkbox"/>	<input type="checkbox"/>	-/-
§15.407(a) RSS - 247 (6.2.1) (1) RSS - 247 (6.2.2) (1) RSS - 247 (6.2.3) (1) RSS - 247 (6.2.4) (1)	Power spectral density	Nominal	Nominal	<input checked="" type="checkbox"/>	<input type="checkbox"/>	<input type="checkbox"/>	<input type="checkbox"/>	-/-
RSS - 247 (6.2.4)	Spectrum bandwidth 6dB bandwidth	Nominal	Nominal	<input checked="" type="checkbox"/>	<input type="checkbox"/>	<input type="checkbox"/>	<input type="checkbox"/>	-/-
§15.407(a)	Spectrum bandwidth 26dB bandwidth	Nominal	Nominal	<input checked="" type="checkbox"/>	<input type="checkbox"/>	<input type="checkbox"/>	<input type="checkbox"/>	-/-
RSS Gen clause 6.6	Spectrum bandwidth 99% bandwidth	Nominal	Nominal	-/-				-/-
§15.205 RSS - 247 (6.2.1) (2) RSS - 247 (6.2.2) (2) RSS - 247 (6.2.3) (2) RSS - 247 (6.2.4) (2)	Band edge compliance radiated	Nominal	Nominal	<input checked="" type="checkbox"/>	<input type="checkbox"/>	<input type="checkbox"/>	<input type="checkbox"/>	-/-
§15.407(b) RSS - 247 (6.2.1) (2) RSS - 247 (6.2.2) (2) RSS - 247 (6.2.3) (2) RSS - 247 (6.2.4) (2)	TX spurious emissions radiated	Nominal	Nominal	<input checked="" type="checkbox"/>	<input type="checkbox"/>	<input type="checkbox"/>	<input type="checkbox"/>	-/-
§15.109 RSS-Gen	RX spurious emissions radiated	Nominal	Nominal	<input checked="" type="checkbox"/>	<input type="checkbox"/>	<input type="checkbox"/>	<input type="checkbox"/>	-/-
§15.209(a) RSS-Gen	Spurious emissions radiated < 30 MHz	Nominal	Nominal	<input checked="" type="checkbox"/>	<input type="checkbox"/>	<input type="checkbox"/>	<input type="checkbox"/>	-/-
§15.107(a) §15.207	Spurious emissions conducted emissions < 30 MHz	Nominal	Nominal	<input checked="" type="checkbox"/>	<input type="checkbox"/>	<input type="checkbox"/>	<input type="checkbox"/>	-/-
§15.407 RSS - 247 (6.3)	DFS	Nominal	Nominal	-/-				See report 1-3116_16-01-21

**Note:** C = Compliant; NC = Not compliant; NA = Not applicable; NP = Not performed

\* Test cases performed under the project number: 1-3116\_16-01-21

## 11 Additional comments

Reference documents: An\_PCB\_2400-5000\_ANTX100P001B24553\_v0.pdf  
 ant-db1-raf-xxx.pdf  
 Prestta-WLAN-1001932PT\_11August2015s.pdf  
 CC6UL – Antennenstecker.docx

Special test descriptions: The EUT has two different ports for external antennas (UFL and MMCX). Simultaneous transmission not possible. The conducted measurements have been performed on both ports. Radiated measurements only on the UFL port due to the higher output power.  
 The radiated tests were performed with the ANT-X100P001B24553 (PCB) antenna and the ANT-DB1-RAF-xxx (dipole) antenna.  
 The ANT-X100P001B24553 antenna has the highest gain among the two PCB antennas from Chapter 12.2.

Configuration descriptions: Used power settings for all measurements:

	Ch36	Ch48	Ch52	Ch64	Ch100	Ch120	Ch140	Ch149	Ch157	Ch165
a-mode	11	13	13	7	10	10	11	9	9	13
nHT20-mode	11	13	13	7	10	10	11	9	9	13
	Ch38	Ch46	Ch54	Ch62	Ch102	Ch118	Ch134	Ch151	Ch159	
nHT40-mode	8	12	12	7	12	12	12	12	12	
	Ch42	Ch58	Ch106	Ch122	Ch155					
acHT80-mode	4	4	4	12	12					

Test mode:  Special software is used.  
 EUT is transmitting pseudo random data by itself

Antennas and transmit operating modes:

Operating mode 1 (single antenna)

- Equipment with 1 antenna,
- Equipment with 2 diversity antennas operating in switched diversity mode by which at any moment in time only 1 antenna is used,
- Smart antenna system with 2 or more transmit/receive chains, but operating in a mode where only 1 transmit/receive chain is used)

Operating mode 2 (multiple antennas, no beamforming)

- Equipment operating in this mode contains a smart antenna system using two or more transmit/receive chains simultaneously but without beamforming.

Operating mode 3 (multiple antennas, with beamforming)

- Equipment operating in this mode contains a smart antenna system using two or more transmit/receive chains simultaneously with beamforming.  
 In addition to the antenna assembly gain (G), the beamforming gain (Y) may have to be taken into account when performing the measurements.

## 12 Measurement results

### 12.1 Identify worst case data rate

**Measurement:**

All modes of the module will be measured with an average power meter or spectrum analyzer to identify the maximum transmission power.

In further tests only the identified worst case modulation scheme or bandwidth will be measured and this mode is used as representative mode for all other modulation schemes.

Additional the band edge compliance test will be performed in the lowest and highest modulation scheme.

**Measurement parameters:**

Measurement parameter	
Detector:	Peak
Sweep time:	Auto
Resolution bandwidth:	3 MHz
Video bandwidth:	3 MHz
Trace mode:	Max hold
Used test setup:	See chapter 7.4 – A
Measurement uncertainty:	See chapter 9

**Results:**

Modulation	Modulation scheme / bandwidth					
	5180 MHz	5320 MHz	5500 MHz	5700 MHz	5745 MHz	5825 MHz
Frequency	6 Mbit/s	6 Mbit/s	6 Mbit/s	6 Mbit/s	6 Mbit/s	6 Mbit/s
OFDM / a – mode	MCS0	MCS0	MCS0	MCS0	MCS0	MCS0
OFDM / n/ac HT20 – mode	5190 MHz	5310 MHz	5510 MHz	5670 MHz	5755 MHz	5815 MHz
Frequency	MCS0	MCS0	MCS0	MCS0	MCS0	MCS0
OFDM / n/ac HT40 – mode	5210 MHz	5290 MHz	5530 MHz	5610 MHz	5690 MHz	5775 MHz
Frequency	MCS0	MCS0	MCS0	MCS0	MCS0	MCS0
OFDM / ac HT80 – mode						

## 12.2 Gain

**Limits:**

Antenna Gain
6 dBi / > 6 dBi output power and power density reduction required

**Results:** Declared by applicant according to antenna data sheets

	U-NII bands
ANTX100P001B24553 (PCB)	5.1 dBi
1001932PT (PCB)	4.4 dBi
ANT-DB1-RAF-xxx (Dipole)	4.6 dBi

## 12.3 Duty cycle

### Description:

The duty cycle is necessary to compute the maximum power during an actual transmission. The shown plots and values are to show an example of the measurement procedure. The real value is measured direct during the power measurement or power density measurement. The correction value is shown in each plot of these measurements.

### Measurement:

Measurement parameter	
According to: KDB789033 D02, B.	
Detector:	Peak
Sweep time:	Auto
Resolution bandwidth:	10 MHz
Video bandwidth:	10 MHz
Span:	Zero
Trace mode:	Video trigger / view / single sweep
Used test setup:	See chapter 7.4 – A
Measurement uncertainty:	See chapter 9

### Results:

#### Duty cycle and correction factor:

OFDM / a – mode:	100 % duty cycle	=>	0.0 dB
OFDM / n/ac HT20 – mode:	100 % duty cycle	=>	0.0 dB
OFDM / n/ac HT40 – mode:	100 % duty cycle	=>	0.0 dB
OFDM / ac HT80 – mode:	100 % duty cycle	=>	0.0 dB

## 12.4 Maximum output power

See Annex 1-3116\_16-01-20-A

## 12.5 Power spectral density

See Annex 1-3116\_16-01-20-A

## 12.6 Minimum emission bandwidth for the band 5.725-5.85 GHz

See Annex 1-3116\_16-01-20-B

## 12.7 Spectrum bandwidth – 26 dB bandwidth

See Annex 1-3116\_16-01-20-B

## 12.8 Occupied bandwidth – 99% emission bandwidth

See Annex 1-3116\_16-01-20-B

## 12.9 Band edge compliance radiated

### Description:

Measurement of the radiated band edge compliance. The EUT is turned in the position that results in the maximum level at the band edge. Then a sweep over the corresponding restricted band is performed. The EUT is set to the lowest channel for the lower restricted band and to the highest channel for the upper restricted band. Measurement distance is 3m.

### Measurement:

Measurement parameter	
Detector:	Peak / RMS
Sweep time:	Auto
Resolution bandwidth:	1 MHz
Video bandwidth:	≥ 3 x RBW
Span:	See plots!
Trace – mode:	Max Hold
Test setup:	See sub clause 7.2 – A
Measurement uncertainty:	See sub clause 9

### Limits:

Band Edge Compliance Radiated
In any 100 kHz bandwidth outside the frequency band in which the spread spectrum or digitally modulated intentional radiator is operating, the radio frequency power that is produced by the intentional radiator shall be at least 20 dB below that in the 100 kHz bandwidth within the band that contains the highest level of the desired power, based on either an RF conducted or a radiated measurement. Attenuation below the general limits specified in Section 15.209(a) is not required. In addition, radiated emissions which fall in the restricted bands, as defined in Section 15.205(a), must also comply with the radiated emission limits specified in Section 15.209(a) (see Section 5.205(c)).
74 dBµV/m (peak) 54 dBµV/m (average)

### Result:

Scenario	Band Edge Compliance Radiated [dBµV/m]
band edge	< 74 dBµV/m (peak) < 54 dBµV/m (average)

**Plots:** ANTX100P001B24553 PCB antenna

**Plot 1:** lower band edge, vertical & horizontal polarization – OFDM 20 MHz, 5180 MHz

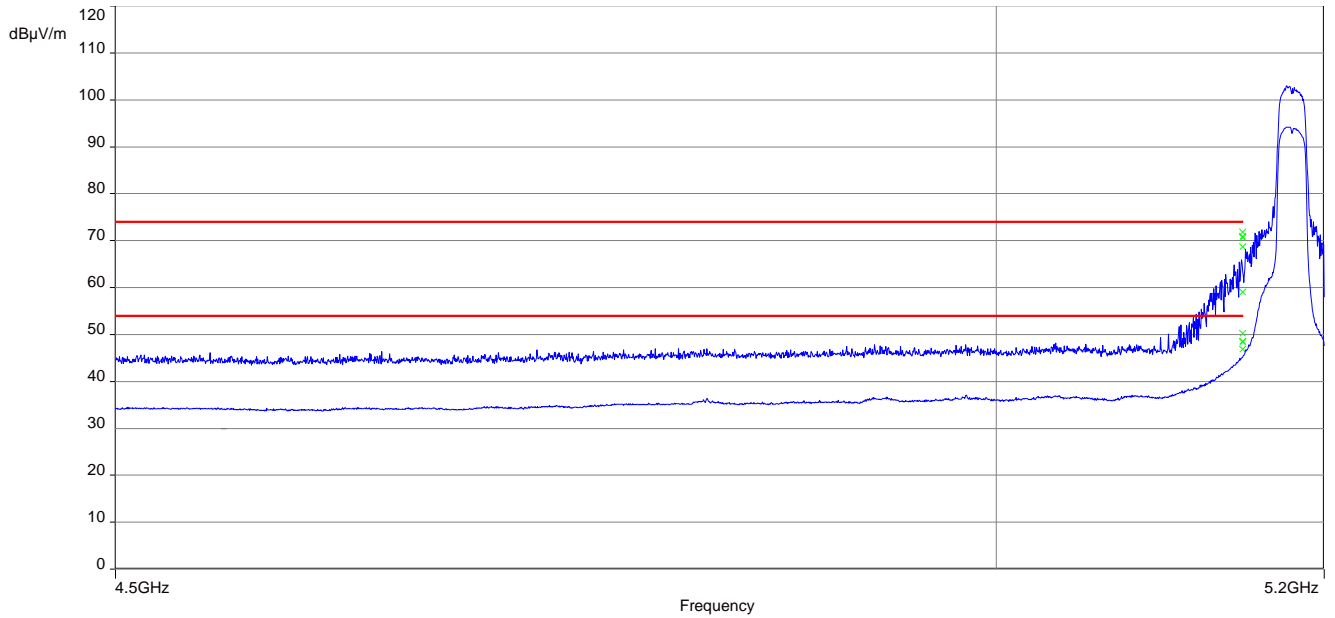

**Plot 2:** upper band edge, vertical & horizontal polarization – OFDM 20 MHz, 5320 MHz

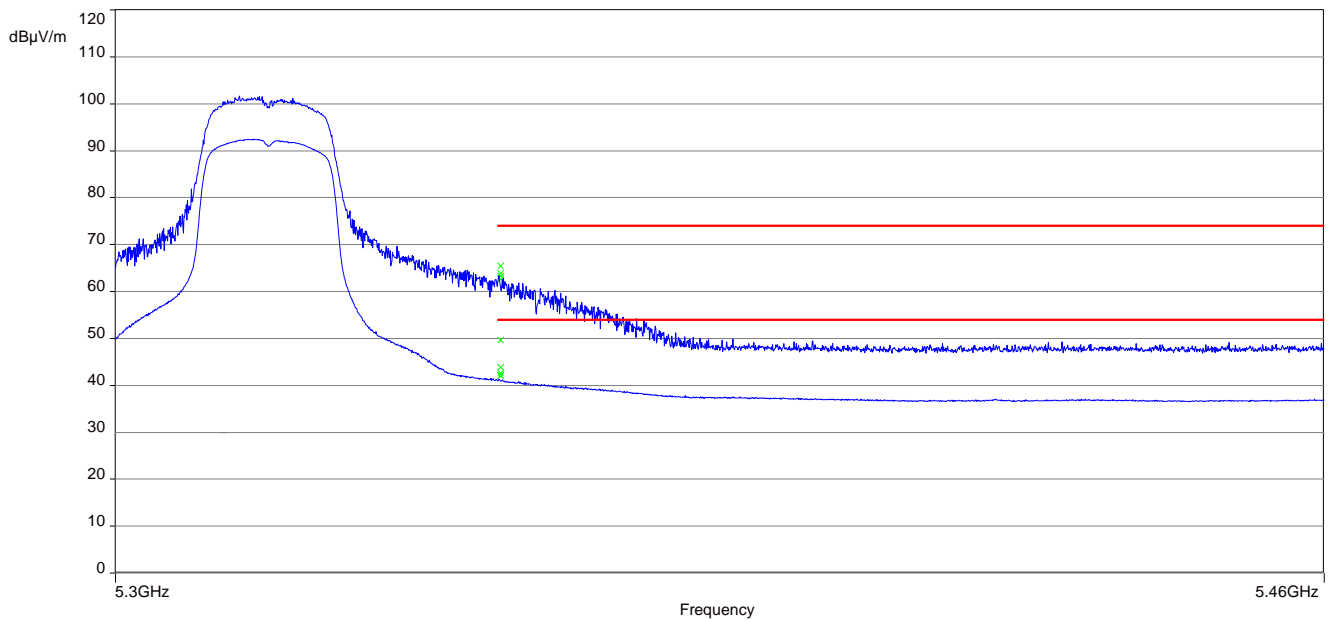



**Plot 3:** lower band edge, vertical & horizontal polarization – OFDM 20 MHz, 5500 MHz

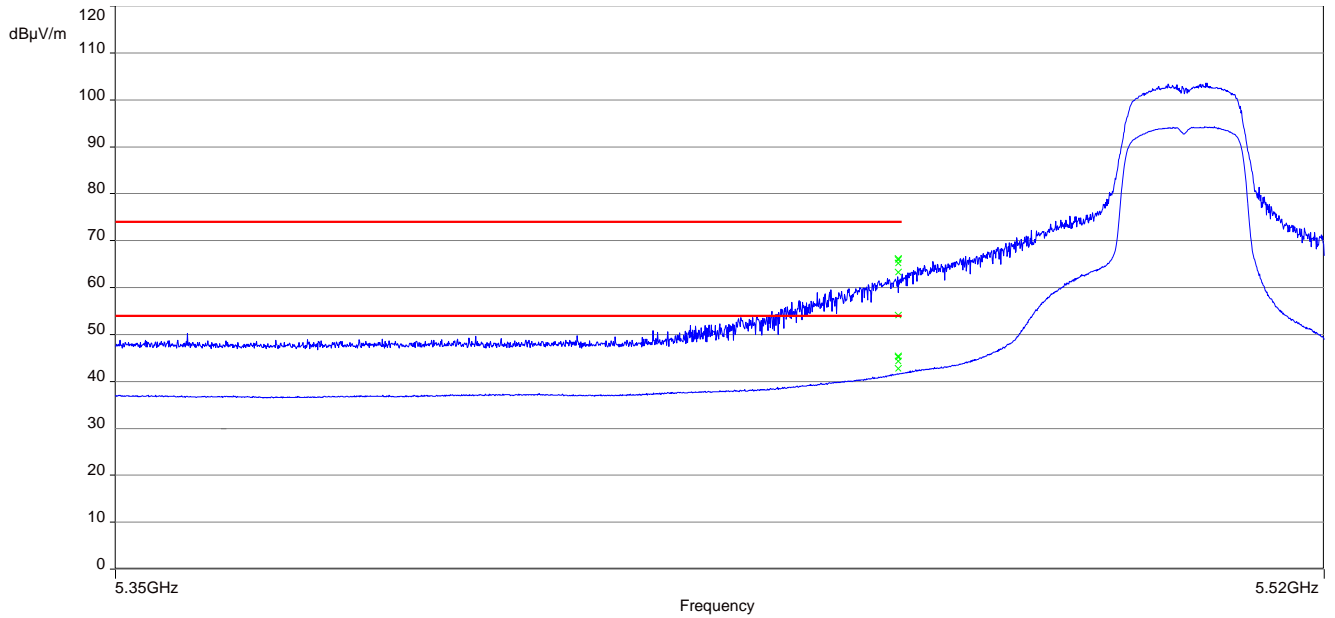

**Plot 4:** lower band edge, vertical & horizontal polarization – OFDM 40 MHz, 5190 MHz

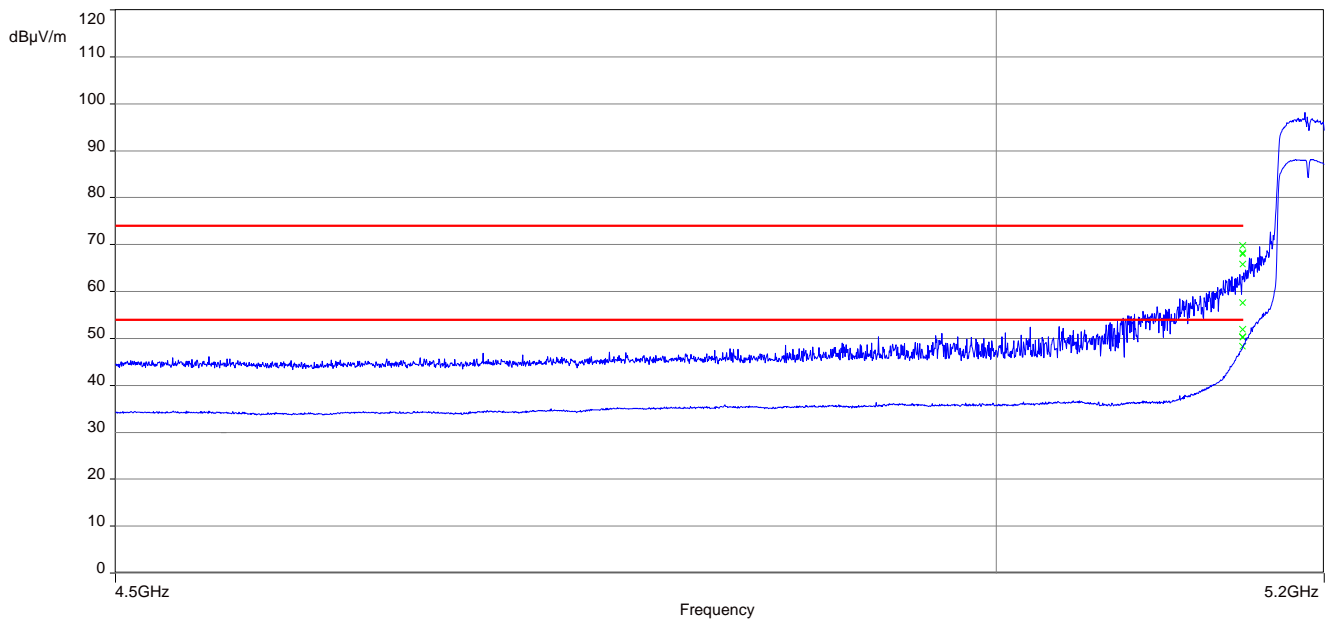

**Plot 5:** upper band edge, vertical & horizontal polarization – OFDM 40 MHz, 5310 MHz

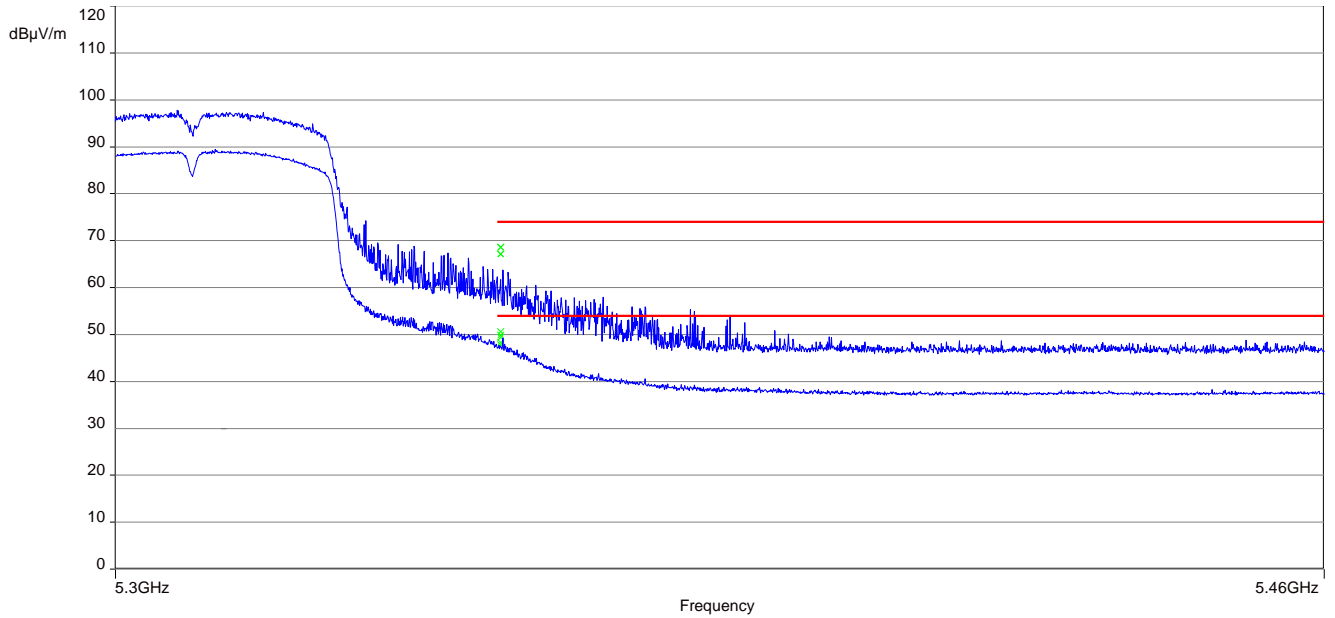

**Plot 6:** lower band edge, vertical & horizontal polarization – OFDM 40 MHz, 5510 MHz

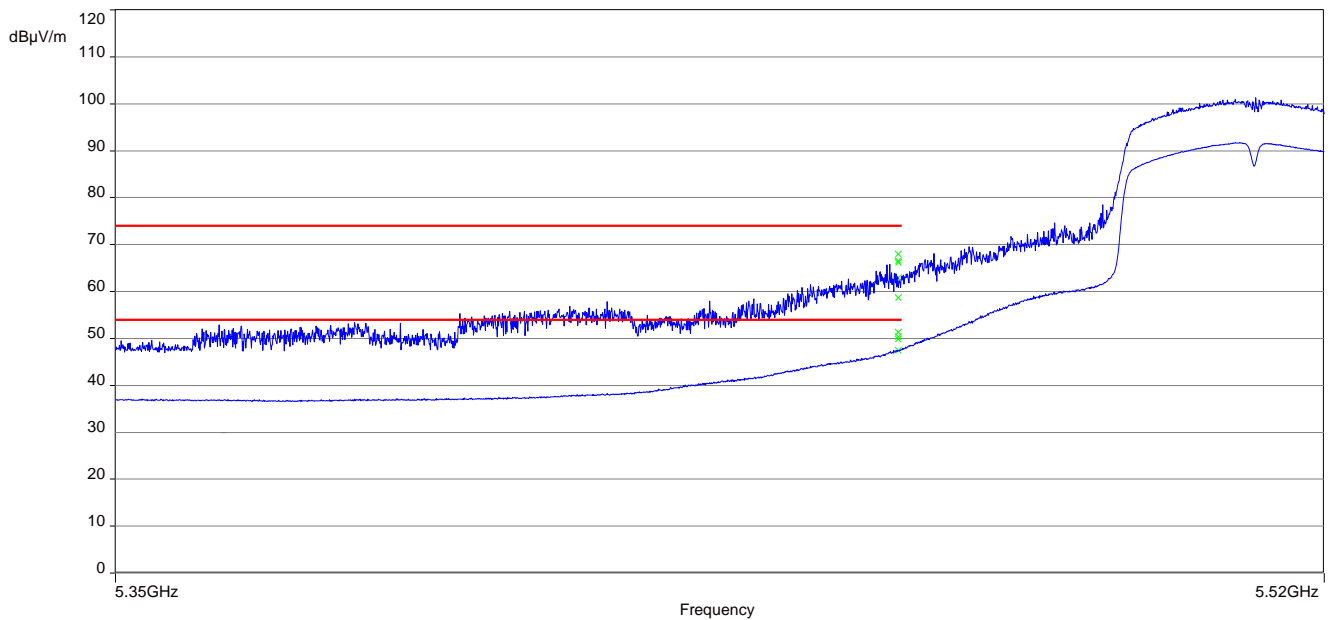

**Plot 7:** lower band edge, vertical & horizontal polarization – OFDM 80 MHz, 5210 MHz

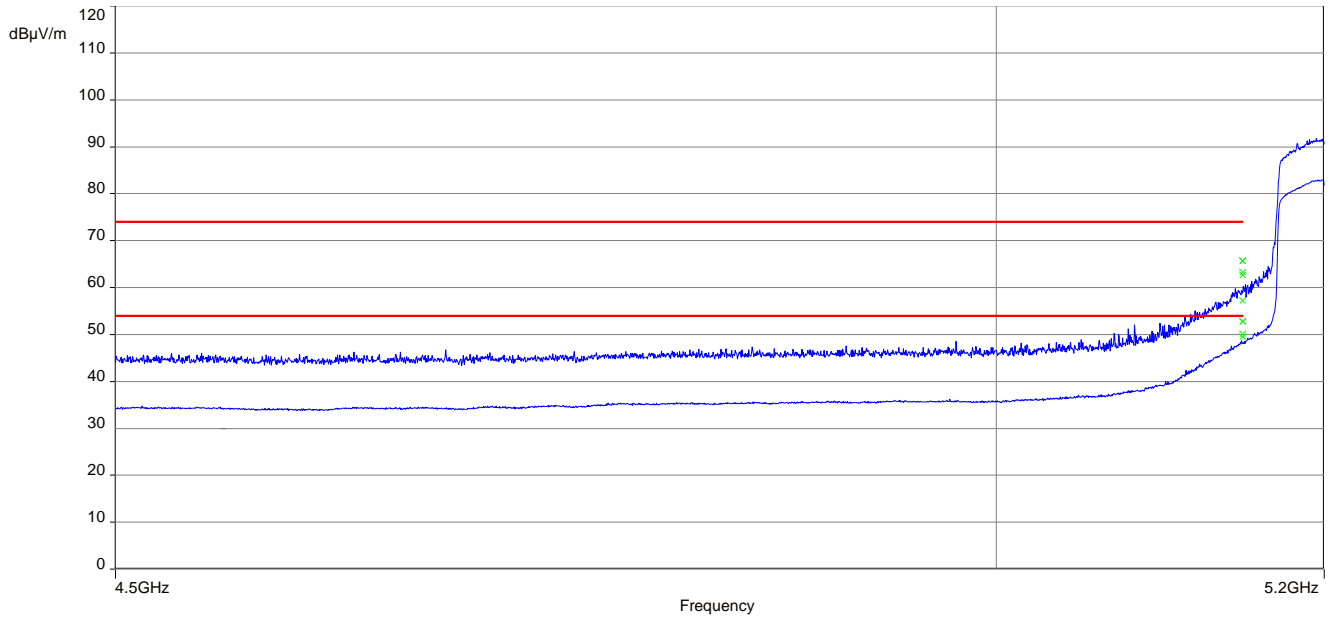

**Plot 8:** upper band edge, vertical & horizontal polarization – OFDM 80 MHz, 5290 MHz

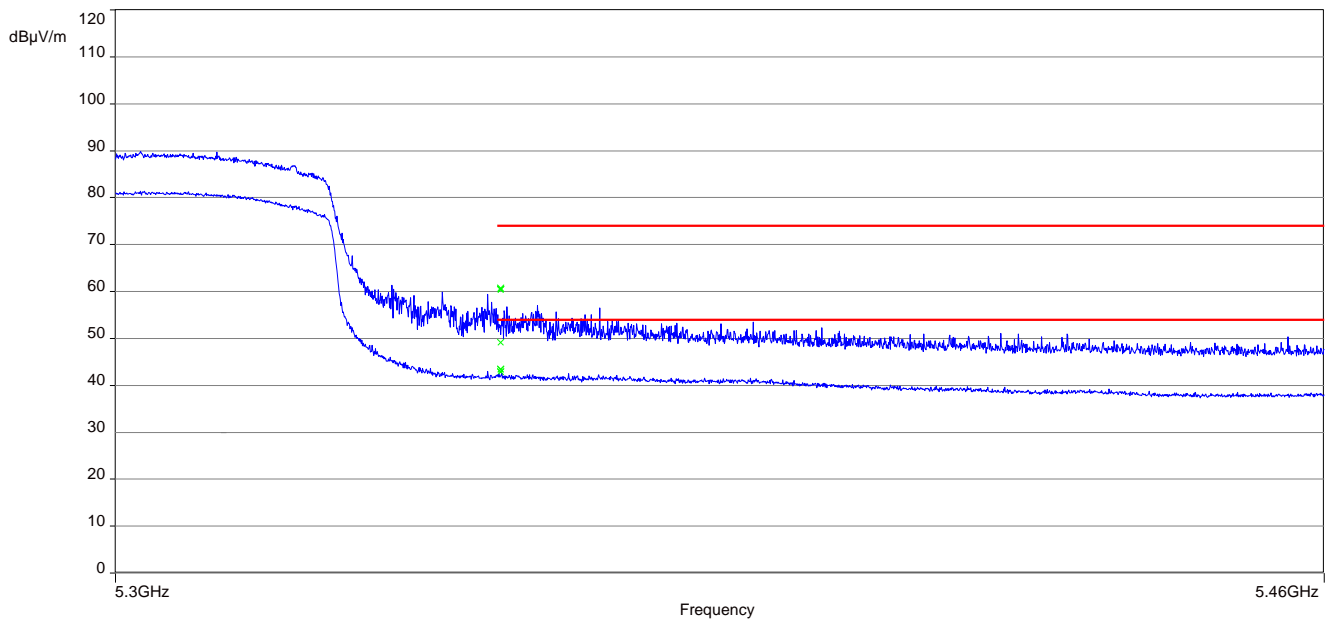

**Plot 9:** lower band edge, vertical & horizontal polarization – OFDM 80 MHz, 5530 MHz

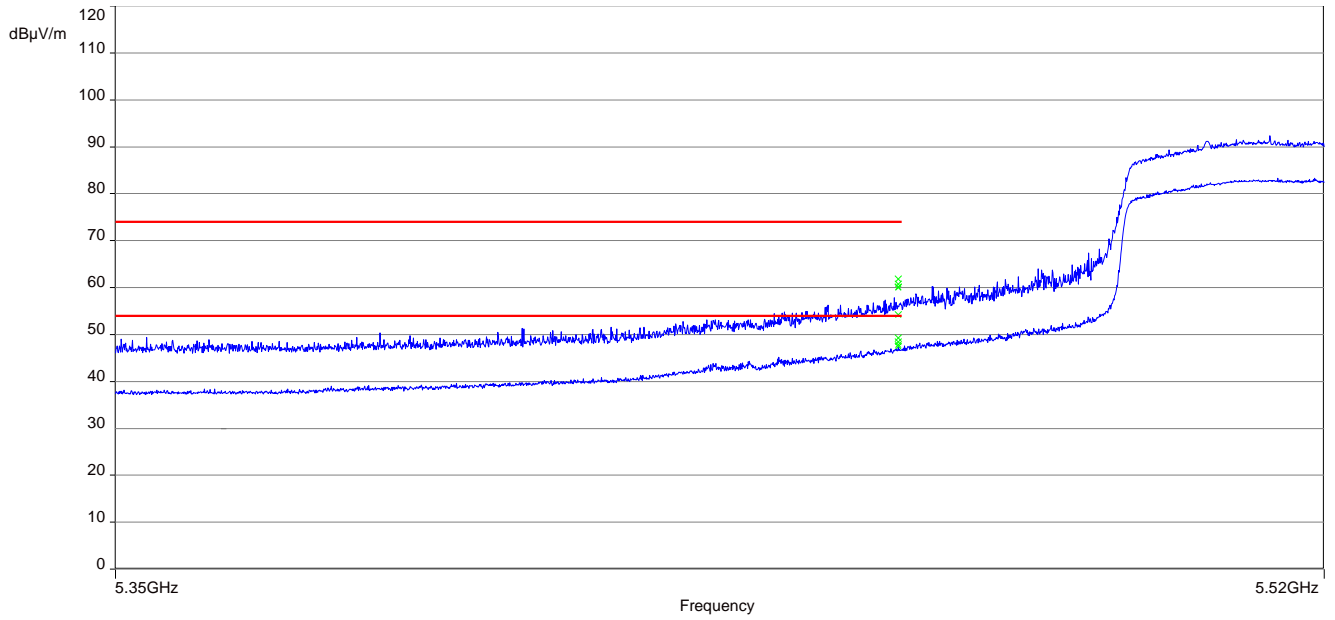

**Plots:** ANT-DB1-RAF-xxx dipole antenna

**Plot 1:** lower band edge, vertical & horizontal polarization – OFDM 20 MHz, 5180 MHz

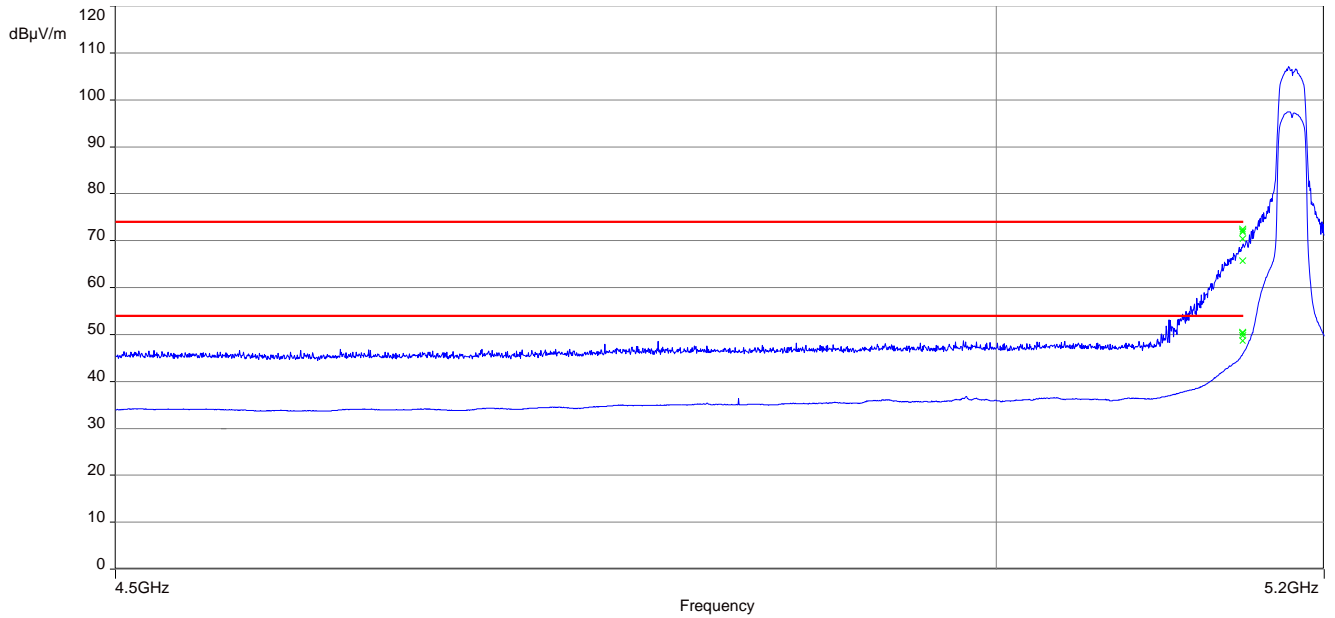

**Plot 2:** upper band edge, vertical & horizontal polarization – OFDM 20 MHz, 5320 MHz

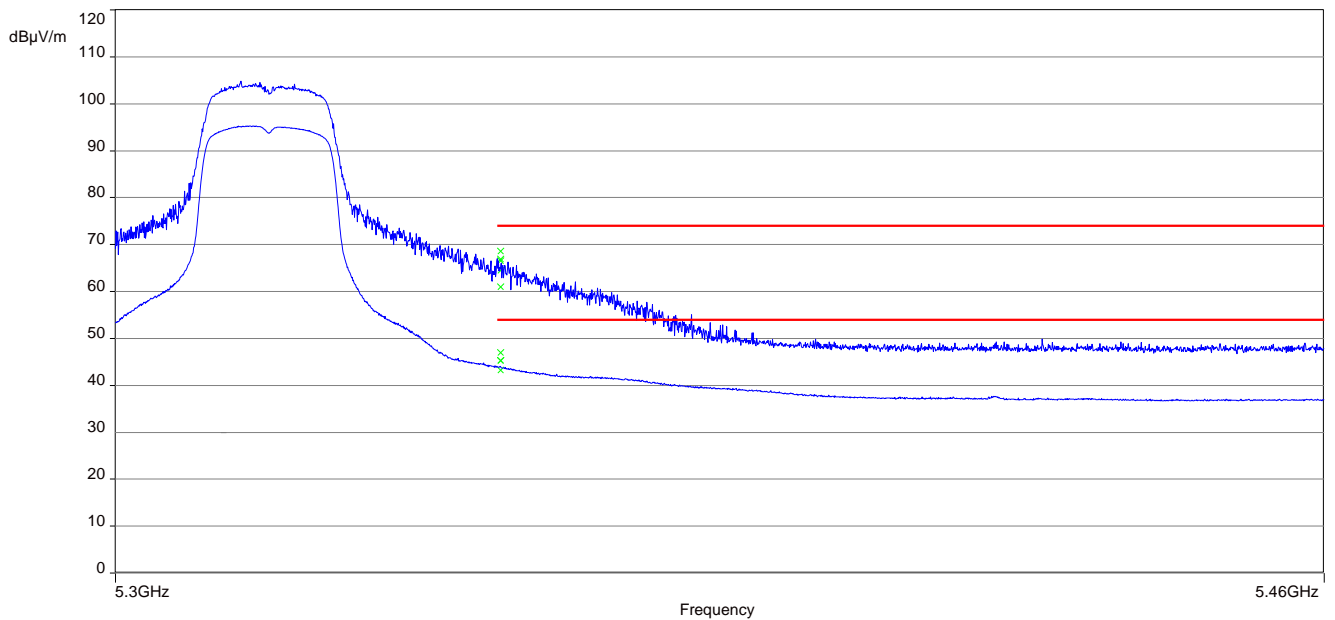

**Plot 3:** lower band edge, vertical & horizontal polarization – OFDM 20 MHz, 5500 MHz

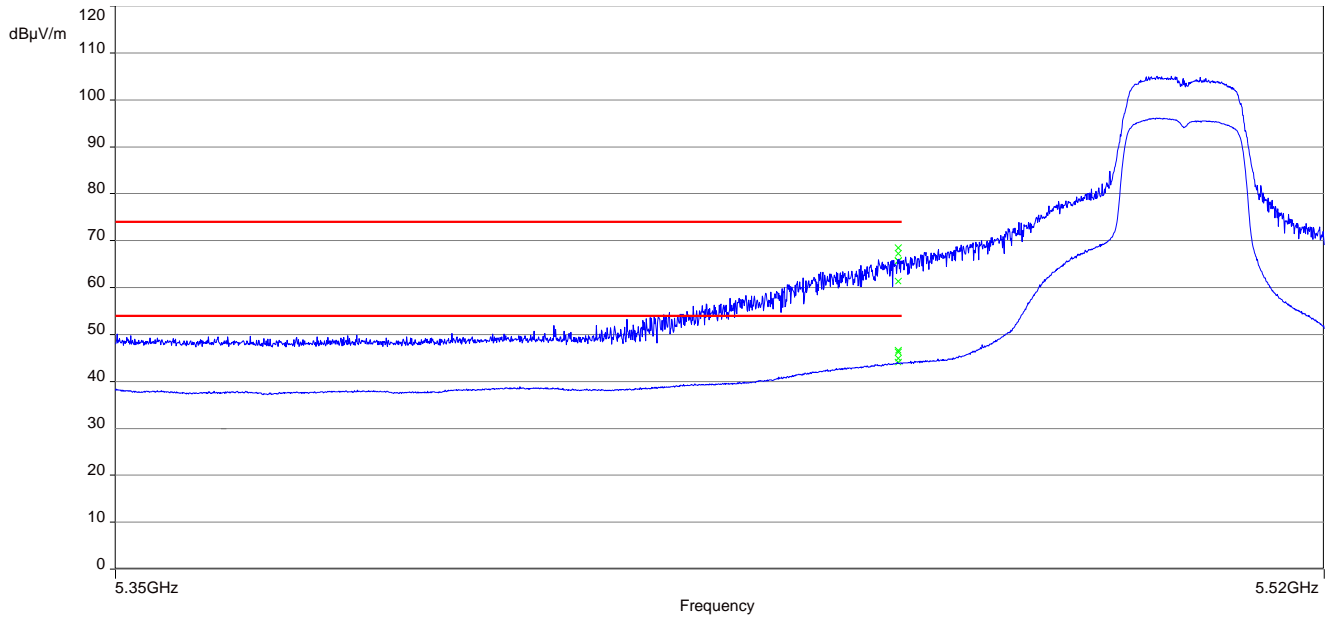

**Plot 4:** lower band edge, vertical & horizontal polarization – OFDM 40 MHz, 5190 MHz

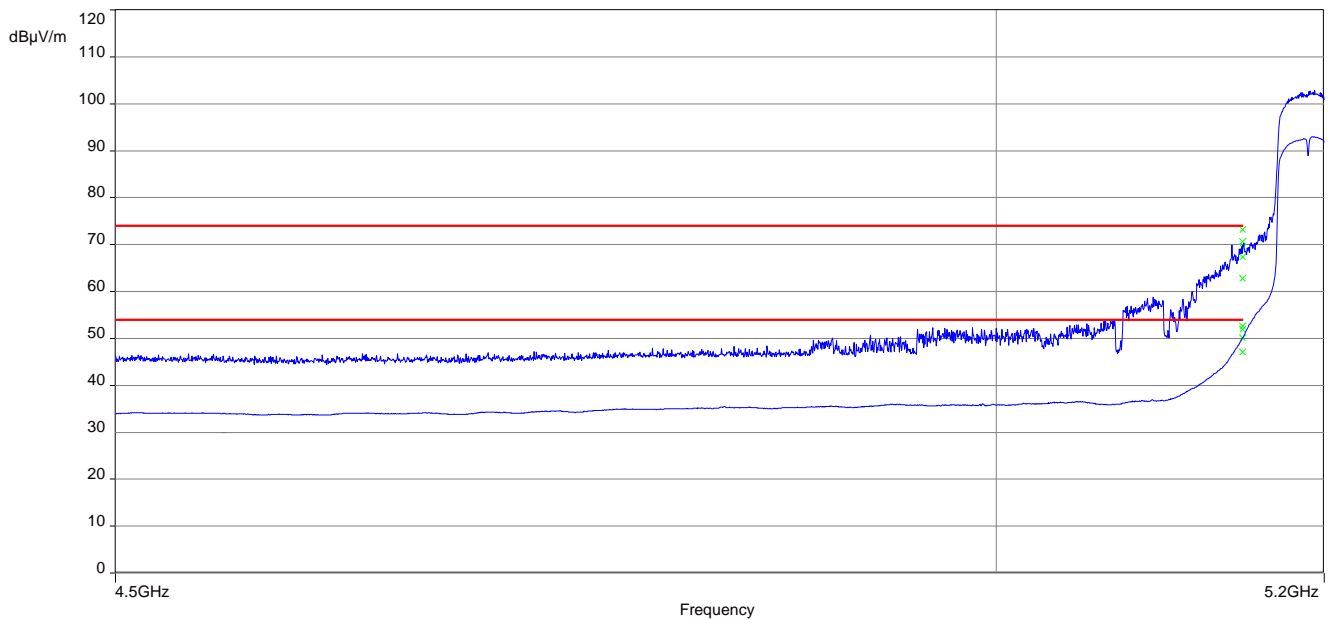

**Plot 5:** upper band edge, vertical & horizontal polarization – OFDM 40 MHz, 5310 MHz

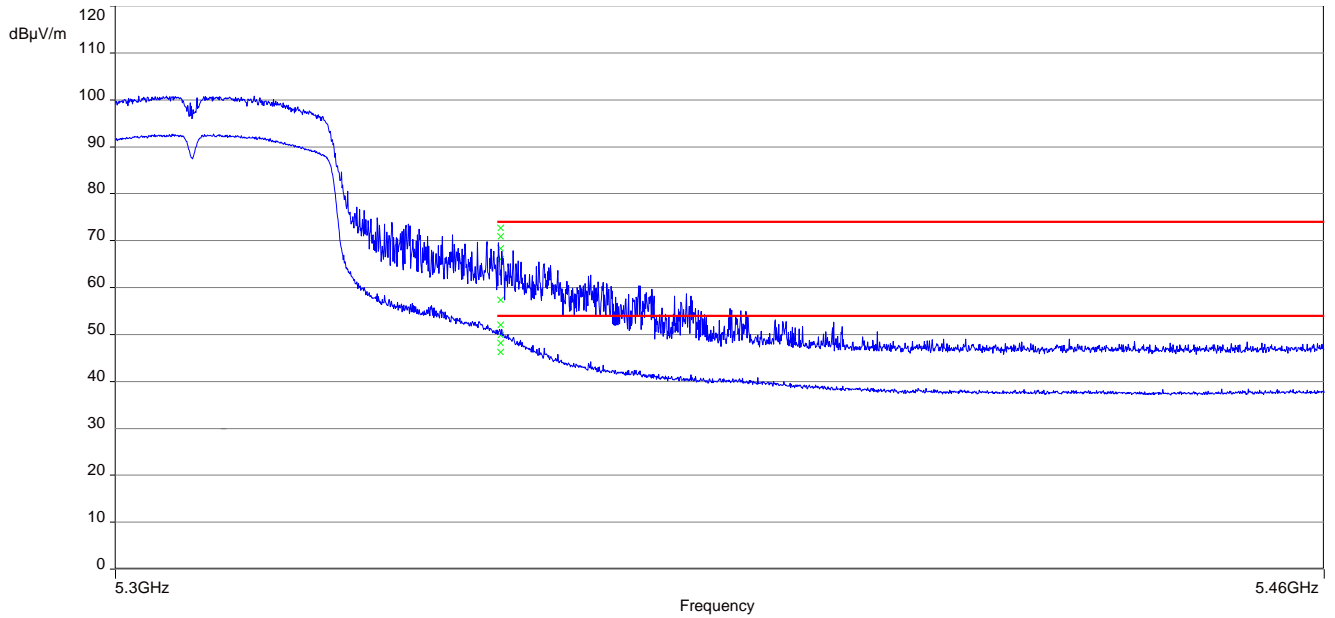

**Plot 6:** lower band edge, vertical & horizontal polarization – OFDM 40 MHz, 5510 MHz

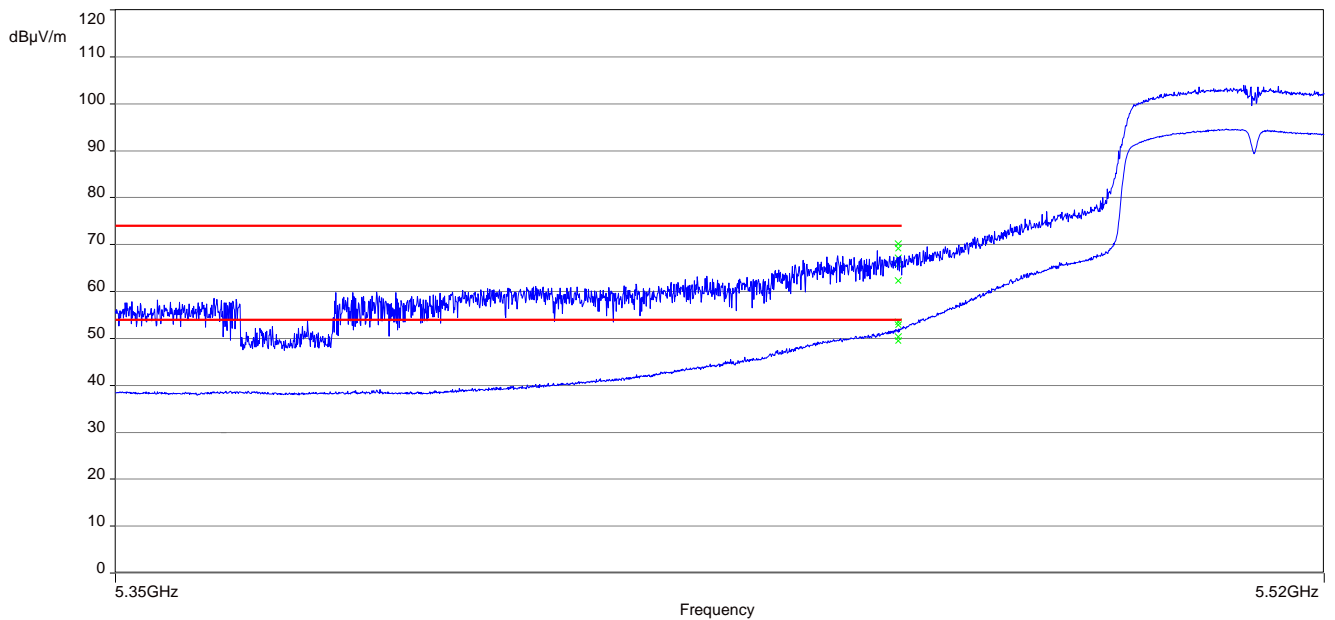

**Plot 7:** lower band edge, vertical & horizontal polarization – OFDM 80 MHz, 5210 MHz

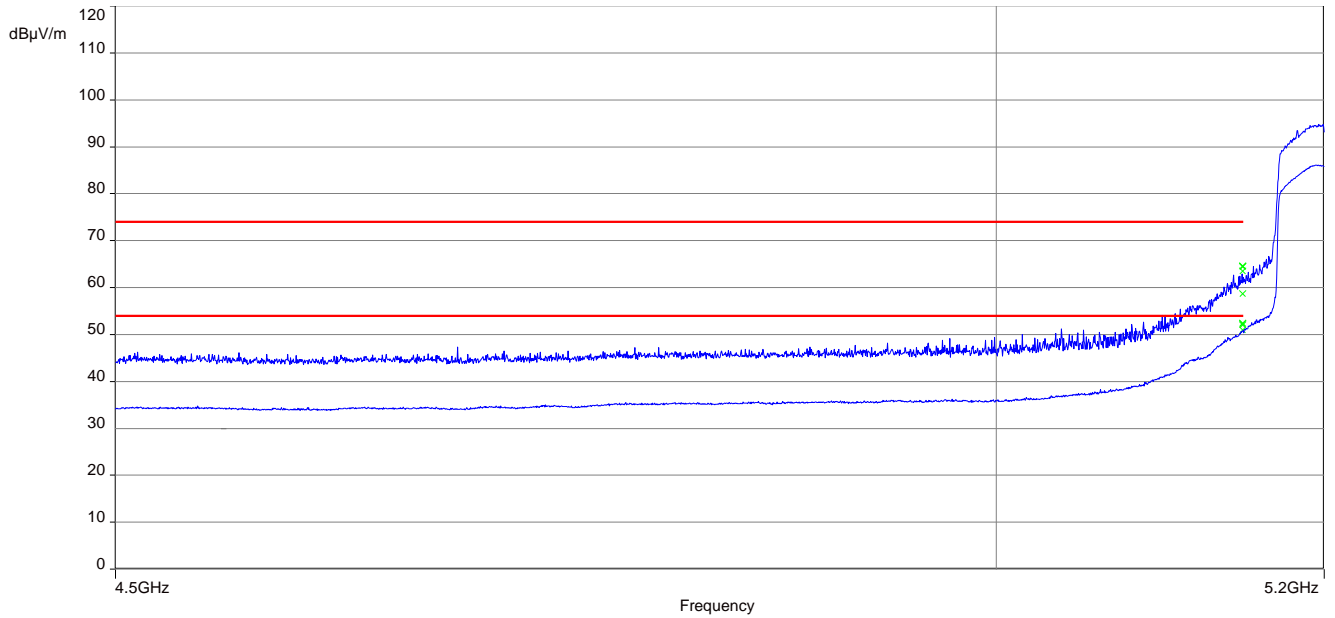

**Plot 8:** upper band edge, vertical & horizontal polarization – OFDM 80 MHz, 5290 MHz

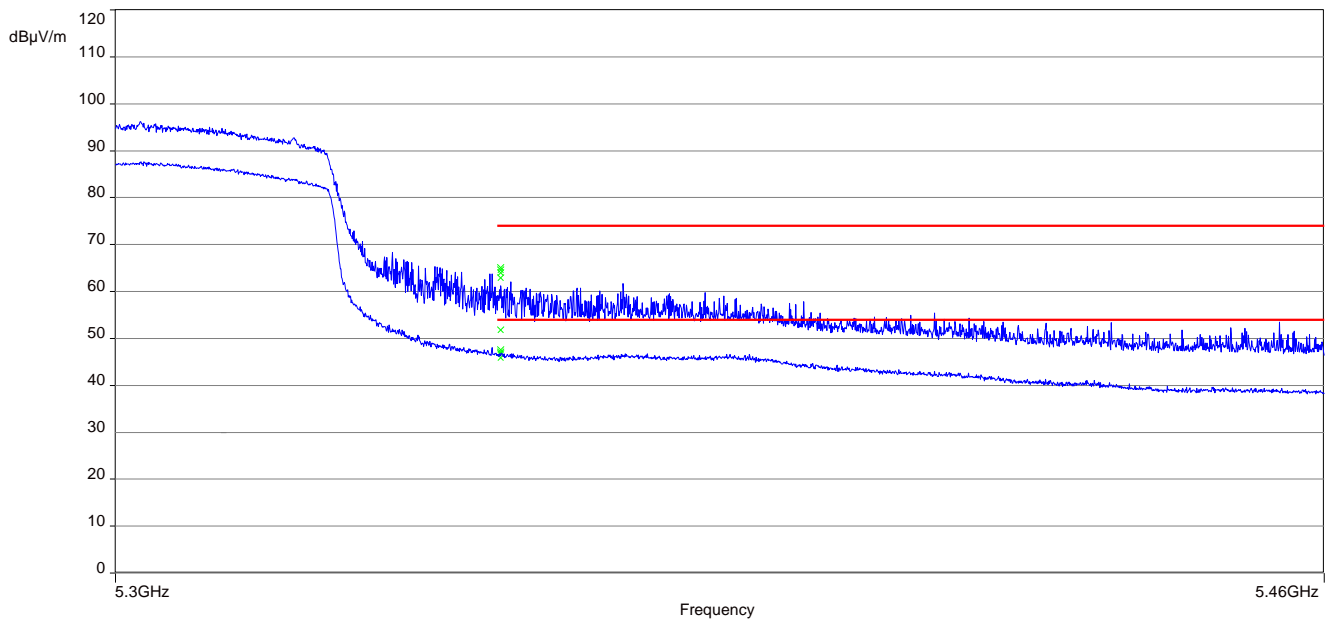



**Plot 9:** lower band edge, vertical & horizontal polarization – OFDM 80 MHz, 5530 MHz

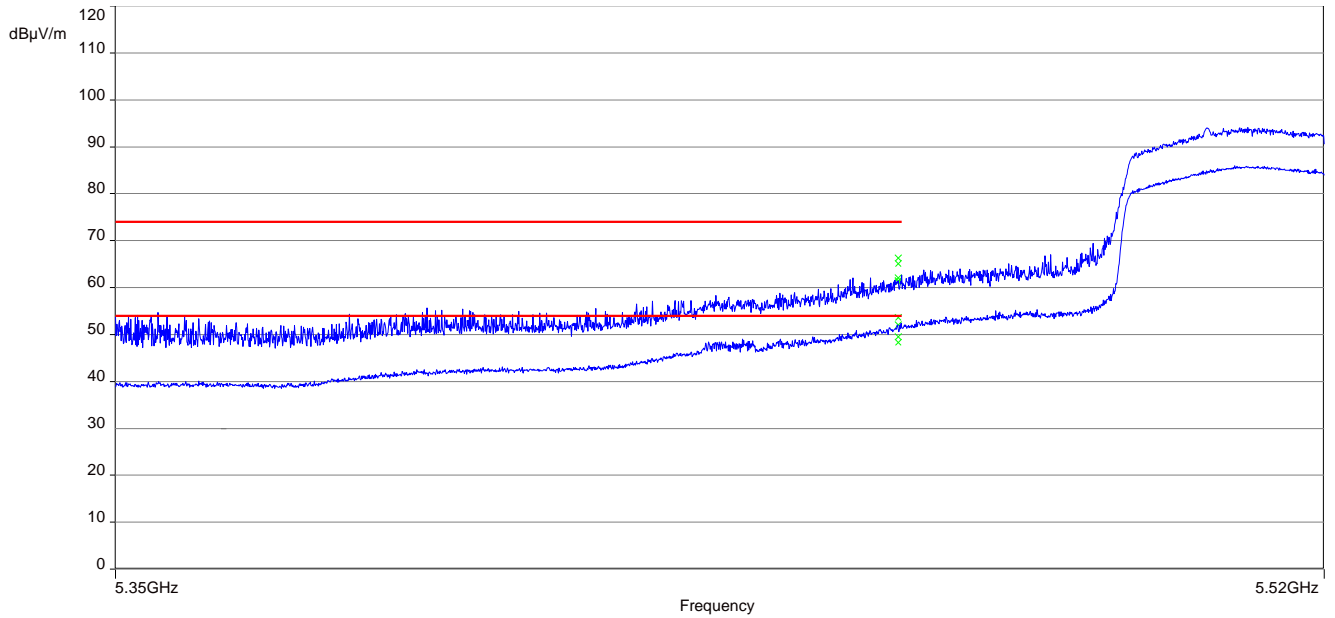

## 12.10 TX spurious emissions radiated

See Annex 1-3116\_16-01-20-C

**12.11 RX spurious emissions radiated**

**Description:**

Measurement of the radiated spurious emissions in idle/receive mode.

Measurement parameter	
Detector:	Quasi Peak below 1 GHz (alternative Peak) Peak above 1 GHz / RMS
Sweep time:	Auto
Resolution bandwidth:	F < 1 GHz: 100 kHz F > 1 GHz: 1 MHz
Video bandwidth:	F < 1 GHz: 100 kHz F > 1 GHz: ≥ 3 MHz
Span:	30 MHz to 40 GHz
Trace – mode:	Max Hold / Average with 100 counts + 20 log (1 / X) for duty cycle lower than 100 %
Test setup:	See sub clause 7.1 – A See sub clause 7.2 – B See sub clause 7.3 – A
Measurement uncertainty:	See sub clause 9

**Limits:**

RX Spurious Emissions Radiated		
Frequency (MHz)	Field Strength (dBµV/m)	Measurement distance
30 - 88	30.0	10
88 – 216	33.5	10
216 – 960	36.0	10
Above 960	54.0	3

**Results:** ANT-X100P001B24553 antenna

RX Spurious Emissions Radiated [dBµV/m]		
F [MHz]	Detector	Level [dBµV/m]

**Results:** ANT-DB1-RAF-xxx antenna

RX Spurious Emissions Radiated [dBµV/m]		
F [MHz]	Detector	Level [dBµV/m]

**Plots:** ANTX100P001B24553 antenna

**Plot 1:** 30 MHz to 1 GHz, vertical & horizontal polarization

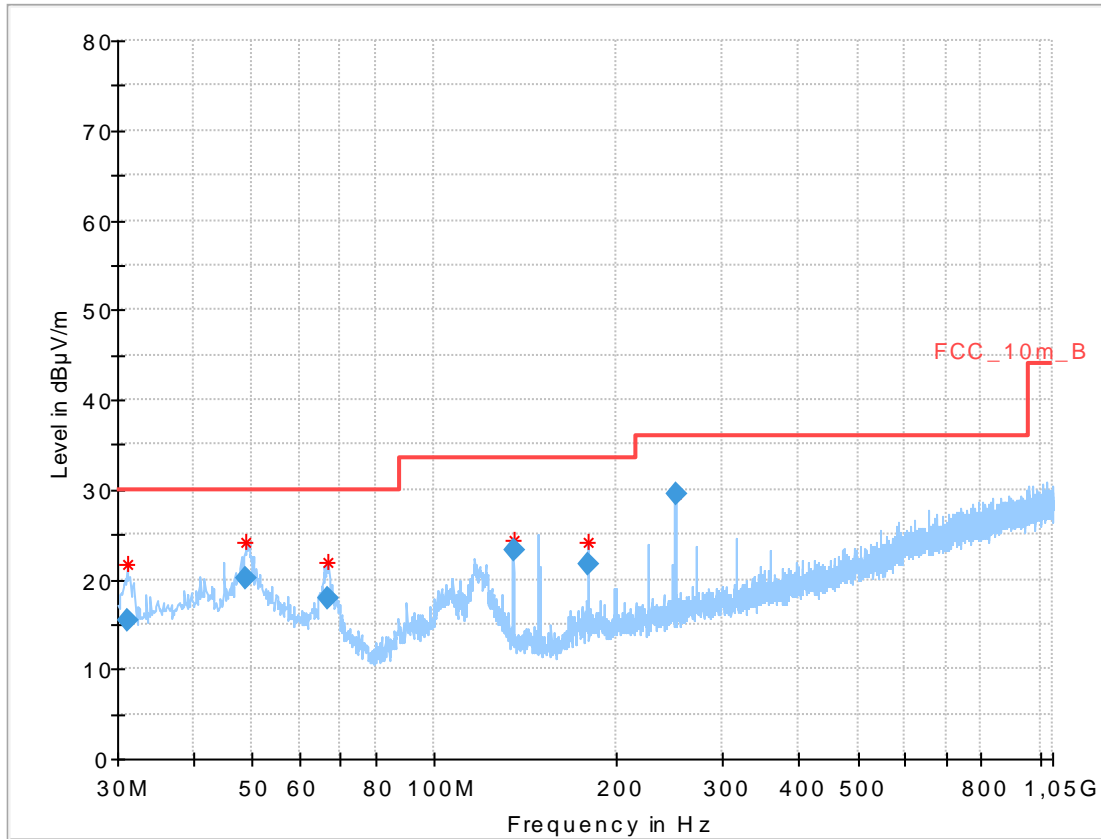

**Final results:**

Frequency (MHz)	QuasiPeak (dBµV/m)	Limit (dBµV/m)	Margin (dB)	Meas. Time (ms)	Bandwidth (kHz)	Height (cm)	Pol	Azimuth (deg)	Corr. (dB)
31.124100	15.39	30.00	14.61	1000.0	120.000	101.0	V	238.0	12.0
48.931950	20.21	30.00	9.79	1000.0	120.000	101.0	V	3.0	13.7
66.918600	17.77	30.00	12.23	1000.0	120.000	185.0	V	146.0	10.4
134.998200	23.21	33.50	10.29	1000.0	120.000	98.0	V	83.0	9.2
179.985750	21.75	33.50	11.75	1000.0	120.000	98.0	V	199.0	10.9
250.003800	29.42	36.00	6.58	1000.0	120.000	101.0	V	48.0	13.4

**Plot 2:** 1 GHz to 18 GHz, vertical & horizontal polarization

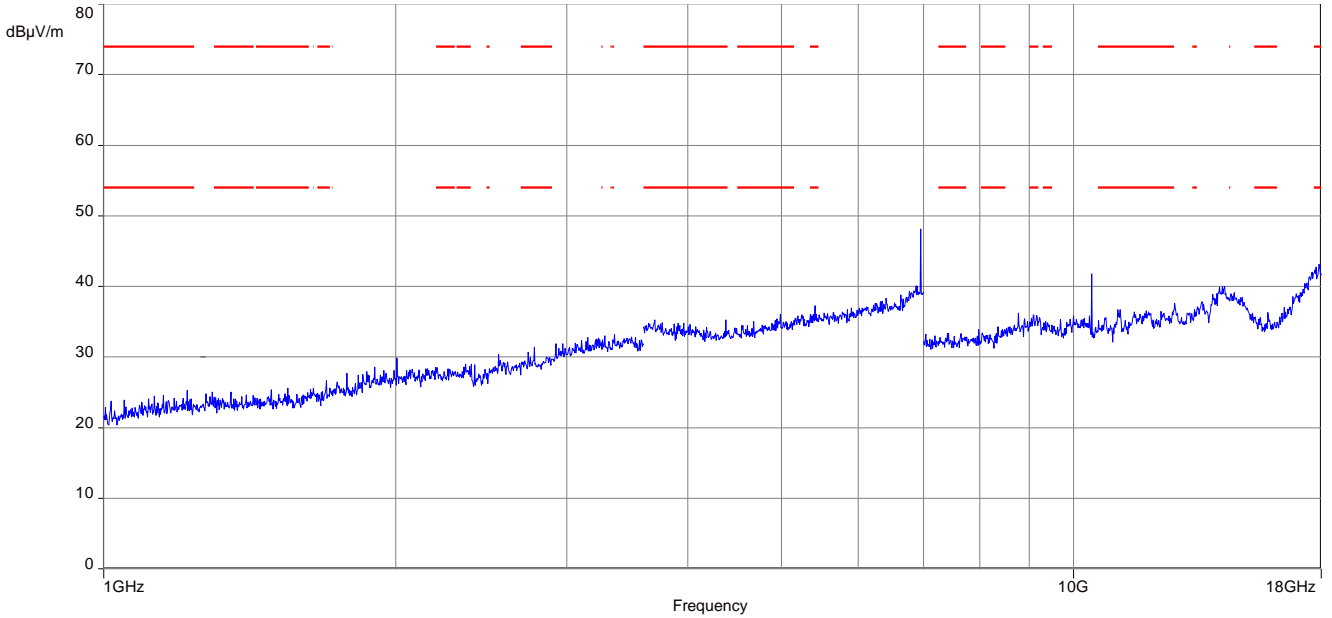

**Plot 3:** 18 GHz to 26 GHz, vertical & horizontal polarization

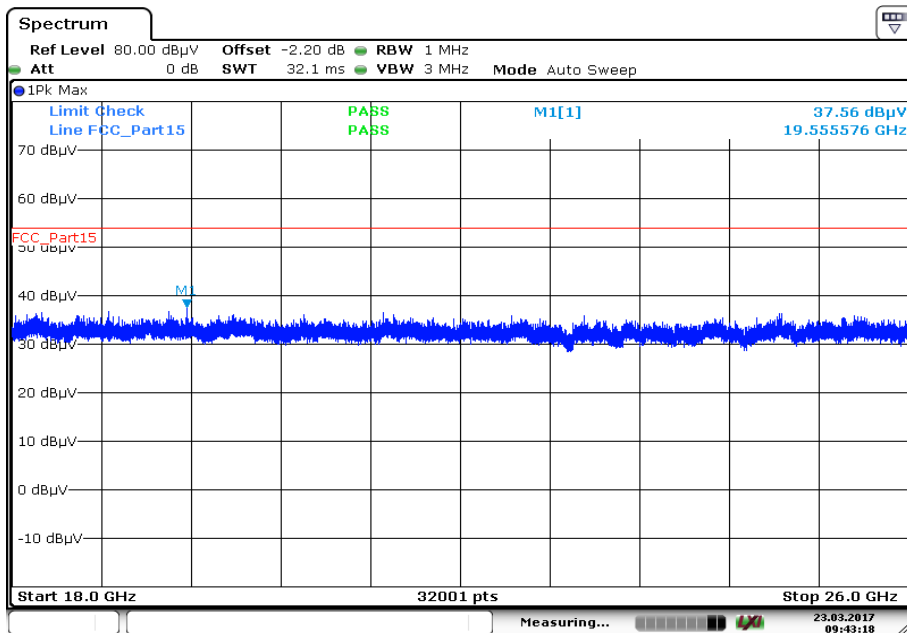

Date: 23.MAR.2017 09:43:18

Plot 4: 26 GHz to 40 GHz, vertical & horizontal polarization

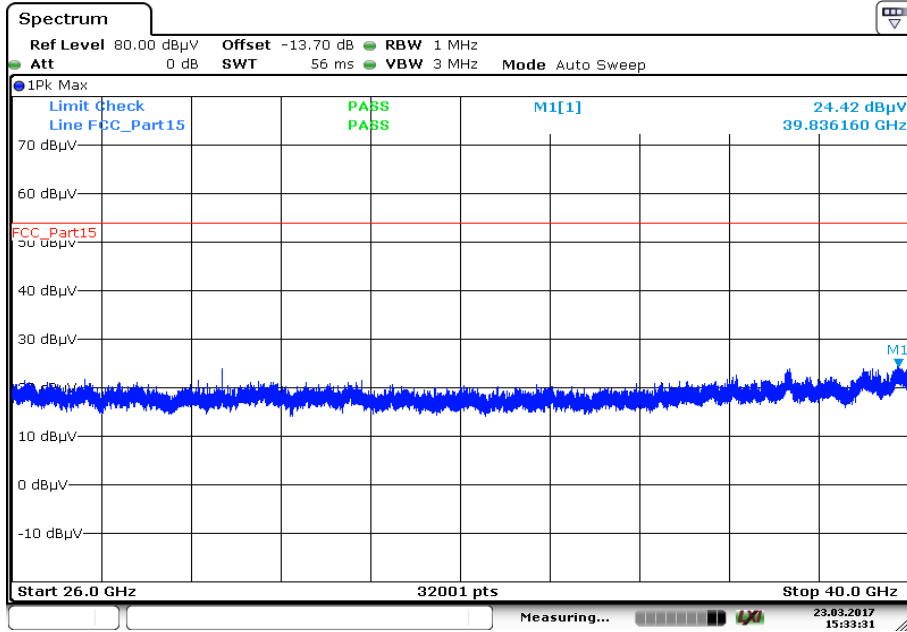

Date: 23.MAR.2017 15:33:31

**Plots:** ANT-DB1-RAF-xxx antenna

**Plot 1:** 30 MHz to 1 GHz, vertical & horizontal polarization

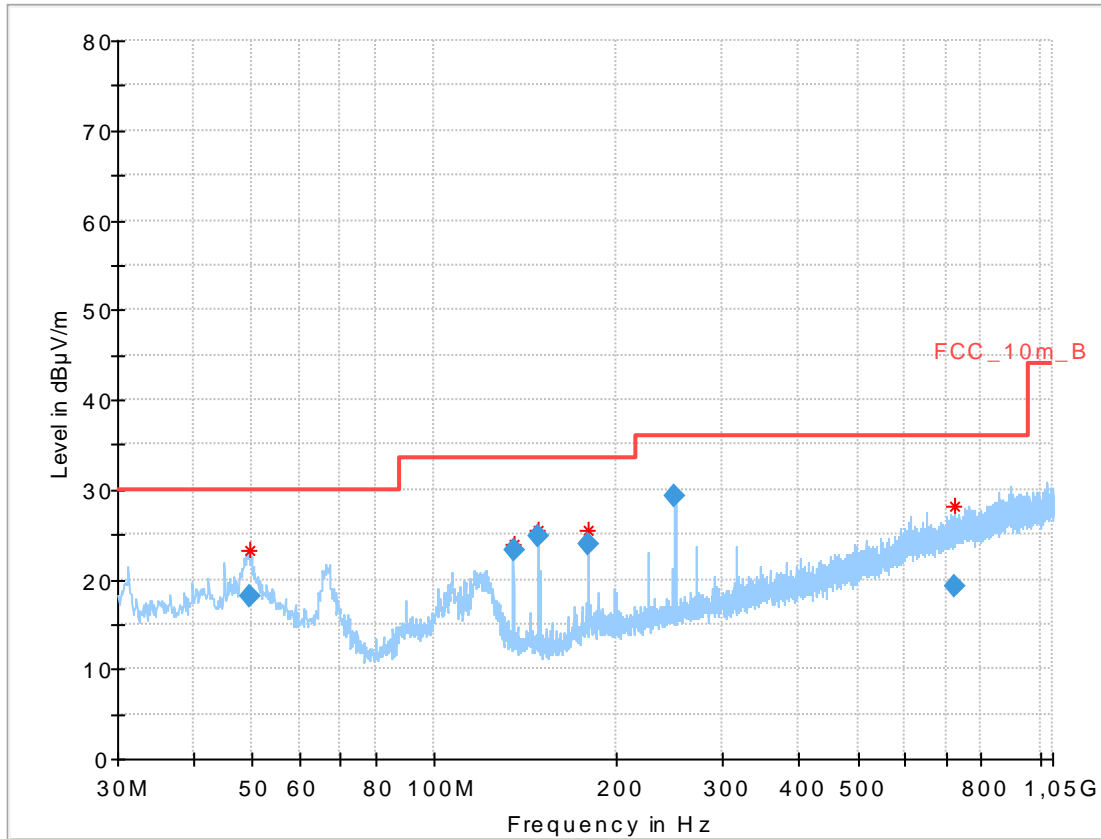

**Final results:**

Frequency (MHz)	QuasiPeak (dBµV/m)	Limit (dBµV/m)	Margin (dB)	Meas. Time (ms)	Bandwidth (kHz)	Height (cm)	Pol	Azimuth (deg)	Corr. (dB)
49.431000	18.05	30.00	11.95	1000.0	120.000	100.0	V	8.0	13.7
134.998350	23.28	33.50	10.22	1000.0	120.000	98.0	V	79.0	9.2
148.486050	24.82	33.50	8.68	1000.0	120.000	98.0	V	8.0	9.2
179.996400	23.83	33.50	9.67	1000.0	120.000	98.0	V	147.0	10.9
249.992550	29.26	36.00	6.74	1000.0	120.000	98.0	V	79.0	13.4
721.929000	19.32	36.00	16.68	1000.0	120.000	185.0	H	137.0	22.1

**Plot 2:** 1 GHz to 18 GHz, vertical & horizontal polarization

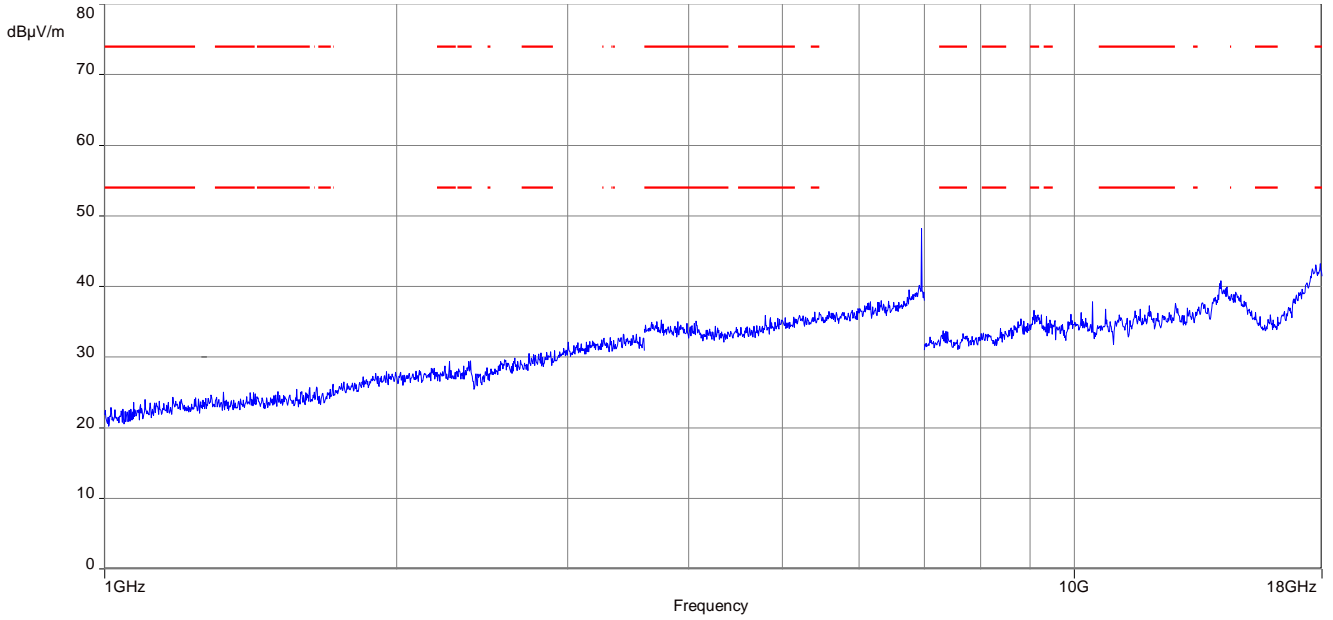

**Plot 3:** 18 GHz to 26 GHz, vertical & horizontal polarization

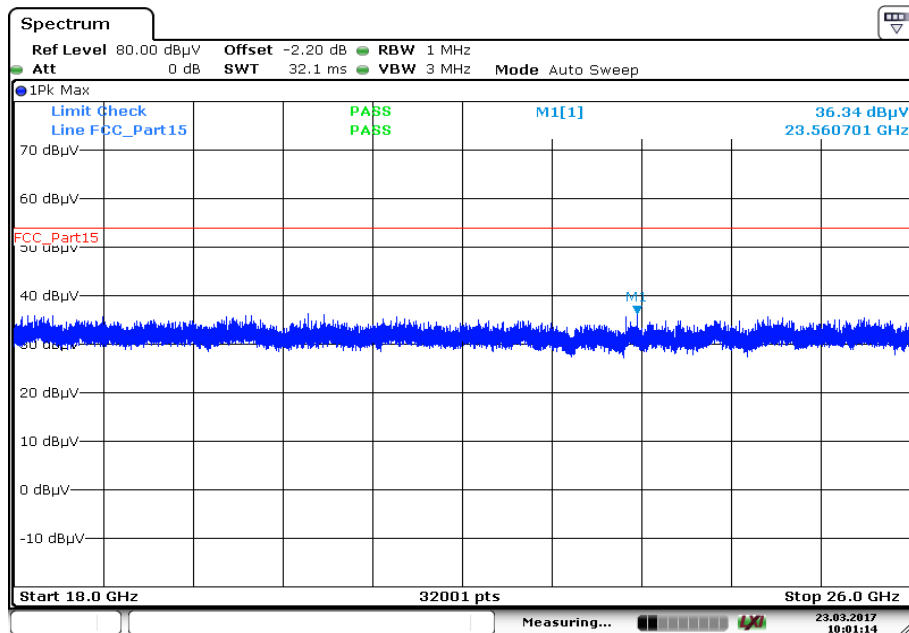

Date: 23.MAR.2017 10:01:14



Plot 4: 26 GHz to 40 GHz, vertical & horizontal polarization

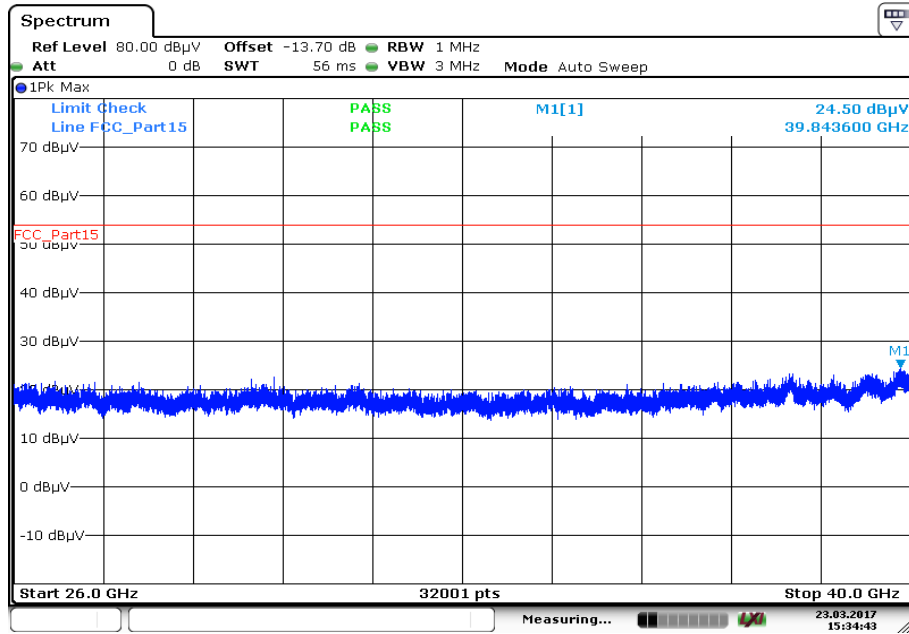

Date: 23.MAR.2017 15:34:43

**12.12 Spurious emissions radiated < 30 MHz**

**Description:**

Measurement of the radiated spurious emissions in transmit mode and receive mode below 30 MHz. The EUT is set first to middle channel. This measurement is representative for all channels and modes. If critical peaks are found the lowest channel and the highest channel will be measured too. Then the EUT is set to receive or idle mode. The limits are recalculated to a measurement distance of 3 m with 40 dB/decade according CFR Part 2.

**Measurement:**

Measurement parameter	
Detector:	Peak / Quasi Peak
Sweep time:	Auto
Video bandwidth:	F < 150 kHz: 200 Hz F > 150 kHz: 9 kHz
Resolution bandwidth:	F < 150 kHz: 1 kHz F > 150 kHz: 100 kHz
Span:	9 kHz to 30 MHz
Trace – mode:	Max Hold
Test setup:	See sub clause 7.2 – C
Measurement uncertainty:	See sub clause 9

**Limits:**

Spurious Emissions Radiated < 30 MHz		
Frequency (MHz)	Field Strength (dBµV/m)	Measurement distance
0.009 – 0.490	2400/F(kHz)	300
0.490 – 1.705	24000/F(kHz)	30
1.705 – 30.0	30	30

**Results:** ANT-X100P001B24553 antenna

Spurious Emissions Radiated < 30 MHz [dBµV/m]		
F [MHz]	Detector	Level [dBµV/m]
All detected emissions are more than 20 dB below the limit.		

**Results:** ANT-DB1-RAF-xxx antenna

Spurious Emissions Radiated < 30 MHz [dBµV/m]		
F [MHz]	Detector	Level [dBµV/m]
All detected emissions are more than 20 dB below the limit.		

**Plots:** ANT-DB1-RAF-xxx antenna

**Plot 1:** 9 kHz to 30 MHz, OFDM 20 MHz, 5180 MHz

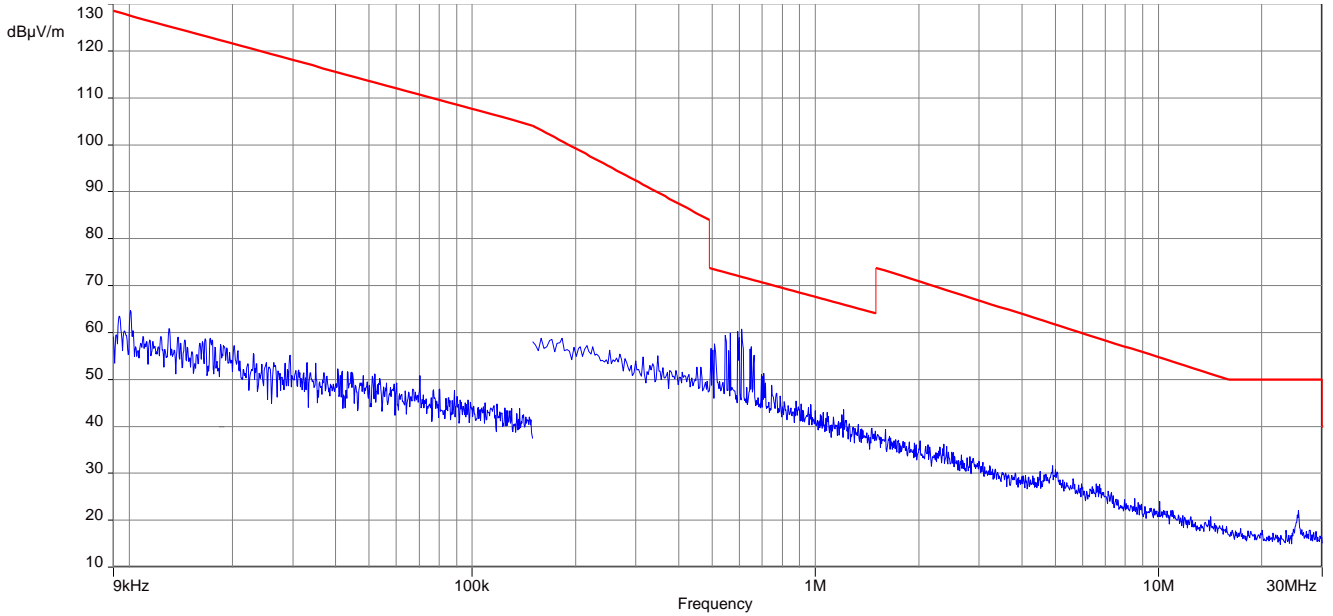

**Plot 2:** 9 kHz to 30 MHz, OFDM 20 MHz, 5240 MHz

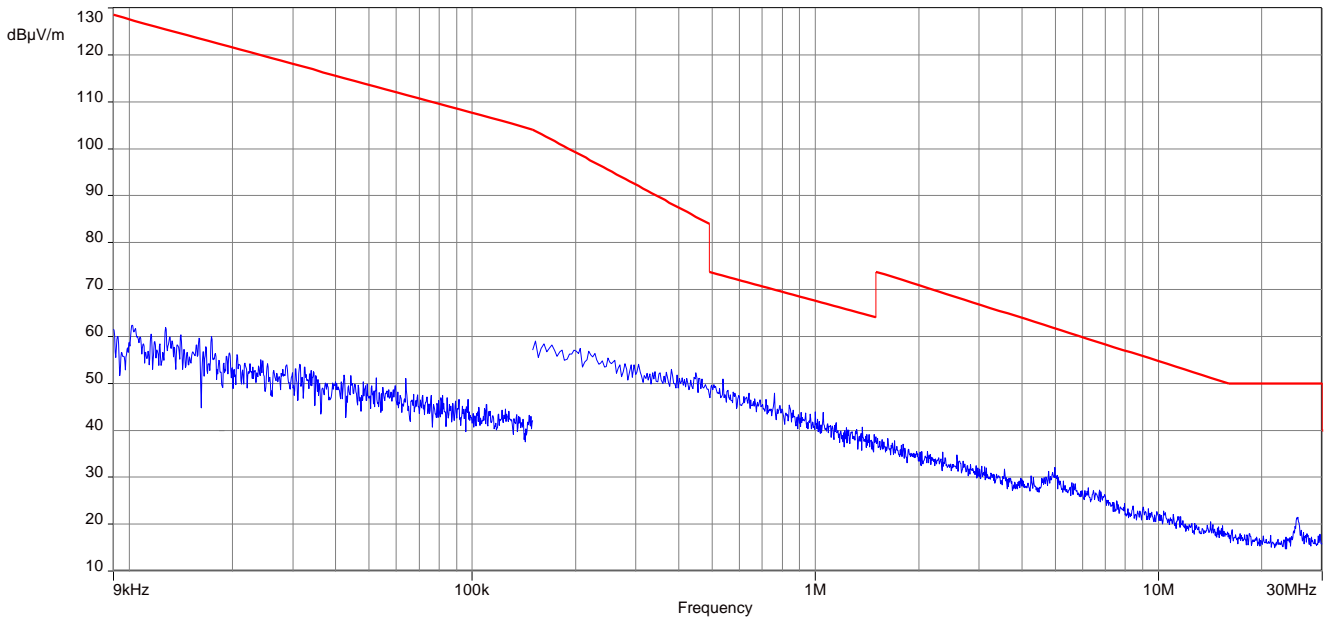

**Plot 3:** 9 kHz to 30 MHz, OFDM 20 MHz, 5260 MHz

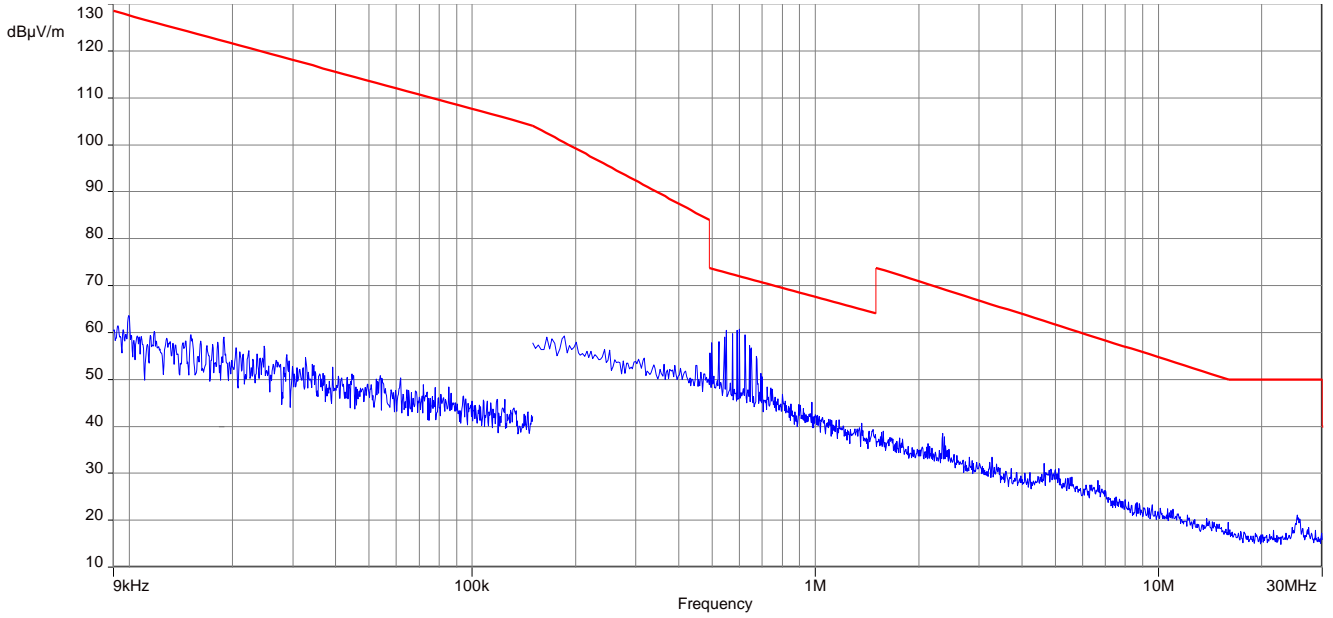

**Plot 4:** 9 kHz to 30 MHz, OFDM 20 MHz, 5320 MHz

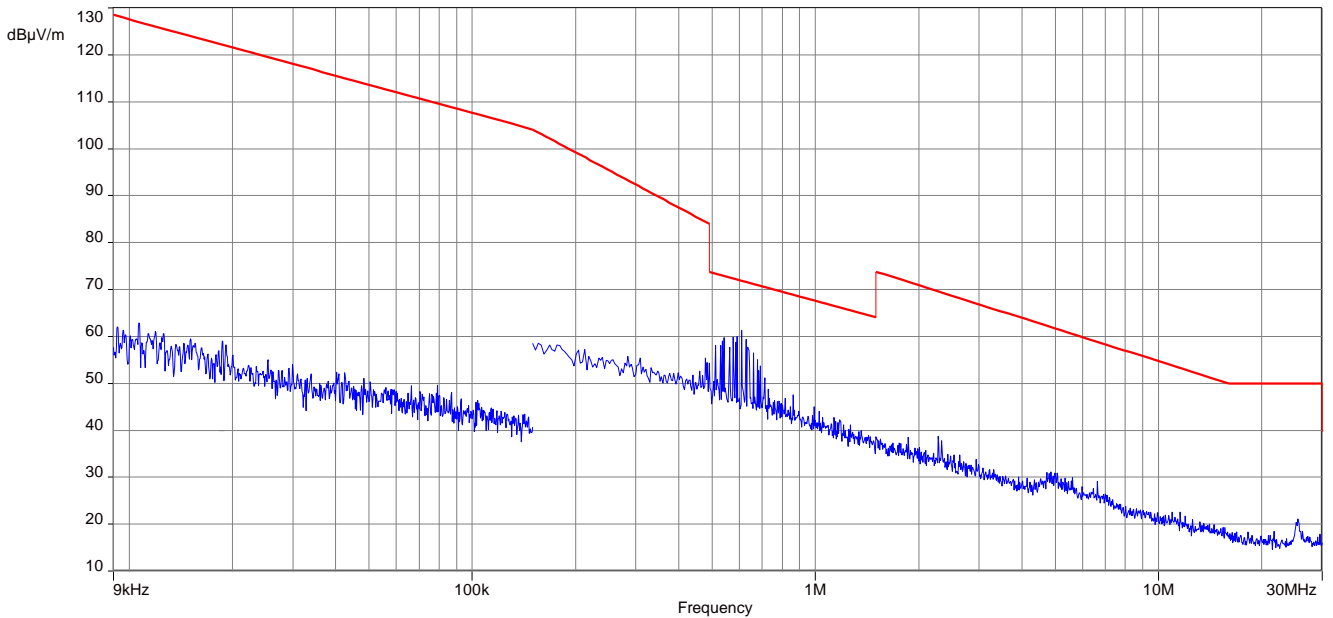

**Plot 5:** 9 kHz to 30 MHz, OFDM 20 MHz, 5500 MHz

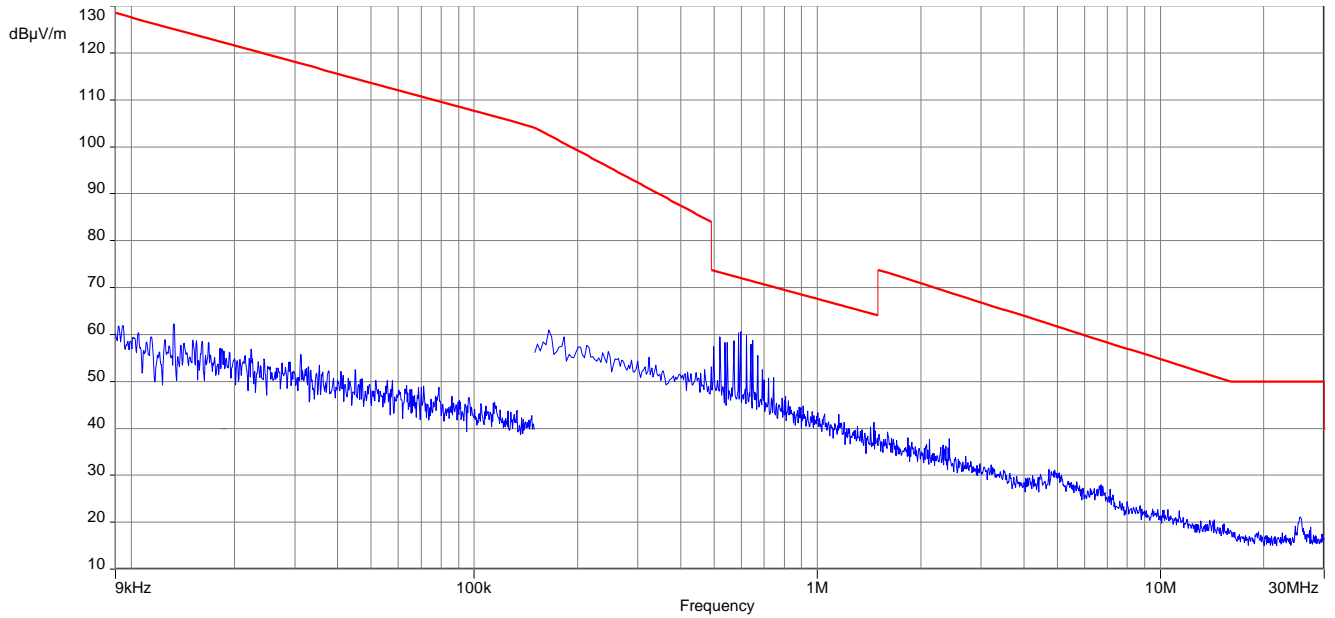

**Plot 6:** 9 kHz to 30 MHz, OFDM 20 MHz, 5600 MHz

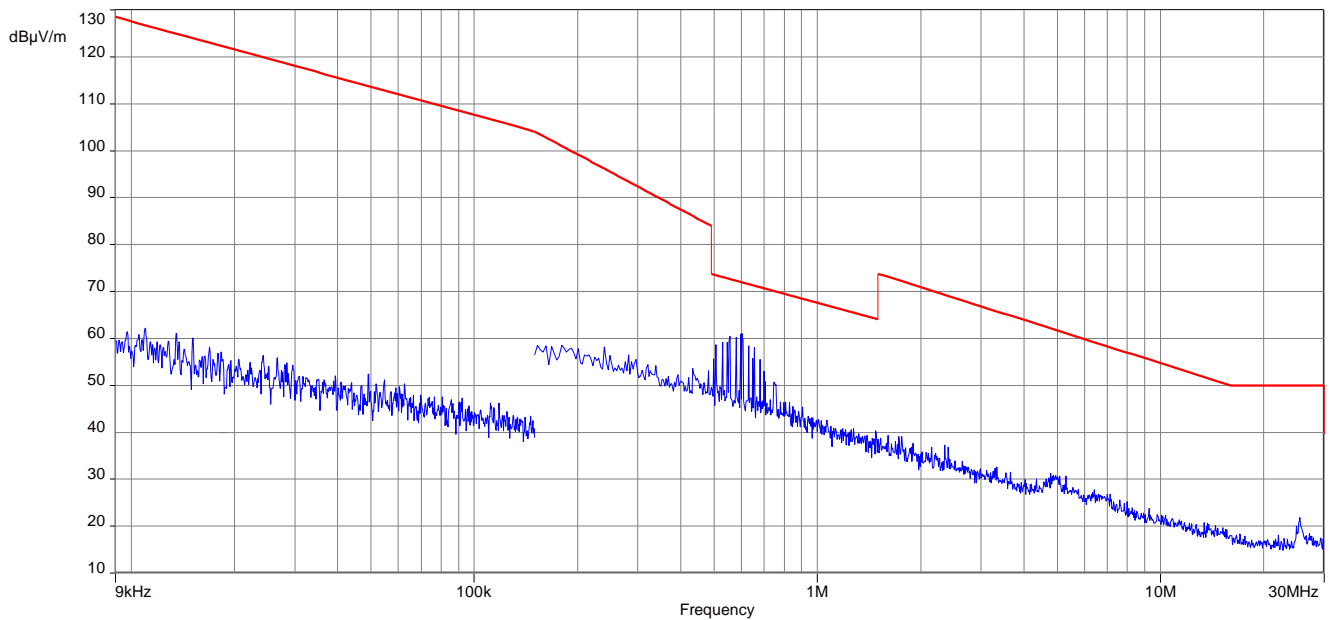

**Plot 7:** 9 kHz to 30 MHz, OFDM 20 MHz, 5700 MHz

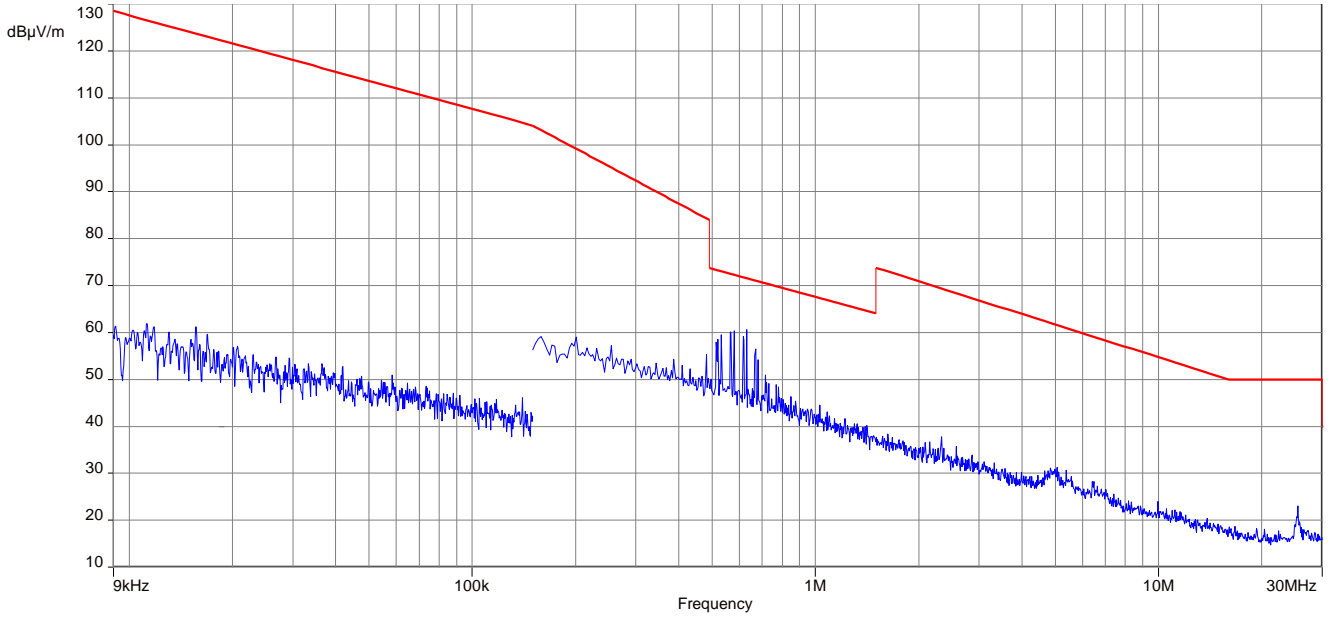

**Plot 8:** 9 kHz to 30 MHz, OFDM 20 MHz, 5745 MHz

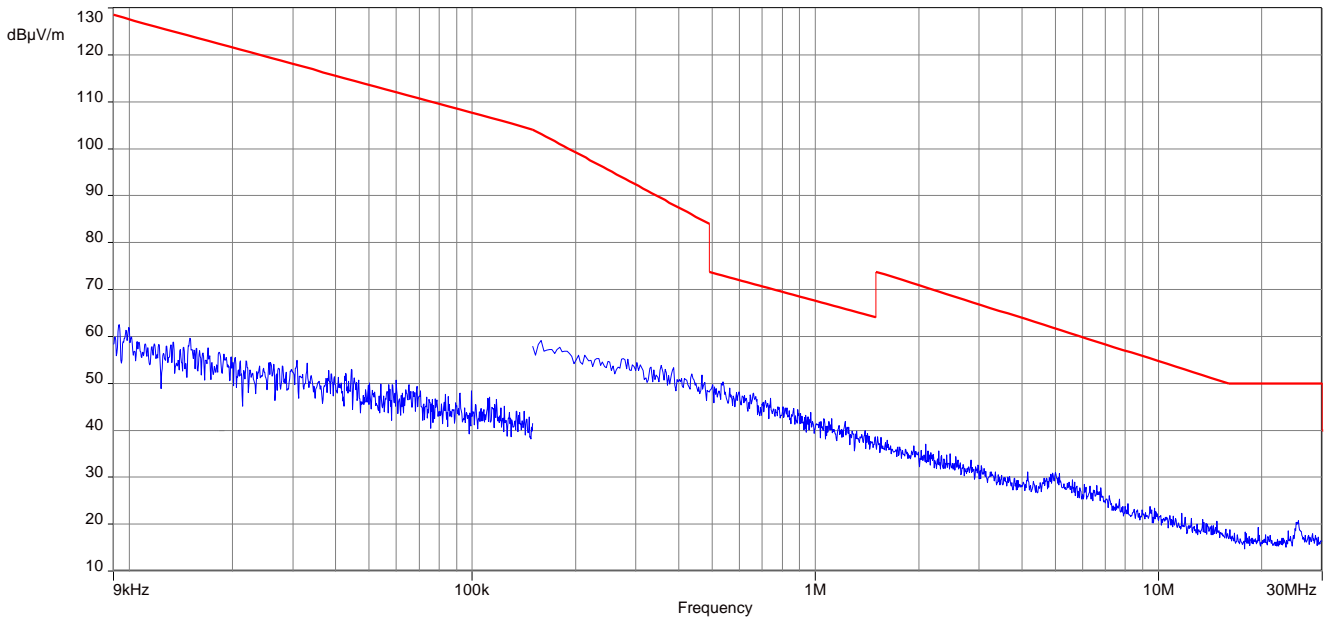

**Plot 9:** 9 kHz to 30 MHz, OFDM 20 MHz, 5785 MHz

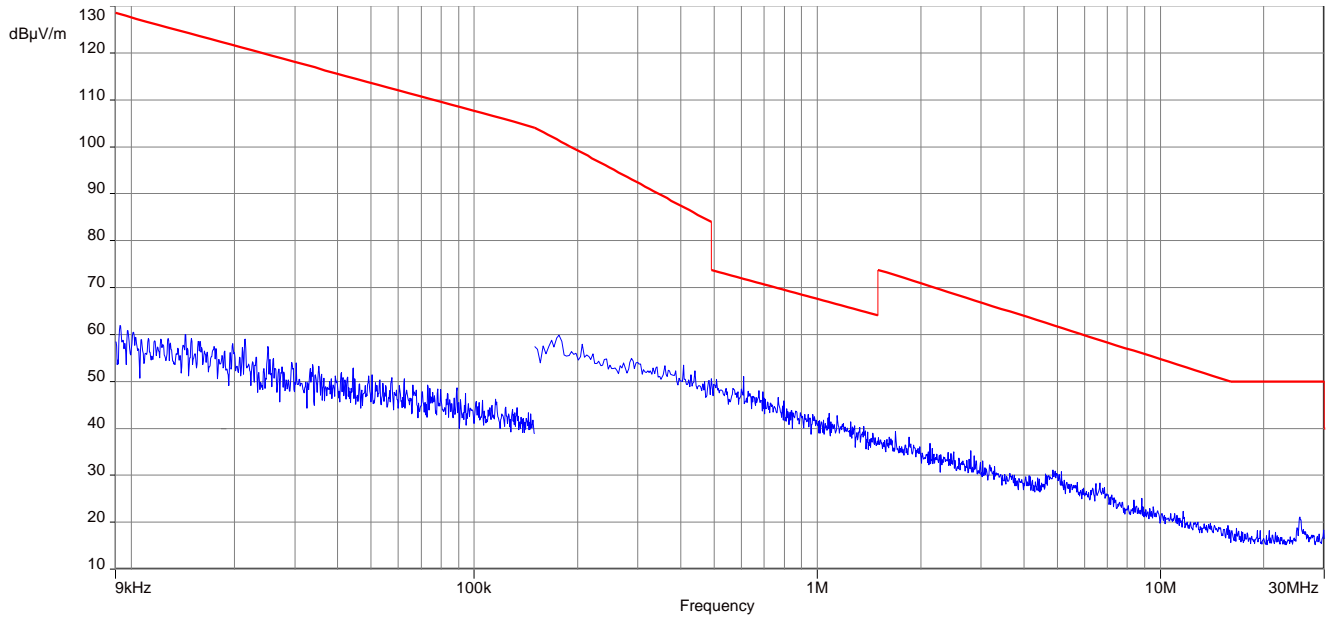

**Plot 10:** 9 kHz to 30 MHz, OFDM 20 MHz, 5825 MHz

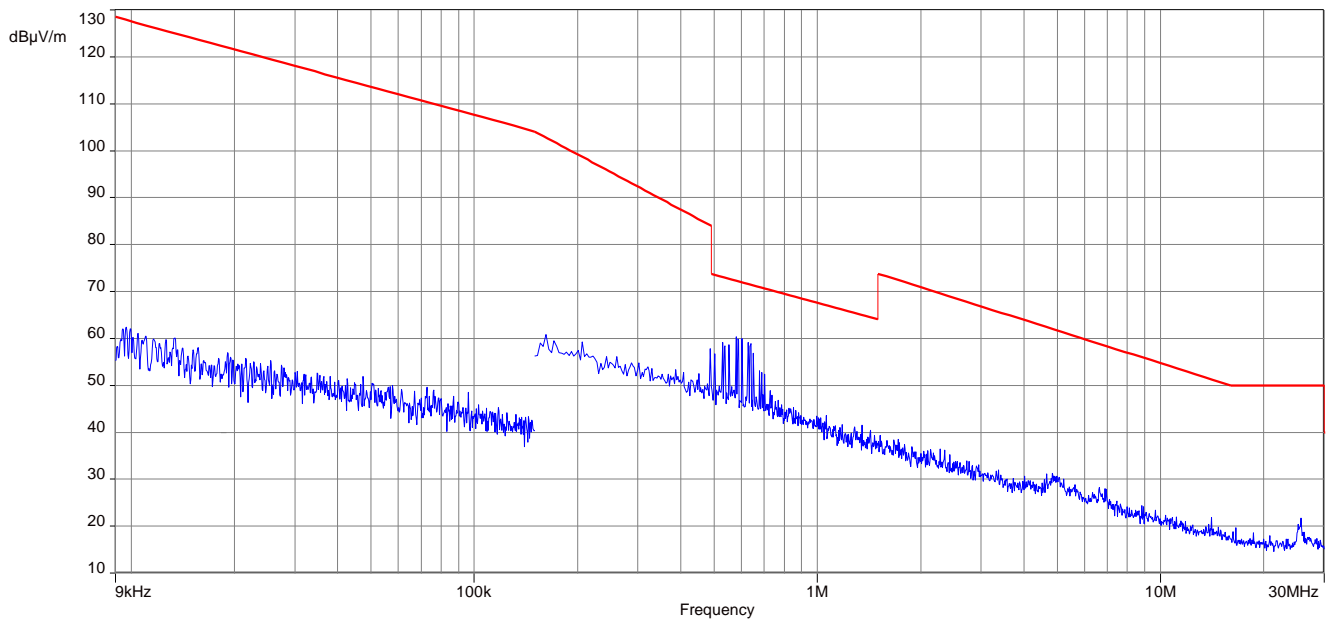

**Plot 11:** 9 kHz to 30 MHz, OFDM 40 MHz, 5190 MHz

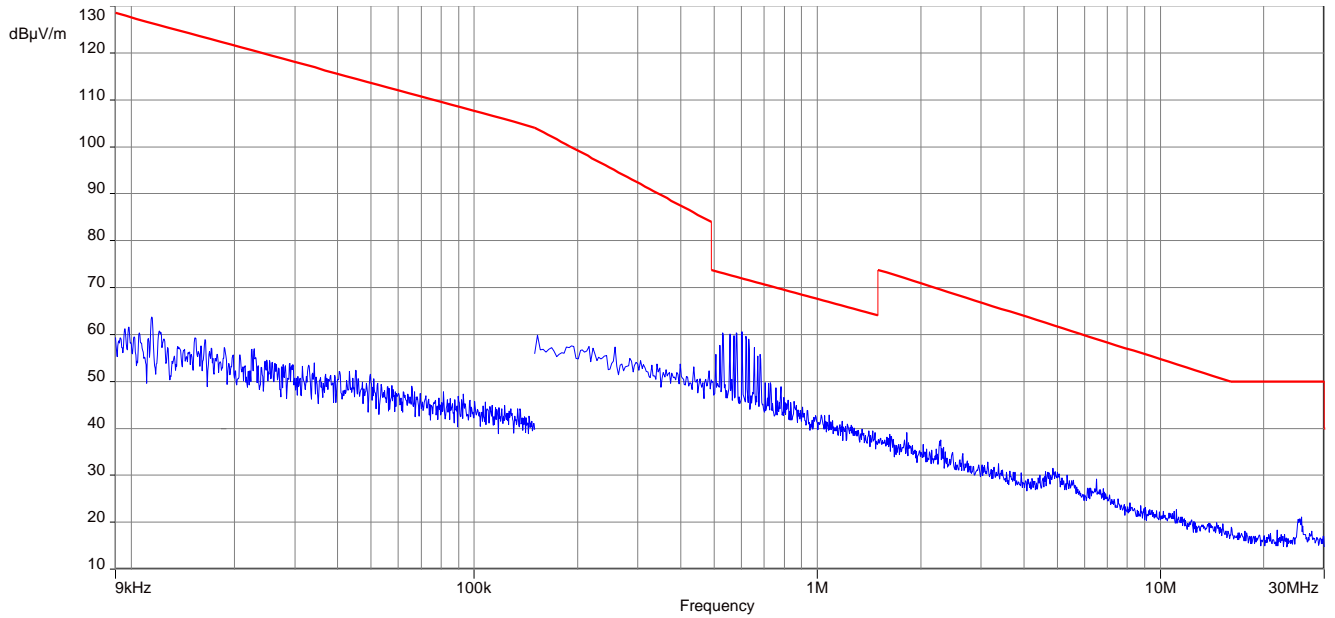

**Plot 12:** 9 kHz to 30 MHz, OFDM 40 MHz, 5210 MHz

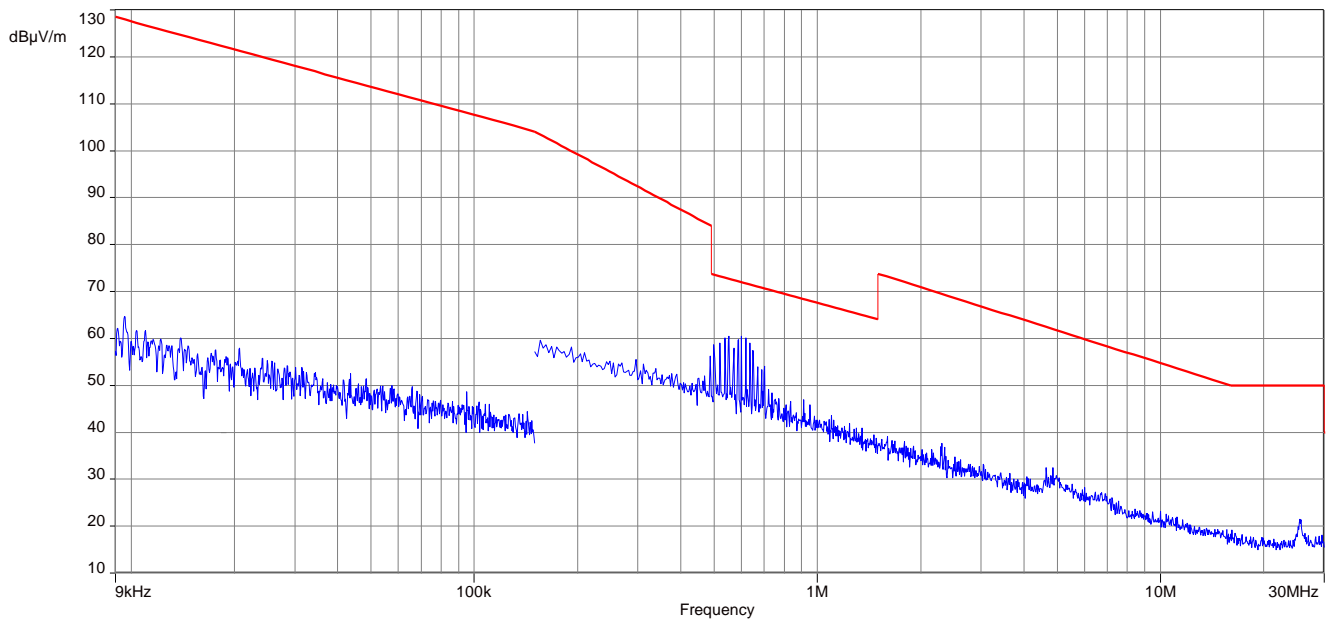



**Plot 13:** 9 kHz to 30 MHz, OFDM 40 MHz, 5270 MHz

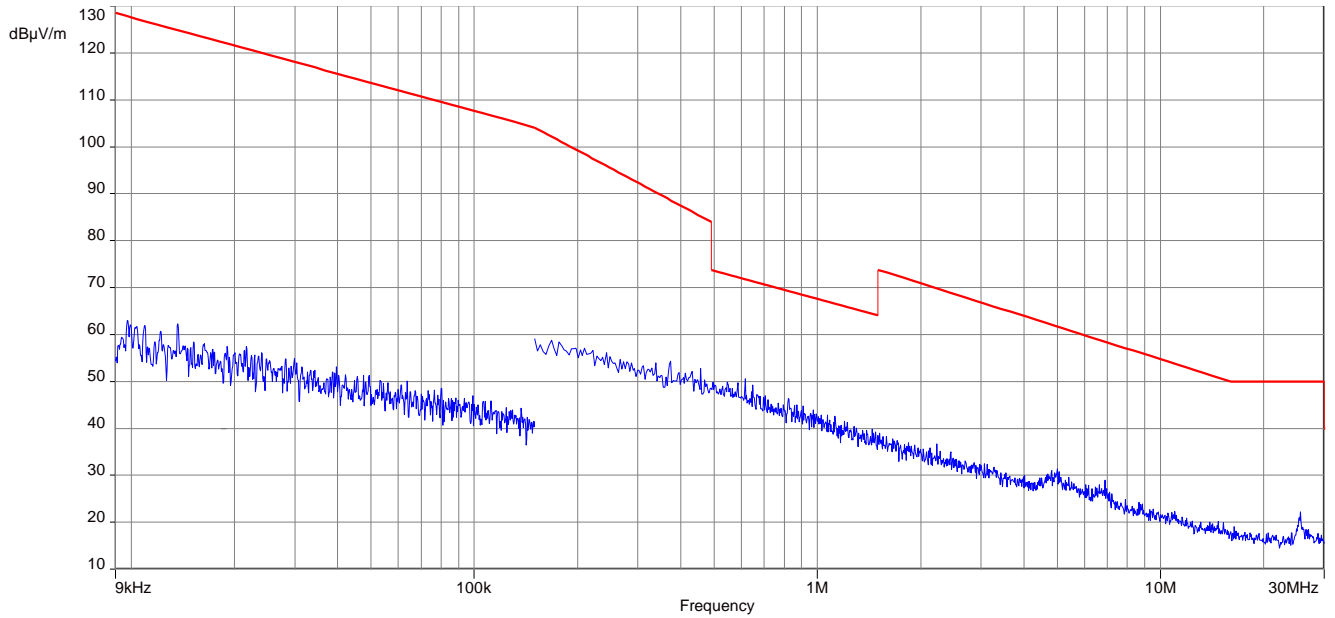

**Plot 14:** 9 kHz to 30 MHz, OFDM 40 MHz, 5310 MHz

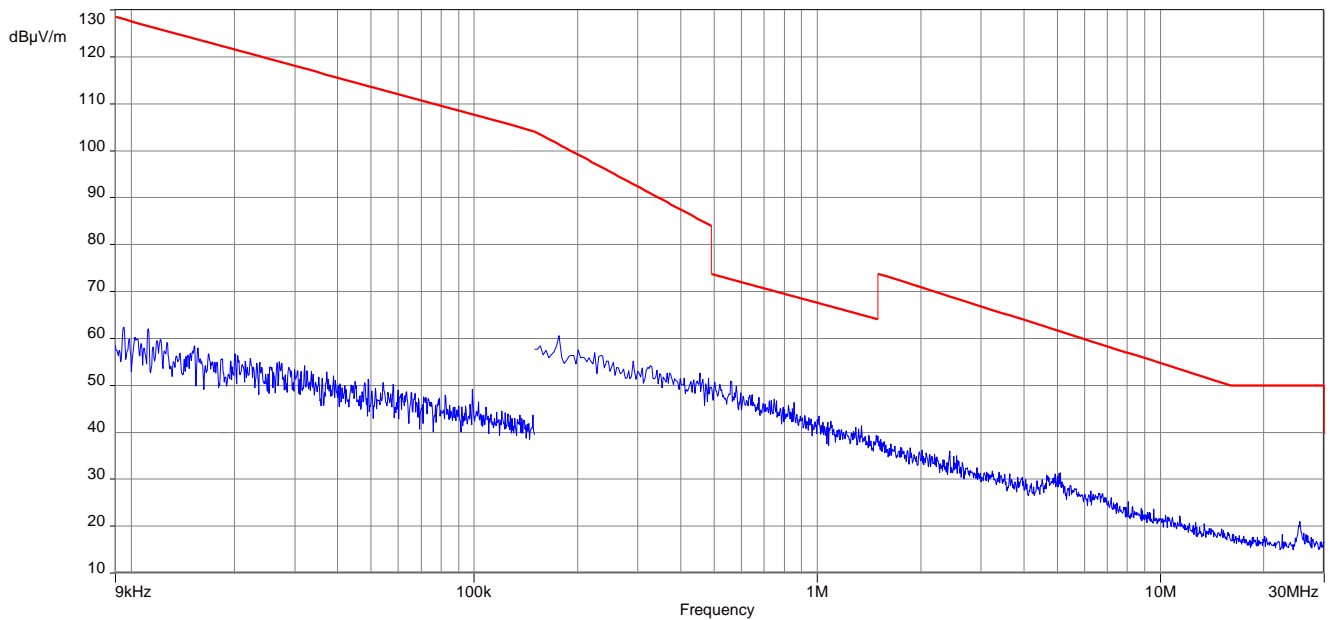

**Plot 15:** 9 kHz to 30 MHz, OFDM 40 MHz, 5510 MHz

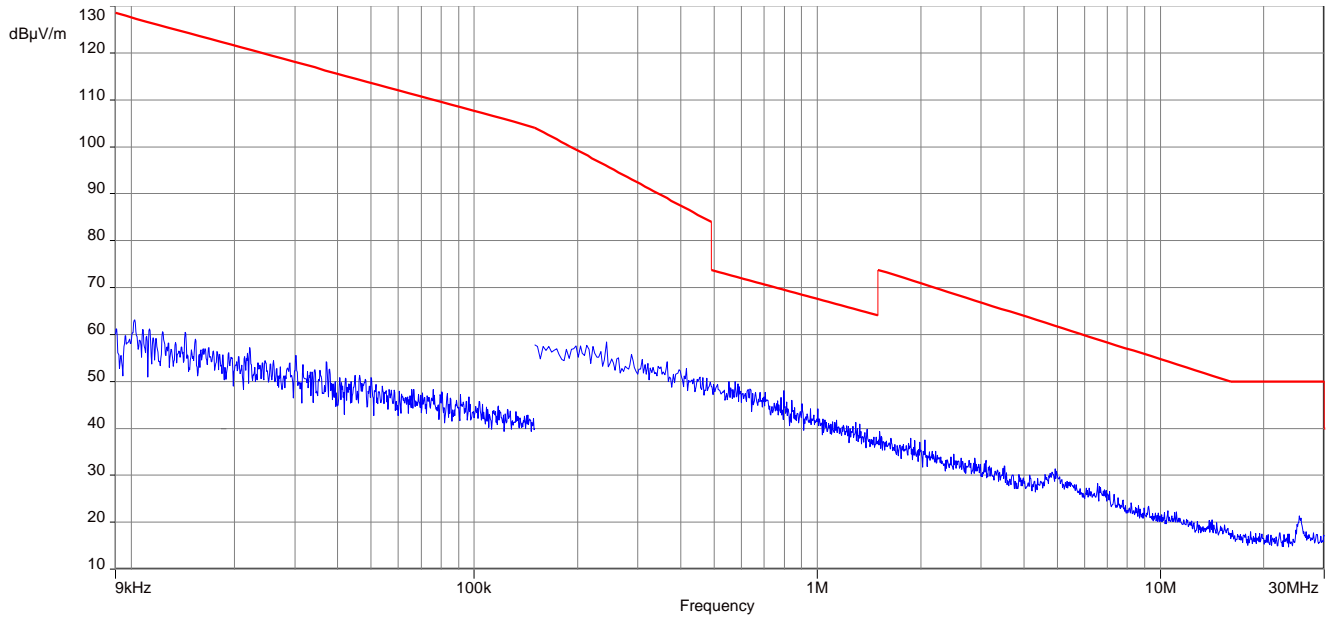

**Plot 16:** 9 kHz to 30 MHz, OFDM 40 MHz, 5590 MHz

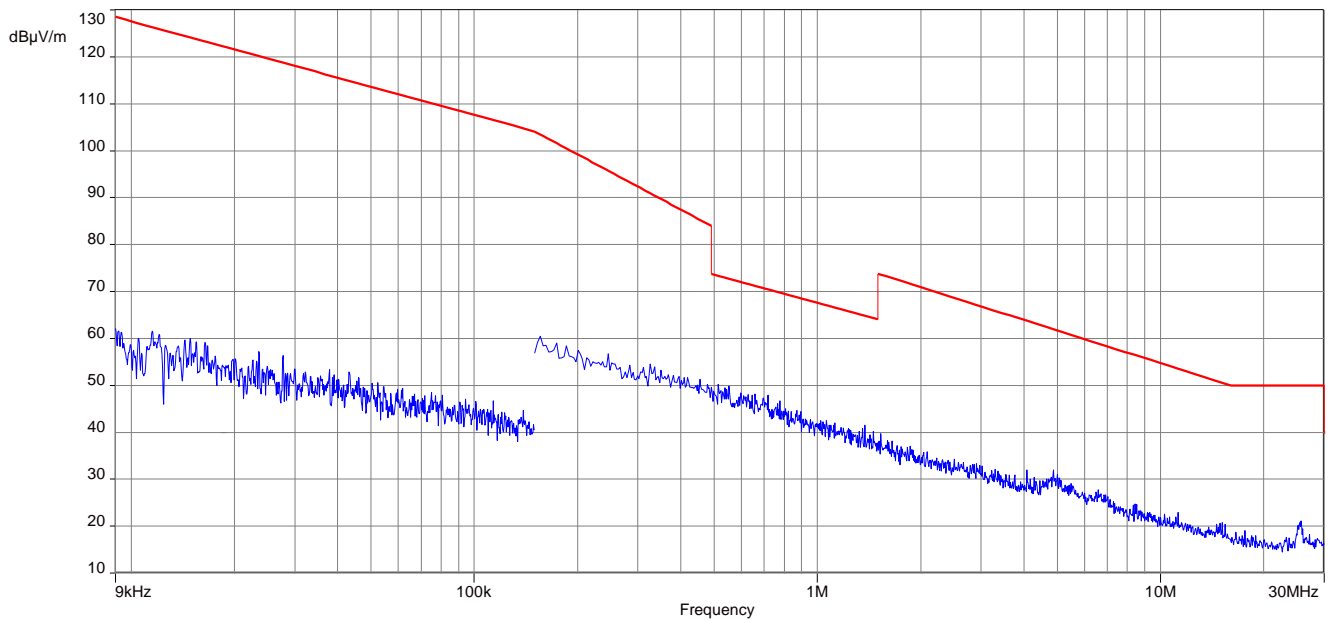

**Plot 17:** 9 kHz to 30 MHz, OFDM 40 MHz, 5670 MHz

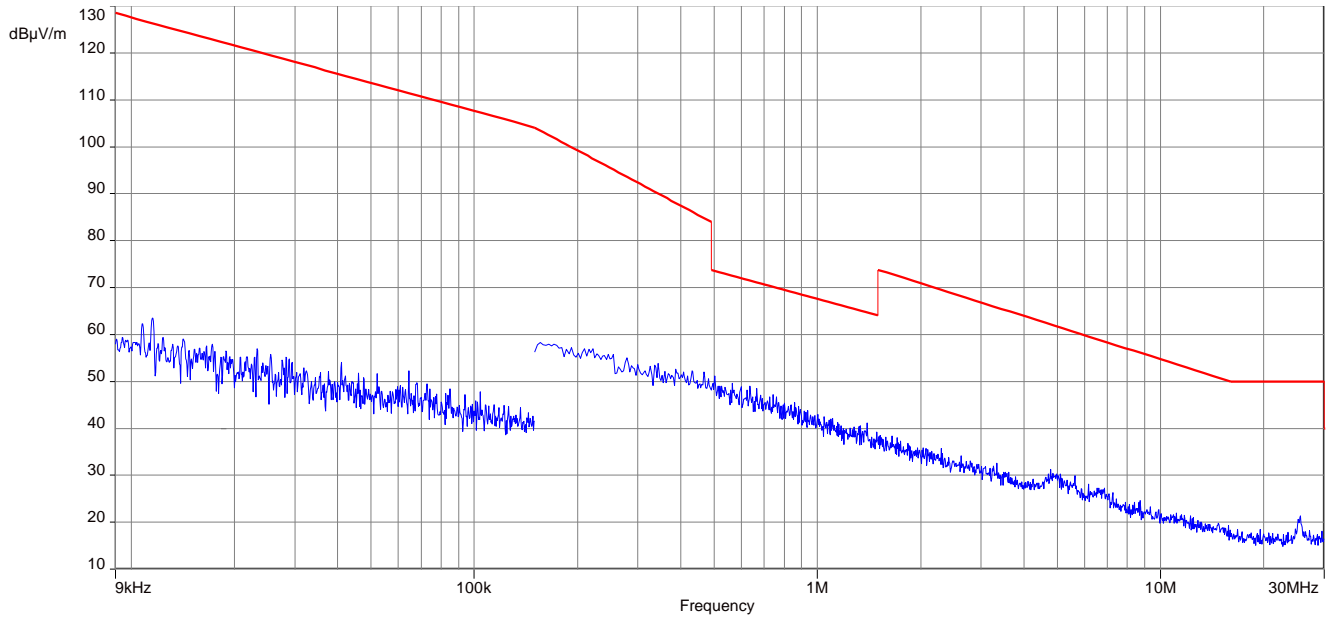

**Plot 18:** 9 kHz to 30 MHz, OFDM 40 MHz, 5755 MHz

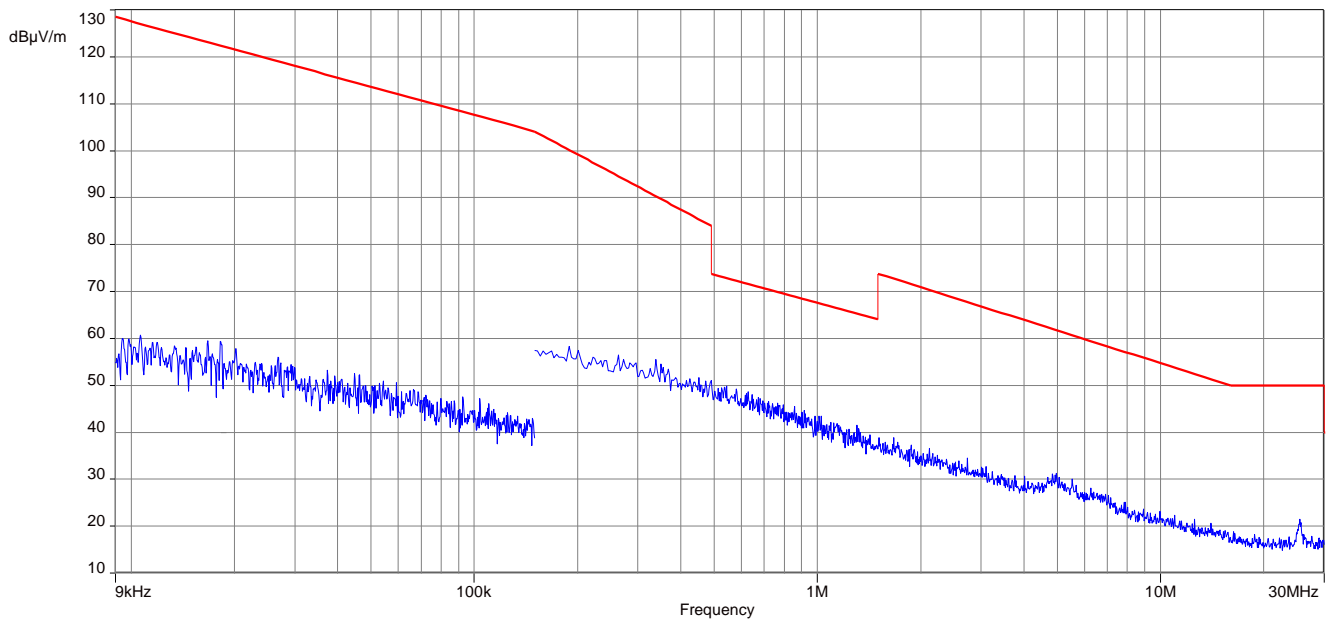

**Plot 19:** 9 kHz to 30 MHz, OFDM 40 MHz, 5795 MHz

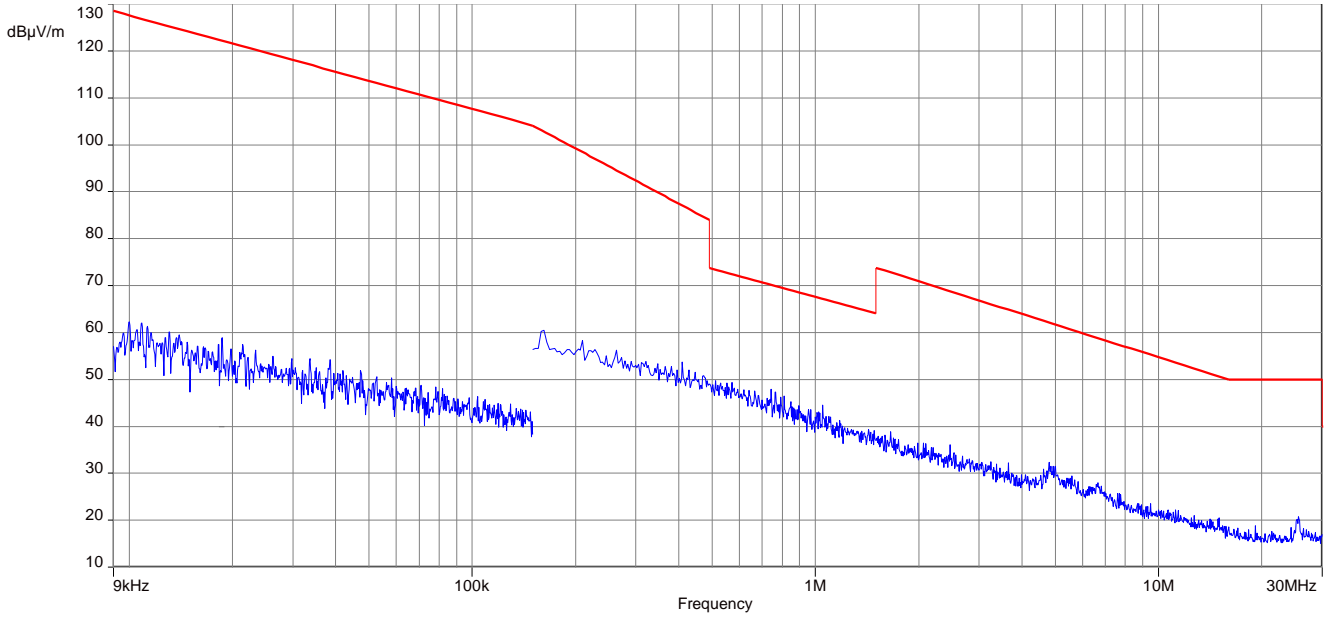

**Plot 20:** 9 kHz to 30 MHz, OFDM 80 MHz, 5210 MHz

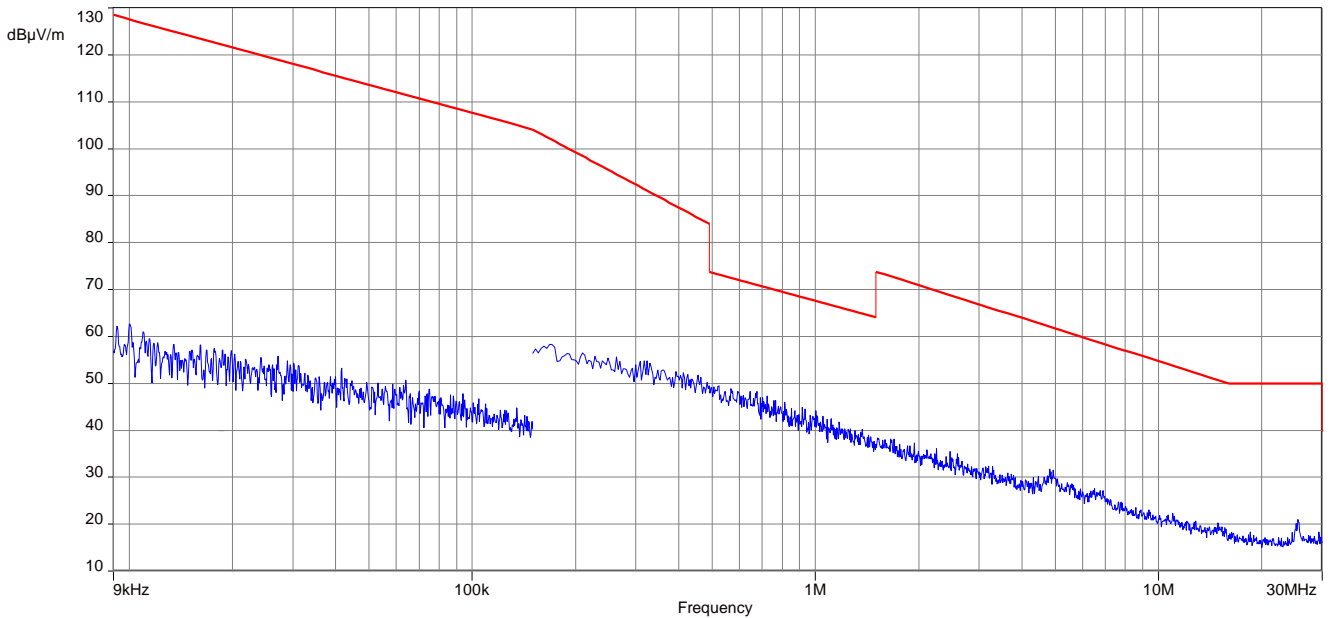

**Plot 21:** 9 kHz to 30 MHz, OFDM 80 MHz, 5290 MHz

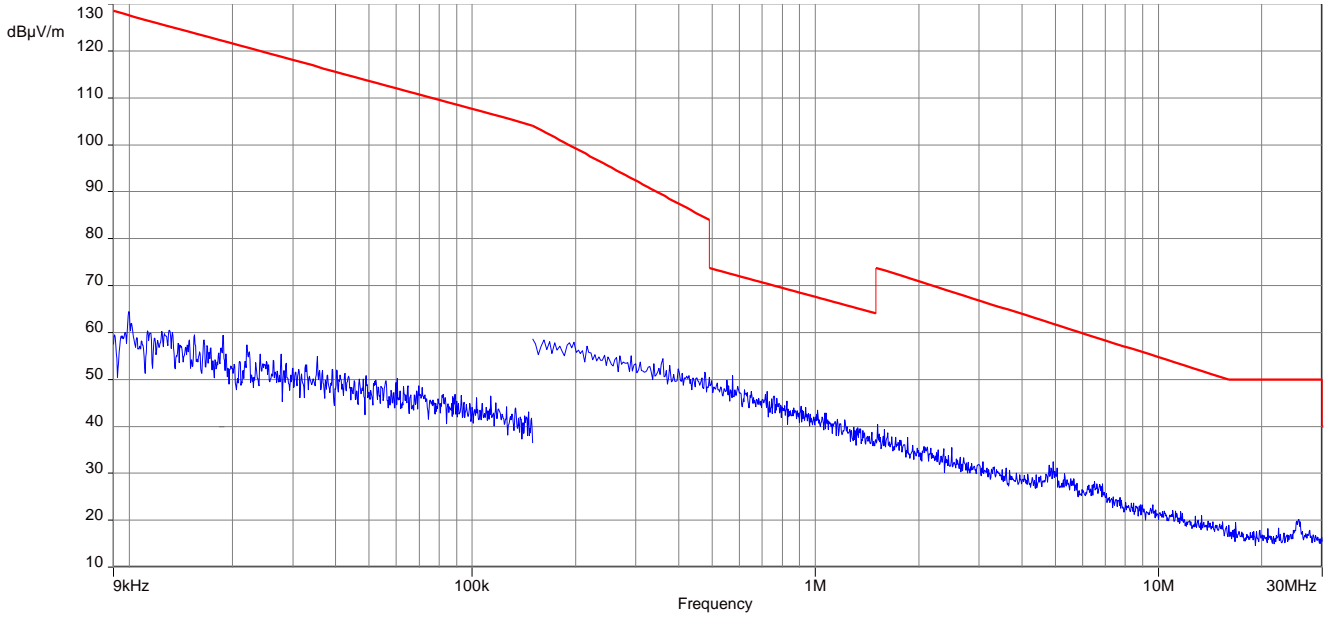

**Plot 22:** 9 kHz to 30 MHz, OFDM 80 MHz, 5530 MHz

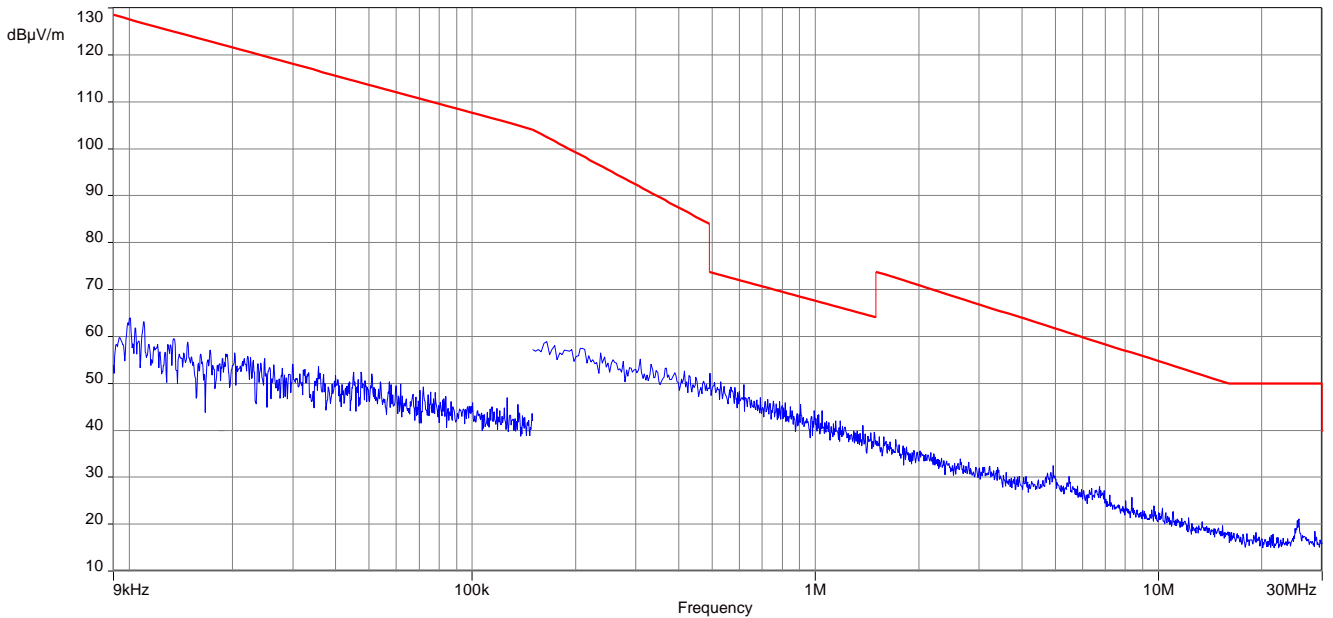

**Plot 23:** 9 kHz to 30 MHz, OFDM 80 MHz, 5610 MHz

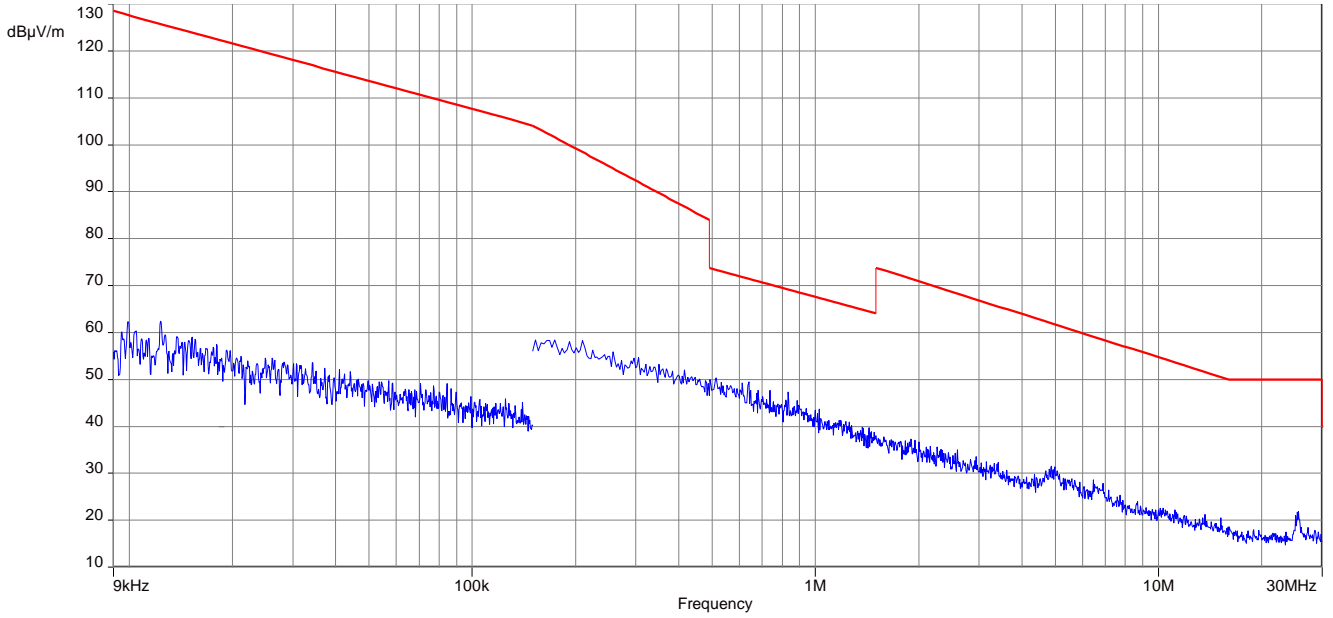

**Plot 24:** 9 kHz to 30 MHz, OFDM 80 MHz, 5775 MHz

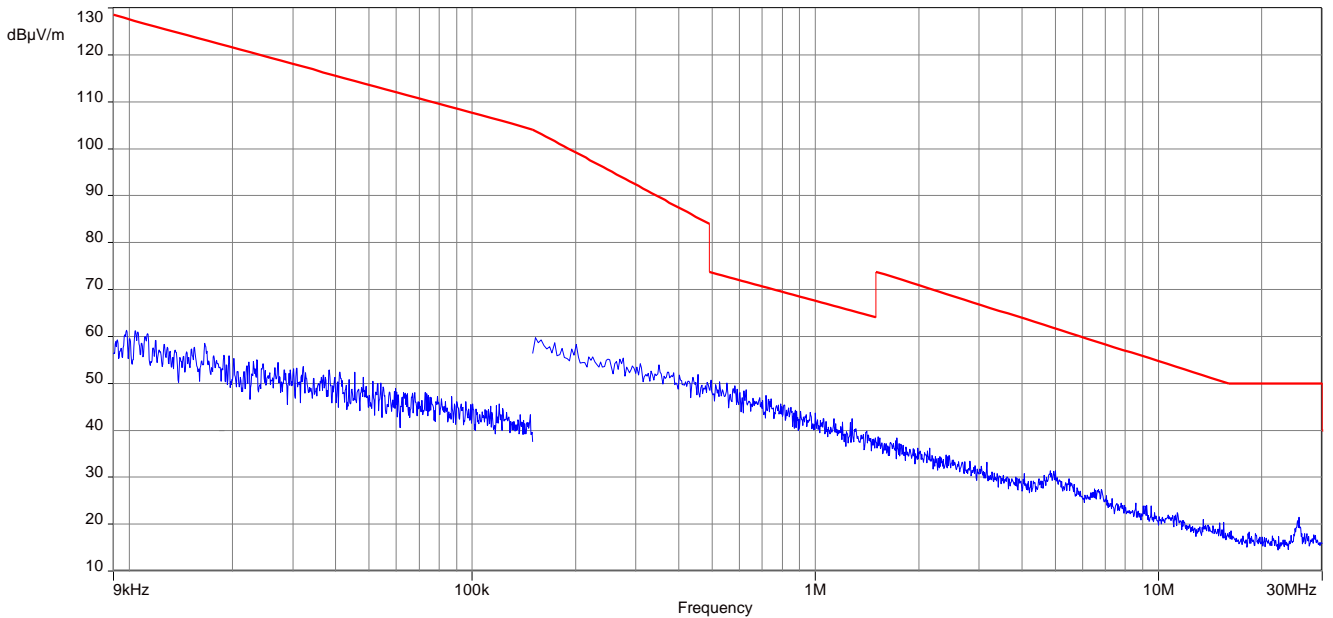

**Plots:** ANTX100P001B24553 antenna

**Plot 1:** 9 kHz to 30 MHz, OFDM 20 MHz, 5180 MHz

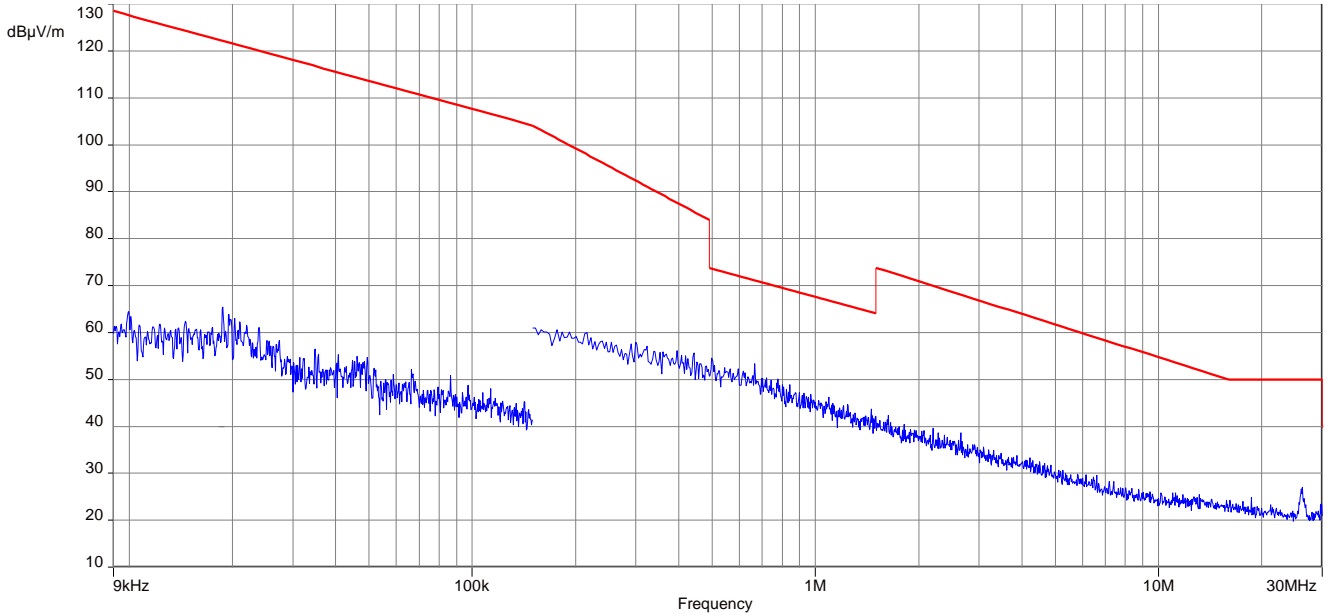

**Plot 2:** 9 kHz to 30 MHz, OFDM 20 MHz, 5240 MHz

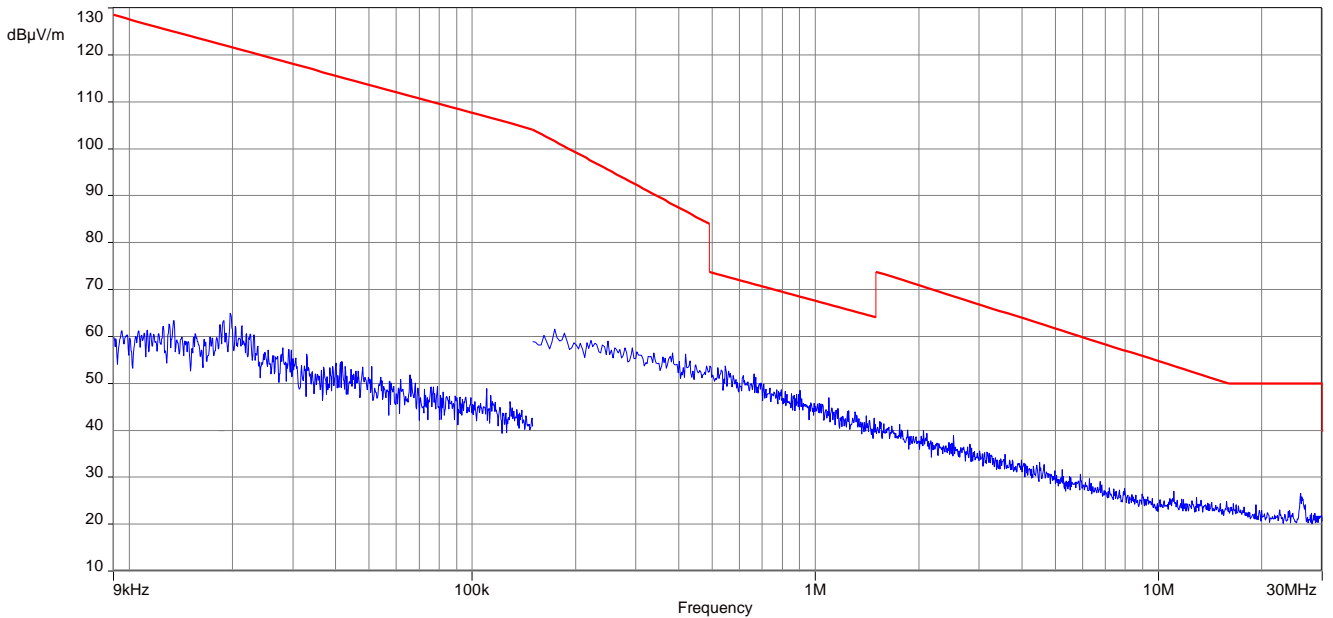

**Plot 3:** 9 kHz to 30 MHz, OFDM 20 MHz, 5260 MHz

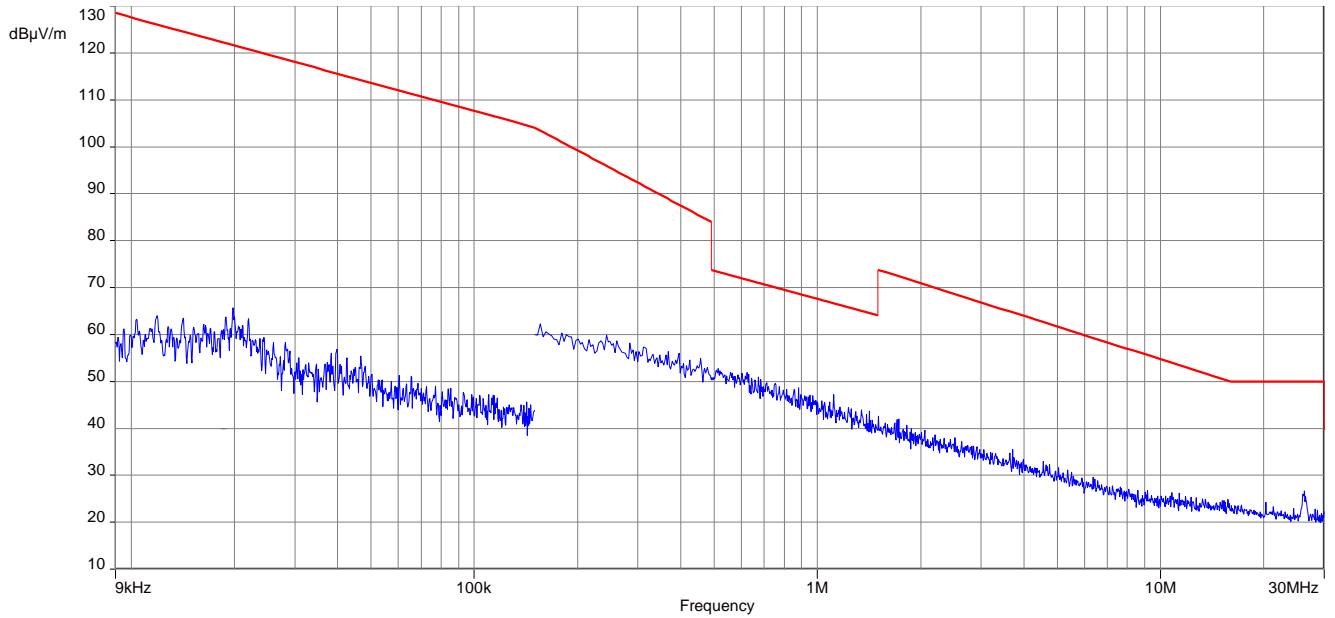

**Plot 4:** 9 kHz to 30 MHz, OFDM 20 MHz, 5320 MHz

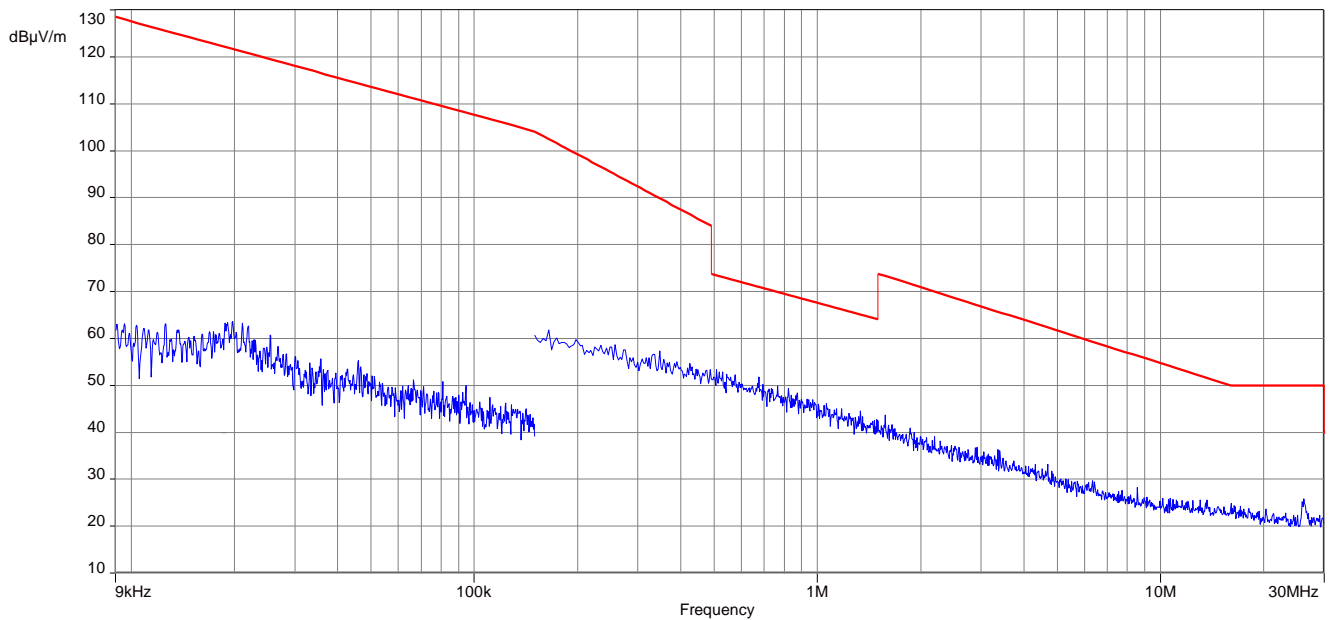



**Plot 5:** 9 kHz to 30 MHz, OFDM 20 MHz, 5500 MHz

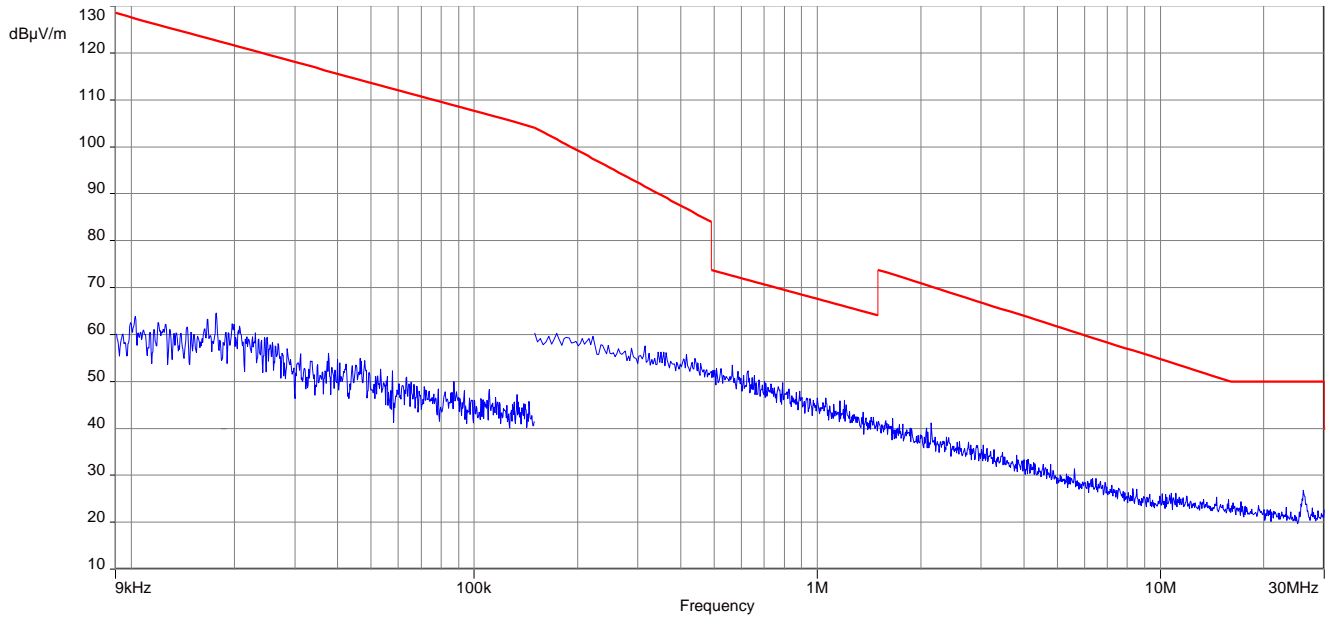

**Plot 6:** 9 kHz to 30 MHz, OFDM 20 MHz, 5600 MHz

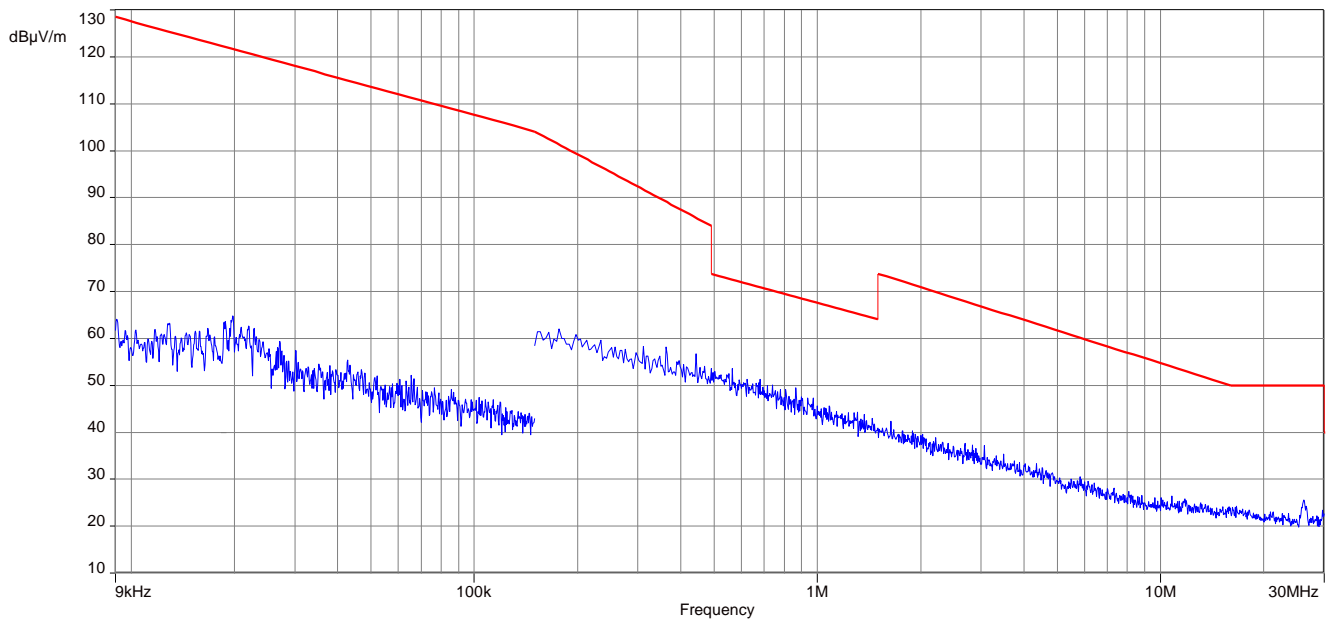

**Plot 7:** 9 kHz to 30 MHz, OFDM 20 MHz, 5700 MHz

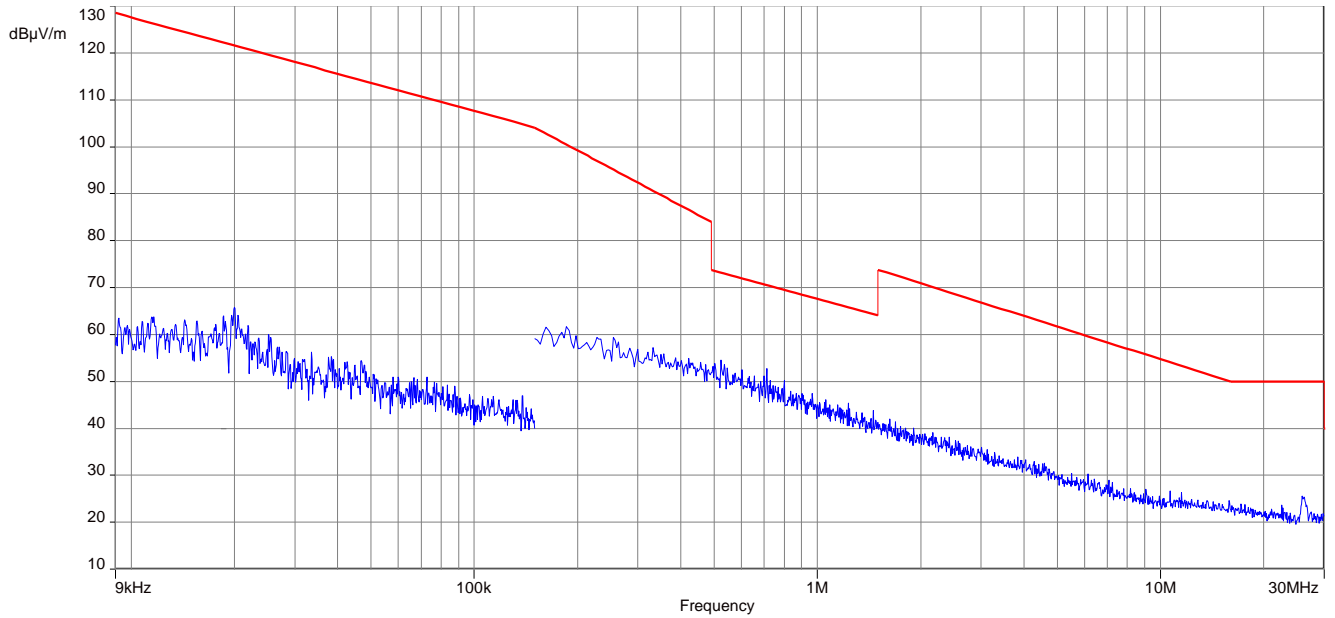

**Plot 8:** 9 kHz to 30 MHz, OFDM 20 MHz, 5745 MHz

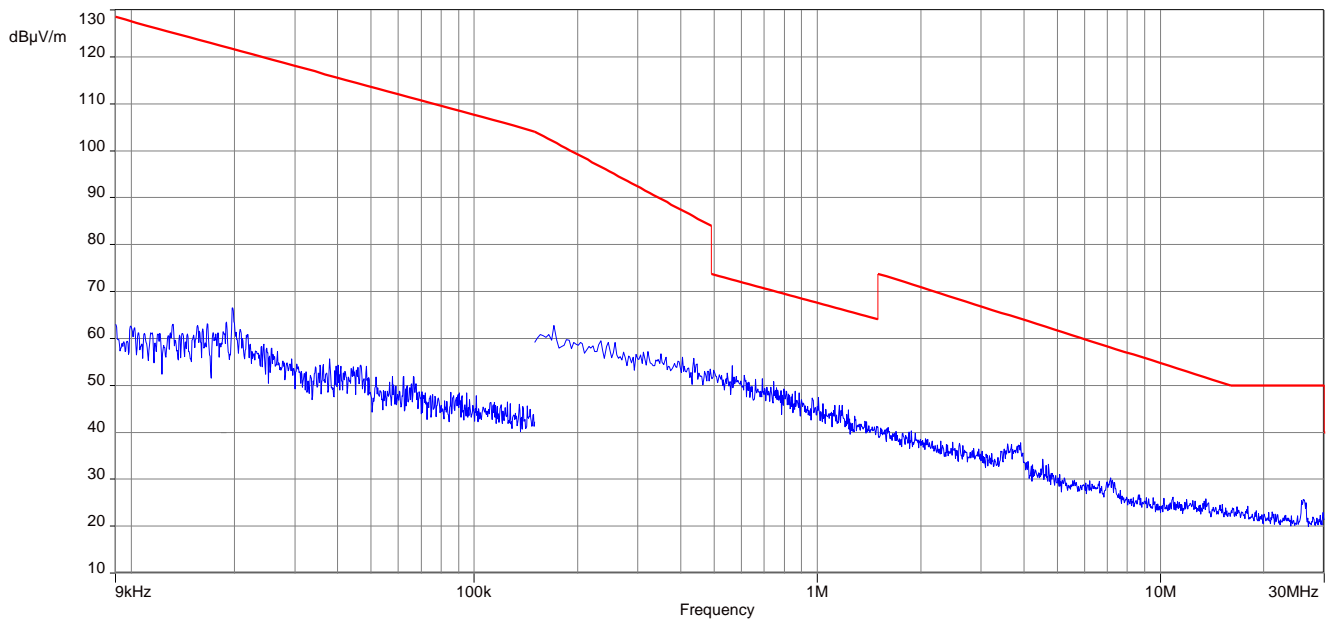

**Plot 9:** 9 kHz to 30 MHz, OFDM 20 MHz, 5785 MHz

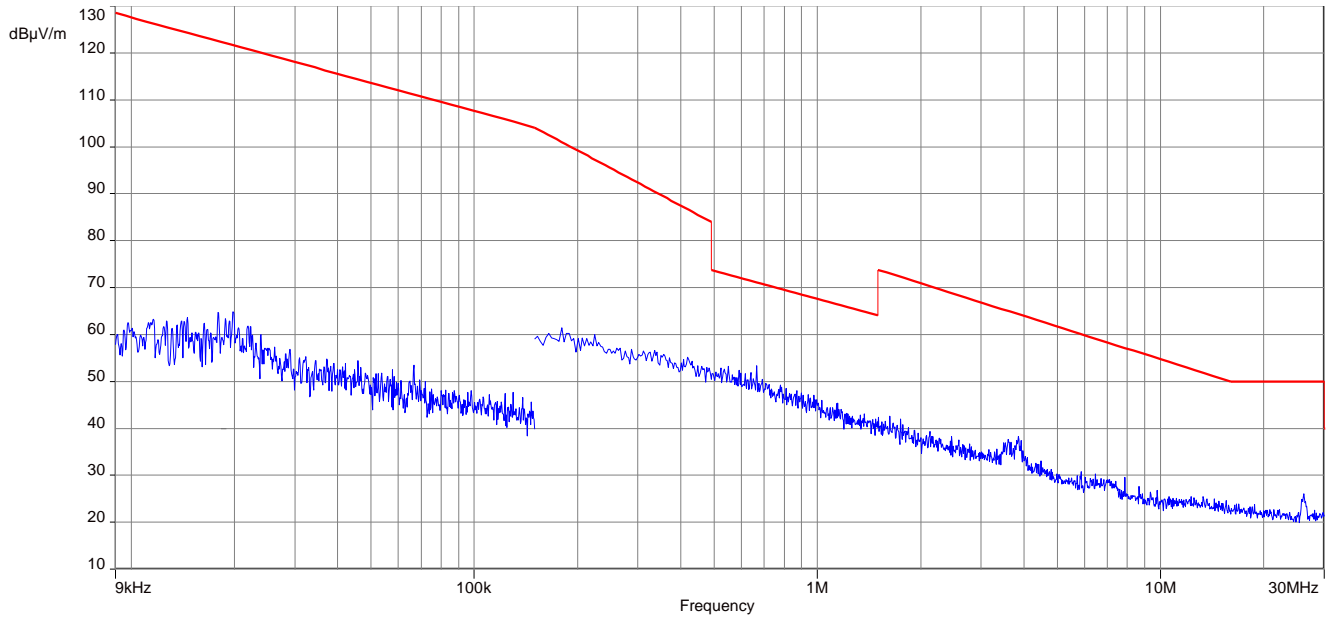

**Plot 10:** 9 kHz to 30 MHz, OFDM 20 MHz, 5825 MHz

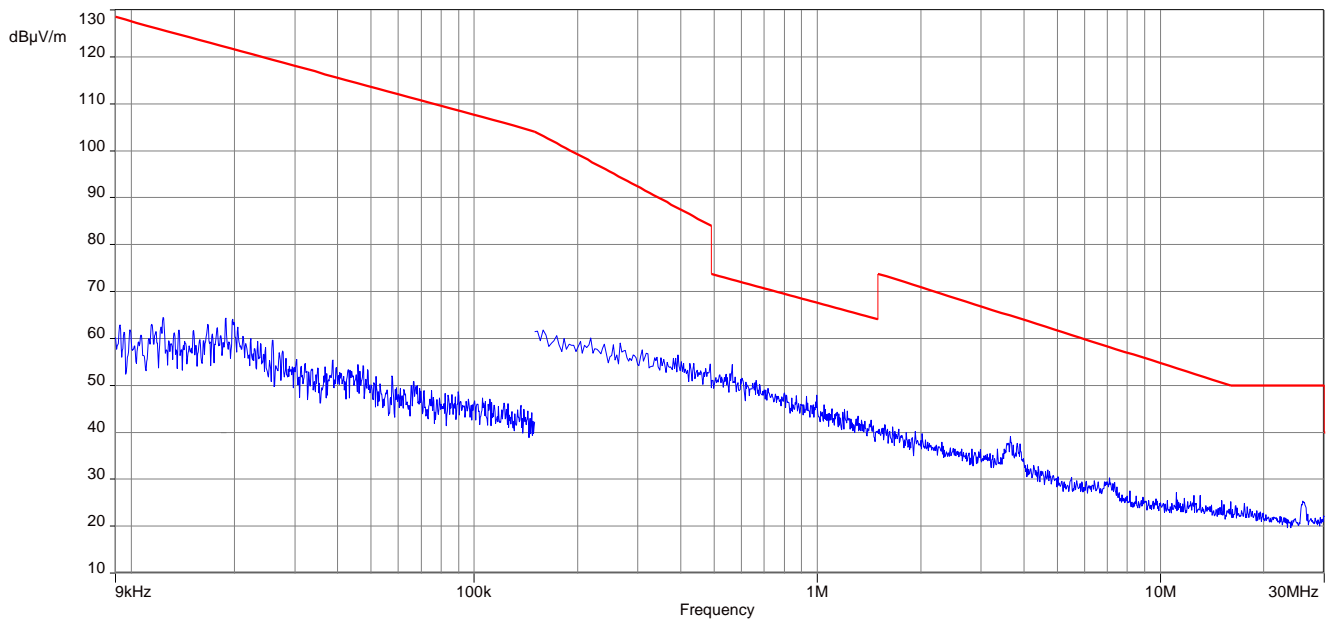

**Plot 11:** 9 kHz to 30 MHz, OFDM 40 MHz, 5190 MHz

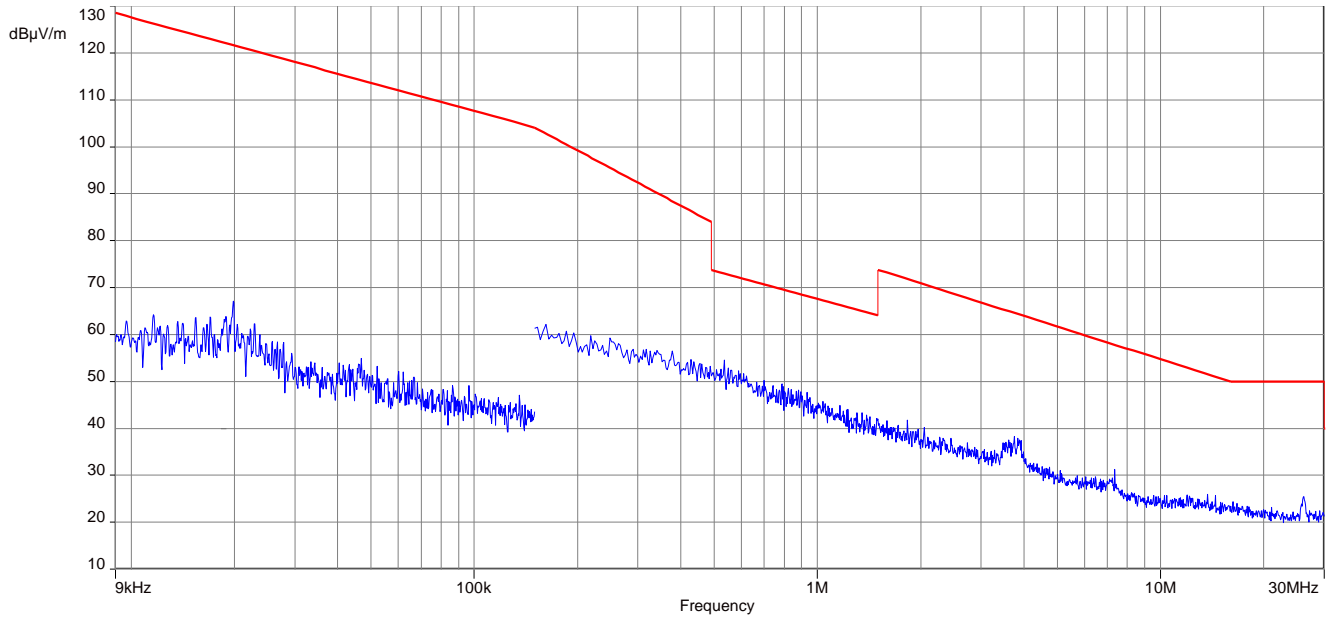

**Plot 12:** 9 kHz to 30 MHz, OFDM 40 MHz, 5210 MHz

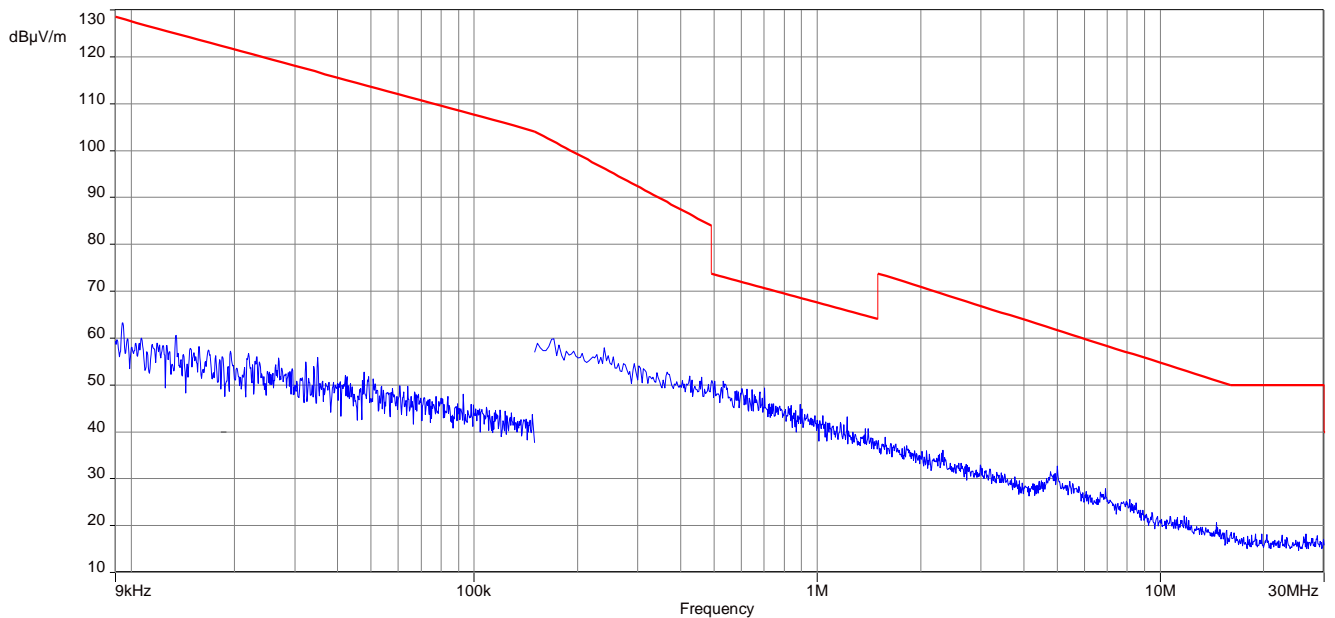

**Plot 13:** 9 kHz to 30 MHz, OFDM 40 MHz, 5270 MHz

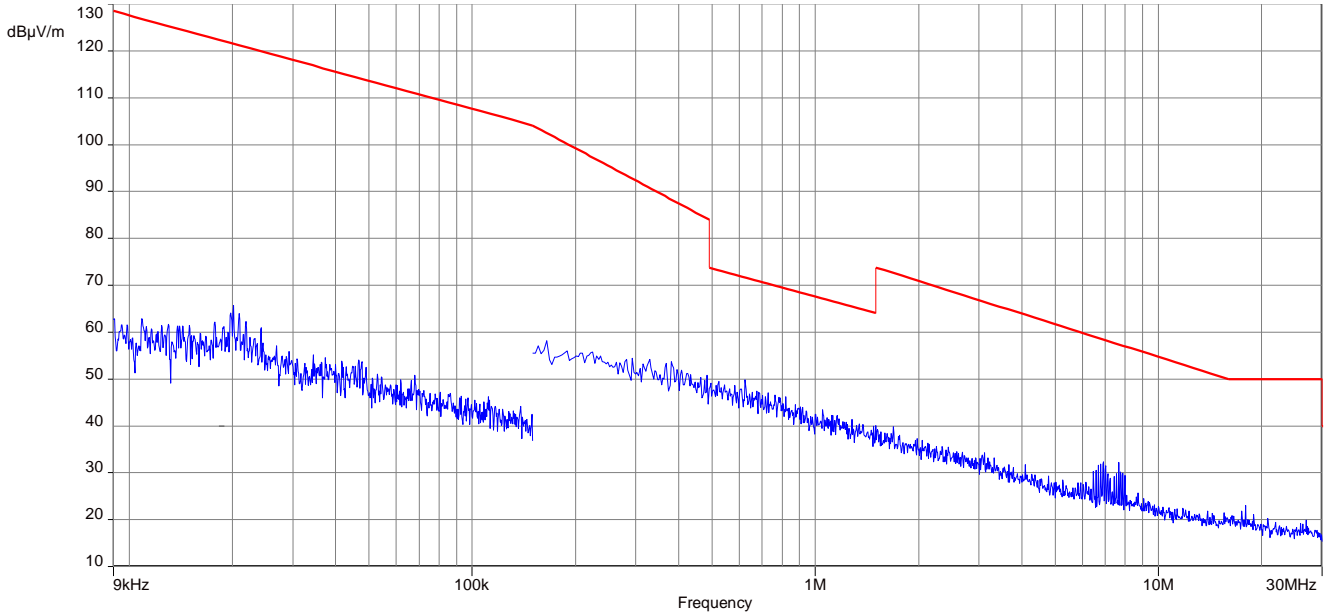

**Plot 14:** 9 kHz to 30 MHz, OFDM 40 MHz, 5310 MHz

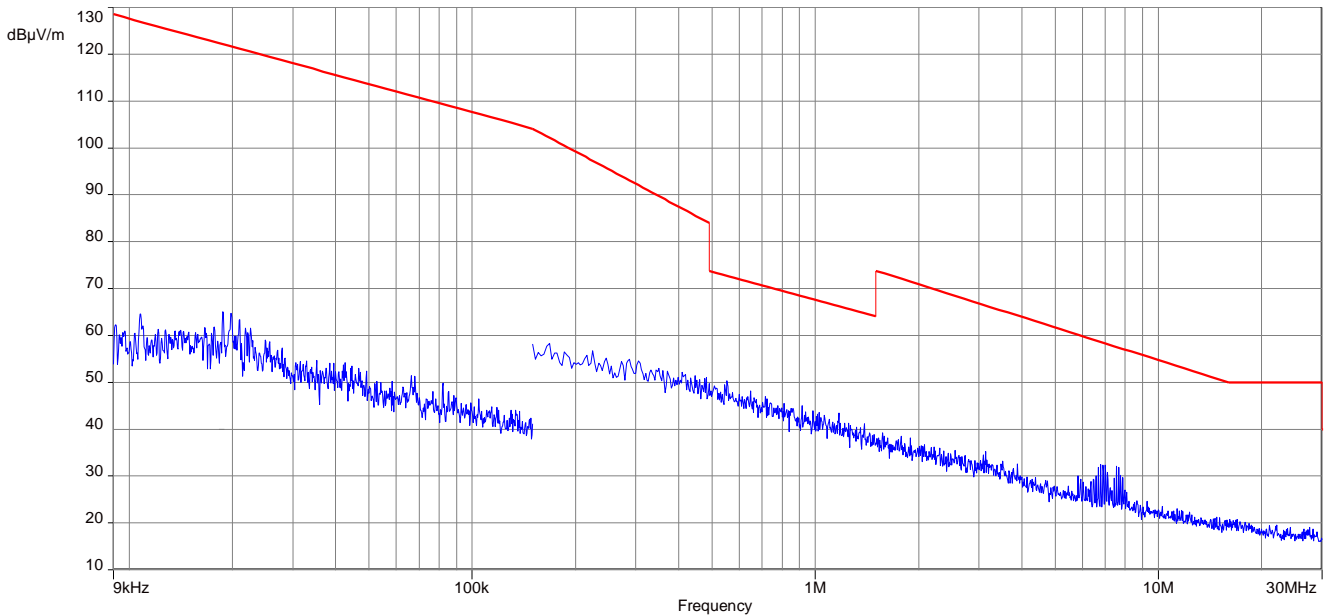

**Plot 15:** 9 kHz to 30 MHz, OFDM 40 MHz, 5510 MHz

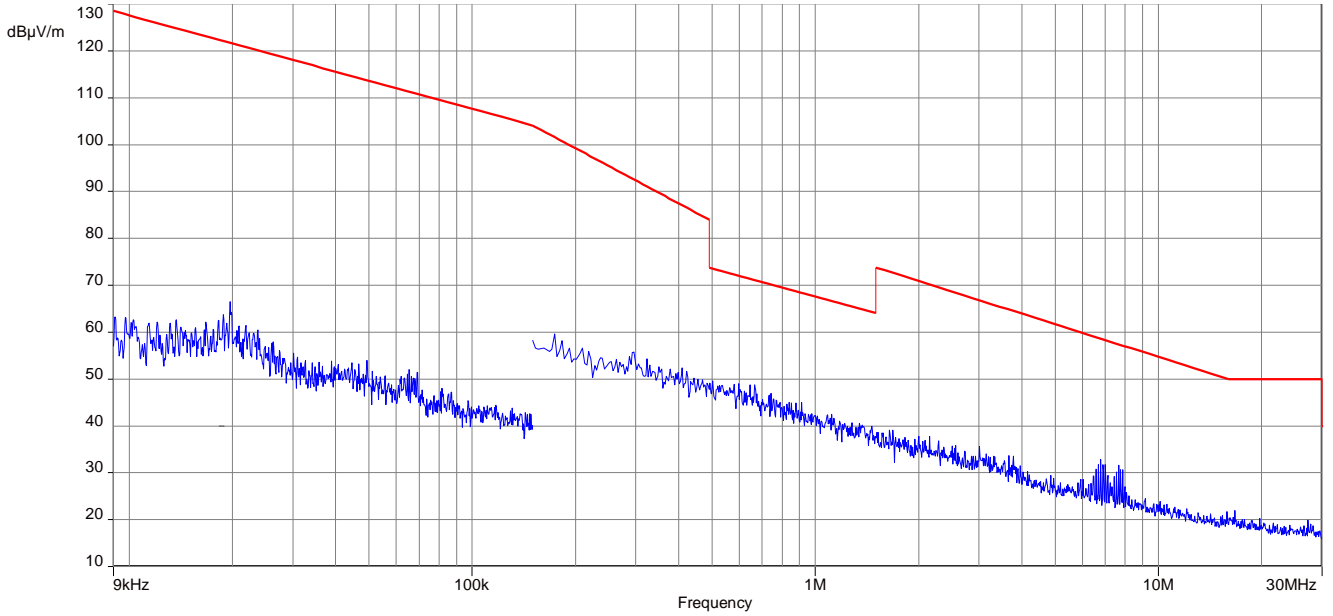

**Plot 16:** 9 kHz to 30 MHz, OFDM 40 MHz, 5590 MHz

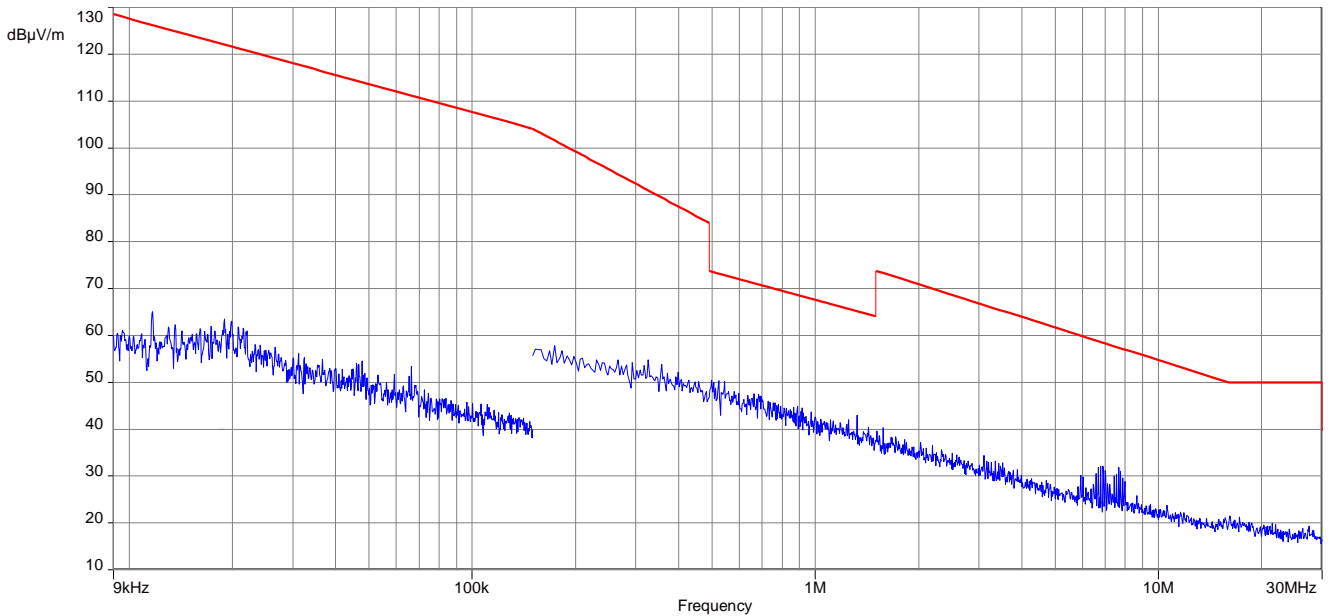

**Plot 17:** 9 kHz to 30 MHz, OFDM 40 MHz, 5670 MHz

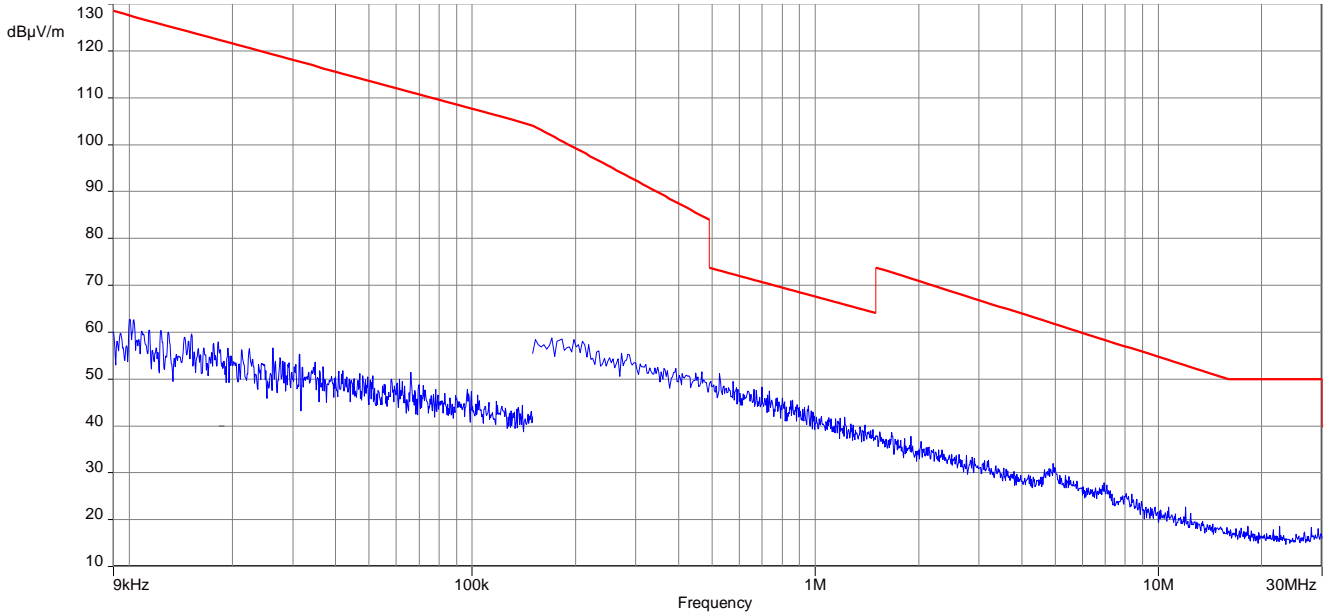

**Plot 18:** 9 kHz to 30 MHz, OFDM 40 MHz, 5755 MHz

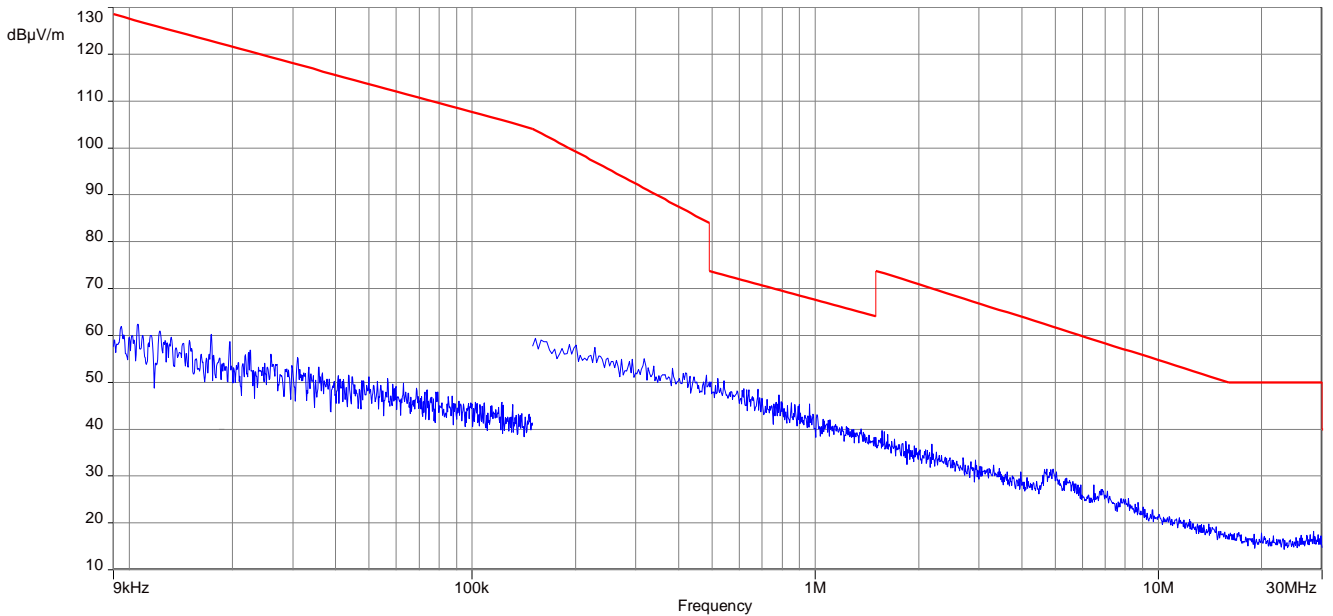

**Plot 19:** 9 kHz to 30 MHz, OFDM 40 MHz, 5795 MHz

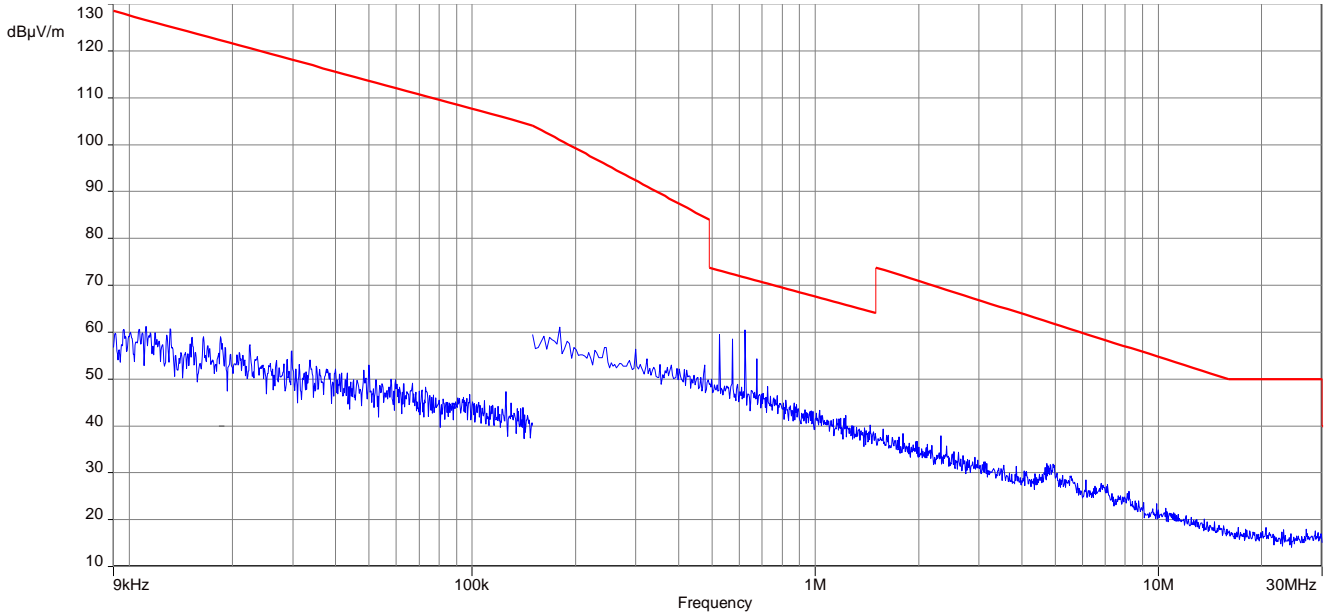

**Plot 20:** 9 kHz to 30 MHz, OFDM 80 MHz, 5210 MHz

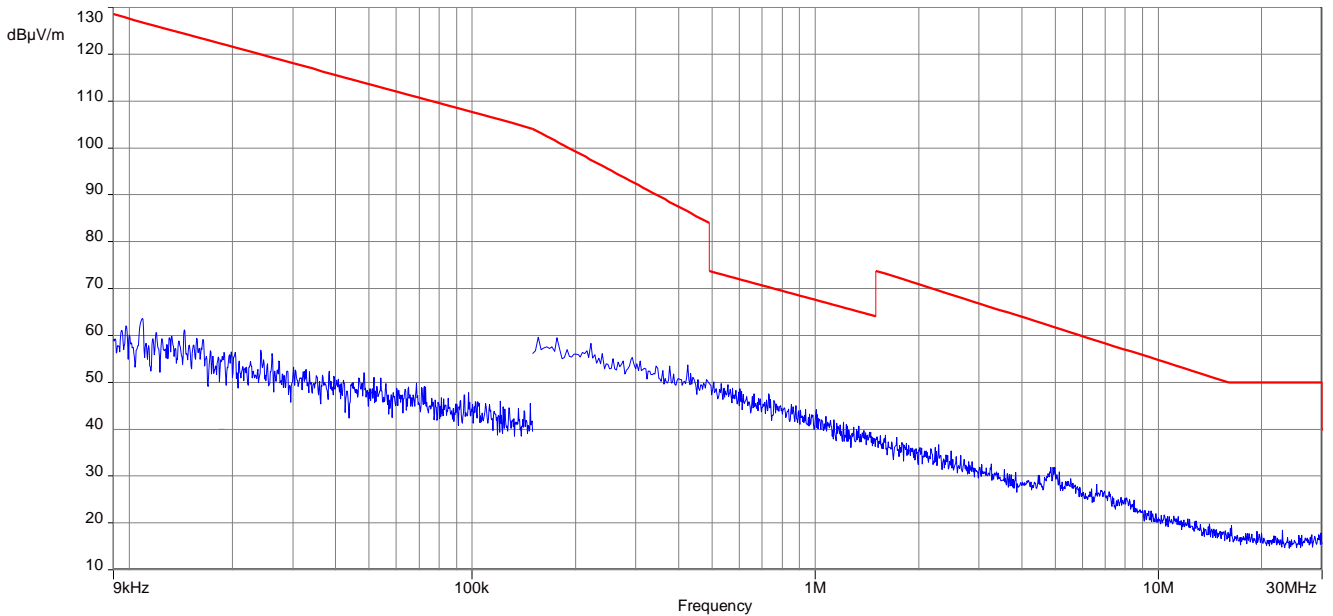



**Plot 21:** 9 kHz to 30 MHz, OFDM 80 MHz, 5290 MHz

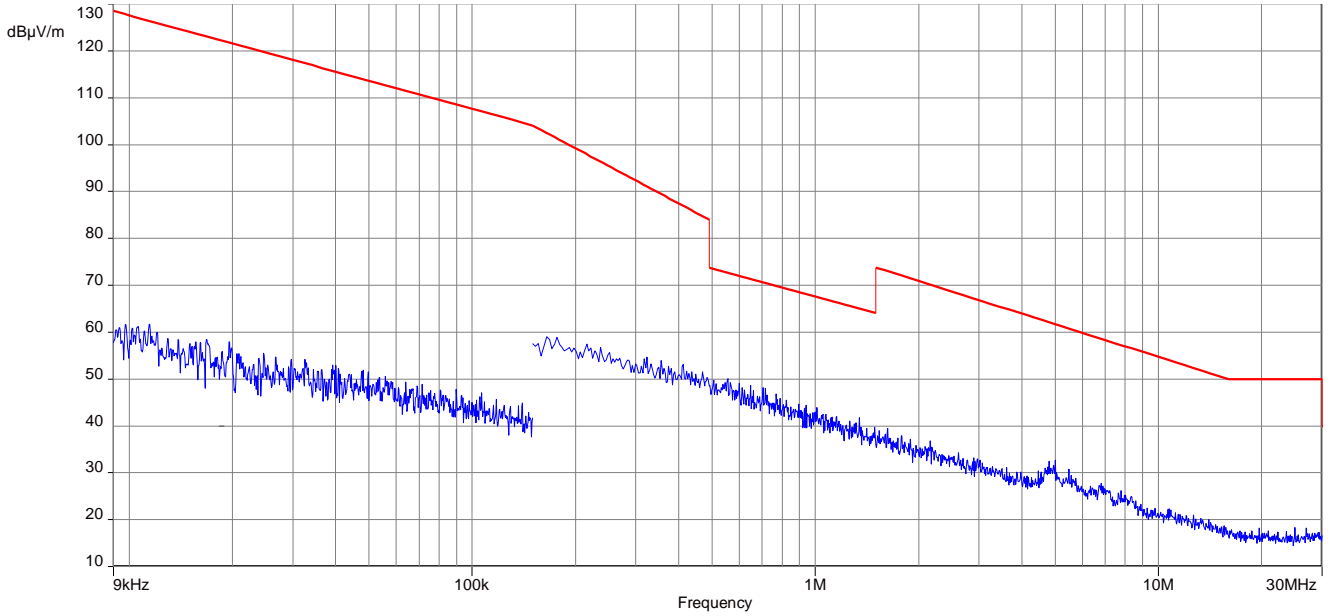

**Plot 22:** 9 kHz to 30 MHz, OFDM 80 MHz, 5530 MHz

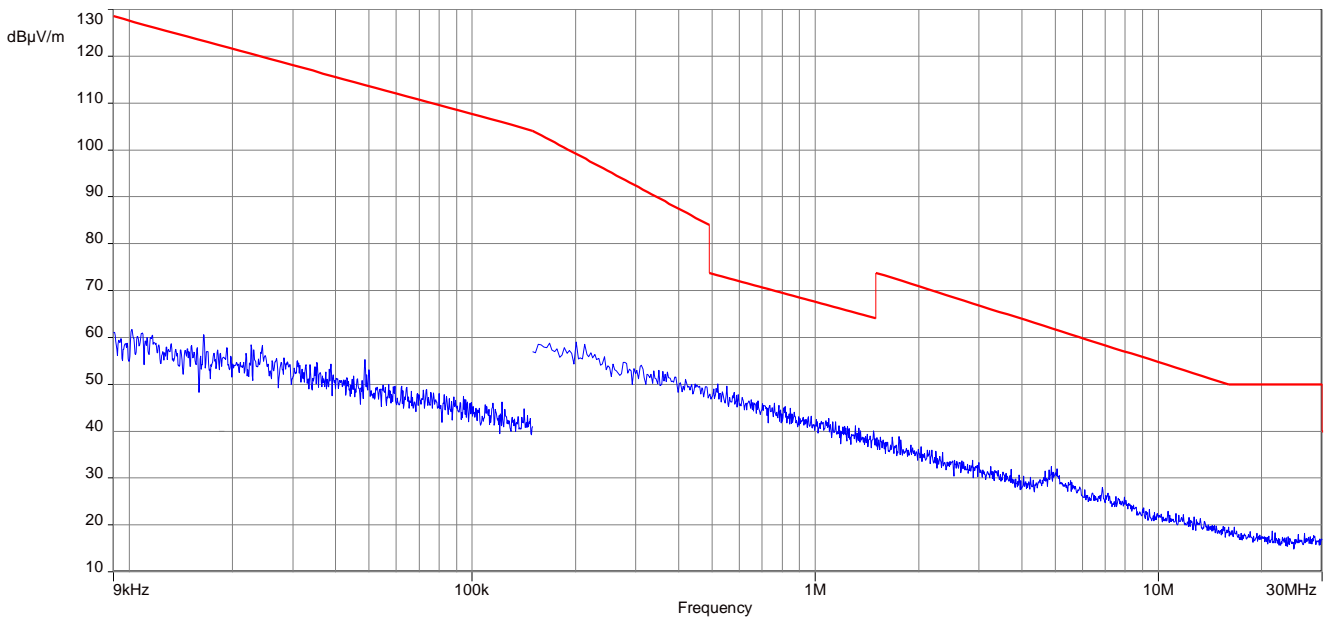

**Plot 23:** 9 kHz to 30 MHz, OFDM 80 MHz, 5610 MHz

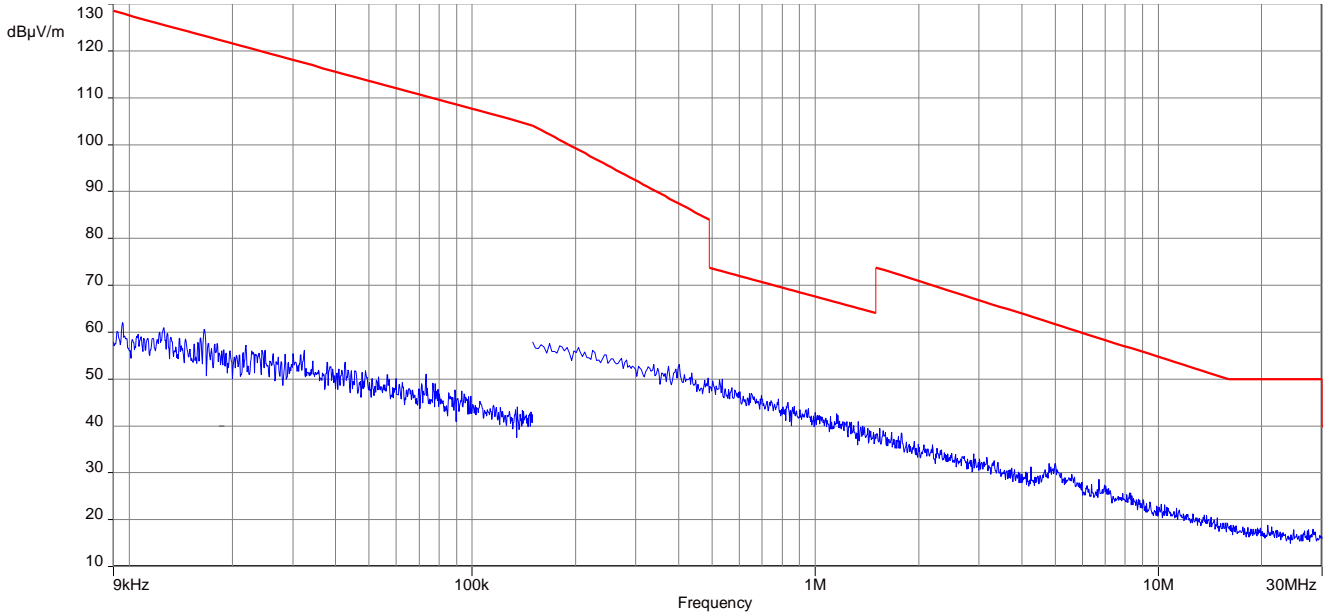

**Plot 24:** 9 kHz to 30 MHz, OFDM 80 MHz, 5775 MHz

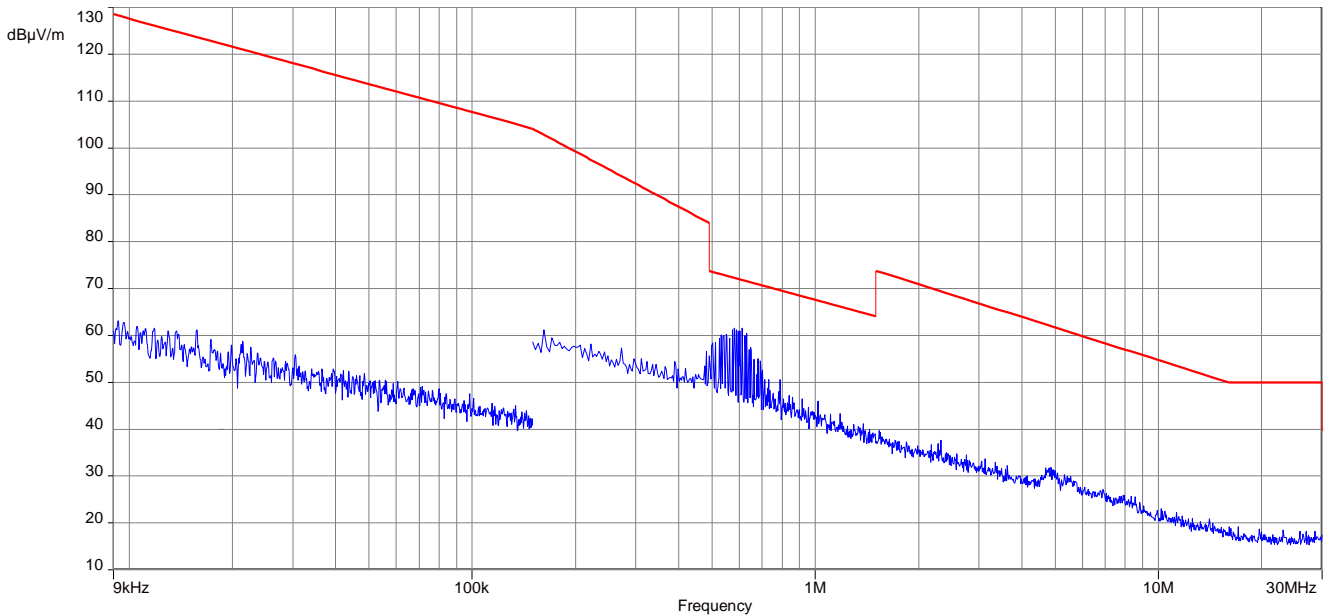

**12.13 Spurious emissions conducted < 30 MHz**

**Description:**

Measurement of the conducted spurious emissions in transmit mode below 30 MHz. The EUT is set to middle channel. If critical peaks are found the lowest channel and the highest channel will be measured too. Both power lines, phase and neutral line, are measured. Found peaks are re-measured with average and quasi peak detection to show compliance to the limits.

**Measurement:**

Measurement parameter	
Detector:	Peak - Quasi Peak / Average
Sweep time:	Auto
Video bandwidth:	9 kHz
Resolution bandwidth:	100 kHz
Span:	150 kHz to 30 MHz
Trace – mode:	Max Hold
Test setup:	See sub clause 7.5 – A
Measurement uncertainty:	See sub clause 9

**Limits:**

Spurious Emissions Conducted < 30 MHz		
Frequency (MHz)	Quasi-Peak (dBµV/m)	Average (dBµV/m)
0.15 – 0.5	66 to 56*	56 to 46*
0.5 – 5	56	46
5 – 30.0	60	50

\*Decreases with the logarithm of the frequency

**Results:**

Spurious Emissions Conducted < 30 MHz [dBµV/m]		
F [MHz]	Detector	Level [dBµV/m]
All detected emissions are more than 20 dB below the limit.		

**Plots:**

**Plot 1:** 150 kHz to 30 MHz, phase line

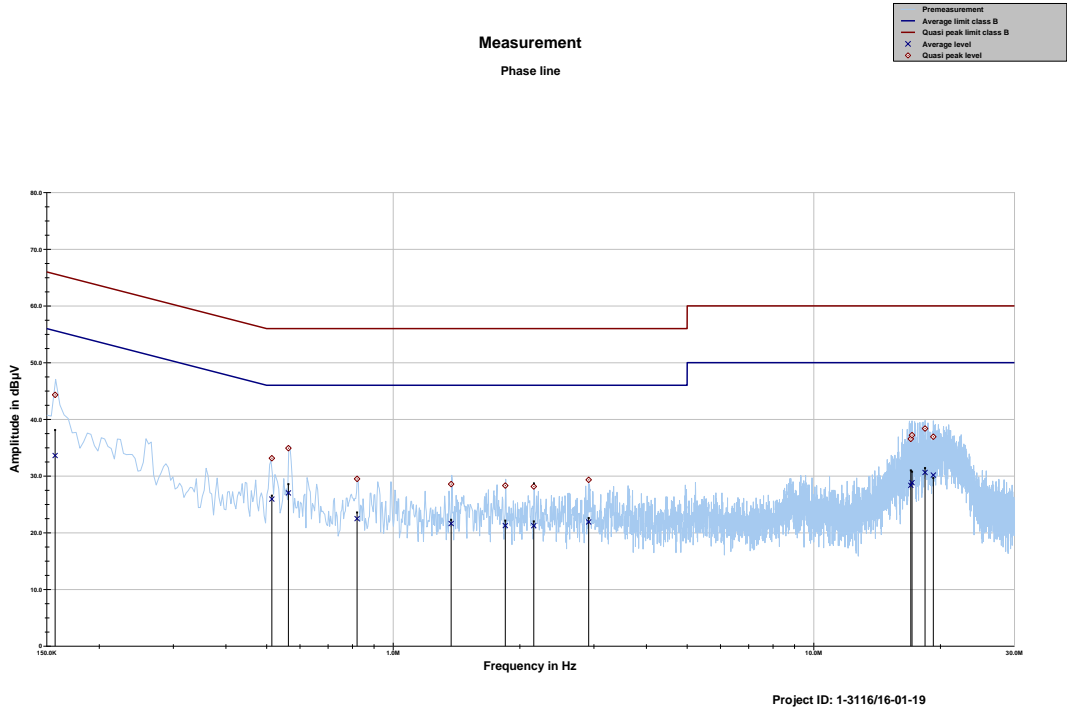

**Final results:**

Frequency	Quasi peak level	Margin quasi peak	Limit QP	Average level	Margin average	Limit AV
MHz	dBµV	dB	dBµV	dBµV	dB	dBµV
0.157098	44.32	21.30	65.616	33.62	22.18	55.797
0.514510	33.14	22.86	56.000	25.93	20.07	46.000
0.563504	34.91	21.09	56.000	27.02	18.98	46.000
0.820587	29.49	26.51	56.000	22.49	23.51	46.000
1.373416	28.57	27.43	56.000	21.62	24.38	46.000
1.847621	28.32	27.68	56.000	21.25	24.75	46.000
2.159128	28.15	27.85	56.000	21.24	24.76	46.000
2.916533	29.34	26.66	56.000	21.90	24.10	46.000
17.010086	36.56	23.44	60.000	28.36	21.64	50.000
17.123597	37.21	22.79	60.000	28.83	21.17	50.000
18.395314	38.38	21.62	60.000	30.63	19.37	50.000
19.243595	36.93	23.07	60.000	30.17	19.83	50.000

**Plot 2:** 150 kHz to 30 MHz, neutral line

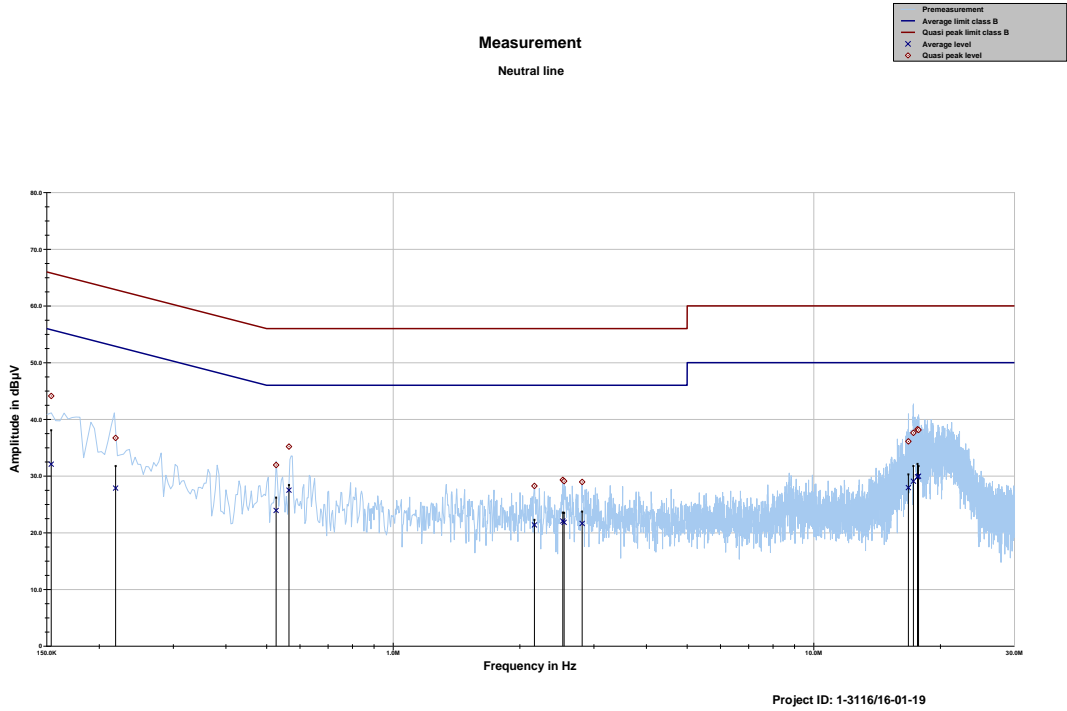

**Final results:**

Frequency	Quasi peak level	Margin quasi peak	Limit QP	Average level	Margin average	Limit AV
MHz	dBµV	dB	dBµV	dBµV	dB	dBµV
0.153761	44.12	21.67	65.794	32.09	23.80	55.893
0.218768	36.72	26.14	62.866	27.87	26.17	54.035
0.526808	31.94	24.06	56.000	23.93	22.07	46.000
0.565014	35.19	20.81	56.000	27.51	18.49	46.000
2.167012	28.25	27.75	56.000	21.37	24.63	46.000
2.530257	29.31	26.69	56.000	22.06	23.94	46.000
2.548758	29.11	26.89	56.000	21.84	24.16	46.000
2.813786	28.95	27.05	56.000	21.64	24.36	46.000
16.790447	36.11	23.89	60.000	27.96	22.04	50.000
17.256773	37.62	22.38	60.000	29.09	20.91	50.000
17.648301	38.24	21.76	60.000	29.88	20.12	50.000
17.751294	38.12	21.88	60.000	29.98	20.02	50.000

## Annex A Document history

Version	Applied changes	Date of release
	Initial release	2017-05-09

## Annex B Further information

### Glossary

AVG	-	Average
DUT	-	Device under test
EMC	-	Electromagnetic Compatibility
EN	-	European Standard
EUT	-	Equipment under test
ETSI	-	European Telecommunications Standard Institute
FCC	-	Federal Communication Commission
FCC ID	-	Company Identifier at FCC
HW	-	Hardware
IC	-	Industry Canada
Inv. No.	-	Inventory number
N/A	-	Not applicable
PP	-	Positive peak
QP	-	Quasi peak
S/N	-	Serial number
SW	-	Software
PMN	-	Product marketing name
HMN	-	Host marketing name
HVIN	-	Hardware version identification number
FVIN	-	Firmware version identification number
OBW		Occupied Bandwidth
OC		Operating Channel
OCW		Operating Channel Bandwidth
OOB		Out Of Band

**Annex C Accreditation Certificate**

first page

last page



Deutsche Akkreditierungsstelle GmbH

Befehlens gemäß § 8 Absatz 1 AkkStelleG i.V.m. § 1 Absatz 1 AkkStelleGBV  
Unterschriftsmitglied der Multilateralen Abkommen  
von EA, ILAC und IAF zur gegenseitigen Anerkennung

**Akkreditierung**



Die Deutsche Akkreditierungsstelle GmbH bestätigt hiermit, dass das Prüflaboratorium

**CTC advanced GmbH**  
Untertürkheimer Straße 6-10, 66117 Saarbrücken

die Kompetenz nach DIN EN ISO/IEC 17025:2005 besitzt, Prüfungen in folgenden Bereichen durchzuführen:

- Funk
- Mobilfunk (GSM / DCS) + OTA
- Elektromagnetische Verträglichkeit (EMV)
- Produktsicherheit
- SAR / EMF
- Umwelt
- Smart Card Technology
- Bluetooth\*
- Automotive
- Wi-Fi-Services
- Kanadische Anforderungen
- US-Anforderungen
- Akustik
- Near Field Communication (NFC)

Die Akkreditierungsurkunde gilt nur in Verbindung mit dem Bescheid vom 25.11.2016 mit der Akkreditierungsnummer D-PL-12076-01 und ist gültig bis 17.01.2018. Sie besteht aus diesem Deckblatt, der Rückseite des Deckblatts und der folgenden Anlage mit insgesamt 63 Seiten.

Registrierungsnummer der Urkunde: D-PL-12076-01-01

Frankfurt, 25.11.2016

Stelle Minister auf der Rückseite

Im Auftrag Dipl.-Ing. (FH) Ralf Egner  
Abteilungsleiter

Deutsche Akkreditierungsstelle GmbH

Standort Berlin  
Spittelmarkt 10  
10117 Berlin

Standort Frankfurt am Main  
Europa-Allee 52  
60327 Frankfurt am Main

Standort Braunschweig  
Bundesallee 100  
38116 Braunschweig

Die auszugsweise Veröffentlichung der Akkreditierungsurkunde bedarf der vorherigen schriftlichen Zustimmung der Deutsche Akkreditierungsstelle GmbH (DAkkS). Ausgenommen davon ist die separate Weiterverbreitung des Deckblattes durch die umseitig genannte Konformitätsbewertungsstelle in unveränderter Form.

Es darf nicht der Anschein erweckt werden, dass sich die Akkreditierung auch auf Bereiche erstreckt, die über den durch die DAkkS bestätigten Akkreditierungsbereich hinausgehen.

Die Akkreditierung erfolgte gemäß des Gesetzes über die Akkreditierungsstelle (AkkStelleG) vom 31. Juli 2009 (BGBl. I S. 2625) sowie der Verordnung (EG) Nr. 765/2008 des Europäischen Parlaments und des Rates vom 9. Juli 2008 über die Vorschriften für die Akkreditierung und Marktüberwachung im Zusammenhang mit der Vermarktung von Produkten (Abt. L 218 vom 9. Juli 2008, S. 30). Die DAkkS ist Unterzeichnerin der Multilateralen Abkommen zur gegenseitigen Anerkennung der European co-operation for Accreditation (EA), des International Accreditation Forum (IAF) und der International Laboratory Accreditation Cooperation (ILAC). Die Unterzeichner dieser Abkommen erkennen ihre Akkreditierungen gegenseitig an.

Der aktuelle Stand der Mitgliedschaft kann folgenden Webseiten entnommen werden:  
EA: [www.european-accrreditation.org](http://www.european-accrreditation.org)  
ILAC: [www.ilac.org](http://www.ilac.org)  
IAF: [www.iaf.nu](http://www.iaf.nu)

**Note:**  
The current certificate including annex can be received on request.