

FCC+IC Test Report

Product Name : ConnectCore 6 Plus
Trade Name : DIGI
Model No. : CC-WMX-KK8D-TN
FCC ID. : MCQ-CCIMX6P
IC ID. : 1846A-CCIMX6P

Applicant : DIGI INTERNATIONAL INC
Address : 11001 Bren Road East Minnetonka, MN 55343 (USA)

Date of Receipt : Dec. 11, 2017
Issued Date : Feb. 08, 2018
Report No. : 17C0115R-RFUSP01V00-A
Report Version : V1.0



The test results relate only to the samples tested.

The test report shall not be reproduced except in full without the written approval of DEKRA Testing and Certification Co., Ltd.

Test Report Certification

Issued Date : Feb. 08, 2018

Report No. : 17C0115R-RFUSP01V00-A



Product Name : ConnectCore 6 Plus
Applicant : DIGI INTERNATIONAL INC
Address : 11001 Bren Road East Minnetonka, MN 55343 (USA)
Manufacturer : DIGI INTERNATIONAL INC
Model No. : CC-WMX-KK8D-TN
FCC ID. : MCQ-CCIMX6P
IC ID. : 1846A-CCIMX6P
EUT Voltage : AC 100-240V, 50/60Hz
Testing Voltage : AC 120V/60Hz
Trade Name : DIGI
Applicable Standard : FCC CFR Title 47 Part 15 Subpart C Section 15.247: 2016
RSS-247 Issue 2 (Feb. 2017)
ANSI C63.10: 2013
Laboratory Name : Hsin Chu Laboratory
Address : No.372-2, Sec. 4, Zhongxing Rd., Zhudong Township, Hsinchu
County 310, Taiwan, R.O.C.
TEL: +886-3-582-8001 / FAX: +886-3-582-8958
Test Result : Complied

Documented By :

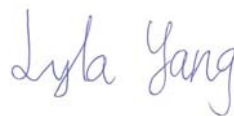

(Lyla Yang / Engineering Adm. Specialist)

Tested By :



(Clemens Fang / Engineer)

Approved By :

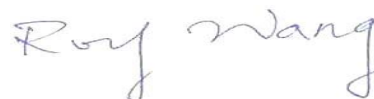

(Roy Wang / Director)

Revision History

Report No.	Version	Description	Issued Date
17C0115R-RFUSP01V00-A	V1.0	Initial issue of report	Feb. 08, 2018

TABLE OF CONTENTS

Description	Page
1. General Information.....	6
1.1. EUT Description	6
1.2. Test Mode	8
1.3. Tested System Details	9
1.4. Configuration of tested System	9
1.5. EUT Exercise Software	9
1.6. Test Facility	10
1.7. Duty Cycle	12
2. Conducted Emission	14
2.1. Test Equipment.....	14
2.2. Test Setup	14
2.3. Limits	14
2.4. Test Procedure	15
2.5. Test Specification.....	15
2.6. Uncertainty	15
2.7. Test Result.....	16
3. Peak Power Output	22
3.1. Test Equipment.....	22
3.2. Test Setup	22
3.3. Test procedures	22
3.4. Limits	22
3.5. Test Specification.....	22
3.6. Test Result.....	23
4. Radiated Emission	24
4.1. Test Equipment.....	24
4.2. Test Setup	24
4.3. Limits	25
4.4. Test Procedure	25
4.5. Test Specification.....	25
4.6. Test Result.....	26
5. RF antenna conducted test	50
5.1. Test Equipment.....	50
5.2. Test Setup	50
5.3. Limits	51
5.4. Test Procedure	51
5.5. Test Specification.....	51
5.6. Test Result.....	52
6. Band Edge.....	64
6.1. Test Equipment.....	64
6.2. Test Setup	64

6.3.	Limits	64
6.4.	Test Procedure	65
6.5.	Test Specification.....	65
6.6.	Test Result.....	66
7.	Number of hopping frequency	102
7.1.	Test Equipment.....	102
7.2.	Test Setup	102
7.3.	Limits	103
7.4.	Test Procedures	103
7.5.	Test Specification.....	103
7.6.	Test Result.....	104
8.	Carrier Frequency Separation	108
8.1.	Test Equipment.....	108
8.2.	Test Setup	108
8.3.	Limits	108
8.4.	Test Procedures	108
8.5.	Test Specification.....	108
8.6.	Test Result.....	109
9.	Occupied Bandwidth	115
9.1.	Test Equipment.....	115
9.2.	Test Setup	115
9.3.	Limits	115
9.4.	Test Procedures	115
9.5.	Test Specification.....	115
9.6.	Test Result.....	116
10.	Dwell Time.....	122
10.1.	Test Equipment.....	122
10.2.	Test Setup	122
10.3.	Limits	122
10.4.	Test Procedures	123
10.5.	Test Specification.....	123
10.6.	Test Result.....	124

1. General Information

1.1. EUT Description

Product Name	ConnectCore 6 Plus
Trade Name	DIGI
Model No.	CC-WMX-KK8D-TN
Frequency Range/Channel Number	2402~2480MHz / 79 Channels
Type of Modulation	GFSK, $\pi/4$ -DQPSK, 8-DPSK

Antenna Information	
MFR. / Model No.	Linx Technologies Inc. / ANT-DB1-RAF-RPS
Antenna Type	Dipole Antenna
Antenna Gain	2.5 dBi

Accessories Information	
Power Adatper	GlobTek [®] , Inc., GT-46180-1605 I/P : 100-240V~, 50-60Hz, 0.6A O/P : 5V \equiv 3.2A, 16W Cable Out: Non-Shielded, 1.2m

Working Frequency of Each Channel							
Channel	Frequency	Channel	Frequency	Channel	Frequency	Channel	Frequency
Channel 00	2402 MHz	Channel 20	2422 MHz	Channel 40	2442 MHz	Channel 60	2462 MHz
Channel 01	2403 MHz	Channel 21	2423 MHz	Channel 41	2443 MHz	Channel 61	2463 MHz
Channel 02	2404 MHz	Channel 22	2424 MHz	Channel 42	2444 MHz	Channel 62	2464 MHz
Channel 03	2405 MHz	Channel 23	2425 MHz	Channel 43	2445 MHz	Channel 63	2465 MHz
Channel 04	2406 MHz	Channel 24	2426 MHz	Channel 44	2446 MHz	Channel 64	2466 MHz
Channel 05	2407 MHz	Channel 25	2427 MHz	Channel 45	2447 MHz	Channel 65	2467 MHz
Channel 06	2408 MHz	Channel 26	2428 MHz	Channel 46	2448 MHz	Channel 66	2468 MHz
Channel 07	2409 MHz	Channel 27	2429 MHz	Channel 47	2449 MHz	Channel 67	2469 MHz
Channel 08	2410 MHz	Channel 28	2430 MHz	Channel 48	2450 MHz	Channel 68	2470 MHz
Channel 09	2411 MHz	Channel 29	2431 MHz	Channel 49	2451 MHz	Channel 69	2471 MHz
Channel 10	2412 MHz	Channel 30	2432 MHz	Channel 50	2452 MHz	Channel 70	2472 MHz
Channel 11	2413 MHz	Channel 31	2433 MHz	Channel 51	2453 MHz	Channel 71	2473 MHz
Channel 12	2414 MHz	Channel 32	2434 MHz	Channel 52	2454 MHz	Channel 72	2474 MHz
Channel 13	2415 MHz	Channel 33	2435 MHz	Channel 53	2455 MHz	Channel 73	2475 MHz
Channel 14	2416 MHz	Channel 34	2436 MHz	Channel 54	2456 MHz	Channel 74	2476 MHz
Channel 15	2417 MHz	Channel 35	2437 MHz	Channel 55	2457 MHz	Channel 75	2477 MHz
Channel 16	2418 MHz	Channel 36	2438 MHz	Channel 56	2458 MHz	Channel 76	2478 MHz
Channel 17	2419 MHz	Channel 37	2439 MHz	Channel 57	2459 MHz	Channel 77	2479 MHz
Channel 18	2420 MHz	Channel 38	2440 MHz	Channel 58	2460 MHz	Channel 78	2480 MHz
Channel 19	2421 MHz	Channel 39	2441 MHz	Channel 59	2461 MHz		

Note:

1. The device is an Wireless Embedded ARM Module with WLAN 802.11a/b/g/n/ac 2.4GHz/5GHz and Bluetooth 4.2 supporting EDR (BT2.0) + LE (BT4.0), including transmitter and receiver.
2. Regards to the frequency band operation; the lowest, middle and highest frequency of channel were selected to perform the test, and then shown on this report.

1.2. Test Mode

DEKRA has verified the construction and function in typical operation. All the test modes were carried out with the EUT in transmitting operation, which was shown in this test report and defined as follows:

Test Mode	Mode 1: Transmit Mode_DH5 Mode 2: Transmit Mode_2DH5 Mode 3: Transmit Mode_3DH5
-----------	---

Emission	Mode 1	Mode 2	Mode 3
Conducted Emission	Yes	Yes	Yes
Peak Power Output	Yes	Yes	Yes
Radiated Emission	Yes	Yes	Yes
RF antenna conducted test	Yes	Yes	Yes
Band Edge	Yes	Yes	Yes
Number of hopping Frequency	Yes	No	No
Carrier Frequency Separation	Yes	Yes	Yes
Occupied Bandwidth	Yes	Yes	Yes
Dwell Time	Yes	Yes	Yes

1.3. Tested System Details

The types for all equipment, plus descriptions of all cables used in the tested system (including inserted cards) are:

Product	Manufacturer	Model No.	Serial No.	FCC ID	Power Cord
1 Notebook PC	DELL	Latitude 600	N/A	DoC	Non-Shielded, 1.7m, one ferrite core bonded

1.4. Configuration of tested System

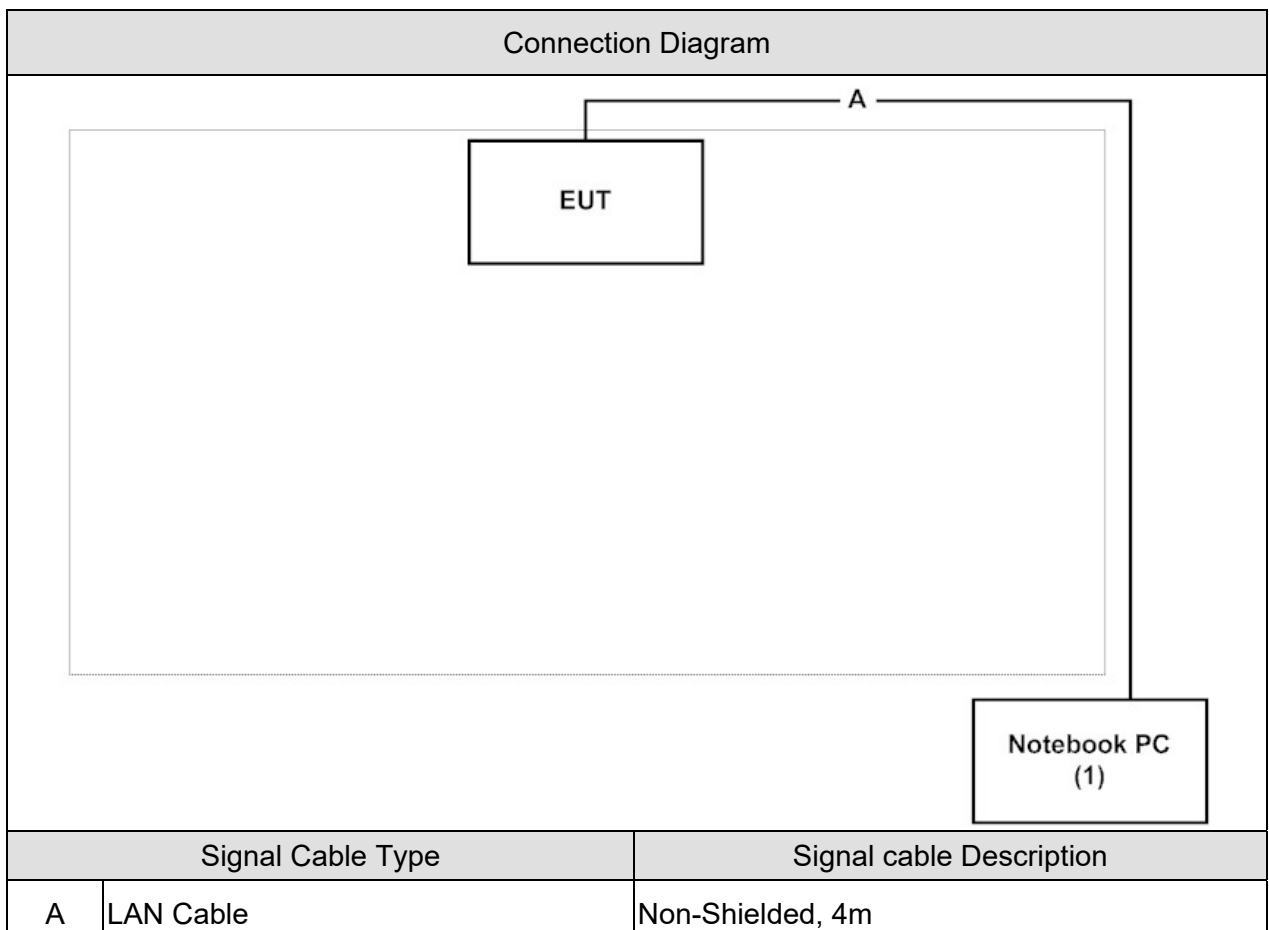

1.5. EUT Exercise Software

1	Setup the EUT as shown in Section 1.4.
2	Execute the "QRCT" on the laptop.
3	Configure the test mode, the test channel, and the data rate.
4	Press "Start TX" to start the continuous transmitting.
5	Verify that the EUT works properly.

1.6. Test Facility

Ambient conditions in the laboratory:

Items	Test Item	Required (IEC 68-1)	Actual	Test Site
Temperature (°C)	FCC PART 15 C 15.207 & RSS-247 Conducted Emission (FHSS)	15 - 35	23	3
Humidity (%RH)		25 - 75	50	
Barometric pressure (mbar)		860 - 1060	950-1000	
Temperature (°C)	FCC PART 15 C 15.247 & RSS-247 Peak Power Output (FHSS)	15 - 35	24	3
Humidity (%RH)		25 - 75	45	
Barometric pressure (mbar)		860 - 1060	950-1000	
Temperature (°C)	FCC PART 15 C 15.247 & RSS-247 Radiated Emission (FHSS)	15 - 35	25	2
Humidity (%RH)		25 - 75	54	
Barometric pressure (mbar)		860 - 1060	950-1000	
Temperature (°C)	FCC PART 15 C 15.247 & RSS-247 RF antenna conducted test (FHSS)	15 - 35	24	3
Humidity (%RH)		25 - 75	45	
Barometric pressure (mbar)		860 - 1060	950-1000	
Temperature (°C)	FCC PART 15 C 15.247 & RSS-247 Band Edge (FHSS)	15 - 35	25	2
Humidity (%RH)		25 - 75	50	
Barometric pressure (mbar)		860 - 1060	950-1000	
Temperature (°C)	FCC PART 15 C 15.247 & RSS-247 Number of hopping Frequency (FHSS)	15 - 35	24	3
Humidity (%RH)		25 - 75	45	
Barometric pressure (mbar)		860 - 1060	950-1000	
Temperature (°C)	FCC PART 15 C 15.247 & RSS-247 Carrier Frequency Separation (FHSS)	15 - 35	24	3
Humidity (%RH)		25 - 75	45	
Barometric pressure (mbar)		860 - 1060	950-1000	
Temperature (°C)	FCC PART 15 C 15.247 & RSS-247 Occupied Bandwidth (FHSS)	15 - 35	24	3
Humidity (%RH)		25 - 75	45	
Barometric pressure (mbar)		860 - 1060	950-1000	
Temperature (°C)	FCC PART 15 C 15.247 & RSS-247 Dwell Time (FHSS)	15 - 35	24	3
Humidity (%RH)		25 - 75	45	
Barometric pressure (mbar)		860 - 1060	950-1000	

Note: Test site information refers to Laboratory Information.

USA : FCC, Registration Number: TW3024

The related certificate for our laboratories about the test site and management system can be downloaded from DEKRA Testing and Certification Co., Ltd. Web Site :

<http://www.dekra.com.tw/english/about/certificates.aspx?bval=5>

The address and introduction of DEKRA Testing and Certification Co., Ltd. laboratories can be founded in our Web site : http://www.dekra.com.tw/index_en.aspx

If you have any comments, Please don't hesitate to contact us. Our test sites as below:

- 1 No. 75-2, 3rd Lin, WangYe Keng, Yonghxing Tsuen, Qionglin Shiang, Hsinchu County 307, Taiwan (R.O.C.)
TEL:+886-3-592-8858 / FAX:+886-3-592-8859 E-Mail : info.tw@dekra.com
- 2 No.372, Sec. 4, Zhongxing Rd., Zhudong Township, Hsinchu County 31061, Taiwan, R.O.C.
TEL: +886-3-582-8001 / FAX: +886-3-582-8958 E-Mail : info.tw@dekra.com
- 3 No.372-2, Sec. 4, Zhongxing Rd., Zhudong Township, Hsinchu County 31061, Taiwan, R.O.C.
TEL: +886-3-582-8001 / FAX: +886-3-582-8958 E-Mail : info.tw@dekra.com

1.7. Duty Cycle

Mode	On Time (ms)	On+Off Time (ms)	Duty Cycle (%)	Off Set (dB)
DH5	2.884	3.749	76.927%	2.278
2DH5	2.885	3.748	76.974%	2.273
3DH5	2.887	3.749	77.007%	2.269

DH5

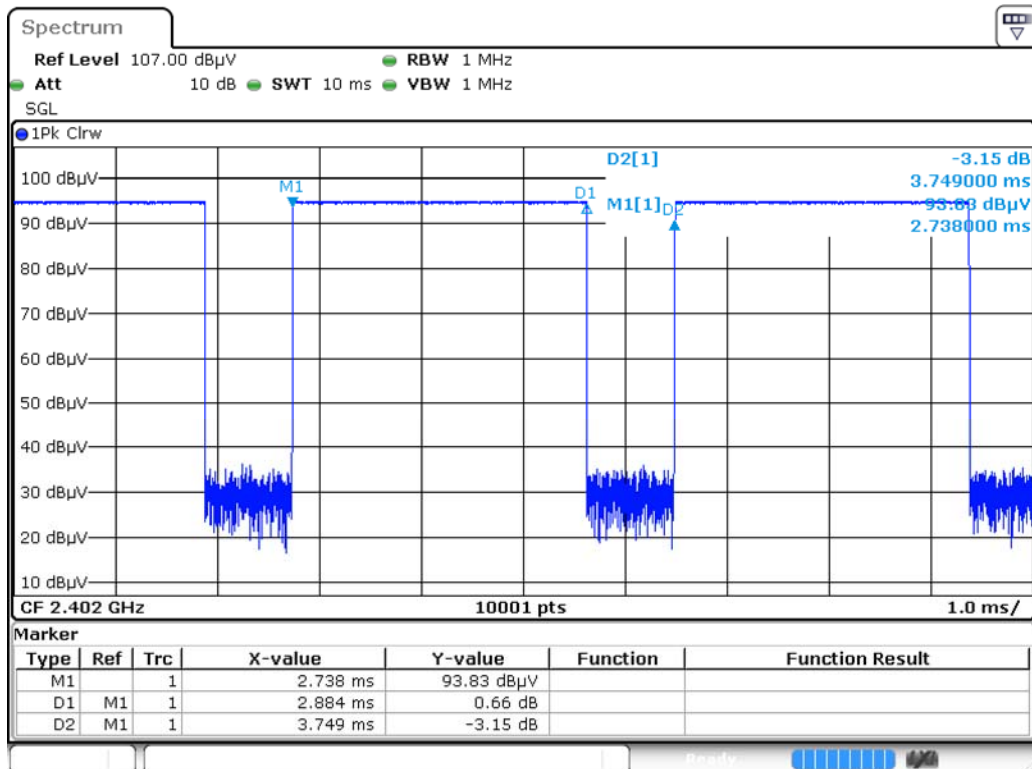

Date: 17.DEC.2017 22:26:26

2DH5

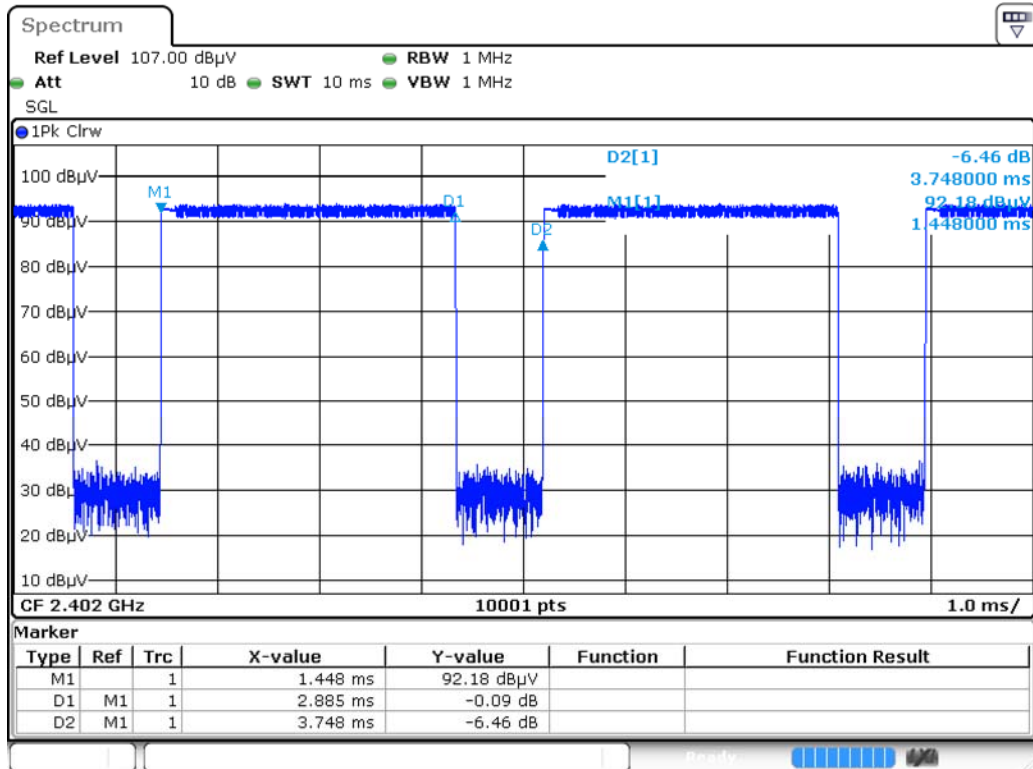

Date: 18.DEC.2017 01:15:04

3DH5

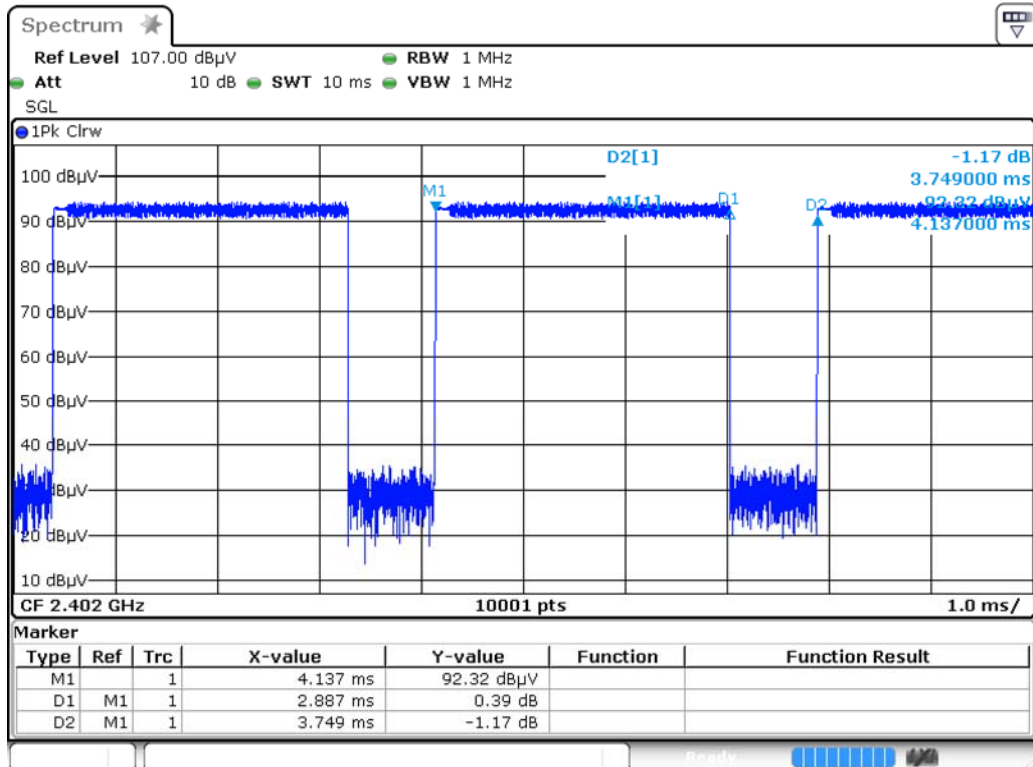

Date: 18.DEC.2017 03:21:35

2. Conducted Emission

2.1. Test Equipment

The following test equipment's are used during the test:

Conducted Emission /SR2-H

Instrument	Manufacturer	Model No.	Serial No.	Cal. Date	Next Cal. Date
Artificial Mains Network	R&S	ENV4200	848411/010	2017/02/06	2018/02/05
Test Receiver	R&S	ESCS 30	836858/022	2017/04/12	2018/04/11
LISN	R&S	ENV216	100092	2017/07/31	2018/07/30

2.2. Test Setup

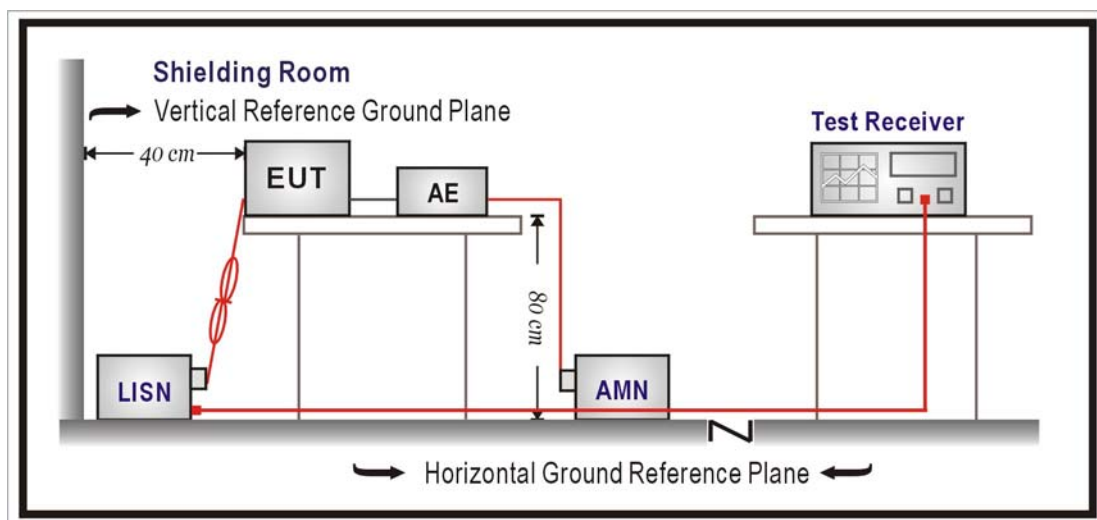

2.3. Limits

FCC Part 15 Subpart C Paragraph 15.207 Limits (dBuV)		
Frequency MHz	QP	AV
0.15 - 0.50	66 - 56	56 - 46
0.50 - 5.0	56	46
5.0 - 30	60	50

Remarks: In the above table, the tighter limit applies at the band edges.

2.4. Test Procedure

The EUT and simulators are connected to the main power through a line impedance stabilization network (L.I.S.N.). This provides a 50 ohm /50uH coupling impedance for the measuring equipment. The peripheral devices are also connected to the main power through a LISN that provides a 50ohm /50uH coupling impedance with 50ohm termination. (Please refer to the block diagram of the test setup and photographs.)

Both sides of A.C. line are checked for maximum conducted interference. In order to find the maximum emission, the relative positions of equipment and all of the interface cables must be changed according to ANSI C63.10: 2013 on conducted measurement.

Conducted emissions were investigated over the frequency range from 0.15MHz to 30MHz using a receiver bandwidth of 9 kHz.

2.5. Test Specification

According to FCC Part 15 Subpart C Paragraph 15.207 and RSS-247.

2.6. Uncertainty

The measurement uncertainty is defined as ± 2.26 dB.

2.7. Test Result

Site : SR2-H	Time : 2018/01/16
Limit : CISPR_B_00M_QP	Margin : 10
Probe : SR2_LISN(16A)-6_0712 - Line1	Power : AC 120V/60Hz
EUT : ConnectCore 6 Plus	Note : Mode 1: Transmit Mode_DH5 802.15.1_DH5_2441MHz

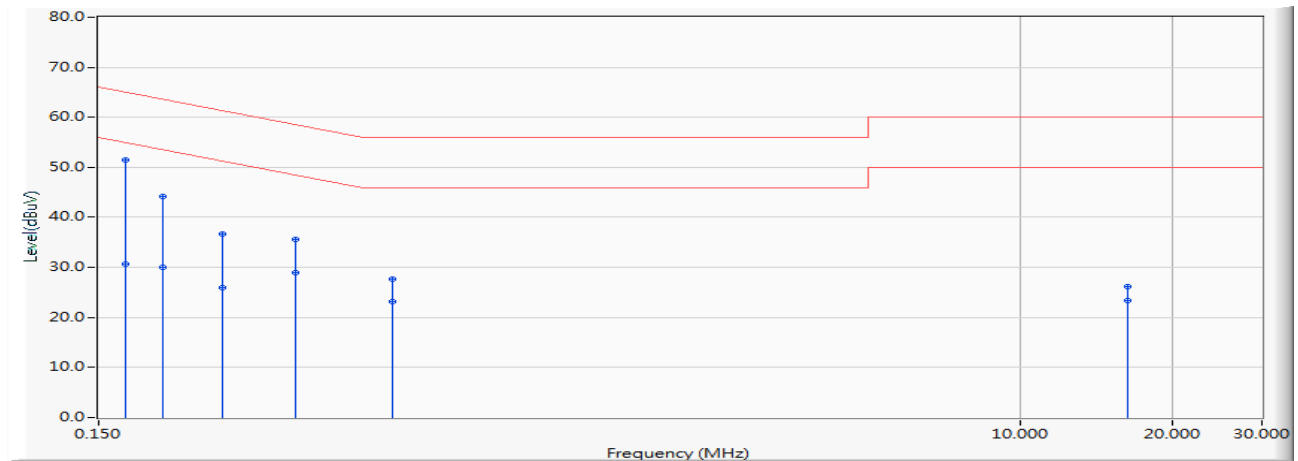

		Frequency (MHz)	Correct Factor (dB)	Reading Level (dBuV)	Measure Level (dBuV)	Margin (dB)	Limit (dBuV)	Detector Type
1	*	0.170	9.753	41.660	51.413	-13.570	64.983	QUASPEAK
2		0.170	9.753	20.910	30.663	-24.320	54.983	AVERAGE
3		0.201	9.750	34.430	44.180	-19.398	63.578	QUASPEAK
4		0.201	9.750	20.270	30.020	-23.558	53.578	AVERAGE
5		0.263	9.744	26.960	36.704	-24.624	61.327	QUASPEAK
6		0.263	9.744	16.220	25.964	-25.364	51.327	AVERAGE
7		0.369	9.733	25.840	35.573	-22.956	58.529	QUASPEAK
8		0.369	9.733	19.290	29.023	-19.506	48.529	AVERAGE
9		0.572	9.741	18.030	27.771	-28.229	56.000	QUASPEAK
10		0.572	9.741	13.350	23.091	-22.909	46.000	AVERAGE
11		16.228	10.250	15.910	26.159	-33.841	60.000	QUASPEAK
12		16.228	10.250	13.220	23.469	-26.531	50.000	AVERAGE

Note:

1. All Reading Levels are Quasi-Peak and average value.
2. " * ", means this data is the worst emission level.
3. Measurement Level = Reading Level + Correct Factor.

Site : SR2-H	Time : 2018/01/16
Limit : CISPR_B_00M_QP	Margin : 10
Probe : SR2_LISN(16A)-6_0712 - Line2	Power : AC 120V/60Hz
EUT : ConnectCore 6 Plus	Note : Mode 1: Transmit Mode_DH5 802.15.1_DH5_2441MHz

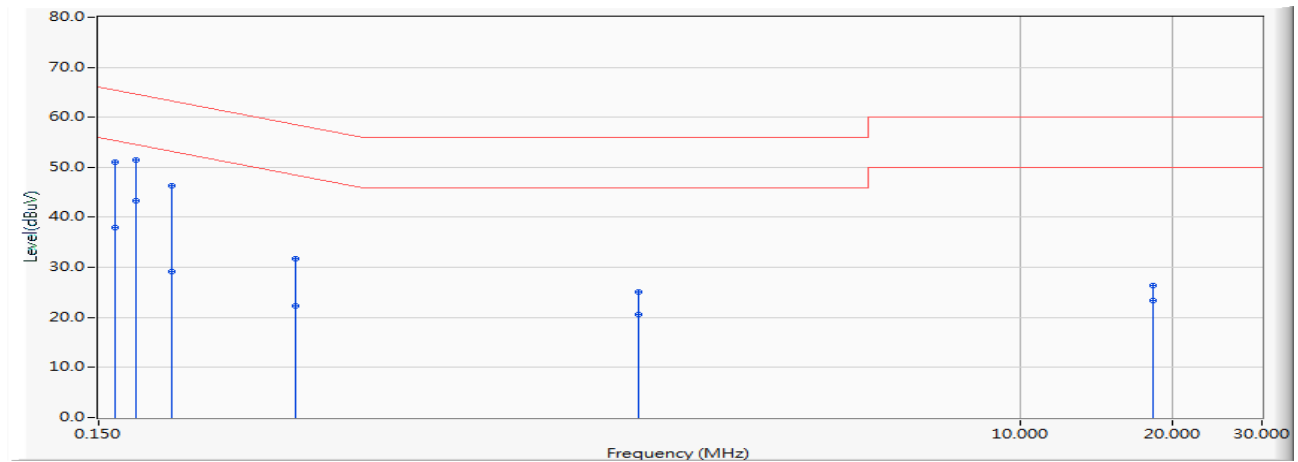

	Frequency (MHz)	Correct Factor (dB)	Reading Level (dBuV)	Measure Level (dBuV)	Margin (dB)	Limit (dBuV)	Detector Type
1	0.162	9.754	41.230	50.984	-14.391	65.375	QUASPEAK
2	0.162	9.754	28.270	38.024	-17.351	55.375	AVERAGE
3	0.177	9.752	41.810	51.562	-13.047	64.609	QUASPEAK
4	*	9.752	33.590	43.342	-11.267	54.609	AVERAGE
5	0.209	9.750	36.470	46.220	-17.041	63.261	QUASPEAK
6	0.209	9.750	19.430	29.180	-24.081	53.261	AVERAGE
7	0.369	9.750	21.990	31.740	-26.789	58.529	QUASPEAK
8	0.369	9.750	12.540	22.290	-26.239	48.529	AVERAGE
9	1.752	9.843	15.220	25.063	-30.937	56.000	QUASPEAK
10	1.752	9.843	10.740	20.583	-25.417	46.000	AVERAGE
11	18.244	10.433	15.990	26.423	-33.577	60.000	QUASPEAK
12	18.244	10.433	12.890	23.323	-26.677	50.000	AVERAGE

Note:

1. All Reading Levels are Quasi-Peak and average value.
2. " * ", means this data is the worst emission level.
3. Measurement Level = Reading Level + Correct Factor.

Site : SR2-H	Time : 2018/01/16
Limit : CISPR_B_00M_QP	Margin : 10
Probe : SR2_LISN(16A)-6_0712 - Line1	Power : AC 120V/60Hz
EUT : ConnectCore 6 Plus	Note : Mode 2: Transmit Mode_2DH5 802.15.1_2DH5_2441MHz

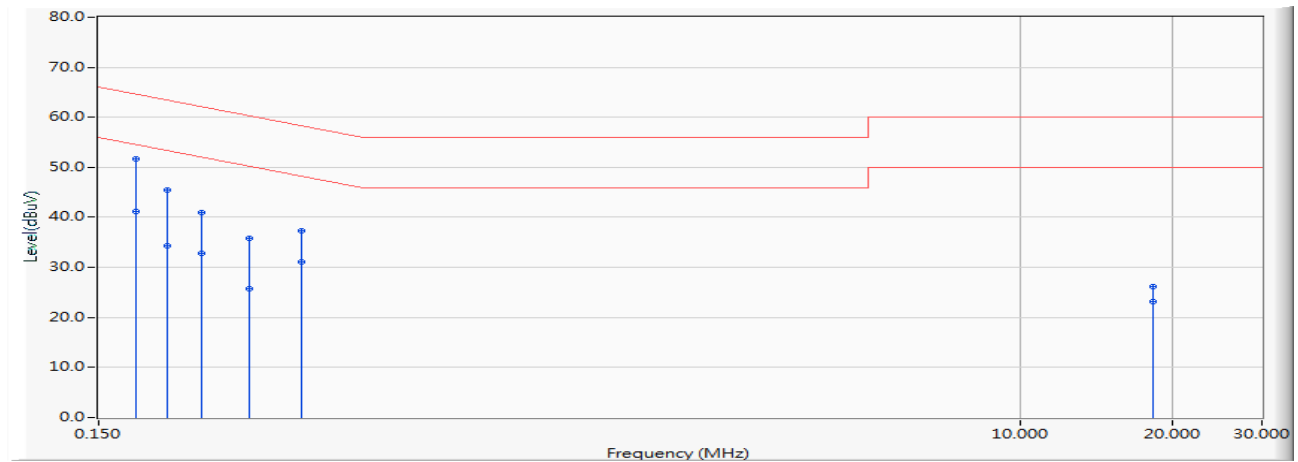

		Frequency (MHz)	Correct Factor (dB)	Reading Level (dBuV)	Measure Level (dBuV)	Margin (dB)	Limit (dBuV)	Detector Type
1	*	0.177	9.752	42.010	51.762	-12.847	64.609	QUASIPeAK
2		0.177	9.752	31.350	41.102	-13.507	54.609	AVERAGE
3		0.205	9.750	35.760	45.510	-17.909	63.418	QUASIPeAK
4		0.205	9.750	24.650	34.400	-19.019	53.418	AVERAGE
5		0.240	9.746	31.260	41.006	-21.096	62.102	QUASIPeAK
6		0.240	9.746	23.100	32.846	-19.256	52.102	AVERAGE
7		0.298	9.740	26.140	35.880	-24.406	60.286	QUASIPeAK
8		0.298	9.740	15.950	25.690	-24.596	50.286	AVERAGE
9		0.377	9.732	27.640	37.372	-20.983	58.355	QUASIPeAK
10		0.377	9.732	21.420	31.152	-17.203	48.355	AVERAGE
11		18.244	10.298	15.930	26.228	-33.772	60.000	QUASIPeAK
12		18.244	10.298	12.830	23.128	-26.872	50.000	AVERAGE

Note:

1. All Reading Levels are Quasi-Peak and average value.
2. " * ", means this data is the worst emission level.
3. Measurement Level = Reading Level + Correct Factor.

Site : SR2-H	Time : 2018/01/16
Limit : CISPR_B_00M_QP	Margin : 10
Probe : SR2_LISN(16A)-6_0712 - Line2	Power : AC 120V/60Hz
EUT : ConnectCore 6 Plus	Note : Mode 2: Transmit Mode_2DH5 802.15.1_2DH5_2441MHz

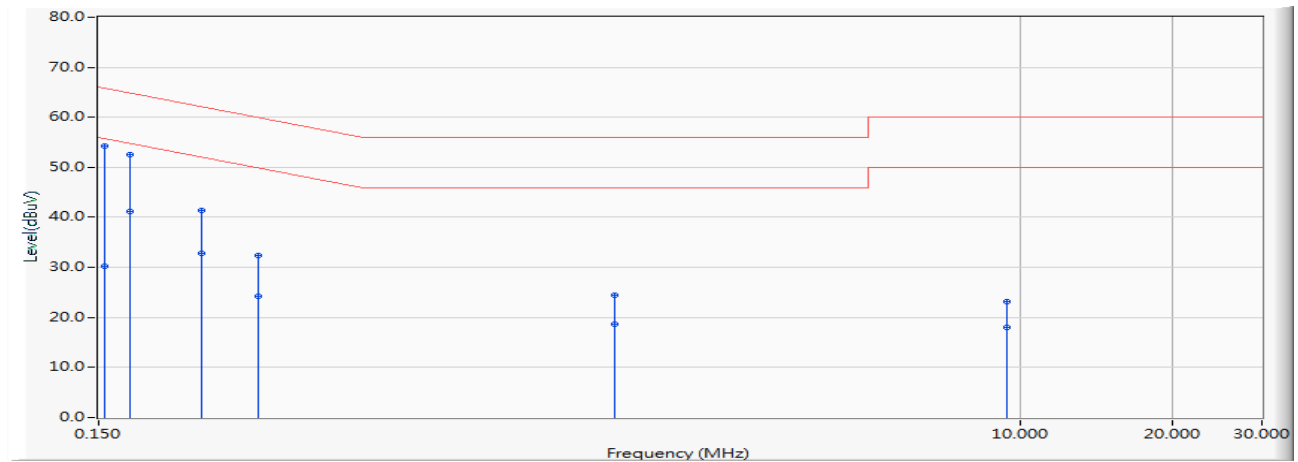

		Frequency (MHz)	Correct Factor (dB)	Reading Level (dBuV)	Measure Level (dBuV)	Margin (dB)	Limit (dBuV)	Detector Type
1	*	0.154	9.747	44.520	54.266	-11.520	65.786	QUASPEAK
2		0.154	9.747	20.600	30.346	-25.440	55.786	AVERAGE
3		0.173	9.753	42.810	52.563	-12.231	64.794	QUASPEAK
4		0.173	9.753	31.360	41.113	-13.681	54.794	AVERAGE
5		0.240	9.750	31.620	41.370	-20.732	62.102	QUASPEAK
6		0.240	9.750	23.100	32.850	-19.252	52.102	AVERAGE
7		0.310	9.750	22.680	32.430	-27.536	59.966	QUASPEAK
8		0.310	9.750	14.580	24.330	-25.636	49.966	AVERAGE
9		1.568	9.837	14.590	24.427	-31.573	56.000	QUASPEAK
10		1.568	9.837	8.850	18.687	-27.313	46.000	AVERAGE
11		9.365	10.113	12.990	23.103	-36.897	60.000	QUASPEAK
12		9.365	10.113	7.810	17.923	-32.077	50.000	AVERAGE

Note:

1. All Reading Levels are Quasi-Peak and average value.
2. " * ", means this data is the worst emission level.
3. Measurement Level = Reading Level + Correct Factor.

Site : SR2-H	Time : 2018/01/16
Limit : CISPR_B_00M_QP	Margin : 10
Probe : SR2_LISN(16A)-6_0712 - Line1	Power : AC 120V/60Hz
EUT : ConnectCore 6 Plus	Note : Mode 3: Transmit Mode_3DH5 802.15.1_3DH5_2441MHz

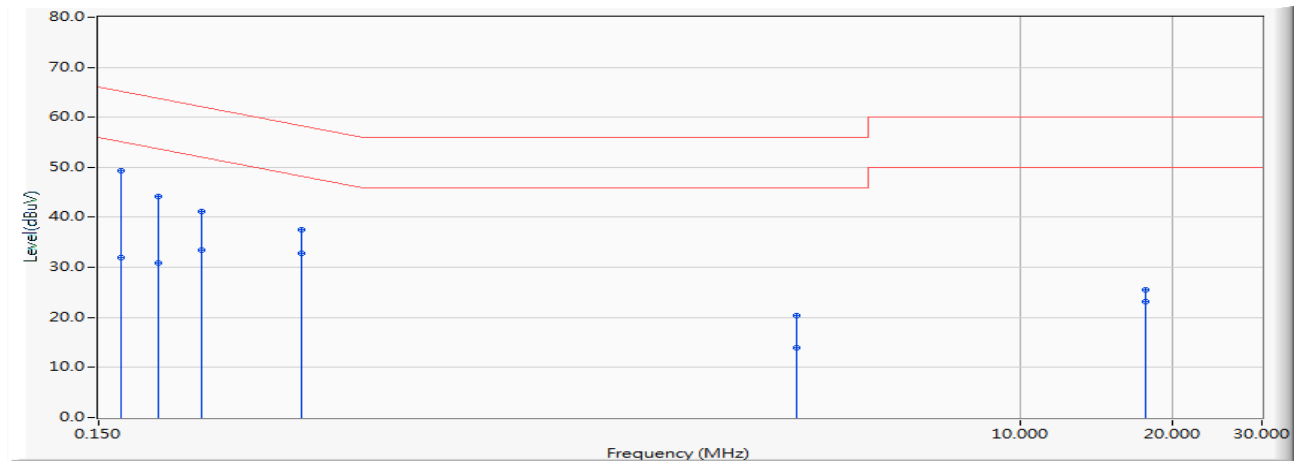

	Frequency (MHz)	Correct Factor (dB)	Reading Level (dBuV)	Measure Level (dBuV)	Margin (dB)	Limit (dBuV)	Detector Type
1	0.166	9.753	39.590	49.343	-15.834	65.177	QUASPEAK
2	0.166	9.753	22.260	32.013	-23.164	55.177	AVERAGE
3	0.197	9.750	34.530	44.280	-19.461	63.741	QUASPEAK
4	0.197	9.750	21.200	30.950	-22.791	53.741	AVERAGE
5	0.240	9.746	31.540	41.286	-20.816	62.102	QUASPEAK
6	0.240	9.746	23.780	33.526	-18.576	52.102	AVERAGE
7	0.377	9.732	27.820	37.552	-20.803	58.355	QUASPEAK
8	* 0.377	9.732	23.090	32.822	-15.533	48.355	AVERAGE
9	3.607	9.908	10.530	20.438	-35.562	56.000	QUASPEAK
10	3.607	9.908	4.020	13.928	-32.072	46.000	AVERAGE
11	17.693	10.285	15.330	25.615	-34.385	60.000	QUASPEAK
12	17.693	10.285	12.850	23.135	-26.865	50.000	AVERAGE

Note:

1. All Reading Levels are Quasi-Peak and average value.
2. " * ", means this data is the worst emission level.
3. Measurement Level = Reading Level + Correct Factor.

Site : SR2-H	Time : 2018/01/16
Limit : CISPR_B_00M_QP	Margin : 10
Probe : SR2_LISN(16A)-6_0712 - Line2	Power : AC 120V/60Hz
EUT : ConnectCore 6 Plus	Note : Mode 3: Transmit Mode_3DH5 802.15.1_3DH5_2441MHz

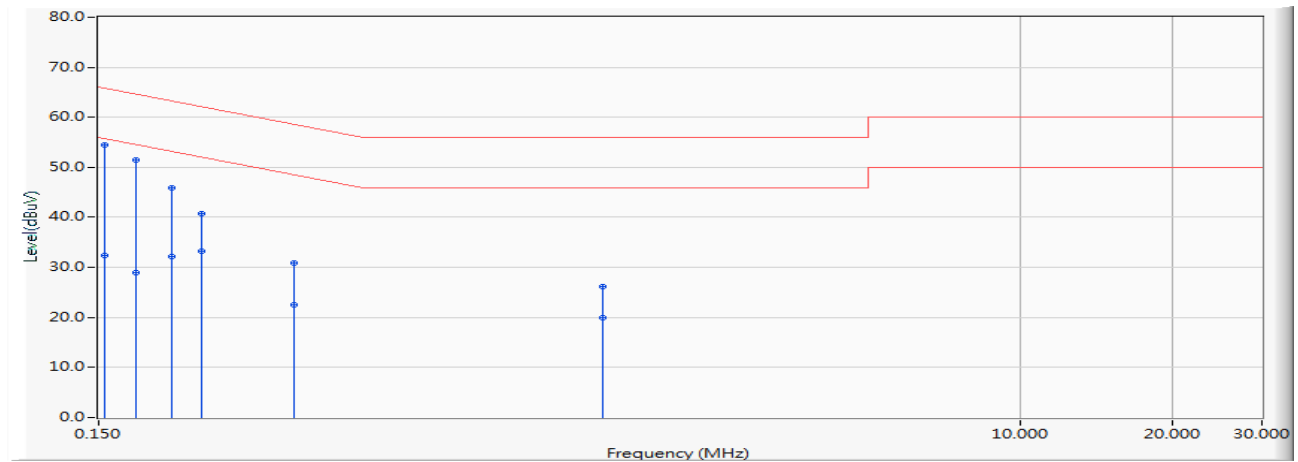

		Frequency (MHz)	Correct Factor (dB)	Reading Level (dBuV)	Measure Level (dBuV)	Margin (dB)	Limit (dBuV)	Detector Type
1	*	0.154	9.747	44.810	54.556	-11.230	65.786	QUASPEAK
2		0.154	9.747	22.740	32.486	-23.300	55.786	AVERAGE
3		0.177	9.752	41.620	51.372	-13.237	64.609	QUASPEAK
4		0.177	9.752	19.230	28.982	-25.627	54.609	AVERAGE
5		0.209	9.750	36.170	45.920	-17.341	63.261	QUASPEAK
6		0.209	9.750	22.520	32.270	-20.991	53.261	AVERAGE
7		0.240	9.750	30.950	40.700	-21.402	62.102	QUASPEAK
8		0.240	9.750	23.510	33.260	-18.842	52.102	AVERAGE
9		0.365	9.750	21.220	30.970	-27.647	58.617	QUASPEAK
10		0.365	9.750	12.750	22.500	-26.117	48.617	AVERAGE
11		1.494	9.835	16.290	26.125	-29.875	56.000	QUASPEAK
12		1.494	9.835	10.090	19.925	-26.075	46.000	AVERAGE

Note:

1. All Reading Levels are Quasi-Peak and average value.
2. " * ", means this data is the worst emission level.
3. Measurement Level = Reading Level + Correct Factor.

3. Peak Power Output

3.1. Test Equipment

The following test equipment is used during the test:

Peak Power Output / SR10-H

Instrument	Manufacturer	Model No.	Serial No.	Cal. Date	Next Cal. Date
High Speed Peak Power Meter Dual Input	Anritsu	ML2496A	1602004	2018/01/02	2019/01/01
Pulse Power Sensor	Anritsu	MA2411B	1531043	2018/01/02	2019/01/01
Pulse Power Sensor	Anritsu	MA2411B	1531044	2018/01/02	2019/01/01

3.2. Test Setup

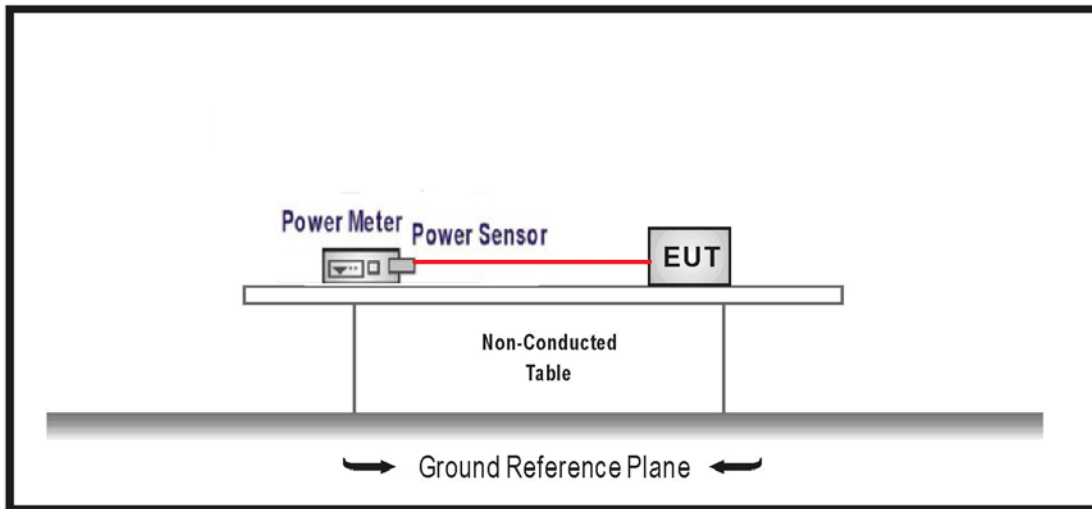

3.3. Test procedures

The EUT was setup according to ANSI C63.10: 2013 and tested according to FHSS test procedure of FCC Public Notice DA 00-705 for compliance to FCC 47CFR 15.247 requirements

3.4. Limits

For frequency hopping systems operating in the 902-928 MHz band: 1 Watt for systems employing at least 50 hopping channels; and, 0.25 Watts for systems employing less than 50 hopping channels.

For frequency hopping systems in the 2400-2483.5 MHz band employing at least 75 hopping channels, and all frequency hopping systems in the 5725-5850 MHz band: 1Watt.

For all other frequency hopping systems in the 2400-2483.5 MHz band: 0.125 Watt.

3.5. Test Specification

According to FCC Part 15 Subpart C Paragraph 15.247 and RSS-247.

3.6. Test Result

Product	ConnectCore 6 Plus		
Test Item	Peak Power Output		
Test Mode	Mode 1: Transmit Mode_DH5 Mode 2: Transmit Mode_2DH5 Mode 3: Transmit Mode_3DH5		
Date of Test	2018/01/05	Test Site	SR10-H

GFSK

Channel No.	Frequency (MHz)	Measure Level (dBm)	Limit (dBm)	Result
00	2402	9.220	30	Pass
39	2441	9.450	30	Pass
78	2480	9.160	30	Pass

$\pi/4$ -DQPSK

Channel No.	Frequency (MHz)	Measure Level (dBm)	Limit (dBm)	Result
00	2402	8.370	30	Pass
39	2441	8.630	30	Pass
78	2480	8.320	30	Pass

8-DPSK

Channel No.	Frequency (MHz)	Measure Level (dBm)	Limit (dBm)	Result
00	2402	8.810	30	Pass
39	2441	9.010	30	Pass
78	2480	8.740	30	Pass

4. Radiated Emission

4.1. Test Equipment

The following test equipment are used during the test:

Radiated Emission / CB2-H

Instrument	Manufacturer	Model No.	Serial No.	Cal. Date	Next Cal. Date
Signal Analyzer	R&S	FSVA40	101455	2017/11/21	2018/11/20
Signal & Spectrum Analyzer	R&S	FSV40	101049	2018/01/10	2019/01/09
EXA Signal Analyzer	Keysight	N9010A	MY51440132	2017/03/13	2018/03/12
Bilog Antenna	Teseq	CBL6112D	23191	2017/06/28	2018/06/27
Horn Antenna	Schwarzbeck	BBHA 9120D	639	2017/06/14	2018/06/13
Horn Antenna	Schwarzbeck	BBHA 9170	202	2017/02/15	2018/02/14
Pre-Amplifier	RF Bay Inc.	LNA-1330	12162511	2017/03/09	2018/03/08
Pre-Amplifier	EMCI	EMCI 1830I	980366	2018/01/08	2019/01/07
Pre-Amplifier	MITEQ	JS44-18004000-45-8P	2014754	2017/12/13	2018/12/12

4.2. Test Setup

Under 1GHz Test Setup:

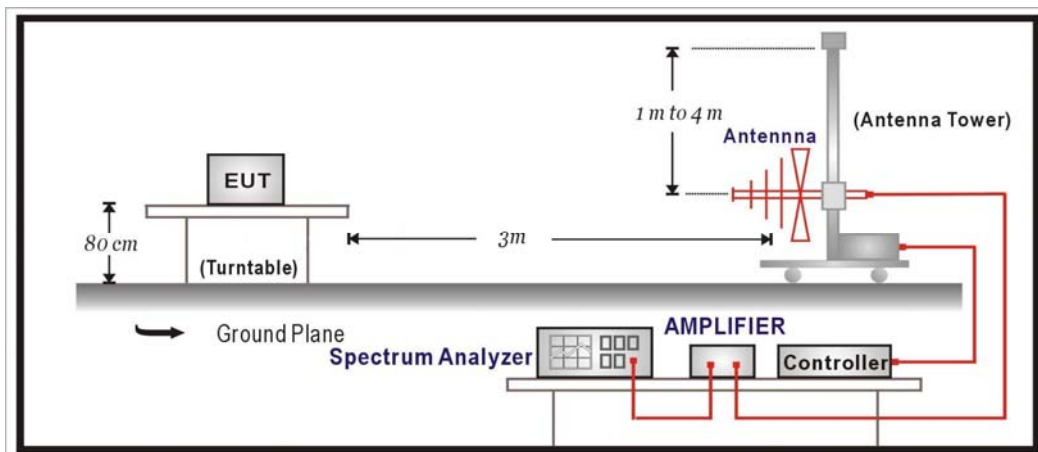

Above 1GHz Test Setup:

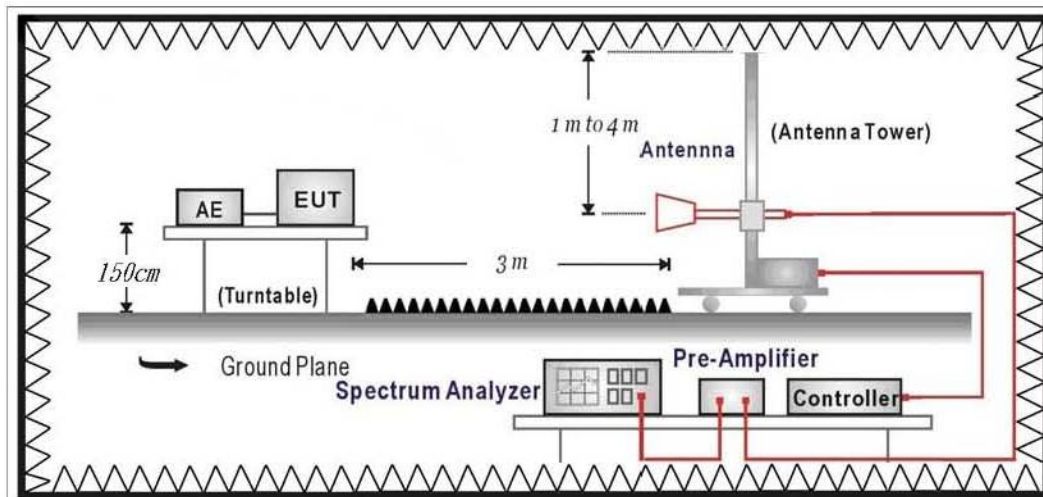

4.3. Limits

Emissions radiated outside of the specified frequency bands, except for harmonics, shall be attenuated by at least 20dB below the level of the fundamental or to the general radiated emission limits in paragraph 15.209, whichever is the lesser attenuation.

FCC Part 15 Subpart C Paragraph 15.209 Limits		
Frequency MHz	uV/m	dBuV/m
30 - 88	100	40
88 - 216	150	43.5
216 - 960	200	46
Above 960	500	54

Remarks : 1. RF Voltage (dBuV) = 20 log RF Voltage (uV)
 2. In the Above Table, the tighter limit applies at the band edges.
 3. Distance refers to the distance in meters between the measuring instrument antenna and the closed point of any part of the device or system.

4.4. Test Procedure

The EUT was setup according to ANSI C63.10: 2013 and tested according to FHSS test procedure of FCC Public Notice DA 00-705 for compliance to FCC 47CFR 15.247 requirements.

The EUT and its simulators are placed on a turn table which is 0.8 or 1.5 meter above ground. The turn table can rotate 360 degrees to determine the position of the maximum emission level.

The antenna can move up and down between 1 meter and 4 meters to find out the maximum emission level.

Both horizontal and vertical polarization of the antenna are set on measurement. In order to find the maximum emission, all of the interface cables must be manipulated according to ANSI C63.10: 2013 on radiated measurement.

On any frequency or frequencies from 9KHz(inclde The the lowest oscillator frequency generated within the device up to the 10th harmonic) to 1000 MHz, the limits shown are based on measuring equipment employing a quasi-peak detector function and on any frequency or frequencies above 1000 MHz the radiated limits shown are based upon the use of measurement instrumentation employing an average detector function. When average radiated emission measurement are included emission measurement below 1000 MHz, there also is a limit on the radio frequency emissions, as measured using instrumentation with a peak detector function, corresponding to 20 dB above the maximum permitted average limit. The bandwidth below 1GHz setting on the field strength meter is 120 kHz and above 1GHz is 1MHz.

4.5. Test Specification

According to FCC Part 15 Subpart C Paragraph 15.247 and RSS-247.

4.6. Test Result

30MHz-1GHz Spurious

Site : DEKRA Taiwan CB2-H	Time : 2017/12/20
Limit : FCC_CLASS_B_03M_QP	Margin : 6
Probe : CB2_FCC_EFS_S2_30M-1GHz_1116 - HORIZONTAL	Power : AC 120V/60Hz
EUT : ConnectCore 6 Plus	Note : Mode 1: Transmit Mode_DH5 802.15.1_DH5_2441MHz

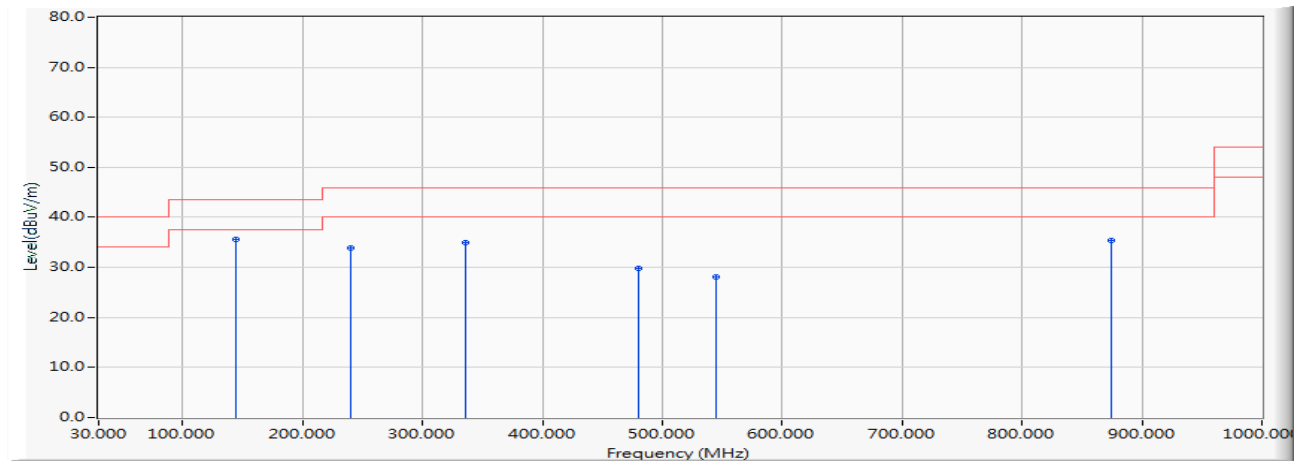

		Frequency (MHz)	Correct Factor (dB)	Reading Level (dBuV)	Measure Level (dBuV/m)	Margin (dB)	Limit (dBuV/m)	Detector Type
1	*	144.072	-22.157	57.812	35.655	-7.845	43.500	QUASIPeAK
2		240.005	-20.987	54.806	33.820	-12.180	46.000	QUASIPeAK
3		336.035	-17.947	52.980	35.033	-10.967	46.000	QUASIPeAK
4		479.983	-14.748	44.487	29.738	-16.262	46.000	QUASIPeAK
5		544.488	-13.943	42.073	28.130	-17.870	46.000	QUASIPeAK
6		874.967	-10.257	45.638	35.380	-10.620	46.000	QUASIPeAK

Note:

1. All Reading Levels is Quasi-Peak value.
2. “ * ”, means this data is the worst emission level.
3. Measurement Level = Reading Level + Correct Factor
4. The Emission under 30MHz were not included is because their levels are too low.

Site : DEKRA Taiwan CB2-H	Time : 2017/12/20
Limit : FCC_CLASS_B_03M_QP	Margin : 6
Probe : CB2 FCC EFS S2_30M-1GHz_1116 - VERTICAL	Power : AC 120V/60Hz
EUT : ConnectCore 6 Plus	Note : Mode 1: Transmit Mode_DH5 802.15.1_DH5_2441MHz

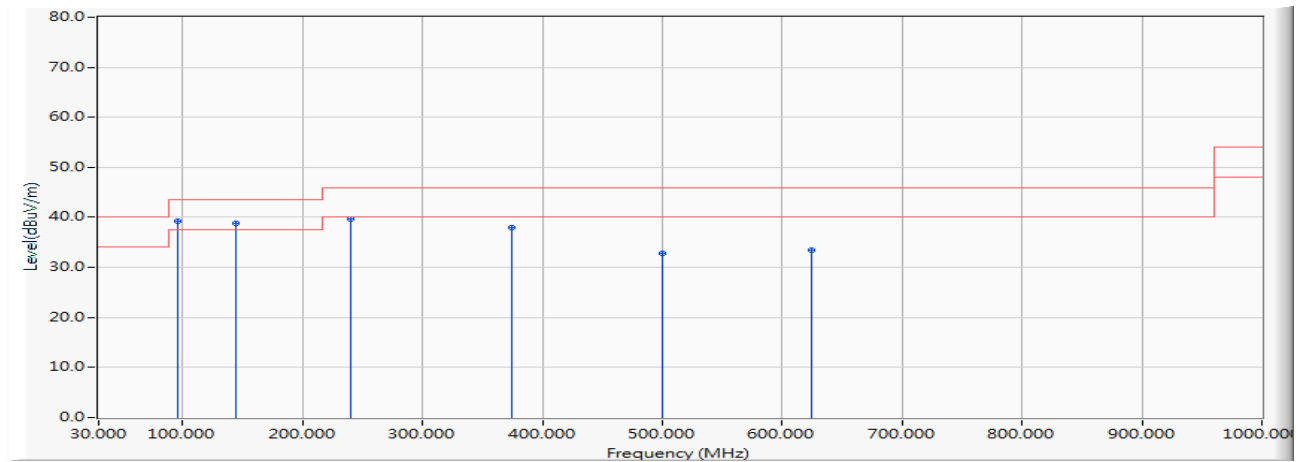

		Frequency (MHz)	Correct Factor (dB)	Reading Level (dBuV)	Measure Level (dBuV/m)	Margin (dB)	Limit (dBuV/m)	Detector Type
1	*	95.960	-24.465	63.807	39.342	-4.158	43.500	QUASPEAK
2		144.072	-22.157	61.015	38.858	-4.642	43.500	QUASPEAK
3		240.005	-20.987	60.594	39.608	-6.392	46.000	QUASPEAK
4		375.029	-16.756	54.686	37.930	-8.070	46.000	QUASPEAK
5		499.965	-14.456	47.226	32.771	-13.229	46.000	QUASPEAK
6		624.998	-13.025	46.439	33.414	-12.586	46.000	QUASPEAK

Note:

1. All Reading Levels is Quasi-Peak value.
2. “ * ”, means this data is the worst emission level.
3. Measurement Level = Reading Level + Correct Factor
4. The Emission under 30MHz were not included is because their levels are too low.

Site : DEKRA Taiwan CB2-H	Time : 2017/12/20
Limit : FCC_CLASS_B_03M_QP	Margin : 6
Probe : CB2_FCC_EFS_S2_30M-1GHz_1116 - HORIZONTAL	Power : AC 120V/60Hz
EUT : ConnectCore 6 Plus	Note : Mode 2: Transmit Mode_2DH5 802.15.1_2DH5_2441MHz

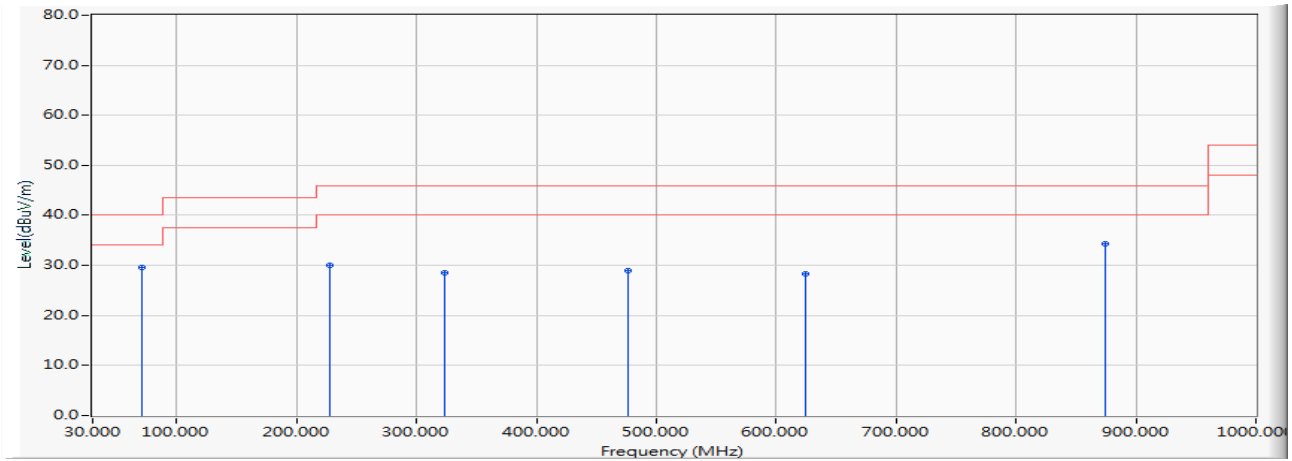

		Frequency (MHz)	Correct Factor (dB)	Reading Level (dBuV)	Measure Level (dBuV/m)	Margin (dB)	Limit (dBuV/m)	Detector Type
1	*	70.934	-28.146	57.752	29.606	-10.394	40.000	QUASPEAK
2		227.977	-21.740	51.820	30.080	-15.920	46.000	QUASPEAK
3		323.910	-18.326	46.875	28.549	-17.451	46.000	QUASPEAK
4		476.200	-14.803	43.782	28.979	-17.021	46.000	QUASPEAK
5		624.028	-13.042	41.442	28.400	-17.600	46.000	QUASPEAK
6		874.870	-10.259	44.654	34.395	-11.605	46.000	QUASPEAK

Note:

1. All Reading Levels is Quasi-Peak value.
2. “ * ”, means this data is the worst emission level.
3. Measurement Level = Reading Level + Correct Factor
4. The Emission under 30MHz were not included is because their levels are too low.

Site : DEKRA Taiwan CB2-H	Time : 2017/12/20
Limit : FCC_CLASS_B_03M_QP	Margin : 6
Probe : CB2 FCC EFS S2_30M-1GHz_1116 - VERTICAL	Power : AC 120V/60Hz
EUT : ConnectCore 6 Plus	Note : Mode 2: Transmit Mode_2DH5 802.15.1_2DH5_2441MHz

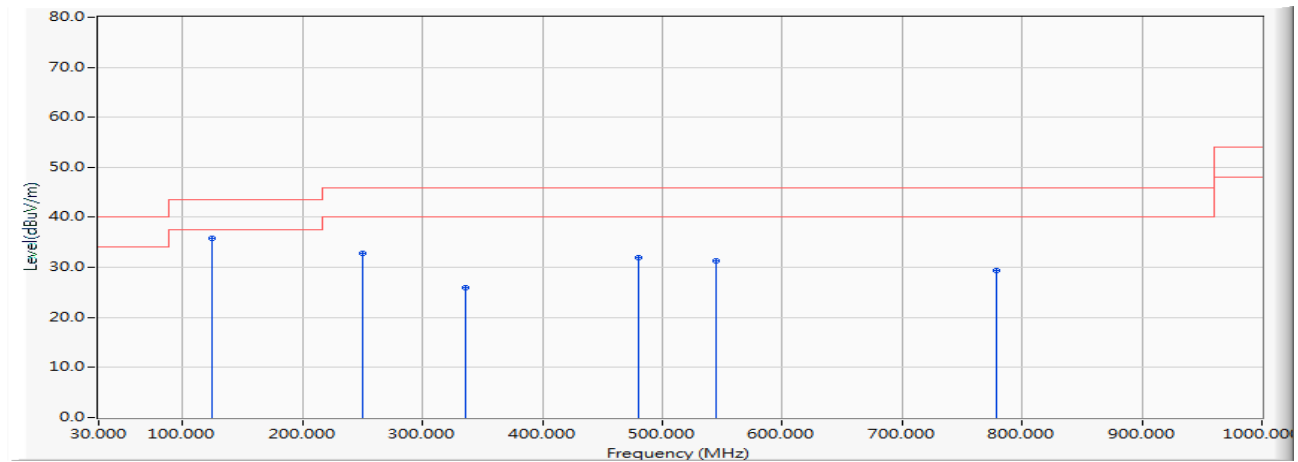

		Frequency (MHz)	Correct Factor (dB)	Reading Level (dBuV)	Measure Level (dBuV/m)	Margin (dB)	Limit (dBuV/m)	Detector Type
1	*	125.060	-21.639	57.524	35.886	-7.614	43.500	QUASPEAK
2		249.899	-20.383	53.140	32.757	-13.243	46.000	QUASPEAK
3		335.744	-17.957	43.889	25.932	-20.068	46.000	QUASPEAK
4		480.080	-14.747	46.620	31.873	-14.127	46.000	QUASPEAK
5		544.488	-13.943	45.226	31.283	-14.717	46.000	QUASPEAK
6		778.937	-11.379	40.786	29.407	-16.593	46.000	QUASPEAK

Note:

1. All Reading Levels is Quasi-Peak value.
2. “ * ”, means this data is the worst emission level.
3. Measurement Level = Reading Level + Correct Factor
4. The Emission under 30MHz were not included is because their levels are too low.

Site : DEKRA Taiwan CB2-H	Time : 2017/12/20
Limit : FCC_CLASS_B_03M_QP	Margin : 6
Probe : CB2_FCC_EFS_S2_30M-1GHz_1116 - HORIZONTAL	Power : AC 120V/60Hz
EUT : ConnectCore 6 Plus	Note : Mode 3: Transmit Mode_3DH5 802.15.1_3DH5_2441MHz

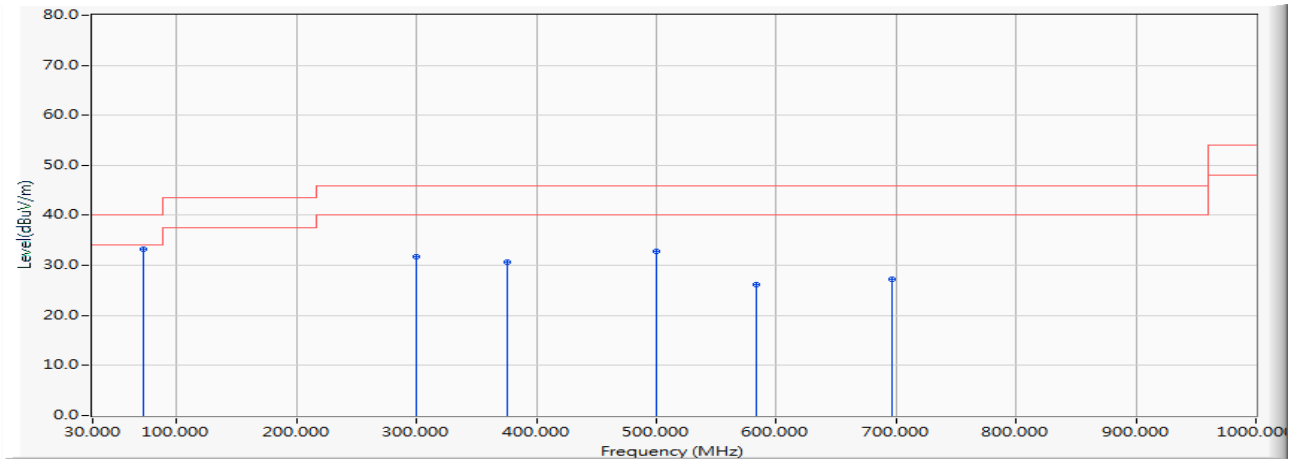

		Frequency (MHz)	Correct Factor (dB)	Reading Level (dBuV)	Measure Level (dBuV/m)	Margin (dB)	Limit (dBuV/m)	Detector Type
1	*	71.710	-28.063	61.404	33.341	-6.659	40.000	QUASPEAK
2		299.951	-19.179	50.828	31.649	-14.351	46.000	QUASPEAK
3		375.126	-16.753	47.317	30.564	-15.436	46.000	QUASPEAK
4		499.965	-14.456	47.324	32.869	-13.131	46.000	QUASPEAK
5		582.803	-13.433	39.496	26.063	-19.937	46.000	QUASPEAK
6		696.002	-12.413	39.677	27.264	-18.736	46.000	QUASPEAK

Note:

1. All Reading Levels is Quasi-Peak value.
2. “ * ”, means this data is the worst emission level.
3. Measurement Level = Reading Level + Correct Factor
4. The Emission under 30MHz were not included is because their levels are too low.

Site : DEKRA Taiwan CB2-H	Time : 2017/12/20
Limit : FCC_CLASS_B_03M_QP	Margin : 6
Probe : CB2 FCC EFS S2_30M-1GHz_1116 - VERTICAL	Power : AC 120V/60Hz
EUT : ConnectCore 6 Plus	Note : Mode 3: Transmit Mode_3DH5 802.15.1_3DH5_2441MHz

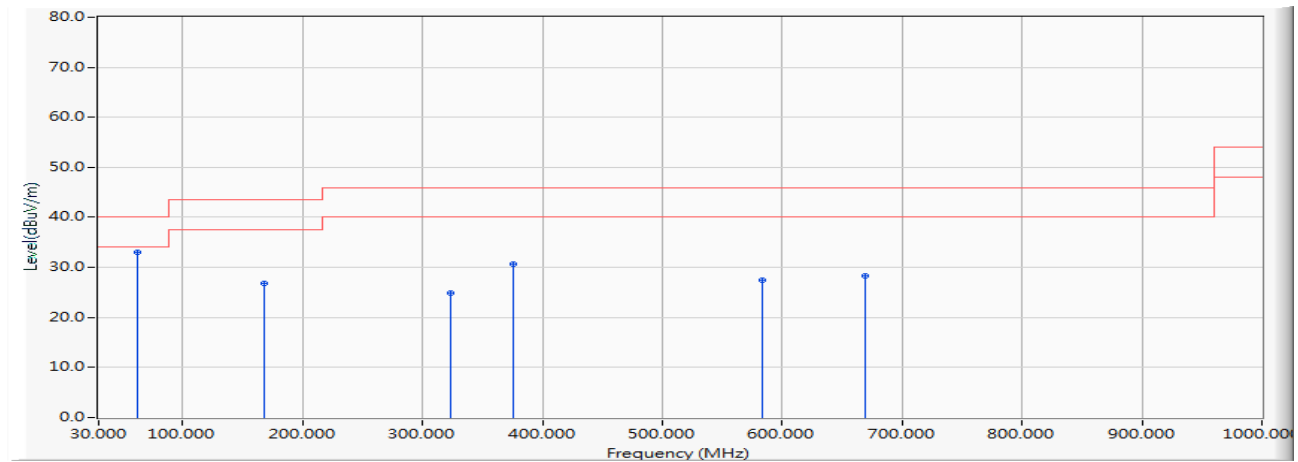

		Frequency (MHz)	Correct Factor (dB)	Reading Level (dBuV)	Measure Level (dBuV/m)	Margin (dB)	Limit (dBuV/m)	Detector Type
1	*	61.913	-28.313	61.387	33.074	-6.926	40.000	QUASPEAK
2		167.837	-23.507	50.366	26.859	-16.641	43.500	QUASPEAK
3		323.716	-18.332	43.317	24.985	-21.015	46.000	QUASPEAK
4		375.126	-16.753	47.317	30.564	-15.436	46.000	QUASPEAK
5		583.288	-13.422	40.939	27.516	-18.484	46.000	QUASPEAK
6		668.745	-12.569	40.929	28.359	-17.641	46.000	QUASPEAK

Note:

1. All Reading Levels is Quasi-Peak value.
2. “ * ”, means this data is the worst emission level.
3. Measurement Level = Reading Level + Correct Factor
4. The Emission under 30MHz were not included is because their levels are too low.

Harmonic & Spurious:

Site : DEKRA Taiwan CB2-H	Time : 2017/12/19
Limit : FCC_SpartC_15.209_03M_PK	Margin : 6
Probe : CB2_FCC_EFS_B091_1-18GHz_3M_0117 - HORIZONTAL	Power : AC 120V/60Hz
EUT : ConnectCore 6 Plus	Note : Mode 1: Transmit Mode_DH5 802.15.1_DH5_2402MHz

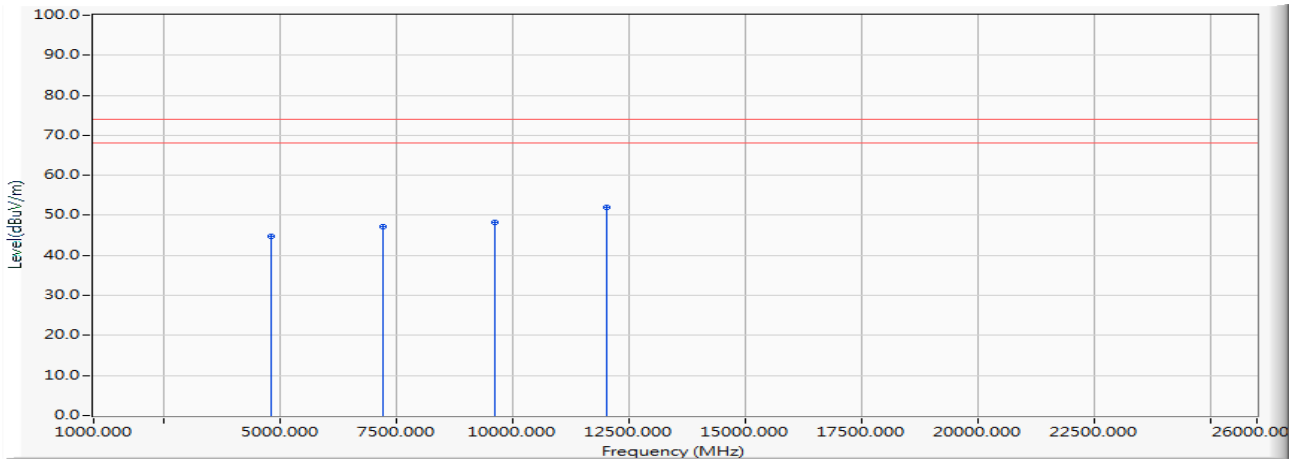

		Frequency (MHz)	Correct Factor (dB)	Reading Level (dBuV)	Measure Level (dBuV/m)	Margin (dB)	Limit (dBuV/m)	Detector Type
1		4804.000	-0.209	45.040	44.832	-29.168	74.000	PEAK
2		7206.000	6.970	40.220	47.189	-26.811	74.000	PEAK
3		9608.000	12.540	35.660	48.201	-25.799	74.000	PEAK
4	*	12010.000	15.516	36.410	51.926	-22.074	74.000	PEAK

Note:

1. All reading above 1GHz is performed with peak and/or average measurements as necessary.
2. Peak measurements: RBW = 1MHz, VBW = 3 MHz, Sweep: Auto.
3. Average measurements: RBW = 1MHz, VBW = 10 Hz, Sweep: Auto.
4. “ * ”, means this data is the worst emission level.
5. Measurement Level = Reading Level + Correct Factor.
6. The average measurement was not performed when the peak measured data under the limit of average detection.
7. The Emission above 13GHz were not included is because their levels are too low.

Site : DEKRA Taiwan CB2-H	Time : 2017/12/19
Limit : FCC_SpartC_15.209_03M_PK	Margin : 6
Probe : CB2_FCC_EFS_B091_1-18GHz_3M_0117 - VERTICAL	Power : AC 120V/60Hz
EUT : ConnectCore 6 Plus	Note : Mode 1: Transmit Mode_DH5 802.15.1_DH5_2402MHz

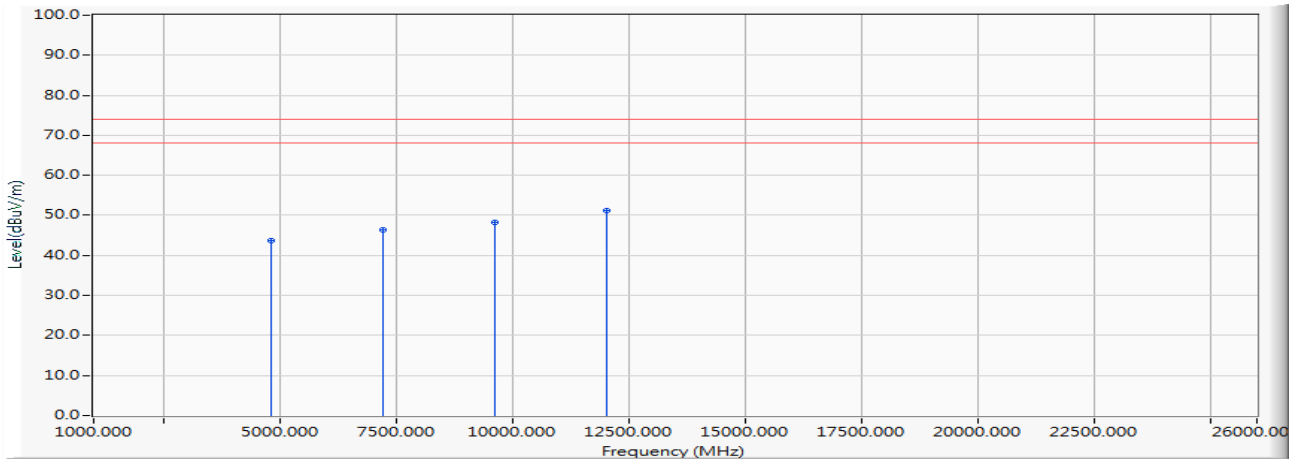

		Frequency (MHz)	Correct Factor (dB)	Reading Level (dBuV)	Measure Level (dBuV/m)	Margin (dB)	Limit (dBuV/m)	Detector Type
1		4804.000	-0.209	43.780	43.572	-30.428	74.000	PEAK
2		7206.000	6.970	39.530	46.499	-27.501	74.000	PEAK
3		9608.000	12.540	35.780	48.321	-25.679	74.000	PEAK
4	*	12010.000	15.516	35.780	51.296	-22.704	74.000	PEAK

Note:

1. All reading above 1GHz is performed with peak and/or average measurements as necessary.
2. Peak measurements: RBW = 1MHz, VBW = 3 MHz, Sweep: Auto.
3. Average measurements: RBW = 1MHz, VBW = 10 Hz, Sweep: Auto.
4. “ * ”, means this data is the worst emission level.
5. Measurement Level = Reading Level + Correct Factor.
6. The average measurement was not performed when the peak measured data under the limit of average detection.
7. The Emission above 13GHz were not included is because their levels are too low.

Site : DEKRA Taiwan CB2-H	Time : 2017/12/19
Limit : FCC_SpartC_15.209_03M_PK	Margin : 6
Probe : CB2_FCC_EFS_B091_1-18GHz_3M_0117 - HORIZONTAL	Power : AC 120V/60Hz
EUT : ConnectCore 6 Plus	Note : Mode 1: Transmit Mode_DH5 802.15.1_DH5_2441MHz

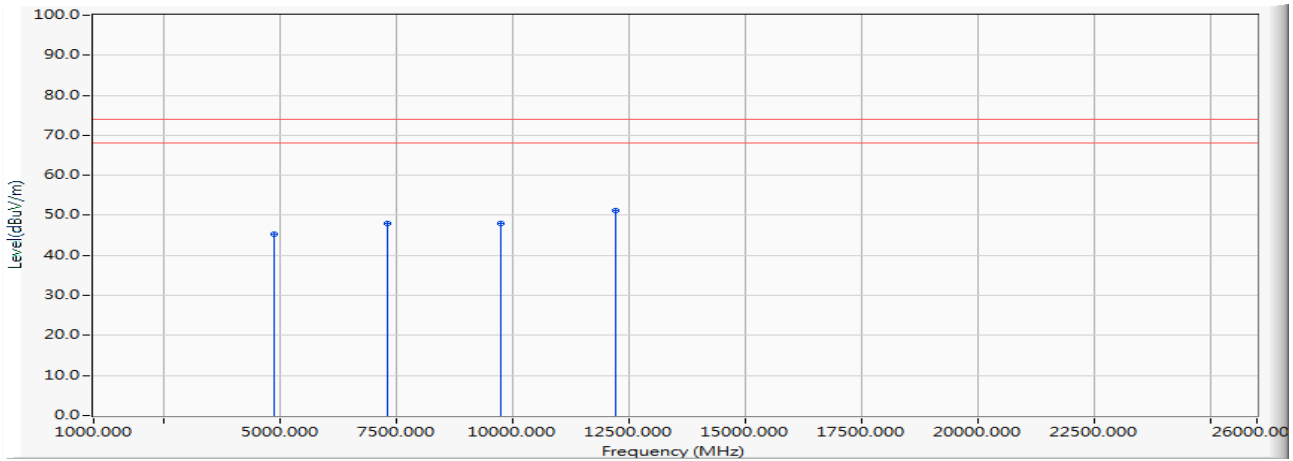

		Frequency (MHz)	Correct Factor (dB)	Reading Level (dBuV)	Measure Level (dBuV/m)	Margin (dB)	Limit (dBuV/m)	Detector Type
1		4882.000	-0.124	45.330	45.207	-28.793	74.000	PEAK
2		7323.000	7.448	40.520	47.967	-26.033	74.000	PEAK
3		9764.000	12.871	35.240	48.111	-25.889	74.000	PEAK
4	*	12205.000	14.834	36.460	51.294	-22.706	74.000	PEAK

Note:

1. All reading above 1GHz is performed with peak and/or average measurements as necessary.
2. Peak measurements: RBW = 1MHz, VBW = 3 MHz, Sweep: Auto.
3. Average measurements: RBW = 1MHz, VBW = 10 Hz, Sweep: Auto.
4. “ * ”, means this data is the worst emission level.
5. Measurement Level = Reading Level + Correct Factor.
6. The average measurement was not performed when the peak measured data under the limit of average detection.
7. The Emission above 13GHz were not included is because their levels are too low.

Site : DEKRA Taiwan CB2-H	Time : 2017/12/19
Limit : FCC_SpartC_15.209_03M_PK	Margin : 6
Probe : CB2_FCC_EFS_B091_1-18GHz_3M_0117 - VERTICAL	Power : AC 120V/60Hz
EUT : ConnectCore 6 Plus	Note : Mode 1: Transmit Mode_DH5 802.15.1_DH5_2441MHz

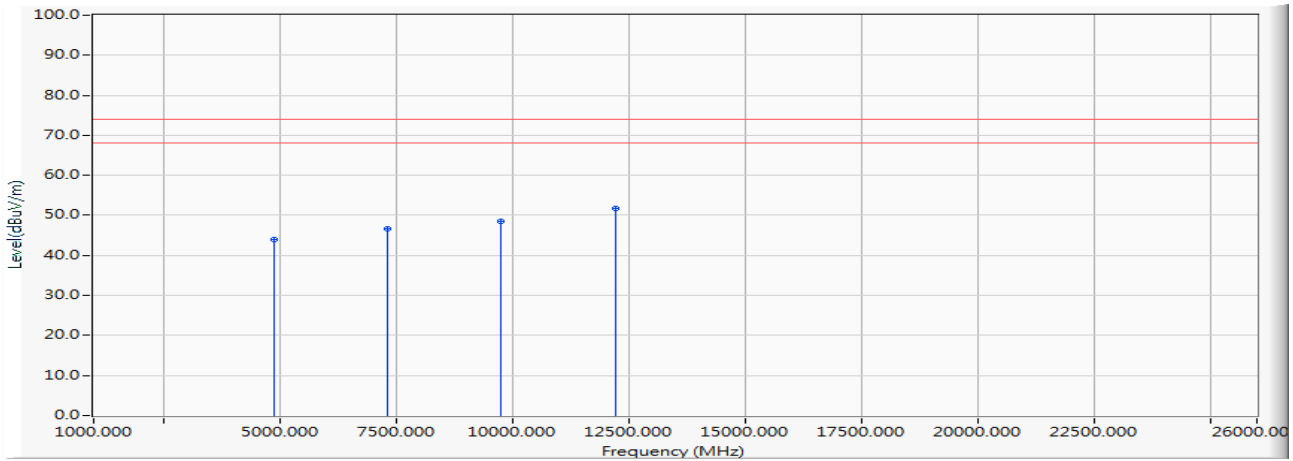

		Frequency (MHz)	Correct Factor (dB)	Reading Level (dBuV)	Measure Level (dBuV/m)	Margin (dB)	Limit (dBuV/m)	Detector Type
1		4882.000	-0.124	43.960	43.837	-30.163	74.000	PEAK
2		7323.000	7.448	39.180	46.627	-27.373	74.000	PEAK
3		9764.000	12.871	35.740	48.611	-25.389	74.000	PEAK
4	*	12205.000	14.834	37.020	51.854	-22.146	74.000	PEAK

Note:

1. All reading above 1GHz is performed with peak and/or average measurements as necessary.
2. Peak measurements: RBW = 1MHz, VBW = 3 MHz, Sweep: Auto.
3. Average measurements: RBW = 1MHz, VBW = 10 Hz, Sweep: Auto.
4. “ * ”, means this data is the worst emission level.
5. Measurement Level = Reading Level + Correct Factor.
6. The average measurement was not performed when the peak measured data under the limit of average detection.
7. The Emission above 13GHz were not included is because their levels are too low.

Site : DEKRA Taiwan CB2-H	Time : 2017/12/19
Limit : FCC_SpartC_15.209_03M_PK	Margin : 6
Probe : CB2_FCC_EFS_B091_1-18GHz_3M_0117 - HORIZONTAL	Power : AC 120V/60Hz
EUT : ConnectCore 6 Plus	Note : Mode 1: Transmit Mode_DH5 802.15.1_DH5_2480MHz

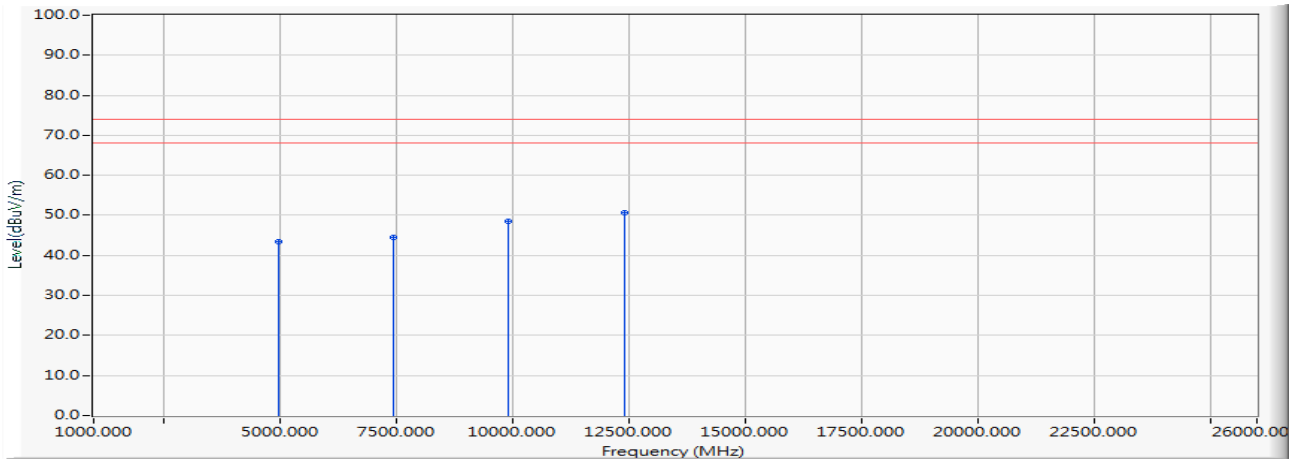

		Frequency (MHz)	Correct Factor (dB)	Reading Level (dBuV)	Measure Level (dBuV/m)	Margin (dB)	Limit (dBuV/m)	Detector Type
1		4960.000	-0.034	43.340	43.306	-30.694	74.000	PEAK
2		7440.000	7.868	36.520	44.388	-29.612	74.000	PEAK
3		9920.000	13.091	35.560	48.651	-25.349	74.000	PEAK
4	*	12400.000	15.733	34.980	50.713	-23.287	74.000	PEAK

Note:

1. All reading above 1GHz is performed with peak and/or average measurements as necessary.
2. Peak measurements: RBW = 1MHz, VBW = 3 MHz, Sweep: Auto.
3. Average measurements: RBW = 1MHz, VBW = 10 Hz, Sweep: Auto.
4. “ * ”, means this data is the worst emission level.
5. Measurement Level = Reading Level + Correct Factor.
6. The average measurement was not performed when the peak measured data under the limit of average detection.
7. The Emission above 13GHz were not included is because their levels are too low.

Site : DEKRA Taiwan CB2-H	Time : 2017/12/19
Limit : FCC_SpartC_15.209_03M_PK	Margin : 6
Probe : CB2_FCC_EFS_B091_1-18GHz_3M_0117 - VERTICAL	Power : AC 120V/60Hz
EUT : ConnectCore 6 Plus	Note : Mode 1: Transmit Mode_DH5 802.15.1_DH5_2480MHz

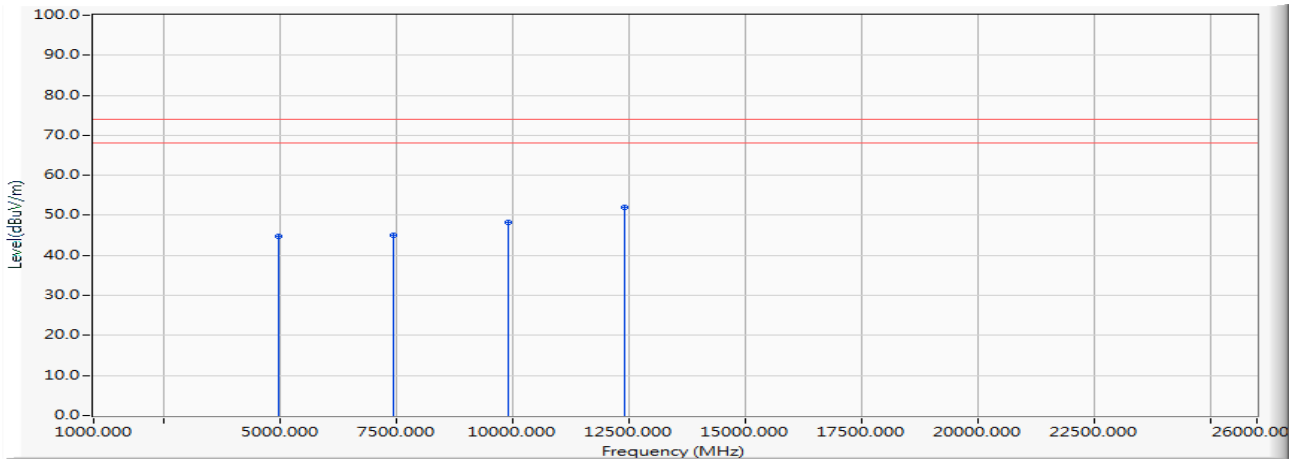

		Frequency (MHz)	Correct Factor (dB)	Reading Level (dBuV)	Measure Level (dBuV/m)	Margin (dB)	Limit (dBuV/m)	Detector Type
1		4960.000	-0.034	44.940	44.906	-29.094	74.000	PEAK
2		7440.000	7.868	37.300	45.168	-28.832	74.000	PEAK
3		9920.000	13.091	35.150	48.241	-25.759	74.000	PEAK
4	*	12400.000	15.733	36.260	51.993	-22.007	74.000	PEAK

Note:

1. All reading above 1GHz is performed with peak and/or average measurements as necessary.
2. Peak measurements: RBW = 1MHz, VBW = 3 MHz, Sweep: Auto.
3. Average measurements: RBW = 1MHz, VBW = 10 Hz, Sweep: Auto.
4. “ * ”, means this data is the worst emission level.
5. Measurement Level = Reading Level + Correct Factor.
6. The average measurement was not performed when the peak measured data under the limit of average detection.
7. The Emission above 13GHz were not included is because their levels are too low.

Site : DEKRA Taiwan CB2-H	Time : 2017/12/19
Limit : FCC_SpartC_15.209_03M_PK	Margin : 6
Probe : CB2_FCC_EFS_B091_1-18GHz_3M_0117 - HORIZONTAL	Power : AC 120V/60Hz
EUT : ConnectCore 6 Plus	Note : Mode 1: Transmit Mode_DH5 802.15.1_2DH5_2402MHz

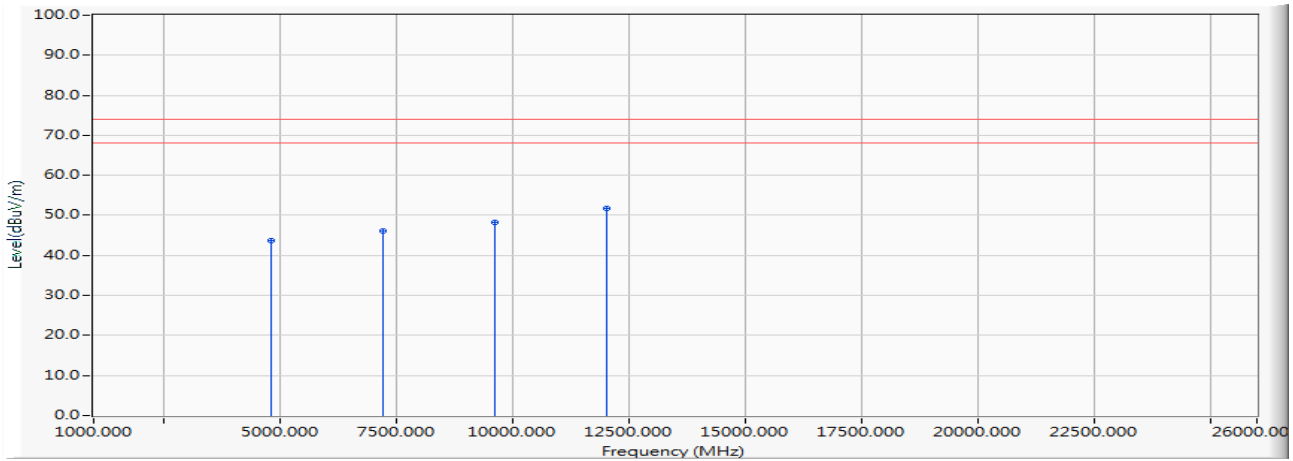

		Frequency (MHz)	Correct Factor (dB)	Reading Level (dBuV)	Measure Level (dBuV/m)	Margin (dB)	Limit (dBuV/m)	Detector Type
1		4804.000	-0.209	44.020	43.812	-30.188	74.000	PEAK
2		7206.000	6.970	39.030	45.999	-28.001	74.000	PEAK
3		9608.000	12.540	35.800	48.341	-25.659	74.000	PEAK
4	*	12010.000	15.516	36.240	51.756	-22.244	74.000	PEAK

Note:

1. All reading above 1GHz is performed with peak and/or average measurements as necessary.
2. Peak measurements: RBW = 1MHz, VBW = 3 MHz, Sweep: Auto.
3. Average measurements: RBW = 1MHz, VBW = 10 Hz, Sweep: Auto.
4. “ * ”, means this data is the worst emission level.
5. Measurement Level = Reading Level + Correct Factor.
6. The average measurement was not performed when the peak measured data under the limit of average detection.
7. The Emission above 13GHz were not included is because their levels are too low.

Site : DEKRA Taiwan CB2-H	Time : 2017/12/19
Limit : FCC_SpartC_15.209_03M_PK	Margin : 6
Probe : CB2_FCC_EFS_B091_1-18GHz_3M_0117 - VERTICAL	Power : AC 120V/60Hz
EUT : ConnectCore 6 Plus	Note : Mode 2: Transmit Mode_2DH5 802.15.1_2DH5_2402MHz

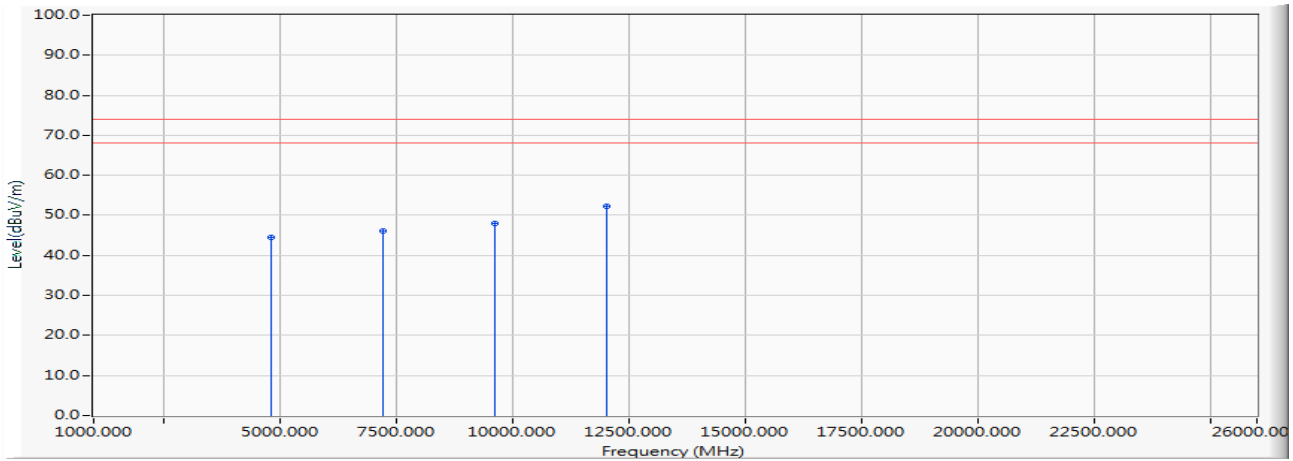

		Frequency (MHz)	Correct Factor (dB)	Reading Level (dBuV)	Measure Level (dBuV/m)	Margin (dB)	Limit (dBuV/m)	Detector Type
1		4804.000	-0.209	44.710	44.502	-29.498	74.000	PEAK
2		7206.000	6.970	39.230	46.199	-27.801	74.000	PEAK
3		9608.000	12.540	35.380	47.921	-26.079	74.000	PEAK
4	*	12010.000	15.516	36.720	52.236	-21.764	74.000	PEAK

Note:

1. All reading above 1GHz is performed with peak and/or average measurements as necessary.
2. Peak measurements: RBW = 1MHz, VBW = 3 MHz, Sweep: Auto.
3. Average measurements: RBW = 1MHz, VBW = 10 Hz, Sweep: Auto.
4. “ * ”, means this data is the worst emission level.
5. Measurement Level = Reading Level + Correct Factor.
6. The average measurement was not performed when the peak measured data under the limit of average detection.
7. The Emission above 13GHz were not included is because their levels are too low.

Site : DEKRA Taiwan CB2-H	Time : 2017/12/19
Limit : FCC_SpartC_15.209_03M_PK	Margin : 6
Probe : CB2_FCC_EFS_B091_1-18GHz_3M_0117 - HORIZONTAL	Power : AC 120V/60Hz
EUT : ConnectCore 6 Plus	Note : Mode 2: Transmit Mode_2DH5 802.15.1_2DH5_2441MHz

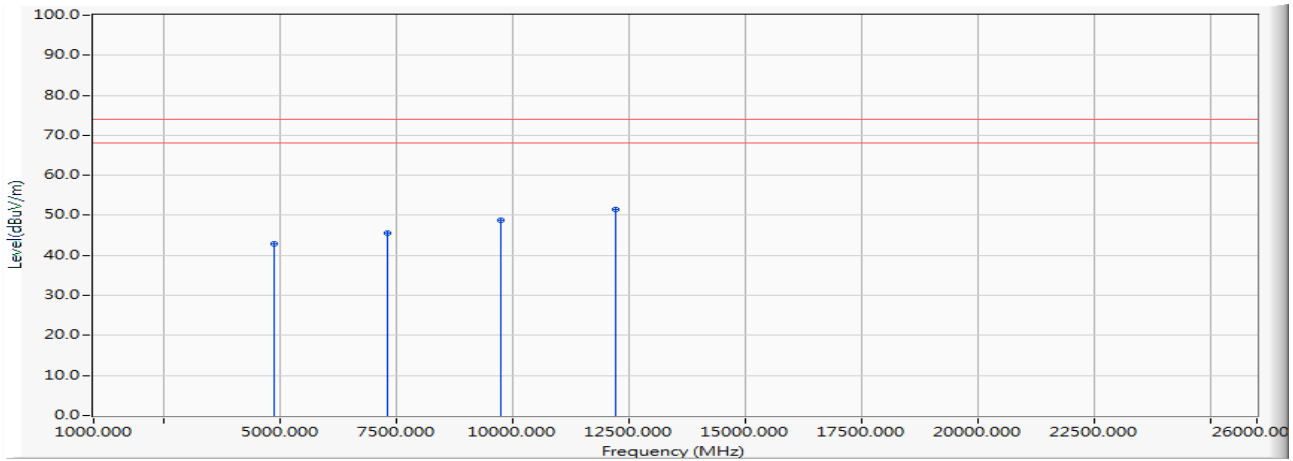

	Frequency (MHz)	Correct Factor (dB)	Reading Level (dBuV)	Measure Level (dBuV/m)	Margin (dB)	Limit (dBuV/m)	Detector Type
1	4882.000	-0.124	42.930	42.807	-31.193	74.000	PEAK
2	7323.000	7.448	38.040	45.487	-28.513	74.000	PEAK
3	9764.000	12.871	35.820	48.691	-25.309	74.000	PEAK
4	* 12205.000	14.834	36.680	51.514	-22.486	74.000	PEAK

Note:

1. All reading above 1GHz is performed with peak and/or average measurements as necessary.
2. Peak measurements: RBW = 1MHz, VBW = 3 MHz, Sweep: Auto.
3. Average measurements: RBW = 1MHz, VBW = 10 Hz, Sweep: Auto.
4. “ * ”, means this data is the worst emission level.
5. Measurement Level = Reading Level + Correct Factor.
6. The average measurement was not performed when the peak measured data under the limit of average detection.
7. The Emission above 13GHz were not included is because their levels are too low.

Site : DEKRA Taiwan CB2-H	Time : 2017/12/19
Limit : FCC_SpartC_15.209_03M_PK	Margin : 6
Probe : CB2_FCC_EFS_B091_1-18GHz_3M_0117 - VERTICAL	Power : AC 120V/60Hz
EUT : ConnectCore 6 Plus	Note : Mode 2: Transmit Mode_2DH5 802.15.1_2DH5_2441MHz

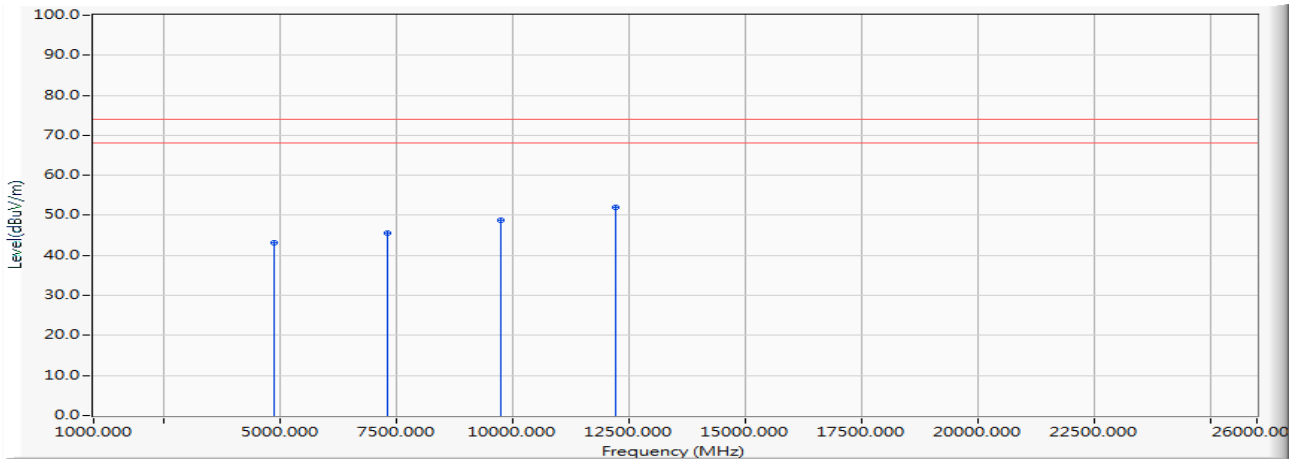

		Frequency (MHz)	Correct Factor (dB)	Reading Level (dBuV)	Measure Level (dBuV/m)	Margin (dB)	Limit (dBuV/m)	Detector Type
1		4882.000	-0.124	43.300	43.177	-30.823	74.000	PEAK
2		7323.000	7.448	38.190	45.637	-28.363	74.000	PEAK
3		9764.000	12.871	35.950	48.821	-25.179	74.000	PEAK
4	*	12205.000	14.834	37.180	52.014	-21.986	74.000	PEAK

Note:

1. All reading above 1GHz is performed with peak and/or average measurements as necessary.
2. Peak measurements: RBW = 1MHz, VBW = 3 MHz, Sweep: Auto.
3. Average measurements: RBW = 1MHz, VBW = 10 Hz, Sweep: Auto.
4. “ * ”, means this data is the worst emission level.
5. Measurement Level = Reading Level + Correct Factor.
6. The average measurement was not performed when the peak measured data under the limit of average detection.
7. The Emission above 13GHz were not included is because their levels are too low.

Site : DEKRA Taiwan CB2-H	Time : 2017/12/19
Limit : FCC_SpartC_15.209_03M_PK	Margin : 6
Probe : CB2_FCC_EFS_B091_1-18GHz_3M_0117 - HORIZONTAL	Power : AC 120V/60Hz
EUT : ConnectCore 6 Plus	Note : Mode 2: Transmit Mode_2DH5 802.15.1_2DH5_2480MHz

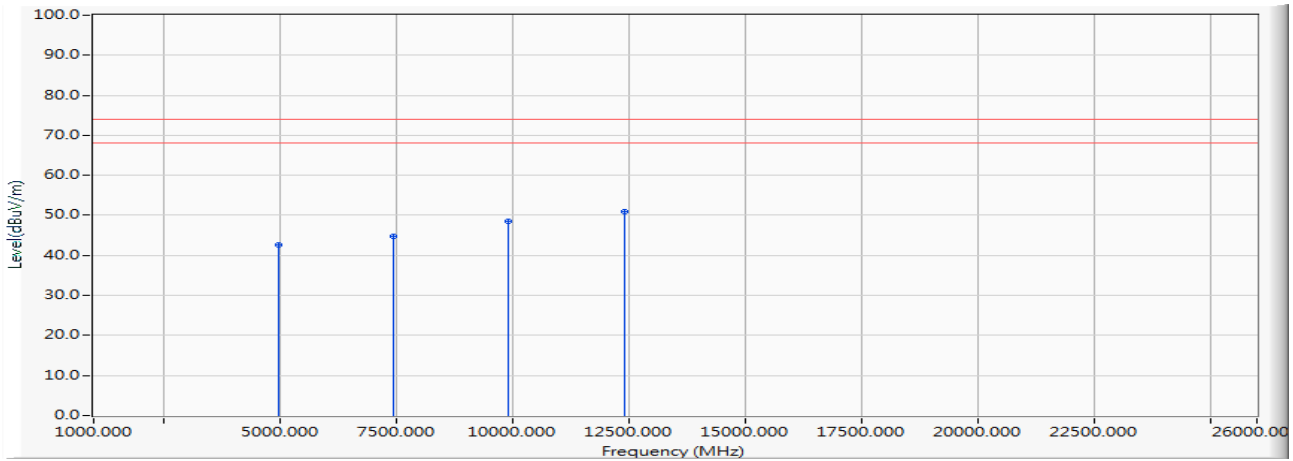

		Frequency (MHz)	Correct Factor (dB)	Reading Level (dBuV)	Measure Level (dBuV/m)	Margin (dB)	Limit (dBuV/m)	Detector Type
1		4960.000	-0.034	42.630	42.596	-31.404	74.000	PEAK
2		7440.000	7.868	36.800	44.668	-29.332	74.000	PEAK
3		9920.000	13.091	35.540	48.631	-25.369	74.000	PEAK
4	*	12400.000	15.733	35.100	50.833	-23.167	74.000	PEAK

Note:

1. All reading above 1GHz is performed with peak and/or average measurements as necessary.
2. Peak measurements: RBW = 1MHz, VBW = 3 MHz, Sweep: Auto.
3. Average measurements: RBW = 1MHz, VBW = 10 Hz, Sweep: Auto.
4. “ * ”, means this data is the worst emission level.
5. Measurement Level = Reading Level + Correct Factor.
6. The average measurement was not performed when the peak measured data under the limit of average detection.
7. The Emission above 13GHz were not included is because their levels are too low.

Site : DEKRA Taiwan CB2-H	Time : 2017/12/19
Limit : FCC_SpartC_15.209_03M_PK	Margin : 6
Probe : CB2_FCC_EFS_B091_1-18GHz_3M_0117 - VERTICAL	Power : AC 120V/60Hz
EUT : ConnectCore 6 Plus	Note : Mode 2: Transmit Mode_2DH5 802.15.1_2DH5_2480MHz

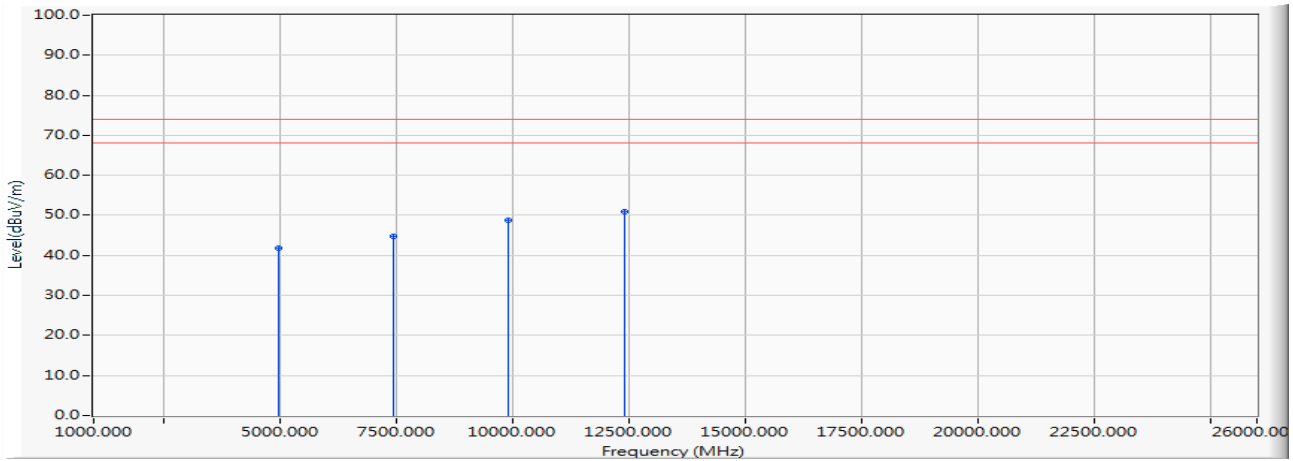

		Frequency (MHz)	Correct Factor (dB)	Reading Level (dBuV)	Measure Level (dBuV/m)	Margin (dB)	Limit (dBuV/m)	Detector Type
1		4960.000	-0.034	41.910	41.876	-32.124	74.000	PEAK
2		7440.000	7.868	36.900	44.768	-29.232	74.000	PEAK
3		9920.000	13.091	35.750	48.841	-25.159	74.000	PEAK
4	*	12400.000	15.733	35.230	50.963	-23.037	74.000	PEAK

Note:

1. All reading above 1GHz is performed with peak and/or average measurements as necessary.
2. Peak measurements: RBW = 1MHz, VBW = 3 MHz, Sweep: Auto.
3. Average measurements: RBW = 1MHz, VBW = 10 Hz, Sweep: Auto.
4. “ * ”, means this data is the worst emission level.
5. Measurement Level = Reading Level + Correct Factor.
6. The average measurement was not performed when the peak measured data under the limit of average detection.
7. The Emission above 13GHz were not included is because their levels are too low.

Site : DEKRA Taiwan CB2-H	Time : 2017/12/19
Limit : FCC_SpartC_15.209_03M_PK	Margin : 6
Probe : CB2_FCC_EFS_B091_1-18GHz_3M_0117 - HORIZONTAL	Power : AC 120V/60Hz
EUT : ConnectCore 6 Plus	Note : Mode 3: Transmit Mode_3DH5 802.15.1_3DH5_2402MHz

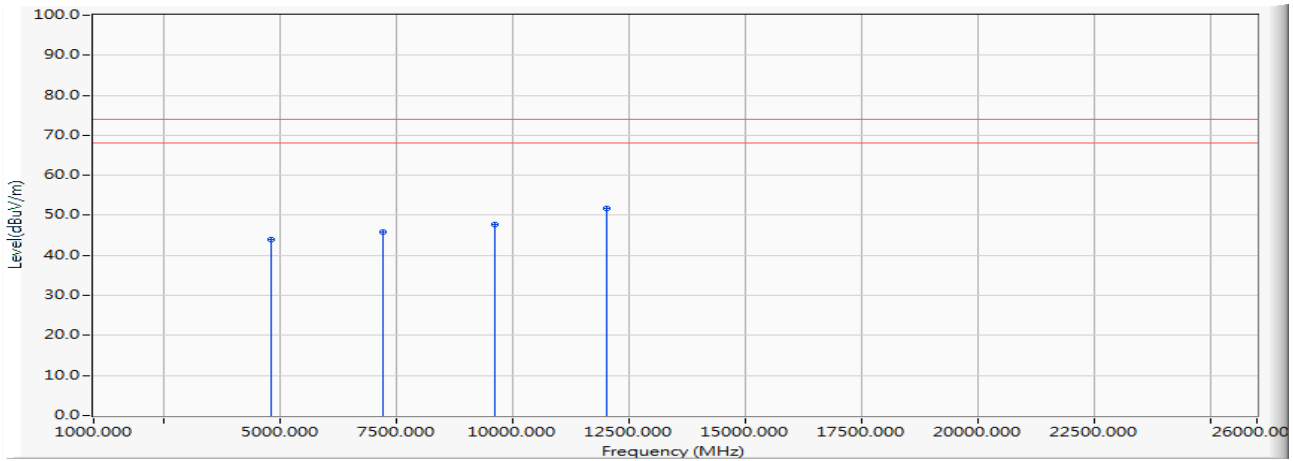

	Frequency (MHz)	Correct Factor (dB)	Reading Level (dBuV)	Measure Level (dBuV/m)	Margin (dB)	Limit (dBuV/m)	Detector Type
1	4804.000	-0.209	44.050	43.842	-30.158	74.000	PEAK
2	7206.000	6.970	38.980	45.949	-28.051	74.000	PEAK
3	9608.000	12.540	35.180	47.721	-26.279	74.000	PEAK
4	* 12010.000	15.516	36.100	51.616	-22.384	74.000	PEAK

Note:

1. All reading above 1GHz is performed with peak and/or average measurements as necessary.
2. Peak measurements: RBW = 1MHz, VBW = 3 MHz, Sweep: Auto.
3. Average measurements: RBW = 1MHz, VBW = 10 Hz, Sweep: Auto.
4. “ * ”, means this data is the worst emission level.
5. Measurement Level = Reading Level + Correct Factor.
6. The average measurement was not performed when the peak measured data under the limit of average detection.
7. The Emission above 13GHz were not included is because their levels are too low.

Site : DEKRA Taiwan CB2-H	Time : 2017/12/19
Limit : FCC_SpartC_15.209_03M_PK	Margin : 6
Probe : CB2_FCC_EFS_B091_1-18GHz_3M_0117 - VERTICAL	Power : AC 120V/60Hz
EUT : ConnectCore 6 Plus	Note : Mode 3: Transmit Mode_3DH5 802.15.1_3DH5_2402MHz

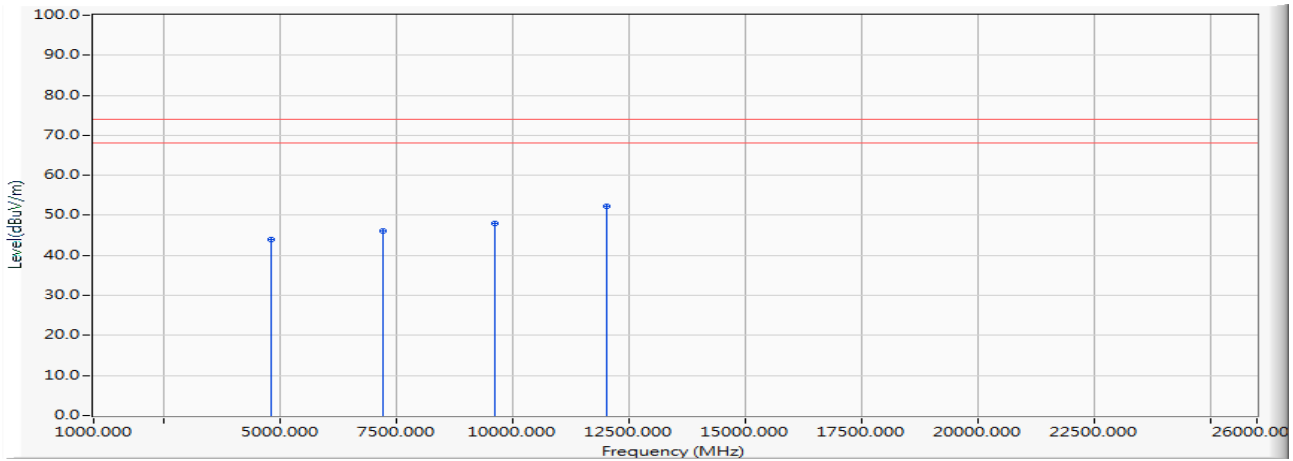

		Frequency (MHz)	Correct Factor (dB)	Reading Level (dBuV)	Measure Level (dBuV/m)	Margin (dB)	Limit (dBuV/m)	Detector Type
1		4804.000	-0.209	44.050	43.842	-30.158	74.000	PEAK
2		7206.000	6.970	39.080	46.049	-27.951	74.000	PEAK
3		9608.000	12.540	35.570	48.111	-25.889	74.000	PEAK
4	*	12010.000	15.516	36.890	52.406	-21.594	74.000	PEAK

Note:

1. All reading above 1GHz is performed with peak and/or average measurements as necessary.
2. Peak measurements: RBW = 1MHz, VBW = 3 MHz, Sweep: Auto.
3. Average measurements: RBW = 1MHz, VBW = 10 Hz, Sweep: Auto.
4. “ * ”, means this data is the worst emission level.
5. Measurement Level = Reading Level + Correct Factor.
6. The average measurement was not performed when the peak measured data under the limit of average detection.
7. The Emission above 13GHz were not included is because their levels are too low.

Site : DEKRA Taiwan CB2-H	Time : 2017/12/19
Limit : FCC_SpartC_15.209_03M_PK	Margin : 6
Probe : CB2_FCC_EFS_B091_1-18GHz_3M_0117 - HORIZONTAL	Power : AC 120V/60Hz
EUT : ConnectCore 6 Plus	Note : Mode 3: Transmit Mode_3DH5 802.15.1_3DH5_2441MHz

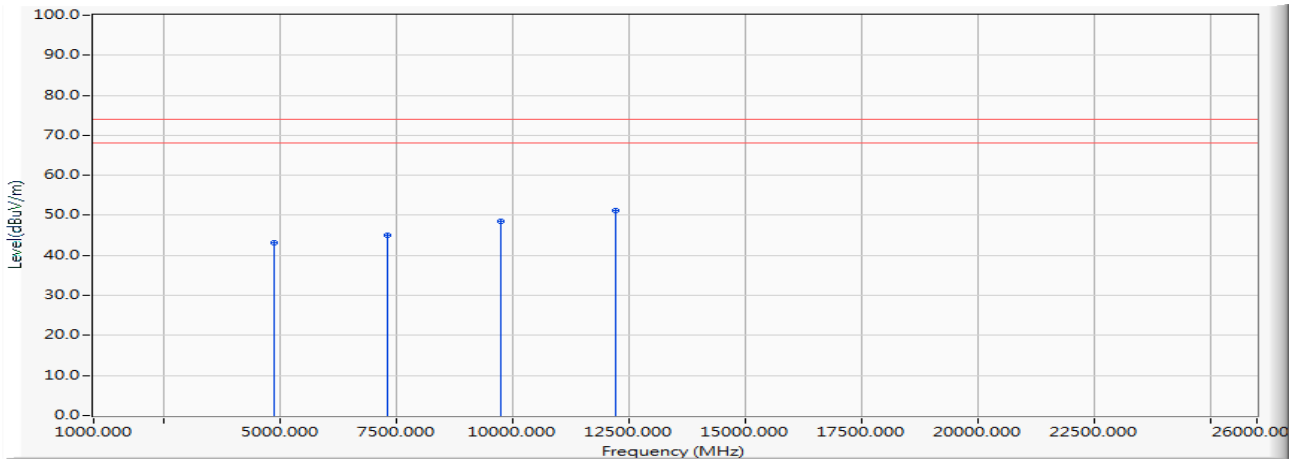

	Frequency (MHz)	Correct Factor (dB)	Reading Level (dBuV)	Measure Level (dBuV/m)	Margin (dB)	Limit (dBuV/m)	Detector Type
1	4882.000	-0.124	43.380	43.257	-30.743	74.000	PEAK
2	7323.000	7.448	37.640	45.087	-28.913	74.000	PEAK
3	9764.000	12.871	35.560	48.431	-25.569	74.000	PEAK
4	* 12205.000	14.834	36.480	51.314	-22.686	74.000	PEAK

Note:

1. All reading above 1GHz is performed with peak and/or average measurements as necessary.
2. Peak measurements: RBW = 1MHz, VBW = 3 MHz, Sweep: Auto.
3. Average measurements: RBW = 1MHz, VBW = 10 Hz, Sweep: Auto.
4. “ * ”, means this data is the worst emission level.
5. Measurement Level = Reading Level + Correct Factor.
6. The average measurement was not performed when the peak measured data under the limit of average detection.
7. The Emission above 13GHz were not included is because their levels are too low.

Site : DEKRA Taiwan CB2-H	Time : 2017/12/19
Limit : FCC_SpartC_15.209_03M_PK	Margin : 6
Probe : CB2_FCC_EFS_B091_1-18GHz_3M_0117 - VERTICAL	Power : AC 120V/60Hz
EUT : ConnectCore 6 Plus	Note : Mode 3: Transmit Mode_3DH5 802.15.1_3DH5_2441MHz

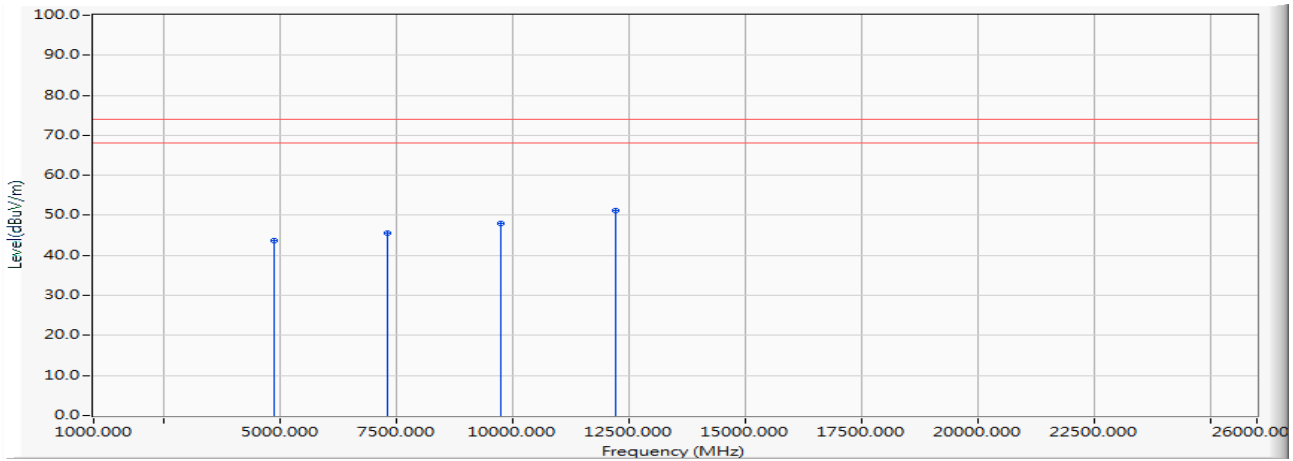

		Frequency (MHz)	Correct Factor (dB)	Reading Level (dBuV)	Measure Level (dBuV/m)	Margin (dB)	Limit (dBuV/m)	Detector Type
1		4882.000	-0.124	43.880	43.757	-30.243	74.000	PEAK
2		7323.000	7.448	38.110	45.557	-28.443	74.000	PEAK
3		9764.000	12.871	35.150	48.021	-25.979	74.000	PEAK
4	*	12205.000	14.834	36.490	51.324	-22.676	74.000	PEAK

Note:

1. All reading above 1GHz is performed with peak and/or average measurements as necessary.
2. Peak measurements: RBW = 1MHz, VBW = 3 MHz, Sweep: Auto.
3. Average measurements: RBW = 1MHz, VBW = 10 Hz, Sweep: Auto.
4. “ * ”, means this data is the worst emission level.
5. Measurement Level = Reading Level + Correct Factor.
6. The average measurement was not performed when the peak measured data under the limit of average detection.
7. The Emission above 13GHz were not included is because their levels are too low.

Site : DEKRA Taiwan CB2-H	Time : 2017/12/19
Limit : FCC_SpartC_15.209_03M_PK	Margin : 6
Probe : CB2_FCC_EFS_B091_1-18GHz_3M_0117 - HORIZONTAL	Power : AC 120V/60Hz
EUT : ConnectCore 6 Plus	Note : Mode 3: Transmit Mode_3DH5 802.15.1_3DH5_2480MHz

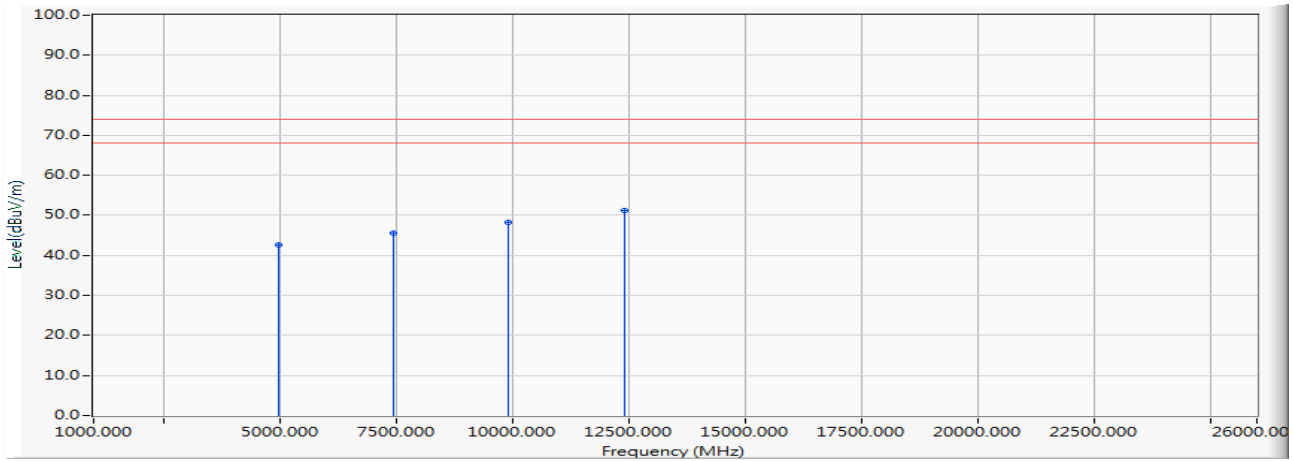

		Frequency (MHz)	Correct Factor (dB)	Reading Level (dBuV)	Measure Level (dBuV/m)	Margin (dB)	Limit (dBuV/m)	Detector Type
1		4960.000	-0.034	42.540	42.506	-31.494	74.000	PEAK
2		7440.000	7.868	37.610	45.478	-28.522	74.000	PEAK
3		9920.000	13.091	35.300	48.391	-25.609	74.000	PEAK
4	*	12400.000	15.733	35.430	51.163	-22.837	74.000	PEAK

Note:

1. All reading above 1GHz is performed with peak and/or average measurements as necessary.
2. Peak measurements: RBW = 1MHz, VBW = 3 MHz, Sweep: Auto.
3. Average measurements: RBW = 1MHz, VBW = 10 Hz, Sweep: Auto.
4. “ * ”, means this data is the worst emission level.
5. Measurement Level = Reading Level + Correct Factor.
6. The average measurement was not performed when the peak measured data under the limit of average detection.
7. The Emission above 13GHz were not included is because their levels are too low.

Site : DEKRA Taiwan CB2-H	Time : 2017/12/19
Limit : FCC_SpartC_15.209_03M_PK	Margin : 6
Probe : CB2_FCC_EFS_B091_1-18GHz_3M_0117 - VERTICAL	Power : AC 120V/60Hz
EUT : ConnectCore 6 Plus	Note : Mode 3: Transmit Mode_3DH5 802.15.1_3DH5_2480MHz

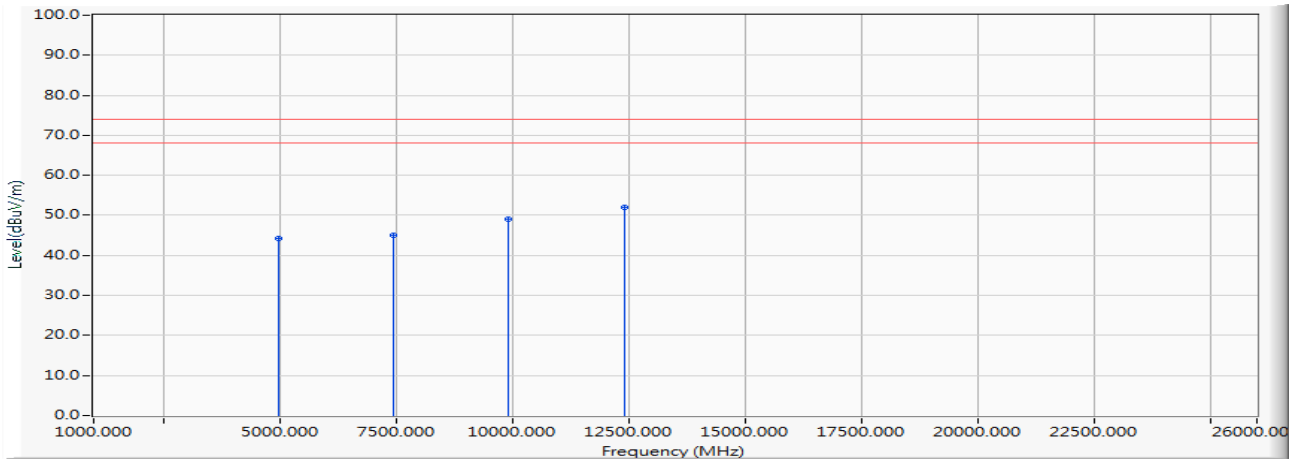

		Frequency (MHz)	Correct Factor (dB)	Reading Level (dBuV)	Measure Level (dBuV/m)	Margin (dB)	Limit (dBuV/m)	Detector Type
1		4960.000	-0.034	44.140	44.106	-29.894	74.000	PEAK
2		7440.000	7.868	37.280	45.148	-28.852	74.000	PEAK
3		9920.000	13.091	35.930	49.021	-24.979	74.000	PEAK
4	*	12400.000	15.733	36.150	51.883	-22.117	74.000	PEAK

Note:

1. All reading above 1GHz is performed with peak and/or average measurements as necessary.
2. Peak measurements: RBW = 1MHz, VBW = 3 MHz, Sweep: Auto.
3. Average measurements: RBW = 1MHz, VBW = 10 Hz, Sweep: Auto.
4. “ * ”, means this data is the worst emission level.
5. Measurement Level = Reading Level + Correct Factor.
6. The average measurement was not performed when the peak measured data under the limit of average detection.
7. The Emission above 13GHz were not included is because their levels are too low.

5. RF antenna conducted test

5.1. Test Equipment

The following test equipment is used during the test:

RF antenna conducted test / SR10-H

Instrument	Manufacturer	Model No.	Serial No.	Cal. Date	Next Cal. Date
Signal & Spectrum Analyzer	R&S	FSV40	101049	2017/01/23	2018/01/22
EXA Signal Analyzer	Keysight	N9010A	MY51440132	2017/03/13	2018/03/12

5.2. Test Setup

RF Conducted Measurement:

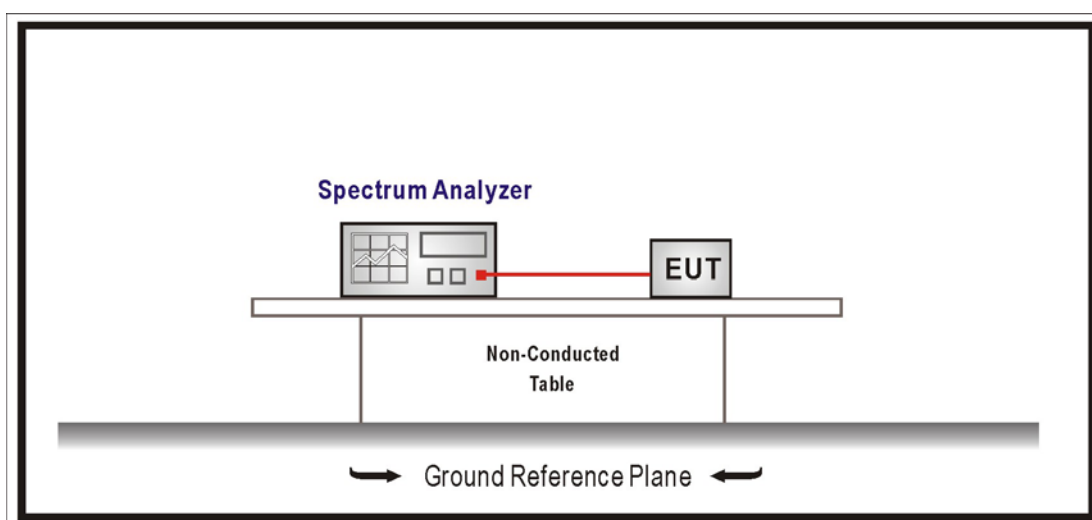

5.3. Limits

In any 100 kHz bandwidth outside the frequency band in which the spread spectrum intentional radiator is operating, the radio frequency power that is produced by the intentional radiator shall be at least 20 dB below that in the 100 kHz bandwidth within the band that contains the highest level of the desired power, based on an RF conducted or radiated measurement. Attenuation below the general limits specified in Section 15.209(a) is not required. In addition, radiated emissions which fall in the restricted bands, as defined in Section 15.205(a), must also comply with the radiated emission limits specified in Section 15.209(a) (see Section 15.205(c)).

5.4. Test Procedure

The EUT was setup according to ANSI C63.10: 2013 and tested according to FHSS test procedure of FCC Public Notice DA 00-705 for compliance to FCC 47CFR 15.247 requirements Set RBW = 100 kHz, Set VBW > RBW, scan up through 10th harmonic.

5.5. Test Specification

According to FCC Part 15 Subpart C Paragraph 15.247 and RSS-247.

5.6. Test Result

Product	ConnectCore 6 Plus		
Test Item	RF antenna conducted test		
Test Mode	Mode 1: Transmit Mode_DH5		
Date of Test	2018/01/02	Test Site	SR10-H

GFSK

Channel	Frequency (MHz)	Measure Level (dBc)	Limit (dBc)	Result
00	2402	51.050	≥ 20	Pass
78	2480	58.370	≥ 20	Pass

Channel 00

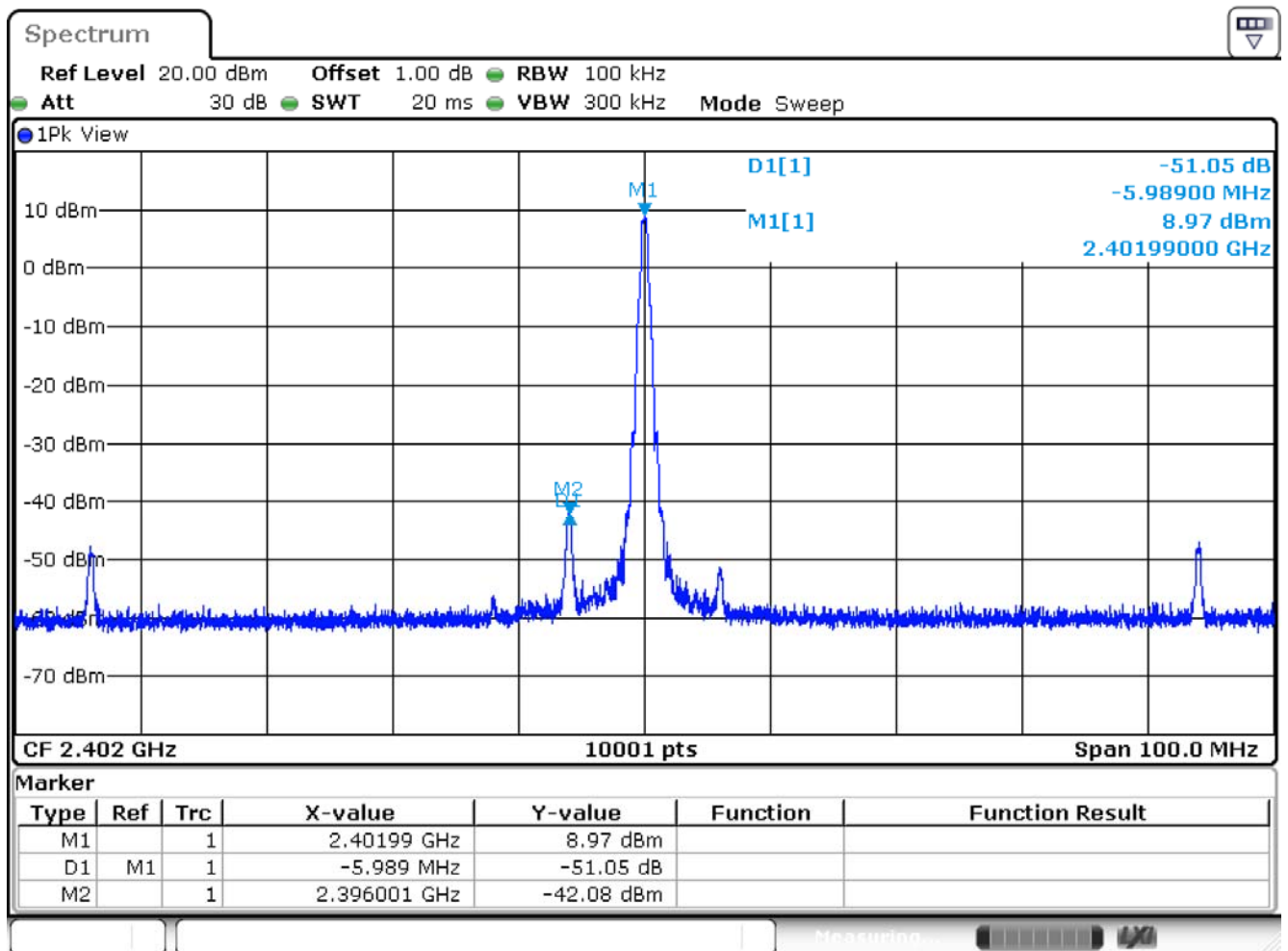

Date: 2.JAN.2018 02:06:45

Channel 78

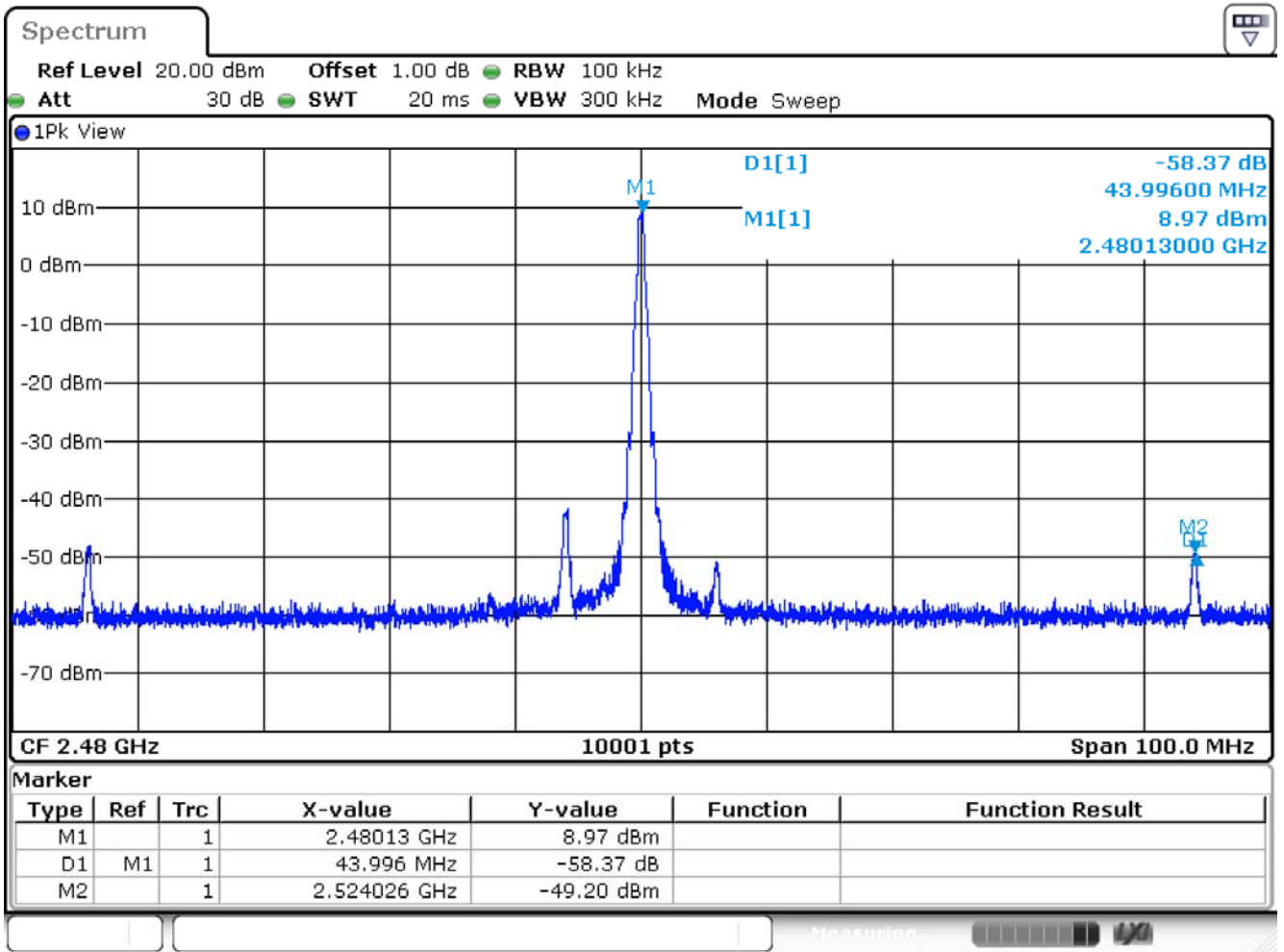

Date: 2.JAN.2018 01:54:39

Product	ConnectCore 6 Plus		
Test Item	RF antenna conducted test		
Test Mode	Mode 2: Transmit Mode_2DH5		
Date of Test	2018/01/02	Test Site	SR10-H

$\pi/4$ -DQPSK

Channel	Frequency (MHz)	Measure Level (dBc)	Limit (dBc)	Result
00	2402	50.090	≥ 20	Pass
78	2480	54.160	≥ 20	Pass

Channel 00

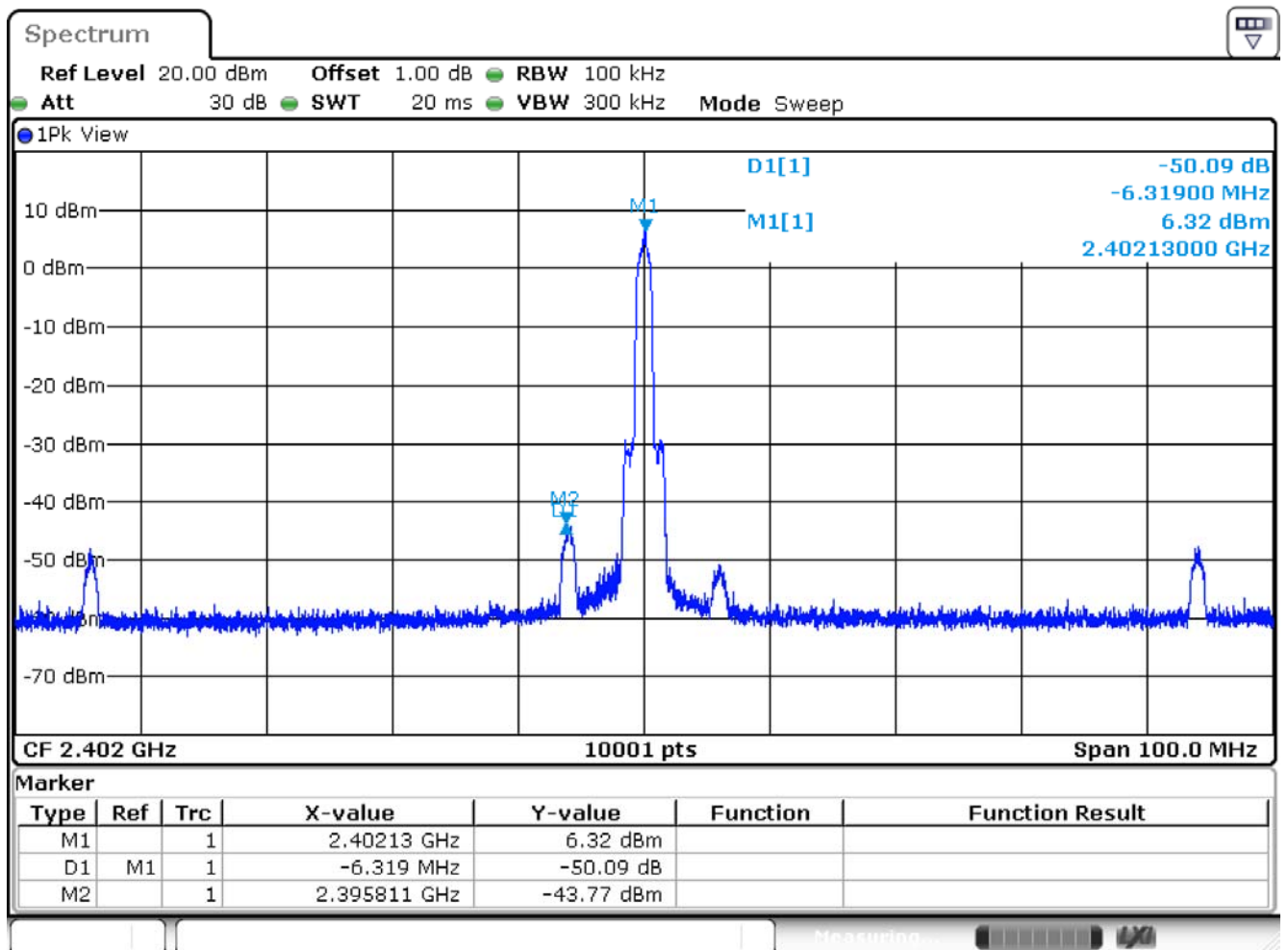

Date: 2.JAN.2018 02:05:46

Channel 78

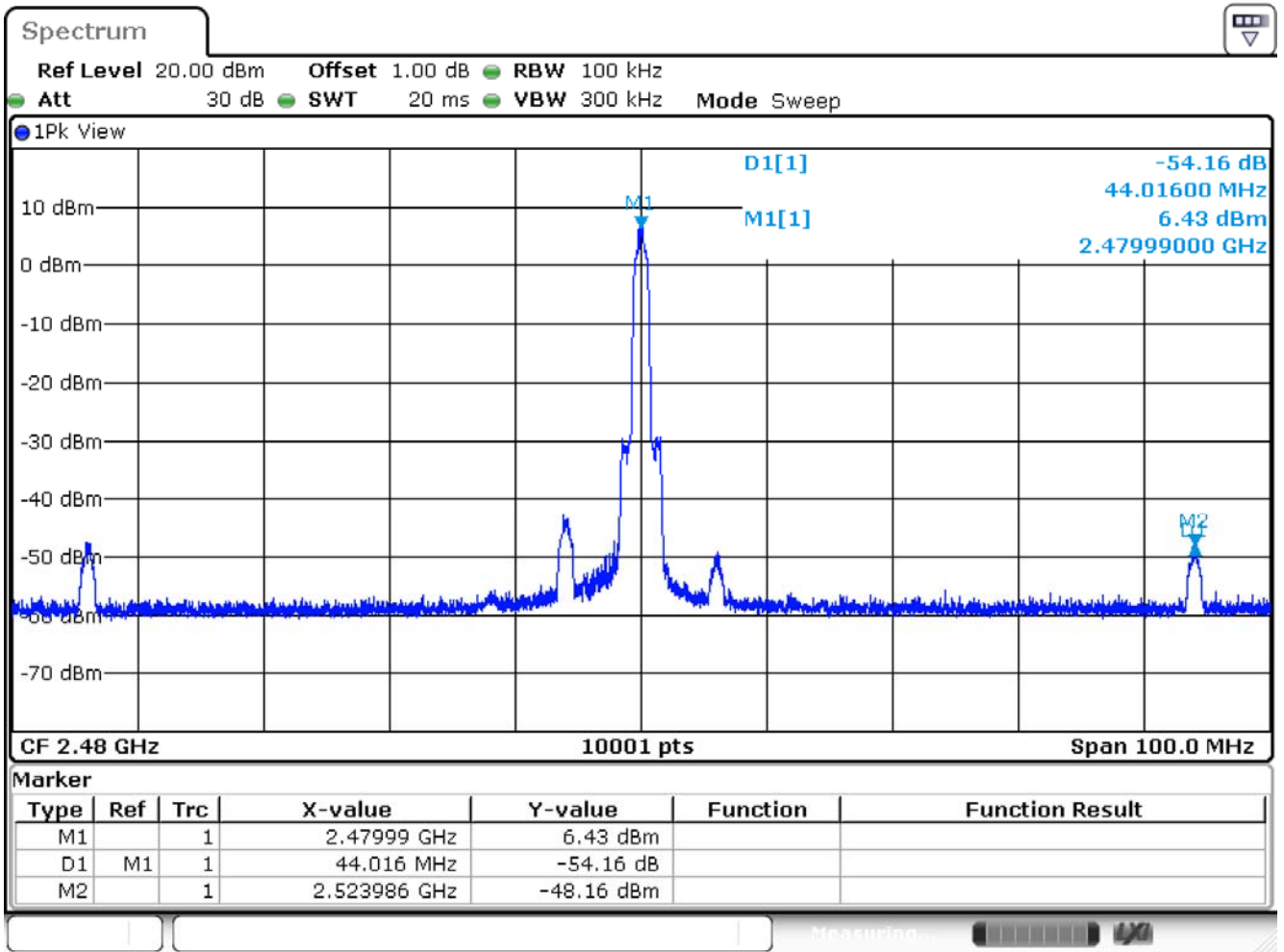

Date: 2.JAN.2018 01:56:00

Product	ConnectCore 6 Plus		
Test Item	RF antenna conducted test		
Test Mode	Mode 3: Transmit Mode_3DH5		
Date of Test	2018/01/02	Test Site	SR10-H

8-DPSK

Channel	Frequency (MHz)	Measure Level (dBc)	Limit (dBc)	Result
00	2402	50.900	≥ 20	Pass
78	2480	54.470	≥ 20	Pass

Channel 00

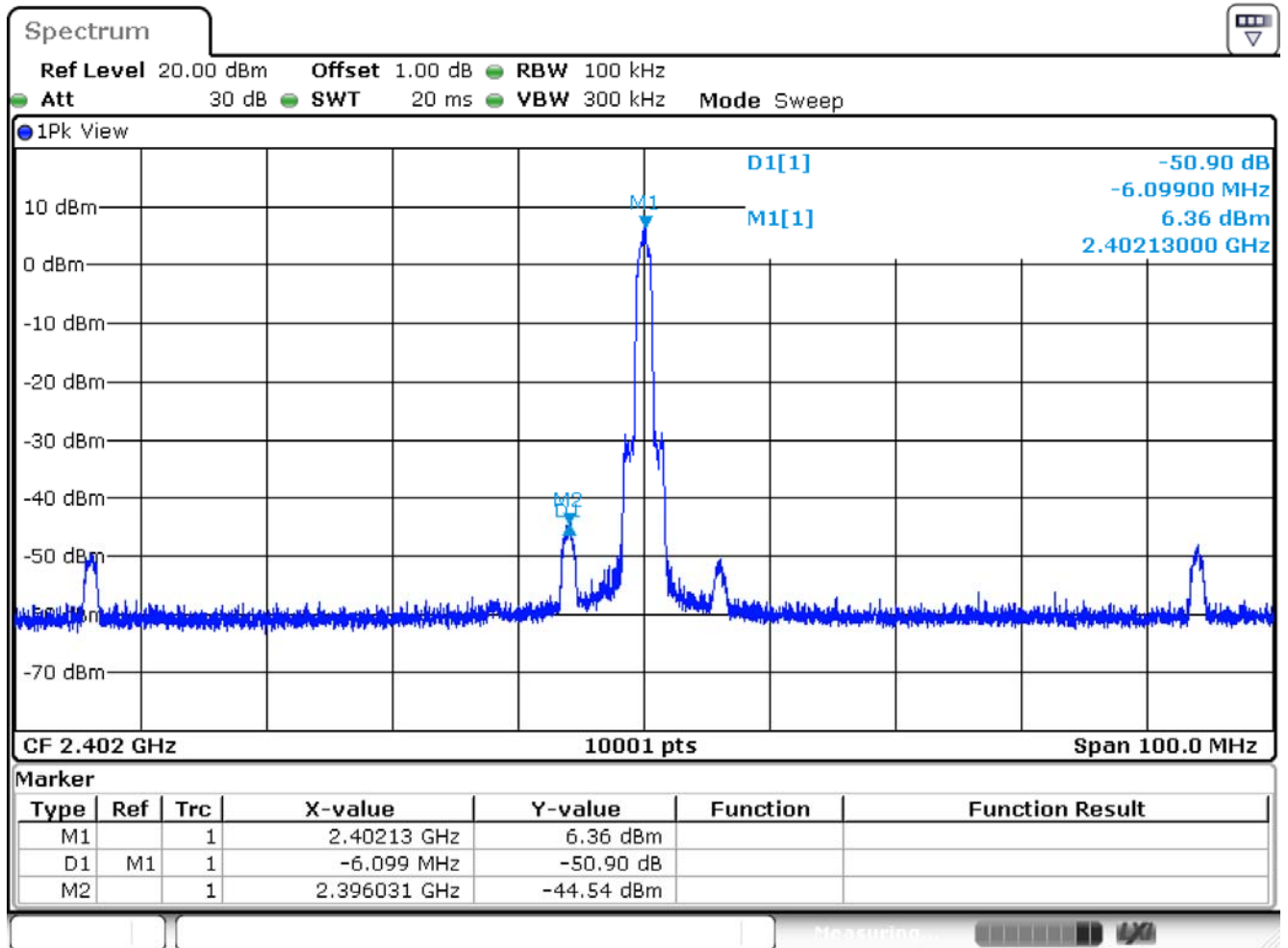

Date: 2.JAN.2018 01:59:18

Channel 78

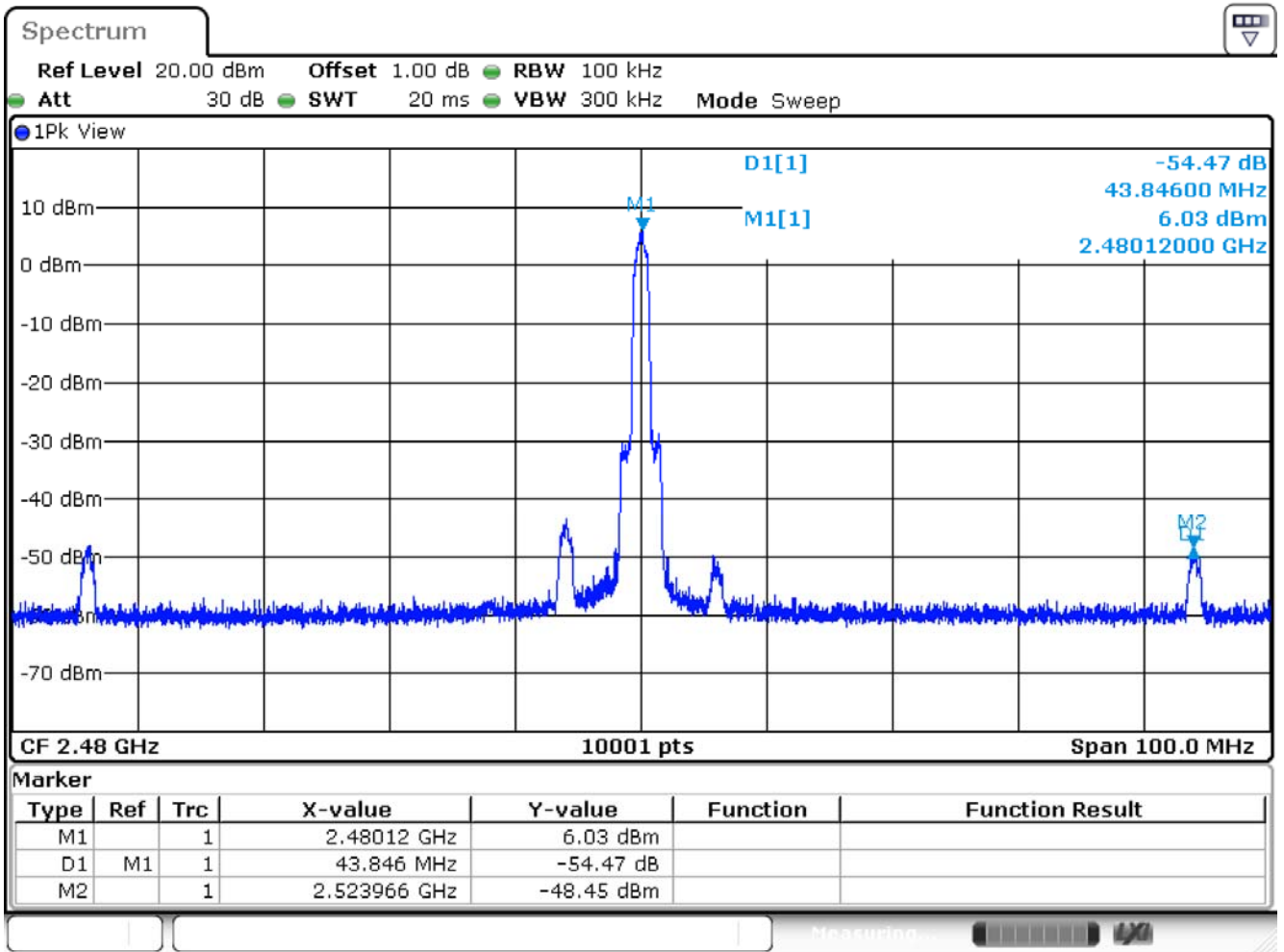

Date: 2.JAN.2018 01:56:57

Product	ConnectCore 6 Plus		
Test Item	RF antenna conducted test		
Test Mode	Mode 1: Transmit Mode_DH5		
Date of Test	2018/01/05	Test Site	SR10-H

Channel 00 (30MHz-25GHz)-GFSK

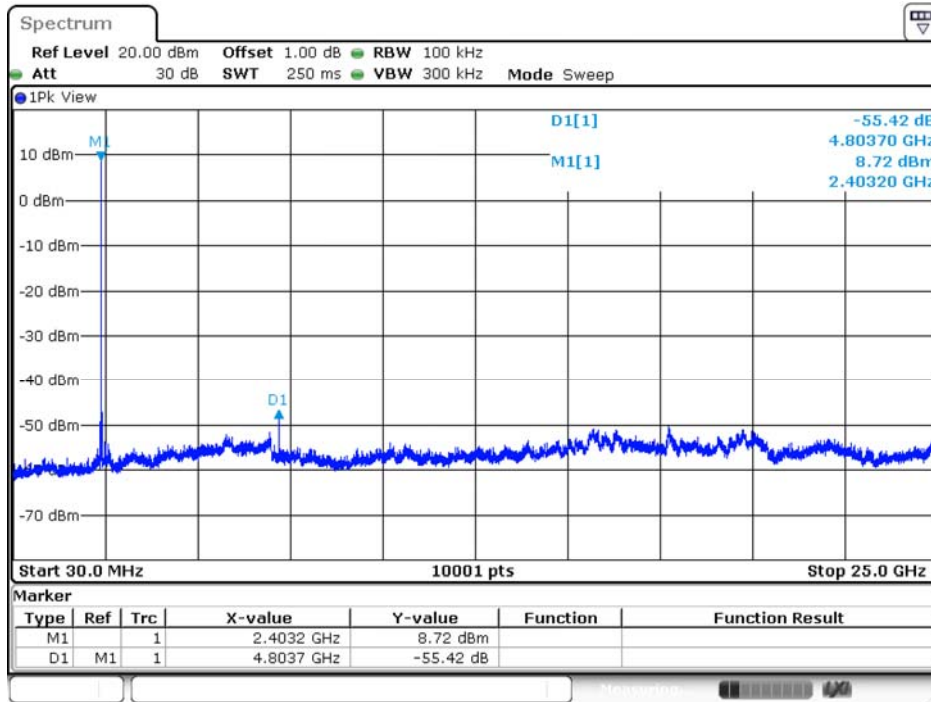

Date: 5.JAN.2018 02:23:44

Channel 39 (30MHz-25GHz)-GFSK

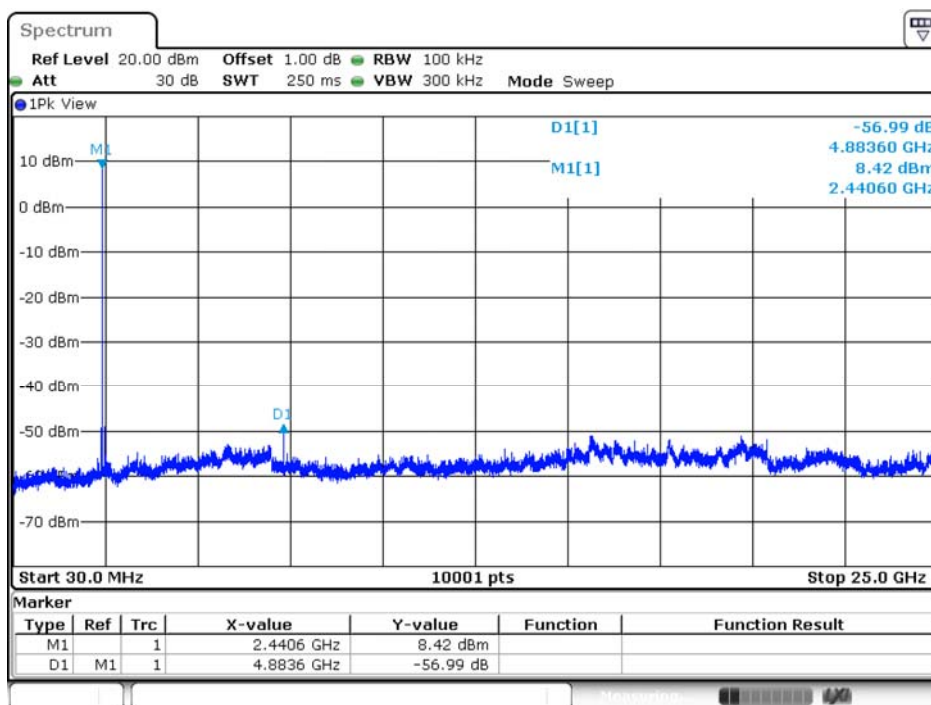

Date: 5.JAN.2018 02:45:24

Channel 78 (30MHz-25GHz)-GFSK

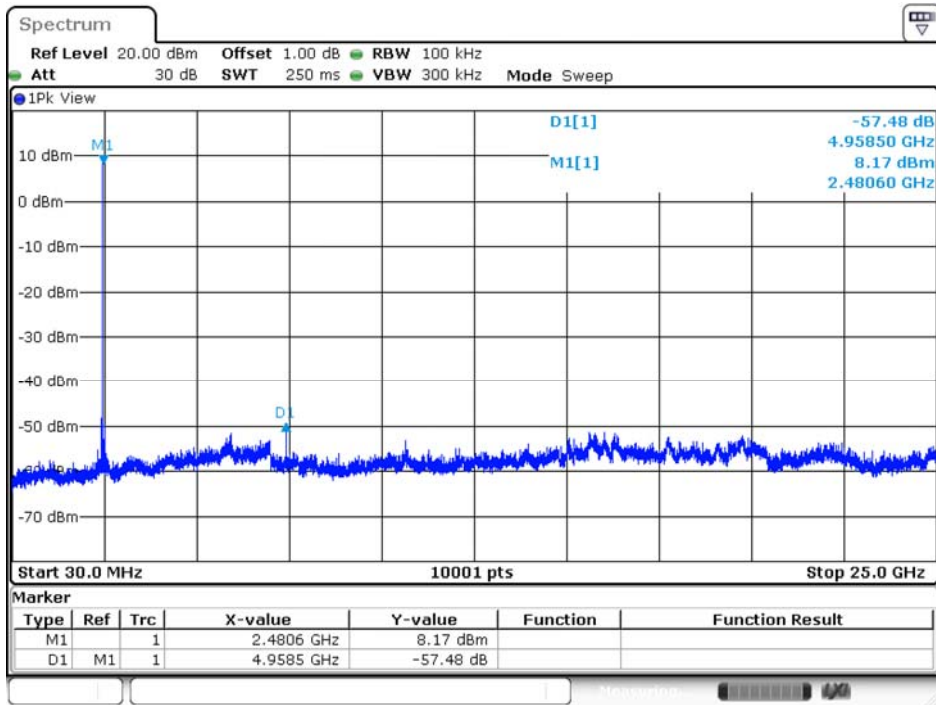

Date: 5 JAN 2018 02:57:31

Product	ConnectCore 6 Plus		
Test Item	RF antenna conducted test		
Test Mode	Mode 2: Transmit Mode_2DH5		
Date of Test	2018/01/05	Test Site	SR10-H

Channel 00 (30MHz-25GHz)- $\pi/4$ -DQPSK

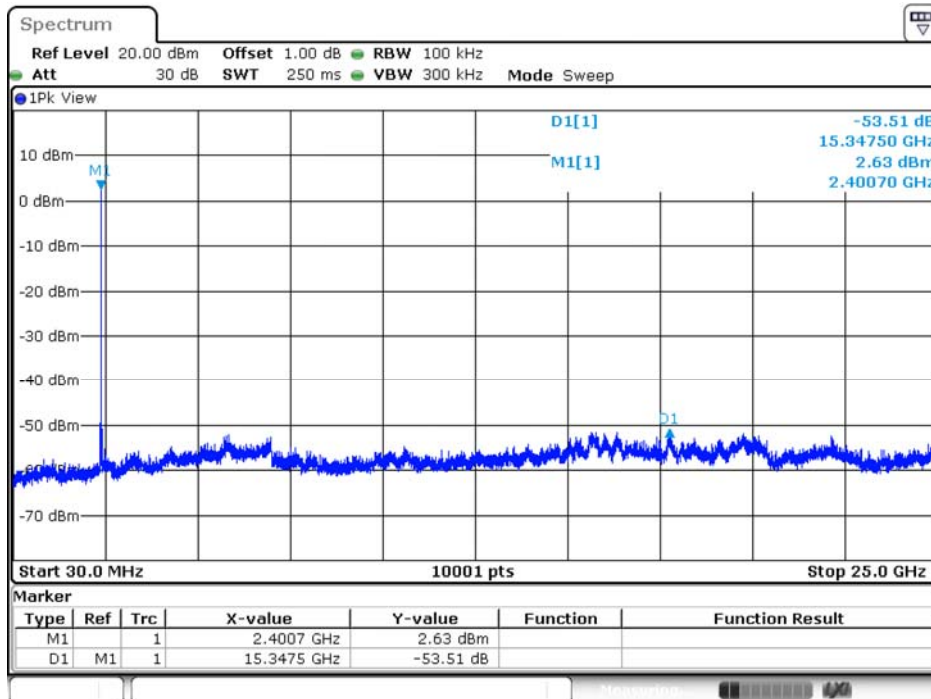

Date: 5 JAN 2018 02:25:07

Channel 39 (30MHz-25GHz)- $\pi/4$ -DQPSK

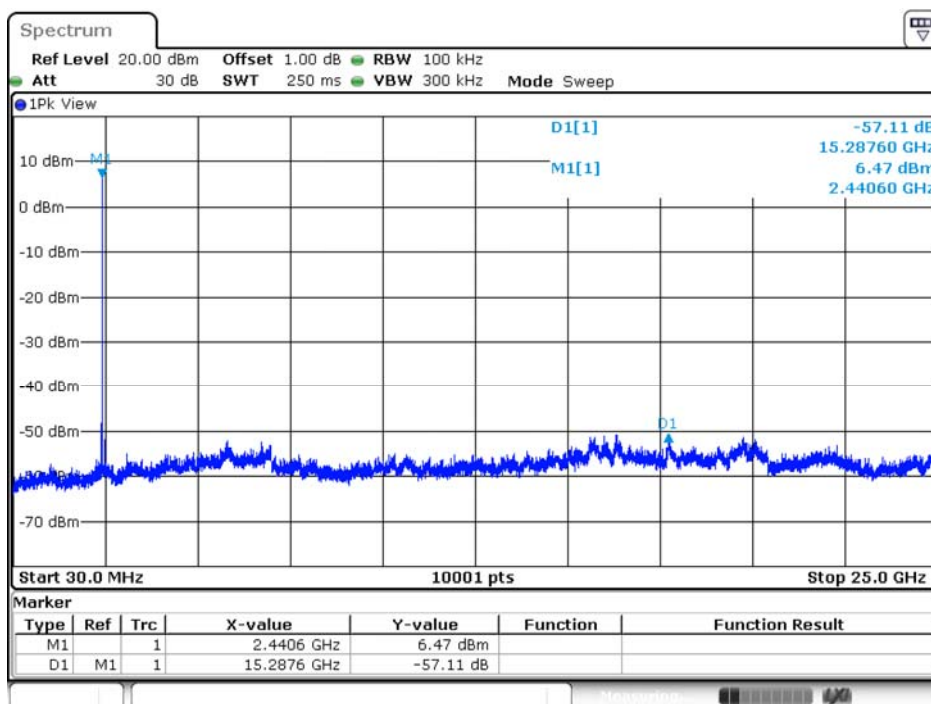

Date: 5 JAN 2018 02:44:15

Channel 78 (30MHz-25GHz)- $\pi/4$ -DQPSK

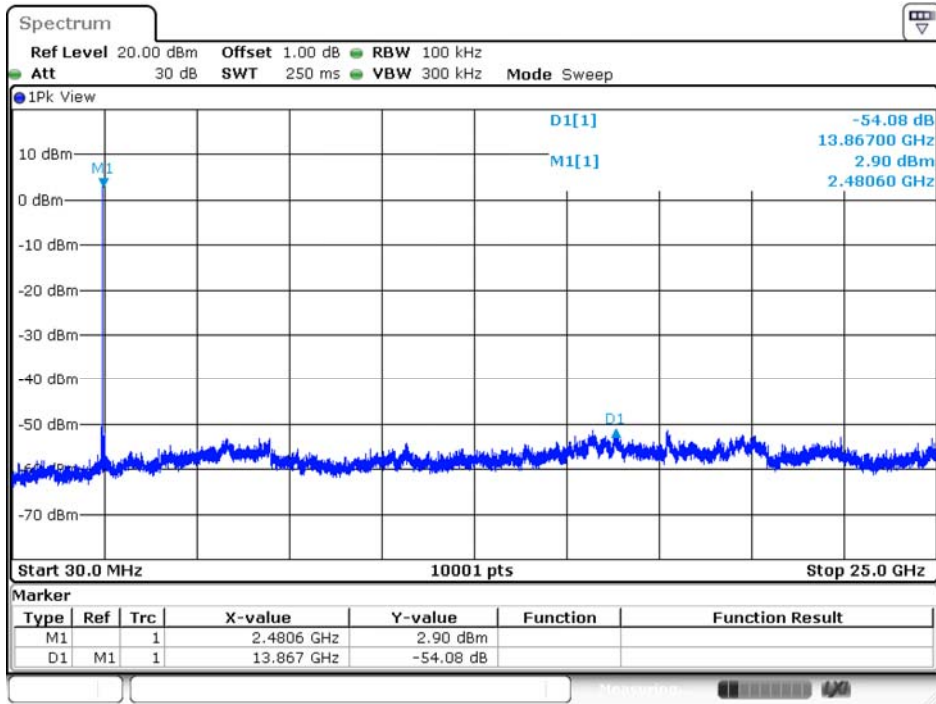

Date: 5.JAN.2018 03:03:29

Product	ConnectCore 6 Plus		
Test Item	RF antenna conducted test		
Test Mode	Mode 3: Transmit Mode_3DH5		
Date of Test	2018/01/05	Test Site	SR10-H

Channel 00 (30MHz-25GHz)-8-DPSK

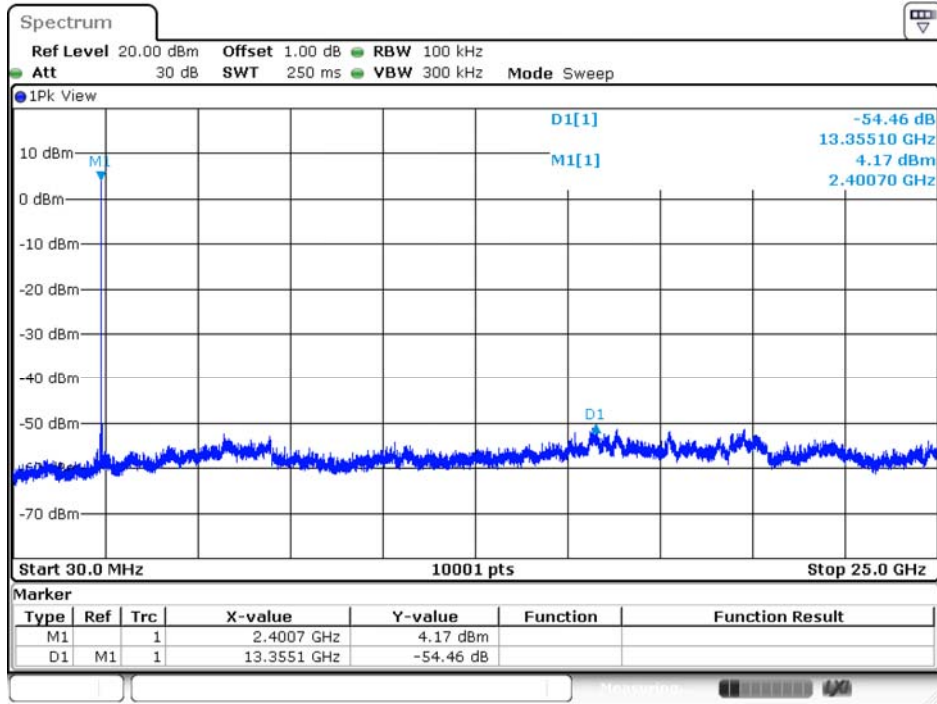

Date: 5 JAN 2018 02:26:10

Channel 39 (30MHz-25GHz)-8-DPSK

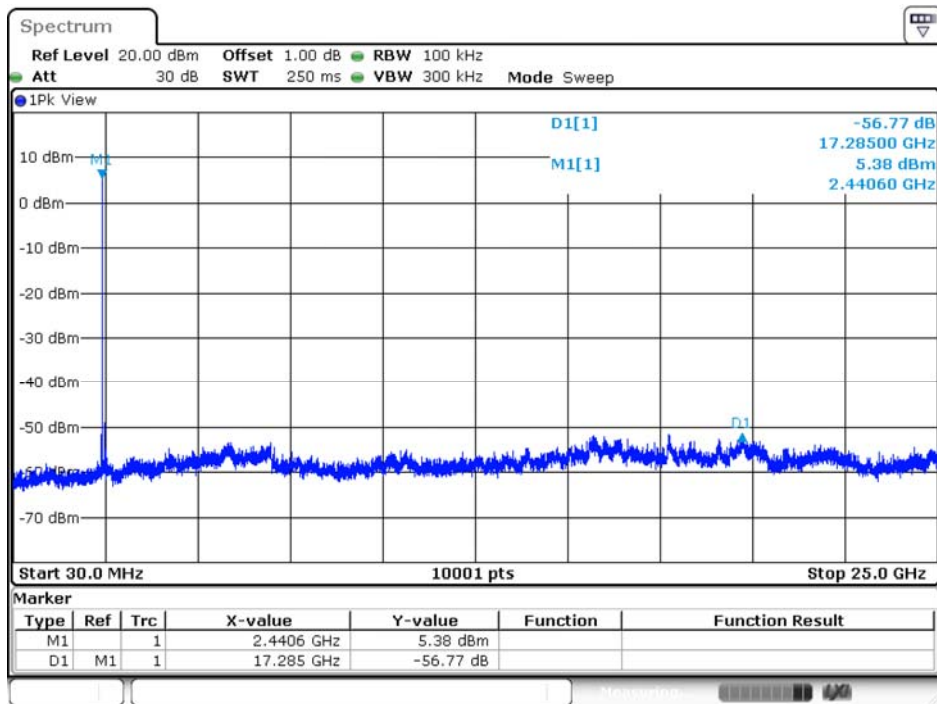

Date: 5 JAN 2018 02:43:05

Channel 78 (30MHz-25GHz)-8-DPSK

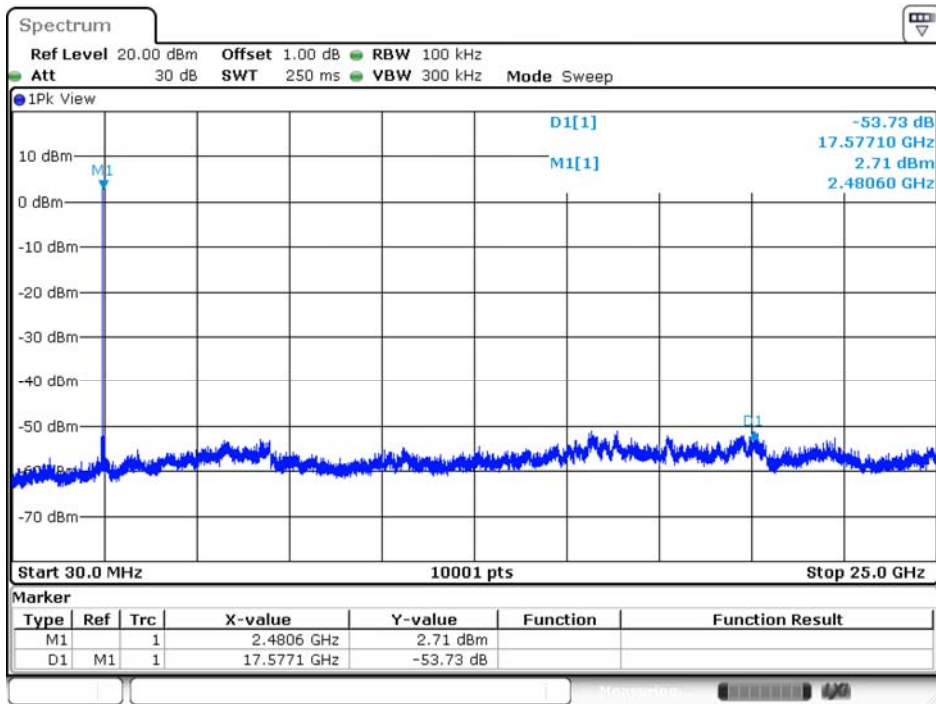

Date: 5.JAN.2018 03:09:48

6. Band Edge

6.1. Test Equipment

The following test equipment are used during the test:

Band Edge / CB2-H

Instrument	Manufacturer	Model No.	Serial No.	Cal. Date	Next Cal. Date
Signal Analyzer	R&S	FSVA40	101455	2017/11/21	2018/11/20
Signal & Spectrum Analyzer	R&S	FSV40	101049	2018/01/10	2019/01/09
EXA Signal Analyzer	Keysight	N9010A	MY51440132	2017/03/13	2018/03/12
Bilog Antenna	Teseq	CBL6112D	23191	2017/06/28	2018/06/27
Horn Antenna	Schwarzbeck	BBHA 9120D	639	2017/06/14	2018/06/13
Horn Antenna	Schwarzbeck	BBHA 9170	202	2017/02/15	2018/02/14
Pre-Amplifier	RF Bay Inc.	LNA-1330	12162511	2017/03/09	2018/03/08
Pre-Amplifier	EMCI	EMCI 1830I	980366	2018/01/08	2019/01/07
Pre-Amplifier	MITEQ	JS44-18004000-45-8P	2014754	2017/12/13	2018/12/12

6.2. Test Setup

RF Radiated Measurement:

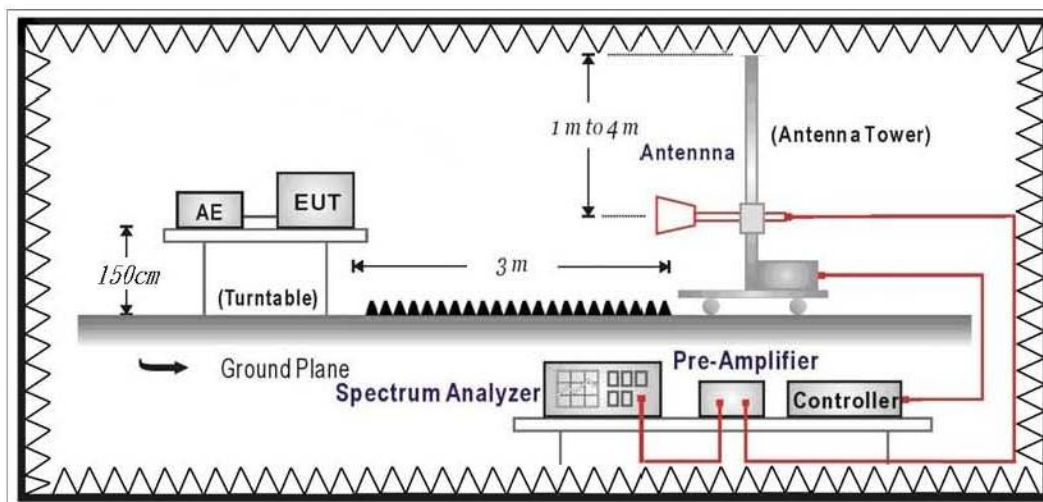

6.3. Limits

Emissions radiated outside of the specified frequency bands, except for harmonics, shall be attenuated by at least 20dB below the level of the fundamental or to the general radiated emission limits in paragraph 15.209, whichever is the lesser attenuation.

6.4. Test Procedure

The EUT was setup according to ANSI C63.10: 2013 and tested according to FHSS test procedure of FCC Public Notice DA 00-705 for compliance to FCC 47CFR 15.247 requirements

The EUT and its simulators are placed on a turn table which is 1.5 meter above ground. The turn table can rotate 360 degrees to determine the position of the maximum emission level. The EUT was positioned such that the distance from antenna to the EUT was 3 meters.

The antenna can move up and down between 1 meter and 4 meters to find out the maximum emission level.

Both horizontal and vertical polarization of the antenna are set on measurement. In order to find the maximum emission, all of the interface cables must be manipulated according to ANSI C63.10: 2013 on radiated measurement.

6.5. Test Specification

According to FCC Part 15 Subpart C Paragraph 15.247 and RSS-247.

6.6. Test Result

Site : DEKRA Taiwan CB2-H	Time : 2017/12/21
Limit : FCC_SpartC_15.209_03M_PK	Margin : 6
Probe : CB2_FCC_EFS_B091_1-18GHz_3M_0117 - HORIZONTAL	Power : AC 120V/60Hz
EUT : ConnectCore 6 Plus	Note : Mode 1: Transmit Mode_DH5 802.15.1_DH5_2402MHz

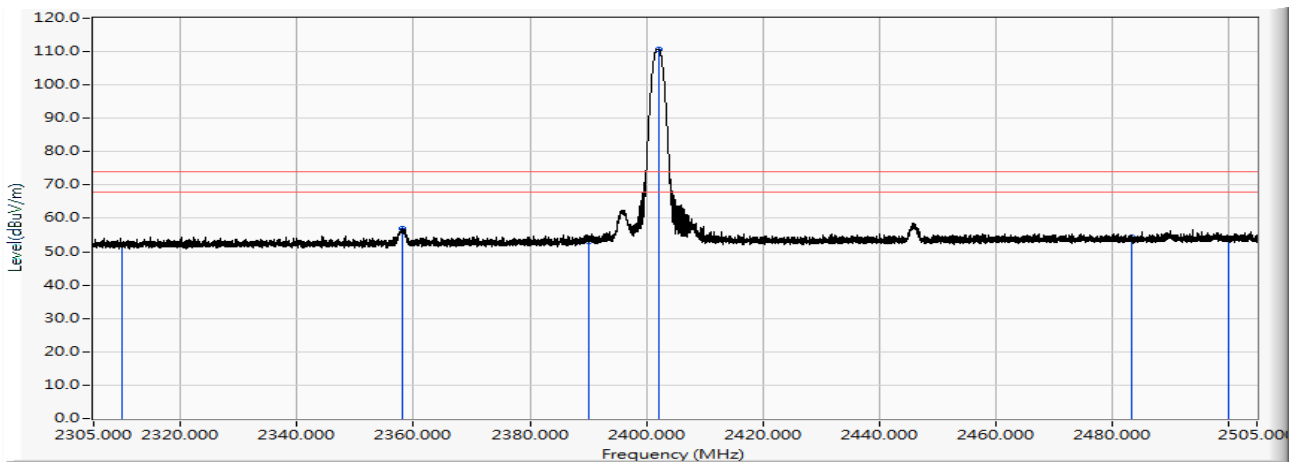

	Frequency (MHz)	Correct Factor (dB)	Reading Level (dBuV)	Measure Level (dBuV/m)	Margin (dB)	Limit (dBuV/m)	Detector Type
1	2310.000	12.384	39.695	52.079	-21.921	74.000	PEAK
2	2358.200	12.702	44.268	56.970	-17.030	74.000	PEAK
3	2390.000	12.911	40.222	53.133	-20.867	74.000	PEAK
4	* 2402.120	12.992	97.710	110.701	36.701	74.000	PEAK
5	2483.500	13.527	40.898	54.425	-19.575	74.000	PEAK
6	2500.000	13.629	40.237	53.866	-20.134	74.000	PEAK

Note:

1. All reading above 1GHz is performed with peak and/or average measurements as necessary.
2. Peak measurements: RBW = 1MHz, VBW = 3 MHz, Sweep: Auto.
3. Average measurements: RBW = 1MHz, VBW = 10 Hz, Sweep: Auto.
4. “ * ”, means this data is the worst emission level.
5. Measurement Level = Reading Level + Correct Factor.
6. The average measurement was not performed when the peak measured data under the limit of average detection. If the readings given are average, peak measurement should also be supplied.
7. The fundamental for reference only, it's not restricted by unwanted emission limit.

Site : DEKRA Taiwan CB2-H	Time : 2017/12/21
Limit : FCC_SpartC_15.209_03M_AV	Margin : 6
Probe : CB2_FCC_EFS_B091_1-18GHz_3M_0117 - HORIZONTAL	Power : AC 120V/60Hz
EUT : ConnectCore 6 Plus	Note : Mode 1: Transmit Mode_DH5 802.15.1_DH5_2402MHz

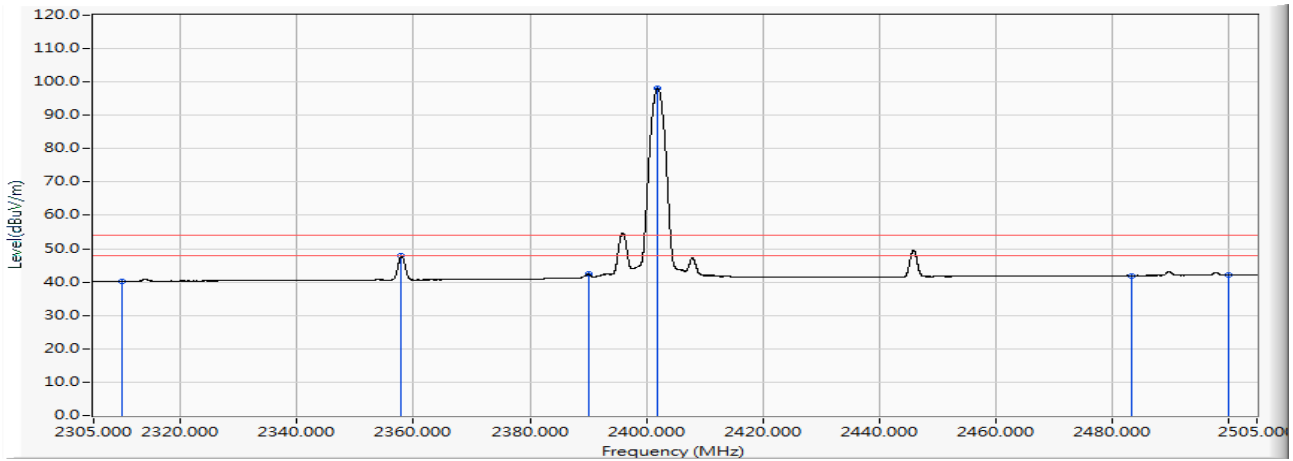

	Frequency (MHz)	Correct Factor (dB)	Reading Level (dBuV)	Measure Level (dBuV/m)	Margin (dB)	Limit (dBuV/m)	Detector Type
1	2310.000	12.384	27.870	40.254	-13.746	54.000	AVERAGE
2	2357.920	12.700	35.165	47.865	-6.135	54.000	AVERAGE
3	2390.000	12.911	29.411	42.322	-11.678	54.000	AVERAGE
4	* 2401.960	12.990	85.199	98.189	44.189	54.000	AVERAGE
5	2483.500	13.527	28.386	41.913	-12.087	54.000	AVERAGE
6	2500.000	13.629	28.445	42.074	-11.926	54.000	AVERAGE

Note:

1. All reading above 1GHz is performed with peak and/or average measurements as necessary.
2. Peak measurements: RBW = 1MHz, VBW = 3 MHz, Sweep: Auto.
3. Average measurements: RBW = 1MHz, VBW = 10 Hz, Sweep: Auto.
4. “ * ”, means this data is the worst emission level.
5. Measurement Level = Reading Level + Correct Factor.
6. The average measurement was not performed when the peak measured data under the limit of average detection. If the readings given are average, peak measurement should also be supplied.
7. The fundamental for reference only, it's not restricted by unwanted emission limit.

Site : DEKRA Taiwan CB2-H	Time : 2017/12/21
Limit : FCC_SpartC_15.209_03M_PK	Margin : 6
Probe : CB2_FCC_EFS_B091_1-18GHz_3M_0117 - VERTICAL	Power : AC 120V/60Hz
EUT : ConnectCore 6 Plus	Note : Mode 1: Transmit Mode_DH5 802.15.1_DH5_2402MHz

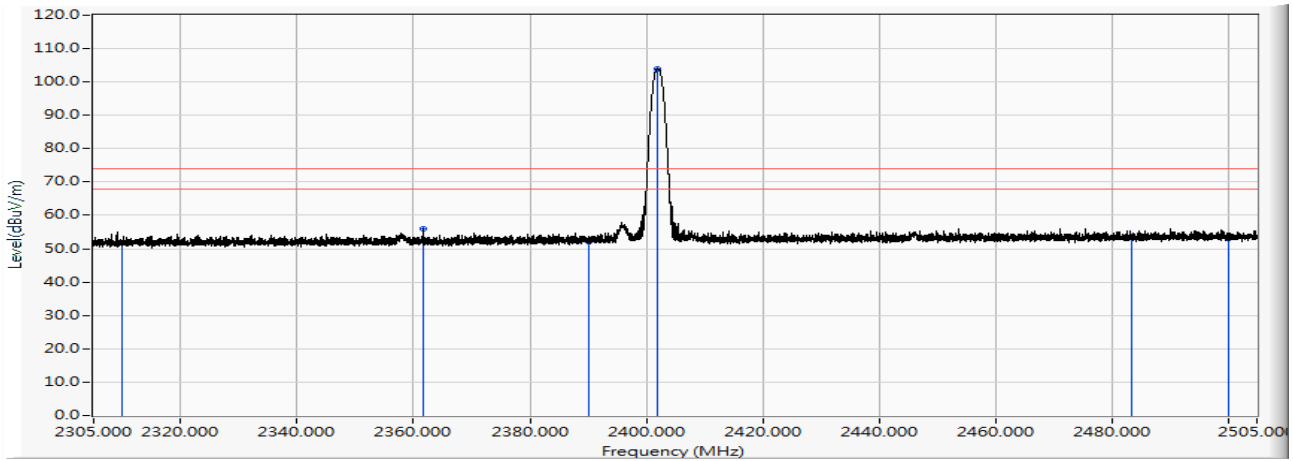

	Frequency (MHz)	Correct Factor (dB)	Reading Level (dBuV)	Measure Level (dBuV/m)	Margin (dB)	Limit (dBuV/m)	Detector Type
1	2310.000	12.384	39.450	51.834	-22.166	74.000	PEAK
2	2361.580	12.724	43.284	56.008	-17.992	74.000	PEAK
3	2390.000	12.911	39.114	52.025	-21.975	74.000	PEAK
4	* 2401.860	12.989	90.951	103.940	29.940	74.000	PEAK
5	2483.500	13.527	40.088	53.615	-20.385	74.000	PEAK
6	2500.000	13.629	39.338	52.967	-21.033	74.000	PEAK

Note:

1. All reading above 1GHz is performed with peak and/or average measurements as necessary.
2. Peak measurements: RBW = 1MHz, VBW = 3 MHz, Sweep: Auto.
3. Average measurements: RBW = 1MHz, VBW = 10 Hz, Sweep: Auto.
4. “ * ”, means this data is the worst emission level.
5. Measurement Level = Reading Level + Correct Factor.
6. The average measurement was not performed when the peak measured data under the limit of average detection. If the readings given are average, peak measurement should also be supplied.
7. The fundamental for reference only, it's not restricted by unwanted emission limit.

Site : DEKRA Taiwan CB2-H	Time : 2017/12/21
Limit : FCC_SpartC_15.209_03M_AV	Margin : 6
Probe : CB2_FCC_EFS_B091_1-18GHz_3M_0117 - VERTICAL	Power : AC 120V/60Hz
EUT : ConnectCore 6 Plus	Note : Mode 1: Transmit Mode_DH5 802.15.1_DH5_2402MHz

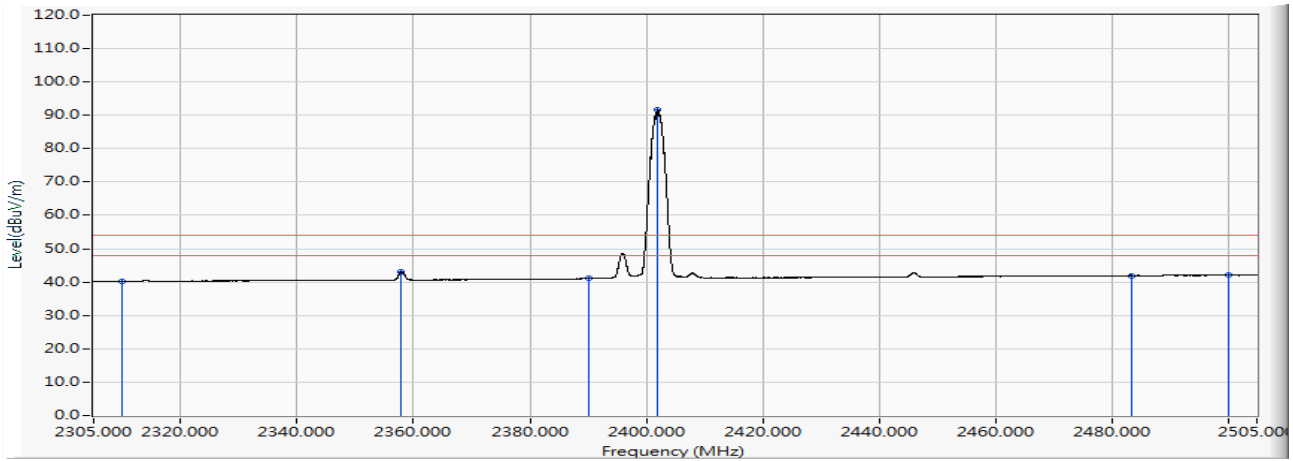

	Frequency (MHz)	Correct Factor (dB)	Reading Level (dBuV)	Measure Level (dBuV/m)	Margin (dB)	Limit (dBuV/m)	Detector Type
1	2310.000	12.384	27.892	40.276	-13.724	54.000	AVERAGE
2	2357.820	12.699	30.355	43.054	-10.946	54.000	AVERAGE
3	2390.000	12.911	28.367	41.278	-12.722	54.000	AVERAGE
4	* 2401.980	12.990	78.647	91.637	37.637	54.000	AVERAGE
5	2483.500	13.527	28.414	41.941	-12.059	54.000	AVERAGE
6	2500.000	13.629	28.407	42.036	-11.964	54.000	AVERAGE

Note:

1. All reading above 1GHz is performed with peak and/or average measurements as necessary.
2. Peak measurements: RBW = 1MHz, VBW = 3 MHz, Sweep: Auto.
3. Average measurements: RBW = 1MHz, VBW = 10 Hz, Sweep: Auto.
4. “ * ”, means this data is the worst emission level.
5. Measurement Level = Reading Level + Correct Factor.
6. The average measurement was not performed when the peak measured data under the limit of average detection. If the readings given are average, peak measurement should also be supplied.
7. The fundamental for reference only, it's not restricted by unwanted emission limit.

Site : DEKRA Taiwan CB2-H	Time : 2017/12/21
Limit : FCC_SpartC_15.209_03M_PK	Margin : 6
Probe : CB2_FCC_EFS_B091_1-18GHz_3M_0117 - HORIZONTAL	Power : AC 120V/60Hz
EUT : ConnectCore 6 Plus	Note : Mode 1: Transmit Mode_DH5 802.15.1_DH5_2441MHz

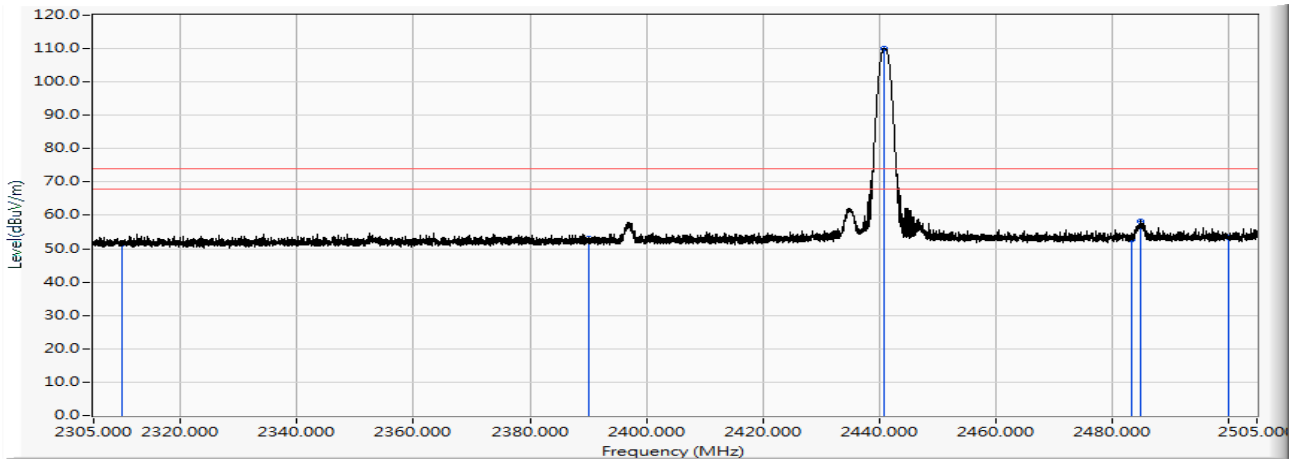

	Frequency (MHz)	Correct Factor (dB)	Reading Level (dBuV)	Measure Level (dBuV/m)	Margin (dB)	Limit (dBuV/m)	Detector Type
1	2310.000	12.384	39.173	51.557	-22.443	74.000	PEAK
2	2390.000	12.911	40.292	53.203	-20.797	74.000	PEAK
3	* 2440.840	13.246	96.736	109.982	35.982	74.000	PEAK
4	2483.500	13.527	39.393	52.920	-21.080	74.000	PEAK
5	2484.920	13.537	44.750	58.287	-15.713	74.000	PEAK
6	2500.000	13.629	39.833	53.462	-20.538	74.000	PEAK

Note:

1. All reading above 1GHz is performed with peak and/or average measurements as necessary.
2. Peak measurements: RBW = 1MHz, VBW = 3 MHz, Sweep: Auto.
3. Average measurements: RBW = 1MHz, VBW = 10 Hz, Sweep: Auto.
4. “ * ”, means this data is the worst emission level.
5. Measurement Level = Reading Level + Correct Factor.
6. The average measurement was not performed when the peak measured data under the limit of average detection. If the readings given are average, peak measurement should also be supplied.
7. The fundamental for reference only, it's not restricted by unwanted emission limit.

Site : DEKRA Taiwan CB2-H	Time : 2017/12/21
Limit : FCC_SpartC_15.209_03M_AV	Margin : 6
Probe : CB2_FCC_EFS_B091_1-18GHz_3M_0117 - HORIZONTAL	Power : AC 120V/60Hz
EUT : ConnectCore 6 Plus	Note : Mode 1: Transmit Mode_DH5 802.15.1_DH5_2441MHz

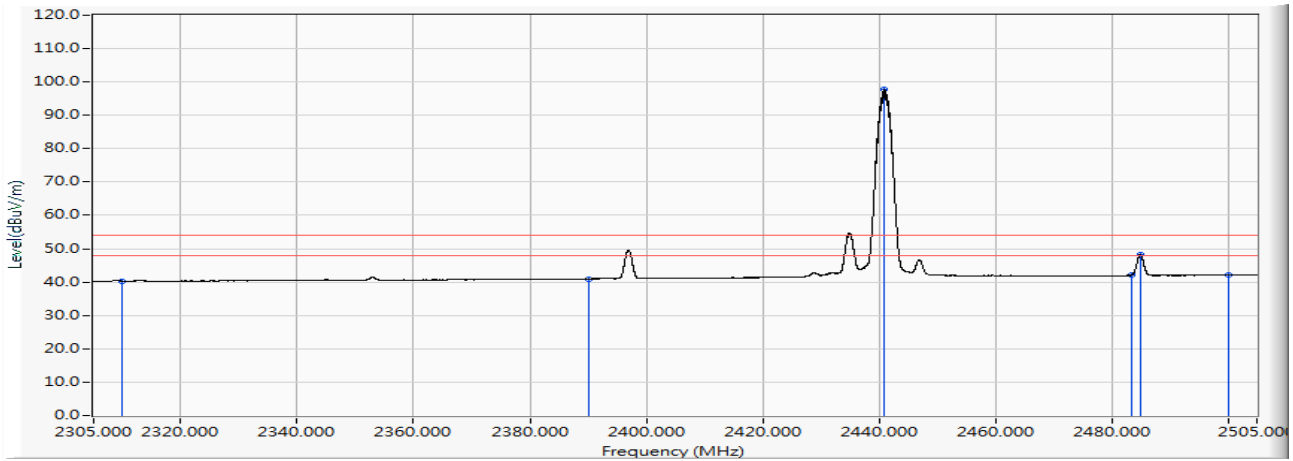

	Frequency (MHz)	Correct Factor (dB)	Reading Level (dBuV)	Measure Level (dBuV/m)	Margin (dB)	Limit (dBuV/m)	Detector Type
1	2310.000	12.384	27.882	40.266	-13.734	54.000	AVERAGE
2	2390.000	12.911	28.028	40.939	-13.061	54.000	AVERAGE
3	* 2440.980	13.248	84.406	97.653	43.653	54.000	AVERAGE
4	2483.500	13.527	28.540	42.067	-11.933	54.000	AVERAGE
5	2484.880	13.537	34.770	48.306	-5.694	54.000	AVERAGE
6	2500.000	13.629	28.431	42.060	-11.940	54.000	AVERAGE

Note:

1. All reading above 1GHz is performed with peak and/or average measurements as necessary.
2. Peak measurements: RBW = 1MHz, VBW = 3 MHz, Sweep: Auto.
3. Average measurements: RBW = 1MHz, VBW = 10 Hz, Sweep: Auto.
4. “ * ”, means this data is the worst emission level.
5. Measurement Level = Reading Level + Correct Factor.
6. The average measurement was not performed when the peak measured data under the limit of average detection. If the readings given are average, peak measurement should also be supplied.
7. The fundamental for reference only, it's not restricted by unwanted emission limit.

Site : DEKRA Taiwan CB2-H	Time : 2017/12/21
Limit : FCC_SpartC_15.209_03M_PK	Margin : 6
Probe : CB2_FCC_EFS_B091_1-18GHz_3M_0117 - VERTICAL	Power : AC 120V/60Hz
EUT : ConnectCore 6 Plus	Note : Mode 1: Transmit Mode_DH5 802.15.1_DH5_2441MHz

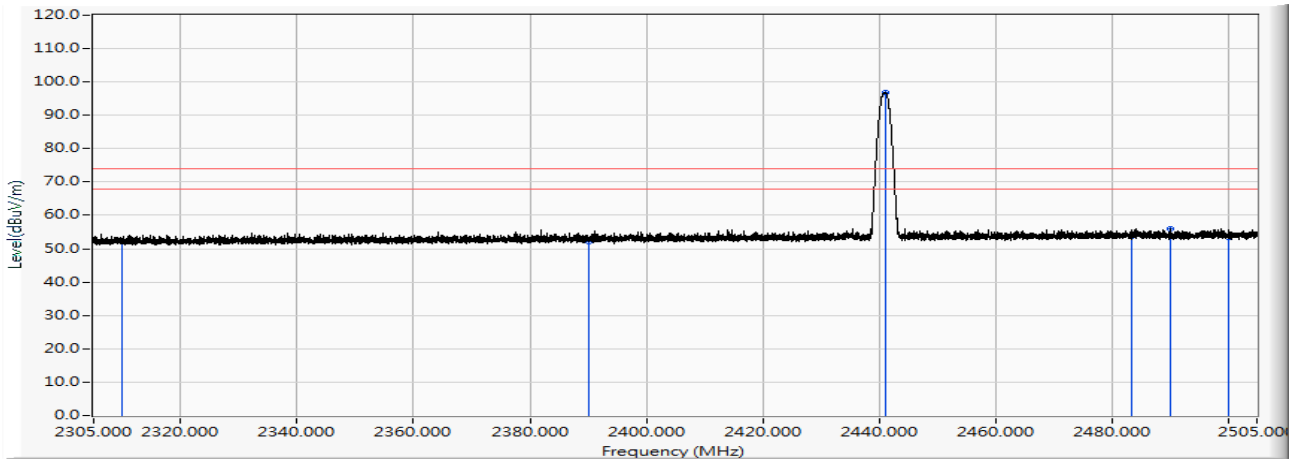

	Frequency (MHz)	Correct Factor (dB)	Reading Level (dBuV)	Measure Level (dBuV/m)	Margin (dB)	Limit (dBuV/m)	Detector Type
1	2310.000	12.384	39.919	52.303	-21.697	74.000	PEAK
2	2390.000	12.911	39.198	52.109	-21.891	74.000	PEAK
3	* 2441.120	13.248	83.511	96.759	22.759	74.000	PEAK
4	2483.500	13.527	40.104	53.631	-20.369	74.000	PEAK
5	2490.060	13.570	42.485	56.055	-17.945	74.000	PEAK
6	2500.000	13.629	39.666	53.295	-20.705	74.000	PEAK

Note:

1. All reading above 1GHz is performed with peak and/or average measurements as necessary.
2. Peak measurements: RBW = 1MHz, VBW = 3 MHz, Sweep: Auto.
3. Average measurements: RBW = 1MHz, VBW = 10 Hz, Sweep: Auto.
4. “ * ”, means this data is the worst emission level.
5. Measurement Level = Reading Level + Correct Factor.
6. The average measurement was not performed when the peak measured data under the limit of average detection. If the readings given are average, peak measurement should also be supplied.
7. The fundamental for reference only, it's not restricted by unwanted emission limit.

Site : DEKRA Taiwan CB2-H	Time : 2017/12/21
Limit : FCC_SpartC_15.209_03M_AV	Margin : 6
Probe : CB2_FCC_EFS_B091_1-18GHz_3M_0117 - VERTICAL	Power : AC 120V/60Hz
EUT : ConnectCore 6 Plus	Note : Mode 1: Transmit Mode_DH5 802.15.1_DH5_2441MHz

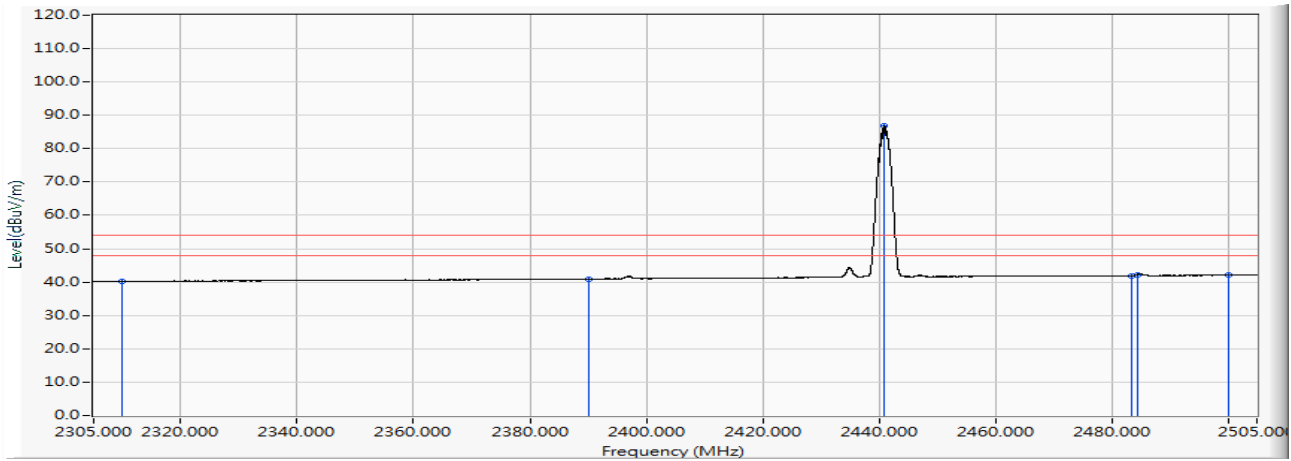

	Frequency (MHz)	Correct Factor (dB)	Reading Level (dBuV)	Measure Level (dBuV/m)	Margin (dB)	Limit (dBuV/m)	Detector Type
1	2310.000	12.384	27.887	40.271	-13.729	54.000	AVERAGE
2	2390.000	12.911	28.074	40.985	-13.015	54.000	AVERAGE
3	* 2440.940	13.247	73.483	86.730	32.730	54.000	AVERAGE
4	2483.500	13.527	28.371	41.898	-12.102	54.000	AVERAGE
5	2484.500	13.534	28.754	42.288	-11.712	54.000	AVERAGE
6	2500.000	13.629	28.448	42.077	-11.923	54.000	AVERAGE

Note:

1. All reading above 1GHz is performed with peak and/or average measurements as necessary.
2. Peak measurements: RBW = 1MHz, VBW = 3 MHz, Sweep: Auto.
3. Average measurements: RBW = 1MHz, VBW = 10 Hz, Sweep: Auto.
4. “ * ”, means this data is the worst emission level.
5. Measurement Level = Reading Level + Correct Factor.
6. The average measurement was not performed when the peak measured data under the limit of average detection. If the readings given are average, peak measurement should also be supplied.
7. The fundamental for reference only, it's not restricted by unwanted emission limit.

Site : DEKRA Taiwan CB2-H	Time : 2017/12/21
Limit : FCC_SpartC_15.209_03M_PK	Margin : 6
Probe : CB2_FCC_EFS_B091_1-18GHz_3M_0117 - HORIZONTAL	Power : AC 120V/60Hz
EUT : ConnectCore 6 Plus	Note : Mode 1: Transmit Mode_DH5 802.15.1_DH5_2480MHz

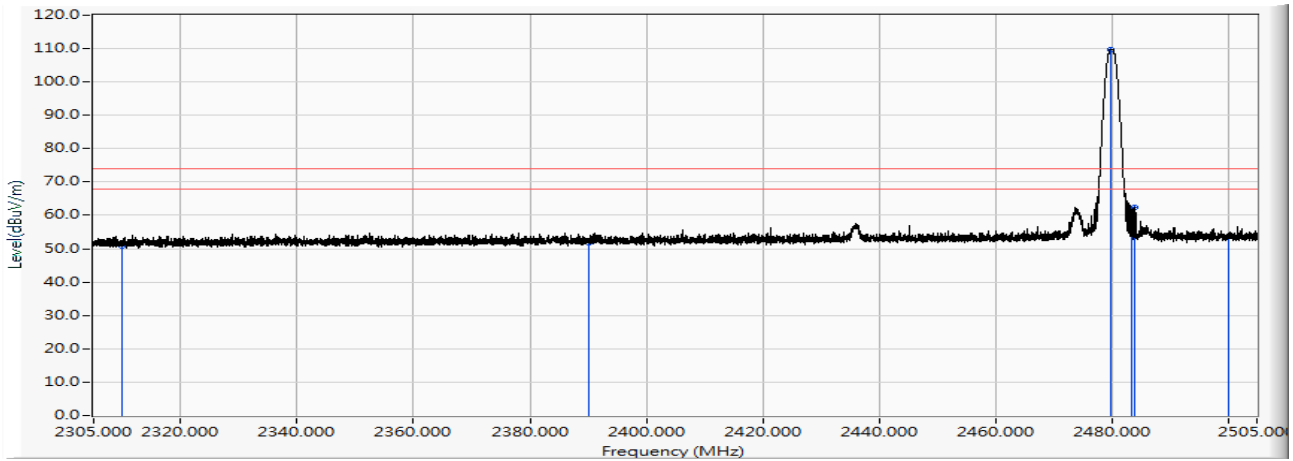

	Frequency (MHz)	Correct Factor (dB)	Reading Level (dBuV)	Measure Level (dBuV/m)	Margin (dB)	Limit (dBuV/m)	Detector Type
1	2310.000	12.384	38.447	50.831	-23.169	74.000	PEAK
2	2390.000	12.911	38.975	51.886	-22.114	74.000	PEAK
3	* 2479.860	13.503	96.313	109.816	35.816	74.000	PEAK
4	2483.500	13.527	47.171	60.698	-13.302	74.000	PEAK
5	2483.980	13.530	48.792	62.322	-11.678	74.000	PEAK
6	2500.000	13.629	40.180	53.809	-20.191	74.000	PEAK

Note:

1. All reading above 1GHz is performed with peak and/or average measurements as necessary.
2. Peak measurements: RBW = 1MHz, VBW = 3 MHz, Sweep: Auto.
3. Average measurements: RBW = 1MHz, VBW = 10 Hz, Sweep: Auto.
4. “ * ”, means this data is the worst emission level.
5. Measurement Level = Reading Level + Correct Factor.
6. The average measurement was not performed when the peak measured data under the limit of average detection. If the readings given are average, peak measurement should also be supplied.
7. The fundamental for reference only, it's not restricted by unwanted emission limit.

Site : DEKRA Taiwan CB2-H	Time : 2017/12/21
Limit : FCC_SpartC_15.209_03M_AV	Margin : 6
Probe : CB2_FCC_EFS_B091_1-18GHz_3M_0117 - HORIZONTAL	Power : AC 120V/60Hz
EUT : ConnectCore 6 Plus	Note : Mode 1: Transmit Mode_DH5 802.15.1_DH5_2480MHz

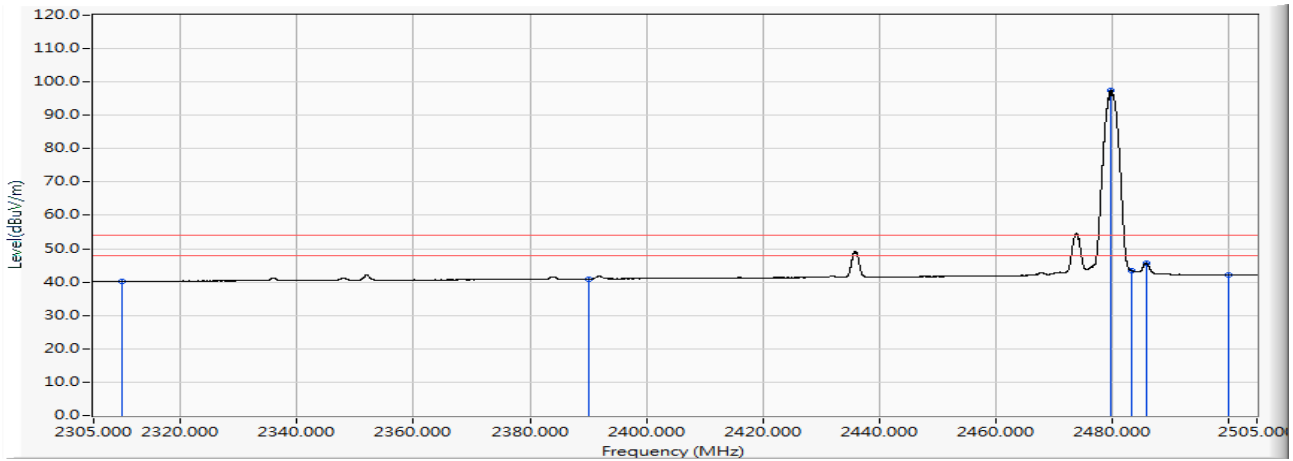

	Frequency (MHz)	Correct Factor (dB)	Reading Level (dBuV)	Measure Level (dBuV/m)	Margin (dB)	Limit (dBuV/m)	Detector Type
1	2310.000	12.384	27.862	40.246	-13.754	54.000	AVERAGE
2	2390.000	12.911	28.059	40.970	-13.030	54.000	AVERAGE
3	* 2479.940	13.504	84.076	97.580	43.580	54.000	AVERAGE
4	2483.500	13.527	29.818	43.345	-10.655	54.000	AVERAGE
5	2485.900	13.543	32.248	45.791	-8.209	54.000	AVERAGE
6	2500.000	13.629	28.523	42.152	-11.848	54.000	AVERAGE

Note:

1. All reading above 1GHz is performed with peak and/or average measurements as necessary.
2. Peak measurements: RBW = 1MHz, VBW = 3 MHz, Sweep: Auto.
3. Average measurements: RBW = 1MHz, VBW = 10 Hz, Sweep: Auto.
4. “ * ”, means this data is the worst emission level.
5. Measurement Level = Reading Level + Correct Factor.
6. The average measurement was not performed when the peak measured data under the limit of average detection. If the readings given are average, peak measurement should also be supplied.
7. The fundamental for reference only, it's not restricted by unwanted emission limit.

Site : DEKRA Taiwan CB2-H	Time : 2017/12/21
Limit : FCC_SpartC_15.209_03M_PK	Margin : 6
Probe : CB2_FCC_EFS_B091_1-18GHz_3M_0117 - VERTICAL	Power : AC 120V/60Hz
EUT : ConnectCore 6 Plus	Note : Mode 1: Transmit Mode_DH5 802.15.1_DH5_2480MHz

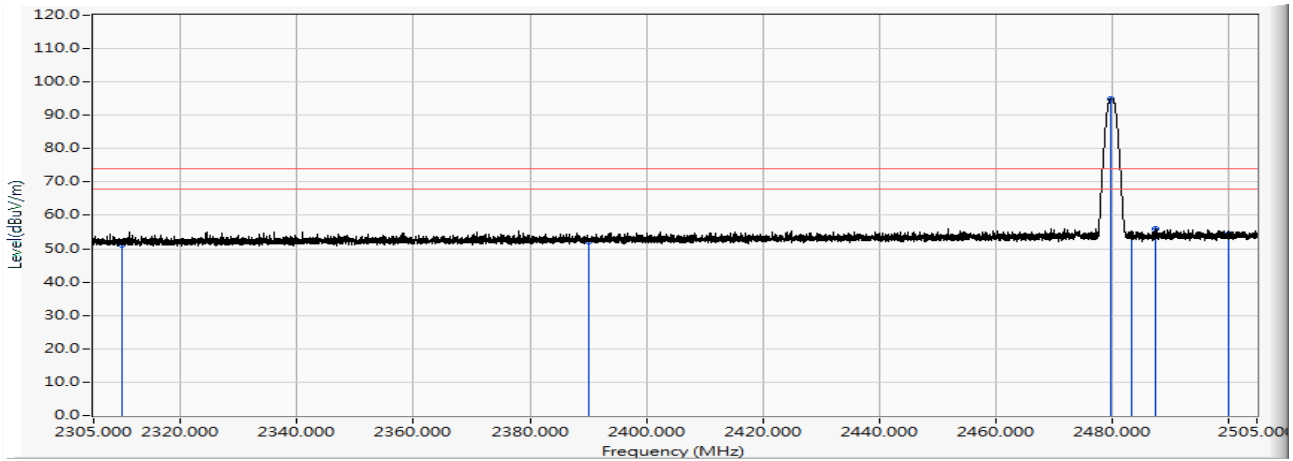

	Frequency (MHz)	Correct Factor (dB)	Reading Level (dBuV)	Measure Level (dBuV/m)	Margin (dB)	Limit (dBuV/m)	Detector Type
1	2310.000	12.384	38.688	51.072	-22.928	74.000	PEAK
2	2390.000	12.911	39.063	51.974	-22.026	74.000	PEAK
3	* 2479.860	13.503	81.560	95.063	21.063	74.000	PEAK
4	2483.500	13.527	40.077	53.604	-20.396	74.000	PEAK
5	2487.540	13.554	42.507	56.061	-17.939	74.000	PEAK
6	2500.000	13.629	40.717	54.346	-19.654	74.000	PEAK

Note:

1. All reading above 1GHz is performed with peak and/or average measurements as necessary.
2. Peak measurements: RBW = 1MHz, VBW = 3 MHz, Sweep: Auto.
3. Average measurements: RBW = 1MHz, VBW = 10 Hz, Sweep: Auto.
4. “ * ”, means this data is the worst emission level.
5. Measurement Level = Reading Level + Correct Factor.
6. The average measurement was not performed when the peak measured data under the limit of average detection. If the readings given are average, peak measurement should also be supplied.
7. The fundamental for reference only, it's not restricted by unwanted emission limit.

Site : DEKRA Taiwan CB2-H	Time : 2017/12/21
Limit : FCC_SpartC_15.209_03M_AV	Margin : 6
Probe : CB2_FCC_EFS_B091_1-18GHz_3M_0117 - VERTICAL	Power : AC 120V/60Hz
EUT : ConnectCore 6 Plus	Note : Mode 1: Transmit Mode_DH5 802.15.1_DH5_2480MHz

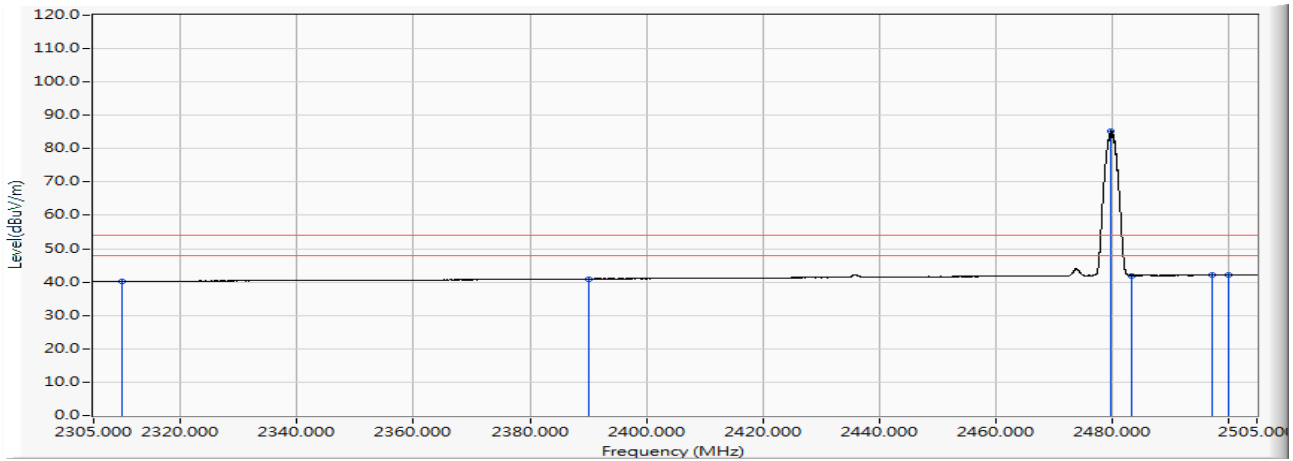

	Frequency (MHz)	Correct Factor (dB)	Reading Level (dBuV)	Measure Level (dBuV/m)	Margin (dB)	Limit (dBuV/m)	Detector Type
1	2310.000	12.384	27.860	40.244	-13.756	54.000	AVERAGE
2	2390.000	12.911	28.019	40.930	-13.070	54.000	AVERAGE
3	* 2479.980	13.504	71.789	85.293	31.293	54.000	AVERAGE
4	2483.500	13.527	28.429	41.956	-12.044	54.000	AVERAGE
5	2497.180	13.616	28.413	42.028	-11.972	54.000	AVERAGE
6	2500.000	13.629	28.441	42.070	-11.930	54.000	AVERAGE

Note:

1. All reading above 1GHz is performed with peak and/or average measurements as necessary.
2. Peak measurements: RBW = 1MHz, VBW = 3 MHz, Sweep: Auto.
3. Average measurements: RBW = 1MHz, VBW = 10 Hz, Sweep: Auto.
4. “ * ”, means this data is the worst emission level.
5. Measurement Level = Reading Level + Correct Factor.
6. The average measurement was not performed when the peak measured data under the limit of average detection. If the readings given are average, peak measurement should also be supplied.
7. The fundamental for reference only, it's not restricted by unwanted emission limit.

Site : DEKRA Taiwan CB2-H	Time : 2017/12/21
Limit : FCC_SpartC_15.209_03M_PK	Margin : 6
Probe : CB2_FCC_EFS_B091_1-18GHz_3M_0117 - HORIZONTAL	Power : AC 120V/60Hz
EUT : ConnectCore 6 Plus	Note : Mode 2: Transmit Mode_2DH5 802.15.1_2DH5_2402MHz

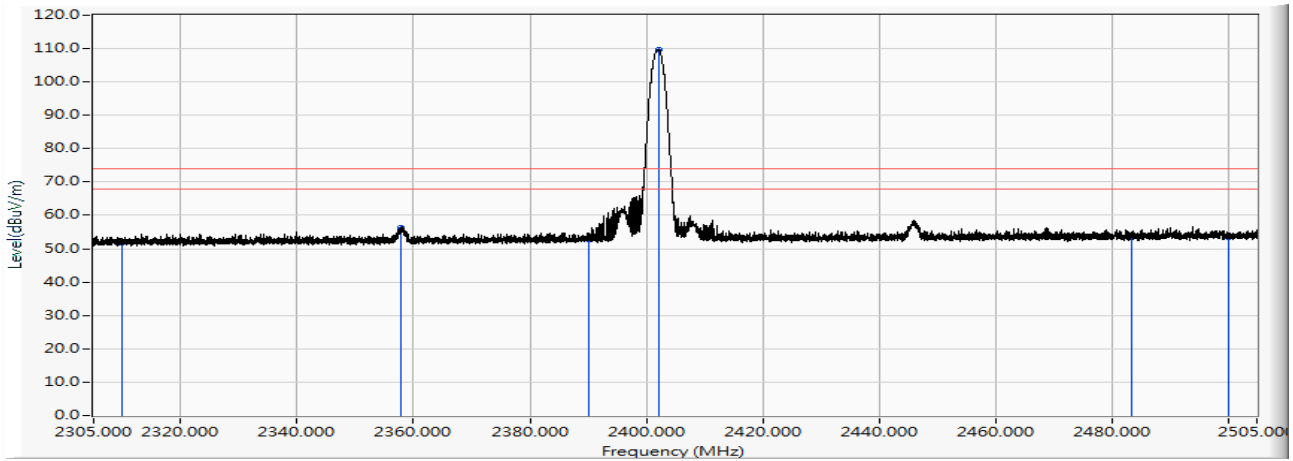

	Frequency (MHz)	Correct Factor (dB)	Reading Level (dBuV)	Measure Level (dBuV/m)	Margin (dB)	Limit (dBuV/m)	Detector Type
1	2310.000	12.384	39.495	51.879	-22.121	74.000	PEAK
2	2357.820	12.699	43.682	56.381	-17.619	74.000	PEAK
3	2390.000	12.911	39.897	52.808	-21.192	74.000	PEAK
4	* 2402.060	12.991	96.649	109.640	35.640	74.000	PEAK
5	2483.500	13.527	40.384	53.911	-20.089	74.000	PEAK
6	2500.000	13.629	39.761	53.390	-20.610	74.000	PEAK

Note:

1. All reading above 1GHz is performed with peak and/or average measurements as necessary.
2. Peak measurements: RBW = 1MHz, VBW = 3 MHz, Sweep: Auto.
3. Average measurements: RBW = 1MHz, VBW = 10 Hz, Sweep: Auto.
4. “ * ”, means this data is the worst emission level.
5. Measurement Level = Reading Level + Correct Factor.
6. The average measurement was not performed when the peak measured data under the limit of average detection. If the readings given are average, peak measurement should also be supplied.
7. The fundamental for reference only, it's not restricted by unwanted emission limit.

Site : DEKRA Taiwan CB2-H	Time : 2017/12/21
Limit : FCC_SpartC_15.209_03M_AV	Margin : 6
Probe : CB2_FCC_EFS_B091_1-18GHz_3M_0117 - HORIZONTAL	Power : AC 120V/60Hz
EUT : ConnectCore 6 Plus	Note : Mode 2: Transmit Mode_2DH5 802.15.1_2DH5_2402MHz

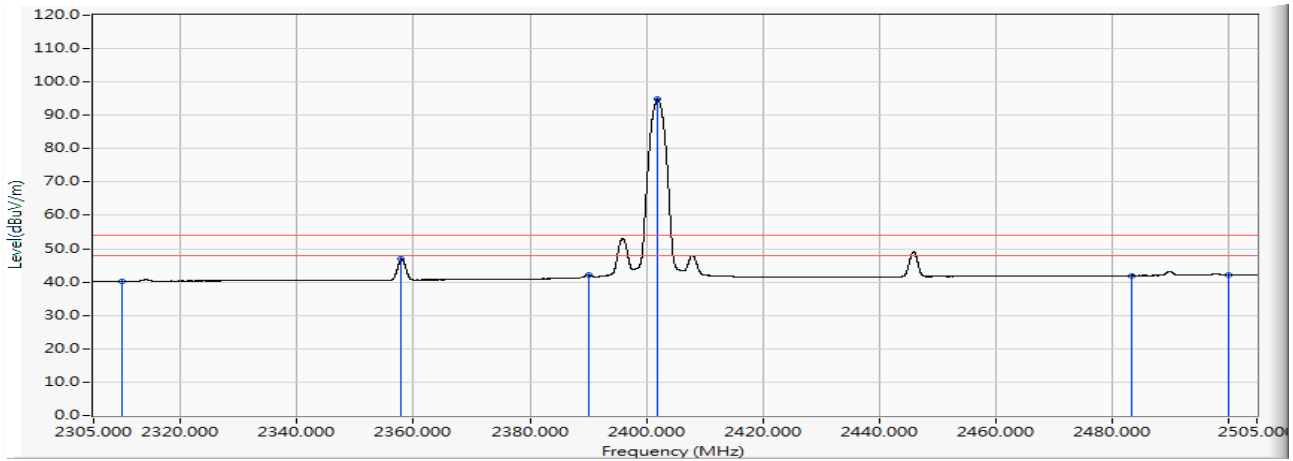

	Frequency (MHz)	Correct Factor (dB)	Reading Level (dBuV)	Measure Level (dBuV/m)	Margin (dB)	Limit (dBuV/m)	Detector Type
1	2310.000	12.384	27.902	40.286	-13.714	54.000	AVERAGE
2	2357.880	12.699	34.189	46.889	-7.111	54.000	AVERAGE
3	2390.000	12.911	29.175	42.086	-11.914	54.000	AVERAGE
4	* 2401.960	12.990	81.929	94.919	40.919	54.000	AVERAGE
5	2483.500	13.527	28.417	41.944	-12.056	54.000	AVERAGE
6	2500.000	13.629	28.438	42.067	-11.933	54.000	AVERAGE

Note:

1. All reading above 1GHz is performed with peak and/or average measurements as necessary.
2. Peak measurements: RBW = 1MHz, VBW = 3 MHz, Sweep: Auto.
3. Average measurements: RBW = 1MHz, VBW = 10 Hz, Sweep: Auto.
4. “ * ”, means this data is the worst emission level.
5. Measurement Level = Reading Level + Correct Factor.
6. The average measurement was not performed when the peak measured data under the limit of average detection. If the readings given are average, peak measurement should also be supplied.
7. The fundamental for reference only, it's not restricted by unwanted emission limit.

Site : DEKRA Taiwan CB2-H	Time : 2017/12/21
Limit : FCC_SpartC_15.209_03M_PK	Margin : 6
Probe : CB2_FCC_EFS_B091_1-18GHz_3M_0117 - VERTICAL	Power : AC 120V/60Hz
EUT : ConnectCore 6 Plus	Note : Mode 2: Transmit Mode_2DH5 802.15.1_2DH5_2402MHz

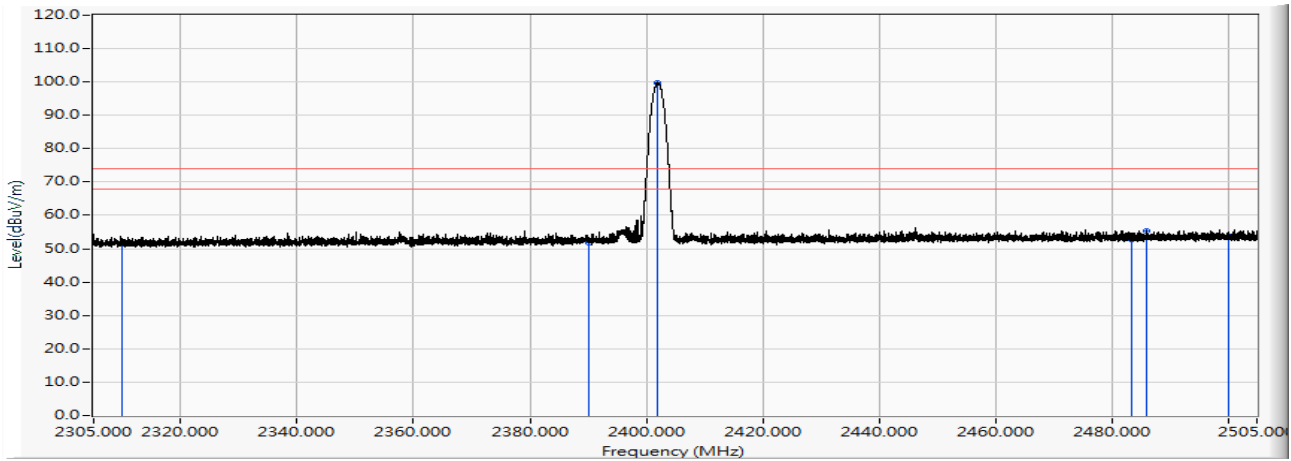

	Frequency (MHz)	Correct Factor (dB)	Reading Level (dBuV)	Measure Level (dBuV/m)	Margin (dB)	Limit (dBuV/m)	Detector Type
1	2310.000	12.384	38.960	51.344	-22.656	74.000	PEAK
2	2390.000	12.911	38.992	51.903	-22.097	74.000	PEAK
3	* 2401.840	12.989	86.888	99.877	25.877	74.000	PEAK
4	2483.500	13.527	39.178	52.705	-21.295	74.000	PEAK
5	2485.960	13.543	41.865	55.408	-18.592	74.000	PEAK
6	2500.000	13.629	40.170	53.799	-20.201	74.000	PEAK

Note:

1. All reading above 1GHz is performed with peak and/or average measurements as necessary.
2. Peak measurements: RBW = 1MHz, VBW = 3 MHz, Sweep: Auto.
3. Average measurements: RBW = 1MHz, VBW = 10 Hz, Sweep: Auto.
4. “ * ”, means this data is the worst emission level.
5. Measurement Level = Reading Level + Correct Factor.
6. The average measurement was not performed when the peak measured data under the limit of average detection. If the readings given are average, peak measurement should also be supplied.
7. The fundamental for reference only, it's not restricted by unwanted emission limit.

Site : DEKRA Taiwan CB2-H	Time : 2017/12/21
Limit : FCC_SpartC_15.209_03M_AV	Margin : 6
Probe : CB2_FCC_EFS_B091_1-18GHz_3M_0117 - VERTICAL	Power : AC 120V/60Hz
EUT : ConnectCore 6 Plus	Note : Mode 2: Transmit Mode_2DH5 802.15.1_2DH5_2402MHz

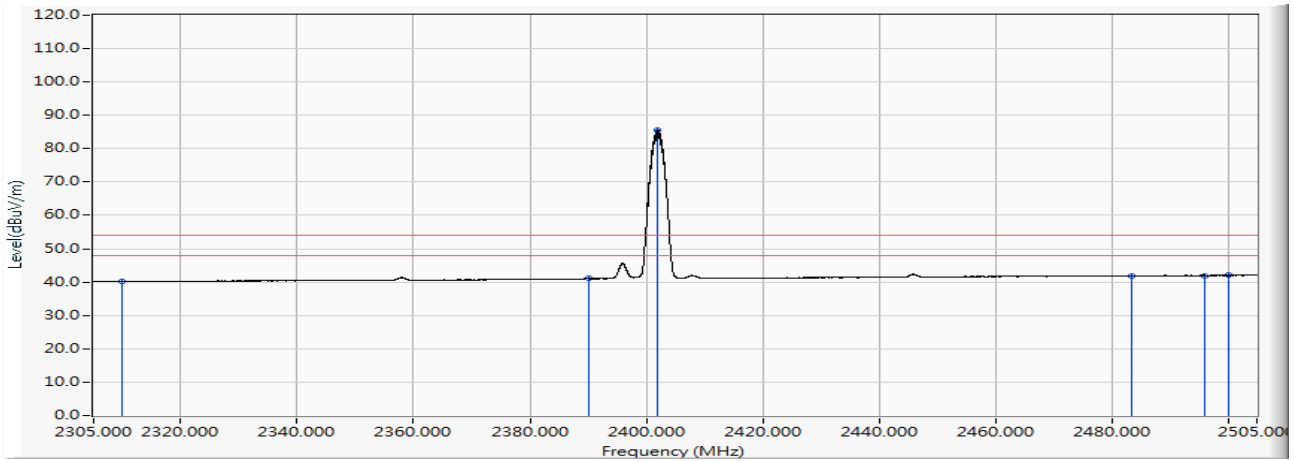

	Frequency (MHz)	Correct Factor (dB)	Reading Level (dBuV)	Measure Level (dBuV/m)	Margin (dB)	Limit (dBuV/m)	Detector Type
1	2310.000	12.384	27.817	40.201	-13.799	54.000	AVERAGE
2	2390.000	12.911	28.210	41.121	-12.879	54.000	AVERAGE
3	* 2401.920	12.989	72.648	85.638	31.638	54.000	AVERAGE
4	2483.500	13.527	28.354	41.881	-12.119	54.000	AVERAGE
5	2495.900	13.609	28.366	41.975	-12.025	54.000	AVERAGE
6	2500.000	13.629	28.391	42.020	-11.980	54.000	AVERAGE

Note:

1. All reading above 1GHz is performed with peak and/or average measurements as necessary.
2. Peak measurements: RBW = 1MHz, VBW = 3 MHz, Sweep: Auto.
3. Average measurements: RBW = 1MHz, VBW = 10 Hz, Sweep: Auto.
4. “ * ”, means this data is the worst emission level.
5. Measurement Level = Reading Level + Correct Factor.
6. The average measurement was not performed when the peak measured data under the limit of average detection. If the readings given are average, peak measurement should also be supplied.
7. The fundamental for reference only, it's not restricted by unwanted emission limit.

Site : DEKRA Taiwan CB2-H	Time : 2017/12/21
Limit : FCC_SpartC_15.209_03M_PK	Margin : 6
Probe : CB2_FCC_EFS_B091_1-18GHz_3M_0117 - HORIZONTAL	Power : AC 120V/60Hz
EUT : ConnectCore 6 Plus	Note : Mode 2: Transmit Mode_2DH5 802.15.1_2DH5_2441MHz

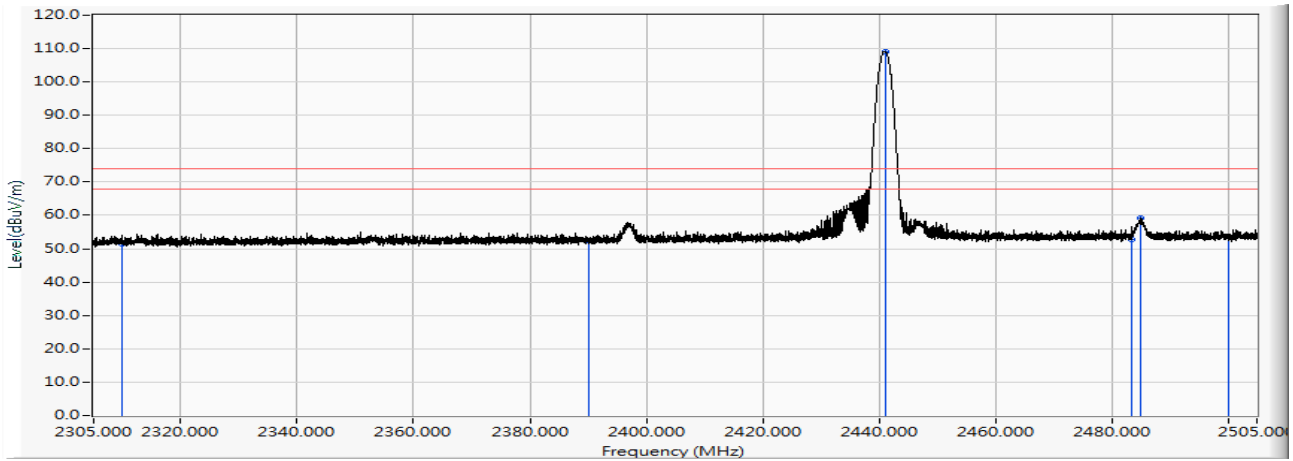

	Frequency (MHz)	Correct Factor (dB)	Reading Level (dBuV)	Measure Level (dBuV/m)	Margin (dB)	Limit (dBuV/m)	Detector Type
1	2310.000	12.384	39.087	51.471	-22.529	74.000	PEAK
2	2390.000	12.911	39.619	52.530	-21.470	74.000	PEAK
3	* 2441.140	13.248	95.954	109.202	35.202	74.000	PEAK
4	2483.500	13.527	39.271	52.798	-21.202	74.000	PEAK
5	2485.080	13.537	45.731	59.269	-14.731	74.000	PEAK
6	2500.000	13.629	40.074	53.703	-20.297	74.000	PEAK

Note:

1. All reading above 1GHz is performed with peak and/or average measurements as necessary.
2. Peak measurements: RBW = 1MHz, VBW = 3 MHz, Sweep: Auto.
3. Average measurements: RBW = 1MHz, VBW = 10 Hz, Sweep: Auto.
4. “ * ”, means this data is the worst emission level.
5. Measurement Level = Reading Level + Correct Factor.
6. The average measurement was not performed when the peak measured data under the limit of average detection. If the readings given are average, peak measurement should also be supplied.
7. The fundamental for reference only, it's not restricted by unwanted emission limit.

Site : DEKRA Taiwan CB2-H	Time : 2017/12/21
Limit : FCC_SpartC_15.209_03M_AV	Margin : 6
Probe : CB2_FCC_EFS_B091_1-18GHz_3M_0117 - HORIZONTAL	Power : AC 120V/60Hz
EUT : ConnectCore 6 Plus	Note : Mode 2: Transmit Mode_2DH5 802.15.1_2DH5_2441MHz

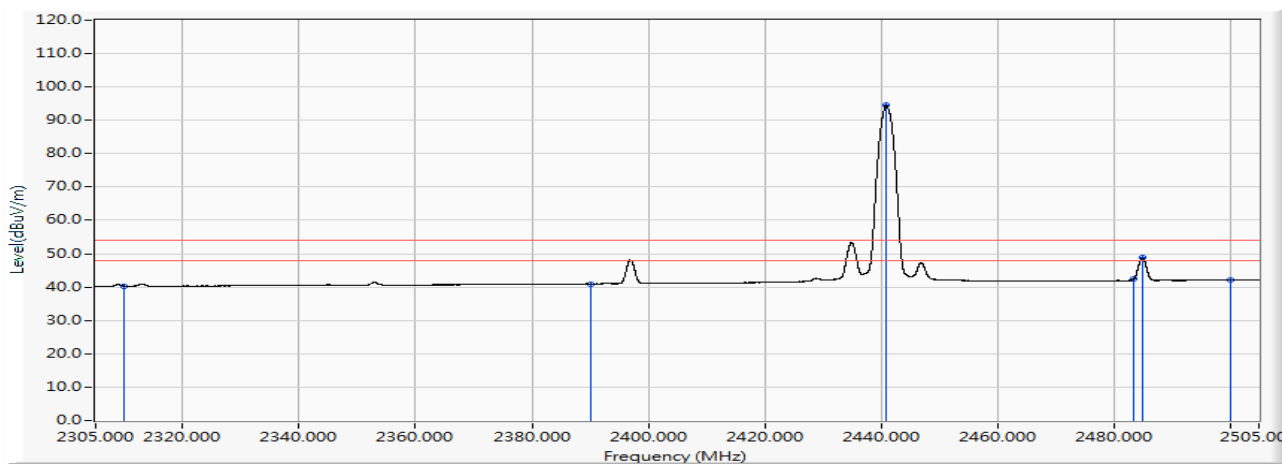

	Frequency (MHz)	Correct Factor (dB)	Reading Level (dBuV)	Measure Level (dBuV/m)	Margin (dB)	Limit (dBuV/m)	Detector Type
1	2310.000	12.384	27.972	40.356	-13.644	54.000	AVERAGE
2	2390.000	12.911	28.094	41.005	-12.995	54.000	AVERAGE
3	* 2440.980	13.248	81.236	94.483	40.483	54.000	AVERAGE
4	2483.500	13.527	28.794	42.321	-11.679	54.000	AVERAGE
5	2484.960	13.537	35.203	48.740	-5.260	54.000	AVERAGE
6	2500.000	13.629	28.488	42.117	-11.883	54.000	AVERAGE

Note:

1. All reading above 1GHz is performed with peak and/or average measurements as necessary.
2. Peak measurements: RBW = 1MHz, VBW = 3 MHz, Sweep: Auto.
3. Average measurements: RBW = 1MHz, VBW = 10 Hz, Sweep: Auto.
4. “ * ”, means this data is the worst emission level.
5. Measurement Level = Reading Level + Correct Factor.
6. The average measurement was not performed when the peak measured data under the limit of average detection. If the readings given are average, peak measurement should also be supplied.
7. The fundamental for reference only, it's not restricted by unwanted emission limit.

Site : DEKRA Taiwan CB2-H	Time : 2017/12/21
Limit : FCC_SpartC_15.209_03M_PK	Margin : 6
Probe : CB2_FCC_EFS_B091_1-18GHz_3M_0117 - VERTICAL	Power : AC 120V/60Hz
EUT : ConnectCore 6 Plus	Note : Mode 2: Transmit Mode_2DH5 802.15.1_2DH5_2441MHz

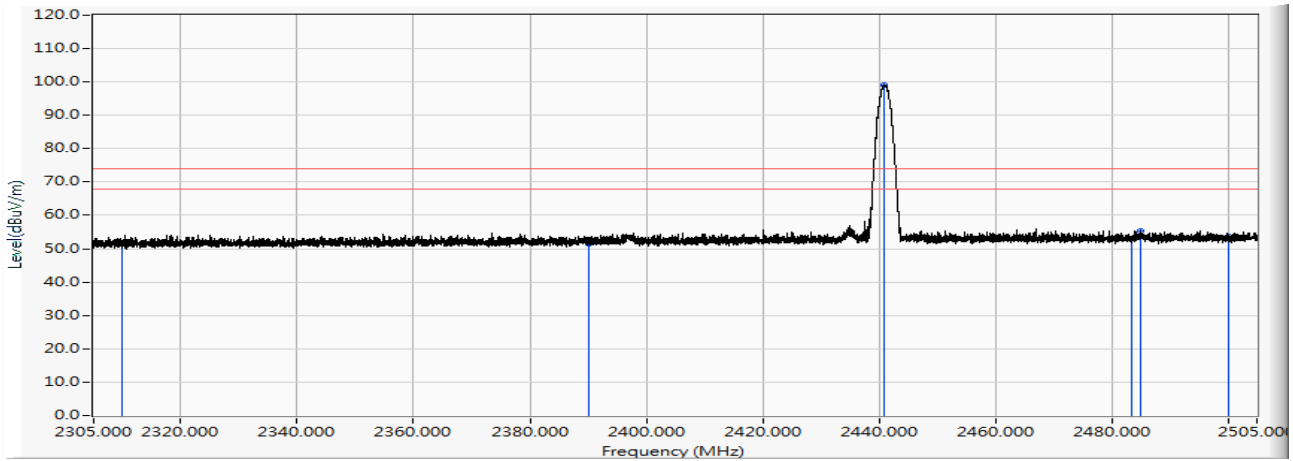

	Frequency (MHz)	Correct Factor (dB)	Reading Level (dBuV)	Measure Level (dBuV/m)	Margin (dB)	Limit (dBuV/m)	Detector Type
1	2310.000	12.384	39.078	51.462	-22.538	74.000	PEAK
2	2390.000	12.911	38.628	51.539	-22.461	74.000	PEAK
3	* 2440.860	13.247	85.853	99.099	25.099	74.000	PEAK
4	2483.500	13.527	39.563	53.090	-20.910	74.000	PEAK
5	2485.060	13.537	41.863	55.401	-18.599	74.000	PEAK
6	2500.000	13.629	40.155	53.784	-20.216	74.000	PEAK

Note:

1. All reading above 1GHz is performed with peak and/or average measurements as necessary.
2. Peak measurements: RBW = 1MHz, VBW = 3 MHz, Sweep: Auto.
3. Average measurements: RBW = 1MHz, VBW = 10 Hz, Sweep: Auto.
4. “ * ”, means this data is the worst emission level.
5. Measurement Level = Reading Level + Correct Factor.
6. The average measurement was not performed when the peak measured data under the limit of average detection. If the readings given are average, peak measurement should also be supplied.
7. The fundamental for reference only, it's not restricted by unwanted emission limit.

Site : DEKRA Taiwan CB2-H	Time : 2017/12/21
Limit : FCC_SpartC_15.209_03M_AV	Margin : 6
Probe : CB2_FCC_EFS_B091_1-18GHz_3M_0117 - VERTICAL	Power : AC 120V/60Hz
EUT : ConnectCore 6 Plus	Note : Mode 2: Transmit Mode_2DH5 802.15.1_2DH5_2441MHz

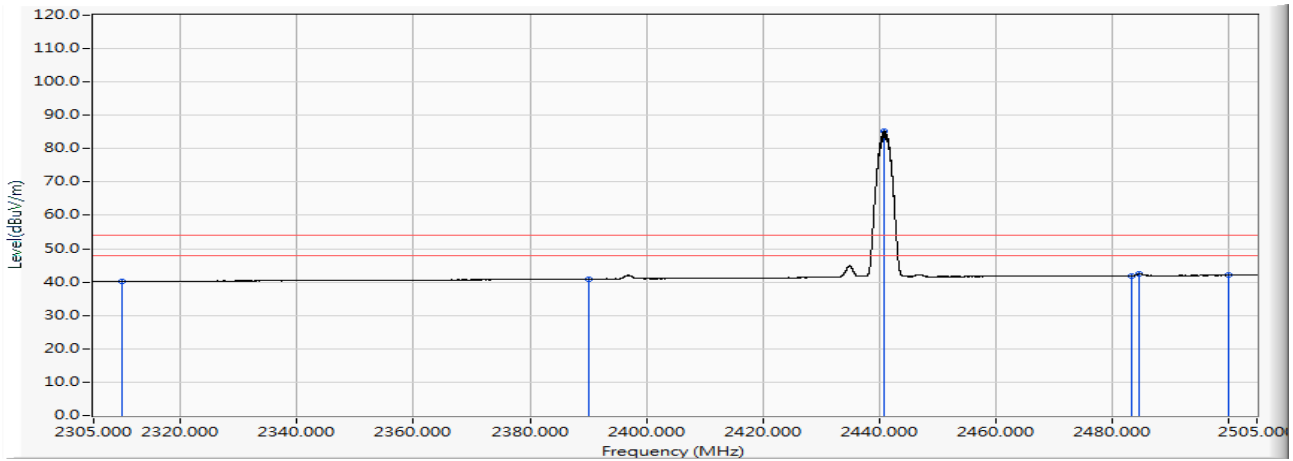

	Frequency (MHz)	Correct Factor (dB)	Reading Level (dBuV)	Measure Level (dBuV/m)	Margin (dB)	Limit (dBuV/m)	Detector Type
1	2310.000	12.384	27.855	40.239	-13.761	54.000	AVERAGE
2	2390.000	12.911	27.948	40.859	-13.141	54.000	AVERAGE
3	* 2440.900	13.247	72.144	85.391	31.391	54.000	AVERAGE
4	2483.500	13.527	28.377	41.904	-12.096	54.000	AVERAGE
5	2484.860	13.536	28.946	42.482	-11.518	54.000	AVERAGE
6	2500.000	13.629	28.393	42.022	-11.978	54.000	AVERAGE

Note:

1. All reading above 1GHz is performed with peak and/or average measurements as necessary.
2. Peak measurements: RBW = 1MHz, VBW = 3 MHz, Sweep: Auto.
3. Average measurements: RBW = 1MHz, VBW = 10 Hz, Sweep: Auto.
4. “ * ”, means this data is the worst emission level.
5. Measurement Level = Reading Level + Correct Factor.
6. The average measurement was not performed when the peak measured data under the limit of average detection. If the readings given are average, peak measurement should also be supplied.
7. The fundamental for reference only, it's not restricted by unwanted emission limit.

Site : DEKRA Taiwan CB2-H	Time : 2017/12/21
Limit : FCC_SpartC_15.209_03M_PK	Margin : 6
Probe : CB2_FCC_EFS_B091_1-18GHz_3M_0117 - HORIZONTAL	Power : AC 120V/60Hz
EUT : ConnectCore 6 Plus	Note : Mode 2: Transmit Mode_2DH5 802.15.1_2DH5_2480MHz

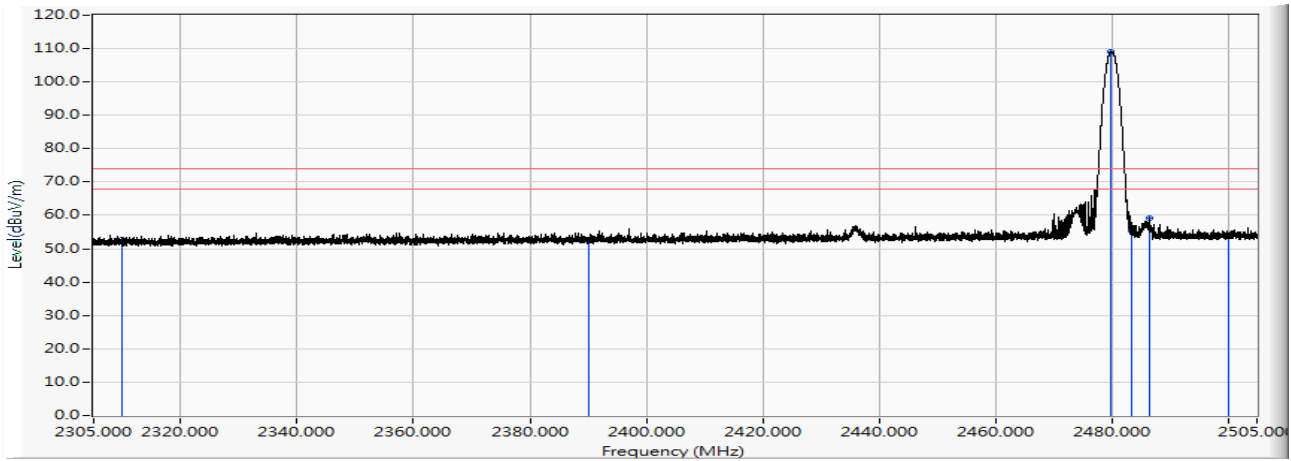

	Frequency (MHz)	Correct Factor (dB)	Reading Level (dBuV)	Measure Level (dBuV/m)	Margin (dB)	Limit (dBuV/m)	Detector Type
1	2310.000	12.384	40.326	52.710	-21.290	74.000	PEAK
2	2390.000	12.911	39.735	52.646	-21.354	74.000	PEAK
3	* 2479.900	13.504	95.583	109.086	35.086	74.000	PEAK
4	2483.500	13.527	41.858	55.385	-18.615	74.000	PEAK
5	2486.420	13.547	45.639	59.185	-14.815	74.000	PEAK
6	2500.000	13.629	39.975	53.604	-20.396	74.000	PEAK

Note:

1. All reading above 1GHz is performed with peak and/or average measurements as necessary.
2. Peak measurements: RBW = 1MHz, VBW = 3 MHz, Sweep: Auto.
3. Average measurements: RBW = 1MHz, VBW = 10 Hz, Sweep: Auto.
4. “ * ”, means this data is the worst emission level.
5. Measurement Level = Reading Level + Correct Factor.
6. The average measurement was not performed when the peak measured data under the limit of average detection. If the readings given are average, peak measurement should also be supplied.
7. The fundamental for reference only, it's not restricted by unwanted emission limit.

Site : DEKRA Taiwan CB2-H	Time : 2017/12/21
Limit : FCC_SpartC_15.209_03M_AV	Margin : 6
Probe : CB2_FCC_EFS_B091_1-18GHz_3M_0117 - HORIZONTAL	Power : AC 120V/60Hz
EUT : ConnectCore 6 Plus	Note : Mode 2: Transmit Mode_2DH5 802.15.1_2DH5_2480MHz

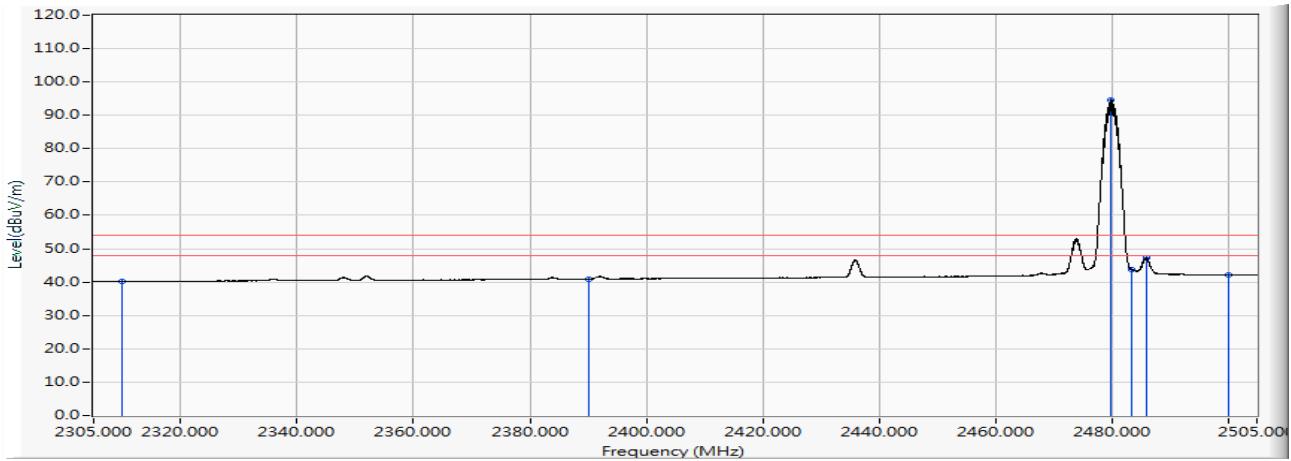

	Frequency (MHz)	Correct Factor (dB)	Reading Level (dBuV)	Measure Level (dBuV/m)	Margin (dB)	Limit (dBuV/m)	Detector Type
1	2310.000	12.384	27.786	40.170	-13.830	54.000	AVERAGE
2	2390.000	12.911	27.972	40.883	-13.117	54.000	AVERAGE
3	* 2479.940	13.504	81.129	94.633	40.633	54.000	AVERAGE
4	2483.500	13.527	30.177	43.704	-10.296	54.000	AVERAGE
5	2485.960	13.543	33.639	47.182	-6.818	54.000	AVERAGE
6	2500.000	13.629	28.497	42.126	-11.874	54.000	AVERAGE

Note:

1. All reading above 1GHz is performed with peak and/or average measurements as necessary.
2. Peak measurements: RBW = 1MHz, VBW = 3 MHz, Sweep: Auto.
3. Average measurements: RBW = 1MHz, VBW = 10 Hz, Sweep: Auto.
4. “ * ”, means this data is the worst emission level.
5. Measurement Level = Reading Level + Correct Factor.
6. The average measurement was not performed when the peak measured data under the limit of average detection. If the readings given are average, peak measurement should also be supplied.
7. The fundamental for reference only, it's not restricted by unwanted emission limit.

Site : DEKRA Taiwan CB2-H	Time : 2017/12/21
Limit : FCC_SpartC_15.209_03M_PK	Margin : 6
Probe : CB2_FCC_EFS_B091_1-18GHz_3M_0117 - VERTICAL	Power : AC 120V/60Hz
EUT : ConnectCore 6 Plus	Note : Mode 2: Transmit Mode_2DH5 802.15.1_2DH5_2480MHz

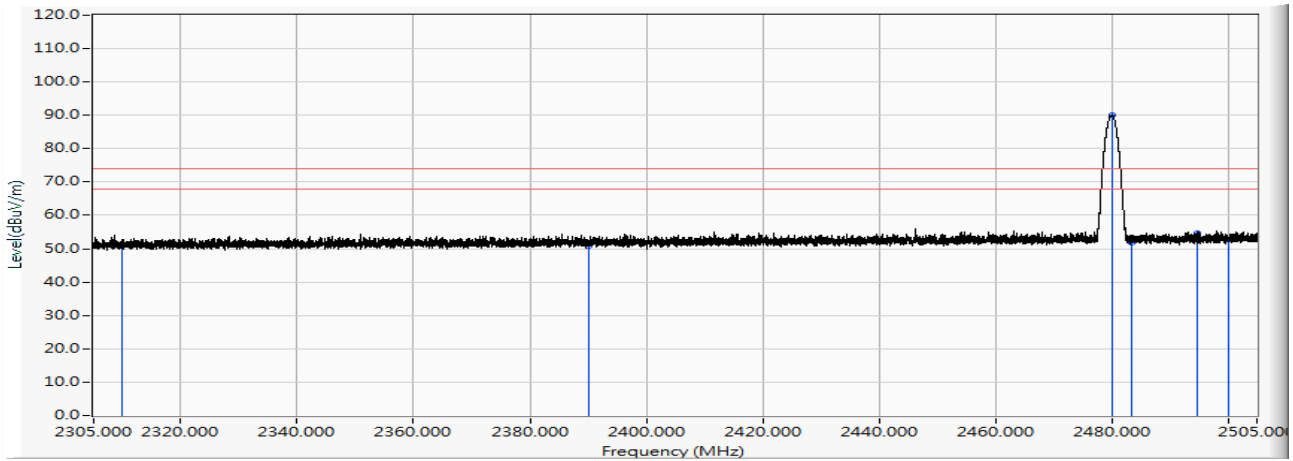

	Frequency (MHz)	Correct Factor (dB)	Reading Level (dBuV)	Measure Level (dBuV/m)	Margin (dB)	Limit (dBuV/m)	Detector Type
1	2310.000	12.384	39.232	51.616	-22.384	74.000	PEAK
2	2390.000	12.911	38.005	50.916	-23.084	74.000	PEAK
3	* 2480.160	13.505	76.456	89.961	15.961	74.000	PEAK
4	2483.500	13.527	38.291	51.818	-22.182	74.000	PEAK
5	2494.860	13.602	41.150	54.752	-19.248	74.000	PEAK
6	2500.000	13.629	39.242	52.871	-21.129	74.000	PEAK

Note:

1. All reading above 1GHz is performed with peak and/or average measurements as necessary.
2. Peak measurements: RBW = 1MHz, VBW = 3 MHz, Sweep: Auto.
3. Average measurements: RBW = 1MHz, VBW = 10 Hz, Sweep: Auto.
4. “ * ”, means this data is the worst emission level.
5. Measurement Level = Reading Level + Correct Factor.
6. The average measurement was not performed when the peak measured data under the limit of average detection. If the readings given are average, peak measurement should also be supplied.
7. The fundamental for reference only, it's not restricted by unwanted emission limit.

Site : DEKRA Taiwan CB2-H	Time : 2017/12/21
Limit : FCC_SpartC_15.209_03M_AV	Margin : 6
Probe : CB2_FCC_EFS_B091_1-18GHz_3M_0117 - VERTICAL	Power : AC 120V/60Hz
EUT : ConnectCore 6 Plus	Note : Mode 2: Transmit Mode_2DH5 802.15.1_2DH5_2480MHz

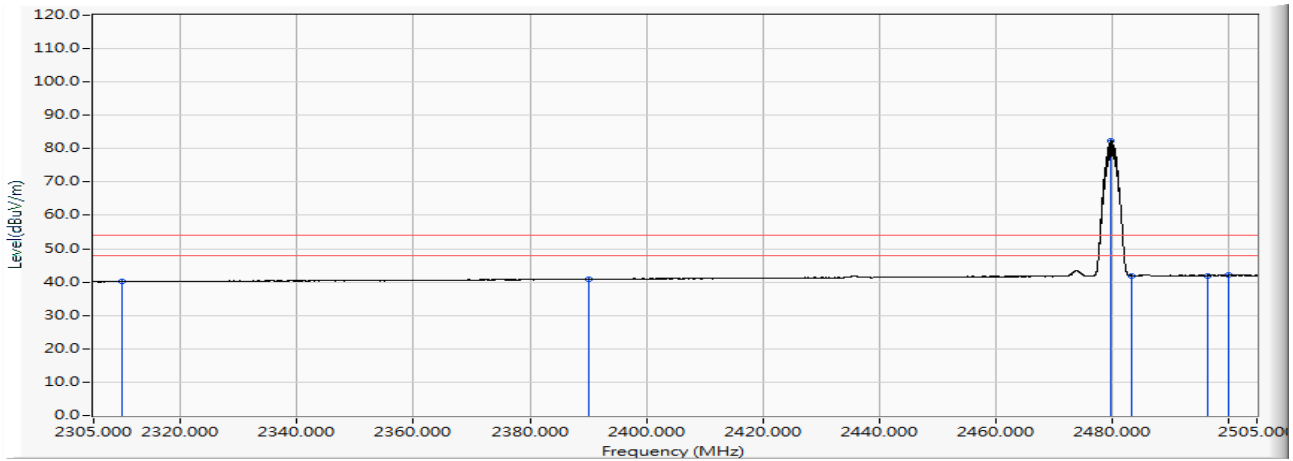

	Frequency (MHz)	Correct Factor (dB)	Reading Level (dBuV)	Measure Level (dBuV/m)	Margin (dB)	Limit (dBuV/m)	Detector Type
1	2310.000	12.384	27.789	40.173	-13.827	54.000	AVERAGE
2	2390.000	12.911	27.983	40.894	-13.106	54.000	AVERAGE
3	* 2479.840	13.503	68.953	82.456	28.456	54.000	AVERAGE
4	2483.500	13.527	28.395	41.922	-12.078	54.000	AVERAGE
5	2496.420	13.611	28.328	41.940	-12.060	54.000	AVERAGE
6	2500.000	13.629	28.370	41.999	-12.001	54.000	AVERAGE

Note:

1. All reading above 1GHz is performed with peak and/or average measurements as necessary.
2. Peak measurements: RBW = 1MHz, VBW = 3 MHz, Sweep: Auto.
3. Average measurements: RBW = 1MHz, VBW = 10 Hz, Sweep: Auto.
4. “ * ”, means this data is the worst emission level.
5. Measurement Level = Reading Level + Correct Factor.
6. The average measurement was not performed when the peak measured data under the limit of average detection. If the readings given are average, peak measurement should also be supplied.
7. The fundamental for reference only, it's not restricted by unwanted emission limit.

Site : DEKRA Taiwan CB2-H	Time : 2017/12/21
Limit : FCC_SpartC_15.209_03M_PK	Margin : 6
Probe : CB2_FCC_EFS_B091_1-18GHz_3M_0117 - HORIZONTAL	Power : AC 120V/60Hz
EUT : ConnectCore 6 Plus	Note : Mode 3: Transmit Mode_3DH5 802.15.1_3DH5_2402MHz

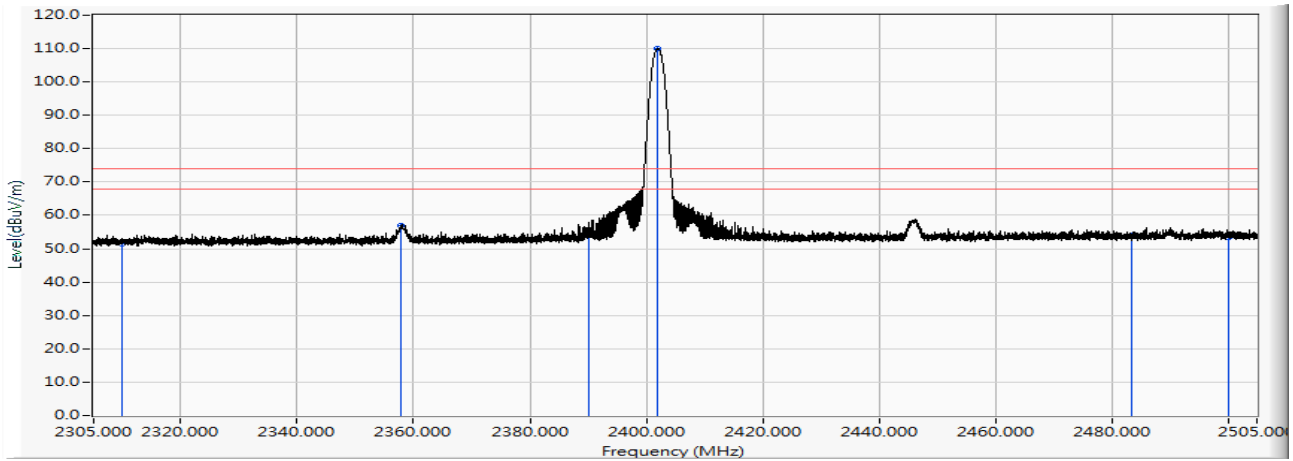

	Frequency (MHz)	Correct Factor (dB)	Reading Level (dBuV)	Measure Level (dBuV/m)	Margin (dB)	Limit (dBuV/m)	Detector Type
1	2310.000	12.384	39.193	51.577	-22.423	74.000	PEAK
2	2357.920	12.700	44.205	56.905	-17.095	74.000	PEAK
3	2390.000	12.911	42.236	55.147	-18.853	74.000	PEAK
4	* 2402.000	12.991	97.141	110.131	36.131	74.000	PEAK
5	2483.500	13.527	40.371	53.898	-20.102	74.000	PEAK
6	2500.000	13.629	39.693	53.322	-20.678	74.000	PEAK

Note:

1. All reading above 1GHz is performed with peak and/or average measurements as necessary.
2. Peak measurements: RBW = 1MHz, VBW = 3 MHz, Sweep: Auto.
3. Average measurements: RBW = 1MHz, VBW = 10 Hz, Sweep: Auto.
4. “ * ”, means this data is the worst emission level.
5. Measurement Level = Reading Level + Correct Factor.
6. The average measurement was not performed when the peak measured data under the limit of average detection. If the readings given are average, peak measurement should also be supplied.
7. The fundamental for reference only, it's not restricted by unwanted emission limit.

Site : DEKRA Taiwan CB2-H	Time : 2017/12/21
Limit : FCC_SpartC_15.209_03M_AV	Margin : 6
Probe : CB2_FCC_EFS_B091_1-18GHz_3M_0117 - HORIZONTAL	Power : AC 120V/60Hz
EUT : ConnectCore 6 Plus	Note : Mode 3: Transmit Mode_3DH5 802.15.1_3DH5_2402MHz

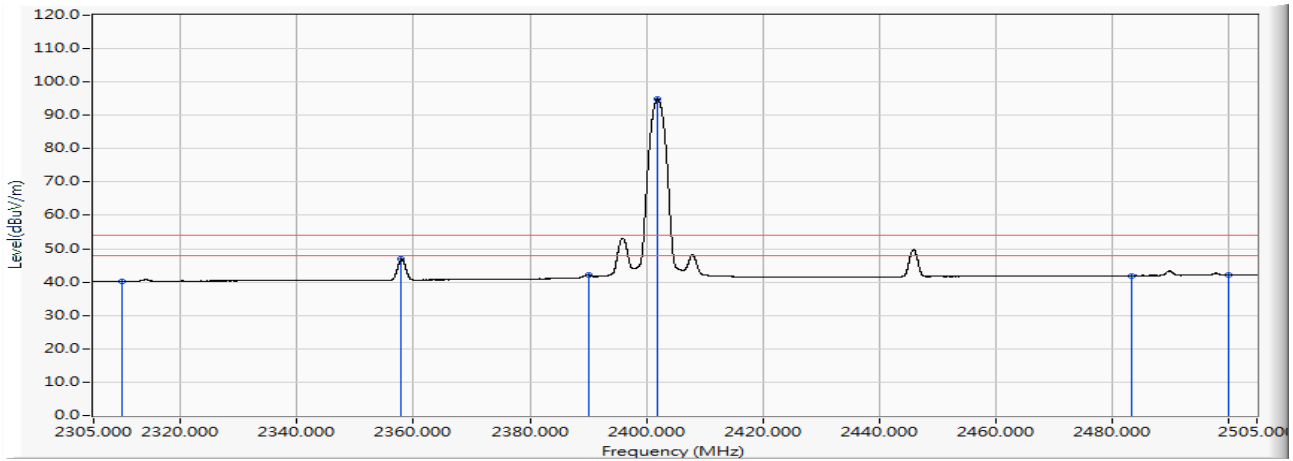

	Frequency (MHz)	Correct Factor (dB)	Reading Level (dBuV)	Measure Level (dBuV/m)	Margin (dB)	Limit (dBuV/m)	Detector Type
1	2310.000	12.384	27.850	40.234	-13.766	54.000	AVERAGE
2	2357.940	12.700	34.167	46.867	-7.133	54.000	AVERAGE
3	2390.000	12.911	29.223	42.134	-11.866	54.000	AVERAGE
4	* 2401.940	12.989	81.983	94.973	40.973	54.000	AVERAGE
5	2483.500	13.527	28.439	41.966	-12.034	54.000	AVERAGE
6	2500.000	13.629	28.441	42.070	-11.930	54.000	AVERAGE

Note:

1. All reading above 1GHz is performed with peak and/or average measurements as necessary.
2. Peak measurements: RBW = 1MHz, VBW = 3 MHz, Sweep: Auto.
3. Average measurements: RBW = 1MHz, VBW = 10 Hz, Sweep: Auto.
4. “ * ”, means this data is the worst emission level.
5. Measurement Level = Reading Level + Correct Factor.
6. The average measurement was not performed when the peak measured data under the limit of average detection. If the readings given are average, peak measurement should also be supplied.
7. The fundamental for reference only, it's not restricted by unwanted emission limit.

Site : DEKRA Taiwan CB2-H	Time : 2017/12/21
Limit : FCC_SpartC_15.209_03M_PK	Margin : 6
Probe : CB2_FCC_EFS_B091_1-18GHz_3M_0117 - VERTICAL	Power : AC 120V/60Hz
EUT : ConnectCore 6 Plus	Note : Mode 3: Transmit Mode_3DH5 802.15.1_3DH5_2402MHz

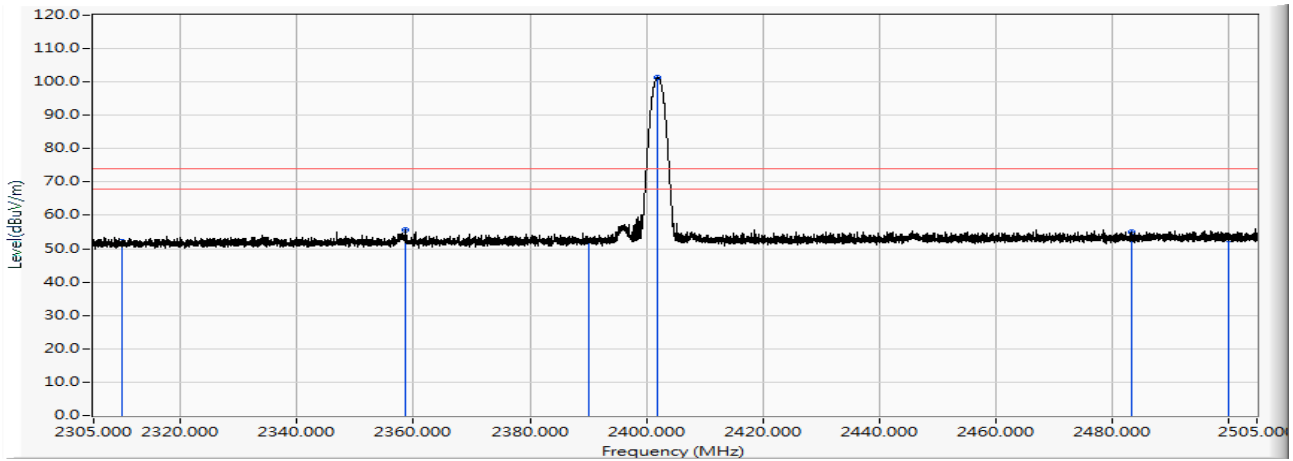

	Frequency (MHz)	Correct Factor (dB)	Reading Level (dBuV)	Measure Level (dBuV/m)	Margin (dB)	Limit (dBuV/m)	Detector Type
1	2310.000	12.384	39.885	52.269	-21.731	74.000	PEAK
2	2358.540	12.704	43.058	55.762	-18.238	74.000	PEAK
3	2390.000	12.911	39.627	52.538	-21.462	74.000	PEAK
4	* 2401.980	12.990	88.507	101.497	27.497	74.000	PEAK
5	2483.500	13.527	41.442	54.969	-19.031	74.000	PEAK
6	2500.000	13.629	39.143	52.772	-21.228	74.000	PEAK

Note:

1. All reading above 1GHz is performed with peak and/or average measurements as necessary.
2. Peak measurements: RBW = 1MHz, VBW = 3 MHz, Sweep: Auto.
3. Average measurements: RBW = 1MHz, VBW = 10 Hz, Sweep: Auto.
4. “ * ”, means this data is the worst emission level.
5. Measurement Level = Reading Level + Correct Factor.
6. The average measurement was not performed when the peak measured data under the limit of average detection. If the readings given are average, peak measurement should also be supplied.
7. The fundamental for reference only, it's not restricted by unwanted emission limit.

Site : DEKRA Taiwan CB2-H	Time : 2017/12/21
Limit : FCC_SpartC_15.209_03M_AV	Margin : 6
Probe : CB2_FCC_EFS_B091_1-18GHz_3M_0117 - VERTICAL	Power : AC 120V/60Hz
EUT : ConnectCore 6 Plus	Note : Mode 3: Transmit Mode_3DH5 802.15.1_3DH5_2402MHz

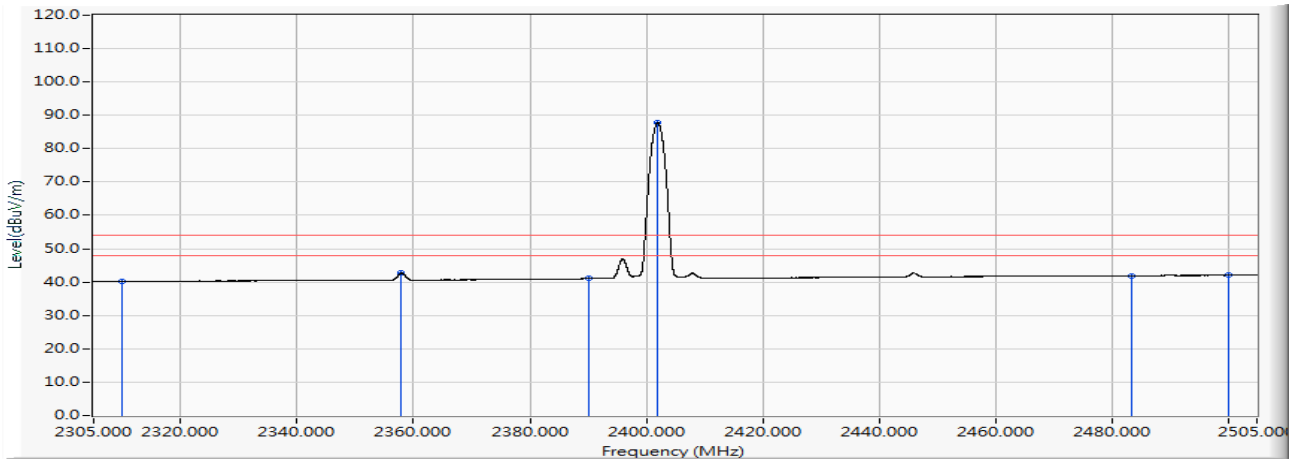

	Frequency (MHz)	Correct Factor (dB)	Reading Level (dBuV)	Measure Level (dBuV/m)	Margin (dB)	Limit (dBuV/m)	Detector Type
1	2310.000	12.384	27.846	40.230	-13.770	54.000	AVERAGE
2	2357.920	12.700	30.188	42.888	-11.112	54.000	AVERAGE
3	2390.000	12.911	28.201	41.112	-12.888	54.000	AVERAGE
4	* 2401.900	12.989	74.810	87.800	33.800	54.000	AVERAGE
5	2483.500	13.527	28.354	41.881	-12.119	54.000	AVERAGE
6	2500.000	13.629	28.378	42.007	-11.993	54.000	AVERAGE

Note:

1. All reading above 1GHz is performed with peak and/or average measurements as necessary.
2. Peak measurements: RBW = 1MHz, VBW = 3 MHz, Sweep: Auto.
3. Average measurements: RBW = 1MHz, VBW = 10 Hz, Sweep: Auto.
4. “ * ”, means this data is the worst emission level.
5. Measurement Level = Reading Level + Correct Factor.
6. The average measurement was not performed when the peak measured data under the limit of average detection. If the readings given are average, peak measurement should also be supplied.
7. The fundamental for reference only, it's not restricted by unwanted emission limit.

Site : DEKRA Taiwan CB2-H	Time : 2017/12/21
Limit : FCC_SpartC_15.209_03M_PK	Margin : 6
Probe : CB2_FCC_EFS_B091_1-18GHz_3M_0117 - HORIZONTAL	Power : AC 120V/60Hz
EUT : ConnectCore 6 Plus	Note : Mode 3: Transmit Mode_3DH5 802.15.1_3DH5_2441MHz

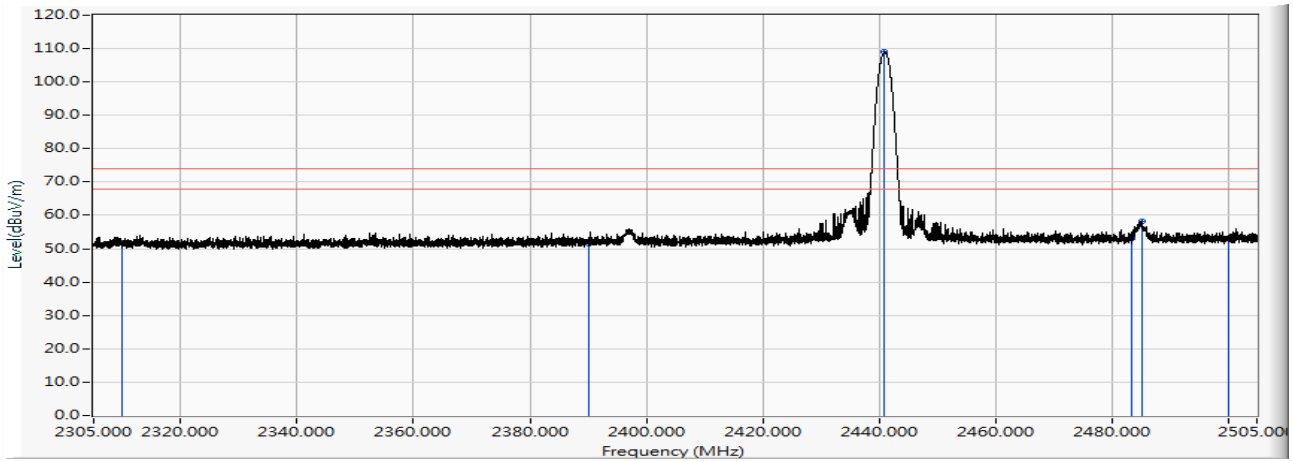

	Frequency (MHz)	Correct Factor (dB)	Reading Level (dBuV)	Measure Level (dBuV/m)	Margin (dB)	Limit (dBuV/m)	Detector Type
1	2310.000	12.384	39.330	51.714	-22.286	74.000	PEAK
2	2390.000	12.911	38.565	51.476	-22.524	74.000	PEAK
3	* 2440.980	13.248	95.840	109.087	35.087	74.000	PEAK
4	2483.500	13.527	39.692	53.219	-20.781	74.000	PEAK
5	2485.260	13.538	44.822	58.361	-15.639	74.000	PEAK
6	2500.000	13.629	39.399	53.028	-20.972	74.000	PEAK

Note:

1. All reading above 1GHz is performed with peak and/or average measurements as necessary.
2. Peak measurements: RBW = 1MHz, VBW = 3 MHz, Sweep: Auto.
3. Average measurements: RBW = 1MHz, VBW = 10 Hz, Sweep: Auto.
4. “ * ”, means this data is the worst emission level.
5. Measurement Level = Reading Level + Correct Factor.
6. The average measurement was not performed when the peak measured data under the limit of average detection. If the readings given are average, peak measurement should also be supplied.
7. The fundamental for reference only, it's not restricted by unwanted emission limit.

Site : DEKRA Taiwan CB2-H	Time : 2017/12/21
Limit : FCC_SpartC_15.209_03M_AV	Margin : 6
Probe : CB2_FCC_EFS_B091_1-18GHz_3M_0117 - HORIZONTAL	Power : AC 120V/60Hz
EUT : ConnectCore 6 Plus	Note : Mode 3: Transmit Mode_3DH5 802.15.1_3DH5_2441MHz

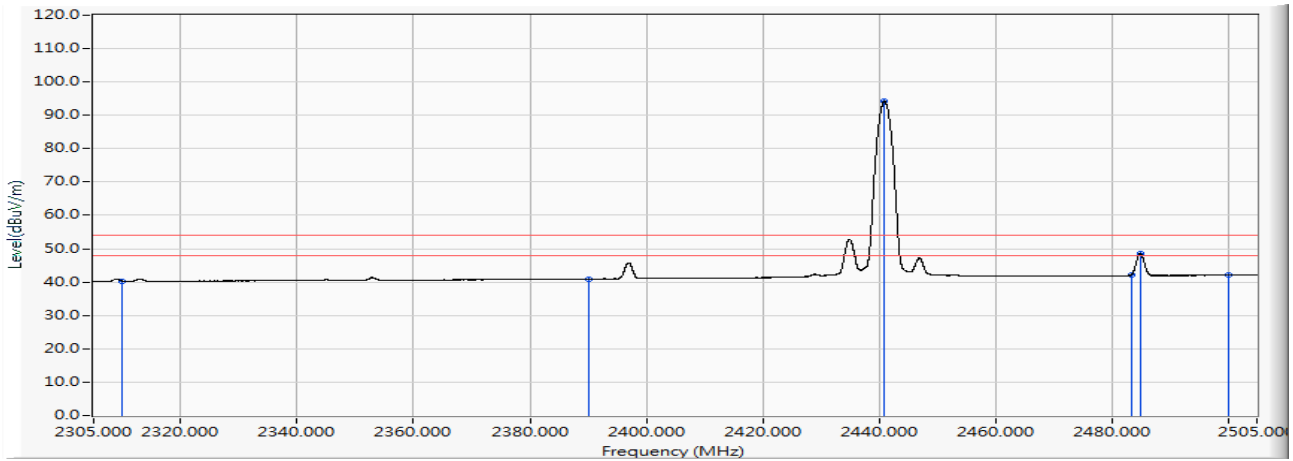

	Frequency (MHz)	Correct Factor (dB)	Reading Level (dBuV)	Measure Level (dBuV/m)	Margin (dB)	Limit (dBuV/m)	Detector Type
1	2310.000	12.384	27.942	40.326	-13.674	54.000	AVERAGE
2	2390.000	12.911	27.998	40.909	-13.091	54.000	AVERAGE
3	* 2440.920	13.247	80.903	94.150	40.150	54.000	AVERAGE
4	2483.500	13.527	28.734	42.261	-11.739	54.000	AVERAGE
5	2484.960	13.537	35.014	48.551	-5.449	54.000	AVERAGE
6	2500.000	13.629	28.439	42.068	-11.932	54.000	AVERAGE

Note:

1. All reading above 1GHz is performed with peak and/or average measurements as necessary.
2. Peak measurements: RBW = 1MHz, VBW = 3 MHz, Sweep: Auto.
3. Average measurements: RBW = 1MHz, VBW = 10 Hz, Sweep: Auto.
4. “ * ”, means this data is the worst emission level.
5. Measurement Level = Reading Level + Correct Factor.
6. The average measurement was not performed when the peak measured data under the limit of average detection. If the readings given are average, peak measurement should also be supplied.
7. The fundamental for reference only, it's not restricted by unwanted emission limit.

Site : DEKRA Taiwan CB2-H	Time : 2017/12/21
Limit : FCC_SpartC_15.209_03M_PK	Margin : 6
Probe : CB2_FCC_EFS_B091_1-18GHz_3M_0117 - VERTICAL	Power : AC 120V/60Hz
EUT : ConnectCore 6 Plus	Note : Mode 3: Transmit Mode_3DH5 802.15.1_3DH5_2441MHz

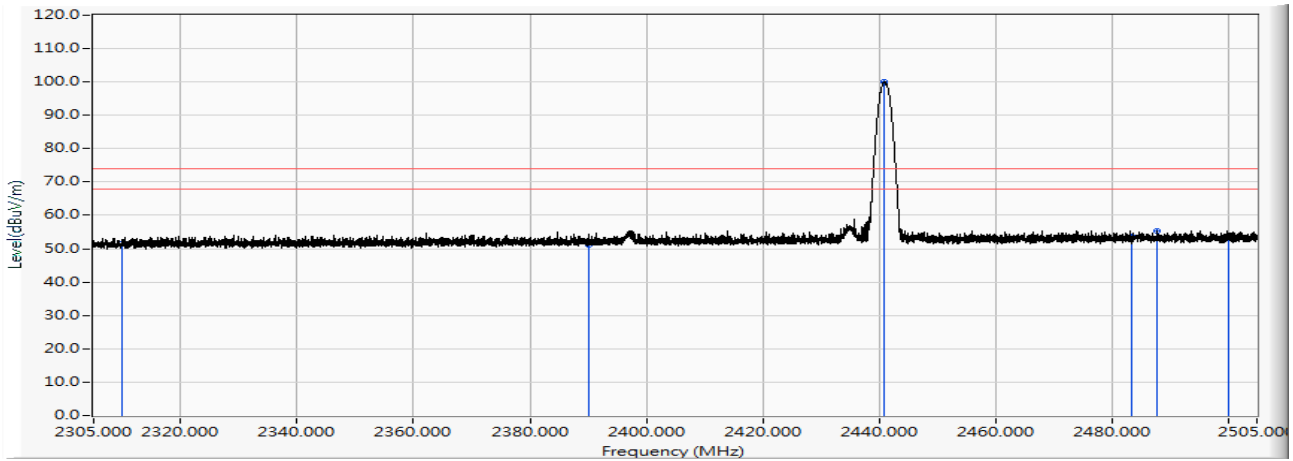

	Frequency (MHz)	Correct Factor (dB)	Reading Level (dBuV)	Measure Level (dBuV/m)	Margin (dB)	Limit (dBuV/m)	Detector Type
1	2310.000	12.384	39.023	51.407	-22.593	74.000	PEAK
2	2390.000	12.911	38.242	51.153	-22.847	74.000	PEAK
3	* 2440.960	13.247	86.840	100.087	26.087	74.000	PEAK
4	2483.500	13.527	40.172	53.699	-20.301	74.000	PEAK
5	2487.820	13.555	41.925	55.481	-18.519	74.000	PEAK
6	2500.000	13.629	39.534	53.163	-20.837	74.000	PEAK

Note:

1. All reading above 1GHz is performed with peak and/or average measurements as necessary.
2. Peak measurements: RBW = 1MHz, VBW = 3 MHz, Sweep: Auto.
3. Average measurements: RBW = 1MHz, VBW = 10 Hz, Sweep: Auto.
4. “ * ”, means this data is the worst emission level.
5. Measurement Level = Reading Level + Correct Factor.
6. The average measurement was not performed when the peak measured data under the limit of average detection. If the readings given are average, peak measurement should also be supplied.
7. The fundamental for reference only, it's not restricted by unwanted emission limit.

Site : DEKRA Taiwan CB2-H	Time : 2017/12/21
Limit : FCC_SpartC_15.209_03M_AV	Margin : 6
Probe : CB2_FCC_EFS_B091_1-18GHz_3M_0117 - VERTICAL	Power : AC 120V/60Hz
EUT : ConnectCore 6 Plus	Note : Mode 3: Transmit Mode_3DH5 802.15.1_3DH5_2441MHz

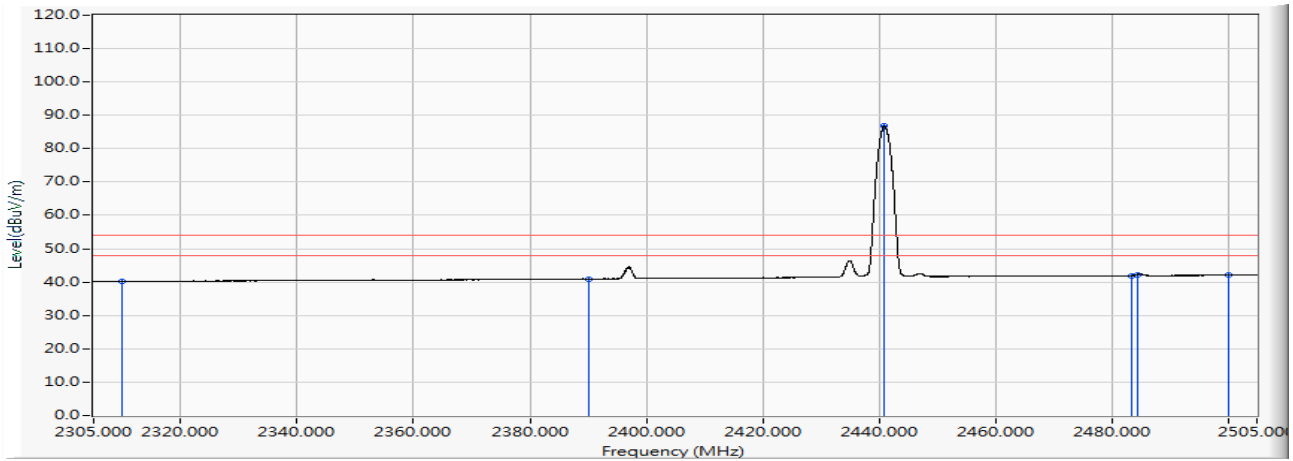

	Frequency (MHz)	Correct Factor (dB)	Reading Level (dBuV)	Measure Level (dBuV/m)	Margin (dB)	Limit (dBuV/m)	Detector Type
1	2310.000	12.384	27.878	40.262	-13.738	54.000	AVERAGE
2	2390.000	12.911	28.041	40.952	-13.048	54.000	AVERAGE
3	* 2440.940	13.247	73.484	86.731	32.731	54.000	AVERAGE
4	2483.500	13.527	28.378	41.905	-12.095	54.000	AVERAGE
5	2484.520	13.534	28.735	42.269	-11.731	54.000	AVERAGE
6	2500.000	13.629	28.422	42.051	-11.949	54.000	AVERAGE

Note:

1. All reading above 1GHz is performed with peak and/or average measurements as necessary.
2. Peak measurements: RBW = 1MHz, VBW = 3 MHz, Sweep: Auto.
3. Average measurements: RBW = 1MHz, VBW = 10 Hz, Sweep: Auto.
4. “ * ”, means this data is the worst emission level.
5. Measurement Level = Reading Level + Correct Factor.
6. The average measurement was not performed when the peak measured data under the limit of average detection. If the readings given are average, peak measurement should also be supplied.
7. The fundamental for reference only, it's not restricted by unwanted emission limit.

Site : DEKRA Taiwan CB2-H	Time : 2017/12/21
Limit : FCC_SpartC_15.209_03M_PK	Margin : 6
Probe : CB2_FCC_EFS_B091_1-18GHz_3M_0117 - HORIZONTAL	Power : AC 120V/60Hz
EUT : ConnectCore 6 Plus	Note : Mode 3: Transmit Mode_3DH5 802.15.1_3DH5_2480MHz

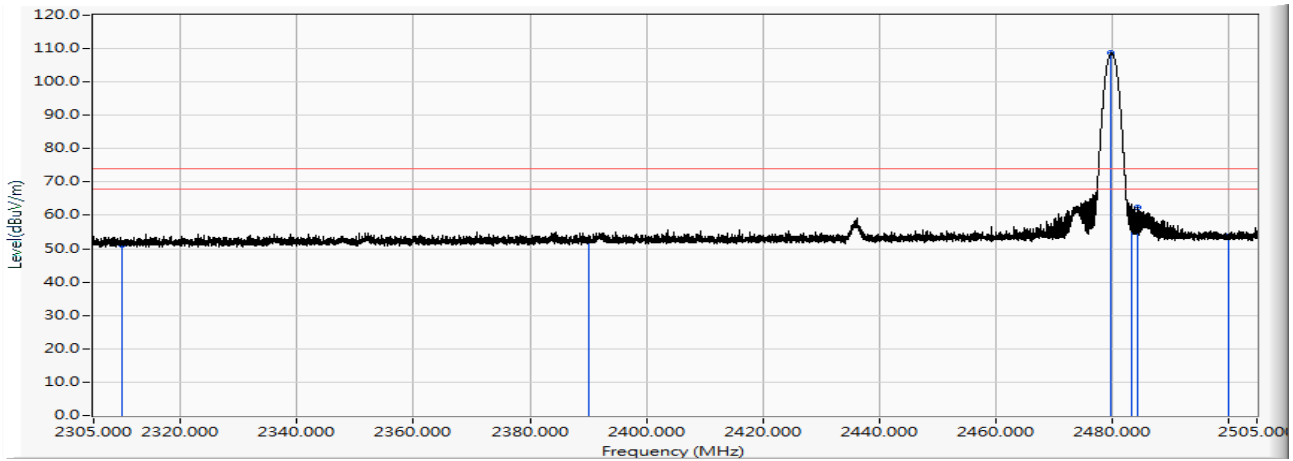

	Frequency (MHz)	Correct Factor (dB)	Reading Level (dBuV)	Measure Level (dBuV/m)	Margin (dB)	Limit (dBuV/m)	Detector Type
1	2310.000	12.384	38.916	51.300	-22.700	74.000	PEAK
2	2390.000	12.911	39.591	52.502	-21.498	74.000	PEAK
3	* 2479.960	13.504	95.103	108.607	34.607	74.000	PEAK
4	2483.500	13.527	47.551	61.078	-12.922	74.000	PEAK
5	2484.540	13.534	48.725	62.259	-11.741	74.000	PEAK
6	2500.000	13.629	39.975	53.604	-20.396	74.000	PEAK

Note:

1. All reading above 1GHz is performed with peak and/or average measurements as necessary.
2. Peak measurements: RBW = 1MHz, VBW = 3 MHz, Sweep: Auto.
3. Average measurements: RBW = 1MHz, VBW = 10 Hz, Sweep: Auto.
4. “ * ”, means this data is the worst emission level.
5. Measurement Level = Reading Level + Correct Factor.
6. The average measurement was not performed when the peak measured data under the limit of average detection. If the readings given are average, peak measurement should also be supplied.
7. The fundamental for reference only, it's not restricted by unwanted emission limit.

Site : DEKRA Taiwan CB2-H	Time : 2017/12/21
Limit : FCC_SpartC_15.209_03M_AV	Margin : 6
Probe : CB2_FCC_EFS_B091_1-18GHz_3M_0117 - HORIZONTAL	Power : AC 120V/60Hz
EUT : ConnectCore 6 Plus	Note : Mode 3: Transmit Mode_3DH5 802.15.1_3DH5_2480MHz

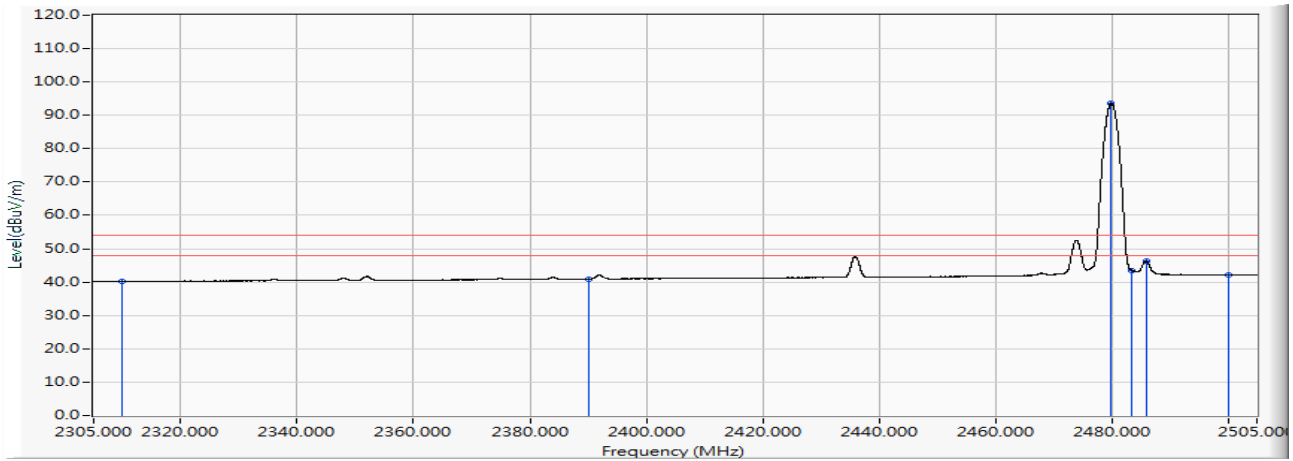

	Frequency (MHz)	Correct Factor (dB)	Reading Level (dBuV)	Measure Level (dBuV/m)	Margin (dB)	Limit (dBuV/m)	Detector Type
1	2310.000	12.384	27.859	40.243	-13.757	54.000	AVERAGE
2	2390.000	12.911	28.020	40.931	-13.069	54.000	AVERAGE
3	* 2479.960	13.504	80.273	93.777	39.777	54.000	AVERAGE
4	2483.500	13.527	29.969	43.496	-10.504	54.000	AVERAGE
5	2485.980	13.544	32.840	46.384	-7.616	54.000	AVERAGE
6	2500.000	13.629	28.471	42.100	-11.900	54.000	AVERAGE

Note:

1. All reading above 1GHz is performed with peak and/or average measurements as necessary.
2. Peak measurements: RBW = 1MHz, VBW = 3 MHz, Sweep: Auto.
3. Average measurements: RBW = 1MHz, VBW = 10 Hz, Sweep: Auto.
4. “ * ”, means this data is the worst emission level.
5. Measurement Level = Reading Level + Correct Factor.
6. The average measurement was not performed when the peak measured data under the limit of average detection. If the readings given are average, peak measurement should also be supplied.
7. The fundamental for reference only, it's not restricted by unwanted emission limit.

Site : DEKRA Taiwan CB2-H	Time : 2017/12/21
Limit : FCC_SpartC_15.209_03M_PK	Margin : 6
Probe : CB2_FCC_EFS_B091_1-18GHz_3M_0117 - VERTICAL	Power : AC 120V/60Hz
EUT : ConnectCore 6 Plus	Note : Mode 3: Transmit Mode_3DH5 802.15.1_3DH5_2480MHz

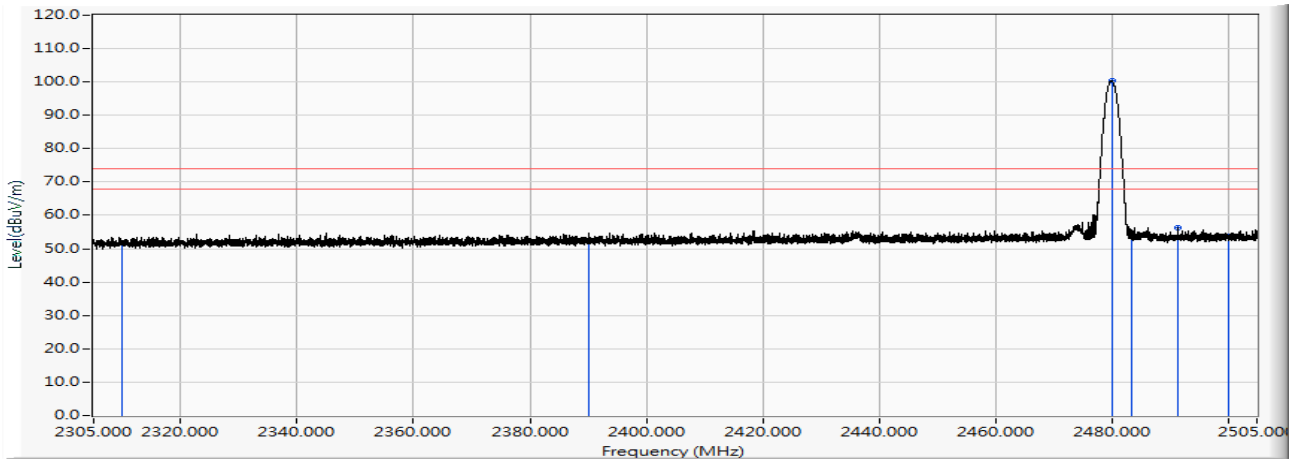

	Frequency (MHz)	Correct Factor (dB)	Reading Level (dBuV)	Measure Level (dBuV/m)	Margin (dB)	Limit (dBuV/m)	Detector Type
1	2310.000	12.384	39.422	51.806	-22.194	74.000	PEAK
2	2390.000	12.911	39.414	52.325	-21.675	74.000	PEAK
3	* 2480.040	13.504	87.019	100.523	26.523	74.000	PEAK
4	2483.500	13.527	40.554	54.081	-19.919	74.000	PEAK
5	2491.320	13.579	42.610	56.189	-17.811	74.000	PEAK
6	2500.000	13.629	39.938	53.567	-20.433	74.000	PEAK

Note:

1. All reading above 1GHz is performed with peak and/or average measurements as necessary.
2. Peak measurements: RBW = 1MHz, VBW = 3 MHz, Sweep: Auto.
3. Average measurements: RBW = 1MHz, VBW = 10 Hz, Sweep: Auto.
4. “ * ”, means this data is the worst emission level.
5. Measurement Level = Reading Level + Correct Factor.
6. The average measurement was not performed when the peak measured data under the limit of average detection. If the readings given are average, peak measurement should also be supplied.
7. The fundamental for reference only, it's not restricted by unwanted emission limit.

Site : DEKRA Taiwan CB2-H	Time : 2017/12/21
Limit : FCC_SpartC_15.209_03M_AV	Margin : 6
Probe : CB2_FCC_EFS_B091_1-18GHz_3M_0117 - VERTICAL	Power : AC 120V/60Hz
EUT : ConnectCore 6 Plus	Note : Mode 3: Transmit Mode_3DH5 802.15.1_3DH5_2480MHz

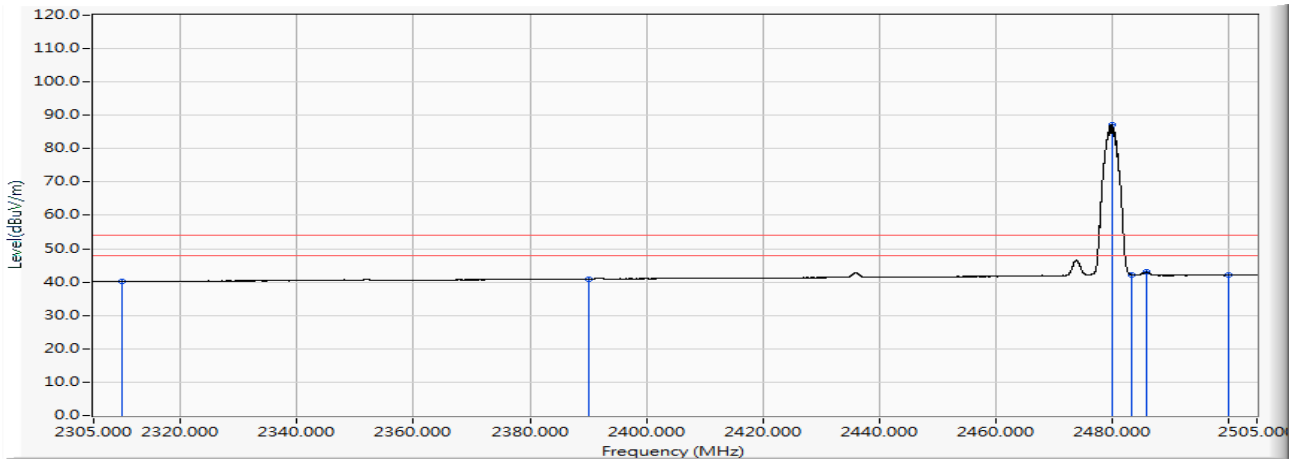

	Frequency (MHz)	Correct Factor (dB)	Reading Level (dBuV)	Measure Level (dBuV/m)	Margin (dB)	Limit (dBuV/m)	Detector Type
1	2310.000	12.384	27.855	40.239	-13.761	54.000	AVERAGE
2	2390.000	12.911	28.007	40.918	-13.082	54.000	AVERAGE
3	* 2480.000	13.504	73.631	87.135	33.135	54.000	AVERAGE
4	2483.500	13.527	28.683	42.210	-11.790	54.000	AVERAGE
5	2486.000	13.544	29.420	42.964	-11.036	54.000	AVERAGE
6	2500.000	13.629	28.408	42.037	-11.963	54.000	AVERAGE

Note:

1. All reading above 1GHz is performed with peak and/or average measurements as necessary.
2. Peak measurements: RBW = 1MHz, VBW = 3 MHz, Sweep: Auto.
3. Average measurements: RBW = 1MHz, VBW = 10 Hz, Sweep: Auto.
4. “ * ”, means this data is the worst emission level.
5. Measurement Level = Reading Level + Correct Factor.
6. The average measurement was not performed when the peak measured data under the limit of average detection. If the readings given are average, peak measurement should also be supplied.
7. The fundamental for reference only, it's not restricted by unwanted emission limit.

7. Number of hopping frequency

7.1. Test Equipment

The following test equipment is used during the test:

Number of hopping frequency / SR10-H

Instrument	Manufacturer	Model No.	Serial No.	Cal. Date	Next Cal. Date
Signal & Spectrum Analyzer	R&S	FSV40	101049	2018/01/10	2019/01/09
EXA Signal Analyzer	Keysight	N9010A	MY51440132	2017/03/13	2018/03/12

7.2. Test Setup

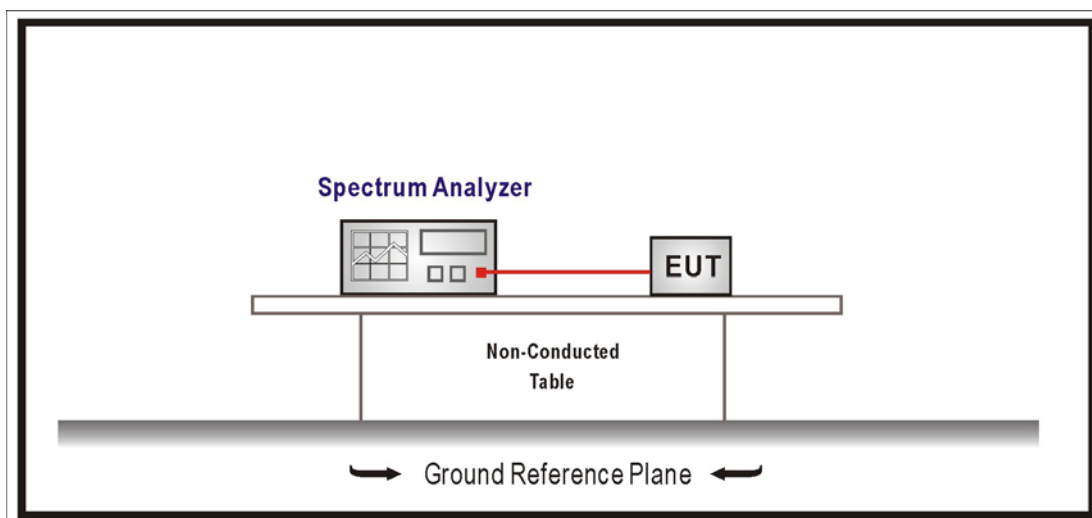

7.3. Limits

For frequency hopping systems operating in the 902-928 MHz band: if the 20 dB bandwidth of the hopping channel is less than 250 kHz, the system shall use at least 50 hopping frequencies and the average time of occupancy on any frequency shall not be greater than 0.4 seconds within a 20 second period; if the 20 dB bandwidth of the hopping channel is 250 kHz or greater, the system shall use at least 25 hopping frequencies and the average time of occupancy on any frequency shall not be greater than 0.4 seconds within a 10 second period. The maximum allowed 20 dB bandwidth of the hopping channel is 500 kHz.

For frequency hopping systems operating in the 2400-2483.5 MHz bands, which use fewer than 75 hopping frequencies, may employ intelligent hopping techniques to avoid interference to other transmissions. Frequency hopping systems may avoid or suppress transmissions on a particular hopping frequency provided that a minimum of 15 non-overlapping channels are used.

For frequency hopping systems operating in the 5725-5850 MHz band shall use at least 75 hopping frequencies.

7.4. Test Procedures

The EUT was setup according to ANSI C63.10: 2013 and tested according to FHSS test procedure of FCC Public Notice DA 00-705 for compliance to FCC 47CFR 15.247 requirements,

Span = the frequency band of operation, $RBW \geq 1\%$ of the span, $VBW \geq RBW$,

Sweep = auto, Detector function = peak, Trace = max hold.

7.5. Test Specification

According to FCC Part 15 Subpart C Paragraph 15.247 and RSS-247.

7.6. Test Result

Product	ConnectCore 6 Plus		
Test Item	Number of hopping frequency		
Test Mode	Mode 1: Transmit Mode_DH5		
Date of Test	2018/01/02	Test Site	SR10-H

Frequency Range (MHz)	Measure Level (Channels)	Limit (Channels)	Result
2402 - 2480	79	≥ 75	Pass

2401.5-2420.5MHz

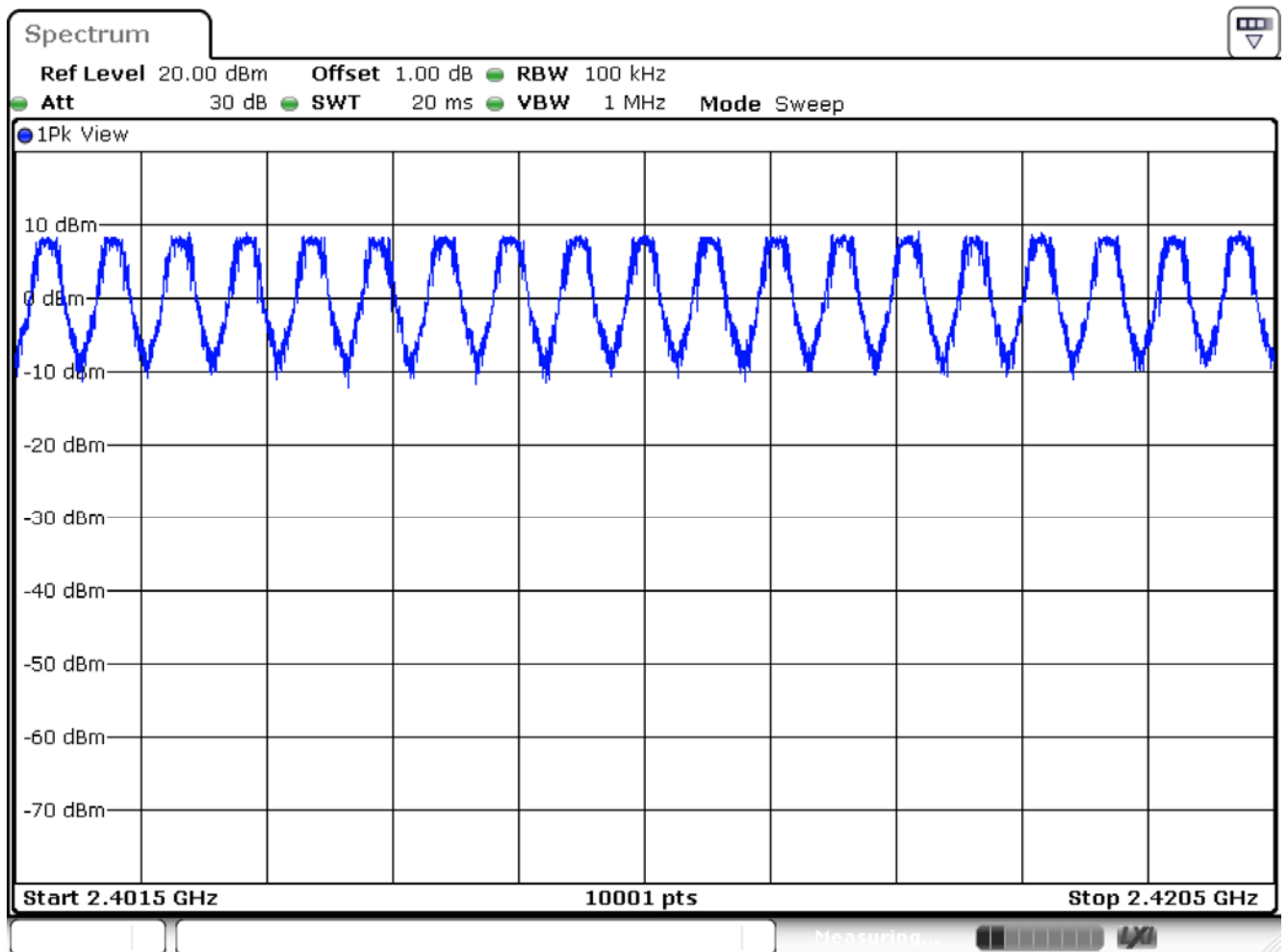

Date: 2.JAN.2018 01:11:34

2420.5-2440.5MHz

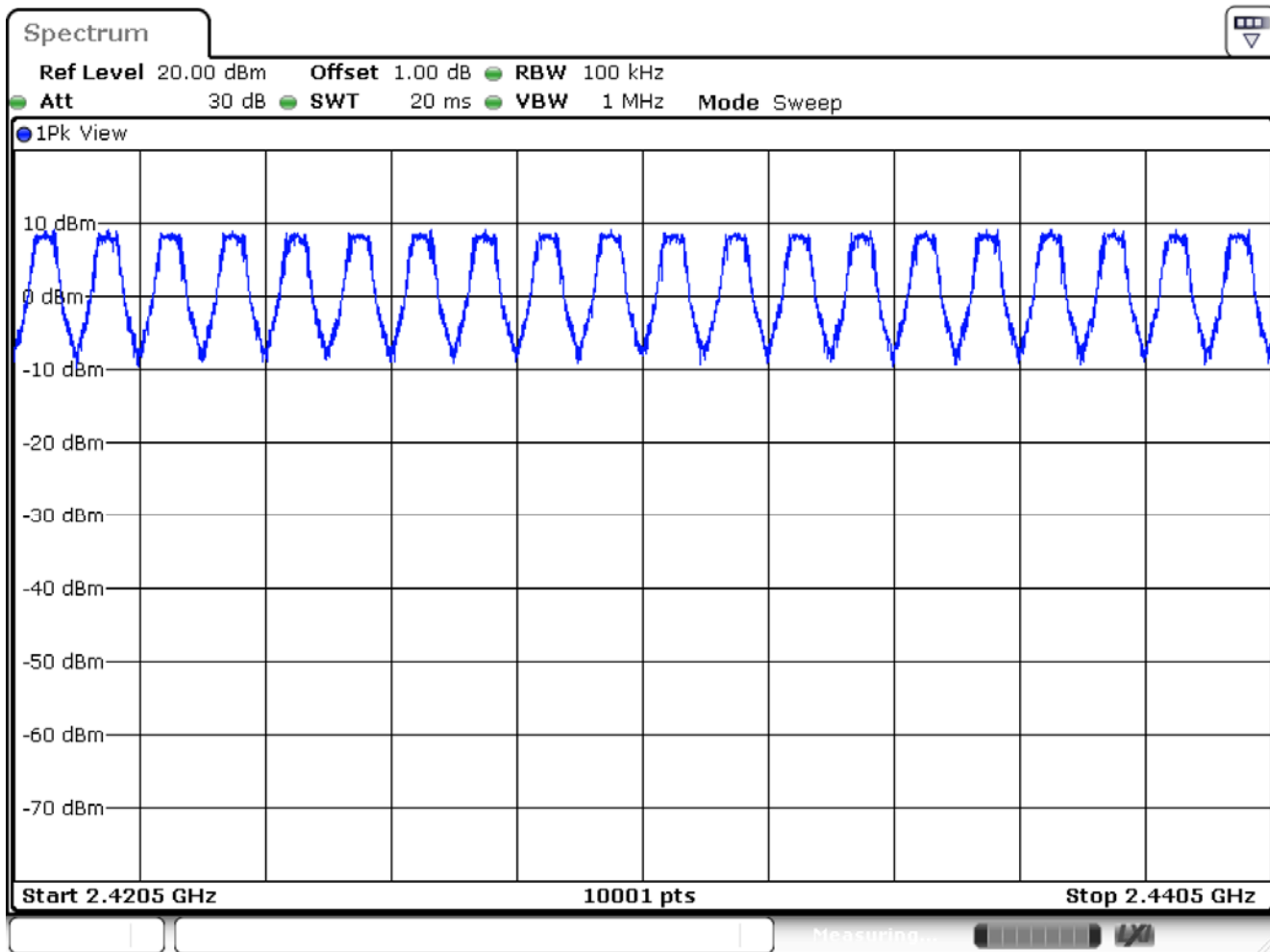

Date: 2.JAN.2018 01:14:12

2440.5-2460.5MHz

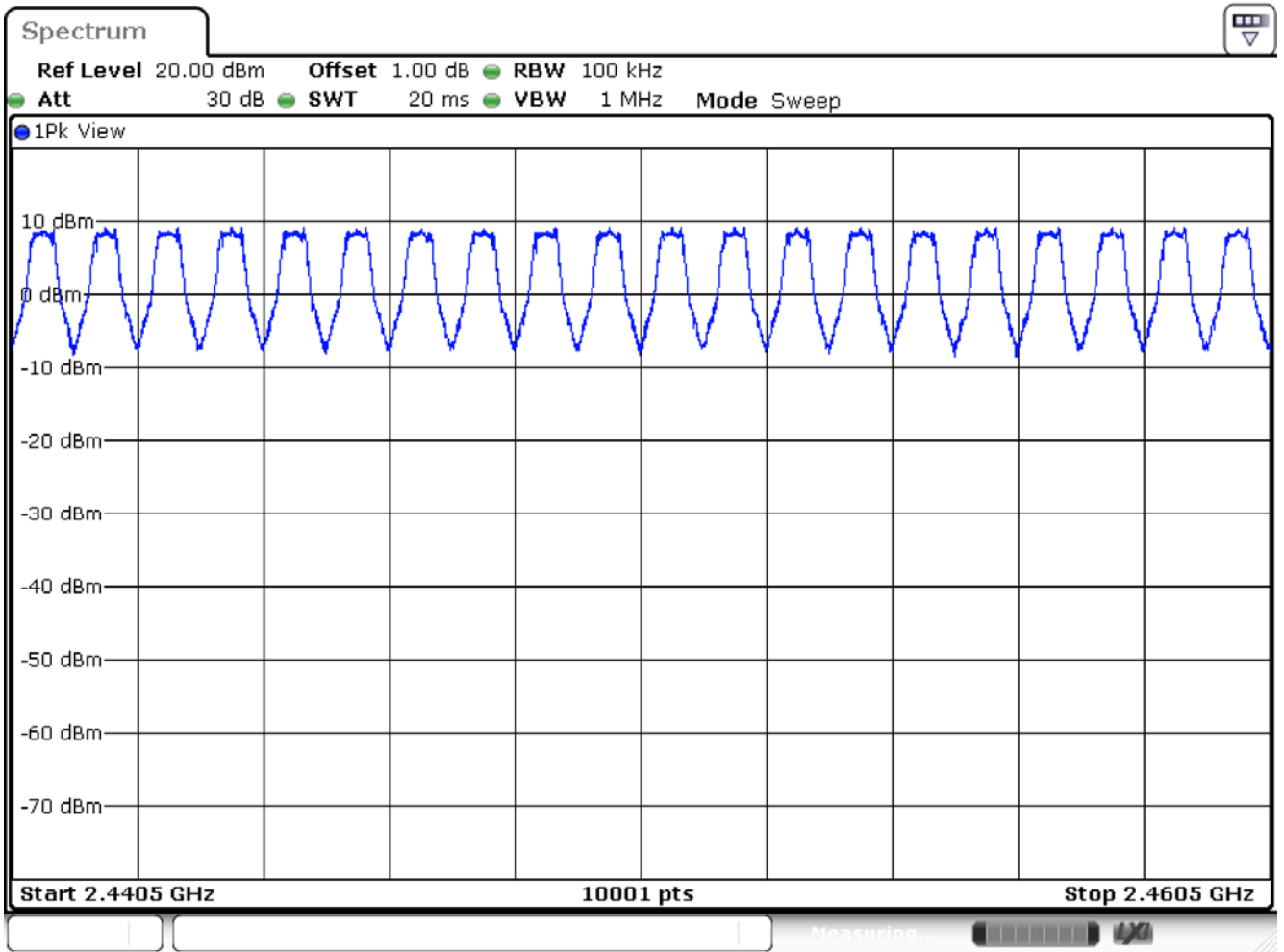

Date: 2.JAN.2018 01:29:12

2460.5-2480.5MHz

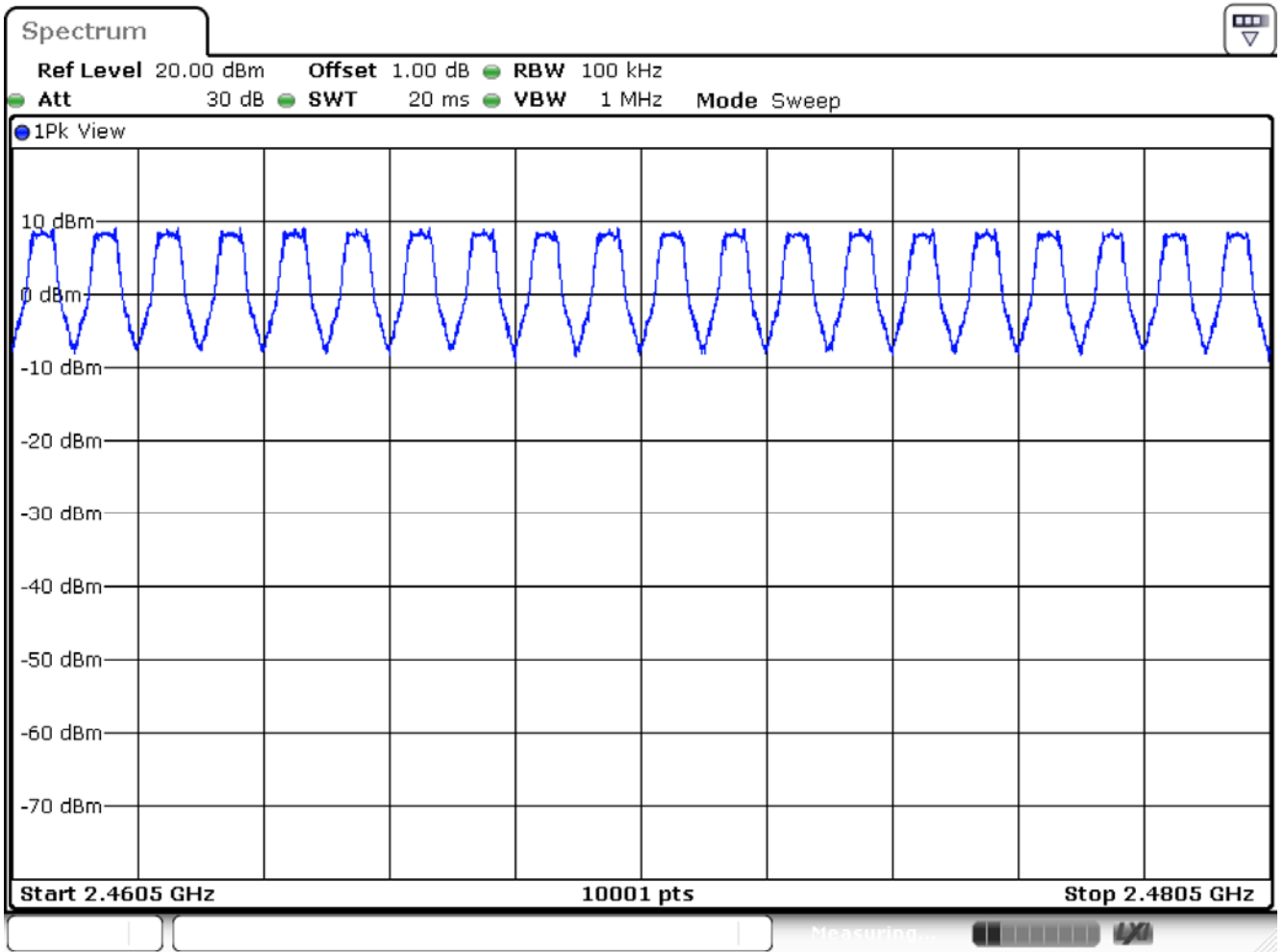

Date: 2.JAN.2018 01:36:07

8. Carrier Frequency Separation

8.1. Test Equipment

The following test equipment is used during the test:

Carrier Frequency Separation / SR10-H

Instrument	Manufacturer	Model No.	Serial No.	Cal. Date	Next Cal. Date
Signal & Spectrum Analyzer	R&S	FSV40	101049	2018/01/10	2019/01/09
EXA Signal Analyzer	Keysight	N9010A	MY51440132	2017/03/13	2018/03/12

8.2. Test Setup

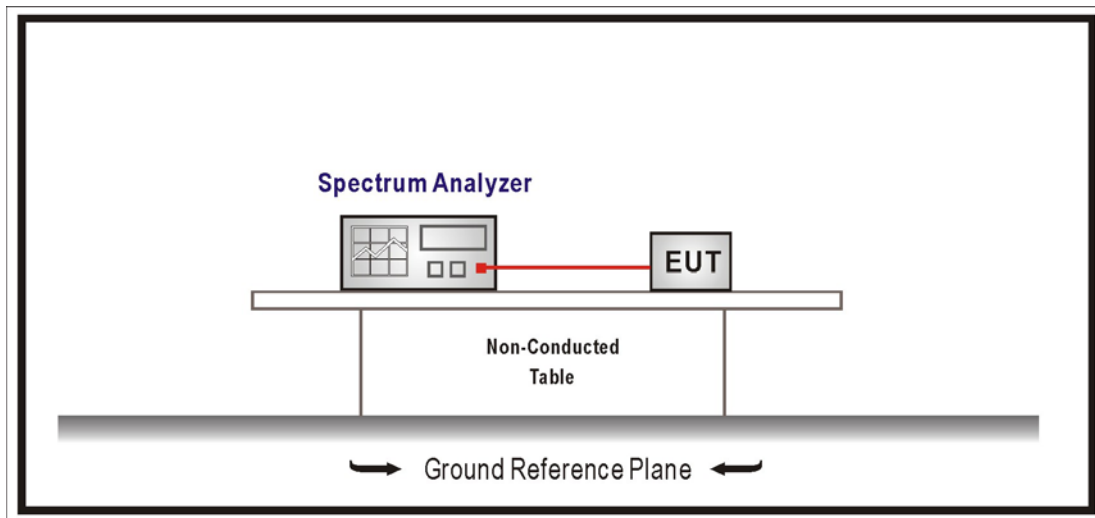

8.3. Limits

For frequency hopping systems shall have hopping channel carrier frequencies separated by a minimum of 25 kHz or two-thirds of the 20 dB bandwidth of the hopping channel, whichever is greater.

8.4. Test Procedures

The EUT was setup according to ANSI C63.10: 2013 and tested according to FHSS test procedure of FCC Public Notice DA 00-705 for compliance to FCC 47CFR 15.247 requirements

Span = wide enough to capture the peaks of two adjacent channels

Resolution Bandwidth (RBW) \geq 1% of the span, VBW \geq RBW

Sweep = auto, Detector function = peak, Trace = max hold

8.5. Test Specification

According to FCC Part 15 Subpart C Paragraph 15.247 and RSS-247.

8.6. Test Result

Product	ConnectCore 6 Plus		
Test Item	Carrier Frequency Separation		
Test Mode	Mode 1: Transmit Mode_DH5		
Date of Test	2018/01/05	Test Site	SR10-H

GFSK

Channel No.	Frequency (MHz)	Measure Level (MHz)	Limit (MHz)	Result
00	2402	0.996	0.661	Pass
39	2441	0.999	0.662	Pass
78	2480	0.998	0.661	Pass

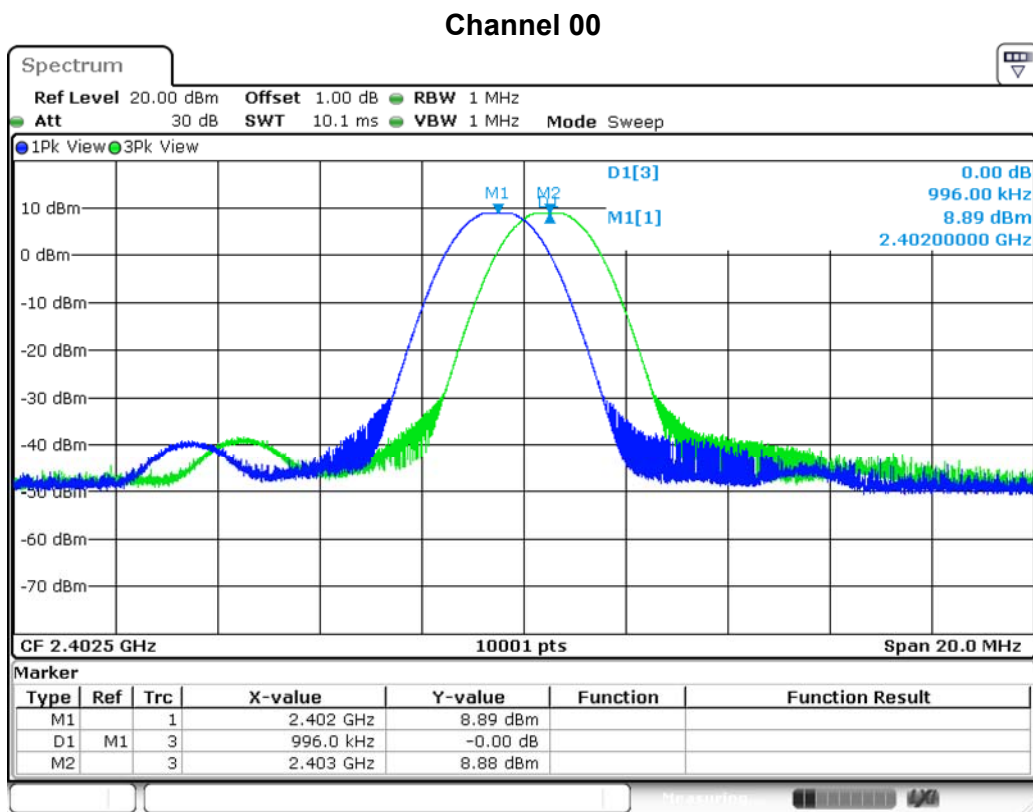

Date: 5.JAN.2018 04:54:15

Channel 39

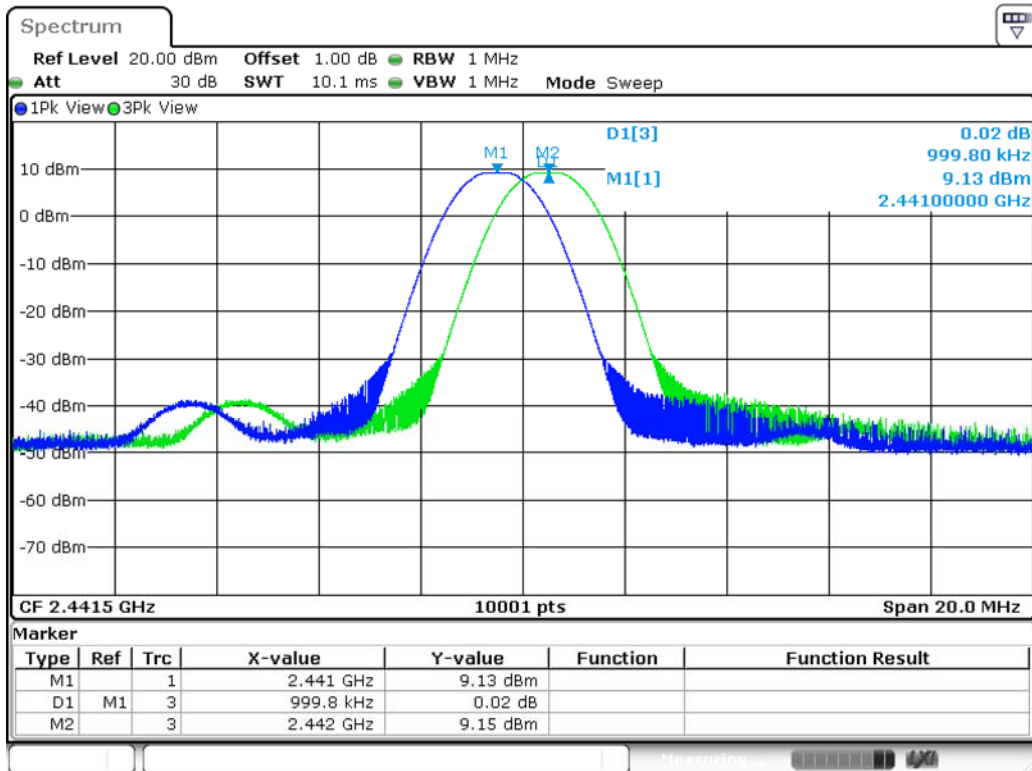

Date: 5.JAN.2018 04:48:31

Channel 78

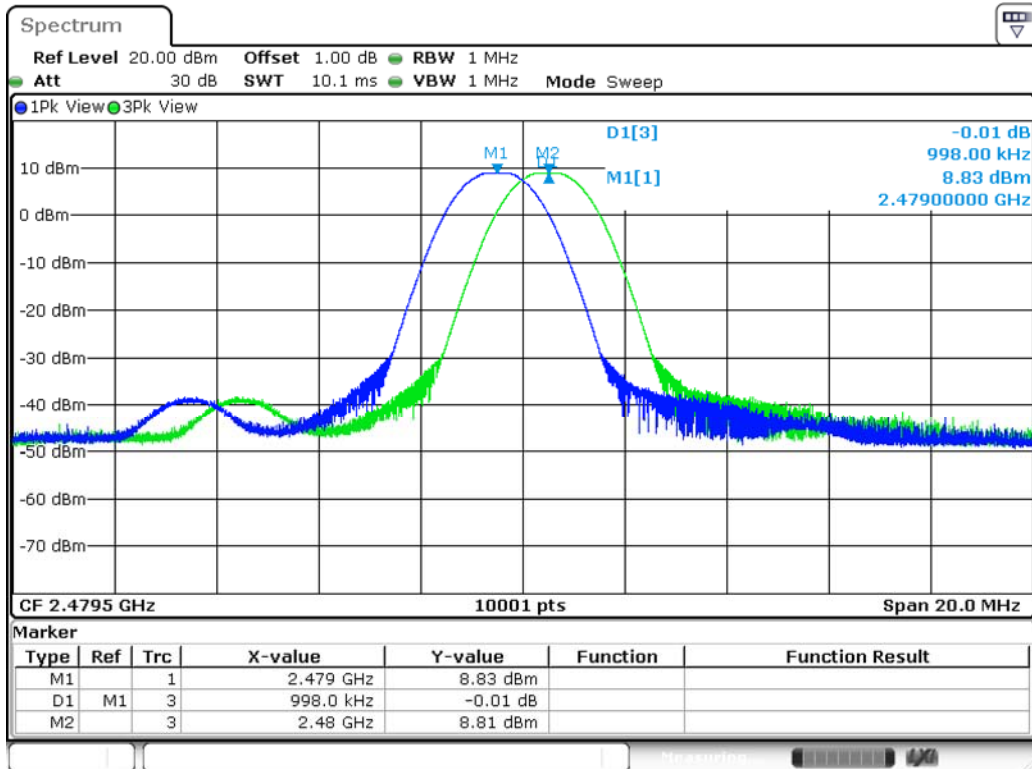

Date: 5.JAN.2018 04:05:35

Product	ConnectCore 6 Plus		
Test Item	Carrier Frequency Separation		
Test Mode	Mode 2: Transmit Mode_2DH5		
Date of Test	2018/01/05	Test Site	SR10-H

π/4-DQPSK

Channel No.	Frequency (MHz)	Measure Level (MHz)	Limit (MHz)	Result
00	2402	1.000	0.805	Pass
39	2441	1.001	0.805	Pass
78	2480	1.003	0.804	Pass

Channel 00

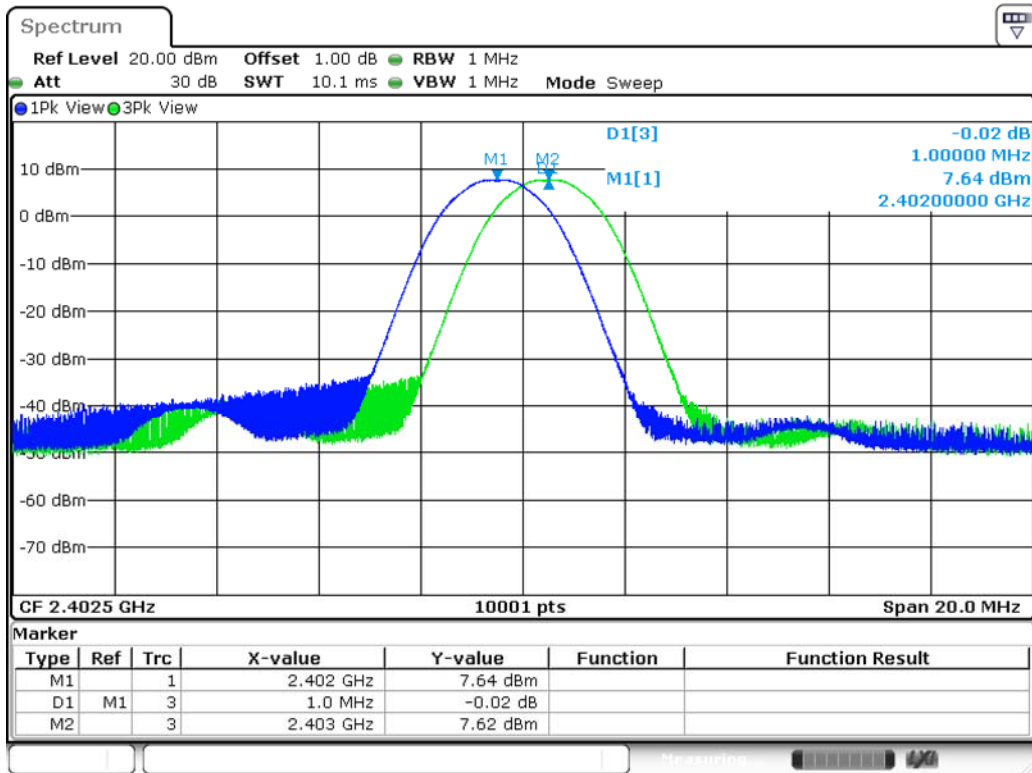

Date: 5.JAN.2018 07:22:30

Channel 39

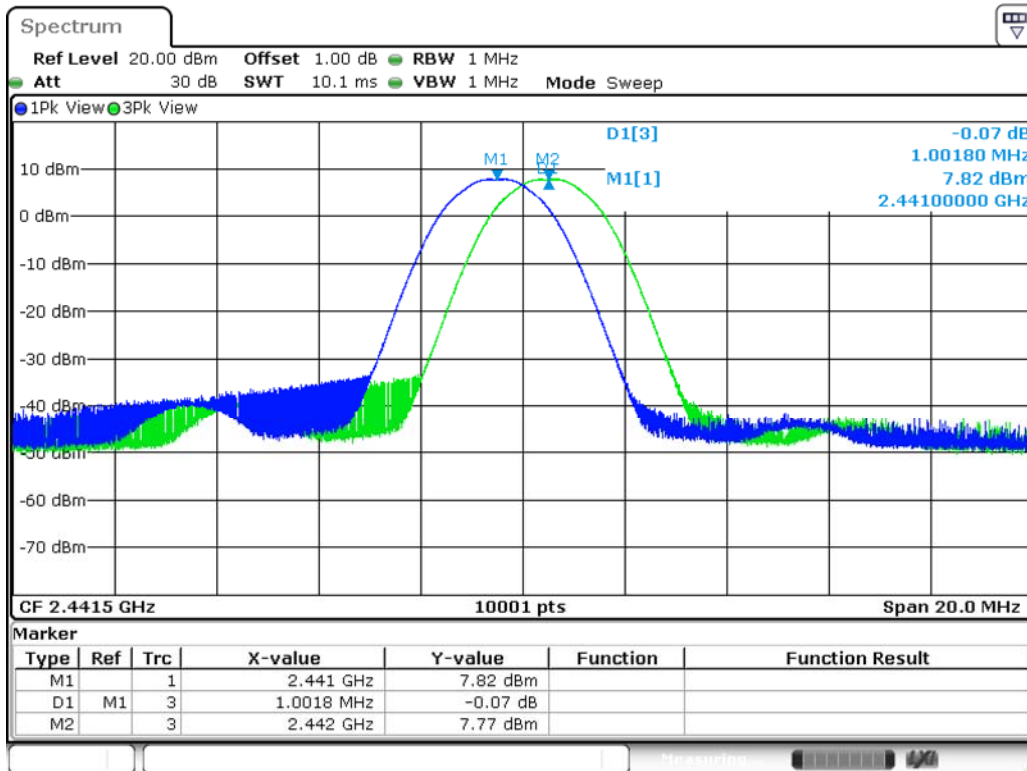

Date: 5.JAN.2018 04:43:29

Channel 78

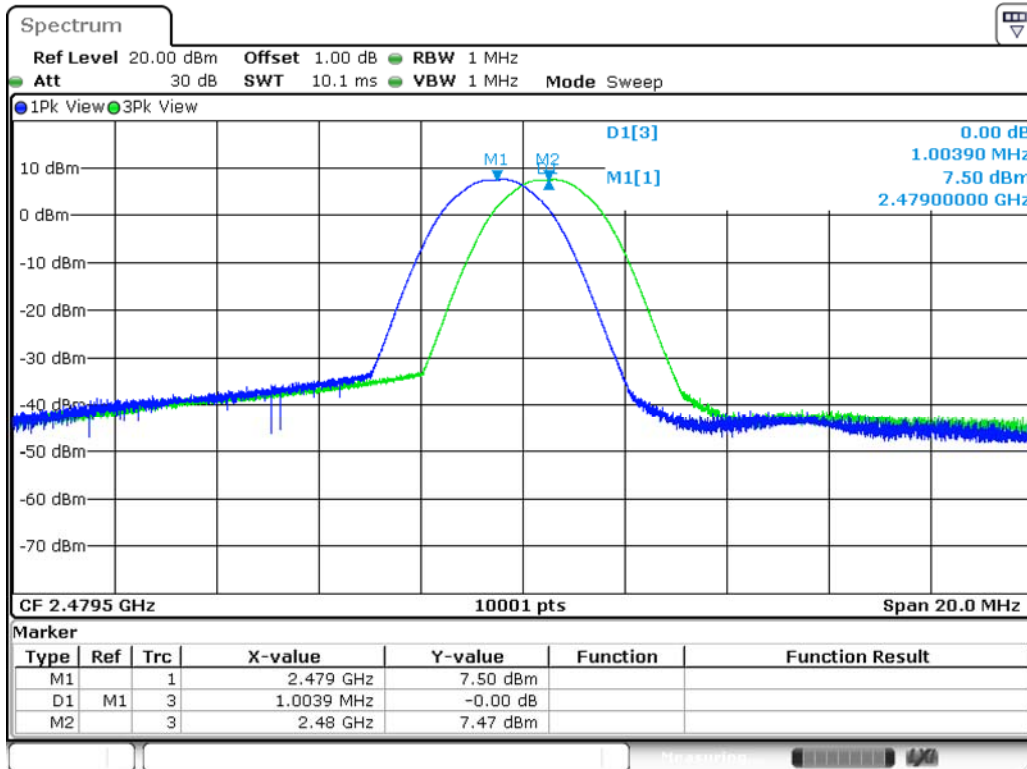

Date: 5.JAN.2018 03:57:18

Product	ConnectCore 6 Plus		
Test Item	Carrier Frequency Separation		
Test Mode	Mode 3: Transmit Mode_3DH5		
Date of Test	2018/01/05	Test Site	SR10-H

8-DPSK

Channel No.	Frequency (MHz)	Measure Level (MHz)	Limit (MHz)	Result
00	2402	1.001	0.810	Pass
39	2441	0.999	0.813	Pass
78	2480	1.000	0.814	Pass

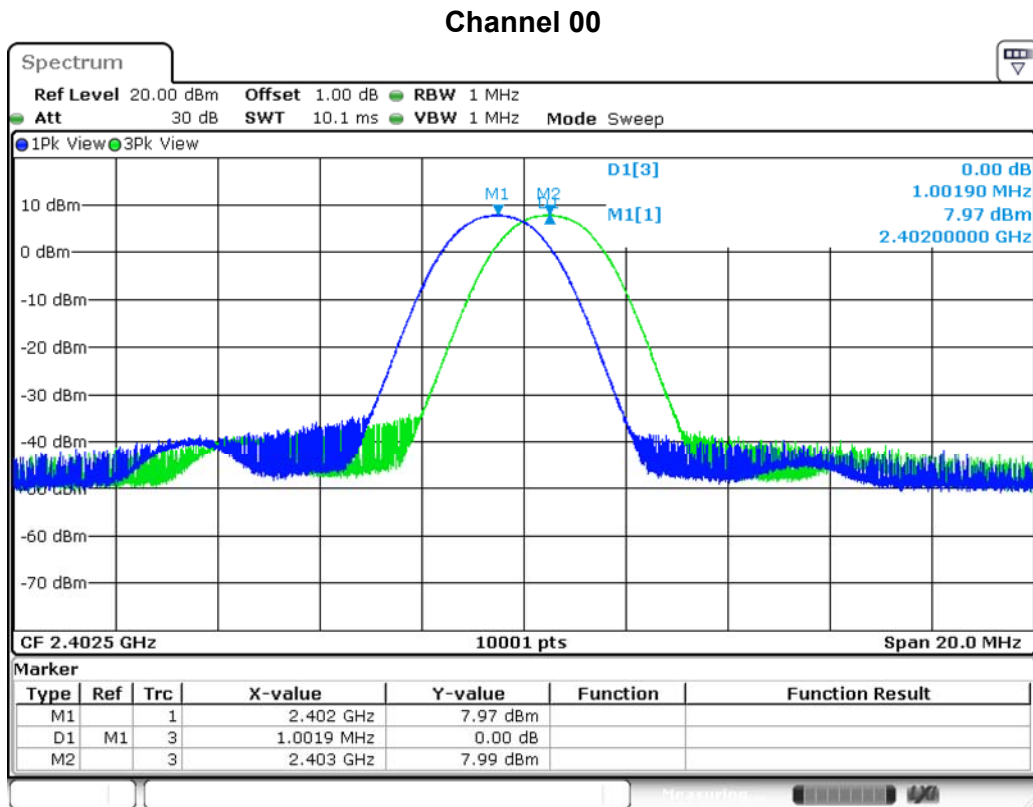

Date: 5.JAN.2018 07:25:10

Channel 39

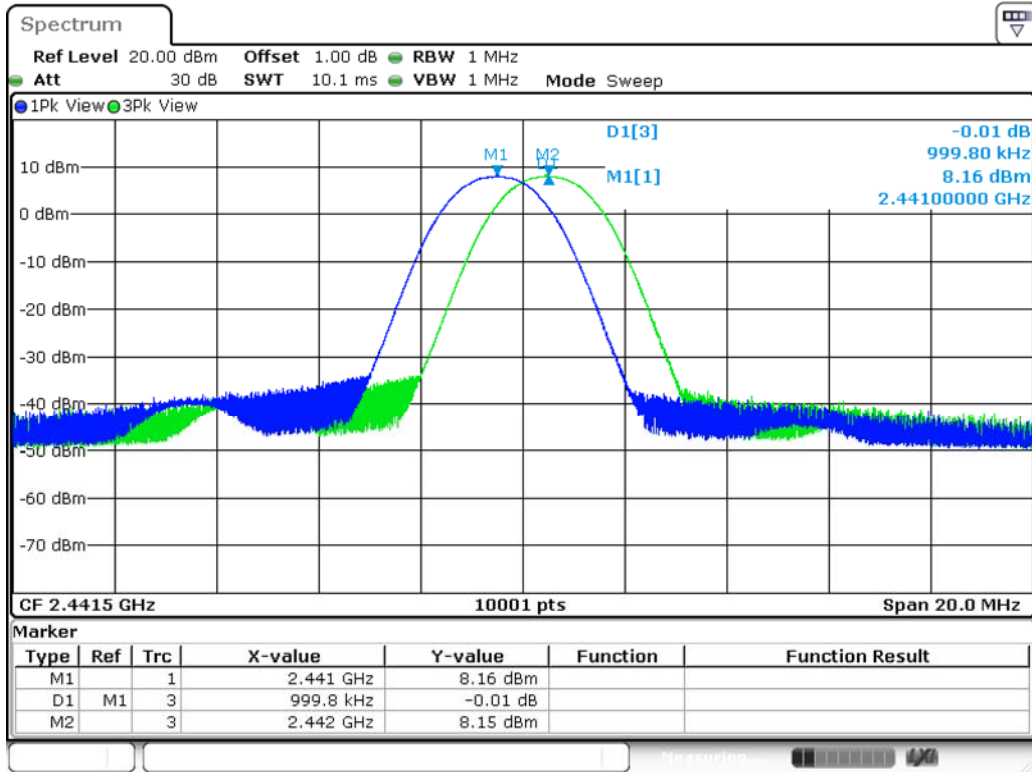

Date: 5.JAN.2018 04:41:29

Channel 78

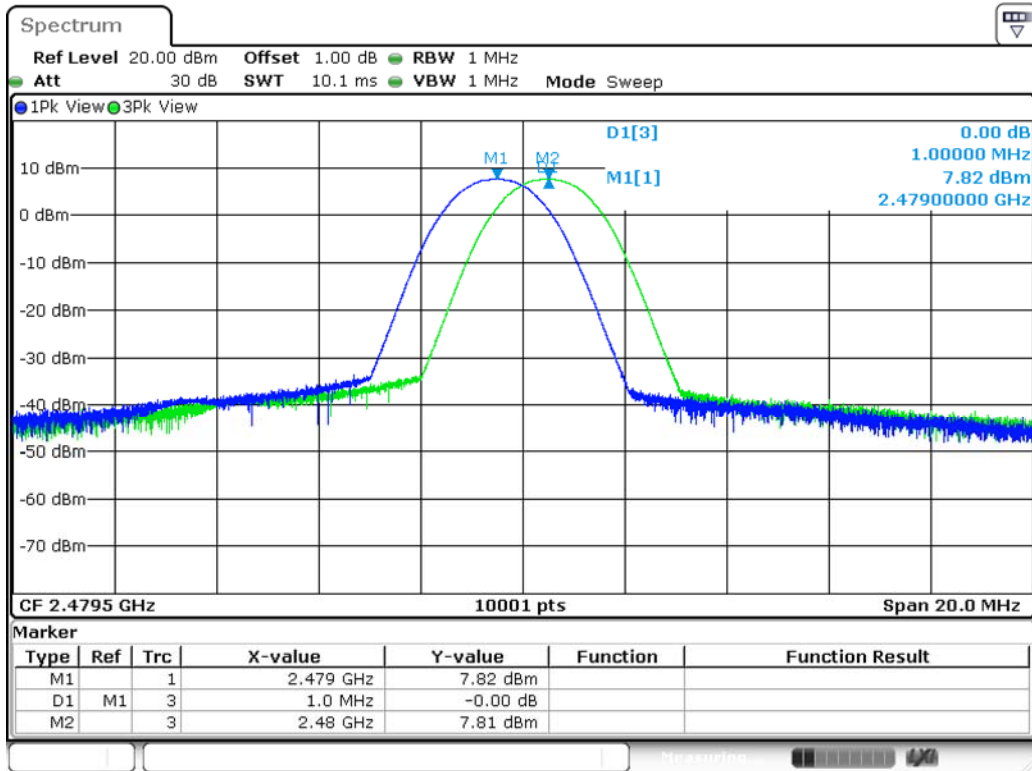

Date: 5.JAN.2018 03:31:18

9. Occupied Bandwidth

9.1. Test Equipment

The following test equipment is used during the test:

Occupied Bandwidth / SR10-H

Instrument	Manufacturer	Model No.	Serial No.	Cal. Date	Next Cal. Date
Signal & Spectrum Analyzer	R&S	FSV40	101049	2018/01/10	2019/01/09
EXA Signal Analyzer	Keysight	N9010A	MY51440132	2017/03/13	2018/03/12

9.2. Test Setup

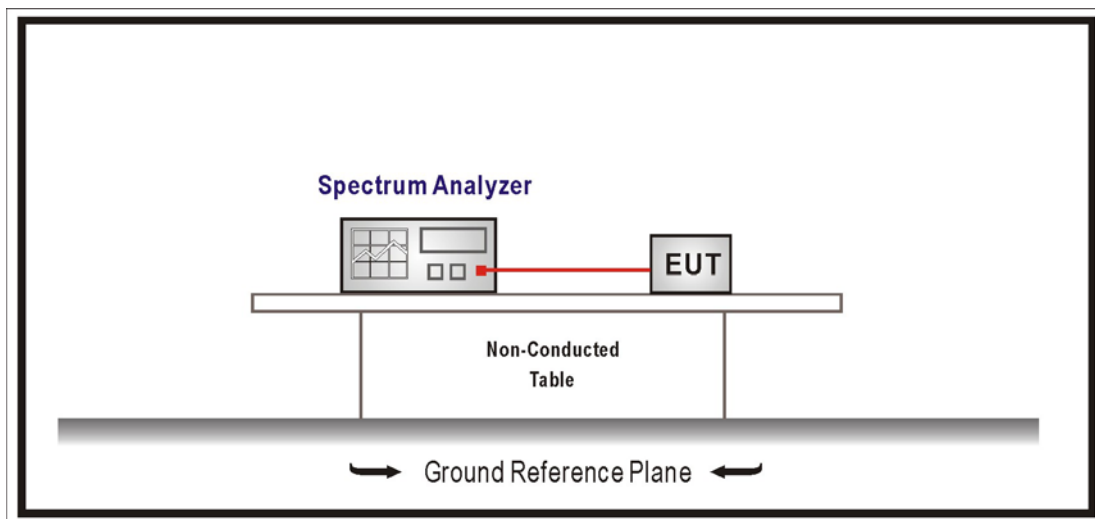

9.3. Limits

N/A

9.4. Test Procedures

The EUT was setup according to ANSI C63.10: 2013 and tested according to FHSS test procedure of FCC Public Notice DA 00-705 for compliance to FCC 47CFR 15.247 requirements

Use the following spectrum analyzer settings:

Span = approximately 2 to 3 times the 20 dB bandwidth, centered on a hopping channel
 RBW \geq 1% of the 20 dB bandwidth, VBW \geq RBW, Sweep = auto, Detector function = peak,
 Trace = max hold, The EUT should be transmitting at its maximum data rate.

9.5. Test Specification

According to FCC Part 15 Subpart C Paragraph 15.247 and RSS-247.

9.6. Test Result

Product	ConnectCore 6 Plus		
Test Item	Occupied Bandwidth		
Test Mode	Mode 1: Transmit Mode_DH5		
Date of Test	2018/01/02	Test Site	SR10-H

GFSK

Channel No.	Frequency (MHz)	Measure Level (MHz)	Limit (MHz)	Result
00	2402	0.992	--	Pass
39	2441	0.993	--	Pass
78	2480	0.992	--	Pass

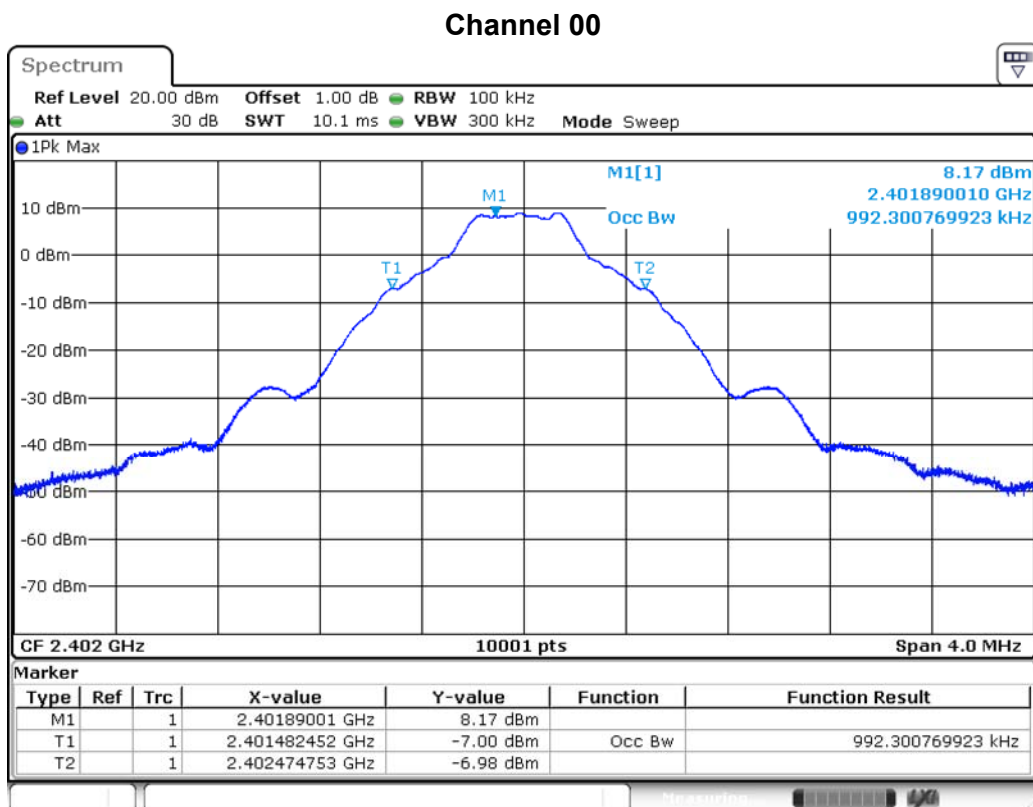

Date: 1.JAN.2018 22:03:28

Channel 39

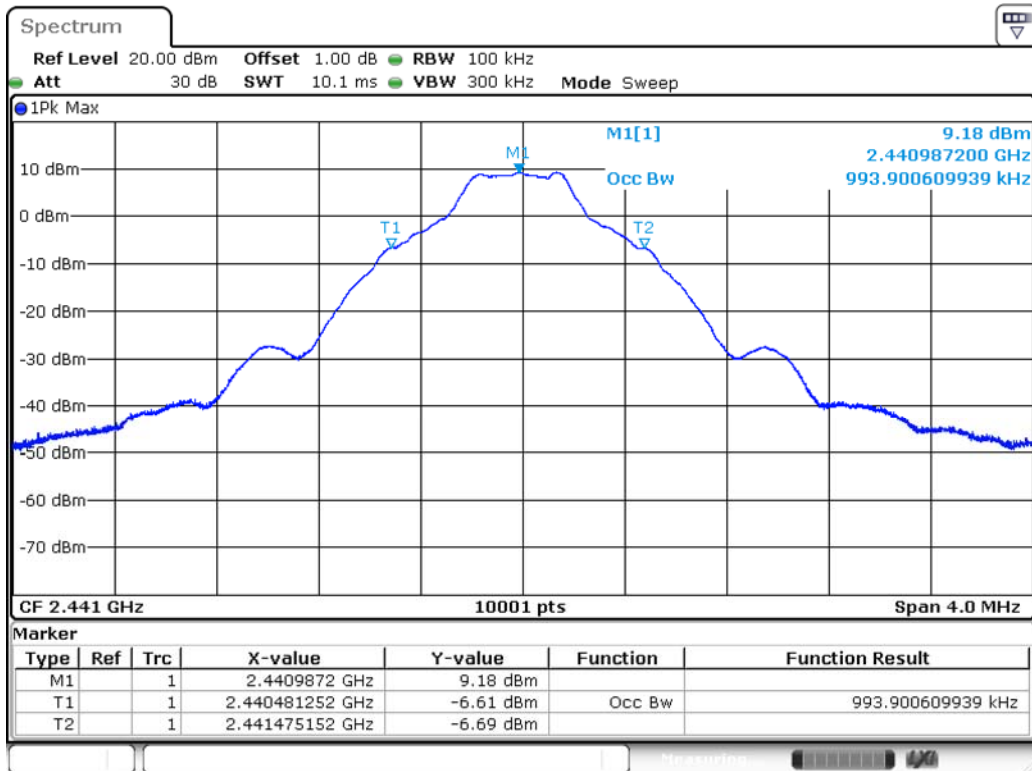

Date: 2.JAN.2018 00:20:13

Channel 78

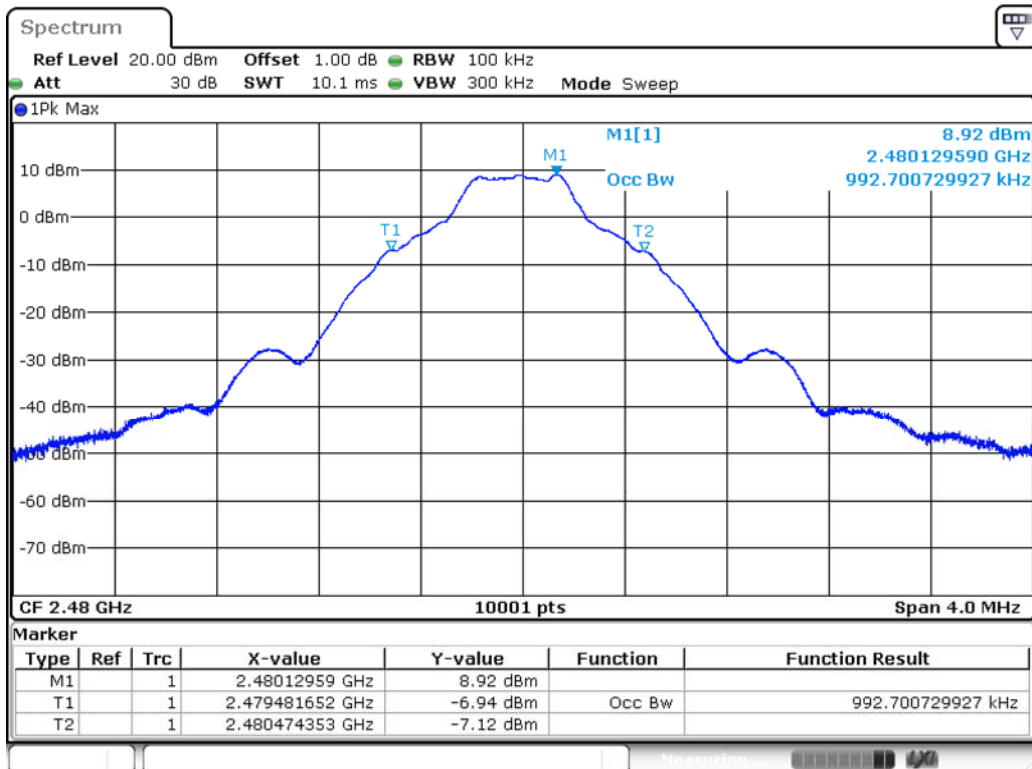

Date: 2.JAN.2018 00:22:43

Product	ConnectCore 6 Plus		
Test Item	Occupied Bandwidth		
Test Mode	Mode 2: Transmit Mode_2DH5		
Date of Test	2018/01/02	Test Site	SR10-H

$\pi/4$ -DQPSK

Channel No.	Frequency (MHz)	Measure Level (MHz)	Limit (MHz)	Result
00	2402	1.207	--	Pass
39	2441	1.207	--	Pass
78	2480	1.206	--	Pass

Channel 00

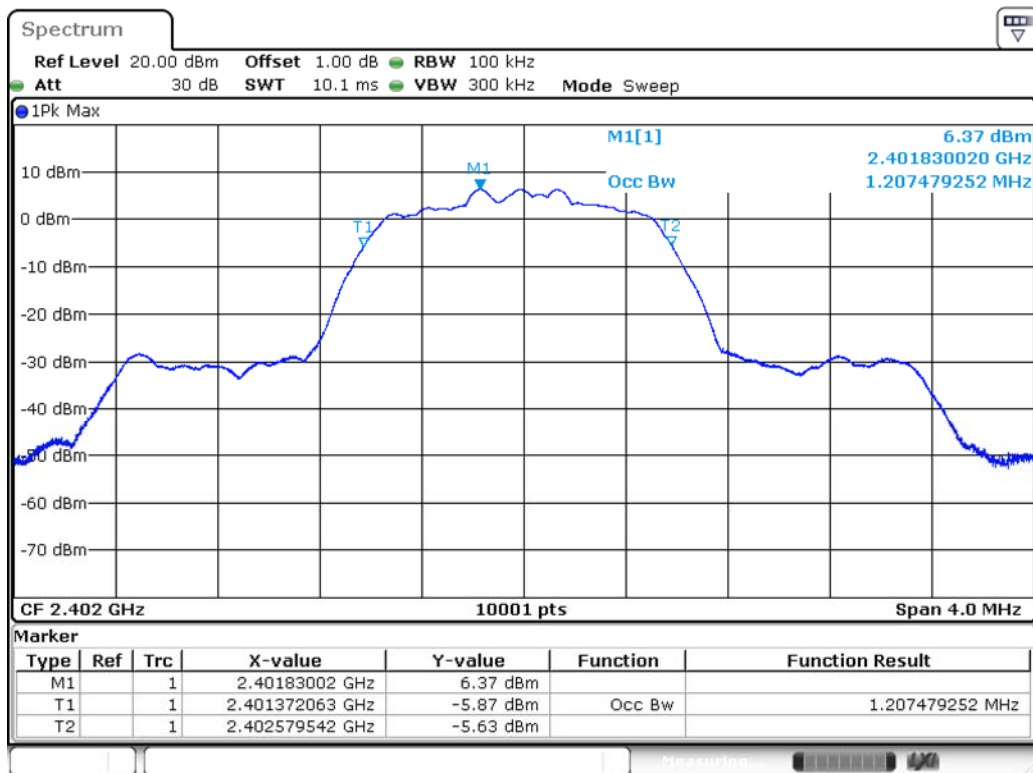

Date: 1.JAN.2018 22:09:07

Channel 39

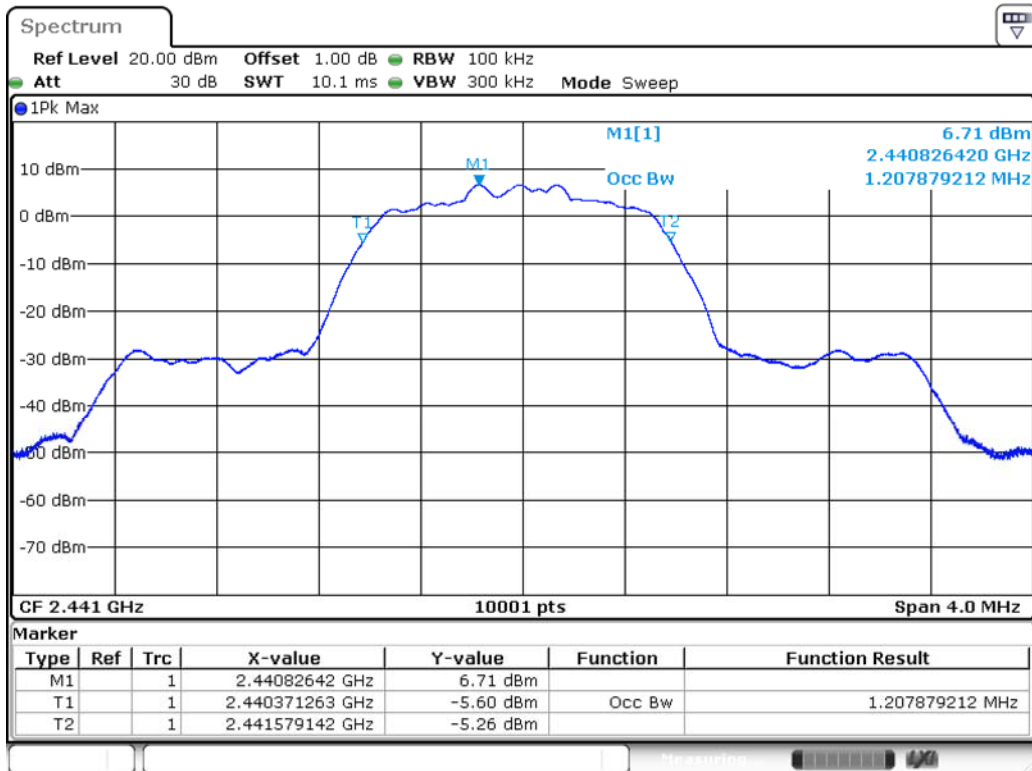

Date: 1.JAN.2018 22:57:49

Channel 78

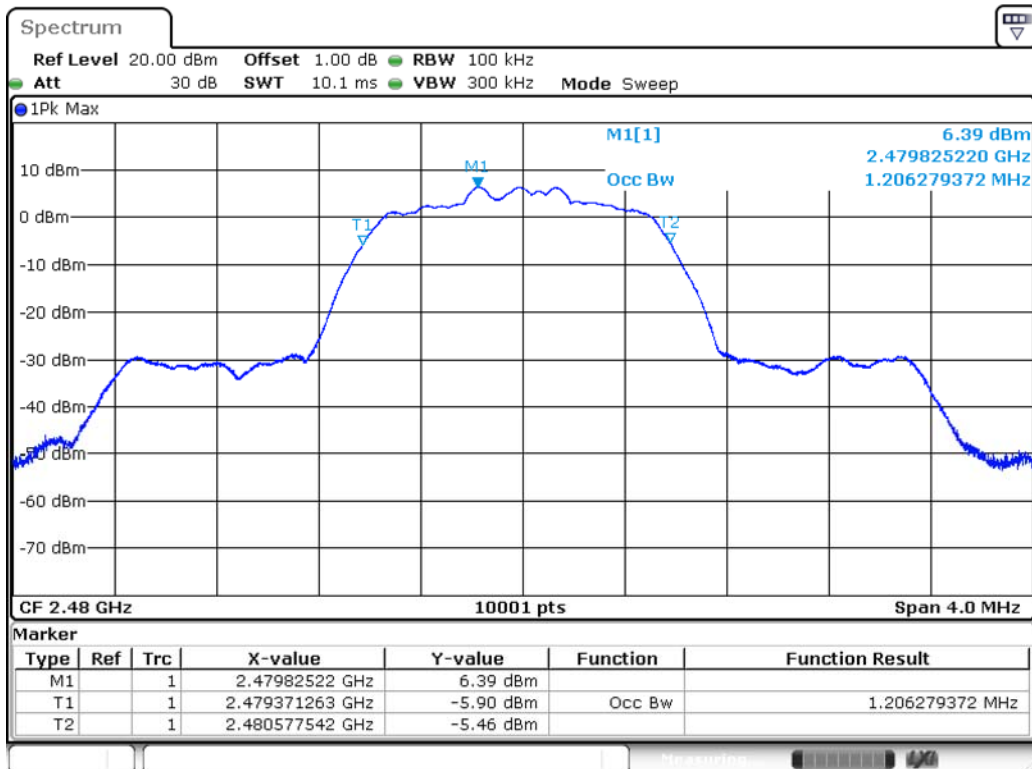

Date: 2.JAN.2018 00:29:21

Product	ConnectCore 6 Plus		
Test Item	Occupied Bandwidth		
Test Mode	Mode 3: Transmit Mode_3DH5		
Date of Test	2018/01/02	Test Site	SR10-H

8-DPSK

Channel No.	Frequency (MHz)	Measure Level (MHz)	Limit (MHz)	Result
00	2402	1.215	--	Pass
39	2441	1.220	--	Pass
78	2480	1.221	--	Pass

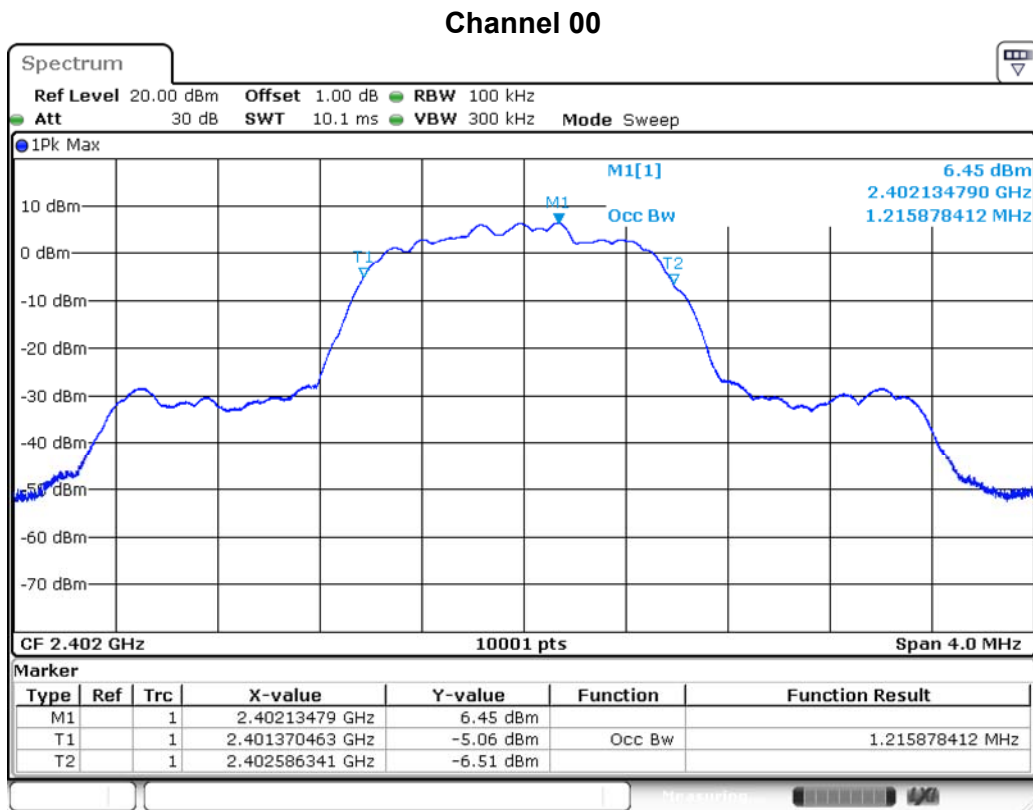

Date: 1.JAN.2018 22:12:54

Channel 39

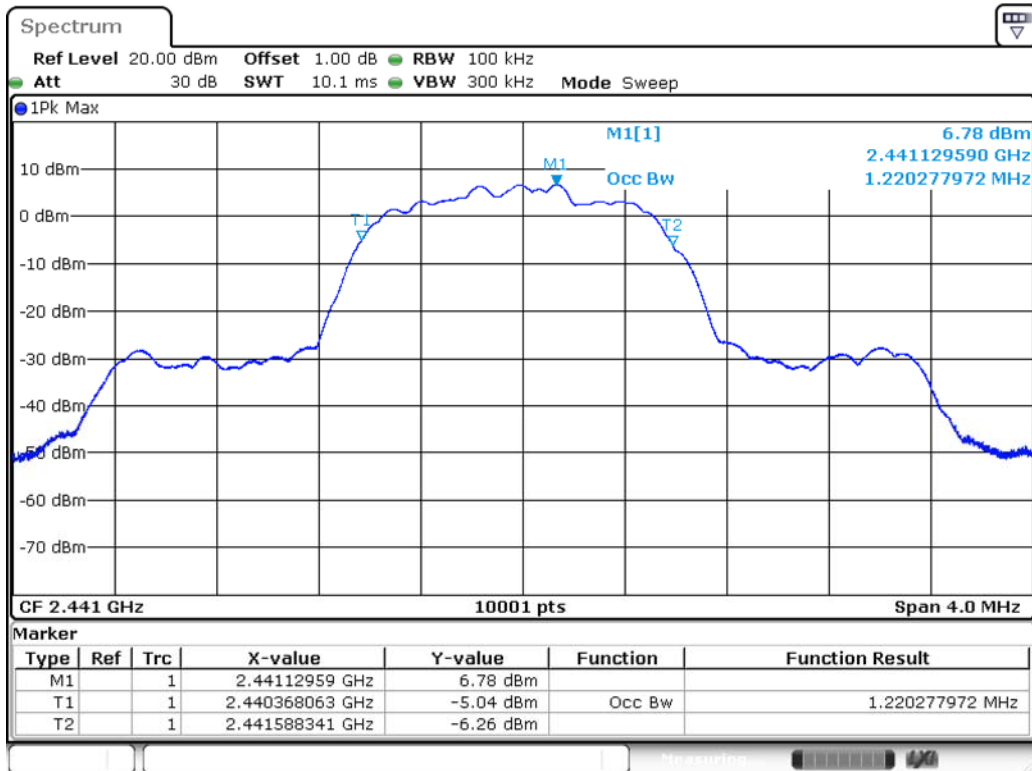

Date: 1.JAN.2018 22:42:08

Channel 78

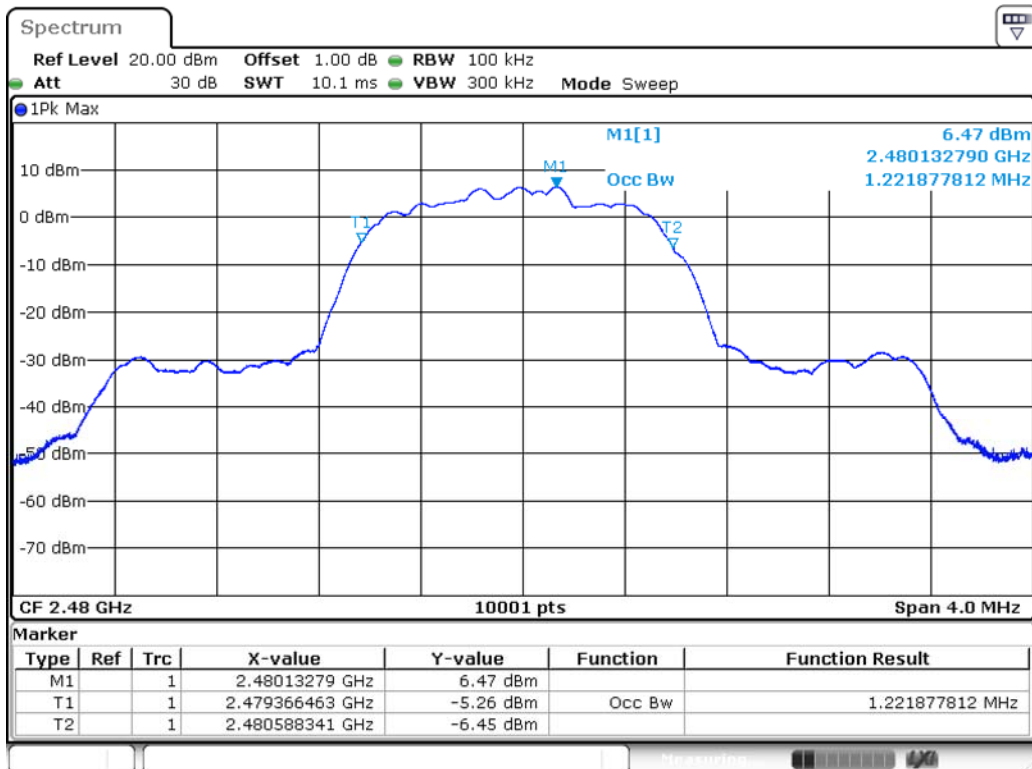

Date: 2.JAN.2018 00:42:52

10. Dwell Time

10.1. Test Equipment

The following test equipment is used during the test:

Dwell Time / SR10-H

Instrument	Manufacturer	Model No.	Serial No.	Cal. Date	Next Cal. Date
Signal & Spectrum Analyzer	R&S	FSV40	101049	2018/01/10	2019/01/09
EXA Signal Analyzer	Keysight	N9010A	MY51440132	2017/03/13	2018/03/12

10.2. Test Setup

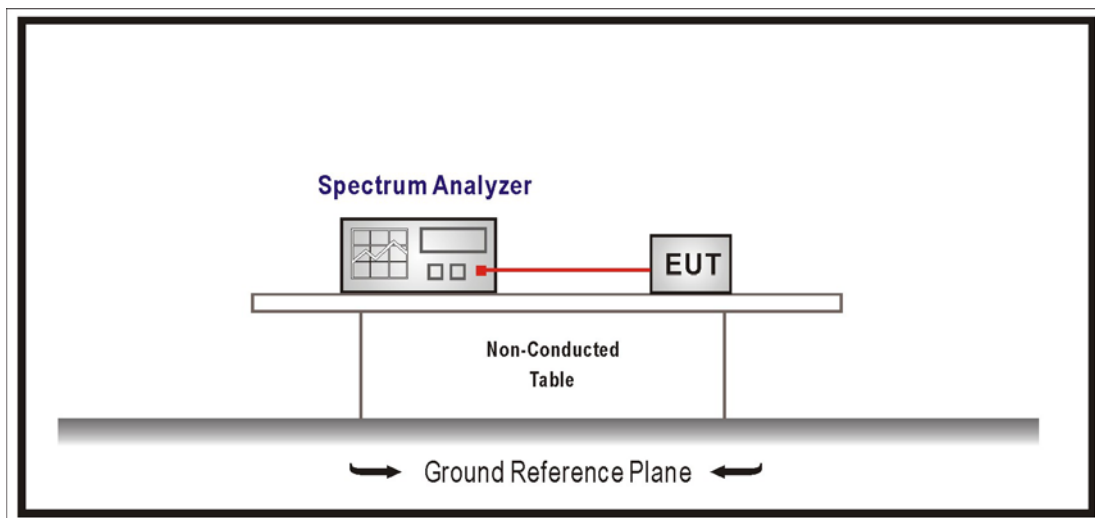

10.3. Limits

For frequency hopping systems operating in the 902-928 MHz band: if the 20 dB bandwidth of the hopping channel is less than 250 kHz, the system shall use at least 50 hopping frequencies and the average time of occupancy on any frequency shall not be greater than 0.4 seconds within a 20 second period; if the 20 dB bandwidth of the hopping channel is 250 kHz or greater, the system shall use at least 25 hopping frequencies and the average time of occupancy on any frequency shall not be greater than 0.4 seconds within a 10 second period. For frequency hopping systems operating in the 2400-2483.5 MHz bands. The average time of occupancy on any channel shall not be greater than 0.4 seconds within a period of 0.4 seconds multiplied by the number of hopping channels employed.

For frequency hopping systems operating in the 5725-5850 MHz bands. The average time of occupancy on any frequency shall not be greater than 0.4 seconds within a 30 second period.

10.4. Test Procedures

The EUT was setup according to ANSI C63.10: 2013 and tested according to FHSS test procedure of FCC Public Notice DA 00-705 for compliance to FCC 47CFR 15.247 requirements

Span = zero span, centered on a hopping channel, RBW = 1 MHz, VBW \geq RBW,

Sweep = as necessary to capture the entire dwell time per hopping channel,

Detector function = peak, Trace = max hold.

10.5. Test Specification

According to FCC Part 15 Subpart C Paragraph 15.247 and RSS-247.

10.6. Test Result

Product	ConnectCore 6 Plus		
Test Item	Dwell Time		
Test Mode	Mode 1: Transmit Mode_DH5		
Date of Test	2018/01/02	Test Site	SR10-H

GFSK, DH5

Occupancy Time of Frequency Hopping System

A) 2402MHz Test Time Period: $0.4 \times 79 = 31.60 \text{sec}$, Time slot length : 2.882 ms = 0.002882 sec

Dwell Time : 0.002882 $\times (266.67/79) \times 31.60 =$ 0.3074 sec ◦

B) 2441MHz Test Time Period: $0.4 \times 79 = 31.60 \text{sec}$, Time slot length : 2.884 ms = 0.002884 sec

Dwell Time : 0.002884 $\times (266.67/79) \times 31.60 =$ 0.3076 sec ◦

C) 2480MHz Test Time Period: $0.4 \times 79 = 31.60 \text{sec}$, Time slot length : 2.882 ms = 0.002882 sec

Dwell Time : 0.002882 $\times (266.67/79) \times 31.60 =$ 0.3074 sec ◦

Test Result: The Average Occupancy Time of Each Highest , Middle and Lowest Channel Is Less Than 0.4sec , And Corresponds to The Standard ◦

Hop rate-2402MHz

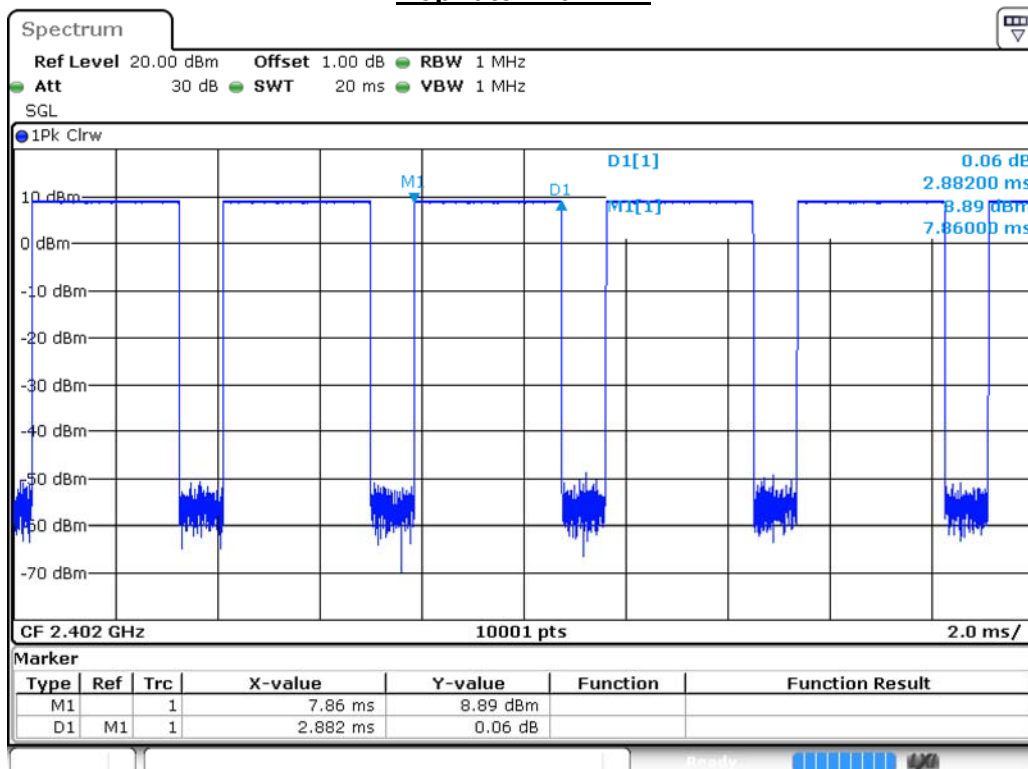

Date: 2.JAN.2018 01:04:41

Hop rate-2441MHz

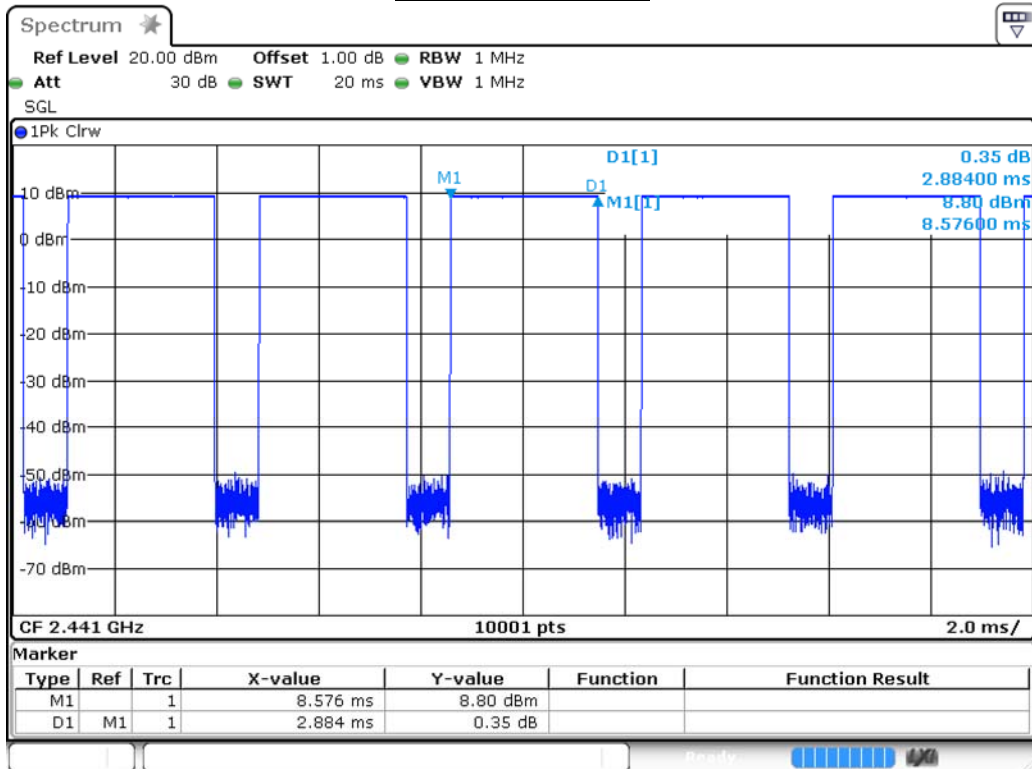

Date: 2.JAN.2018 00:52:18

Hop rate-2480MHz

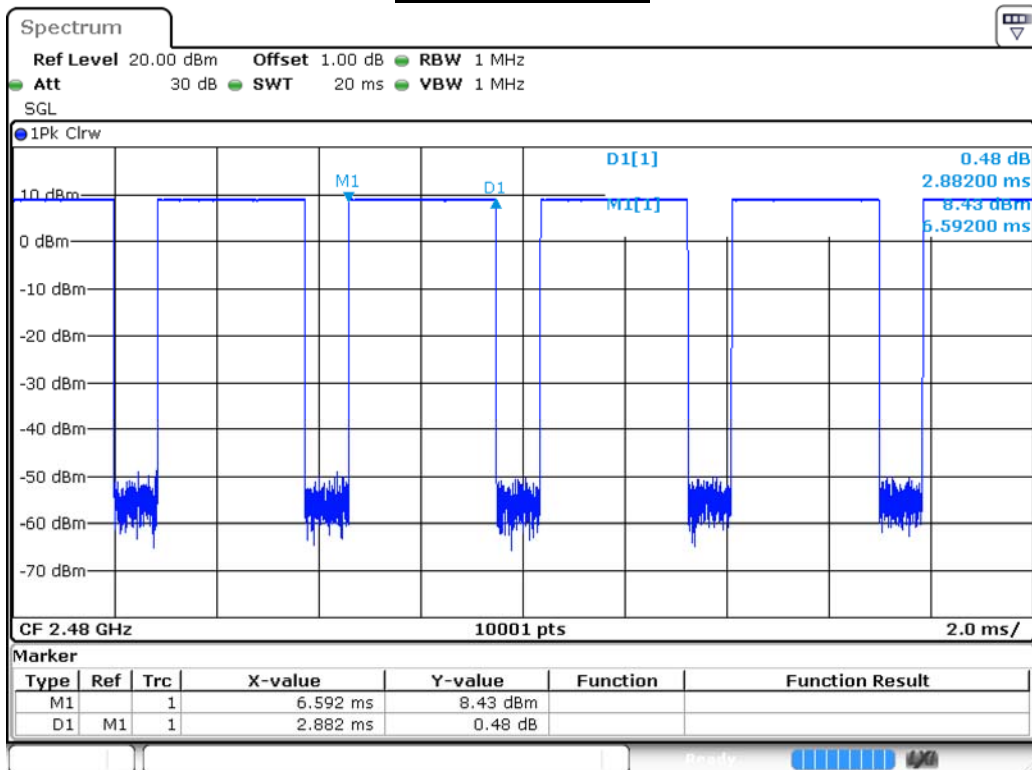

Date: 2.JAN.2018 00:51:29

Note: Dwell time = time slot length * hop rate / number of hopping channels * period

Product	ConnectCore 6 Plus		
Test Item	Dwell Time		
Test Mode	Mode 2: Transmit Mode_2DH5		
Date of Test	2018/01/02	Test Site	SR10-H

π/4-DQPSK, 2DH5

Occupancy Time of Frequency Hopping System

A) 2402MHz Test Time Period: $0.4 \times 79 = 31.60\text{sec}$, Time slot length : 2.882 ms = 0.002882 sec
 Dwell Time : 0.002882 $\times (266.67/79) \times 31.60 =$ 0.3074 sec ◦

B) 2441MHz Test Time Period: $0.4 \times 79 = 31.60\text{sec}$, Time slot length : 2.882 ms = 0.002882 sec
 Dwell Time : 0.002882 $\times (266.67/79) \times 31.60 =$ 0.3074 sec ◦

C) 2480MHz Test Time Period: $0.4 \times 79 = 31.60\text{sec}$, Time slot length : 2.884 ms = 0.002884 sec
 Dwell Time : 0.002884 $\times (266.67/79) \times 31.60 =$ 0.3076 sec ◦

Test Result: The Average Occupancy Time of Each Highest , Middle and Lowest Channel Is Less Than 0.4sec , And Corresponds to The Standard ◦

Hop rate-2402MHz

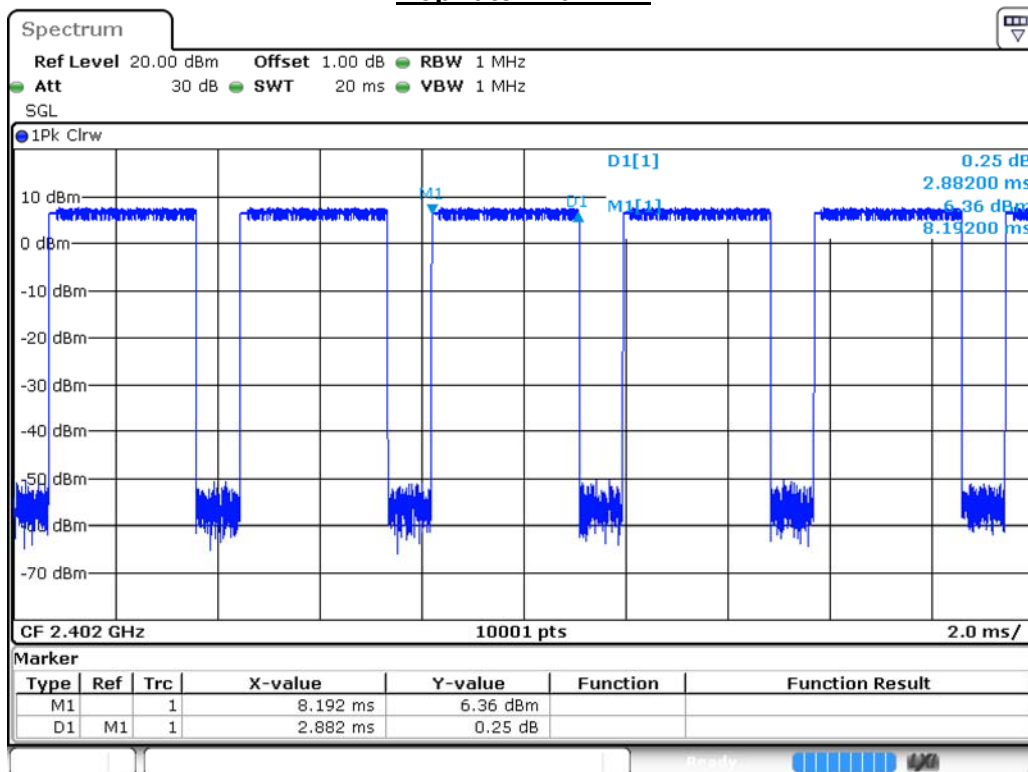

Date: 2.JAN.2018 01:04:01

Hop rate-2441MHz

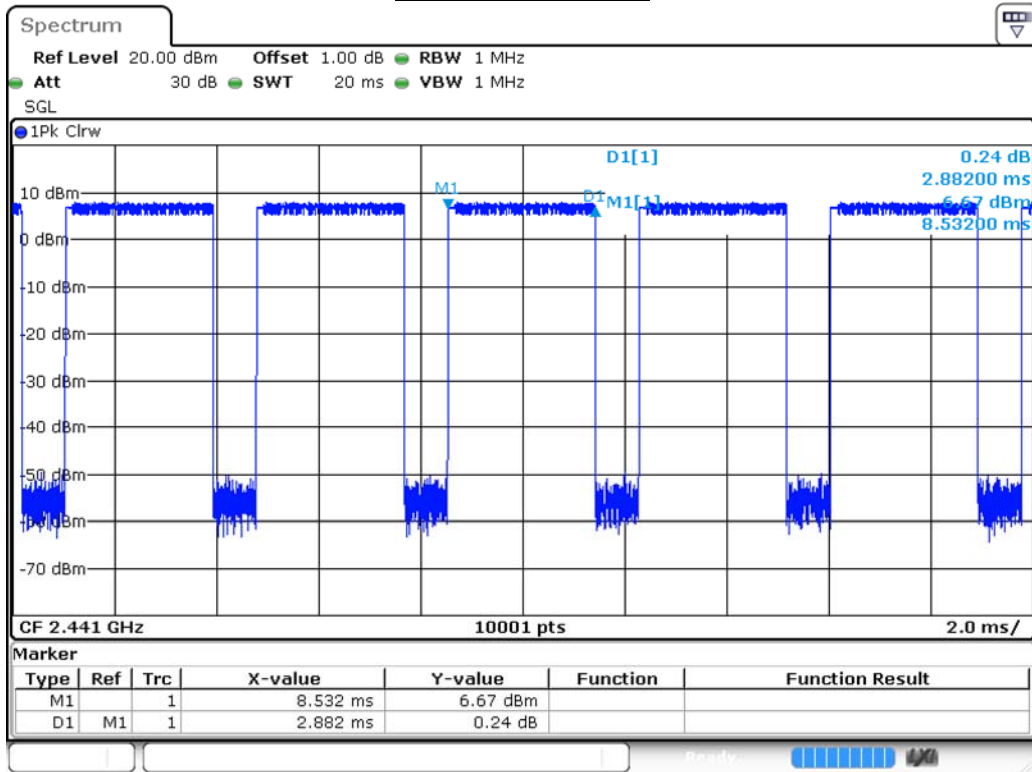

Date: 2.JAN.2018 00:56:58

Hop rate-2480MHz

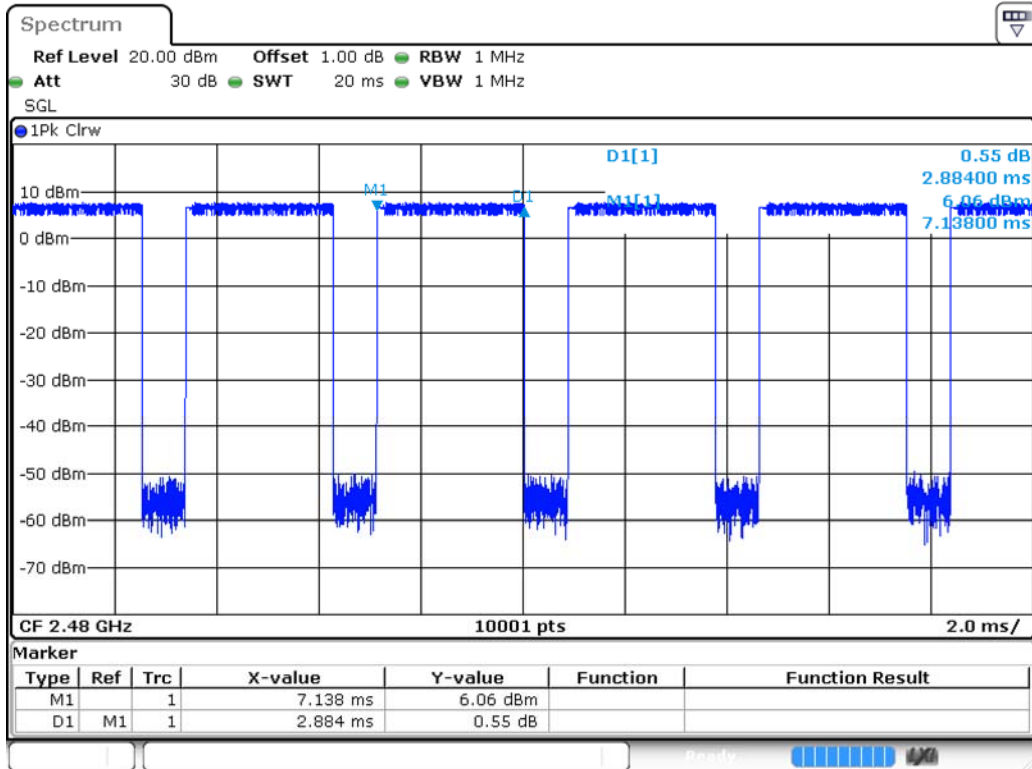

Date: 2.JAN.2018 00:45:36

Note: Dwell time = time slot length * hop rate / number of hopping channels * period

Product	ConnectCore 6 Plus		
Test Item	Dwell Time		
Test Mode	Mode 3: Transmit Mode_3DH5		
Date of Test	2018/01/02	Test Site	SR10-H

8-DPSK, 3DH5

Occupancy Time of Frequency Hopping System

A) 2402MHz Test Time Period: $0.4 \times 79 = 31.60 \text{sec}$, Time slot length : 2.884 ms = 0.002884 sec
 Dwell Time : 0.002884 * (266.67/79)* 31.60= 0.3076 sec ◦

B) 2441MHz Test Time Period: $0.4 \times 79 = 31.60 \text{sec}$, Time slot length : 2.884 ms = 0.002884 sec
 Dwell Time : 0.002884 * (266.67/79)* 31.60= 0.3076 sec ◦

C) 2480MHz Test Time Period: $0.4 \times 79 = 31.60 \text{sec}$, Time slot length : 2.886 ms = 0.002886 sec
 Dwell Time : 0.002886 * (266.67/79)* 31.60= 0.3078 sec ◦

Test Result: The Average Occupancy Time of Each Highest , Middle and Lowest Channel Is Less Than 0.4sec , And Corresponds to The Standard ◦

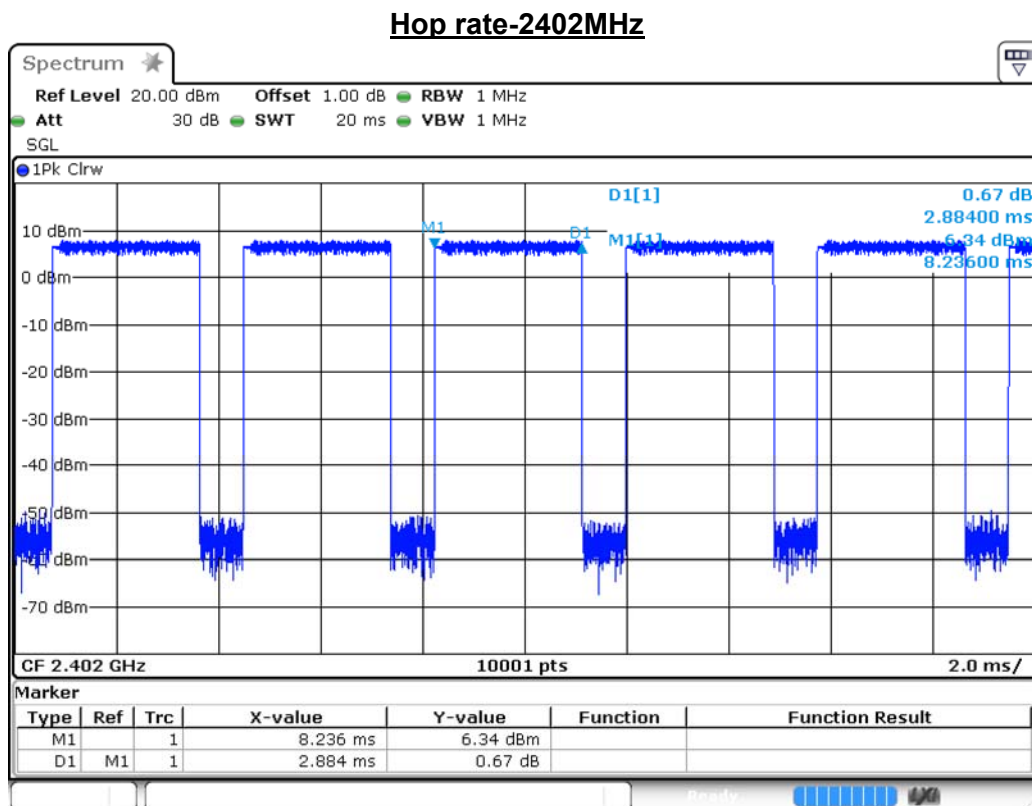

Date: 2.JAN.2018 01:03:04

Hop rate-2441MHz

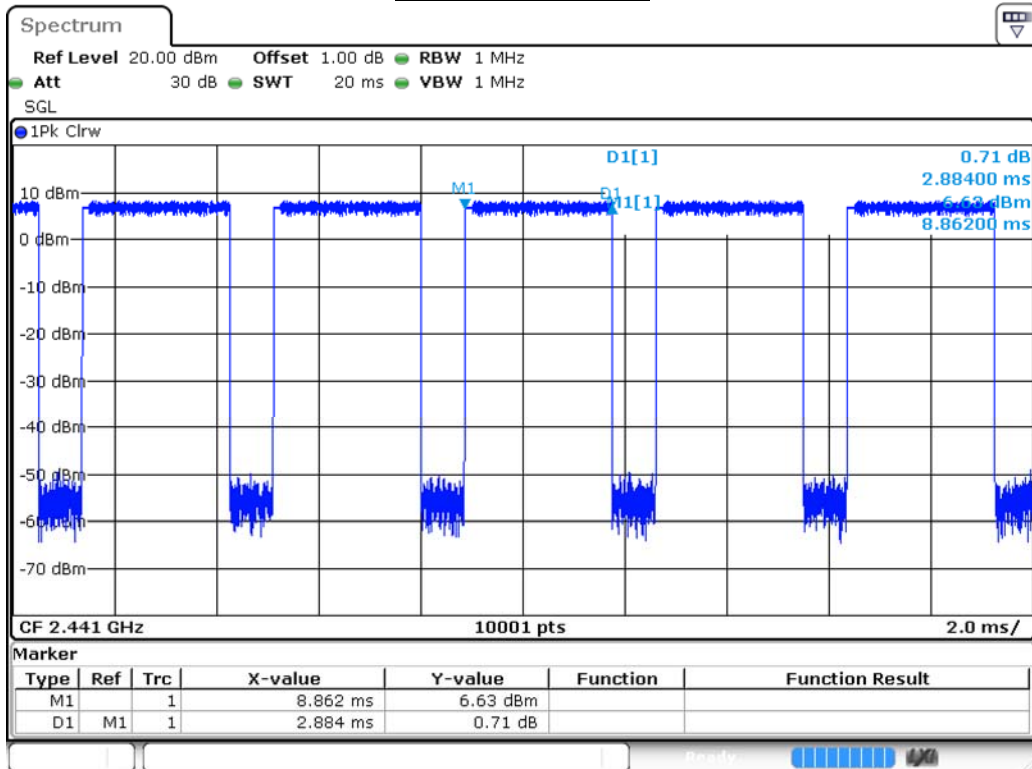

Date: 2.JAN.2018 00:58:10

Hop rate-2480MHz

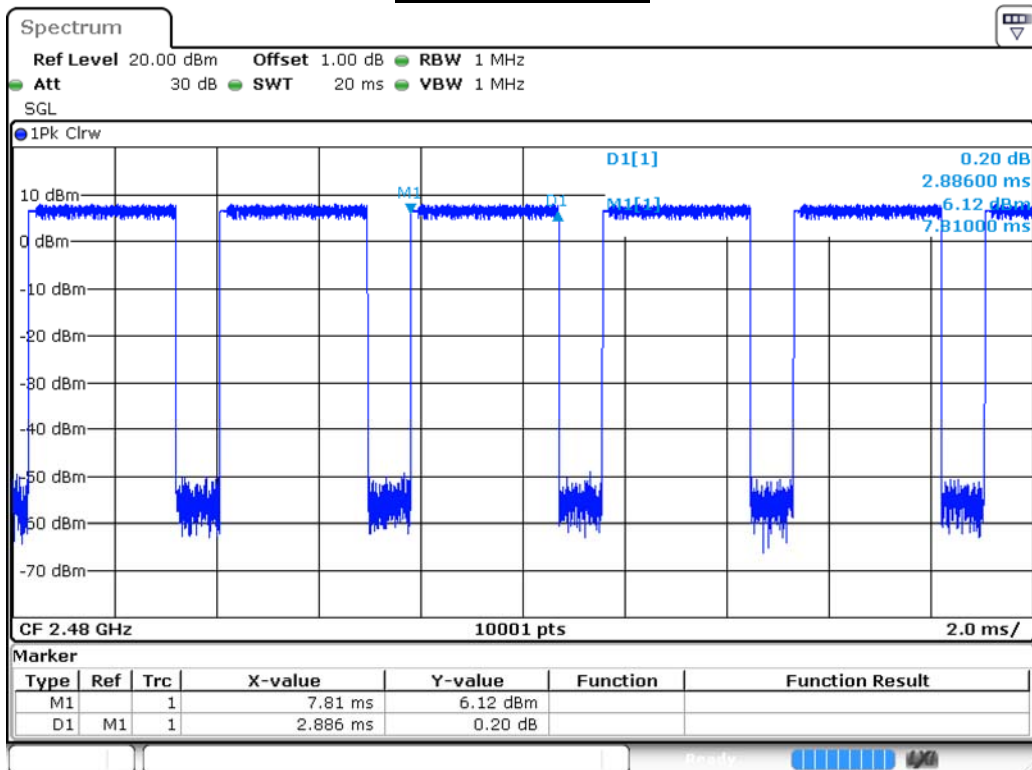

Date: 2.JAN.2018 00:44:31

Note: Dwell time = time slot length * hop rate / number of hopping channels * period