



TEST REPORT

Test report no.: 1-3547/21-01-15-A

BNNetzA-CAB-02/21-102

Testing laboratory

CTC advanced GmbH

Untertuerkheimer Strasse 6 – 10
66117 Saarbruecken / Germany
Phone: + 49 681 5 98 - 0
Fax: + 49 681 5 98 - 9075
Internet: <https://www.ctcadvanced.com>
e-mail: mail@ctcadvanced.com

Accredited Testing Laboratory:

The testing laboratory (area of testing) is accredited according to DIN EN ISO/IEC 17025 (2018-03) by the Deutsche Akkreditierungsstelle GmbH (DAkkS)
The accreditation is valid for the scope of testing procedures as stated in the accreditation certificate starting with the registration number: D-PL-12076-01.

Applicant

Digi International Inc.

9350 Excelsior Blvd, Suite 700
Hopkins, 55343 / UNITED STATES
Phone: -/
Contact: Dan Kobylarz
e-mail: daniel.kobylarz@digi.com

Manufacturer

Digi International Inc.

9350 Excelsior Blvd, Suite 700
Hopkins, 55343 / UNITED STATES

Test standard/s

FCC - Title 47 CFR Part 15 FCC - Title 47 of the Code of Federal Regulations; Chapter I; Part 15 - Radio frequency devices
RSS - 247 Issue 2 Digital Transmission Systems (DTSS), Frequency Hopping Systems (FHSs) and Licence - Exempt Local Area Network (LE-LAN) Devices
For further applied test standards please refer to section 3 of this test report.

Test Item

Kind of test item: Embedded ARM module
Model name: CCWMX28N
FCC ID: MCQ-CCIMX28N
ISED certification number: 1846A-CCIMX28N
Frequency: UNII bands: 5150 MHz to 5250 MHz; 5250 MHz to 5350 MHz; 5470 MHz to 5725 MHz; 5725 MHz to 5850 MHz
Technology tested: WLAN
Antenna: Three different external antennas
Power supply: 5.0 V DC by external power supply
Temperature range: -40°C to +85°C

This test report is electronically signed and valid without handwritten signature. For verification of the electronic signatures, the public keys can be requested at the testing laboratory.

Test report authorized:

Marco Bertolino
Lab Manager
Radio Communications

Test performed:

Michael Dorongovski
Lab Manager
Radio Communications

1 Table of contents

1	Table of contents	2
2	General information	4
2.1	Notes and disclaimer	4
2.2	Application details	4
2.3	Test laboratories sub-contracted	4
3	Test standard/s, references and accreditations	5
4	Reporting statements of conformity – decision rule	6
5	Test environment	7
6	Test item	7
6.1	General description	7
6.2	Additional information	7
7	Description of the test setup.....	8
7.1	Shielded semi anechoic chamber	9
7.2	Shielded fully anechoic chamber.....	10
7.3	Radiated measurements > 18 GHz.....	12
7.4	Conducted measurements	13
7.5	AC conducted	14
8	Sequence of testing	15
8.1	Sequence of testing radiated spurious 9 kHz to 30 MHz	15
8.2	Sequence of testing radiated spurious 30 MHz to 1 GHz	16
8.3	Sequence of testing radiated spurious 1 GHz to 18 GHz	17
8.4	Sequence of testing radiated spurious above 18 GHz	18
9	Measurement uncertainty	19
10	Summary of measurement results	20
11	Additional comments.....	21
12	Measurement results	24
12.1	Identify worst case data rate	24
12.2	Antenna gain.....	25
12.3	Duty cycle	26
12.4	Maximum output power.....	27
12.4.1	Maximum output power according to FCC requirements	27
12.4.2	Maximum output power according to ISED requirements.....	31
12.5	Power spectral density	36
12.5.1	Power spectral density according to FCC requirements.....	36
12.5.2	Power spectral density according to ISED requirements	39
12.6	Minimum emission bandwidth for the band 5.725-5.85 GHz.....	42
12.7	Spectrum bandwidth / 26 dB bandwidth.....	44
12.8	Occupied bandwidth / 99% emission bandwidth	47
12.9	Band edge compliance radiated.....	50
12.10	Spurious emissions radiated below 30 MHz.....	62
12.11	Spurious emissions radiated 30 MHz to 1 GHz.....	92

12.12	Spurious emissions radiated 1 GHz to 40 GHz	101
12.13	Spurious emissions conducted below 30 MHz (AC conducted).....	138
13	Glossary	141
14	Document history.....	142
15	Accreditation Certificate – D-PL-12076-01-04	142
16	Accreditation Certificate – D-PL-12076-01-05	143

2 General information

2.1 Notes and disclaimer

The test results of this test report relate exclusively to the test item specified in this test report. CTC advanced GmbH does not assume responsibility for any conclusions and generalizations drawn from the test results with regard to other specimens or samples of the type of the equipment represented by the test item.

The test report may only be reproduced or published in full. Reproduction or publication of extracts from the report requires the prior written approval of CTC advanced GmbH.

The testing service provided by CTC advanced GmbH has been rendered under the current "General Terms and Conditions for CTC advanced GmbH".

CTC advanced GmbH will not be liable for any loss or damage resulting from false, inaccurate, inappropriate or incomplete product information provided by the customer.

Under no circumstances does the CTC advanced GmbH test report include any endorsement or warranty regarding the functionality, quality or performance of any other product or service provided.

Under no circumstances does the CTC advanced GmbH test report include or imply any product or service warranties from CTC advanced GmbH, including, without limitation, any implied warranties of merchantability, fitness for purpose, or non-infringement, all of which are expressly disclaimed by CTC advanced GmbH.

All rights and remedies regarding vendor's products and services for which CTC advanced GmbH has prepared this test report shall be provided by the party offering such products or services and not by CTC advanced GmbH. In no case this test report can be considered as a Letter of Approval.

This test report is electronically signed and valid without handwritten signature. For verification of the electronic signatures, the public keys can be requested at the testing laboratory.

This test report replaces the test report with the number 1-3547/21-01-15 and dated 2022-09-23.

2.2 Application details

Date of receipt of order: 2022-06-22

Date of receipt of test item: 2022-06-22

Start of test:* 2022-06-30

End of test:* 2022-09-12

Person(s) present during the test: -/-

*Date of each measurement, if not shown in the plot, can be requested. Dates are stored in the measurement software.

2.3 Test laboratories sub-contracted





None

3 Test standard/s, references and accreditations

Test standard	Date	Description
FCC - Title 47 CFR Part 15	-/-	FCC - Title 47 of the Code of Federal Regulations; Chapter I; Part 15 - Radio frequency devices
RSS - 247 Issue 2	February 2017	Digital Transmission Systems (DTSs), Frequency Hopping Systems (FHSs) and Licence - Exempt Local Area Network (LE-LAN) Devices
RSS - Gen Issue 5 incl. Amendment 1 & 2	February 2021	Spectrum Management and Telecommunications Radio Standards Specification - General Requirements for Compliance of Radio Apparatus

Guidance	Version	Description
KDB 789033 D02	v02r01	Guidelines for Compliance Testing of Unlicensed National Information Infrastructure (U-NII) Devices - Part 15, Subpart E
ANSI C63.4-2014	-/-	American National Standard for Methods of Measurement of Radio-Noise Emissions from Low-Voltage Electrical and Electronic Equipment in the Range of 9 kHz to 40 GHz
ANSI C63.10-2013	-/-	American National Standard of Procedures for Compliance Testing of Unlicensed Wireless Devices

Accreditation	Description
---------------	-------------

D-PL-12076-01-04	Telecommunication and EMC Canada https://www.dakks.de/as/ast/d/D-PL-12076-01-04e.pdf	  Deutsche Akkreditierungsstelle D-PL-12076-01-04
D-PL-12076-01-05	Telecommunication FCC requirements https://www.dakks.de/as/ast/d/D-PL-12076-01-05e.pdf	  Deutsche Akkreditierungsstelle D-PL-12076-01-05

ISED Testing Laboratory Recognized Listing Number: DE0001
 FCC designation number: DE0002

4 Reporting statements of conformity – decision rule

Only the measured values related to their corresponding limits will be used to decide whether the equipment under test meets the requirements of the test standards listed in chapter 3.

The measurement uncertainty is mentioned in this test report, see chapter 9, but is not taken into account - neither to the limits nor to the measurement results. Measurement results with a smaller margin to the corresponding limits than the measurement uncertainty have a potential risk of more than 5% that the decision might be wrong."

measured value, measurement uncertainty, verdict

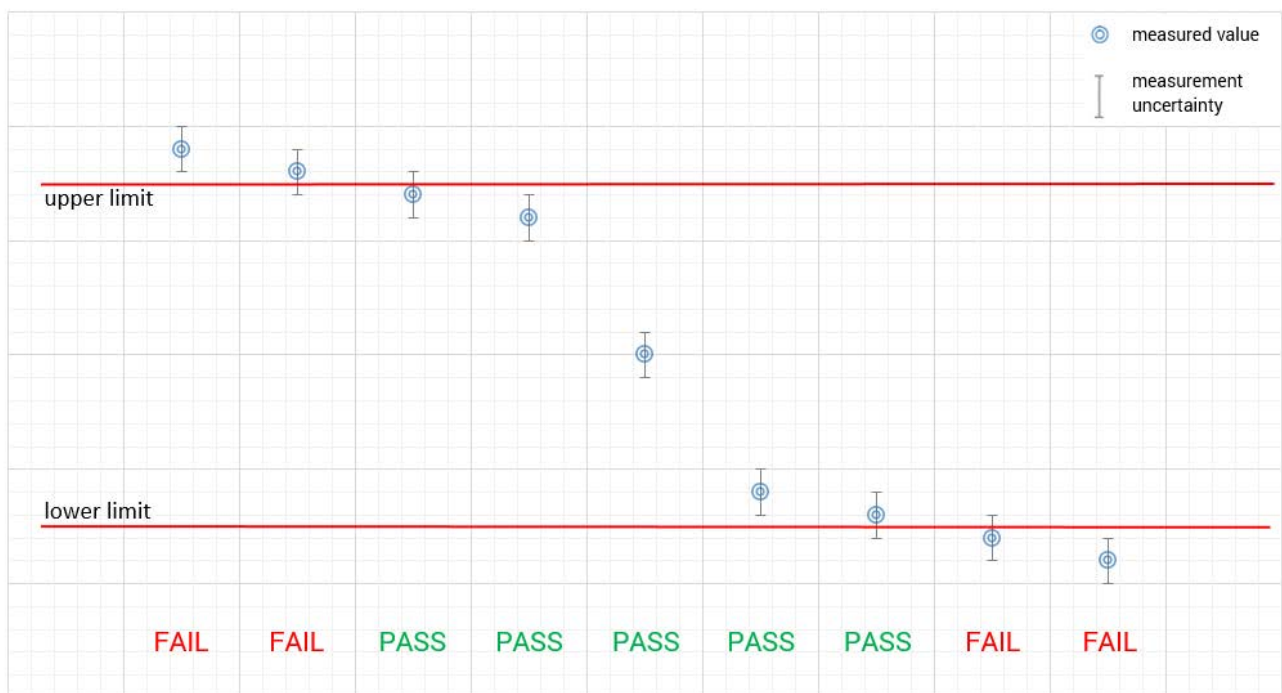

7 Description of the test setup

Typically, the calibrations of the test apparatus are commissioned to and performed by an accredited calibration laboratory. The calibration intervals are determined in accordance with the DIN EN ISO/IEC 17025. In addition to the external calibrations, the laboratory executes comparison measurements with other calibrated test systems or effective verifications. Weekly chamber inspections and range calibrations are performed. Where possible, RF generating and signaling equipment as well as measuring receivers and analyzers are connected to an external high-precision 10 MHz reference (GPS-based or rubidium frequency standard).

In order to simplify the identification of the equipment used at some special tests, some items of test equipment and ancillaries can be provided with an identifier or number in the equipment list below (Lab/Item).

Agenda: Kind of Calibration

k	calibration / calibrated	EK	limited calibration
ne	not required (k, ev, izw, zw not required)	zw	cyclical maintenance (external cyclical maintenance)
ev	periodic self verification	izw	internal cyclical maintenance
Ve	long-term stability recognized	g	blocked for accredited testing
vlk!	Attention: extended calibration interval		
NK!	Attention: not calibrated	*)	next calibration ordered / currently in progress

7.1 Shielded semi anechoic chamber

The radiated measurements are performed in vertical and horizontal plane in the frequency range from 30 MHz to 1 GHz in semi-anechoic chambers. The EUT is positioned on a non-conductive support with a height of 0.80 m above a conductive ground plane that covers the whole chamber. The receiving antennas are conform to specifications ANSI C63. These antennas can be moved over the height range between 1.0 m and 4.0 m in order to search for maximum field strength emitted from EUT. The measurement distances between EUT and receiving antennas are indicated in the test setups for the various frequency ranges. For each measurement, the EUT is rotated in all three axes until the maximum field strength is received. The wanted and unwanted emissions are received by spectrum analyzers where the detector modes and resolution bandwidths over various frequency ranges are set according to requirement ANSI C63.

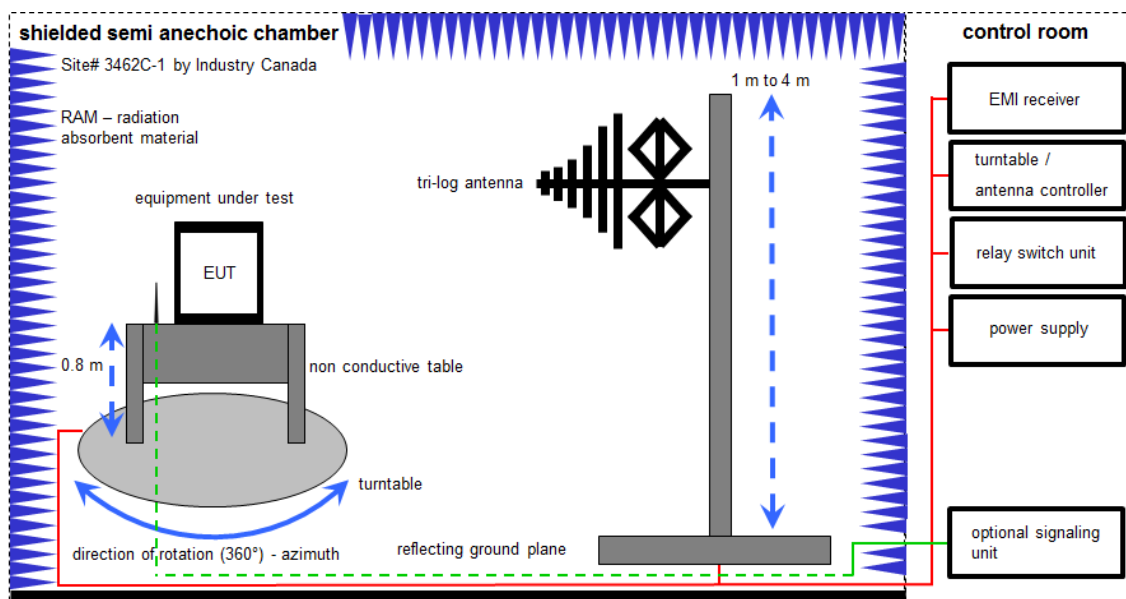

Measurement distance: tri-log antenna 10 meter; EMC32 software version: 10.59.00

$$FS = UR + CL + AF$$

(FS-field strength; UR-voltage at the receiver; CL-loss of the cable; AF-antenna factor)

Example calculation:

$$FS [dB\mu V/m] = 12.35 [dB\mu V/m] + 1.90 [dB] + 16.80 [dB/m] = 31.05 [dB\mu V/m] (35.69 \mu V/m)$$

Equipment table:

No.	Setup	Equipment	Type	Manufacturer	Serial No.	INV. No.	Kind of Calibration	Last Calibration	Next Calibration
1	A	Switch-Unit	3488A	HP	2719A14505	300000368	ev	-/-	-/-
2	A	Semi anechoic chamber	3000023	MWB AG	-/-	300000551	ne	-/-	-/-
3	A	Antenna Tower	Model 2175	ETS-Lindgren	64762	300003745	izw	-/-	-/-
4	A	Positioning Controller	Model 2090	ETS-Lindgren	64672	300003746	izw	-/-	-/-
5	A	Turntable Interface-Box	Model 105637	ETS-Lindgren	44583	300003747	izw	-/-	-/-
6	A	TRILOG Broadband Test-Antenna 30 MHz - 3 GHz	VULB9163	Schwarzbeck Mess - Elektronik	318	300003696	vIKI!	30.09.2021	29.09.2023
7	A	Turntable	2089-4.0	EMCO	-/-	300004394	ne	-/-	-/-
8	A	PC	TeLine	F+W	-/-	300004388	ne	-/-	-/-
9	A	EMI Test Receiver	ESR3	Rohde & Schwarz	102587	300005771	k	20.05.2022	19.05.2023

7.2 Shielded fully anechoic chamber

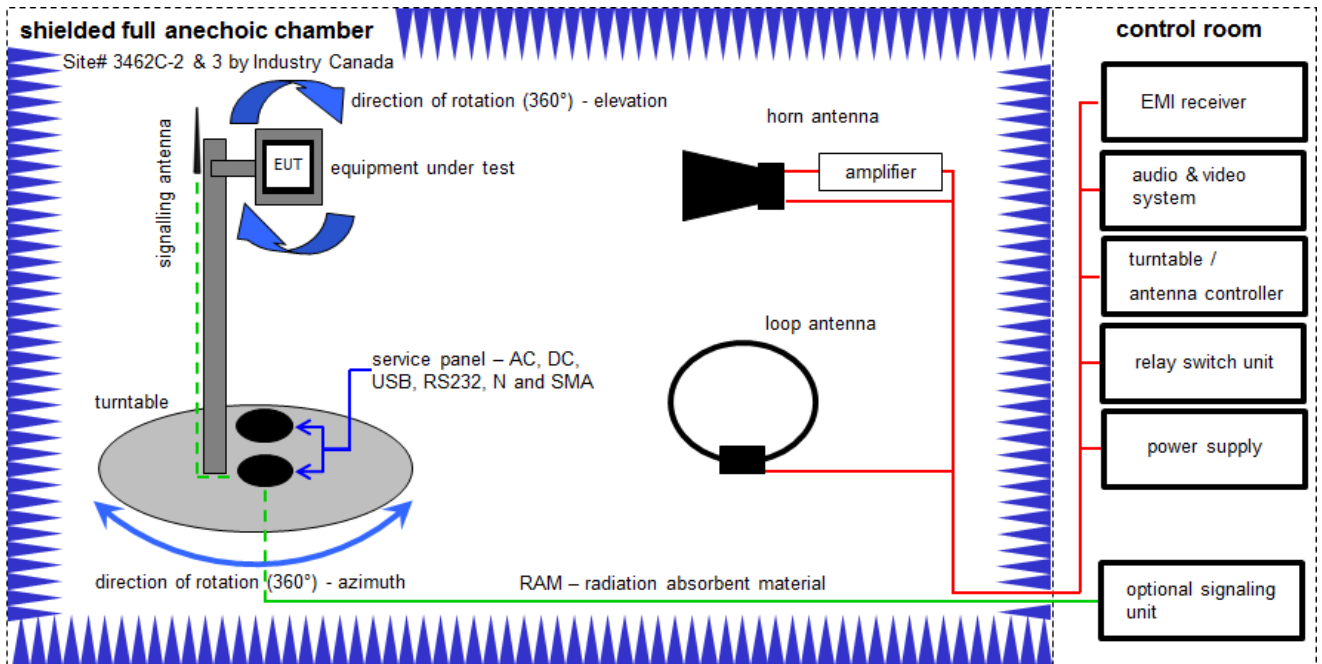

Measurement distance: horn antenna 3 meter; loop antenna 3 meter

$$FS = UR + CA + AF$$

(FS-field strength; UR-voltage at the receiver; CA-loss of the signal path; AF-antenna factor)

Example calculation:

$$FS [dB\mu V/m] = 40.0 [dB\mu V/m] + (-35.8) [dB] + 32.9 [dB/m] = 37.1 [dB\mu V/m] (71.61 \mu V/m)$$

Equipment table:

No.	Setup	Equipment	Type	Manufacturer	Serial No.	INV. No.	Kind of Calibration	Last Calibration	Next Calibration
1	C	Active Loop Antenna 9 kHz to 30 MHz	6502	EMCO	2210	300001015	vKI!	01.07.2021	31.07.2023
2	A, B	Double-Ridged Waveguide Horn Antenna 1-18.0GHz	3115	EMCO	9107-3696	300001604	vKI!	12.03.2021	11.03.2023
3	A	Highpass Filter	WHKX7.0/18G-8SS	Wainwright	18	300003789	ne	-/-	-/-
4	A, B	Broadband Amplifier 0.5-18 GHz	CBLU5184540	CERNEK	22051	300004483	ev	-/-	-/-
5	A, B, C	4U RF Switch Platform	L4491A	Agilent Technologies	MY50000032	300004510	ne	-/-	-/-
6	A, B, C	Computer	Intel Core i3 3220/3,3 GHz, Prozessor		2V2403033A54 21	300004591	ne	-/-	-/-
7	A, B, C	NEXIO EMV-Software	BAT EMC V3.21.0.27	EMCO		300004682	ne	-/-	-/-
8	A, B, C	Anechoic chamber		TDK		300003726	ne	-/-	-/-
9	A, B, C	EMI Test Receiver 9kHz-26,5GHz	ESR26	Rohde & Schwarz	101376	300005063	k	15.12.2021	31.12.2022
10	A	Band Reject Filter	WRCJV12-5120-5150-5350-5380-40SS	Wainwright	5	300005168	ev	-/-	-/-
11	A	Band Reject Filter	WRCJV12-5695-5725-5850-5880-40SS	Wainwright	5	300005169	ev	-/-	-/-

12	A	Band Reject Filter	WRCJV16-5440-5470-5725-5755-40SS	Wainwright	9	300005170	ev	-/-	-/-
13	A, B	RF-Amplifier	AMF-6F06001800-30-10P-R	NARDA-MITEQ Inc	2011571	300005240	ev	-/-	-/-

7.3 Radiated measurements > 18 GHz

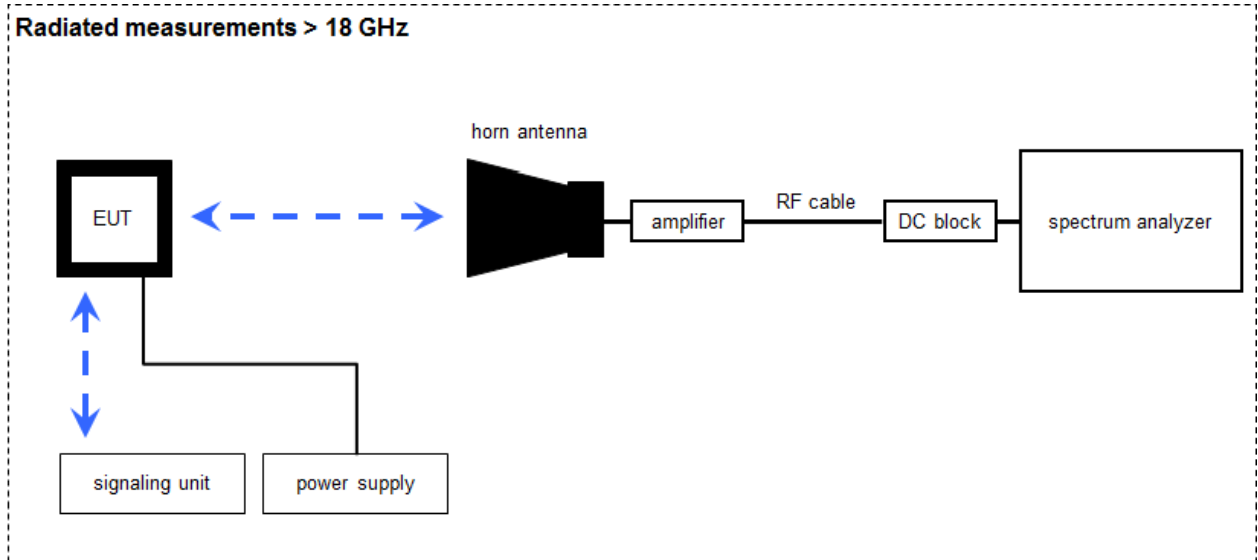

Measurement distance: horn antenna 50 cm

$$FS = UR + CA + AF$$

(FS-field strength; UR-voltage at the receiver; CA-loss signal path & distance correction; AF-antenna factor)

Example calculation:

$$FS [dB\mu V/m] = 40.0 [dB\mu V/m] + (-60.1) [dB] + 36.74 [dB/m] = 16.64 [dB\mu V/m] (6.79 \mu V/m)$$

Equipment table:

No.	Lab / Item	Equipment	Type	Manufacturer	Serial No.	INV. No.	Kind of Calibration	Last Calibration	Next Calibration
1	A	Microwave System Amplifier, 0.5-26.5 GHz	83017A	HP	00419	300002268	ev	-/-	-/-
2	A	Std. Gain Horn Antenna 18.0-26.5 GHz	638	Narda	01096	300000486	vKI!	17.01.2022	31.01.2024
3	A	Std. Gain Horn Antenna 26.5-40.0 GHz	V637	Narda	82-16	300000510	vKI!	17.01.2022	31.01.2024
4	A	Broadband Low Noise Amplifier 18-50 GHz	CBL18503070-XX	CERNEX	19338	300004273	ev	-/-	-/-
5	A	RF-Cable	ST18/SMAM/SMAM/48	Huber & Suhner	Batch no. 600918	400001182	ev	-/-	-/-
6	A	Signal Analyzer 40 GHz	FSV40	R&S	101042	300004517	k	25.01.2022	31.01.2023

7.4 Conducted measurements

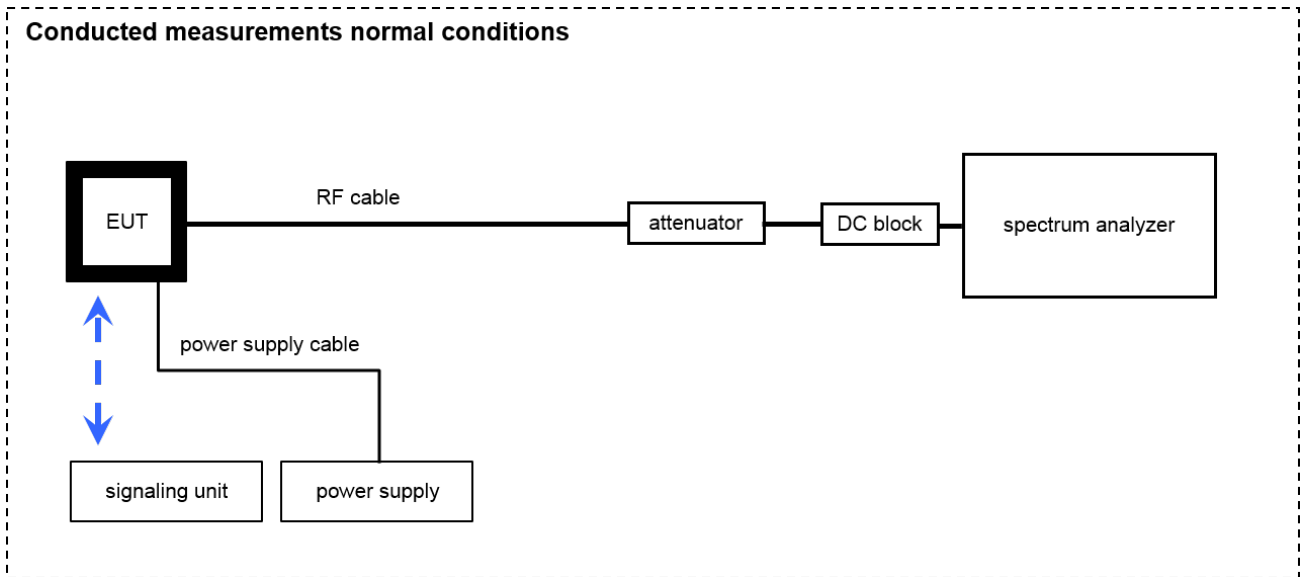

OP = AV + CA
(OP-output power; AV-analyzer value; CA-loss signal path)

Example calculation:

OP [dBm] = 6.0 [dBm] + 11.7 [dB] = 17.7 [dBm] (58.88 mW)

Equipment table:

No.	Setup	Equipment	Type	Manufacturer	Serial No.	INV. No.	Kind of Calibration	Last Calibration	Next Calibration
1	A	USB/GPIB interface	82357B	Agilent Technologies	MY52103346	300004390	ne	-/-	-/-
2	A	PC Laboratory	Exone	Fröhlich + Walter	S2642279-03 / 10	300004179	ne	-/-	-/-
3	A	Signal analyzer	FSV30	Rohde&Schwarz	1321.3008K30/103809	300005359	vIKI!	08.12.2020	07.12.2022
4	A	Tester Software RadioStar (C.BER2 for BT Conformance)	Version 1.0.0.X	CTC advanced GmbH	0001	400001380	ne	-/-	-/-

7.5 AC conducted

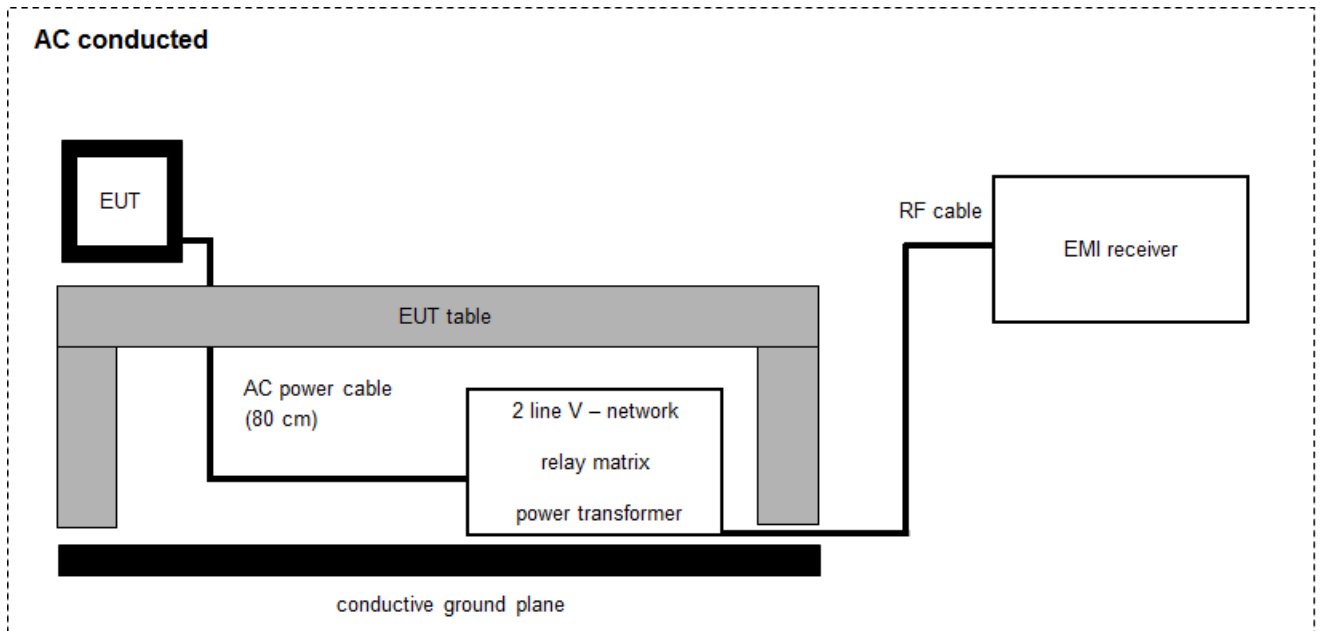

$$FS = UR + CF + VC$$

(FS-field strength; UR-voltage at the receiver; CR-loss of the cable and filter; VC-correction factor of the ISN)

Example calculation:

$$FS [dB\mu V/m] = 37.62 [dB\mu V/m] + 9.90 [dB] + 0.23 [dB] = 47.75 [dB\mu V/m] \quad (244.06 \mu V/m)$$

Equipment table:

No.	Setup	Equipment	Type	Manufacturer	Serial No.	INV. No.	Kind of Calibration	Last Calibration	Next Calibration
1	A	Two-line V-Network (LISN) 9 kHz to 30 MHz	ESH3-Z5	Rohde & Schwarz	892475/017	300002209	vKI!	14.12.2021	13.12.2023
2	A	RF-Filter-section	85420E	HP	3427A00162	300002214	NK!	-/-	-/-
3	A	EMI Test Receiver	ESCI 3	R&S	100083	300003312	k	09.12.2021	08.12.2022
4	A	Analyzer-Reference-System (Harmonics and Flicker)	ARS 16/1	SPS	A3509 07/0 0205	300003314	vKI!	29.12.2021	28.12.2023
5	A	Hochpass 150 kHz	EZ-25	R&S	100010	300003798	ev	-/-	-/-
6	A	PC	TecLine	F+W		300003532	ne	-/-	-/-
7	A	Switch-Unit	3488A	HP	2719A14505	300000368	ev	-/-	-/-

8 Sequence of testing

8.1 Sequence of testing radiated spurious 9 kHz to 30 MHz

Setup

- The equipment is set up to simulate normal operation mode as described in the user manual or defined by the manufacturer.
- If the EUT is a tabletop system, it is placed on a table with 0.8 m height.
- If the EUT is a floor standing device, it is placed directly on the turn table.
- Auxiliary equipment and cables are positioned to simulate normal operation conditions as described in ANSI C 63.4.
- The AC power port of the EUT (if available) is connected to a power outlet below the turntable.
- Measurement distance is 3 m (see ANSI C 63.4) – see test details.
- EUT is set into operation.

Premeasurement*

- The turntable rotates from 0° to 315° using 45° steps.
- The antenna height is 1 m.
- At each turntable position the analyzer sweeps with positive-peak detector to find the maximum of all emissions.

Final measurement

- Identified emissions during the pre-measurement are maximized by the software by rotating the turntable from 0° to 360°.
- Loop antenna is rotated about its vertical axis for maximum response at each azimuth about the EUT. (For certain applications, the loop antenna plane may also need to be positioned horizontally at the specified distance from the EUT)
- The final measurement is done in the position (turntable and elevation) causing the highest emissions with quasi-peak (as described in ANSI C 63.4).
- Final levels, frequency, measuring time, bandwidth, turntable position, correction factor, margin to the limit and limit will be recorded. A plot with the graph of the premeasurement and the limit is stored.

*Note: The sequence will be repeated three times with different EUT orientations.

8.2 Sequence of testing radiated spurious 30 MHz to 1 GHz

Setup

- The equipment is set up to simulate normal operation mode as described in the user manual or defined by the manufacturer.
- If the EUT is a tabletop system, a table with 0.8 m height is used, which is placed on the ground plane.
- If the EUT is a floor standing device, it is placed on the ground plane with insulation between both.
- Auxiliary equipment and cables are positioned to simulate normal operation conditions as described in ANSI C 63.4.
- The AC power port of the EUT (if available) is connected to a power outlet below the turntable.
- Measurement distance is 10 m or 3 m (see ANSI C 63.4) – see test details.
- EUT is set into operation.

Premeasurement

- The turntable rotates from 0° to 315° using 45° steps.
- The antenna is polarized vertical and horizontal.
- The antenna height changes from 1 m to 3 m.
- At each turntable position, antenna polarization and height the analyzer sweeps three times in peak to find the maximum of all emissions.

Final measurement

- The final measurement is performed for at least six highest peaks according to the requirements of the ANSI C63.4.
- Based on antenna and turntable positions at which the peak values are measured the software maximize the peaks by changing turntable position $\pm 45^\circ$ and antenna height between 1 and 4 m.
- The final measurement is done with quasi-peak detector (as described in ANSI C 63.4).
- Final levels, frequency, measuring time, bandwidth, antenna height, antenna polarization, turntable angle, correction factor, margin to the limit and limit are recorded. A plot with the graph of the premeasurement with marked maximum final results and the limit is stored.

8.3 Sequence of testing radiated spurious 1 GHz to 18 GHz

Setup

- The equipment is set up to simulate normal operation mode as described in the user manual or defined by the manufacturer.
- If the EUT is a tabletop system, a 2-axis positioner with 1.5 m height is used.
- If the EUT is a floor standing device, it is placed directly on the turn table.
- Auxiliary equipment and cables are positioned to simulate normal operation conditions as described in ANSI C 63.4.
- The AC power port of the EUT (if available) is connected to a power outlet below the turntable.
- Measurement distance is 3 m (see ANSI C 63.4) – see test details.
- EUT is set into operation.

Premeasurement

- The turntable rotates from 0° to 315° using 45° steps.
- The antenna is polarized vertical and horizontal.
- The antenna height is 1.5 m.
- At each turntable position and antenna polarization the analyzer sweeps with positive peak detector to find the maximum of all emissions.

Final measurement

- The final measurement is performed for at least six highest peaks according to the requirements of the ANSI C63.4.
- Based on antenna and turntable positions at which the peak values are measured the software maximizes the peaks by rotating the turntable from 0° to 360°. This measurement is repeated for different EUT-table positions (0° to 150° in 30°-steps) and for both antenna polarizations.
- The final measurement is done in the position (turntable, EUT-table and antenna polarization) causing the highest emissions with Peak and RMS detector (as described in ANSI C 63.4).
- Final levels, frequency, measuring time, bandwidth, turntable position, EUT-table position, antenna polarization, correction factor, margin to the limit and limit are recorded. A plot with the graph of the premeasurement with marked maximum final results and the limit is stored.

8.4 Sequence of testing radiated spurious above 18 GHz

Setup

- The equipment is set up to simulate normal operation mode as described in the user manual or defined by the manufacturer.
- Auxiliary equipment and cables are positioned to simulate normal operation conditions as described in ANSI C 63.4.
- The AC power port of the EUT (if available) is connected to a power outlet.
- The measurement distance is as appropriate (e.g. 0.5 m).
- The EUT is set into operation.

Premeasurement

- The test antenna is handheld and moved carefully over the EUT to cover the EUT's whole sphere and different polarizations of the antenna.

Final measurement

- The final measurement is performed at the position and antenna orientation causing the highest emissions with Peak and RMS detector (as described in ANSI C 63.4).
- Final levels, frequency, measuring time, bandwidth, correction factor, margin to the limit and limit are recorded. A plot with the graph of the premeasurement and the limit is stored.

9 Measurement uncertainty

Measurement uncertainty		
Test case	Uncertainty	
Antenna gain	± 3 dB	
Power spectral density	± 1.56 dB	
DTS bandwidth	± 100 kHz (depends on the used RBW)	
Occupied bandwidth	± 100 kHz (depends on the used RBW)	
Maximum output power conducted	± 1.56 dB	
Detailed spurious emissions @ the band edge - conducted	± 1.56 dB	
Band edge compliance radiated	± 3 dB	
Spurious emissions conducted	> 3.6 GHz	± 1.56 dB
	> 7 GHz	± 1.56 dB
	> 18 GHz	± 2.31 dB
	≥ 40 GHz	± 2.97 dB
Spurious emissions radiated below 30 MHz	± 3 dB	
Spurious emissions radiated 30 MHz to 1 GHz	± 3 dB	
Spurious emissions radiated 1 GHz to 12.75 GHz	± 3.7 dB	
Spurious emissions radiated above 12.75 GHz	± 4.5 dB	
Spurious emissions conducted below 30 MHz (AC conducted)	± 2.6 dB	

10 Summary of measurement results

<input checked="" type="checkbox"/>	No deviations from the technical specifications were ascertained
<input type="checkbox"/>	There were deviations from the technical specifications ascertained
<input type="checkbox"/>	This test report is only a partial test report. The content and verdict of the performed test cases are listed below.

TC Identifier	Description	Verdict	Date	Remark
RF-Testing	CFR Title 47 Part 15 RSS 247, Issue 2	See table	2022-12-12	-/-

Test specification clause	Test case	C	NC	NA	NP	Remark
-/-	Output power verification (cond.)	-/-				Declared
-/-	Antenna gain	-/-				Declared
U-NII Part 15	Duty cycle	-/-				-/-
§15.407(a) RSS - 247 (6.2.x.1)	Maximum output power (conducted & radiated)	<input checked="" type="checkbox"/>	<input type="checkbox"/>	<input type="checkbox"/>	<input type="checkbox"/>	-/-
§15.407(a) RSS - 247 (6.2.x.1)	Power spectral density	<input checked="" type="checkbox"/>	<input type="checkbox"/>	<input type="checkbox"/>	<input type="checkbox"/>	-/-
RSS - 247 (6.2.4.1)	Spectrum bandwidth 6dB bandwidth	<input checked="" type="checkbox"/>	<input type="checkbox"/>	<input type="checkbox"/>	<input type="checkbox"/>	-/-
§15.407(a) RSS - 247 (6.2.x.2)	Spectrum bandwidth 26dB bandwidth	<input checked="" type="checkbox"/>	<input type="checkbox"/>	<input type="checkbox"/>	<input type="checkbox"/>	-/-
RSS Gen clause 6.6	Spectrum bandwidth 99% bandwidth	-/-				-/-
§15.205 RSS - 247 (6.2.x.2)	Band edge compliance radiated	<input checked="" type="checkbox"/>	<input type="checkbox"/>	<input type="checkbox"/>	<input type="checkbox"/>	-/-
§15.407(b) RSS - 247 (6.2.x.2)	TX spurious emissions radiated	<input checked="" type="checkbox"/>	<input type="checkbox"/>	<input type="checkbox"/>	<input type="checkbox"/>	-/-
§15.209(a) RSS-Gen	Spurious emissions radiated < 30 MHz	<input checked="" type="checkbox"/>	<input type="checkbox"/>	<input type="checkbox"/>	<input type="checkbox"/>	-/-
§15.107(a) §15.207	Spurious emissions conducted emissions< 30 MHz	<input checked="" type="checkbox"/>	<input type="checkbox"/>	<input type="checkbox"/>	<input type="checkbox"/>	-/-
§15.407 RSS - 247 (6.3)	DFS	-/-				See report 1-3547/21-01-16

Notes:

C: Compliant	NC: Not compliant	NA: Not applicable	NP: Not performed
---------------------	--------------------------	---------------------------	--------------------------

11 Additional comments

Reference documents: DFS report: 1-3547/21-01-16

Special test descriptions: None

Configuration descriptions: User power settings for all tests:
 20 MHz modes all channels: 13
 40 MHz modes channels 38 and 62: 10
 40 MHz modes all other channels: 12
 80 MHz mode channels 42 and 106: 9
 80 MHz mode all other channels: 11

EUT selection:

- Only one device available
- Devices selected by the customer
- Devices selected by the laboratory (Randomly)

Provided channels:

Channels with 20 MHz channel bandwidth:

U-NII-1 & U-NII-2A (5150 MHz to 5250 MHz & 5250 MHz to 5350 MHz) channel number & center frequency								
channel	36	40	44	48	52	56	60	64
f _c / MHz	5180	5200	5220	5240	5260	5280	5300	5320

U-NII-2C (5470 MHz to 5725 MHz) channel number & center frequency											
channel	100	104	108	112	116	120	124	128	132	136	144
f _c / MHz	5500	5520	5540	5560	5580	5600	5620	5640	5660	5680	5720

U-NII-3 (5725 MHz to 5850 MHz) channel number & center frequency					
channel	149	153	157	161	165
f _c / MHz	5745	5765	5785	5805	5825

Channels with 40 MHz channel bandwidth:

U-NII-1 & U-NII-2A (5150 MHz to 5250 MHz & 5250 MHz to 5350 MHz) channel number & center frequency				
channel	38	46	54	62
f _c / MHz	5190	5230	5270	5310

U-NII-2C (5470 MHz to 5725 MHz) channel number & center frequency				
channel	102	110	118	126
f _c / MHz	5510	5550	5590	5630

U-NII-3 (5725 MHz to 5850 MHz) channel number & center frequency		
channel	151	159
f _c / MHz	5755	5795

Channels with 80 MHz channel bandwidth:

U-NII-1 & U-NII-2A (5150 MHz to 5250 MHz & 5250 MHz to 5350 MHz) channel number & center frequency		
channel	42	58
f _c / MHz	5210	5290

U-NII-2C (5470 MHz to 5725 MHz) channel number & center frequency		
channel	106	122
f _c / MHz	5530	5610

U-NII-3 (5725 MHz to 5850 MHz) channel number & center frequency	
channel	155
f _c / MHz	5775

Note: The channels used for the tests were marked in bold in the list.

Test mode:

- No test mode available.
Iperf is used to transmit data to a companion device
- Special software is used.
EUT is transmitting pseudo random data by itself

Antennas and transmit operating modes:

- Operating mode 1 (single antenna)
 - Equipment with 1 antenna,
 - Equipment with 2 diversity antennas operating in switched diversity mode by which at any moment in time only 1 antenna is used,
 - Smart antenna system with 2 or more transmit/receive chains, but operating in a mode where only 1 transmit/receive chain is used)
- Operating mode 2 (multiple antennas, no beamforming)
 - Equipment operating in this mode contains a smart antenna system using two or more transmit/receive chains simultaneously but without beamforming.
- Operating mode 3 (multiple antennas, with beamforming)
 - Equipment operating in this mode contains a smart antenna system using two or more transmit/receive chains simultaneously with beamforming.
In addition to the antenna assembly gain (G), the beamforming gain (Y) may have to be taken into account when performing the measurements.

12 Measurement results

12.1 Identify worst case data rate

Measurement:

All modes of the module will be measured with an average power meter to identify the maximum transmission power on mid channel. In the case that only one or two channels are available, only these will be measured.

In further tests only the identified worst case modulation scheme or bandwidth will be measured.

Measurement parameters:

Measurement parameter	
Detector:	Peak
Sweep time:	Auto
Resolution bandwidth:	3 MHz
Video bandwidth:	3 MHz
Trace mode:	Max hold
Used test setup:	See chapter 7.4 – A
Measurement uncertainty:	See chapter 9

Results:

OFDM – mode	Modulation scheme / bandwidth					
	U-NII-1 & U-NII-2A		U-NII-2C		U-NII-3	
	lowest channel	highest channel	lowest channel	highest channel	lowest channel	highest channel
a – mode	6 Mbit/s	6 Mbit/s	6 Mbit/s	6 Mbit/s	6 Mbit/s	6 Mbit/s
n/ac HT20 – mode	MCS0	MCS0	MCS0	MCS0	MCS0	MCS0
n/ac HT40 – mode	MCS0	MCS0	MCS0	MCS0	MCS0	MCS0
ac VHT80 – mode	MCS0	MCS0	MCS0	MCS0	MCS0	MCS0

12.2 Antenna gain

Limits:

Antenna Gain
6 dBi / > 6 dBi output power and power density reduction required

Gain [dBi] declared	5 GHz
ANT1-DB1-RAF-xxx Dipole	5.0
A24-HASM-450 Model no: SA-006 Rev. C R- AN2400-5701RS-Z Dipole	Not suited for 5 GHz
TAOGLAS FXP830.07.0100C PCB	4.7
TAOGLAS PC11.07.0100A PCB	4.5

12.3 Duty cycle

Description:

The duty cycle is necessary to compute the maximum power during an actual transmission. The shown plots and values are to show an example of the measurement procedure. The real value is measured direct during the power measurement or power density measurement. The correction value is shown in each plot of these measurements.

Measurement:

Measurement parameter	
According to: KDB789033 D02, B.	
External result file(s)	1-3547_21-01-15_Annex_MR_A_1.pdf FCC Part 15.407 Max Output Power and PSD
Used test setup:	See chapter 7.4 – A
Measurement uncertainty:	See chapter 9

Results:

Duty cycle and correction factor:

OFDM – mode	Calculation method			
	$T_{on} (D2_{plot}) * 100 / T_{complete} (D3_{plot}) = \text{duty cycle}$ $10 * \log(\text{duty cycle}) = \text{correction factor}$			
	$T_{on} (D2_{plot})$	$T_{complete} (D3_{plot})$	Duty cycle	Correction factor
a – mode			100%	0.0 dB
n/ac HT20 – mode			100%	0.0 dB
n/ac HT40 – mode			100%	0.0 dB
ac VHT80 – mode			100%	0.0 dB

12.4 Maximum output power

12.4.1 Maximum output power according to FCC requirements

Description:

Measurement of the maximum output power conducted

Measurement:

Measurement parameter	
According to: KDB789033 D02, E.2.e.	
External result file(s)	1-3547_21-01-15_Annex_MR_A_1.pdf FCC Part 15.407 Max Output Power and PSD
Used test setup:	See chapter 7.4 – A
Measurement uncertainty:	See chapter 9
Standard parts:	FCC: § 15.407 (a)

Limits:

Limits	
Radiated output power	Conducted output power
Band 5150 MHz – 5250 MHz	
<p>For an outdoor access point: Conducted power + 6 dBi antenna gain</p> <p>For an indoor access point: Conducted power + 6 dBi antenna gain</p> <p>For fixed point-to-point access points Conducted power + 23 dBi antenna gain</p> <p>For client devices Conducted power + 6 dBi antenna gain</p> <p>(If the Antenna gain is greater than the Limit: 1dB reduction in the max. conducted output power for each 1 dB of antenna gain in excess of the Limit)</p>	<p>For an outdoor access point: output power $\leq 1\text{W}/30\text{dBm}$ The maximum e.i.r.p. at any elevation angle above 30 degrees as measured from the horizon must not exceed 125 mW (21 dBm)</p> <p>For an indoor access point output power $\leq 1\text{W}/30\text{dBm}$</p> <p>For fixed point-to-point access points output power $\leq 1\text{W}/30\text{dBm}$</p> <p>For client devices output power $\leq 250\text{ mW}/24\text{dBm}$</p>

Band 5250MHz – 5350 MHz	
<p>Conducted power + 6 dBi antenna gain</p> <p>(Antenna gain higher than the Limit: 1dB reduction in the max. conducted output power for each 1 dB of antenna gain in excess of the Limit)</p>	<p>Output power \leq lesser of 250mW or $11\text{dBm} + 10\log B$ (B is the 26 dB emission bandwidth in megahertz)</p>
Band 5470MHz – 5725 MHz	
<p>Conducted power + 6 dBi antenna gain</p> <p>(Antenna gain higher than the Limit: 1dB reduction in the max. conducted output power for each 1 dB of antenna gain in excess of the Limit)</p>	<p>Output power \leq lesser of 250mW or $11\text{dBm} + 10\log B$ (B is the 26 dB emission bandwidth in megahertz)</p>
Band 5725MHz – 5850 MHz	
<p>Conducted power + 6 dBi antenna gain</p> <p>(Antenna gain higher than the Limit: 1dB reduction in the max. conducted output power for each 1 dB of antenna gain in excess of the Limit Exception: fixed point-to-point U-NII devices, no corresponding reduction in transmitter conducted power)</p>	<p>output power \leq 1W/30dBm</p>

Results:

a	Maximum output power conducted [dBm]		
	U-NII-1 (5150 MHz to 5250 MHz)		
	Lowest channel	Middle channel	Highest channel
	11.2	11.1	11.3
	U-NII-2A (5250 MHz to 5350 MHz)		
	Lowest channel	Middle channel	Highest channel
	11.9	12.6	12.2
	U-NII-2C (5470 MHz to 5725 MHz)		
	Lowest channel	Middle channel	Highest channel
	9.2	9.7	10.3
	U-NII-3 (5725 MHz to 5850 MHz)		
	Lowest channel	Middle channel	Highest channel
10.4	9.5	10.2	

Results:

n/ac HT20	Maximum output power conducted [dBm]		
	U-NII-1 (5150 MHz to 5250 MHz)		
	Lowest channel	Middle channel	Highest channel
	10.9	10.8	11.0
	U-NII-2A (5250 MHz to 5350 MHz)		
	Lowest channel	Middle channel	Highest channel
	11.6	12.2	11.8
	U-NII-2C (5470 MHz to 5725 MHz)		
	Lowest channel	Middle channel	Highest channel
	8.9	8.7	10.1
	U-NII-3 (5725 MHz to 5850 MHz)		
	Lowest channel	Middle channel	Highest channel
10.1	9.2	10.0	

Results:

n/ac HT40	Maximum output power conducted [dBm]		
	U-NII-1 (5150 MHz to 5250 MHz)		
	Lowest channel		Highest channel
	8.7		11.1
	U-NII-2A (5250 MHz to 5350 MHz)		
	Lowest channel		Highest channel
	11.3		7.8
	U-NII-2C (5470 MHz to 5725 MHz)		
	Lowest channel	Middle channel	Highest channel
	8.7	8.9	9.4
	U-NII-3 (5725 MHz to 5850 MHz)		
	Lowest channel		Highest channel
9.9		9.1	

Results:

ac VHT80	Maximum output power conducted [dBm]		
	U-NII-1 (5150 MHz to 5250 MHz)		
	Middle channel		
	6.9		
	U-NII-2A (5250 MHz to 5350 MHz)		
	Middle channel		
	9.9		
	U-NII-2C (5470 MHz to 5725 MHz)		
	Lowest channel	Middle channel	Highest channel
	6.3	7.7	8.5
	U-NII-3 (5725 MHz to 5850 MHz)		
	Middle channel		
7.7			

12.4.2 Maximum output power according to ISED requirements

Description:

Measurement of the maximum output power conducted + radiated

Measurement:

Measurement parameter	
External result file(s)	1-3547_21-01-15_Annex_MR_A_1.pdf ISED Max Output Power and PSD
Used test setup:	See chapter 7.4 – A
Measurement uncertainty:	See chapter 9

Limits:

Radiated output power	Conducted output power for mobile equipment
The lesser one of 200 mW or 10 dBm + 10 log Bandwidth 5.150-5.250 GHz 1 W or 17 dBm + 10 log Bandwidth 5.250-5.350 GHz 1 W or 17 dBm + 10 log Bandwidth 5.470-5.725 GHz (where Bandwidth is the 99% Bandwidth [MHz]) Conducted power + 6dBi antenna gain 5.725-5.825 GHz Devices other than client devices 5925-7125 MHz: ≤ 30dBm Client devices 5925-7125 MHz: ≤ 24dBm	The lesser one of 250mW or 11 dBm + 10 log Bandwidth 5.250-5.350 GHz 250mW or 11 dBm + 10 log Bandwidth 5.470-5.725 GHz (where Bandwidth is the 99% Bandwidth [MHz]) 1W 5.725-5.825 GHz

Results:

a	Maximum output power [dBm]		
	U-NII-1 (5150 MHz to 5250 MHz)		
	Lowest channel	Middle channel	Highest channel
	Conducted		
	11.1	10.8	11.2
	Radiated (calculated – see chapter antenna gain)		
	16.1	15.8	16.2
	U-NII-2A (5250 MHz to 5350 MHz)		
	Lowest channel	Middle channel	Highest channel
	Conducted		
	11.8	11.5	12.1
	Radiated (calculated – see chapter antenna gain)		
	16.8	16.5	17.1
	U-NII-2C (5470 MHz to 5725 MHz)		
	Lowest channel	Middle channel	Highest channel
	Conducted		
	9.1	9.6	10.2
	Radiated (calculated – see chapter antenna gain)		
	14.1	14.6	15.2
	U-NII-3 (5725 MHz to 5850 MHz)		
Lowest channel	Middle channel	Highest channel	
Conducted			
10.3	9.3	10.1	
Radiated (calculated – see chapter antenna gain)			
15.3	14.3	15.1	

Results:

n/ac HT20	Maximum output power [dBm]		
	U-NII-1 (5150 MHz to 5250 MHz)		
	Lowest channel	Middle channel	Highest channel
	Conducted		
	10.5	10.7	11.0
	Radiated (calculated – see chapter antenna gain)		
	15.5	15.7	16.0
	U-NII-2A (5250 MHz to 5350 MHz)		
	Lowest channel	Middle channel	Highest channel
	Conducted		
	11.6	12.1	11.6
	Radiated (calculated – see chapter antenna gain)		
	16.6	17.1	16.6
	U-NII-2C (5470 MHz to 5725 MHz)		
	Lowest channel	Middle channel	Highest channel
	Conducted		
	8.8	7.6	10.1
	Radiated (calculated – see chapter antenna gain)		
	13.8	12.6	15.1
	U-NII-3 (5725 MHz to 5850 MHz)		
Lowest channel	Middle channel	Highest channel	
Conducted			
10.0	9.1	9.9	
Radiated (calculated – see chapter antenna gain)			
15.0	14.1	14.9	

Results:

n/ac HT40	Maximum output power [dBm]		
	U-NII-1 (5150 MHz to 5250 MHz)		
	Lowest channel		Highest channel
	Conducted		
	8.6		11.0
	Radiated (calculated – see chapter antenna gain)		
	13.6		16.0
	U-NII-2A (5250 MHz to 5350 MHz)		
	Lowest channel		Highest channel
	Conducted		
	11.3		7.7
	Radiated (calculated – see chapter antenna gain)		
	16.3		12.7
	U-NII-2C (5470 MHz to 5725 MHz)		
	Lowest channel	Middle channel	Highest channel
	Conducted		
	8.7	8.9	9.4
	Radiated (calculated – see chapter antenna gain)		
	13.7	14.9	14.4
	U-NII-3 (5725 MHz to 5850 MHz)		
Lowest channel		Highest channel	
Conducted			
9.9		9.1	
Radiated (calculated – see chapter antenna gain)			
14.9		14.1	

Results:

ac VHT80	Maximum output power [dBm]		
	U-NII-1 (5150 MHz to 5250 MHz)		
	Middle channel		
	Conducted		
	6.9		
	Radiated (calculated – see chapter antenna gain)		
	11.9		
	U-NII-2A (5250 MHz to 5350 MHz)		
	Middle channel		
	Conducted		
	9.9		
	Radiated (calculated – see chapter antenna gain)		
	14.9		
	U-NII-2C (5470 MHz to 5725 MHz)		
	Lowest channel	Middle channel	Highest channel
	Conducted		
	6.3	7.6	8.5
	Radiated (calculated – see chapter antenna gain)		
	11.3	12.6	13.5
	U-NII-3 (5725 MHz to 5850 MHz)		
Middle channel			
Conducted			
7.8			
Radiated (calculated – see chapter antenna gain)			
12.8			

12.5 Power spectral density

12.5.1 Power spectral density according to FCC requirements

Description:

Measurement of the power spectral density of a digital modulated system. The measurement is repeated at the lowest, middle and highest channel.

Measurement:

Measurement parameter	
According to: KDB789033 D02, F.	
External result file(s)	1-3547_21-01-15_Annex_MR_A_1.pdf FCC Part 15.407 Max Output Power and PSD
Used test setup:	See chapter 7.4 – A
Measurement uncertainty:	See chapter 9
Standard parts:	FCC: § 15.407 (a)

Limits:

Power Spectral Density
Band 5150 MHz – 5250 MHz
<p>For an outdoor access point power spectral density conducted ≤ 17 dBm in any 1 MHz band*</p> <p>For an indoor access point power spectral density conducted ≤ 17 dBm in any 1 MHz band*</p> <p>For fixed point-to-point access points power spectral density conducted ≤ 17 dBm in any 1 MHz band**</p> <p>For client devices point power spectral density conducted ≤ 11 dBm in any 1 MHz band*</p> <p>*If transmitting antennas of directional gain greater than 6 dBi are used the maximum power spectral density shall be reduced by the amount in dB that the directional gain of the antenna exceeds 6 dBi</p> <p>**Fixed point-to-point U-NII devices may employ antennas with directional gain up to 23 dBi without any corresponding reduction in the maximum power spectral density. For fixed point-to-point transmitters that employ a directional antenna gain greater than 23 dBi, a 1 dB reduction in maximum power spectral density is required for each 1 dB of antenna gain in excess of 23 dBi.</p>
Band 5250MHz – 5350 MHz
<p>power spectral density conducted ≤ 11 dBm in any 1 MHz band*</p> <p>*If transmitting antennas of directional gain greater than 6 dBi are used the maximum power spectral density shall be reduced by the amount in dB that the directional gain of the antenna exceeds 6 dBi</p>
Band 5470MHz – 5725 MHz
<p>power spectral density conducted ≤ 11 dBm in any 1 MHz band*</p> <p>*If transmitting antennas of directional gain greater than 6 dBi are used the maximum power spectral density shall be reduced by the amount in dB that the directional gain of the antenna exceeds 6 dBi</p>

Band 5725MHz – 5850 MHz
power spectral density conducted ≤ 30 dBm in any 500 kHz band
If transmitting antennas of directional gain greater than 6 dBi are used the maximum power spectral density shall be reduced by the amount in dB that the directional gain of the antenna exceeds 6 dBi

Results:

a	Power spectral density (dBm/1MHz or dBm/500kHz)		
	U-NII-1 (5150 MHz to 5250 MHz)		
	Lowest channel	Middle channel	Highest channel
	0.2	0.0	0.2
	U-NII-2A (5250 MHz to 5350 MHz)		
	Lowest channel	Middle channel	Highest channel
	0.9	1.5	1.1
	U-NII-2C (5470 MHz to 5725 MHz)		
	Lowest channel	Middle channel	Highest channel
	-1.9	-1.4	-0.7
	U-NII-3 (5725 MHz to 5850 MHz)		
	Lowest channel	Middle channel	Highest channel
-3.7	-4.7	-3.9	

Results:

n/ac HT20	Power spectral density (dBm/1MHz or dBm/500kHz)		
	U-NII-1 (5150 MHz to 5250 MHz)		
	Lowest channel	Middle channel	Highest channel
	-0.3	-0.5	-0.2
	U-NII-2A (5250 MHz to 5350 MHz)		
	Lowest channel	Middle channel	Highest channel
	0.4	1.1	0.6
	U-NII-2C (5470 MHz to 5725 MHz)		
	Lowest channel	Middle channel	Highest channel
	-2.4	-2.2	-1.1
	U-NII-3 (5725 MHz to 5850 MHz)		
	Lowest channel	Middle channel	Highest channel
-4.1	-5.1	-4.2	

Results:

n/ac HT40	Power spectral density (dBm/1MHz or dBm/500kHz)		
	U-NII-1 (5150 MHz to 5250 MHz)		
	Lowest channel		Highest channel
	-5.7		-3.1
	U-NII-2A (5250 MHz to 5350 MHz)		
	Lowest channel		Highest channel
	-3.0		-6.3
	U-NII-2C (5470 MHz to 5725 MHz)		
	Lowest channel	Middle channel	Highest channel
	-5.7	-5.2	-5.0
	U-NII-3 (5725 MHz to 5850 MHz)		
	Lowest channel		Highest channel
-7.3		-8.3	

Results:

ac VHT80	Power spectral density (dBm/1MHz or dBm/500kHz)		
	U-NII-1 (5150 MHz to 5250 MHz)		
	Middle channel		
	-10.5		
	U-NII-2A (5250 MHz to 5350 MHz)		
	Middle channel		
	-7.6		
	U-NII-2C (5470 MHz to 5725 MHz)		
	Lowest channel	Middle channel	Highest channel
	-10.9	-10.1	-8.9
	U-NII-3 (5725 MHz to 5850 MHz)		
	Middle channel		
-12.1			

12.5.2 Power spectral density according to ISED requirements

Description:

Measurement of the power spectral density of a digital modulated system. The measurement is repeated at the lowest, middle and highest channel.

Measurement:

Measurement parameter	
External result file(s)	1-3547_21-01-15_Annex_MR_A_1.pdf ISED Max Output Power and PSD
Used test setup:	See chapter 7.4 – A
Measurement uncertainty:	See chapter 9
Standard parts:	RSS-248i 4.6.2 / 4.6.3

Limits:

Power Spectral Density
power spectral density e.i.r.p. ≤ 10 dBm in any 1 MHz band (band 5150 – 5250 MHz)
power spectral density conducted ≤ 11 dBm in any 1 MHz band (band 5250 – 5350 MHz)
power spectral density conducted ≤ 11 dBm in any 1 MHz band (band 5470 – 5725 MHz)
power spectral density conducted ≤ 30 dBm in any 500 kHz band (band 5725 – 5850 MHz)
for devices other than client devices
power spectral density e.i.r.p. ≤ 5 dBm in any 1 MHz band (band 5925 – 7125 MHz)
for client devices
power spectral density e.i.r.p. ≤ 1 dBm in any 1 MHz band (band 5925 – 7125 MHz)

Results:

a	Power spectral density (dBm/1MHz or dBm/500kHz)		
	U-NII-1 (5150 MHz to 5250 MHz)		
	Lowest channel	Middle channel	Highest channel
	Conducted		
	0.2	-0.2	0.2
	Radiated (calculated – see chapter antenna gain)		
	5.2	4.8	5.2
	U-NII-2A (5250 MHz to 5350 MHz)		
	Lowest channel	Middle channel	Highest channel
	0.9	1.5	1.1
	U-NII-2C (5470 MHz to 5725 MHz)		
	Lowest channel	Middle channel	Highest channel
	-1.9	-1.4	-0.7
	U-NII-3 (5725 MHz to 5850 MHz)		
	Lowest channel	Middle channel	Highest channel
-3.7	-4.7	-3.9	

Results:

n/ac HT20	Power spectral density (dBm/1MHz or dBm/500kHz)		
	U-NII-1 (5150 MHz to 5250 MHz)		
	Lowest channel	Middle channel	Highest channel
	Conducted		
	-0.5	-0.5	-0.3
	Radiated (calculated – see chapter antenna gain)		
	4.5	4.5	4.7
	U-NII-2A (5250 MHz to 5350 MHz)		
	Lowest channel	Middle channel	Highest channel
	0.4	1.0	0.5
	U-NII-2C (5470 MHz to 5725 MHz)		
	Lowest channel	Middle channel	Highest channel
	-2.4	-3.0	-1.1
	U-NII-3 (5725 MHz to 5850 MHz)		
	Lowest channel	Middle channel	Highest channel
-4.1	-5.1	-4.2	

Results:

n/ac HT40	Power spectral density (dBm/1MHz or dBm/500kHz)		
	U-NII-1 (5150 MHz to 5250 MHz)		
	Lowest channel		Highest channel
	Conducted		
	-5.8		-3.1
	Radiated (calculated – see chapter antenna gain)		
	-0.8		1.9
	U-NII-2A (5250 MHz to 5350 MHz)		
	Lowest channel		Highest channel
	-2.9		-6..3
	U-NII-2C (5470 MHz to 5725 MHz)		
	Lowest channel	Middle channel	Highest channel
	-5.7	-5.2	-5.0
	U-NII-3 (5725 MHz to 5850 MHz)		
	Lowest channel		Highest channel
-7.3		-8.3	

Results:

ac VHT80	Power spectral density (dBm/1MHz or dBm/500kHz)		
	U-NII-1 (5150 MHz to 5250 MHz)		
	Middle channel		
	Conducted		
	-10.5		
	Radiated (calculated – see chapter antenna gain)		
	-5.5		
	U-NII-2A (5250 MHz to 5350 MHz)		
	Middle channel		
	-7.6		
	U-NII-2C (5470 MHz to 5725 MHz)		
	Lowest channel	Middle channel	Highest channel
	-10.9	-10.1	-8.9
U-NII-3 (5725 MHz to 5850 MHz)			
Middle channel			
-12.1			

12.6 Minimum emission bandwidth for the band 5.725-5.85 GHz

Description:

Measurement of the 6 dB bandwidth of the modulated signal.

Measurement:

Measurement parameter	
According to: KDB789033 D02, C.2.	
External result file(s)	1-3547_21-01-15_Annex_MR_A_1.pdf FCC Part 15.407 & ISED Minimum Emission BW
Used test setup:	See chapter 7.4 – A
Measurement uncertainty:	See chapter 9

Limits:

FCC	ISED
The minimum 6 dB bandwidth shall be at least 500 kHz.	

Results:

a	6 dB emission bandwidth (MHz)		
	U-NII-3 (5725 MHz to 5850 MHz)		
	Lowest channel	Middle channel	Highest channel
	15.4	15.5	15.2

Results:

n/ac HT20	6 dB emission bandwidth (MHz)		
	U-NII-3 (5725 MHz to 5850 MHz)		
	Lowest channel	Middle channel	Highest channel
	15.2	15.2	15.2

Results:

n/ac HT40	6 dB emission bandwidth (MHz)	
	U-NII-3 (5725 MHz to 5850 MHz)	
	Lowest channel	Highest channel
	35.1	35.1

Results:

ac VHT80	6 dB emission bandwidth (MHz)
	U-NII-3 (5725 MHz to 5850 MHz)
	Middle channel
	75.0

12.7 Spectrum bandwidth / 26 dB bandwidth

Description:

Measurement of the 26 dB bandwidth of the modulated signal.

Measurement:

Measurement parameter	
According to: KDB789033 D02, C.1.	
External result file(s)	1-3547_21-01-15_Annex_MR_A_1.pdf FCC Part 15.407 & ISED Bandwidths
Used test setup:	See chapter 7.4 – A
Measurement uncertainty:	See chapter 9

Limits:

Spectrum Bandwidth – 26 dB Bandwidth
<p>IC: Any unwanted emissions that fall into the band 5250-5350 MHz shall be attenuated below the channel power by at least 26 dB, when measured using a resolution bandwidth between 1 and 5% of the occupied bandwidth (i.e. 99% bandwidth), above 5250 MHz. The 26 dB bandwidth may fall into the 5250-5350 MHz band; however, if the occupied bandwidth also falls within the 5250-5350 MHz band, the transmission is considered as intentional and the devices shall comply with all requirements in the band 5250-5350 MHz including implementing dynamic frequency selection (DFS) and TPC, on the portion of the emission that resides in the 5250-5350 MHz band.</p> <p>FCC: Radar Detection Function of Dynamic Frequency Selection (DFS). U-NII devices operating with any part of its 26 dB emission bandwidth in the 5.25-5.35 GHz and 5.47-5.725 GHz bands shall employ a DFS radar detection mechanism to detect the presence of radar systems and to avoid co-channel operation with radar systems.</p>

Results:

a	26 dB bandwidth (MHz)		
	U-NII-1 (5150 MHz to 5250 MHz)		
	Lowest channel	Middle channel	Highest channel
	19.8	20.0	20.1
	Lowest frequency		Highest frequency
	5170.2		5250.3
	U-NII-2A (5250 MHz to 5350 MHz)		
	Lowest channel	Middle channel	Highest channel
	20.3	19.9	19.9
	U-NII-2C (5470 MHz to 5725 MHz)		
	Lowest channel	Middle channel	Highest channel
	20.8	19.9	20.5
	U-NII-3 (5725 MHz to 5850 MHz)		
	Lowest channel	Middle channel	Highest channel
	19.8	19.9	20.1
	Lowest frequency		Highest frequency
5735.4		5835.3	

Results:

n/ac HT20	26 dB bandwidth (MHz)		
	U-NII-1 (5150 MHz to 5250 MHz)		
	Lowest channel	Middle channel	Highest channel
	20.3	20.8	20.9
	Lowest frequency		Highest frequency
	5169.9		5250.6
	U-NII-2A (5250 MHz to 5350 MHz)		
	Lowest channel	Middle channel	Highest channel
	20.7	20.6	20.5
	U-NII-2C (5470 MHz to 5725 MHz)		
	Lowest channel	Middle channel	Highest channel
	21.4	20.4	20.5
	U-NII-3 (5725 MHz to 5850 MHz)		
	Lowest channel	Middle channel	Highest channel
	20.5	20.3	20.0
	Lowest frequency		Highest frequency
5734.9		5835.1	

Results:

n/ac HT40	26 dB bandwidth (MHz)		
	U-NII-1 (5150 MHz to 5250 MHz)		
	Lowest channel		Highest channel
	42.2		43.5
	Lowest frequency		Highest frequency
	5169.6		5251.3
	U-NII-2A (5250 MHz to 5350 MHz)		
	Lowest channel		Highest channel
	43.4		40.5
	U-NII-2C (5470 MHz to 5725 MHz)		
	Lowest channel	Middle channel	Highest channel
	53.4	41.7	45.1
	U-NII-3 (5725 MHz to 5850 MHz)		
	Lowest channel		Highest channel
41.6		41.8	
Lowest frequency		Highest frequency	
5734.6		5815.9	

Results:

ac VHT80	26 dB bandwidth (MHz)		
	U-NII-1 (5150 MHz to 5250 MHz)		
	Middle channel		
	81.4		
	Lowest frequency		Highest frequency
	5169.4		5250.8
	U-NII-2A (5250 MHz to 5350 MHz)		
	Middle channel		
	82.0		
	U-NII-2C (5470 MHz to 5725 MHz)		
	Lowest channel	Middle channel	Highest channel
	82.4	82.4	82.4
	U-NII-3 (5725 MHz to 5850 MHz)		
	Middle channel		
82220			
Lowest frequency		Highest frequency	
5734.0		5816.2	

12.8 Occupied bandwidth / 99% emission bandwidth

Description:

Measurement of the 99% bandwidth of the modulated signal acc. RSS-GEN.

Measurement:

Measurement parameter	
External result file(s)	1-3547_21-01-15_Annex_MR_A_1.pdf FCC Part 15.407 & ISED Bandwidths
Test setup:	See chapter 7.4 – A
Measurement uncertainty:	See chapter 9

Usage:

-/-	ISED
OBW is necessary for Emission Designator	

Results:

a	99% bandwidth (kHz)		
	U-NII-1 (5150 MHz to 5250 MHz)		
	Lowest channel	Middle channel	Highest channel
	16334	16384	16334
	U-NII-2A (5250 MHz to 5350 MHz)		
	Lowest channel	Middle channel	Highest channel
	16334	16334	16334
	U-NII-2C (5470 MHz to 5725 MHz)		
	Lowest channel	Middle channel	Highest channel
	16434	16334	16384
	U-NII-3 (5725 MHz to 5850 MHz)		
	Lowest channel	Middle channel	Highest channel
16334	16384	16384	

Results:

n/ac HT20	99% bandwidth (kHz)		
	U-NII-1 (5150 MHz to 5250 MHz)		
	Lowest channel	Middle channel	Highest channel
	17433	17433	17483
	U-NII-2A (5250 MHz to 5350 MHz)		
	Lowest channel	Middle channel	Highest channel
	17433	17433	17433
	U-NII-2C (5470 MHz to 5725 MHz)		
	Lowest channel	Middle channel	Highest channel
	17483	17433	17532
	U-NII-3 (5725 MHz to 5850 MHz)		
	Lowest channel	Middle channel	Highest channel
17433	17483	17433	

Results:

n/ac HT40	99% bandwidth (kHz)		
	U-NII-1 (5150 MHz to 5250 MHz)		
	Lowest channel		Highest channel
	36064		35964
	U-NII-2A (5250 MHz to 5350 MHz)		
	Lowest channel		Highest channel
	35864		35964
	U-NII-2C (5470 MHz to 5725 MHz)		
	Lowest channel	Middle channel	Highest channel
	36064	35864	36064
	U-NII-3 (5725 MHz to 5850 MHz)		
	Lowest channel		Highest channel
35864		36064	

Results:

ac VHT80	99% bandwidth (kHz)		
	U-NII-1 (5150 MHz to 5250 MHz)		
	Middle channel		
	75125		
	U-NII-2A (5250 MHz to 5350 MHz)		
	Middle channel		
	75125		
	U-NII-2C (5470 MHz to 5725 MHz)		
	Lowest channel	Middle channel	Highest channel
	75325	75325	74925
	U-NII-3 (5725 MHz to 5850 MHz)		
	Middle channel		
75125			

12.9 Band edge compliance radiated

Description:

Measurement of the radiated band edge compliance. The EUT is turned in the position that results in the maximum level at the band edge. Then a sweep over the corresponding restricted band is performed. The EUT is set to the lowest channel for the lower restricted band and to the highest channel for the upper restricted band. Measurement distance is 3m.

Measurement:

Measurement parameter	
Detector:	Peak / RMS
Sweep time:	Auto
Resolution bandwidth:	1 MHz
Video bandwidth:	≥ 3 x RBW
Span:	See plots!
Trace mode:	Max Hold
Test setup:	See chapter 7.2 – B
Measurement uncertainty:	See chapter 9

Limits:

Band Edge Compliance Radiated
In any 100 kHz bandwidth outside the frequency band in which the spread spectrum or digitally modulated intentional radiator is operating, the radio frequency power that is produced by the intentional radiator shall be at least 20 dB below that in the 100 kHz bandwidth within the band that contains the highest level of the desired power, based on either an RF conducted or a radiated measurement. Attenuation below the general limits specified in Section 15.209(a) is not required. In addition, radiated emissions which fall in the restricted bands, as defined in Section 15.205(a), must also comply with the radiated emission limits specified in Section 15.209(a) (see Section 5.205(c)).
74 dBµV/m (peak) 54 dBµV/m (average)

Result: ANT1-DB1-RAF-xxx antenna

Band Edge Compliance radiated	Emission frequency [MHz]	Detector	Level [dBuV/m]
Lower band edge; U-NII-1; lowest channel, 802.11a	5150	Peak	73.1
		AVG	52.2
Upper band edge; U-NII-2A; highest channel, 802.11a	5350	Peak	71.3
		AVG	48.6
Lower band edge; U-NII-2C; lowest channel, 802.11a	5460	Peak	70.0
		AVG	46.6
Lower band edge; U-NII-1; lowest channel, 802.11n HT40	5150	Peak	72.4
		AVG	50.1
Upper band edge; U-NII-2A; highest channel, 802.11n HT40	5350	Peak	73.6
		AVG	53.0
Lower band edge; U-NII-2C; lowest channel, 802.11n HT40	5460	Peak	69.0
		AVG	49.1
Lower band edge; U-NII-1; lowest channel, 802.11ac VHT80	5150	Peak	66.8
		AVG	53.1
Upper band edge; U-NII-2A; highest channel, 802.11ac VHT80	5350	Peak	65.4
		AVG	50.9
Lower band edge; U-NII-2C; lowest channel, 802.11ac VHT80	5460	Peak	64.7
		AVG	51.8

Result: TAOGLAS PC11.07.0100A antenna

Band Edge Compliance radiated	Emission frequency [MHz]	Detector	Level [dBuV/m]
Lower band edge; U-NII-1; lowest channel, 802.11a	5150	Peak	71.4
		AVG	49.2
Upper band edge; U-NII-2A; highest channel, 802.11a	5350	Peak	70.4
		AVG	46.9
Lower band edge; U-NII-2C; lowest channel, 802.11a	5460	Peak	68.4
		AVG	45.3
Lower band edge; U-NII-1; lowest channel, 802.11n HT40	5150	Peak	72.3
		AVG	48.3
Upper band edge; U-NII-2A; highest channel, 802.11n HT40	5350	Peak	70.2
		AVG	49.4
Lower band edge; U-NII-2C; lowest channel, 802.11n HT40	5460	Peak	69.7
		AVG	51.6
Lower band edge; U-NII-1; lowest channel, 802.11ac VHT80	5150	Peak	67.8
		AVG	52.8
Upper band edge; U-NII-2A; highest channel, 802.11ac VHT80	5350	Peak	68.6
		AVG	53.5
Lower band edge; U-NII-2C; lowest channel, 802.11ac VHT80	5460	Peak	68.4
		AVG	52.0

Plots: ANT1-DB1-RAF-xxx antenna

Plot 1: lower band edge; U-NII-1; lowest channel; 20 MHz channel bandwidth

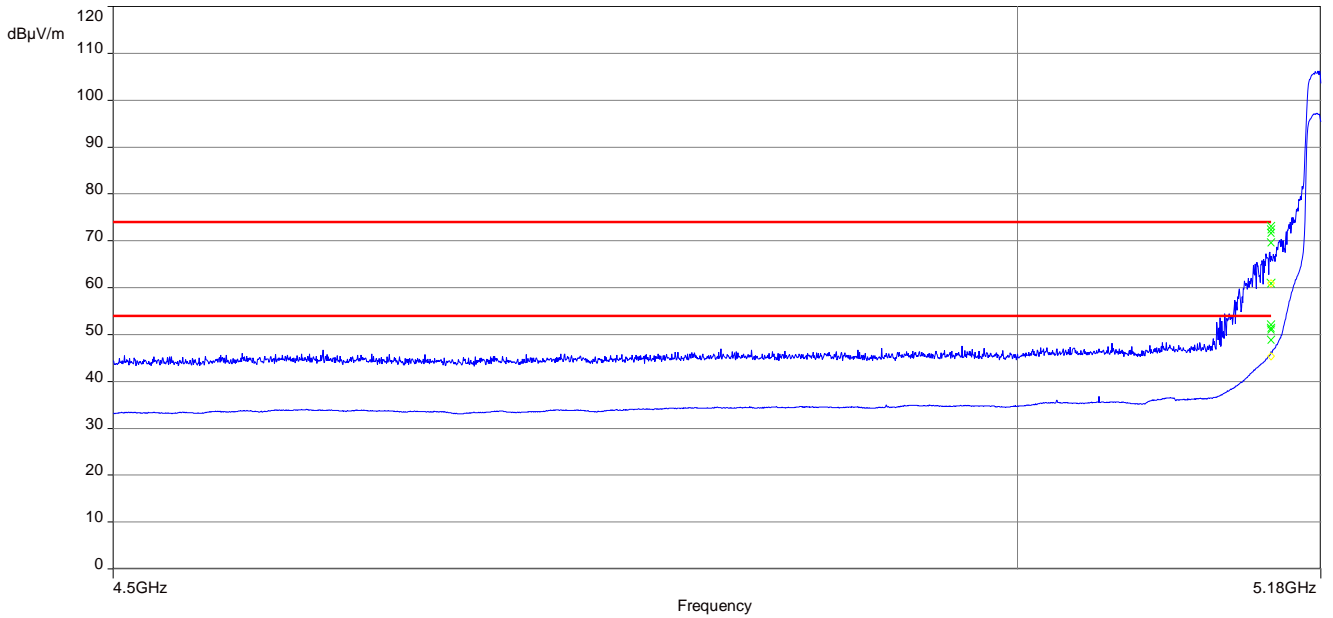

Plot 2: upper band edge; U-NII-2A; highest channel; 20 MHz channel bandwidth

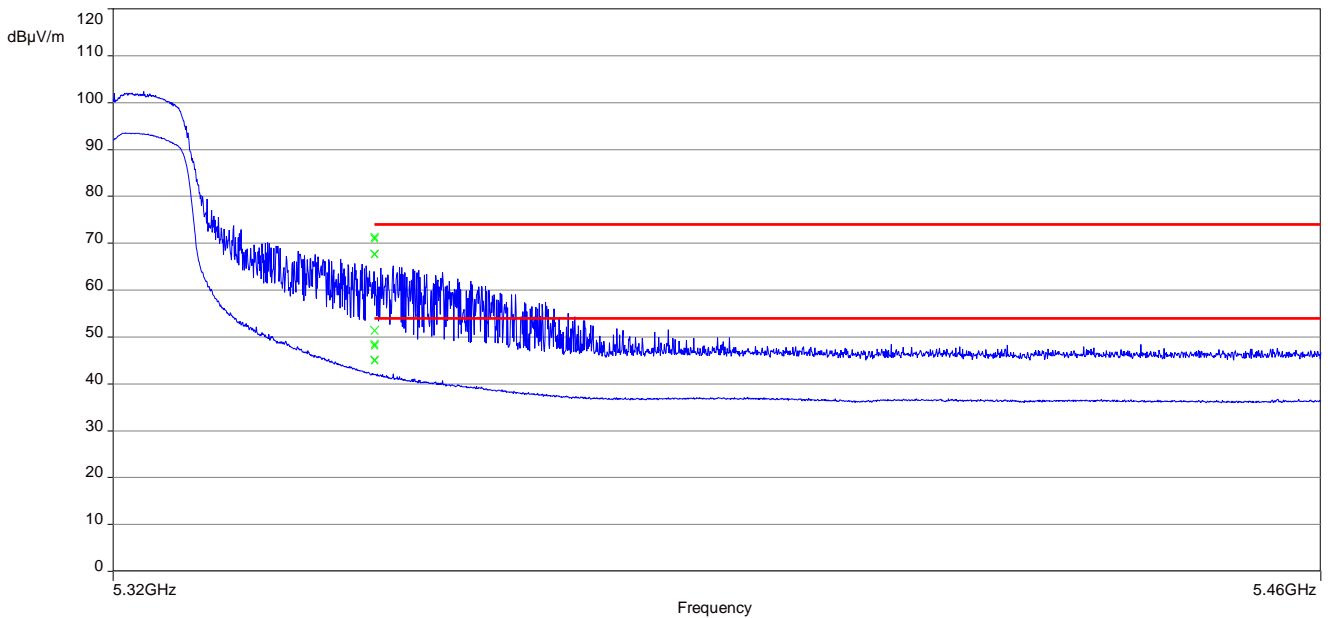

Plot 3: lower band edge; U-NII-2C; lowest channel; 20 MHz channel bandwidth

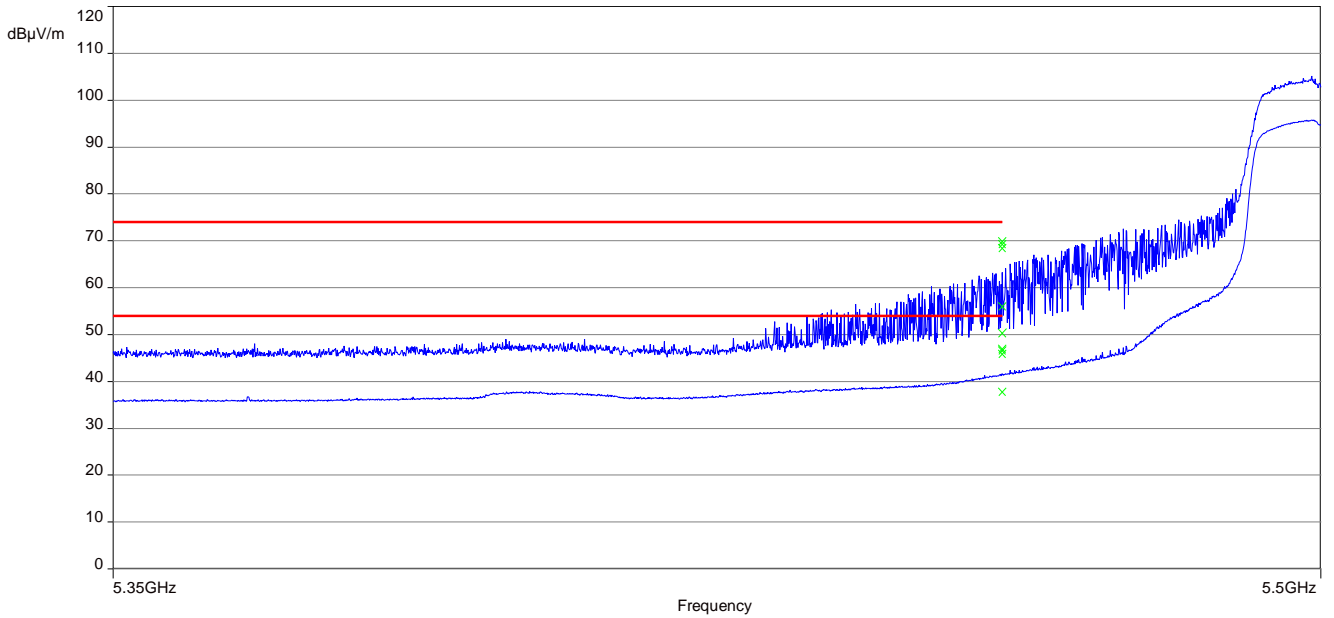

Plot 4: lower band edge; U-NII-1; lowest channel; 40 MHz channel bandwidth

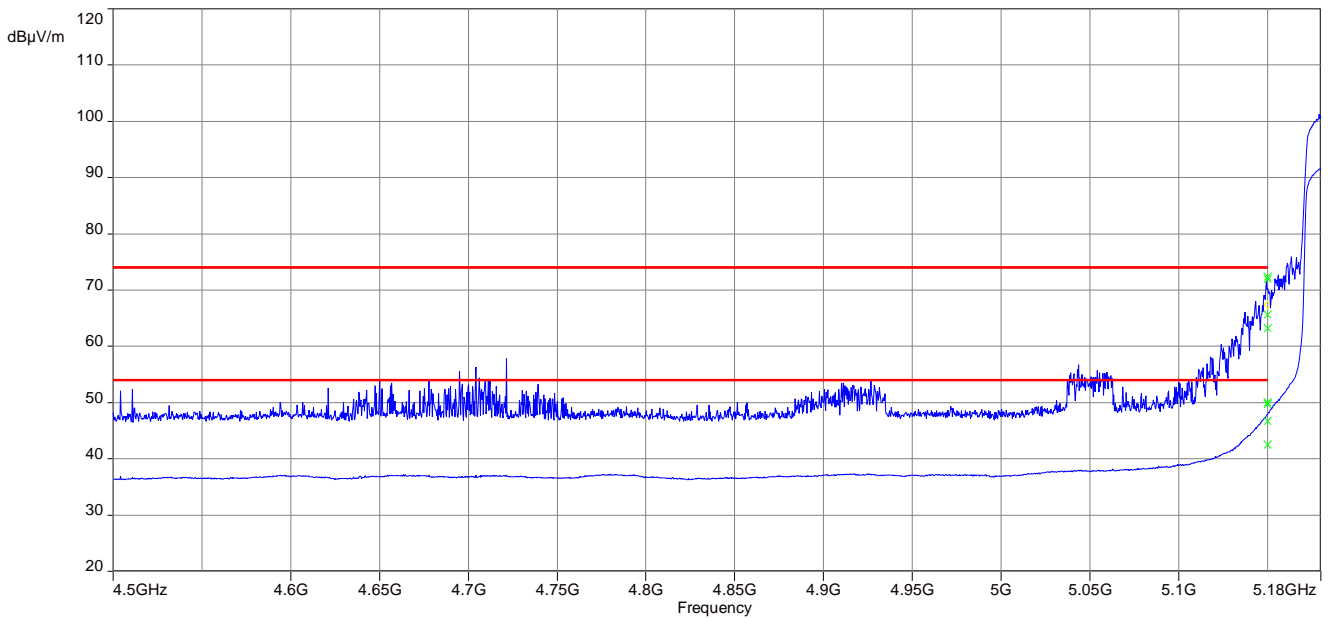

Plot 5: upper band edge; U-NII-2A; highest channel; 40 MHz channel bandwidth



Plot 6: lower band edge; U-NII-2C; lowest channel; 40 MHz channel bandwidth

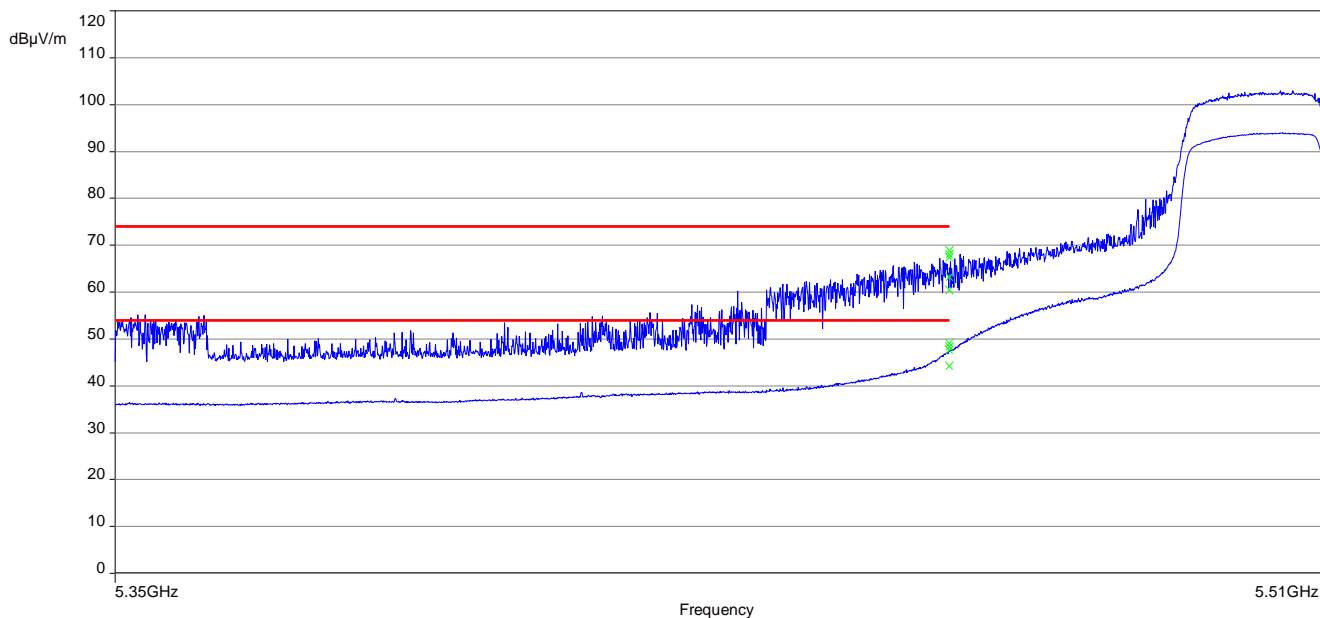

Plot 7: lower band edge; U-NII-1; middle channel; 80 MHz channel bandwidth

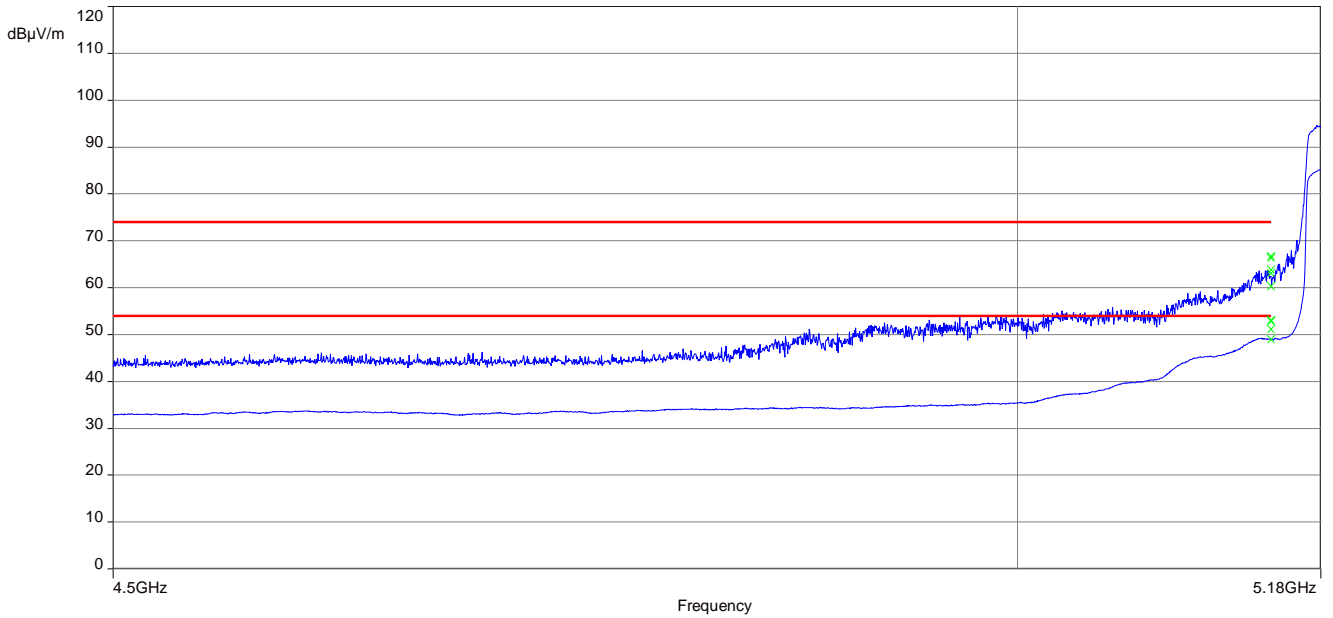

Plot 8: upper band edge; U-NII-2A; middle channel; 80 MHz channel bandwidth

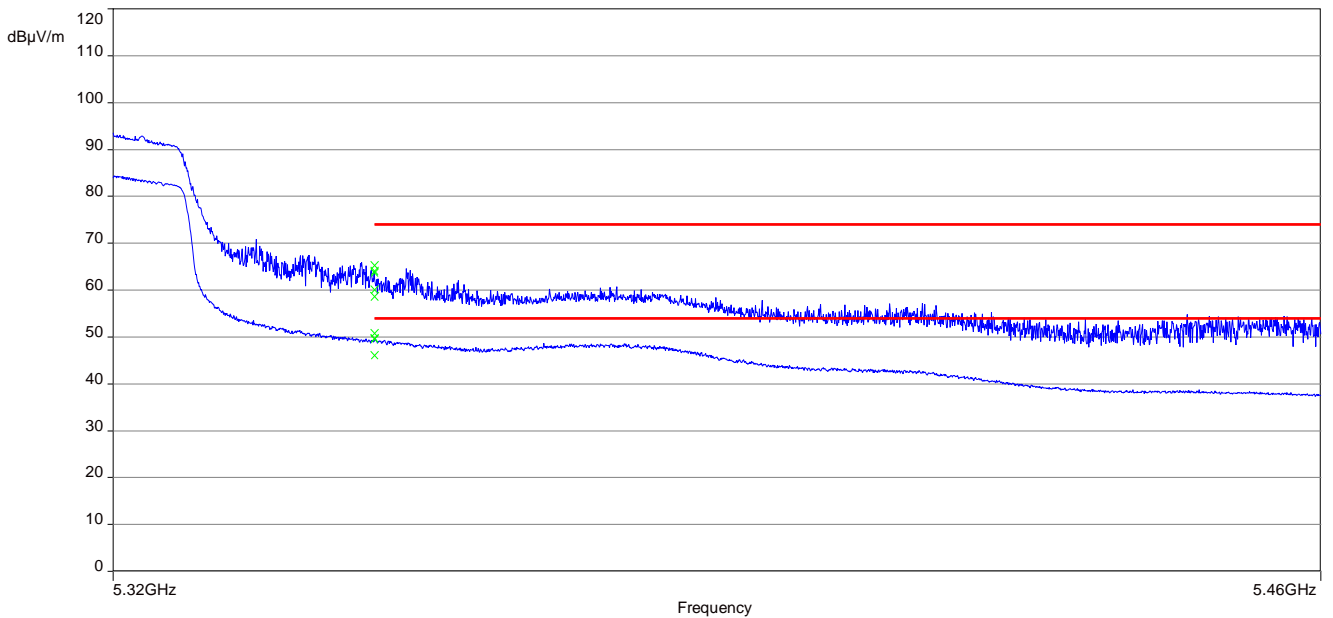

Plot 9: lower band edge; U-NII-2C; lowest channel; 80 MHz channel bandwidth

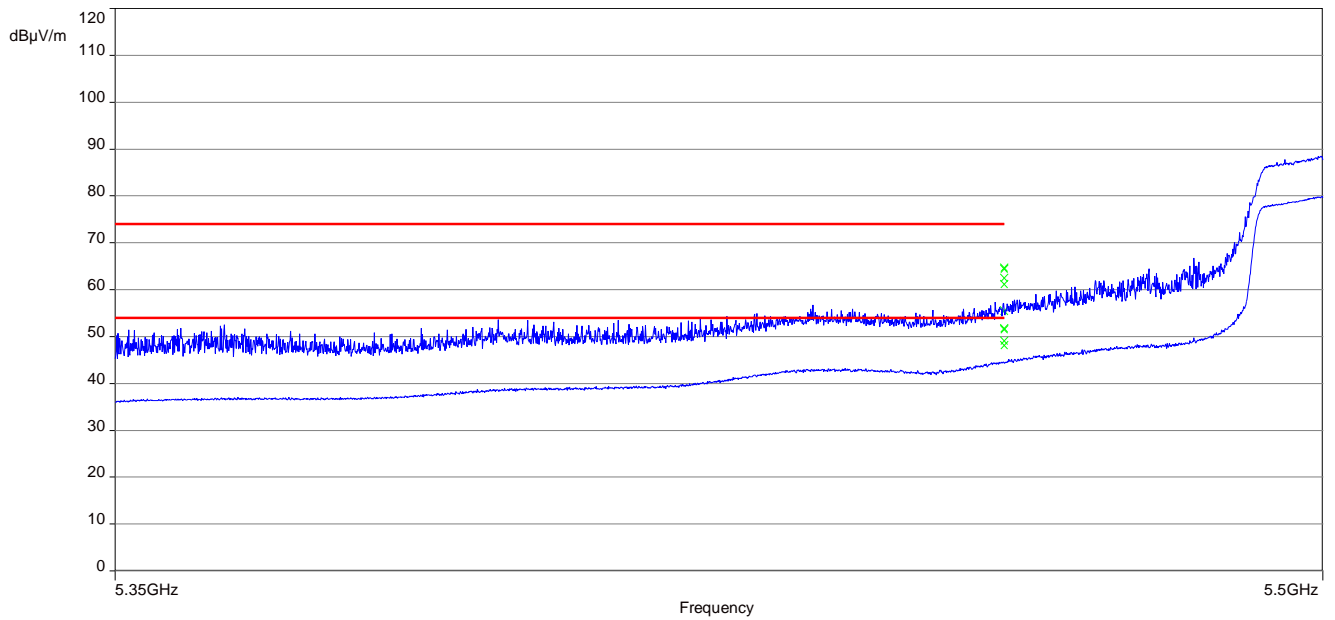

Plots: TAOGLAS PC11.07.0100A antenna

Plot 10: lower band edge; U-NII-1; lowest channel; 20 MHz channel bandwidth

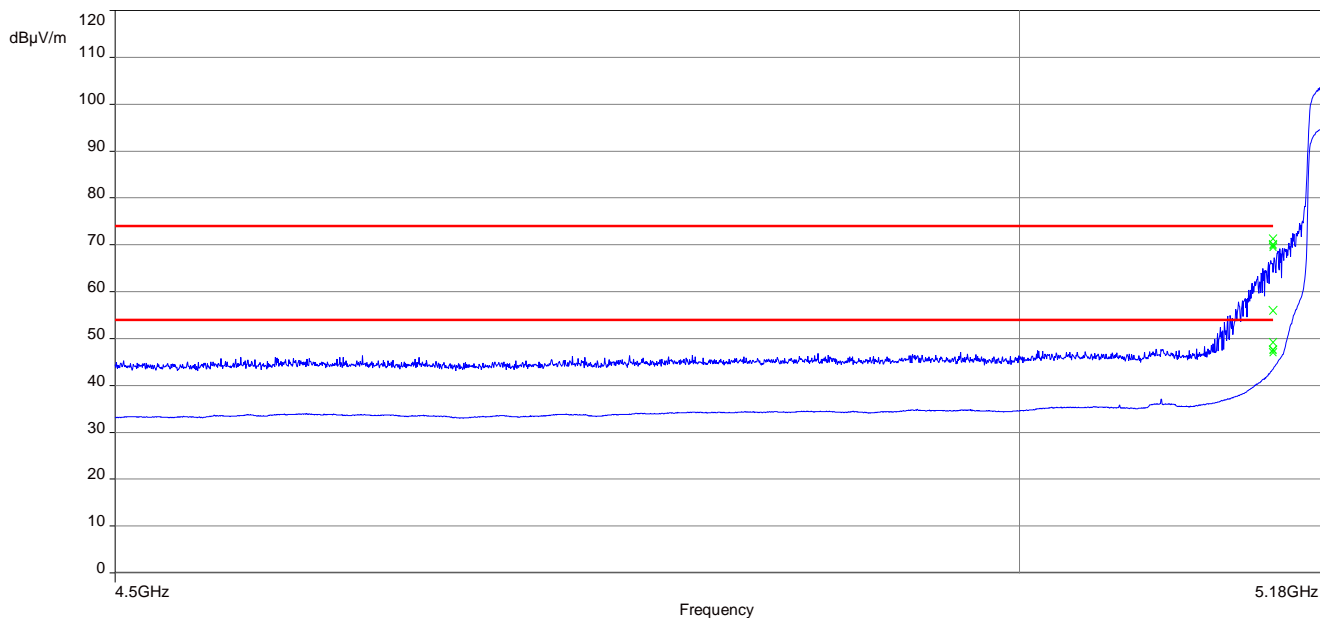

Plot 11: upper band edge; U-NII-2A; highest channel; 20 MHz channel bandwidth

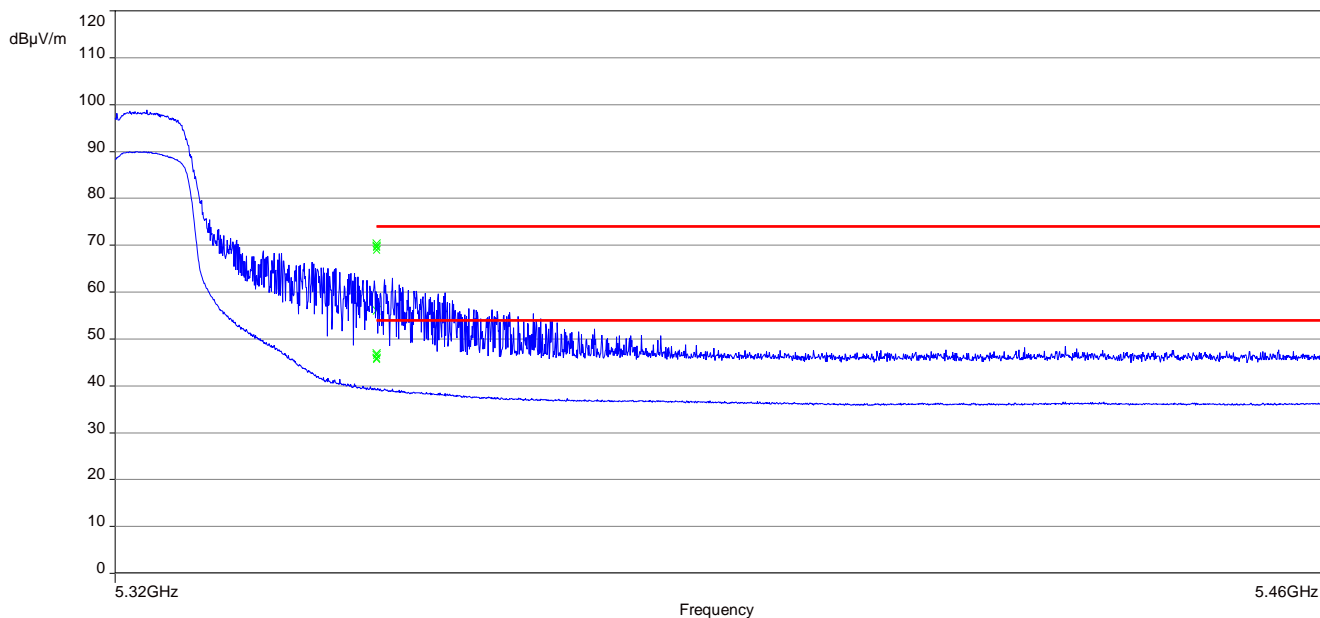

Plot 12: lower band edge; U-NII-2C; lowest channel; 20 MHz channel bandwidth

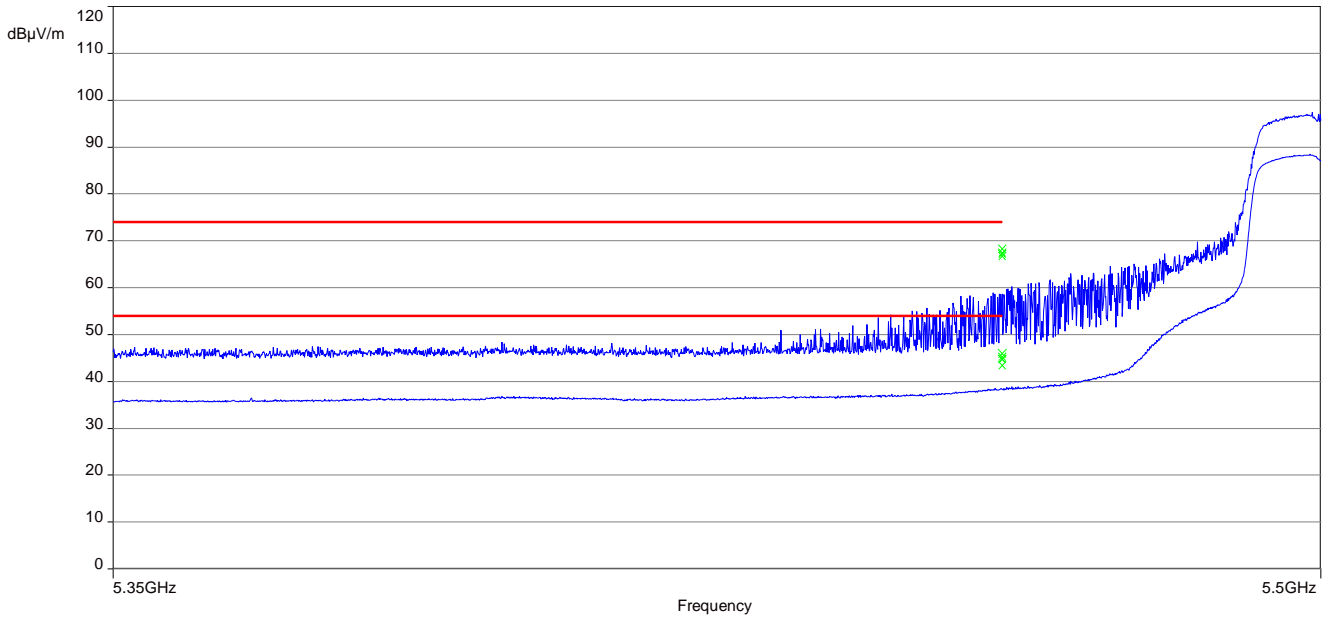

Plot 13: lower band edge; U-NII-1; lowest channel; 40 MHz channel bandwidth

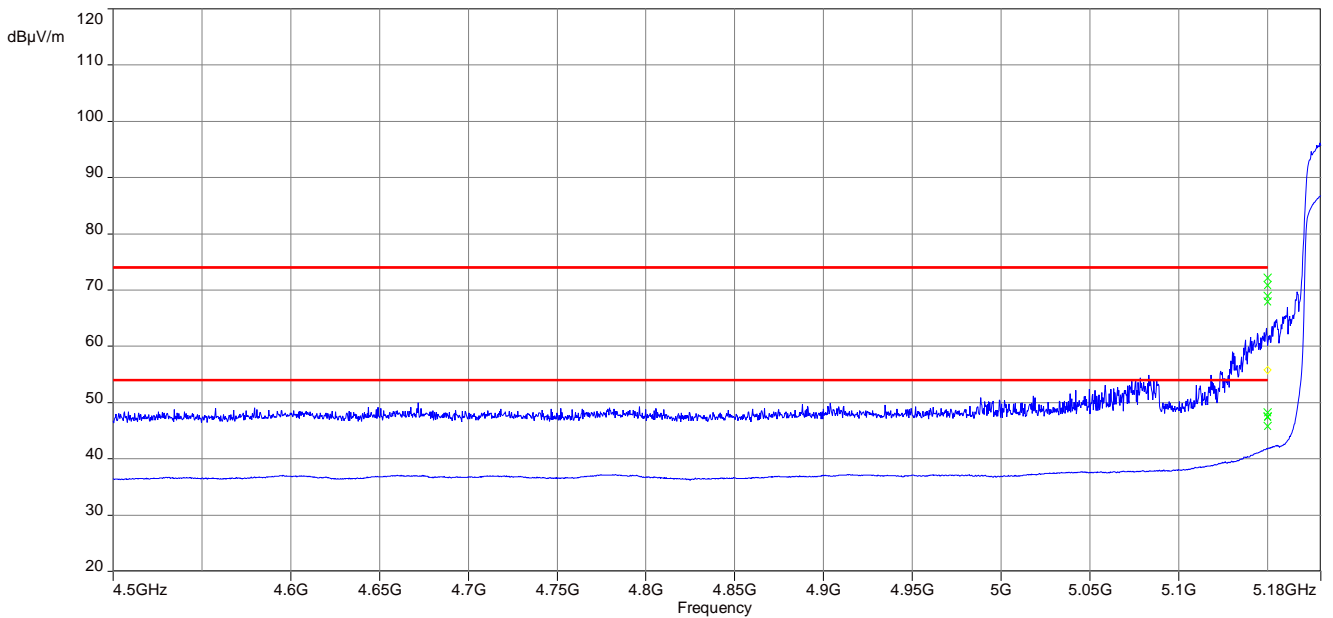

Plot 14: upper band edge; U-NII-2A; highest channel; 40 MHz channel bandwidth

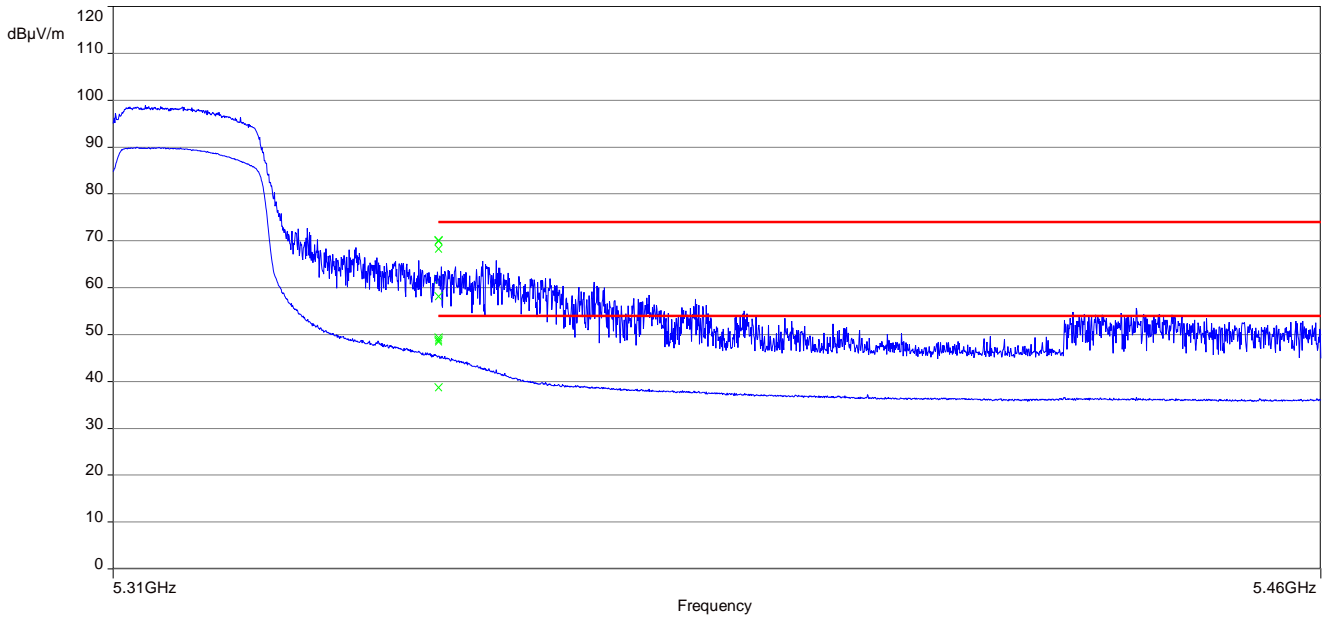

Plot 15: lower band edge; U-NII-2C; lowest channel; 40 MHz channel bandwidth

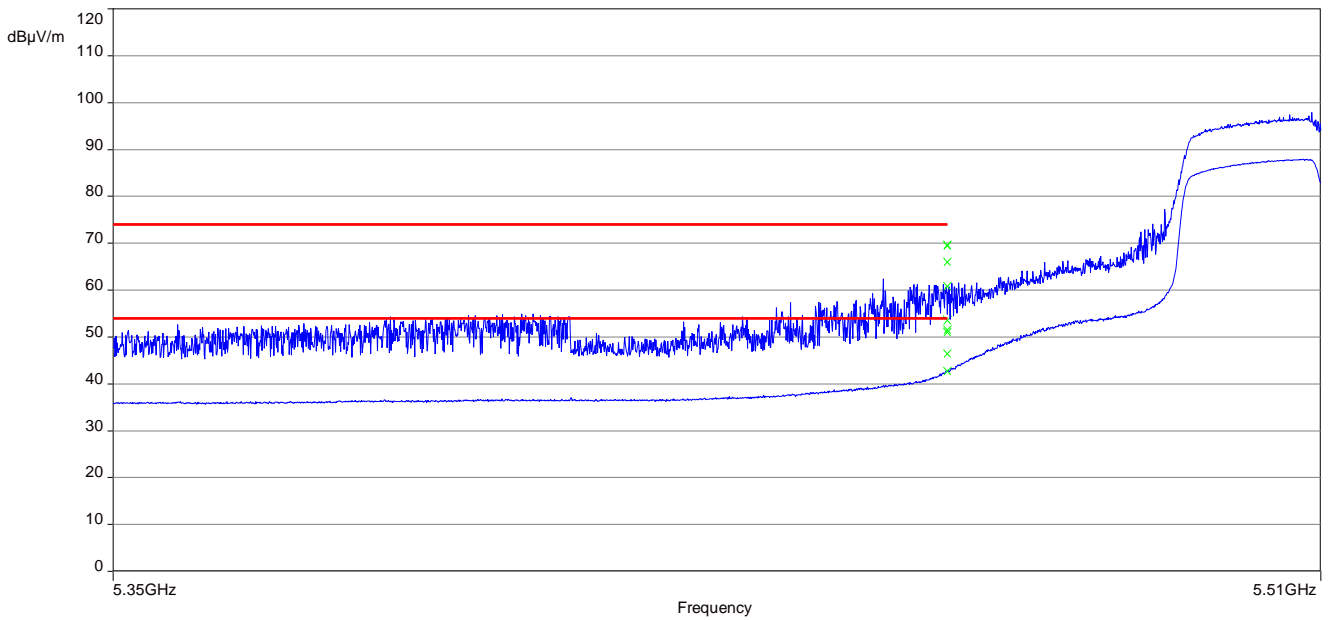

Plot 16: lower band edge; U-NII-1; middle channel; 80 MHz channel bandwidth

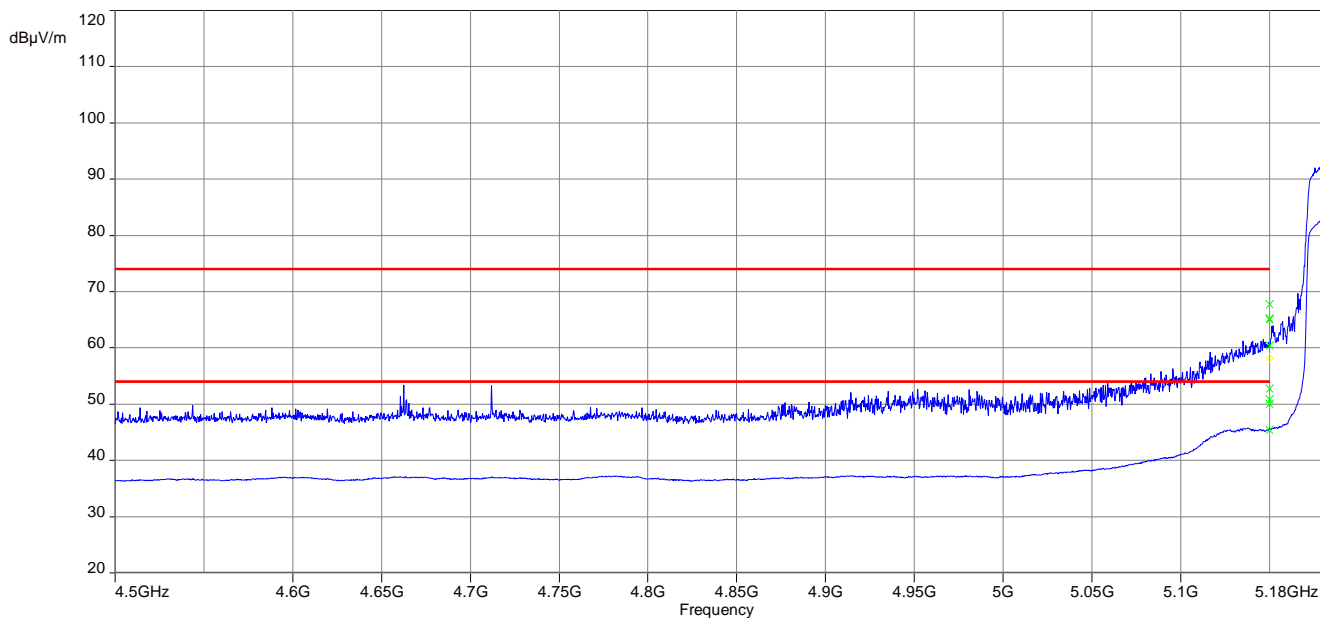

Plot 17: upper band edge; U-NII-2A; middle channel; 80 MHz channel bandwidth

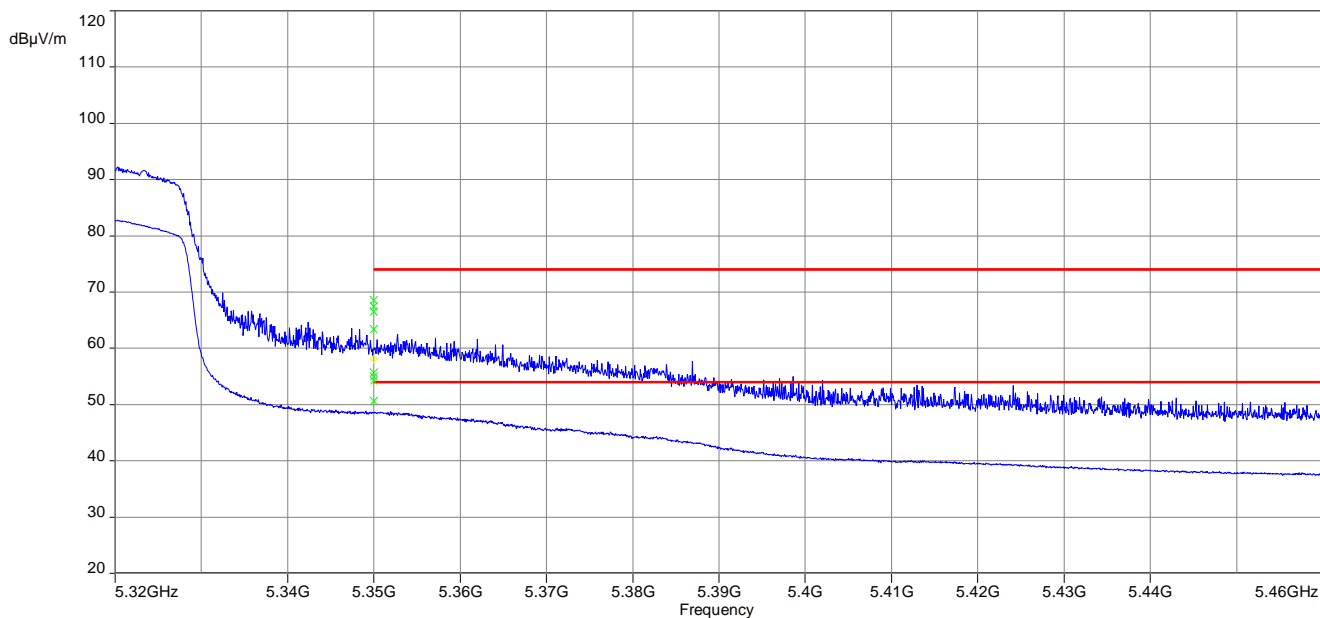

Plot 18: lower band edge; U-NII-2C; lowest channel; 80 MHz channel bandwidth

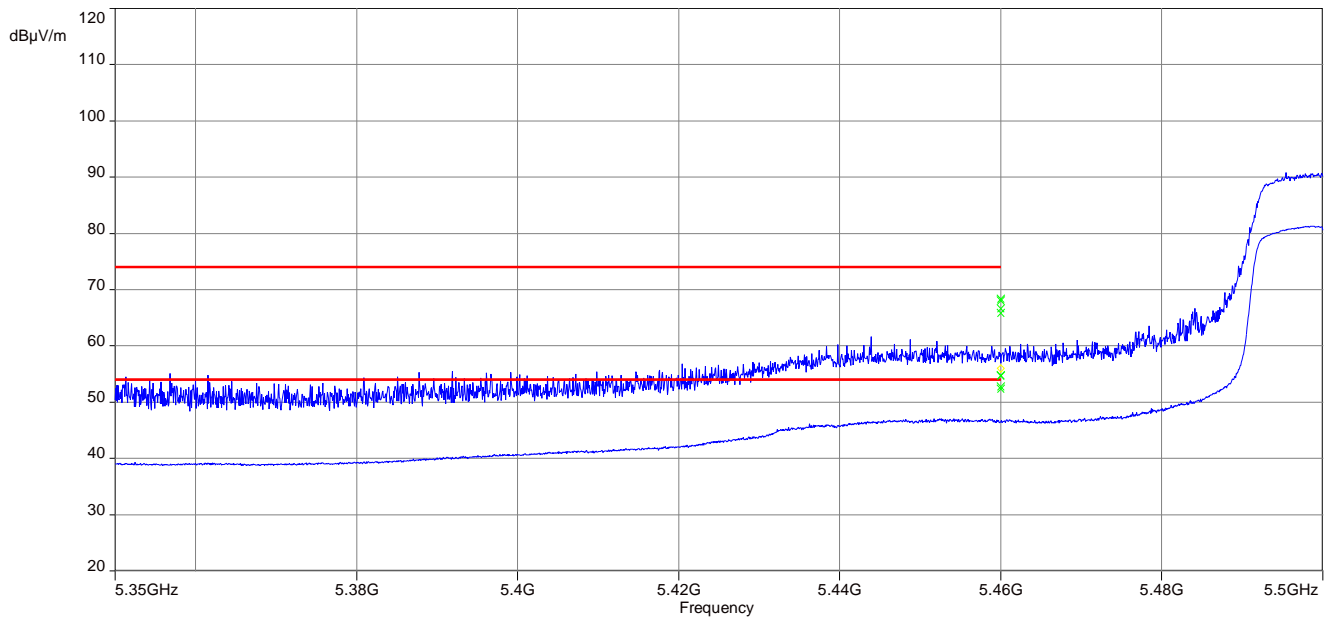

12.10 Spurious emissions radiated below 30 MHz

Description:

Measurement of the radiated spurious emissions in transmit mode below 30 MHz. The limits are re-calculated to a measurement distance of 3 m with 40 dB/decade according CFR Part 2.

Measurement:

Measurement parameter	
Detector:	Peak / Quasi Peak
Sweep time:	Auto
Video bandwidth:	F < 150 kHz: 200 Hz F > 150 kHz: 9 kHz
Resolution bandwidth:	F < 150 kHz: 1 kHz F > 150 kHz: 100 kHz
Span:	9 kHz to 30 MHz
Trace mode:	Max Hold
Test setup:	See chapter 7.2 – C
Measurement uncertainty:	See chapter 9

Limits:

Spurious Emissions Radiated < 30 MHz		
Frequency (MHz)	Field Strength (dBµV/m)	Measurement distance
0.009 – 0.490	2400/F(kHz)	300
0.490 – 1.705	24000/F(kHz)	30
1.705 – 30.0	30	30

Results: ANT1-DB1-RAF-xxx antenna

Spurious Emissions Radiated < 30 MHz [dBµV/m]		
F [MHz]	Detector	Level [dBµV/m]
All detected emissions are more than 20 dB below the limit.		

Results: TAOGLAS PC11.07.0100A antenna

Spurious Emissions Radiated < 30 MHz [dBµV/m]		
F [MHz]	Detector	Level [dBµV/m]
All detected emissions are more than 20 dB below the limit.		

Plots: 20 MHz channel bandwidth, ANT1-DB1-RAF-xxx antenna

Plot 1: 9 kHz to 30 MHz, U-NII-1; lowest channel

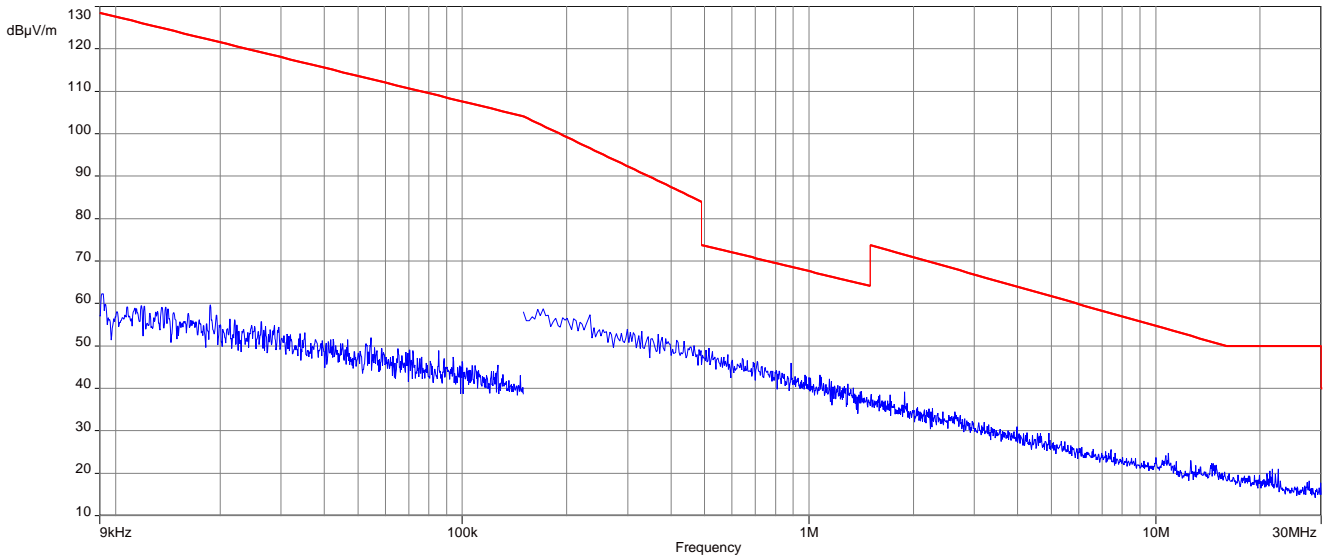

Plot 2: 9 kHz to 30 MHz, U-NII-1; middle channel

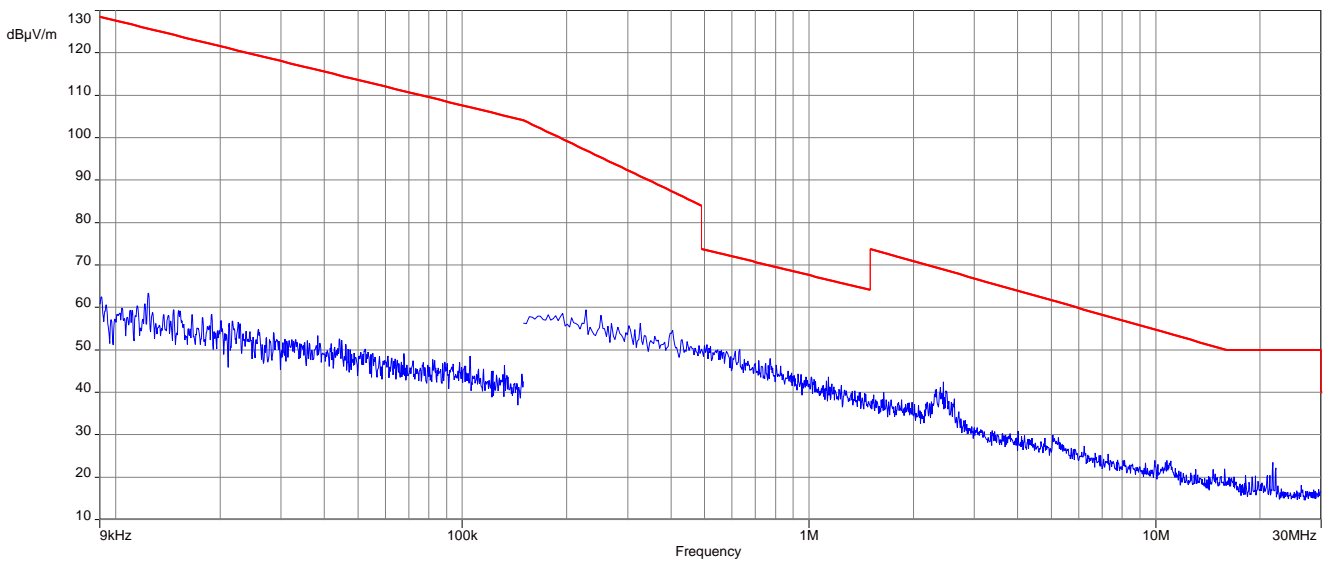

Plot 3: 9 kHz to 30 MHz, U-NII-1; highest channel

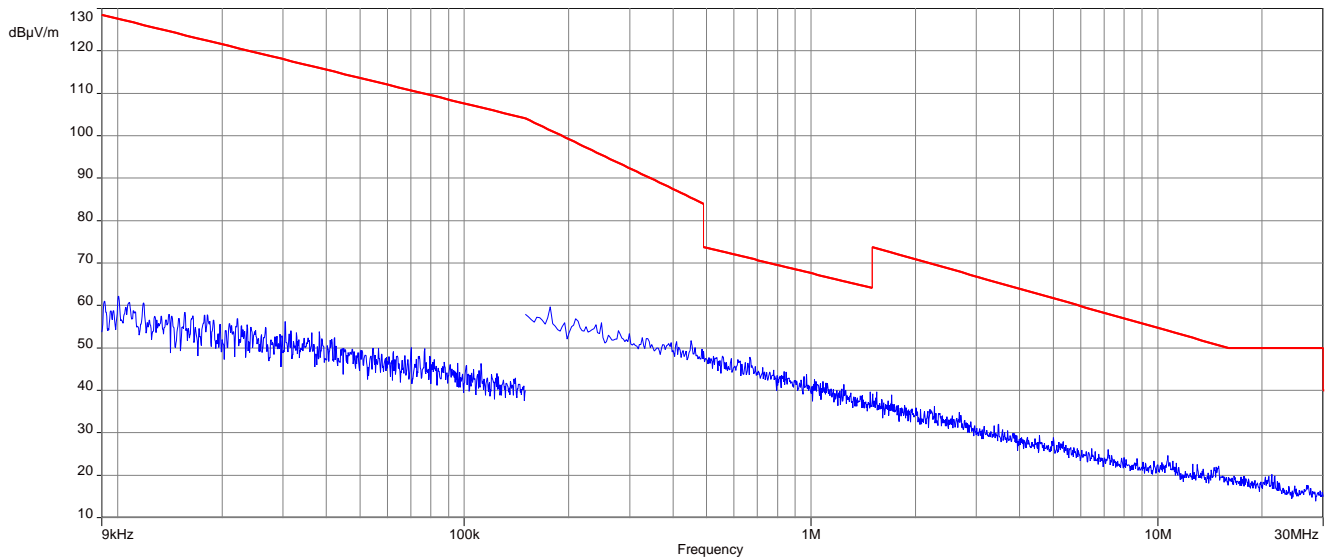

Plot 4: 9 kHz to 30 MHz, U-NII-2A; lowest channel

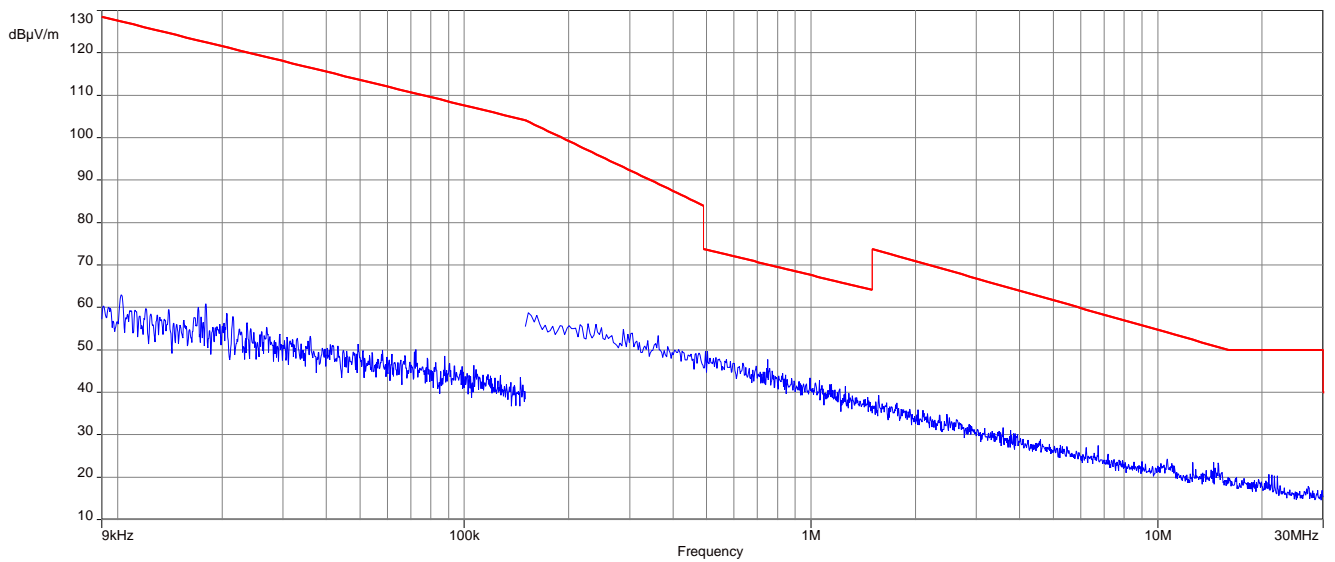

Plot 5: 9 kHz to 30 MHz, U-NII-2A; middle channel

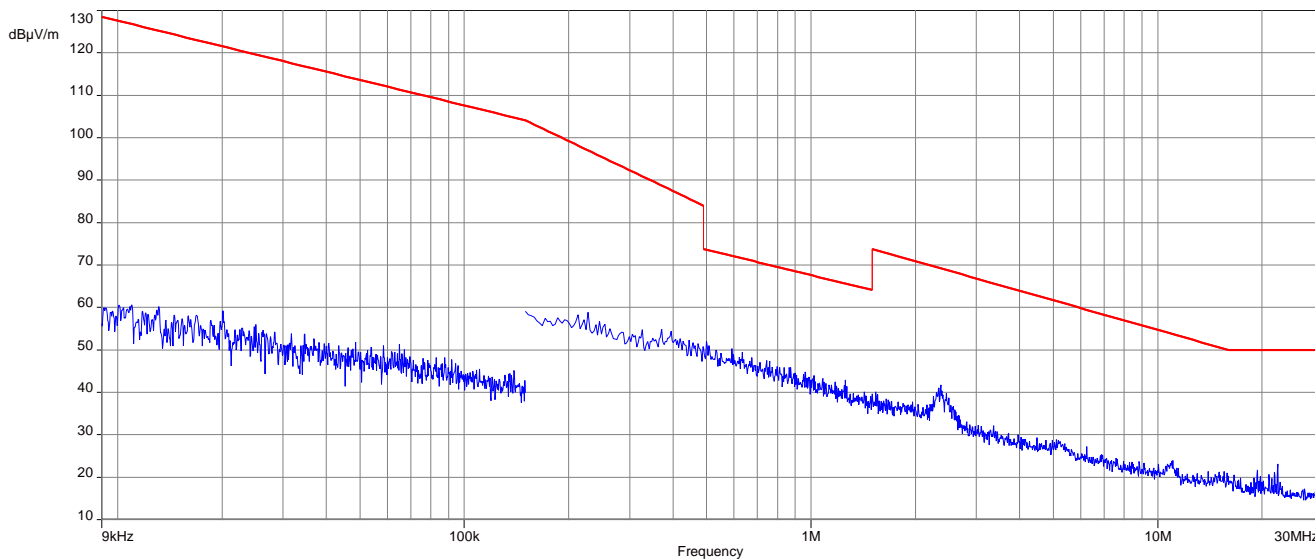

Plot 6: 9 kHz to 30 MHz, U-NII-2A; highest channel

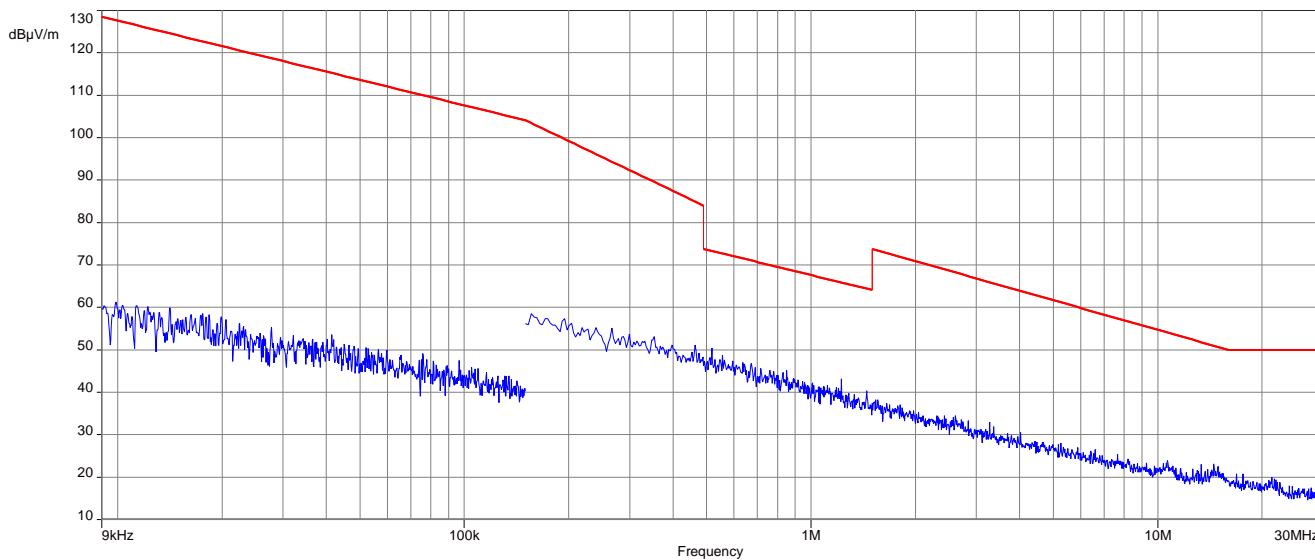

Plot 7: 9 kHz to 30 MHz, U-NII-2C; lowest channel

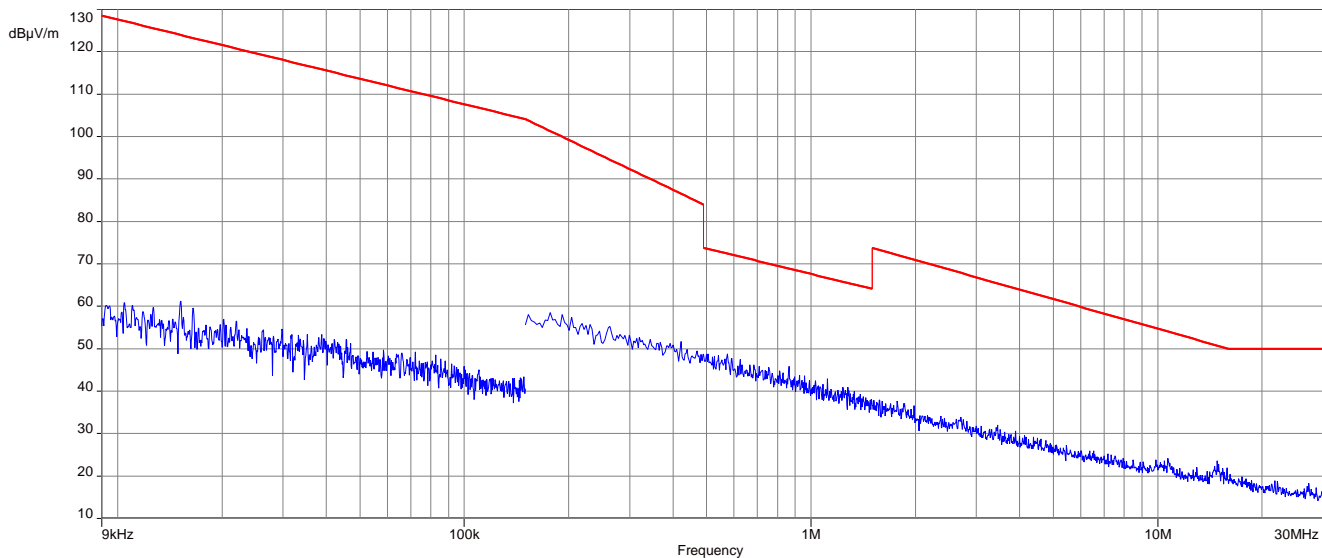

Plot 8: 9 kHz to 30 MHz, U-NII-2C; middle channel

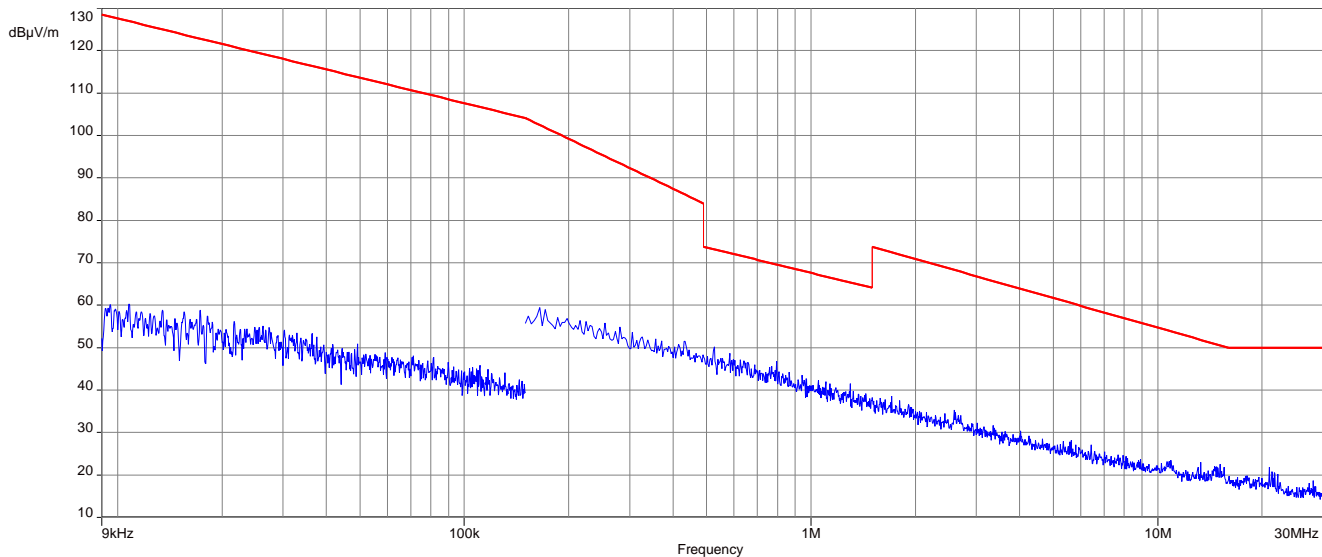

Plot 9: 9 kHz to 30 MHz, U-NII-2C; highest channel

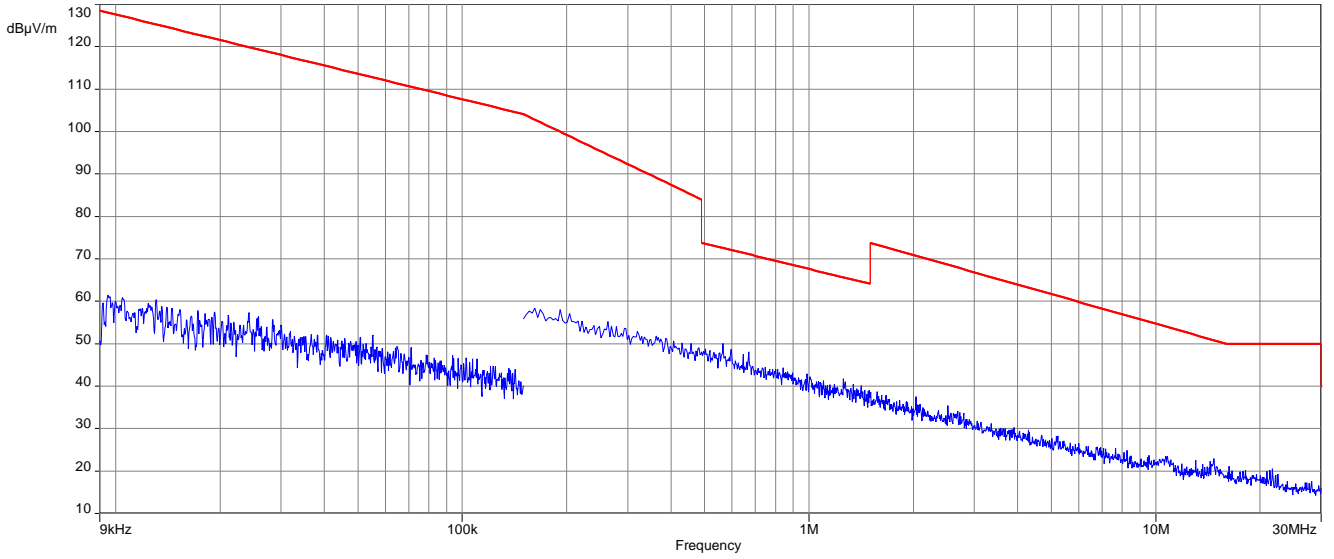

Plot 10: 9 kHz to 30 MHz, U-NII-3; lowest channel

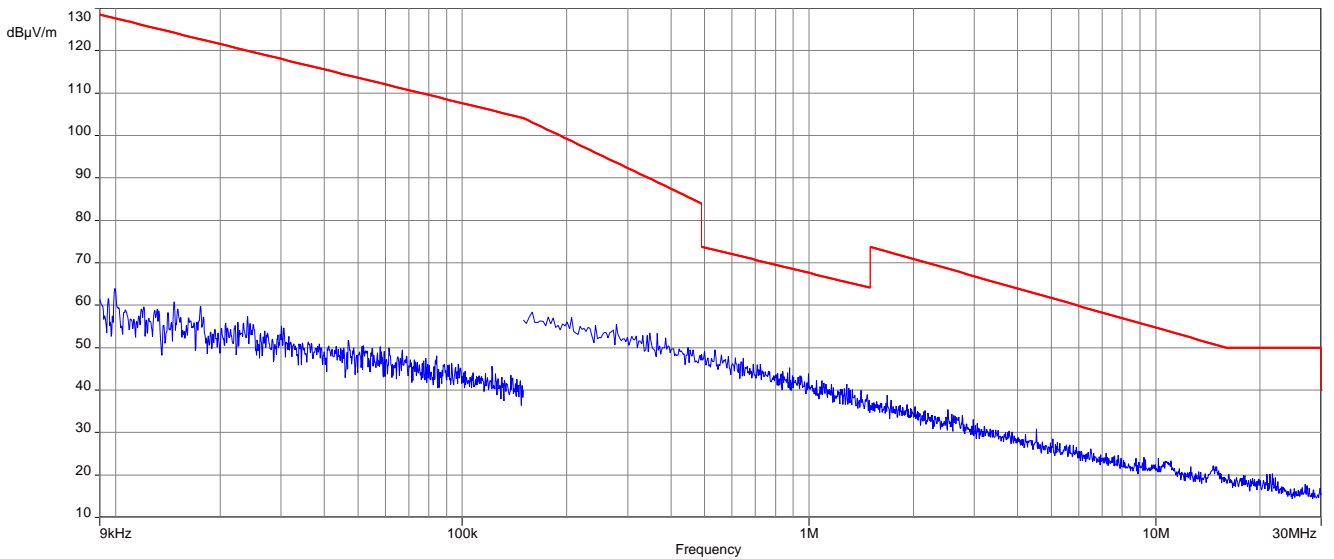

Plot 11: 9 kHz to 30 MHz, U-NII-3; middle channel

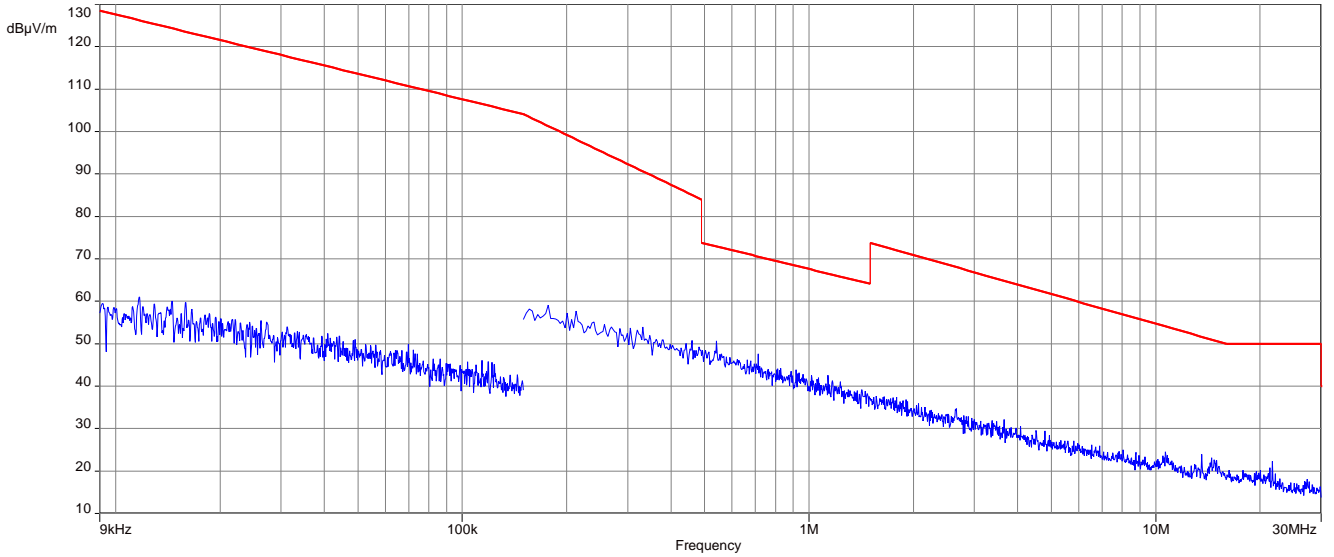

Plot 12: 9 kHz to 30 MHz, U-NII-3; highest channel

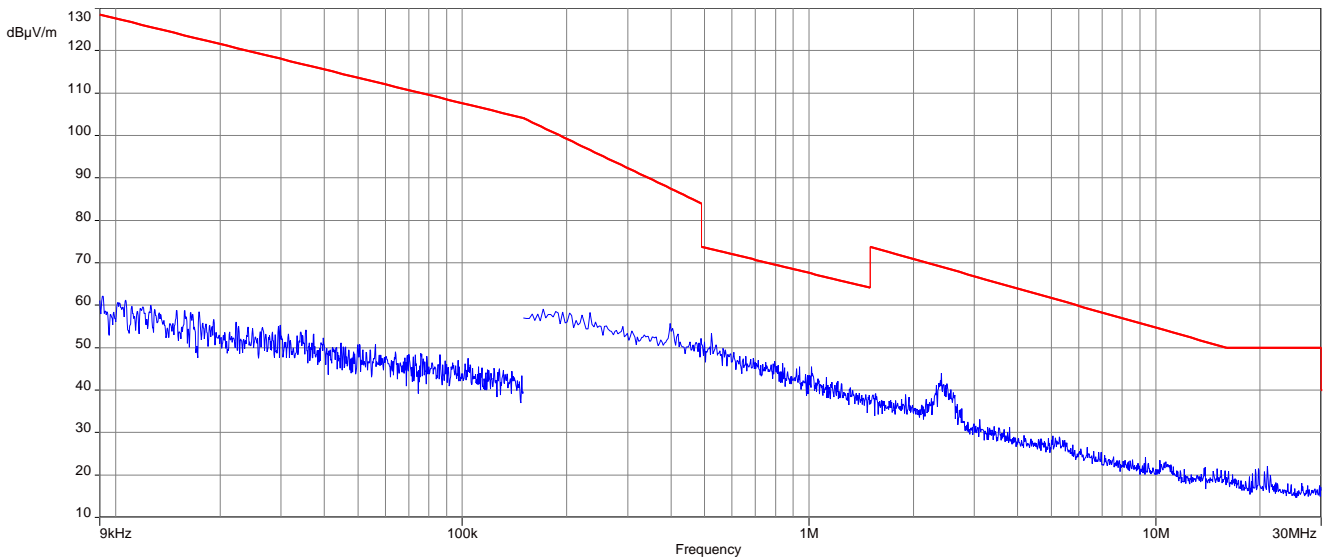

Plots: 40 MHz channel bandwidth, ANT1-DB1-RAF-xxx antenna

Plot 1: 9 kHz to 30 MHz, U-NII-1; lowest channel

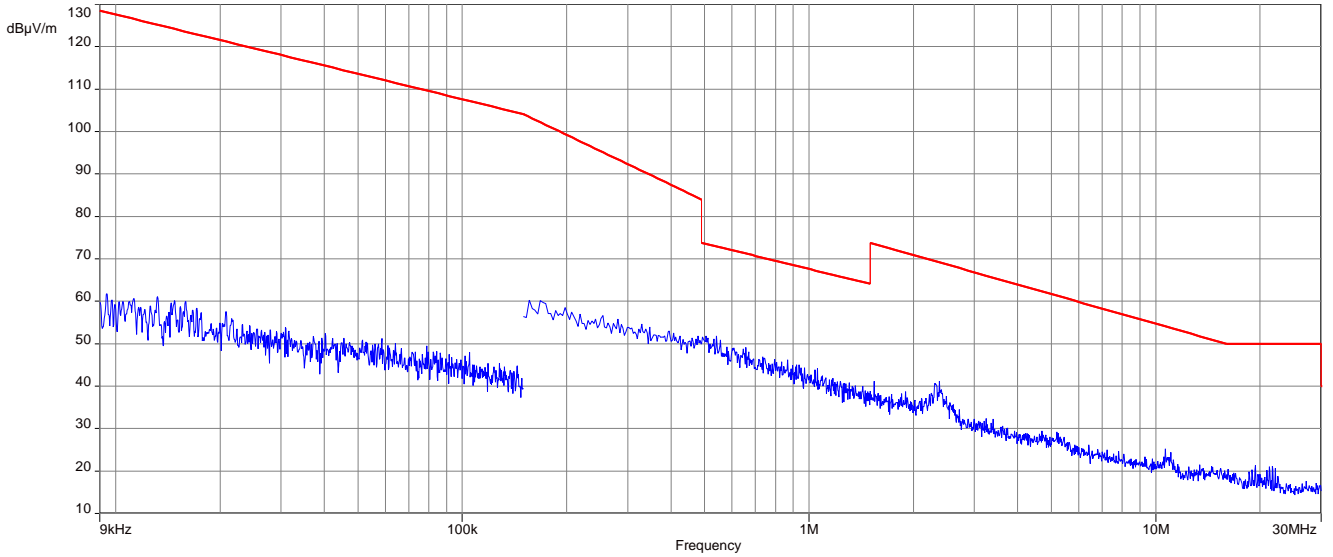

Plot 2: 9 kHz to 30 MHz, U-NII-1; highest channel

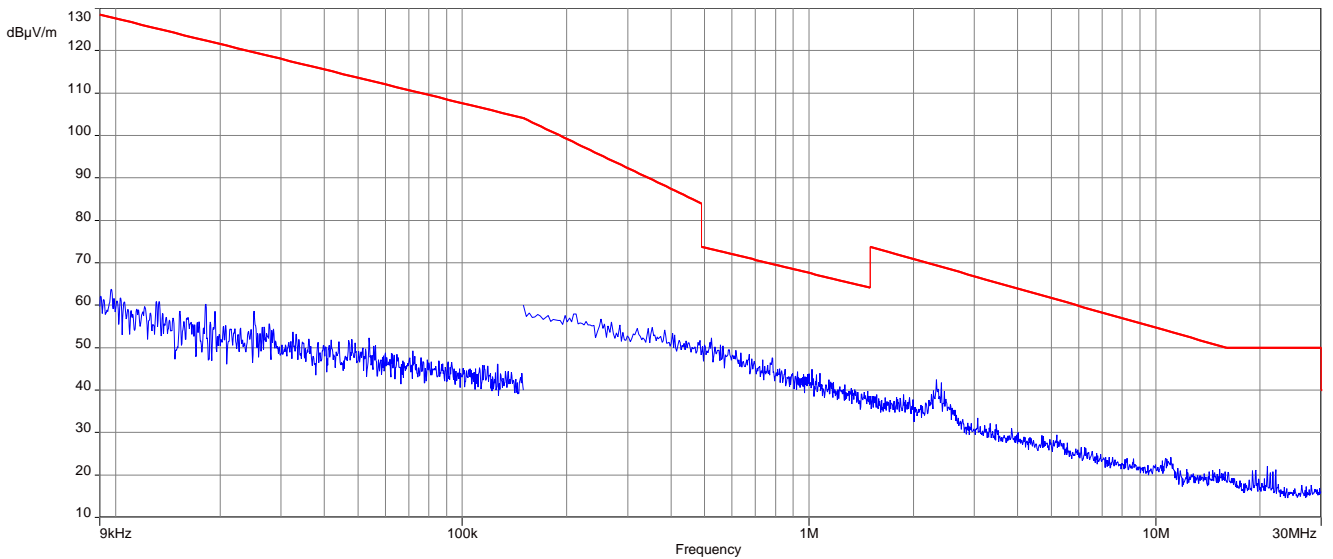

Plot 3: 9 kHz to 30 MHz, U-NII-2A; lowest channel

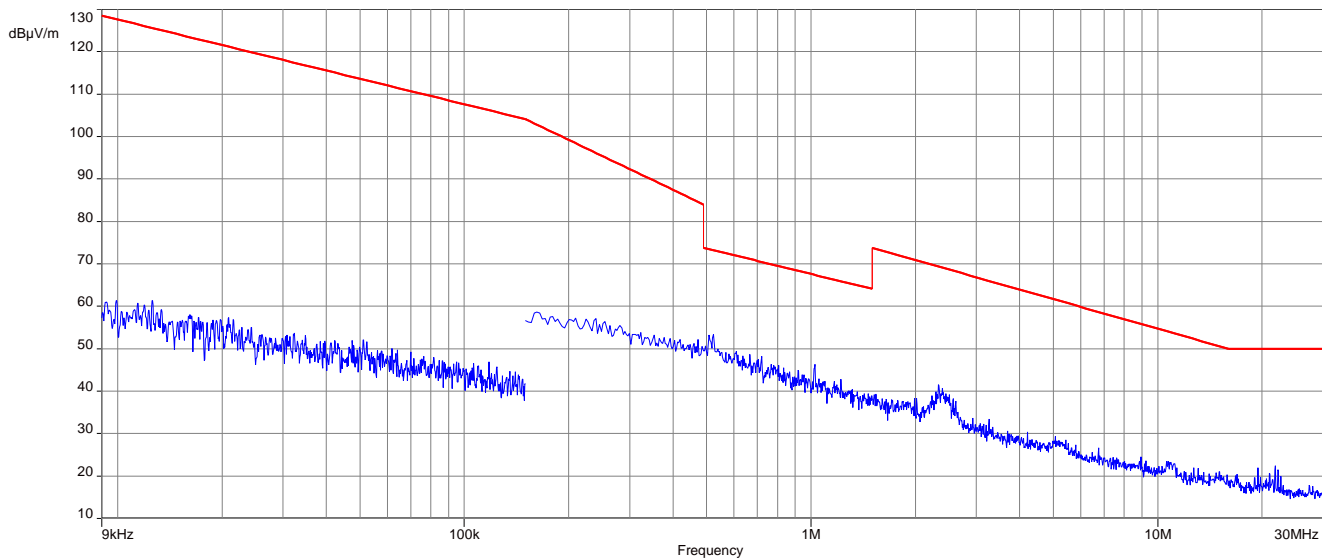

Plot 4: 9 kHz to 30 MHz, U-NII-2A; highest channel

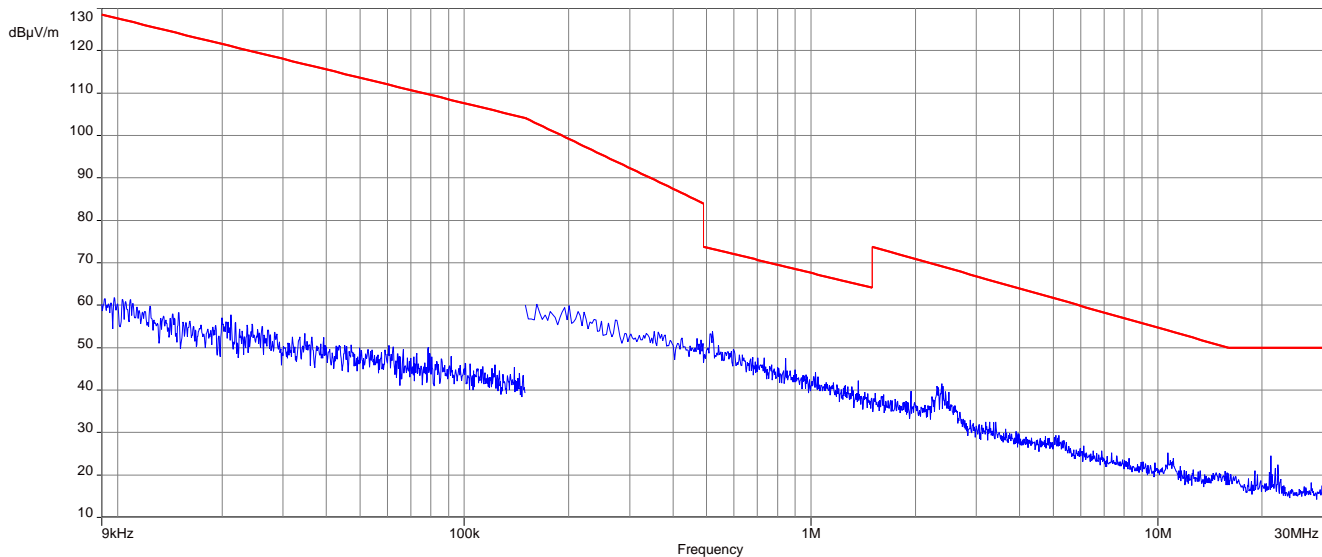

Plot 5: 9 kHz to 30 MHz, U-NII-2C; lowest channel

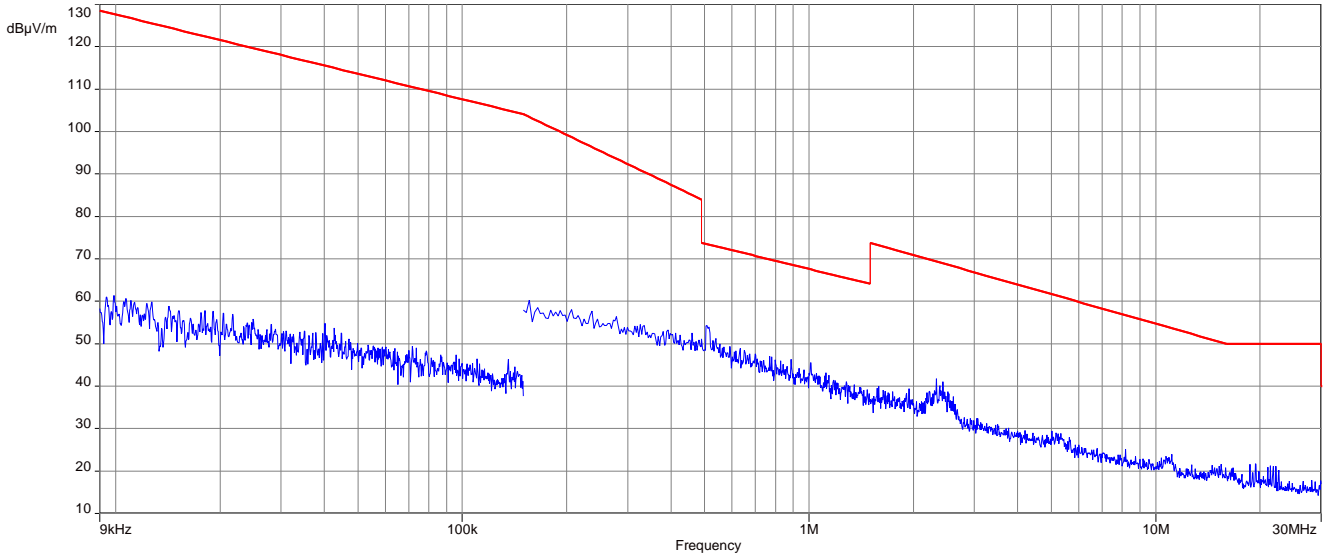

Plot 6: 9 kHz to 30 MHz, U-NII-2C; middle channel

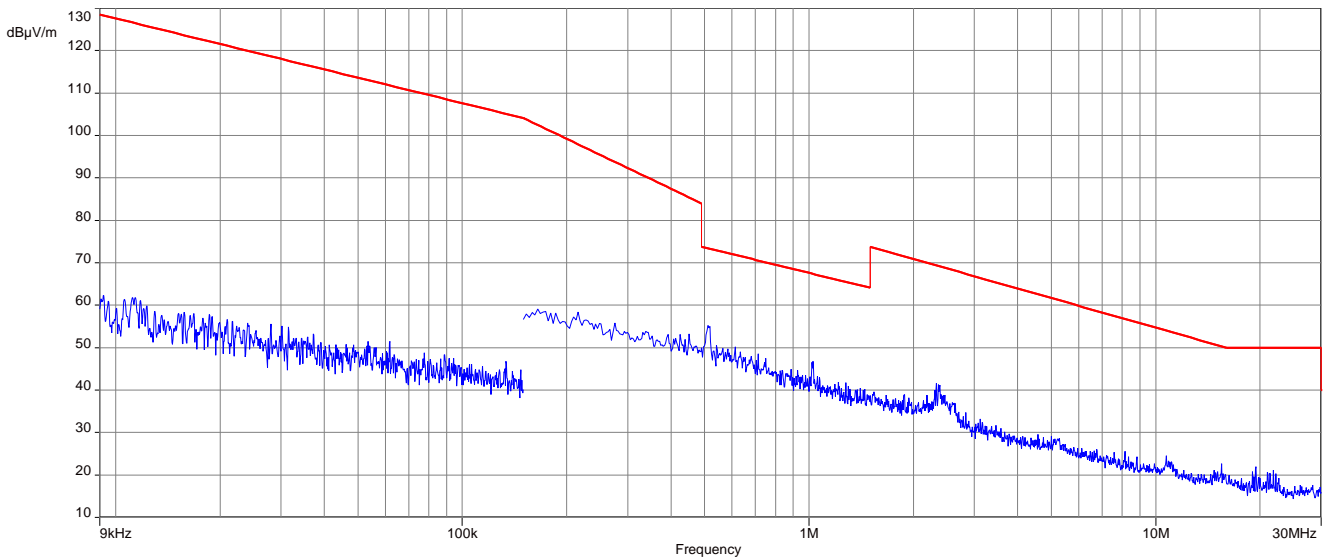

Plot 7: 9 kHz to 30 MHz, U-NII-2C; highest channel

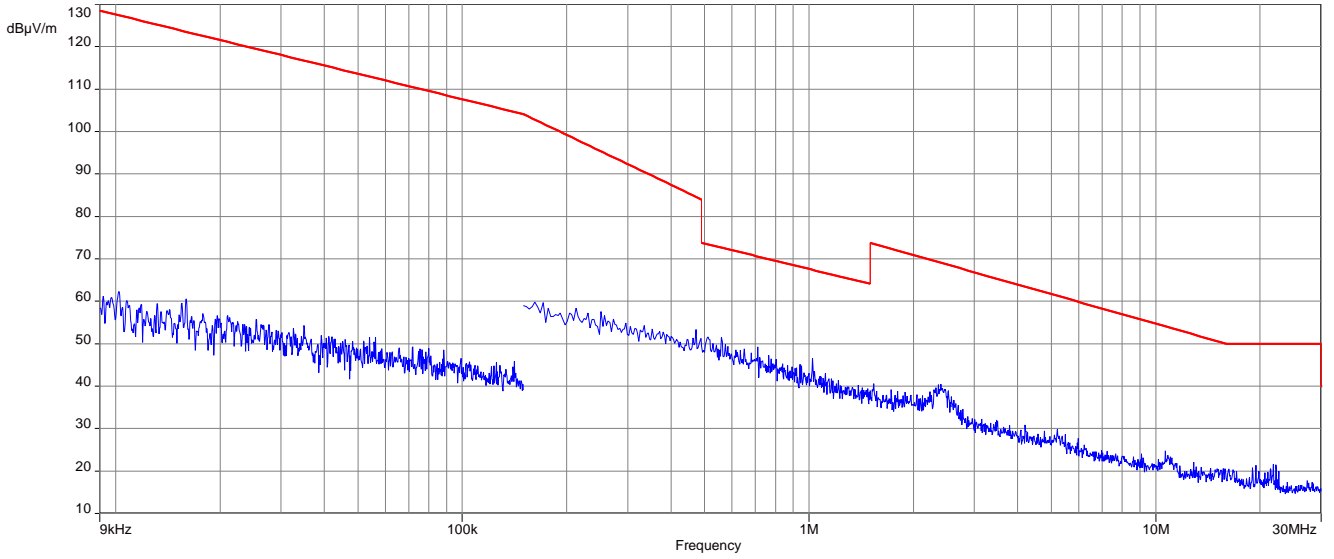

Plot 8: 9 kHz to 30 MHz, U-NII-3; lowest channel

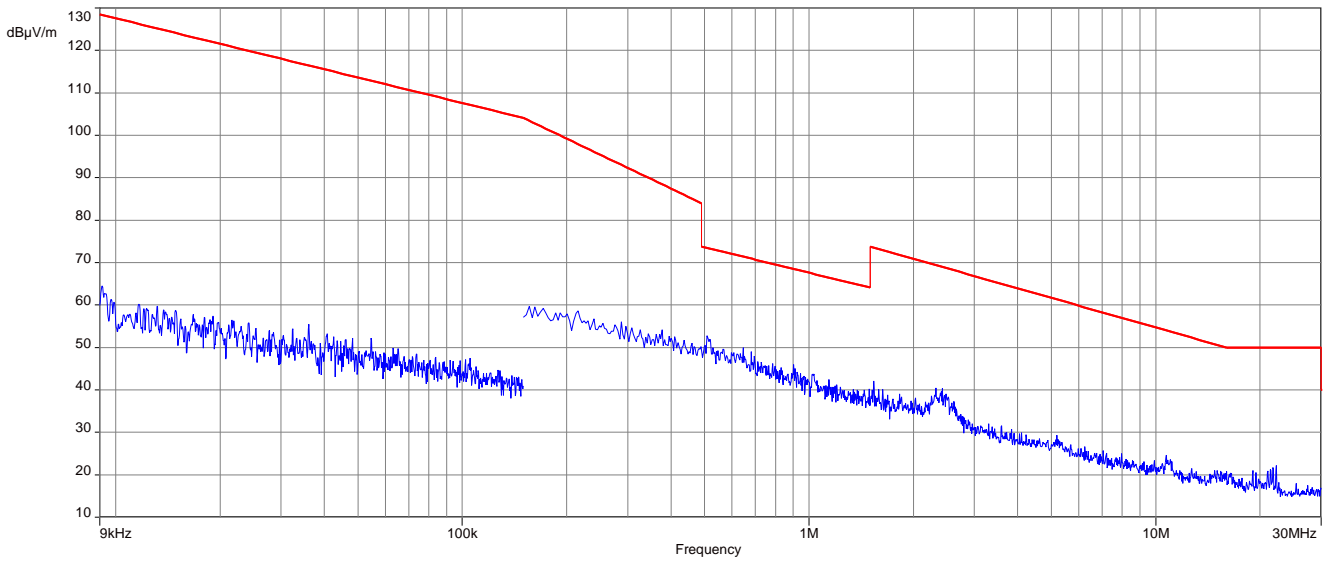

Plot 9: 9 kHz to 30 MHz, U-NII-3; highest channel

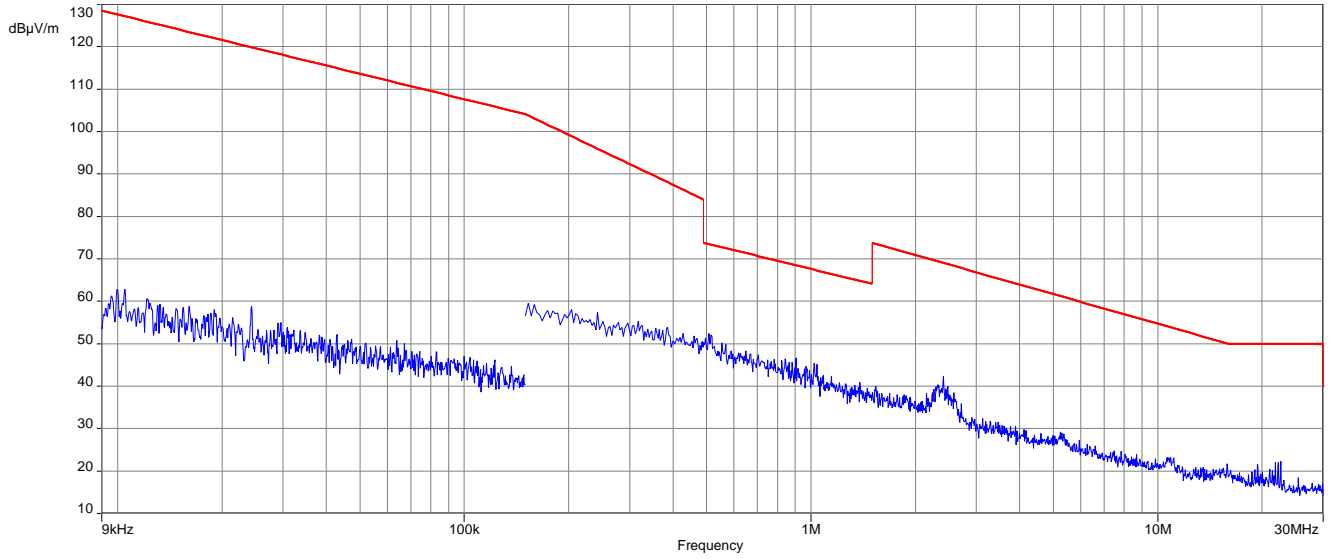

Plots: 80 MHz channel bandwidth, ANT1-DB1-RAF-xxx antenna

Plot 1: 9 kHz to 30 MHz, U-NII-1; middle channel

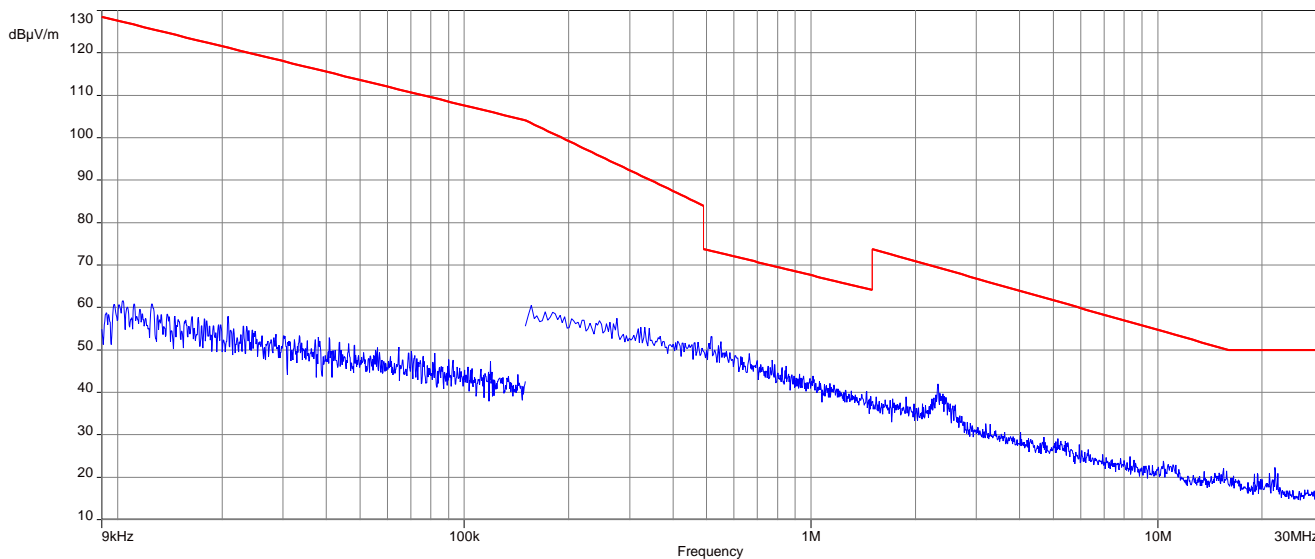

Plot 2: 9 kHz to 30 MHz, U-NII-2A; middle channel

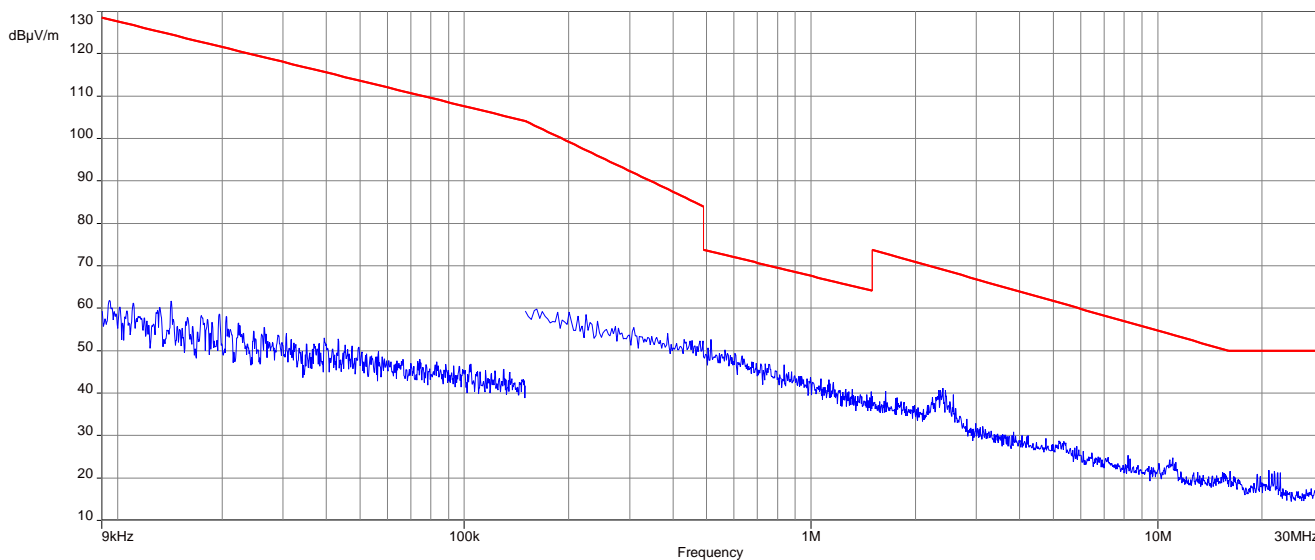

Plot 3: 9 kHz to 30 MHz, U-NII-2C; lowest channel

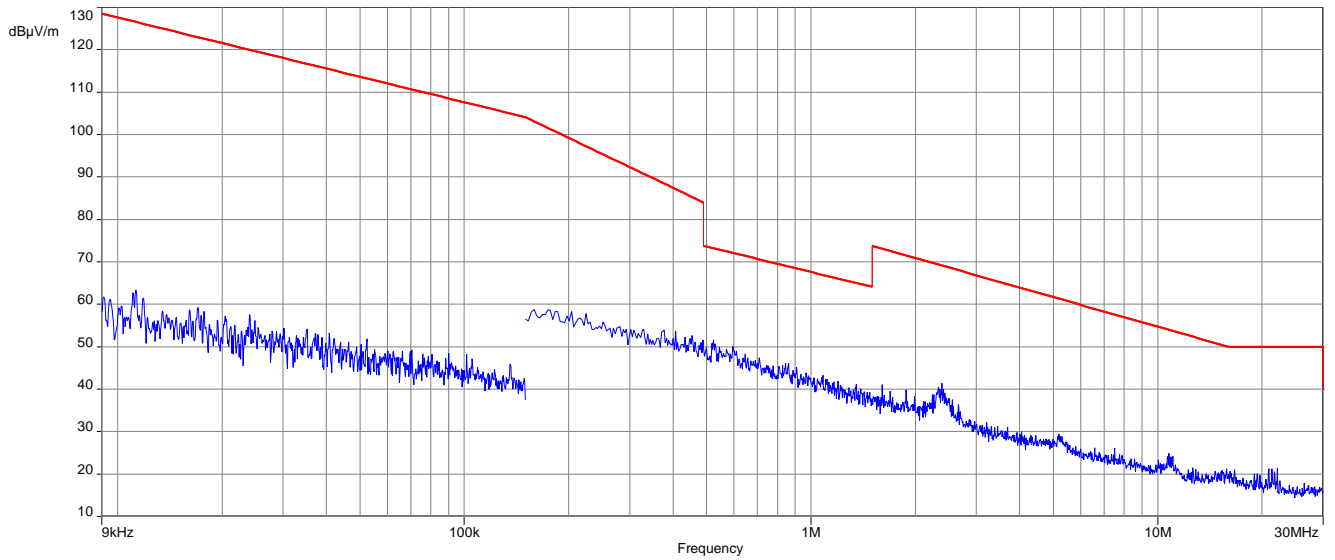

Plot 4: 9 kHz to 30 MHz, U-NII-2C; middle channel

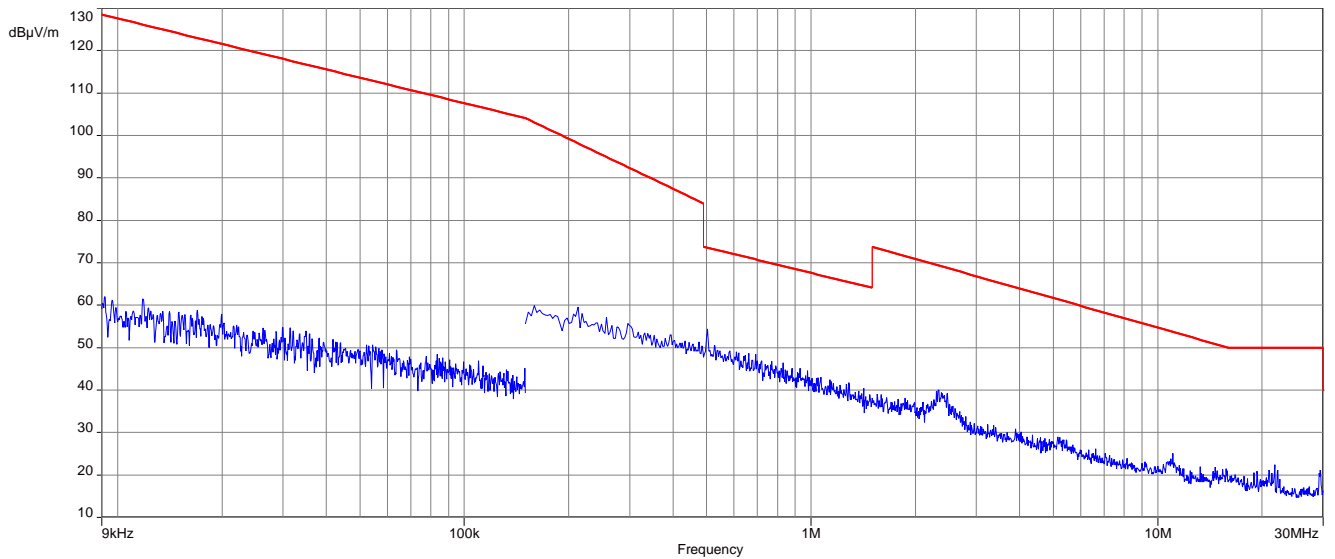

Plot 5: 9 kHz to 30 MHz, U-NII-2C; highest channel

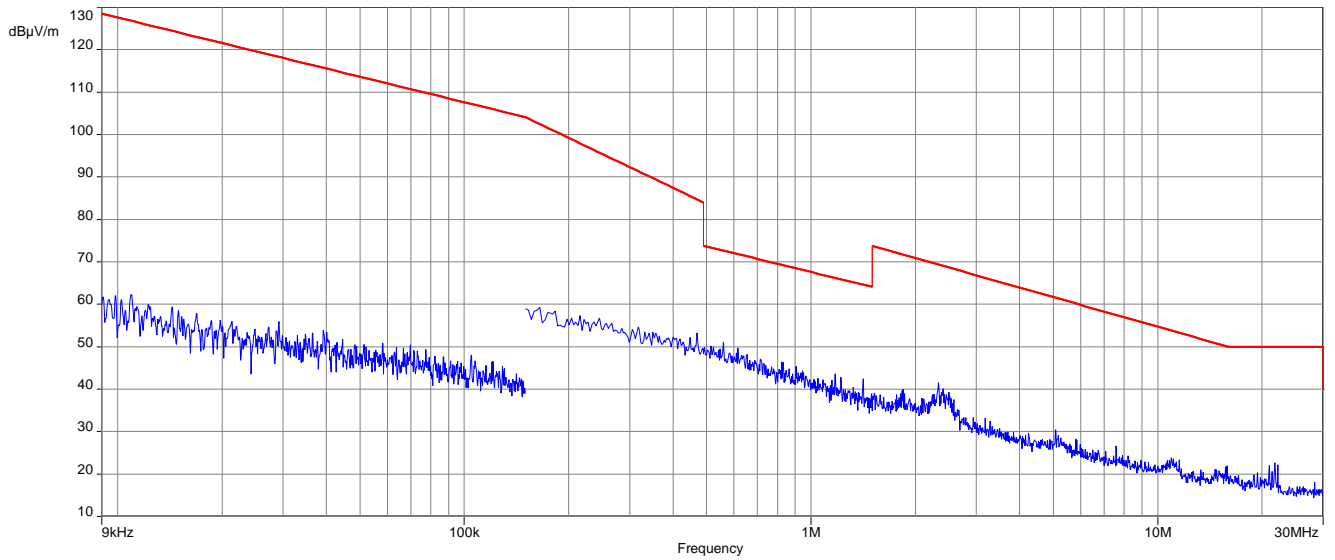

Plot 6: 9 kHz to 30 MHz, U-NII-3; middle channel

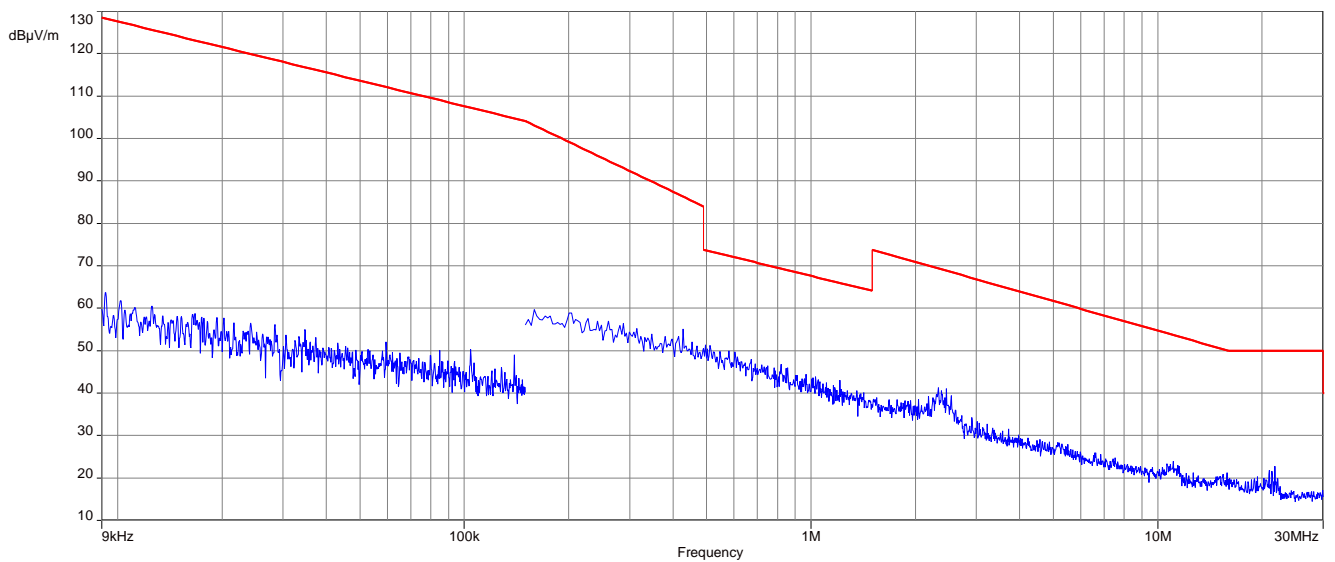

Plots: 20 MHz channel bandwidth, TAOGLAS PC11.07.0100A antenna

Plot 1: 9 kHz to 30 MHz, U-NII-1; lowest channel

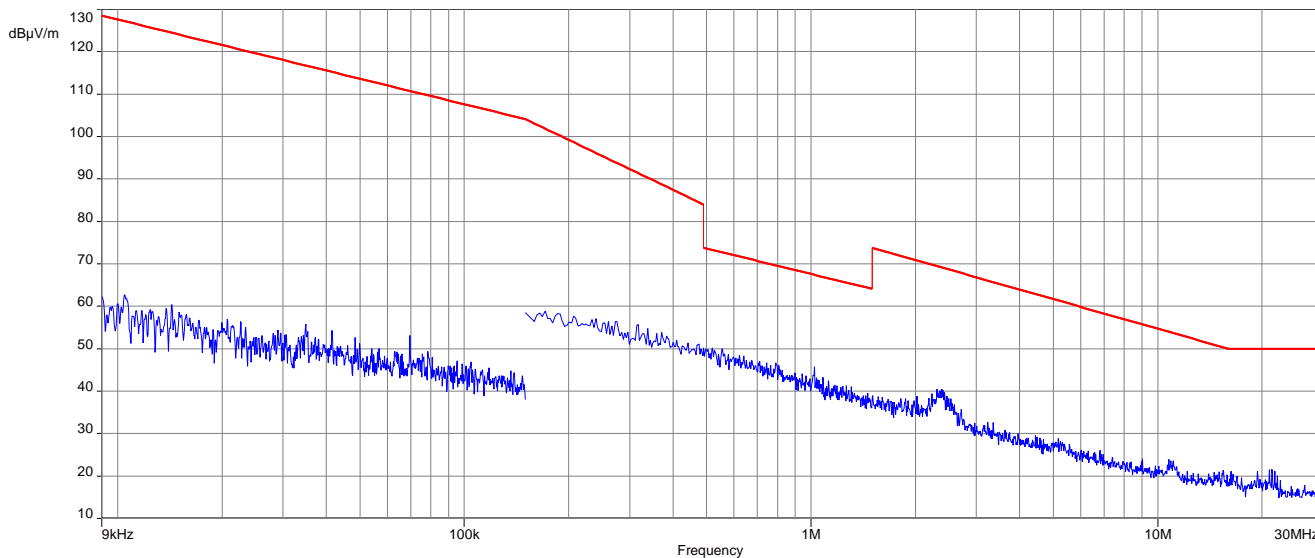

Plot 2: 9 kHz to 30 MHz, U-NII-1; middle channel

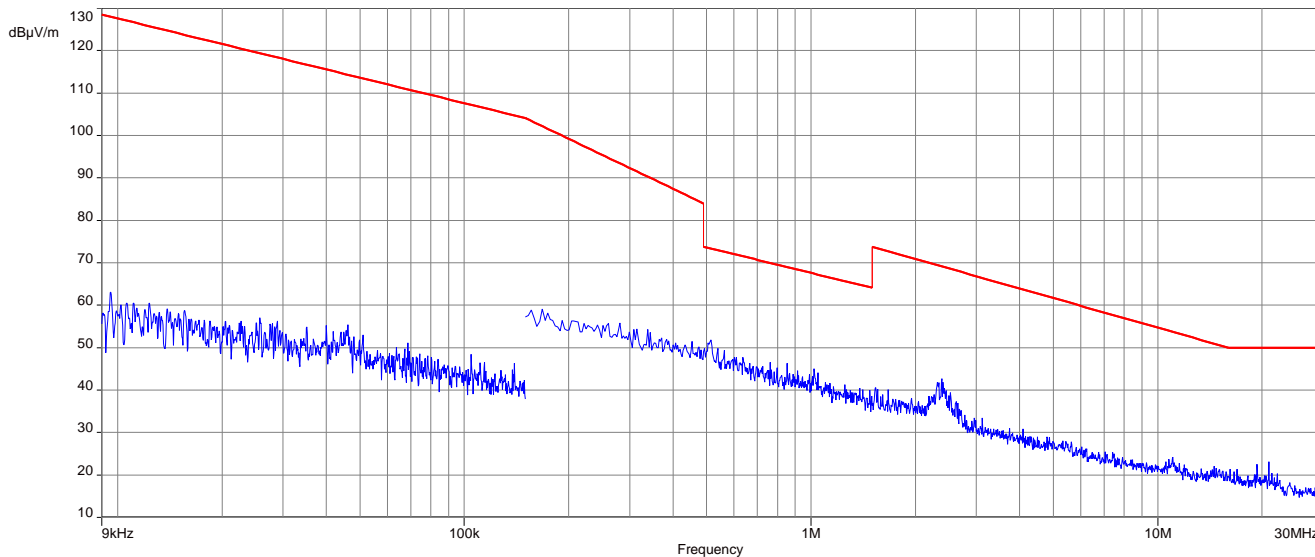

Plot 3: 9 kHz to 30 MHz, U-NII-1; highest channel

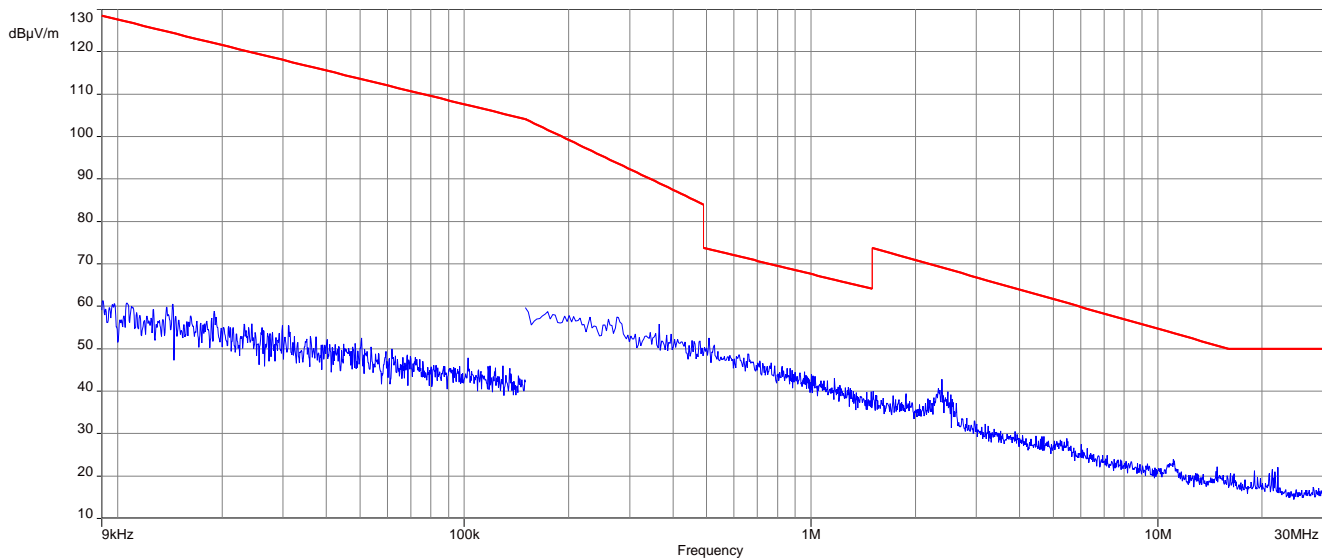

Plot 4: 9 kHz to 30 MHz, U-NII-2A; lowest channel

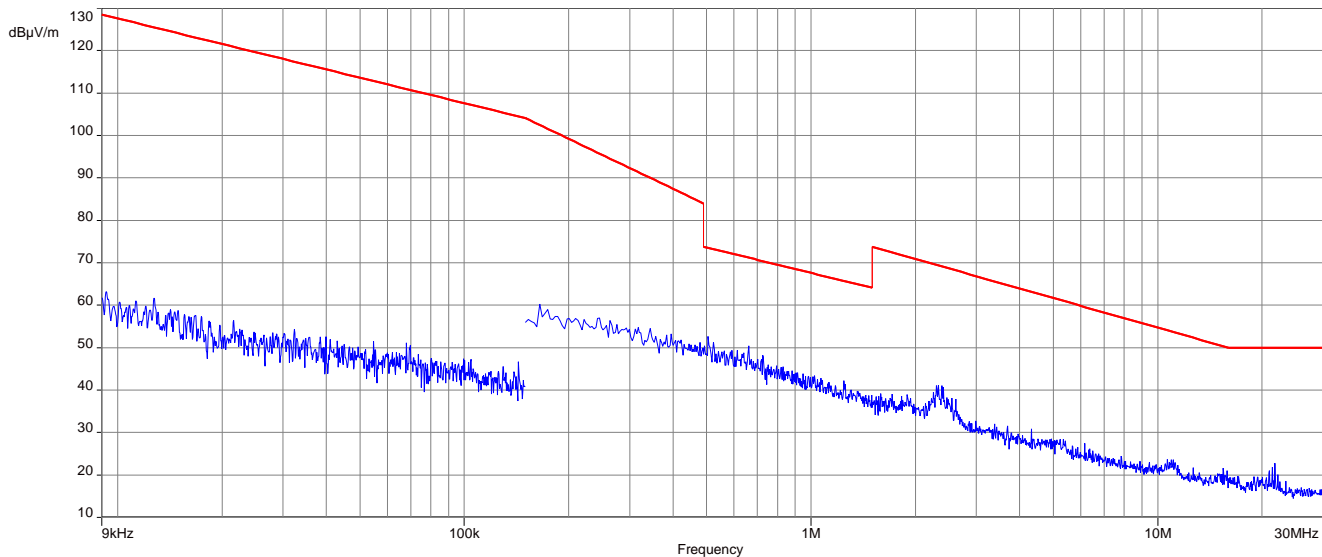

Plot 5: 9 kHz to 30 MHz, U-NII-2A; middle channel

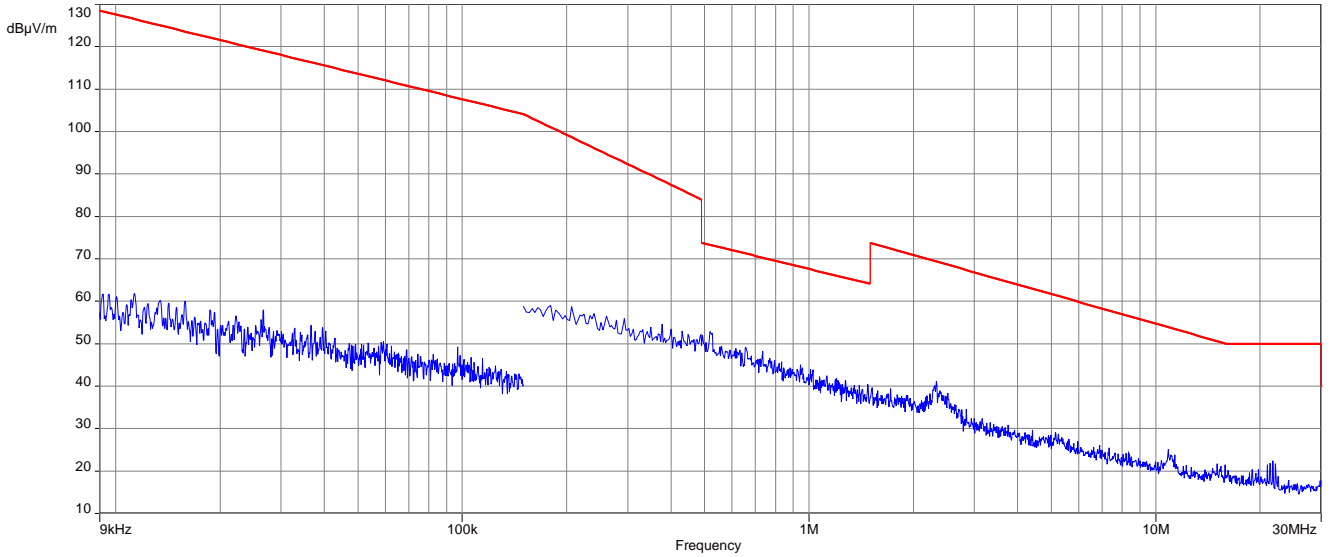

Plot 6: 9 kHz to 30 MHz, U-NII-2A; highest channel

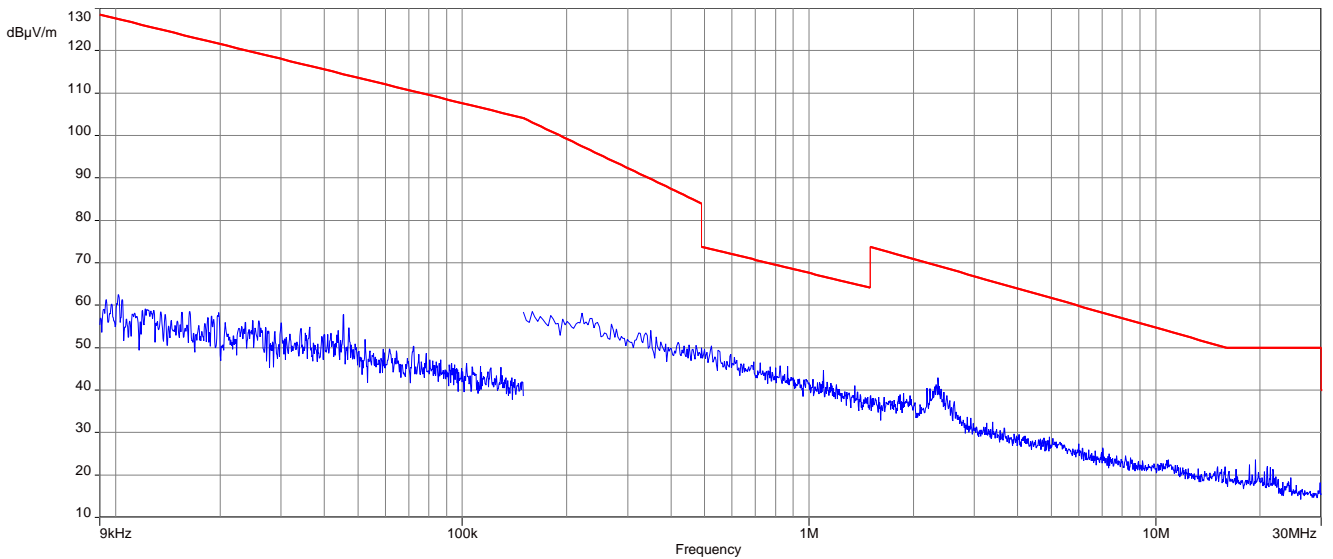

Plot 7: 9 kHz to 30 MHz, U-NII-2C; lowest channel

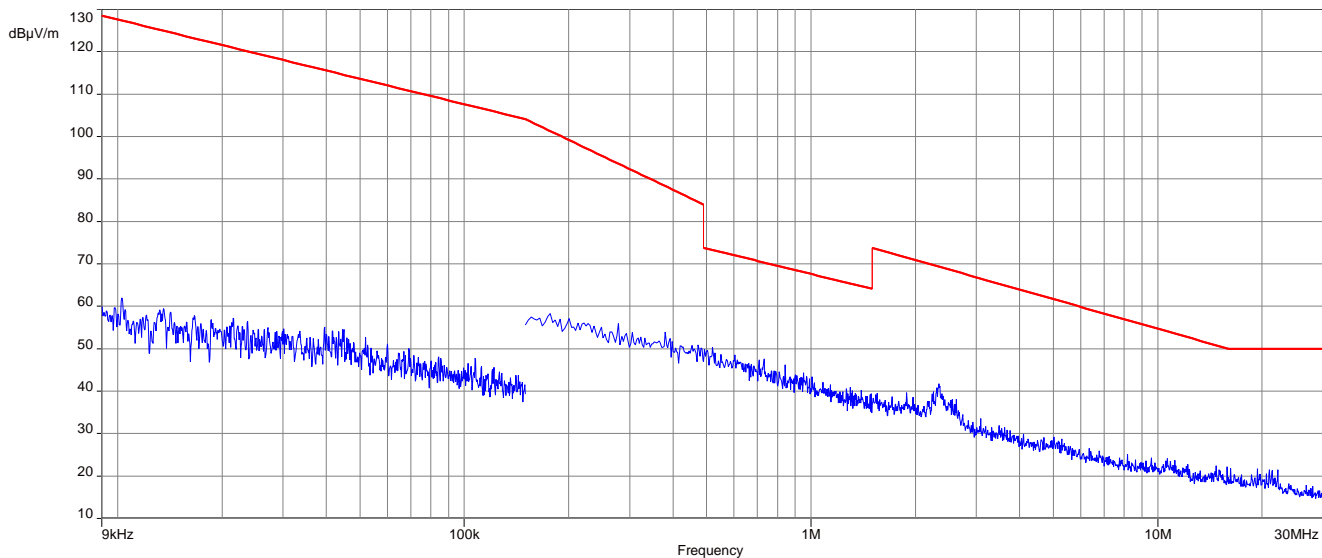

Plot 8: 9 kHz to 30 MHz, U-NII-2C; middle channel

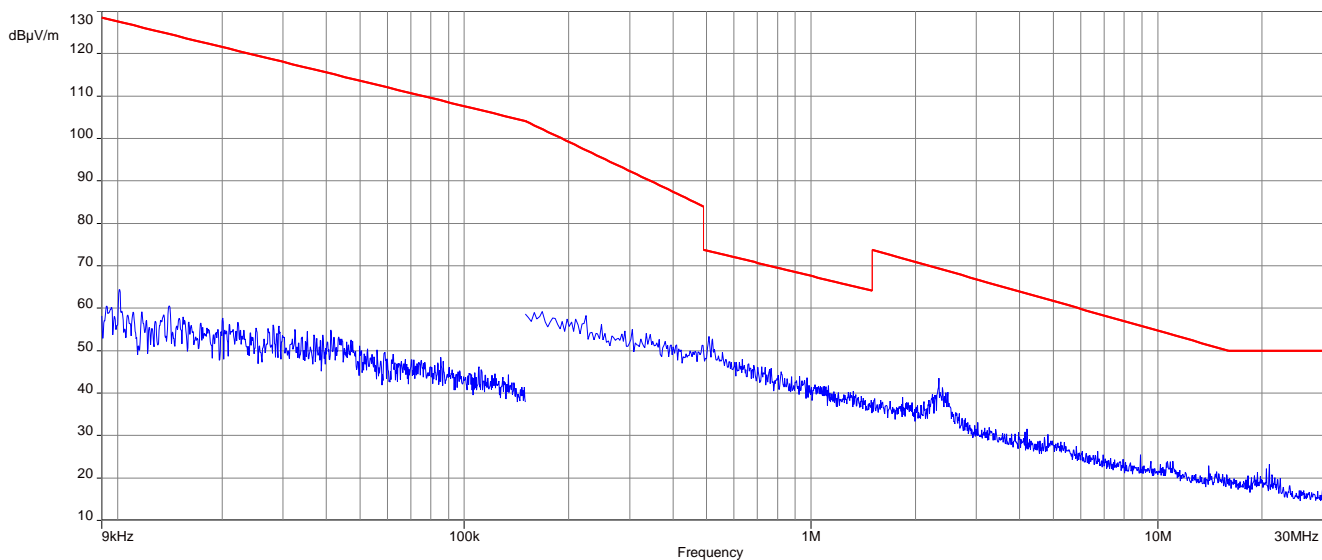

Plot 9: 9 kHz to 30 MHz, U-NII-2C; highest channel

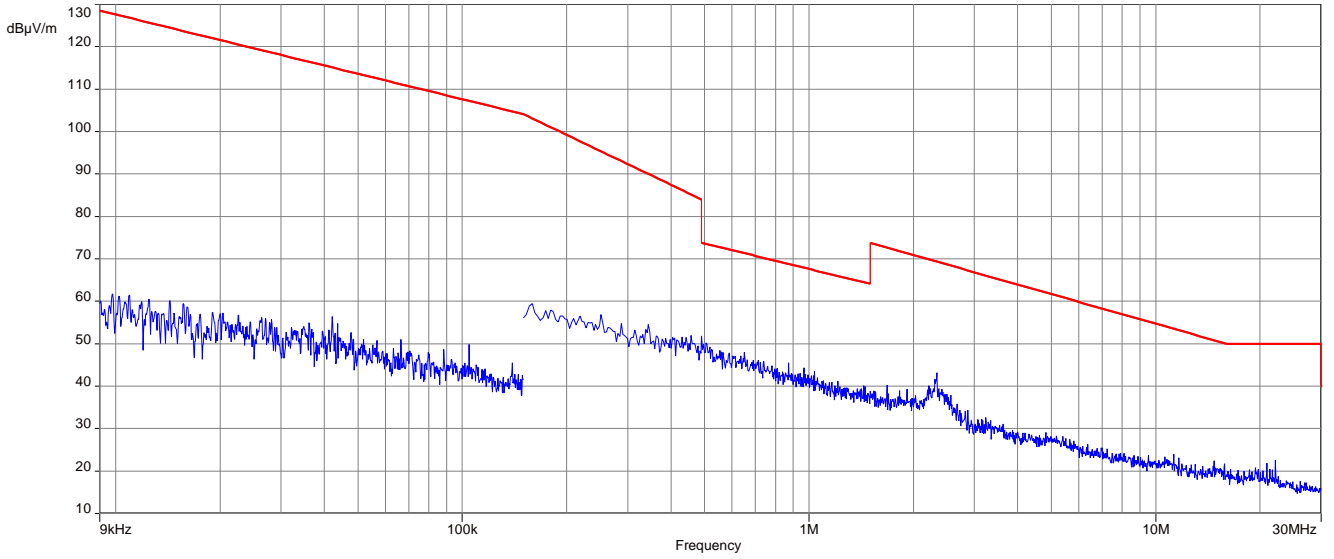

Plot 10: 9 kHz to 30 MHz, U-NII-3; lowest channel

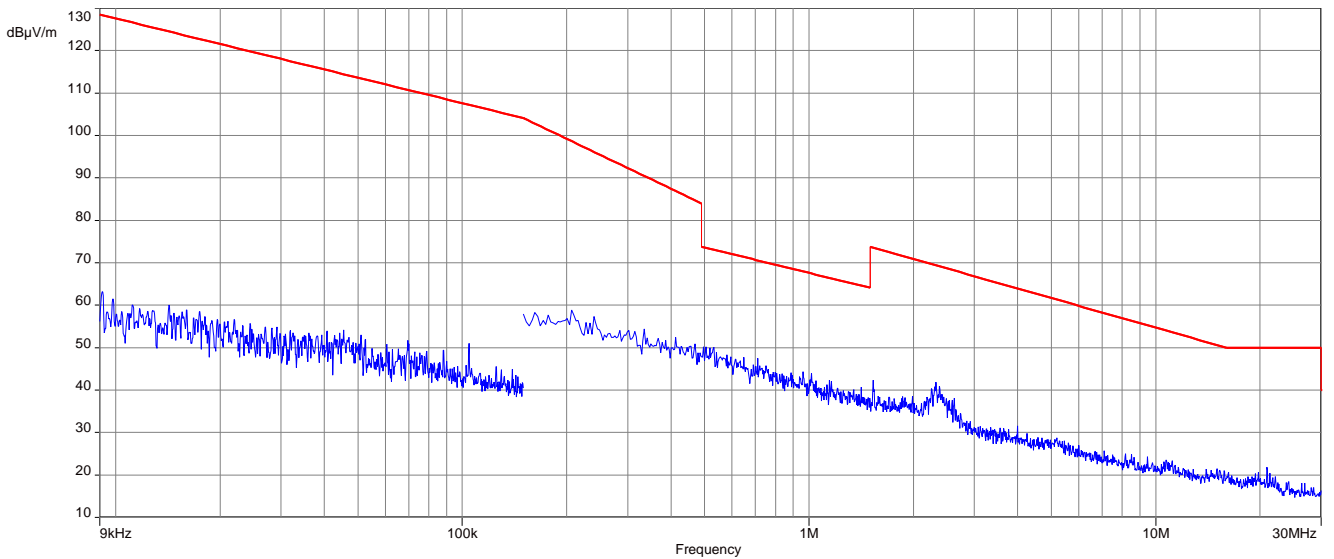

Plot 11: 9 kHz to 30 MHz, U-NII-3; middle channel

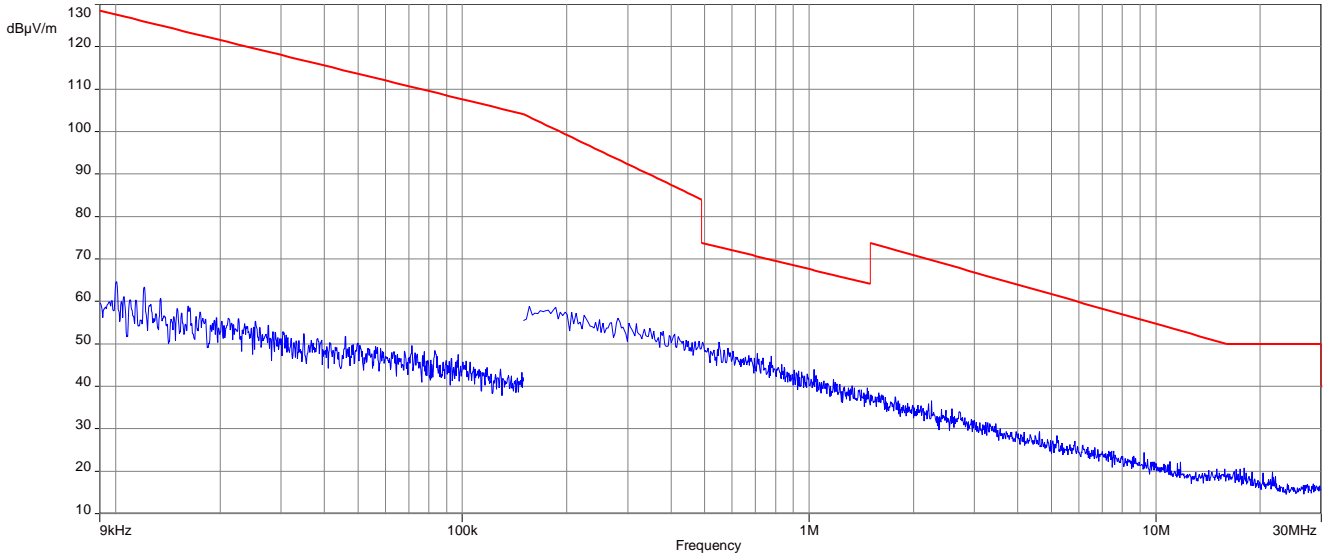

Plot 12: 9 kHz to 30 MHz, U-NII-3; highest channel

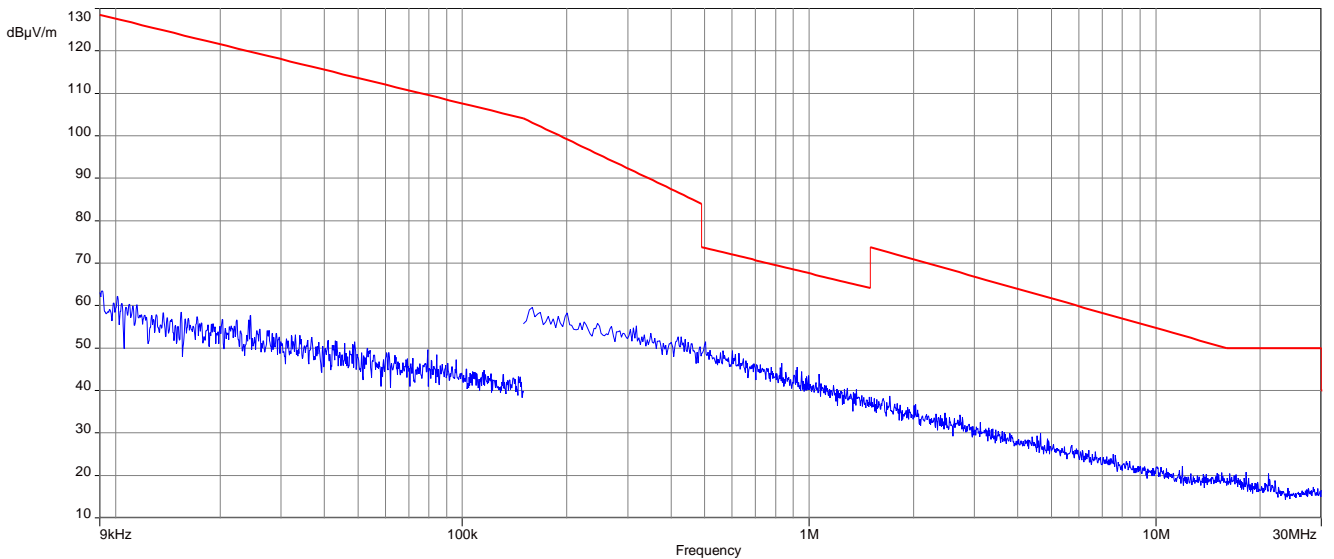

Plots: 40 MHz channel bandwidth, TAOGLAS PC11.07.0100A antenna

Plot 10: 9 kHz to 30 MHz, U-NII-1; lowest channel

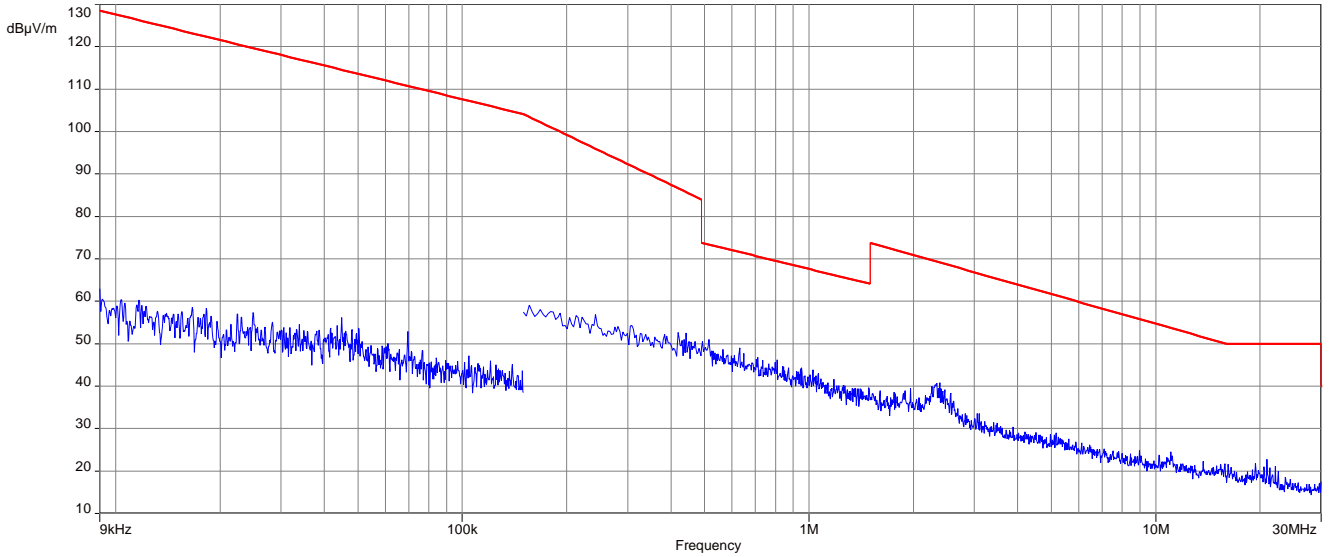

Plot 11: 9 kHz to 30 MHz, U-NII-1; highest channel

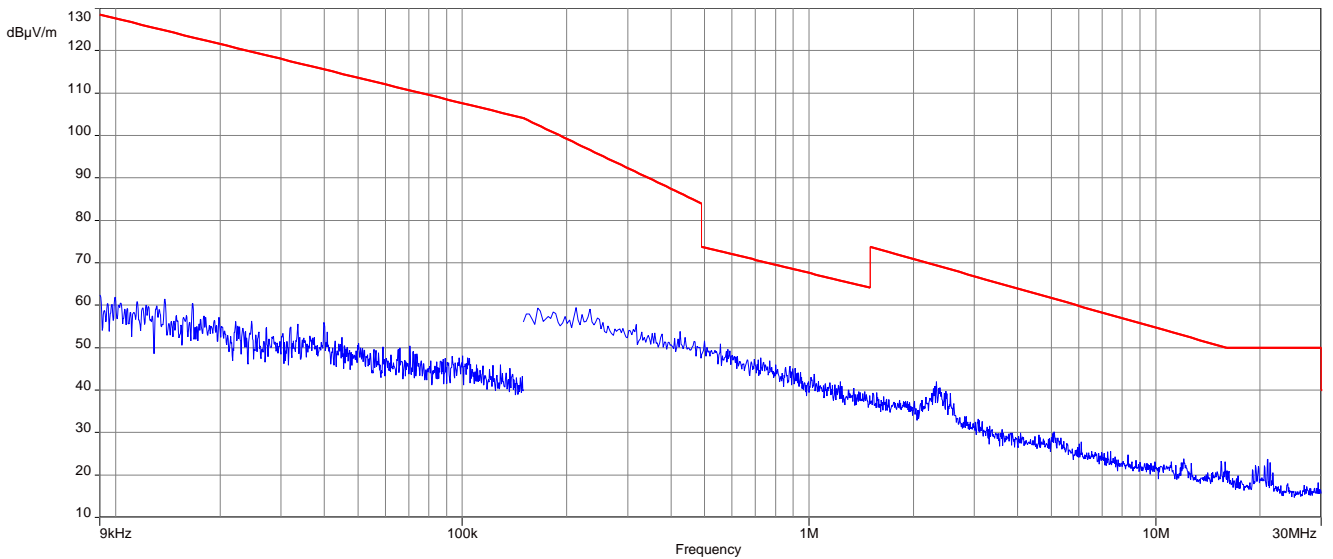

Plot 12: 9 kHz to 30 MHz, U-NII-2A; lowest channel

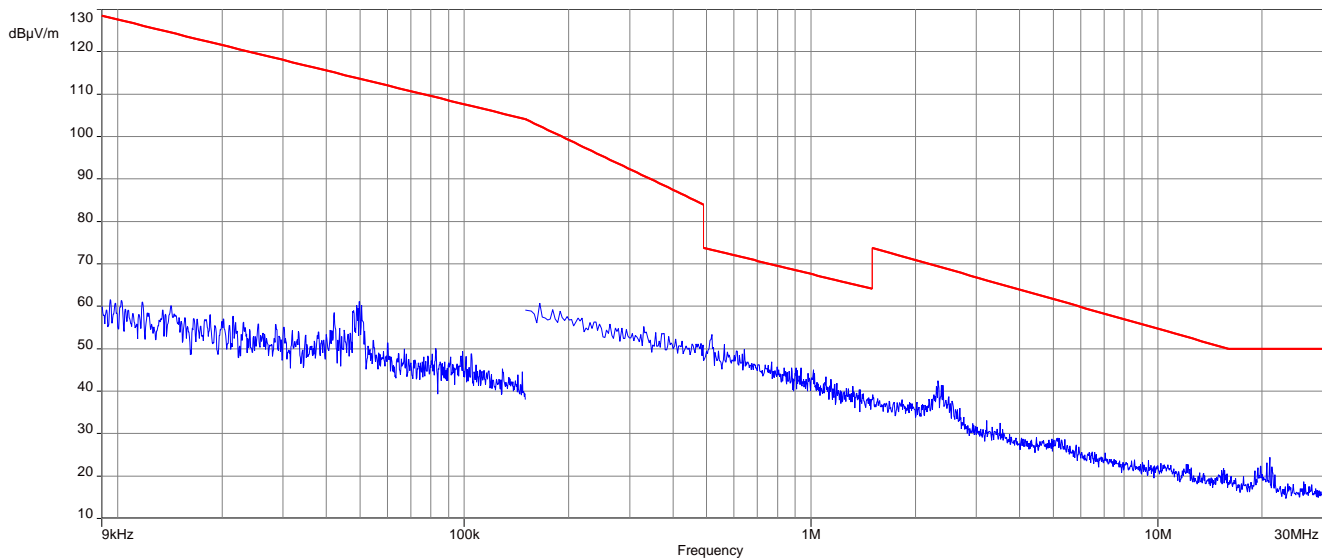

Plot 13: 9 kHz to 30 MHz, U-NII-2A; highest channel

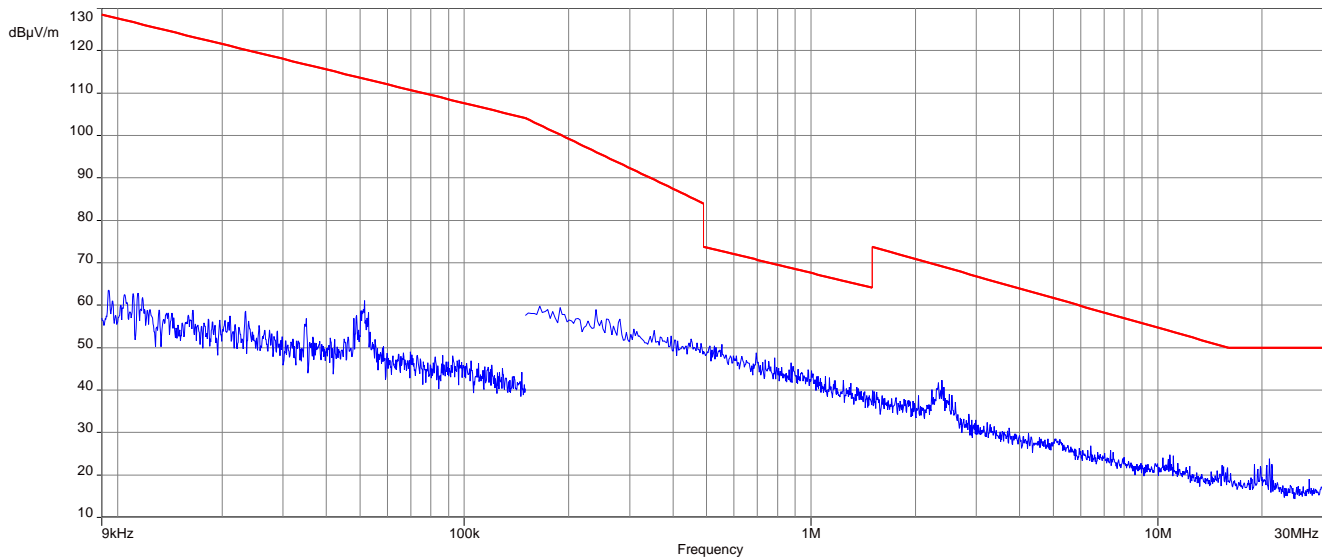

Plot 14: 9 kHz to 30 MHz, U-NII-2C; lowest channel

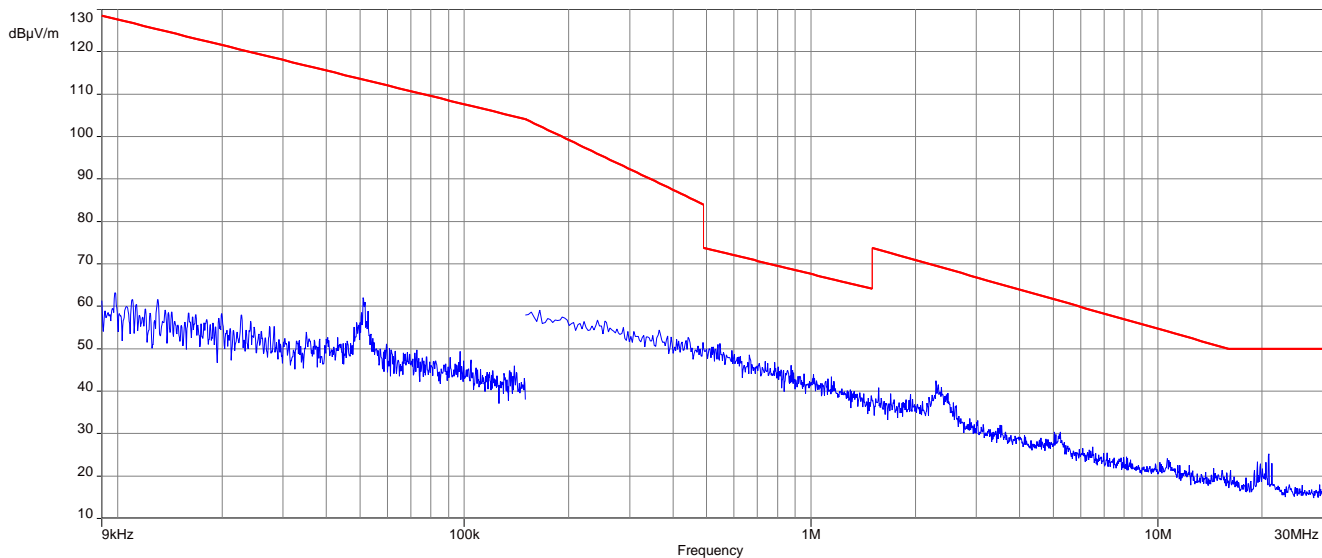

Plot 15: 9 kHz to 30 MHz, U-NII-2C; middle channel

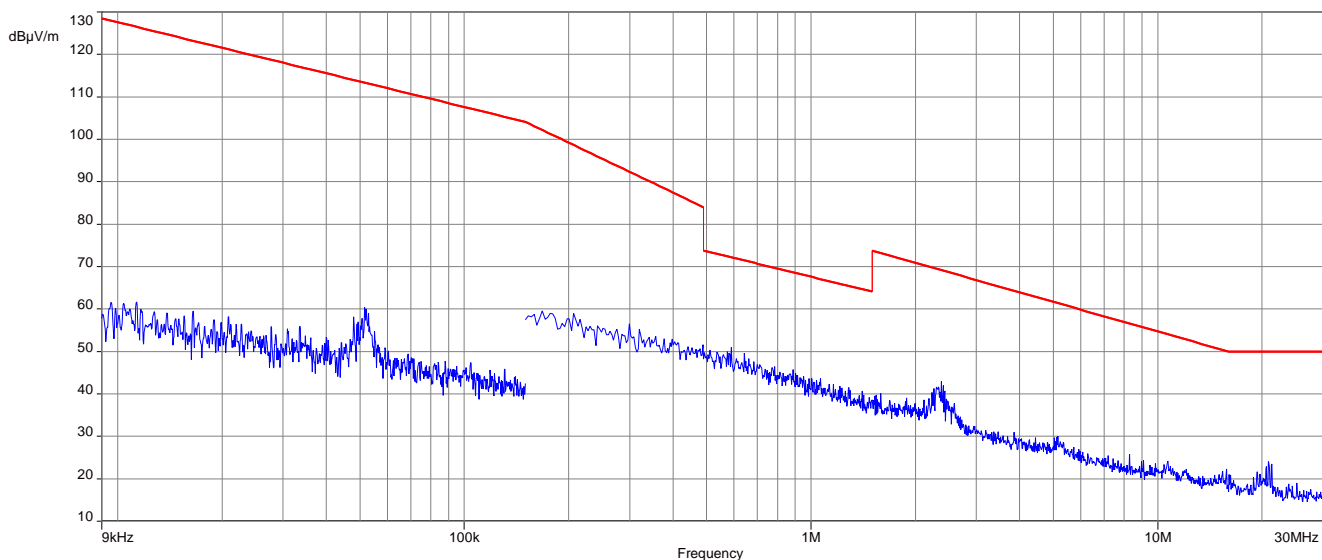

Plot 16: 9 kHz to 30 MHz, U-NII-2C; highest channel

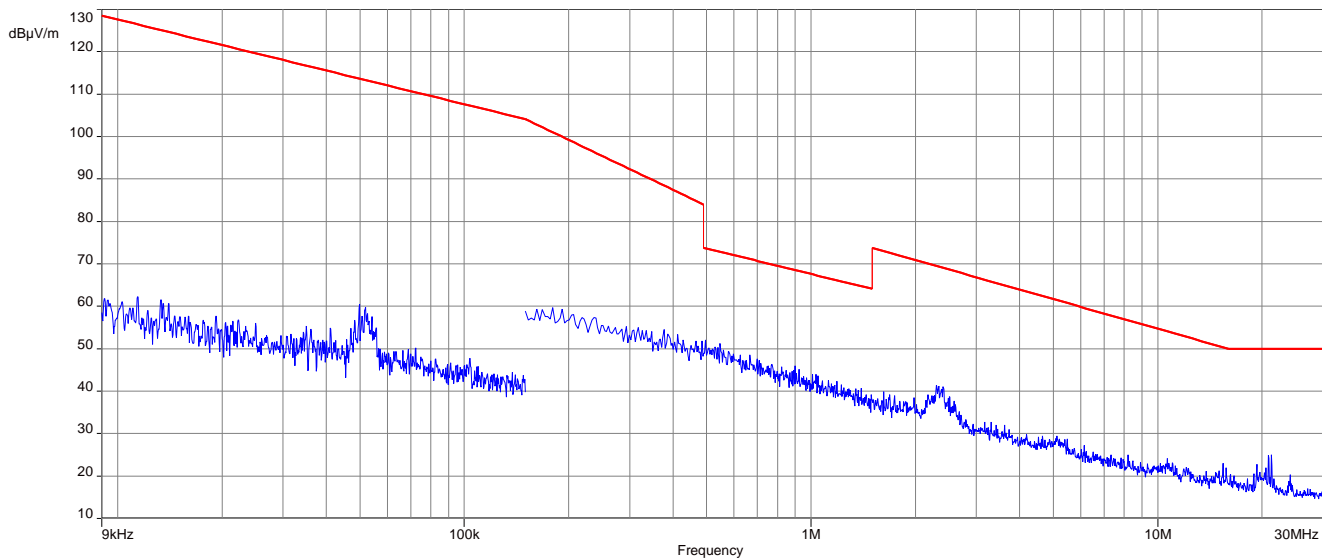

Plot 17: 9 kHz to 30 MHz, U-NII-3; lowest channel

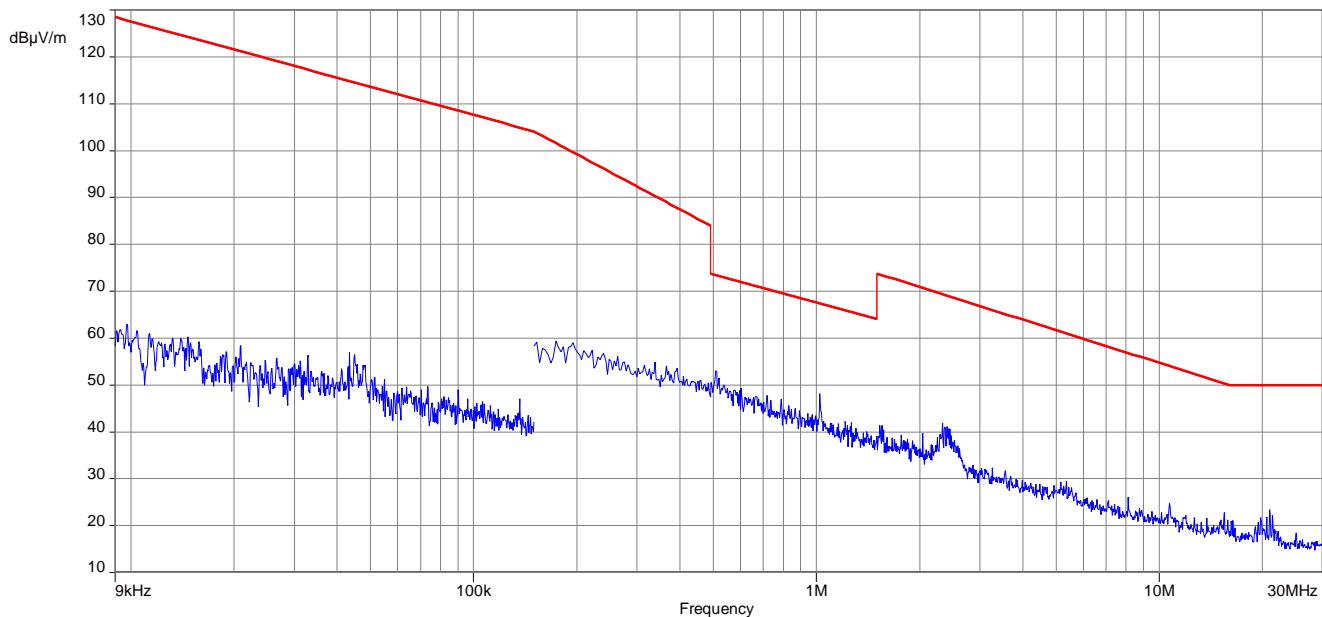

Plot 18: 9 kHz to 30 MHz, U-NII-3; highest channel

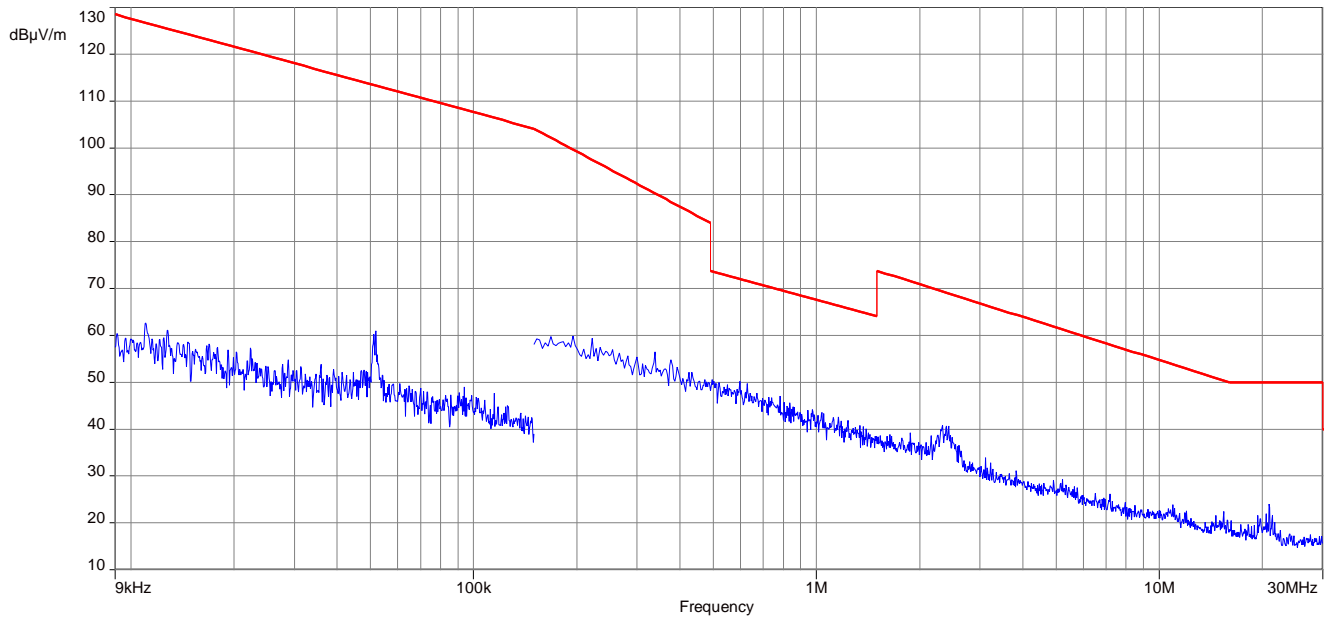

Plots: 80 MHz channel bandwidth, TAOGLAS PC11.07.0100A antenna

Plot 7: 9 kHz to 30 MHz, U-NII-1; middle channel

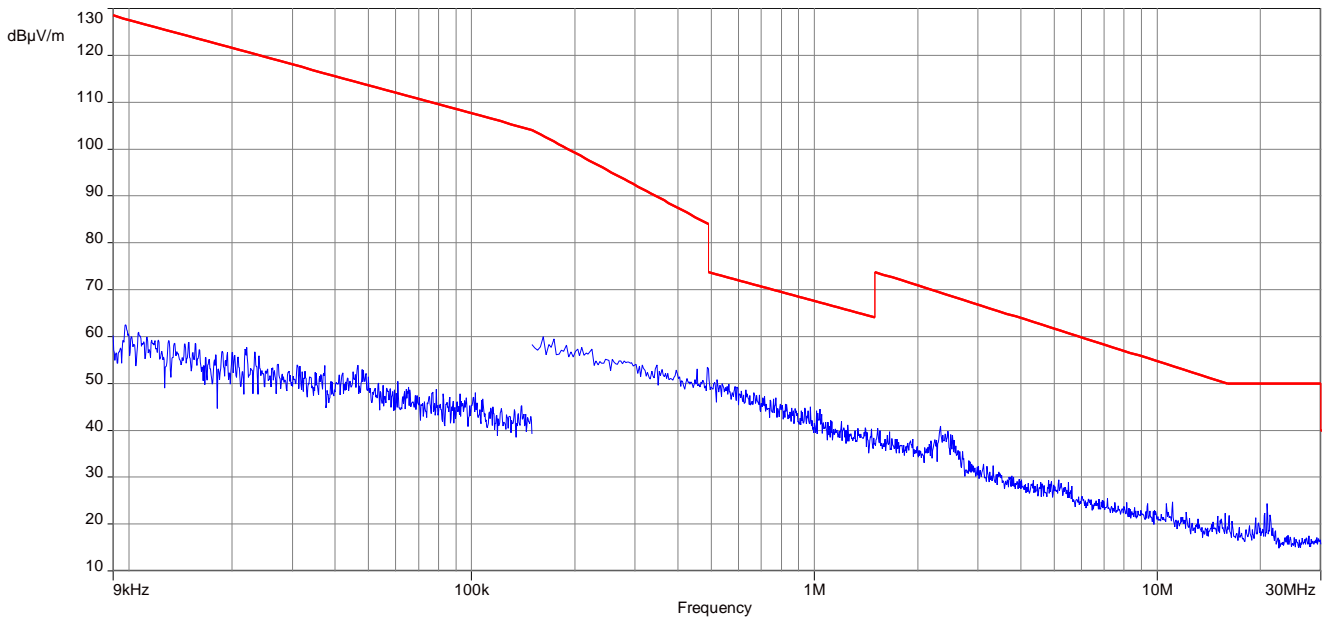

Plot 8: 9 kHz to 30 MHz, U-NII-2A; middle channel

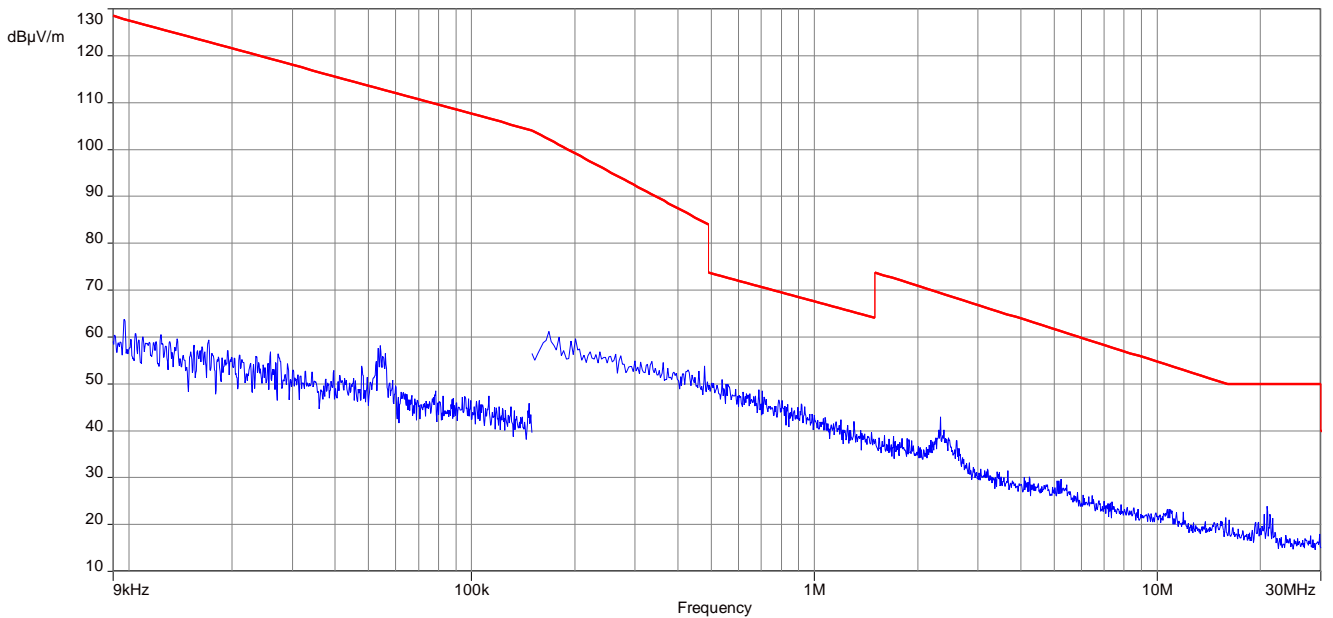

Plot 9: 9 kHz to 30 MHz, U-NII-2C; lowest channel

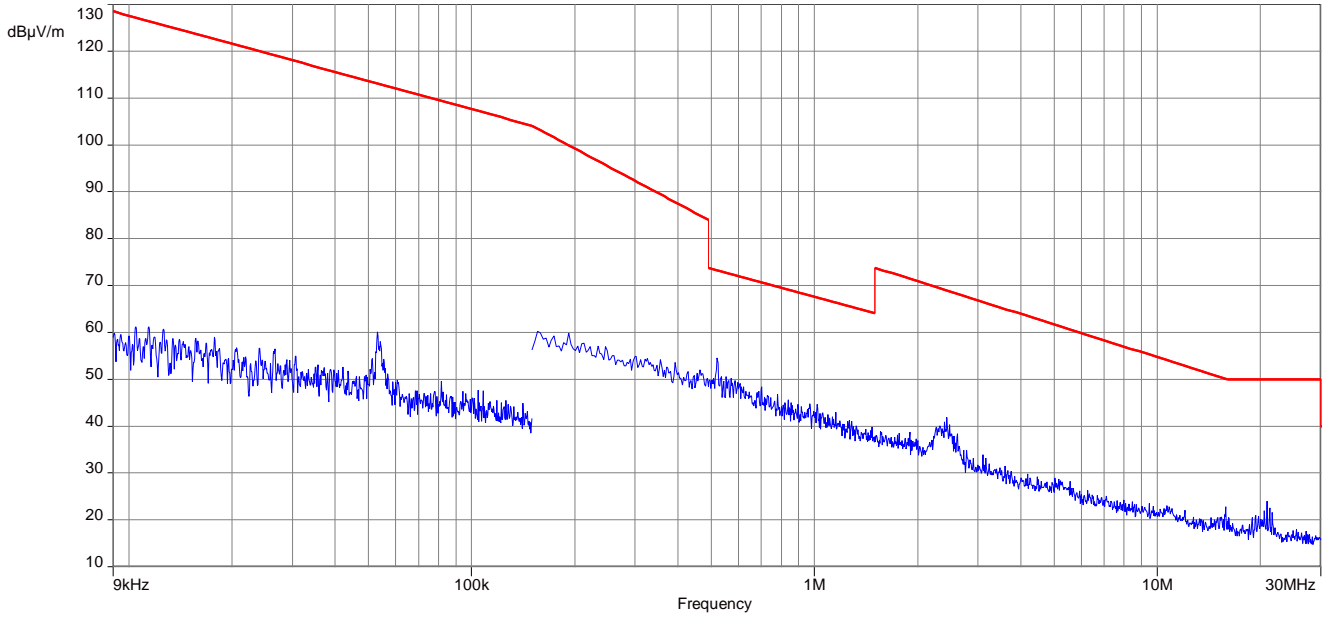

Plot 10: 9 kHz to 30 MHz, U-NII-2C; middle channel

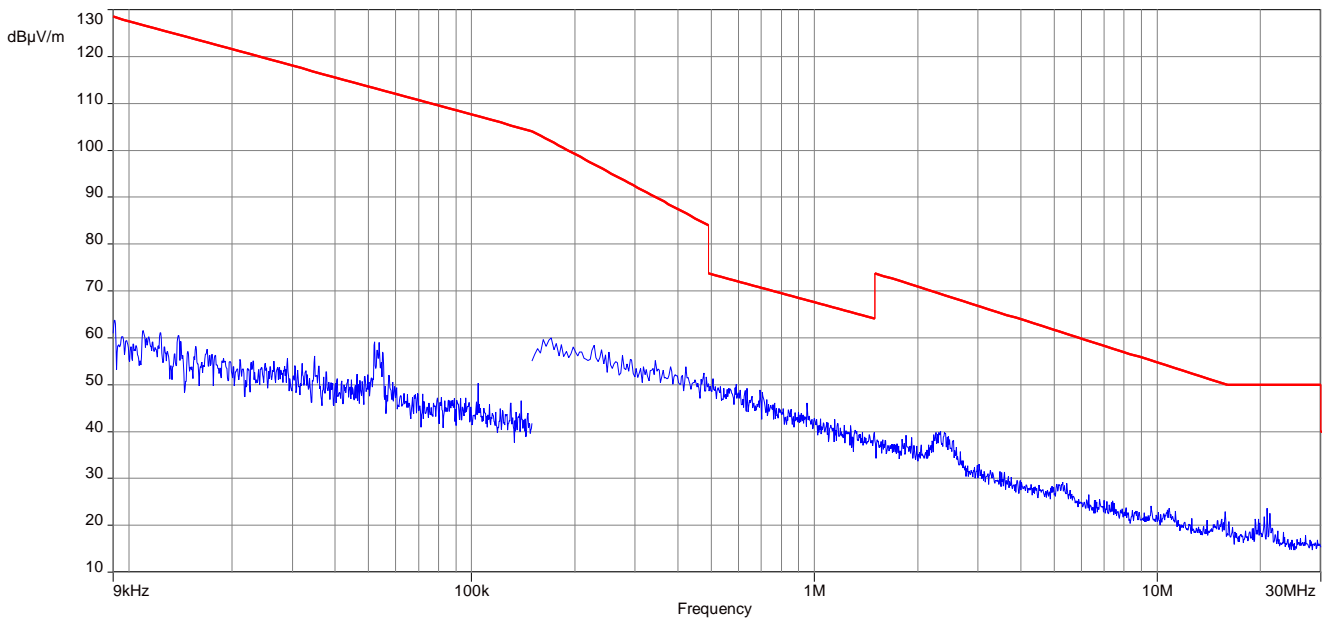

Plot 11: 9 kHz to 30 MHz, U-NII-2C; highest channel

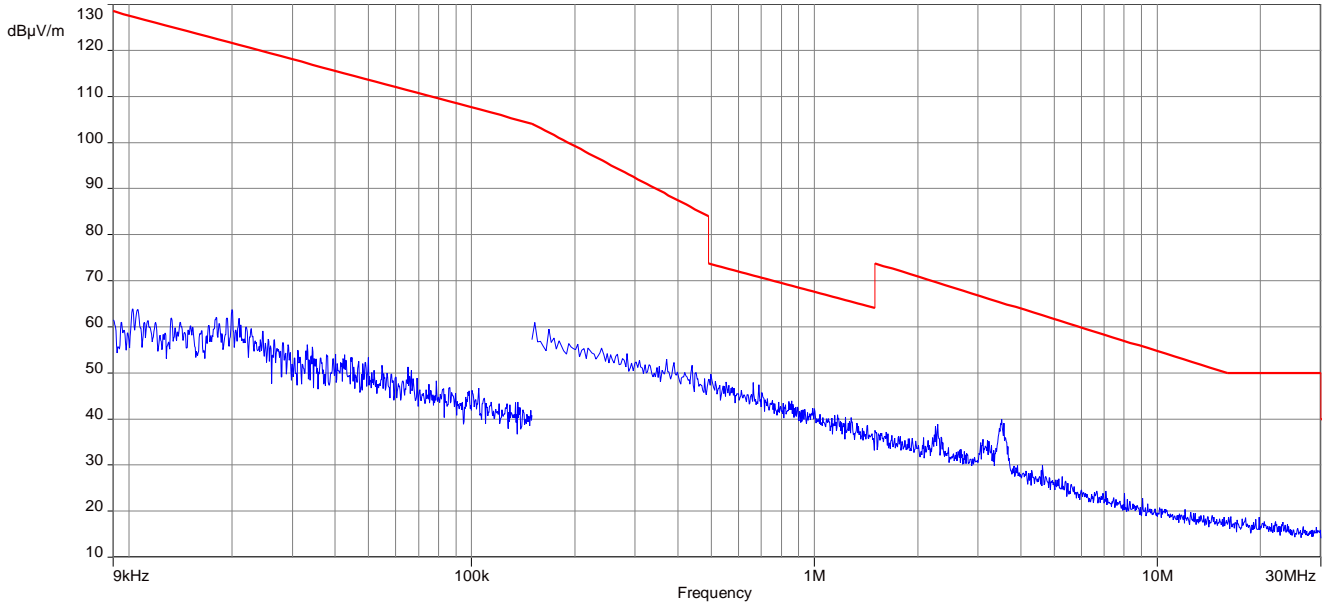

Plot 12: 9 kHz to 30 MHz, U-NII-3; middle channel

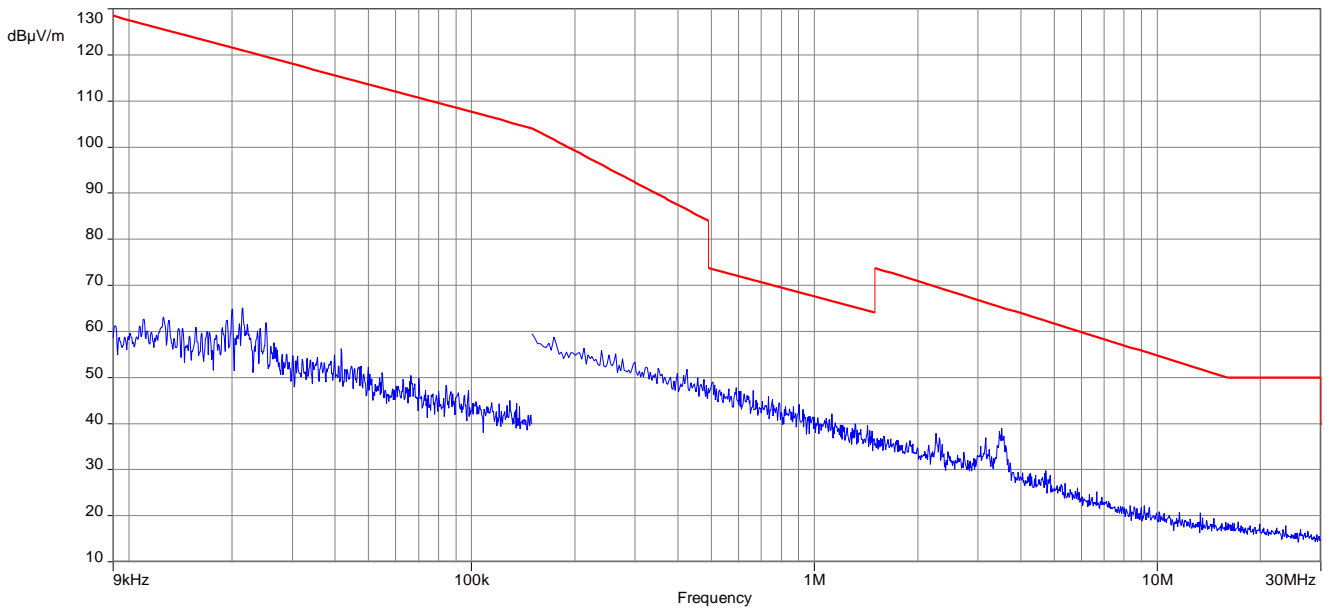

12.11 Spurious emissions radiated 30 MHz to 1 GHz

Description:

Measurement of the radiated spurious emissions and cabinet radiations below 1 GHz.

Measurement:

Measurement parameter	
Detector:	Quasi Peak
Sweep time:	Auto
Resolution bandwidth:	120 kHz
Video bandwidth:	500 kHz
Span:	30 MHz to 1 GHz
Test setup:	See chapter 7.1 – A See chapter 7.2 – B See chapter 7.3 – A
Measurement uncertainty:	See chapter 9

Limits:

TX Spurious Emissions Radiated		
§15.209 / RSS-247		
Frequency (MHz)	Field Strength (dBµV/m)	Measurement distance
30 - 88	30.0	10
88 – 216	33.5	10
216 – 960	36.0	10
Above 960	54.0	3
§15.407		
Outside the restricted bands!	-27 dBm / MHz	

Plots: ANT1-DB1-RAF-xxx antenna

Plot 1: 30 MHz to 1 GHz; vertical & horizontal polarization; a-mode, valid for all channels

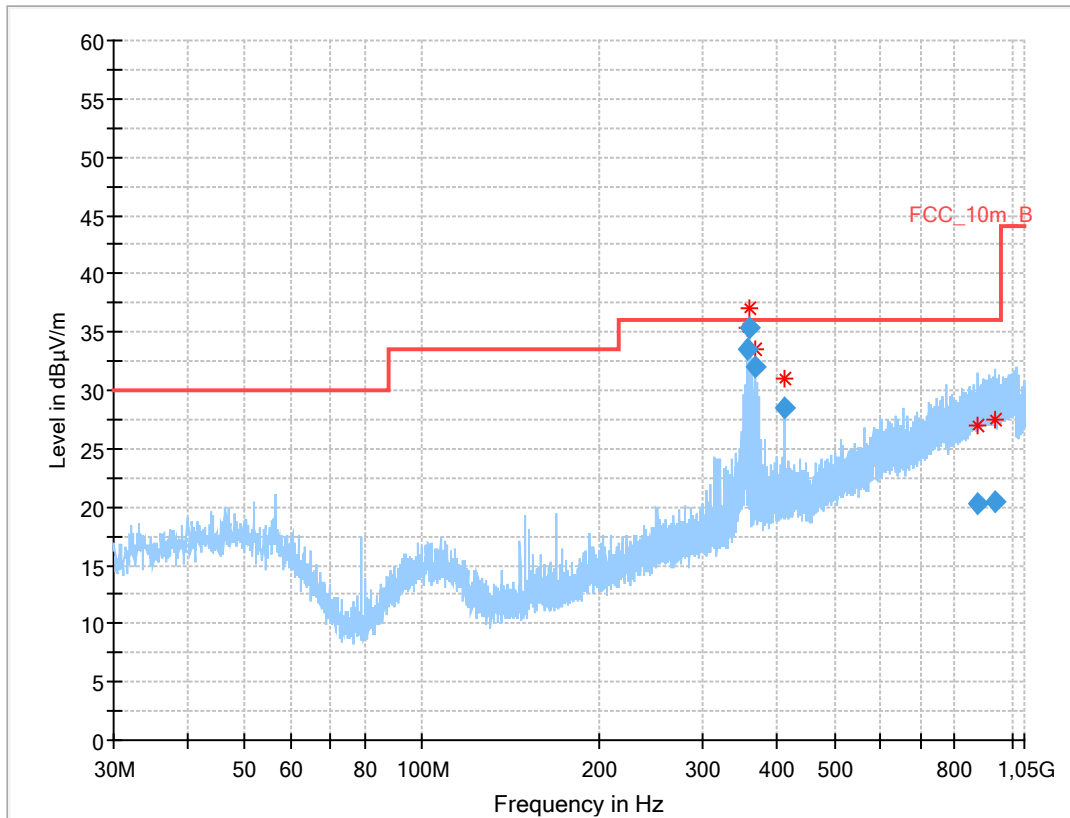

Results:

Frequency (MHz)	QuasiPeak (dBµV/m)	Limit (dBµV/m)	Margin (dB)	Meas. Time (ms)	Bandwidth (kHz)	Height (cm)	Pol	Azimuth (deg)	Corr. (dB)
356.996	33.44	36.0	2.6	1000	120.0	234.0	H	193	17
360.008	35.42	36.0	0.6	1000	120.0	221.0	H	191	17
366.010	31.94	36.0	4.1	1000	120.0	233.0	H	186	17
411.432	28.50	36.0	7.5	1000	120.0	200.0	H	45	18
871.476	20.28	36.0	15.7	1000	120.0	112.0	H	32	25
934.125	20.41	36.0	15.6	1000	120.0	400.0	H	-45	26

Plot 2: 30 MHz to 1 GHz; vertical & horizontal polarization; nHT20-mode, valid for all channels

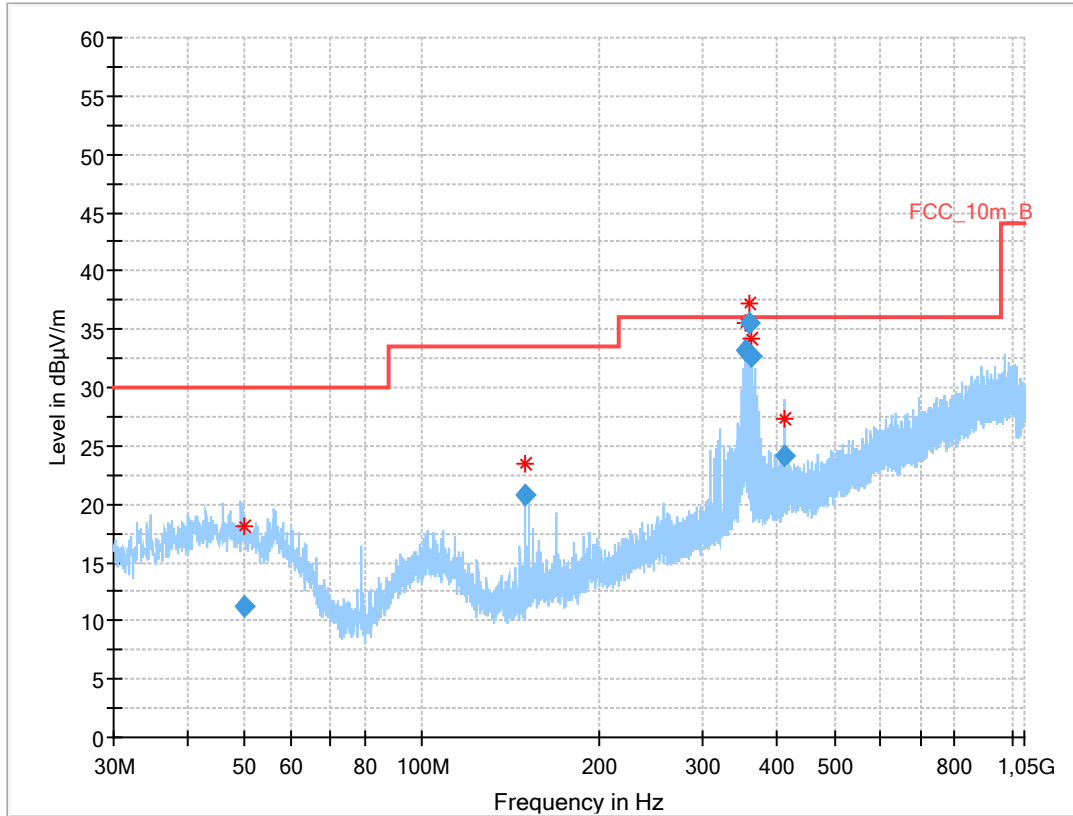

Results:

Frequency (MHz)	QuasiPeak (dBµV/m)	Limit (dBµV/m)	Margin (dB)	Meas. Time (ms)	Bandwidth (kHz)	Height (cm)	Pol	Azimuth (deg)	Corr. (dB)
49.964	11.24	30.0	18.8	1000	120.0	212.0	V	287	16
149.997	20.79	33.5	12.7	1000	120.0	106.0	V	69	10
354.002	33.23	36.0	2.8	1000	120.0	203.0	H	190	17
360.003	35.61	36.0	0.4	1000	120.0	238.0	H	182	17
363.001	32.60	36.0	3.4	1000	120.0	237.0	H	181	17
411.450	24.08	36.0	11.9	1000	120.0	257.0	H	135	18

Plot 3: 30 MHz to 1 GHz; vertical & horizontal polarization; nHT40-mode, valid for all channels

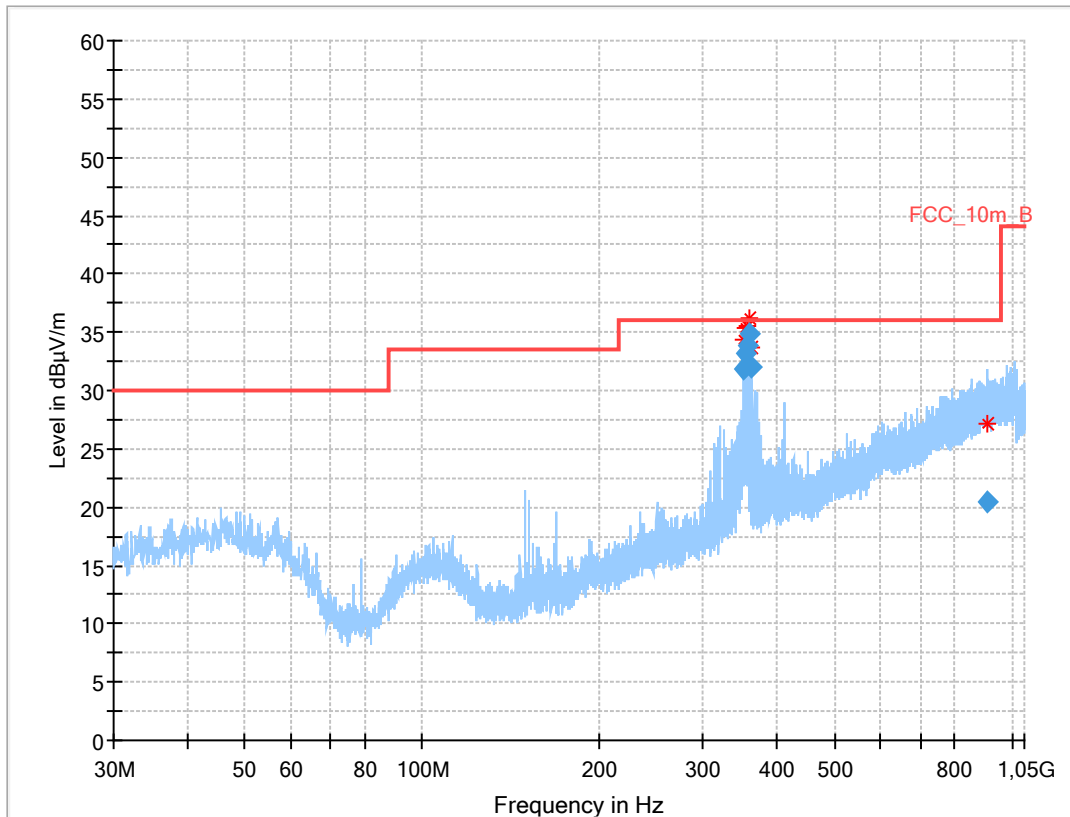

Results:

Frequency (MHz)	QuasiPeak (dBµV/m)	Limit (dBµV/m)	Margin (dB)	Meas. Time (ms)	Bandwidth (kHz)	Height (cm)	Pol	Azimuth (deg)	Corr. (dB)
351.000	31.87	36.0	4.1	1000	120.0	203.0	H	197	17
354.012	33.14	36.0	2.9	1000	120.0	206.0	H	190	17
357.004	33.88	36.0	2.1	1000	120.0	222.0	H	15	17
359.999	34.91	36.0	1.1	1000	120.0	243.0	H	11	17
363.004	31.96	36.0	4.0	1000	120.0	243.0	H	17	17
905.685	20.44	36.0	15.6	1000	120.0	200.0	V	202	26

Plot 4: 30 MHz to 1 GHz; vertical & horizontal polarization; acVHT80-mode, valid for all channels

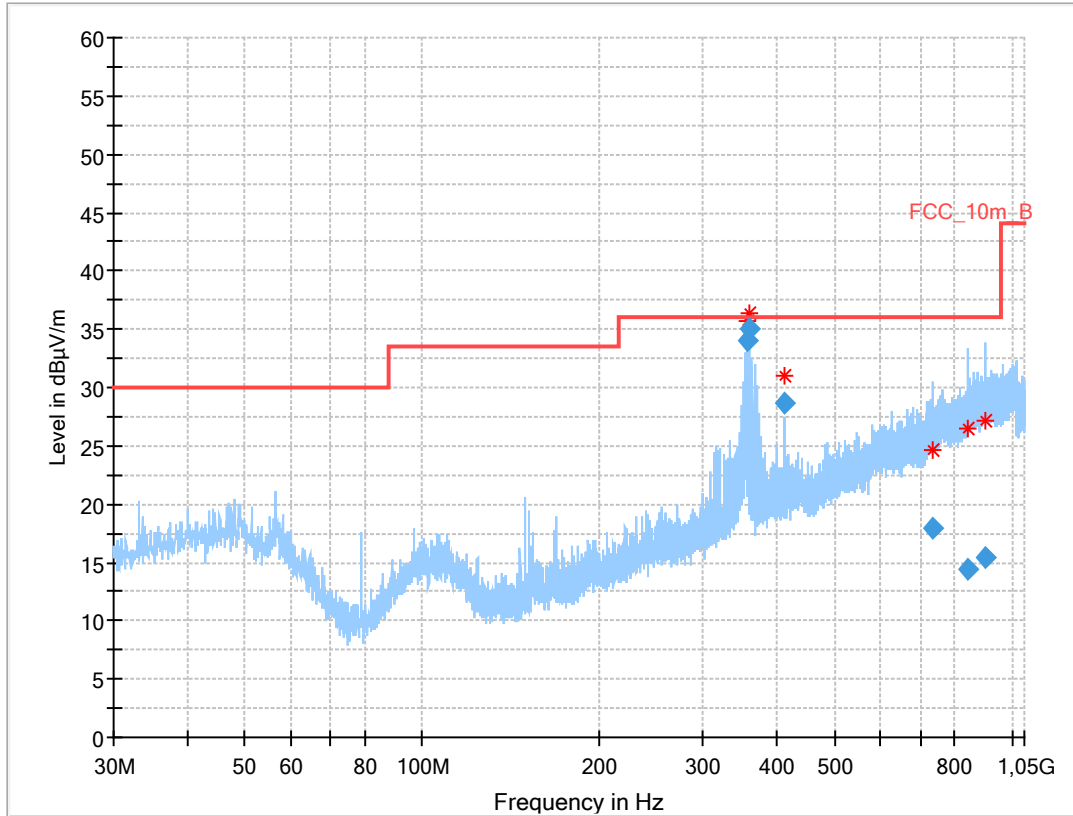

Results:

Frequency (MHz)	QuasiPeak (dBµV/m)	Limit (dBµV/m)	Margin (dB)	Meas. Time (ms)	Bandwidth (kHz)	Height (cm)	Pol	Azimuth (deg)	Corr. (dB)
357.013	34.02	36.0	2.0	1000	120.0	240.0	H	191	17
360.009	35.03	36.0	1.0	1000	120.0	225.0	H	190	17
411.432	28.67	36.0	7.3	1000	120.0	263.0	H	14	18
731.418	17.96	36.0	18.0	1000	120.0	345.0	H	90	23
841.443	14.44	36.0	21.6	1000	120.0	400.0	V	180	24
901.096	15.41	36.0	20.6	1000	120.0	213.0	V	90	26

Plots: TAOGLAS PC11.07.0100A antenna

Plot 5: 30 MHz to 1 GHz; vertical & horizontal polarization; a-mode, valid for all channels

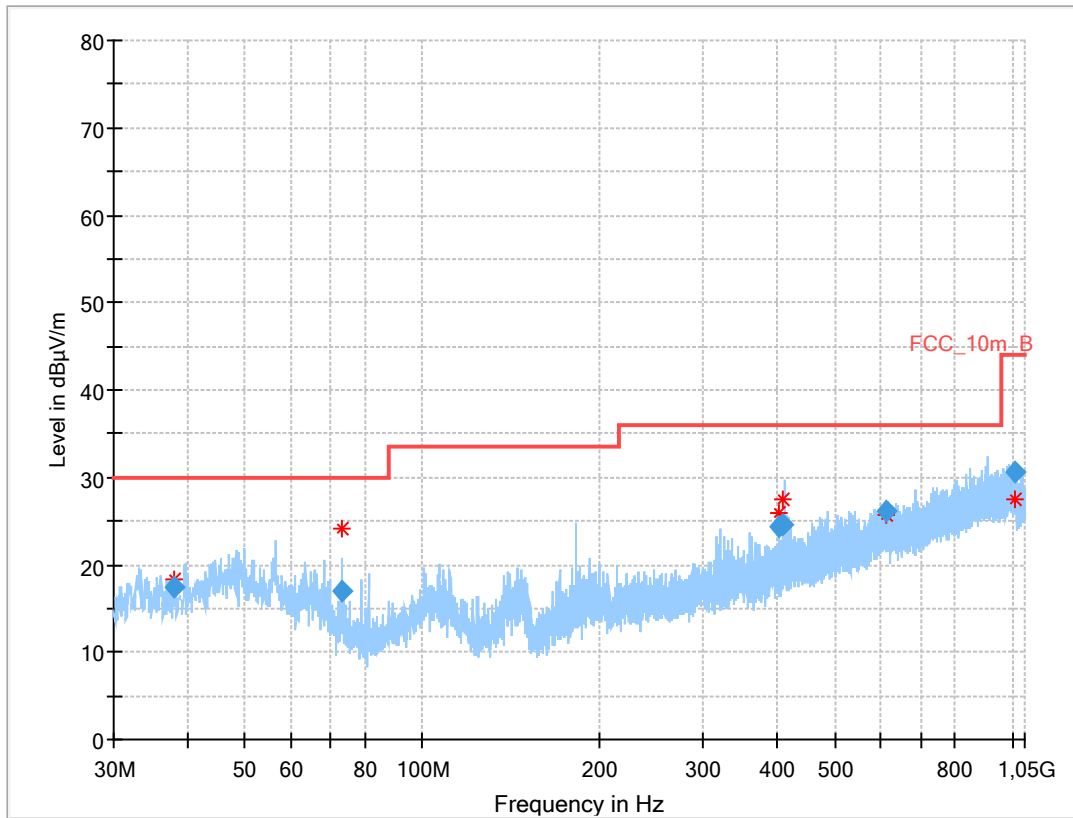

Results:

Frequency (MHz)	QuasiPeak (dBµV/m)	Limit (dBµV/m)	Margin (dB)	Meas. Time (ms)	Bandwidth (kHz)	Height (cm)	Pol	Azimuth (deg)	Corr. (dB)
38.084	17.53	30.0	12.5	1000	120.0	111.0	V	157	15
73.077	17.02	30.0	13.0	1000	120.0	170.0	V	283	8
401.994	24.36	36.0	11.6	1000	120.0	170.0	H	105	18
407.996	24.53	36.0	11.5	1000	120.0	170.0	H	112	18
612.003	26.11	36.0	9.9	1000	120.0	147.0	H	247	22
1011.837	30.57	44.0	13.4	1000	120.0	170.0	H	22	26

Plot 6: 30 MHz to 1 GHz; vertical & horizontal polarization; nHT20-mode, valid for all channels

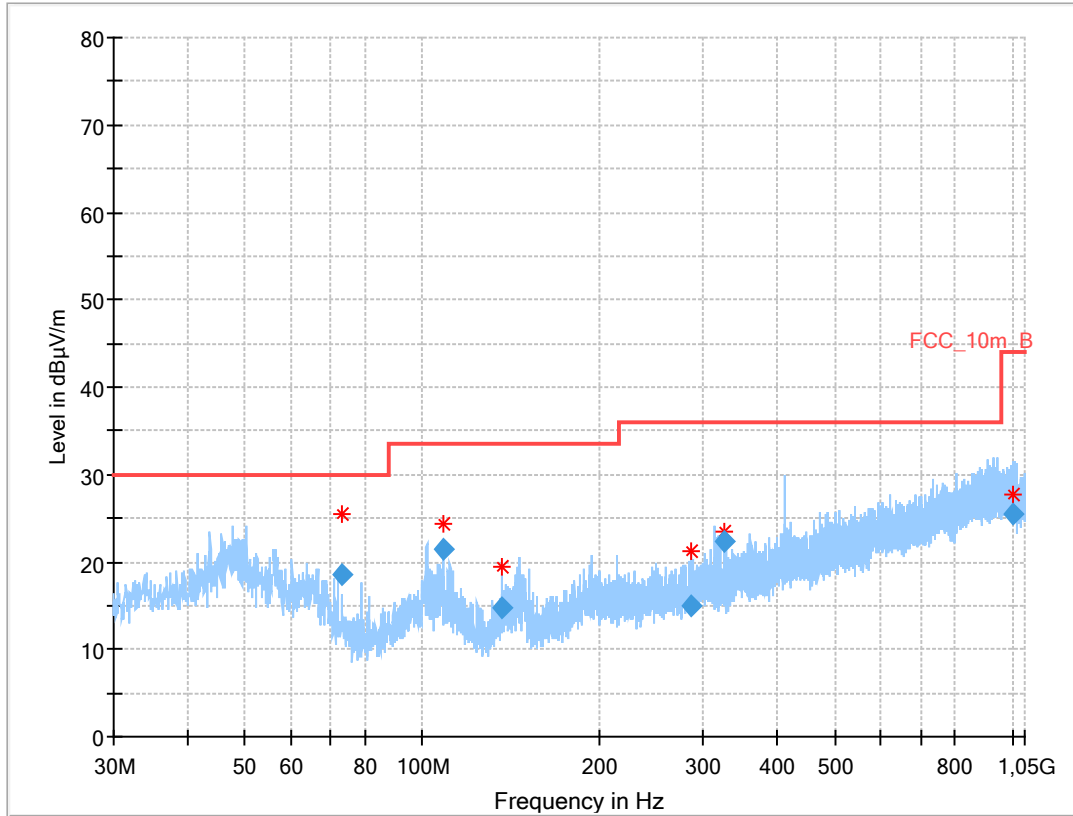

Results:

Frequency (MHz)	QuasiPeak (dBµV/m)	Limit (dBµV/m)	Margin (dB)	Meas. Time (ms)	Bandwidth (kHz)	Height (cm)	Pol	Azimuth (deg)	Corr. (dB)
73.087	18.51	30.0	11.5	1000	120.0	170.0	V	273	8
108.819	21.41	33.5	12.1	1000	120.0	105.0	V	80	13
136.870	14.75	33.5	18.8	1000	120.0	170.0	V	67	10
284.944	14.92	36.0	21.1	1000	120.0	106.0	V	247	15
324.032	22.28	36.0	13.7	1000	120.0	101.0	V	157	16
1003.937	25.44	44.0	18.6	1000	120.0	170.0	V	67	26

Plot 7: 30 MHz to 1 GHz; vertical & horizontal polarization; nHT40-mode, valid for all channels

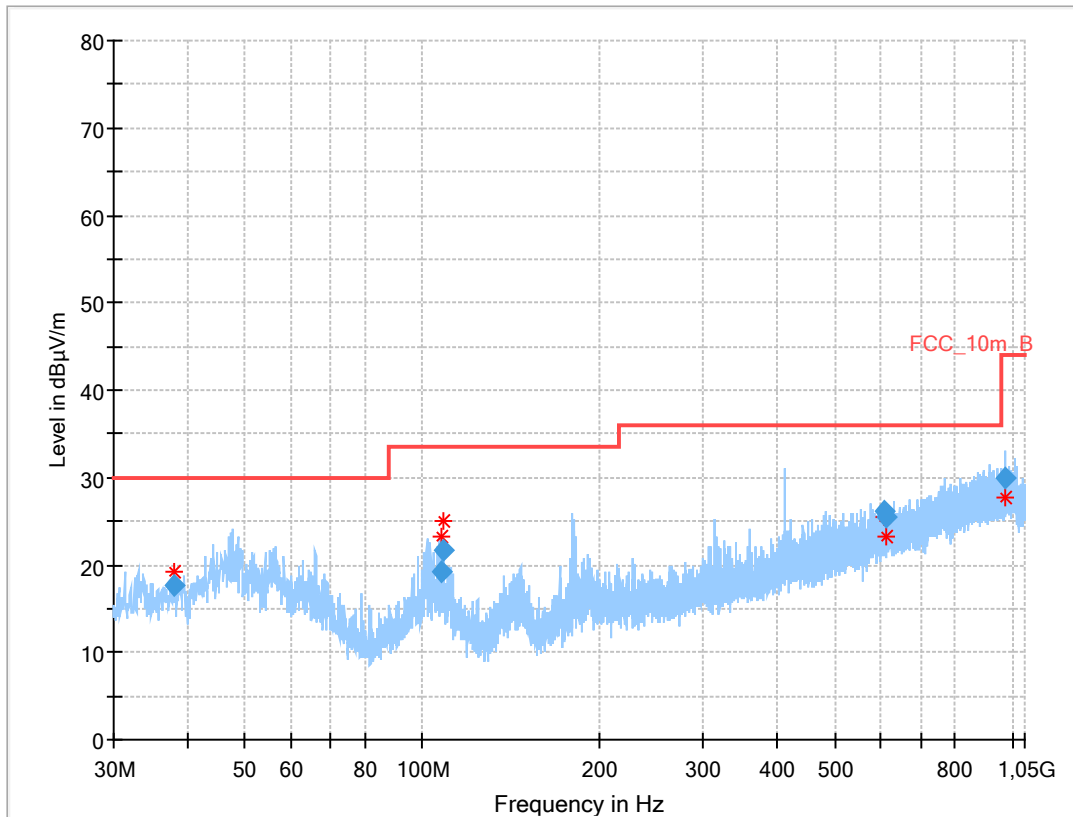

Results:

Frequency (MHz)	QuasiPeak (dBµV/m)	Limit (dBµV/m)	Margin (dB)	Meas. Time (ms)	Bandwidth (kHz)	Height (cm)	Pol	Azimuth (deg)	Corr. (dB)
38.031	17.59	30.0	12.4	1000	120.0	170.0	V	78	15
108.158	19.23	33.5	14.3	1000	120.0	112.0	V	67	14
108.804	21.60	33.5	11.9	1000	120.0	98.0	V	67	13
609.008	26.08	36.0	9.9	1000	120.0	141.0	H	247	22
611.111	25.54	36.0	10.5	1000	120.0	136.0	V	157	22
973.521	29.96	44.0	14.0	1000	120.0	98.0	V	157	26

Plot 8: 30 MHz to 1 GHz; vertical & horizontal polarization; acVHT80-mode, valid for all channels

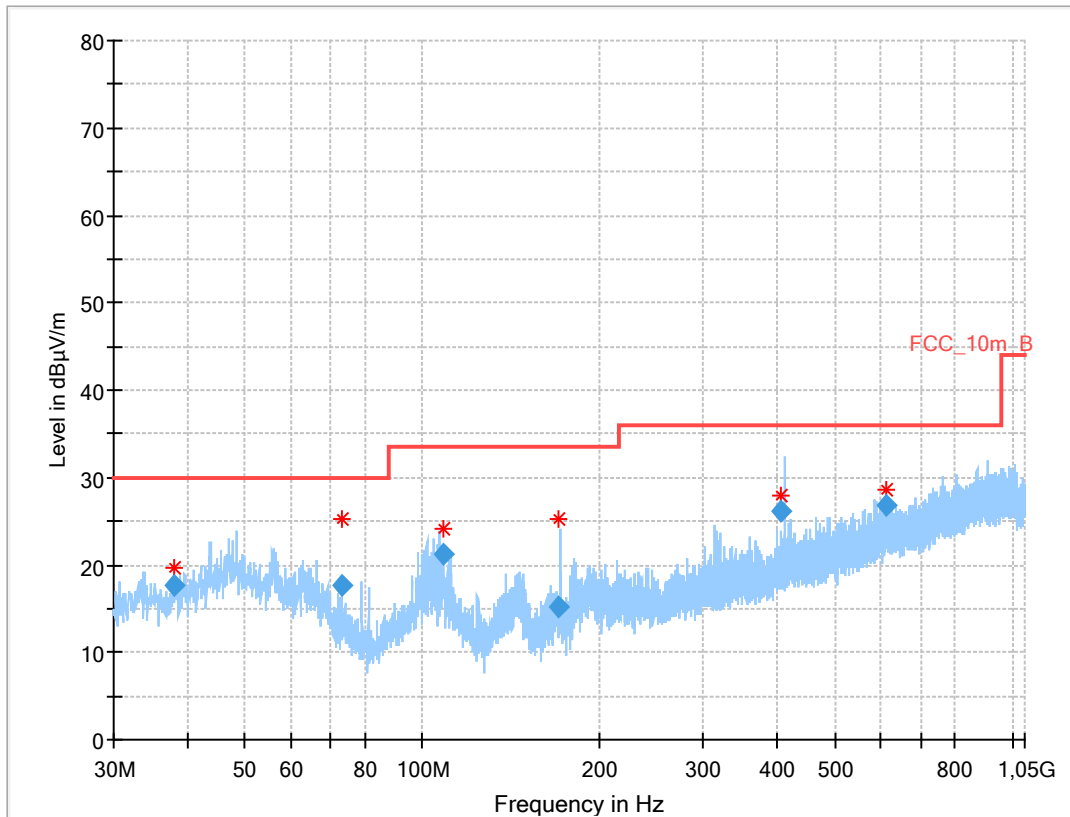

Results:

Frequency (MHz)	QuasiPeak (dBµV/m)	Limit (dBµV/m)	Margin (dB)	Meas. Time (ms)	Bandwidth (kHz)	Height (cm)	Pol	Azimuth (deg)	Corr. (dB)
38.042	17.59	30.0	12.4	1000	120.0	170.0	V	190	15
73.097	17.72	30.0	12.3	1000	120.0	170.0	V	202	8
108.800	21.19	33.5	12.3	1000	120.0	115.0	V	67	13
170.814	15.30	33.5	18.2	1000	120.0	140.0	V	100	11
404.990	26.15	36.0	9.9	1000	120.0	170.0	H	112	18
612.008	26.90	36.0	9.1	1000	120.0	170.0	H	268	22

12.12 Spurious emissions radiated 1 GHz to 40 GHz

Description:

Measurement of the radiated spurious emissions and cabinet radiations from 1 GHz to 40 GHz.

Measurement:

Measurement parameter	
Detector:	Quasi Peak below 1 GHz (alternative Peak) Peak above 1 GHz / RMS
Sweep time:	Auto
Resolution bandwidth:	1 MHz
Video bandwidth:	3 MHz
Span:	1 GHz to 40 GHz
Trace mode:	Max Hold / Average with 100 counts + 20 log (1 / X) for duty cycle lower than 100 %
Test setup:	See chapter 7.1 – A See chapter 7.2 – A See chapter 7.3 – A
Measurement uncertainty:	See chapter 9

Limits:

TX Spurious Emissions Radiated		
§15.209 / RSS-247		
Frequency (MHz)	Field Strength (dBµV/m)	Measurement distance
Above 960	54.0	3
§15.407		
Outside the restricted bands!	-27 dBm / MHz	

Results: 20 MHz channel bandwidth, ANT1-DB1-RAF-xxx antenna

TX Spurious Emissions Radiated [dBµV/m] / dBm								
U-NII-1 (5150 MHz to 5250 MHz)								
Lowest channel			Middle channel			Highest channel		
F [MHz]	Detector	Level [dBµV/m]	F [MHz]	Detector	Level [dBµV/m]	F [MHz]	Detector	Level [dBµV/m]
-/-	Peak	-/-	-/-	Peak	-/-	-/-	Peak	-/-
	AVG	-/-	-/-	AVG	-/-		AVG	-/-

TX Spurious Emissions Radiated [dBµV/m] / dBm								
U-NII-2A (5250 MHz to 5350 MHz)								
Lowest channel			Middle channel			Highest channel		
F [MHz]	Detector	Level [dBµV/m]	F [MHz]	Detector	Level [dBµV/m]	F [MHz]	Detector	Level [dBµV/m]
-/-	Peak	-/-	-/-	Peak	-/-	-/-	Peak	-/-
	AVG	-/-	-/-	AVG	-/-		AVG	-/-

TX Spurious Emissions Radiated [dBµV/m] / dBm								
U-NII-2C (5470 MHz to 5725 MHz)								
Lowest channel			Middle channel			Highest channel		
F [MHz]	Detector	Level [dBµV/m]	F [MHz]	Detector	Level [dBµV/m]	F [MHz]	Detector	Level [dBµV/m]
-/-	Peak	-/-	-/-	Peak	-/-	-/-	Peak	-/-
	AVG	-/-	-/-	AVG	-/-		AVG	-/-

TX Spurious Emissions Radiated [dBµV/m] / dBm								
U-NII-3 (5725 MHz to 5850 MHz)								
Lowest channel			Middle channel			Highest channel		
F [MHz]	Detector	Level [dBµV/m]	F [MHz]	Detector	Level [dBµV/m]	F [MHz]	Detector	Level [dBµV/m]
7660	Peak	53.6	-/-	Peak	-/-	3883	Peak	52.2
	AVG	50.1	-/-	AVG	-/-		AVG	46.9

Results: 40 MHz channel bandwidth, ANT1-DB1-RAF-xxx antenna

TX Spurious Emissions Radiated [dBµV/m] / dBm								
U-NII-1 (5150 MHz to 5250 MHz)								
Lowest channel			Middle channel			Highest channel		
F [MHz]	Detector	Level [dBµV/m]	F [MHz]	Detector	Level [dBµV/m]	F [MHz]	Detector	Level [dBµV/m]
-/-	Peak	-/-		Peak		-/-	Peak	-/-
	AVG	-/-		AVG			AVG	-/-

TX Spurious Emissions Radiated [dBµV/m] / dBm								
U-NII-2A (5250 MHz to 5350 MHz)								
Lowest channel			Middle channel			Highest channel		
F [MHz]	Detector	Level [dBµV/m]	F [MHz]	Detector	Level [dBµV/m]	F [MHz]	Detector	Level [dBµV/m]
-/-	Peak	-/-		Peak		-/-	Peak	-/-
	AVG	-/-		AVG			AVG	-/-

TX Spurious Emissions Radiated [dBµV/m] / dBm								
U-NII-2C (5470 MHz to 5725 MHz)								
Lowest channel			Middle channel			Highest channel		
F [MHz]	Detector	Level [dBµV/m]	F [MHz]	Detector	Level [dBµV/m]	F [MHz]	Detector	Level [dBµV/m]
7347	Peak	50.1	7453	Peak	50.2	7613	Peak	54.2
	AVG	45.4		AVG	45.6		AVG	50.8

TX Spurious Emissions Radiated [dBµV/m] / dBm								
U-NII-3 (5725 MHz to 5850 MHz)								
Lowest channel			Middle channel			Highest channel		
F [MHz]	Detector	Level [dBµV/m]	F [MHz]	Detector	Level [dBµV/m]	F [MHz]	Detector	Level [dBµV/m]
7673	Peak	53.1		Peak		3863	Peak	50.7
	AVG	49.8		AVG			AVG	45.3
-/-	Peak	-/-		Peak		7726	Peak	51.8
	AVG	-/-		AVG			AVG	48.2

Results: 80 MHz channel bandwidth, ANT1-DB1-RAF-xxx antenna

TX Spurious Emissions Radiated [dBµV/m] / dBm		
U-NII-1 (5150 MHz to 5250 MHz)		
Middle channel		
F [MHz]	Detector	Level [dBµV/m]
-/-	Peak	-/-
	AVG	-/-

TX Spurious Emissions Radiated [dBµV/m] / dBm		
U-NII-2A (5250 MHz to 5350 MHz)		
Middle channel		
F [MHz]	Detector	Level [dBµV/m]
7053	Peak	56.3
	AVG	52.9

TX Spurious Emissions Radiated [dBµV/m] / dBm								
U-NII-2C (5470 MHz to 5725 MHz)								
Lowest channel			Middle channel			Highest channel		
F [MHz]	Detector	Level [dBµV/m]	F [MHz]	Detector	Level [dBµV/m]	F [MHz]	Detector	Level [dBµV/m]
7373	Peak	49.8	7480	Peak	51.1	3793	Peak	48.0
	AVG	45.4		AVG	47.4		AVG	40.8
-/-	Peak	-/-	-/-	Peak	-/-	7586	Peak	53.0
	AVG	-/-		AVG	-/-		AVG	50.1

TX Spurious Emissions Radiated [dBµV/m] / dBm		
U-NII-3 (5725 MHz to 5850 MHz)		
Middle channel		
F [MHz]	Detector	Level [dBµV/m]
3850	Peak	49.6
	AVG	42.7
7700	Peak	51.2
	AVG	47.8

Results: 20 MHz channel bandwidth, TAOGLAS PC11.07.0100A antenna

TX Spurious Emissions Radiated [dBµV/m] / dBm								
U-NII-1 (5150 MHz to 5250 MHz)								
Lowest channel			Middle channel			Highest channel		
F [MHz]	Detector	Level [dBµV/m]	F [MHz]	Detector	Level [dBµV/m]	F [MHz]	Detector	Level [dBµV/m]
-/-	Peak	-/-	-/-	Peak	-/-	-/-	Peak	-/-
	AVG	-/-	-/-	AVG	-/-		AVG	-/-

TX Spurious Emissions Radiated [dBµV/m] / dBm								
U-NII-2A (5250 MHz to 5350 MHz)								
Lowest channel			Middle channel			Highest channel		
F [MHz]	Detector	Level [dBµV/m]	F [MHz]	Detector	Level [dBµV/m]	F [MHz]	Detector	Level [dBµV/m]
7013	Peak	57.5	-/-	Peak	-/-	-/-	Peak	-/-
	AVG	52.9		AVG	-/-		AVG	-/-

TX Spurious Emissions Radiated [dBµV/m] / dBm								
U-NII-2C (5470 MHz to 5725 MHz)								
Lowest channel			Middle channel			Highest channel		
F [MHz]	Detector	Level [dBµV/m]	F [MHz]	Detector	Level [dBµV/m]	F [MHz]	Detector	Level [dBµV/m]
7333	Peak	56.3	7466	Peak	54.3	7600	Peak	51.8
	AVG	52.0		AVG	50.0		AVG	47.7

TX Spurious Emissions Radiated [dBµV/m] / dBm								
U-NII-3 (5725 MHz to 5850 MHz)								
Lowest channel			Middle channel			Highest channel		
F [MHz]	Detector	Level [dBµV/m]	F [MHz]	Detector	Level [dBµV/m]	F [MHz]	Detector	Level [dBµV/m]
7660	Peak	50.9	7713	Peak	51.0	3884	Peak	49.9
	AVG	46.7		AVG	47.0		AVG	43.1

Results: 40 MHz channel bandwidth, TAOGLAS PC11.07.0100A antenna

TX Spurious Emissions Radiated [dBµV/m] / dBm								
U-NII-1 (5150 MHz to 5250 MHz)								
Lowest channel			Middle channel			Highest channel		
F [MHz]	Detector	Level [dBµV/m]	F [MHz]	Detector	Level [dBµV/m]	F [MHz]	Detector	Level [dBµV/m]
-/-	Peak	-/-		Peak		-/-	Peak	-/-
	AVG	-/-		AVG			AVG	-/-

TX Spurious Emissions Radiated [dBµV/m] / dBm								
U-NII-2A (5250 MHz to 5350 MHz)								
Lowest channel			Middle channel			Highest channel		
F [MHz]	Detector	Level [dBµV/m]	F [MHz]	Detector	Level [dBµV/m]	F [MHz]	Detector	Level [dBµV/m]
-/-	Peak	-/-		Peak		-/-	Peak	-/-
	AVG	-/-		AVG			AVG	-/-

TX Spurious Emissions Radiated [dBµV/m] / dBm								
U-NII-2C (5470 MHz to 5725 MHz)								
Lowest channel			Middle channel			Highest channel		
F [MHz]	Detector	Level [dBµV/m]	F [MHz]	Detector	Level [dBµV/m]	F [MHz]	Detector	Level [dBµV/m]
7347	Peak	54.5	7453	Peak	54.1	7613	Peak	53.2
	AVG	50.5		AVG	50.4		AVG	49.8

TX Spurious Emissions Radiated [dBµV/m] / dBm								
U-NII-3 (5725 MHz to 5850 MHz)								
Lowest channel			Middle channel			Highest channel		
F [MHz]	Detector	Level [dBµV/m]	F [MHz]	Detector	Level [dBµV/m]	F [MHz]	Detector	Level [dBµV/m]
7673	Peak	53.1		Peak		7726	Peak	51.4
	AVG	49.3		AVG			AVG	47.9

Results: 80 MHz channel bandwidth, TAOGLAS PC11.07.0100A antenna

TX Spurious Emissions Radiated [dBµV/m] / dBm		
U-NII-1 (5150 MHz to 5250 MHz)		
Middle channel		
F [MHz]	Detector	Level [dBµV/m]
-/-	Peak	-/-
	AVG	-/-

TX Spurious Emissions Radiated [dBµV/m] / dBm		
U-NII-2A (5250 MHz to 5350 MHz)		
Middle channel		
F [MHz]	Detector	Level [dBµV/m]
-/-	Peak	-/-
	AVG	-/-

TX Spurious Emissions Radiated [dBµV/m] / dBm								
U-NII-2C (5470 MHz to 5725 MHz)								
Lowest channel			Middle channel			Highest channel		
F [MHz]	Detector	Level [dBµV/m]	F [MHz]	Detector	Level [dBµV/m]	F [MHz]	Detector	Level [dBµV/m]
5440	Peak	66.5	7480	Peak	52.3	7587	Peak	52.5
	AVG	53.0		AVG	48.8		AVG	49.6
7373	Peak	54.4	-/-	Peak	-/-	-/-	Peak	-/-
	AVG	51.3		AVG	-/-		AVG	-/-

TX Spurious Emissions Radiated [dBµV/m] / dBm		
U-NII-3 (5725 MHz to 5850 MHz)		
Middle channel		
F [MHz]	Detector	Level [dBµV/m]
7700	Peak	50.9
	AVG	47.1

Plots: 20 MHz channel bandwidth, ANT1-DB1-RAF-xxx antenna

Plot 1: 1 GHz to 18 GHz; vertical & horizontal polarization; U-NII-1; lowest channel

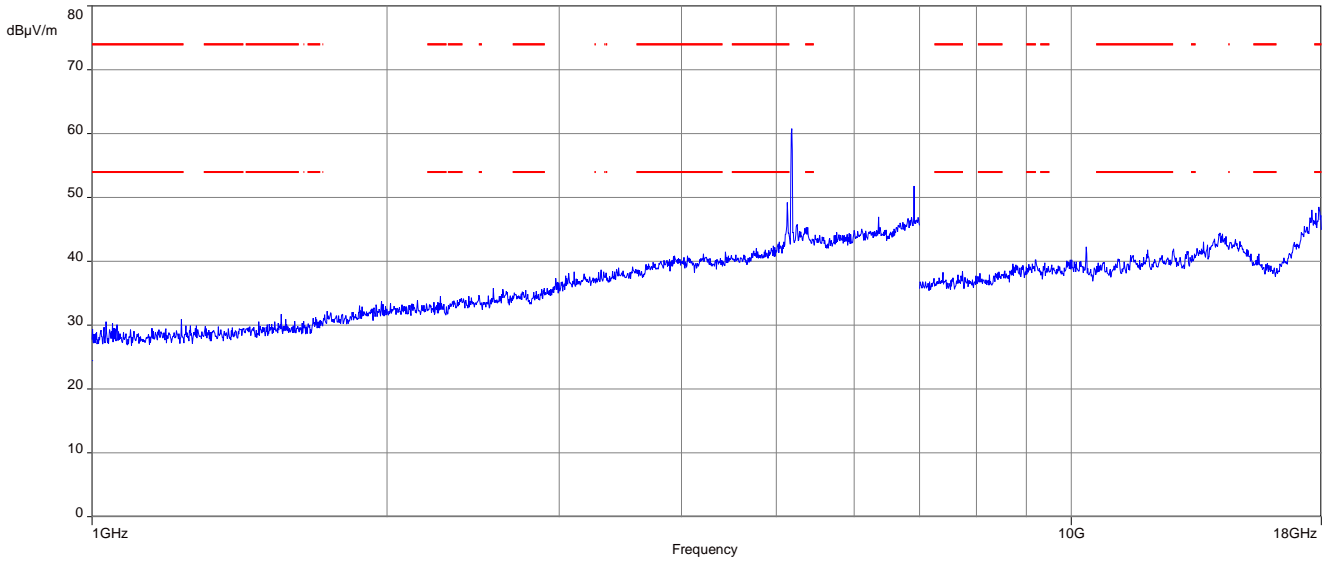

Plot 2: 1 GHz to 18 GHz; vertical & horizontal polarization; U-NII-1; middle channel

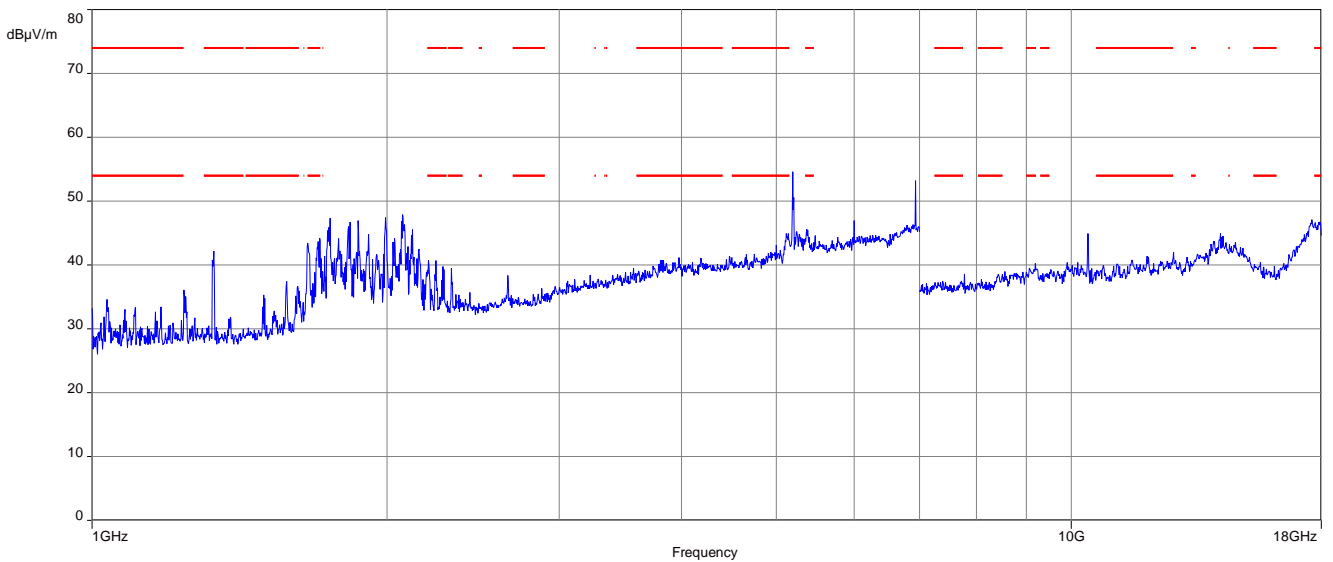

Plot 3: 1 GHz to 18 GHz; vertical & horizontal polarization; U-NII-1; highest channel

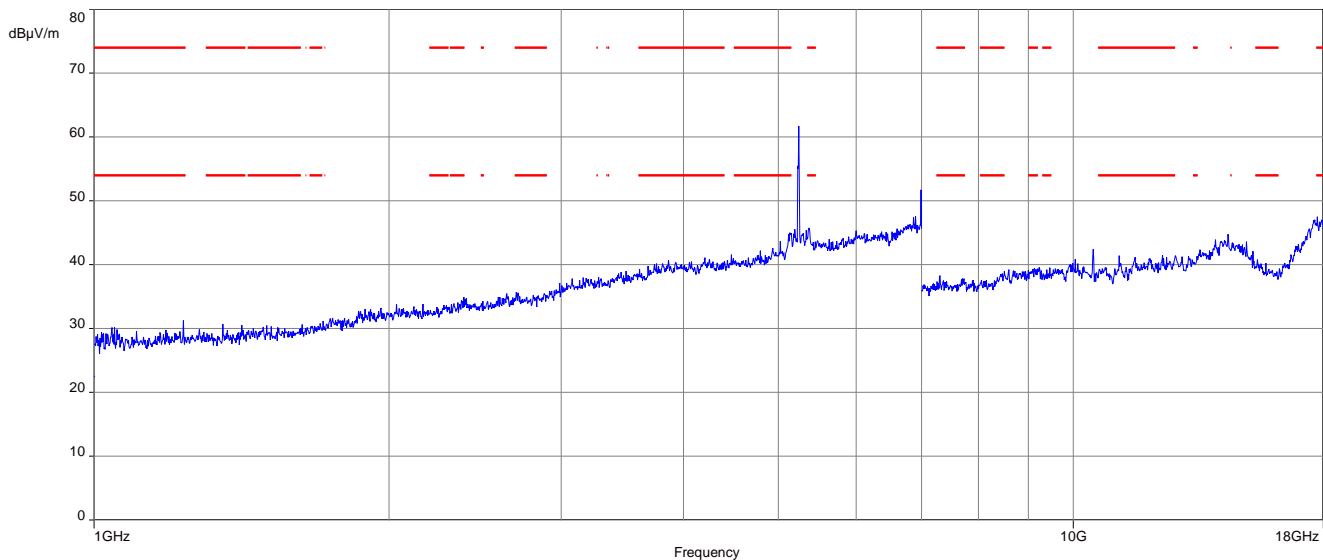

Plot 4: 1 GHz to 18 GHz; vertical & horizontal polarization; U-NII-2A; lowest channel

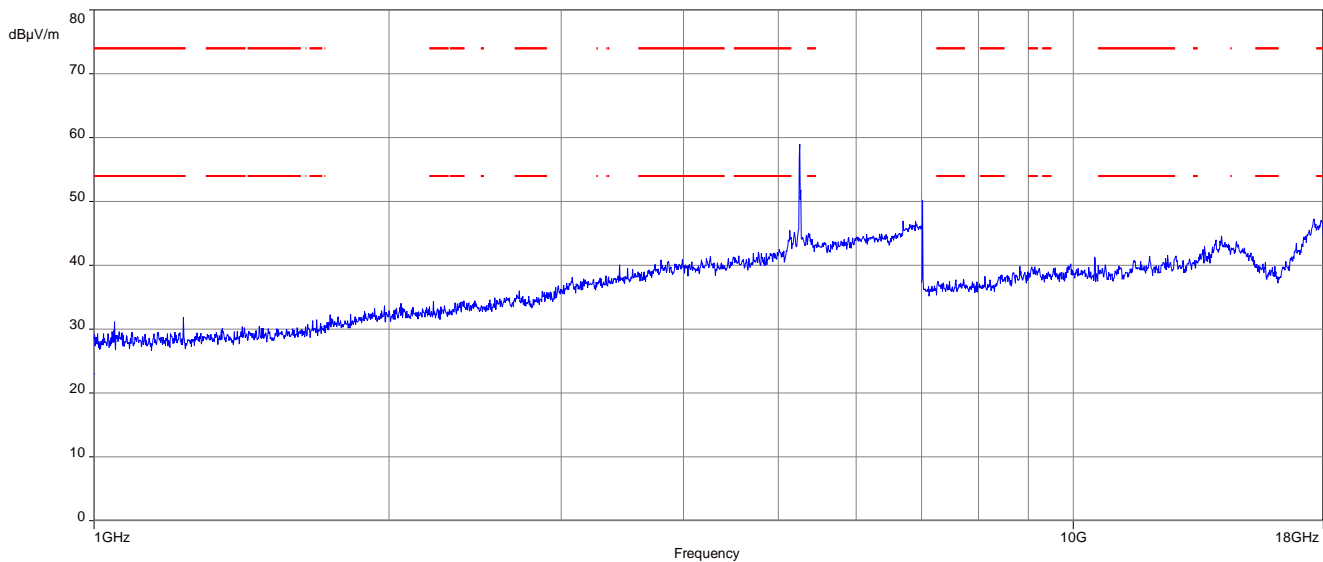

Plot 5: 1 GHz to 18 GHz; vertical & horizontal polarization; U-NII-2A; middle channel

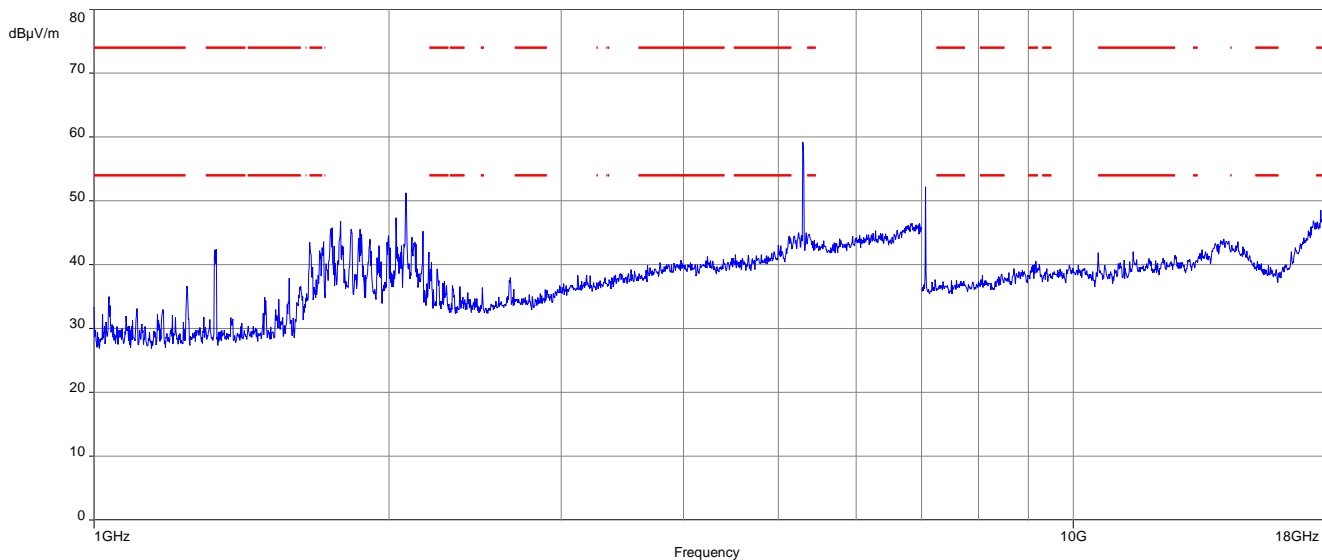

Plot 6: 1 GHz to 18 GHz; vertical & horizontal polarization; U-NII-2A; highest channel

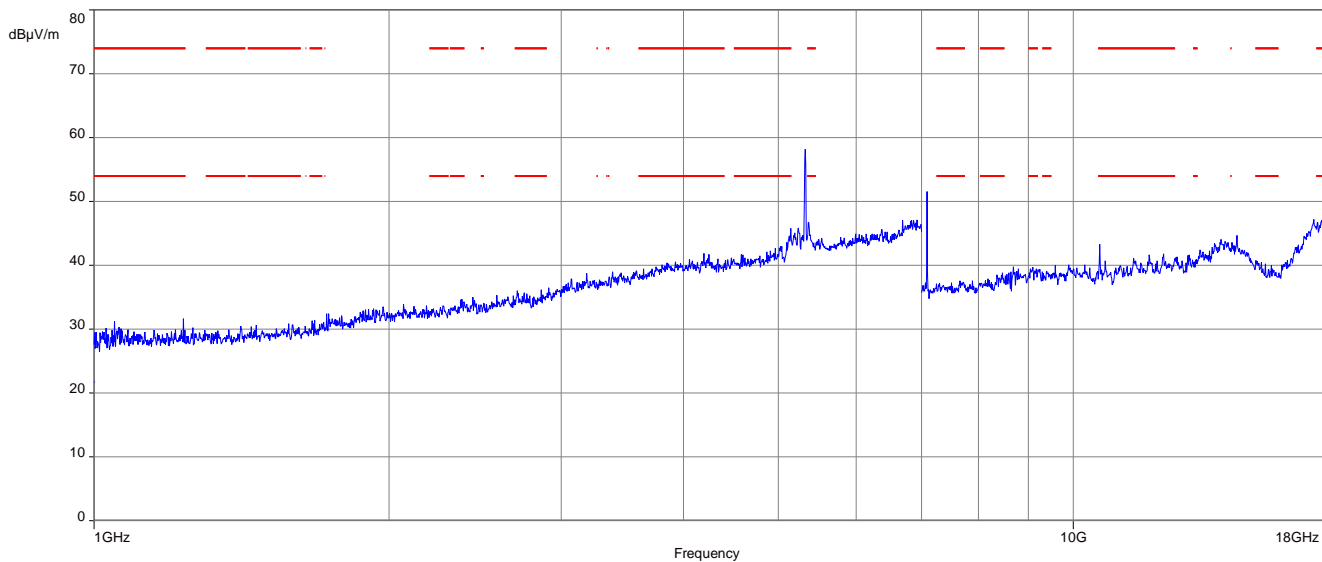

Plot 7: 1 GHz to 18 GHz; vertical & horizontal polarization; U-NII-2C; lowest channel

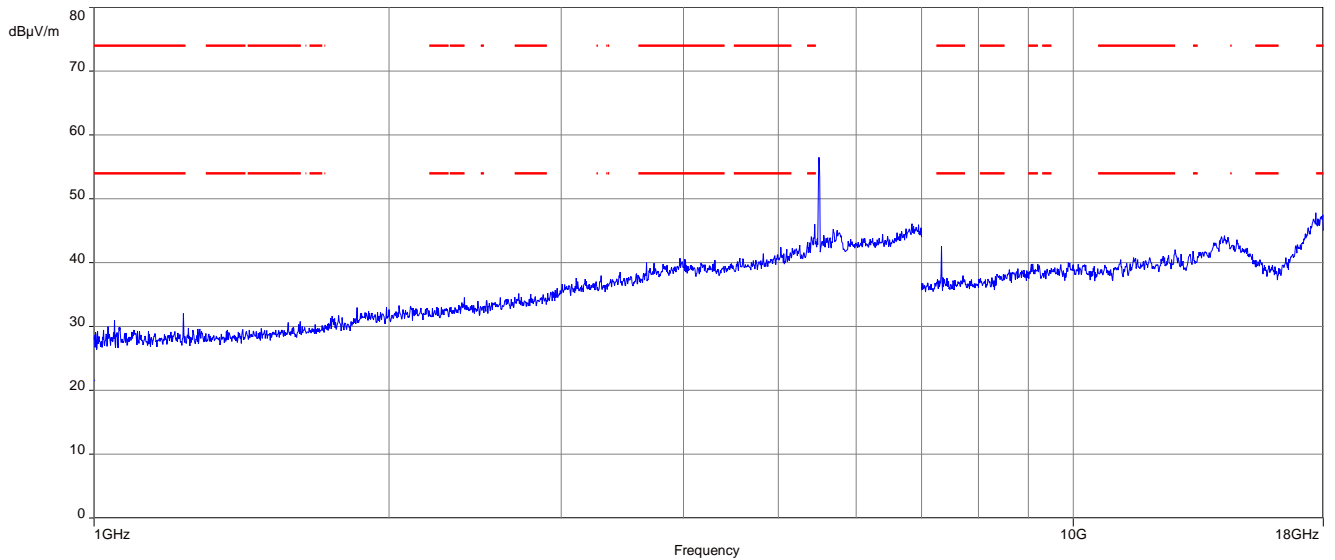

Plot 8: 1 GHz to 18 GHz; vertical & horizontal polarization; U-NII-2C; middle channel

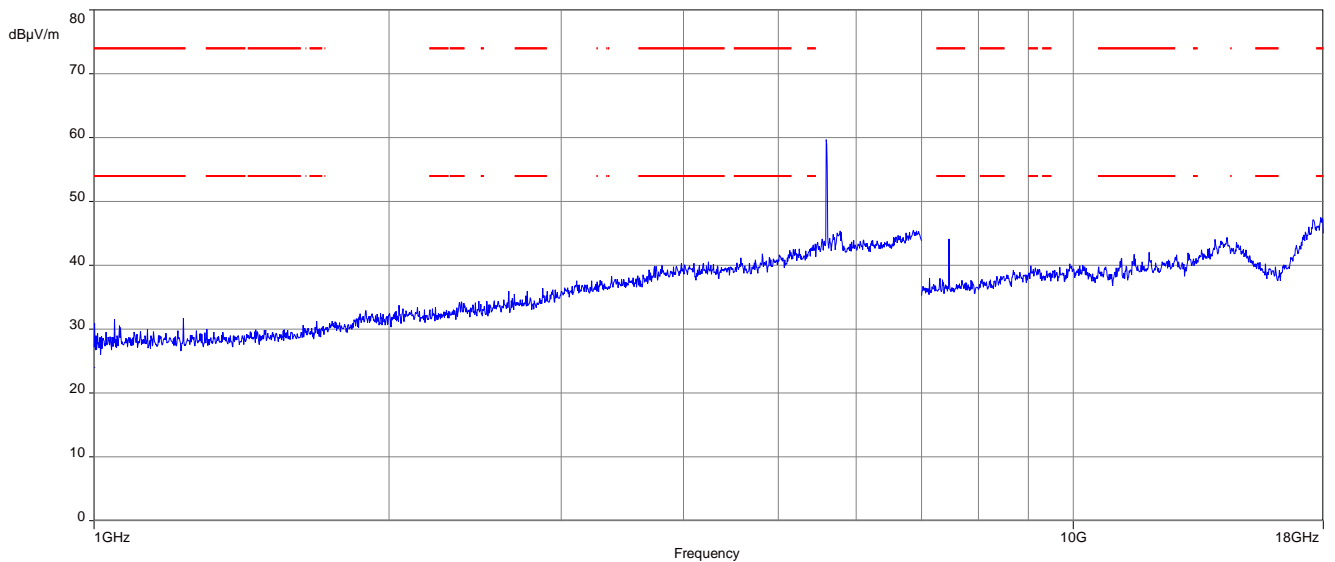

Plot 9: 1 GHz to 18 GHz; vertical & horizontal polarization; U-NII-2C; highest channel

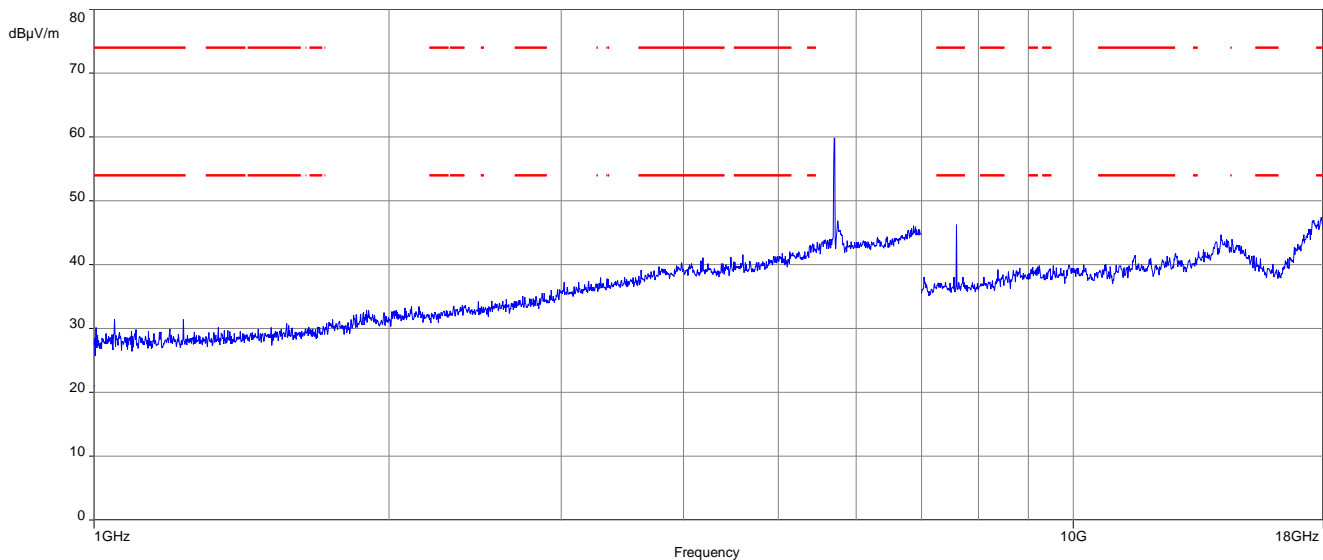

Plot 10: 1 GHz to 18 GHz; vertical & horizontal polarization; U-NII-3; lowest channel

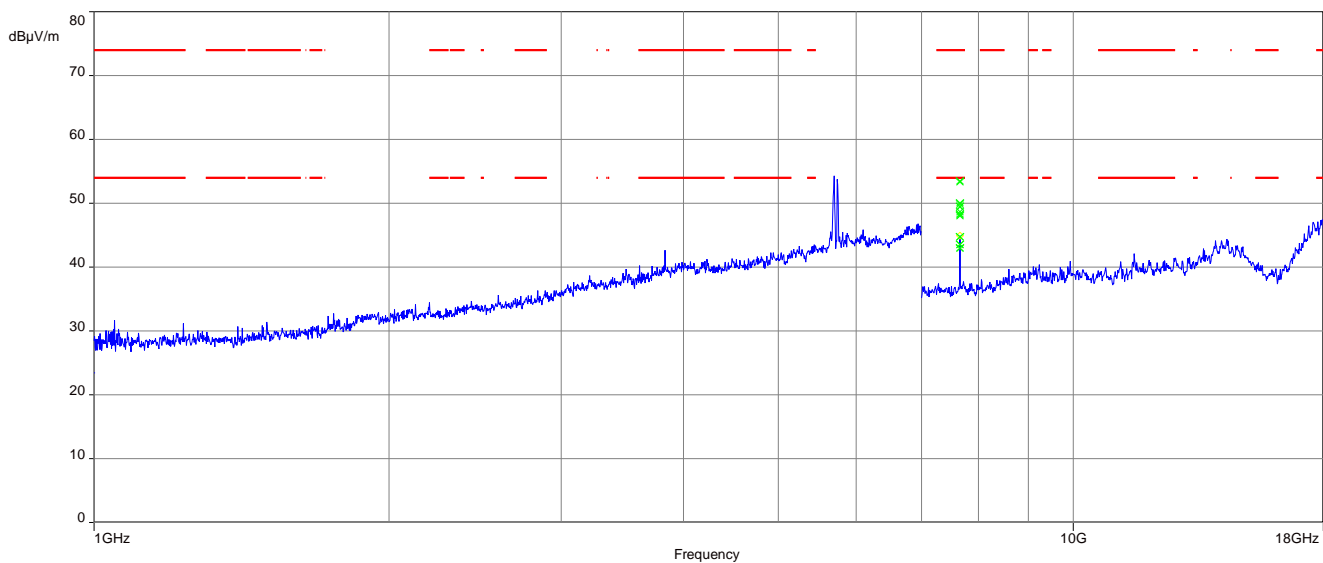

Plot 11: 1 GHz to 18 GHz; vertical & horizontal polarization; U-NII-3; middle channel

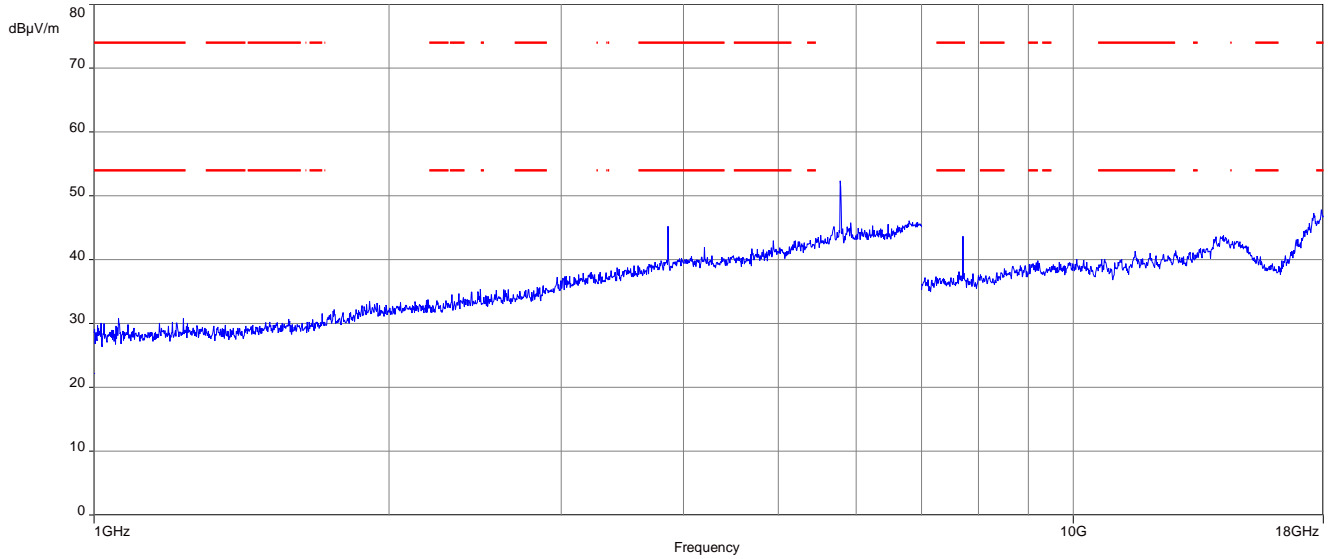

Plot 12: 1 GHz to 18 GHz; vertical & horizontal polarization; U-NII-3; highest channel

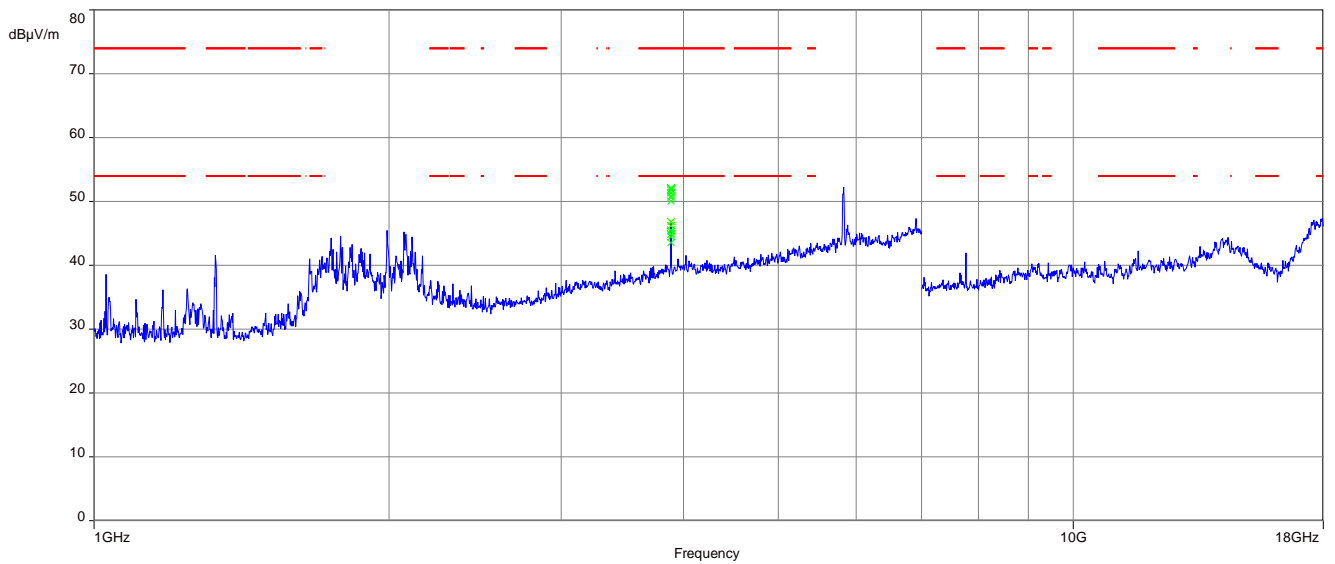

Plots: 40 MHz channel bandwidth, ANT1-DB1-RAF-xxx antenna

Plot 1: 1 GHz to 18 GHz; vertical & horizontal polarization; U-NII-1; lowest channel

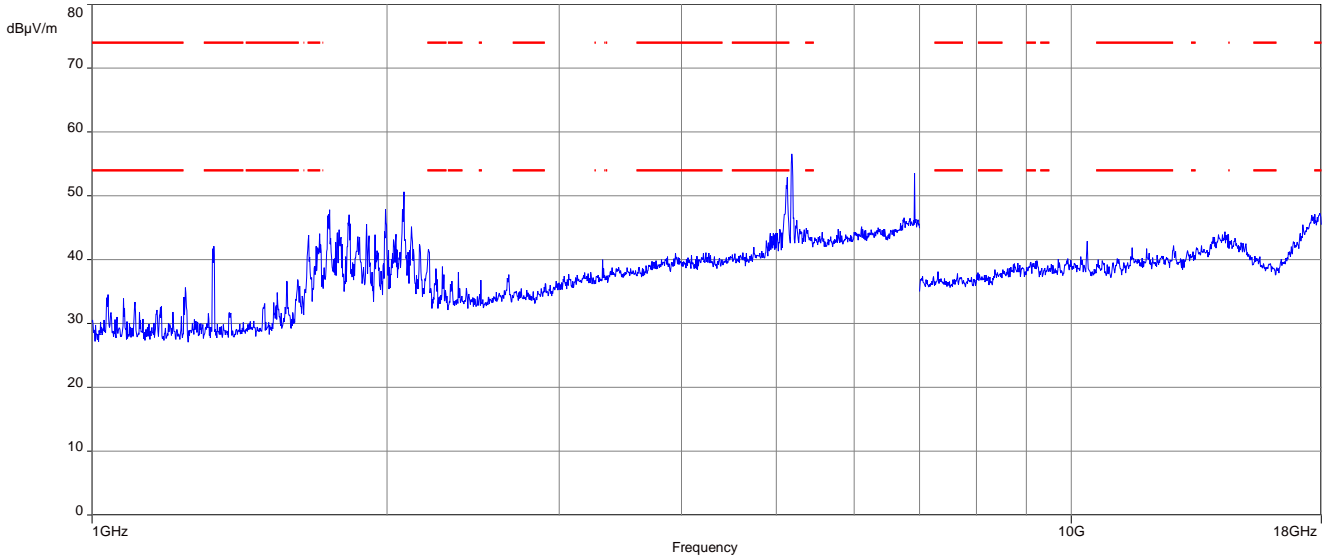

Plot 2: 1 GHz to 18 GHz; vertical & horizontal polarization; U-NII-1; highest channel

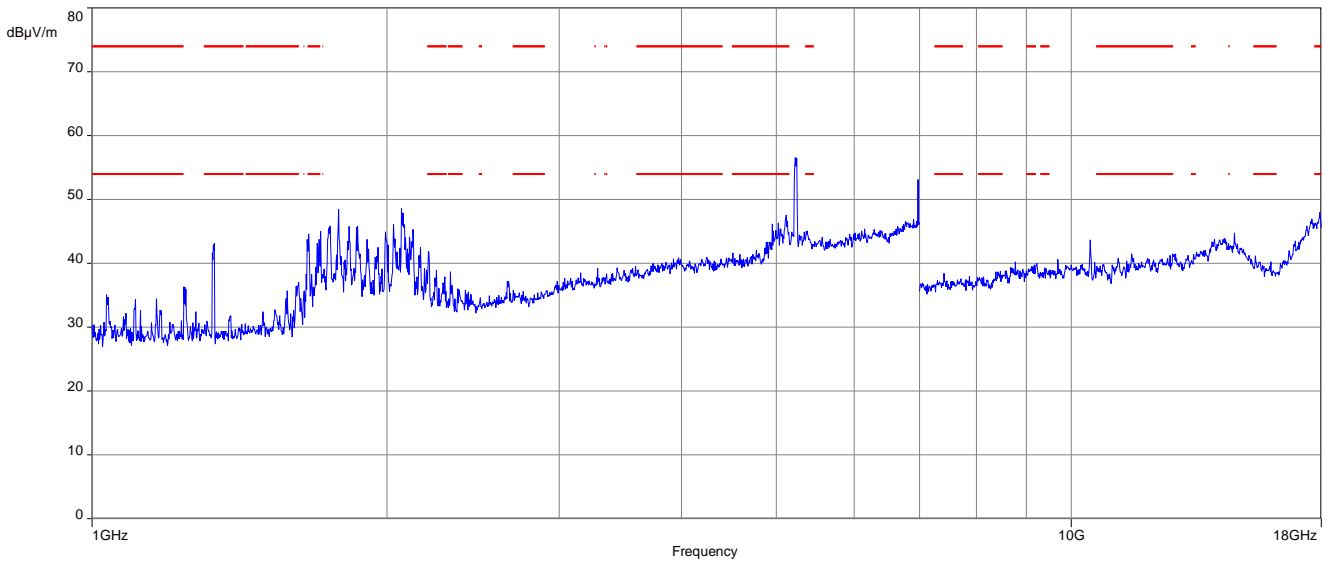

Plot 3: 1 GHz to 18 GHz; vertical & horizontal polarization; U-NII-2A; lowest channel

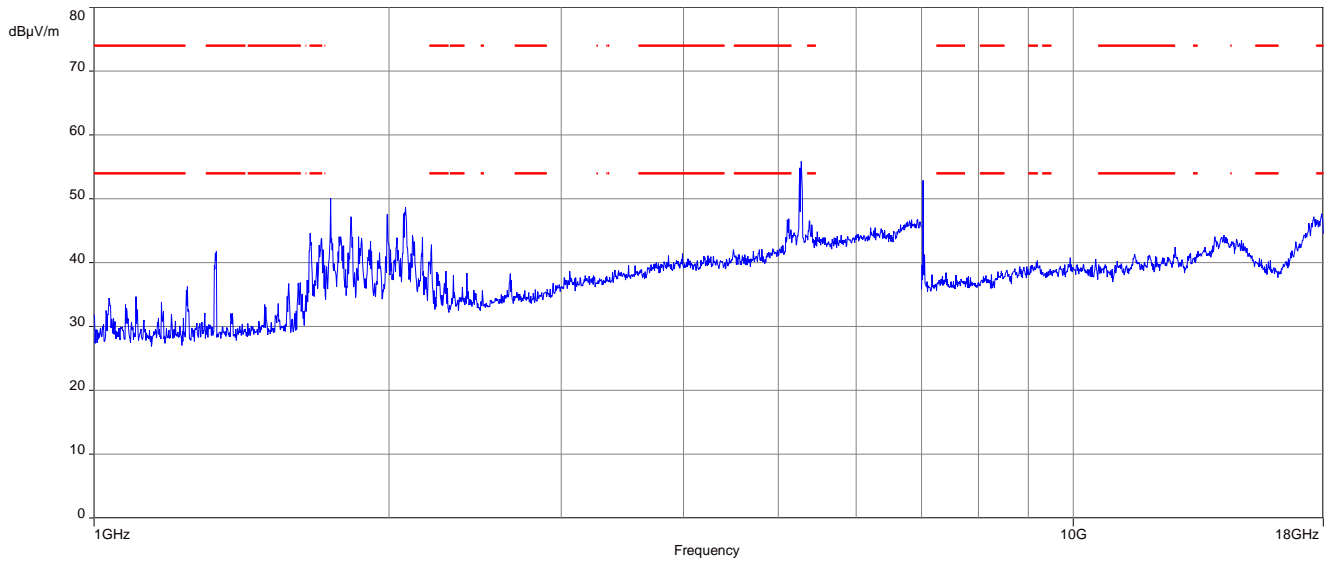

Plot 4: 1 GHz to 18 GHz; vertical & horizontal polarization; U-NII-2A; highest channel

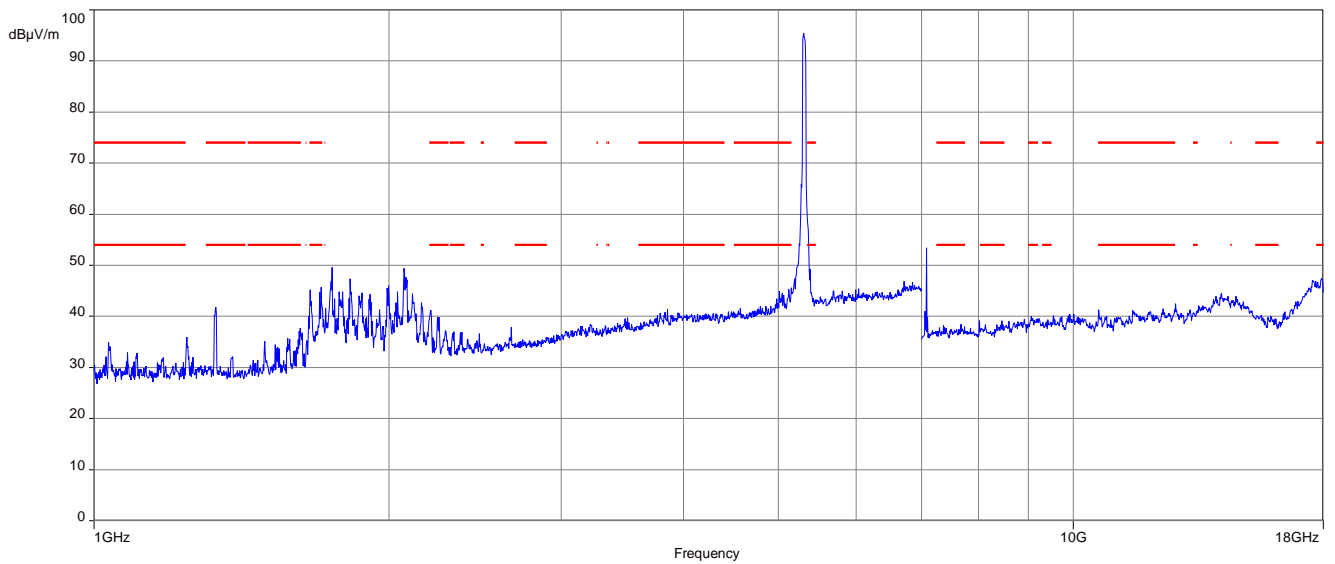

Plot 5: 1 GHz to 18 GHz; vertical & horizontal polarization; U-NII-2C; lowest channel

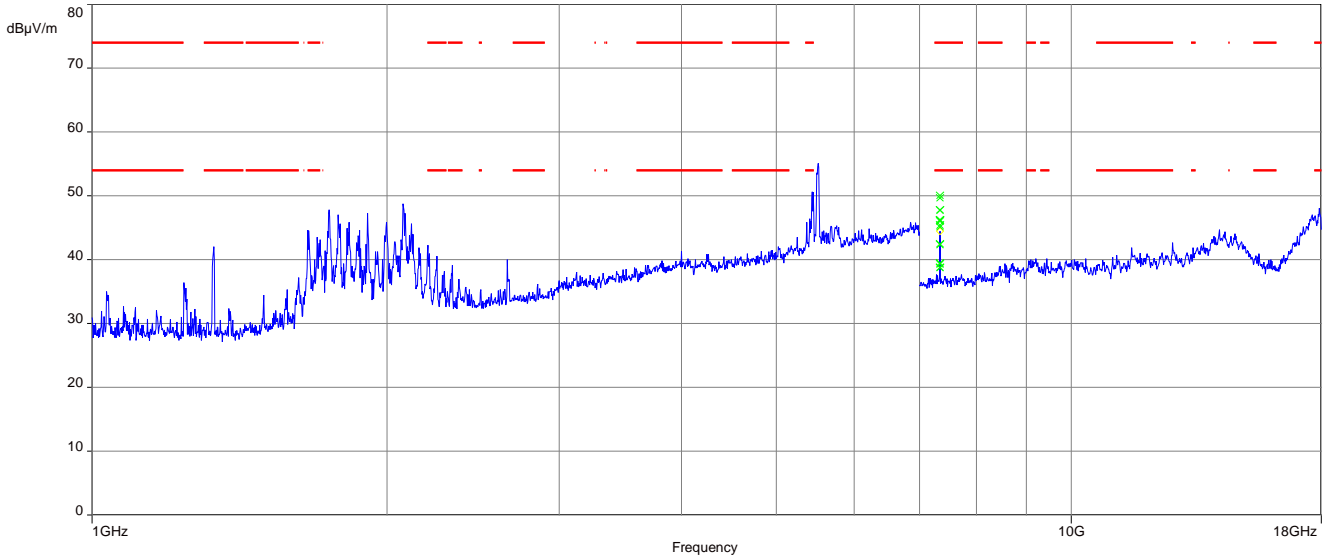

Plot 6: 1 GHz to 18 GHz; vertical & horizontal polarization; U-NII-2C; middle channel

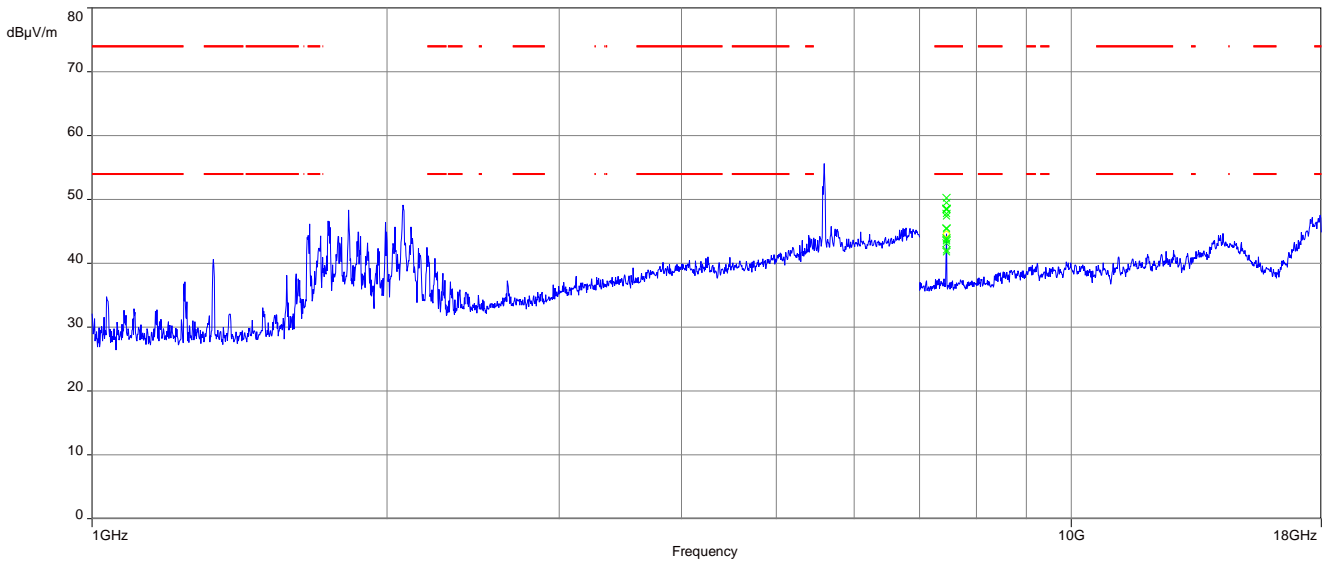

Plot 7: 1 GHz to 18 GHz; vertical & horizontal polarization; U-NII-2C; highest channel

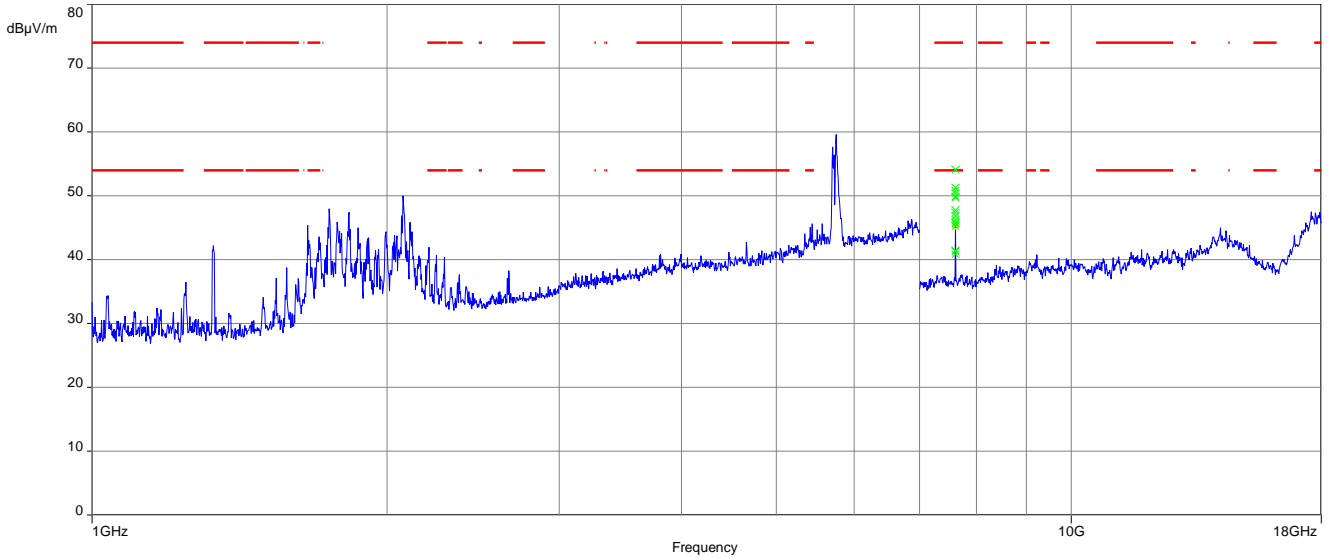

Plot 8: 1 GHz to 18 GHz; vertical & horizontal polarization; U-NII-3; lowest channel

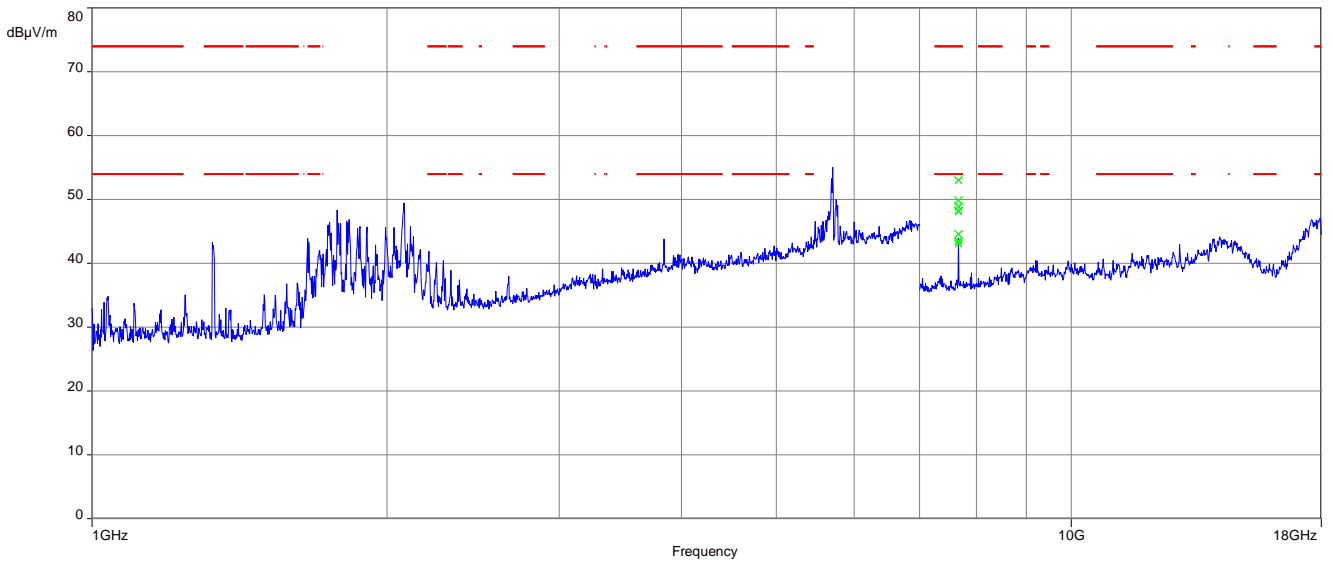

Plot 9: 1 GHz to 18 GHz; vertical & horizontal polarization; U-NII-3; highest channel

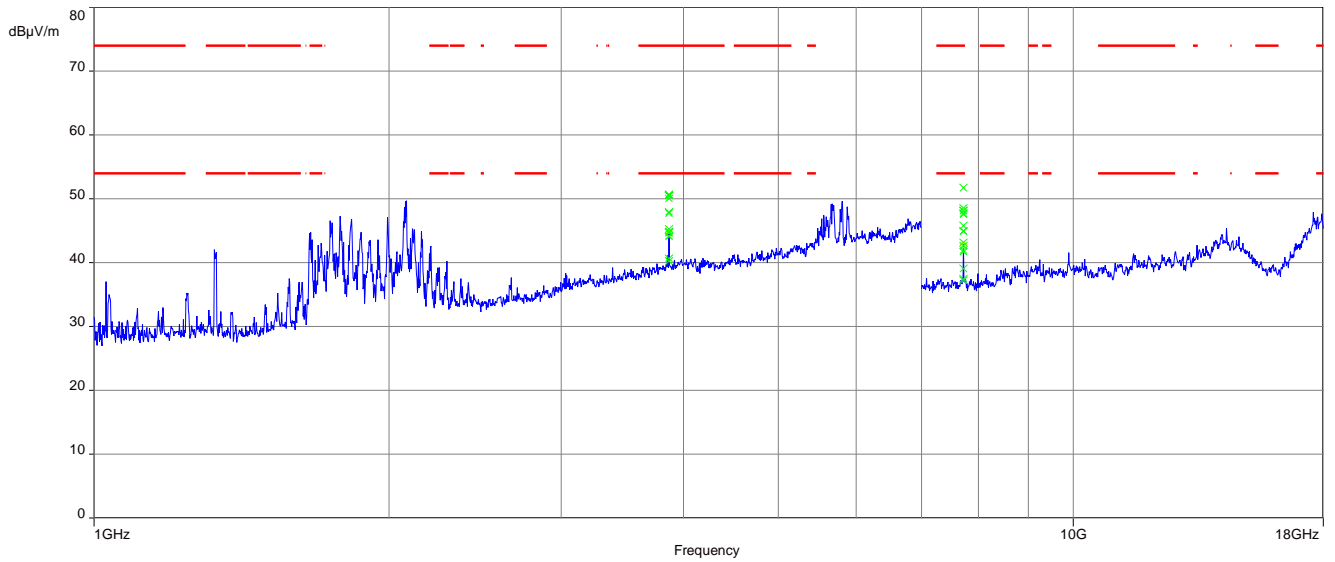

Plots: 80 MHz channel bandwidth, ANT1-DB1-RAF-xxx antenna

Plot 1: 1 GHz to 18 GHz; vertical & horizontal polarization; U-NII-1; middle channel

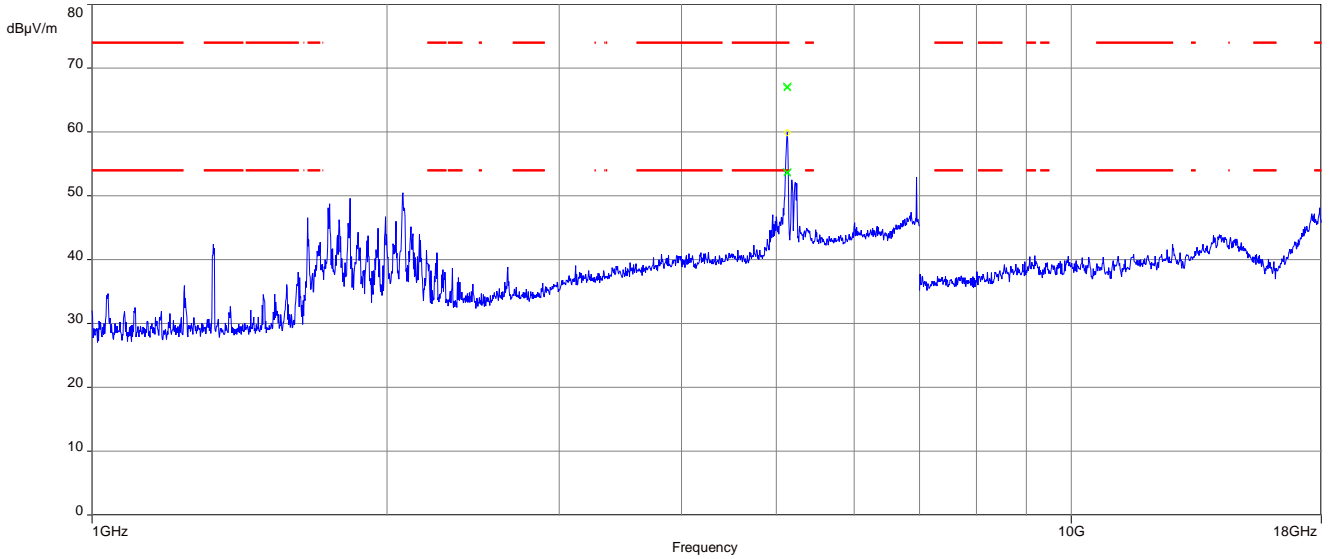

Plot 2: 1 GHz to 18 GHz; vertical & horizontal polarization; U-NII-2A; middle channel

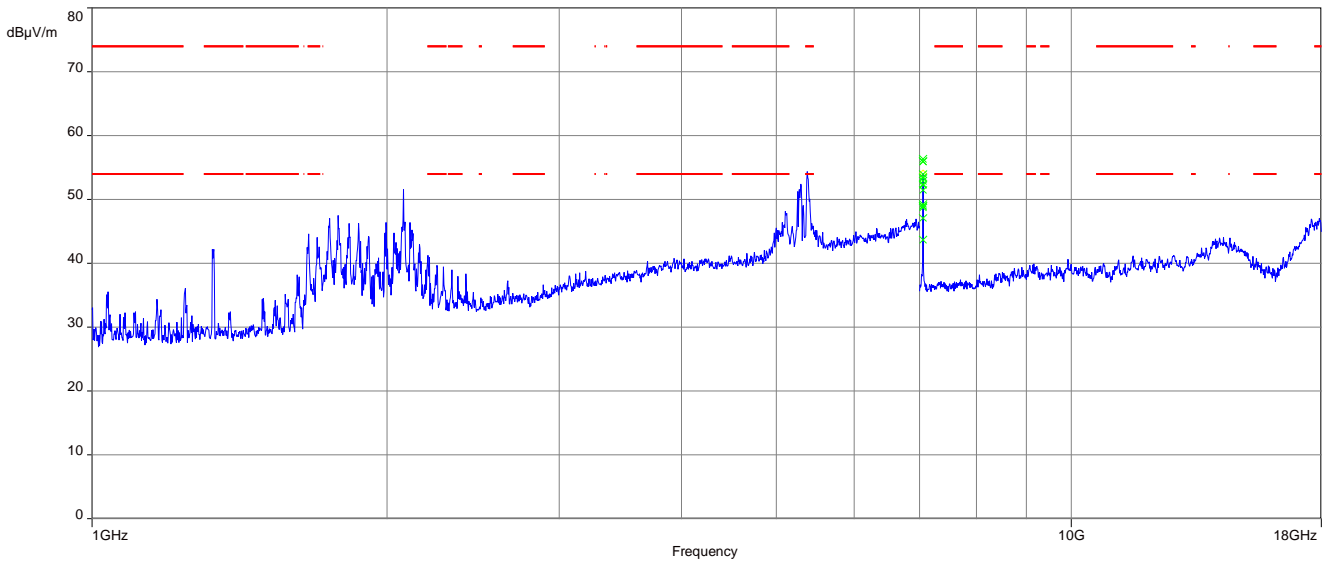

Plot 3: 1 GHz to 18 GHz; vertical & horizontal polarization; U-NII-2C; lowest channel

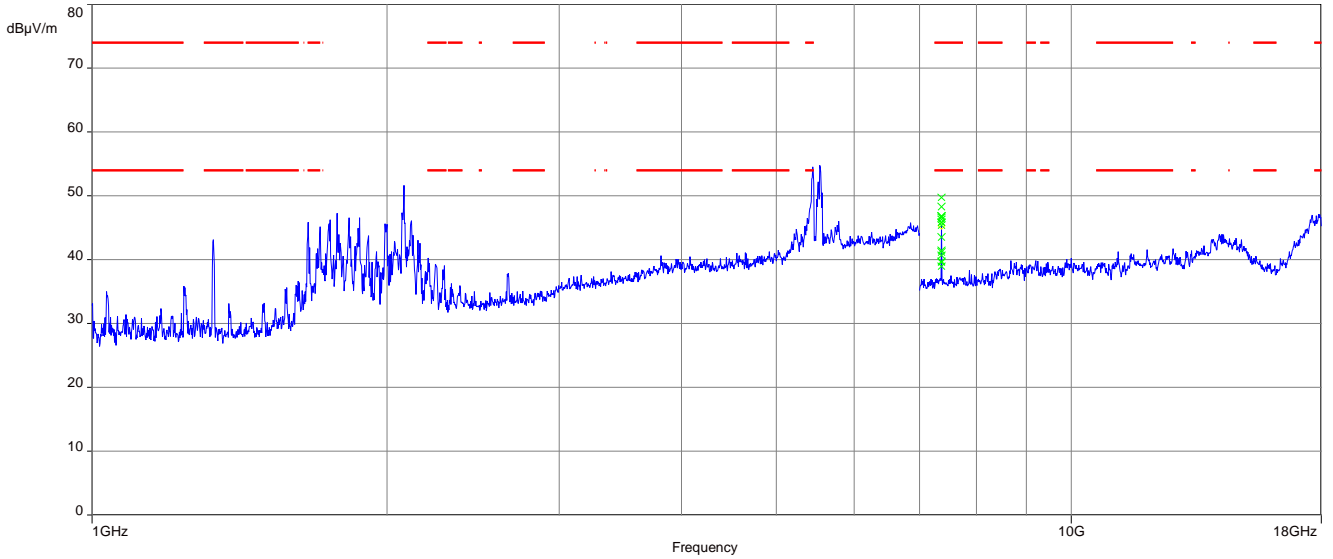

Plot 4: 1 GHz to 18 GHz; vertical & horizontal polarization; U-NII-2C; middle channel

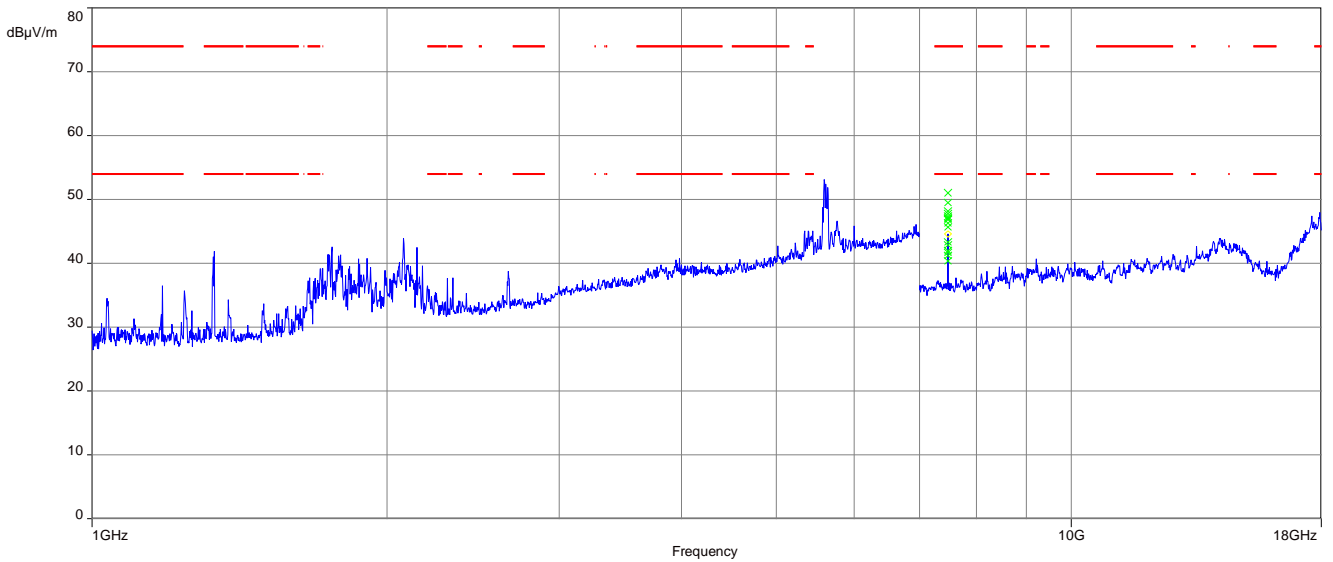

Plot 5: 1 GHz to 18 GHz; vertical & horizontal polarization; U-NII-2C; highest channel

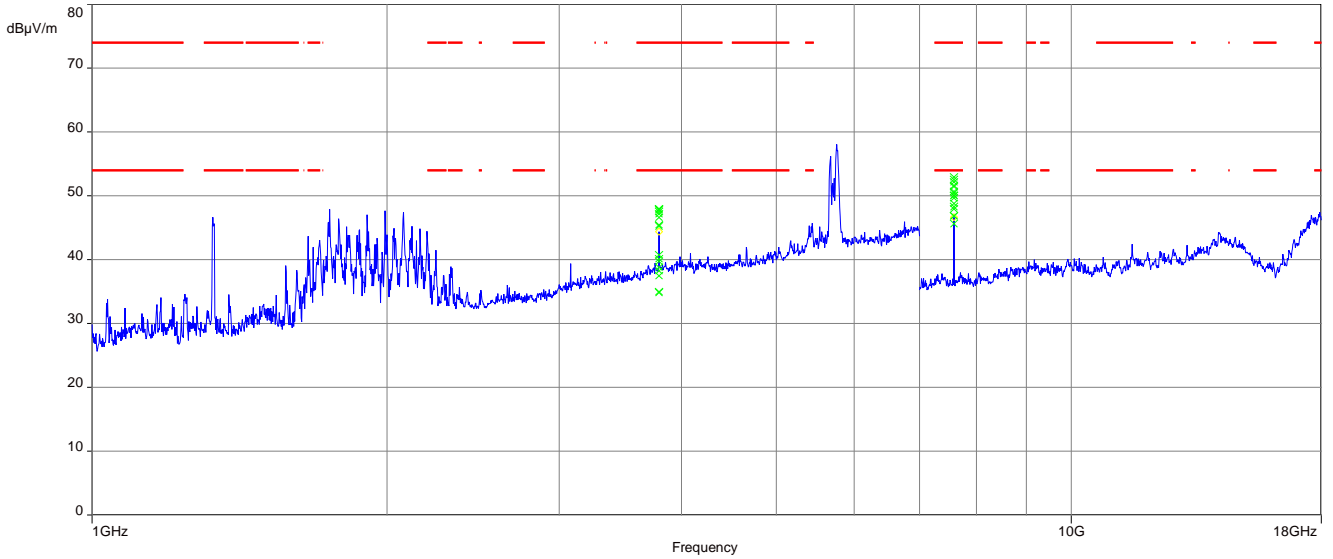

Plot 6: 1 GHz to 18 GHz; vertical & horizontal polarization; U-NII-3; middle channel

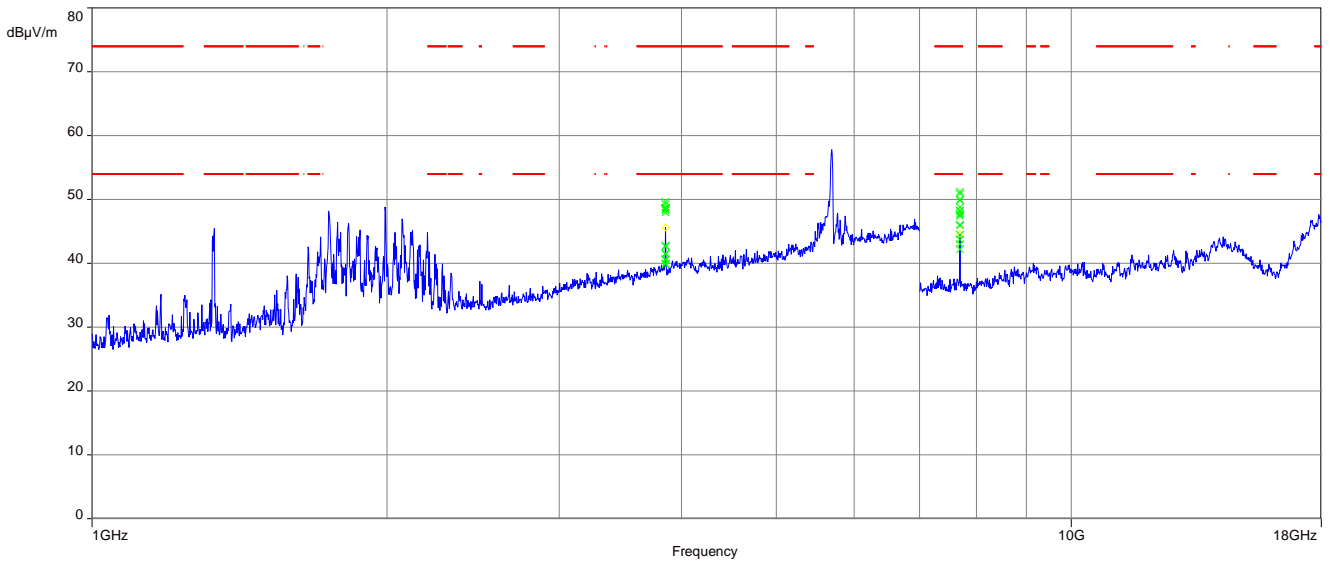

Plot 7: 18 GHz to 26 GHz; vertical & horizontal polarization; valid for all bands, all channels and modes

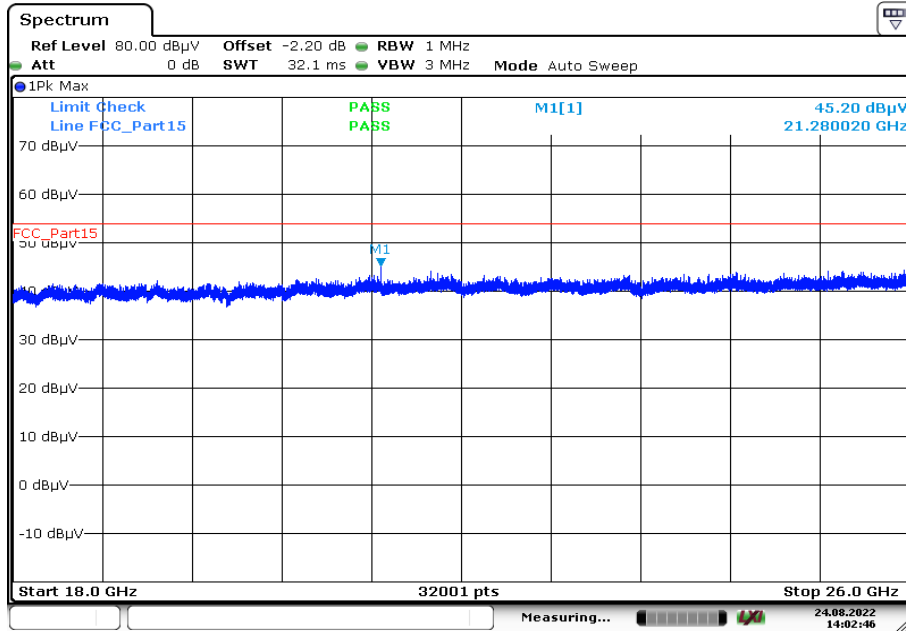

Date: 24 AUG 2022 14:02:46

Plot 8: 26 GHz to 40 GHz; vertical & horizontal polarization; valid for all bands, all channels and modes

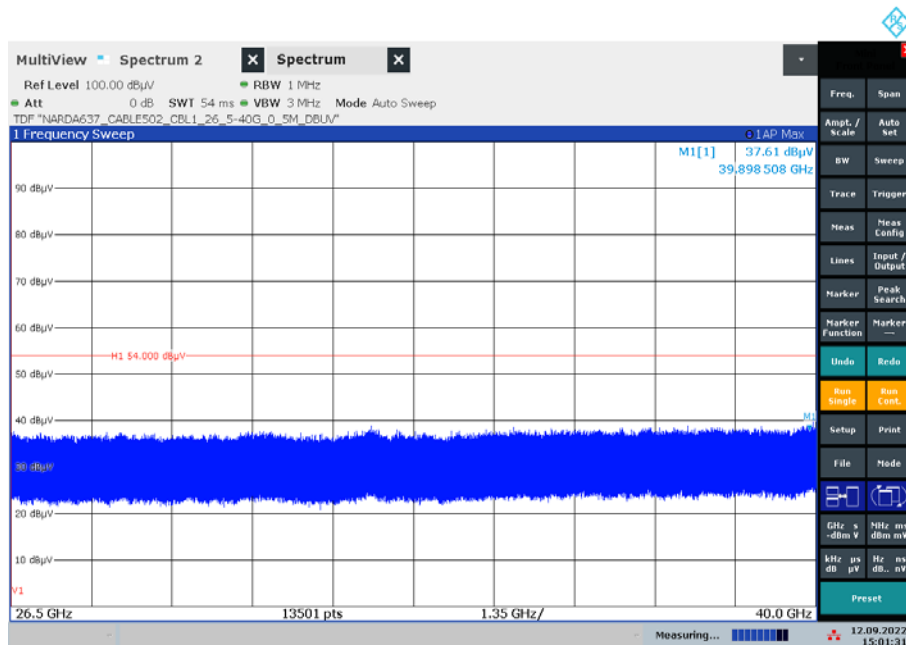

15:01:31 12.09.2022

Plots: 20 MHz channel bandwidth, A TAOGLAS PC11.07.0100A antenna

Plot 1: 1 GHz to 18 GHz; vertical & horizontal polarization; U-NII-1; lowest channel

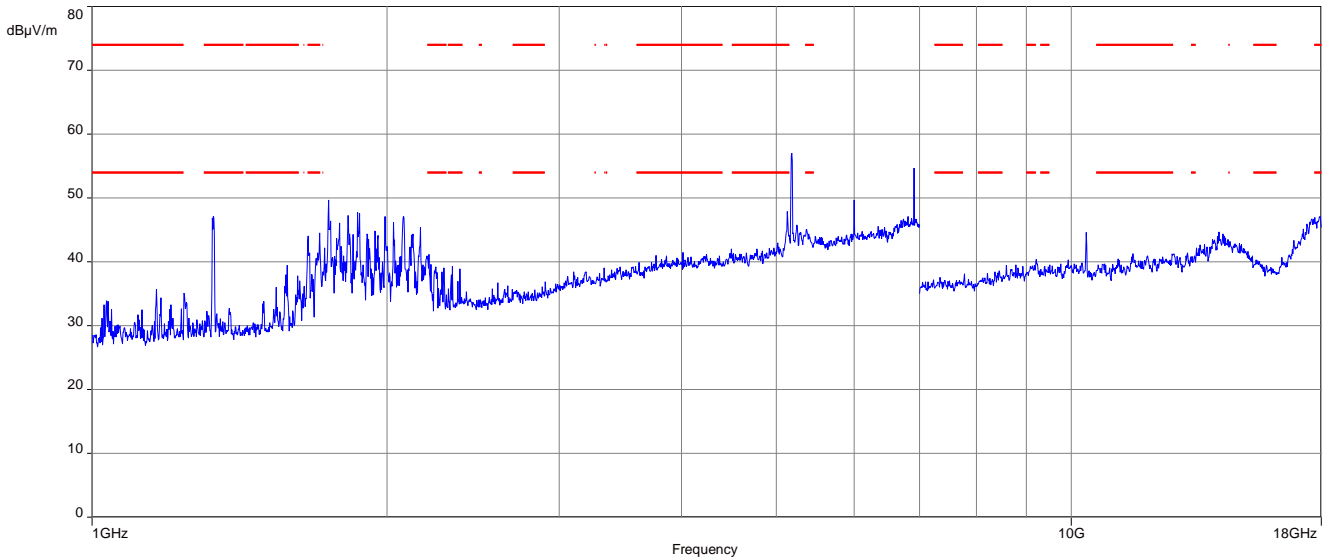

Plot 2: 1 GHz to 18 GHz; vertical & horizontal polarization; U-NII-1; middle channel

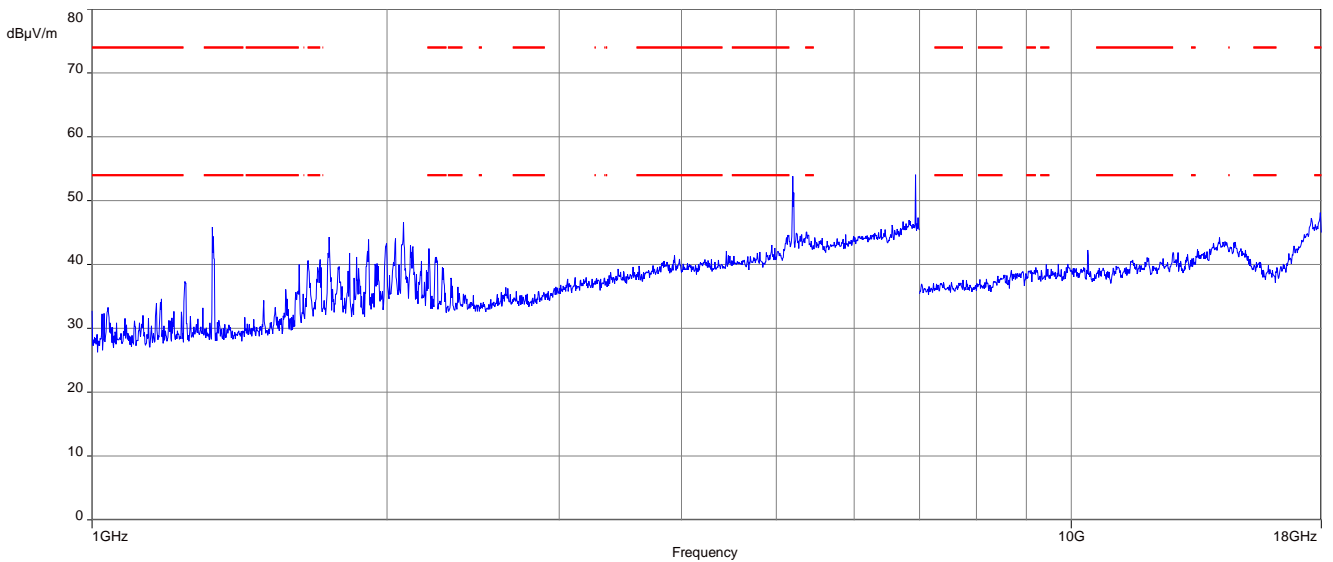

Plot 3: 1 GHz to 18 GHz; vertical & horizontal polarization; U-NII-1; highest channel

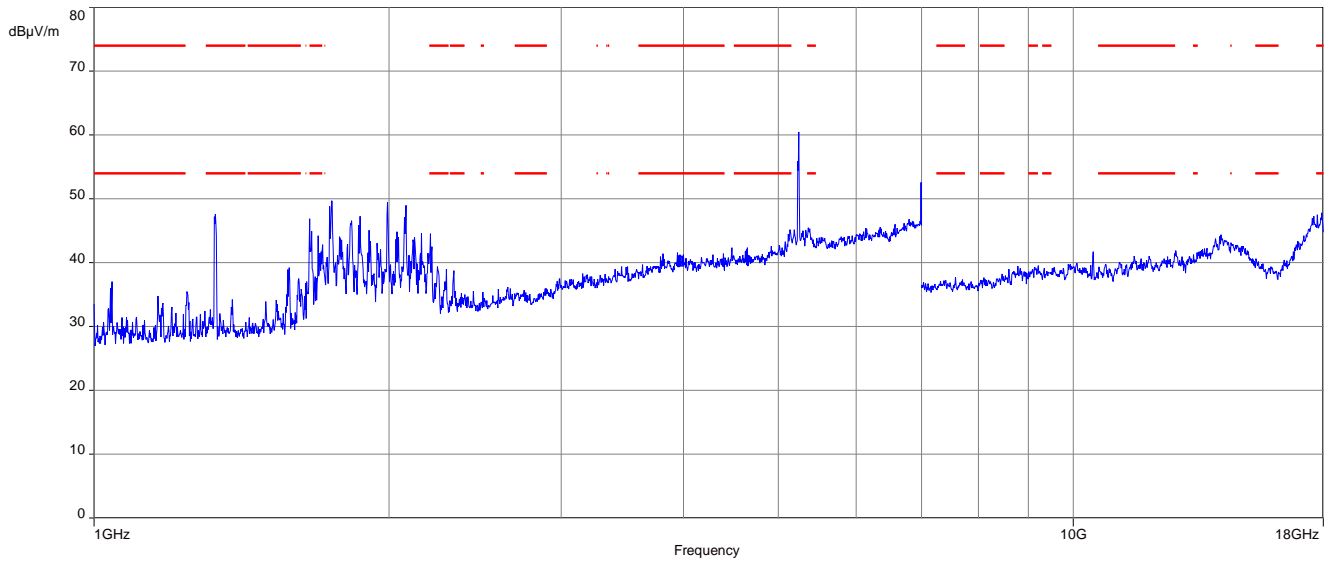

Plot 4: 1 GHz to 18 GHz; vertical & horizontal polarization; U-NII-2A; lowest channel

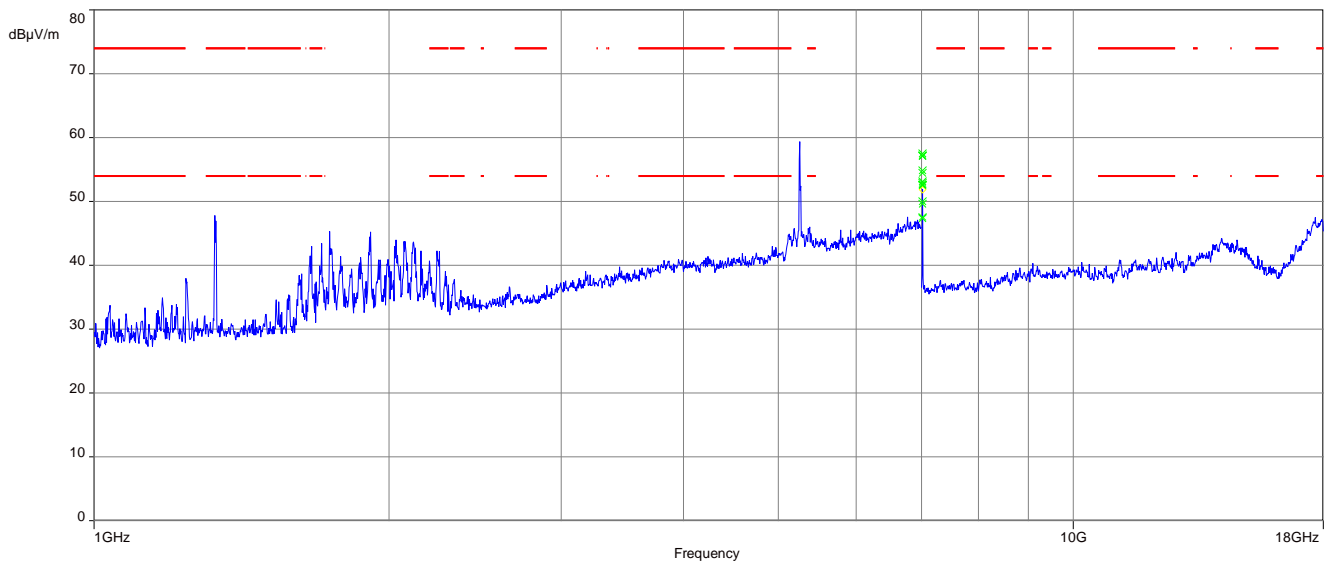

Plot 5: 1 GHz to 18 GHz; vertical & horizontal polarization; U-NII-2A; middle channel

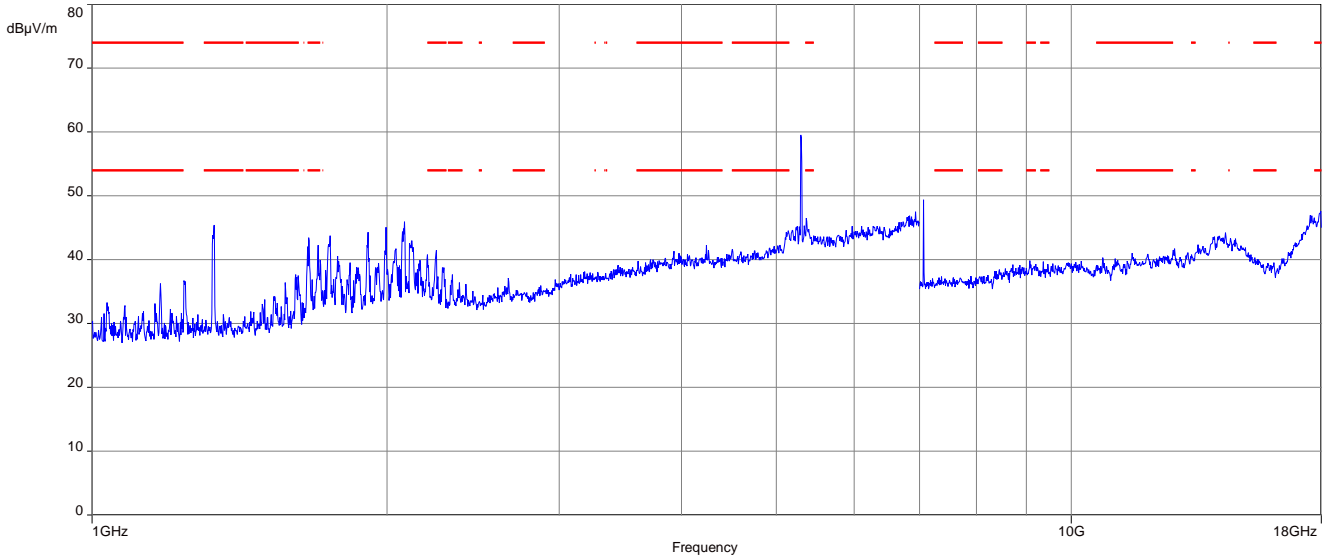

Plot 6: 1 GHz to 18 GHz; vertical & horizontal polarization; U-NII-2A; highest channel

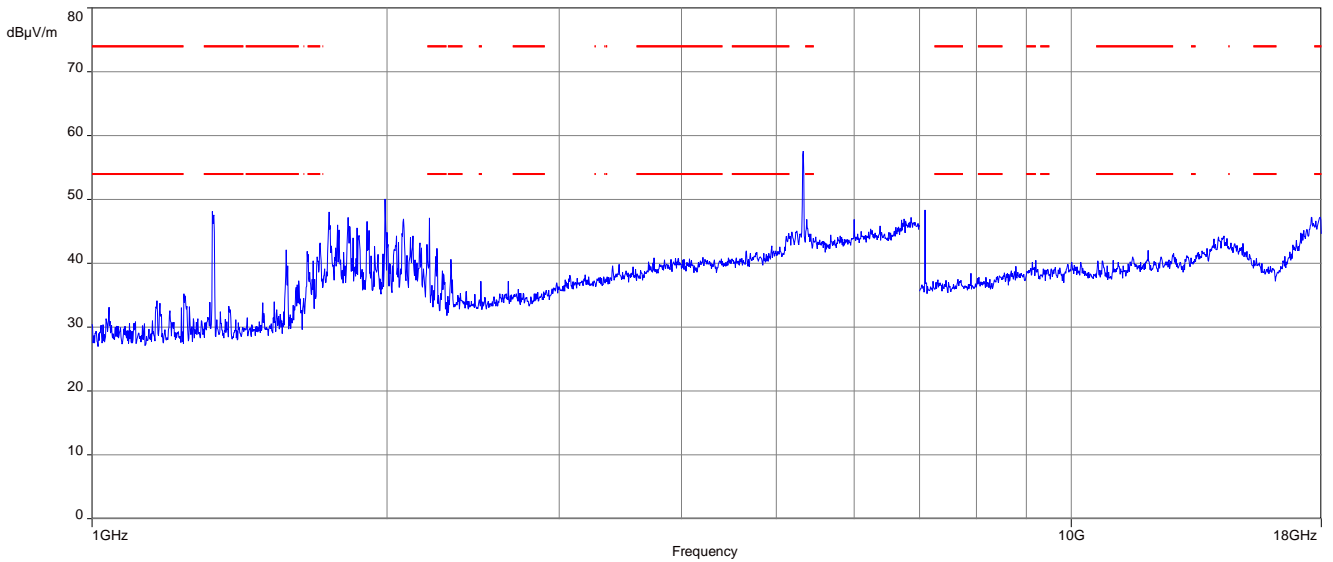

Plot 7: 1 GHz to 18 GHz; vertical & horizontal polarization; U-NII-2C; lowest channel

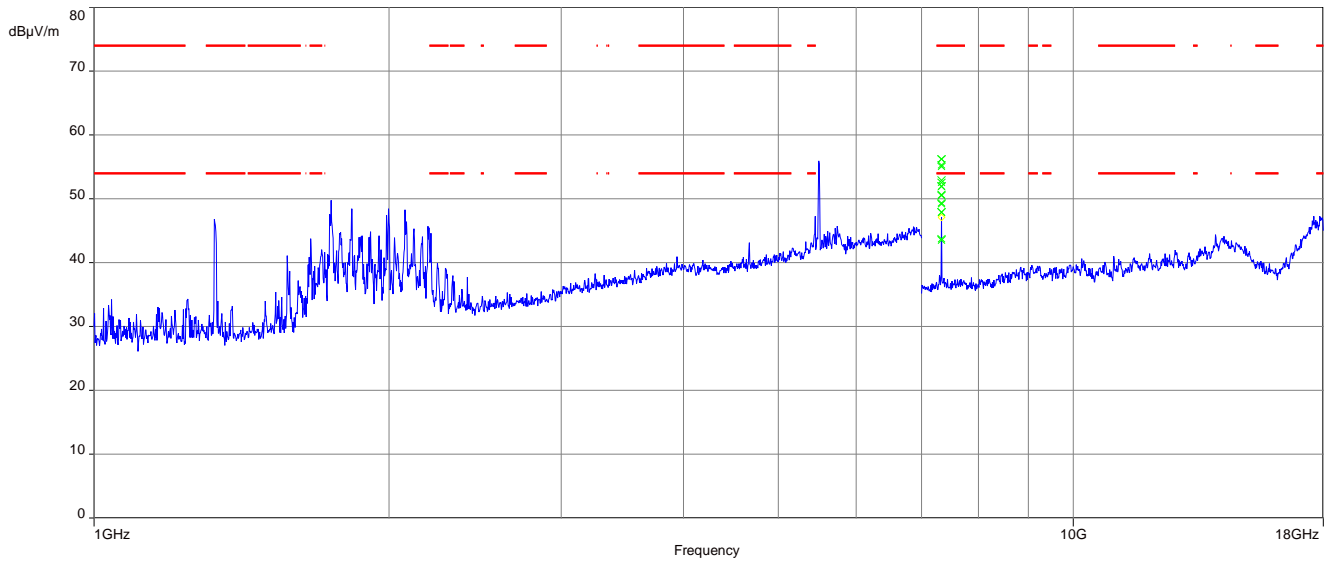

Plot 8: 1 GHz to 18 GHz; vertical & horizontal polarization; U-NII-2C; middle channel

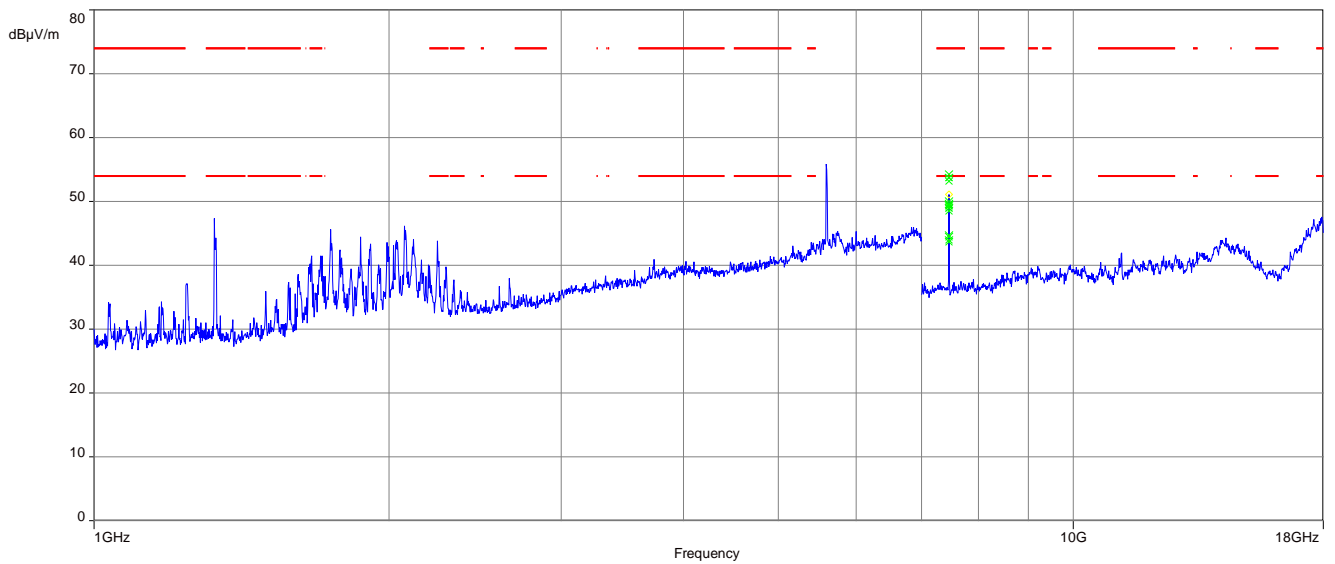

Plot 9: 1 GHz to 18 GHz; vertical & horizontal polarization; U-NII-2C; highest channel

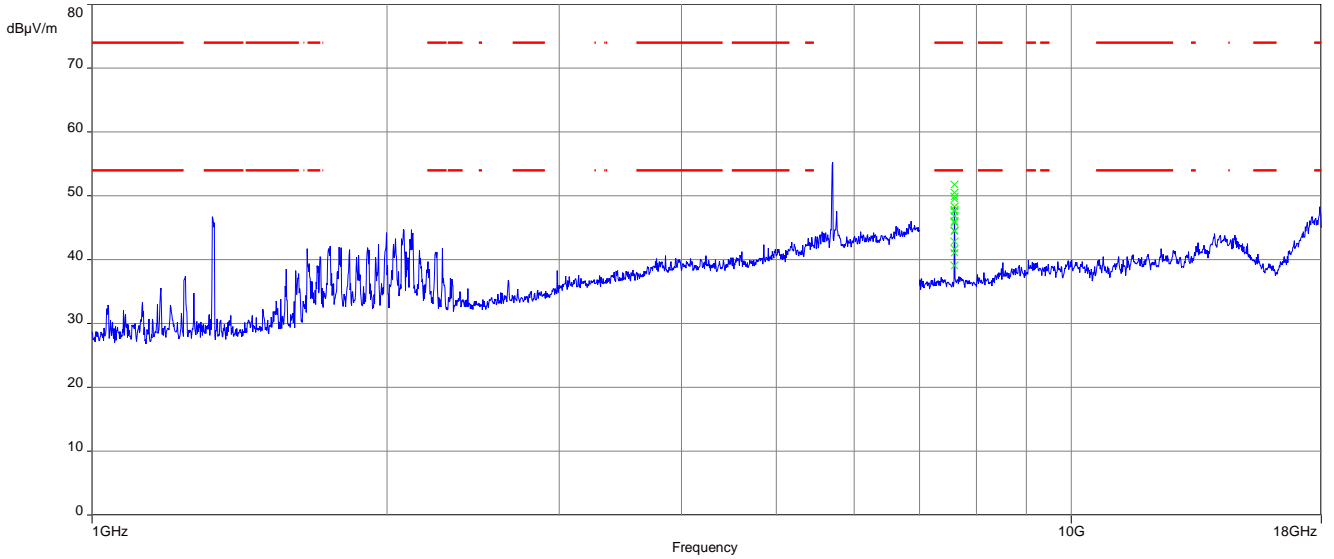

Plot 10: 1 GHz to 18 GHz; vertical & horizontal polarization; U-NII-3; lowest channel

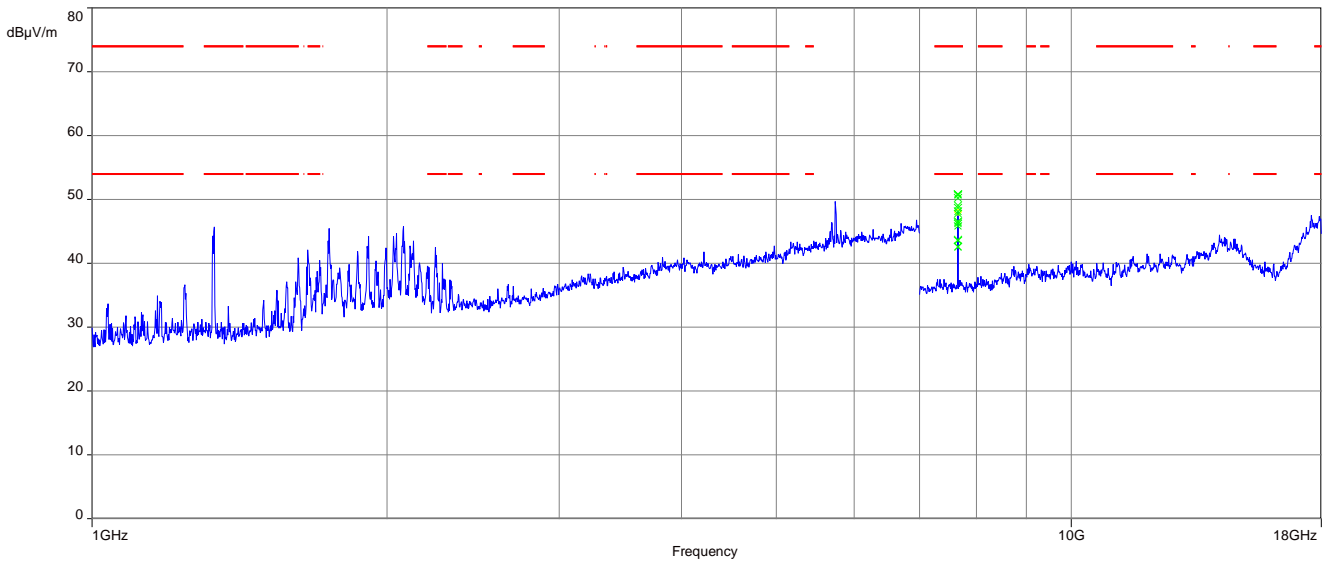

Plot 11: 1 GHz to 18 GHz; vertical & horizontal polarization; U-NII-3; middle channel

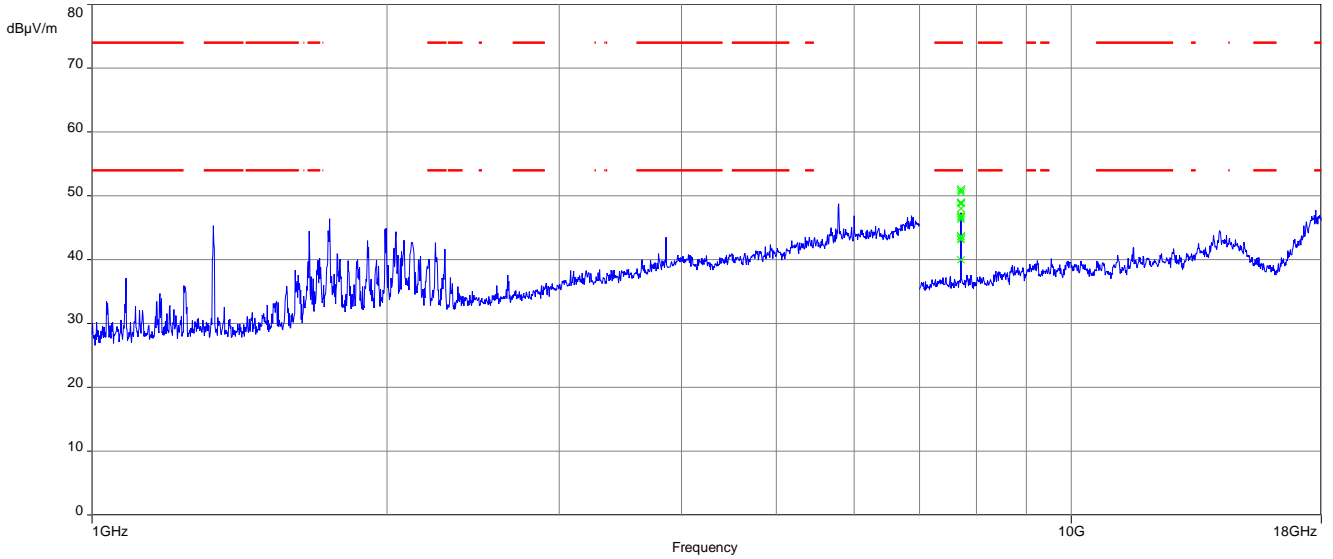

Plot 12: 1 GHz to 18 GHz; vertical & horizontal polarization; U-NII-3; highest channel

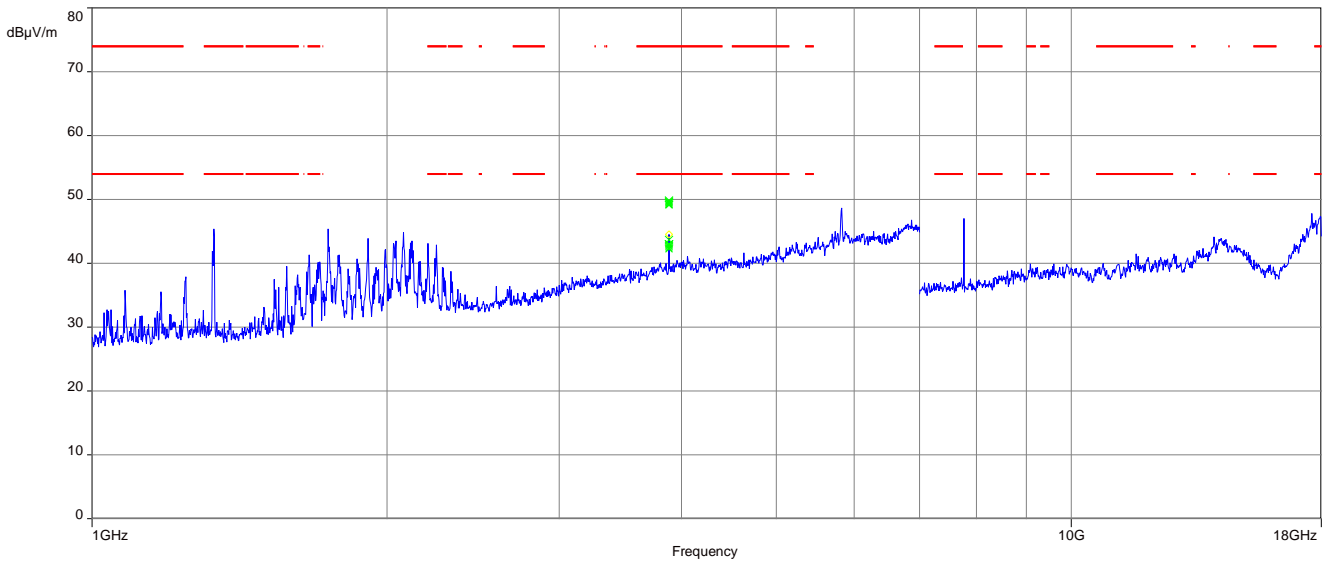

Plots: 40 MHz channel bandwidth, TAOGLAS PC11.07.0100A antenna

Plot 10: 1 GHz to 18 GHz; vertical & horizontal polarization; U-NII-1; lowest channel

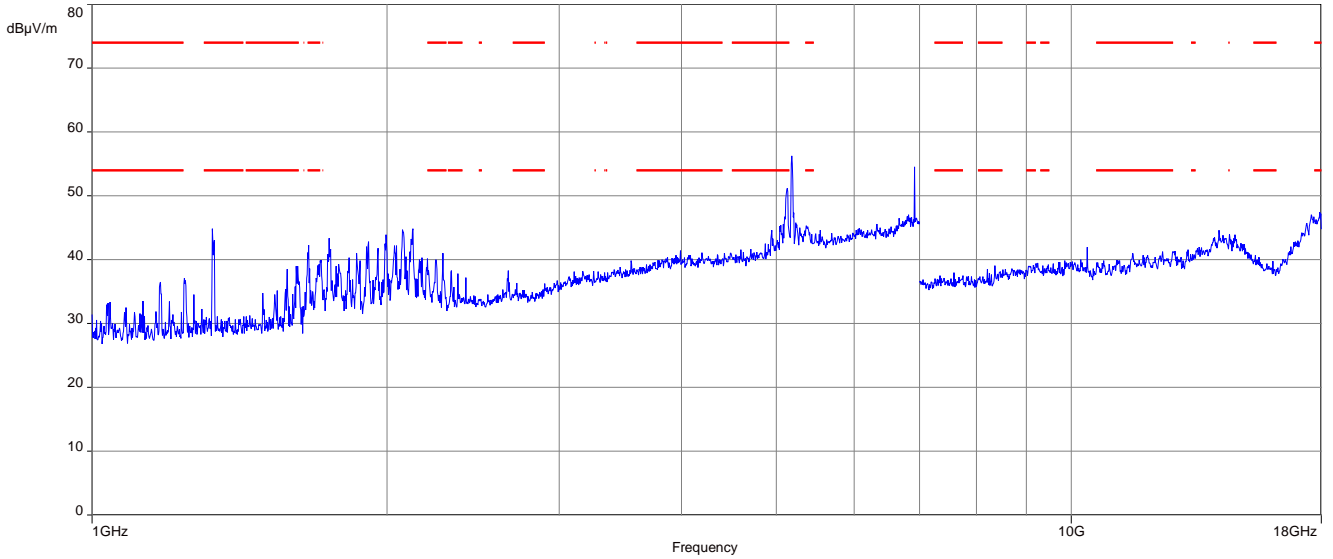

Plot 11: 1 GHz to 18 GHz; vertical & horizontal polarization; U-NII-1; highest channel

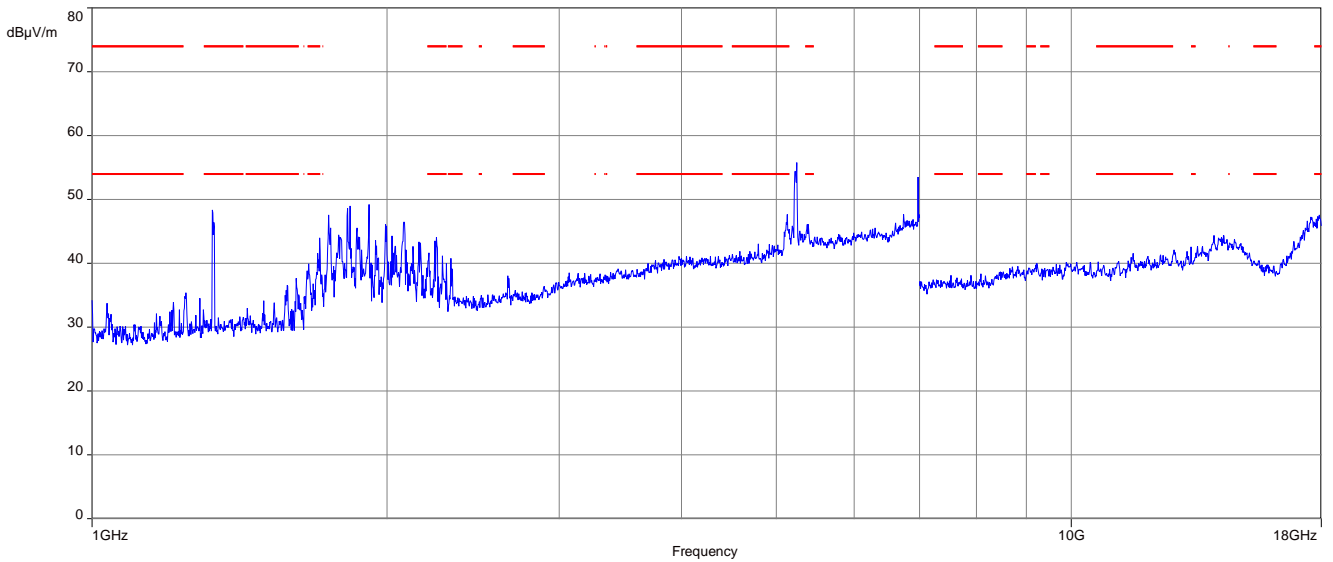

Plot 12: 1 GHz to 18 GHz; vertical & horizontal polarization; U-NII-2A; lowest channel

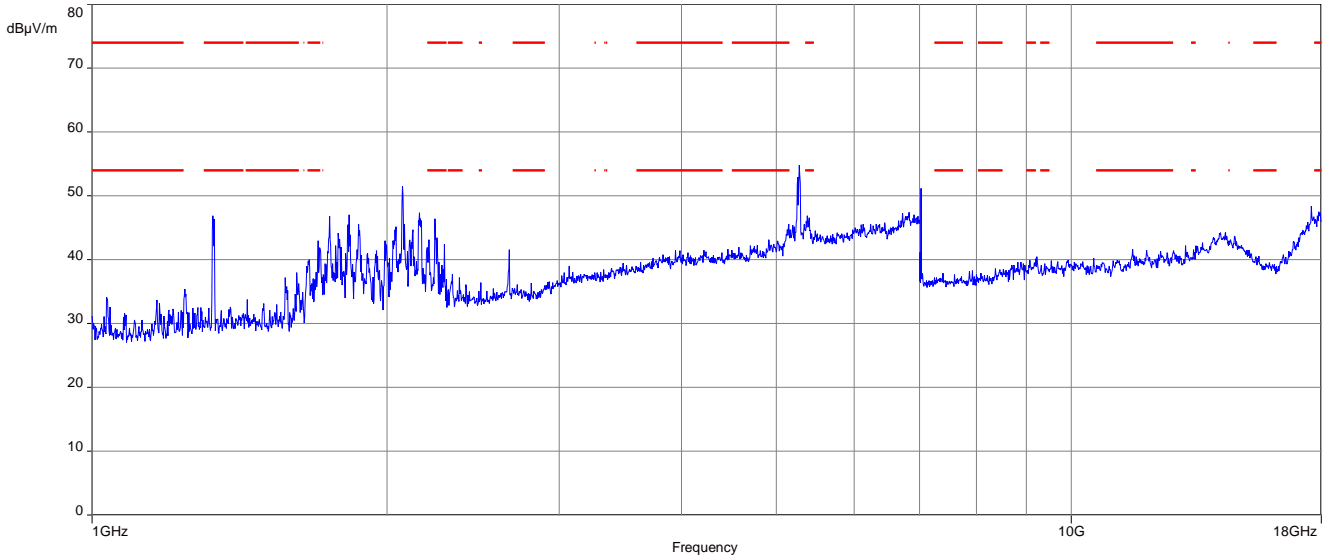

Plot 13: 1 GHz to 18 GHz; vertical & horizontal polarization; U-NII-2A; highest channel

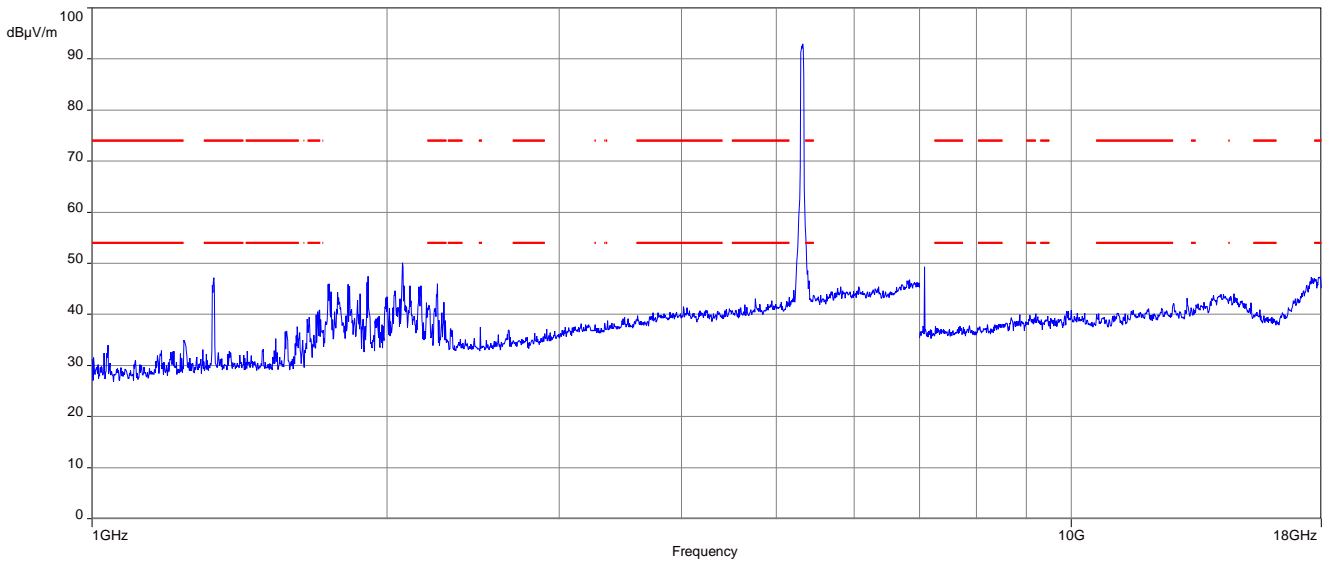

Plot 14: 1 GHz to 18 GHz; vertical & horizontal polarization; U-NII-2C; lowest channel

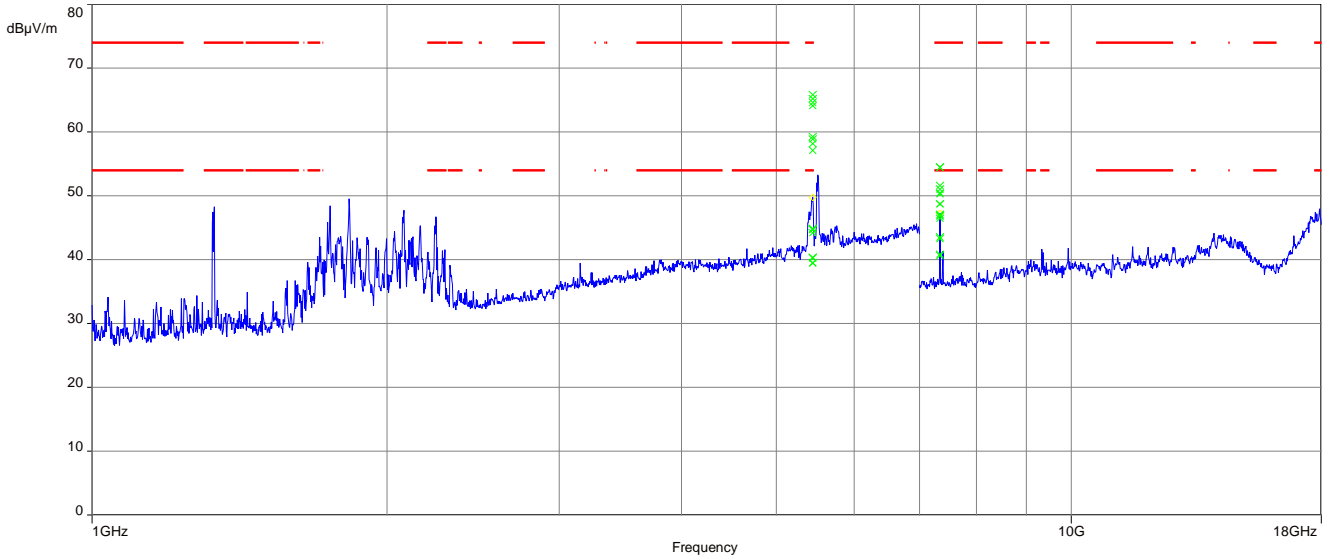

Plot 15: 1 GHz to 18 GHz; vertical & horizontal polarization; U-NII-2C; middle channel

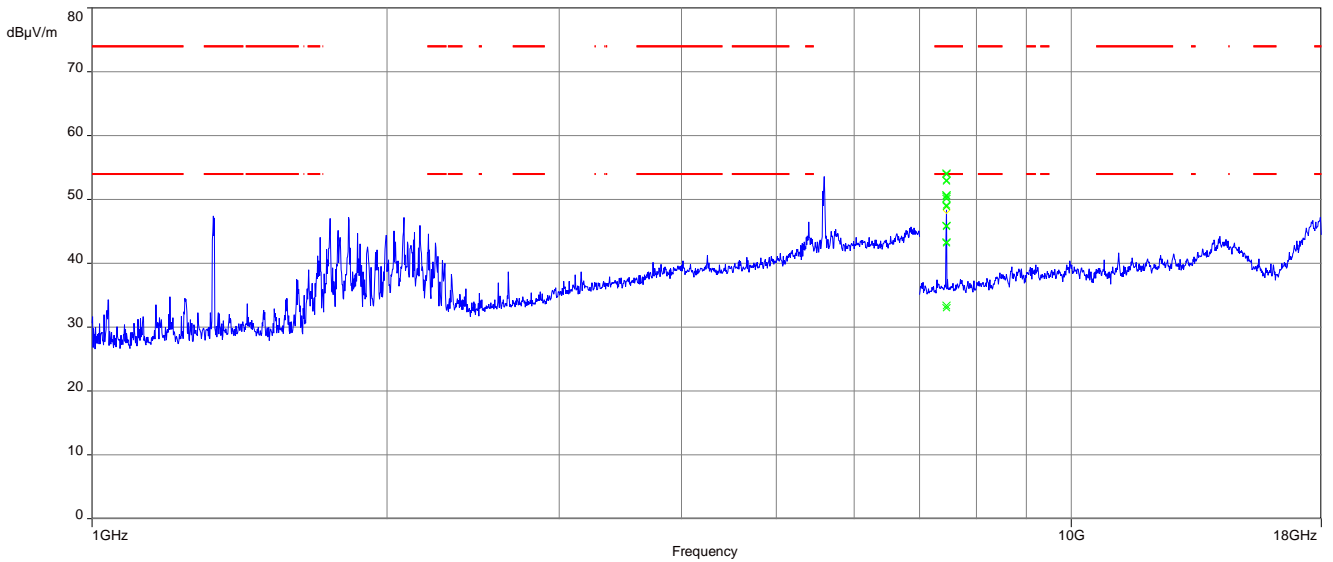

Plot 16: 1 GHz to 18 GHz; vertical & horizontal polarization; U-NII-2C; highest channel

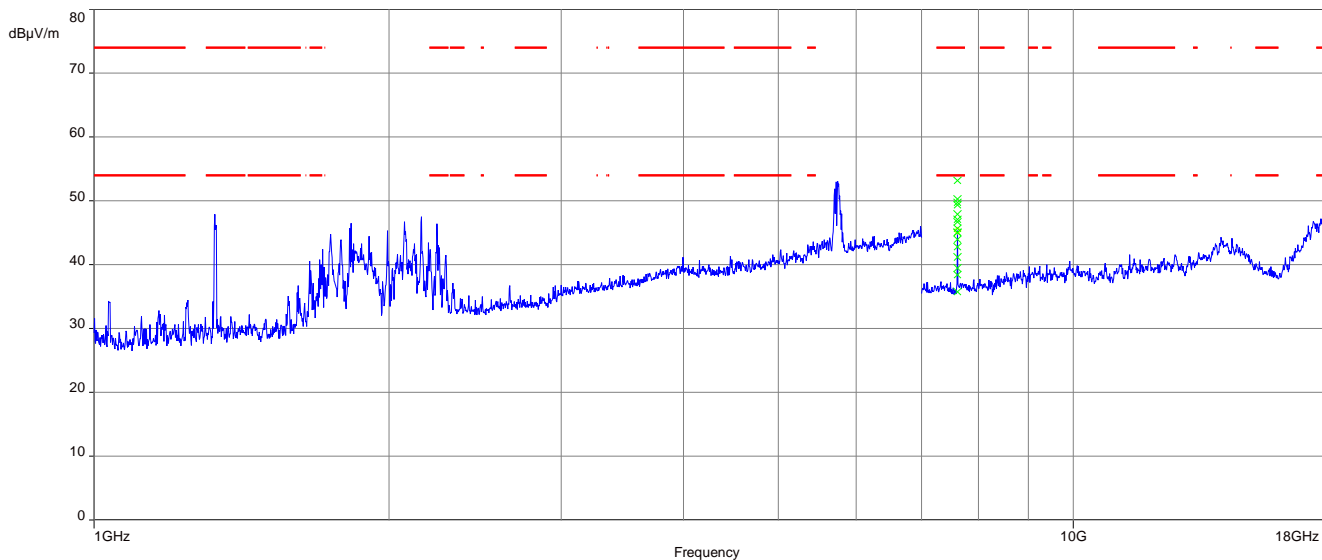

Plot 17: 1 GHz to 18 GHz; vertical & horizontal polarization; U-NII-3; lowest channel

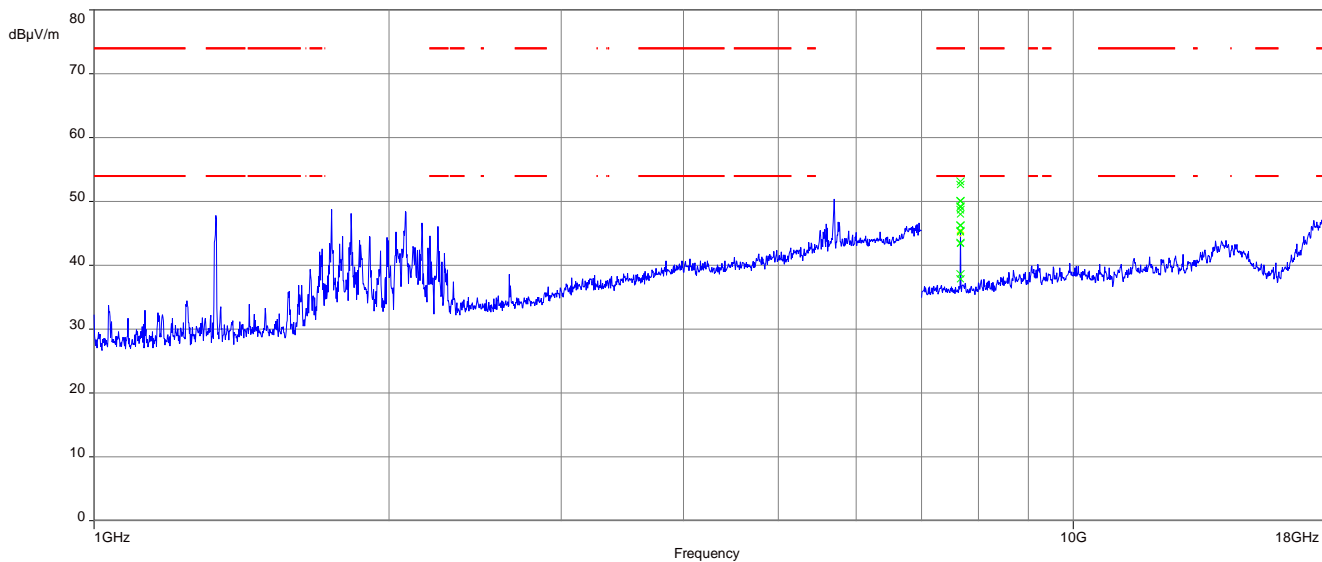

Plot 18: 1 GHz to 18 GHz; vertical & horizontal polarization; U-NII-3; highest channel

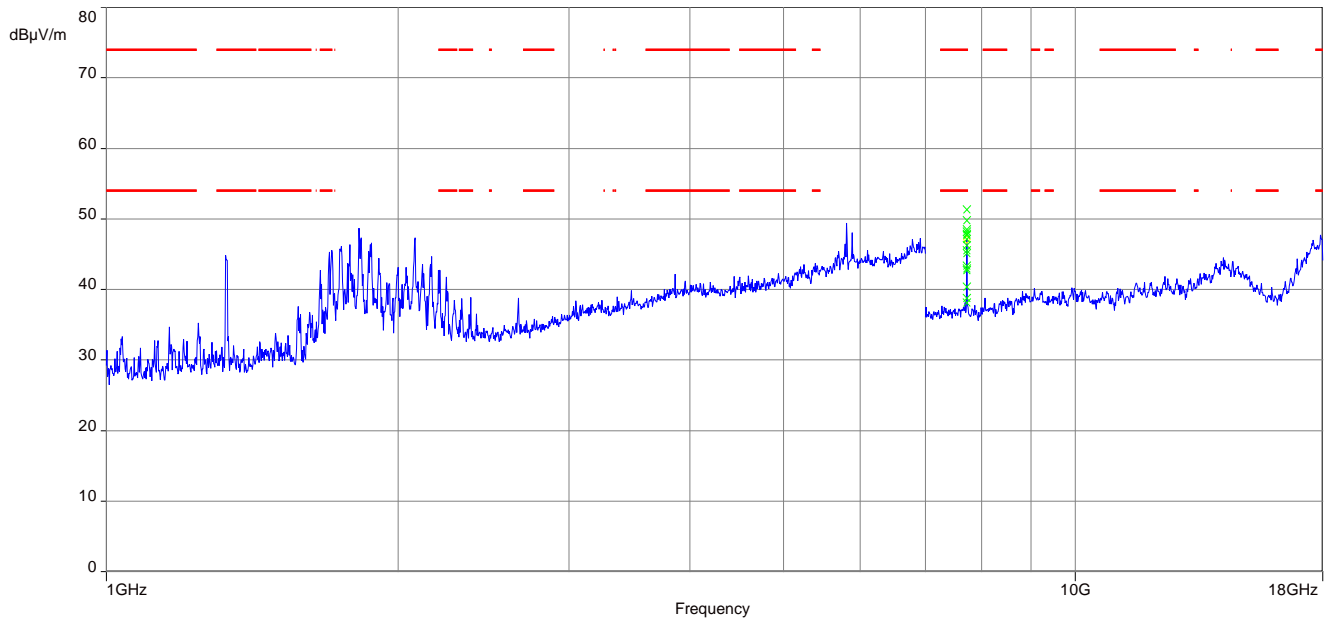

Plots: 80 MHz channel bandwidth, TAOGLAS PC11.07.0100A antenna

Plot 9: 1 GHz to 18 GHz; vertical & horizontal polarization; U-NII-1; middle channel

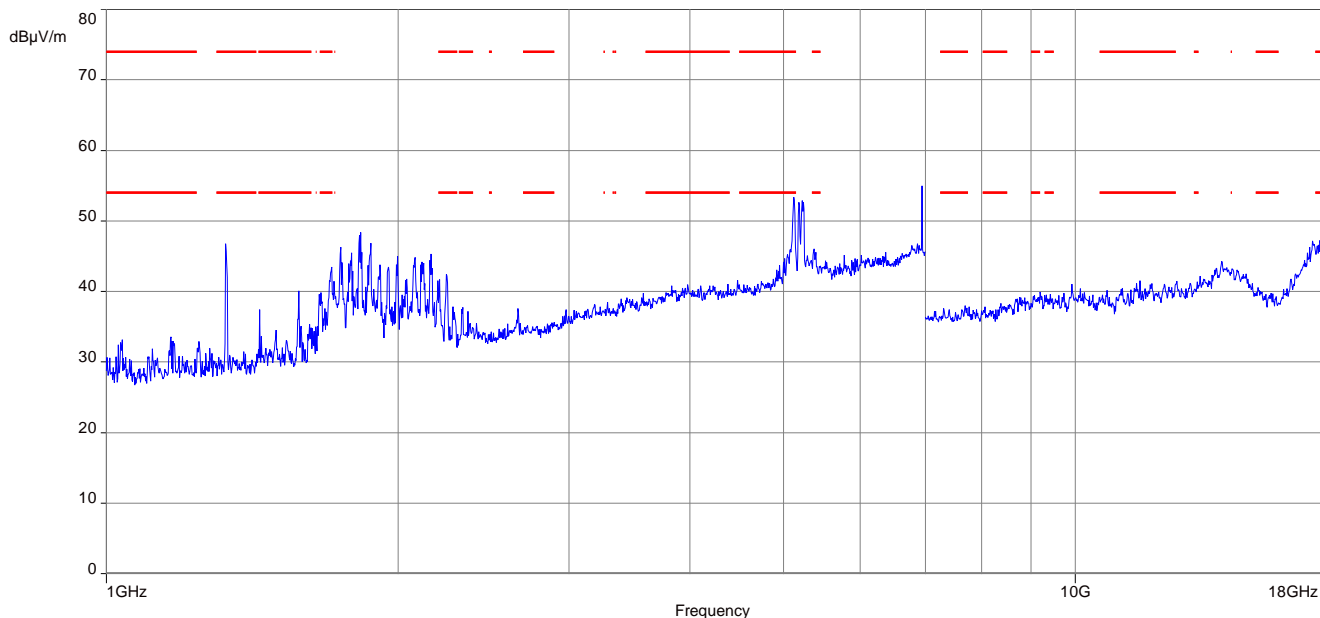

Plot 10: 1 GHz to 18 GHz; vertical & horizontal polarization; U-NII-2A; middle channel

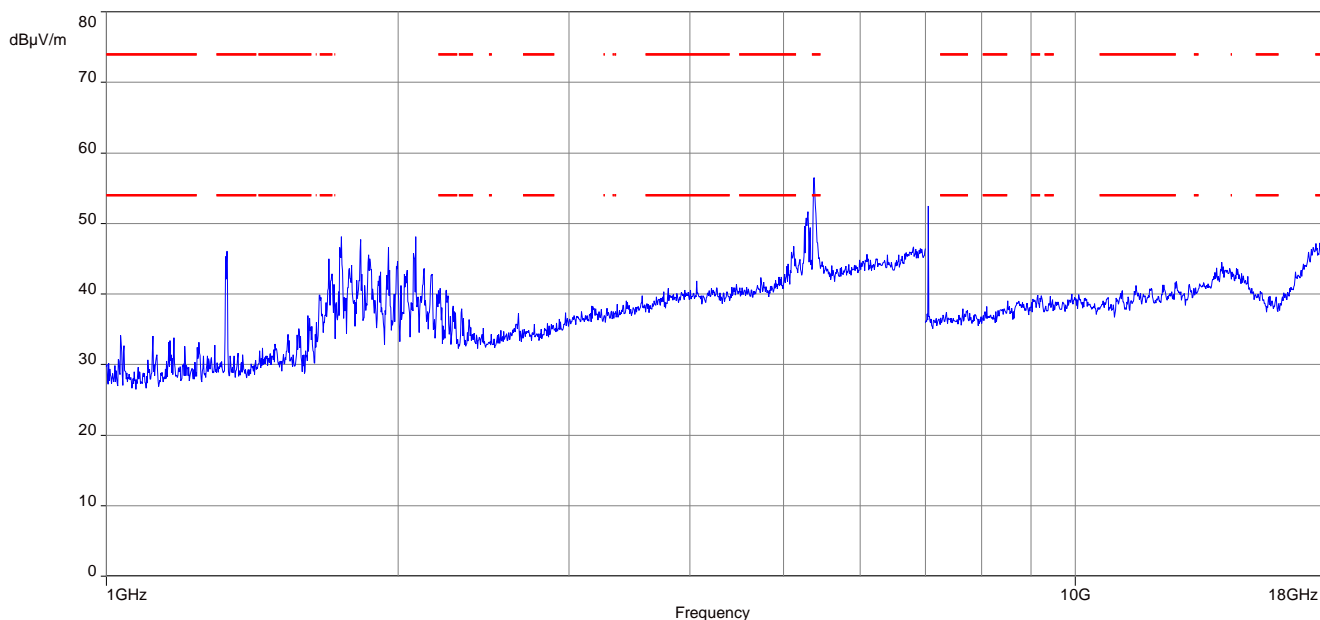

Plot 11: 1 GHz to 18 GHz; vertical & horizontal polarization; U-NII-2C; lowest channel

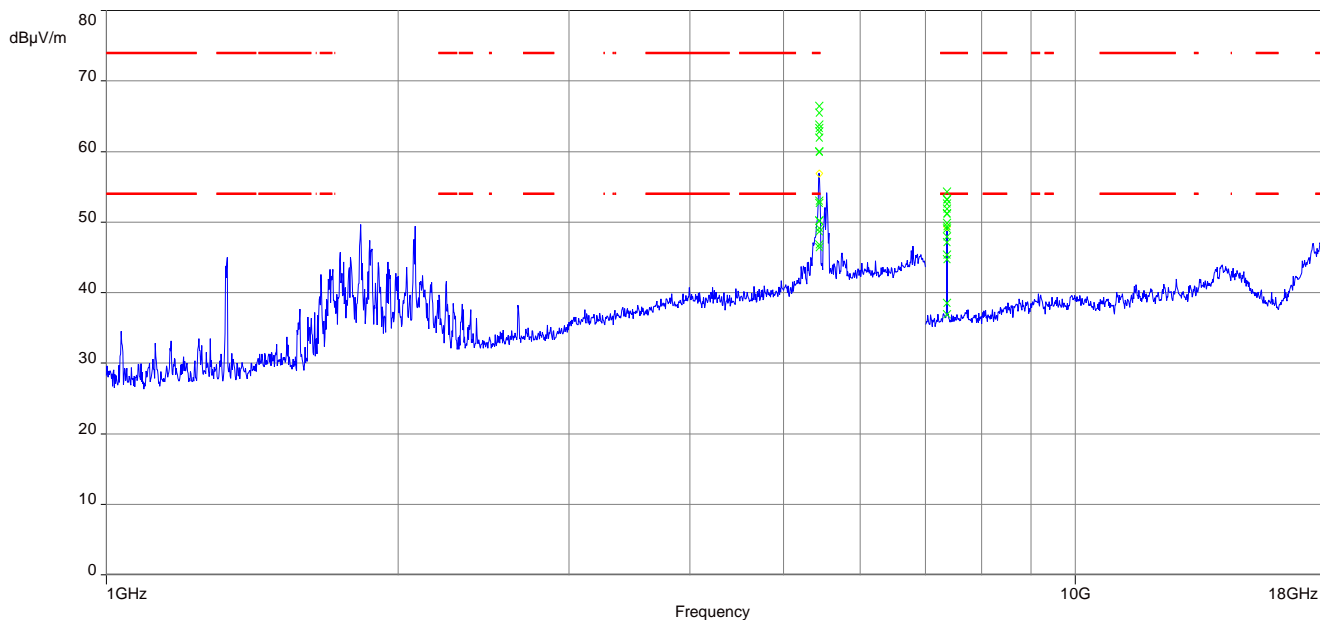

Plot 12: 1 GHz to 18 GHz; vertical & horizontal polarization; U-NII-2C; middle channel

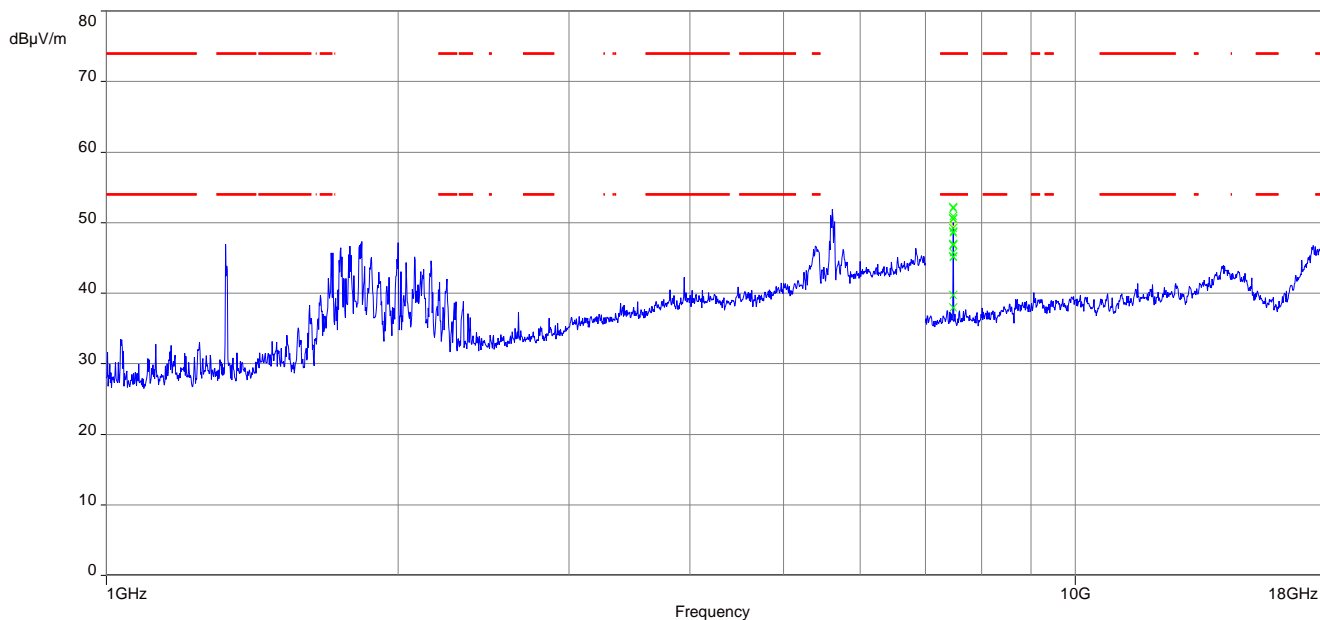

Plot 13: 1 GHz to 18 GHz; vertical & horizontal polarization; U-NII-2C; highest channel

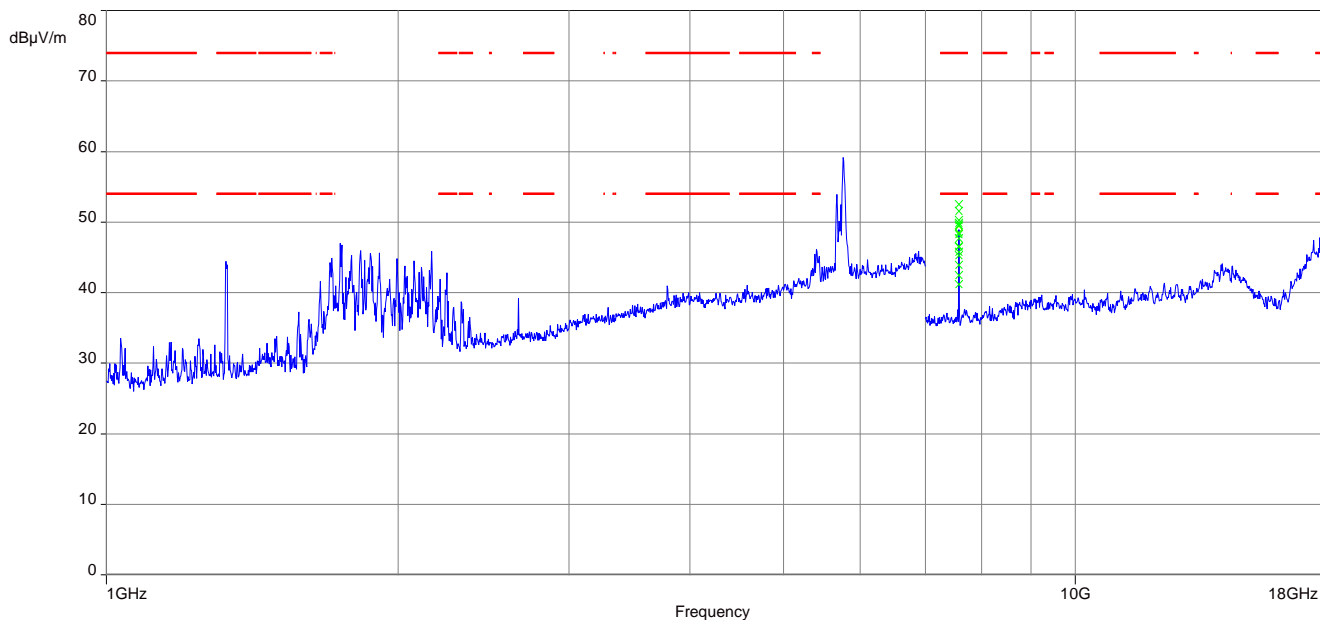

Plot 14: 1 GHz to 18 GHz; vertical & horizontal polarization; U-NII-3; middle channel

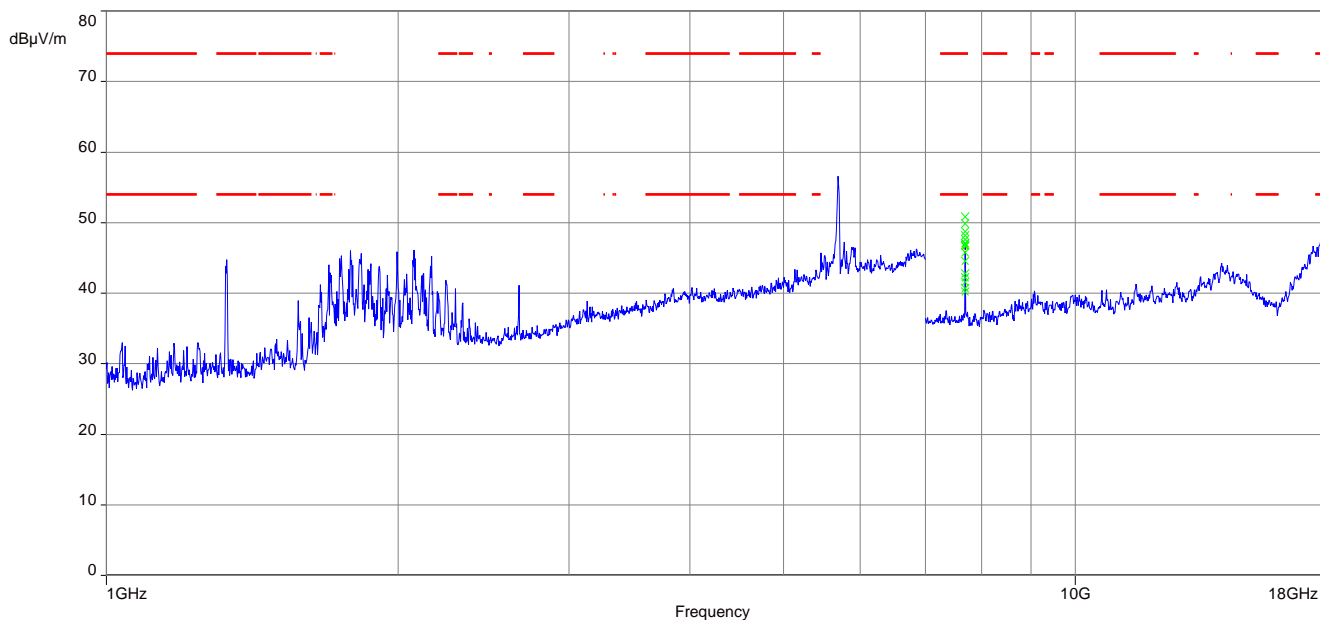

Plot 15: 18 GHz to 26 GHz; vertical & horizontal polarization; valid for all bands, all channels and modes

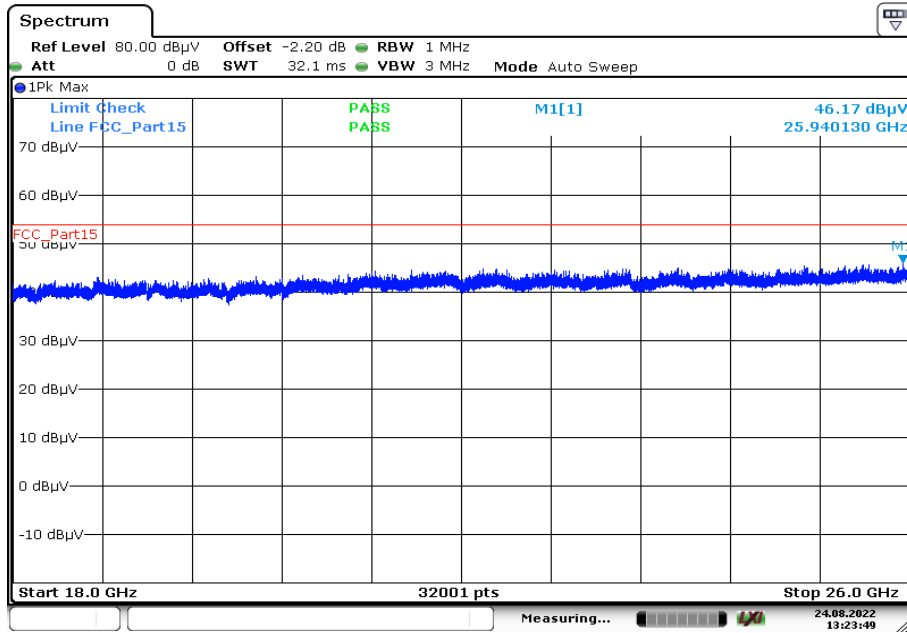

Plot 16: 26 GHz to 40 GHz; vertical & horizontal polarization; valid for all bands, all channels and modes

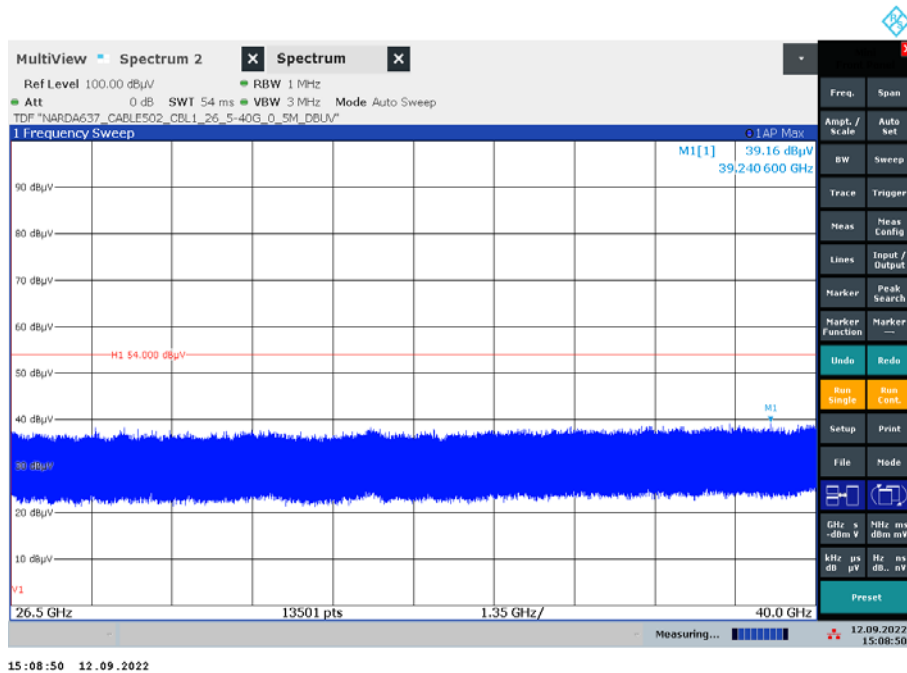

12.13 Spurious emissions conducted below 30 MHz (AC conducted)

Description:

Measurement of the conducted spurious emissions in transmit mode below 30 MHz. Both power lines, phase and neutral line, are measured. Found peaks are re-measured with average and quasi peak detection to show compliance to the limits.

Measurement:

Measurement parameter	
Detector	Peak - Quasi Peak / Average
Sweep time	Auto
Resolution bandwidth	F < 150 kHz: 200 Hz F > 150 kHz: 9 kHz
Video bandwidth	F < 150 kHz: 1 kHz F > 150 kHz: 100 kHz
Span	9 kHz to 30 MHz
Trace mode	Max. hold
Test setup	See chapter 7.5 setup A
Measurement uncertainty	See chapter 9

Limits:

FCC		ISED	
Frequency / MHz	Quasi-Peak / (dB μ V / m)	Average / (dB μ V / m)	
0.15 – 0.5	66 to 56*	56 to 46*	
0.5 – 5	56	46	
5 – 30.0	60	50	

*Decreases with the logarithm of the frequency

Plots:

Plot 1: 150 kHz to 30 MHz, phase line

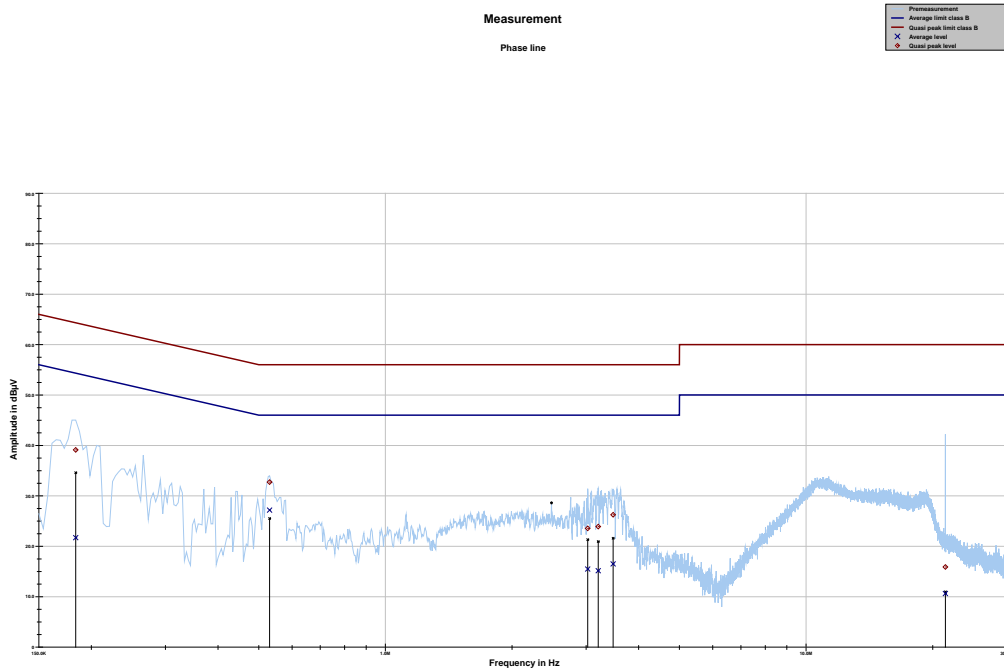

Project ID: 3547

Final results:

Frequency	Quasi peak level	Margin quasi peak	Limit QP	Average level	Margin average	Limit AV
MHz	dBµV	dB	dBµV	dBµV	dB	dBµV
0.183581	39.12	25.20	64.322	21.70	33.34	55.041
0.530587	32.73	23.27	56.000	27.16	18.84	46.000
3.026794	23.56	32.44	56.000	15.48	30.52	46.000
3.205894	23.90	32.10	56.000	15.15	30.85	46.000
3.478275	26.24	29.76	56.000	16.50	29.50	46.000
21.440513	15.89	44.11	60.000	10.62	39.38	50.000

Plot 2: 150 kHz to 30 MHz, neutral line

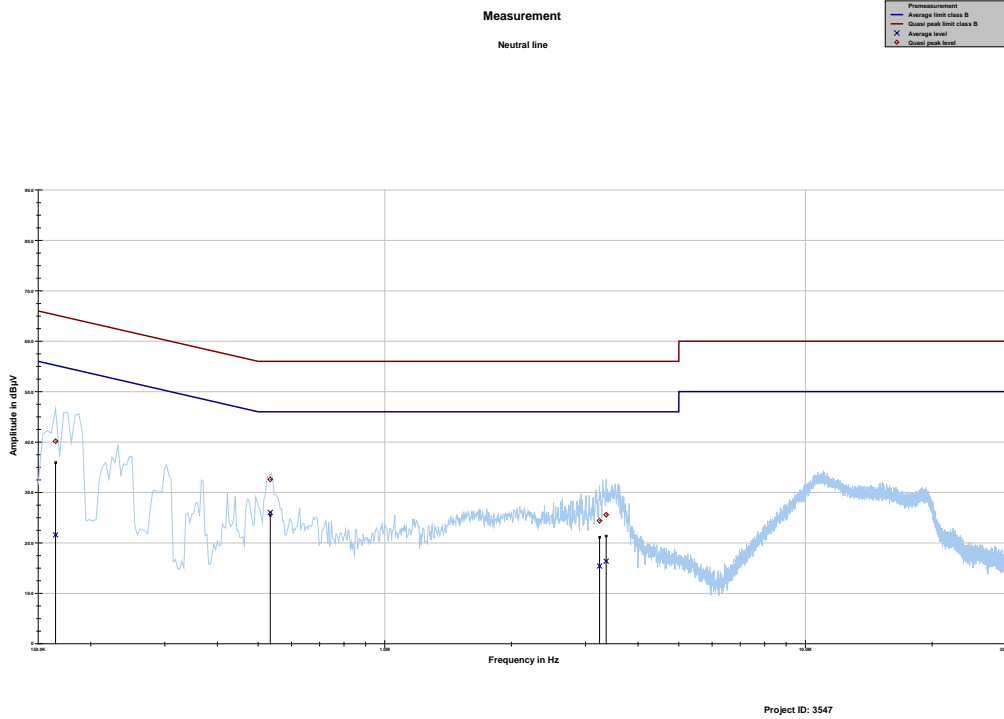

Final results:

Frequency MHz	Quasi peak level dBµV	Margin quasi peak dB	Limit QP dBµV	Average level dBµV	Margin Average dB	Limit AV dBµV
0.164925	40.16	25.05	65.212	21.59	33.99	55.574
0.534319	32.59	23.41	56.000	26.04	19.96	46.000
3.239475	24.39	31.61	56.000	15.41	30.59	46.000
3.358875	25.57	30.43	56.000	16.37	29.63	46.000

13 Glossary

EUT	Equipment under test
DUT	Device under test
UUT	Unit under test
GUE	GNSS User Equipment
ETSI	European Telecommunications Standards Institute
EN	European Standard
FCC	Federal Communications Commission
FCC ID	Company Identifier at FCC
IC	Industry Canada
PMN	Product marketing name
HMN	Host marketing name
HVIN	Hardware version identification number
FVIN	Firmware version identification number
EMC	Electromagnetic Compatibility
HW	Hardware
SW	Software
Inv. No.	Inventory number
S/N or SN	Serial number
C	Compliant
NC	Not compliant
NA	Not applicable
NP	Not performed
PP	Positive peak
QP	Quasi peak
AVG	Average
OC	Operating channel
OCW	Operating channel bandwidth
OBW	Occupied bandwidth
OOB	Out of band
DFS	Dynamic frequency selection
CAC	Channel availability check
OP	Occupancy period
NOP	Non occupancy period
DC	Duty cycle
PER	Packet error rate
CW	Clean wave
MC	Modulated carrier
WLAN	Wireless local area network
RLAN	Radio local area network
DSSS	Dynamic sequence spread spectrum
OFDM	Orthogonal frequency division multiplexing
FHSS	Frequency hopping spread spectrum
GNSS	Global Navigation Satellite System
C/N₀	Carrier to noise-density ratio, expressed in dB-Hz

14 Document history

Version	Applied changes	Date of release
-/-	Initial release	2022-09-23
A	FCC ID, IC ID and model name changed	2022-12-12

15 Accreditation Certificate – D-PL-12076-01-04

first page	last page
 <p>Deutsche Akkreditierungsstelle GmbH</p> <p>Entrusted according to Section 8 subsection 1 AkkStelleG in connection with Section 1 subsection 1 AkkStelleGBV Signatory to the Multilateral Agreements of EA, ILAC and IAF for Mutual Recognition</p> <p>Accreditation </p> <p>The Deutsche Akkreditierungsstelle GmbH attests that the testing laboratory CTC advanced GmbH Untertürkheimer Straße 6-10, 66117 Saarbrücken is competent under the terms of DIN EN ISO/IEC 17025:2018 to carry out tests in the following fields: Telecommunication (TC) and Electromagnetic Compatibility (EMC) for Canadian Standards</p> <p>The accreditation certificate shall only apply in connection with the notice of accreditation of 09.06.2020 with the accreditation number D-PL-12076-01. It comprises the cover sheet, the reverse side of the cover sheet and the following annex with a total of 07 pages. Registration number of the certificate: D-PL-12076-01-04</p> <p>Frankfurt am Main, 09.06.2020</p> <p>by order  Ingrid Egner Head of Division</p> <p><small>The certificate together with its annex reflects the status at the time of the date of issue. The current status of the scope of accreditation can be found in the database of accredited bodies of Deutsche Akkreditierungsstelle GmbH. https://www.dakks.de/en/content/accredited-bodies-dakks See notes on method.</small></p>	<p>Deutsche Akkreditierungsstelle GmbH</p> <p>Office Berlin Spittelmarkt 10 10117 Berlin</p> <p>Office Frankfurt am Main Europa-Allee 52 60327 Frankfurt am Main</p> <p>Office Braunschweig Bundesallee 100 38116 Braunschweig</p> <p>The publication of extracts of the accreditation certificate is subject to the prior written approval by Deutsche Akkreditierungsstelle GmbH (DAKKS). Exempted is the unchanged form of separate disseminations of the cover sheet by the conformity assessment body mentioned overleaf.</p> <p>No impression shall be made that the accreditation also extends to fields beyond the scope of accreditation attested by DAKKS.</p> <p>The accreditation was granted pursuant to the Act on the Accreditation Body (AkkStelleG) of 31 July 2009 (Federal Law Gazette I p. 2625) and the Regulation (EC) No 765/2008 of the European Parliament and of the Council of 9 July 2008 setting out the requirements for accreditation and market surveillance relating to the marketing of products (Official Journal of the European Union L 218 of 9 July 2008, p. 30). DAKKS is a signatory to the Multilateral Agreements for Mutual Recognition of the European co-operation for Accreditation (EA), International Accreditation Forum (IAF) and International Laboratory Accreditation Cooperation (ILAC). The signatories to these agreements recognise each other's accreditations.</p> <p>The up-to-date state of membership can be retrieved from the following websites: EA: www.european-accreditation.org ILAC: www.ilac.org IAF: www.iaf.ng</p>

Note: The current certificate annex is published on the websites (link see below).

<https://www.dakks.de/files/data/as/pdf/D-PL-12076-01-04e.pdf>

OR

https://ctcadvanced.com/app/uploads/2020/06/D-PL-12076-01-04_Canada_TCEMC.pdf

16 Accreditation Certificate – D-PL-12076-01-05

first page	last page
 <p>Deutsche Akkreditierungsstelle GmbH</p> <p>Entrusted according to Section 8 subsection 1 AkkStelleG in connection with Section 1 subsection 1 AkkStelleGBV Signatory to the Multilateral Agreements of EA, ILAC and IAF for Mutual Recognition</p> <p>Accreditation </p> <p>The Deutsche Akkreditierungsstelle GmbH attests that the testing laboratory CTC advanced GmbH Untertürkheimer Straße 6-10, 66117 Saarbrücken is competent under the terms of DIN EN ISO/IEC 17025:2018 to carry out tests in the following fields: Telecommunication (FCC Requirements)</p> <p>The accreditation certificate shall only apply in connection with the notice of accreditation of 09.06.2020 with the accreditation number D-PL-12076-01. It comprises the cover sheet, the reverse side of the cover sheet and the following annex with a total of 05 pages. Registration number of the certificate: D-PL-12076-01-05</p> <p>Frankfurt am Main, 09.06.2020  by Dipl.-Ing. (FH) Ralf Egner Head of Division</p> <p><small>The certificate together with its annex reflects the status at the time of the date of issue. The current status of the scope of accreditation can be found in the database of accredited bodies of Deutsche Akkreditierungsstelle GmbH. https://www.dakks.de/en/content/accredited-bodies-dakks See also annex 1.</small></p>	<p>Deutsche Akkreditierungsstelle GmbH</p> <p>Office Berlin Spittelmarkt 10 10117 Berlin</p> <p>Office Frankfurt am Main Europa-Allee 52 60327 Frankfurt am Main</p> <p>Office Braunschweig Bundesallee 100 38116 Braunschweig</p> <p>The publication of extracts of the accreditation certificate is subject to the prior written approval by Deutsche Akkreditierungsstelle GmbH (DAkKS). Exempted is the unchanged form of separate disseminations of the cover sheet by the conformity assessment body mentioned overleaf.</p> <p>No impression shall be made that the accreditation also extends to fields beyond the scope of accreditation attested by DAkKS.</p> <p>The accreditation was granted pursuant to the Act on the Accreditation Body (AkkStelleG) of 31 July 2009 (Federal Law Gazette I p. 2625) and the Regulation (EC) No 765/2008 of the European Parliament and of the Council of 9 July 2008 setting out the requirements for accreditation and market surveillance relating to the marketing of products (Official Journal of the European Union L 218 of 9 July 2008, p. 30). DAkKS is a signatory to the Multilateral Agreements for Mutual Recognition of the European co-operation for Accreditation (EA), International Accreditation Forum (IAF) and International Laboratory Accreditation Cooperation (ILAC). The signatories to these agreements recognise each other's accreditations.</p> <p>The up-to-date state of membership can be retrieved from the following websites: EA: www.european-accreditation.org ILAC: www.ilac.org IAF: www.iaf.nu</p>

Note: The current certificate annex is published on the websites (link see below).

<https://www.dakks.de/files/data/as/pdf/D-PL-12076-01-05e.pdf>

or

https://ctcadvanced.com/app/uploads/2020/06/D-PL-12076-01-05_TCB_USA.pdf

END OF TEST REPORT