

Company: Digi International

Test of: i.MX28 with Atheros AR6203
To: FCC CFR 47 Part 15 Subpart E 15.407

Report No.: DIGI60-U6 Rev A

CONDUCTED, RADIATED TEST REPORT



CONDUCTED, RADIATED TEST REPORT

FROM



Test of: Digi International i.MX28 with Atheros AR6203
to

To: FCC CFR 47 Part 15 Subpart E 15.407

Test Report Serial No.: DIGI60-U6 Rev A

This report supersedes: NONE

Applicant: Digi International
355 South 520 West Suite 180
Lindon, Utah 84042
USA

Product Function: 802.11 a/b/g/n Wireless Module

Issue Date: 27th May 2016

This Test Report is Issued Under the Authority of:

MiCOM Labs, Inc.
575 Boulder Court
Pleasanton California 94566
USA
Phone: +1 (925) 462-0304
Fax: +1 (925) 462-0306
www.micomlabs.com



MiCOM Labs is an ISO 17025 Accredited Testing Laboratory



Table of Contents

1. ACCREDITATION, LISTINGS & RECOGNITION.....	5
1.1. Test Accreditation	5
1.2. Recognition	6
1.3. Product Certification	7
2. DOCUMENT HISTORY	8
3. TEST RESULT CERTIFICATE.....	9
4. REFERENCES AND MEASUREMENT UNCERTAINTY	10
4.1. Normative References	10
4.2. Test and Uncertainty Procedure	11
5. PRODUCT DETAILS AND TEST CONFIGURATIONS	12
5.1. Technical Details	12
5.2. Scope of Test Program	13
5.3. Equipment Model(s) and Serial Number(s)	15
5.4. Antenna Details	15
5.5. Cabling and I/O Ports	15
5.6. Test Configurations	16
5.7. Equipment Modifications	16
5.8. Deviations from the Test Standard	16
6. TEST SUMMARY	17
7. TEST EQUIPMENT CONFIGURATION(S)	18
7.1. Conducted	18
7.2. Radiated Emissions - 3m Chamber	20
8. MEASUREMENT AND PRESENTATION OF TEST DATA	22
9. TEST RESULTS	23
9.1. Peak Transmit Power	23
9.2. 26 dB & 99% Bandwidth	28
9.3. Power Spectral Density	32
9.4. Radiated	37
9.4.1. <i>Restricted Band Emissions</i>	40
9.4.1.1. Antenna Factor ANT-DB1-xxx	40
9.4.1.2. Digi International 3100016-01	43
9.4.1.3. Taoglas FXP.830	46
9.4.1.4. Taoglas PC.11	49
9.4.2. <i>Restricted Band-Edge Emissions</i>	52
9.4.2.5. Antenna Factor ANT-DB1-xxx	52
9.4.2.6. Digi International 3100016-01	59
9.4.2.7. Taoglas FXP.830	66
9.4.2.8. Taoglas PC.11	73

This test report may be reproduced in full only. The document may only be updated by MiCOM Labs personnel. All changes will be noted in the Document History section of the report.



Title: Digi International AR6203
To: FCC CFR 47 Part 15 Subpart E 15.407
Serial #: DIGI60-U6 Rev A
Issue Date: 27th May 2016
Page: 4 of 141

APPENDIX A - GRAPHICAL IMAGES	80
A.1. 26 dB & 99% Bandwidth	81
A.2. Power Spectral Density	89
A.3. Radiated	105
<i>A.3.1. Restricted Band Emissions.....</i>	<i>105</i>
A.3.1.1. Antenna Factor ANT-DB1-xxx	105
A.3.1.2. Digi International 3100016-01.....	108
A.3.1.3. Taoglas FXP.830	111
A.3.1.4. Taoglas PC.11	114
<i>A.3.2. Restricted Band-Edge Emissions.....</i>	<i>117</i>
A.3.2.5. Antenna Factor ANT-DB1-xxx	117
A.3.2.6. Digi International 3100016-01.....	123
A.3.2.7. Taoglas FXP.830	129
A.3.2.8. Taoglas PC.11	135

This test report may be reproduced in full only. The document may only be updated by MiCOM Labs personnel. All changes will be noted in the Document History section of the report.

1. ACCREDITATION, LISTINGS & RECOGNITION

1.1. Test Accreditation

MiCOM Labs, Inc. is an accredited Electrical testing laboratory per the international standard ISO/IEC 17025:2005. The company is accredited by the American Association for Laboratory Accreditation (A2LA) www.a2la.org test laboratory number 2381.01. MiCOM Labs test schedule is available at the following URL; <http://www.a2la.org/scopepdf/2381-01.pdf>



Accredited Laboratory

A2LA has accredited

MICOM LABS

Pleasanton, CA

for technical competence in the field of

Electrical Testing

This laboratory is accredited in accordance with the recognized International Standard ISO/IEC 17025:2005 General requirements for the competence of testing and calibration laboratories. This accreditation demonstrates technical competence for a defined scope and the operation of a laboratory quality management system (refer to joint ISO-ILAC-IAF Communiqué dated 8 January 2009).



Presented this 4th day of February 2016.



Senior Director of Quality & Communications
For the Accreditation Council
Certificate Number 2381.01
Valid to November 30, 2017

For the tests or types of tests to which this accreditation applies, please refer to the laboratory's Electrical Scope of Accreditation.

This test report may be reproduced in full only. The document may only be updated by MiCOM Labs personnel. All changes will be noted in the Document History section of the report.



1.2. Recognition

MiCOM Labs, Inc has widely recognized wireless testing capabilities. Our international recognition includes Conformity Assessment Body designation by APEC MRA countries. MiCOM Labs test reports are accepted globally.

Country	Recognition Body	Status	Phase	Identification No.
USA	Federal Communications Commission (FCC)	TCB	-	US0159 Listing #: 102167
Canada	Industry Canada (IC)	FCB	APEC MRA 2	US0159 Listing #: 4143A-2 4143A-3
Japan	MIC (Ministry of Internal Affairs and Communication)	CAB	APEC MRA 2	RCB 210
	VCCI	--	--	A-0012
Europe	European Commission	NB	EU MRA	NB 2280
Australia	Australian Communications and Media Authority (ACMA)	CAB	APEC MRA 1	US0159
Hong Kong	Office of the Telecommunication Authority (OFTA)	CAB	APEC MRA 1	
Korea	Ministry of Information and Communication Radio Research Laboratory (RRL)	CAB	APEC MRA 1	
Singapore	Infocomm Development Authority (IDA)	CAB	APEC MRA 1	
Taiwan	National Communications Commission (NCC) Bureau of Standards, Metrology and Inspection (BSMI)	CAB	APEC MRA 1	
Vietnam	Ministry of Communication (MIC)	CAB	APEC MRA 1	

EU MRA – European Union Mutual Recognition Agreement.

NB – Notified Body

APEC MRA – Asia Pacific Economic Community Mutual Recognition Agreement. Recognition agreement under which test lab is accredited to regulatory standards of the APEC member countries.

Phase I - recognition for product testing

Phase II – recognition for both product testing and certification

1.3. Product Certification

MiCOM Labs, Inc. is an accredited Product Certification Body per the international standard ISO/IEC 17065:2012. The company is accredited by the American Association for Laboratory Accreditation (A2LA) www.a2la.org test laboratory number 2381.02. MiCOM Labs test schedule is available at the following URL; <http://www.a2la.org/scopepdf/2381-02.pdf>



United States of America – Telecommunication Certification Body (TCB)
Industry Canada – Certification Body, CAB Identifier – US0159
Europe – Notified Body (NB), NB Identifier - 2280
Japan – Recognized Certification Body (RCB), RCB Identifier - 210



Title: Digi International AR6203
To: FCC CFR 47 Part 15 Subpart E 15.407
Serial #: DIGI60-U6 Rev A
Issue Date: 27th May 2016
Page: 8 of 141

2. DOCUMENT HISTORY

Document History		
Revision	Date	Comments
Draft	26 th May 2016	Testing was completed on this device to comply with the FCC update requirements to relocate the 5725-5850 MHz band from DTS (15.247) to UNII (15.407)
Rev A	27 th May 2016	Initial Release

In the above table the latest report revision will replace all earlier versions.

This test report may be reproduced in full only. The document may only be updated by MiCOM Labs personnel. All changes will be noted in the Document History section of the report.



Title: Digi International AR6203
To: FCC CFR 47 Part 15 Subpart E 15.407
Serial #: DIGI60-U6 Rev A
Issue Date: 27th May 2016
Page: 9 of 141

3. TEST RESULT CERTIFICATE

Manufacturer: Digi International 355 South 520 West Suite 180 Lindon Utah 84042 USA	Tested By: MiCOM Labs, Inc. 575 Boulder Court Pleasanton California 94566 USA
Model: i.MX28 with Atheros AR6203	Telephone: +1 925 462 0304 Fax: +1 925 462 0306
Equipment Type: Wireless Module	
S/N's: 50001838-05-revD	
Test Date(s): 24 th – 26 th May 2016	Website: www.micomlabs.com

STANDARD(S)	TEST RESULTS
FCC CFR 47 Part 15 Subpart E 15.407	EQUIPMENT COMPLIES

MiCOM Labs, Inc. tested the equipment mentioned in accordance with the requirements set forth in the above standards. Test results indicate that the equipment tested is capable of demonstrating compliance with the requirements as documented within this report.

Notes:

1. This document reports conditions under which testing was conducted and the results of testing performed.
2. Details of test methods used have been recorded and kept on file by the laboratory.
3. Test results apply only to the item(s) tested.

Approved & Released for MiCOM Labs, Inc. by:



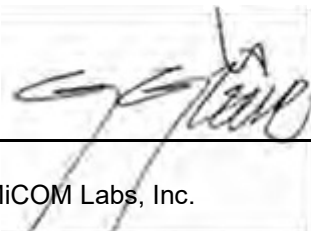

Graeme Grieve
Quality Manager MiCOM Labs, Inc.

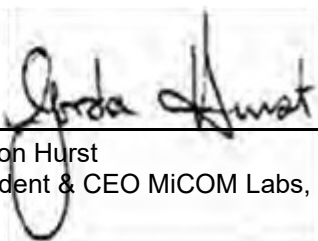

Gordon Hurst
President & CEO MiCOM Labs, Inc.

This test report may be reproduced in full only. The document may only be updated by MiCOM Labs personnel. All changes will be noted in the Document History section of the report.

4. REFERENCES AND MEASUREMENT UNCERTAINTY

4.1. Normative References

REF.	PUBLICATION	YEAR	TITLE
I	KDB 662911 D01 & D02	Oct 31 2013	Guidance for measurement of output emission of devices that employ single transmitter with multiple outputs or systems with multiple transmitters operating simultaneously in the same frequency band
II	KDB 905462 D07 v01r01	8th April 2016	Test guidance to demonstrate compliance for U-NII devices subject to DFS requirements.
III	KDB 926956 D01 v01r06	8th April 2016	U-NII Device Transition Plan
IV	KDB 789033 D02 v01r02	8th April 2016	General UNII Test Procedures New Rules
V	A2LA	February 2016	R105 - Requirement's When Making Reference to A2LA Accreditation Status
VI	ANSI C63.10	2013	American National Standard for Testing Unlicensed Wireless Devices
VII	ANSI C63.4	2014	American National Standards for Methods of Measurement of Radio-Noise Emissions from Low-Voltage Electrical and Electronic Equipment in the Range of 9 kHz to 40 GHz
VIII	CISPR 22	2008	Information technology equipment - Radio disturbance characteristics - Limits and methods of measurement
IX	ETSI TR 100 028	2001-12	Parts 1 and 2 Electromagnetic compatibility and Radio Spectrum Matters (ERM); Uncertainties in the measurement of mobile radio equipment characteristics
X	FCC 06-96	Jun 30 2006	Memorandum Opinion and Order
XI	FCC 47 CFR Part 15.407	2014	Radio Frequency Devices; Subpart E –Unlicensed National Information Infrastructure Devices
XII	ICES-003	Issue 6 Jan 2016	Spectrum Management and Telecommunications; Interference-Causing Equipment Standard. Information Technology Equipment (Including Digital Apparatus) – Limits and methods of measurement.
XIII	M 3003	Edition 3 Nov.2012	Expression of Uncertainty and Confidence in Measurements
XIV	RSS-247 Issue 1	May 2015	Digital Transmission Systems (DTSs), Frequency Hopping System (FHSs) and Licence-Exempt Local Area Network (LE-LEN) Devices
XV	RSS-Gen Issue 4	November 2014	General Requirements and Information for the Certification of Radiocommunication Equipment
XVI	KDB 644545 D03 v01	August 14th 2014	Guidance for IEEE 802.11ac New Rules
XVII	FCC 47 CFR Part 2.1033	2016	FCC requirements and rules regarding photographs and test setup diagrams.

This test report may be reproduced in full only. The document may only be updated by MiCOM Labs personnel. All changes will be noted in the Document History section of the report.



Title: Digi International AR6203
To: FCC CFR 47 Part 15 Subpart E 15.407
Serial #: DIGI60-U6 Rev A
Issue Date: 27th May 2016
Page: 11 of 141

4.2. Test and Uncertainty Procedure

Conducted and radiated emission measurements were conducted in accordance with American National Standards Institute ANSI C63.4, listed in the Normative References section of this report.

Measurement uncertainty figures are calculated in accordance with ETSI TR 100 028 Parts 1 and 2.

Measurement uncertainties stated are based on a standard uncertainty multiplied by a coverage factor $k = 2$, providing a level of confidence of approximately 95 % in accordance with UKAS document M 3003 listed in the Normative References section of this report.

This test report may be reproduced in full only. The document may only be updated by MiCOM Labs personnel. All changes will be noted in the Document History section of the report.



Title: Digi International AR6203
To: FCC CFR 47 Part 15 Subpart E 15.407
Serial #: DIGI60-U6 Rev A
Issue Date: 27th May 2016
Page: 12 of 141

5. PRODUCT DETAILS AND TEST CONFIGURATIONS

5.1. Technical Details

Details	Description
Purpose:	Test of the Digi International i.MX28 with Atheros AR6203 to FCC CFR 47 Part 15 Subpart E 15.407. Radio Frequency Devices; Subpart E –Unlicensed National Information Infrastructure Devices
Applicant:	Digi International 355 South 520 West Suite 180 Lindon Utah 84042 USA
Manufacturer:	Digital International
Laboratory performing the tests:	MiCOM Labs, Inc. 575 Boulder Court Pleasanton California 94566 USA
Test report reference number:	DIGI60 - CCIMX28 FCC Update
Date EUT received:	23rd of May 2016
Standard(s) applied:	FCC CFR 47 Part 15 Subpart E 15.407
Dates of test (from - to):	24 - 26 May 2016
No of Units Tested:	3
Type of Equipment:	Wireless Module
Product Family Name:	I MX28
Model(s):	AR6203
Location for use:	Indoor
Declared Frequency Range(s):	5150 - 5250 MHz; 5250 - 5350 MHz; 5470 - 5725 MHz; 5725 - 5850 MHz;
Primary function of equipment:	802.11 a/b/g/n wireless module
Type of Modulation:	OFDM
EUT Modes of Operation:	5725 - 5850 MHz: 802.11a; 802.11n HT-20; 802.11n HT-40;
Declared Nominal Output Power (Ave):	5725 - 5850 MHz: 802.11a: -; 802.11n HT-20: -; 802.11n HT-40:
Transmit/Receive Operation:	Time Division Duplex
Rated Input Voltage and Current:	5 VDC 625 mA
Operating Temperature Range:	Declared Range -40°C to +75°C
ITU Emission Designator:	802.11a 18M0D1D 802.11n HT-20 19M6D1D 802.11n HT-40 41M0D1D
Equipment Dimensions:	2" (L) x 1.375 (W) x 0.162" (H) inches
Weight:	< 0.5 oz
Hardware Rev:	revD
Software Rev:	BusyBox 1.19.4

This test report may be reproduced in full only. The document may only be updated by MiCOM Labs personnel. All changes will be noted in the Document History section of the report.



Title: Digi International AR6203
To: FCC CFR 47 Part 15 Subpart E 15.407
Serial #: DIGI60-U6 Rev A
Issue Date: 27th May 2016
Page: 13 of 141

5.2. Scope of Test Program

Digi International i.MX28 with Atheros AR6203

The scope of the test program was to test the Digi International i.MX28 with Atheros AR6203 configurations in the frequency ranges 5725 - 5850 MHz; for compliance against the following specification:

FCC CFR 47 Part 15 Subpart E 15.407

Radio Frequency Devices; Subpart E –Unlicensed National Information Infrastructure Devices

Compliance was to the FCC new rules for:

- a). introduction of the 5725 – 5850 MHz band into UNII band regulations, and

Test Suite

To prove compliance with the FCC's new rules the following tests were completed;

- i) Full Conducted testing
- ii) Full Radiated testing on all antenna's (Radiated Spurious Emissions and Radiated Band-Edge)

Model Identification

Wireless Module: i.MX28 with Atheros AR6203

Operational Modes

- i) 802.11a
- ii) 802.11n HT20
- iii) 802.11n HT40

Frequency Bands 5150-5250, 5250-5350, 5470-5725, and Digital Emissions have already been tested and results are available under MiCOM Labs test report # **DIGI36-U6 REV A.**

This test report may be reproduced in full only. The document may only be updated by MiCOM Labs personnel. All changes will be noted in the Document History section of the report.

Digi International i.MX28 with Atheros AR6203

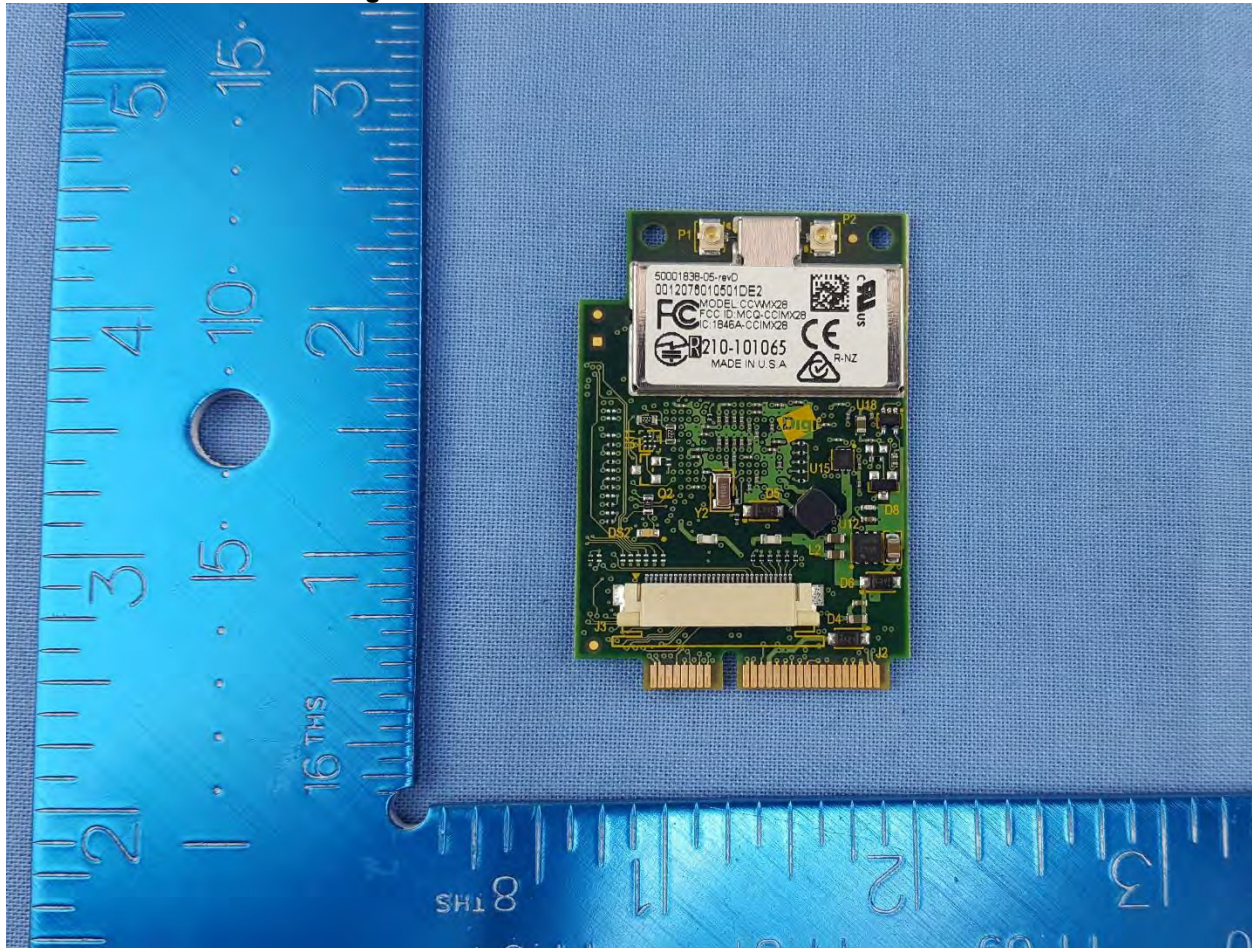

This test report may be reproduced in full only. The document may only be updated by MiCOM Labs personnel. All changes will be noted in the Document History section of the report.



5.3. Equipment Model(s) and Serial Number(s)

Type (EUT/Support)	Equipment Description (Including Brand Name)	Mfr	Model No.	Serial No.
EUT	802.11a/b/g/n Module – Dual Port Module	Digi International	AR6203	50001838-05-revD
Support	Laptop PC	IBM	Thinkpad	None

5.4. Antenna Details

Type	Manufacturer	Model	Family	Gain (dBi)	BF Gain	Dir BW	X-Pol	Frequency Band (MHz)
Integral	Taoglas	PC.11	Patch	4.5	-	360	-	5150 – 5250 5250 – 5350 5470 – 5725 5725 - 5850
Integral	Taoglas	FXP.830	Patch	4.0	-	360	-	5150 – 5250 5250 – 5350 5470 – 5725 5725 - 5850
External	Antenna Factor	ANT-DB1-xxx	Omni-Dual Band	4.3	-	360	-	5150 – 5250 5250 – 5350 5470 – 5725 5725 - 5850
Integral	Digi International	3100016-01	Dipole	2.0	-	360	-	5150 – 5250 5250 – 5350 5470 – 5725 5725 - 5850

BF Gain - Beamforming Gain
Dir BW - Directional Beam-width
X-Pol - Cross Polarization

5.5. Cabling and I/O Ports

Port Type	Max Cable Length	# Of Ports	Screened	Conn Type	Data Type
Ethernet	100m	1	N	RJ-45	Packet Data
RS232	100m	1	N	RJ-45	Digital

This test report may be reproduced in full only. The document may only be updated by MiCOM Labs personnel. All changes will be noted in the Document History section of the report.



5.6. Test Configurations

Results for the following configurations are provided in this report:

Operational Mode(s) (802.11a/b/g/n/ac)	Data Rate with Highest Power MBit/s	Channel Frequency (MHz)		
		Low	Mid	High
5725 - 5850 MHz				
802.11a	6	5,745.00	5,785.00	5,825.00
802.11n HT-20	6.5	5,745.00	5,785.00	5,825.00
802.11n HT-40	13.5	5,755.00	--	5,795.00

5.7. Equipment Modifications

The following modifications were required to bring the equipment into compliance:

1. NONE

5.8. Deviations from the Test Standard

The following deviations from the test standard were required in order to complete the test program:

1. NONE



Title: Digi International AR6203
To: FCC CFR 47 Part 15 Subpart E 15.407
Serial #: DIGI60-U6 Rev A
Issue Date: 27th May 2016
Page: 17 of 141

6. TEST SUMMARY

List of Measurements

Test Header	Result	Data Link
(a) Peak Transmit Power	Complies	View Data
(a) 26 dB & 99% Bandwidth	Complies	View Data
(a)(5) Power Spectral Density	Complies	View Data
(b)(2) Radiated		
i).. Restricted Band Emissions		
Antenna Factor ANT-DB1-xxx	Complies	View Data
Digi International 3100016-01	Complies	View Data
Taoglas FXP.830	Complies	View Data
Taoglas PC.11	Complies	View Data
ii).. Restricted Band-Edge Emissions		
Antenna Factor ANT-DB1-xxx	Complies	View Data
Digi International 3100016-01	Complies	View Data
Taoglas FXP.830	Complies	View Data
Taoglas PC.11	Complies	View Data

This test report may be reproduced in full only. The document may only be updated by MiCOM Labs personnel. All changes will be noted in the Document History section of the report.

7. TEST EQUIPMENT CONFIGURATION(S)

7.1. Conducted

Conducted RF Emission Test Set-up(s)

The following tests were performed using the conducted test set-up shown in the diagram below.

- 1).. Peak Transmit Power
- 2).. 26 dB & 99% Bandwidth
- 3).. Power Spectral Density

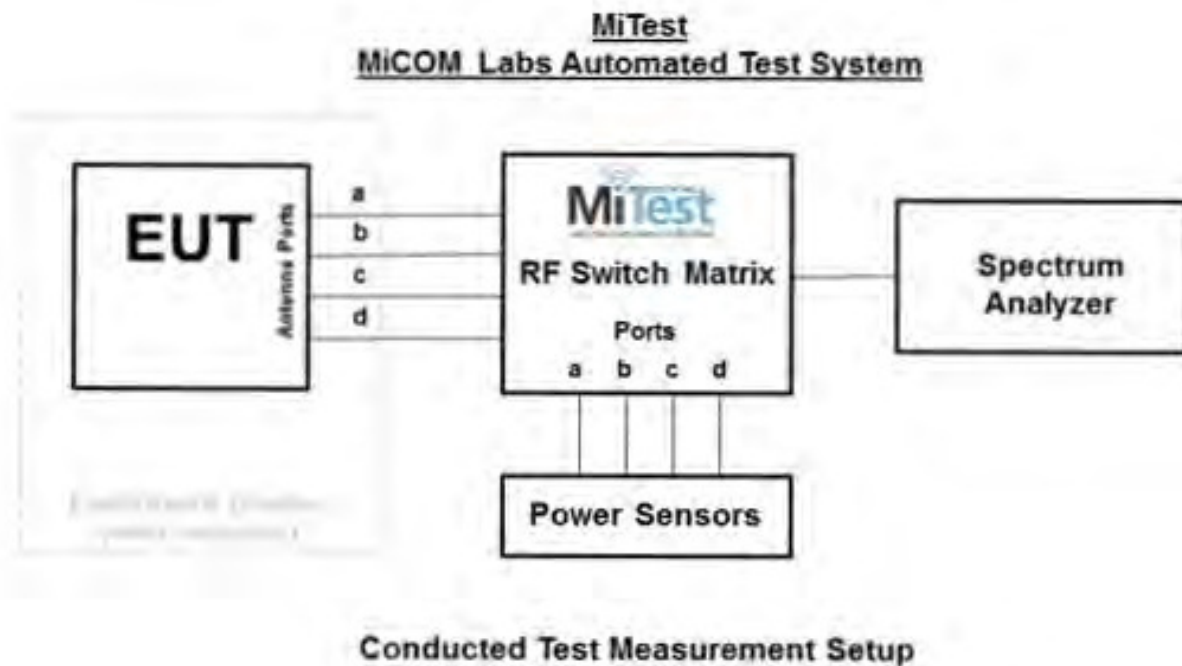

A full system calibration was performed on the test station and any resulting system losses (or gains) were taken into account in the production of all final measurement data.



Title: Digi International AR6203
To: FCC CFR 47 Part 15 Subpart E 15.407
Serial #: DIGI60-U6 Rev A
Issue Date: 27th May 2016
Page: 19 of 141

Asset#	Description	Manufacturer	Model#	Serial#	Calibration Due Date
158	Barometer/Thermometer	Control Company	4196	E2846	01 Dec 2016
249	Resistance Thermometer	Thermotronics	GR2105-02	9340 #2	23 Oct 2016
287	Rohde & Schwarz 40 GHz Receiver	Rhode & Schwarz	ESIB40	100201	27 Aug 2016
361	Desktop for RF#1, Labview Software installed	Dell	Vostro 220	WS RF#1	Not Required
378	Rohde & Schwarz 40 GHz Receiver with Generator	Rhode & Schwarz	ESIB40	100107/040	04 Aug 2016
380	4x4 RF Switch Box	MiCOM Labs	MiTest RF Switch Box	MIC001	18 Jun 2016
390	USB Power Head 50MHz - 24GHz -60 to +20dBm	Agilent	U2002A	MY50000103	17 Oct 2016
398	Test Software	MiCOM	MiTest ATS	Version 3.0.0.16	Not Required
405	DC Power Supply 0-60V	Agilent	6654A	MY4001826	Cal when used
408	USB to GPIB interface	National Instruments	GPIB-USB HS	14C0DE9	Not Required
436	USB Wideband Power Sensor	Boonton	55006	8731	31 Jul 2016
437	USB Wideband Power Sensor	Boonton	55006	8759	31 Jul 2016
445	PoE Injector	D-Link	DPE-101GL	QTAH1E2000625	Not Required
461	Spectrum Analyzer	Agilent	E4440A	MY46185537	13 Aug 2016
75	Environmental Chamber	Thermatron	SE-300-2-2	27946	24 Nov 2016
RF#1 GPIB#1	GPIB cable to Power Supply	HP	GPIB	None	Not Required
RF#1 SMA SA #452	Precision SMA Male RG-402 Spectrun Analyzer	Fairview Microwave	Precision SMA Male RG 402 coax	None	18 Jun 2016
RF#1 SMA#1	EUT to Mitest box port 1	Flexco	SMA Cable port1	None	18 Jun 2016
RF#1 SMA#2	EUT to Mitest box port 2	Flexco	SMA Cable port2	None	18 Jun 2016
RF#1 SMA#3	EUT to Mitest box port 3	Flexco	SMA Cable port3	None	18 Jun 2016
RF#1 SMA#4	EUT to Mitest box port 4	Flexco	SMA Cable port4	None	18 Jun 2016
RF#1 USB#1	USB Cable to Mitest Box	Dynex	USB Cable	None	Not Required

This test report may be reproduced in full only. The document may only be updated by MiCOM Labs personnel. All changes will be noted in the Document History section of the report.

7.2. Radiated Emissions - 3m Chamber

The following tests were performed using the radiated test set-up shown in the diagram below.

Radiated Emissions below 1GHz.

Radiated Emissions above 1GHz

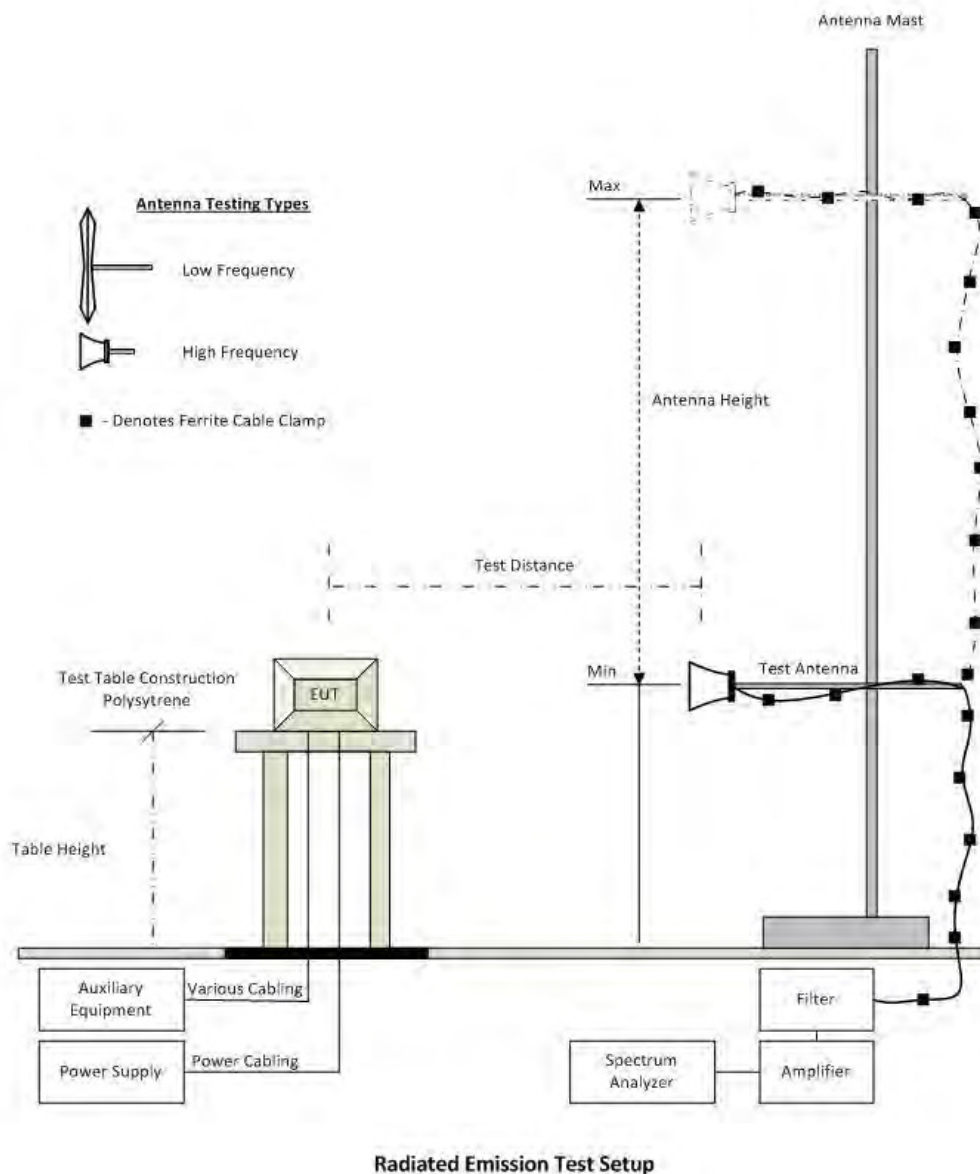

A full system calibration was performed on the test station and any resulting system losses (or gains) were taken into account in the production of all final measurement data.

This test report may be reproduced in full only. The document may only be updated by MiCOM Labs personnel. All changes will be noted in the Document History section of the report.



Title: Digi International AR6203
To: FCC CFR 47 Part 15 Subpart E 15.407
Serial #: DIGI60-U6 Rev A
Issue Date: 27th May 2016
Page: 21 of 141

Asset#	Description	Manufacturer	Model#	Serial#	Calibration Due Date
158	Barometer/Thermometer	Control Company	4196	E2846	01 Dec 2016
170	Video System Controller for Semi Anechoic Chamber	Panasonic	WV-CY101	04R08507	Not Required
303	5725 to 5875 MHz Notch filter	Microtronics	BRC50705	003	18 Aug 2016
338	Sunol 30 to 3000 MHz Antenna	Sunol	JB3	A052907	15 Aug 2016
378	Rohde & Schwarz 40 GHz Receiver with Generator	Rhode & Schwarz	ESIB40	100107/040	04 Aug 2016
397	Amp 10 - 2500MHz	MiCOM Labs	Amp 10 - 2500 MHz	NA	24 Jun 2016
399	ETS 1-18 GHz Horn Antenna	ETS	3117	00154575	10 Oct 2016
406	Amplifier for Radiated Emissions	MiCOM Labs	40dB 1 to 18GHz Amp	0406	28 May 2016
410	Desktop Computer	Dell	Inspiron 620	WS38	Not Required
411	Mast/Turntable Controller	Sunol Sciences	SC98V	060199-1D	Not Required
412	USB to GPIB Interface	National Instruments	GPIB-USB HS	11B8DC2	Not Required
413	Mast Controller	Sunol Science	TWR95-4	030801-3	Not Required
415	Turntable Controller	Sunol Sciences	Turntable Controller	None	Not Required
447	Rad Emissions Test Software	MiCOM	Version 1.0.73	447	Not Required
462	Schwarzbeck cable from Antenna to Amplifier.	Schwarzbeck	AK 9513	462	25 Jun 2016
463	Schwarzbeck cable from Amplifier to Bulkhead.	Schwarzbeck	AK 9513	463	25 Jun 2016
464	Schwarzbeck cable from Bulkhead to Receiver	Schwarzbeck	AK 9513	464	25 Jun 2016
480	Cable - Bulkhead to Amp	SRC Haverhill	157-157-3050360	480	11 Aug 2016
481	Cable - Bulkhead to Receiver	SRC Haverhill	151-151-3050787	481	11 Aug 2016
482	Cable - Amp to Antenna	SRC Haverhill	157-157-3051574	482	11 Aug 2016

This test report may be reproduced in full only. The document may only be updated by MiCOM Labs personnel. All changes will be noted in the Document History section of the report.

8. MEASUREMENT AND PRESENTATION OF TEST DATA

The measurement and graphical data presented in this test report was generated automatically using state-of-the-art technology creating an easy to read report structure. Numerical measurement data is separated from supporting graphical data (plots) through hyperlinks. Numerical measurement data can be reviewed without scrolling through numerous graphical pages to arrive at the next data matrix.

Plots have been relegated into the Appendix 'Graphical Data'.

Test and report automation was performed by [MiTest](#). [MiTest](#) is an automated test system developed by MiCOM Labs. [MiTest](#) is the first cloud based modular test system enabling end-to-end automation of regulatory compliance testing for conducted RF testing.



The MiCOM Labs "[MiTest](#)" Automated Test System" (Patent Pending)

This test report may be reproduced in full only. The document may only be updated by MiCOM Labs personnel. All changes will be noted in the Document History section of the report.



9. TEST RESULTS

9.1. Peak Transmit Power

Conducted Test Conditions for Maximum Conducted Output Power			
Standard:	FCC CFR 47:15.407	Ambient Temp. (°C):	24.0 - 27.5
Test Heading:	Maximum Conducted Output Power	Rel. Humidity (%):	32 - 45
Standard Section(s):	15.407 (a)	Pressure (mBars):	999 - 1001
Reference Document(s):	See Normative References		

Test Procedure for Maximum Conducted Output Power Measurement

Method PM (Measurement using an RF average power meter). KDB 789033 defines a methodology using an average wideband power meter. Measurements were made while the EUT was operating in a continuous transmission mode (100% duty cycle) at the appropriate center frequency. All operational modes and frequency bands were measured independently and the resultant calculated. Where the device operated with multiple antenna ports i.e. MIMO device, each port was measured and reported separately. A summation (Σ) of each antenna port output power is provided which includes any offset due to Duty Cycle Correction Factor (DCCF). Testing was performed under ambient conditions at nominal voltage.

Test configuration and setup used for the measurement was per the Conducted Test Set-up section specified in this document.

Supporting Information

Calculated Power = $A + G + Y + 10 \log(1/x)$ dBm

A = Total Power [$10 * \log_{10}(10^{a/10} + 10^{b/10} + 10^{c/10} + 10^{d/10})$]

G = Antenna Gain

Y = Beamforming Gain

x = Duty Cycle (average power measurements only)

Limits Maximum Conducted Output Power

Operating Frequency Band 5150-5250 MHz

15.407 (a)(1)

(i) For an outdoor access point operating in the band 5.15-5.25 GHz, the maximum conducted output power over the frequency band of operation shall not exceed 1 W provided the maximum antenna gain does not exceed 6 dBi. In addition, the maximum power spectral density shall not exceed 17 dBm in any 1 megahertz band. If transmitting antennas of directional gain greater than 6 dBi are used, both the maximum conducted output power and the maximum power spectral density shall be reduced by the amount in dB that the directional gain of the antenna exceeds 6 dBi. The maximum e.i.r.p. at any elevation angle above 30 degrees as measured from the horizon must not exceed 125 mW (21 dBm).

(ii) For an indoor access point operating in the band 5.15-5.25 GHz, the maximum conducted output power over the frequency band of operation shall not exceed 1 W provided the maximum antenna gain does not exceed 6 dBi. In addition, the maximum power spectral density shall not exceed 17 dBm in any 1 megahertz band. If transmitting antennas of directional gain greater than 6 dBi are used, both the maximum conducted output power and the maximum power spectral density shall be reduced by the amount in dB that the directional gain of the antenna exceeds 6 dBi.

(iii) For fixed point-to-point access points operating in the band 5.15-5.25 GHz, the maximum conducted output power over the frequency band of operation shall not exceed 1 W. In addition, the maximum power spectral density shall not exceed 17 dBm in any 1 megahertz band. Fixed point-to-point U-NII devices may employ antennas with directional gain up to 23 dBi without any corresponding reduction in the maximum conducted output power or maximum power spectral density. For fixed point-to-point transmitters that employ a directional antenna gain greater than 23 dBi, a 1 dB reduction in maximum conducted output power and maximum power spectral density is required for each 1 dB of antenna gain in excess of 23 dBi. Fixed, point-to-point operations exclude the use of point-to-multipoint systems, omnidirectional applications, and multiple collocated transmitters transmitting the same information. The operator of the U-NII device, or if the equipment is professionally installed, the installer, is responsible for ensuring that systems employing high gain directional antennas are used exclusively for fixed, point-to-point operations.

(iv) For mobile and portable client devices in the 5.15-5.25 GHz band, the maximum conducted output power over the frequency band

This test report may be reproduced in full only. The document may only be updated by MiCOM Labs personnel. All changes will be noted in the Document History section of the report.



Title: Digi International AR6203
To: FCC CFR 47 Part 15 Subpart E 15.407
Serial #: DIGI60-U6 Rev A
Issue Date: 27th May 2016
Page: 24 of 141

of operation shall not exceed 250 mW provided the maximum antenna gain does not exceed 6 dBi. In addition, the maximum power spectral density shall not exceed 11 dBm in any 1 megahertz band. If transmitting antennas of directional gain greater than 6 dBi are used, both the maximum conducted output power and the maximum power spectral density shall be reduced by the amount in dB that the directional gain of the antenna exceeds 6 dBi.

Operating Frequency Band 5250-5350 and 5470 – 5725 MHz

15. 407 (a)(2)

For the 5.25-5.35 GHz and 5.47-5.725 GHz bands, the maximum conducted output power over the frequency bands of operation shall not exceed the lesser of 250 mW or 11 dBm + 10 log B, where B is the 26 dB emission bandwidth in megahertz. In addition, the maximum power spectral density shall not exceed 11 dBm in any 1 megahertz band. If transmitting antennas of directional gain greater than 6 dBi are used, both the maximum conducted output power and the maximum power spectral density shall be reduced by the amount in dB that the directional gain of the antenna exceeds 6 dBi.

Operating Frequency Band 5725 – 5850 MHz

15. 407 (a)(3)

For the band 5.725-5.85 GHz, the maximum conducted output power over the frequency band of operation shall not exceed 1 W. In addition, the maximum power spectral density shall not exceed 30 dBm in any 500-kHz band. If transmitting antennas of directional gain greater than 6 dBi are used, both the maximum conducted output power and the maximum power spectral density shall be reduced by the amount in dB that the directional gain of the antenna exceeds 6 dBi. However, fixed point-to-point U-NII devices operating in this band may employ transmitting antennas with directional gain greater than 6 dBi without any corresponding reduction in transmitter conducted power. Fixed, point-to-point operations exclude the use of point-to-multipoint systems, omnidirectional applications, and multiple collocated transmitters transmitting the same information. The operator of the U-NII device, or if the equipment is professionally installed, the installer, is responsible for ensuring that systems employing high gain directional antennas are used exclusively for fixed, point-to-point operations.

This test report may be reproduced in full only. The document may only be updated by MiCOM Labs personnel. All changes will be noted in the Document History section of the report.



Title: Digi International AR6203
To: FCC CFR 47 Part 15 Subpart E 15.407
Serial #: DIGI60-U6 Rev A
Issue Date: 27th May 2016
Page: 25 of 141

Equipment Configuration for Peak Transmit Power

Variant:	802.11a	Duty Cycle (%):	99.0
Data Rate:	6.00 MBit/s	Antenna Gain (dBi):	2.00
Modulation:	OFDM	Beam Forming Gain (Y)(dB):	Not Applicable
TPC:	Not Applicable	Tested By:	SB
Engineering Test Notes:			

Test Measurement Results

Test Frequency	Measured Conducted Output Power + DCCF (+0.04 dB) (dBm)				Calculated Total Power	Minimum 26 dB Bandwidth	Limit	Margin	EUT Power Setting
	Port(s)								
MHz	a	b	c	d	Σ Port(s) dBm	MHz	dBm	dB	
5745.0	10.22	--	--	--	10.22	--	30.00	-19.78	11.50
5785.0	17.37	--	--	--	17.37	--	30.00	-12.63	20.00
5825.0	9.76	--	--	--	9.76	--	30.00	-20.24	10.00

Traceability to Industry Recognized Test Methodologies

Work Instruction:	WI-01 MEASURING RF OUTPUT POWER
Measurement Uncertainty:	±1.33 dB

DCCF - Duty Cycle Correction Factor

Note: Power restricted by Spurious Emission and Band-Edge (please see section 9.4.1 and 9.4.2)

This test report may be reproduced in full only. The document may only be updated by MiCOM Labs personnel. All changes will be noted in the Document History section of the report.



Title: Digi International AR6203
To: FCC CFR 47 Part 15 Subpart E 15.407
Serial #: DIGI60-U6 Rev A
Issue Date: 27th May 2016
Page: 26 of 141

Equipment Configuration for Peak Transmit Power

Variant:	802.11n HT-20	Duty Cycle (%):	99.0
Data Rate:	6.50 MBit/s	Antenna Gain (dBi):	2.00
Modulation:	OFDM	Beam Forming Gain (Y)(dB):	Not Applicable
TPC:	Not Applicable	Tested By:	SB
Engineering Test Notes:			

Test Measurement Results									
Test Frequency	Measured Conducted Output Power + DCCF (+0.04 dB) (dBm)				Calculated Total Power	Minimum 26 dB Bandwidth	Limit	Margin	EUT Power Setting
	Port(s)								
MHz	a	b	c	d	Σ Port(s) dBm	MHz	dBm	dB	
5745.0	10.28	--	--	--	10.28	--	30.00	-19.72	11.50
5785.0	17.36	--	--	--	17.36	--	30.00	-12.64	20.00
5825.0	9.12	--	--	--	9.12	--	30.00	-20.88	10.00

Traceability to Industry Recognized Test Methodologies	
Work Instruction:	WI-01 MEASURING RF OUTPUT POWER
Measurement Uncertainty:	±1.33 dB

DCCF - Duty Cycle Correction Factor

Note: Power restricted by Spurious Emission and Band-Edge (please see section 9.4.1 and 9.4.2)

This test report may be reproduced in full only. The document may only be updated by MiCOM Labs personnel. All changes will be noted in the Document History section of the report.



Title: Digi International AR6203
To: FCC CFR 47 Part 15 Subpart E 15.407
Serial #: DIGI60-U6 Rev A
Issue Date: 27th May 2016
Page: 27 of 141

Equipment Configuration for Peak Transmit Power

Variant:	802.11n HT-40	Duty Cycle (%):	99.0
Data Rate:	13.50 MBit/s	Antenna Gain (dBi):	2.00
Modulation:	OFDM	Beam Forming Gain (Y)(dB):	Not Applicable
TPC:	Not Applicable	Tested By:	SB
Engineering Test Notes:			

Test Measurement Results

Test Frequency	Measured Conducted Output Power + DCCF (+0.04 dB) (dBm)				Calculated Total Power	Minimum 26 dB Bandwidth	Limit	Margin	EUT Power Setting
	Port(s)								
MHz	a	b	c	d	Σ Port(s) dBm	MHz	dBm	dB	
5755.0	10.24	--	--	--	10.24	--	30.00	-19.76	11.50
5795.0	10.27	--	--	--	10.27	--	30.00	-19.73	10.00

Traceability to Industry Recognized Test Methodologies

Work Instruction:	WI-01 MEASURING RF OUTPUT POWER
Measurement Uncertainty:	1.33 dB

DCCF - Duty Cycle Correction Factor

Note: Power restricted by Spurious Emission and Band-Edge (please see section 9.4.1 and 9.4.2)

This test report may be reproduced in full only. The document may only be updated by MiCOM Labs personnel. All changes will be noted in the Document History section of the report.



Title: Digi International AR6203
To: FCC CFR 47 Part 15 Subpart E 15.407
Serial #: DIGI60-U6 Rev A
Issue Date: 27th May 2016
Page: 28 of 141

9.2. 26 dB & 99% Bandwidth

Conducted Test Conditions for 26 dB and 99% Bandwidth			
Standard:	FCC CFR 47:15.407	Ambient Temp. (°C):	24.0 - 27.5
Test Heading:	26 dB and 99 % Bandwidth	Rel. Humidity (%):	32 - 45
Standard Section(s):	15.407 (a)	Pressure (mBars):	999 - 1001
Reference Document(s):	See Normative References		
Test Procedure for 26 dB and 99% Bandwidth Measurement The bandwidth at 26 dB and 99 % is measured with a spectrum analyzer connected to the antenna terminal, while EUT is operating in transmission mode at the appropriate center frequency. The Resolution Bandwidth was set to approximately 1% of the emission bandwidth. Testing was performed under ambient conditions at nominal voltage. Where the device operated with multiple antenna ports i.e. MIMO device, each port was measured and reported. Test configuration and setup used for the measurement was per the Conducted Test Set-up section specified in this document.			

This test report may be reproduced in full only. The document may only be updated by MiCOM Labs personnel. All changes will be noted in the Document History section of the report.



Title: Digi International AR6203
To: FCC CFR 47 Part 15 Subpart E 15.407
Serial #: DIGI60-U6 Rev A
Issue Date: 27th May 2016
Page: 29 of 141

Equipment Configuration for 26 dB & 99% Occupied Bandwidth

Variant:	802.11a	Duty Cycle (%):	99.0
Data Rate:	6.00 MBit/s	Antenna Gain (dBi):	2.00
Modulation:	OFDM	Beam Forming Gain (Y)(dB):	Not Applicable
TPC:	Not Applicable	Tested By:	SB
Engineering Test Notes:			

Test Measurement Results

Test Frequency	Measured 26 dB Bandwidth (MHz)				26 dB Bandwidth (MHz)			
	Port(s)				Highest	Lowest		
MHz	a	b	c	d				
5745.0	34.750	--	--	--	34.750	34.750		
5785.0	35.920	--	--	--	35.920	35.920		
5825.0	38.330	--	--	--	38.330	38.330		

Test Frequency	Measured 99% Bandwidth (MHz)				99% Bandwidth (MHz)			
	Port(s)				Highest	Lowest		
MHz	a	b	c	d				
5745.0	20.202	--	--	--	20.202	20.202		
5785.0	22.343	--	--	--	22.343	22.343		
5825.0	24.749	--	--	--	24.749	24.749		

Traceability to Industry Recognized Test Methodologies

Work Instruction:	WI-03 MEASURING RF SPECTRUM MASK
Measurement Uncertainty:	2.81 dB

Note: click the links in the above matrix to view the graphical image (plot).

This test report may be reproduced in full only. The document may only be updated by MiCOM Labs personnel. All changes will be noted in the Document History section of the report.



Title: Digi International AR6203
To: FCC CFR 47 Part 15 Subpart E 15.407
Serial #: DIGI60-U6 Rev A
Issue Date: 27th May 2016
Page: 30 of 141

Equipment Configuration for 26 dB & 99% Occupied Bandwidth

Variant:	802.11n HT-20	Duty Cycle (%):	99.0
Data Rate:	6.50 MBit/s	Antenna Gain (dBi):	2.00
Modulation:	OFDM	Beam Forming Gain (Y)(dB):	Not Applicable
TPC:	Not Applicable	Tested By:	SB
Engineering Test Notes:			

Test Measurement Results

Test Frequency	Measured 26 dB Bandwidth (MHz)				26 dB Bandwidth (MHz)			
	Port(s)				Highest	Lowest		
MHz	a	b	c	d				
5745.0	39.080	--	--	--	39.080	39.080		
5785.0	40.080	--	--	--	40.080	40.080		
5825.0	41.250	--	--	--	41.250	41.250		

Test Frequency	Measured 99% Bandwidth (MHz)				99% Bandwidth (MHz)			
	Port(s)				Highest	Lowest		
MHz	a	b	c	d				
5745.0	21.974	--	--	--	21.974	21.974		
5785.0	23.779	--	--	--	23.779	23.779		
5825.0	26.502	--	--	--	26.502	26.502		

Traceability to Industry Recognized Test Methodologies

Work Instruction:	WI-03 MEASURING RF SPECTRUM MASK
Measurement Uncertainty:	2.81 dB

Note: click the links in the above matrix to view the graphical image (plot).

This test report may be reproduced in full only. The document may only be updated by MiCOM Labs personnel. All changes will be noted in the Document History section of the report.



Title: Digi International AR6203
To: FCC CFR 47 Part 15 Subpart E 15.407
Serial #: DIGI60-U6 Rev A
Issue Date: 27th May 2016
Page: 31 of 141

Equipment Configuration for 26 dB & 99% Occupied Bandwidth

Variant:	802.11n HT-40	Duty Cycle (%):	99.0
Data Rate:	13.50 MBit/s	Antenna Gain (dBi):	2.00
Modulation:	OFDM	Beam Forming Gain (Y)(dB):	Not Applicable
TPC:	Not Applicable	Tested By:	SB
Engineering Test Notes:			

Test Measurement Results

Test Frequency	Measured 26 dB Bandwidth (MHz)				26 dB Bandwidth (MHz)			
	Port(s)				Highest	Lowest		
MHz	a	b	c	d				
5755.0	81.000	--	--	--	81.000	81.000		
5795.0	80.670	--	--	--	80.670	80.670		

Test Frequency	Measured 99% Bandwidth (MHz)				99% Bandwidth (MHz)			
	Port(s)				Highest	Lowest		
MHz	a	b	c	d				
5755.0	46.559	--	--	--	46.559	46.559		
5795.0	46.173	--	--	--	46.173	46.173		

Traceability to Industry Recognized Test Methodologies

Work Instruction:	WI-03 MEASURING RF SPECTRUM MASK
Measurement Uncertainty:	2.81 dB

Note: click the links in the above matrix to view the graphical image (plot).

This test report may be reproduced in full only. The document may only be updated by MiCOM Labs personnel. All changes will be noted in the Document History section of the report.



9.3. Power Spectral Density

Conducted Test Conditions for Power Spectral Density			
Standard:	FCC CFR 47:15.407	Ambient Temp. (°C):	24.0 - 27.5
Test Heading:	Power Spectral Density	Rel. Humidity (%):	32 - 45
Standard Section(s):	15.407 (a)	Pressure (mBars):	999 - 1001
Reference Document(s):	See Normative References		

Test Procedure for Power Spectral Density

The in-band power spectral density was measured using the test technique specified in KDB 789033. A 1 MHz measurement bandwidth was implemented for the analyzer sweep. Once the sweep is complete the analyzer trace data is downloaded and used for post processing purposes.

Where the device operated with multiple antenna ports i.e. MIMO device, each port was measured separately. The Peak Power Spectral Density is the highest level found across the emission bandwidth. With multiple antenna port measurements the numerical analyzer data from each port is summed (∑) and a link to this additional graphic is provided.

Test configuration and setup used for the measurement was per the Conducted Test Set-up section specified in this document.

Measure and sum the spectra across the outputs. With this technique, spectra are measured at each output of the device at the required resolution bandwidth. The individual spectra are then summed mathematically in linear power units. Unlike in-band power measurements, in which the sum involves a single measured value (output power) from each output, measurements for compliance with PSD limits involve summing entire spectra across corresponding frequency bins on the various outputs. Consistency is maintained for any device with multiple transmitter outputs to be certain the individual outputs are all aligned with the same span and same number of points. In this instance, the linear power spectrum value within the first spectral bin of output 0 is summed with that in the first spectral bin of output 1, and the first spectral bin of output 2, and so on up to the Nth output to obtain the true value for the first frequency bin of the summed spectrum. The summed spectrum value for each frequency bin is computed in this fashion. These summed spectral values were post processed and the resulting numerical and graphical data presented.

NOTE: It may be observed that spectrum in some plots break the limit line however this in itself does NOT constitute a failure. In all cases a spectrum summation plot is provided in order to prove compliance. A failure occurs only after the summation of all spectrum plots have been summed and are found to be greater than the limit line.

Supporting Information

Calculated Power = $A + 10 \log(1/x)$ dBm

A = Total Power Spectral Density [$10 \cdot \log_{10}(10^{a/10} + 10^{b/10} + 10^{c/10} + 10^{d/10})$]

x = Duty Cycle

Limits Power Spectral Density

Operating Frequency Band 5150-5250 MHz

15.407 (a)(1)

(i) For an outdoor access point operating in the band 5.15-5.25 GHz, the maximum conducted output power over the frequency band of operation shall not exceed 1 W provided the maximum antenna gain does not exceed 6 dBi. In addition, the maximum power spectral density shall not exceed 17 dBm in any 1 megahertz band. If transmitting antennas of directional gain greater than 6 dBi are used, both the maximum conducted output power and the maximum power spectral density shall be reduced by the amount in dB that the directional gain of the antenna exceeds 6 dBi. The maximum e.i.r.p. at any elevation angle above 30 degrees as measured from the horizon must not exceed 125 mW (21 dBm).

(ii) For an indoor access point operating in the band 5.15-5.25 GHz, the maximum conducted output power over the frequency band of operation shall not exceed 1 W provided the maximum antenna gain does not exceed 6 dBi. In addition, the maximum power spectral density shall not exceed 17 dBm in any 1 megahertz band. If transmitting antennas of directional gain greater than 6 dBi are used, both the maximum conducted output power and the maximum power spectral density shall be reduced by the amount in dB that the directional gain of the antenna exceeds 6 dBi.

(iii) For fixed point-to-point access points operating in the band 5.15-5.25 GHz, the maximum conducted output power over the



Title: Digi International AR6203
To: FCC CFR 47 Part 15 Subpart E 15.407
Serial #: DIGI60-U6 Rev A
Issue Date: 27th May 2016
Page: 33 of 141

frequency band of operation shall not exceed 1 W. In addition, the maximum power spectral density shall not exceed 17 dBm in any 1 megahertz band. Fixed point-to-point U-NII devices may employ antennas with directional gain up to 23 dBi without any corresponding reduction in the maximum conducted output power or maximum power spectral density. For fixed point-to-point transmitters that employ a directional antenna gain greater than 23 dBi, a 1 dB reduction in maximum conducted output power and maximum power spectral density is required for each 1 dB of antenna gain in excess of 23 dBi. Fixed, point-to-point operations exclude the use of point-to-multipoint systems, omnidirectional applications, and multiple collocated transmitters transmitting the same information. The operator of the U-NII device, or if the equipment is professionally installed, the installer, is responsible for ensuring that systems employing high gain directional antennas are used exclusively for fixed, point-to-point operations.

(iv) For mobile and portable client devices in the 5.15-5.25 GHz band, the maximum conducted output power over the frequency band of operation shall not exceed 250 mW provided the maximum antenna gain does not exceed 6 dBi. In addition, the maximum power spectral density shall not exceed 11 dBm in any 1 megahertz band. If transmitting antennas of directional gain greater than 6 dBi are used, both the maximum conducted output power and the maximum power spectral density shall be reduced by the amount in dB that the directional gain of the antenna exceeds 6 dBi.

Operating Frequency Band 5250-5350 and 5470 – 5725 MHz

15. 407 (a)(2)

For the 5.25-5.35 GHz and 5.47-5.725 GHz bands, the maximum conducted output power over the frequency bands of operation shall not exceed the lesser of 250 mW or 11 dBm + 10 log B, where B is the 26 dB emission bandwidth in megahertz. In addition, the maximum power spectral density shall not exceed 11 dBm in any 1 megahertz band. If transmitting antennas of directional gain greater than 6 dBi are used, both the maximum conducted output power and the maximum power spectral density shall be reduced by the amount in dB that the directional gain of the antenna exceeds 6 dBi.

Operating Frequency Band 5725 – 5850 MHz

15. 407 (a)(3)

For the band 5.725-5.85 GHz, the maximum conducted output power over the frequency band of operation shall not exceed 1 W. In addition, the maximum power spectral density shall not exceed 30 dBm in any 500-kHz band. If transmitting antennas of directional gain greater than 6 dBi are used, both the maximum conducted output power and the maximum power spectral density shall be reduced by the amount in dB that the directional gain of the antenna exceeds 6 dBi. However, fixed point-to-point U-NII devices operating in this band may employ transmitting antennas with directional gain greater than 6 dBi without any corresponding reduction in transmitter conducted power. Fixed, point-to-point operations exclude the use of point-to-multipoint systems, omnidirectional applications, and multiple collocated transmitters transmitting the same information. The operator of the U-NII device, or if the equipment is professionally installed, the installer, is responsible for ensuring that systems employing high gain directional antennas are used exclusively for fixed, point-to-point operations.

This test report may be reproduced in full only. The document may only be updated by MiCOM Labs personnel. All changes will be noted in the Document History section of the report.



Title: Digi International AR6203
To: FCC CFR 47 Part 15 Subpart E 15.407
Serial #: DIGI60-U6 Rev A
Issue Date: 27th May 2016
Page: 34 of 141

Equipment Configuration for Power Spectral Density

Variant:	802.11a	Duty Cycle (%):	99.0
Data Rate:	6.00 MBit/s	Antenna Gain (dBi):	2.00
Modulation:	OFDM	Beam Forming Gain (Y)(dB):	Not Applicable
TPC:	Not Applicable	Tested By:	SB
Engineering Test Notes:			

Test Measurement Results

Test Frequency	Measured Power Spectral Density				Summation Peak Marker + DCCF (+0.04 dB)	Limit	Margin
	Port(s) (dBm/500 KHz)						
MHz	a	b	c	d	dBm/500 KHz	dBm/500 KHz	dB
5745.0	-3.027	--	--	--	-2.983	30.0	-33.0
5785.0	3.865	--	--	--	3.909	30.0	-26.1
5825.0	-3.567	--	--	--	-3.523	30.0	-33.5

Traceability to Industry Recognized Test Methodologies

Work Instruction:	WI-03 MEASURING RF SPECTRUM MASK
Measurement Uncertainty:	±2.81 dB

DCCF - Duty Cycle Correction Factor

Note: click the links in the above matrix to view the graphical image (plot).

This test report may be reproduced in full only. The document may only be updated by MiCOM Labs personnel. All changes will be noted in the Document History section of the report.



Title: Digi International AR6203
To: FCC CFR 47 Part 15 Subpart E 15.407
Serial #: DIGI60-U6 Rev A
Issue Date: 27th May 2016
Page: 35 of 141

Equipment Configuration for Power Spectral Density

Variant:	802.11n HT-20	Duty Cycle (%):	99.0
Data Rate:	6.50 MBit/s	Antenna Gain (dBi):	2.00
Modulation:	OFDM	Beam Forming Gain (Y)(dB):	Not Applicable
TPC:	Not Applicable	Tested By:	SB
Engineering Test Notes:			

Test Measurement Results

Test Frequency	Measured Power Spectral Density				Summation Peak Marker + DCCF (+0.04 dB)	Limit	Margin
	Port(s) (dBm/500 KHz)						
MHz	a	b	c	d	dBm/500 KHz	dBm/500 KHz	dB
5745.0	-2.995	--	--	--	-2.951	30.0	-33.0
5785.0	3.740	--	--	--	3.784	30.0	-26.2
5825.0	-4.199	--	--	--	-4.155	30.0	-34.2

Traceability to Industry Recognized Test Methodologies

Work Instruction:	WI-03 MEASURING RF SPECTRUM MASK
Measurement Uncertainty:	±2.81 dB

DCCF - Duty Cycle Correction Factor

Note: click the links in the above matrix to view the graphical image (plot).

This test report may be reproduced in full only. The document may only be updated by MiCOM Labs personnel. All changes will be noted in the Document History section of the report.



Title: Digi International AR6203
To: FCC CFR 47 Part 15 Subpart E 15.407
Serial #: DIGI60-U6 Rev A
Issue Date: 27th May 2016
Page: 36 of 141

Equipment Configuration for Power Spectral Density

Variant:	802.11n HT-40	Duty Cycle (%):	99.0
Data Rate:	13.50 MBit/s	Antenna Gain (dBi):	2.00
Modulation:	OFDM	Beam Forming Gain (Y)(dB):	Not Applicable
TPC:	Not Applicable	Tested By:	SB
Engineering Test Notes:			

Test Measurement Results

Test Frequency	Measured Power Spectral Density				Summation Peak Marker + DCCF (+0.04 dB)	Limit	Margin
	Port(s) (dBm/500 KHz)						
MHz	a	b	c	d	dBm/500 KHz	dBm/500 KHz	dB
5755.0	-5.161	--	--	--	-5.117	30.0	-35.1
5795.0	-6.343	--	--	--	-6.299	30.0	-36.3

Traceability to Industry Recognized Test Methodologies

Work Instruction:	WI-03 MEASURING RF SPECTRUM MASK
Measurement Uncertainty:	2.81 dB

DCCF - Duty Cycle Correction Factor

Note: click the links in the above matrix to view the graphical image (plot).

This test report may be reproduced in full only. The document may only be updated by MiCOM Labs personnel. All changes will be noted in the Document History section of the report.



9.4. Radiated

Radiated Test Conditions for Radiated Spurious and Band-Edge Emissions			
Standard:	FCC CFR 47:15.407	Ambient Temp. (°C):	20.0 - 24.5
Test Heading:	Radiated Spurious and Band-Edge Emissions	Rel. Humidity (%):	32 - 45
Standard Section(s):	15.407 (b), 15.205, 15.209	Pressure (mBars):	999 - 1001
Reference Document(s):	See Normative References		

Test Procedure for Radiated Spurious and Band-Edge Emissions

Radiated emissions for restricted bands above 1 GHz are measured in the anechoic chamber at a 3-meter distance on every azimuth in both horizontal and vertical polarities. The emissions are recorded and maximized as a function of azimuth by rotation through 360° with a spectrum analyzer in peak hold mode. Depending on the frequency band spanned a notch filter and waveguide filter was used to remove the fundamental frequency. The highest emissions relative to the limit are listed for each frequency spanned. Measurements on any restricted band frequency or frequencies above 1 GHz are based on the use of measurement instrumentation employing peak and average detectors. All measurements were performed using a resolution bandwidth of 1 MHz.

Test configuration and setup for Undesirable Measurement were per the Radiated Test Set-up specified in this document.

15.407 (b) Undesirable emission limits. Except as shown in paragraph (b)(7) of this section, the maximum emissions outside of the frequency bands of operation shall be attenuated in accordance with the following limits:

- (1) For transmitters operating in the 5.15-5.25 GHz band: All emissions outside of the 5.15-5.35 GHz band shall not exceed an e.i.r.p. of -27 dBm/MHz.
- (2) For transmitters operating in the 5.25-5.35 GHz band: All emissions outside of the 5.15-5.35 GHz band shall not exceed an e.i.r.p. of -27 dBm/MHz.
- (3) For transmitters operating in the 5.47-5.725 GHz band: All emissions outside of the 5.47-5.725 GHz band shall not exceed an e.i.r.p. of -27 dBm/MHz.
- (4) For transmitters operating in the 5.725-5.85 GHz band: All emissions within the frequency range from the band edge to 10 MHz above or below the band edge shall not exceed an e.i.r.p. of -17 dBm/MHz; for frequencies 10 MHz or greater above or below the band edge, emissions shall not exceed an e.i.r.p. of -27 dBm/MHz.
- (5) The emission measurements shall be performed using a minimum resolution bandwidth of 1 MHz. A lower resolution bandwidth may be employed near the band edge, when necessary, provided the measured energy is integrated to show the total power over 1 MHz.
- (6) Unwanted emissions below 1 GHz must comply with the general field strength limits set forth in §15.209. Further, any U-NII devices using an AC power line are required to comply also with the conducted limits set forth in §15.207.
- (7) The provisions of §15.205 apply to intentional radiators operating under this section.
- (8) When measuring the emission limits, the nominal carrier frequency shall be adjusted as close to the upper and lower frequency band edges as the design of the equipment permits.

Limits for Restricted Bands (15.205, 15.209)

Peak emission: 74 dBuV/m

Average emission: 54 dBuV/m

Field Strength Calculation

The field strength is calculated by adding the Antenna Factor and Cable Loss, and subtracting Amplifier Gain from the measured reading. All factors are included in the reported data.

$$FS = R + AF + CORR - FO$$

where:

This test report may be reproduced in full only. The document may only be updated by MiCOM Labs personnel. All changes will be noted in the Document History section of the report.



FS = Field Strength
R = Measured Spectrum analyzer Input Amplitude
AF = Antenna Factor
CORR = Correction Factor = CL – AG + NFL
CL = Cable Loss
AG = Amplifier Gain
FO = Distance Falloff Factor
NFL = Notch Filter Loss or Waveguide Loss

Example:

The following formula is used to convert the equipment isotropic radiated power (eirp) to field strength (dBµV/m);

$$E = 1000000 \times \sqrt{30P} / 3 \mu\text{V/m}$$

where P is the EIRP in Watts

Therefore: -27 dBm/MHz equates to 68.23 dBuV/m
Conversion between dBmV/m (or dBmV) and mV/m (or mV) are as follows:
Level (dBmV/m) = 20 * Log (level (mV/m))

40 dBmV/m = 100 mV/m
48 dBmV/m = 250 mV/m

Restricted Bands of Operation (15.205)

(a) Except as shown in paragraph (d) of this section, only spurious emissions are permitted in any of the frequency bands listed below:

Frequency Band			
MHz	MHz	MHz	GHz
0.090-0.110	16.42-16.423	399.9-410	4.5-5.15
0.495-0.505	16.69475-16.69525	608-614	5.35-5.46
2.1735-2.1905	16.80425-16.80475	960-1240	7.25-7.75
4.125-4.128	25.5-25.67	1300-1427	8.025-8.5
4.17725-4.17775	37.5-38.25	1435-1626.5	9.0-9.2
4.20725-4.20775	73-74.6	1645.5-1646.5	9.3-9.5
6.215-6.218	74.8-75.2	1660-1710	10.6-12.7
6.26775-6.26825	108-121.94	1718.8-1722.2	13.25-13.4
6.31175-6.31225	123-138	2200-2300	14.47-14.5
8.291-8.294	149.9-150.05	2310-2390	15.35-16.2
8.362-8.366	156.52475-156.52525	2483.5-2500	17.7-21.4
8.37625-8.38675	156.7-156.9	2690-2900	22.01-23.12
8.41425-8.41475	162.0125-167.17	3260-3267	23.6-24.0
12.29-12.293	167.72-173.2	3332-3339	31.2-31.8
12.51975-12.52025	240-285	3345.8-3358	36.43-36.5
12.57675-12.57725	322-335.4	3600-4400	Above 38.6
13.36-13.41			

This test report may be reproduced in full only. The document may only be updated by MiCOM Labs personnel. All changes will be noted in the Document History section of the report.



Title: Digi International AR6203
To: FCC CFR 47 Part 15 Subpart E 15.407
Serial #: DIGI60-U6 Rev A
Issue Date: 27th May 2016
Page: 39 of 141

(b) Except as provided in paragraphs (d) and (e) of this section, the field strength of emissions appearing within these frequency bands shall not exceed the limits shown in §15.209. At frequencies equal to or less than 1000 MHz, compliance with the limits in §15.209 shall be demonstrated using measurement instrumentation employing a CISPR quasi-peak detector. Above 1000 MHz, compliance with the emission limits in §15.209 shall be demonstrated based on the average value of the measured emissions. The provisions in §15.35 apply to these measurements.

(c) Except as provided in paragraphs (d) and (e) of this section, regardless of the field strength limits specified elsewhere in this subpart, the provisions of this section apply to emissions from any intentional radiator.

(d) The following devices are exempt from the requirements of this section:

- (1) Swept frequency field disturbance sensors operating between 1.705 and 37 MHz provided their emissions only sweep through the bands listed in paragraph (a) of this section, the sweep is never stopped with the fundamental emission within the bands listed in paragraph (a) of this section, and the fundamental emission is outside of the bands listed in paragraph (a) of this section more than 99% of the time the device is actively transmitting, without compensation for duty cycle.
- (2) Transmitters used to detect buried electronic markers at 101.4 kHz which are employed by telephone companies.
- (3) Cable locating equipment operated pursuant to §15.213.
- (4) Any equipment operated under the provisions of §15.253, 15.255, and 15.256 in the frequency band 75-85 GHz, or §15.257 of this part.
- (5) Biomedical telemetry devices operating under the provisions of §15.242 of this part are not subject to the restricted band 608-614 MHz but are subject to compliance within the other restricted bands.
- (6) Transmitters operating under the provisions of subparts D or F of this part.
- (7) Devices operated pursuant to §15.225 are exempt from complying with this section for the 13.36-13.41 MHz band only.
- (8) Devices operated in the 24.075-24.175 GHz band under §15.245 are exempt from complying with the requirements of this section for the 48.15-48.35 GHz and 72.225-72.525 GHz bands only, and shall not exceed the limits specified in §15.245(b).
- (9) Devices operated in the 24.0-24.25 GHz band under §15.249 are exempt from complying with the requirements of this section for the 48.0-48.5 GHz and 72.0-72.75 GHz bands only, and shall not exceed the limits specified in §15.249(a).

(e) Harmonic emissions appearing in the restricted bands above 17.7 GHz from field disturbance sensors operating under the provisions of §15.245 shall not exceed the limits specified in §15.245(b).

This test report may be reproduced in full only. The document may only be updated by MiCOM Labs personnel. All changes will be noted in the Document History section of the report.



Title: Digi International AR6203
To: FCC CFR 47 Part 15 Subpart E 15.407
Serial #: DIGI60-U6 Rev A
Issue Date: 27th May 2016
Page: 40 of 141

9.4.1. Restricted Band Emissions

9.4.1.1. Antenna Factor ANT-DB1-xxx

Equipment Configuration for Radiated Spurious - Restricted Band Emissions

Antenna:	Antenna Factor ANT-DB1-xxx	Variant:	802.11a
Antenna Gain (dBi):	4.30	Modulation:	OFDM
Beam Forming Gain (Y):	Not Applicable	Duty Cycle (%):	99
Channel Frequency (MHz):	5745.00	Data Rate:	6.00 MBit/s
Power Setting:	13.5	Tested By:	JMH

Test Measurement Results

Num	Frequency MHz	Raw dBµV	Cable Loss	AF dB	Level dBµV/m	Measurement Type	Pol	Hgt cm	Azt Deg	Limit dBµV/m	Margin dB	Pass /Fail
#1	5737.60	52.70	3.82	-10.67	45.85	Fundamental	Vertical	101	91	--	--	
#2	11490.87	68.45	5.45	-4.84	69.06	Max Peak	Vertical	123	32	74.0	-4.9	Pass
#3	11490.87	52.80	5.45	-4.84	53.39	Max Avg	Vertical	123	32	54.0	-0.6	Pass
#4	17252.30	45.80	6.39	0.31	52.50	Peak (NRB)	Vertical	101	91	--	--	Pass

Test Notes: EUT on 150cm table powered by host. Power reduced to 13.5 to meet limit at 11.49 GHz

This test report may be reproduced in full only. The document may only be updated by MiCOM Labs personnel. All changes will be noted in the Document History section of the report.



Title: Digi International AR6203
To: FCC CFR 47 Part 15 Subpart E 15.407
Serial #: DIGI60-U6 Rev A
Issue Date: 27th May 2016
Page: 41 of 141

Equipment Configuration for Radiated Spurious - Restricted Band Emissions

Antenna:	Antenna Factor ANT-DB1-xxx	Variant:	802.11a
Antenna Gain (dBi):	4.30	Modulation:	OFDM
Beam Forming Gain (Y):	Not Applicable	Duty Cycle (%):	99
Channel Frequency (MHz):	5785.00	Data Rate:	6.00 MBit/s
Power Setting:	20	Tested By:	JMH

Test Measurement Results

Num	Frequency MHz	Raw dBµV	Cable Loss	AF dB	Level dBµV/m	Measurement Type	Pol	Hgt cm	Azt Deg	Limit dBµV/m	Margin dB	Pass /Fail
#1	3856.76	55.58	3.23	-10.81	48.00	Max Peak	Vertical	155	165	74.0	-26.0	Pass
#2	3856.76	49.55	3.23	-10.81	41.97	Max Avg	Vertical	155	165	54.0	-12.0	Pass
#3	5791.51	53.00	3.78	-10.40	46.38	Fundamental	Vertical	151	1	--	--	
#4	11570.78	66.66	5.44	-4.64	67.46	Max Peak	Vertical	130	31	74.0	-6.5	Pass
#5	11570.78	53.09	5.44	-4.64	53.89	Max Avg	Vertical	130	31	54.0	-0.1	Pass

Test Notes: EUT on 150cm table powered by host.

This test report may be reproduced in full only. The document may only be updated by MiCOM Labs personnel. All changes will be noted in the Document History section of the report.



Title: Digi International AR6203
To: FCC CFR 47 Part 15 Subpart E 15.407
Serial #: DIGI60-U6 Rev A
Issue Date: 27th May 2016
Page: 42 of 141

Equipment Configuration for Radiated Spurious - Restricted Band Emissions

Antenna:	Antenna Factor ANT-DB1-xxx	Variant:	802.11a
Antenna Gain (dBi):	4.30	Modulation:	OFDM
Beam Forming Gain (Y):	Not Applicable	Duty Cycle (%):	99
Channel Frequency (MHz):	5825.00	Data Rate:	6.00 MBit/s
Power Setting:	20	Tested By:	JMH

Test Measurement Results

Num	Frequency MHz	Raw dB μ V	Cable Loss	AF dB	Level dB μ V/m	Measurement Type	Pol	Hgt cm	Azt Deg	Limit dB μ V/m	Margin dB	Pass /Fail
#1	3883.34	56.60	3.25	-10.76	49.09	Max Peak	Vertical	167	3	74.0	-24.9	Pass
#2	3883.34	51.48	3.25	-10.76	43.97	Max Avg	Vertical	167	3	54.0	-10.0	Pass
#3	5826.78	53.57	3.84	-10.24	47.17	Fundamental	Vertical	101	1	--	--	
#4	11650.73	65.82	5.46	-4.47	66.81	Max Peak	Vertical	123	33	74.0	-7.2	Pass
#5	11650.73	52.20	5.46	-4.47	53.19	Max Avg	Vertical	123	33	54.0	-0.8	Pass
#6	17471.10	46.97	6.23	-0.57	52.63	Peak (NRB)	Vertical	151	60	--	--	Pass

Test Notes: EUT on 150cm table powered by host.

This test report may be reproduced in full only. The document may only be updated by MiCOM Labs personnel. All changes will be noted in the Document History section of the report.



Title: Digi International AR6203
To: FCC CFR 47 Part 15 Subpart E 15.407
Serial #: DIGI60-U6 Rev A
Issue Date: 27th May 2016
Page: 43 of 141

9.4.1.2. Digi International 3100016-01

Equipment Configuration for Radiated Spurious - Restricted Band Emissions

Antenna:	3100016-01	Variant:	802.11a
Antenna Gain (dBi):	2.00	Modulation:	OFDM
Beam Forming Gain (Y):	Not Applicable	Duty Cycle (%):	99
Channel Frequency (MHz):	5745.00	Data Rate:	6.00 MBit/s
Power Setting:	11.5	Tested By:	JMH

Test Measurement Results

Num	Frequency MHz	Raw dBμV	Cable Loss	AF dB	Level dBμV/m	Measurement Type	Pol	Hgt cm	Azt Deg	Limit dBμV/m	Margin dB	Pass /Fail
#1	11490.75	67.12	5.45	-4.84	67.73	Max Peak	Horizontal	140	54	74.0	-6.3	Pass
#2	11490.75	52.99	5.45	-4.84	53.60	Max Avg	Horizontal	140	54	54.0	-0.4	Pass
#3	14278.37	46.17	5.63	-5.25	46.55	Peak (NRB)	Horizontal	151	0	--	--	Pass

Test Notes: EUT on 150cm table powered by host. Power reduced to 11.5 to meet limit at 11.49 GHz

This test report may be reproduced in full only. The document may only be updated by MiCOM Labs personnel. All changes will be noted in the Document History section of the report.



Title: Digi International AR6203
To: FCC CFR 47 Part 15 Subpart E 15.407
Serial #: DIGI60-U6 Rev A
Issue Date: 27th May 2016
Page: 44 of 141

Equipment Configuration for Radiated Spurious - Restricted Band Emissions

Antenna:	3100016-01	Variant:	802.11a
Antenna Gain (dBi):	2.00	Modulation:	OFDM
Beam Forming Gain (Y):	Not Applicable	Duty Cycle (%):	99
Channel Frequency (MHz):	5785.00	Data Rate:	6.00 MBit/s
Power Setting:	11.5	Tested By:	JMH

Test Measurement Results

Num	Frequency MHz	Raw dB μ V	Cable Loss	AF dB	Level dB μ V/m	Measurement Type	PoI	Hgt cm	Azt Deg	Limit dB μ V/m	Margin dB	Pass /Fail
#1	3856.67	57.97	3.23	-10.81	50.39	Max Peak	Vertical	154	282	74.0	-23.6	Pass
#2	3856.67	54.49	3.23	-10.81	46.91	Max Avg	Vertical	154	282	54.0	-7.1	Pass
#3	5791.51	53.33	3.78	-10.40	46.71	Fundamental	Vertical	151	234	--	--	
#4	11566.21	66.75	5.54	-4.65	67.64	Max Peak	Horizontal	143	55	74.0	-6.4	Pass
#5	11566.21	52.86	5.54	-4.65	53.75	Max Avg	Horizontal	143	55	54.0	-0.3	Pass

Test Notes: EUT on 150cm table powered by host. Power reduced to 11.5 to meet limit at 11.56 GHz

This test report may be reproduced in full only. The document may only be updated by MiCOM Labs personnel. All changes will be noted in the Document History section of the report.



Title: Digi International AR6203
To: FCC CFR 47 Part 15 Subpart E 15.407
Serial #: DIGI60-U6 Rev A
Issue Date: 27th May 2016
Page: 45 of 141

Equipment Configuration for Radiated Spurious - Restricted Band Emissions

Antenna:	3100016-01	Variant:	802.11a
Antenna Gain (dBi):	2.00	Modulation:	OFDM
Beam Forming Gain (Y):	Not Applicable	Duty Cycle (%):	99
Channel Frequency (MHz):	5825.00	Data Rate:	6.00 MBit/s
Power Setting:	10	Tested By:	JMH

Test Measurement Results

Num	Frequency MHz	Raw dBµV	Cable Loss	AF dB	Level dBµV/m	Measurement Type	PoI	Hgt cm	Azt Deg	Limit dBµV/m	Margin dB	Pass /Fail
#1	3883.35	60.17	3.25	-10.76	52.66	Max Peak	Vertical	143	262	74.0	-21.3	Pass
#2	3883.35	57.19	3.25	-10.76	49.68	Max Avg	Vertical	143	262	54.0	-4.3	Pass
#3	5826.94	50.44	3.84	-10.24	44.04	Fundamental	Vertical	151	1	--	--	
#4	11650.58	67.54	5.46	-4.47	68.53	Max Peak	Horizontal	134	55	74.0	-5.5	Pass
#5	11650.58	52.78	5.46	-4.47	53.77	Max Avg	Horizontal	134	55	54.0	-0.2	Pass

Test Notes: EUT on 150cm table powered by host. Power reduced to 10 to meet limit at 11.65 GHz

This test report may be reproduced in full only. The document may only be updated by MiCOM Labs personnel. All changes will be noted in the Document History section of the report.



Title: Digi International AR6203
To: FCC CFR 47 Part 15 Subpart E 15.407
Serial #: DIGI60-U6 Rev A
Issue Date: 27th May 2016
Page: 46 of 141

9.4.1.3. Taoglas FXP.830

Equipment Configuration for Radiated Spurious - Restricted Band Emissions

Antenna:	Taoglas FXP.830	Variant:	802.11a
Antenna Gain (dBi):	4.00	Modulation:	OFDM
Beam Forming Gain (Y):	Not Applicable	Duty Cycle (%):	99
Channel Frequency (MHz):	5745.00	Data Rate:	6.00 MBit/s
Power Setting:	20	Tested By:	JMH

Test Measurement Results

Num	Frequency MHz	Raw dB μ V	Cable Loss	AF dB	Level dB μ V/m	Measurement Type	Pol	Hgt cm	Azt Deg	Limit dB μ V/m	Margin dB	Pass /Fail
#1	5737.40	52.79	3.82	-10.67	45.94	Fundamental	Horizontal	151	187	--	--	
#2	11489.18	66.26	5.45	-4.85	66.86	Max Avg	Horizontal	157	297	54.0	-7.1	Pass
#3	11489.18	52.45	5.45	-4.85	53.05	Max Peak	Horizontal	157	297	74.0	-1.0	Pass
#4	17241.40	49.63	6.47	0.34	56.44	Peak (NRB)	Horizontal	151	20	--	--	Pass

Test Notes: Eut on 150cm table powered by host.

This test report may be reproduced in full only. The document may only be updated by MiCOM Labs personnel. All changes will be noted in the Document History section of the report.



Title: Digi International AR6203
To: FCC CFR 47 Part 15 Subpart E 15.407
Serial #: DIGI60-U6 Rev A
Issue Date: 27th May 2016
Page: 47 of 141

Equipment Configuration for Radiated Spurious - Restricted Band Emissions

Antenna:	Taoglas FXP.830	Variant:	802.11a
Antenna Gain (dBi):	4.00	Modulation:	OFDM
Beam Forming Gain (Y):	Not Applicable	Duty Cycle (%):	99
Channel Frequency (MHz):	5785.00	Data Rate:	6.00 MBit/s
Power Setting:	20	Tested By:	JMH

Test Measurement Results

Num	Frequency MHz	Raw dBµV	Cable Loss	AF dB	Level dBµV/m	Measurement Type	PoI	Hgt cm	Azt Deg	Limit dBµV/m	Margin dB	Pass /Fail
#1	3856.65	56.59	3.23	-10.81	49.01	Max Avg	Horizontal	177	169	54.0	-25.0	Pass
#2	3856.65	51.55	3.23	-10.81	43.97	Max Peak	Horizontal	177	169	74.0	-10.0	Pass
#3	5790.39	54.78	3.79	-10.42	48.15	Fundamental	Horizontal	151	0	--	--	
#4	11566.05	64.19	5.54	-4.65	65.08	Max Avg	Horizontal	165	299	54.0	-8.9	Pass
#5	11566.05	50.44	5.54	-4.65	51.33	Max Peak	Horizontal	165	299	74.0	-2.7	Pass
#6	17361.52	54.19	6.30	-0.05	60.44	Peak (NRB)	Horizontal	151	144	--	--	Pass

Test Notes: Eut on 150cm table powered by host.

This test report may be reproduced in full only. The document may only be updated by MiCOM Labs personnel. All changes will be noted in the Document History section of the report.



Title: Digi International AR6203
To: FCC CFR 47 Part 15 Subpart E 15.407
Serial #: DIGI60-U6 Rev A
Issue Date: 27th May 2016
Page: 48 of 141

Equipment Configuration for Radiated Spurious - Restricted Band Emissions

Antenna:	Taoglas FXP.830	Variant:	802.11a
Antenna Gain (dBi):	4.00	Modulation:	OFDM
Beam Forming Gain (Y):	Not Applicable	Duty Cycle (%):	99
Channel Frequency (MHz):	5825.00	Data Rate:	6.00 MBit/s
Power Setting:	20	Tested By:	JMH

Test Measurement Results

Num	Frequency MHz	Raw dB μ V	Cable Loss	AF dB	Level dB μ V/m	Measurement Type	PoI	Hgt cm	Azt Deg	Limit dB μ V/m	Margin dB	Pass /Fail
#1	3883.37	57.48	3.25	-10.76	49.97	Max Avg	Horizontal	156	181	54.0	-24.0	Pass
#2	3883.37	52.33	3.25	-10.76	44.82	Max Peak	Horizontal	156	181	74.0	-9.2	Pass
#3	5828.10	58.03	3.84	-10.24	51.63	Fundamental	Horizontal	151	1	--	--	
#4	11643.93	64.10	5.47	-4.47	65.10	Max Avg	Horizontal	150	300	54.0	-8.9	Pass
#5	11643.93	50.36	5.47	-4.47	51.36	Max Peak	Horizontal	150	300	74.0	-2.6	Pass
#6	17476.19	54.88	6.28	-0.59	60.57	Peak (NRB)	Horizontal	151	1	--	--	Pass

Test Notes: Eut on 150cm table powered by host.

This test report may be reproduced in full only. The document may only be updated by MiCOM Labs personnel. All changes will be noted in the Document History section of the report.



Title: Digi International AR6203
To: FCC CFR 47 Part 15 Subpart E 15.407
Serial #: DIGI60-U6 Rev A
Issue Date: 27th May 2016
Page: 49 of 141

9.4.1.4. Taoglas PC.11

Equipment Configuration for Radiated Spurious - Restricted Band Emissions

Antenna:	Taoglas PC.11	Variant:	802.11a
Antenna Gain (dBi):	4.50	Modulation:	OFDM
Beam Forming Gain (Y):	Not Applicable	Duty Cycle (%):	99
Channel Frequency (MHz):	5745.00	Data Rate:	6.00 MBit/s
Power Setting:	20	Tested By:	JMH

Test Measurement Results

Num	Frequency MHz	Raw dBμV	Cable Loss	AF dB	Level dBμV/m	Measurement Type	Pol	Hgt cm	Azt Deg	Limit dBμV/m	Margin dB	Pass /Fail
#1	3830.18	58.75	3.21	-10.83	51.13	Max Peak	Vertical	129	212	74.0	-22.9	Pass
#2	3830.18	54.85	3.21	-10.83	47.23	Max Avg	Vertical	129	212	54.0	-6.8	Pass
#3	5740.01	54.22	3.83	-10.67	47.38	Fundamental	Vertical	151	71	--	--	
#4	11490.06	65.74	5.45	-4.84	66.35	Max Peak	Vertical	145	144	74.0	-7.7	Pass
#5	11490.06	53.03	5.45	-4.84	53.64	Max Avg	Vertical	145	144	54.0	-0.4	Pass

Test Notes: Eut on 150cm table powered by host.

This test report may be reproduced in full only. The document may only be updated by MiCOM Labs personnel. All changes will be noted in the Document History section of the report.



Title: Digi International AR6203
To: FCC CFR 47 Part 15 Subpart E 15.407
Serial #: DIGI60-U6 Rev A
Issue Date: 27th May 2016
Page: 50 of 141

Equipment Configuration for Radiated Spurious - Restricted Band Emissions

Antenna:	Taoglas PC.11	Variant:	802.11a
Antenna Gain (dBi):	4.50	Modulation:	OFDM
Beam Forming Gain (Y):	Not Applicable	Duty Cycle (%):	99
Channel Frequency (MHz):	5785.00	Data Rate:	6.00 MBit/s
Power Setting:	20	Tested By:	JMH

Test Measurement Results

Num	Frequency MHz	Raw dBµV	Cable Loss	AF dB	Level dBµV/m	Measurement Type	Pol	Hgt cm	Azt Deg	Limit dBµV/m	Margin dB	Pass /Fail
#1	3856.68	60.97	3.23	-10.81	53.39	Max Peak	Vertical	180	213	74.0	-20.6	Pass
#2	3856.68	57.53	3.23	-10.81	49.95	Max Avg	Vertical	180	213	54.0	-4.1	Pass
#3	5791.19	53.54	3.79	-10.41	46.92	Fundamental	Vertical	151	157	--	--	
#4	11567.97	64.99	5.50	-4.65	65.84	Max Peak	Vertical	159	231	74.0	-8.2	Pass
#5	11567.97	50.59	5.50	-4.65	51.44	Max Avg	Vertical	159	231	54.0	-2.6	Pass

Test Notes: Eut on 150cm table powered by host.

This test report may be reproduced in full only. The document may only be updated by MiCOM Labs personnel. All changes will be noted in the Document History section of the report.



Title: Digi International AR6203
To: FCC CFR 47 Part 15 Subpart E 15.407
Serial #: DIGI60-U6 Rev A
Issue Date: 27th May 2016
Page: 51 of 141

Equipment Configuration for Radiated Spurious - Restricted Band Emissions

Antenna:	Taoglas PC.11	Variant:	802.11a
Antenna Gain (dBi):	4.50	Modulation:	OFDM
Beam Forming Gain (Y):	Not Applicable	Duty Cycle (%):	99
Channel Frequency (MHz):	5825.00	Data Rate:	6.00 MBit/s
Power Setting:	20	Tested By:	JMH

Test Measurement Results

Num	Frequency MHz	Raw dBµV	Cable Loss	AF dB	Level dBµV/m	Measurement Type	Pol	Hgt cm	Azt Deg	Limit dBµV/m	Margin dB	Pass /Fail
#1	3883.42	60.44	3.25	-10.76	52.93	Max Peak	Vertical	181	282	74.0	-21.1	Pass
#2	3883.42	56.78	3.25	-10.76	49.27	Max Avg	Vertical	181	282	54.0	-4.7	Pass
#3	5828.06	58.63	3.84	-10.24	52.23	Fundamental	Vertical	151	16	--	--	
#4	11647.06	60.70	5.45	-4.47	61.68	Max Peak	Vertical	196	228	74.0	-12.3	Pass
#5	11647.06	47.88	5.45	-4.47	48.86	Max Avg	Vertical	196	228	54.0	-5.1	Pass
#6	17476.27	53.26	6.28	-0.59	58.95	Peak (NRB)	Vertical	151	16	--	--	Pass

Test Notes: Eut on 150cm table powered by host.

This test report may be reproduced in full only. The document may only be updated by MiCOM Labs personnel. All changes will be noted in the Document History section of the report.



9.4.2. Restricted Band-Edge Emissions

9.4.2.5. Antenna Factor ANT-DB1-xxx

RESULTS SUMMARY FOR RADIATED BAND-EDGE EMISSIONS

5725 - 5850 MHz

Antenna Factor ANT-DB1-xxx		Band-Edge Freq	Limit 68.2dB μ V/m	Limit 78.2dB μ V/m	Power Setting
Operational Mode	Operating Frequency (MHz)	MHz	dB μ V/m	dB μ V/m	
802.11a	5745.00	5725.00	58.20	69.76	20
802.11n HT-20	5745.00	5725.00	58.82	70.49	20
802.11n HT-40	5755.00	5725.00	66.22	70.49	13

5725 - 5850 MHz

Antenna Factor ANT-DB1-xxx		Band-Edge Freq	Limit 78.2dB μ V/m	Limit 68.2dB μ V/m	Power Setting
Operational Mode	Operating Frequency (MHz)	MHz	dB μ V/m	dB μ V/m	
802.11a	5825.00	5850.00	63.54	54.02	20
802.11n HT-20	5825.00	5850.00	64.23	54.55	20
802.11n HT-40	5795.00	5850.00	56.36	52.86	20

Click on the links to view the data.



Title: Digi International AR6203
To: FCC CFR 47 Part 15 Subpart E 15.407
Serial #: DIGI60-U6 Rev A
Issue Date: 27th May 2016
Page: 53 of 141

Equipment Configuration for 5725 MHz Radiated Band-Edge Emissions

Antenna:	Antenna Factor ANT-DB1-xxx	Variant:	802.11a
Antenna Gain (dBi):	4.30	Modulation:	OFDM
Beam Forming Gain (Y):	Not Applicable	Duty Cycle (%):	99
Channel Frequency (MHz):	5745.00	Data Rate:	6.00 MBit/s
Power Setting:	20	Tested By:	JMH

Test Measurement Results

Num	Frequency MHz	Raw dBµV	Cable Loss	AF dB	Level dBµV/m	Measurement Type	Pol	Hgt cm	Azt Deg	Limit dBµV/m	Margin dB	Pass /Fail
#1	5715.00	20.05	3.81	34.34	58.20	Max Avg	Vertical	194	21	68.2	-10.0	Pass
#2	5725.00	31.62	3.79	34.35	69.76	Max Avg	Vertical	194	21	78.2	-8.5	Pass
#3	5725.00	--	--	--	--	Band Edge	--	--	--	--	--	--

Test Notes: EUT on 150cm table powered by host.

[back to table](#)

This test report may be reproduced in full only. The document may only be updated by MiCOM Labs personnel. All changes will be noted in the Document History section of the report.



Title: Digi International AR6203
To: FCC CFR 47 Part 15 Subpart E 15.407
Serial #: DIGI60-U6 Rev A
Issue Date: 27th May 2016
Page: 54 of 141

Equipment Configuration for 5725 MHz Radiated Band-Edge Emissions

Antenna:	Antenna Factor ANT-DB1-xxx	Variant:	802.11n HT-20
Antenna Gain (dBi):	4.30	Modulation:	OFDM
Beam Forming Gain (Y):	Not Applicable	Duty Cycle (%):	99
Channel Frequency (MHz):	5745.00	Data Rate:	6.50 MBit/s
Power Setting:	20	Tested By:	JMH

Test Measurement Results

Num	Frequency MHz	Raw dBµV	Cable Loss	AF dB	Level dBµV/m	Measurement Type	Pol	Hgt cm	Azt Deg	Limit dBµV/m	Margin dB	Pass /Fail
#1	5715.00	20.67	3.81	34.34	58.82	Max Avg	Vertical	194	21	68.2	-9.4	Pass
#2	5725.00	32.35	3.79	34.35	70.49	Max Avg	Vertical	194	21	78.2	-7.7	Pass
#3	5725.00	--	--	--	--	Band Edge	--	--	--	--	--	--

Test Notes: EUT on 150cm table powered by host.

[back to table](#)

This test report may be reproduced in full only. The document may only be updated by MiCOM Labs personnel. All changes will be noted in the Document History section of the report.



Title: Digi International AR6203
To: FCC CFR 47 Part 15 Subpart E 15.407
Serial #: DIGI60-U6 Rev A
Issue Date: 27th May 2016
Page: 55 of 141

Equipment Configuration for 5725 MHz Radiated Band-Edge Emissions

Antenna:	Antenna Factor ANT-DB1-xxx	Variant:	802.11n HT-40
Antenna Gain (dBi):	4.30	Modulation:	OFDM
Beam Forming Gain (Y):	Not Applicable	Duty Cycle (%):	99
Channel Frequency (MHz):	5755.00	Data Rate:	13.50 MBit/s
Power Setting:	13	Tested By:	JMH

Test Measurement Results

Num	Frequency MHz	Raw dBµV	Cable Loss	AF dB	Level dBµV/m	Measurement Type	Pol	Hgt cm	Azt Deg	Limit dBµV/m	Margin dB	Pass /Fail
#1	5715.00	28.07	3.81	34.34	66.22	Max Avg	Vertical	194	21	68.2	-2.0	Pass
#2	5724.03	32.35	3.79	34.35	70.49	Max Avg	Vertical	194	21	78.2	-7.7	Pass
#3	5725.00	--	--	--	--	Band Edge	--	--	--	--	--	--

Test Notes: EUT on 150cm table powered by host. Power reduction to meet Band Edge limit

[back to table](#)

This test report may be reproduced in full only. The document may only be updated by MiCOM Labs personnel. All changes will be noted in the Document History section of the report.



Title: Digi International AR6203
To: FCC CFR 47 Part 15 Subpart E 15.407
Serial #: DIGI60-U6 Rev A
Issue Date: 27th May 2016
Page: 56 of 141

Equipment Configuration for 5850 MHz Radiated Band-Edge Emissions

Antenna:	Antenna Factor ANT-DB1-xxx	Variant:	802.11a
Antenna Gain (dBi):	4.30	Modulation:	OFDM
Beam Forming Gain (Y):	Not Applicable	Duty Cycle (%):	99
Channel Frequency (MHz):	5825.00	Data Rate:	6.00 MBit/s
Power Setting:	20	Tested By:	JMH

Test Measurement Results

Num	Frequency MHz	Raw dB μ V	Cable Loss	AF dB	Level dB μ V/m	Measurement Type	Pol	Hgt cm	Azt Deg	Limit dB μ V/m	Margin dB	Pass /Fail
#1	5850.00	25.10	3.81	34.63	63.54	Max Avg	Vertical	194	21	78.2	-14.7	Pass
#3	5860.42	15.51	3.86	34.65	54.02	Max Avg	Vertical	194	21	68.2	-14.2	Pass
#2	5850.00	--	--	--	--	Band Edge	--	--	--	--	--	--

Test Notes: EUT on 150cm table powered by host.

[back to table](#)

This test report may be reproduced in full only. The document may only be updated by MiCOM Labs personnel. All changes will be noted in the Document History section of the report.



Title: Digi International AR6203
To: FCC CFR 47 Part 15 Subpart E 15.407
Serial #: DIGI60-U6 Rev A
Issue Date: 27th May 2016
Page: 57 of 141

Equipment Configuration for 5850 MHz Radiated Band-Edge Emissions

Antenna:	Antenna Factor ANT-DB1-xxx	Variant:	802.11n HT-20
Antenna Gain (dBi):	4.30	Modulation:	OFDM
Beam Forming Gain (Y):	Not Applicable	Duty Cycle (%):	99
Channel Frequency (MHz):	5825.00	Data Rate:	6.50 MBit/s
Power Setting:	20	Tested By:	JMH

Test Measurement Results

Num	Frequency MHz	Raw dB μ V	Cable Loss	AF dB	Level dB μ V/m	Measurement Type	Pol	Hgt cm	Azt Deg	Limit dB μ V/m	Margin dB	Pass /Fail
#1	5850.00	25.79	3.81	34.63	64.23	Max Avg	Vertical	194	21	78.2	-14.0	Pass
#3	5860.00	16.04	3.86	34.65	54.55	Max Avg	Vertical	194	21	68.2	-13.7	Pass
#2	5850.00	--	--	--	--	Band Edge	--	--	--	--	--	--

Test Notes: EUT on 150cm table powered by host.

[back to table](#)

This test report may be reproduced in full only. The document may only be updated by MiCOM Labs personnel. All changes will be noted in the Document History section of the report.



Title: Digi International AR6203
To: FCC CFR 47 Part 15 Subpart E 15.407
Serial #: DIGI60-U6 Rev A
Issue Date: 27th May 2016
Page: 58 of 141

Equipment Configuration for 5850 MHz Radiated Band-Edge Emissions

Antenna:	Antenna Factor ANT-DB1-xxx	Variant:	802.11n HT-40
Antenna Gain (dBi):	4.30	Modulation:	OFDM
Beam Forming Gain (Y):	Not Applicable	Duty Cycle (%):	99
Channel Frequency (MHz):	5795.00	Data Rate:	13.50 MBit/s
Power Setting:	20	Tested By:	JMH

Test Measurement Results

Num	Frequency MHz	Raw dB μ V	Cable Loss	AF dB	Level dB μ V/m	Measurement Type	Pol	Hgt cm	Azt Deg	Limit dB μ V/m	Margin dB	Pass /Fail
#1	5850.00	17.92	3.81	34.63	56.36	Max Avg	Vertical	194	21	78.2	-21.9	Pass
#3	5860.00	14.35	3.86	34.65	52.86	Max Avg	Vertical	194	21	68.2	-15.4	Pass
#2	5850.00	--	--	--	--	Band Edge	--	--	--	--	--	--

Test Notes: EUT on 150cm table powered by host.

[back to table](#)

This test report may be reproduced in full only. The document may only be updated by MiCOM Labs personnel. All changes will be noted in the Document History section of the report.



9.4.2.6. Digi International 3100016-01

RESULTS SUMMARY FOR RADIATED BAND-EDGE EMISSIONS

5725 - 5850 MHz

3100016-01		Band-Edge Freq	Limit 68.2dB μ V/m	Limit 78.2dB μ V/m	Power Setting
Operational Mode	Operating Frequency (MHz)	MHz	dB μ V/m	dB μ V/m	
802.11a	5745.00	5725.00	56.80	69.23	20
802.11n HT-20	5745.00	5725.00	55.59	68.67	20
802.11n HT-40	5755.00	5725.00	67.63	72.81	20

5725 - 5850 MHz

3100016-01		Band-Edge Freq	Limit 78.2dB μ V/m	Limit 68.2dB μ V/m	Power Setting
Operational Mode	Operating Frequency (MHz)	MHz	dB μ V/m	dB μ V/m	
802.11a	5825.00	5850.00	62.58	54.55	20
802.11n HT-20	5825.00	5850.00	62.98	54.55	20
802.11n HT-40	5795.00	5850.00	54.52	52.22	20

Click on the links to view the data.



Title: Digi International AR6203
To: FCC CFR 47 Part 15 Subpart E 15.407
Serial #: DIGI60-U6 Rev A
Issue Date: 27th May 2016
Page: 60 of 141

Equipment Configuration for 5725 MHz Radiated Band-Edge Emissions

Antenna:	3100016-01	Variant:	802.11a
Antenna Gain (dBi):	2.00	Modulation:	OFDM
Beam Forming Gain (Y):	Not Applicable	Duty Cycle (%):	99
Channel Frequency (MHz):	5745.00	Data Rate:	6.00 MBit/s
Power Setting:	20	Tested By:	JMH

Test Measurement Results

Num	Frequency MHz	Raw dBµV	Cable Loss	AF dB	Level dBµV/m	Measurement Type	Pol	Hgt cm	Azt Deg	Limit dBµV/m	Margin dB	Pass /Fail
#1	5715.00	18.65	3.81	34.34	56.80	Max Avg	Vertical	153	199	68.2	-11.4	Pass
#2	5725.00	31.09	3.79	34.35	69.23	Max Avg	Vertical	153	199	78.2	-9.0	Pass
#3	5725.00	--	--	--	--	Band Edge	--	--	--	--	--	--

Test Notes: EUT on 150cm table powered by host.

[back to table](#)

This test report may be reproduced in full only. The document may only be updated by MiCOM Labs personnel. All changes will be noted in the Document History section of the report.



Title: Digi International AR6203
To: FCC CFR 47 Part 15 Subpart E 15.407
Serial #: DIGI60-U6 Rev A
Issue Date: 27th May 2016
Page: 61 of 141

Equipment Configuration for 5725 MHz Radiated Band-Edge Emissions

Antenna:	3100016-01	Variant:	802.11n HT-20
Antenna Gain (dBi):	2.00	Modulation:	OFDM
Beam Forming Gain (Y):	Not Applicable	Duty Cycle (%):	99
Channel Frequency (MHz):	5745.00	Data Rate:	6.50 MBit/s
Power Setting:	20	Tested By:	JMH

Test Measurement Results

Num	Frequency MHz	Raw dB μ V	Cable Loss	AF dB	Level dB μ V/m	Measurement Type	Pol	Hgt cm	Azt Deg	Limit dB μ V/m	Margin dB	Pass /Fail
#1	5715.00	17.44	3.81	34.34	55.59	Max Avg	Vertical	153	199	68.2	-12.6	Pass
#2	5725.00	30.53	3.79	34.35	68.67	Max Avg	Vertical	153	199	78.2	-9.6	Pass
#3	5725.00	--	--	--	--	Band Edge	--	--	--	--	--	--

Test Notes: EUT on 150cm table powered by host.

[back to table](#)

This test report may be reproduced in full only. The document may only be updated by MiCOM Labs personnel. All changes will be noted in the Document History section of the report.



Title: Digi International AR6203
To: FCC CFR 47 Part 15 Subpart E 15.407
Serial #: DIGI60-U6 Rev A
Issue Date: 27th May 2016
Page: 62 of 141

Equipment Configuration for 5725 MHz Radiated Band-Edge Emissions

Antenna:	3100016-01	Variant:	802.11n HT-40
Antenna Gain (dBi):	2.00	Modulation:	OFDM
Beam Forming Gain (Y):	Not Applicable	Duty Cycle (%):	99
Channel Frequency (MHz):	5755.00	Data Rate:	13.50 MBit/s
Power Setting:	20	Tested By:	JMH

Test Measurement Results

Num	Frequency MHz	Raw dBµV	Cable Loss	AF dB	Level dBµV/m	Measurement Type	Pol	Hgt cm	Azt Deg	Limit dBµV/m	Margin dB	Pass /Fail
#1	5715.00	29.48	3.81	34.34	67.63	Max Avg	Vertical	153	199	68.2	-0.6	Pass
#2	5724.03	34.67	3.79	34.35	72.81	Max Avg	Vertical	153	199	78.2	-5.4	Pass
#3	5725.00	--	--	--	--	Band Edge	--	--	--	--	--	--

Test Notes: EUT on 150cm table powered by host.

[back to table](#)

This test report may be reproduced in full only. The document may only be updated by MiCOM Labs personnel. All changes will be noted in the Document History section of the report.



Title: Digi International AR6203
To: FCC CFR 47 Part 15 Subpart E 15.407
Serial #: DIGI60-U6 Rev A
Issue Date: 27th May 2016
Page: 63 of 141

Equipment Configuration for 5850 MHz Radiated Band-Edge Emissions

Antenna:	3100016-01	Variant:	802.11a
Antenna Gain (dBi):	2.00	Modulation:	OFDM
Beam Forming Gain (Y):	Not Applicable	Duty Cycle (%):	99
Channel Frequency (MHz):	5825.00	Data Rate:	6.00 MBit/s
Power Setting:	20	Tested By:	JMH

Test Measurement Results

Num	Frequency MHz	Raw dBµV	Cable Loss	AF dB	Level dBµV/m	Measurement Type	Pol	Hgt cm	Azt Deg	Limit dBµV/m	Margin dB	Pass /Fail
#1	5850.00	24.14	3.81	34.63	62.58	Max Avg	Vertical	153	199	78.2	-15.7	Pass
#3	5860.00	16.04	3.86	34.65	54.55	Max Avg	Vertical	153	199	68.2	-13.7	Pass
#2	5850.00	--	--	--	--	Band Edge	--	--	--	--	--	--

Test Notes: EUT on 150cm table powered by host.

[back to table](#)

This test report may be reproduced in full only. The document may only be updated by MiCOM Labs personnel. All changes will be noted in the Document History section of the report.



Title: Digi International AR6203
To: FCC CFR 47 Part 15 Subpart E 15.407
Serial #: DIGI60-U6 Rev A
Issue Date: 27th May 2016
Page: 64 of 141

Equipment Configuration for 5850 MHz Radiated Band-Edge Emissions

Antenna:	3100016-01	Variant:	802.11n HT-20
Antenna Gain (dBi):	2.00	Modulation:	OFDM
Beam Forming Gain (Y):	Not Applicable	Duty Cycle (%):	99
Channel Frequency (MHz):	5825.00	Data Rate:	6.50 MBit/s
Power Setting:	20	Tested By:	JMH

Test Measurement Results

Num	Frequency MHz	Raw dBµV	Cable Loss	AF dB	Level dBµV/m	Measurement Type	Pol	Hgt cm	Azt Deg	Limit dBµV/m	Margin dB	Pass /Fail
#1	5850.00	24.54	3.81	34.63	62.98	Max Avg	Vertical	153	199	78.2	-15.3	Pass
#3	5860.00	16.04	3.86	34.65	54.55	Max Avg	Vertical	153	199	68.2	-13.7	Pass
#2	5850.00	--	--	--	--	Band Edge	--	--	--	--	--	--

Test Notes: EUT on 150cm table powered by host.

[back to table](#)

This test report may be reproduced in full only. The document may only be updated by MiCOM Labs personnel. All changes will be noted in the Document History section of the report.



Title: Digi International AR6203
To: FCC CFR 47 Part 15 Subpart E 15.407
Serial #: DIGI60-U6 Rev A
Issue Date: 27th May 2016
Page: 65 of 141

Equipment Configuration for 5850 MHz Radiated Band-Edge Emissions

Antenna:	3100016-01	Variant:	802.11n HT-40
Antenna Gain (dBi):	2.00	Modulation:	OFDM
Beam Forming Gain (Y):	Not Applicable	Duty Cycle (%):	99
Channel Frequency (MHz):	5795.00	Data Rate:	13.50 MBit/s
Power Setting:	20	Tested By:	JMH

Test Measurement Results

Num	Frequency MHz	Raw dBµV	Cable Loss	AF dB	Level dBµV/m	Measurement Type	Pol	Hgt cm	Azt Deg	Limit dBµV/m	Margin dB	Pass /Fail
#1	5850.00	16.08	3.81	34.63	54.52	Max Avg	Vertical	153	199	78.2	-23.7	Pass
#3	5860.00	13.71	3.86	34.65	52.22	Max Avg	Vertical	153	199	68.2	-16.0	Pass
#2	5850.00	--	--	--	--	Band Edge	--	--	--	--	--	--

Test Notes: EUT on 150cm table powered by host.

[back to table](#)

This test report may be reproduced in full only. The document may only be updated by MiCOM Labs personnel. All changes will be noted in the Document History section of the report.



9.4.2.7. Taoglas FXP.830

RESULTS SUMMARY FOR RADIATED BAND-EDGE EMISSIONS

5725 - 5850 MHz

Taoglas FXP.830		Band-Edge Freq	Limit 68.2dBµV/m	Limit 78.2dBµV/m	Power Setting
Operational Mode	Operating Frequency (MHz)	MHz	dBµV/m	dBµV/m	
802.11a	5745.00	5725.00	55.59	65.43	20
802.11n HT-20	5745.00	5725.00	56.42	66.49	20
802.11n HT-40	5755.00	5725.00	66.84	70.09	20

5725 - 5850 MHz

Taoglas FXP.830		Band-Edge Freq	Limit 78.2dBµV/m	Limit 68.2dBµV/m	Power Setting
Operational Mode	Operating Frequency (MHz)	MHz	dBµV/m	dBµV/m	
802.11a	5825.00	5850.00	62.38	54.55	20
802.11n HT-20	5825.00	5850.00	64.06	55.96	20
802.11n HT-40	5795.00	5850.00	56.36	52.86	20

Click on the links to view the data.



Title: Digi International AR6203
To: FCC CFR 47 Part 15 Subpart E 15.407
Serial #: DIGI60-U6 Rev A
Issue Date: 27th May 2016
Page: 67 of 141

Equipment Configuration for 5725 MHz Radiated Band-Edge Emissions

Antenna:	Taoglas FXP.830	Variant:	802.11a
Antenna Gain (dBi):	4.00	Modulation:	OFDM
Beam Forming Gain (Y):	Not Applicable	Duty Cycle (%):	99
Channel Frequency (MHz):	5745.00	Data Rate:	6.00 MBit/s
Power Setting:	20	Tested By:	JMH

Test Measurement Results

Num	Frequency MHz	Raw dBµV	Cable Loss	AF dB	Level dBµV/m	Measurement Type	PoI	Hgt cm	Azt Deg	Limit dBµV/m	Margin dB	Pass /Fail
#1	5715.00	17.44	3.81	34.34	55.59	Max Avg	Horizontal	192	13	68.2	-12.6	Pass
#2	5725.00	27.29	3.79	34.35	65.43	Max Avg	Horizontal	192	13	78.2	-12.8	Pass
#3	5725.00	--	--	--	--	Band Edge	--	--	--	--	--	--

Test Notes: EUT on 150cm table powered by host.

[back to table](#)

This test report may be reproduced in full only. The document may only be updated by MiCOM Labs personnel. All changes will be noted in the Document History section of the report.



Title: Digi International AR6203
To: FCC CFR 47 Part 15 Subpart E 15.407
Serial #: DIGI60-U6 Rev A
Issue Date: 27th May 2016
Page: 68 of 141

Equipment Configuration for 5725 MHz Radiated Band-Edge Emissions

Antenna:	Taoglas FXP.830	Variant:	802.11n HT-20
Antenna Gain (dBi):	4.00	Modulation:	OFDM
Beam Forming Gain (Y):	Not Applicable	Duty Cycle (%):	99
Channel Frequency (MHz):	5745.00	Data Rate:	6.50 MBit/s
Power Setting:	20	Tested By:	JMH

Test Measurement Results

Num	Frequency MHz	Raw dB μ V	Cable Loss	AF dB	Level dB μ V/m	Measurement Type	PoI	Hgt cm	Azt Deg	Limit dB μ V/m	Margin dB	Pass /Fail
#1	5715.00	18.27	3.81	34.34	56.42	Max Avg	Horizontal	192	13	68.2	-11.8	Pass
#2	5725.00	28.35	3.79	34.35	66.49	Max Avg	Horizontal	192	13	78.2	-11.7	Pass
#3	5725.00	--	--	--	--	Band Edge	--	--	--	--	--	--

Test Notes: EUT on 150cm table powered by host.

[back to table](#)

This test report may be reproduced in full only. The document may only be updated by MiCOM Labs personnel. All changes will be noted in the Document History section of the report.



Title: Digi International AR6203
To: FCC CFR 47 Part 15 Subpart E 15.407
Serial #: DIGI60-U6 Rev A
Issue Date: 27th May 2016
Page: 69 of 141

Equipment Configuration for 5725 MHz Radiated Band-Edge Emissions

Antenna:	Taoglas FXP.830	Variant:	802.11n HT-40
Antenna Gain (dBi):	4.00	Modulation:	OFDM
Beam Forming Gain (Y):	Not Applicable	Duty Cycle (%):	99
Channel Frequency (MHz):	5755.00	Data Rate:	13.50 MBit/s
Power Setting:	20	Tested By:	JMH

Test Measurement Results

Num	Frequency MHz	Raw dB μ V	Cable Loss	AF dB	Level dB μ V/m	Measurement Type	PoI	Hgt cm	Azt Deg	Limit dB μ V/m	Margin dB	Pass /Fail
#1	5715.00	28.69	3.81	34.34	66.84	Max Avg	Horizontal	192	13	68.2	-1.4	Pass
#2	5724.03	31.95	3.79	34.35	70.09	Max Avg	Horizontal	192	13	78.2	-8.1	Pass
#3	5725.00	--	--	--	--	Band Edge	--	--	--	--	--	--

Test Notes: EUT on 150cm table powered by host.

[back to table](#)

This test report may be reproduced in full only. The document may only be updated by MiCOM Labs personnel. All changes will be noted in the Document History section of the report.



Title: Digi International AR6203
To: FCC CFR 47 Part 15 Subpart E 15.407
Serial #: DIGI60-U6 Rev A
Issue Date: 27th May 2016
Page: 70 of 141

Equipment Configuration for 5850 MHz Radiated Band-Edge Emissions

Antenna:	Taoglas FXP.830	Variant:	802.11a
Antenna Gain (dBi):	4.00	Modulation:	OFDM
Beam Forming Gain (Y):	Not Applicable	Duty Cycle (%):	99
Channel Frequency (MHz):	5825.00	Data Rate:	6.00 MBit/s
Power Setting:	20	Tested By:	JMH

Test Measurement Results

Num	Frequency MHz	Raw dBµV	Cable Loss	AF dB	Level dBµV/m	Measurement Type	PoI	Hgt cm	Azt Deg	Limit dBµV/m	Margin dB	Pass /Fail
#1	5850.00	23.94	3.81	34.63	62.38	Max Avg	Horizontal	192	13	78.2	-15.9	Pass
#3	5860.00	16.04	3.86	34.65	54.55	Max Avg	Horizontal	192	13	68.2	-13.7	Pass
#2	5850.00	--	--	--	--	Band Edge	--	--	--	--	--	--

Test Notes: EUT on 150cm table powered by host.

[back to table](#)

This test report may be reproduced in full only. The document may only be updated by MiCOM Labs personnel. All changes will be noted in the Document History section of the report.



Title: Digi International AR6203
To: FCC CFR 47 Part 15 Subpart E 15.407
Serial #: DIGI60-U6 Rev A
Issue Date: 27th May 2016
Page: 71 of 141

Equipment Configuration for 5850 MHz Radiated Band-Edge Emissions

Antenna:	Taoglas FXP.830	Variant:	802.11n HT-20
Antenna Gain (dBi):	4.00	Modulation:	OFDM
Beam Forming Gain (Y):	Not Applicable	Duty Cycle (%):	99
Channel Frequency (MHz):	5825.00	Data Rate:	6.50 MBit/s
Power Setting:	20	Tested By:	JMH

Test Measurement Results

Num	Frequency MHz	Raw dBµV	Cable Loss	AF dB	Level dBµV/m	Measurement Type	PoI	Hgt cm	Azt Deg	Limit dBµV/m	Margin dB	Pass /Fail
#1	5850.00	25.62	3.81	34.63	64.06	Max Avg	Horizontal	192	13	78.2	-14.2	Pass
#3	5860.00	17.45	3.86	34.65	55.96	Max Avg	Horizontal	192	13	68.2	-12.3	Pass
#2	5850.00	--	--	--	--	Band Edge	--	--	--	--	--	--

Test Notes: EUT on 150cm table powered by host.

[back to table](#)

This test report may be reproduced in full only. The document may only be updated by MiCOM Labs personnel. All changes will be noted in the Document History section of the report.



Title: Digi International AR6203
To: FCC CFR 47 Part 15 Subpart E 15.407
Serial #: DIGI60-U6 Rev A
Issue Date: 27th May 2016
Page: 72 of 141

Equipment Configuration for 5850 MHz Radiated Band-Edge Emissions

Antenna:	Taoglas FXP.830	Variant:	802.11n HT-40
Antenna Gain (dBi):	4.00	Modulation:	OFDM
Beam Forming Gain (Y):	Not Applicable	Duty Cycle (%):	99
Channel Frequency (MHz):	5795.00	Data Rate:	13.50 MBit/s
Power Setting:	20	Tested By:	JMH

Test Measurement Results

Num	Frequency MHz	Raw dB μ V	Cable Loss	AF dB	Level dB μ V/m	Measurement Type	PoI	Hgt cm	Azt Deg	Limit dB μ V/m	Margin dB	Pass /Fail
#2	5850.42	17.92	3.81	34.63	56.36	Max Avg	Horizontal	192	13	78.2	-21.9	Pass
#3	5860.00	14.35	3.86	34.65	52.86	Max Avg	Horizontal	192	13	68.2	-15.4	Pass
#1	5850.00	--	--	--	--	Band Edge	--	--	--	--	--	--

Test Notes: EUT on 150cm table powered by host.

[back to table](#)

This test report may be reproduced in full only. The document may only be updated by MiCOM Labs personnel. All changes will be noted in the Document History section of the report.



9.4.2.8. Taoglas PC.11

RESULTS SUMMARY FOR RADIATED BAND-EDGE EMISSIONS

5725 - 5850 MHz

Taoglas PC.11		Band-Edge Freq	Limit 68.2dBµV/m	Limit 78.2dBµV/m	Power Setting
Operational Mode	Operating Frequency (MHz)	MHz	dBµV/m	dBµV/m	
802.11a	5745.00	5725.00	54.18	62.46	20
802.11n HT-20	5745.00	5725.00	55.14	64.39	20
802.11n HT-40	5755.00	5725.00	64.38	66.85	20

5725 - 5850 MHz

Taoglas PC.11		Band-Edge Freq	Limit 78.2dBµV/m	Limit 68.2dBµV/m	Power Setting
Operational Mode	Operating Frequency (MHz)	MHz	dBµV/m	dBµV/m	
802.11a	5825.00	5850.00	58.54	52.22	20
802.11n HT-20	5825.00	5850.00	60.28	52.86	20
802.11n HT-40	5795.00	5850.00	53.43	51.52	20

Click on the links to view the data.



Title: Digi International AR6203
To: FCC CFR 47 Part 15 Subpart E 15.407
Serial #: DIGI60-U6 Rev A
Issue Date: 27th May 2016
Page: 74 of 141

Equipment Configuration for 5725 MHz Radiated Band-Edge Emissions

Antenna:	Taoglas PC.11	Variant:	802.11a
Antenna Gain (dBi):	4.50	Modulation:	OFDM
Beam Forming Gain (Y):	Not Applicable	Duty Cycle (%):	99
Channel Frequency (MHz):	5745.00	Data Rate:	6.00 MBit/s
Power Setting:	20	Tested By:	JMH

Test Measurement Results

Num	Frequency MHz	Raw dBµV	Cable Loss	AF dB	Level dBµV/m	Measurement Type	Pol	Hgt cm	Azt Deg	Limit dBµV/m	Margin dB	Pass /Fail
#1	5715.00	16.03	3.81	34.34	54.18	Max Avg	Vertical	199	197	68.2	-14.1	Pass
#2	5725.00	24.32	3.79	34.35	62.46	Max Avg	Vertical	199	197	78.2	-15.8	Pass
#3	5725.00	--	--	--	--	Band Edge	--	--	--	--	--	--

Test Notes: EUT on 150cm table powered by host.

[back to table](#)

This test report may be reproduced in full only. The document may only be updated by MiCOM Labs personnel. All changes will be noted in the Document History section of the report.



Title: Digi International AR6203
To: FCC CFR 47 Part 15 Subpart E 15.407
Serial #: DIGI60-U6 Rev A
Issue Date: 27th May 2016
Page: 75 of 141

Equipment Configuration for 5725 MHz Radiated Band-Edge Emissions

Antenna:	Taoglas PC.11	Variant:	802.11n HT-20
Antenna Gain (dBi):	4.50	Modulation:	OFDM
Beam Forming Gain (Y):	Not Applicable	Duty Cycle (%):	99
Channel Frequency (MHz):	5745.00	Data Rate:	6.50 MBit/s
Power Setting:	20	Tested By:	JMH

Test Measurement Results

Num	Frequency MHz	Raw dB μ V	Cable Loss	AF dB	Level dB μ V/m	Measurement Type	Pol	Hgt cm	Azt Deg	Limit dB μ V/m	Margin dB	Pass /Fail
#1	5715.00	16.99	3.81	34.34	55.14	Max Avg	Vertical	199	197	68.2	-13.1	Pass
#2	5725.00	26.25	3.79	34.35	64.39	Max Avg	Vertical	199	197	78.2	-13.8	Pass
#3	5725.00	--	--	--	--	Band Edge	--	--	--	--	--	--

Test Notes: EUT on 150cm table powered by host.

[back to table](#)

This test report may be reproduced in full only. The document may only be updated by MiCOM Labs personnel. All changes will be noted in the Document History section of the report.



Title: Digi International AR6203
To: FCC CFR 47 Part 15 Subpart E 15.407
Serial #: DIGI60-U6 Rev A
Issue Date: 27th May 2016
Page: 76 of 141

Equipment Configuration for 5725 MHz Radiated Band-Edge Emissions

Antenna:	Taoglas PC.11	Variant:	802.11n HT-40
Antenna Gain (dBi):	4.50	Modulation:	OFDM
Beam Forming Gain (Y):	Not Applicable	Duty Cycle (%):	99
Channel Frequency (MHz):	5755.00	Data Rate:	13.50 MBit/s
Power Setting:	20	Tested By:	JMH

Test Measurement Results

Num	Frequency MHz	Raw dBµV	Cable Loss	AF dB	Level dBµV/m	Measurement Type	Pol	Hgt cm	Azt Deg	Limit dBµV/m	Margin dB	Pass /Fail
#1	5715.00	26.23	3.81	34.34	64.38	Max Avg	Vertical	199	197	68.2	-3.9	Pass
#2	5723.79	28.71	3.79	34.35	66.85	Max Avg	Vertical	199	197	78.2	-11.4	Pass
#3	5725.00	--	--	--	--	Band Edge	--	--	--	--	--	--

Test Notes: EUT on 150cm table powered by host.

[back to table](#)

This test report may be reproduced in full only. The document may only be updated by MiCOM Labs personnel. All changes will be noted in the Document History section of the report.



Title: Digi International AR6203
To: FCC CFR 47 Part 15 Subpart E 15.407
Serial #: DIGI60-U6 Rev A
Issue Date: 27th May 2016
Page: 77 of 141

Equipment Configuration for 5850 MHz Radiated Band-Edge Emissions

Antenna:	Taoglas PC.11	Variant:	802.11a
Antenna Gain (dBi):	4.50	Modulation:	OFDM
Beam Forming Gain (Y):	Not Applicable	Duty Cycle (%):	99
Channel Frequency (MHz):	5825.00	Data Rate:	6.00 MBit/s
Power Setting:	20	Tested By:	JMH

Test Measurement Results

Num	Frequency MHz	Raw dBµV	Cable Loss	AF dB	Level dBµV/m	Measurement Type	Pol	Hgt cm	Azt Deg	Limit dBµV/m	Margin dB	Pass /Fail
#1	5850.00	20.10	3.81	34.63	58.54	Max Avg	Vertical	199	197	78.2	-19.7	Pass
#3	5860.00	13.71	3.86	34.65	52.22	Max Avg	Vertical	199	197	68.2	-16.0	Pass
#2	5850.00	--	--	--	--	Band Edge	--	--	--	--	--	--

Test Notes: EUT on 150cm table powered by host.

[back to table](#)

This test report may be reproduced in full only. The document may only be updated by MiCOM Labs personnel. All changes will be noted in the Document History section of the report.



Title: Digi International AR6203
To: FCC CFR 47 Part 15 Subpart E 15.407
Serial #: DIGI60-U6 Rev A
Issue Date: 27th May 2016
Page: 78 of 141

Equipment Configuration for 5850 MHz Radiated Band-Edge Emissions

Antenna:	Taoglas PC.11	Variant:	802.11n HT-20
Antenna Gain (dBi):	4.50	Modulation:	OFDM
Beam Forming Gain (Y):	Not Applicable	Duty Cycle (%):	99
Channel Frequency (MHz):	5825.00	Data Rate:	6.50 MBit/s
Power Setting:	20	Tested By:	JMH

Test Measurement Results

Num	Frequency MHz	Raw dBµV	Cable Loss	AF dB	Level dBµV/m	Measurement Type	Pol	Hgt cm	Azt Deg	Limit dBµV/m	Margin dB	Pass /Fail
#1	5850.00	21.84	3.81	34.63	60.28	Max Avg	Vertical	199	197	78.2	-18.0	Pass
#3	5860.00	14.35	3.86	34.65	52.86	Max Avg	Vertical	199	197	68.2	-15.4	Pass
#2	5850.00	--	--	--	--	Band Edge	--	--	--	--	--	--

Test Notes: EUT on 150cm table powered by host.

[back to table](#)

This test report may be reproduced in full only. The document may only be updated by MiCOM Labs personnel. All changes will be noted in the Document History section of the report.



Title: Digi International AR6203
To: FCC CFR 47 Part 15 Subpart E 15.407
Serial #: DIGI60-U6 Rev A
Issue Date: 27th May 2016
Page: 79 of 141

Equipment Configuration for 5850 MHz Radiated Band-Edge Emissions

Antenna:	Taoglas PC.11	Variant:	802.11n HT-40
Antenna Gain (dBi):	4.50	Modulation:	OFDM
Beam Forming Gain (Y):	Not Applicable	Duty Cycle (%):	99
Channel Frequency (MHz):	5795.00	Data Rate:	13.50 MBit/s
Power Setting:	20	Tested By:	JMH

Test Measurement Results

Num	Frequency MHz	Raw dB μ V	Cable Loss	AF dB	Level dB μ V/m	Measurement Type	Pol	Hgt cm	Azt Deg	Limit dB μ V/m	Margin dB	Pass /Fail
#1	5850.00	14.99	3.81	34.63	53.43	Max Avg	Vertical	199	197	78.2	-24.8	Pass
#3	5860.00	13.01	3.86	34.65	51.52	Max Avg	Vertical	199	197	68.2	-16.7	Pass
#2	5850.00	--	--	--	--	Band Edge	--	--	--	--	--	--

Test Notes: EUT on 150cm table powered by host.

[back to table](#)

This test report may be reproduced in full only. The document may only be updated by MiCOM Labs personnel. All changes will be noted in the Document History section of the report.



Title: Digi International AR6203
To: FCC CFR 47 Part 15 Subpart E 15.407
Serial #: DIGI60-U6 Rev A
Issue Date: 27th May 2016
Page: 80 of 141

APPENDIX A - GRAPHICAL IMAGES

This test report may be reproduced in full only. The document may only be updated by MiCOM Labs personnel. All changes will be noted in the Document History section of the report.



A.1. 26 dB & 99% Bandwidth

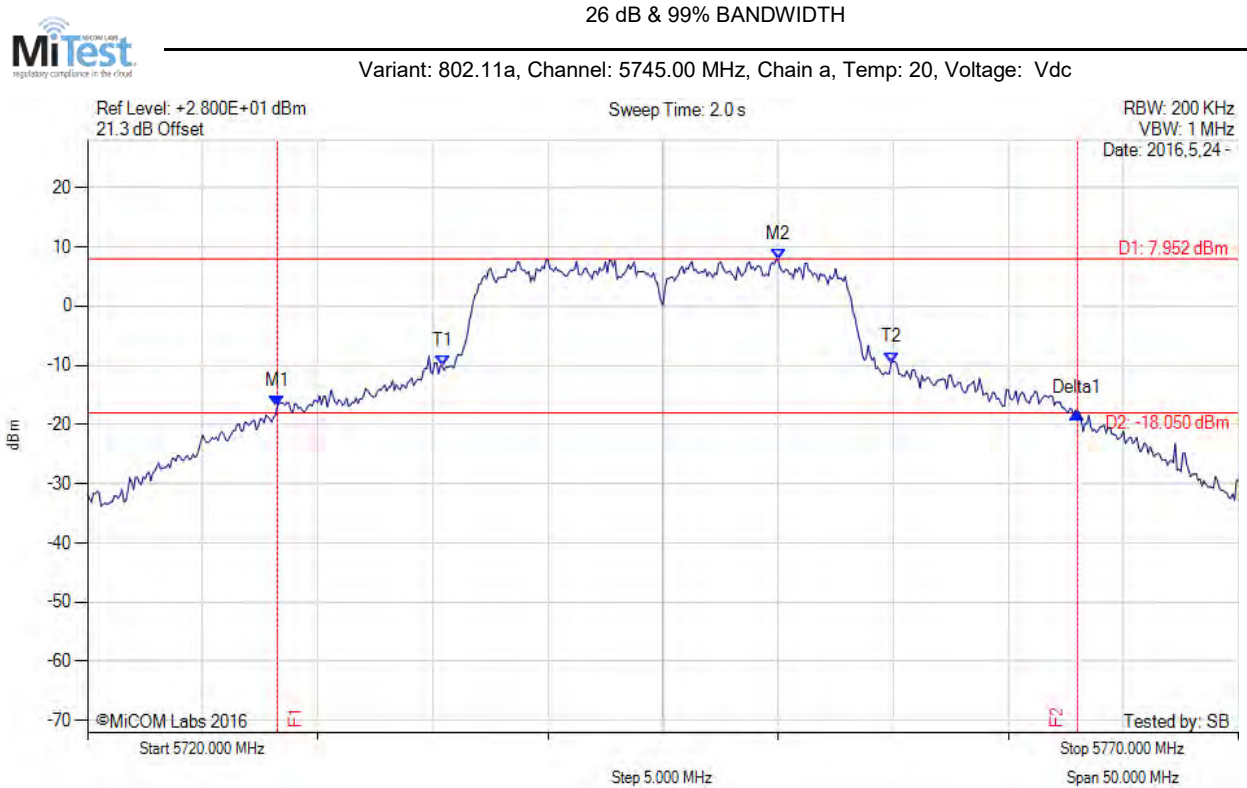

Analyzer Setup	Marker:Frequency:Amplitude	Test Results
Detector = POS Sweep Count = 0 RF Atten (dB) = 20 Trace Mode = MAXH	M1 : 5728.250 MHz : -16.893 dBm M2 : 5750.000 MHz : 7.952 dBm Delta1 : 34.750 MHz : -1.079 dB T1 : 5735.417 MHz : -10.205 dBm T2 : 5754.917 MHz : -9.544 dBm OBW : 20.202 MHz	Measured 26 dB Bandwidth: 34.750 MHz Measured 99% Bandwidth: 20.202 MHz

[back to matrix](#)

This test report may be reproduced in full only. The document may only be updated by MiCOM Labs personnel. All changes will be noted in the Document History section of the report.

26 dB & 99% BANDWIDTH



Variant: 802.11a, Channel: 5785.00 MHz, Chain a, Temp: 20, Voltage: Vdc

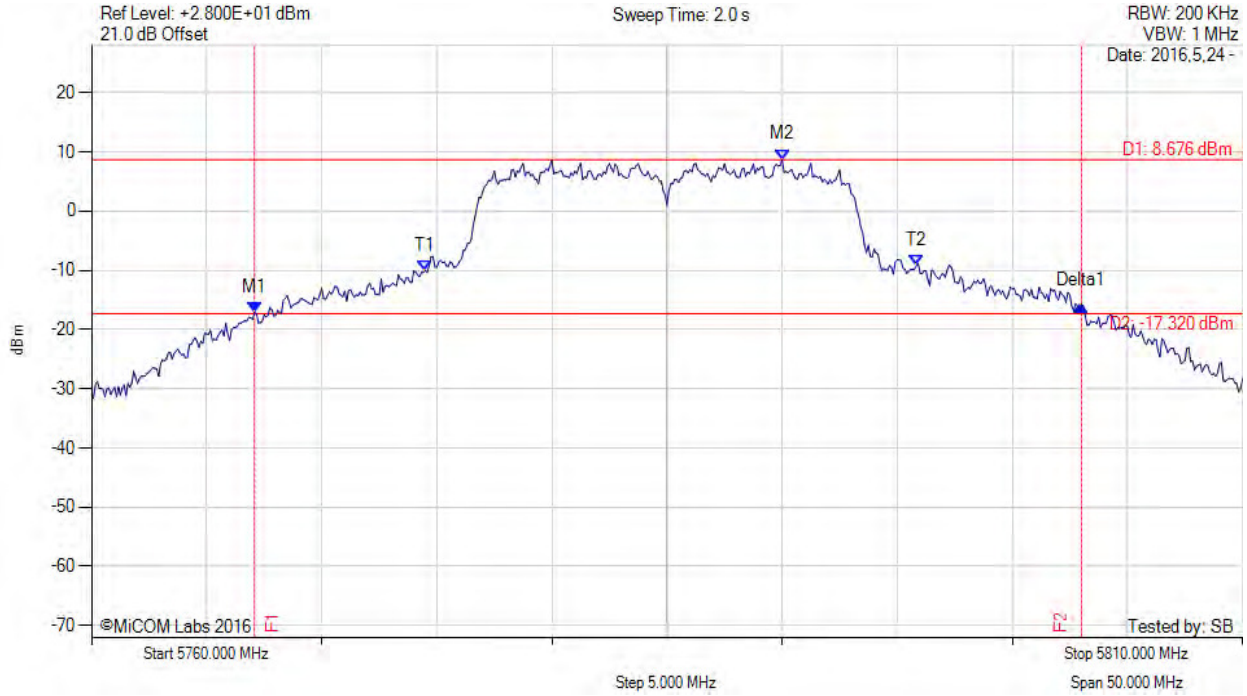

Analyzer Setup	Marker:Frequency:Amplitude	Test Results
Detector = POS Sweep Count = 0 RF Atten (dB) = 20 Trace Mode = MAXH	M1 : 5767.080 MHz : -17.058 dBm M2 : 5790.000 MHz : 8.676 dBm Delta1 : 35.920 MHz : 1.182 dB T1 : 5774.500 MHz : -10.075 dBm T2 : 5795.833 MHz : -9.223 dBm OBW : 22.343 MHz	Measured 26 dB Bandwidth: 35.920 MHz Measured 99% Bandwidth: 22.343 MHz

[back to matrix](#)

This test report may be reproduced in full only. The document may only be updated by MiCOM Labs personnel. All changes will be noted in the Document History section of the report.

26 dB & 99% BANDWIDTH



Variant: 802.11a, Channel: 5825.00 MHz, Chain a, Temp: 20, Voltage: Vdc

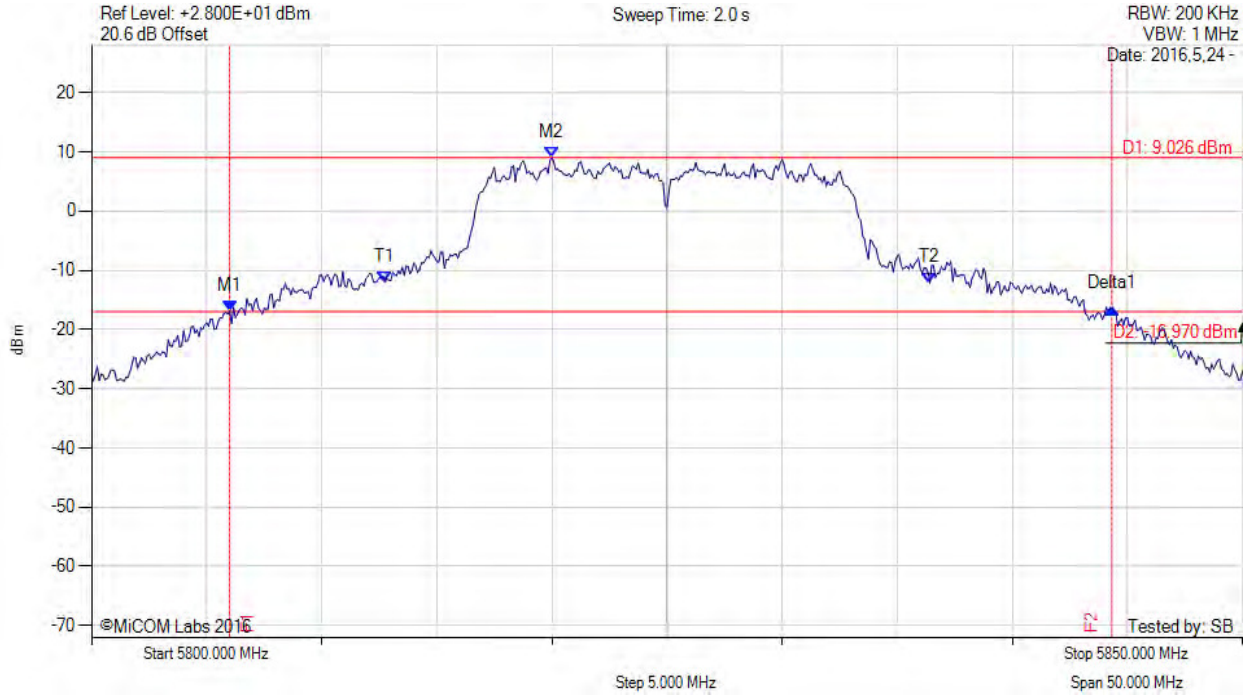

Analyzer Setup	Marker:Frequency:Amplitude	Test Results
Detector = POS Sweep Count = 0 RF Atten (dB) = 20 Trace Mode = MAXH	M1 : 5806.000 MHz : -16.831 dBm M2 : 5820.000 MHz : 9.026 dBm Delta1 : 38.330 MHz : 0.330 dB T1 : 5812.750 MHz : -12.018 dBm T2 : 5836.417 MHz : -12.120 dBm OBW : 24.749 MHz	Measured 26 dB Bandwidth: 38.330 MHz Measured 99% Bandwidth: 24.749 MHz

[back to matrix](#)

This test report may be reproduced in full only. The document may only be updated by MiCOM Labs personnel. All changes will be noted in the Document History section of the report.

26 dB & 99% BANDWIDTH



Variant: 802.11n HT-20, Channel: 5745.00 MHz, Chain a, Temp: 20, Voltage: Vdc

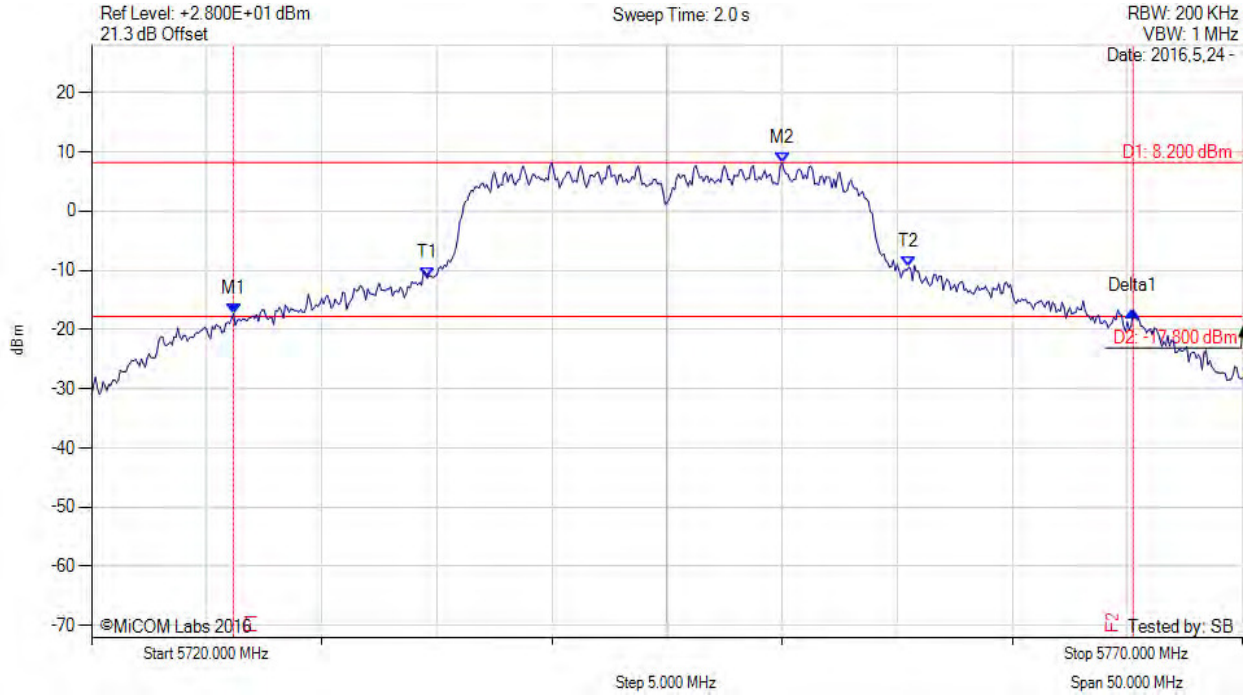

Analyzer Setup	Marker:Frequency:Amplitude	Test Results
Detector = POS Sweep Count = 0 RF Atten (dB) = 20 Trace Mode = MAXH	M1 : 5726.170 MHz : -17.289 dBm M2 : 5750.000 MHz : 8.200 dBm Delta1 : 39.080 MHz : 0.466 dB T1 : 5734.583 MHz : -11.323 dBm T2 : 5755.500 MHz : -9.457 dBm OBW : 21.974 MHz	Measured 26 dB Bandwidth: 39.080 MHz Measured 99% Bandwidth: 21.974 MHz

[back to matrix](#)

This test report may be reproduced in full only. The document may only be updated by MiCOM Labs personnel. All changes will be noted in the Document History section of the report.

26 dB & 99% BANDWIDTH



Variant: 802.11n HT-20, Channel: 5785.00 MHz, Chain a, Temp: 20, Voltage: Vdc

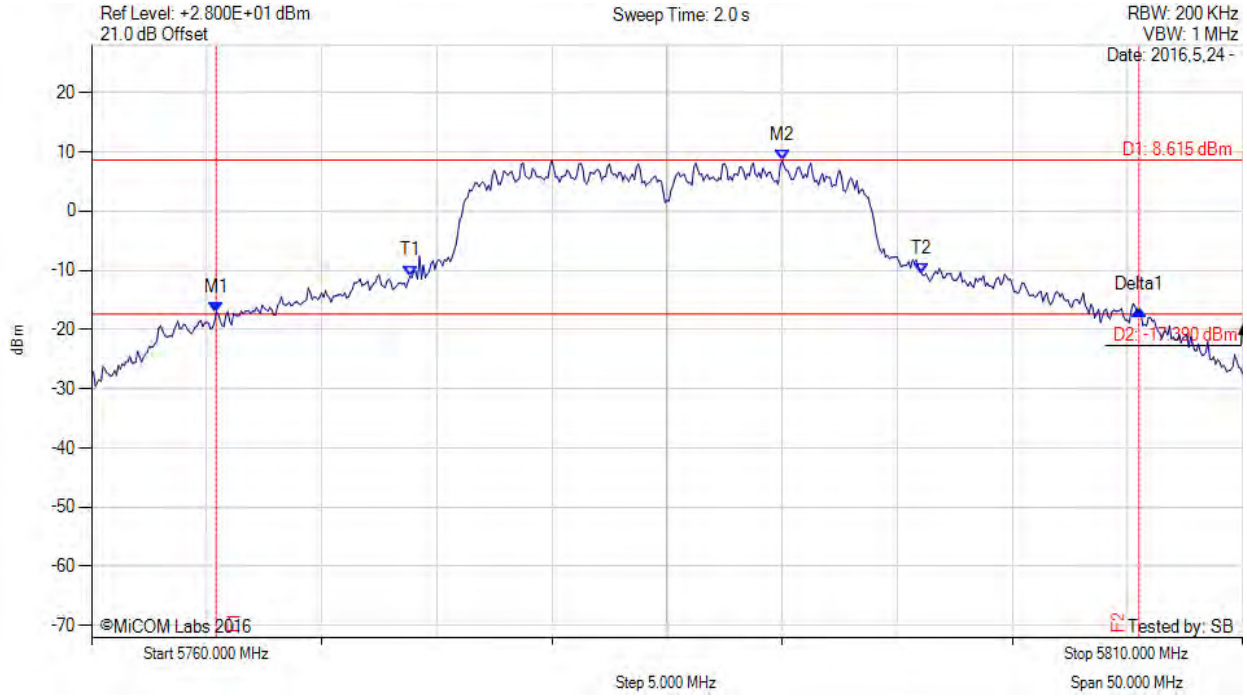

Analyzer Setup	Marker:Frequency:Amplitude	Test Results
Detector = POS Sweep Count = 0 RF Atten (dB) = 20 Trace Mode = MAXH	M1 : 5765.420 MHz : -17.125 dBm M2 : 5790.000 MHz : 8.615 dBm Delta1 : 40.080 MHz : 0.378 dB T1 : 5773.833 MHz : -10.952 dBm T2 : 5796.083 MHz : -10.664 dBm OBW : 23.779 MHz	Measured 26 dB Bandwidth: 40.080 MHz Measured 99% Bandwidth: 23.779 MHz

[back to matrix](#)

This test report may be reproduced in full only. The document may only be updated by MiCOM Labs personnel. All changes will be noted in the Document History section of the report.



26 dB & 99% BANDWIDTH



Variant: 802.11n HT-20, Channel: 5825.00 MHz, Chain a, Temp: 20, Voltage: Vdc

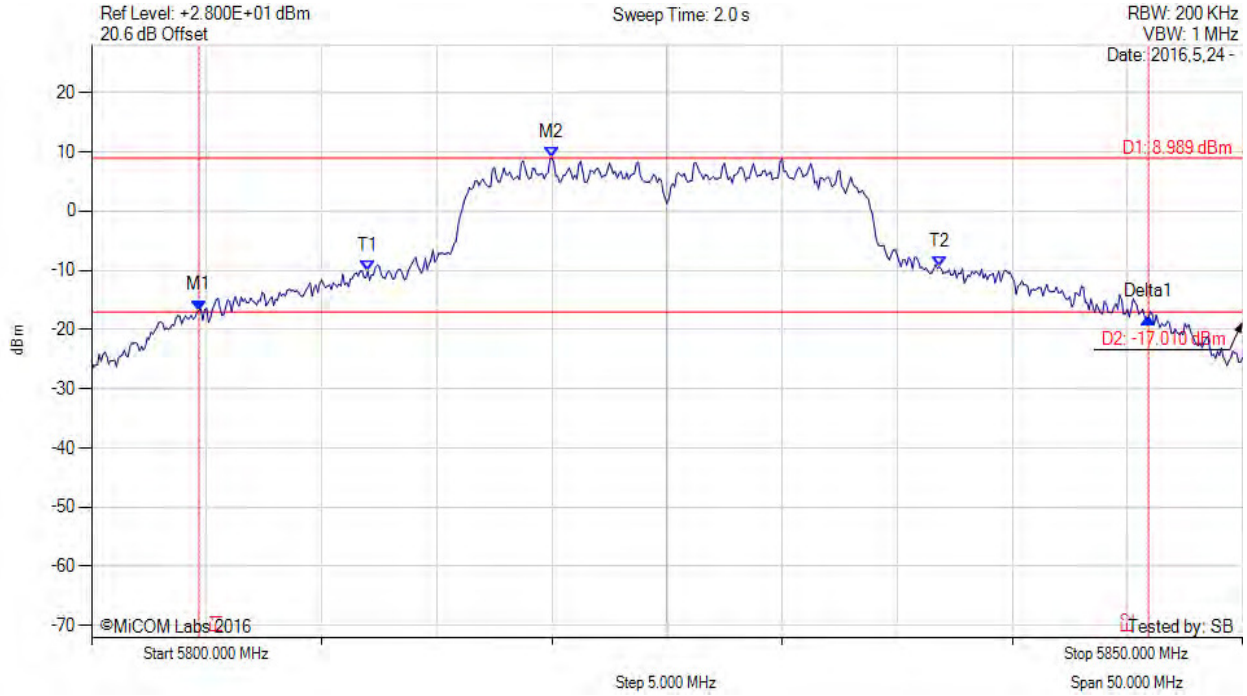

Analyzer Setup	Marker:Frequency:Amplitude	Test Results
Detector = POS Sweep Count = 0 RF Atten (dB) = 20 Trace Mode = MAXH	M1 : 5804.670 MHz : -16.780 dBm M2 : 5820.000 MHz : 8.989 dBm Delta1 : 41.250 MHz : -1.161 dB T1 : 5812.000 MHz : -10.171 dBm T2 : 5836.833 MHz : -9.419 dBm OBW : 26.502 MHz	Measured 26 dB Bandwidth: 41.250 MHz Measured 99% Bandwidth: 26.502 MHz

[back to matrix](#)

This test report may be reproduced in full only. The document may only be updated by MiCOM Labs personnel. All changes will be noted in the Document History section of the report.

26 dB & 99% BANDWIDTH



Variant: 802.11n HT-40, Channel: 5755.00 MHz, Chain a, Temp: 20, Voltage: Vdc

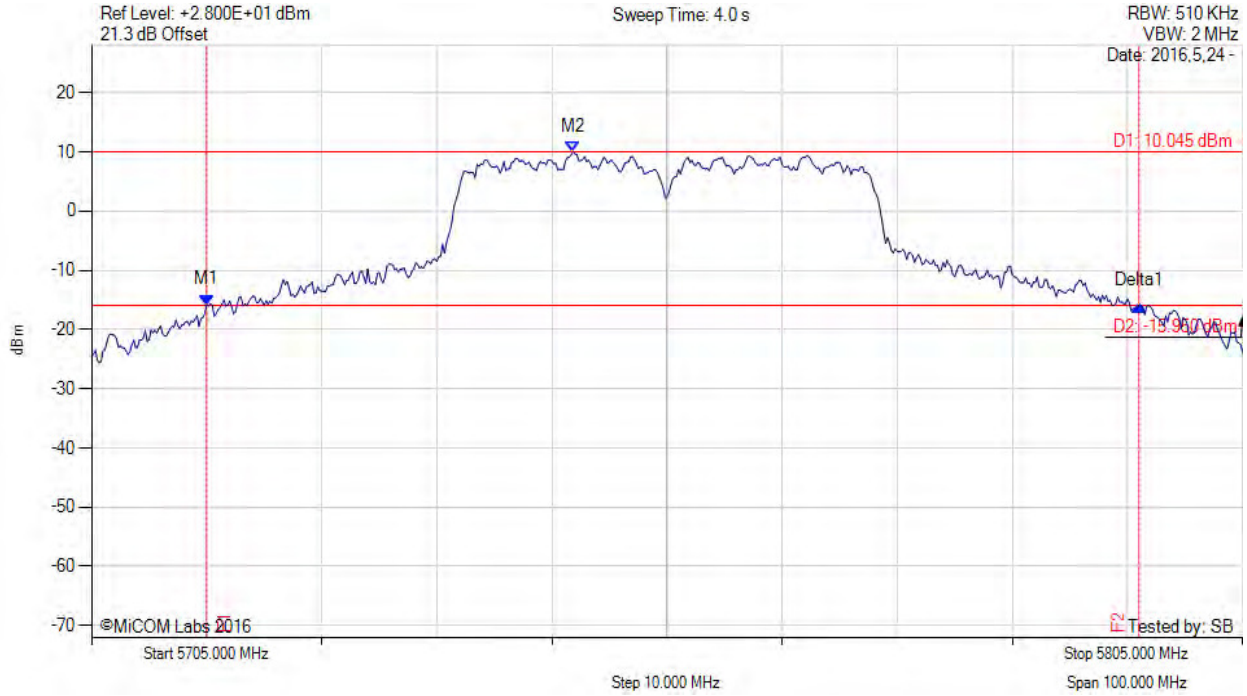

Analyzer Setup	Marker:Frequency:Amplitude	Test Results
Detector = POS Sweep Count = 0 RF Atten (dB) = 20 Trace Mode = MAXH	M1 : 5715.000 MHz : -15.839 dBm M2 : 5746.830 MHz : 10.045 dBm Delta1 : 81.000 MHz : -0.099 dB T1 : 0 Hz : 0.000 dBm T2 : 0 Hz : 0.000 dBm OBW : 46.559 MHz	Measured 26 dB Bandwidth: 81.000 MHz Measured 99% Bandwidth: 46.559 MHz

[back to matrix](#)

This test report may be reproduced in full only. The document may only be updated by MiCOM Labs personnel. All changes will be noted in the Document History section of the report.

26 dB & 99% BANDWIDTH



Variant: 802.11n HT-40, Channel: 5795.00 MHz, Chain a, Temp: 20, Voltage: Vdc

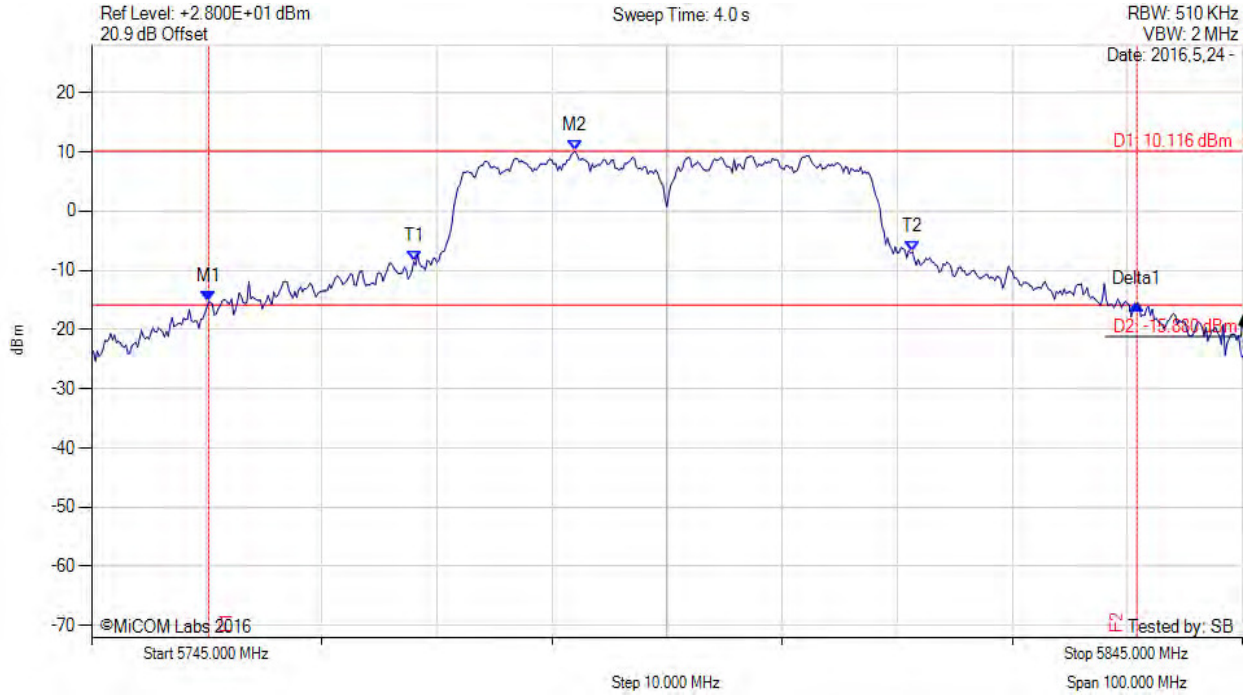

Analyzer Setup	Marker:Frequency:Amplitude	Test Results
Detector = POS Sweep Count = 0 RF Atten (dB) = 20 Trace Mode = MAXH	M1 : 5755.170 MHz : -15.327 dBm M2 : 5787.000 MHz : 10.116 dBm Delta1 : 80.670 MHz : -0.375 dB T1 : 5773.000 MHz : -8.523 dBm T2 : 5816.333 MHz : -6.905 dBm OBW : 46.173 MHz	Measured 26 dB Bandwidth: 80.670 MHz Measured 99% Bandwidth: 46.173 MHz

[back to matrix](#)

This test report may be reproduced in full only. The document may only be updated by MiCOM Labs personnel. All changes will be noted in the Document History section of the report.



A.2. Power Spectral Density

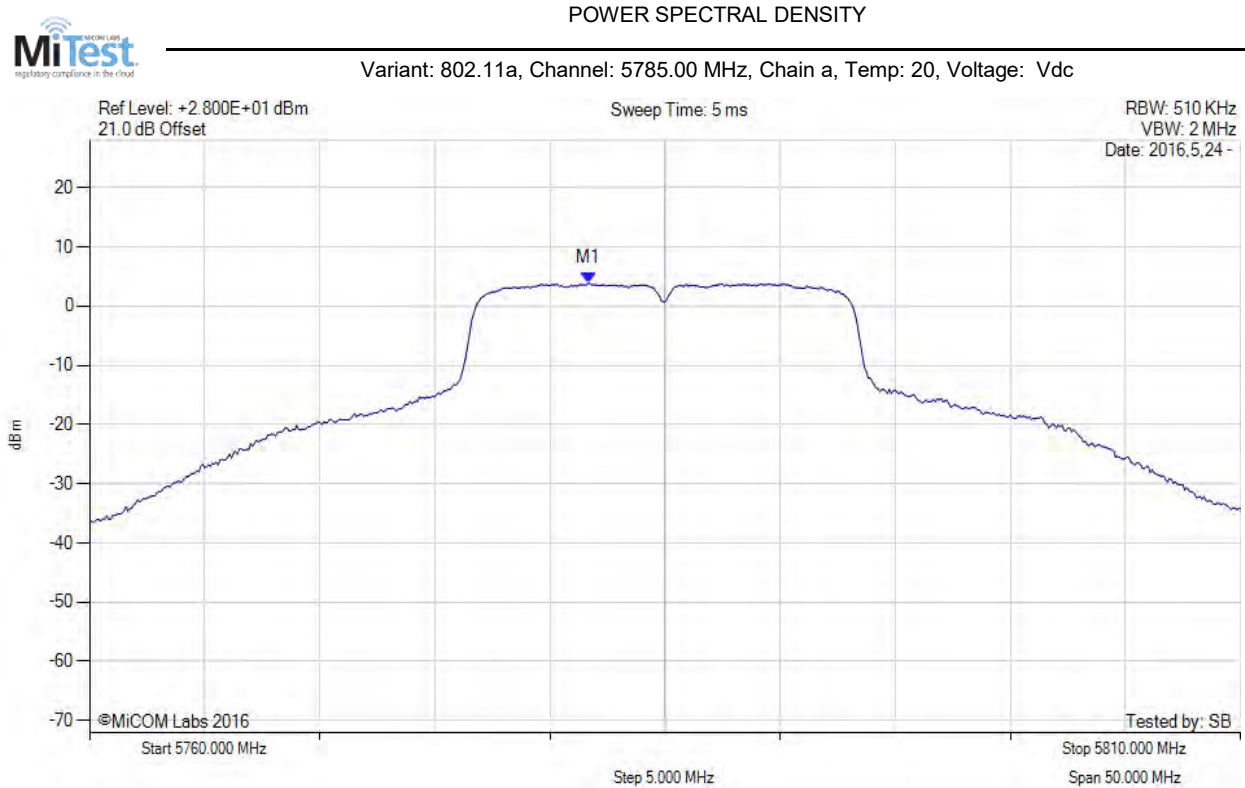

Analyzer Setup	Marker:Frequency:Amplitude	Test Results
Detector = AVER Sweep Count = +100 RF Atten (dB) = 20 Trace Mode = VIEW	M1 : 5781.670 MHz : 3.865 dBm	Limit: ≤ 30.000 dBm

[back to matrix](#)

This test report may be reproduced in full only. The document may only be updated by MiCOM Labs personnel. All changes will be noted in the Document History section of the report.



Title: Digi International AR6203
To: FCC CFR 47 Part 15 Subpart E 15.407
Serial #: DIGI60-U6 Rev A
Issue Date: 27th May 2016
Page: 90 of 141

POWER SPECTRAL DENSITY



Variant: 802.11a, Channel: 5785.00 MHz, SUM, Temp: 20, Voltage: Vdc

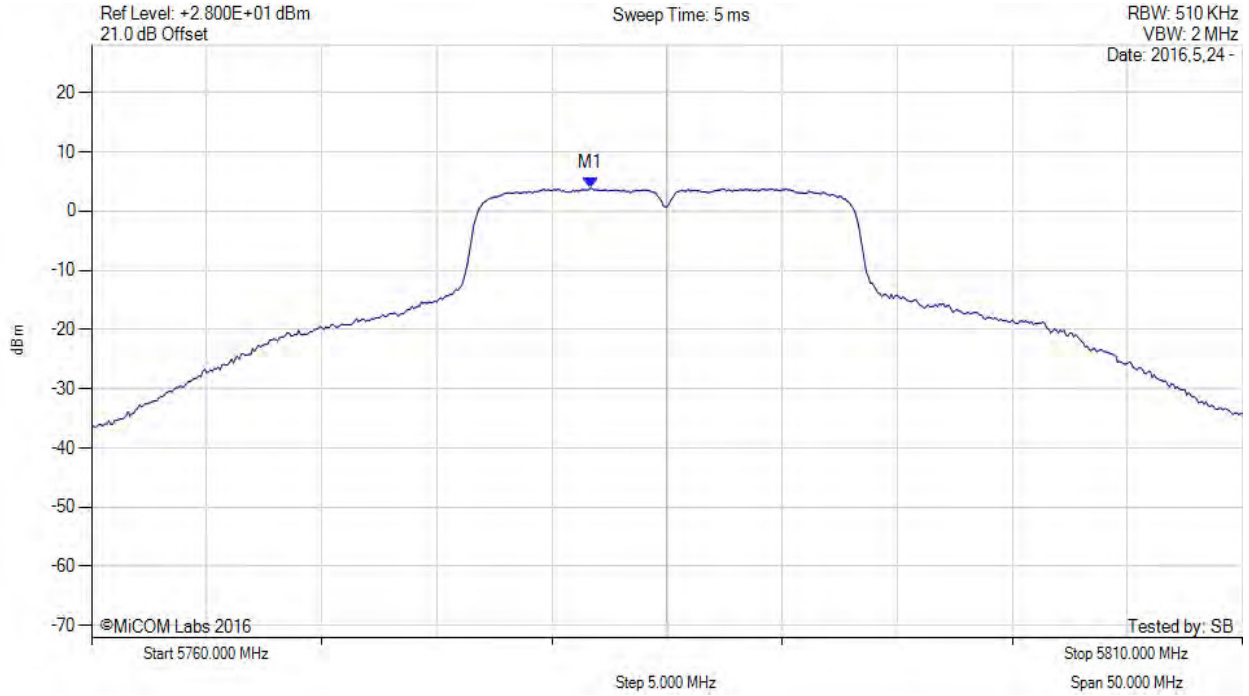

Analyzer Setup	Marker:Frequency:Amplitude	Test Results
Detector = AVER Sweep Count = +100 RF Atten (dB) = 20 Trace Mode = VIEW	M1 : 5781.700 MHz : 3.865 dBm M1 + DCCF : 5781.700 MHz : 3.909 dBm Duty Cycle Correction Factor : +0.04 dB	Limit: ≤ 30.0 dBm Margin: -26.1 dB

[back to matrix](#)

This test report may be reproduced in full only. The document may only be updated by MiCOM Labs personnel. All changes will be noted in the Document History section of the report.



POWER SPECTRAL DENSITY



Variant: 802.11n HT-20, Channel: 5785.00 MHz, Chain a, Temp: 20, Voltage: Vdc

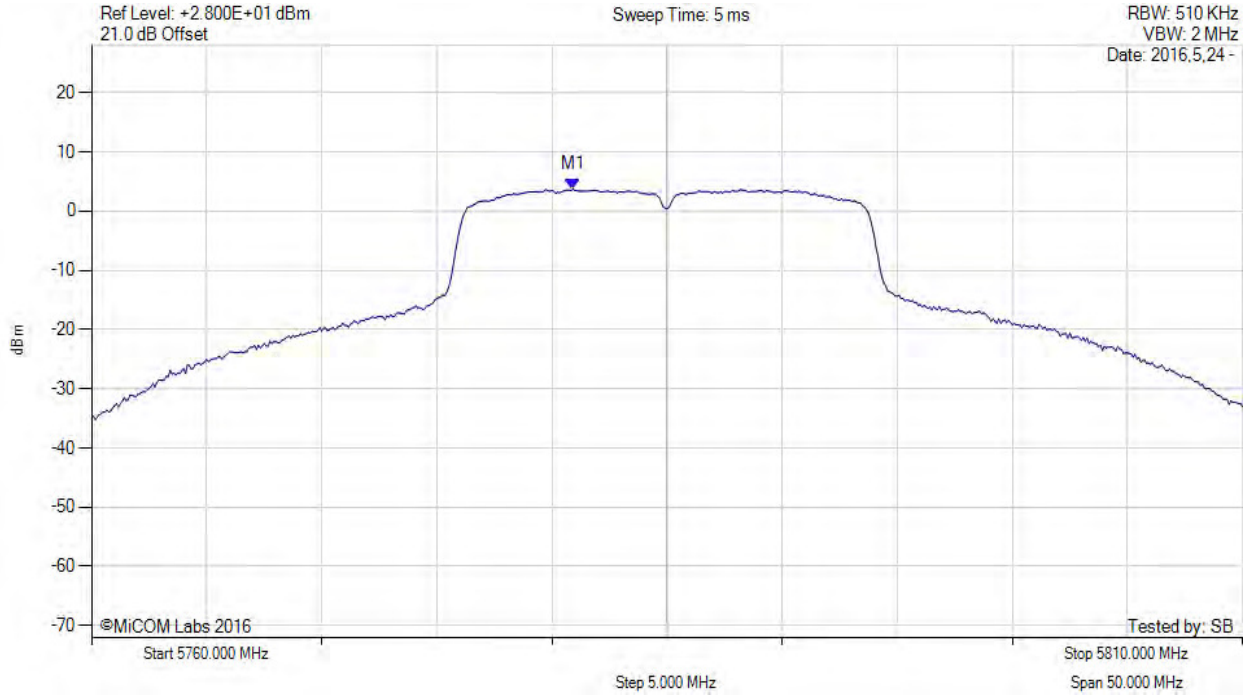

Analyzer Setup	Marker:Frequency:Amplitude	Test Results
Detector = AVER Sweep Count = +100 RF Atten (dB) = 20 Trace Mode = VIEW	M1 : 5780.920 MHz : 3.740 dBm	Limit: ≤ 30.000 dBm

[back to matrix](#)

This test report may be reproduced in full only. The document may only be updated by MiCOM Labs personnel. All changes will be noted in the Document History section of the report.

POWER SPECTRAL DENSITY



Variant: 802.11n HT-20, Channel: 5785.00 MHz, SUM, Temp: 20, Voltage: Vdc

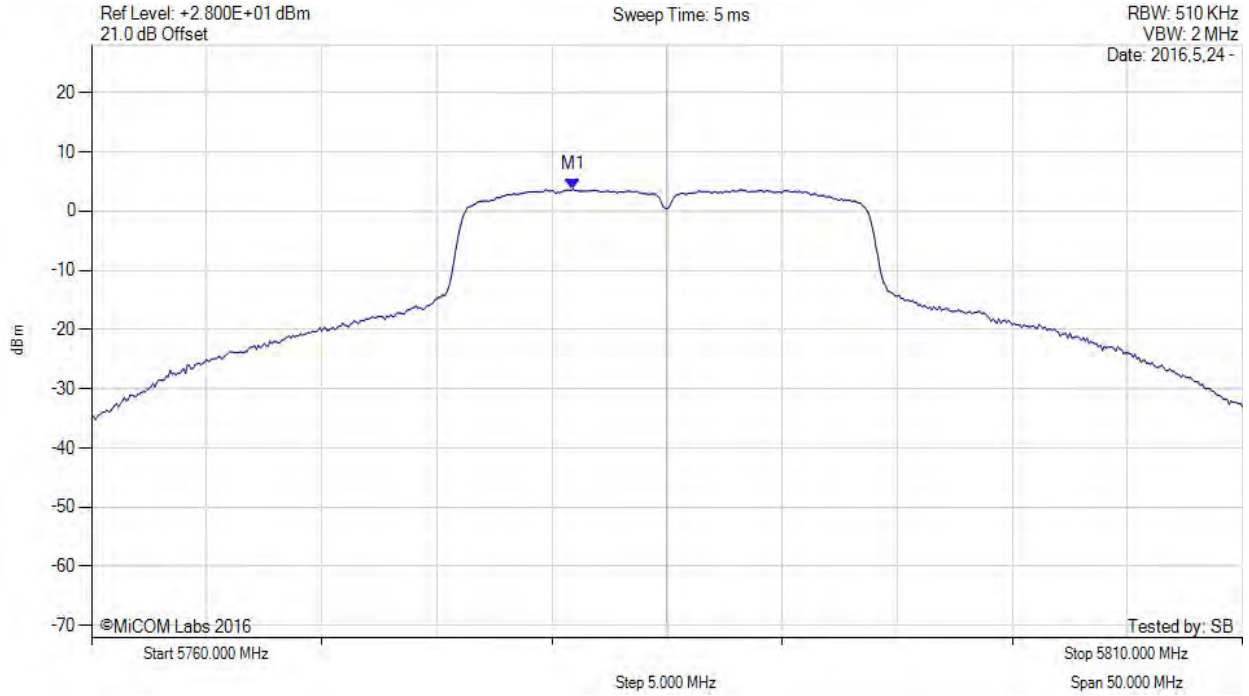

Analyzer Setup	Marker:Frequency:Amplitude	Test Results
Detector = AVER Sweep Count = +100 RF Atten (dB) = 20 Trace Mode = VIEW	M1 : 5780.900 MHz : 3.740 dBm M1 + DCCF : 5780.900 MHz : 3.784 dBm Duty Cycle Correction Factor : +0.04 dB	Limit: ≤ 30.0 dBm Margin: -26.2 dB

[back to matrix](#)

This test report may be reproduced in full only. The document may only be updated by MiCOM Labs personnel. All changes will be noted in the Document History section of the report.

POWER SPECTRAL DENSITY



Variant: 802.11a, Channel: 5745.00 MHz, Chain a, Temp: 20, Voltage: Vdc

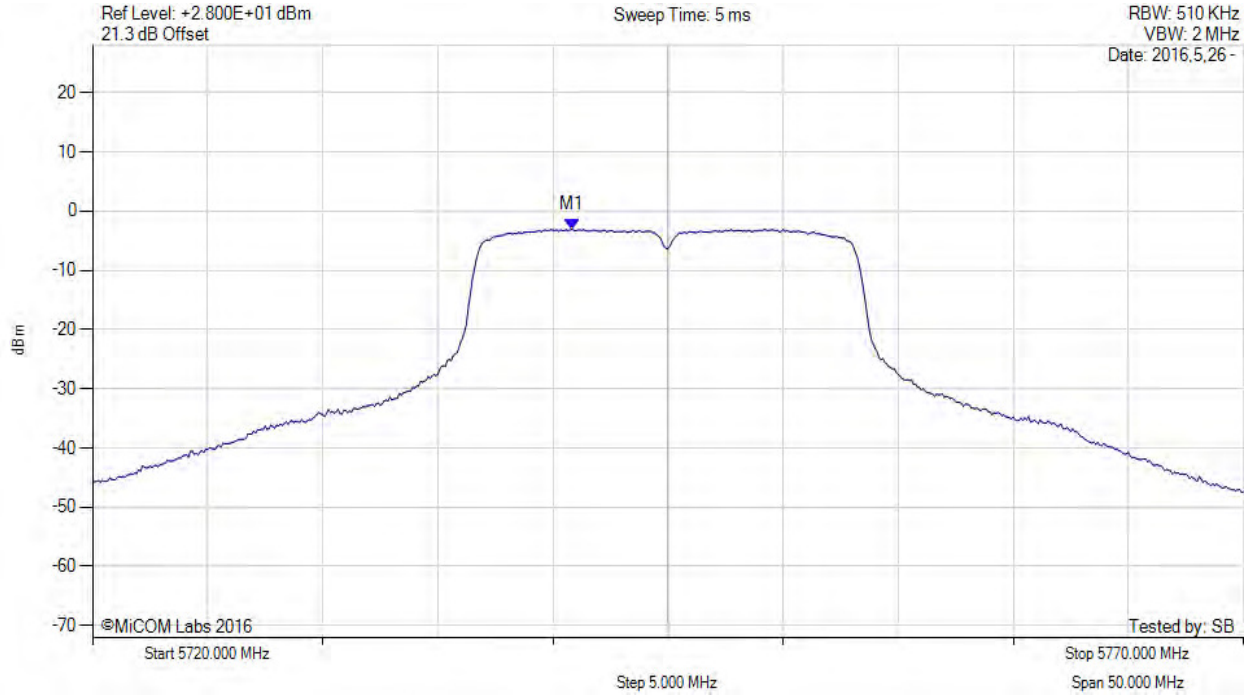

Analyzer Setup	Marker:Frequency:Amplitude	Test Results
Detector = AVER Sweep Count = +100 RF Atten (dB) = 20 Trace Mode = VIEW	M1 : 5740.830 MHz : -3.027 dBm	Limit: ≤ 30.000 dBm

[back to matrix](#)

This test report may be reproduced in full only. The document may only be updated by MiCOM Labs personnel. All changes will be noted in the Document History section of the report.



POWER SPECTRAL DENSITY



Variant: 802.11a, Channel: 5745.00 MHz, SUM, Temp: 20, Voltage: Vdc

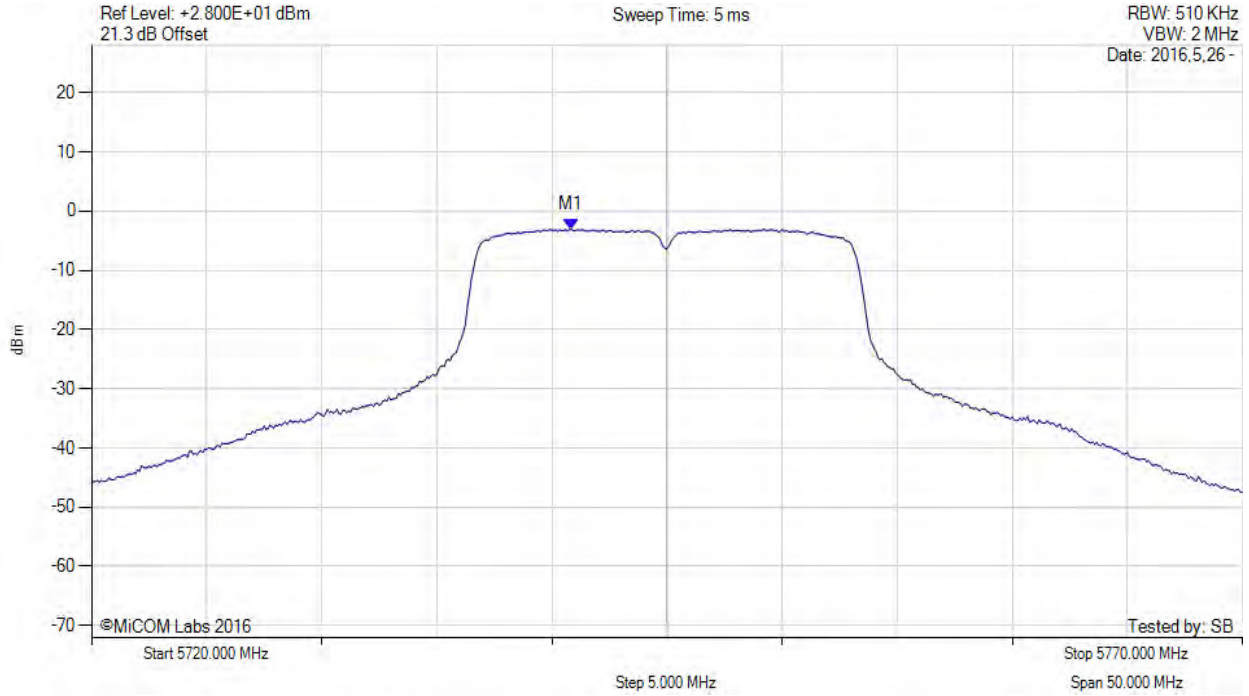

Analyzer Setup	Marker:Frequency:Amplitude	Test Results
Detector = AVER Sweep Count = +100 RF Atten (dB) = 20 Trace Mode = VIEW	M1 : 5740.800 MHz : -3.027 dBm M1 + DCCF : 5740.800 MHz : -2.983 dBm Duty Cycle Correction Factor : +0.04 dB	Limit: ≤ 30.0 dBm Margin: -33.0 dB

[back to matrix](#)

This test report may be reproduced in full only. The document may only be updated by MiCOM Labs personnel. All changes will be noted in the Document History section of the report.

POWER SPECTRAL DENSITY



Variant: 802.11a, Channel: 5825.00 MHz, Chain a, Temp: 20, Voltage: Vdc

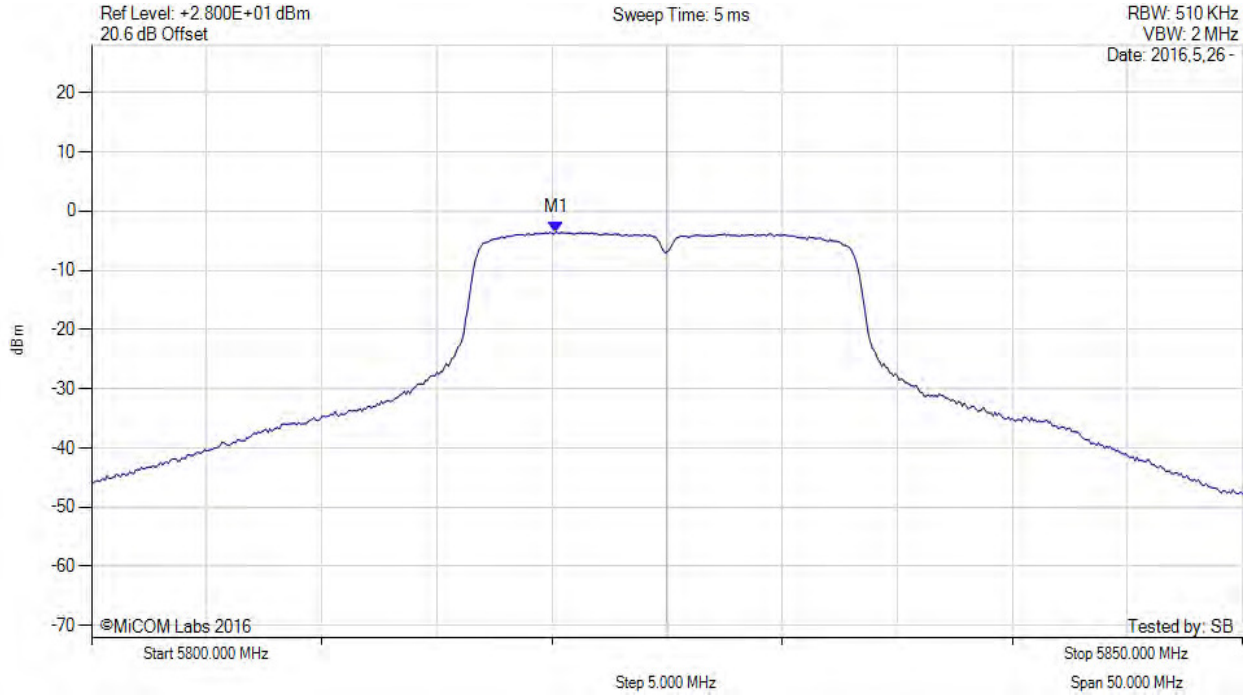

Analyzer Setup	Marker:Frequency:Amplitude	Test Results
Detector = AVER Sweep Count = +100 RF Atten (dB) = 20 Trace Mode = VIEW	M1 : 5820.170 MHz : -3.567 dBm	Limit: ≤ 30.000 dBm

[back to matrix](#)

This test report may be reproduced in full only. The document may only be updated by MiCOM Labs personnel. All changes will be noted in the Document History section of the report.

POWER SPECTRAL DENSITY



Variant: 802.11a, Channel: 5825.00 MHz, SUM, Temp: 20, Voltage: Vdc

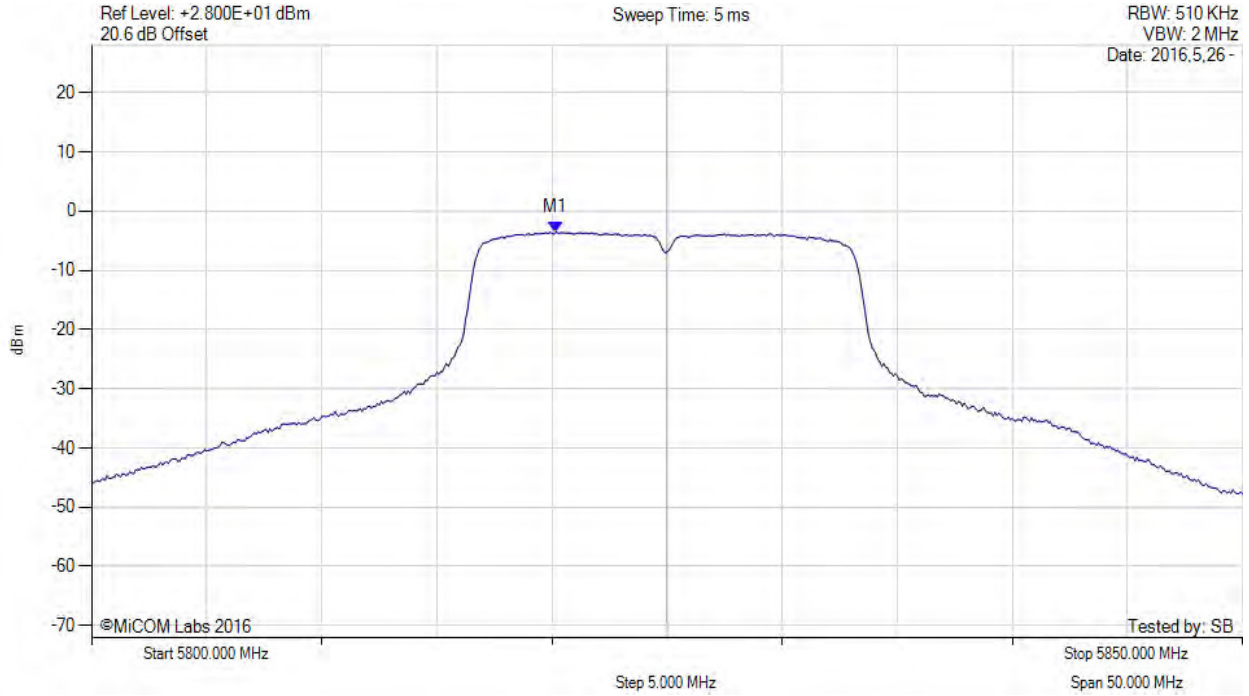

Analyzer Setup	Marker:Frequency:Amplitude	Test Results
Detector = AVER Sweep Count = +100 RF Atten (dB) = 20 Trace Mode = VIEW	M1 : 5820.200 MHz : -3.567 dBm M1 + DCCF : 5820.200 MHz : -3.523 dBm Duty Cycle Correction Factor : +0.04 dB	Limit: ≤ 30.0 dBm Margin: -33.5 dB

[back to matrix](#)

This test report may be reproduced in full only. The document may only be updated by MiCOM Labs personnel. All changes will be noted in the Document History section of the report.



POWER SPECTRAL DENSITY



Variant: 802.11n HT-20, Channel: 5745.00 MHz, Chain a, Temp: 20, Voltage: Vdc

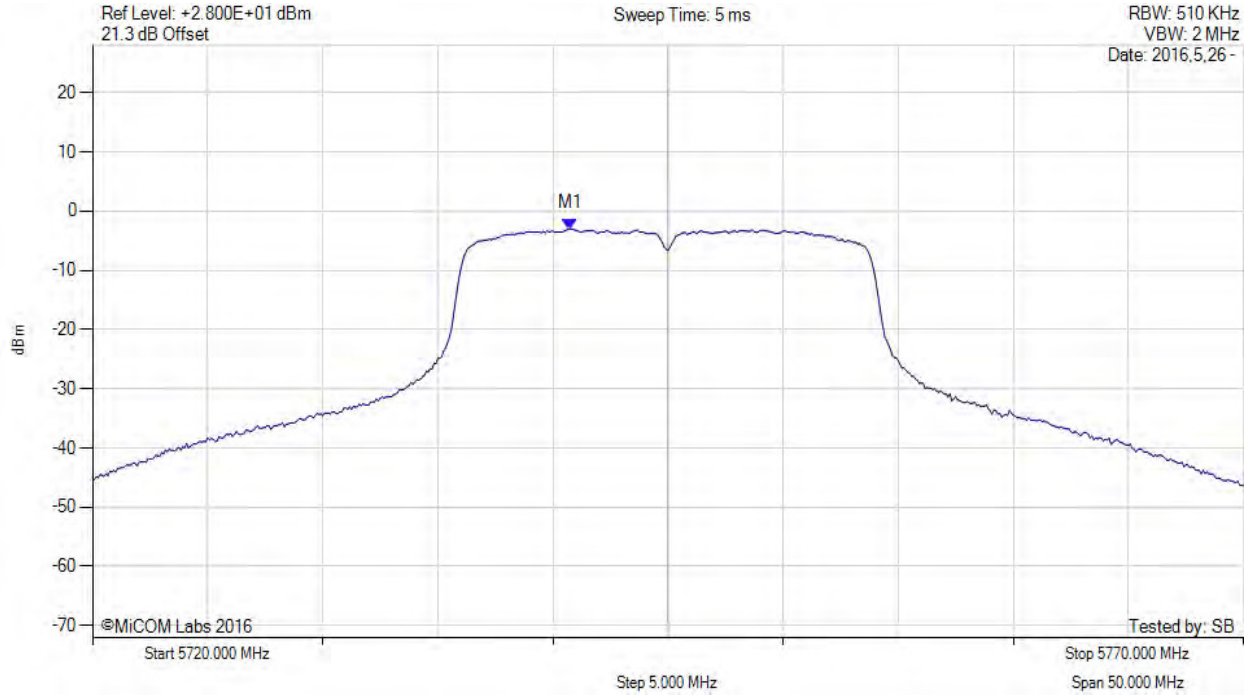

Analyzer Setup	Marker:Frequency:Amplitude	Test Results
Detector = AVER Sweep Count = +100 RF Atten (dB) = 20 Trace Mode = VIEW	M1 : 5740.750 MHz : -2.995 dBm	Limit: ≤ 30.000 dBm

[back to matrix](#)

This test report may be reproduced in full only. The document may only be updated by MiCOM Labs personnel. All changes will be noted in the Document History section of the report.

POWER SPECTRAL DENSITY



Variant: 802.11n HT-20, Channel: 5745.00 MHz, SUM, Temp: 20, Voltage: Vdc

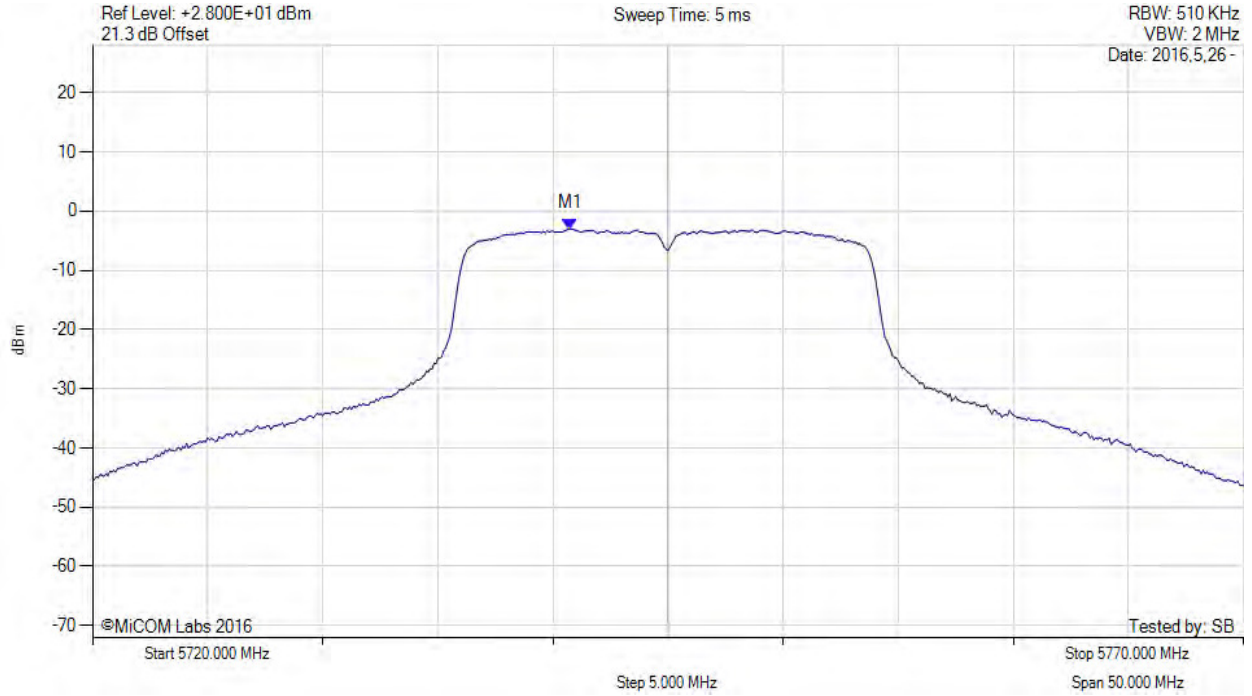

Analyzer Setup	Marker:Frequency:Amplitude	Test Results
Detector = AVER Sweep Count = +100 RF Atten (dB) = 20 Trace Mode = VIEW	M1 : 5740.800 MHz : -2.995 dBm M1 + DCCF : 5740.800 MHz : -2.951 dBm Duty Cycle Correction Factor : +0.04 dB	Limit: ≤ 30.0 dBm Margin: -33.0 dB

[back to matrix](#)

This test report may be reproduced in full only. The document may only be updated by MiCOM Labs personnel. All changes will be noted in the Document History section of the report.



POWER SPECTRAL DENSITY



Variant: 802.11n HT-20, Channel: 5825.00 MHz, Chain a, Temp: 20, Voltage: Vdc

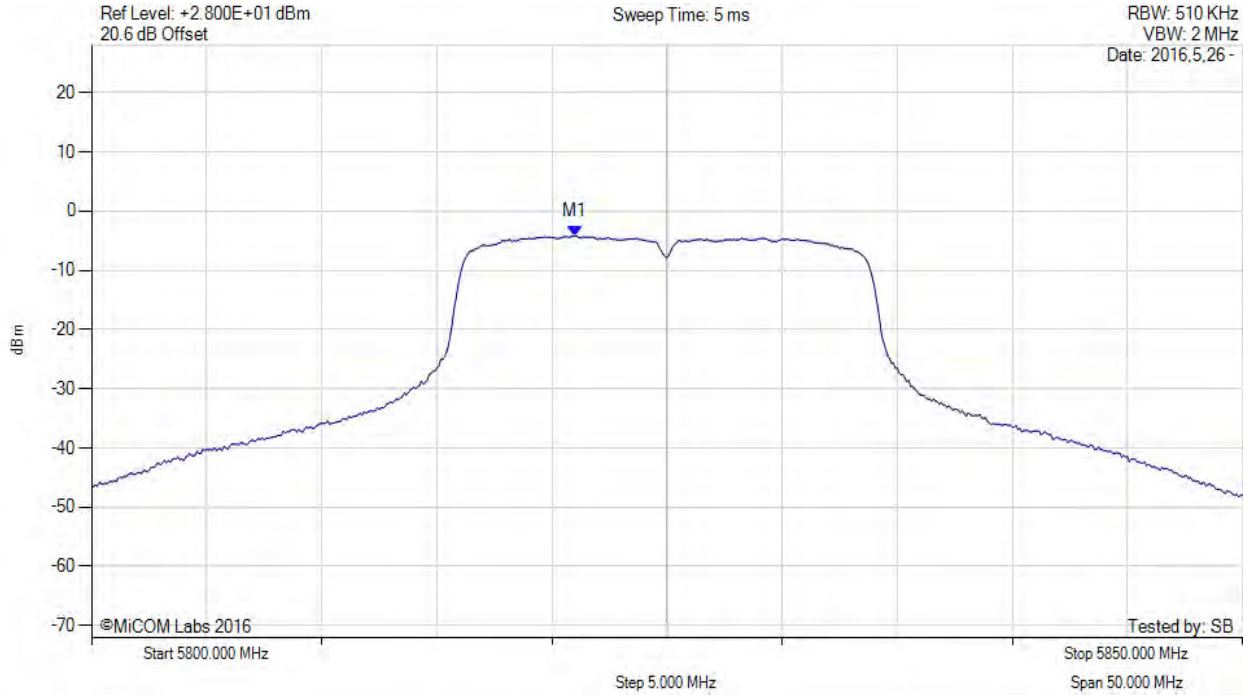

Analyzer Setup	Marker:Frequency:Amplitude	Test Results
Detector = AVER Sweep Count = +100 RF Atten (dB) = 20 Trace Mode = VIEW	M1 : 5821.000 MHz : -4.199 dBm	Limit: ≤ 30.000 dBm

[back to matrix](#)

This test report may be reproduced in full only. The document may only be updated by MiCOM Labs personnel. All changes will be noted in the Document History section of the report.



POWER SPECTRAL DENSITY



Variant: 802.11n HT-20, Channel: 5825.00 MHz, SUM, Temp: 20, Voltage: Vdc

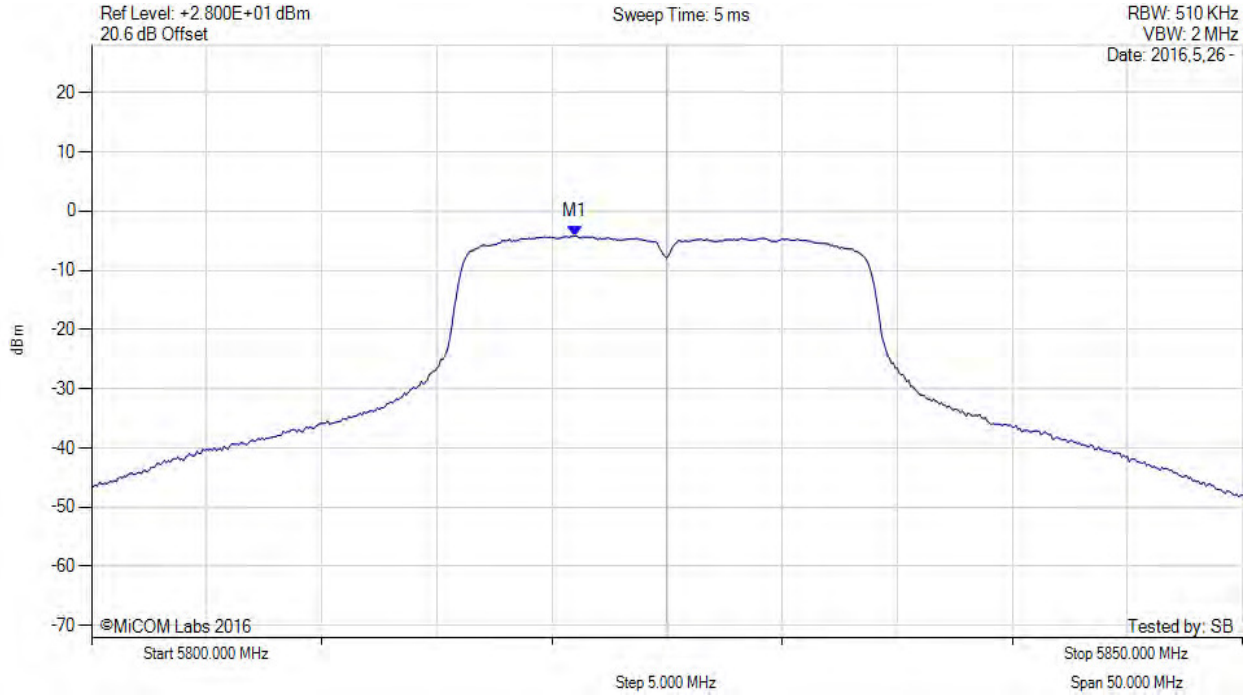

Analyzer Setup	Marker:Frequency:Amplitude	Test Results
Detector = AVER Sweep Count = +100 RF Atten (dB) = 20 Trace Mode = VIEW	M1 : 5821.000 MHz : -4.199 dBm M1 + DCCF : 5821.000 MHz : -4.155 dBm Duty Cycle Correction Factor : +0.04 dB	Limit: ≤ 30.0 dBm Margin: -34.2 dB

[back to matrix](#)

This test report may be reproduced in full only. The document may only be updated by MiCOM Labs personnel. All changes will be noted in the Document History section of the report.



Title: Digi International AR6203
To: FCC CFR 47 Part 15 Subpart E 15.407
Serial #: DIGI60-U6 Rev A
Issue Date: 27th May 2016
Page: 101 of 141

POWER SPECTRAL DENSITY



Variant: 802.11n HT-40, Channel: 5755.00 MHz, Chain a, Temp: 20, Voltage: Vdc

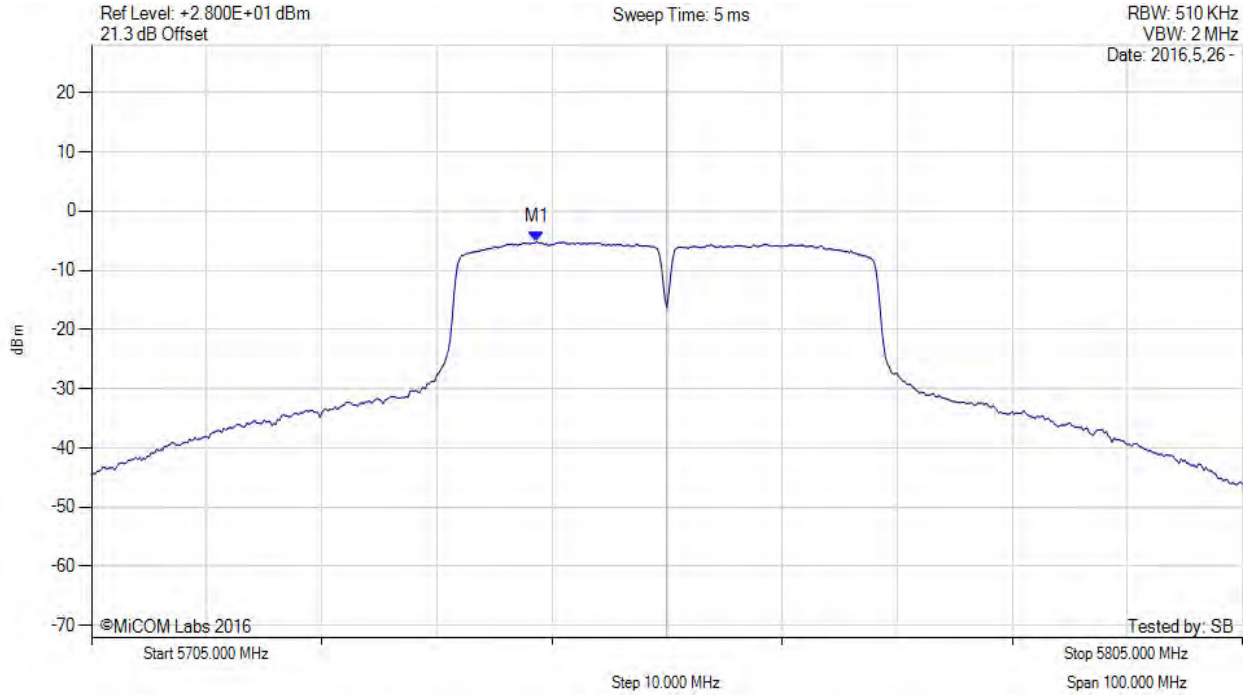

Analyzer Setup	Marker:Frequency:Amplitude	Test Results
Detector = AVER Sweep Count = +100 RF Atten (dB) = 20 Trace Mode = VIEW	M1 : 5743.670 MHz : -5.161 dBm	Limit: ≤ 30.000 dBm

[back to matrix](#)

This test report may be reproduced in full only. The document may only be updated by MiCOM Labs personnel. All changes will be noted in the Document History section of the report.

POWER SPECTRAL DENSITY



Variant: 802.11n HT-40, Channel: 5755.00 MHz, SUM, Temp: 20, Voltage: Vdc

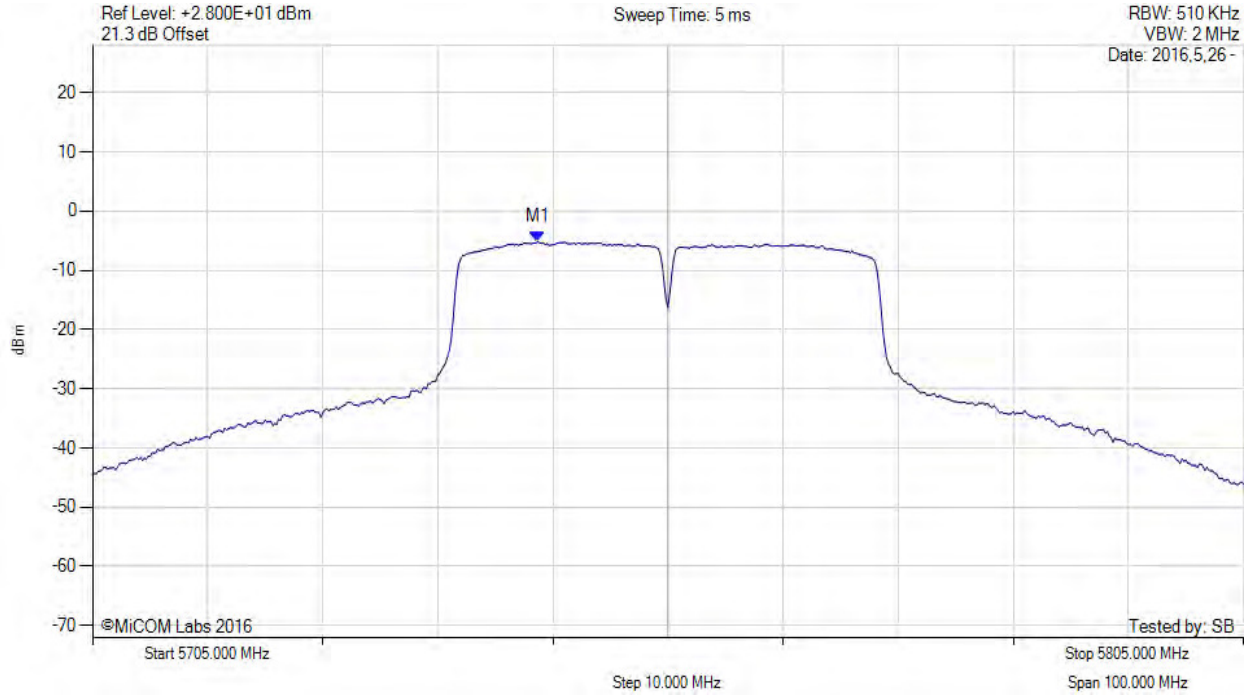

Analyzer Setup	Marker:Frequency:Amplitude	Test Results
Detector = AVER Sweep Count = +100 RF Atten (dB) = 20 Trace Mode = VIEW	M1 : 5743.700 MHz : -5.161 dBm M1 + DCCF : 5743.700 MHz : -5.117 dBm Duty Cycle Correction Factor : +0.04 dB	Limit: ≤ 30.0 dBm Margin: -35.1 dB

[back to matrix](#)

This test report may be reproduced in full only. The document may only be updated by MiCOM Labs personnel. All changes will be noted in the Document History section of the report.



Title: Digi International AR6203
To: FCC CFR 47 Part 15 Subpart E 15.407
Serial #: DIGI60-U6 Rev A
Issue Date: 27th May 2016
Page: 103 of 141

POWER SPECTRAL DENSITY



Variant: 802.11n HT-40, Channel: 5795.00 MHz, Chain a, Temp: 20, Voltage: Vdc

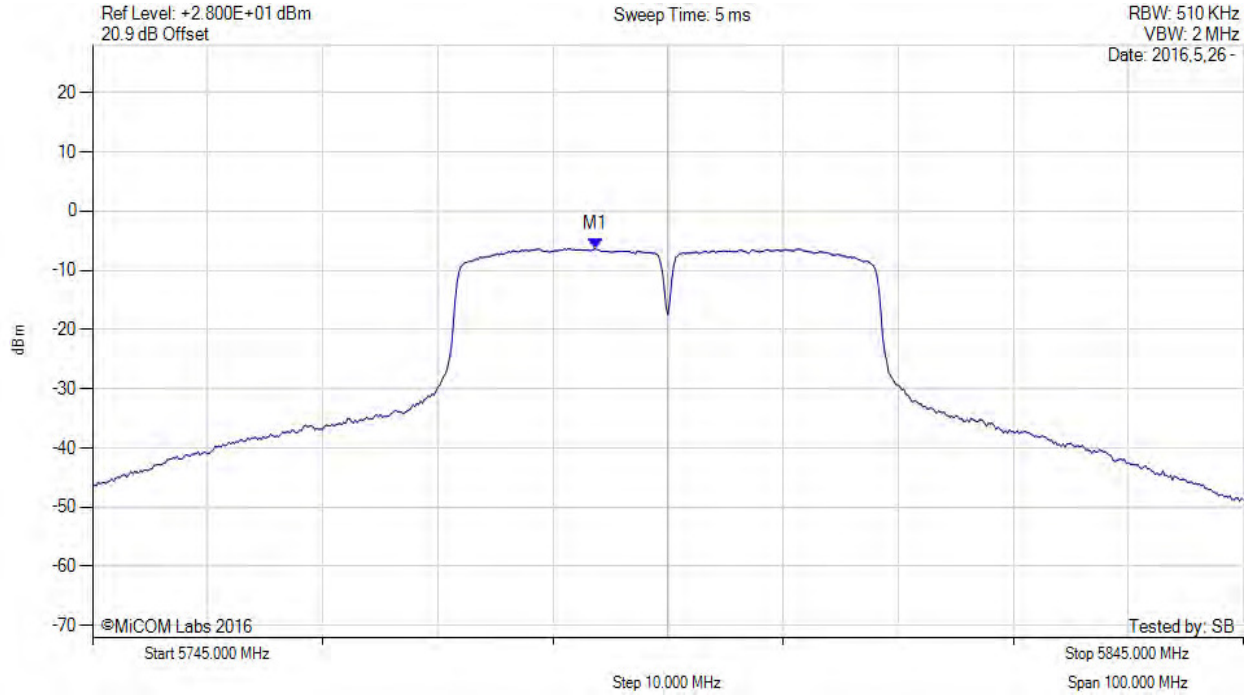

Analyzer Setup	Marker:Frequency:Amplitude	Test Results
Detector = AVER Sweep Count = +100 RF Atten (dB) = 20 Trace Mode = VIEW	M1 : 5788.670 MHz : -6.343 dBm	Limit: ≤ 30.000 dBm

[back to matrix](#)

This test report may be reproduced in full only. The document may only be updated by MiCOM Labs personnel. All changes will be noted in the Document History section of the report.



Title: Digi International AR6203
To: FCC CFR 47 Part 15 Subpart E 15.407
Serial #: DIGI60-U6 Rev A
Issue Date: 27th May 2016
Page: 104 of 141

POWER SPECTRAL DENSITY



Variant: 802.11n HT-40, Channel: 5795.00 MHz, SUM, Temp: 20, Voltage: Vdc

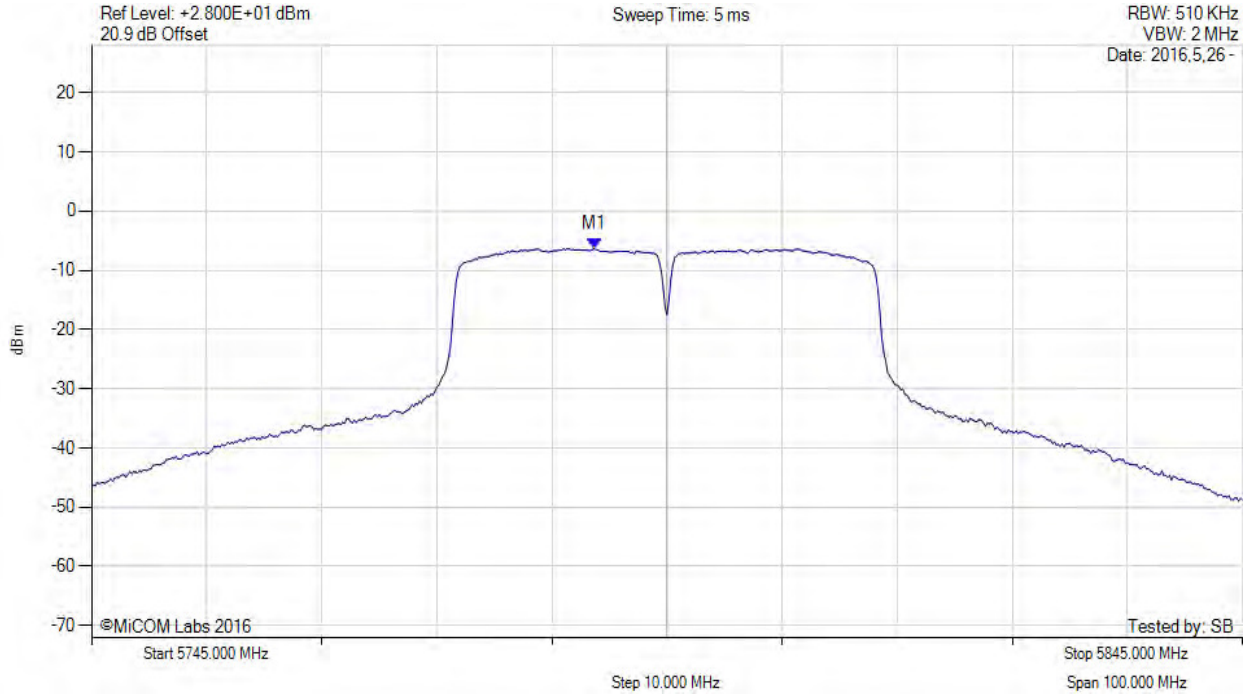

Analyzer Setup	Marker:Frequency:Amplitude	Test Results
Detector = AVER Sweep Count = +100 RF Atten (dB) = 20 Trace Mode = VIEW	M1 : 5788.700 MHz : -6.343 dBm M1 + DCCF : 5788.700 MHz : -6.299 dBm Duty Cycle Correction Factor : +0.04 dB	Limit: ≤ 30.0 dBm Margin: -36.3 dB

[back to matrix](#)

This test report may be reproduced in full only. The document may only be updated by MiCOM Labs personnel. All changes will be noted in the Document History section of the report.

A.3. Radiated

A.3.1. Restricted Band Emissions

A.3.1.1. Antenna Factor ANT-DB1-xxx



RADIATED SPURIOUS - RESTRICTED BAND EMISSIONS

Variant: 802.11a, Test Freq: 5745.00 MHz, Antenna: Antenna Factor ANT-DB1-xxx, Power Setting: 13.5, Duty Cycle (%): 99

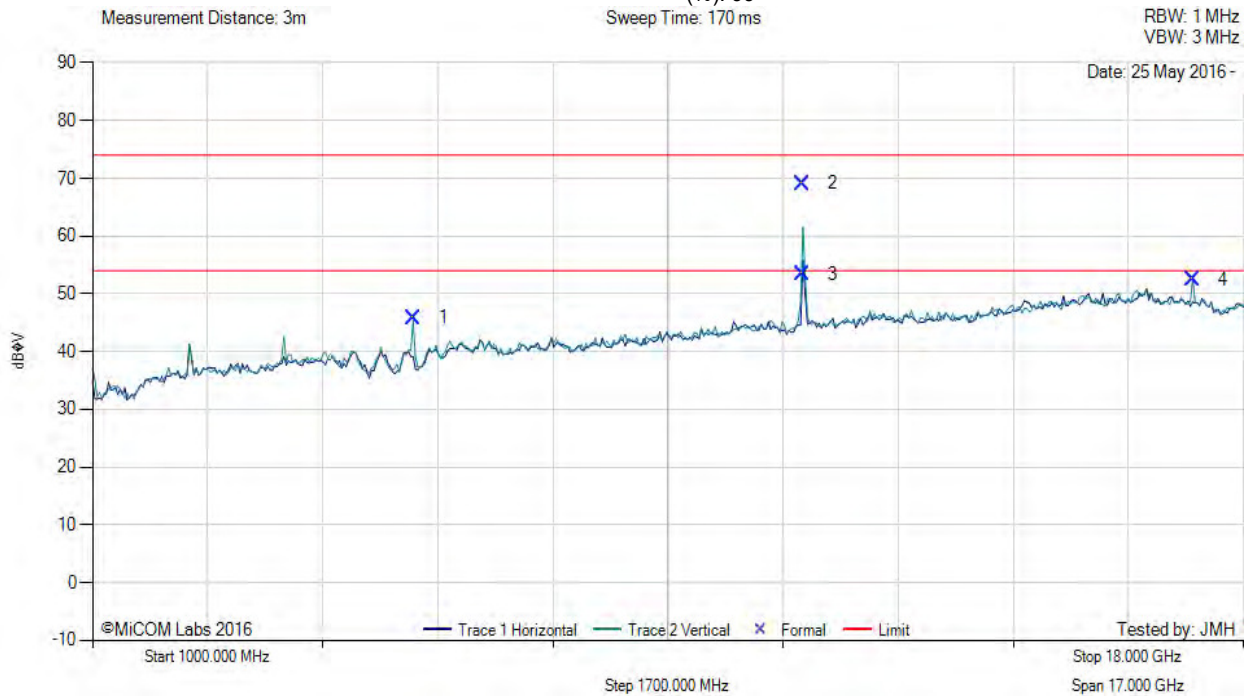

Num	Frequency MHz	Raw dBµV	Cable Loss	AF dB	Level dBµV/m	Measurement Type	Pol	Hgt cm	Azt Deg	Limit dBµV/m	Margin dB	Pass /Fail
1	5737.60	52.70	3.82	-10.67	45.85	Fundamental	Vertical	101	91	--	--	
2	11490.87	68.45	5.45	-4.84	69.06	Max Peak	Vertical	123	32	74.0	-4.9	Pass
3	11490.87	52.80	5.45	-4.84	53.39	Max Avg	Vertical	123	32	54.0	-0.6	Pass
4	17252.30	45.80	6.39	0.31	52.50	Peak (NRB)	Vertical	101	91	--	--	Pass

Test Notes: EUT on 150cm table powered by host. Power reduced to 13.5 to meet limit at 11.49 GHz

[back to matrix](#)

This test report may be reproduced in full only. The document may only be updated by MiCOM Labs personnel. All changes will be noted in the Document History section of the report.

RADIATED SPURIOUS - RESTRICTED BAND EMISSIONS



Variant: 802.11a, Test Freq: 5785.00 MHz, Antenna: Antenna Factor ANT-DB1-xxx, Power Setting: 20, Duty Cycle (%): 99

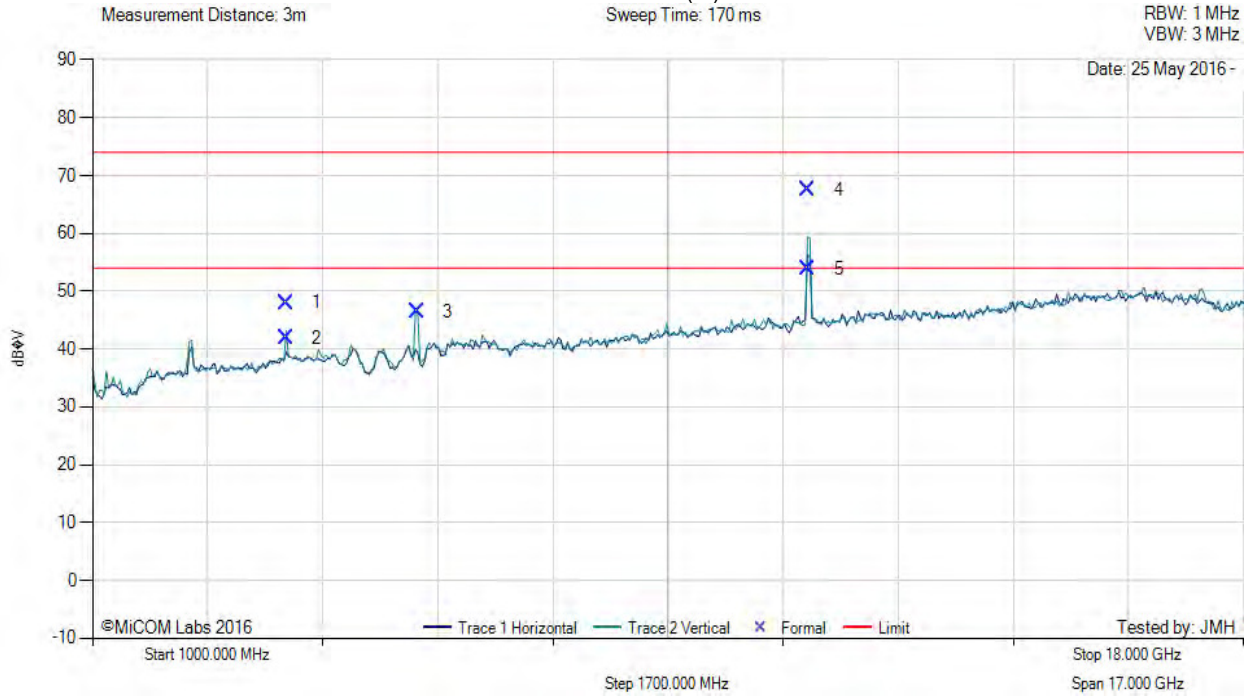

Num	Frequency MHz	Raw dBµV	Cable Loss	AF dB	Level dBµV/m	Measurement Type	Pol	Hgt cm	Azt Deg	Limit dBµV/m	Margin dB	Pass /Fail
1	3856.76	55.58	3.23	-10.81	48.00	Max Peak	Vertical	155	165	74.0	-26.0	Pass
2	3856.76	49.55	3.23	-10.81	41.97	Max Avg	Vertical	155	165	54.0	-12.0	Pass
3	5791.51	53.00	3.78	-10.40	46.38	Fundamental	Vertical	151	1	--	--	
4	11570.78	66.66	5.44	-4.64	67.46	Max Peak	Vertical	130	31	74.0	-6.5	Pass
5	11570.78	53.09	5.44	-4.64	53.89	Max Avg	Vertical	130	31	54.0	-0.1	Pass

Test Notes: EUT on 150cm table powered by host.

[back to matrix](#)

This test report may be reproduced in full only. The document may only be updated by MiCOM Labs personnel. All changes will be noted in the Document History section of the report.



Title: Digi International AR6203
To: FCC CFR 47 Part 15 Subpart E 15.407
Serial #: DIGI60-U6 Rev A
Issue Date: 27th May 2016
Page: 107 of 141

RADIATED SPURIOUS - RESTRICTED BAND EMISSIONS



Variant: 802.11a, Test Freq: 5825.00 MHz, Antenna: Antenna Factor ANT-DB1-xxx, Power Setting: 20, Duty Cycle (%): 99

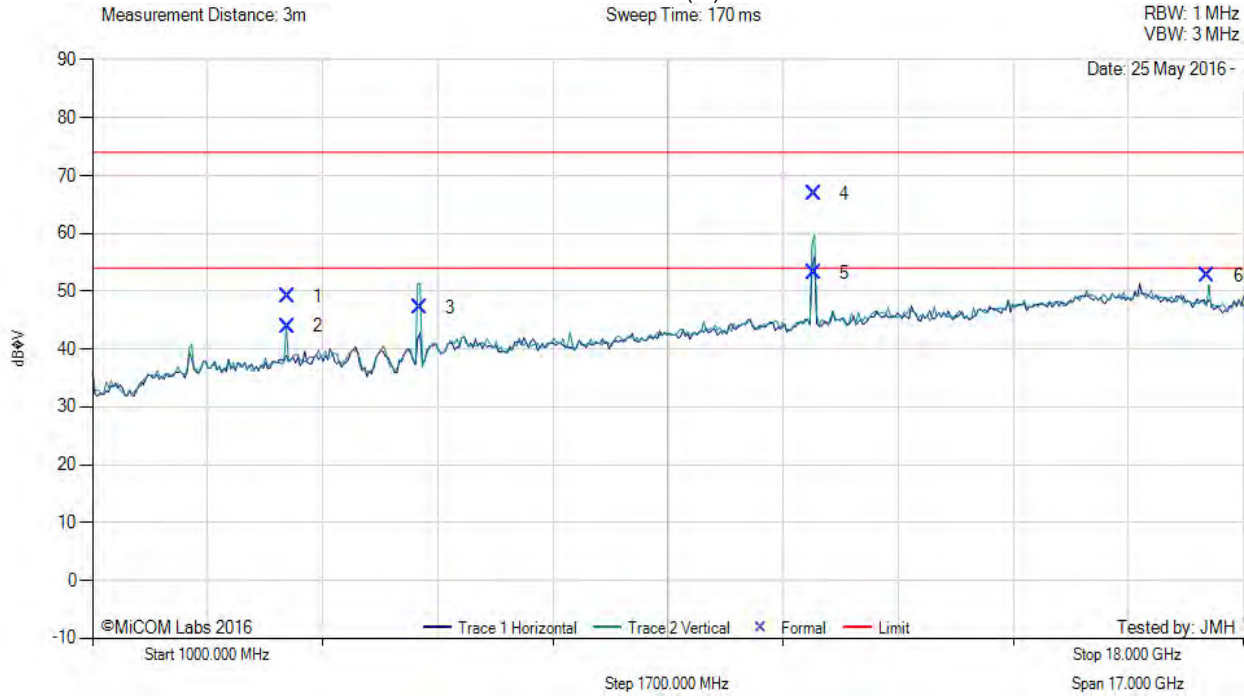

Num	Frequency MHz	Raw dBµV	Cable Loss	AF dB	Level dBµV/m	Measurement Type	Pol	Hgt cm	Azt Deg	Limit dBµV/m	Margin dB	Pass /Fail
1	3883.34	56.60	3.25	-10.76	49.09	Max Peak	Vertical	167	3	74.0	-24.9	Pass
2	3883.34	51.48	3.25	-10.76	43.97	Max Avg	Vertical	167	3	54.0	-10.0	Pass
3	5826.78	53.57	3.84	-10.24	47.17	Fundamental	Vertical	101	1	--	--	
4	11650.73	65.82	5.46	-4.47	66.81	Max Peak	Vertical	123	33	74.0	-7.2	Pass
5	11650.73	52.20	5.46	-4.47	53.19	Max Avg	Vertical	123	33	54.0	-0.8	Pass
6	17471.10	46.97	6.23	-0.57	52.63	Peak (NRB)	Vertical	151	60	--	--	Pass

Test Notes: EUT on 150cm table powered by host.

[back to matrix](#)

This test report may be reproduced in full only. The document may only be updated by MiCOM Labs personnel. All changes will be noted in the Document History section of the report.



A.3.1.2. Digi International 3100016-01



RADIATED SPURIOUS - RESTRICTED BAND EMISSIONS

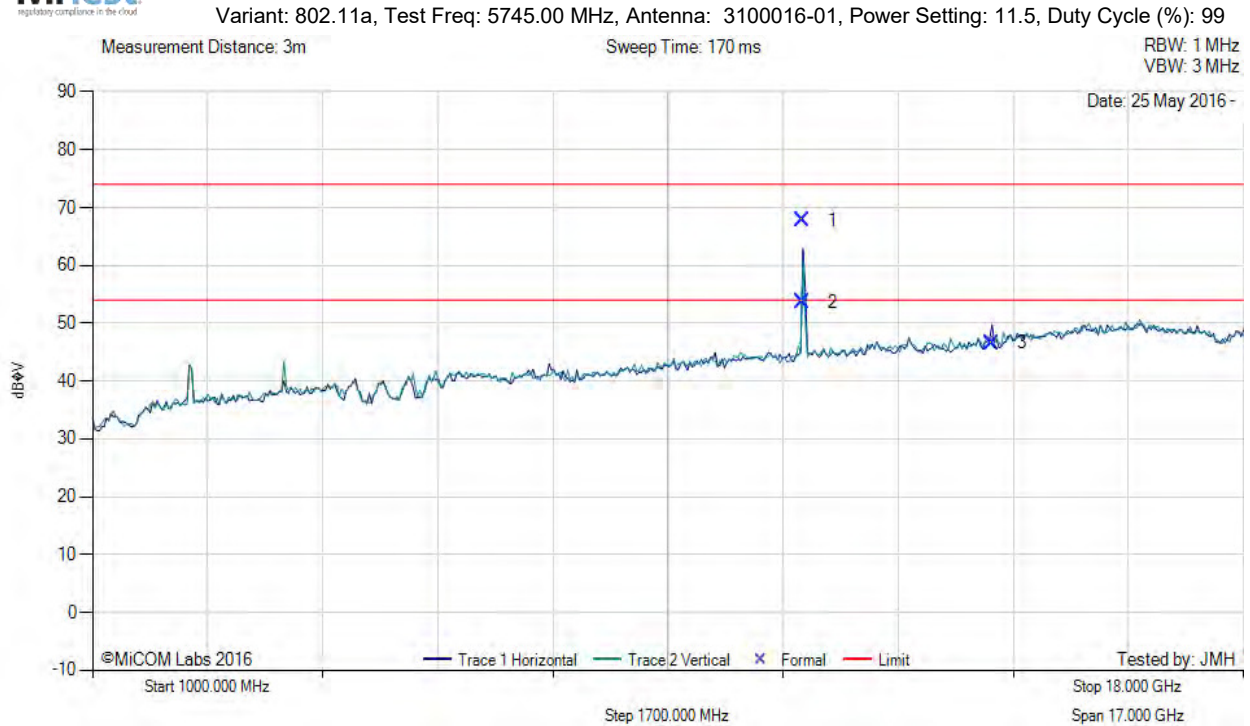

Num	Frequency MHz	Raw dBµV	Cable Loss	AF dB	Level dBµV/m	Measurement Type	Pol	Hgt cm	Azt Deg	Limit dBµV/m	Margin dB	Pass /Fail
1	11490.75	67.12	5.45	-4.84	67.73	Max Peak	Horizontal	140	54	74.0	-6.3	Pass
2	11490.75	52.99	5.45	-4.84	53.60	Max Avg	Horizontal	140	54	54.0	-0.4	Pass
3	14278.37	46.17	5.63	-5.25	46.55	Peak (NRB)	Horizontal	151	0	--	--	Pass

Test Notes: EUT on 150cm table powered by host. Power reduced to 11.5 to meet limit at 11.49 GHz

[back to matrix](#)

This test report may be reproduced in full only. The document may only be updated by MiCOM Labs personnel. All changes will be noted in the Document History section of the report.



RADIATED SPURIOUS - RESTRICTED BAND EMISSIONS

Variant: 802.11a, Test Freq: 5785.00 MHz, Antenna: 3100016-01, Power Setting: 11.5, Duty Cycle (%): 99

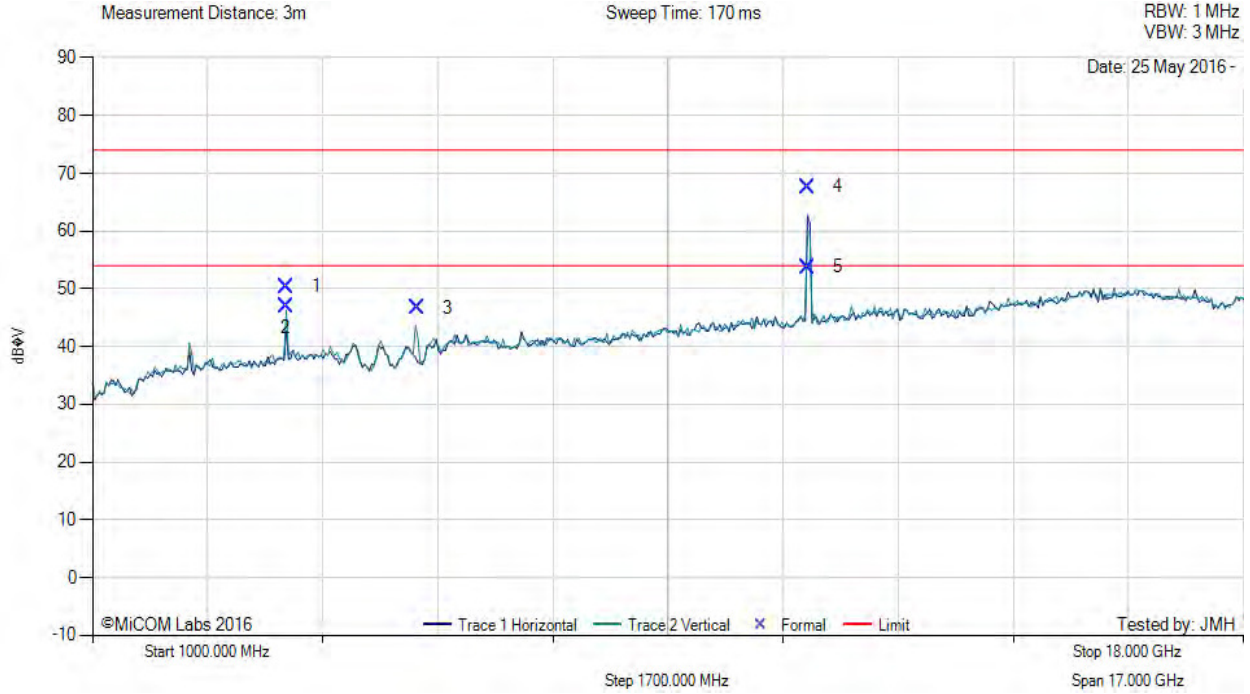

Num	Frequency MHz	Raw dBµV	Cable Loss	AF dB	Level dBµV/m	Measurement Type	Pol	Hgt cm	Azt Deg	Limit dBµV/m	Margin dB	Pass /Fail
1	3856.67	57.97	3.23	-10.81	50.39	Max Peak	Vertical	154	282	74.0	-23.6	Pass
2	3856.67	54.49	3.23	-10.81	46.91	Max Avg	Vertical	154	282	54.0	-7.1	Pass
3	5791.51	53.33	3.78	-10.40	46.71	Fundamental	Vertical	151	234	--	--	
4	11566.21	66.75	5.54	-4.65	67.64	Max Peak	Horizontal	143	55	74.0	-6.4	Pass
5	11566.21	52.86	5.54	-4.65	53.75	Max Avg	Horizontal	143	55	54.0	-0.3	Pass

Test Notes: EUT on 150cm table powered by host. Power reduced to 11.5 to meet limit at 11.56 GHz

[back to matrix](#)

This test report may be reproduced in full only. The document may only be updated by MiCOM Labs personnel. All changes will be noted in the Document History section of the report.



Title: Digi International AR6203
To: FCC CFR 47 Part 15 Subpart E 15.407
Serial #: DIGI60-U6 Rev A
Issue Date: 27th May 2016
Page: 110 of 141

RADIATED SPURIOUS - RESTRICTED BAND EMISSIONS



Variant: 802.11a, Test Freq: 5825.00 MHz, Antenna: 3100016-01, Power Setting: 10, Duty Cycle (%): 99

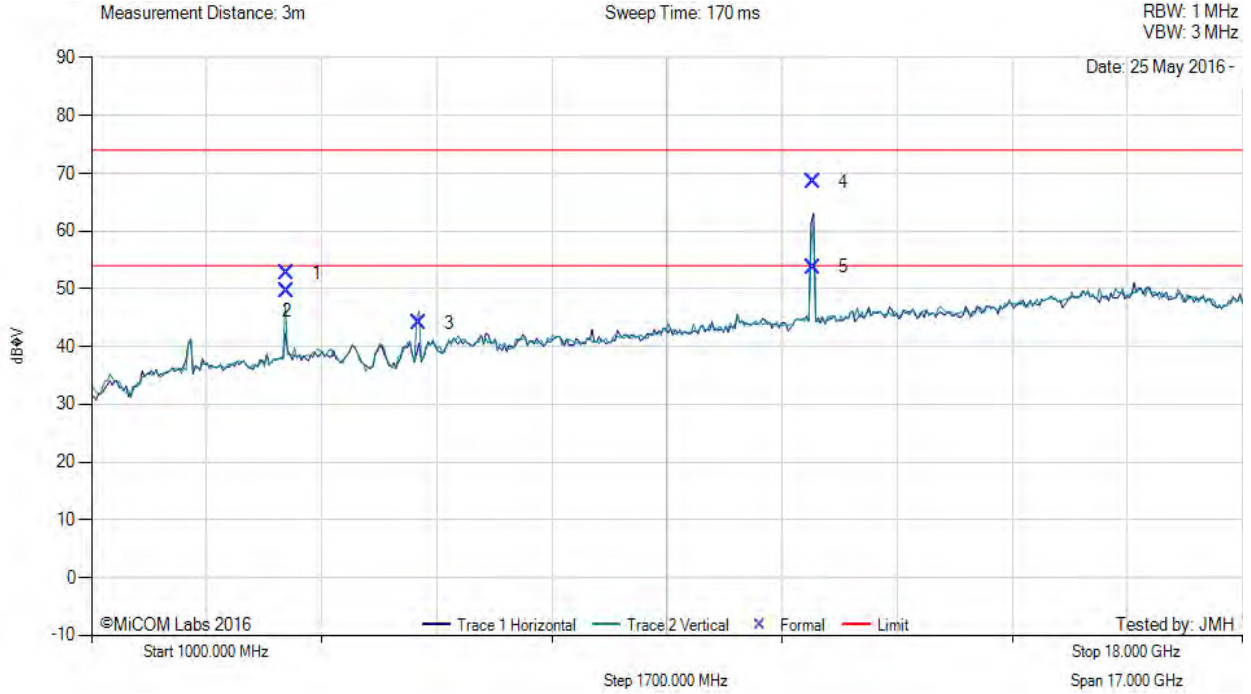

Num	Frequency MHz	Raw dBμV	Cable Loss	AF dB	Level dBμV/m	Measurement Type	Pol	Hgt cm	Azt Deg	Limit dBμV/m	Margin dB	Pass /Fail
1	3883.35	60.17	3.25	-10.76	52.66	Max Peak	Vertical	143	262	74.0	-21.3	Pass
2	3883.35	57.19	3.25	-10.76	49.68	Max Avg	Vertical	143	262	54.0	-4.3	Pass
3	5826.94	50.44	3.84	-10.24	44.04	Fundamental	Vertical	151	1	--	--	
4	11650.58	67.54	5.46	-4.47	68.53	Max Peak	Horizontal	134	55	74.0	-5.5	Pass
5	11650.58	52.78	5.46	-4.47	53.77	Max Avg	Horizontal	134	55	54.0	-0.2	Pass

Test Notes: EUT on 150cm table powered by host. Power reduced to 10 to meet limit at 11.65 GHz

[back to matrix](#)

This test report may be reproduced in full only. The document may only be updated by MiCOM Labs personnel. All changes will be noted in the Document History section of the report.



A.3.1.3. Taoglas FXP.830



RADIATED SPURIOUS - RESTRICTED BAND EMISSIONS

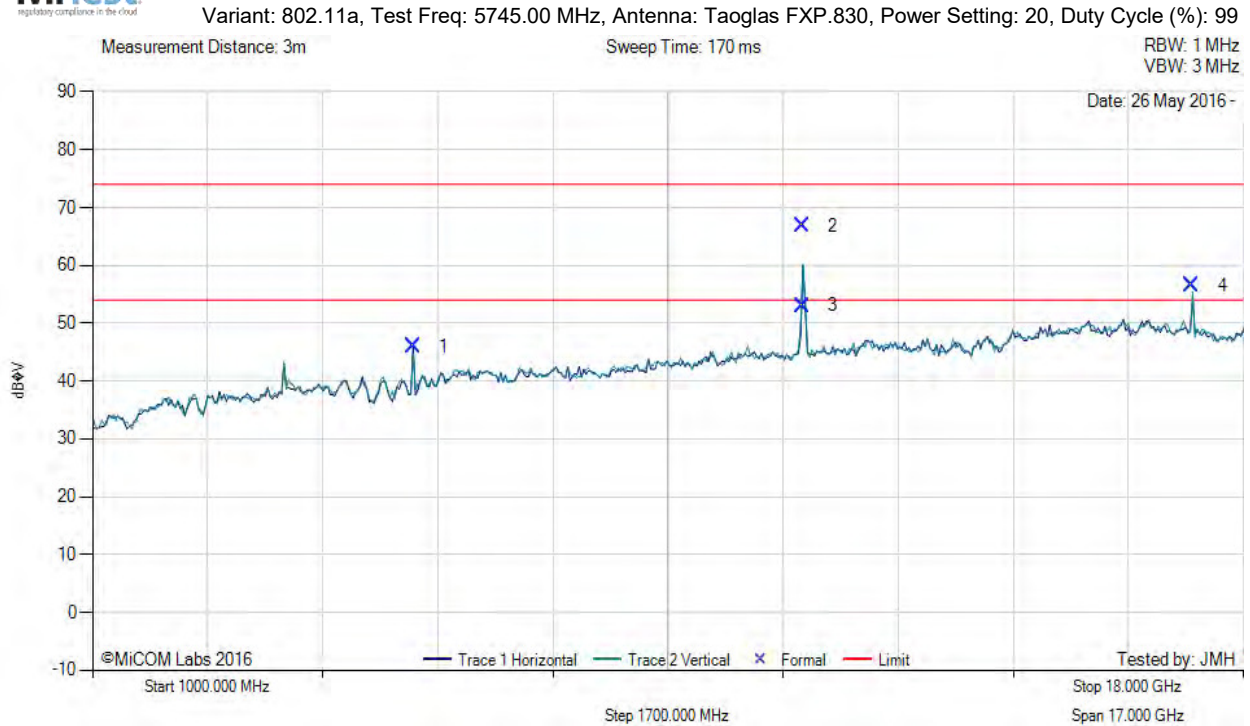

Num	Frequency MHz	Raw dBµV	Cable Loss	AF dB	Level dBµV/m	Measurement Type	Pol	Hgt cm	Azt Deg	Limit dBµV/m	Margin dB	Pass /Fail
1	5737.40	52.79	3.82	-10.67	45.94	Fundamental	Horizontal	151	187	--	--	
2	11489.18	66.26	5.45	-4.85	66.86	Max Avg	Horizontal	157	297	54.0	-7.1	Pass
3	11489.18	52.45	5.45	-4.85	53.05	Max Peak	Horizontal	157	297	74.0	-1.0	Pass
4	17241.40	49.63	6.47	0.34	56.44	Peak (NRB)	Horizontal	151	20	--	--	Pass

Test Notes: Eut on 150cm table powered by host.

[back to matrix](#)

This test report may be reproduced in full only. The document may only be updated by MiCOM Labs personnel. All changes will be noted in the Document History section of the report.



RADIATED SPURIOUS - RESTRICTED BAND EMISSIONS



Variant: 802.11a, Test Freq: 5785.00 MHz, Antenna: Taoglas FXP.830, Power Setting: 20, Duty Cycle (%): 99

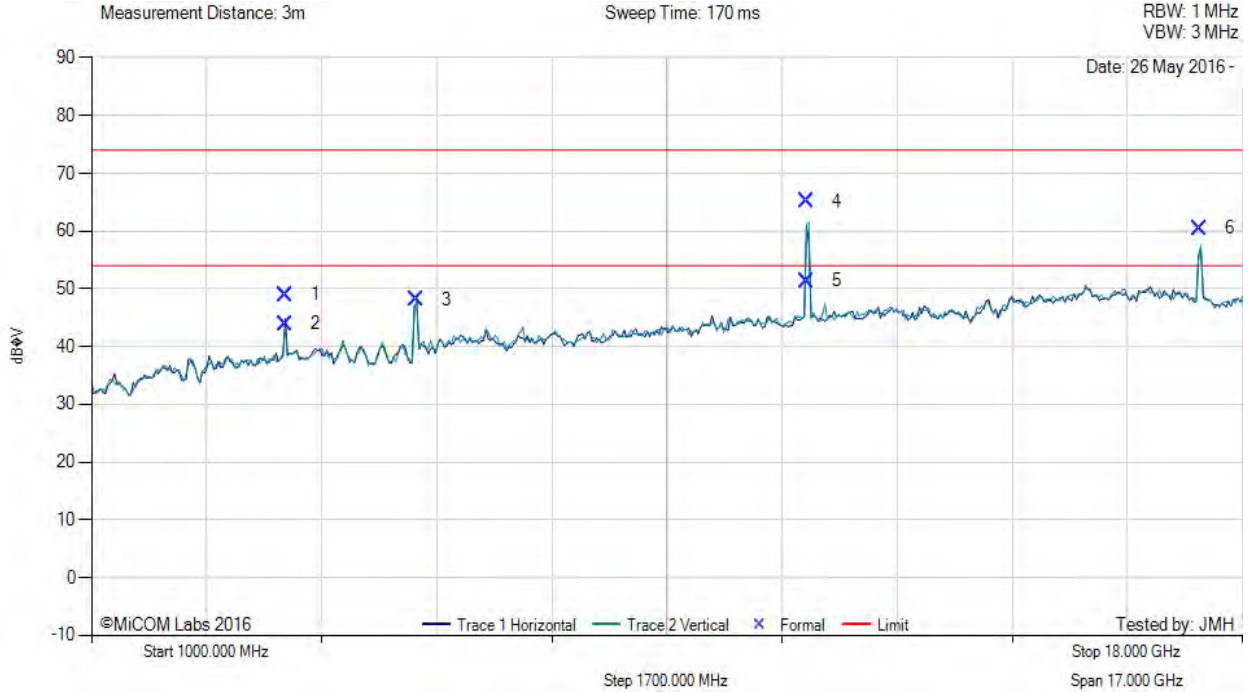

Num	Frequency MHz	Raw dBµV	Cable Loss	AF dB	Level dBµV/m	Measurement Type	Pol	Hgt cm	Azt Deg	Limit dBµV/m	Margin dB	Pass /Fail
1	3856.65	56.59	3.23	-10.81	49.01	Max Avg	Horizontal	177	169	54.0	-25.0	Pass
2	3856.65	51.55	3.23	-10.81	43.97	Max Peak	Horizontal	177	169	74.0	-10.0	Pass
3	5790.39	54.78	3.79	-10.42	48.15	Fundamental	Horizontal	151	0	--	--	
4	11566.05	64.19	5.54	-4.65	65.08	Max Avg	Horizontal	165	299	54.0	-8.9	Pass
5	11566.05	50.44	5.54	-4.65	51.33	Max Peak	Horizontal	165	299	74.0	-2.7	Pass
6	17361.52	54.19	6.30	-0.05	60.44	Peak (NRB)	Horizontal	151	144	--	--	Pass

Test Notes: Eut on 150cm table powered by host.

[back to matrix](#)

This test report may be reproduced in full only. The document may only be updated by MiCOM Labs personnel. All changes will be noted in the Document History section of the report.



RADIATED SPURIOUS - RESTRICTED BAND EMISSIONS



Variant: 802.11a, Test Freq: 5825.00 MHz, Antenna: Taoglas FXP.830, Power Setting: 20, Duty Cycle (%): 99

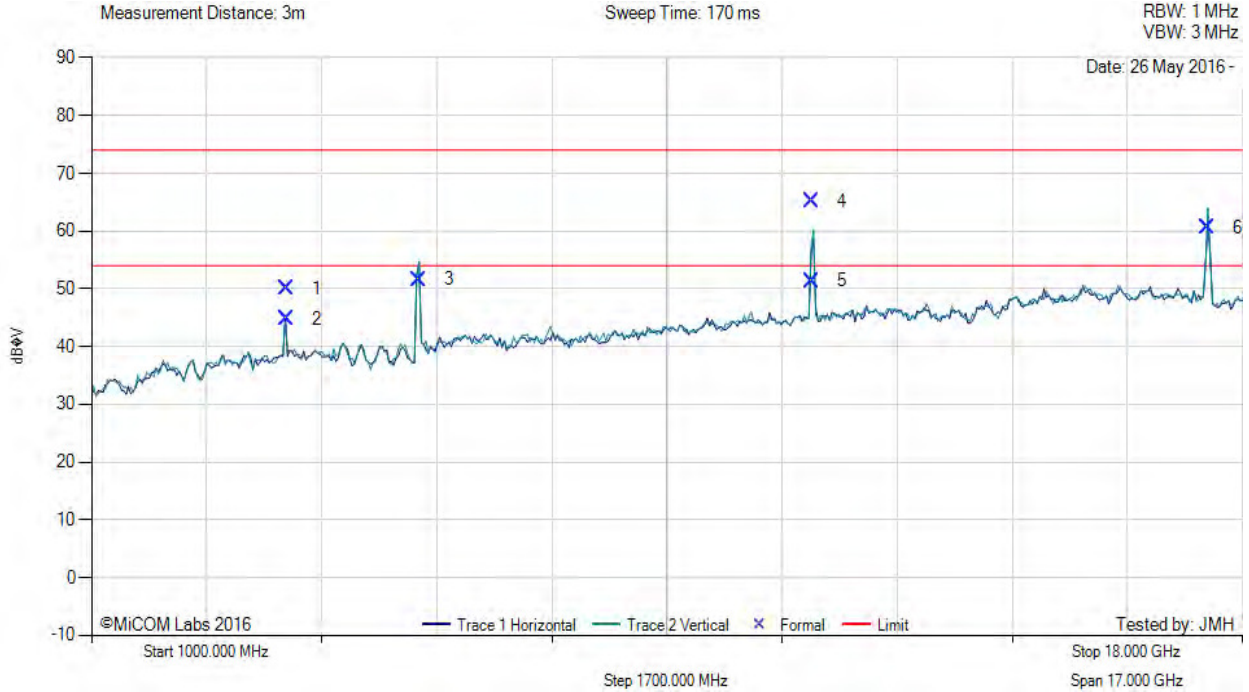

Num	Frequency MHz	Raw dBμV	Cable Loss	AF dB	Level dBμV/m	Measurement Type	Pol	Hgt cm	Azt Deg	Limit dBμV/m	Margin dB	Pass /Fail
1	3883.37	57.48	3.25	-10.76	49.97	Max Avg	Horizontal	156	181	54.0	-24.0	Pass
2	3883.37	52.33	3.25	-10.76	44.82	Max Peak	Horizontal	156	181	74.0	-9.2	Pass
3	5828.10	58.03	3.84	-10.24	51.63	Fundamental	Horizontal	151	1	--	--	
4	11643.93	64.10	5.47	-4.47	65.10	Max Avg	Horizontal	150	300	54.0	-8.9	Pass
5	11643.93	50.36	5.47	-4.47	51.36	Max Peak	Horizontal	150	300	74.0	-2.6	Pass
6	17476.19	54.88	6.28	-0.59	60.57	Peak (NRB)	Horizontal	151	1	--	--	Pass

Test Notes: Eut on 150cm table powered by host.

[back to matrix](#)

This test report may be reproduced in full only. The document may only be updated by MiCOM Labs personnel. All changes will be noted in the Document History section of the report.



A.3.1.4. Taoglas PC.11



RADIATED SPURIOUS - RESTRICTED BAND EMISSIONS

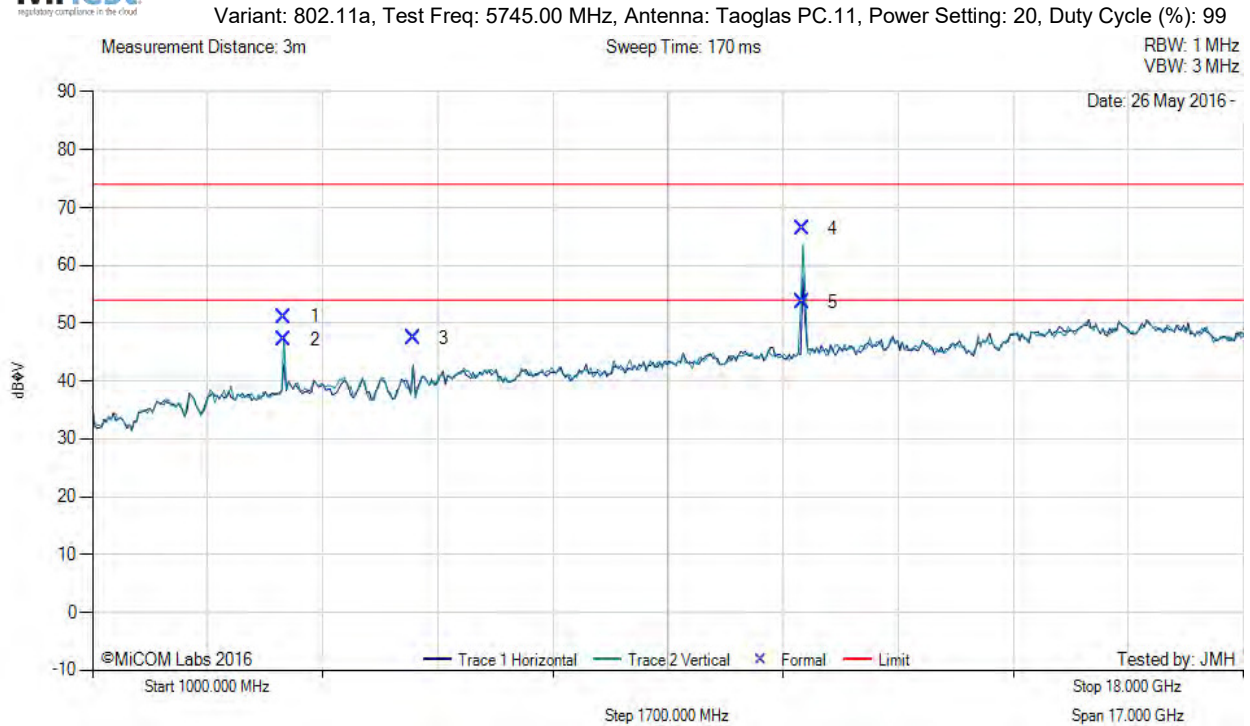

Num	Frequency MHz	Raw dBµV	Cable Loss	AF dB	Level dBµV/m	Measurement Type	Pol	Hgt cm	Azt Deg	Limit dBµV/m	Margin dB	Pass /Fail
1	3830.18	58.75	3.21	-10.83	51.13	Max Peak	Vertical	129	212	74.0	-22.9	Pass
2	3830.18	54.85	3.21	-10.83	47.23	Max Avg	Vertical	129	212	54.0	-6.8	Pass
3	5740.01	54.22	3.83	-10.67	47.38	Fundamental	Vertical	151	71	--	--	
4	11490.06	65.74	5.45	-4.84	66.35	Max Peak	Vertical	145	144	74.0	-7.7	Pass
5	11490.06	53.03	5.45	-4.84	53.64	Max Avg	Vertical	145	144	54.0	-0.4	Pass

Test Notes: Eut on 150cm table powered by host.

[back to matrix](#)

This test report may be reproduced in full only. The document may only be updated by MiCOM Labs personnel. All changes will be noted in the Document History section of the report.



RADIATED SPURIOUS - RESTRICTED BAND EMISSIONS

Variant: 802.11a, Test Freq: 5785.00 MHz, Antenna: Taoglas PC.11, Power Setting: 20, Duty Cycle (%): 99

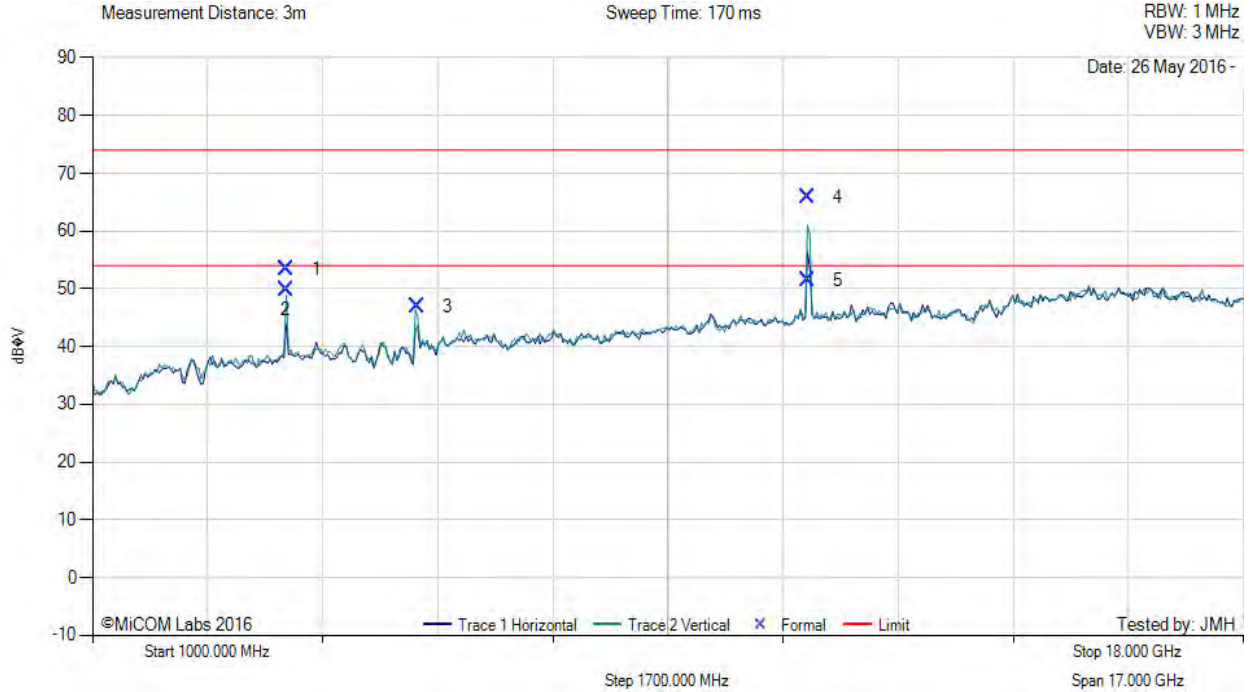

Num	Frequency MHz	Raw dBµV	Cable Loss	AF dB	Level dBµV/m	Measurement Type	Pol	Hgt cm	Azt Deg	Limit dBµV/m	Margin dB	Pass /Fail
1	3856.68	60.97	3.23	-10.81	53.39	Max Peak	Vertical	180	213	74.0	-20.6	Pass
2	3856.68	57.53	3.23	-10.81	49.95	Max Avg	Vertical	180	213	54.0	-4.1	Pass
3	5791.19	53.54	3.79	-10.41	46.92	Fundamental	Vertical	151	157	--	--	
4	11567.97	64.99	5.50	-4.65	65.84	Max Peak	Vertical	159	231	74.0	-8.2	Pass
5	11567.97	50.59	5.50	-4.65	51.44	Max Avg	Vertical	159	231	54.0	-2.6	Pass

Test Notes: Eut on 150cm table powered by host.

[back to matrix](#)

This test report may be reproduced in full only. The document may only be updated by MiCOM Labs personnel. All changes will be noted in the Document History section of the report.



RADIATED SPURIOUS - RESTRICTED BAND EMISSIONS



Variant: 802.11a, Test Freq: 5825.00 MHz, Antenna: Taoglas PC.11, Power Setting: 20, Duty Cycle (%): 99

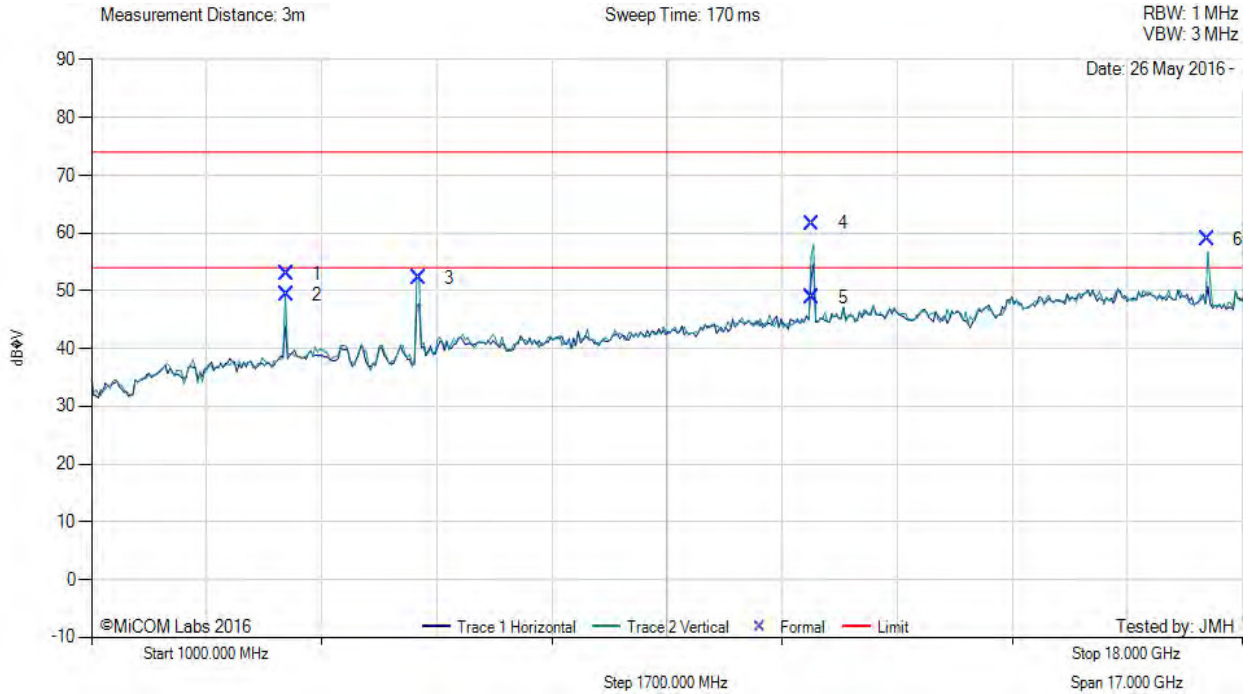

Num	Frequency MHz	Raw dBµV	Cable Loss	AF dB	Level dBµV/m	Measurement Type	Pol	Hgt cm	Azt Deg	Limit dBµV/m	Margin dB	Pass /Fail
1	3883.42	60.44	3.25	-10.76	52.93	Max Peak	Vertical	181	282	74.0	-21.1	Pass
2	3883.42	56.78	3.25	-10.76	49.27	Max Avg	Vertical	181	282	54.0	-4.7	Pass
3	5828.06	58.63	3.84	-10.24	52.23	Fundamental	Vertical	151	16	--	--	
4	11647.06	60.70	5.45	-4.47	61.68	Max Peak	Vertical	196	228	74.0	-12.3	Pass
5	11647.06	47.88	5.45	-4.47	48.86	Max Avg	Vertical	196	228	54.0	-5.1	Pass
6	17476.27	53.26	6.28	-0.59	58.95	Peak (NRB)	Vertical	151	16	--	--	Pass

Test Notes: Eut on 150cm table powered by host.

[back to matrix](#)

This test report may be reproduced in full only. The document may only be updated by MiCOM Labs personnel. All changes will be noted in the Document History section of the report.



A.3.2. Restricted Band-Edge Emissions

A.3.2.5. Antenna Factor ANT-DB1-xxx

5725 MHz RADIATED BAND-EDGE EMISSIONS



Variant: 802.11a, Test Freq: 5745.00 MHz, Antenna: Antenna Factor ANT-DB1-xxx, Power Setting: 20, Duty Cycle (%): 99

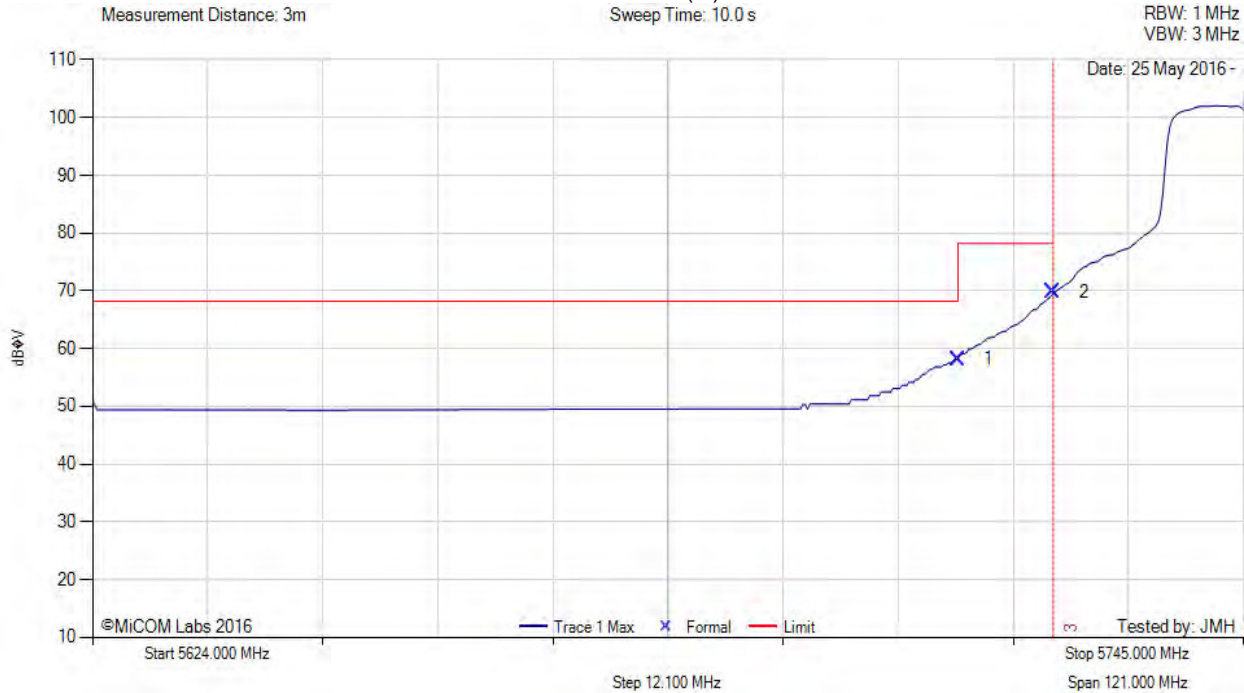

Num	Frequency MHz	Raw dBµV	Cable Loss	AF dB	Level dBµV/m	Measurement Type	Pol	Hgt cm	Azt Deg	Limit dBµV/m	Margin dB	Pass /Fail
1	5715.00	20.05	3.81	34.34	58.20	Max Avg	Vertical	194	21	68.2	-10.0	Pass
2	5725.00	31.62	3.79	34.35	69.76	Max Avg	Vertical	194	21	78.2	-8.5	Pass
3	5725.00	--	--	--	--	Band Edge	--	--	--	--	--	--

Test Notes: EUT on 150cm table powered by host.

[back to matrix](#)

This test report may be reproduced in full only. The document may only be updated by MiCOM Labs personnel. All changes will be noted in the Document History section of the report.



Title: Digi International AR6203
To: FCC CFR 47 Part 15 Subpart E 15.407
Serial #: DIGI60-U6 Rev A
Issue Date: 27th May 2016
Page: 118 of 141

5725 MHz RADIATED BAND-EDGE EMISSIONS



Variant: 802.11n HT-20, Test Freq: 5745.00 MHz, Antenna: Antenna Factor ANT-DB1-xxx, Power Setting: 20, Duty Cycle (%): 99

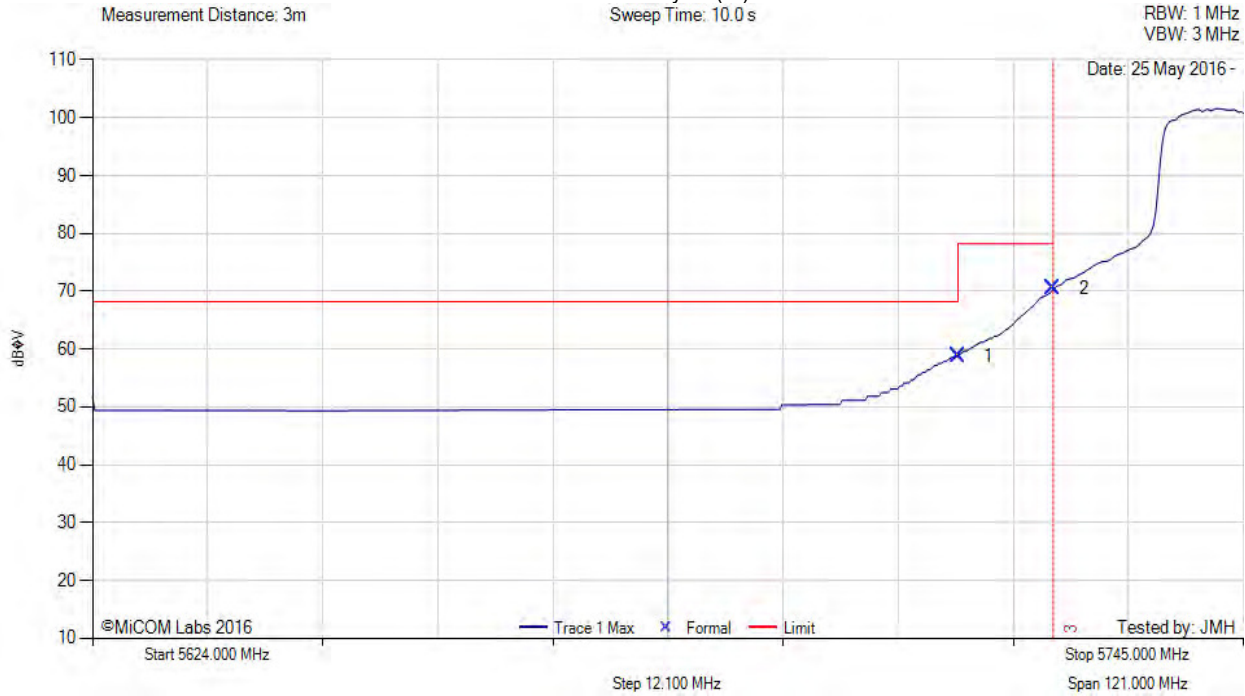

Num	Frequency MHz	Raw dBµV	Cable Loss	AF dB	Level dBµV/m	Measurement Type	Pol	Hgt cm	Azt Deg	Limit dBµV/m	Margin dB	Pass /Fail
1	5715.00	20.67	3.81	34.34	58.82	Max Avg	Vertical	194	21	68.2	-9.4	Pass
2	5725.00	32.35	3.79	34.35	70.49	Max Avg	Vertical	194	21	78.2	-7.7	Pass
3	5725.00	--	--	--	--	Band Edge	--	--	--	--	--	--

Test Notes: EUT on 150cm table powered by host.

[back to matrix](#)

This test report may be reproduced in full only. The document may only be updated by MiCOM Labs personnel. All changes will be noted in the Document History section of the report.



5725 MHz RADIATED BAND-EDGE EMISSIONS



Variant: 802.11n HT-40, Test Freq: 5755.00 MHz, Antenna: Antenna Factor ANT-DB1-xxx, Power Setting: 13, Duty Cycle (%): 99

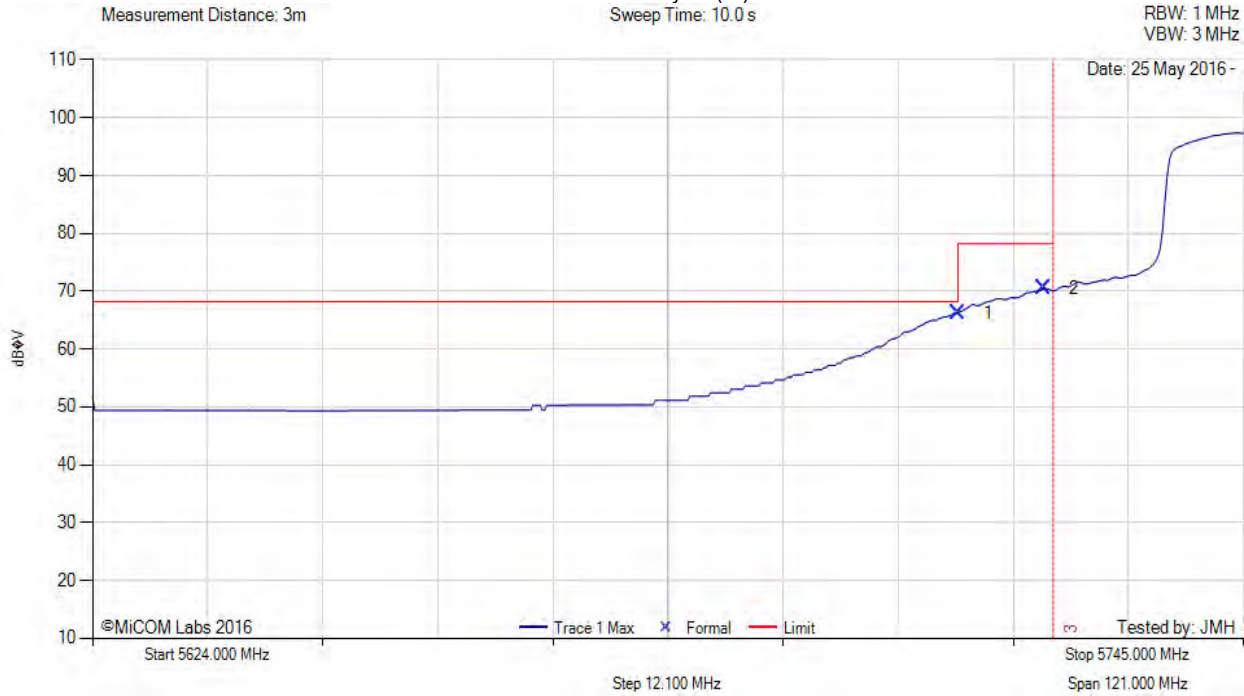

Num	Frequency MHz	Raw dBµV	Cable Loss	AF dB	Level dBµV/m	Measurement Type	Pol	Hgt cm	Azt Deg	Limit dBµV/m	Margin dB	Pass /Fail
1	5715.00	28.07	3.81	34.34	66.22	Max Avg	Vertical	194	21	68.2	-2.0	Pass
2	5724.03	32.35	3.79	34.35	70.49	Max Avg	Vertical	194	21	78.2	-7.7	Pass
3	5725.00	--	--	--	--	Band Edge	--	--	--	--	--	--

Test Notes: EUT on 150cm table powered by host. Power reduction to meet Band Edge limit

[back to matrix](#)

This test report may be reproduced in full only. The document may only be updated by MiCOM Labs personnel. All changes will be noted in the Document History section of the report.



Title: Digi International AR6203
To: FCC CFR 47 Part 15 Subpart E 15.407
Serial #: DIGI60-U6 Rev A
Issue Date: 27th May 2016
Page: 120 of 141

5850 MHz RADIATED BAND-EDGE EMISSIONS



Variant: 802.11a, Test Freq: 5825.00 MHz, Antenna: Antenna Factor ANT-DB1-xxx, Power Setting: 20, Duty Cycle (%): 99

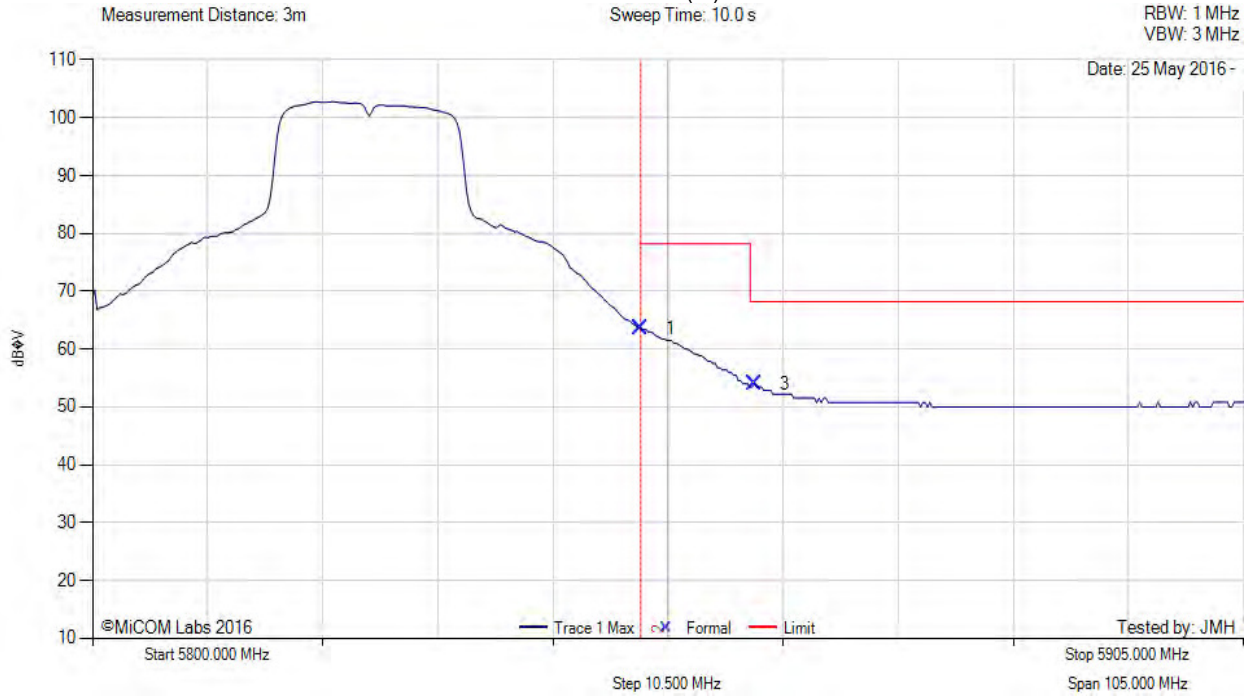

Num	Frequency MHz	Raw dBµV	Cable Loss	AF dB	Level dBµV/m	Measurement Type	Pol	Hgt cm	Azt Deg	Limit dBµV/m	Margin dB	Pass /Fail
1	5850.00	25.10	3.81	34.63	63.54	Max Avg	Vertical	194	21	78.2	-14.7	Pass
3	5860.42	15.51	3.86	34.65	54.02	Max Avg	Vertical	194	21	68.2	-14.2	Pass
2	5850.00	--	--	--	--	Band Edge	--	--	--	--	--	--

Test Notes: EUT on 150cm table powered by host.

[back to matrix](#)

This test report may be reproduced in full only. The document may only be updated by MiCOM Labs personnel. All changes will be noted in the Document History section of the report.



5850 MHz RADIATED BAND-EDGE EMISSIONS



Variant: 802.11n HT-20, Test Freq: 5825.00 MHz, Antenna: Antenna Factor ANT-DB1-xxx, Power Setting: 20, Duty Cycle (%): 99

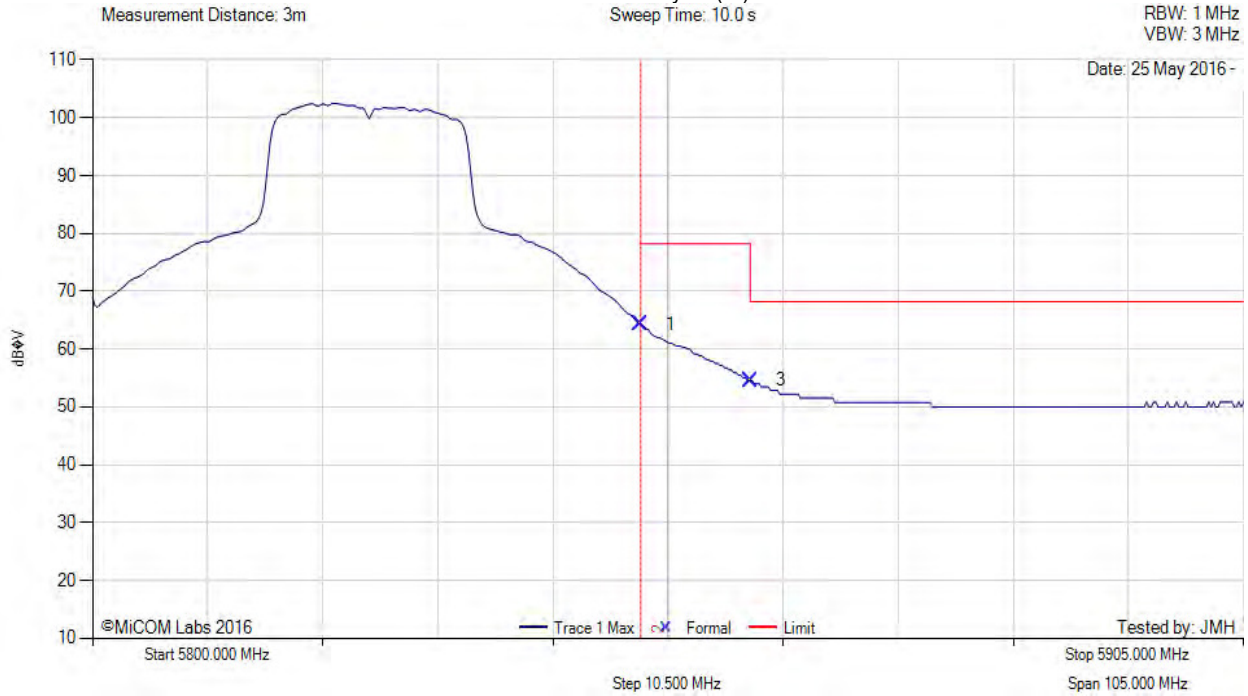

Num	Frequency MHz	Raw dBµV	Cable Loss	AF dB	Level dBµV/m	Measurement Type	Pol	Hgt cm	Azt Deg	Limit dBµV/m	Margin dB	Pass /Fail
1	5850.00	25.79	3.81	34.63	64.23	Max Avg	Vertical	194	21	78.2	-14.0	Pass
3	5860.00	16.04	3.86	34.65	54.55	Max Avg	Vertical	194	21	68.2	-13.7	Pass
2	5850.00	--	--	--	--	Band Edge	--	--	--	--	--	--

Test Notes: EUT on 150cm table powered by host.

[back to matrix](#)

This test report may be reproduced in full only. The document may only be updated by MiCOM Labs personnel. All changes will be noted in the Document History section of the report.



5850 MHz RADIATED BAND-EDGE EMISSIONS



Variant: 802.11n HT-40, Test Freq: 5795.00 MHz, Antenna: Antenna Factor ANT-DB1-xxx, Power Setting: 20, Duty Cycle (%): 99

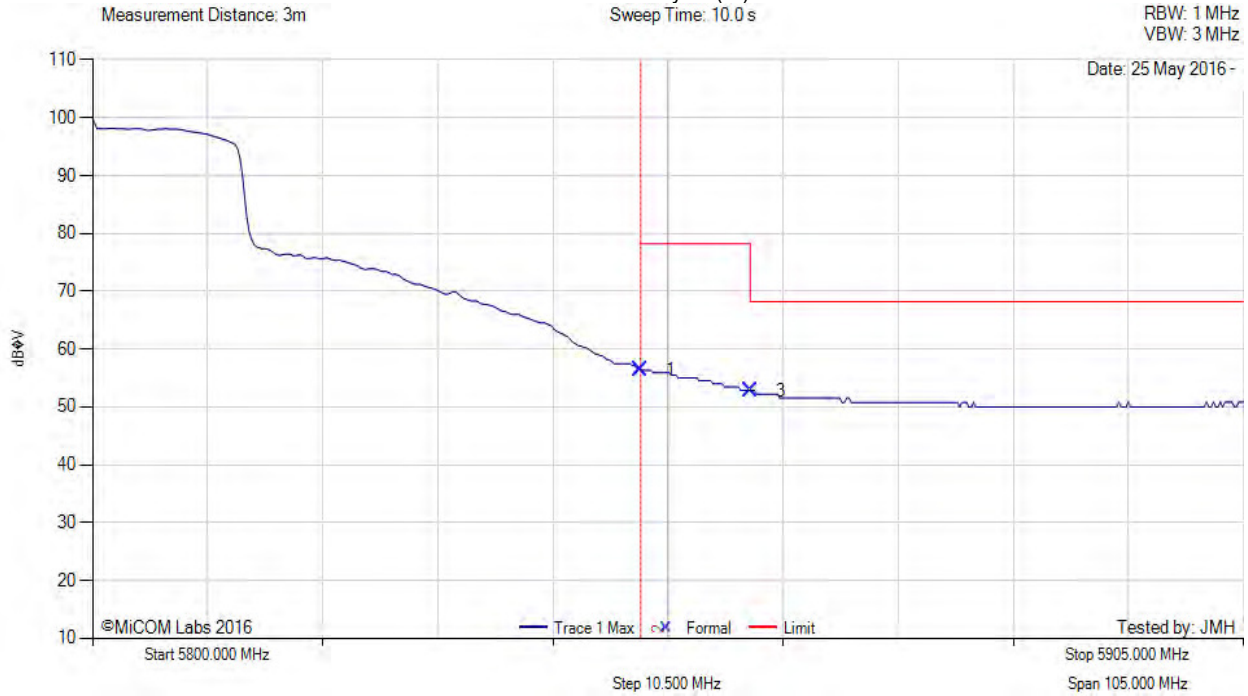

Num	Frequency MHz	Raw dBµV	Cable Loss	AF dB	Level dBµV/m	Measurement Type	Pol	Hgt cm	Azt Deg	Limit dBµV/m	Margin dB	Pass /Fail
1	5850.00	17.92	3.81	34.63	56.36	Max Avg	Vertical	194	21	78.2	-21.9	Pass
3	5860.00	14.35	3.86	34.65	52.86	Max Avg	Vertical	194	21	68.2	-15.4	Pass
2	5850.00	--	--	--	--	Band Edge	--	--	--	--	--	--

Test Notes: EUT on 150cm table powered by host.

[back to matrix](#)

This test report may be reproduced in full only. The document may only be updated by MiCOM Labs personnel. All changes will be noted in the Document History section of the report.



A.3.2.6. Digi International 3100016-01



5725 MHz RADIATED BAND-EDGE EMISSIONS

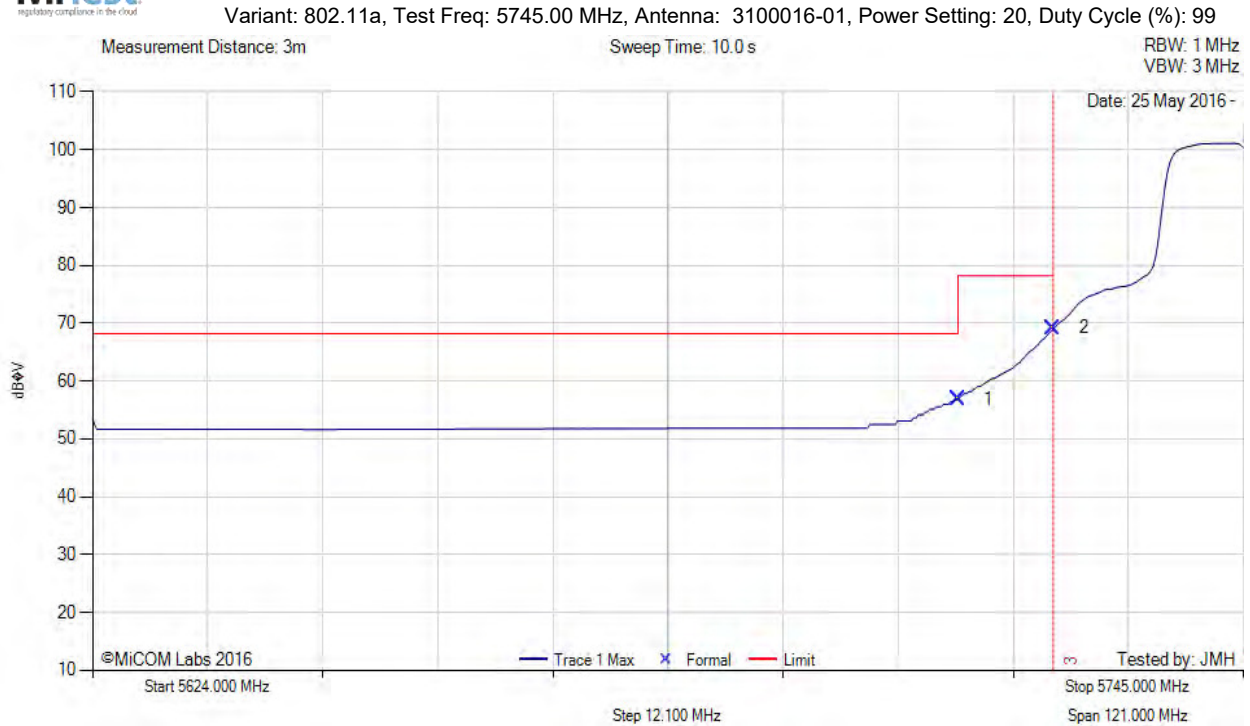

Num	Frequency MHz	Raw dBµV	Cable Loss	AF dB	Level dBµV/m	Measurement Type	Pol	Hgt cm	Azt Deg	Limit dBµV/m	Margin dB	Pass /Fail
1	5715.00	18.65	3.81	34.34	56.80	Max Avg	Vertical	153	199	68.2	-11.4	Pass
2	5725.00	31.09	3.79	34.35	69.23	Max Avg	Vertical	153	199	78.2	-9.0	Pass
3	5725.00	--	--	--	--	Band Edge	--	--	--	--	--	--

Test Notes: EUT on 150cm table powered by host.

[back to matrix](#)

This test report may be reproduced in full only. The document may only be updated by MiCOM Labs personnel. All changes will be noted in the Document History section of the report.



5725 MHz RADIATED BAND-EDGE EMISSIONS

Variant: 802.11n HT-20, Test Freq: 5745.00 MHz, Antenna: 3100016-01, Power Setting: 20, Duty Cycle (%): 99

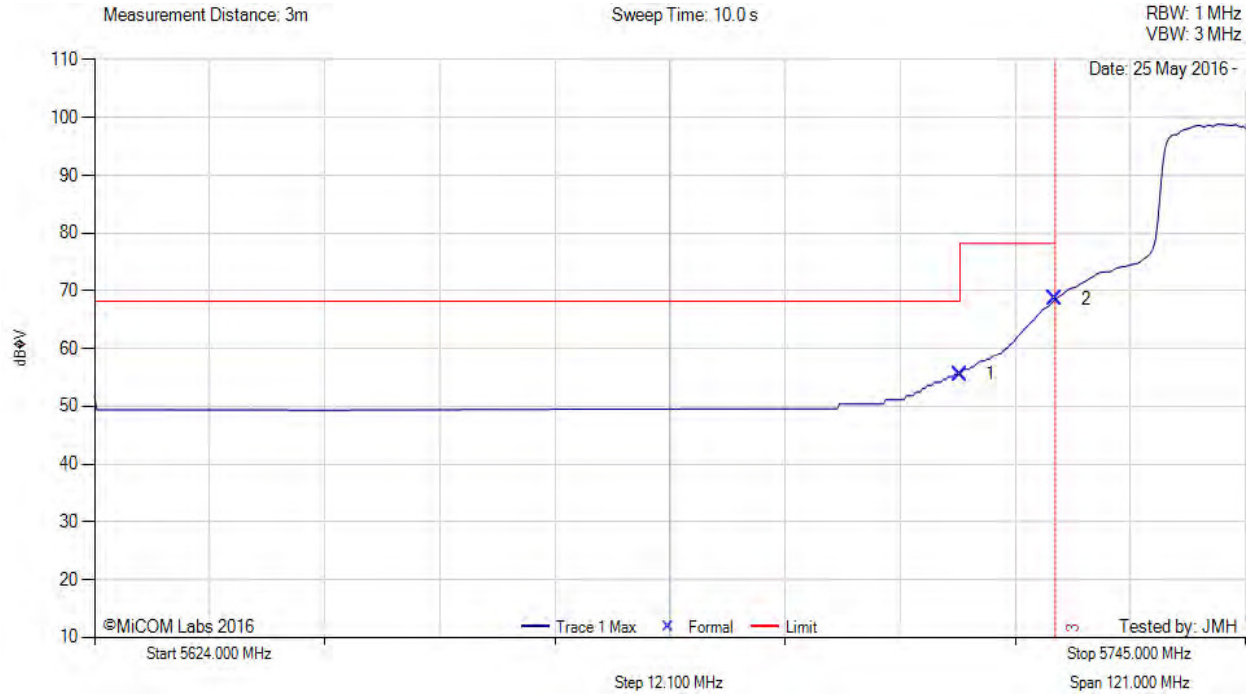

Num	Frequency MHz	Raw dBµV	Cable Loss	AF dB	Level dBµV/m	Measurement Type	Pol	Hgt cm	Azt Deg	Limit dBµV/m	Margin dB	Pass /Fail
1	5715.00	17.44	3.81	34.34	55.59	Max Avg	Vertical	153	199	68.2	-12.6	Pass
2	5725.00	30.53	3.79	34.35	68.67	Max Avg	Vertical	153	199	78.2	-9.6	Pass
3	5725.00	--	--	--	--	Band Edge	--	--	--	--	--	--

Test Notes: EUT on 150cm table powered by host.

[back to matrix](#)

This test report may be reproduced in full only. The document may only be updated by MiCOM Labs personnel. All changes will be noted in the Document History section of the report.



5725 MHz RADIATED BAND-EDGE EMISSIONS

Variant: 802.11n HT-40, Test Freq: 5755.00 MHz, Antenna: 3100016-01, Power Setting: 20, Duty Cycle (%): 99

Measurement Distance: 3m

Sweep Time: 10.0 s

RBW: 1 MHz
VBW: 3 MHz

Date: 25 May 2016

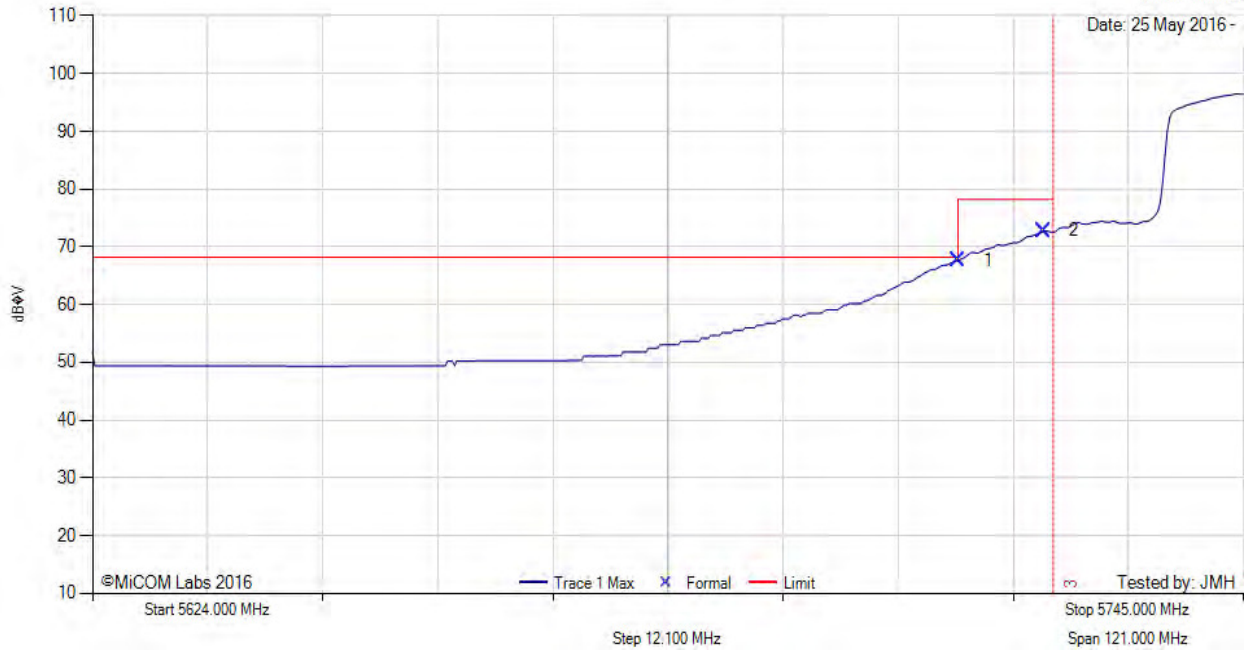

Num	Frequency MHz	Raw dBµV	Cable Loss	AF dB	Level dBµV/m	Measurement Type	Pol	Hgt cm	Azt Deg	Limit dBµV/m	Margin dB	Pass /Fail
1	5715.00	29.48	3.81	34.34	67.63	Max Avg	Vertical	153	199	68.2	-0.6	Pass
2	5724.03	34.67	3.79	34.35	72.81	Max Avg	Vertical	153	199	78.2	-5.4	Pass
3	5725.00	--	--	--	--	Band Edge	--	--	--	--	--	--

Test Notes: EUT on 150cm table powered by host.

[back to matrix](#)

This test report may be reproduced in full only. The document may only be updated by MiCOM Labs personnel. All changes will be noted in the Document History section of the report.



5850 MHz RADIATED BAND-EDGE EMISSIONS

Variant: 802.11a, Test Freq: 5825.00 MHz, Antenna: 3100016-01, Power Setting: 20, Duty Cycle (%): 99

Measurement Distance: 3m

Sweep Time: 10.0 s

RBW: 1 MHz
VBW: 3 MHz

Date: 25 May 2016

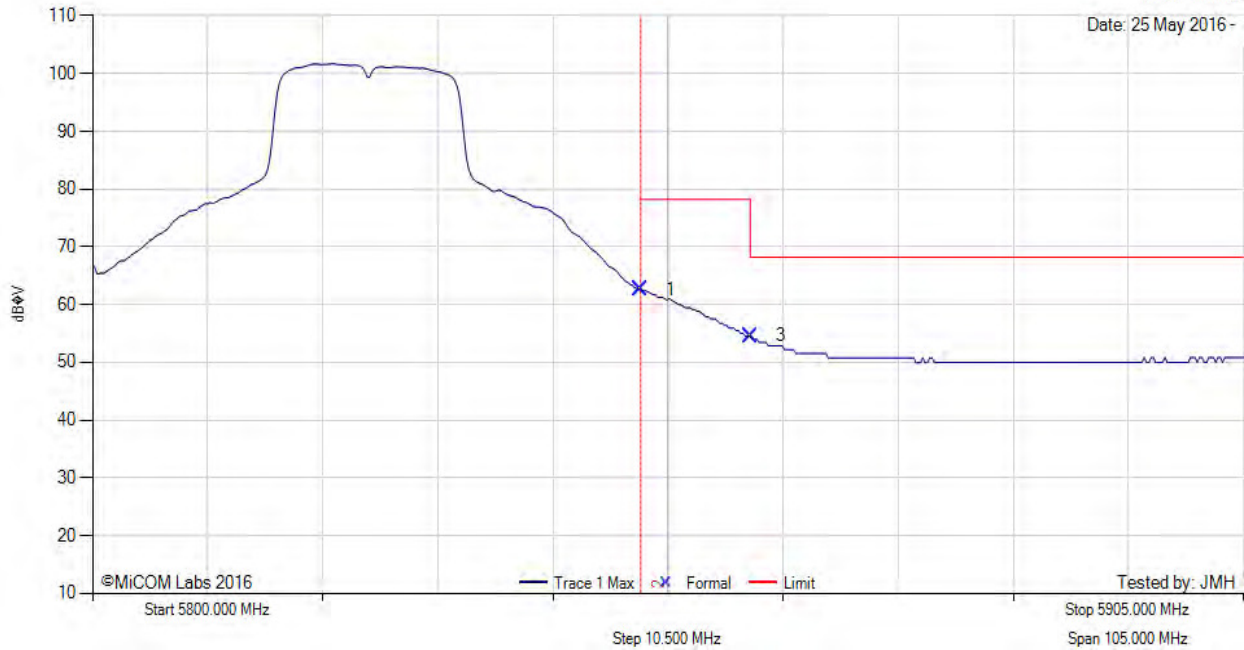

Num	Frequency MHz	Raw dBµV	Cable Loss	AF dB	Level dBµV/m	Measurement Type	Pol	Hgt cm	Azt Deg	Limit dBµV/m	Margin dB	Pass /Fail
1	5850.00	24.14	3.81	34.63	62.58	Max Avg	Vertical	153	199	78.2	-15.7	Pass
3	5860.00	16.04	3.86	34.65	54.55	Max Avg	Vertical	153	199	68.2	-13.7	Pass
2	5850.00	--	--	--	--	Band Edge	--	--	--	--	--	--

Test Notes: EUT on 150cm table powered by host.

[back to matrix](#)

This test report may be reproduced in full only. The document may only be updated by MiCOM Labs personnel. All changes will be noted in the Document History section of the report.

5850 MHz RADIATED BAND-EDGE EMISSIONS



Variant: 802.11n HT-20, Test Freq: 5825.00 MHz, Antenna: 3100016-01, Power Setting: 20, Duty Cycle (%): 99

Measurement Distance: 3m

Sweep Time: 10.0 s

RBW: 1 MHz
VBW: 3 MHz

Date: 25 May 2016

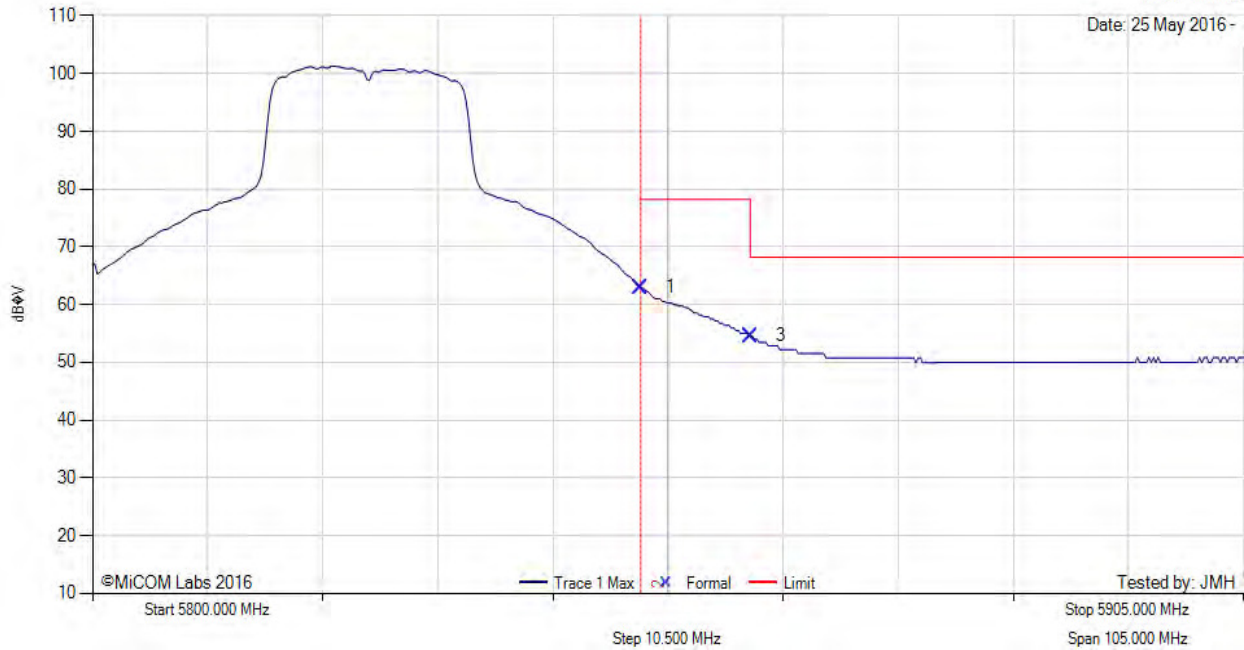

Num	Frequency MHz	Raw dBµV	Cable Loss	AF dB	Level dBµV/m	Measurement Type	Pol	Hgt cm	Azt Deg	Limit dBµV/m	Margin dB	Pass /Fail
1	5850.00	24.54	3.81	34.63	62.98	Max Avg	Vertical	153	199	78.2	-15.3	Pass
3	5860.00	16.04	3.86	34.65	54.55	Max Avg	Vertical	153	199	68.2	-13.7	Pass
2	5850.00	--	--	--	--	Band Edge	--	--	--	--	--	--

Test Notes: EUT on 150cm table powered by host.

[back to matrix](#)

This test report may be reproduced in full only. The document may only be updated by MiCOM Labs personnel. All changes will be noted in the Document History section of the report.



5850 MHz RADIATED BAND-EDGE EMISSIONS

Variant: 802.11n HT-40, Test Freq: 5795.00 MHz, Antenna: 3100016-01, Power Setting: 20, Duty Cycle (%): 99

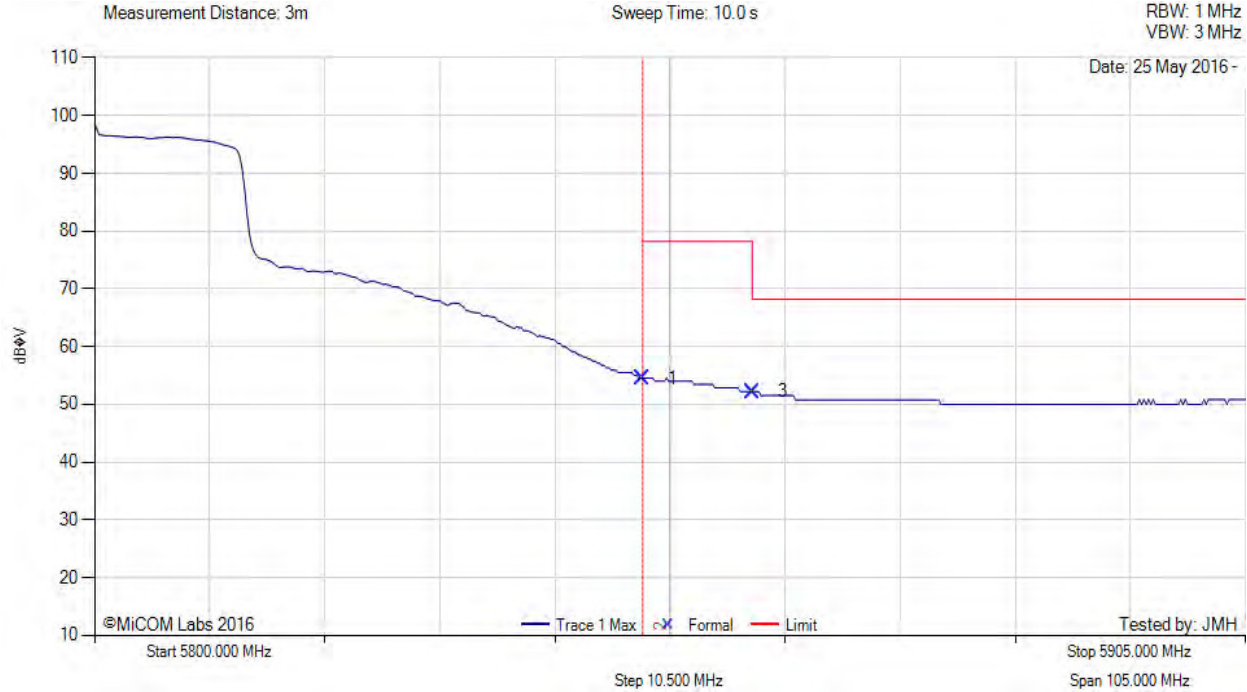

Num	Frequency MHz	Raw dBµV	Cable Loss	AF dB	Level dBµV/m	Measurement Type	Pol	Hgt cm	Azt Deg	Limit dBµV/m	Margin dB	Pass /Fail
1	5850.00	16.08	3.81	34.63	54.52	Max Avg	Vertical	153	199	78.2	-23.7	Pass
3	5860.00	13.71	3.86	34.65	52.22	Max Avg	Vertical	153	199	68.2	-16.0	Pass
2	5850.00	--	--	--	--	Band Edge	--	--	--	--	--	--

Test Notes: EUT on 150cm table powered by host.

[back to matrix](#)

This test report may be reproduced in full only. The document may only be updated by MiCOM Labs personnel. All changes will be noted in the Document History section of the report.



A.3.2.7. Taoglas FXP.830



5725 MHz RADIATED BAND-EDGE EMISSIONS

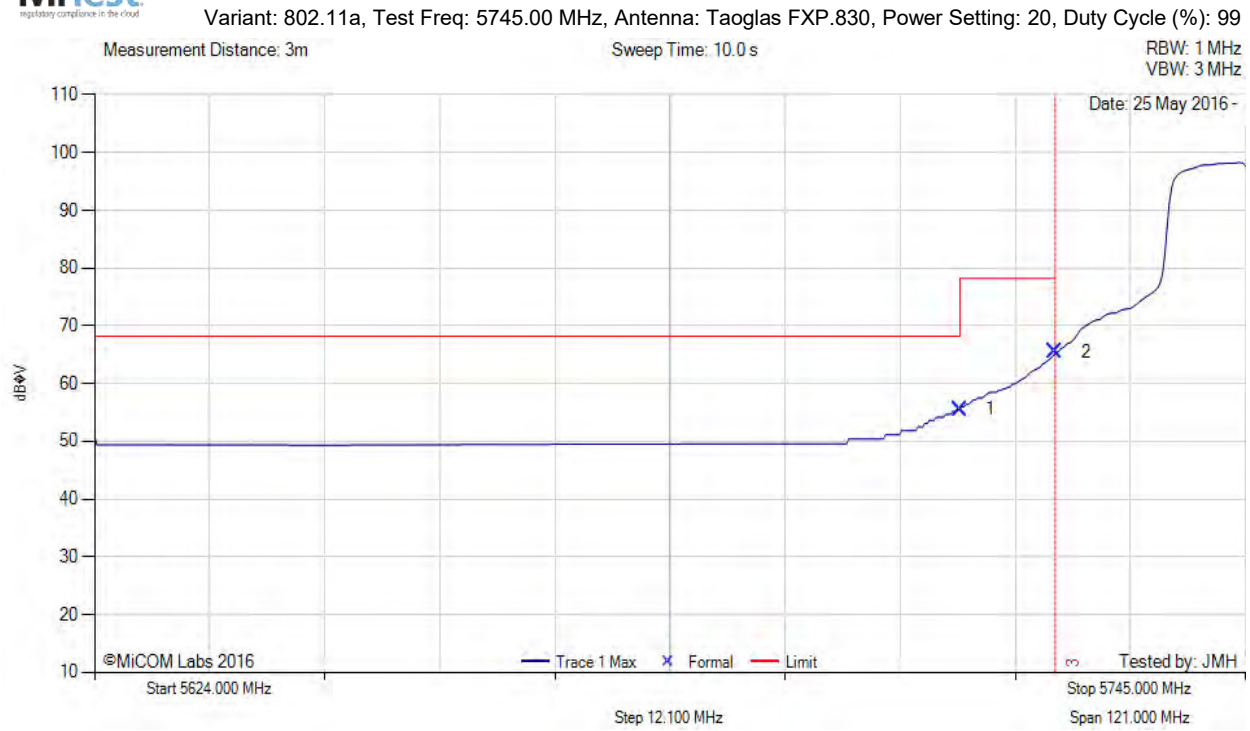

Num	Frequency MHz	Raw dBµV	Cable Loss	AF dB	Level dBµV/m	Measurement Type	Pol	Hgt cm	Azt Deg	Limit dBµV/m	Margin dB	Pass /Fail
1	5715.00	17.44	3.81	34.34	55.59	Max Avg	Horizontal	192	13	68.2	-12.6	Pass
2	5725.00	27.29	3.79	34.35	65.43	Max Avg	Horizontal	192	13	78.2	-12.8	Pass
3	5725.00	--	--	--	--	Band Edge	--	--	--	--	--	--

Test Notes: EUT on 150cm table powered by host.

[back to matrix](#)

This test report may be reproduced in full only. The document may only be updated by MiCOM Labs personnel. All changes will be noted in the Document History section of the report.



5725 MHz RADIATED BAND-EDGE EMISSIONS



Variant: 802.11n HT-20, Test Freq: 5745.00 MHz, Antenna: Taoglas FXP.830, Power Setting: 20, Duty Cycle (%): 99

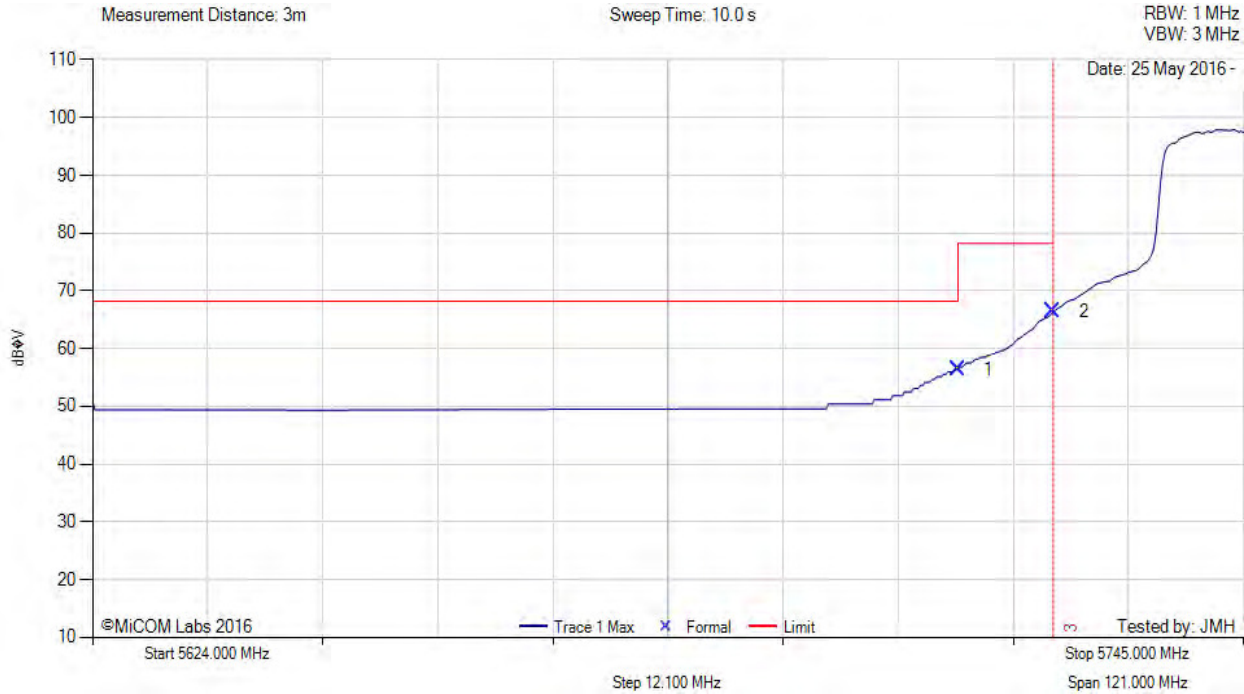

Num	Frequency MHz	Raw dBµV	Cable Loss	AF dB	Level dBµV/m	Measurement Type	Pol	Hgt cm	Azt Deg	Limit dBµV/m	Margin dB	Pass /Fail
1	5715.00	18.27	3.81	34.34	56.42	Max Avg	Horizontal	192	13	68.2	-11.8	Pass
2	5725.00	28.35	3.79	34.35	66.49	Max Avg	Horizontal	192	13	78.2	-11.7	Pass
3	5725.00	--	--	--	--	Band Edge	--	--	--	--	--	--

Test Notes: EUT on 150cm table powered by host.

[back to matrix](#)

This test report may be reproduced in full only. The document may only be updated by MiCOM Labs personnel. All changes will be noted in the Document History section of the report.

5725 MHz RADIATED BAND-EDGE EMISSIONS



Variant: 802.11n HT-40, Test Freq: 5755.00 MHz, Antenna: Taoglas FXP.830, Power Setting: 20, Duty Cycle (%): 99

Measurement Distance: 3m

Sweep Time: 10.0 s

RBW: 1 MHz
VBW: 3 MHz

Date: 25 May 2016

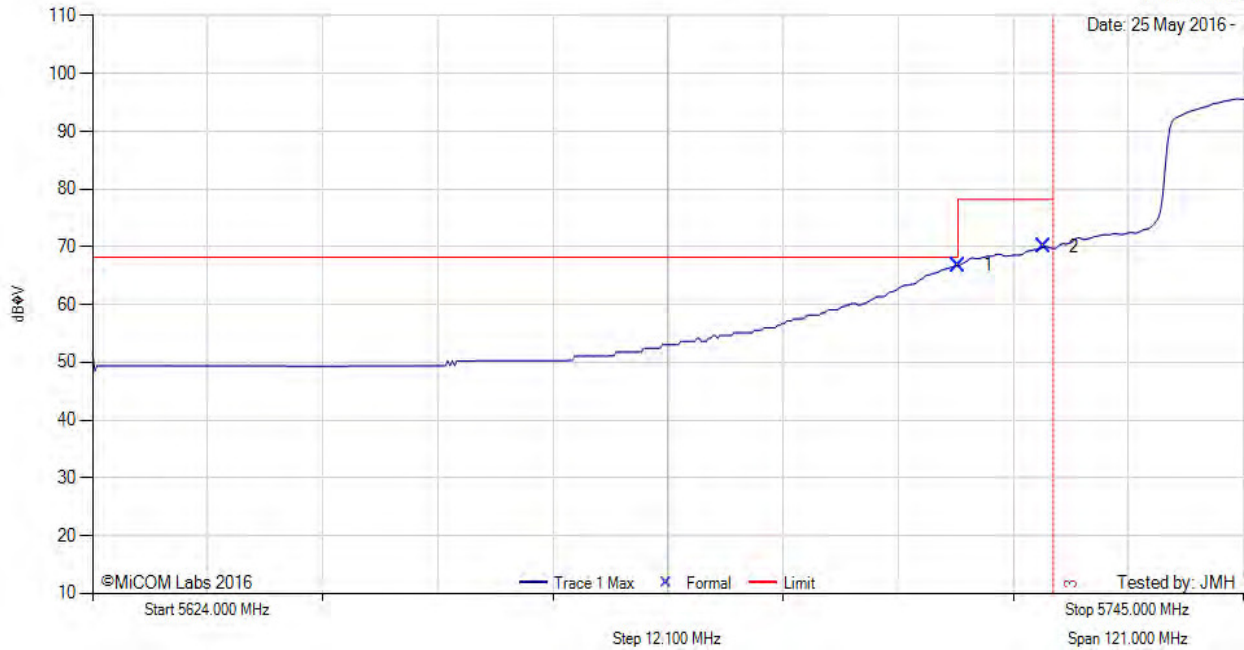

Num	Frequency MHz	Raw dBµV	Cable Loss	AF dB	Level dBµV/m	Measurement Type	Pol	Hgt cm	Azt Deg	Limit dBµV/m	Margin dB	Pass /Fail
1	5715.00	28.69	3.81	34.34	66.84	Max Avg	Horizontal	192	13	68.2	-1.4	Pass
2	5724.03	31.95	3.79	34.35	70.09	Max Avg	Horizontal	192	13	78.2	-8.1	Pass
3	5725.00	--	--	--	--	Band Edge	--	--	--	--	--	--

Test Notes: EUT on 150cm table powered by host.

[back to matrix](#)

This test report may be reproduced in full only. The document may only be updated by MiCOM Labs personnel. All changes will be noted in the Document History section of the report.

5850 MHz RADIATED BAND-EDGE EMISSIONS



Variant: 802.11a, Test Freq: 5825.00 MHz, Antenna: Taoglas FXP.830, Power Setting: 20, Duty Cycle (%): 99

Measurement Distance: 3m

Sweep Time: 10.0 s

RBW: 1 MHz
VBW: 3 MHz

Date: 25 May 2016

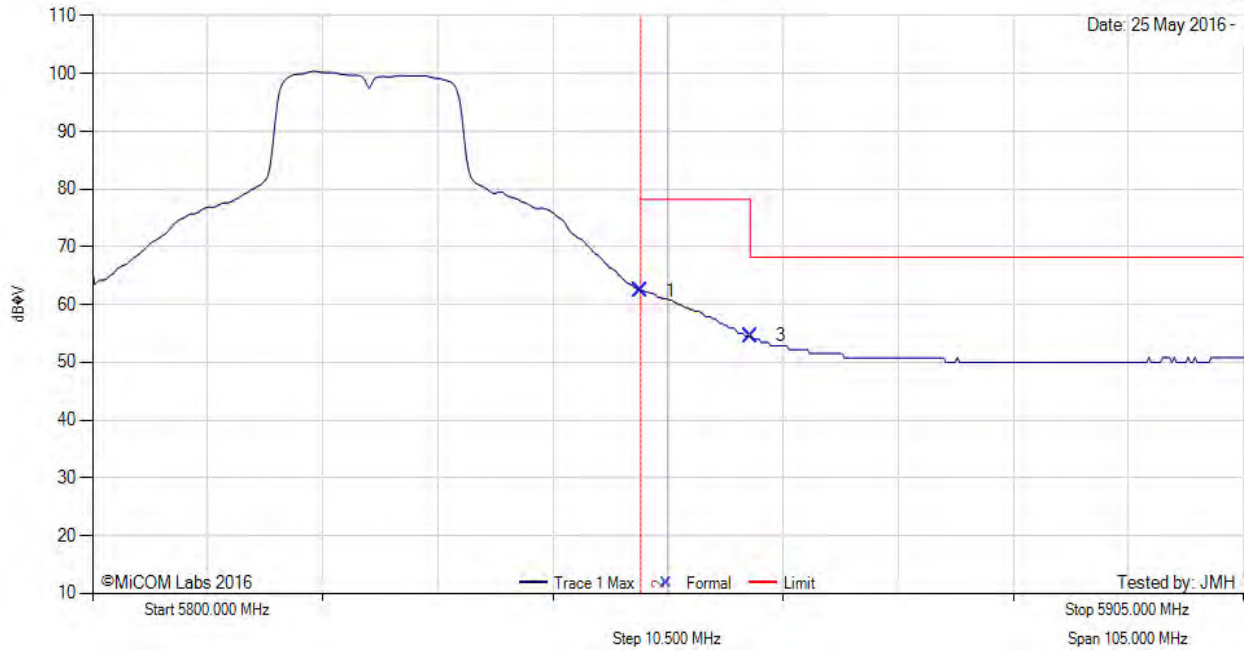

Num	Frequency MHz	Raw dBµV	Cable Loss	AF dB	Level dBµV/m	Measurement Type	Pol	Hgt cm	Azt Deg	Limit dBµV/m	Margin dB	Pass /Fail
1	5850.00	23.94	3.81	34.63	62.38	Max Avg	Horizontal	192	13	78.2	-15.9	Pass
3	5860.00	16.04	3.86	34.65	54.55	Max Avg	Horizontal	192	13	68.2	-13.7	Pass
2	5850.00	--	--	--	--	Band Edge	--	--	--	--	--	--

Test Notes: EUT on 150cm table powered by host.

[back to matrix](#)

This test report may be reproduced in full only. The document may only be updated by MiCOM Labs personnel. All changes will be noted in the Document History section of the report.

5850 MHz RADIATED BAND-EDGE EMISSIONS



Variant: 802.11n HT-20, Test Freq: 5825.00 MHz, Antenna: Taoglas FXP.830, Power Setting: 20, Duty Cycle (%): 99

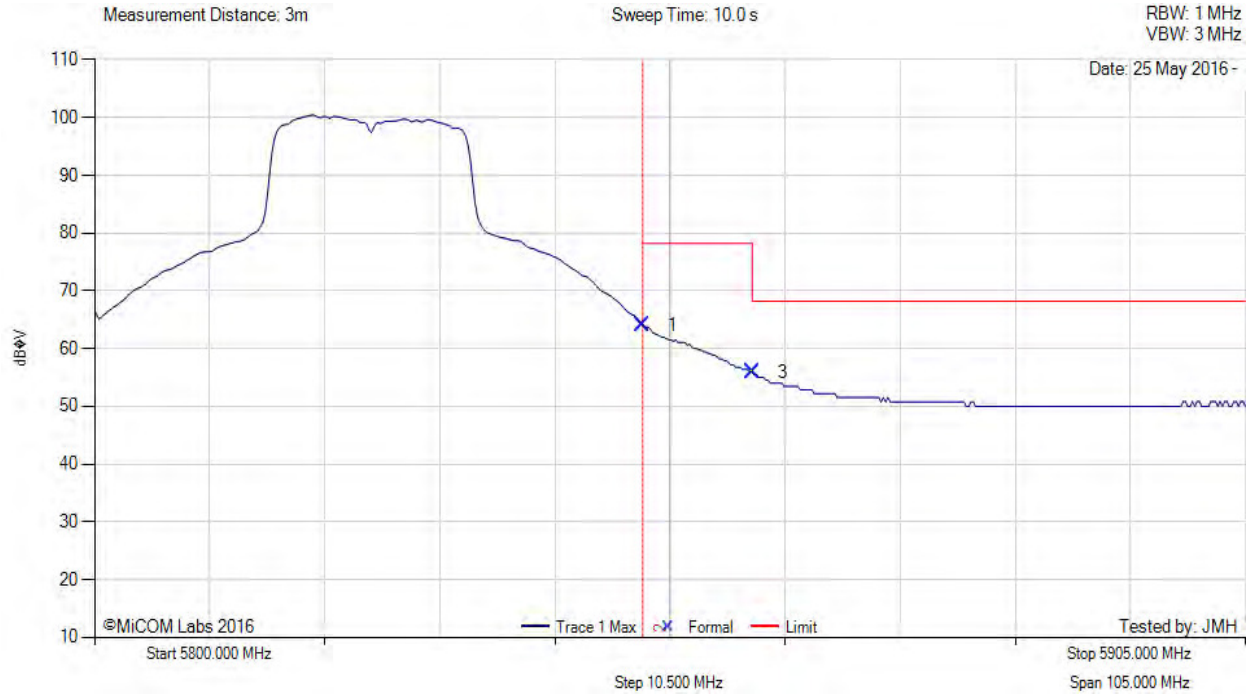

Num	Frequency MHz	Raw dBμV	Cable Loss	AF dB	Level dBμV/m	Measurement Type	Pol	Hgt cm	Azt Deg	Limit dBμV/m	Margin dB	Pass /Fail
1	5850.00	25.62	3.81	34.63	64.06	Max Avg	Horizontal	192	13	78.2	-14.2	Pass
3	5860.00	17.45	3.86	34.65	55.96	Max Avg	Horizontal	192	13	68.2	-12.3	Pass
2	5850.00	--	--	--	--	Band Edge	--	--	--	--	--	--

Test Notes: EUT on 150cm table powered by host.

[back to matrix](#)

This test report may be reproduced in full only. The document may only be updated by MiCOM Labs personnel. All changes will be noted in the Document History section of the report.

5850 MHz RADIATED BAND-EDGE EMISSIONS



Variant: 802.11n HT-40, Test Freq: 5795.00 MHz, Antenna: Taoglas FXP.830, Power Setting: 20, Duty Cycle (%): 99

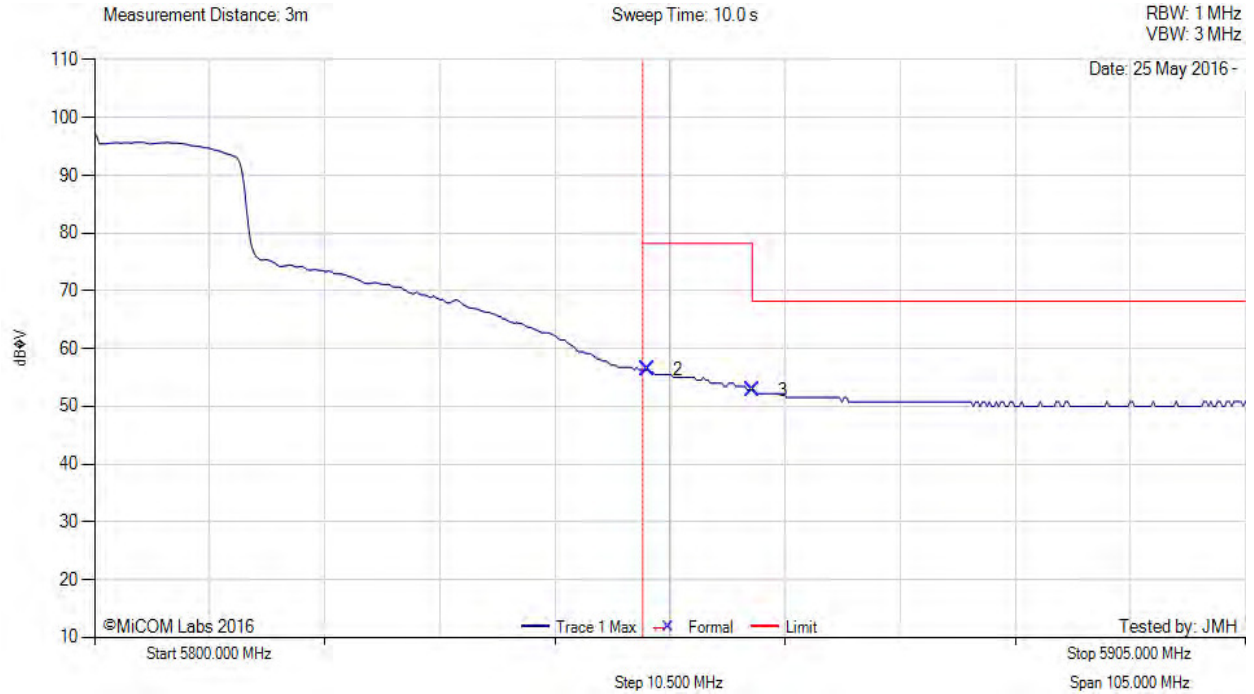

Num	Frequency MHz	Raw dBµV	Cable Loss	AF dB	Level dBµV/m	Measurement Type	Pol	Hgt cm	Azt Deg	Limit dBµV/m	Margin dB	Pass /Fail
2	5850.42	17.92	3.81	34.63	56.36	Max Avg	Horizontal	192	13	78.2	-21.9	Pass
3	5860.00	14.35	3.86	34.65	52.86	Max Avg	Horizontal	192	13	68.2	-15.4	Pass
1	5850.00	--	--	--	--	Band Edge	--	--	--	--	--	--

Test Notes: EUT on 150cm table powered by host.

[back to matrix](#)

This test report may be reproduced in full only. The document may only be updated by MiCOM Labs personnel. All changes will be noted in the Document History section of the report.



A.3.2.8. Taoglas PC.11



5725 MHz RADIATED BAND-EDGE EMISSIONS



Num	Frequency MHz	Raw dBµV	Cable Loss	AF dB	Level dBµV/m	Measurement Type	Pol	Hgt cm	Azt Deg	Limit dBµV/m	Margin dB	Pass /Fail
1	5715.00	16.03	3.81	34.34	54.18	Max Avg	Vertical	199	197	68.2	-14.1	Pass
2	5725.00	24.32	3.79	34.35	62.46	Max Avg	Vertical	199	197	78.2	-15.8	Pass
3	5725.00	--	--	--	--	Band Edge	--	--	--	--	--	--

Test Notes: EUT on 150cm table powered by host.

[back to matrix](#)

This test report may be reproduced in full only. The document may only be updated by MiCOM Labs personnel. All changes will be noted in the Document History section of the report.

5725 MHz RADIATED BAND-EDGE EMISSIONS



Variant: 802.11n HT-20, Test Freq: 5745.00 MHz, Antenna: Taoglas PC.11, Power Setting: 20, Duty Cycle (%): 99

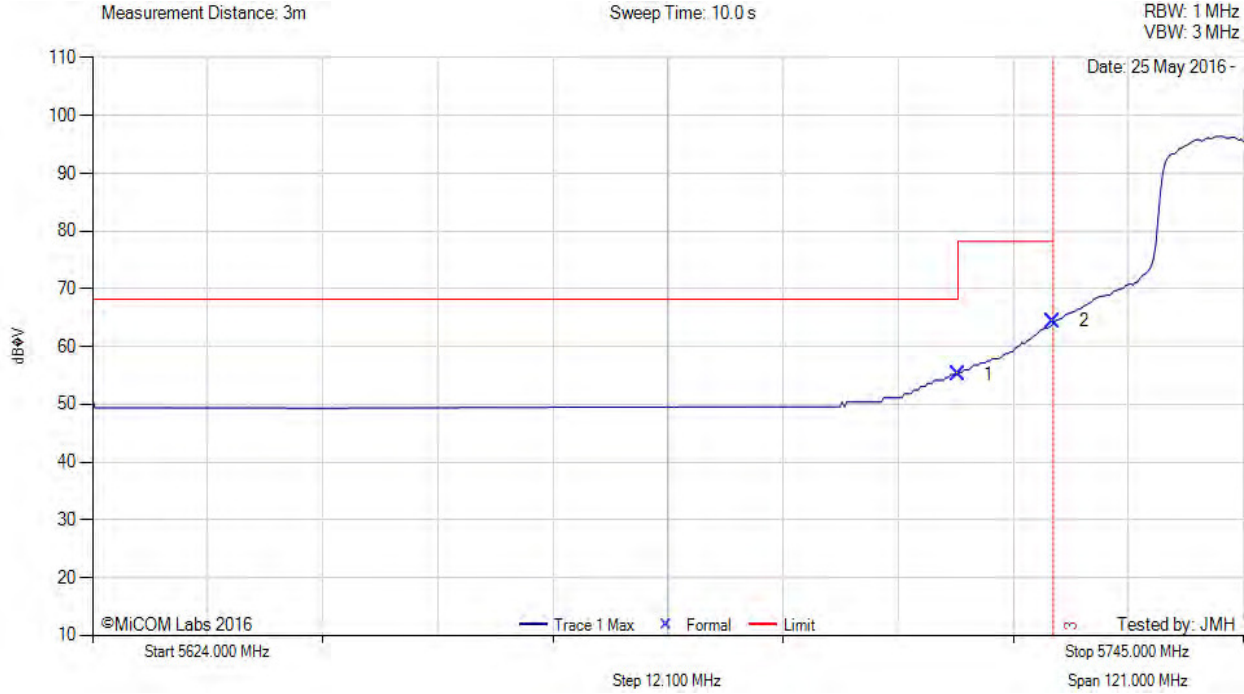

Num	Frequency MHz	Raw dBµV	Cable Loss	AF dB	Level dBµV/m	Measurement Type	Pol	Hgt cm	Azt Deg	Limit dBµV/m	Margin dB	Pass /Fail
1	5715.00	16.99	3.81	34.34	55.14	Max Avg	Vertical	199	197	68.2	-13.1	Pass
2	5725.00	26.25	3.79	34.35	64.39	Max Avg	Vertical	199	197	78.2	-13.8	Pass
3	5725.00	--	--	--	--	Band Edge	--	--	--	--	--	--

Test Notes: EUT on 150cm table powered by host.

[back to matrix](#)

This test report may be reproduced in full only. The document may only be updated by MiCOM Labs personnel. All changes will be noted in the Document History section of the report.

5725 MHz RADIATED BAND-EDGE EMISSIONS



Variant: 802.11n HT-40, Test Freq: 5755.00 MHz, Antenna: Taoglas PC.11, Power Setting: 20, Duty Cycle (%): 99

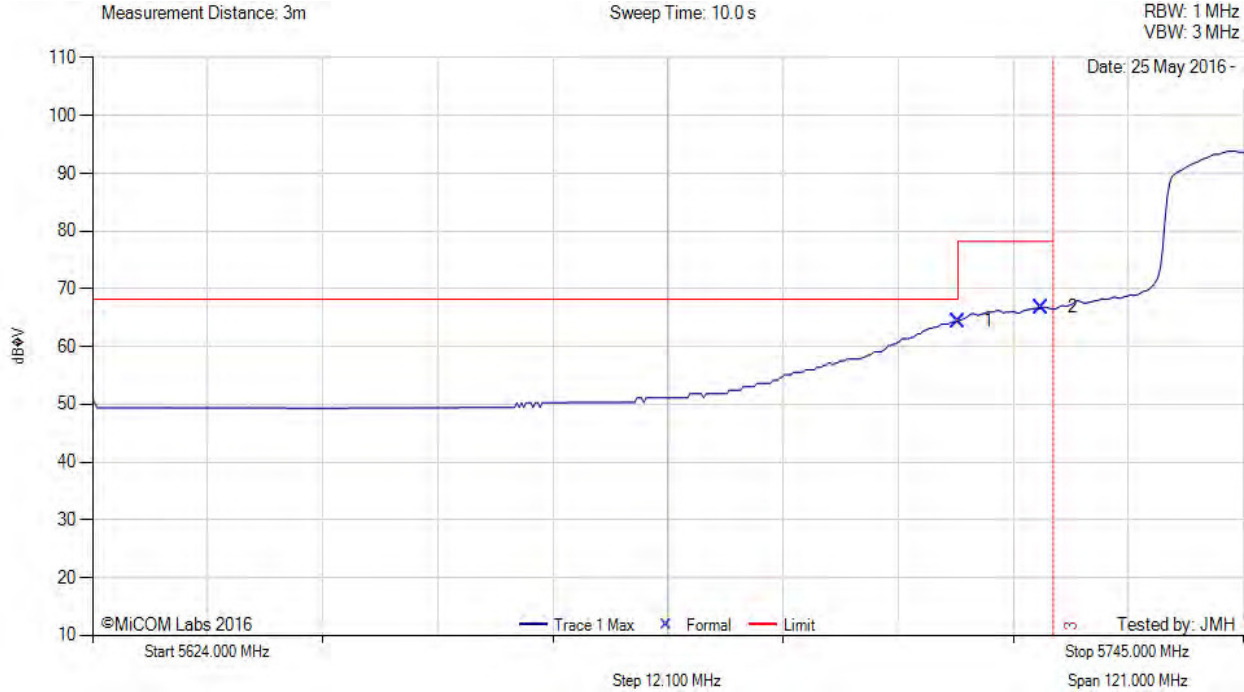

Num	Frequency MHz	Raw dBµV	Cable Loss	AF dB	Level dBµV/m	Measurement Type	Pol	Hgt cm	Azt Deg	Limit dBµV/m	Margin dB	Pass /Fail
1	5715.00	26.23	3.81	34.34	64.38	Max Avg	Vertical	199	197	68.2	-3.9	Pass
2	5723.79	28.71	3.79	34.35	66.85	Max Avg	Vertical	199	197	78.2	-11.4	Pass
3	5725.00	--	--	--	--	Band Edge	--	--	--	--	--	--

Test Notes: EUT on 150cm table powered by host.

[back to matrix](#)

This test report may be reproduced in full only. The document may only be updated by MiCOM Labs personnel. All changes will be noted in the Document History section of the report.

5850 MHz RADIATED BAND-EDGE EMISSIONS



Variant: 802.11a, Test Freq: 5825.00 MHz, Antenna: Taoglas PC.11, Power Setting: 20, Duty Cycle (%): 99

Measurement Distance: 3m

Sweep Time: 10.0 s

RBW: 1 MHz
VBW: 3 MHz

Date: 25 May 2016

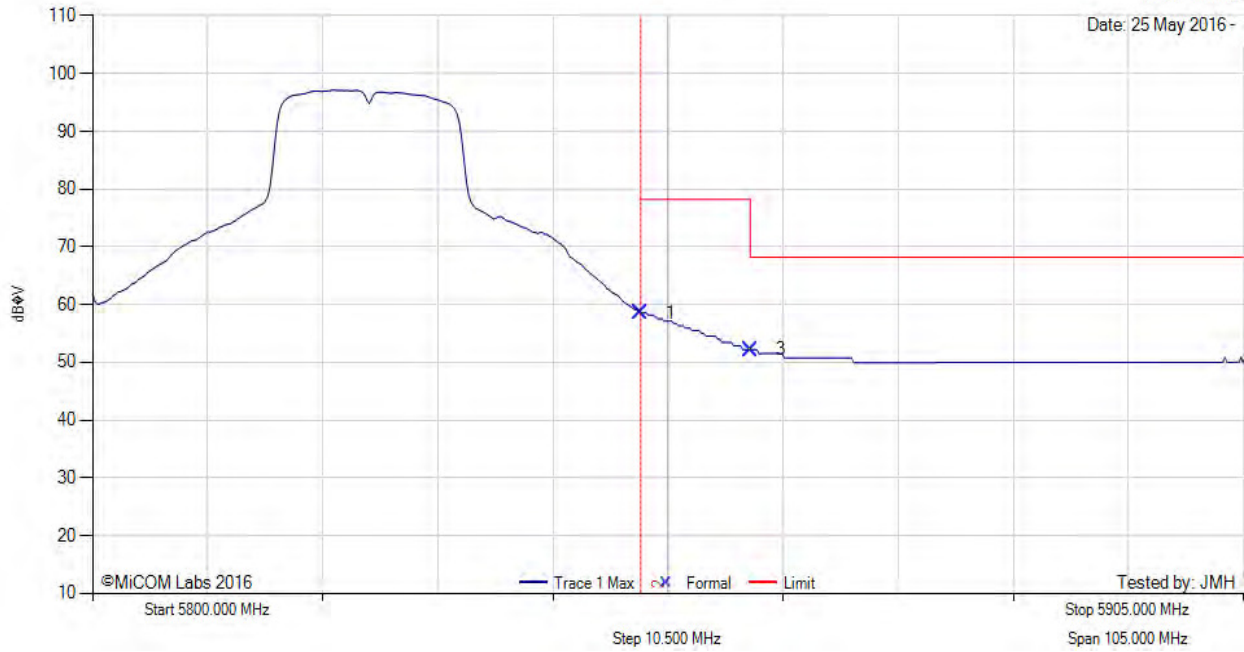

Num	Frequency MHz	Raw dBµV	Cable Loss	AF dB	Level dBµV/m	Measurement Type	Pol	Hgt cm	Azt Deg	Limit dBµV/m	Margin dB	Pass /Fail
1	5850.00	20.10	3.81	34.63	58.54	Max Avg	Vertical	199	197	78.2	-19.7	Pass
3	5860.00	13.71	3.86	34.65	52.22	Max Avg	Vertical	199	197	68.2	-16.0	Pass
2	5850.00	--	--	--	--	Band Edge	--	--	--	--	--	--

Test Notes: EUT on 150cm table powered by host.

[back to matrix](#)

This test report may be reproduced in full only. The document may only be updated by MiCOM Labs personnel. All changes will be noted in the Document History section of the report.

5850 MHz RADIATED BAND-EDGE EMISSIONS



Variant: 802.11n HT-20, Test Freq: 5825.00 MHz, Antenna: Taoglas PC.11, Power Setting: 20, Duty Cycle (%): 99

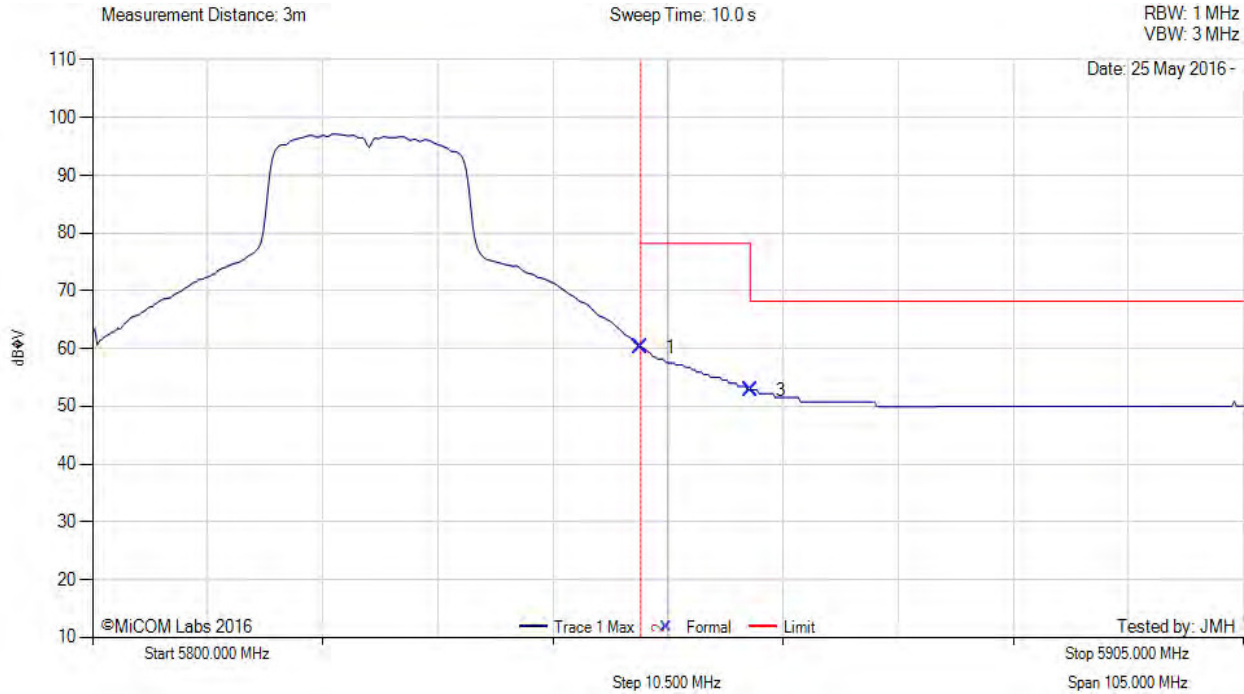

Num	Frequency MHz	Raw dBµV	Cable Loss	AF dB	Level dBµV/m	Measurement Type	Pol	Hgt cm	Azt Deg	Limit dBµV/m	Margin dB	Pass /Fail
1	5850.00	21.84	3.81	34.63	60.28	Max Avg	Vertical	199	197	78.2	-18.0	Pass
3	5860.00	14.35	3.86	34.65	52.86	Max Avg	Vertical	199	197	68.2	-15.4	Pass
2	5850.00	--	--	--	--	Band Edge	--	--	--	--	--	--

Test Notes: EUT on 150cm table powered by host.

[back to matrix](#)

This test report may be reproduced in full only. The document may only be updated by MiCOM Labs personnel. All changes will be noted in the Document History section of the report.

5850 MHz RADIATED BAND-EDGE EMISSIONS



Variant: 802.11n HT-40, Test Freq: 5795.00 MHz, Antenna: Taoglas PC.11, Power Setting: 20, Duty Cycle (%): 99

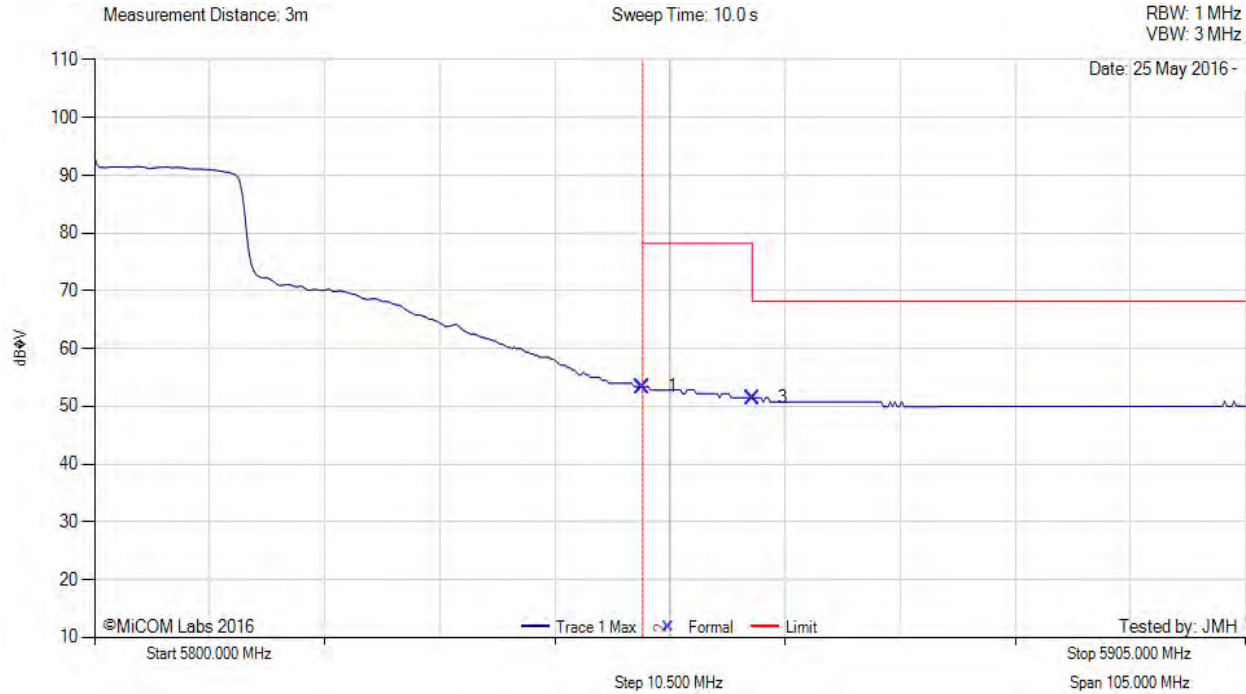

Num	Frequency MHz	Raw dBµV	Cable Loss	AF dB	Level dBµV/m	Measurement Type	Pol	Hgt cm	Azt Deg	Limit dBµV/m	Margin dB	Pass /Fail
1	5850.00	14.99	3.81	34.63	53.43	Max Avg	Vertical	199	197	78.2	-24.8	Pass
3	5860.00	13.01	3.86	34.65	51.52	Max Avg	Vertical	199	197	68.2	-16.7	Pass
2	5850.00	--	--	--	--	Band Edge	--	--	--	--	--	--

Test Notes: EUT on 150cm table powered by host.

[back to matrix](#)

This test report may be reproduced in full only. The document may only be updated by MiCOM Labs personnel. All changes will be noted in the Document History section of the report.



575 Boulder Court
Pleasanton, California 94566, USA
Tel: +1 (925) 462 0304
Fax: +1 (925) 462 0306
www.micomlabs.com