

Test of
Digi Connect Card for i.MX28 with Atheros AR6203
Wi-Fi Mode
To: FCC 47 CFR Part 15.247 & IC RSS-210
Test Report Serial No.: DIGI36-U2 Rev A



TEST REPORT

FROM



Test of Digi Connect Card for i.MX28 with Atheros AR6203
Wi-Fi Mode

To FCC 47 CFR Part 15.247 & IC RSS-210

Test Report Serial No.: DIGI36-U2 Rev A

Note: this report contains data with regard to the 2400 to 2483.5 MHz and 5725 to 5850 MHz operational modes of the Digi Connect Card for i.MX28 with Atheros AR6203. Test data for the 5,150 - 5,350 and 5,470 – 5,725 MHz is reported in MiCOM Labs test report DIGI36-U3

This report supersedes: NONE

Applicant: Digi International
355 South 520 West, Suite 180
Lindon
Utah, 84042 USA

Product Function: 802.11 a/b/g/n Wireless Module

Copy No: pdf Issue Date: 22nd May 2014

This Test Report is Issued Under the Authority of:

MiCOM Labs, Inc.

575 Boulder Court

Pleasanton, CA 94566 USA

Phone: +1 (925) 462-0304

Fax: +1 (925) 462-0306

www.micomlabs.com



TESTING CERT #2381.01

MiCOM Labs is an ISO 17025 Accredited Testing Laboratory



Title: Digi Connect Card for i.MX28 with Atheros AR6203
To: FCC 47 CFR Part 15.247 & IC RSS-210
Serial #: DIGI36-U2 Rev A
Issue Date: 22nd May 2014
Page: 3 of 261

This page has been left intentionally blank



TABLE OF CONTENTS

ACCREDITATION, LISTINGS & RECOGNITION	5
TESTING ACCREDITATION	5
RECOGNITION	6
PRODUCT CERTIFICATION	7
1. TEST RESULT CERTIFICATE	9
2. REFERENCES AND MEASUREMENT UNCERTAINTY	10
2.1. Normative References	10
2.2. Test and Uncertainty Procedures	11
3. PRODUCT DETAILS AND TEST CONFIGURATIONS	12
3.1. Technical Details	12
3.2. Scope of Test Program	13
3.3. Equipment Model(s) and Serial Number(s)	15
3.4. Antenna Details	15
3.5. Cabling and I/O Ports	15
3.6. Test Configurations	16
3.7. Equipment Modifications	18
3.8. Deviations from the Test Standard	19
4. TEST EQUIPMENT CONFIGURATION(S)	20
4.1. Conducted RF Emission Test Set-up	20
4.2. Radiated Spurious Emission Test Set-up > 1 GHz	21
4.3. Digital Emissions Test Set-up (0.03 – 1 GHz)	22
4.4. ac Wireline Emission Test Set-up	23
5. TEST SUMMARY	24
6. TEST RESULTS	26
6.1. Device Characteristics	26
6.1.1. <i>Conducted Testing</i>	26
6.1.2. <i>Radiated Emission Testing</i>	64
6.1.3. <i>AC Wireline Conducted Emissions (150 kHz – 30 MHz)</i>	159
7. PHOTOGRAPHS	161
7.1. Conducted Test Setup	161
7.2. Test Setup - Digital Emissions below 1 GHz	162
7.3. Radiated Emissions Test Setup >1 GHz	163
8. TEST EQUIPMENT	165
APPENDIX	166
A. SUPPORTING INFORMATION	166
A.1. CONDUCTED TEST PLOTS	166
A.1.1. <i>6 dB & 99% Bandwidth</i>	167
A.1.2. <i>Peak Output Power</i>	187
A.1.3. <i>Power Spectral Density</i>	207
A.1.4. <i>Conducted Spurious Emissions</i>	227

This test report may be reproduced in full only. The document may only be updated by MiCOM Labs personnel. Any changes will be noted in the Document History section of the report.



Title: Digi Connect Card for i.MX28 with Atheros AR6203
To: FCC 47 CFR Part 15.247 & IC RSS-210
Serial #: DIGI36-U2 Rev A
Issue Date: 22nd May 2014
Page: 5 of 261

ACCREDITATION, LISTINGS & RECOGNITION

TESTING ACCREDITATION

MiCOM Labs, Inc. is an accredited Electrical testing laboratory per the international standard EN ISO/IEC 17025. The company is accredited by the American Association for Laboratory Accreditation (A2LA) www.a2la.org test laboratory number 2381.01. MiCOM Labs test schedule is available at the following URL; <http://www.a2la.org/scopepdf/2381-01.pdf>



This test report may be reproduced in full only. The document may only be updated by MiCOM Labs personnel. Any changes will be noted in the Document History section of the report.



Title: Digi Connect Card for i.MX28 with Atheros AR6203
To: FCC 47 CFR Part 15.247 & IC RSS-210
Serial #: DIGI36-U2 Rev A
Issue Date: 22nd May 2014
Page: 6 of 261

RECOGNITION

MiCOM Labs, Inc has widely recognized Electrical testing capabilities. Our international recognition includes Conformity Assessment Body designation by APEC MRA** countries. Our test reports are widely accepted for global type approvals.

Country	Recognition Body	Status	Phase	Identification No.
USA	Federal Communications Commission (FCC)	TCB	-	US0159 Listing #: 102167
Canada	Industry Canada (IC)	FCB	APEC MRA 2	US0159 Listing #: 4143A-2
Japan	MIC (Ministry of Internal Affairs and Communication)	CAB	APEC MRA 2	RCB 210
	VCCI	--	--	A-0012
Europe	European Commission	NB	EU MRA	NB 2280
Australia	Australian Communications and Media Authority (ACMA)	CAB	APEC MRA 1	US0159
Hong Kong	Office of the Telecommunication Authority (OFTA)	CAB	APEC MRA 1	
Korea	Ministry of Information and Communication Radio Research Laboratory (RRL)	CAB	APEC MRA 1	
Singapore	Infocomm Development Authority (IDA)	CAB	APEC MRA 1	
Taiwan	National Communications Commission (NCC) Bureau of Standards, Metrology and Inspection (BSMI)	CAB	APEC MRA 1	
Vietnam	Ministry of Communication (MIC)	CAB	APEC MRA 1	

**APEC MRA – Asia Pacific Economic Community Mutual Recognition Agreement.

Is a recognition agreement under which test lab is accredited to regulatory standards of the APEC member countries.

Phase I - recognition for product testing

Phase II – recognition for both product testing and certification

N/A – Not Applicable

**EU MRA – European Union Mutual Recognition Agreement.

Is a recognition agreement under which test lab is accredited to regulatory standards of the EU member countries.

**NB – Notified Body

This test report may be reproduced in full only. The document may only be updated by MiCOM Labs personnel. Any changes will be noted in the Document History section of the report.



Title: Digi Connect Card for i.MX28 with Atheros AR6203
To: FCC 47 CFR Part 15.247 & IC RSS-210
Serial #: DIGI36-U2 Rev A
Issue Date: 22nd May 2014
Page: 7 of 261

PRODUCT CERTIFICATION

MiCOM Labs, Inc. is an accredited Product Certification Body per the international standard EN ISO/IEC 17065. The company is accredited by the American Association for Laboratory Accreditation (A2LA) www.a2la.org test laboratory number 2381.02. MiCOM Labs test schedule is available at the following URL; <http://www.a2la.org/scopepdf/2381-02.pdf>



United States of America – Telecommunication Certification Body (TCB)

TCB Identifier – US0159

Industry Canada – Certification Body

CAB Identifier – US0159

Europe – Notified Body

Notified Body Identifier - 2280

Japan – Recognized Certification Body (RCB)

RCB Identifier - 210

This test report may be reproduced in full only. The document may only be updated by MiCOM Labs personnel. Any changes will be noted in the Document History section of the report.



Title: Digi Connect Card for i.MX28 with Atheros AR6203
To: FCC 47 CFR Part 15.247 & IC RSS-210
Serial #: DIGI36-U2 Rev A
Issue Date: 22nd May 2014
Page: 8 of 261

DOCUMENT HISTORY

Document History		
Revision	Date	Comments
Rev A	22 nd May 2014	Additional antenna added - performed radiated emissions above 1 GHz See Section 6.1.2.5 Dual Band – Compact Balanced Dipole
Test Report initially released as DIGI28-U2B		
Draft		
Rev A	29 th March 2013	Initial release.

This test report may be reproduced in full only. The document may only be updated by MiCOM Labs personnel. Any changes will be noted in the Document History section of the report.



Title: Digi Connect Card for i.MX28 with Atheros AR6203
To: FCC 47 CFR Part 15.247 & IC RSS-210
Serial #: DIGI36-U2 Rev A
Issue Date: 22nd May 2014
Page: 9 of 261

1. TEST RESULT CERTIFICATE

Manufacturer:	Digi International 355 South 520 West, Suite 180 Lindon Utah, 84042 USA	Tested By:	MiCOM Labs, Inc. 575 Boulder Court Pleasanton California, 94566, USA
EUT:	802.11a/b/g/n AR6203 802.11 a/b/g/n (Operating in Wi-Fi Mode)	Telephone:	+1 925 462 0304
Model:	CCWMX28	Fax:	+1 925 462 0306
S/N's:	5501671-01		
Test Date(s):	26th Sept - 27th Nov '12, 24th - 25th Feb '14	Website:	www.micomlabs.com

STANDARD(S)	TEST RESULTS
FCC 47 CFR Part 15.247 & IC RSS-210	EQUIPMENT COMPLIES

MiCOM Labs, Inc. tested the equipment mentioned in accordance with the requirements set forth in the above standards. Test results indicate that the equipment tested is capable of demonstrating compliance with the requirements as documented within this report.

Notes:

1. This document reports conditions under which testing was conducted and the results of testing performed.
2. Details of test methods used have been recorded and kept on file by the laboratory.
3. Test results apply only to the item(s) tested.

Approved & Released for MiCOM Labs, Inc. by:



TESTING CERT #2381.01



Graeme Grieve
Quality Manager MiCOM Labs,

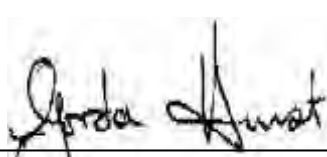

Gordon Hurst
President & CEO MiCOM Labs, Inc.

This test report may be reproduced in full only. The document may only be updated by MiCOM Labs personnel. Any changes will be noted in the Document History section of the report.



Title: Digi Connect Card for i.MX28 with Atheros AR6203
To: FCC 47 CFR Part 15.247 & IC RSS-210
Serial #: DIGI36-U2 Rev A
Issue Date: 22nd May 2014
Page: 10 of 261

2. REFERENCES AND MEASUREMENT UNCERTAINTY

2.1. Normative References

REF.	PUBLICATION	YEAR	TITLE
i.	FCC 47 CFR Part 15, Subpart C	2012	Title 47: Telecommunication PART 15—RADIO FREQUENCY DEVICES Subpart C—Intentional Radiators
ii.	RSS-210 Annex 8	2010	Radio Standards Specification 210, Issue 8, Low-power Licence-exempt Radiocommunication Devices (All Frequency Bands): Category I Equipment
iii.	FCC OET KDB 662911	4 th April 2011	Emissions Testing of Transmitters with Multiple Outputs in the Same Band
iv.	DA 00-705	2000	FCC DA 00-705 "Filing and Measurement Guidelines for Frequency Hopping Spread Spectrum Systems" released March 30, 2000
v.	RSS-GEN	2010	Radio Standards Specification-Gen, Issue 3, General Requirements and Information for the Certification of Radiocommunication Equipment
vi.	FCC 47 CFR Part 15 B	2012	47 CFR Part 15, SubPart B; Unintentional Radiators
vii.	ICES-003	2004	Spectrum Management and Telecommunications Policy Interference-Causing Equipment Standard Digital Apparatus; Issue 4
viii.	ANSI C63.4	2009	American National Standards for Methods of Measurement of Radio-Noise Emissions from Low-Voltage Electrical and Electronic Equipment in the Range of 9 kHz to 40 GHz
ix.	CISPR 22/ EN 55022	2008 2006+A1:2007	Limits and Methods of Measurements of Radio Disturbance Characteristics of Information Technology Equipment
x.	M 3003	Edition 1 Dec. 1997	Expression of Uncertainty and Confidence in Measurements
xi.	LAB34	Edition 1 Aug 2002	The expression of uncertainty in EMC Testing
xii.	ETSI TR 100 028	2001	Parts 1 and 2 Electromagnetic compatibility and Radio Spectrum Matters (ERM); Uncertainties in the measurement of mobile radio equipment characteristics
xiii.	A2LA	July 2012	Reference to A2LA Accreditation Status – A2LA Advertising Policy

This test report may be reproduced in full only. The document may only be updated by MiCOM Labs personnel. Any changes will be noted in the Document History section of the report.



Title: Digi Connect Card for i.MX28 with Atheros AR6203
To: FCC 47 CFR Part 15.247 & IC RSS-210
Serial #: DIGI36-U2 Rev A
Issue Date: 22nd May 2014
Page: 11 of 261

2.2. Test and Uncertainty Procedures

Conducted and radiated emission measurements were conducted in accordance with American National Standards Institute ANSI C63.4, listed in the Normative References section of this report.

Measurement uncertainty figures are calculated in accordance with ETSI TR 100 028 Parts 1 and 2.

Measurement uncertainties stated are based on a standard uncertainty multiplied by a coverage factor $k = 2$, providing a level of confidence of approximately 95 % in accordance with UKAS document M 3003 listed in the Normative References section of this report.

This test report may be reproduced in full only. The document may only be updated by MiCOM Labs personnel. Any changes will be noted in the Document History section of the report.



Title: Digi Connect Card for i.MX28 with Atheros AR6203
To: FCC 47 CFR Part 15.247 & IC RSS-210
Serial #: DIGI36-U2 Rev A
Issue Date: 22nd May 2014
Page: 12 of 261

3. PRODUCT DETAILS AND TEST CONFIGURATIONS

3.1. Technical Details

Details	Description
Purpose:	Test of the Digi Connect Card for i.MX28 with Atheros AR6203 to FCC Part 15.247 and Industry Canada RSS-210 regulations.
Applicant:	Digi International 355 South 520 West, Suite 180 Lindon, Utah, 84042 USA
Manufacturer:	As applicant.
Laboratory performing the tests:	MiCOM Labs, Inc. 440 Boulder Court, Suite 200 Pleasanton, California 94566 USA
Test report reference number:	DIGI36-U2 Rev A
Date EUT received:	26 th September 2012, 10 th February 2014
Standard(s) applied:	FCC 47 CFR Part 15.247 & IC RSS-210
Dates of test (from - to):	26th Sept - 27th Nov '12, 24th - 25th Feb '14
No of Units Tested:	One
Type of Equipment:	802.11a/b/g/n Wi-Fi Module
Manufacturers Trade Name:	Wi-Fi Module
Model(s):	CCWMX28
Location for use:	Indoor
Declared Frequency Range(s):	2400 - 2483.5 MHz; 5725 - 5850 MHz
Hardware Rev	30013772-04
Software Rev	DEL-5.9 Rev B
Type of Modulation:	Per 802.11 –CCK, BPSK, QPSK, DSSS, OFDM
Declared Nominal Average Output Power:	2400 – 2483.5 MHz 802.11b: +19 dBm; 802.11g: +23 dBm; HT-20 +24 dBm; HT-40 +24 dBm 5725 - 5850 MHz 802.11a:+24 dBm,HT-20 +23 dBm,HT-40 +23 dBm
EUT Modes of Operation:	Legacy 802.11a/b/g, 802.11n HT-20, HT-40
Transmit/Receive Operation:	Time Division Duplex
System Beam Forming:	EUT has no capability for antenna beam forming
Rated Input Voltage and Current:	5 Vdc 0.625 A
Operating Temperature Range:	Declared range -40° to +75°C at 95% humidity non condensing
ITU Emission Designator:	2400 – 2483.5 MHz 802.11b 13M9G1D 2400 – 2483.5 MHz 802.11g 17M6D1D 2400 – 2483.5 MHz 802.11n – HT-20 18M3D1D 2400 – 2483.5 MHz 802.11n – HT-40 36M9D1D 5725 – 5850 MHz 802.11a 16M8D1D 5725 – 5850 MHz 802.11n – HT-20 17M9D1D 5725 – 5850 MHz 802.11n – HT-40 36M6D1D
Equipment Dimensions:	2" (L) x 1.375 (W) x 0.162" (H) inches
Weight:	< 0.5 oz
Primary function of equipment:	Wi-Fi Module for transmitting data and voice.

This test report may be reproduced in full only. The document may only be updated by MiCOM Labs personnel. Any changes will be noted in the Document History section of the report.



Title: Digi Connect Card for i.MX28 with Atheros AR6203
To: FCC 47 CFR Part 15.247 & IC RSS-210
Serial #: DIGI36-U2 Rev A
Issue Date: 22nd May 2014
Page: 13 of 261

3.2. Scope of Test Program

Digi Connect Card for i.MX28 with Atheros AR6203 RF Testing

The scope of the test program was to test the Digi Connect Card for i.MX28 with Atheros AR6203 dual port module in the frequency ranges 2400 - 2483.5 MHz and 5725 – 5850 MHz for compliance against FCC 47 CFR Part 15.247 and Industry Canada RSS-210 specifications.

Wi-Fi Dual Port Module: 5501671-01

The following operational description of the module was provided by the customer.

The ConnectCard for i.MX28 module set contains a full 802.11 a b g n and Bluetooth radio with a programmable Freescale i.MX28 Processor. The RF section of the part is handled by a Qualcomm Atheros Wi-Fi/BT module with a 5GHz RF front end module. Data is entered into the processor through a variety of interfaces including Ethernet, CAN, UART, SPI, I2C, I2S, USB, SDIO, etc. Data is sent to the Wi-Fi/BT module where it is processed and sent to the RF Antenna(s). Likewise data is received in the Wi-Fi/BT module and converted to baseband data where it is sent to the processor for baseband processing and sent out of the module using one of the interface ports.

The module is comprised of a Freescale i.MX28 processor, a Qualcomm Atheros Wi-Fi/Bluetooth Module, an RFMD 5GHz front end module, Diplex filter, and either a BT-2.4GHz Wi-Fi switch or Diversity antenna switch (if no BT). The ConnectCard for i.MX28 functions in both the 2.4 to 2.5GHz, and 4.9 to 6 GHz ISM bands.

The module uses an efficient architecture in which data streams directly from the processor (at baseband) to the Wi-Fi/BT module through data lines. The processor also controls the transceiver's modes within the 802.11 a, b, g, and n modes. The Wi-Fi module includes LNA's for the receive modes and a power amplifier for the transmit mode within the 2.4GHz band. Further a there are transmit-receive switches within the module for the 2.4GHz bands. The antenna(s) are connected to the module through u.FL connectors. With BT capable modules there is a single u.FL connector for a single antenna. For modules without BT, there is a diversity antenna switch and 2 u.FL antenna connectors. The module is available with different amounts of FLASH, and RAM, as well as various processors within the i.MX28 family for customers to store their programs.

This test report may be reproduced in full only. The document may only be updated by MiCOM Labs personnel. Any changes will be noted in the Document History section of the report.

Digi Connect Card for i.MX28 with Atheros AR6203 – Dual Port



This test report may be reproduced in full only. The document may only be updated by MiCOM Labs personnel. Any changes will be noted in the Document History section of the report.



Title: Digi Connect Card for i.MX28 with Atheros AR6203
To: FCC 47 CFR Part 15.247 & IC RSS-210
Serial #: DIGI36-U2 Rev A
Issue Date: 22nd May 2014
Page: 15 of 261

3.3. Equipment Model(s) and Serial Number(s)

Equipment Type	Equipment Description (Including Brand Name)	Mfr	Model No.	Serial No.
EUT	802.11a/b/g/n Module – Dual Port	Digi International	CCWMX28	55001671.01
Support	Laptop PC	IBM	Thinkpad	None

3.4. Antenna Details

Antenna Type	Manufacturer	Model Number	Antenna Gain (dBi)	
			2.4 GHz	5 GHz
Patch	Taoglas	PC.11	3.0	4.5
Patch	Taoglas	FXP.830	1.8	4
Dual Band Omni	Antenna Factor	ANT-DB1-xxx	-3.10	4.30
Single Band Omni	Bobbintron Electrical Corp.	SA-006-1	1.8	---
Compacted Balanced Dipole	Digi International	3100016-01	0.0	2.0

3.5. Cabling and I/O Ports

Number and type of I/O ports

1. 1 x DB9 control port on interface card
2. 2 x 2.5 mm DC Power ports on interface card

This test report may be reproduced in full only. The document may only be updated by MiCOM Labs personnel. Any changes will be noted in the Document History section of the report.



3.6. Test Configurations

Testing was performed to determine the highest power level versus bit rate. The variant with the highest power was used to exercise the product.

Operational Mode(s) (802.11a/b/g/n)	Variant	Data Rate with Highest Power	Frequencies (MHz)
b	Legacy	1 MBit/s	2,412
g	Legacy	6 MBit/s	2,437
n	HT-20	6.5 (MCS 0)	2,462
	HT-40	13.5 (MCS 0)	2,422 2,437 2,452
a	Legacy	6 MBit/s	5,745
n	HT-20	6.5 (MCS 0)	5,785
	HT-40	13.5 (MCS 0)	5,825 5,755 5,795

Legacy – data rates for 802.11abg products

Results for the above configurations are provided in this report.



Antenna Test Configurations for Radiated Emissions

Results for the following configurations are provided in this report.

Modes with the highest spectral density will have the highest spurious emissions, only those modes were tested for this test program.

2,400 – 2483.5 MHz

5,725 – 5850 MHz

15.247	
802.11b	b SE 2412
	b SE 2437
	b SE 2462
	BE b 2390
	BE b 2483.5
802.11g	g SE 2412
	g SE 2437
	g SE 2462
	BE g 2390
	BE g 2483.5
802.11n HT-20	BE n HT-20 2390
	BE n HT-20 2483.5
802.11n HT-40	BE n HT-40 2390
	BE n HT-40 2483.5

15.247	
802.11a	a SE 5745
	a SE 5785
	a SE 5825
	BE a 5490
802.11n HT-20	BE a 5490
802.11n HT-40	BE a 5490

KEY;-

SE – Spurious Emission
BE – Band-Edge

This test report may be reproduced in full only. The document may only be updated by MiCOM Labs personnel. Any changes will be noted in the Document History section of the report.



3.7. Equipment Modifications

The following modifications were required to bring the equipment into compliance:

1. Band-Edge and Radiated Spurious Power Reduction

All conducted spurious emission testing was performed with the device set for maximum power at all times. During radiated spurious and band-edge emission testing the output power was reduced in order to comply with the Restricted Band limit criteria.

Dual Port Module		PC.11	FXP.830	ANT-DB1-xxx	SA-006-1*
	Channel (MHz)	Maximum Power Level			
2.4 GHz	b	2412	20	20	20
		2437	20	20	20
		2462	20	19	20
	g	2412	19	17	15
		2437	20	20	20
		2462	20	19	14
	HT-20	2412	18	16	14
		2437	20	20	20
		2462	20	18	13
	HT-40	2422	16	13	10
		2437	19	17	16
	2452	17	16	9	
5.8 GHz	a	5745	18	20	13
		5785	16	18	11
		5825	15	13	9
	HT-20	5745	18	20	13
		5785	16	18	11
		5825	15	13	9
	HT-40	5755	18	20	13
		5795	15	13	9

*Antenna is limited to 2.4 GHz operation



Dual Port Module		Dual Band – Compacted Balanced Dipole	
		Channel (MHz)	Maximum Power Level
2.4 GHz	b	2412	20
		2437	20
		2462	20
	g	2412	16
		2437	20
		2462	20
	HT-20	2412	15
		2437	20
		2462	20
	HT-40	2422	11
		2437	20
		2452	18
5.8 GHz	a	5745	18
		5785	14
		5825	14
	HT-20	5745	18
		5785	15
		5825	15
	HT-40	5755	18
		5795	16

3.8. Deviations from the Test Standard

The following deviations from the test standard were required in order to complete the test program:

1. NONE

4. TEST EQUIPMENT CONFIGURATION(S)

4.1. Conducted RF Emission Test Set-up

The following tests were performed using the conducted test set-up shown in the diagram below.

1. Section 6.1.1.1. 6 dB and 99% Bandwidth
2. Section 6.1.1.2. Peak Output Power
3. Section 6.1.1.3. Power Spectral Density
4. Section 6.1.1.4. Conducted Spurious Emissions

Conducted Test Set-Up Pictorial Representation

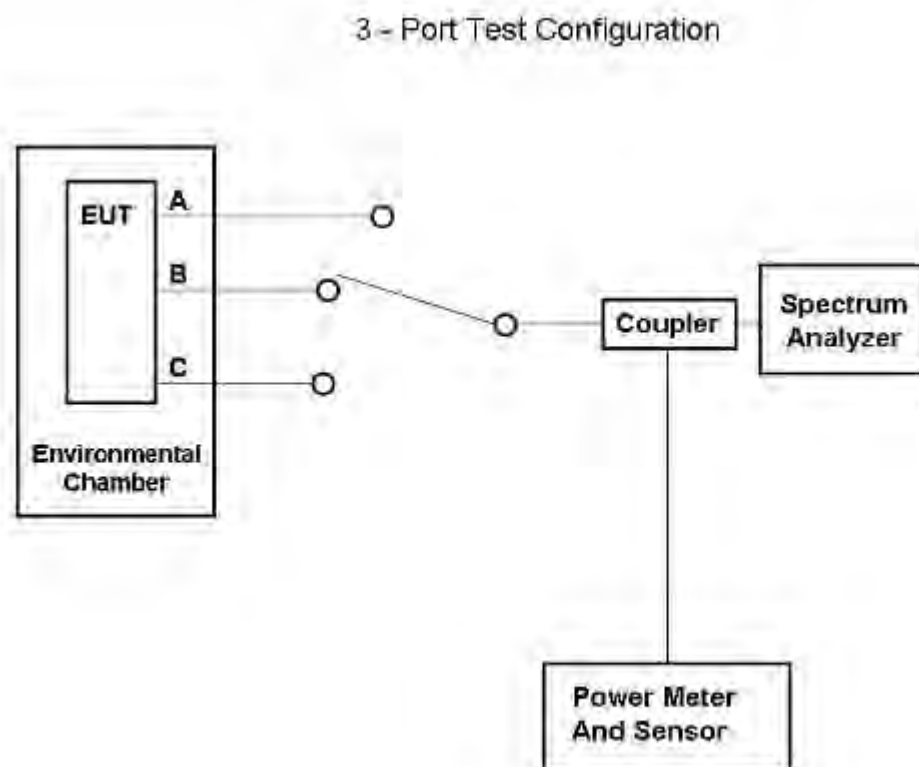

This test report may be reproduced in full only. The document may only be updated by MiCOM Labs personnel. Any changes will be noted in the Document History section of the report.

4.2. Radiated Spurious Emission Test Set-up > 1 GHz

The following tests were performed using the conducted test set-up shown in the diagram below.

1. Section 6.1.2.2. Dual Band Patch PC.11 - Dual Port Module
2. Section 6.1.2.4. Dual Band Patch FXP.830 - Dual Port Module
3. Section 6.1.2.6. Dual Band Omni ANT-DB1-xxx - Dual Port Module
4. Section 6.1.2.8 Single Band Omni SA-006-1 - Dual Port Module

Radiated Emission Measurement Setup – Above 1 GHz

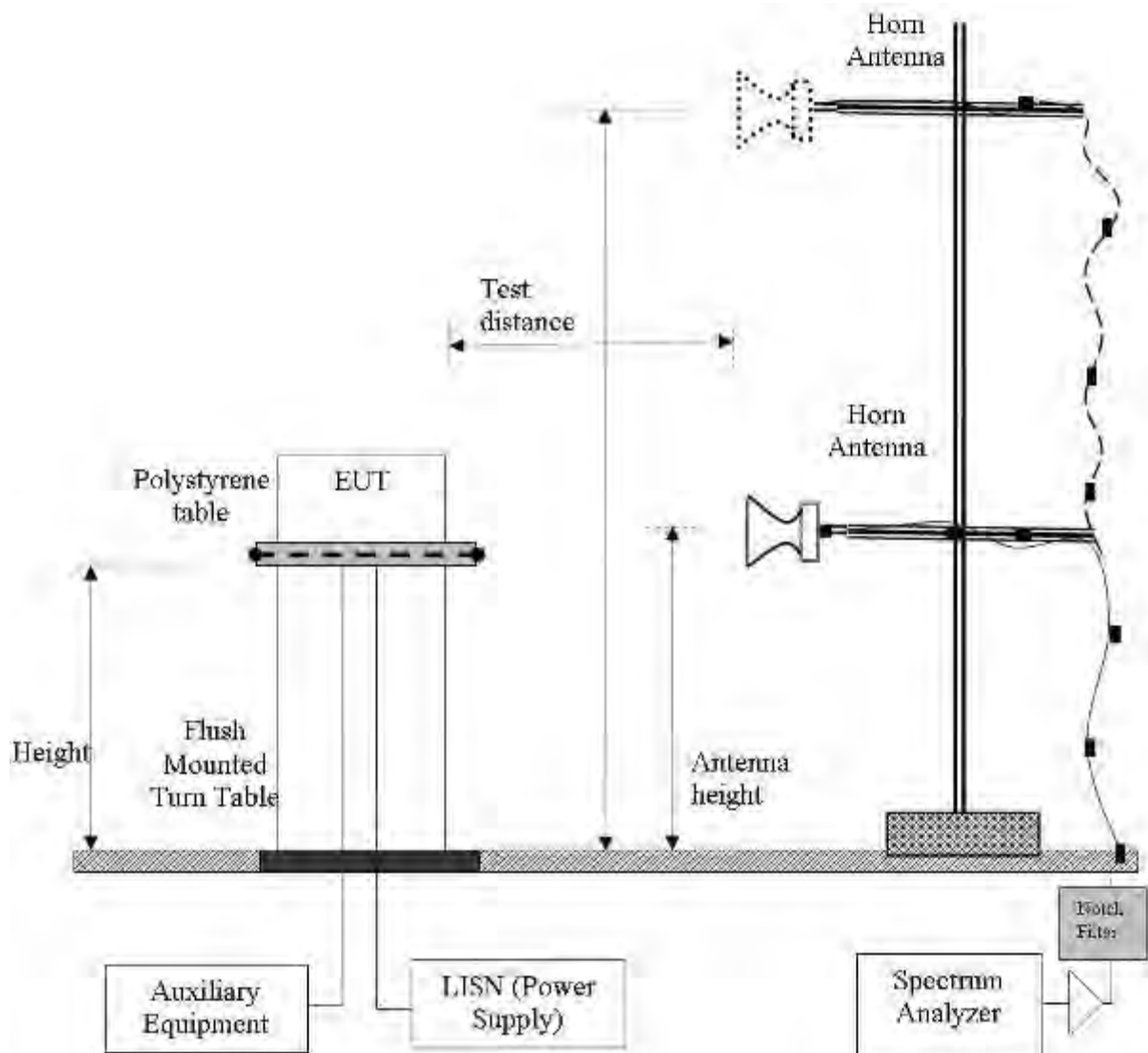

This test report may be reproduced in full only. The document may only be updated by MiCOM Labs personnel. Any changes will be noted in the Document History section of the report.

4.3. Digital Emissions Test Set-up (0.03 – 1 GHz)

The following tests were performed using the conducted test set-up shown in the diagram below.

1. Section 6.1.2.9. Dual Band OMNI ANT-DB1-xxx

Digital Emission Measurement Setup – Below 1 GHz

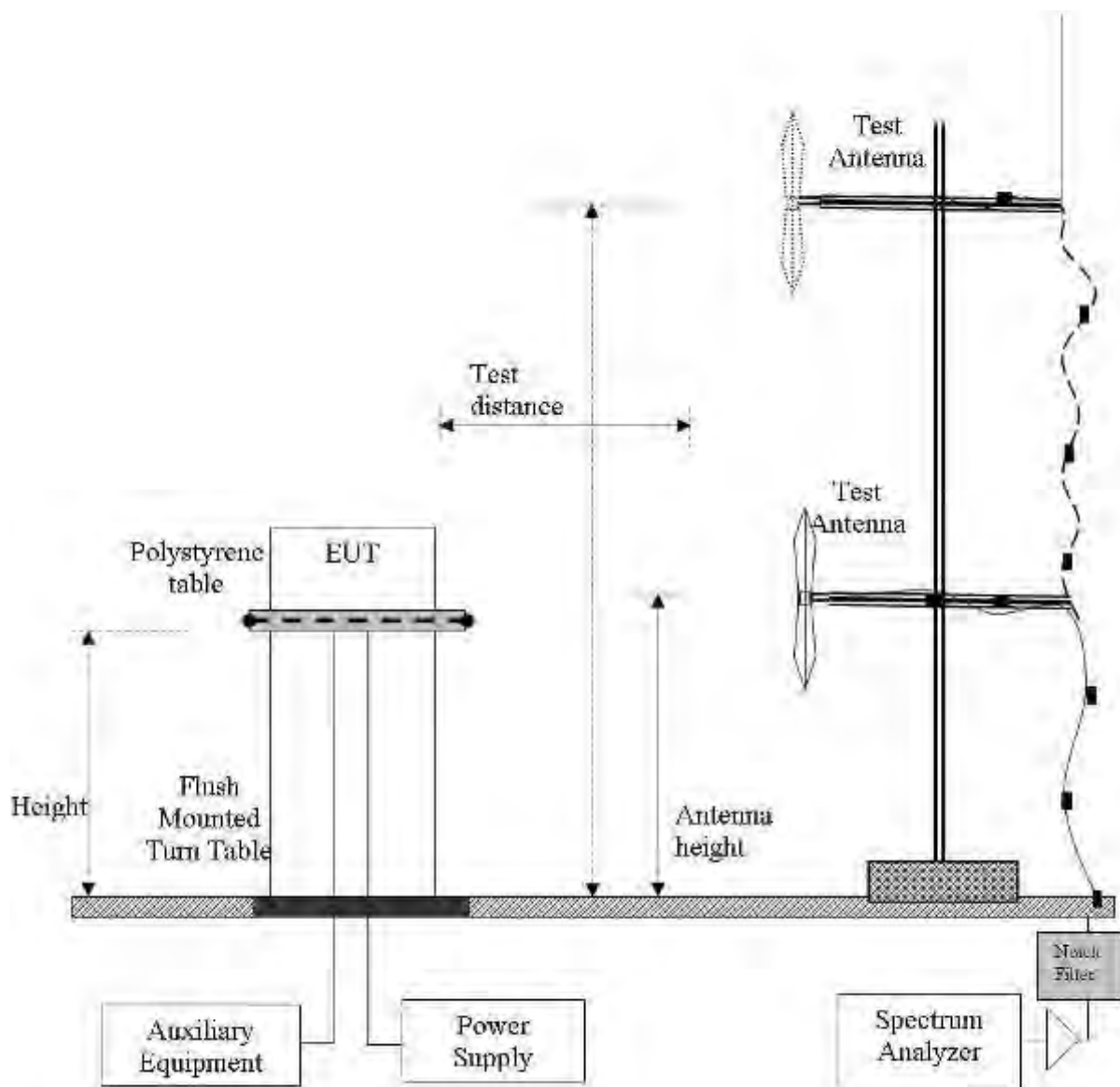

This test report may be reproduced in full only. The document may only be updated by MiCOM Labs personnel. Any changes will be noted in the Document History section of the report.

4.4. ac Wireline Emission Test Set-up

The following tests were performed using the conducted test set-up shown in the diagram below.

Refer to MiCOM Labs test report DIGI28-U4.

1. Section 6.1.3 ac Wireline Conducted Emissions

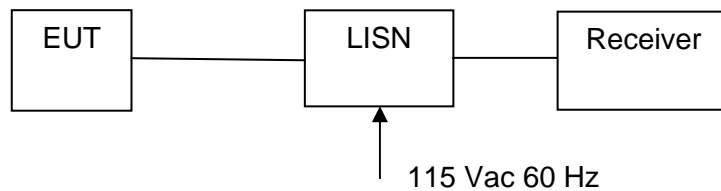

Measurement Setup for Conducted Emissions Test



Title: Digi Connect Card for i.MX28 with Atheros AR6203
To: FCC 47 CFR Part 15.247 & IC RSS-210
Serial #: DIGI36-U2 Rev A
Issue Date: 22nd May 2014
Page: 24 of 261

5. TEST SUMMARY

List of Measurements

The following table represents the list of measurements required under the **FCC CFR47 Part 15.247** and **Industry Canada RSS-210** and **Industry Canada RSS-Gen**.

Section(s)	Test Items	Description	Condition	Result	Test Report Section
15.247(a)(2) A8.2(1) 4.4	6 dB and 99 % Bandwidths	≥500 kHz	Conducted	Complies	6.1.1
15.247(b)(3) 15.31(e) A8.4(4)	Peak Output Power Voltage Variation	Shall not exceed 1W Variation of supply voltage 85 % -115 %	Conducted	Complies	6.1.2
15.247(e) A8.2	Peak Power Spectral Density	Shall not be greater than +8 dBm in any 3 kHz band	Conducted	Complies	6.1.3
15.247(i) 5.5	Maximum Permissible Exposure	Exposure to radio frequency energy levels	Conducted	Complies	6.1.4
15.247(d) 15.205 / 15.209 A8.5 2.2 4.7	Spurious Emissions (30MHz - 26 GHz b/g and 30 MHz – 40 GHz a)	The radiated emission in any 100 kHz of out- band shall be at least 20 dB below the highest in- band spectral density	Conducted	Complies	6.1.5

This test report may be reproduced in full only. The document may only be updated by MiCOM Labs personnel. Any changes will be noted in the Document History section of the report.



List of Measurements (continued)

The following table represents the list of measurements required under the **FCC CFR47 Part 15.247**, **Industry Canada RSS-210**, and **Industry Canada RSS-Gen**.

Section(s)	Test Items	Description	Condition	Result	Test Report Section
15.247(d) 15.205 / 15.209 A8.5 2.2 2.6 4.7	Radiated Emissions	Restricted Bands	Radiated	Complies	6.1.2.1- 6.1.2.8
	Transmitter Radiated Spurious Emissions	Emissions above 1 GHz		Complies	6.1.2.1- 6.1.2.8
	Radiated Band Edge	Band-edge results Peak Emissions		Complies	6.1.2.1- 6.1.2.8
15.205 / 15.209 2.2	Radiated Spurious Emissions	Emissions <1 GHz (30M-1 GHz)	Radiated	Complies	6.1.2.9
15.207 7.2.2	AC Wireline Conducted Emissions 150 kHz– 30 MHz	Conducted Emissions	Conducted	N/A EUT is DC powered	6.1.3

Note 1: Test results reported in this document relate only to the items tested

Note 2: The required tests demonstrated compliance as per client declaration of test configuration, monitoring methodology and associated pass/fail criteria

Note 3: Section 3.7 Equipment Modifications highlights the equipment modifications that were required to bring the product into compliance with the above test matrix



Title: Digi Connect Card for i.MX28 with Atheros AR6203
To: FCC 47 CFR Part 15.247 & IC RSS-210
Serial #: DIGI36-U2 Rev A
Issue Date: 22nd May 2014
Page: 26 of 261

6. TEST RESULTS

6.1. Device Characteristics

6.1.1. Conducted Testing

6.1.1.1. 6 dB and 99 % Bandwidth

Conducted Test Conditions for 6 dB and 99% Bandwidth			
Standard:	FCC CFR 47:15.247	Ambient Temp. (°C):	24.0 - 27.5
Test Heading:	6 dB and 99 % Bandwidth	Rel. Humidity (%):	32 - 45
Standard Section(s):	15.247 (a)(2)	Pressure (mBars):	999 - 1001
Reference Document(s):	KDB 558074 - D01 DTS Measurement Guidance v01: Section 5.1 Emission Bandwidth		

Test Procedure for 6 dB and 99% Bandwidth Measurement
The bandwidth at 6 dB and 99 % was measured with a spectrum analyzer connected to the antenna terminal, while EUT is operating in transmission mode at the appropriate centre frequency.

This test report may be reproduced in full only. The document may only be updated by MiCOM Labs personnel. Any changes will be noted in the Document History section of the report.



Title: Digi Connect Card for i.MX28 with Atheros AR6203
To: FCC 47 CFR Part 15.247 & IC RSS-210
Serial #: DIGI36-U2 Rev A
Issue Date: 22nd May 2014
Page: 27 of 261

Dual Port Module:

Equipment Configuration for 6 dB 99%

Variant:	802.11b	Duty Cycle (%):	100
Data Rate:	6 Mbps	Antenna Gain (dBi):	Not Applicable
Modulation:	CCK	Beam Forming Gain (Y):	Not Applicable
TPC:	Max Power		
Engineering Test Notes:			

Test Measurement Results

Test Frequency	Measured 6 dB Bandwidth (MHz)				6 dB Bandwidth (MHz)		Limit	Lowest Margin
	Port(s)				Highest	Lowest		
	a	b	c	d				
MHz							MHz	MHz
2412.0	10.261	--	--	--	10.261	10.261	≥ 0.5	-9.76
2437.0	10.180	--	--	--	10.180	10.180	≥ 0.5	-9.68
2462.0	10.261	--	--	--	10.261	10.261	≥ 0.5	-9.76

Test Frequency	Measured 99% Bandwidth (MHz)				Maximum 99% Bandwidth (MHz)		
	Port(s)						
	a	b	c	d			
MHz							
2412.0	14.349	--	--	--	14.349		
2437.0	14.429	--	--	--	14.429		
2462.0	14.589	--	--	--	14.589		

Traceability to Industry Recognized Test Methodologies	
Work Instruction:	WI-03 MEASURING RF SPECTRUM MASK
Measurement Uncertainty:	±2.81 dB

Note: [click the link in the above results matrix to view the plot](#)

This test report may be reproduced in full only. The document may only be updated by MiCOM Labs personnel. Any changes will be noted in the Document History section of the report.



Title: Digi Connect Card for i.MX28 with Atheros AR6203
To: FCC 47 CFR Part 15.247 & IC RSS-210
Serial #: DIGI36-U2 Rev A
Issue Date: 22nd May 2014
Page: 28 of 261

Dual Port Module:

Equipment Configuration for 6 dB 99%

Variant:	802.11g	Duty Cycle (%):	100
Data Rate:	6 mbps	Antenna Gain (dBi):	Not Applicable
Modulation:	OFDM	Beam Forming Gain (Y):	Not Applicable
TPC:	Max Power		
Engineering Test Notes:			

Test Measurement Results

Test Frequency MHz	Measured 6 dB Bandwidth (MHz)				6 dB Bandwidth (MHz)		Limit MHz	Lowest Margin MHz
	Port(s)				Highest	Lowest		
	a	b	c	d				
2412.0	16.353	--	--	--	16.353	16.353	≥ 0.5	-15.85
2437.0	16.353	--	--	--	16.353	16.353	≥ 0.5	-15.85
2462.0	16.353	--	--	--	16.353	16.353	≥ 0.5	-15.85

Test Frequency MHz	Measured 99% Bandwidth (MHz)				Maximum 99% Bandwidth (MHz)		
	Port(s)						
	a	b	c	d			
2412.0	16.754	--	--	--	16.754		
2437.0	17.315	--	--	--	17.315		
2462.0	17.555	--	--	--	17.555		

Traceability to Industry Recognized Test Methodologies	
Work Instruction:	WI-03 MEASURING RF SPECTRUM MASK
Measurement Uncertainty:	±2.81 dB

Note: [click the link in the above results matrix to view the plot](#)

This test report may be reproduced in full only. The document may only be updated by MiCOM Labs personnel. Any changes will be noted in the Document History section of the report.



Title: Digi Connect Card for i.MX28 with Atheros AR6203
To: FCC 47 CFR Part 15.247 & IC RSS-210
Serial #: DIGI36-U2 Rev A
Issue Date: 22nd May 2014
Page: 29 of 261

Dual Port Module:

Equipment Configuration for 6 dB 99%

Variant:	802.11n HT-20	Duty Cycle (%):	100
Data Rate:	6.5 MCS	Antenna Gain (dBi):	Not Applicable
Modulation:	OFDM	Beam Forming Gain (Y):	Not Applicable
TPC:	Max Power		
Engineering Test Notes:			

Test Measurement Results

Test Frequency	Measured 6 dB Bandwidth (MHz)				6 dB Bandwidth (MHz)		Limit	Lowest Margin
	Port(s)				Highest	Lowest		
	a	b	c	d				
MHz							MHz	MHz
2412.0	16.994	--	--	--	16.994	16.994	≥ 0.5	-16.49
2437.0	17.395	--	--	--	17.395	17.395	≥ 0.5	-16.90
2462.0	17.395	--	--	--	17.395	17.395	≥ 0.5	-16.90

Test Frequency	Measured 99% Bandwidth (MHz)				Maximum 99% Bandwidth (MHz)		
	Port(s)						
	a	b	c	d			
MHz							
2412.0	18.036	--	--	--	18.036		
2437.0	18.277	--	--	--	18.277		
2462.0	18.517	--	--	--	18.517		

Traceability to Industry Recognized Test Methodologies	
Work Instruction:	WI-03 MEASURING RF SPECTRUM MASK
Measurement Uncertainty:	±2.81 dB

Note: [click the link in the above results matrix to view the plot](#)

This test report may be reproduced in full only. The document may only be updated by MiCOM Labs personnel. Any changes will be noted in the Document History section of the report.



Title: Digi Connect Card for i.MX28 with Atheros AR6203
To: FCC 47 CFR Part 15.247 & IC RSS-210
Serial #: DIGI36-U2 Rev A
Issue Date: 22nd May 2014
Page: 30 of 261

Dual Port Module:

Equipment Configuration for 6 dB 99%

Variant:	802.11n HT-40	Duty Cycle (%):	100
Data Rate:	13.5 MCS	Antenna Gain (dBi):	Not Applicable
Modulation:	OFDM	Beam Forming Gain (Y):	Not Applicable
TPC:	Max Power		
Engineering Test Notes:			

Test Measurement Results

Test Frequency	Measured 6 dB Bandwidth (MHz)				6 dB Bandwidth (MHz)		Limit	Lowest Margin
	Port(s)				Highest	Lowest		
	a	b	c	d				
MHz							MHz	MHz
2422.0	36.232	--	--	--	36.232	36.232	≥ 0.5	-35.73
2437.0	36.232	--	--	--	36.232	36.232	≥ 0.5	-35.73
2452.0	36.393	--	--	--	36.393	36.393	≥ 0.5	-35.89

Test Frequency	Measured 99% Bandwidth (MHz)				Maximum 99% Bandwidth (MHz)		
	Port(s)						
	a	b	c	d			
MHz							
2422.0	36.713	--	--	--	36.713		
2437.0	36.713	--	--	--	36.713		
2452.0	37.515	--	--	--	37.515		

Traceability to Industry Recognized Test Methodologies	
Work Instruction:	WI-03 MEASURING RF SPECTRUM MASK
Measurement Uncertainty:	±2.81 dB

Note: [click the link in the above results matrix to view the plot](#)

This test report may be reproduced in full only. The document may only be updated by MiCOM Labs personnel. Any changes will be noted in the Document History section of the report.



Title: Digi Connect Card for i.MX28 with Atheros AR6203
To: FCC 47 CFR Part 15.247 & IC RSS-210
Serial #: DIGI36-U2 Rev A
Issue Date: 22nd May 2014
Page: 31 of 261

Dual Port Module:

Equipment Configuration for 6 dB 99%

Variant:	802.11a	Duty Cycle (%):	100
Data Rate:	6 mbps	Antenna Gain (dBi):	Not Applicable
Modulation:	OFDM	Beam Forming Gain (Y):	Not Applicable
TPC:	Max Power		
Engineering Test Notes:			

Test Measurement Results

Test Frequency	Measured 6 dB Bandwidth (MHz)				6 dB Bandwidth (MHz)		Limit	Lowest Margin
	Port(s)				Highest	Lowest		
	a	b	c	d				
MHz							MHz	MHz
5745.0	15.952	--	--	--	15.952	15.952	≥ 0.5	-15.45
5785.0	15.711	--	--	--	15.711	15.711	≥ 0.5	-15.21
5825.0	15.551	--	--	--	15.551	15.551	≥ 0.5	-15.05

Test Frequency	Measured 99% Bandwidth (MHz)				Maximum 99% Bandwidth (MHz)		
	Port(s)						
	a	b	c	d			
MHz							
5745.0	28.617	--	--	--	28.617		
5785.0	29.579	--	--	--	29.579		
5825.0	29.259	--	--	--	29.259		

Traceability to Industry Recognized Test Methodologies	
Work Instruction:	WI-03 MEASURING RF SPECTRUM MASK
Measurement Uncertainty:	±2.81 dB

Note: [click the link in the above results matrix to view the plot](#)

This test report may be reproduced in full only. The document may only be updated by MiCOM Labs personnel. Any changes will be noted in the Document History section of the report.



Title: Digi Connect Card for i.MX28 with Atheros AR6203
To: FCC 47 CFR Part 15.247 & IC RSS-210
Serial #: DIGI36-U2 Rev A
Issue Date: 22nd May 2014
Page: 32 of 261

Dual Port Module:

Equipment Configuration for 6 dB 99%

Variant:	802.11n HT-20	Duty Cycle (%):	100
Data Rate:	6.5 MCS	Antenna Gain (dBi):	Not Applicable
Modulation:	OFDM	Beam Forming Gain (Y):	Not Applicable
TPC:	Max Power		
Engineering Test Notes:			

Test Measurement Results

Test Frequency MHz	Measured 6 dB Bandwidth (MHz) Port(s)				6 dB Bandwidth (MHz)		Limit MHz	Lowest Margin MHz
	a	b	c	d	Highest	Lowest		
5745.0	16.834	--	--	--	16.834	16.834	≥ 0.5	-16.33
5785.0	16.834	--	--	--	16.834	16.834	≥ 0.5	-16.33
5825.0	16.834	--	--	--	16.834	16.834	≥ 0.5	-16.33

Test Frequency MHz	Measured 99% Bandwidth (MHz) Port(s)				Maximum 99% Bandwidth (MHz)		
	a	b	c	d			
5745.0	30.220	--	--	--	30.220		
5785.0	30.301	--	--	--	30.301		
5825.0	30.862	--	--	--	30.862		

Traceability to Industry Recognized Test Methodologies	
Work Instruction:	WI-03 MEASURING RF SPECTRUM MASK
Measurement Uncertainty:	±2.81 dB

Note: [click the link in the above results matrix to view the plot](#)

This test report may be reproduced in full only. The document may only be updated by MiCOM Labs personnel. Any changes will be noted in the Document History section of the report.



Title: Digi Connect Card for i.MX28 with Atheros AR6203
To: FCC 47 CFR Part 15.247 & IC RSS-210
Serial #: DIGI36-U2 Rev A
Issue Date: 22nd May 2014
Page: 33 of 261

Dual Port Module:

Equipment Configuration for 6 dB 99%

Variant:	802.11n HT-40	Duty Cycle (%):	100
Data Rate:	13.5 MCS	Antenna Gain (dBi):	Not Applicable
Modulation:	OFDM	Beam Forming Gain (Y):	Not Applicable
TPC:	Max Power		
Engineering Test Notes:			

Test Measurement Results

Test Frequency MHz	Measured 6 dB Bandwidth (MHz)				6 dB Bandwidth (MHz)		Limit MHz	Lowest Margin MHz
	Port(s)				Highest	Lowest		
	a	b	c	d				
5755.0	35.271	--	--	--	35.271	35.271	≥ 0.5	-34.77
5795.0	35.431	--	--	--	35.431	35.431	≥ 0.5	-34.93

Test Frequency MHz	Measured 99% Bandwidth (MHz)				Maximum 99% Bandwidth (MHz)		
	Port(s)						
	a	b	c	d			
5755.0	38.156	--	--	--	38.156		
5795.0	48.417	--	--	--	48.417		

Traceability to Industry Recognized Test Methodologies	
Work Instruction:	WI-03 MEASURING RF SPECTRUM MASK
Measurement Uncertainty:	±2.81 dB

Note: [click the link in the above results matrix to view the plot](#)

This test report may be reproduced in full only. The document may only be updated by MiCOM Labs personnel. Any changes will be noted in the Document History section of the report.



Title: Digi Connect Card for i.MX28 with Atheros AR6203
To: FCC 47 CFR Part 15.247 & IC RSS-210
Serial #: DIGI36-U2 Rev A
Issue Date: 22nd May 2014
Page: 34 of 261

Specification

Limits

§15.247 (a)(2) & RSS-210 §A8.2(1)

The minimum 6 dB bandwidth shall be at least 500 kHz.

§ IC RSS-Gen 4.4.1 Occupied Bandwidth When an occupied bandwidth value is not specified in the applicable RSS, the transmitted signal bandwidth to be reported is to be its 99% emission bandwidth, as calculated or measured.

§ IC RSS-Gen 4.4.2 6 dB Bandwidth Where indicated, the 6 dB bandwidth is measured at the points when the spectral density of the signal is 6 dB down from the in-band spectral density of the modulated signal, with the transmitter modulated by a representative signal.

Traceability

Test Equipment Used
0158, 0287, 0252, 0313, 0314, 0070, 0116, 0117

This test report may be reproduced in full only. The document may only be updated by MiCOM Labs personnel. Any changes will be noted in the Document History section of the report.



Title: Digi Connect Card for i.MX28 with Atheros AR6203
To: FCC 47 CFR Part 15.247 & IC RSS-210
Serial #: DIGI36-U2 Rev A
Issue Date: 22nd May 2014
Page: 35 of 261

6.1.1.2. Peak Output Power

Conducted Test Conditions for Fundamental Emission Output Power			
Standard:	FCC CFR 47:15.247	Ambient Temp. (°C):	24.0 - 27.5
Test Heading:	Emission Output Power	Rel. Humidity (%):	32 - 45
Standard Section(s):	15.247 (a)(2)	Pressure (mBars):	999 - 1004
Reference Document(s):	KDB 558074 - D01 DTS Measurement Guidance v01: Section 5.2 Fundamental Emission Output Power KDB 662911 was implemented for In-band power measurements. The measure and sum technique was implemented in all cases.		

Test Procedure for Fundamental Emission Output Power Measurement

The transmitter terminal of EUT was connected to the input of the spectrum analyzer set to measure peak power. The resolution filter bandwidth was set to 6 dB, peak detector selected and the analyzer built-in power function was used to integrate peak power over the 20 dB bandwidth.

Supporting Information

Calculated Power = A + G + 10 log (1/x) dBm

A = Total Power [10 Log₁₀ (10^{a/10} + 10^{b/10} + 10^{c/10} + 10^{d/10})], G = Antenna Gain,

x = Duty Cycle

This test report may be reproduced in full only. The document may only be updated by MiCOM Labs personnel. Any changes will be noted in the Document History section of the report.



Title: Digi Connect Card for i.MX28 with Atheros AR6203
To: FCC 47 CFR Part 15.247 & IC RSS-210
Serial #: DIGI36-U2 Rev A
Issue Date: 22nd May 2014
Page: 36 of 261

The following Peak Power Matrix(s) was tested using the system maximum power setting dBm = 20, see Section 3.7 Equipment Modifications

Dual Port Module:

Equipment Configuration for peak output power

Variant:	802.11b	Duty Cycle (%):	100
Data Rate:	6 mbps	Antenna Gain (dBi):	Not Applicable
Modulation:	CCK	Beam Forming Gain (Y):	Not Applicable
TPC:	Max Power		
Engineering Test Notes:			

Test Measurement Results

Test Frequency	Measured Output Power (dBm)				Calculated Total Power (dBm)	Limit	Margin	EUT Power Setting
	Port(s)							
MHz	a	b	c	d	Σ Port(s)	dBm	dBm	
2412.0	19.15	--	--	--	19.15	30.00	-10.85	20
2437.0	19.31	--	--	--	19.31	30.00	-10.69	20
2462.0	19.47	--	--	--	19.47	30.00	-10.53	20

Traceability to Industry Recognized Test Methodologies

Work Instruction:	WI-01 MEASURING RF OUTPUT POWER
Measurement Uncertainty:	±1.33 dB

Note: [click the link in the above results matrix to view the plot](#)

This test report may be reproduced in full only. The document may only be updated by MiCOM Labs personnel. Any changes will be noted in the Document History section of the report.



Title: Digi Connect Card for i.MX28 with Atheros AR6203
To: FCC 47 CFR Part 15.247 & IC RSS-210
Serial #: DIGI36-U2 Rev A
Issue Date: 22nd May 2014
Page: 37 of 261

Dual Port Module:

Equipment Configuration for peak output power			
Variant:	802.11g	Duty Cycle (%):	100
Data Rate:	6 mbps	Antenna Gain (dBi):	Not Applicable
Modulation:	OFDM	Beam Forming Gain (Y):	Not Applicable
TPC:	Max Power		
Engineering Test Notes:			

Test Measurement Results								
Test Frequency	Measured Output Power (dBm)				Calculated Total Power (dBm)	Limit	Margin	EUT Power Setting
	Port(s)							
MHz	a	b	c	d	Σ Port(s)	dBm	dBm	
2412.0	23.44	--	--	--	23.44	30.00	-6.56	20
2437.0	23.98	--	--	--	23.98	30.00	-6.02	20
2462.0	23.66	--	--	--	23.66	30.00	-6.34	20

Traceability to Industry Recognized Test Methodologies	
Work Instruction:	WI-01 MEASURING RF OUTPUT POWER
Measurement Uncertainty:	±1.33 dB

Note: [click the link in the above results matrix to view the plot](#)

This test report may be reproduced in full only. The document may only be updated by MiCOM Labs personnel. Any changes will be noted in the Document History section of the report.



Title: Digi Connect Card for i.MX28 with Atheros AR6203
To: FCC 47 CFR Part 15.247 & IC RSS-210
Serial #: DIGI36-U2 Rev A
Issue Date: 22nd May 2014
Page: 38 of 261

Dual Port Module:

Equipment Configuration for peak output power

Variant:	802.11n HT-20	Duty Cycle (%):	100
Data Rate:	6.5 MCS	Antenna Gain (dBi):	Not Applicable
Modulation:	OFDM	Beam Forming Gain (Y):	Not Applicable
TPC:	Max Power		
Engineering Test Notes:			

Test Measurement Results

Test Frequency	Measured Output Power (dBm)				Calculated Total Power (dBm)	Limit	Margin	EUT Power Setting
	Port(s)							
MHz	a	b	c	d	Σ Port(s)	dBm	dBm	
2412.0	23.95	--	--	--	23.95	30.00	-6.05	20
2437.0	24.08	--	--	--	24.08	30.00	-5.92	20
2462.0	23.74	--	--	--	23.74	30.00	-6.26	20

Traceability to Industry Recognized Test Methodologies

Work Instruction:	WI-01 MEASURING RF OUTPUT POWER
Measurement Uncertainty:	±1.33 dB

Note: [click the link in the above results matrix to view the plot](#)

This test report may be reproduced in full only. The document may only be updated by MiCOM Labs personnel. Any changes will be noted in the Document History section of the report.



Title: Digi Connect Card for i.MX28 with Atheros AR6203
To: FCC 47 CFR Part 15.247 & IC RSS-210
Serial #: DIGI36-U2 Rev A
Issue Date: 22nd May 2014
Page: 39 of 261

Dual Port Module:

Equipment Configuration for peak output power
--

Variant:	802.11n HT-40	Duty Cycle (%):	100
Data Rate:	13.5 MCS	Antenna Gain (dBi):	Not Applicable
Modulation:	OFDM	Beam Forming Gain (Y):	Not Applicable
TPC:	Max Power		
Engineering Test Notes:			

Test Measurement Results

Test Frequency	Measured Output Power (dBm)				Calculated Total Power (dBm)	Limit	Margin	EUT Power Setting
	Port(s)							
MHz	a	b	c	d	Σ Port(s)	dBm	dBm	
2422.0	24.53	--	--	--	24.53	30.00	-5.47	20
2437.0	24.65	--	--	--	24.65	30.00	-5.35	20
2452.0	24.64	--	--	--	24.64	30.00	-5.36	20

Traceability to Industry Recognized Test Methodologies

Work Instruction:	WI-01 MEASURING RF OUTPUT POWER
Measurement Uncertainty:	±1.33 dB

Note: [click the link in the above results matrix to view the plot](#)

This test report may be reproduced in full only. The document may only be updated by MiCOM Labs personnel. Any changes will be noted in the Document History section of the report.



Title: Digi Connect Card for i.MX28 with Atheros AR6203
To: FCC 47 CFR Part 15.247 & IC RSS-210
Serial #: DIGI36-U2 Rev A
Issue Date: 22nd May 2014
Page: 40 of 261

Dual Port Module:

Equipment Configuration for peak output power			
Variant:	802.11a	Duty Cycle (%):	100
Data Rate:	6 mbps	Antenna Gain (dBi):	Not Applicable
Modulation:	OFDM	Beam Forming Gain (Y):	Not Applicable
TPC:	Max Power		
Engineering Test Notes:			

Test Measurement Results								
Test Frequency	Measured Output Power (dBm)				Calculated Total Power (dBm)	Limit	Margin	EUT Power Setting
	Port(s)							
MHz	a	b	c	d	Σ Port(s)	dBm	dBm	
5745.0	24.34	--	--	--	24.34	30.00	-5.66	20
5785.0	24.60	--	--	--	24.60	30.00	-5.40	20
5825.0	24.11	--	--	--	24.11	30.00	-5.89	20

Traceability to Industry Recognized Test Methodologies	
Work Instruction:	WI-01 MEASURING RF OUTPUT POWER
Measurement Uncertainty:	±1.33 dB

Note: [click the link in the above results matrix to view the plot](#)

This test report may be reproduced in full only. The document may only be updated by MiCOM Labs personnel. Any changes will be noted in the Document History section of the report.



Title: Digi Connect Card for i.MX28 with Atheros AR6203
To: FCC 47 CFR Part 15.247 & IC RSS-210
Serial #: DIGI36-U2 Rev A
Issue Date: 22nd May 2014
Page: 41 of 261

Dual Port Module:

Equipment Configuration for Peak Output Power

Variant:	802.11n HT-20	Duty Cycle (%):	100%
Data Rate:	6.5 MCS	Antenna Gain (dBi):	Not Applicable
Modulation:	OFDM	Beam Forming Gain (Y):	Not Applicable
TPC:	Max Power		
Engineering Test Notes:			

Test Measurement Results

Test Frequency	Measured Output Power (dBm)				Calculated Total Power (dBm)	Limit	Margin	EUT Power Setting
	Port(s)							
MHz	a	b	c	d	Σ Port(s)	dBm	dBm	
5745.0	22.90	--	--	--	22.90	30.00	-7.10	20.00
5785.0	22.89	--	--	--	22.89	30.00	-7.11	20.00
5825.0	23.84	--	--	--	23.84	30.00	-6.16	20.00

Traceability to Industry Recognized Test Methodologies

Work Instruction:	WI-01 MEASURING RF OUTPUT POWER
Measurement Uncertainty:	±1.33 dB

Note: [click the link in the above results matrix to view the plot](#)

This test report may be reproduced in full only. The document may only be updated by MiCOM Labs personnel. Any changes will be noted in the Document History section of the report.



Title: Digi Connect Card for i.MX28 with Atheros AR6203
To: FCC 47 CFR Part 15.247 & IC RSS-210
Serial #: DIGI36-U2 Rev A
Issue Date: 22nd May 2014
Page: 42 of 261

Dual Port Module:

Equipment Configuration for peak output power

Variant:	802.11n HT-40	Duty Cycle (%):	100
Data Rate:	13.5 MCS	Antenna Gain (dBi):	Not Applicable
Modulation:	OFDM	Beam Forming Gain (Y):	Not Applicable
TPC:	Max Power		
Engineering Test Notes:			

Test Measurement Results

Test Frequency	Measured Output Power (dBm)				Calculated Total Power (dBm)	Limit	Margin	EUT Power Setting
	Port(s)							
MHz	a	b	c	d	Σ Port(s)	dBm	dBm	
5755.0	21.96	--	--	--	21.96	30.00	-8.04	20
5795.0	23.47	--	--	--	23.47	30.00	-6.53	20

Traceability to Industry Recognized Test Methodologies

Work Instruction:	WI-01 MEASURING RF OUTPUT POWER
Measurement Uncertainty:	±1.33 dB

Note: [click the link in the above results matrix to view the plot](#)

This test report may be reproduced in full only. The document may only be updated by MiCOM Labs personnel. Any changes will be noted in the Document History section of the report.



Specification

Limits

§15.247 (b) The maximum peak output power of the intentional radiator shall not exceed the following:

§15.247 (b) (3) For systems using digital modulation in the 902-928 MHz, 2400-2483.5 MHz and 5725-5850 MHz bands: 1.0 watt.

15.247 (b) (4) The conducted output power limit specified in paragraph (b) of this section is based on the use of antennas with directional gains that do not exceed 6 dBi. Except as shown in paragraph (c) of this section, if transmitting antennas of directional gain greater than 6 dBi are used, the conducted output power from the intentional radiator shall be reduced below the stated values in paragraphs (b)(1), (b)(2), and (b)(3) of this section, as appropriate, by the amount in dB that the directional gain of the antenna exceeds 6 dBi.

15.247 (c) Operation with directional antenna gains greater than 6 dBi.

(1) Fixed point-to-point operation:

(i) Systems operating in the 2400–2483.5 MHz band that are used exclusively for fixed, point-to-point operations may employ transmitting antennas with directional gain greater than 6 dBi provided the maximum conducted output power of the intentional radiator is reduced by 1 dB for every 3 dB that the directional gain of the antenna exceeds 6 dBi.

(ii) Systems operating in the 5725–5850 MHz band that are used exclusively for fixed, point-to-point operations may employ transmitting antennas with directional gain greater than 6 dBi without any corresponding reduction in transmitter conducted output power.

§15.31 (e) For intentional radiators, measurements of the variation of the input power or the radiated signal level of the fundamental frequency component of the emission, as appropriate, shall be performed with the supply voltage varied between 85% and 115% of the nominal rated supply voltage. For battery operated equipment, the equipment tests shall be performed using a new battery.

§ RSS-210 A8.4(4) For systems employing digital modulation techniques operating in the 902-928 MHz, 2400-2483.5 MHz and 5725-5850 MHz bands the maximum peak conducted power shall not exceed 1 watt.

Traceability

Method	Test Equipment Used
Measurements were made per work instruction WI-01 'Measuring RF Output Power'	0158, 0287, 0252, 0313, 0314, 0070, 0116, 0117

This test report may be reproduced in full only. The document may only be updated by MiCOM Labs personnel. Any changes will be noted in the Document History section of the report.



Title: Digi Connect Card for i.MX28 with Atheros AR6203
To: FCC 47 CFR Part 15.247 & IC RSS-210
Serial #: DIGI36-U2 Rev A
Issue Date: 22nd May 2014
Page: 44 of 261

6.1.1.3. Power Spectral Density

Conducted Test Conditions for Power Spectral Density			
Standard:	FCC CFR 47:15.247	Ambient Temp. (°C):	24.0 - 27.5
Test Heading:	Power Spectral Density	Rel. Humidity (%):	32 - 45
Standard Section(s):	15.247 (e)	Pressure (mBars):	999 - 1001
Reference Document(s):	KDB 558074 - D01 DTS Measurement Guidance v01: Section 5.3 Maximum Power Spectral Density Level in the Emission Bandwidth		
Test Procedure for Power Spectral Density The transmitter output was connected to a spectrum analyzer and the maximum level in a 3 kHz bandwidth was measured. A peak value was found over the full emission bandwidth and the frequency span reduced to obtain enhanced resolution. Sweep time \geq span / 3 kHz with video averaging turned off. The Peak Power Spectral Density is the highest level found across the emission in a 3 kHz resolution bandwidth.			
Supporting Information Calculated Power = $A + 10 \log (1/x)$ dBm $A = \text{Total Power Spectral Density } [10 \text{ Log}_{10} (10^{a/10} + 10^{b/10} + 10^{c/10} + 10^{d/10})]$ $x = \text{Duty Cycle}$ Limit Line: KDB 662911 was implemented for In-band power spectral density (PSD) measurements - Option (2) measure and subtract $10 \log (N)$ dB from the limit for devices with multiple RF ports			

This test report may be reproduced in full only. The document may only be updated by MiCOM Labs personnel. Any changes will be noted in the Document History section of the report.



Title: Digi Connect Card for i.MX28 with Atheros AR6203
To: FCC 47 CFR Part 15.247 & IC RSS-210
Serial #: DIGI36-U2 Rev A
Issue Date: 22nd May 2014
Page: 45 of 261

Dual Port Module:

Equipment Configuration for power density

Variant:	802.11b	Duty Cycle (%):	100
Data Rate:	6 mbps	Antenna Gain (dBi):	Not Applicable
Modulation:	CCK	Beam Forming Gain (Y):	Not Applicable
TPC:	Max Power		
Engineering Test Notes:			

Test Measurement Results

Test Frequency	Measured Power Spectral Density (dBm)				Calculated Total Power Spectral Density		Limit	Margin
	Port(s)				dBm			
MHz	a	b	c	d	Σ Port(s)	Conversion to 3 kHz RBW	dBm	dB
2412.0	-7.459	--	--	--	-7.459	N/A	≤ 8.0	-15.46
2437.0	-7.367	--	--	--	-7.367	N/A	≤ 8.0	-15.37
2462.0	-7.172	--	--	--	-7.172	N/A	≤ 8.0	-15.17

Traceability to Industry Recognized Test Methodologies

Work Instruction:	WI-03 MEASURING RF SPECTRUM MASK
Measurement Uncertainty:	± 2.81 dB

Note: [click the link in the above results matrix to view the plot](#)

This test report may be reproduced in full only. The document may only be updated by MiCOM Labs personnel. Any changes will be noted in the Document History section of the report.



Title: Digi Connect Card for i.MX28 with Atheros AR6203
To: FCC 47 CFR Part 15.247 & IC RSS-210
Serial #: DIGI36-U2 Rev A
Issue Date: 22nd May 2014
Page: 46 of 261

Dual Port Module:

Equipment Configuration for power density

Variant:	802.11g	Duty Cycle (%):	100
Data Rate:	6 mbps	Antenna Gain (dBi):	Not Applicable
Modulation:	OFDM	Beam Forming Gain (Y):	Not Applicable
TPC:	Max Power		
Engineering Test Notes:			

Test Measurement Results

Test Frequency	Measured Power Spectral Density (dBm)				Calculated Total Power Spectral Density		Limit	Margin
	Port(s)				dBm			
MHz	a	b	c	d	Σ Port(s)	Conversion to 3 kHz RBW	dBm	dB
2412.0	-8.337	--	--	--	-8.337	N/A	≤ 8.0	-16.34
2437.0	-9.185	--	--	--	-9.185	N/A	≤ 8.0	-17.19
2462.0	-8.427	--	--	--	-8.427	N/A	≤ 8.0	-16.43

Traceability to Industry Recognized Test Methodologies

Work Instruction:	WI-03 MEASURING RF SPECTRUM MASK
Measurement Uncertainty:	± 2.81 dB

Note: [click the link in the above results matrix to view the plot](#)

This test report may be reproduced in full only. The document may only be updated by MiCOM Labs personnel. Any changes will be noted in the Document History section of the report.



Title: Digi Connect Card for i.MX28 with Atheros AR6203
To: FCC 47 CFR Part 15.247 & IC RSS-210
Serial #: DIGI36-U2 Rev A
Issue Date: 22nd May 2014
Page: 47 of 261

Dual Port Module:

Equipment Configuration for power density			
Variant:	802.11n HT-20	Duty Cycle (%):	100
Data Rate:	6.5 MCS	Antenna Gain (dBi):	Not Applicable
Modulation:	OFDM	Beam Forming Gain (Y):	Not Applicable
TPC:	Max Power		
Engineering Test Notes:			

Test Measurement Results								
Test Frequency	Measured Power Spectral Density (dBm)				Calculated Total Power Spectral Density		Limit	Margin
	Port(s)				dBm			
MHz	a	b	c	d	Σ Port(s)	Conversion to 3 kHz RBW	dBm	dB
2412.0	-8.964	--	--	--	-8.964	N/A	≤ 8.0	-16.96
2437.0	-9.094	--	--	--	-9.094	N/A	≤ 8.0	-17.09
2462.0	-9.494	--	--	--	-9.494	N/A	≤ 8.0	-17.49

Traceability to Industry Recognized Test Methodologies	
Work Instruction:	WI-03 MEASURING RF SPECTRUM MASK
Measurement Uncertainty:	± 2.81 dB

Note: [click the link in the above results matrix to view the plot](#)

This test report may be reproduced in full only. The document may only be updated by MiCOM Labs personnel. Any changes will be noted in the Document History section of the report.



Title: Digi Connect Card for i.MX28 with Atheros AR6203
To: FCC 47 CFR Part 15.247 & IC RSS-210
Serial #: DIGI36-U2 Rev A
Issue Date: 22nd May 2014
Page: 48 of 261

Dual Port Module:

Equipment Configuration for power density

Variant:	802.11n HT-40	Duty Cycle (%):	100
Data Rate:	13.5 MCS	Antenna Gain (dBi):	Not Applicable
Modulation:	OFDM	Beam Forming Gain (Y):	Not Applicable
TPC:	Max Power		
Engineering Test Notes:			

Test Measurement Results

Test Frequency	Measured Power Spectral Density (dBm)				Calculated Total Power Spectral Density		Limit	Margin
	Port(s)				dBm			
MHz	a	b	c	d	Σ Port(s)	Conversion to 3 kHz RBW	dBm	dB
2422.0	-12.775	--	--	--	-12.775	N/A	≤8.0	-20.78
2437.0	-12.466	--	--	--	-12.466	N/A	≤8.0	-20.47
2452.0	-10.790	--	--	--	-10.790	N/A	≤8.0	-18.79

Traceability to Industry Recognized Test Methodologies

Work Instruction:	WI-03 MEASURING RF SPECTRUM MASK
Measurement Uncertainty:	±2.81 dB

Note: click the link in the above results matrix to view the plot

This test report may be reproduced in full only. The document may only be updated by MiCOM Labs personnel. Any changes will be noted in the Document History section of the report.



Title: Digi Connect Card for i.MX28 with Atheros AR6203
To: FCC 47 CFR Part 15.247 & IC RSS-210
Serial #: DIGI36-U2 Rev A
Issue Date: 22nd May 2014
Page: 49 of 261

Dual Port Module:

Equipment Configuration for power density

Variant:	802.11a	Duty Cycle (%):	100
Data Rate:	6 mbps	Antenna Gain (dBi):	Not Applicable
Modulation:	OFDM	Beam Forming Gain (Y):	Not Applicable
TPC:	Max Power		
Engineering Test Notes:			

Test Measurement Results

Test Frequency	Measured Power Spectral Density (dBm)				Calculated Total Power Spectral Density		Limit	Margin
	Port(s)				dBm			
MHz	a	b	c	d	Σ Port(s)	Conversion to 3 kHz RBW	dBm	dB
5745.0	-9.153	--	--	--	-9.153	N/A	≤8.0	-17.15
5785.0	-8.978	--	--	--	-8.978	N/A	≤8.0	-16.98
5825.0	-8.227	--	--	--	-8.227	N/A	≤8.0	-16.23

Traceability to Industry Recognized Test Methodologies

Work Instruction:	WI-03 MEASURING RF SPECTRUM MASK
Measurement Uncertainty:	±2.81 dB

Note: [click the link in the above results matrix to view the plot](#)

This test report may be reproduced in full only. The document may only be updated by MiCOM Labs personnel. Any changes will be noted in the Document History section of the report.



Title: Digi Connect Card for i.MX28 with Atheros AR6203
To: FCC 47 CFR Part 15.247 & IC RSS-210
Serial #: DIGI36-U2 Rev A
Issue Date: 22nd May 2014
Page: 50 of 261

Dual Port Module:

Equipment Configuration for power density

Variant:	802.11n HT-20	Duty Cycle (%):	100
Data Rate:	6.5 MCS	Antenna Gain (dBi):	Not Applicable
Modulation:	OFDM	Beam Forming Gain (Y):	Not Applicable
TPC:	Max Power		
Engineering Test Notes:			

Test Measurement Results

Test Frequency	Measured Power Spectral Density (dBm)				Calculated Total Power Spectral Density		Limit	Margin
	Port(s)				dBm			
MHz	a	b	c	d	Σ Port(s)	Conversion to 3 kHz RBW	dBm	dB
5745.0	-8.532	--	--	--	-8.532	N/A	≤8.0	-16.53
5785.0	-7.127	--	--	--	-7.127	N/A	≤8.0	-15.13
5825.0	-6.881	--	--	--	-6.881	N/A	≤8.0	-14.88

Traceability to Industry Recognized Test Methodologies

Work Instruction:	WI-03 MEASURING RF SPECTRUM MASK
Measurement Uncertainty:	±2.81 dB

Note: [click the link in the above results matrix to view the plot](#)

This test report may be reproduced in full only. The document may only be updated by MiCOM Labs personnel. Any changes will be noted in the Document History section of the report.



Title: Digi Connect Card for i.MX28 with Atheros AR6203
To: FCC 47 CFR Part 15.247 & IC RSS-210
Serial #: DIGI36-U2 Rev A
Issue Date: 22nd May 2014
Page: 51 of 261

Dual Port Module:

Equipment Configuration for power density			
Variant:	802.11n HT-40	Duty Cycle (%):	100
Data Rate:	13.5 MCS	Antenna Gain (dBi):	Not Applicable
Modulation:	OFDM	Beam Forming Gain (Y):	Not Applicable
TPC:	Max Power		
Engineering Test Notes:			

Test Measurement Results								
Test Frequency	Measured Power Spectral Density (dBm)				Calculated Total Power Spectral Density		Limit	Margin
	Port(s)				dBm			
MHz	a	b	c	d	Σ Port(s)	Conversion to 3 kHz RBW	dBm	dB
5755.0	-14.691	--	--	--	-14.691	N/A	≤ 8.0	-22.69
5795.0	-14.725	--	--	--	-14.725	N/A	≤ 8.0	-22.73

Traceability to Industry Recognized Test Methodologies	
Work Instruction:	WI-03 MEASURING RF SPECTRUM MASK
Measurement Uncertainty:	± 2.81 dB

Note: [click the link in the above results matrix to view the plot](#)

This test report may be reproduced in full only. The document may only be updated by MiCOM Labs personnel. Any changes will be noted in the Document History section of the report.



Title: Digi Connect Card for i.MX28 with Atheros AR6203
To: FCC 47 CFR Part 15.247 & IC RSS-210
Serial #: DIGI36-U2 Rev A
Issue Date: 22nd May 2014
Page: 52 of 261

Specification
Peak Power Spectral Density Limits

§15.247(e) For digitally modulated systems, the power spectral density conducted from the intentional radiator to the antenna shall not be greater than +8 dBm in any 3 kHz band during any time interval of continuous transmission

RSS-210 §A8.2(2) The transmitter power spectral density (into the antenna) shall not be greater than +8 dBm in any 3 kHz band during any time interval of continuous transmission or over 1.0 second if the transmission exceeds 1.0 second duration.

Traceability

Method	Test Equipment Used
Measurements were made per work instruction WI-01 'Measuring RF Output Power'	0158, 0287, 0252, 0313, 0314, 0070, 0116, 0117

This test report may be reproduced in full only. The document may only be updated by MiCOM Labs personnel. Any changes will be noted in the Document History section of the report.



Title: Digi Connect Card for i.MX28 with Atheros AR6203
To: FCC 47 CFR Part 15.247 & IC RSS-210
Serial #: DIGI36-U2 Rev A
Issue Date: 22nd May 2014
Page: 53 of 261

6.1.1.4. Conducted Spurious Emissions

Conducted Test Conditions for Transmitter Conducted Spurious and Band-Edge Emissions			
Standard:	FCC CFR 47:15.247	Ambient Temp. (°C):	24.0 - 27.5
Test Heading:	Max Unwanted Emission Levels	Rel. Humidity (%):	32 - 45
Standard Section(s):	15.247 (d)	Pressure (mBars):	999 - 1001
Reference Document(s):	KDB 558074 - D01 DTS Measurement Guidance v01: Section 5.4 Maximum Unwanted Emission Levels		
Test Procedure for Transmitter Conducted Spurious and Band-Edge Emissions Measurement Transmitter Conducted Spurious and Band-Edge emissions were measured at a limit of 20 dB below the highest in-band spectral density measured with a spectrum analyzer connected to the antenna terminal. Measurements were made while EUT was operating in transmit mode of operation at the appropriate centre frequency closest to the band-edge. Emissions were maximized during the measurement and limits derived from the peak spectral power and drawn on each plot.			

This test report may be reproduced in full only. The document may only be updated by MiCOM Labs personnel. Any changes will be noted in the Document History section of the report.



Title: Digi Connect Card for i.MX28 with Atheros AR6203
To: FCC 47 CFR Part 15.247 & IC RSS-210
Serial #: DIGI36-U2 Rev A
Issue Date: 22nd May 2014
Page: 54 of 261

Dual Port Module:

Equipment Configuration for Transmitter Conducted Spurious and Band-Edge Emissions

Variant:	802.11b	Duty Cycle (%):	100
Data Rate:	6 mbps	Antenna Gain (dBi):	Not Applicable
Modulation:	CCK	Beam Forming Gain (Y):	Not Applicable
TPC:	Max Power		
Engineering Test Notes:			

Test Measurement Results

Test Frequency	Frequency Range	Transmitter Conducted Spurious Emissions (dBm)							
		Port a		Port b		Port c		Port d	
		SE	Limit	SE	Limit	SE	Limit	SE	Limit
2412.0	30.0 - 26000.0	-44.278	-14.24	--	--	--	--	--	--
2437.0	30.0 - 26000.0	-43.229	-14.07	--	--	--	--	--	--
2462.0	30.0 - 26000.0	-52.295	-13.92	--	--	--	--	--	--

SE - Maximum spurious emission found

Test Frequency	Band-Edge Frequency	Transmitter Conducted Band-Edge Emissions (dBm)							
		Port a		Port b		Port c		Port d	
		BE	Limit	BE	Limit	BE	Limit	BE	Limit
2412.0	2400.0	-41.392	-14.10	--	--	--	--	--	--
2462.0	2483.5	-42.706	-13.90	--	--	--	--	--	--

BE - Maximum band-edge emission found

Traceability to Industry Recognized Test Methodologies

Work Instruction:	WI-05 MEASUREMENT OF SPURIOUS EMISSIONS
Measurement Uncertainty:	= 40 GHz \pm 2.37 dB, > 40 GHz \pm 4.6 dB

Note: [click the link in the above results matrix to view the plot](#)

This test report may be reproduced in full only. The document may only be updated by MiCOM Labs personnel. Any changes will be noted in the Document History section of the report.



Title: Digi Connect Card for i.MX28 with Atheros AR6203
To: FCC 47 CFR Part 15.247 & IC RSS-210
Serial #: DIGI36-U2 Rev A
Issue Date: 22nd May 2014
Page: 55 of 261

Dual Port Module:

Equipment Configuration for Transmitter Conducted Spurious and Band-Edge Emissions

Variant:	802.11g	Duty Cycle (%):	100
Data Rate:	6 mbps	Antenna Gain (dBi):	Not Applicable
Modulation:	OFDM	Beam Forming Gain (Y):	Not Applicable
TPC:	Max Power		
Engineering Test Notes:			

Test Measurement Results

Test Frequency	Frequency Range	Transmitter Conducted Spurious Emissions (dBm)							
		Port a		Port b		Port c		Port d	
		SE	Limit	SE	Limit	SE	Limit	SE	Limit
2412.0	30.0 - 26000.0	-43.585	-15.58	--	--	--	--	--	--
2437.0	30.0 - 26000.0	-43.060	-16.06	--	--	--	--	--	--
2462.0	30.0 - 26000.0	-54.134	-14.35	--	--	--	--	--	--

SE - Maximum spurious emission found

Test Frequency	Band-Edge Frequency	Transmitter Conducted Band-Edge Emissions (dBm)							
		Port a		Port b		Port c		Port d	
		BE	Limit	BE	Limit	BE	Limit	BE	Limit
2412.0	2400.0	-20.484	-14.40	--	--	--	--	--	--
2462.0	2483.5	-28.604	-14.13	--	--	--	--	--	--

BE - Maximum band-edge emission found

Traceability to Industry Recognized Test Methodologies

Work Instruction:	WI-05 MEASUREMENT OF SPURIOUS EMISSIONS
Measurement Uncertainty:	= 40 GHz \pm 2.37 dB, > 40 GHz \pm 4.6 dB

Note: [click the link in the above results matrix to view the plot](#)

This test report may be reproduced in full only. The document may only be updated by MiCOM Labs personnel. Any changes will be noted in the Document History section of the report.



Title: Digi Connect Card for i.MX28 with Atheros AR6203
To: FCC 47 CFR Part 15.247 & IC RSS-210
Serial #: DIGI36-U2 Rev A
Issue Date: 22nd May 2014
Page: 56 of 261

Dual Port Module:

Equipment Configuration for Transmitter Conducted Spurious and Band-Edge Emissions

Variant:	802.11n HT-20	Duty Cycle (%):	100
Data Rate:	6.5 MCS	Antenna Gain (dBi):	Not Applicable
Modulation:	OFDM	Beam Forming Gain (Y):	Not Applicable
TPC:	Max Power		
Engineering Test Notes:			

Test Measurement Results

Test Frequency	Frequency Range	Transmitter Conducted Spurious Emissions (dBm)							
		Port a		Port b		Port c		Port d	
		SE	Limit	SE	Limit	SE	Limit	SE	Limit
2412.0	30.0 - 26000.0	-43.719	-14.98	--	--	--	--	--	--
2437.0	30.0 - 26000.0	-43.502	-14.46	--	--	--	--	--	--
2462.0	30.0 - 26000.0	-53.754	-14.42	--	--	--	--	--	--

SE - Maximum spurious emission found

Test Frequency	Band-Edge Frequency	Transmitter Conducted Band-Edge Emissions (dBm)							
		Port a		Port b		Port c		Port d	
		BE	Limit	BE	Limit	BE	Limit	BE	Limit
2412.0	2400.0	-19.153	-13.94	--	--	--	--	--	--
2462.0	2483.5	-26.518	-14.14	--	--	--	--	--	--

BE - Maximum band-edge emission found

Traceability to Industry Recognized Test Methodologies

Work Instruction:	WI-05 MEASUREMENT OF SPURIOUS EMISSIONS
Measurement Uncertainty:	= 40 GHz \pm 2.37 dB, > 40 GHz \pm 4.6 dB

Note: [click the link in the above results matrix to view the plot](#)

This test report may be reproduced in full only. The document may only be updated by MiCOM Labs personnel. Any changes will be noted in the Document History section of the report.



Title: Digi Connect Card for i.MX28 with Atheros AR6203
To: FCC 47 CFR Part 15.247 & IC RSS-210
Serial #: DIGI36-U2 Rev A
Issue Date: 22nd May 2014
Page: 57 of 261

Dual Port Module:

Equipment Configuration for Transmitter Conducted Spurious and Band-Edge Emissions

Variant:	802.11n HT-40	Duty Cycle (%):	100
Data Rate:	13.5 MCS	Antenna Gain (dBi):	Not Applicable
Modulation:	OFDM	Beam Forming Gain (Y):	Not Applicable
TPC:	Max Power		
Engineering Test Notes:			

Test Measurement Results

Test Frequency	Frequency Range	Transmitter Conducted Spurious Emissions (dBm)							
		Port a		Port b		Port c		Port d	
		SE	Limit	SE	Limit	SE	Limit	SE	Limit
2422.0	30.0 - 26000.0	-44.132	-17.73	--	--	--	--	--	--
2437.0	30.0 - 26000.0	-43.662	-17.55	--	--	--	--	--	--
2452.0	30.0 - 26000.0	-54.167	-17.63	--	--	--	--	--	--

SE - Maximum spurious emission found

Test Frequency	Band-Edge Frequency	Transmitter Conducted Band-Edge Emissions (dBm)							
		Port a		Port b		Port c		Port d	
		BE	Limit	BE	Limit	BE	Limit	BE	Limit
2422.0	2400.0	-19.542	-17.28	--	--	--	--	--	--
2452.0	2483.5	-20.217	-17.31	--	--	--	--	--	--

BE - Maximum band-edge emission found

Traceability to Industry Recognized Test Methodologies

Work Instruction:	WI-05 MEASUREMENT OF SPURIOUS EMISSIONS
Measurement Uncertainty:	= 40 GHz \pm 2.37 dB, > 40 GHz \pm 4.6 dB

Note: [click the link in the above results matrix to view the plot](#)

This test report may be reproduced in full only. The document may only be updated by MiCOM Labs personnel. Any changes will be noted in the Document History section of the report.



Title: Digi Connect Card for i.MX28 with Atheros AR6203
To: FCC 47 CFR Part 15.247 & IC RSS-210
Serial #: DIGI36-U2 Rev A
Issue Date: 22nd May 2014
Page: 58 of 261

Dual Port Module:

Equipment Configuration for Transmitter Conducted Spurious and Band-Edge Emissions

Variant:	802.11a	Duty Cycle (%):	100
Data Rate:	6 mbps	Antenna Gain (dBi):	Not Applicable
Modulation:	OFDM	Beam Forming Gain (Y):	Not Applicable
TPC:	Max Power		
Engineering Test Notes:			

Test Measurement Results

Test Frequency	Frequency Range	Transmitter Conducted Spurious Emissions (dBm)							
		Port a		Port b		Port c		Port d	
		SE	Limit	SE	Limit	SE	Limit	SE	Limit
5745.0	30.0 - 26000.0	-44.062	-14.09	--	--	--	--	--	--
5785.0	30.0 - 26000.0	-39.953	-16.75	--	--	--	--	--	--
5825.0	30.0 - 26000.0	-40.695	-13.31	--	--	--	--	--	--

SE - Maximum spurious emission found

Test Frequency	Band-Edge Frequency	Transmitter Conducted Band-Edge Emissions (dBm)							
		Port a		Port b		Port c		Port d	
		BE	Limit	BE	Limit	BE	Limit	BE	Limit
5745.0	5725.0	-18.270	-12.84	--	--	--	--	--	--
5825.0	5850.0	-24.464	-13.13	--	--	--	--	--	--

BE - Maximum band-edge emission found

Traceability to Industry Recognized Test Methodologies

Work Instruction:	WI-05 MEASUREMENT OF SPURIOUS EMISSIONS
Measurement Uncertainty:	= 40 GHz ±2.37 dB, > 40 GHz ±4.6 dB

Note: [click the link in the above results matrix to view the plot](#)

This test report may be reproduced in full only. The document may only be updated by MiCOM Labs personnel. Any changes will be noted in the Document History section of the report.



Title: Digi Connect Card for i.MX28 with Atheros AR6203
To: FCC 47 CFR Part 15.247 & IC RSS-210
Serial #: DIGI36-U2 Rev A
Issue Date: 22nd May 2014
Page: 59 of 261

Dual Port Module:

Equipment Configuration for Transmitter Conducted Spurious and Band-Edge Emissions

Variant:	802.11n HT-20	Duty Cycle (%):	100
Data Rate:	6.5 MCS	Antenna Gain (dBi):	Not Applicable
Modulation:	OFDM	Beam Forming Gain (Y):	Not Applicable
TPC:	Max Power		
Engineering Test Notes:			

Test Measurement Results

Test Frequency	Frequency Range	Transmitter Conducted Spurious Emissions (dBm)							
		Port a		Port b		Port c		Port d	
		SE	Limit	SE	Limit	SE	Limit	SE	Limit
5745.0	30.0 - 26000.0	-44.938	-13.94	--	--	--	--	--	--
5785.0	30.0 - 26000.0	-39.825	-16.75	--	--	--	--	--	--
5825.0	30.0 - 26000.0	-40.642	-16.17	--	--	--	--	--	--

SE - Maximum spurious emission found

Test Frequency	Band-Edge Frequency	Transmitter Conducted Band-Edge Emissions (dBm)							
		Port a		Port b		Port c		Port d	
		BE	Limit	BE	Limit	BE	Limit	BE	Limit
5745.0	5725.0	-15.697	-12.46	--	--	--	--	--	--
5825.0	5850.0	-22.151	-12.72	--	--	--	--	--	--

BE - Maximum band-edge emission found

Traceability to Industry Recognized Test Methodologies

Work Instruction:	WI-05 MEASUREMENT OF SPURIOUS EMISSIONS
Measurement Uncertainty:	= 40 GHz \pm 2.37 dB, > 40 GHz \pm 4.6 dB

Note: [click the link in the above results matrix to view the plot](#)

This test report may be reproduced in full only. The document may only be updated by MiCOM Labs personnel. Any changes will be noted in the Document History section of the report.



Title: Digi Connect Card for i.MX28 with Atheros AR6203
To: FCC 47 CFR Part 15.247 & IC RSS-210
Serial #: DIGI36-U2 Rev A
Issue Date: 22nd May 2014
Page: 60 of 261

Dual Port Module:

Equipment Configuration for Transmitter Conducted Spurious and Band-Edge Emissions
--

Variant:	802.11n HT-40	Duty Cycle (%):	100
Data Rate:	13.5 MCS	Antenna Gain (dBi):	Not Applicable
Modulation:	OFDM	Beam Forming Gain (Y):	Not Applicable
TPC:	Max Power		
Engineering Test Notes:			

Test Measurement Results									
--------------------------	--	--	--	--	--	--	--	--	--

Test Frequency	Frequency Range	Transmitter Conducted Spurious Emissions (dBm)							
		Port a		Port b		Port c		Port d	
		SE	Limit	SE	Limit	SE	Limit	SE	Limit
5755.0	30.0 - 26000.0	-40.220	-20.45	--	--	--	--	--	--
5795.0	30.0 - 26000.0	-39.844	-18.29	--	--	--	--	--	--

SE - Maximum spurious emission found

Test Frequency	Band-Edge Frequency	Transmitter Conducted Band-Edge Emissions (dBm)							
		Port a		Port b		Port c		Port d	
		BE	Limit	BE	Limit	BE	Limit	BE	Limit
5755.0	5725.0	-24.169	-19.43	--	--	--	--	--	--
5795.0	5850.0	2.226	-17.77	--	--	--	--	--	--

BE - Maximum band-edge emission found

Traceability to Industry Recognized Test Methodologies	
--	--

Work Instruction:	WI-05 MEASUREMENT OF SPURIOUS EMISSIONS
Measurement Uncertainty:	= 40 GHz \pm 2.37 dB, > 40 GHz \pm 4.6 dB

Note: [click the link in the above results matrix to view the plot](#)

This test report may be reproduced in full only. The document may only be updated by MiCOM Labs personnel. Any changes will be noted in the Document History section of the report.



Title: Digi Connect Card for i.MX28 with Atheros AR6203
To: FCC 47 CFR Part 15.247 & IC RSS-210
Serial #: DIGI36-U2 Rev A
Issue Date: 22nd May 2014
Page: 61 of 261

Specification

Limits Band-Edge

Lower Limit Band-edge	Upper Limit Band-edge	Limit below highest level of desired power
2,400 MHz	2,483.5 MHz	≥ 20 dB
5725 MHz	5850 MHz	

§15.247(d) and RSS-210 §A8.5 In any 100 kHz bandwidth outside the frequency band in which the spread spectrum or digitally modulated intentional radiator is operating, the radio frequency power that is produced by the intentional radiator shall be at least 20 dB below that in the 100 kHz bandwidth within the band that contains the highest level of the desired power, based on either an RF conducted or radiated measurement, provided the transmitter demonstrates compliance with the peak conducted power limits.

§15.247(d)

If the transmitter complies with the conducted power limits based on the use of RMS averaging over a time interval, as permitted under paragraph (b)(3) of this section, the attenuation required under this paragraph shall be 30 dB instead of 20 dB. Attenuation below the general limits specified §15.209(a) is not required. In addition, radiated emissions which fall in the restricted bands, as defined in Section §15.205(a), must also comply with the radiated emission limits specified in Section 15.209(a) (see Section 15.205(a)).

RSS-210 §A8.5 If the transmitter complies with the conducted power limits based on the use of RMS averaging over a time interval, as permitted under section A8.4(4), the attenuation required shall be 30 dB instead of 20 dB. Attenuation below the general limits specified in Tables 2 and 3 is not required. In addition, radiated emissions which fall in the restricted bands of Table 1 must also comply with the radiated emission limits specified in Tables 2 and 3.

RSS-Gen §4.7

The search for unwanted emissions shall be from the lowest frequency internally generated or used in the device (local oscillator, intermediate of carrier frequency), or from 30 MHz , whichever is the lowest frequency, to the 5th harmonic of the highest frequency generated without exceeding 40 GHz.

Laboratory Measurement Uncertainty for Conducted Spurious Emissions

Measurement uncertainty	±2.37 dB
-------------------------	----------

Traceability

Method	Test Equipment Used
Measurements were made per work instruction WI-05 'Measurement of Spurious Emissions'	0088, 0158, 0287, 0252, 0313, 0314, 0070, 0116, 0117.

This test report may be reproduced in full only. The document may only be updated by MiCOM Labs personnel. Any changes will be noted in the Document History section of the report.



6.1.1.5. Maximum Permissible Exposure

FCC, Part 15 Subpart C §15.247(i)
Industry Canada RSS-Gen §5.6

Calculations for Maximum Permissible Exposure Levels

$$\text{Power Density} = P_d \text{ (mW/cm}^2\text{)} = \text{EIRP}/(4\pi d^2)$$

$$\text{EIRP} = P * G$$

P = Peak output power (mW)

G = Antenna numeric gain (numeric)

d = Separation distance (cm)

$$\text{Numeric Gain} = 10^{(G \text{ (dBi)}/10)}$$

Because the EUT belongs to the General Population/Uncontrolled Exposure the limit of power density is 1.0 mW/cm²

Dual Port Module:

Antenna	Freq. Band (GHz)	Antenna Gain (dBi)	Numeric Gain (numeric)	Peak Output Power (dBm)	Peak Output Power (mW)	Calculated Safe Distance @ 1mW/cm ² Limit(cm)	Minimum Separation Distance (cm)
PC.11	2.4	3	2	24.65	291.74	6.81	20.0*
	5.8	4.5	3	24.60	288.40	8.04	20.0*
FXP.830	2.4	1.8	2	24.65	291.74	5.93	20.0*
	5.8	4	3	24.60	288.40	7.59	20.0*
ANT-DB1-xxx	2.4	-3.1	0	24.65	291.74	3.37	20.0*
	5.8	4.3	3	24.60	288.40	7.86	20.0*
SA-006-1	2.4	1.8	2	24.65	291.74	5.93	20.0*
	5.8						

*Note: for mobile or fixed location transmitters the minimum separation distance is 20cm, even if calculations indicate the MPE distance to be less.



Title: Digi Connect Card for i.MX28 with Atheros AR6203
To: FCC 47 CFR Part 15.247 & IC RSS-210
Serial #: DIGI36-U2 Rev A
Issue Date: 22nd May 2014
Page: 63 of 261

Specification

Maximum Permissible Exposure Limits

§15.247(i) Systems operating under the provisions of this section shall be operated in a manner that ensures that the public is not exposed to radio frequency levels in excess of the Commission's guidelines.

FCC §1.1310 Limit = $1\text{mW} / \text{cm}^2$ from 1.310 Table 1

RSS-Gen §5.6 Category I and Category II equipment shall comply with the applicable requirements of RSS-102.

Laboratory Measurement Uncertainty for Power Measurements

Measurement uncertainty	±1.33 dB
-------------------------	----------

This test report may be reproduced in full only. The document may only be updated by MiCOM Labs personnel. Any changes will be noted in the Document History section of the report.



6.1.2. Radiated Emission Testing

Transmitter Radiated Spurious Emissions (above 1 GHz); Peak Field Strength Measurements; and Radiated Band Edge Measurements – Restricted Bands

FCC, Part 15 Subpart C §15.247(d) 15.205; 15.209

Industry Canada RSS-210 §A8.5, §2.2, §2.6

Industry Canada RSS-Gen §4.7

Test Procedure

The worst case highest spectral density radiated emissions above 1 GHz are measured in the anechoic chamber at a 3-meter distance on every azimuth in both horizontal and vertical polarities. The emissions are recorded and maximized as a function of azimuth by rotation through 360° with a spectrum analyzer in peak hold mode. Depending on the frequency band spanned a notch filter and waveguide filter was used to remove the fundamental frequency. The highest emissions relative to the limit are listed for each frequency spanned.

All measurements on any frequency or frequencies over 1 MHz are based on the use of measurement instrumentation employing an average detector function. All measurements above 1 GHz were performed using a minimum resolution bandwidth of 1 MHz.

Field Strength Calculation

The field strength is calculated by adding the Antenna Factor and Cable Loss, and subtracting Amplifier Gain from the measured reading. All factors are included in the reported data.

$$FS = R + AF + CORR - FO$$

where: FS = Field Strength

R = Measured Spectrum analyzer Input Amplitude

AF = Antenna Factor

CORR = Correction Factor = CL – AG + NFL

CL = Cable Loss

AG = Amplifier Gain

FO = Distance Falloff Factor

NFL = Notch Filter Loss or Waveguide Loss

For example:

Given receiver input reading of 51.5 dB μ V; Antenna Factor of 8.5 dB; Cable Loss of 1.3 dB; Falloff Factor of 0 dB, an Amplifier Gain of 26 dB and Notch Filter Loss of 1 dB. The Field Strength of the measured emission is:

$$FS = 51.5 + 8.5 + 1.3 - 26.0 + 1 = 36.3 \text{ dB}\mu\text{V/m}$$

Conversion between dB μ V/m (or dB μ V) and μ V/m (or μ V) are done as:

$$\text{Level (dB}\mu\text{V/m)} = 20 * \text{Log (level (\mu\text{V/m}))}$$

$$40 \text{ dB}\mu\text{V/m} = 100 \mu\text{V/m}$$

$$48 \text{ dB}\mu\text{V/m} = 250 \mu\text{V/m}$$

This test report may be reproduced in full only. The document may only be updated by MiCOM Labs personnel. Any changes will be noted in the Document History section of the report.



Title: Digi Connect Card for i.MX28 with Atheros AR6203
To: FCC 47 CFR Part 15.247 & IC RSS-210
Serial #: DIGI36-U2 Rev A
Issue Date: 22nd May 2014
Page: 65 of 261

6.1.2.1. Dual Band Patch PC.11 – Dual Port Module

Test Freq.	2412 MHz	Engineer	JMH
Variant	802.11b; 1 Mbs	Temp (°C)	25
Freq. Range	1000 MHz - 18000 MHz	Rel. Hum.(%)	38
Power Setting	20	Press. (mBars)	1004
Antenna	PC.11 x2	Duty Cycle (%)	100
Test Notes 1	Dual Port module		
Test Notes 2			

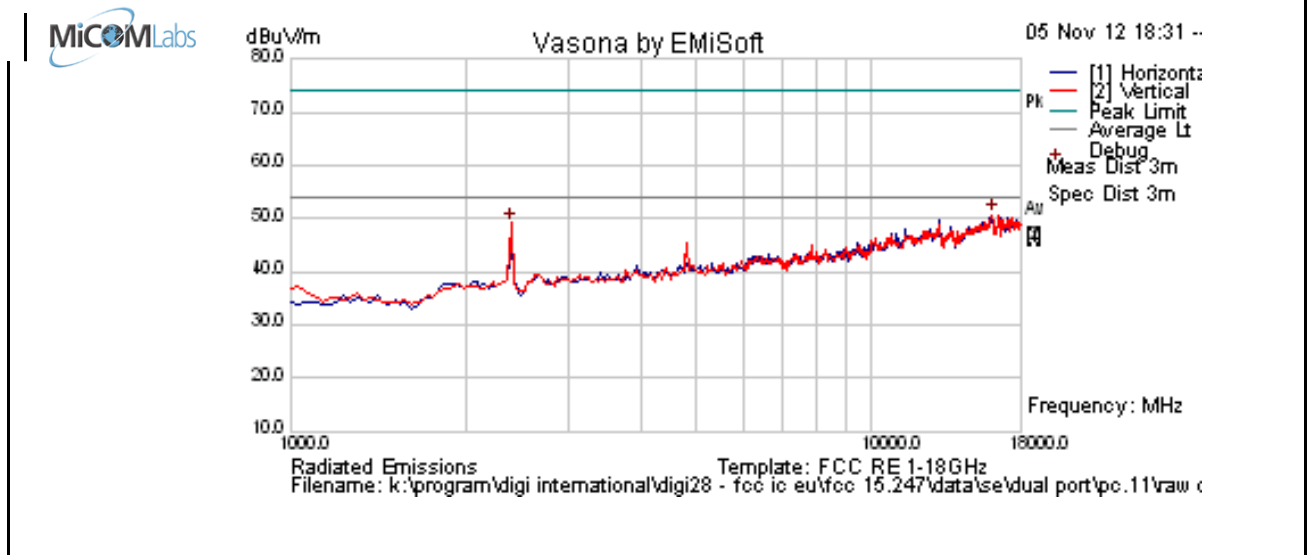

Formally measured emission peaks

Frequency MHz	Raw dBuV	Cable Loss	AF dB	Level dBuV/m	Measurement Type	Pol	Hgt cm	Azt Deg	Limit dBuV/m	Margin dB	Pass /Fail	Comments
16092.184	41.4	9.0	0.3	50.7	Peak [Scan]	V	100	0	54.0	-3.3	Pass	Noise
2396.79359	57.8	3.0	11.7	49.1	Peak [Scan]	V						FUND

Legend: TX = Transmitter Emissions; DIG = Digital Emissions; FUND = Fundamental; WB = Wideband Emission
 RB = Restricted Band (15.209 Limits); NRB = Non Restricted Band, Limit is 20dB below fundamental peak

This test report may be reproduced in full only. The document may only be updated by MiCOM Labs personnel. Any changes will be noted in the Document History section of the report.



Title: Digi Connect Card for i.MX28 with Atheros AR6203
To: FCC 47 CFR Part 15.247 & IC RSS-210
Serial #: DIGI36-U2 Rev A
Issue Date: 22nd May 2014
Page: 66 of 261

Band Edge

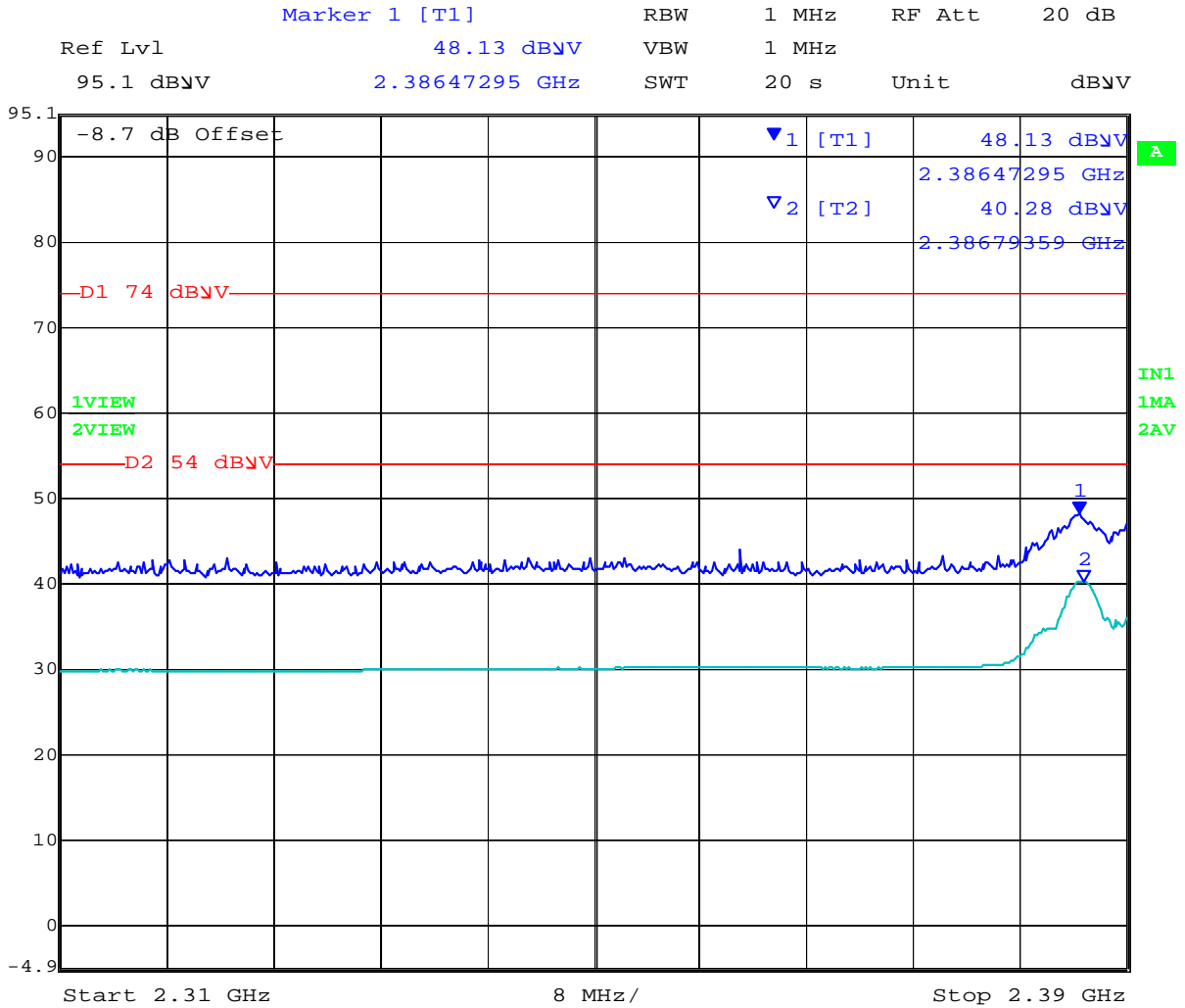

Date: 6.NOV.2012 12:13:50

This test report may be reproduced in full only. The document may only be updated by MiCOM Labs personnel. Any changes will be noted in the Document History section of the report.



Title: Digi Connect Card for i.MX28 with Atheros AR6203
To: FCC 47 CFR Part 15.247 & IC RSS-210
Serial #: DIGI36-U2 Rev A
Issue Date: 22nd May 2014
Page: 67 of 261

Test Freq.	2437 MHz	Engineer	JMH
Variant	802.11b; 1 Mbs	Temp (°C)	25
Freq. Range	1000 MHz - 18000 MHz	Rel. Hum.(%)	38
Power Setting	20	Press. (mBars)	1004
Antenna	PC.11 x2	Duty Cycle (%)	100
Test Notes 1	Dual Port module		
Test Notes 2			

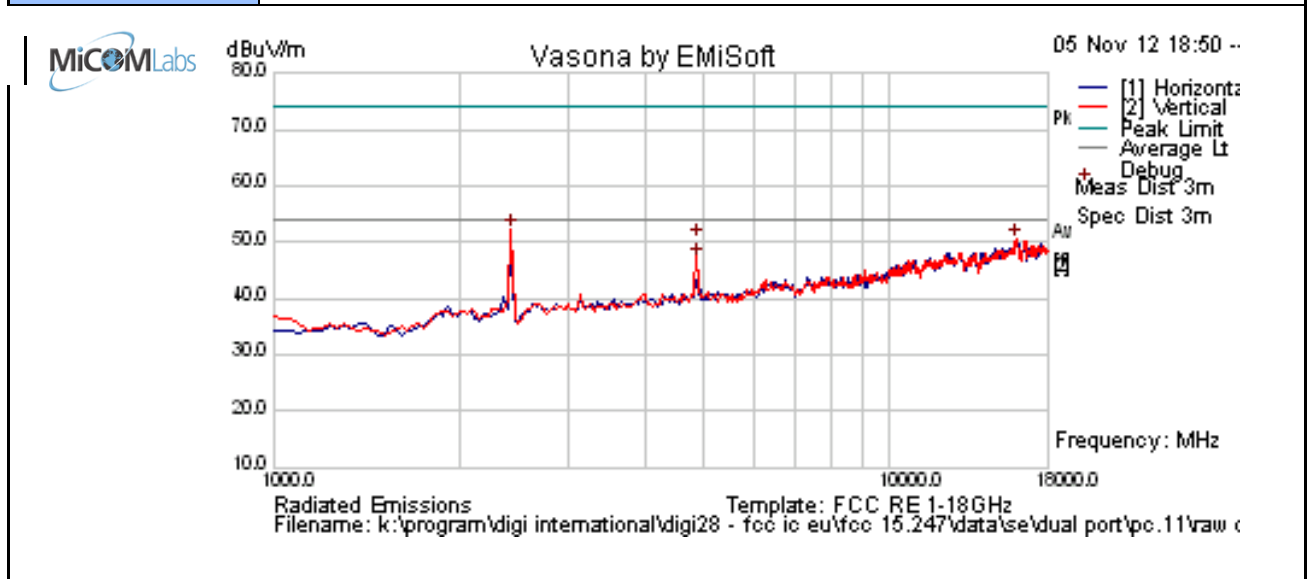

Formally measured emission peaks

Frequency MHz	Raw dBuV	Cable Loss	AF dB	Level dBuV/m	Measurement Type	Pol	Hgt cm	Azt Deg	Limit dBuV/m	Margin dB	Pass /Fail	Comments
2430.862	60.7	3.0	-11.6	52.1	Peak [Scan]	V						FUND
16058.116	41.3	9.0	0.3	50.6	Peak [Scan]	V	100	0	54.0	-3.5	Pass	Noise
4873.988	55.7	4.5	-9.7	50.5	Peak Max	V	99	360	74	-23.5	Pass	RB
4873.988	52.0	4.5	-9.7	46.8	Average Max	V	99	360	54	-7.2	Pass	RB

Legend: TX = Transmitter Emissions; DIG = Digital Emissions; FUND = Fundamental; WB = Wideband Emission
 RB = Restricted Band (15.209 Limits); NRB = Non Restricted Band, Limit is 20dB below fundamental peak

This test report may be reproduced in full only. The document may only be updated by MiCOM Labs personnel. Any changes will be noted in the Document History section of the report.



Title: Digi Connect Card for i.MX28 with Atheros AR6203
To: FCC 47 CFR Part 15.247 & IC RSS-210
Serial #: DIGI36-U2 Rev A
Issue Date: 22nd May 2014
Page: 68 of 261

Test Freq.	2462 MHz	Engineer	JMH
Variant	802.11b; 1 Mbs	Temp (°C)	25
Freq. Range	1000 MHz - 18000 MHz	Rel. Hum.(%)	38
Power Setting	20	Press. (mBars)	1004
Antenna	PC.11 x2	Duty Cycle (%)	100
Test Notes 1	Dual Port module		
Test Notes 2			

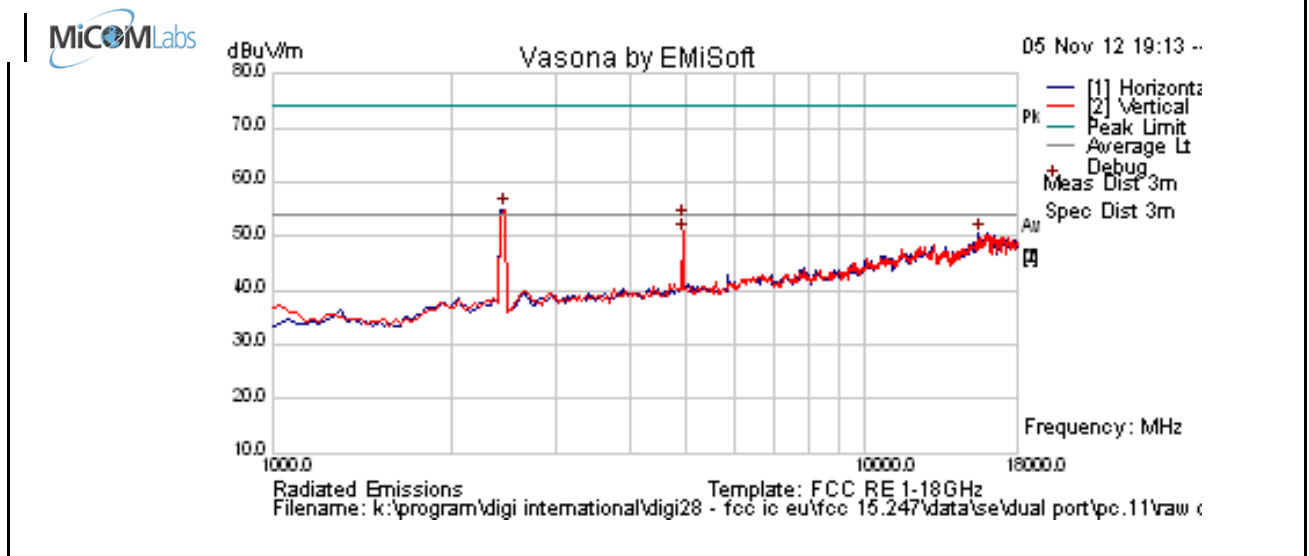

Formally measured emission peaks

Frequency MHz	Raw dBuV	Cable Loss	AF dB	Level dBuV/m	Measurement Type	Pol	Hgt cm	Azt Deg	Limit dBuV/m	Margin dB	Pass /Fail	Comments
2464.930	63.4	3.0	-11.5	54.9	Peak [Scan]	V						FUND
15547.094	42.8	8.3	-0.6	50.5	Peak [Scan]	H	150	0	54.0	-3.5	Pass	Noise
4924.048	58.2	4.6	-9.8	53.0	Peak Max	V	107	346	74	-21.0	Pass	RB
4924.048	55.8	4.6	-9.8	50.5	Average Max	V	107	346	54	-3.5	Pass	RB

Legend: TX = Transmitter Emissions; DIG = Digital Emissions; FUND = Fundamental; WB = Wideband Emission
 RB = Restricted Band (15.209 Limits); NRB = Non Restricted Band, Limit is 20dB below fundamental peak

This test report may be reproduced in full only. The document may only be updated by MiCOM Labs personnel. Any changes will be noted in the Document History section of the report.



Band Edge

Marker 1 [T1] RBW 1 MHz RF Att 20 dB
Ref Lvl 48.02 dBμV VBW 1 MHz
95.7 dBμV 2.48812926 GHz SWT 20 s Unit dBμV

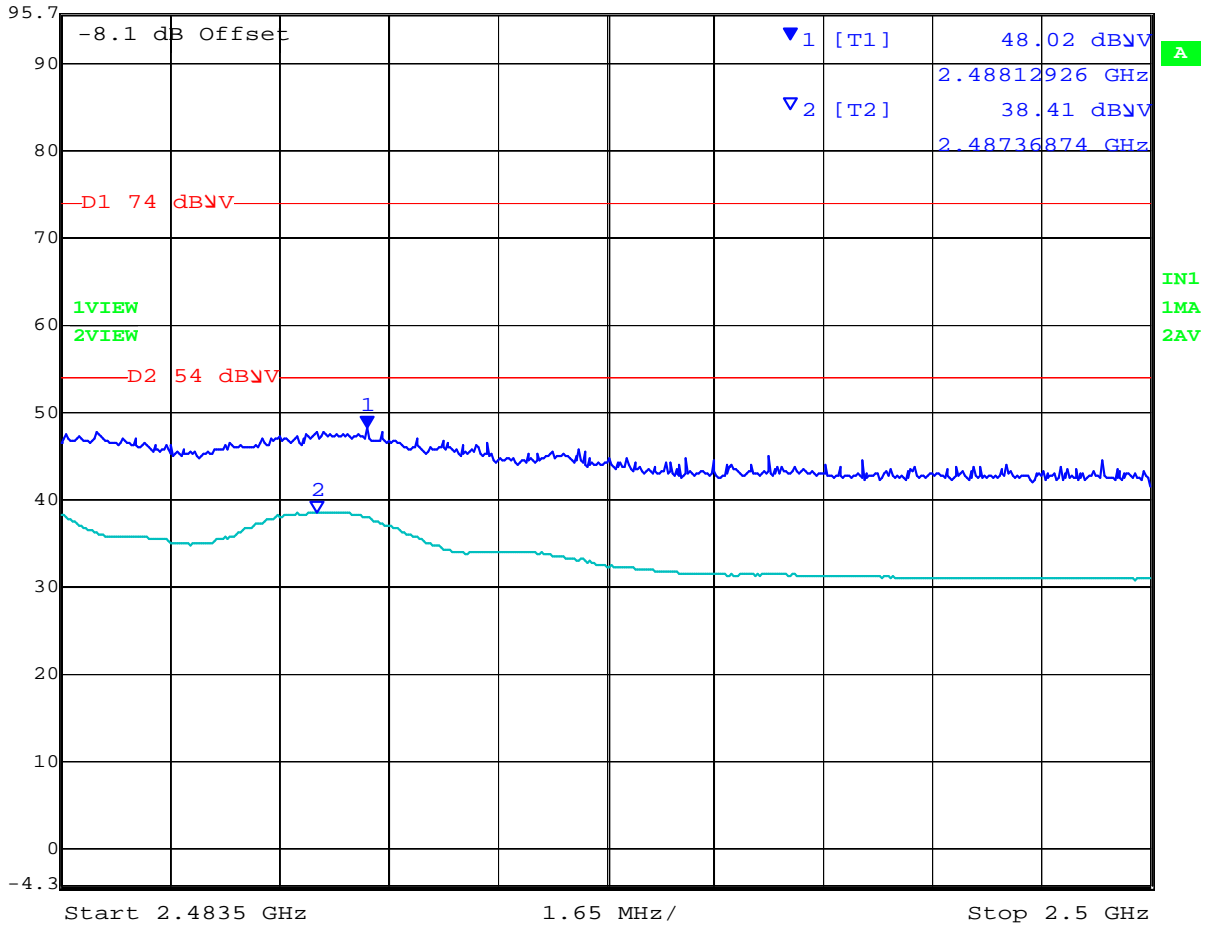

Date: 6.NOV.2012 12:17:36

This test report may be reproduced in full only. The document may only be updated by MiCOM Labs personnel. Any changes will be noted in the Document History section of the report.



Title: Digi Connect Card for i.MX28 with Atheros AR6203
To: FCC 47 CFR Part 15.247 & IC RSS-210
Serial #: DIGI36-U2 Rev A
Issue Date: 22nd May 2014
Page: 70 of 261

Test Freq.	2412 MHz	Engineer	JMH
Variant	802.11g; 6 Mbs	Temp (°C)	25
Freq. Range	1000 MHz - 18000 MHz	Rel. Hum.(%)	38
Power Setting	20	Press. (mBars)	1004
Antenna	PC.11 x2	Duty Cycle (%)	100
Test Notes 1	Dual Port module		
Test Notes 2			

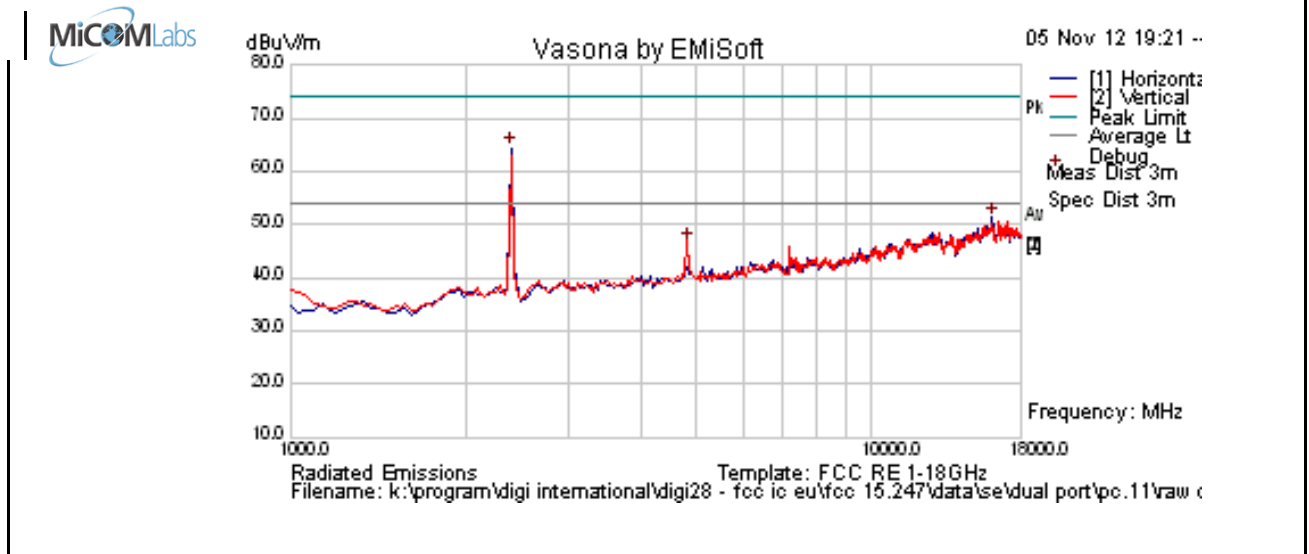

Formally measured emission peaks

Frequency MHz	Raw dBuV	Cable Loss	AF dB	Level dBuV/m	Measurement Type	Pol	Hgt cm	Azt Deg	Limit dBuV/m	Margin dB	Pass /Fail	Comments
2396.794	73.1	3.0	-11.7	64.4	Peak [Scan]	H						FUND
16092.184	42.1	9.0	0.3	51.3	Peak [Scan]	H	150	0	54.0	-2.7	Pass	Noise
4817.873	51.8	4.5	-9.7	46.6	Peak [Scan]	V	98	360	54	-7.4	Pass	RB

Legend: TX = Transmitter Emissions; DIG = Digital Emissions; FUND = Fundamental; WB = Wideband Emission
 RB = Restricted Band (15.209 Limits); NRB = Non Restricted Band, Limit is 20dB below fundamental peak

This test report may be reproduced in full only. The document may only be updated by MiCOM Labs personnel. Any changes will be noted in the Document History section of the report.



Band Edge

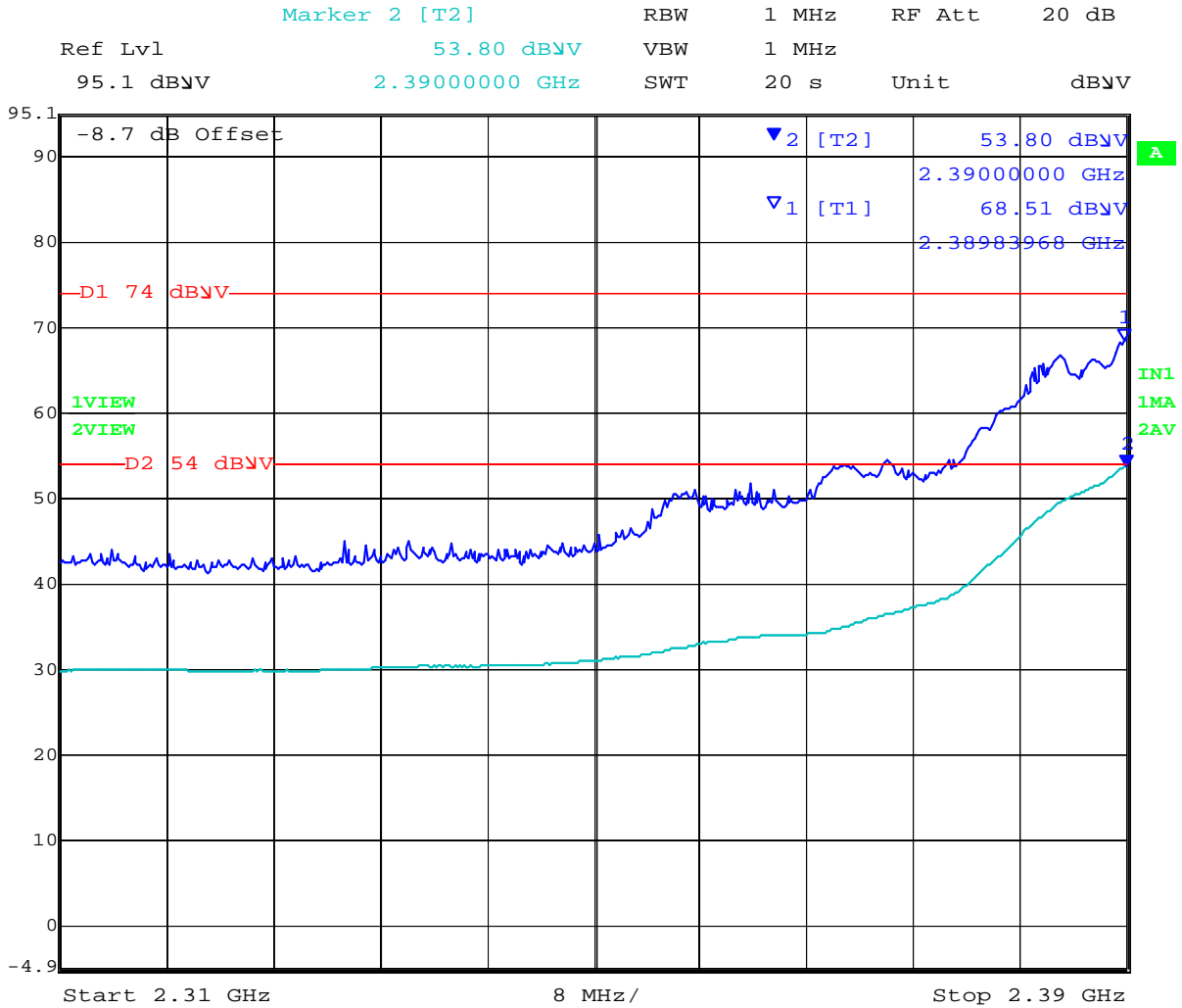

Date: 6.NOV.2012 12:09:53

Power reduction required in order to bring unit into compliance Power = 19



Title: Digi Connect Card for i.MX28 with Atheros AR6203
To: FCC 47 CFR Part 15.247 & IC RSS-210
Serial #: DIGI36-U2 Rev A
Issue Date: 22nd May 2014
Page: 72 of 261

Test Freq.	2437 MHz	Engineer	JMH
Variant	802.11g; 6 Mbs	Temp (°C)	25
Freq. Range	1000 MHz - 18000 MHz	Rel. Hum.(%)	38
Power Setting	20	Press. (mBars)	1004
Antenna	PC.11 x2	Duty Cycle (%)	100
Test Notes 1	Dual Port module		
Test Notes 2			

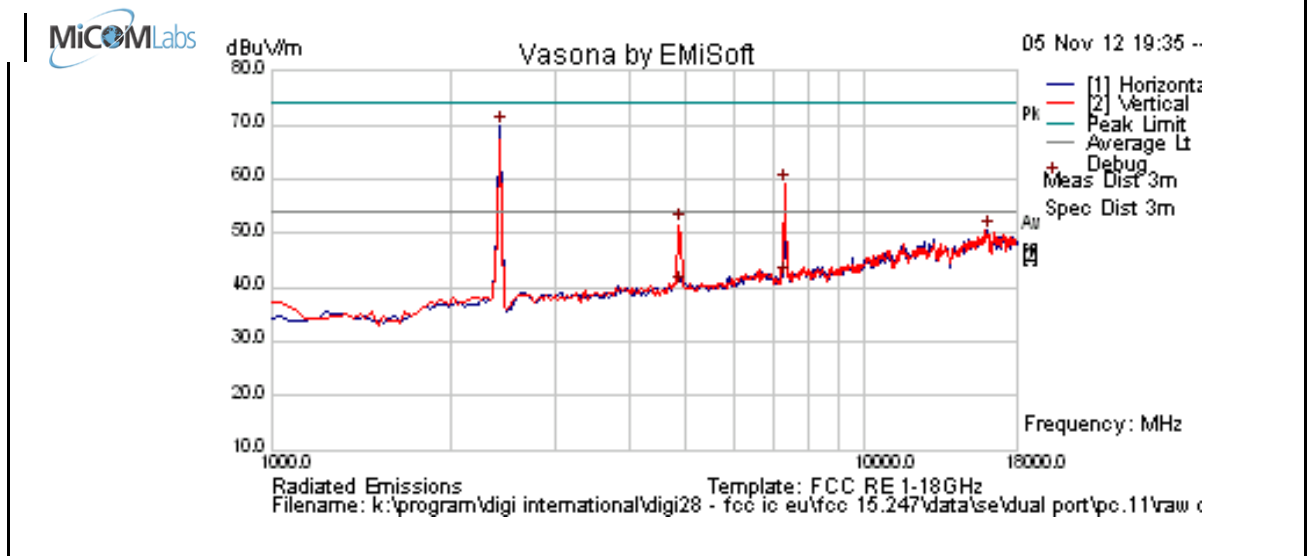

Formally measured emission peaks

Frequency MHz	Raw dBuV	Cable Loss	AF dB	Level dBuV/m	Measurement Type	Pol	Hgt cm	Azt Deg	Limit dBuV/m	Margin dB	Pass /Fail	Comments
2430.862	78.3	3.0	-11.6	69.8	Peak [Scan]	H						FUND
16092.184	41.3	9.0	0.3	50.5	Peak [Scan]	H	100	0	54.0	-3.5	Pass	Noise
4875.992	57.0	4.5	-9.7	51.8	Peak Max	V	156	360	74	-22.2	Pass	RB
4875.992	45.2	4.5	-9.7	40.0	Average Max	V	156	360	54	-14.0	Pass	RB
7309.739	42.3	5.4	-5.7	42.0	Average Max	V	98	37	54	-12.0	Pass	RB
7309.739	59.3	5.4	-5.7	59.1	Peak Max	V	98	37	74	-14.9	Pass	RB

Legend: TX = Transmitter Emissions; DIG = Digital Emissions; FUND = Fundamental; WB = Wideband Emission
 RB = Restricted Band (15.209 Limits); NRB = Non Restricted Band, Limit is 20dB below fundamental peak

This test report may be reproduced in full only. The document may only be updated by MiCOM Labs personnel. Any changes will be noted in the Document History section of the report.



Title: Digi Connect Card for i.MX28 with Atheros AR6203
To: FCC 47 CFR Part 15.247 & IC RSS-210
Serial #: DIGI36-U2 Rev A
Issue Date: 22nd May 2014
Page: 73 of 261

Test Freq.	2462 MHz	Engineer	JMH
Variant	802.11g; 6 Mbs	Temp (°C)	25
Freq. Range	1000 MHz - 18000 MHz	Rel. Hum.(%)	38
Power Setting	20	Press. (mBars)	1004
Antenna	PC.11 x2	Duty Cycle (%)	100
Test Notes 1	Dual Port module		
Test Notes 2			

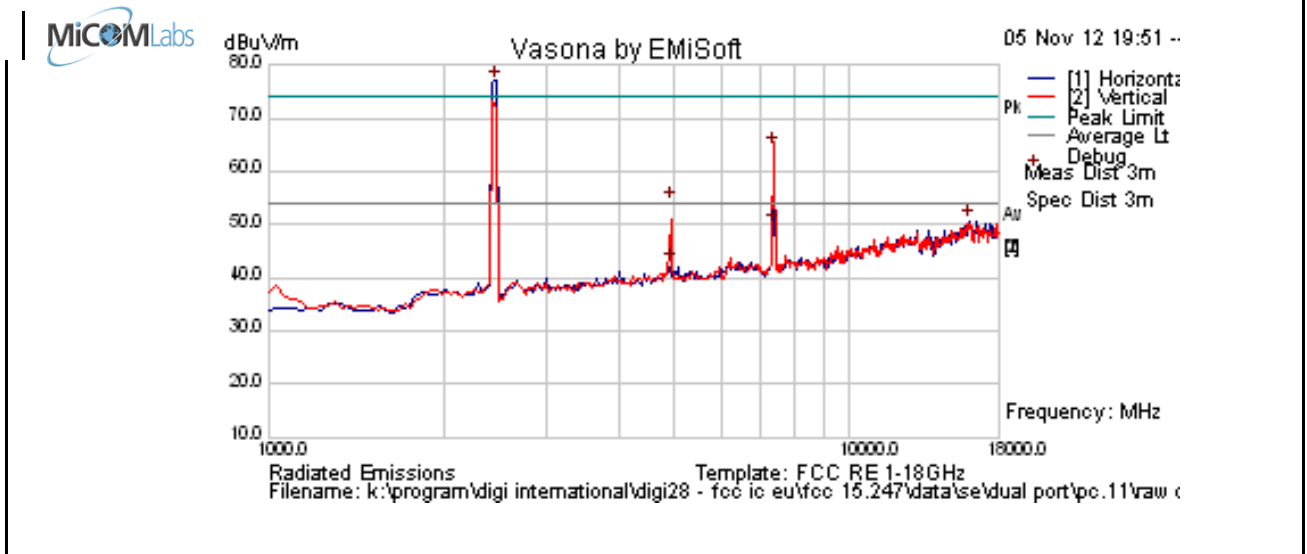

Formally measured emission peaks

Frequency MHz	Raw dBuV	Cable Loss	AF dB	Level dBuV/m	Measurement Type	Pol	Hgt cm	Azt Deg	Limit dBuV/m	Margin dB	Pass /Fail	Comments
2464.930	85.5	3.0	-11.5	77.0	Peak [Scan]	H						FUND
16024.048	41.4	9.0	0.2	50.6	Peak [Scan]	H	150	0	54.0	-3.4	Pass	Noise
7385.251	49.8	5.5	-5.5	49.8	Average Max	V	190	327	54	-4.2	Pass	RB
7385.251	64.7	5.5	-5.5	64.7	Peak Max	V	190	327	74	-9.3	Pass	RB
4924.168	47.7	4.6	-9.8	42.5	Average Max	V	98	2	54	-11.5	Pass	RB
4924.168	59.5	4.6	-9.8	54.2	Peak Max	V	98	2	74	-19.8	Pass	RB

Legend: TX = Transmitter Emissions; DIG = Digital Emissions; FUND = Fundamental; WB = Wideband Emission
 RB = Restricted Band (15.209 Limits); NRB = Non Restricted Band, Limit is 20dB below fundamental peak

This test report may be reproduced in full only. The document may only be updated by MiCOM Labs personnel. Any changes will be noted in the Document History section of the report.



Band Edge

Marker 1 [T1] RBW 1 MHz RF Att 20 dB
Ref Lvl 65.91 dBμV VBW 1 MHz
95.7 dBμV 2.48350000 GHz SWT 20 s Unit dBμV

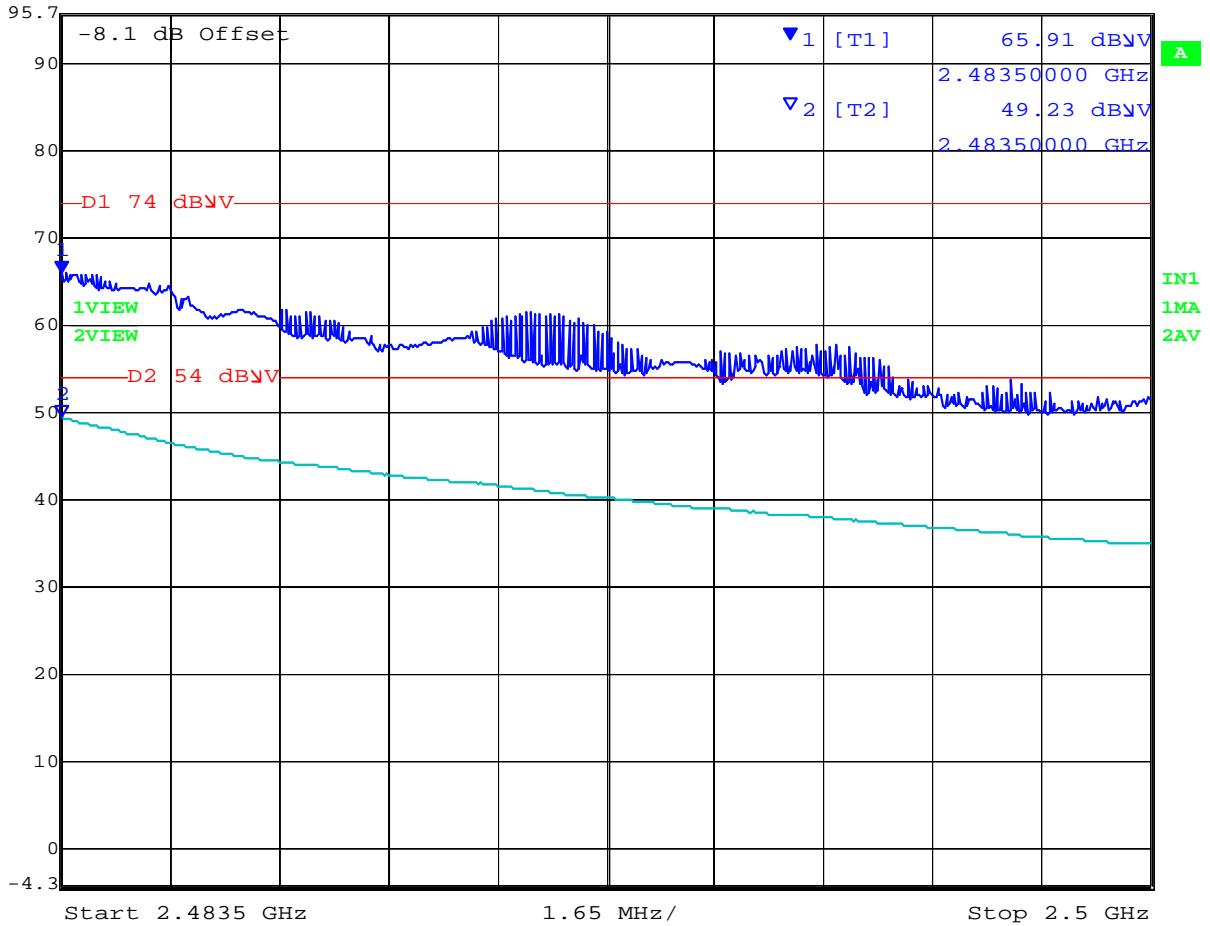

Date: 6.NOV.2012 12:21:59

This test report may be reproduced in full only. The document may only be updated by MiCOM Labs personnel. Any changes will be noted in the Document History section of the report.



Title: Digi Connect Card for i.MX28 with Atheros AR6203
To: FCC 47 CFR Part 15.247 & IC RSS-210
Serial #: DIGI36-U2 Rev A
Issue Date: 22nd May 2014
Page: 75 of 261

Band Edge 802.11n HT20 2412 MHz

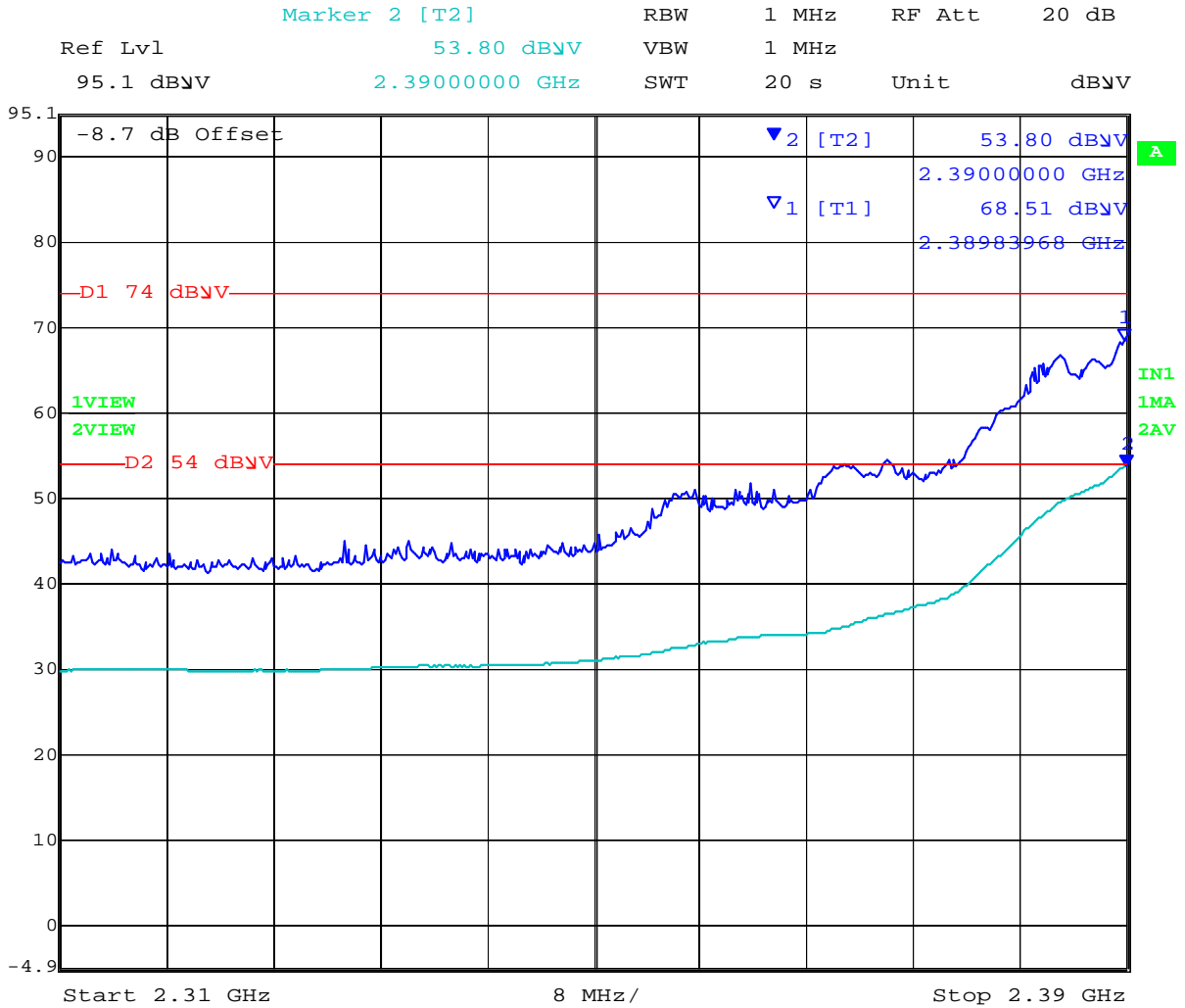

Date: 6.NOV.2012 12:09:53

Power reduction required in order to bring unit into compliance Power = 18

This test report may be reproduced in full only. The document may only be updated by MiCOM Labs personnel. Any changes will be noted in the Document History section of the report.



Title: Digi Connect Card for i.MX28 with Atheros AR6203
To: FCC 47 CFR Part 15.247 & IC RSS-210
Serial #: DIGI36-U2 Rev A
Issue Date: 22nd May 2014
Page: 76 of 261

Band Edge 802.11n HT20 2462 MHz

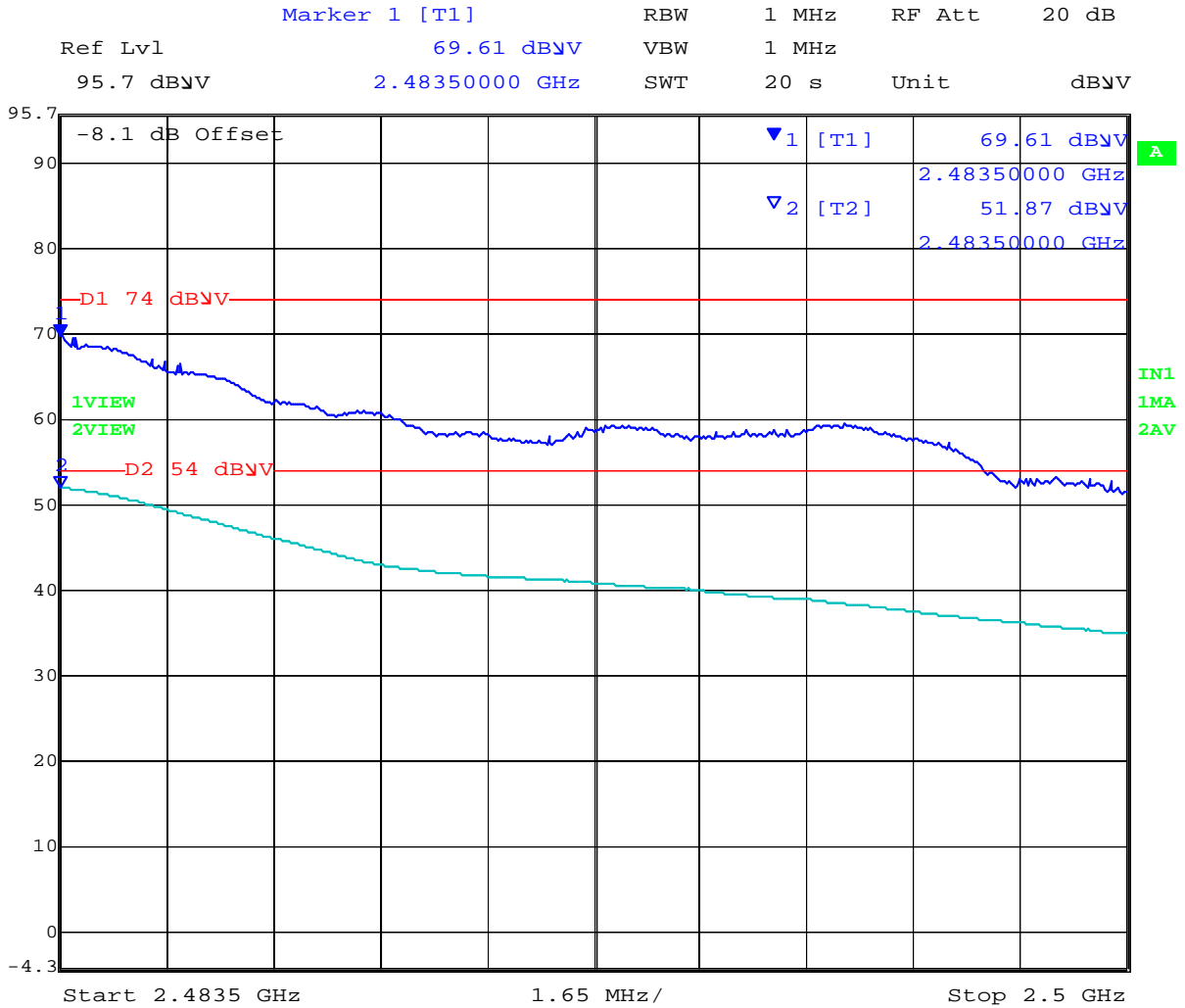

Date: 6.NOV.2012 12:25:25

This test report may be reproduced in full only. The document may only be updated by MiCOM Labs personnel. Any changes will be noted in the Document History section of the report.



Title: Digi Connect Card for i.MX28 with Atheros AR6203
To: FCC 47 CFR Part 15.247 & IC RSS-210
Serial #: DIGI36-U2 Rev A
Issue Date: 22nd May 2014
Page: 77 of 261

Band Edge 802.11n HT40 2422 MHz

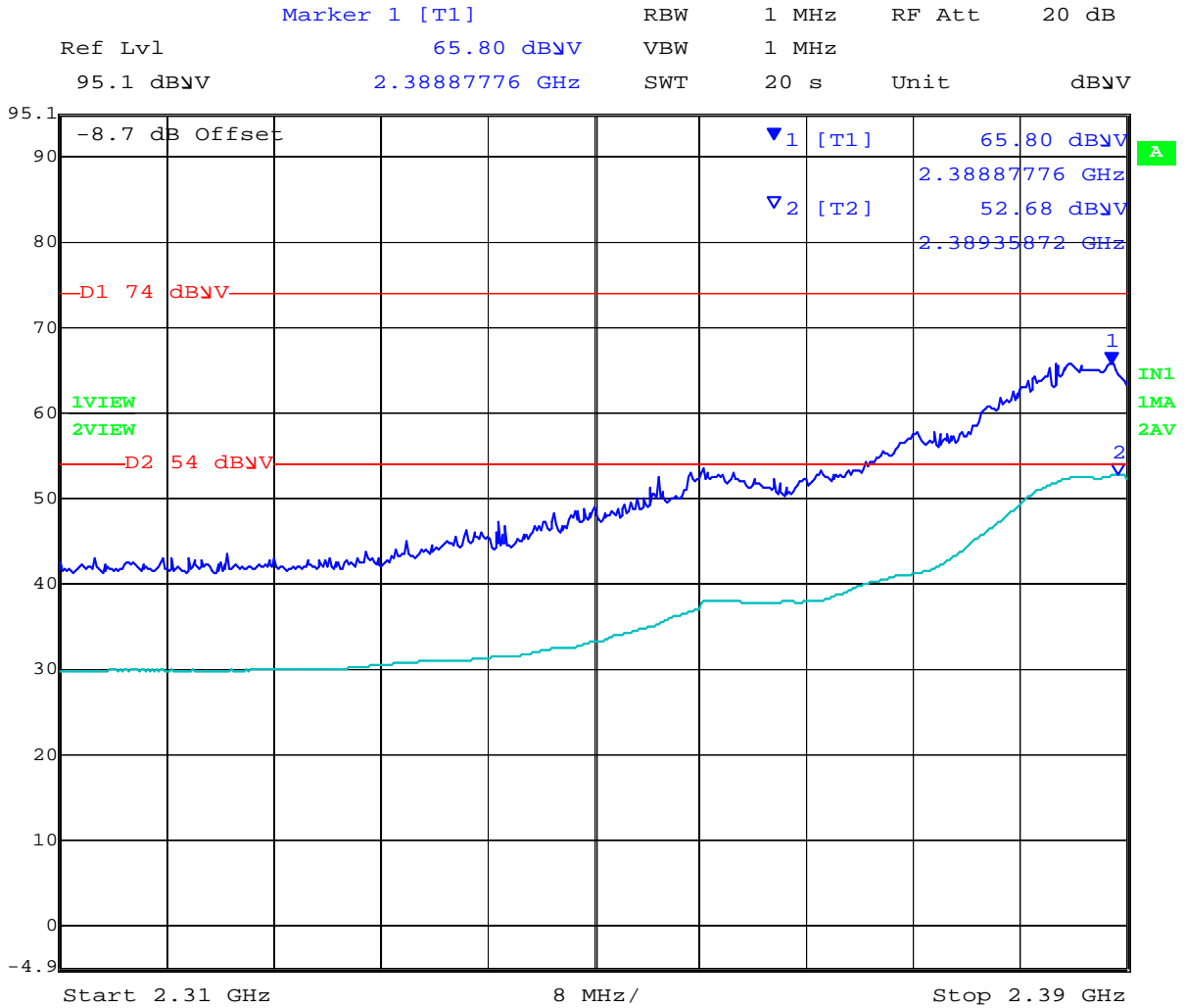

Date: 6.NOV.2012 11:57:02

Power reduction required in order to bring unit into compliance Power = 16

This test report may be reproduced in full only. The document may only be updated by MiCOM Labs personnel. Any changes will be noted in the Document History section of the report.



Title: Digi Connect Card for i.MX28 with Atheros AR6203
To: FCC 47 CFR Part 15.247 & IC RSS-210
Serial #: DIGI36-U2 Rev A
Issue Date: 22nd May 2014
Page: 78 of 261

Band Edge 802.11n HT40 2452 MHz

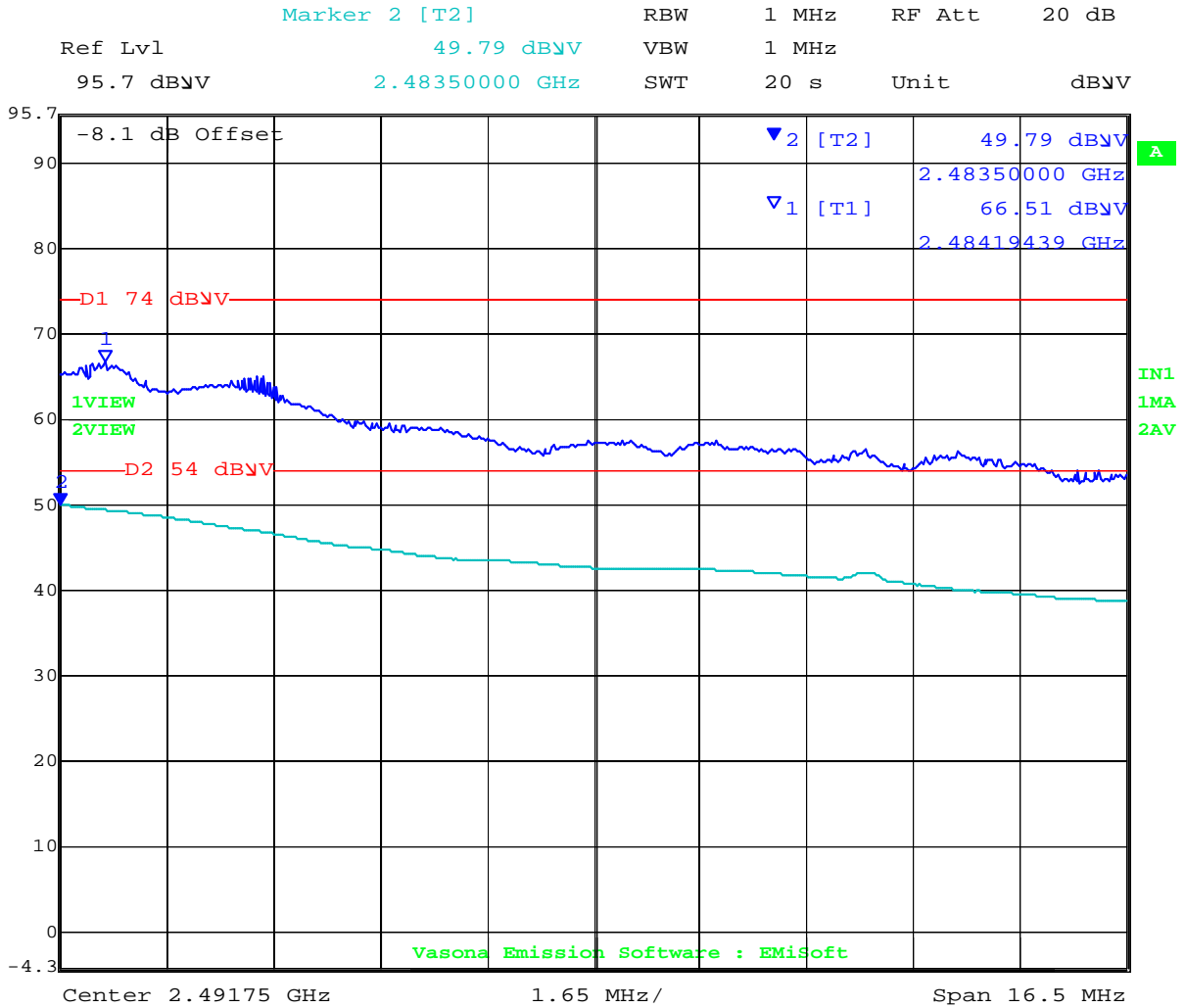

Date: 6.NOV.2012 11:40:52

Power reduction required in order to bring unit into compliance Power = 17

This test report may be reproduced in full only. The document may only be updated by MiCOM Labs personnel. Any changes will be noted in the Document History section of the report.



Title: Digi Connect Card for i.MX28 with Atheros AR6203
To: FCC 47 CFR Part 15.247 & IC RSS-210
Serial #: DIGI36-U2 Rev A
Issue Date: 22nd May 2014
Page: 79 of 261

Test Freq.	5745 MHz	Engineer	JMH
Variant	802.11a; 6.5 Mbs	Temp (°C)	25
Freq. Range	1000 MHz - 18000 MHz	Rel. Hum.(%)	38
Power Setting	18	Press. (mBars)	1002
Antenna	PC.11 x2	Duty Cycle (%)	100
Test Notes 1	Dual Port Module		
Test Notes 2	Power reduced to meet limit		

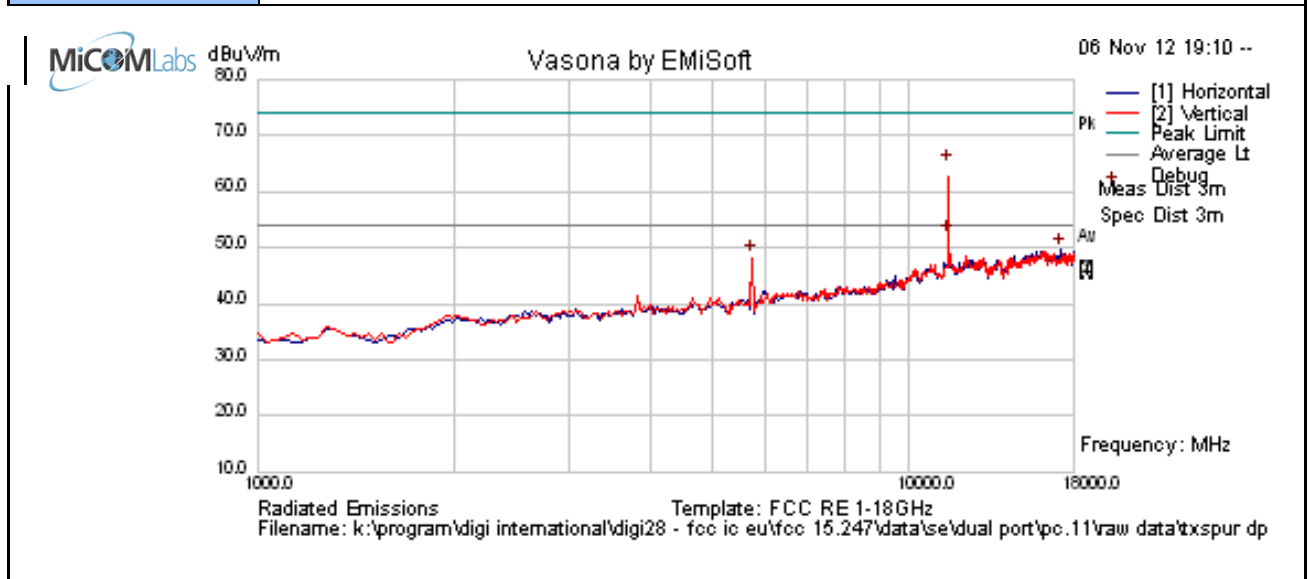

Formally measured emission peaks

Frequency MHz	Raw dBuV	Cable Loss	AF dB	Level dBuV/m	Measurement Type	Pol	Hgt cm	Azt Deg	Limit dBuV/m	Margin dB	Pass /Fail	Comments
5735.471	52.9	4.8	-9.5	48.1	Peak [Scan]	H						FUND
17148.297	40.5	8.6	0.5	49.6	Peak [Scan]	H	150	0	54.0	-4.4	Pass	Noise
11493.255	59.5	6.8	-2.0	64.4	Peak Max	V	133	37	74	-9.6	Pass	RB
11493.255	46.9	6.8	-2.0	51.7	Average Max	V	133	37	54	-2.3	Pass	RB

Legend: TX = Transmitter Emissions; DIG = Digital Emissions; FUND = Fundamental; WB = Wideband Emission
 RB = Restricted Band (15.209 Limits); NRB = Non Restricted Band, Limit is 20dB below fundamental peak

This test report may be reproduced in full only. The document may only be updated by MiCOM Labs personnel. Any changes will be noted in the Document History section of the report.



Title: Digi Connect Card for i.MX28 with Atheros AR6203
To: FCC 47 CFR Part 15.247 & IC RSS-210
Serial #: DIGI36-U2 Rev A
Issue Date: 22nd May 2014
Page: 80 of 261

Band Edge

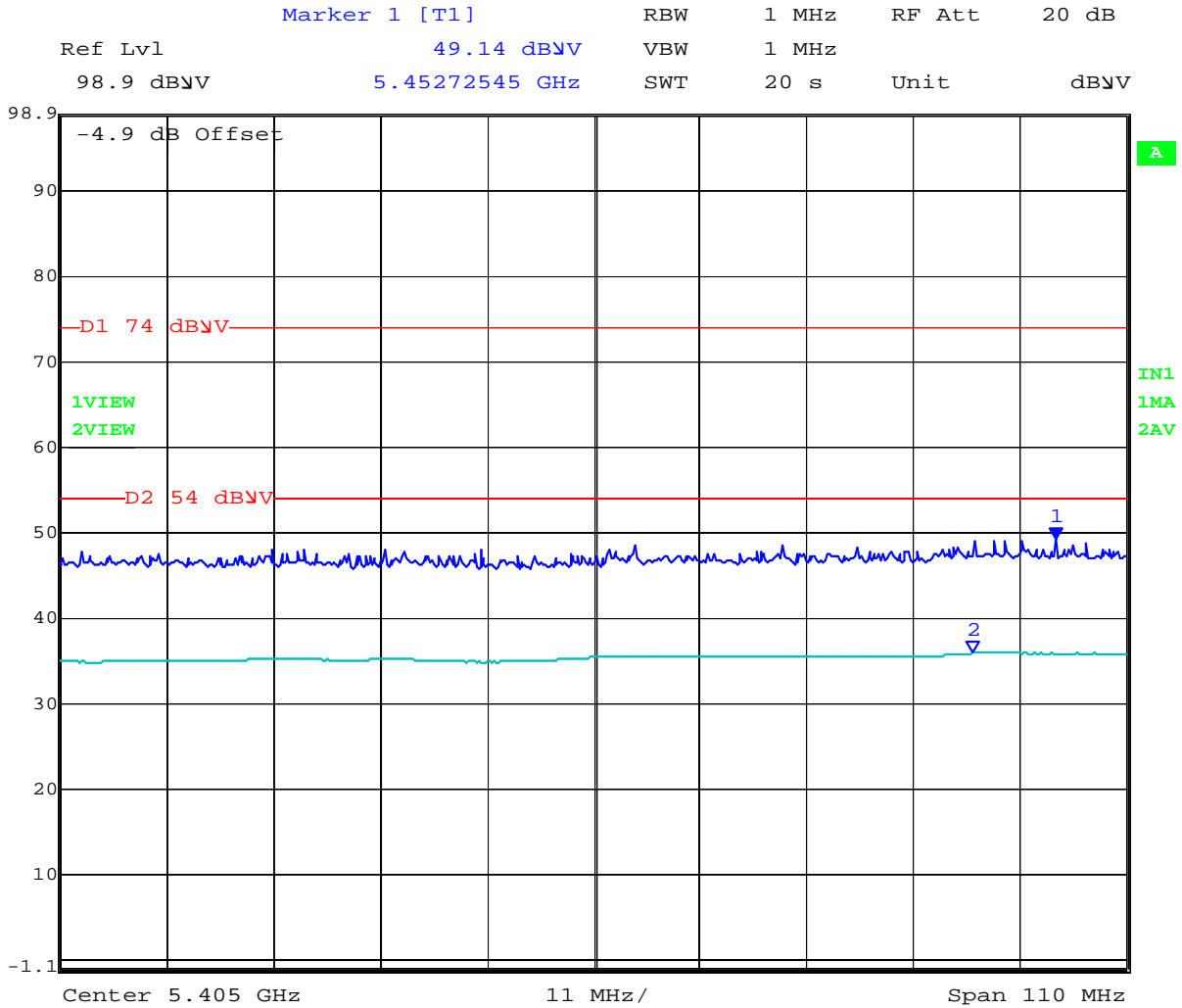

Date: 6.NOV.2012 12:45:46

This test report may be reproduced in full only. The document may only be updated by MiCOM Labs personnel. Any changes will be noted in the Document History section of the report.



Title: Digi Connect Card for i.MX28 with Atheros AR6203
To: FCC 47 CFR Part 15.247 & IC RSS-210
Serial #: DIGI36-U2 Rev A
Issue Date: 22nd May 2014
Page: 81 of 261

Test Freq.	5785 MHz	Engineer	JMH
Variant	802.11a; 6.5 Mbs	Temp (°C)	25
Freq. Range	1000 MHz - 18000 MHz	Rel. Hum.(%)	38
Power Setting	18	Press. (mBars)	1002
Antenna	PC.11 x2	Duty Cycle (%)	100
Test Notes 1	Dual Port Module		
Test Notes 2	Power reduced to meet limit		

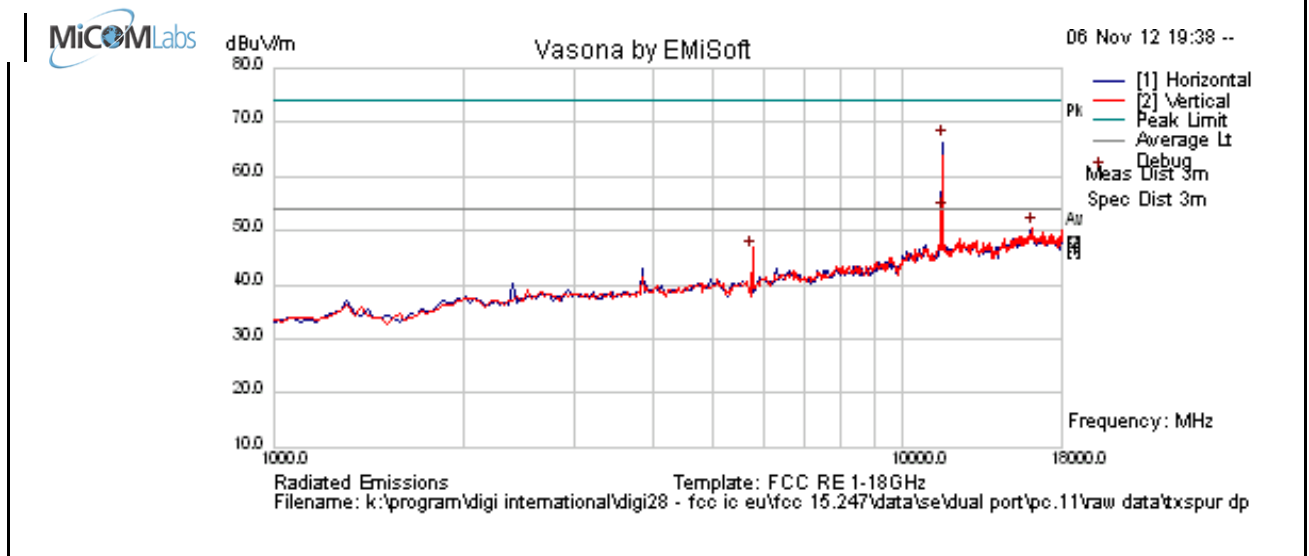

Formally measured emission peaks

Frequency MHz	Raw dBuV	Cable Loss	AF dB	Level dBuV/m	Measurement Type	Pol	Hgt cm	Azt Deg	Limit dBuV/m	Margin dB	Pass /Fail	Comments
5770.035	50.6	4.8	-9.5	45.9	Peak [Scan]	V						FUND
16092.184	41.2	9.0	0.3	50.4	Peak [Scan]	V	100	0	54.0	-3.6	Pass	Noise
11570.761	61.6	6.8	-2.0	66.4	Peak Max	V	107	23	74	-7.6	Pass	RB
11570.761	48.4	6.8	-2.0	53.2	Average Max	V	107	23	54	-0.8	Pass	RB

Legend: TX = Transmitter Emissions; DIG = Digital Emissions; FUND = Fundamental; WB = Wideband Emission
 RB = Restricted Band (15.209 Limits); NRB = Non Restricted Band, Limit is 20dB below fundamental peak

This test report may be reproduced in full only. The document may only be updated by MiCOM Labs personnel. Any changes will be noted in the Document History section of the report.



Title: Digi Connect Card for i.MX28 with Atheros AR6203
To: FCC 47 CFR Part 15.247 & IC RSS-210
Serial #: DIGI36-U2 Rev A
Issue Date: 22nd May 2014
Page: 82 of 261

Test Freq.	5825 MHz	Engineer	JMH
Variant	802.11a; 6.5 Mbs	Temp (°C)	25
Freq. Range	1000 MHz - 18000 MHz	Rel. Hum.(%)	38
Power Setting	15	Press. (mBars)	1002
Antenna	PC.11 x2	Duty Cycle (%)	100
Test Notes 1	Dual Port Module		
Test Notes 2	Power reduced to meet limit		

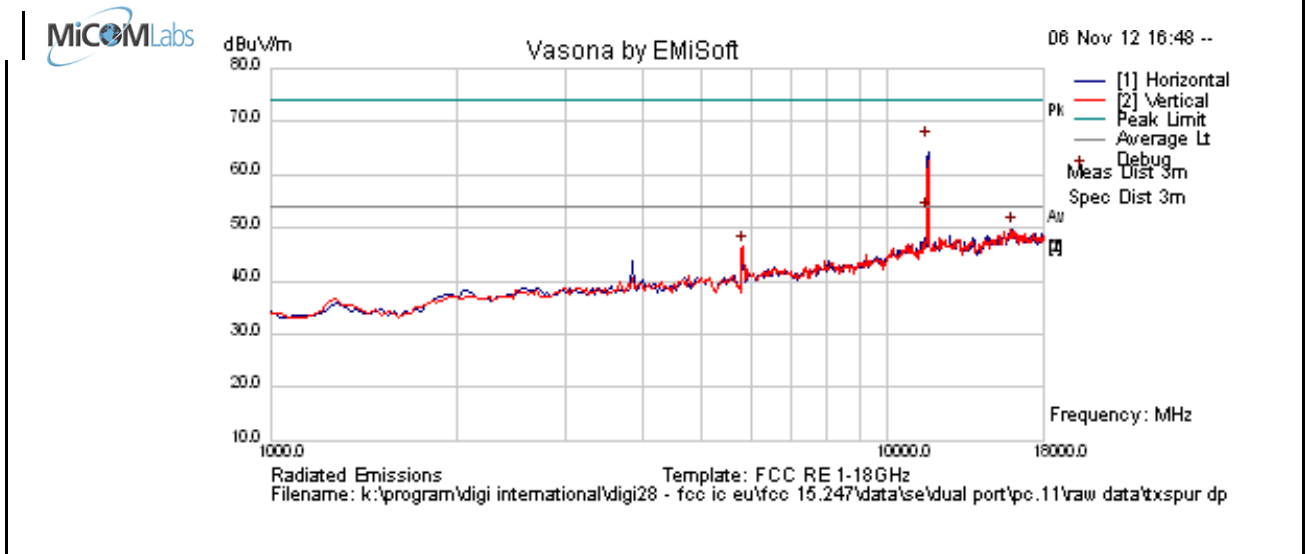

Formally measured emission peaks

Frequency MHz	Raw dBuV	Cable Loss	AF dB	Level dBuV/m	Measurement Type	Pol	Hgt cm	Azt Deg	Limit dBuV/m	Margin dB	Pass /Fail	Comments
5821.548	50.7	4.8	-9.3	46.2	Peak [Scan]	V						FUND
16024.048	40.6	9.0	0.2	49.8	Peak [Scan]	H	200	0	54.0	-4.2	Pass	Noise
11646.493	61.4	6.8	-2.3	65.9	Peak Max	V	103	23	74	-8.1	Pass	RB
11646.493	48.2	6.8	-2.3	52.8	Average Max	V	103	23	54	-1.2	Pass	RB

Legend: TX = Transmitter Emissions; DIG = Digital Emissions; FUND = Fundamental; WB = Wideband Emission
 RB = Restricted Band (15.209 Limits); NRB = Non Restricted Band, Limit is 20dB below fundamental peak

This test report may be reproduced in full only. The document may only be updated by MiCOM Labs personnel. Any changes will be noted in the Document History section of the report.



Title: Digi Connect Card for i.MX28 with Atheros AR6203
To: FCC 47 CFR Part 15.247 & IC RSS-210
Serial #: DIGI36-U2 Rev A
Issue Date: 22nd May 2014
Page: 83 of 261

Band Edge 802.11n HT20 5745 MHz

Marker 1 [T1] RBW 1 MHz RF Att 20 dB
Ref Lvl 48.82 dBµV VBW 1 MHz
98.9 dBµV 5.44192385 GHz SWT 20 s Unit dBµV

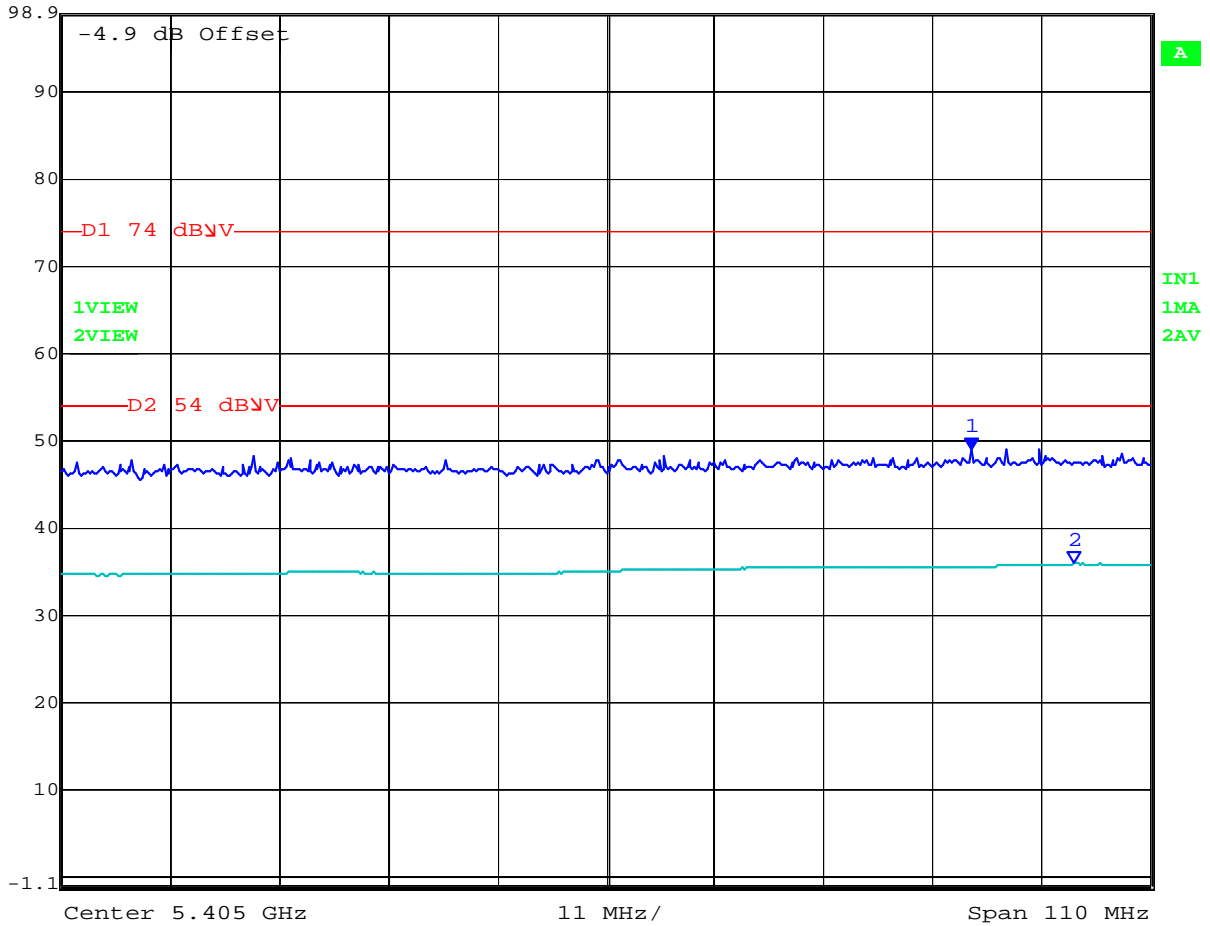

Date: 6.NOV.2012 12:49:37

This test report may be reproduced in full only. The document may only be updated by MiCOM Labs personnel. Any changes will be noted in the Document History section of the report.



Title: Digi Connect Card for i.MX28 with Atheros AR6203
To: FCC 47 CFR Part 15.247 & IC RSS-210
Serial #: DIGI36-U2 Rev A
Issue Date: 22nd May 2014
Page: 84 of 261

Band Edge 802.11n HT40 5755 MHz

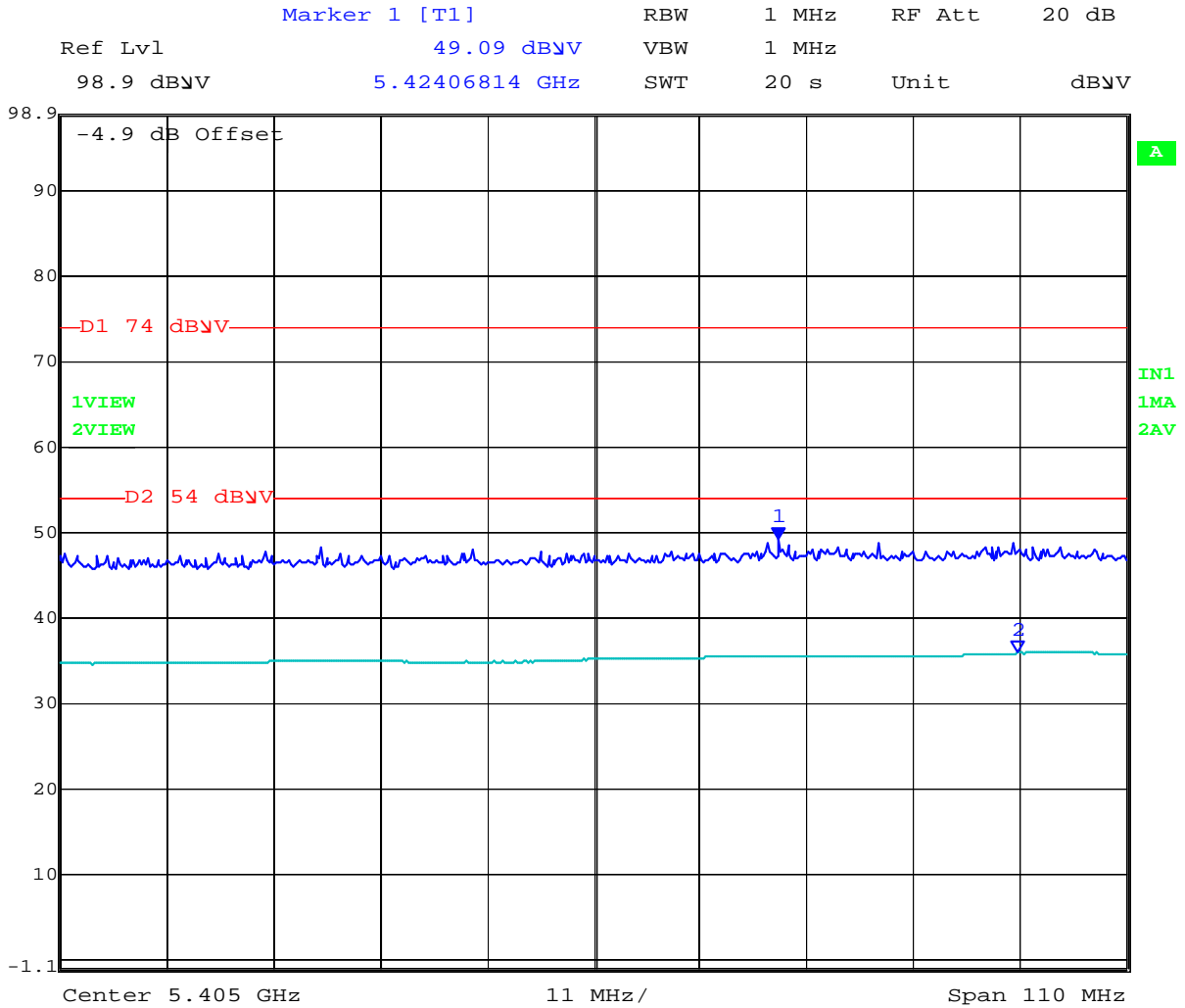

Date: 6.NOV.2012 12:52:03

This test report may be reproduced in full only. The document may only be updated by MiCOM Labs personnel. Any changes will be noted in the Document History section of the report.



Title: Digi Connect Card for i.MX28 with Atheros AR6203
To: FCC 47 CFR Part 15.247 & IC RSS-210
Serial #: DIGI36-U2 Rev A
Issue Date: 22nd May 2014
Page: 85 of 261

6.1.2.2. Dual Band Patch FXP.830 – Dual Port Module

Test Freq.	2412 MHz	Engineer	JMH
Variant	802.11b; 1 Mbs	Temp (°C)	23
Freq. Range	1000 MHz - 18000 MHz	Rel. Hum.(%)	33
Power Setting	20	Press. (mBars)	1001
Antenna	FXP830 x2	Duty Cycle (%)	100
Test Notes 1	Dual Port Module		
Test Notes 2			

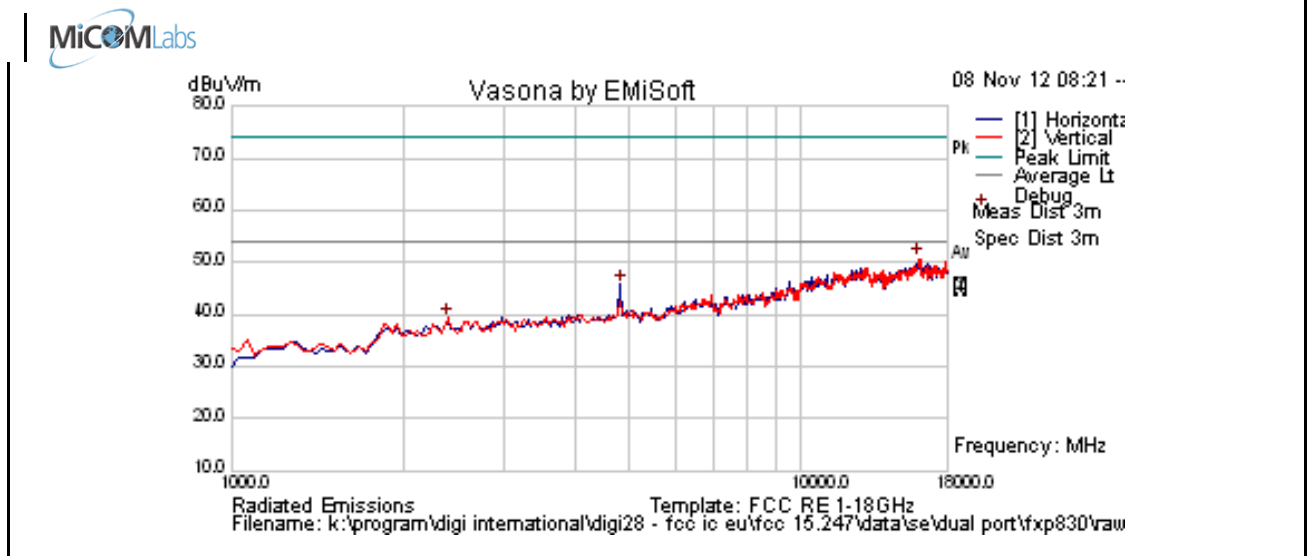

Formally measured emission peaks

Frequency MHz	Raw dBuV	Cable Loss	AF dB	Level dBuV/m	Measurement Type	Pol	Hgt cm	Azt Deg	Limit dBuV/m	Margin dB	Pass /Fail	Comments
2396.797	48.1	3.0	-11.7	39.4	Peak [Scan]	V						FUND
4814.036	50.7	4.5	-9.7	45.5	Peak [Scan]	H	98	360	54.0	-8.5	Pass	RB
16024.048	41.5	9.0	0.2	50.7	Peak [Scan]	V	150	0	54	-3.3	Pass	Noise

Legend: TX = Transmitter Emissions; DIG = Digital Emissions; FUND = Fundamental; WB = Wideband Emission
 RB = Restricted Band (15.209 Limits); NRB = Non Restricted Band, Limit is 20dB below fundamental peak

This test report may be reproduced in full only. The document may only be updated by MiCOM Labs personnel. Any changes will be noted in the Document History section of the report.



Band Edge

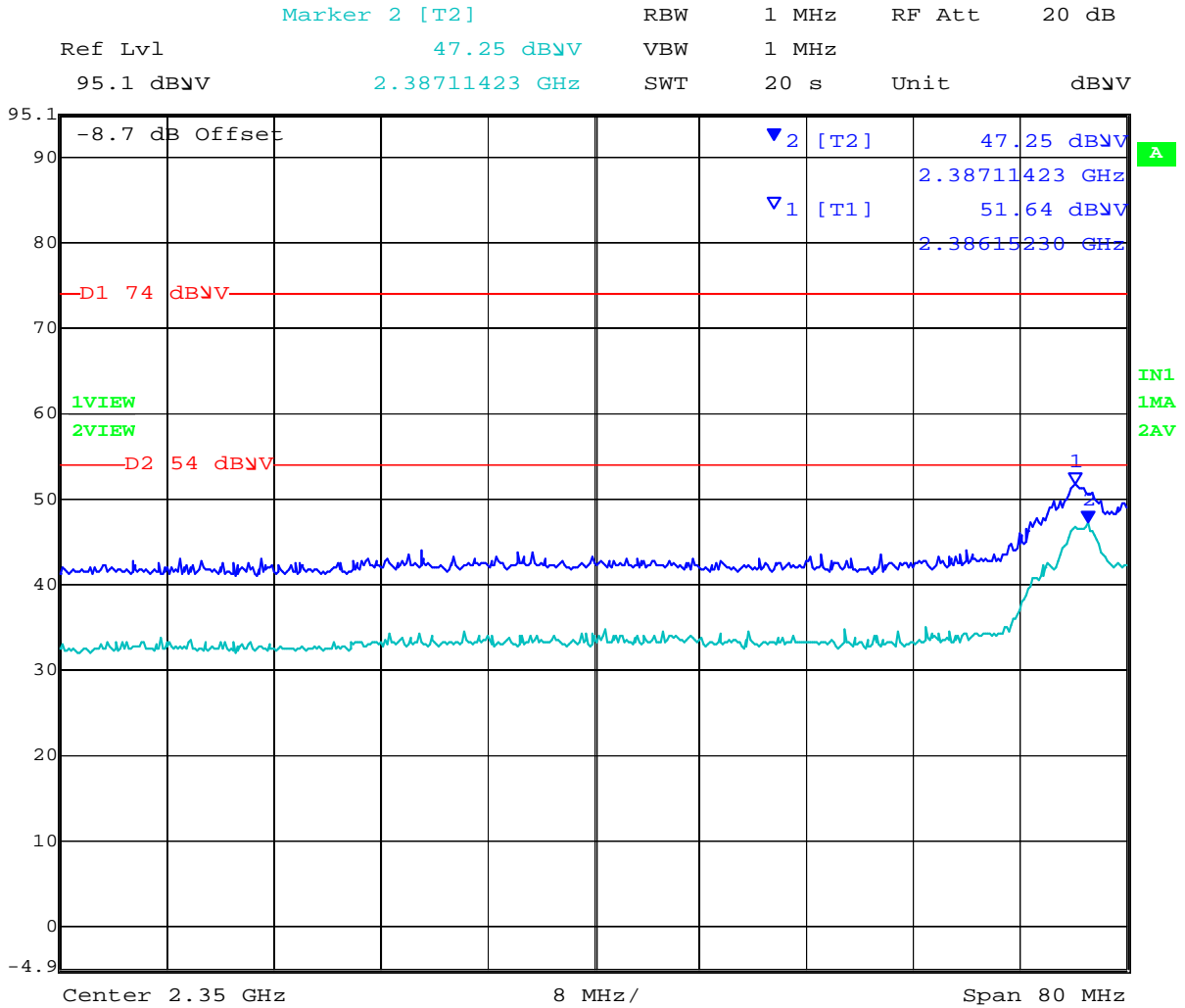

Date: 8.NOV.2012 13:19:07

This test report may be reproduced in full only. The document may only be updated by MiCOM Labs personnel. Any changes will be noted in the Document History section of the report.



Title: Digi Connect Card for i.MX28 with Atheros AR6203
To: FCC 47 CFR Part 15.247 & IC RSS-210
Serial #: DIGI36-U2 Rev A
Issue Date: 22nd May 2014
Page: 87 of 261

Test Freq.	2437 MHz	Engineer	JMH
Variant	802.11b; 1 Mbs	Temp (°C)	23
Freq. Range	1000 MHz - 18000 MHz	Rel. Hum.(%)	33
Power Setting	20	Press. (mBars)	1001
Antenna	FXP830 x2	Duty Cycle (%)	100
Test Notes 1	Dual Port Module		
Test Notes 2			

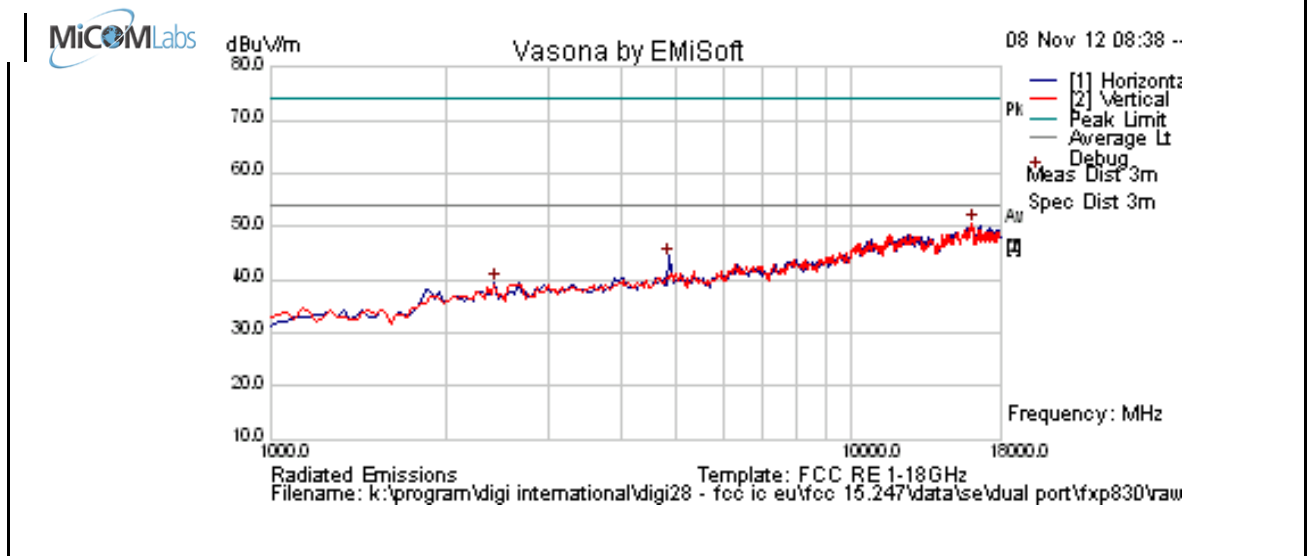

Formally measured emission peaks

Frequency MHz	Raw dBuV	Cable Loss	AF dB	Level dBuV/m	Measurement Type	Pol	Hgt cm	Azt Deg	Limit dBuV/m	Margin dB	Pass /Fail	Comments
2432.414	48.0	3.0	-11.6	39.4	Peak [Scan]	H						FUND
4856.783	49.2	4.5	-9.7	44.0	Peak [Scan]	H	98	360	54.0	-10.0	Pass	RB
16092.184	41.1	9.0	0.3	50.4	Peak [Scan]	V	100	0	54	-3.7	Pass	Noise

Legend: TX = Transmitter Emissions; DIG = Digital Emissions; FUND = Fundamental; WB = Wideband Emission
 RB = Restricted Band (15.209 Limits); NRB = Non Restricted Band, Limit is 20dB below fundamental peak

This test report may be reproduced in full only. The document may only be updated by MiCOM Labs personnel. Any changes will be noted in the Document History section of the report.



Title: Digi Connect Card for i.MX28 with Atheros AR6203
To: FCC 47 CFR Part 15.247 & IC RSS-210
Serial #: DIGI36-U2 Rev A
Issue Date: 22nd May 2014
Page: 88 of 261

Test Freq.	2462 MHz	Engineer	JMH
Variant	802.11b; 1 Mbs	Temp (°C)	23
Freq. Range	1000 MHz - 18000 MHz	Rel. Hum.(%)	33
Power Setting	20	Press. (mBars)	1001
Antenna	FXP830 x2	Duty Cycle (%)	100
Test Notes 1	Dual Port Module		
Test Notes 2			

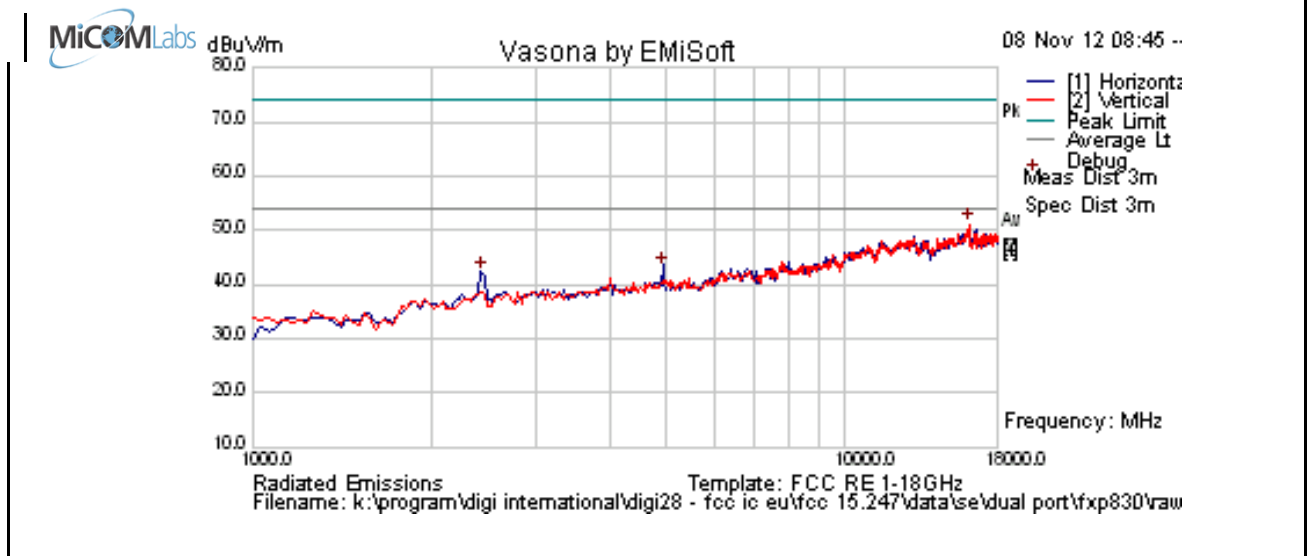

Formally measured emission peaks

Frequency MHz	Raw dBuV	Cable Loss	AF dB	Level dBuV/m	Measurement Type	Pol	Hgt cm	Azt Deg	Limit dBuV/m	Margin dB	Pass /Fail	Comments
2434.769	51.0	3.0	-11.6	42.4	Peak [Scan]	H						FUND
4921.107	48.4	4.6	-9.8	43.2	Peak [Scan]	H	98	98	54.0	-10.8	Pass	RB
16160.321	42.1	9.0	0.2	51.2	Peak [Scan]	V	150	0	54	-2.8	Pass	Noise

Legend: TX = Transmitter Emissions; DIG = Digital Emissions; FUND = Fundamental; WB = Wideband Emission
 RB = Restricted Band (15.209 Limits); NRB = Non Restricted Band, Limit is 20dB below fundamental peak

This test report may be reproduced in full only. The document may only be updated by MiCOM Labs personnel. Any changes will be noted in the Document History section of the report.



Band Edge

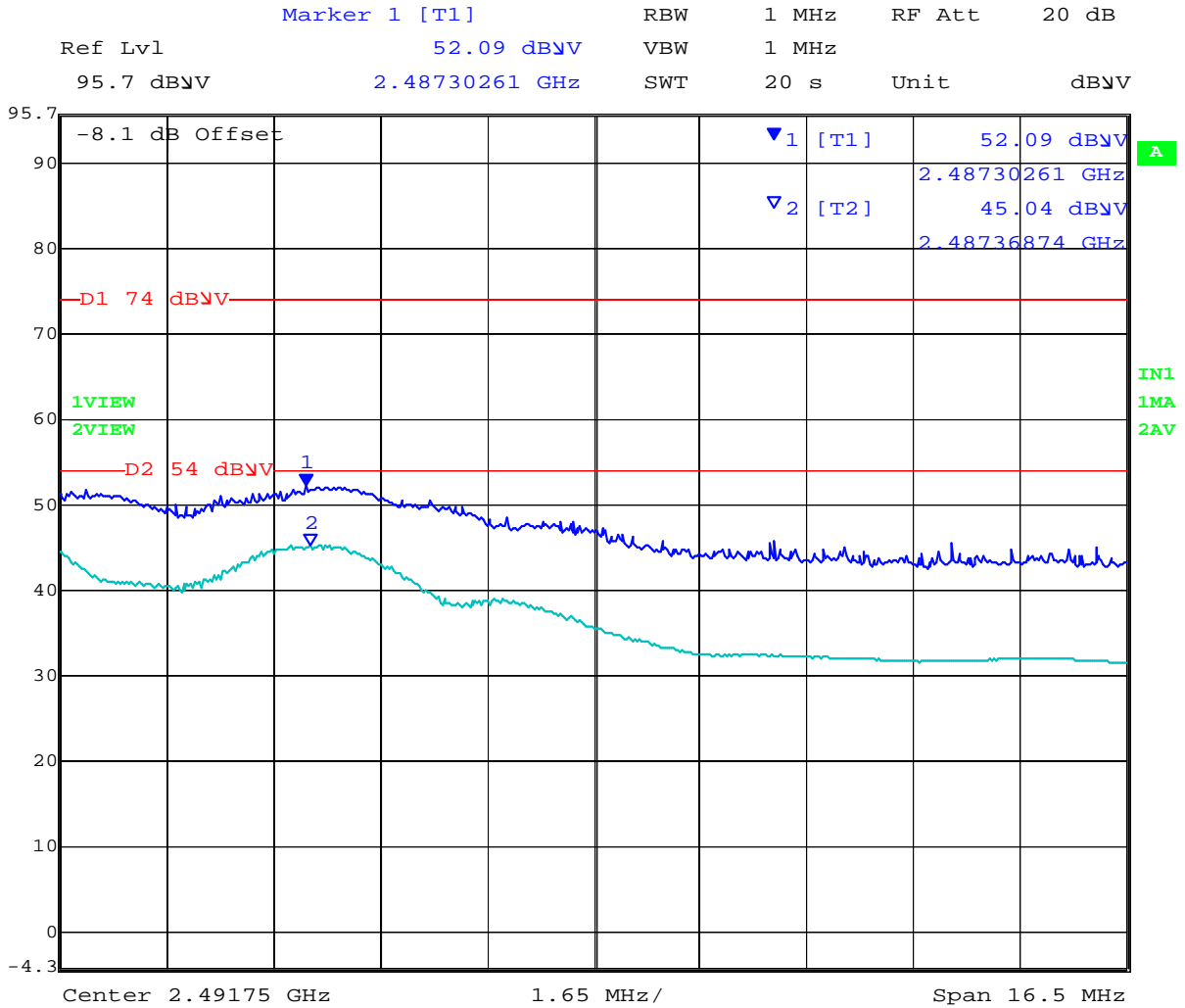

Date: 8.NOV.2012 13:38:15

This test report may be reproduced in full only. The document may only be updated by MiCOM Labs personnel. Any changes will be noted in the Document History section of the report.



Title: Digi Connect Card for i.MX28 with Atheros AR6203
To: FCC 47 CFR Part 15.247 & IC RSS-210
Serial #: DIGI36-U2 Rev A
Issue Date: 22nd May 2014
Page: 90 of 261

Test Freq.	2412 MHz	Engineer	JMH
Variant	802.11g; 6 Mbs	Temp (°C)	23
Freq. Range	1000 MHz - 18000 MHz	Rel. Hum.(%)	33
Power Setting	20	Press. (mBars)	1001
Antenna	FXP830 x2	Duty Cycle (%)	100
Test Notes 1	Dual Port Module		
Test Notes 2			

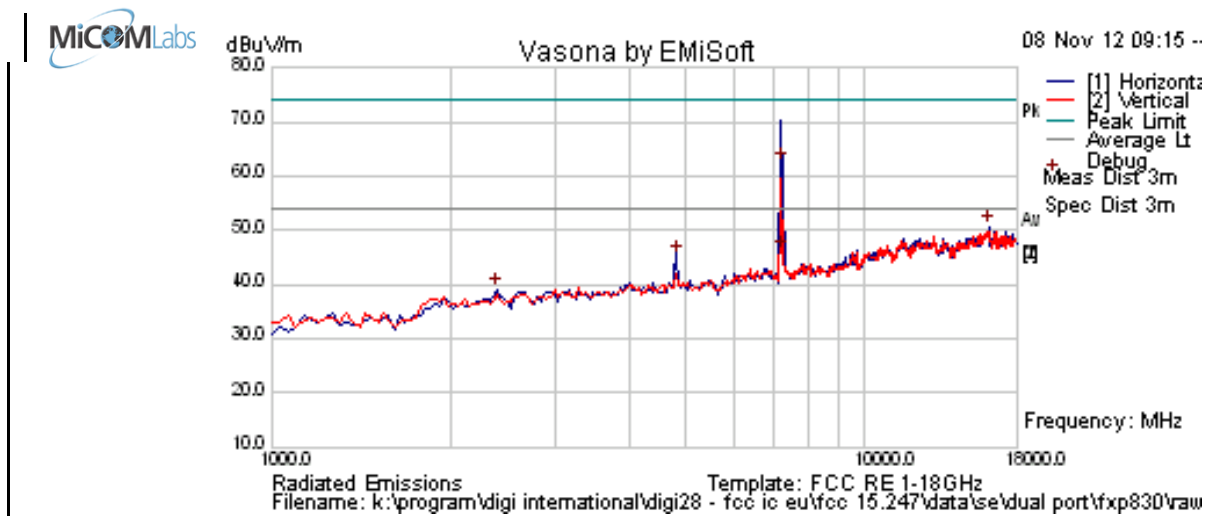

Formally measured emission peaks

Frequency MHz	Raw dBuV	Cable Loss	AF dB	Level dBuV/m	Measurement Type	Pol	Hgt cm	Azt Deg	Limit dBuV/m	Margin dB	Pass /Fail	Comments
2395.708	47.8	3.0	-11.7	39.1	Peak [Scan]	H						FUND
4818.459	50.6	4.5	-9.7	45.4	Peak [Scan]	H	98	98	54.0	-8.6	Pass	RB
16160.321	41.5	9.0	0.2	50.7	Peak [Scan]	H	100	0	54	-3.4	Pass	Noise
7250.030	62.9	5.4	-5.8	62.5	Peak.	H	106	106	74	-11.5	Pass	RB
7250.030	46.3	5.4	-5.8	45.9	Average.	H	106	106	54	-8.1	Pass	RB

Legend: TX = Transmitter Emissions; DIG = Digital Emissions; FUND = Fundamental; WB = Wideband Emission
 RB = Restricted Band (15.209 Limits); NRB = Non Restricted Band, Limit is 20dB below fundamental peak

This test report may be reproduced in full only. The document may only be updated by MiCOM Labs personnel. Any changes will be noted in the Document History section of the report.



Title: Digi Connect Card for i.MX28 with Atheros AR6203
To: FCC 47 CFR Part 15.247 & IC RSS-210
Serial #: DIGI36-U2 Rev A
Issue Date: 22nd May 2014
Page: 91 of 261

Band Edge

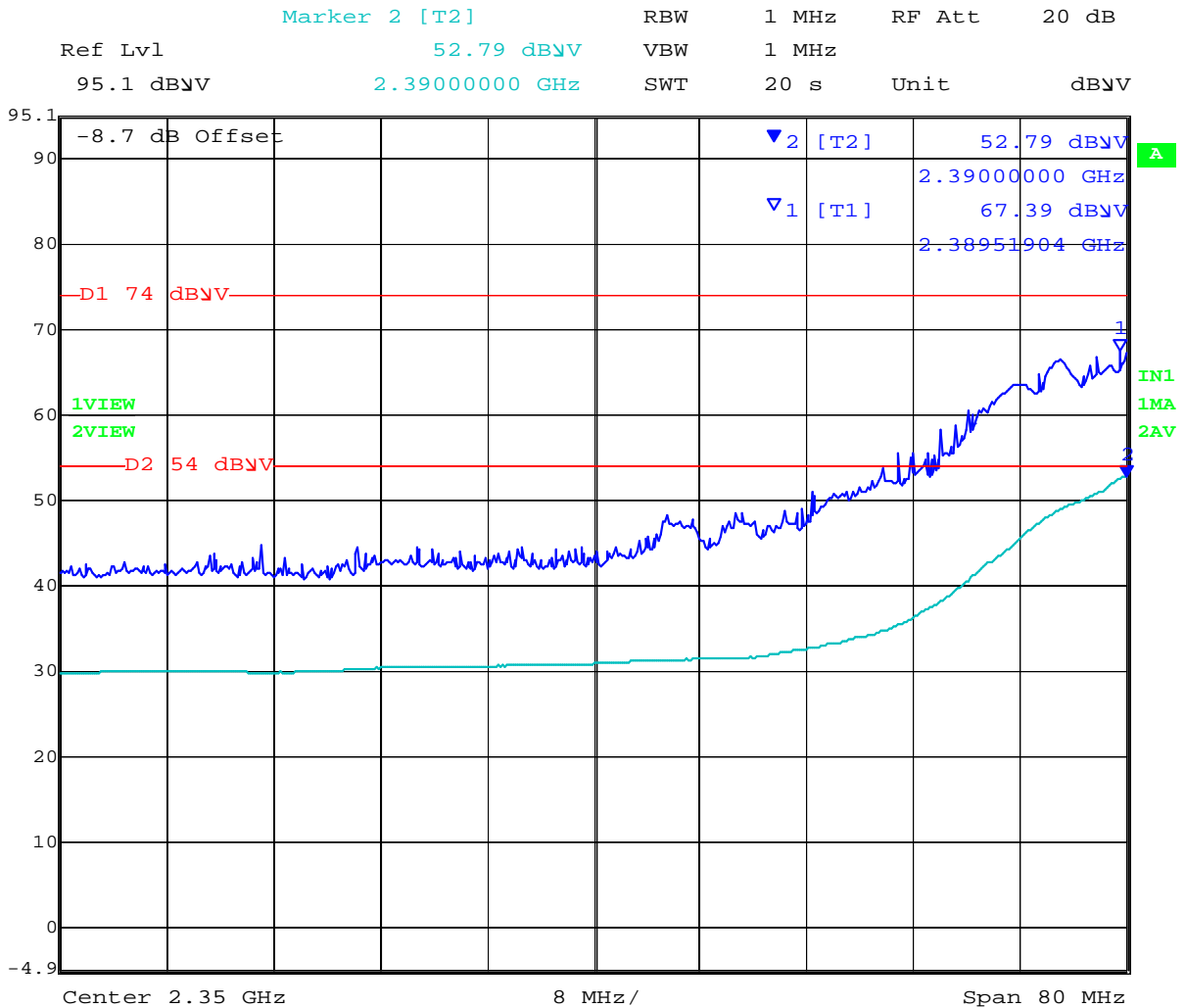

Date: 8.NOV.2012 13:22:43

Power reduction required in order to bring unit into compliance Power = 17

This test report may be reproduced in full only. The document may only be updated by MiCOM Labs personnel. Any changes will be noted in the Document History section of the report.



Title: Digi Connect Card for i.MX28 with Atheros AR6203
To: FCC 47 CFR Part 15.247 & IC RSS-210
Serial #: DIGI36-U2 Rev A
Issue Date: 22nd May 2014
Page: 92 of 261

Test Freq.	2437 MHz	Engineer	JMH
Variant	802.11g; 6 Mbs	Temp (°C)	23
Freq. Range	1000 MHz - 18000 MHz	Rel. Hum.(%)	33
Power Setting	20	Press. (mBars)	1001
Antenna	FXP830 x2	Duty Cycle (%)	100
Test Notes 1	Dual Port Module		
Test Notes 2			

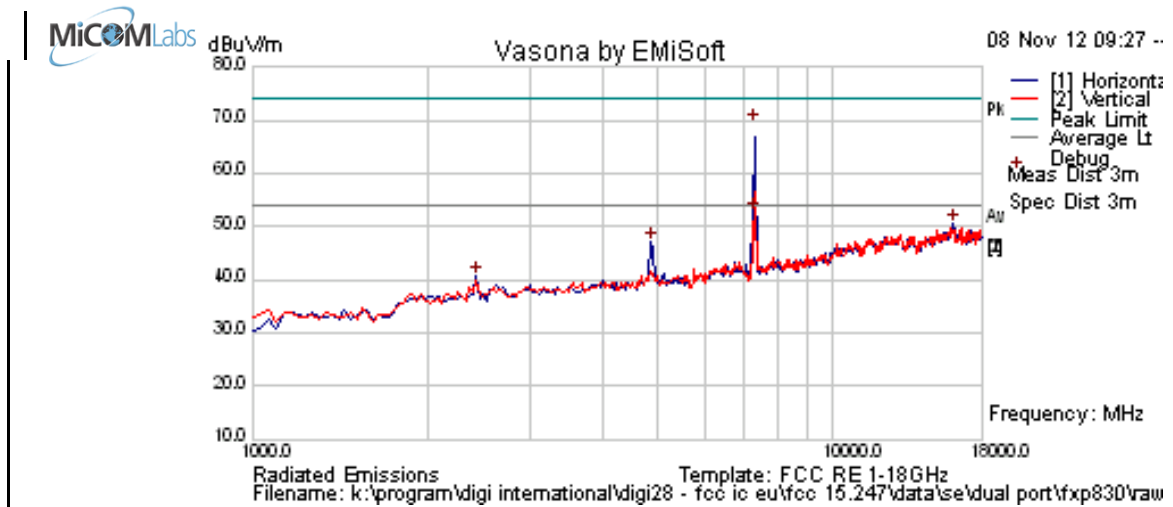

Formally measured emission peaks

Frequency MHz	Raw dBuV	Cable Loss	AF dB	Level dBuV/m	Measurement Type	Pol	Hgt cm	Azt Deg	Limit dBuV/m	Margin dB	Pass /Fail	Comments
2431.954	49.3	3.0	-11.6	40.7	Peak [Scan]	H						FUND
4860.764	52.0	4.5	-9.7	46.8	Peak [Scan]	H	98	98	54.0	-7.2	Pass	RB
16092.184	41.3	9.0	0.3	50.5	Peak [Scan]	H	100	0	54	-3.5	Pass	Noise
7307.816	69.3	5.4	-5.7	69.0	Peak Max	H	140	140	74	-5.0	Pass	RB
7307.816	52.7	5.4	-5.7	52.5	Average Max	H	140	140	54	-1.5	Pass	RB

Legend: TX = Transmitter Emissions; DIG = Digital Emissions; FUND = Fundamental; WB = Wideband Emission
 RB = Restricted Band (15.209 Limits); NRB = Non Restricted Band, Limit is 20dB below fundamental peak

This test report may be reproduced in full only. The document may only be updated by MiCOM Labs personnel. Any changes will be noted in the Document History section of the report.



Title: Digi Connect Card for i.MX28 with Atheros AR6203
To: FCC 47 CFR Part 15.247 & IC RSS-210
Serial #: DIGI36-U2 Rev A
Issue Date: 22nd May 2014
Page: 93 of 261

Test Freq	2462 MHz	Engineer	JMH
Variant	802.11g; 6 Mbs	Temp (°C)	23
Freq. Range	1000 MHz - 18000 MHz	Rel. Hum.(%)	33
Power Setting	20	Press. (mBars)	1001
Antenna	FXP830 x2	Duty Cycle (%)	100
Test Notes 1	Dual Port Module		
Test Notes 2			

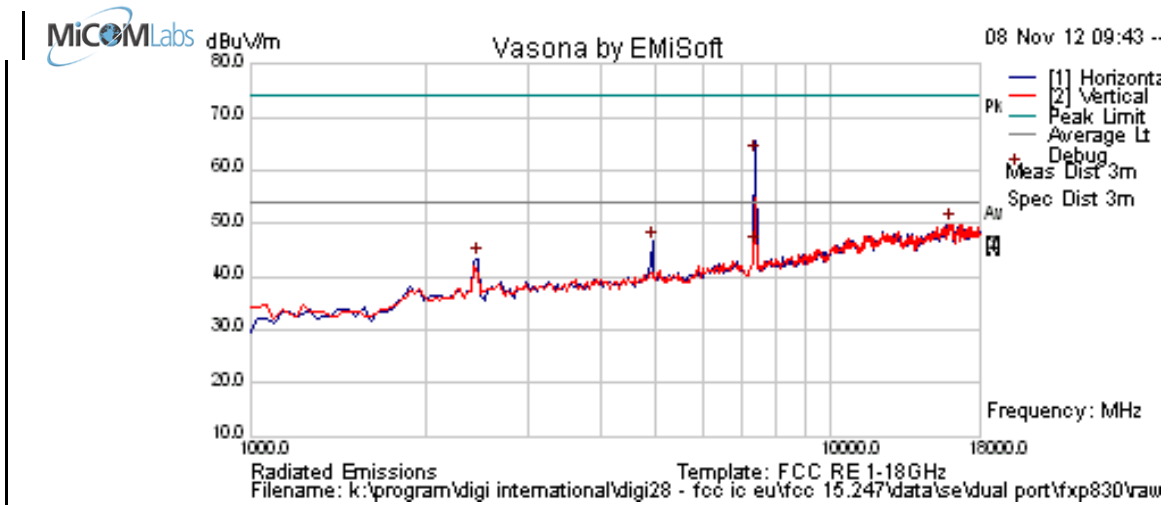

Formally measured emission peaks

Frequency MHz	Raw dBuV	Cable Loss	AF dB	Level dBuV/m	Measurement Type	Pol	Hgt cm	Azt Deg	Limit dBuV/m	Margin dB	Pass /Fail	Comments
2465.372	51.9	3.0	-11.5	43.4	Peak [Scan]	H						FUND
4916.789	51.7	4.6	-9.8	46.5	Peak [Scan]	H	98	98	54.0	-7.5	Pass	RB
15955.912	40.9	9.0	0.0	49.9	Peak [Scan]	V	150	0	54	-4.2	Pass	Noise
7383.006	62.7	5.5	-5.5	62.7	Peak Max	H	137	137	74	-11.3	Pass	RB
7383.006	45.8	5.5	-5.5	45.7	Average Max	H	137	137	54	-8.3	Pass	RB

Legend: TX = Transmitter Emissions; DIG = Digital Emissions; FUND = Fundamental; WB = Wideband Emission
 RB = Restricted Band (15.209 Limits); NRB = Non Restricted Band, Limit is 20dB below fundamental peak

This test report may be reproduced in full only. The document may only be updated by MiCOM Labs personnel. Any changes will be noted in the Document History section of the report.



Band Edge

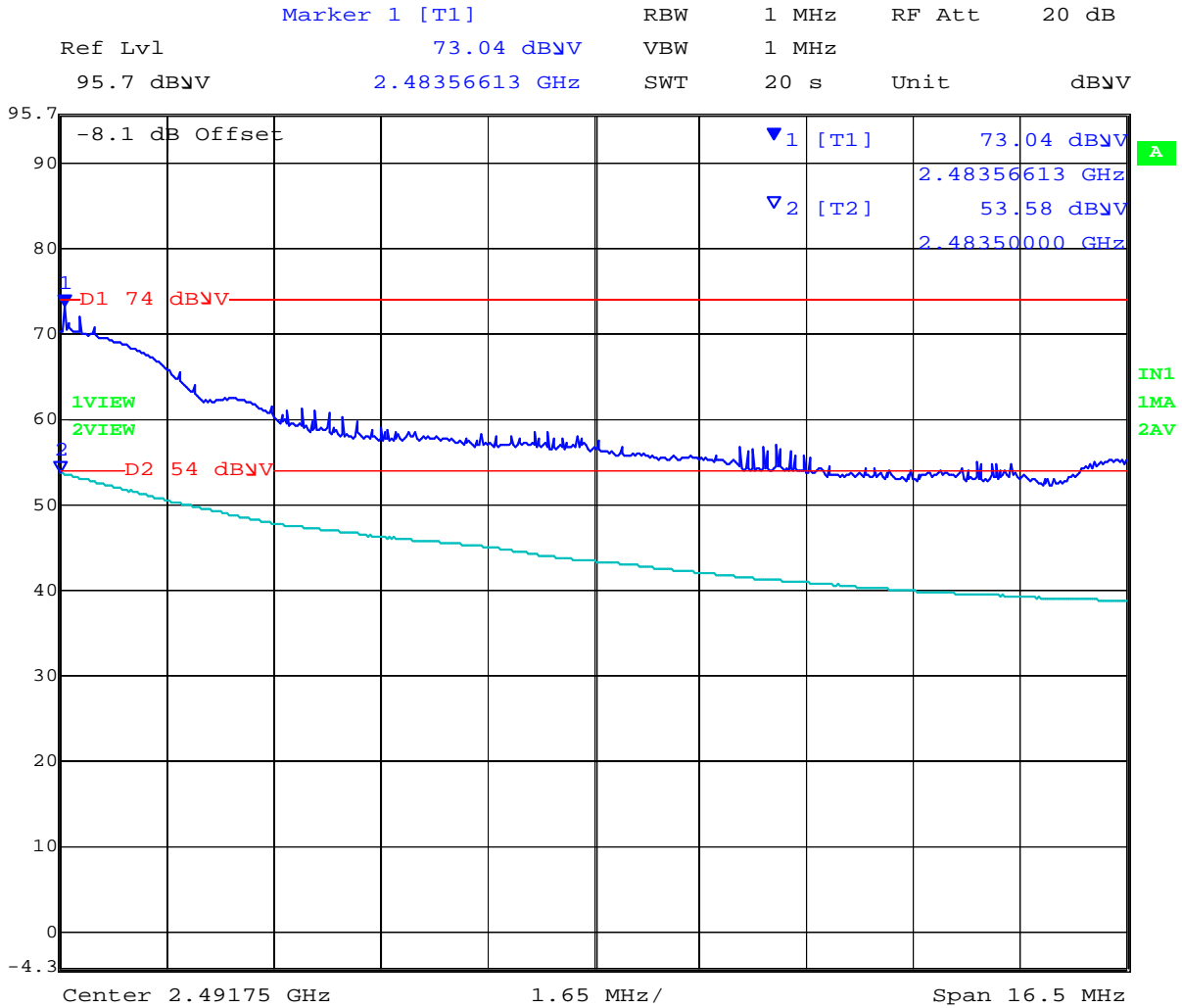

Date: 8.NOV.2012 13:34:37

Power reduction required in order to bring unit into compliance Power = 19

This test report may be reproduced in full only. The document may only be updated by MiCOM Labs personnel. Any changes will be noted in the Document History section of the report.



Title: Digi Connect Card for i.MX28 with Atheros AR6203
To: FCC 47 CFR Part 15.247 & IC RSS-210
Serial #: DIGI36-U2 Rev A
Issue Date: 22nd May 2014
Page: 95 of 261

Band Edge 802.11n HT20 2412 MHz

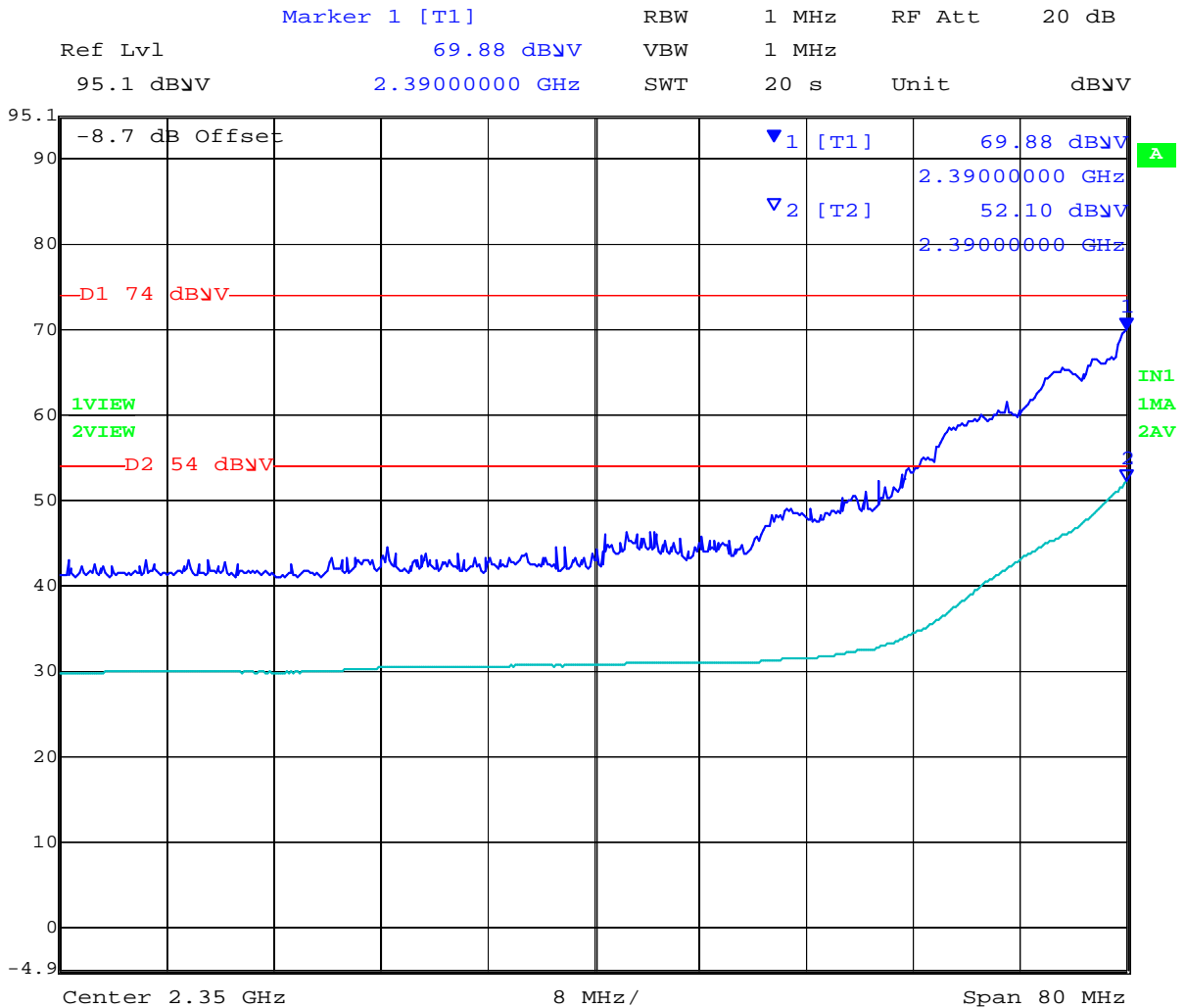

Date: 8.NOV.2012 13:25:09

Power reduction required in order to bring unit into compliance Power = 16

This test report may be reproduced in full only. The document may only be updated by MiCOM Labs personnel. Any changes will be noted in the Document History section of the report.



Band Edge 802.11n HT20 2462 MHz

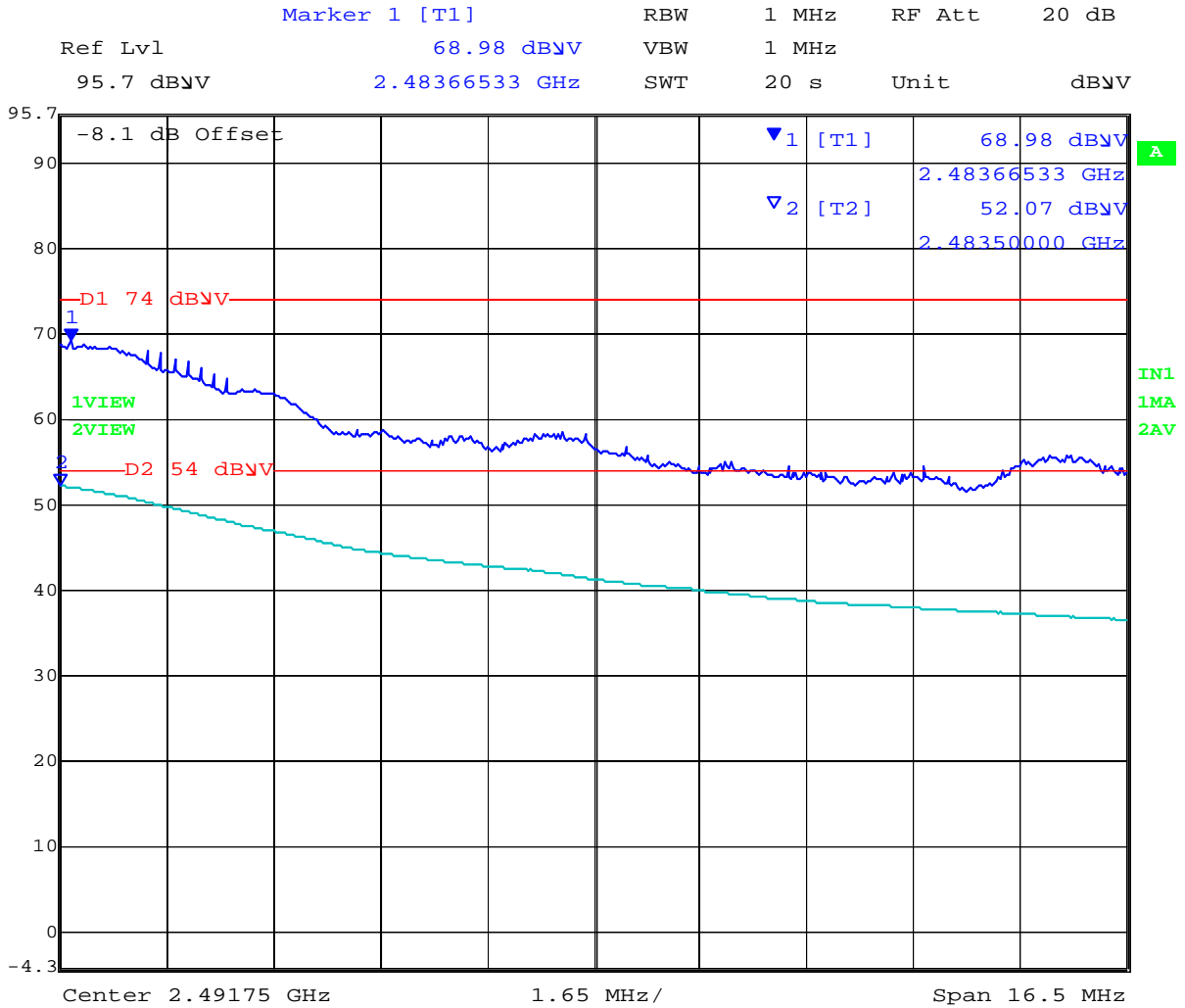

Date: 8.NOV.2012 13:32:03

Power reduction required in order to bring unit into compliance Power = 18

This test report may be reproduced in full only. The document may only be updated by MiCOM Labs personnel. Any changes will be noted in the Document History section of the report.



Title: Digi Connect Card for i.MX28 with Atheros AR6203
To: FCC 47 CFR Part 15.247 & IC RSS-210
Serial #: DIGI36-U2 Rev A
Issue Date: 22nd May 2014
Page: 97 of 261

Band Edge 802.11n HT40 2422 MHz

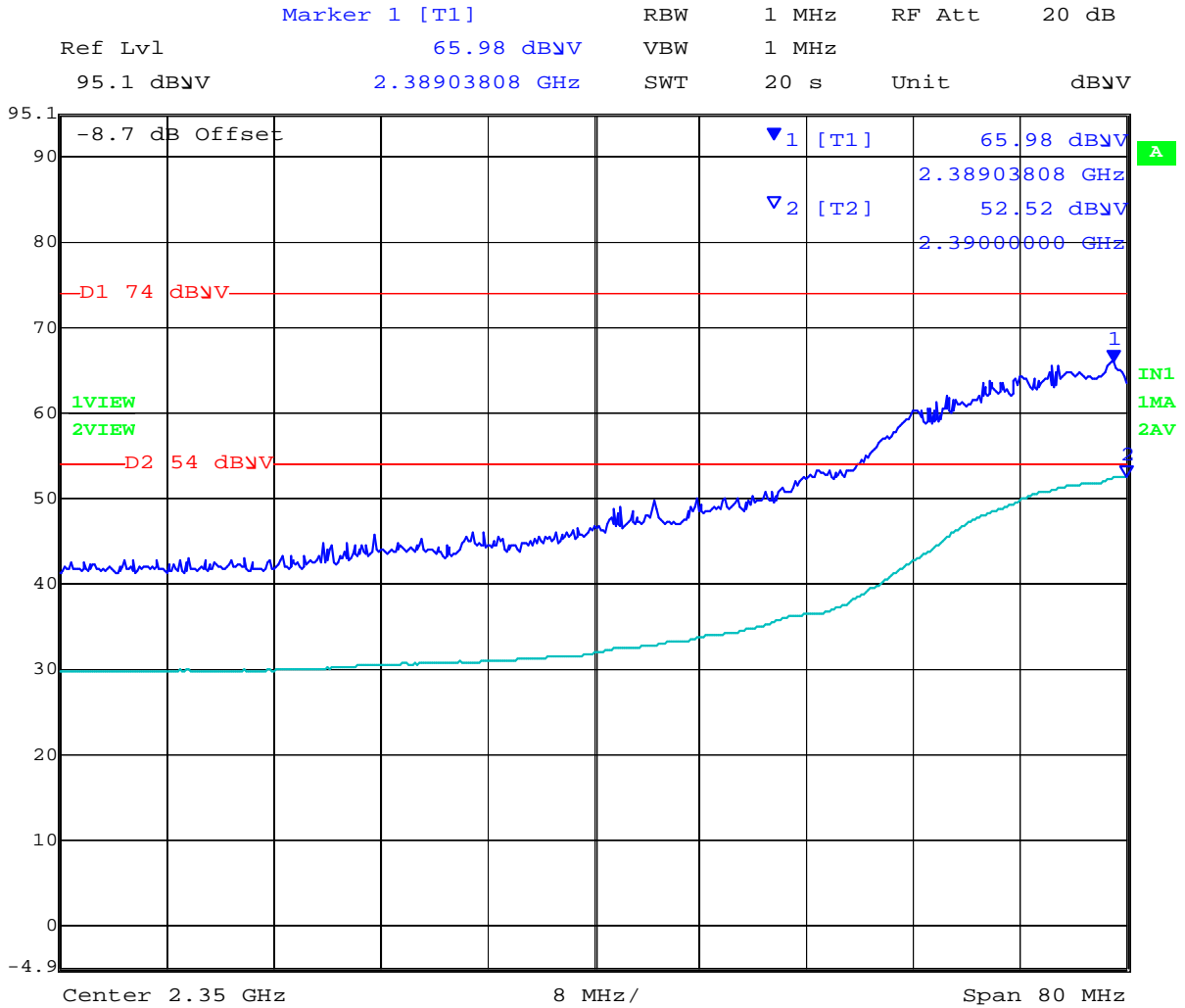

Date: 8.NOV.2012 12:49:29

Power reduction required in order to bring unit into compliance Power = 13

This test report may be reproduced in full only. The document may only be updated by MiCOM Labs personnel. Any changes will be noted in the Document History section of the report.



Title: Digi Connect Card for i.MX28 with Atheros AR6203
To: FCC 47 CFR Part 15.247 & IC RSS-210
Serial #: DIGI36-U2 Rev A
Issue Date: 22nd May 2014
Page: 98 of 261

Band Edge 802.11n HT40 2462 MHz

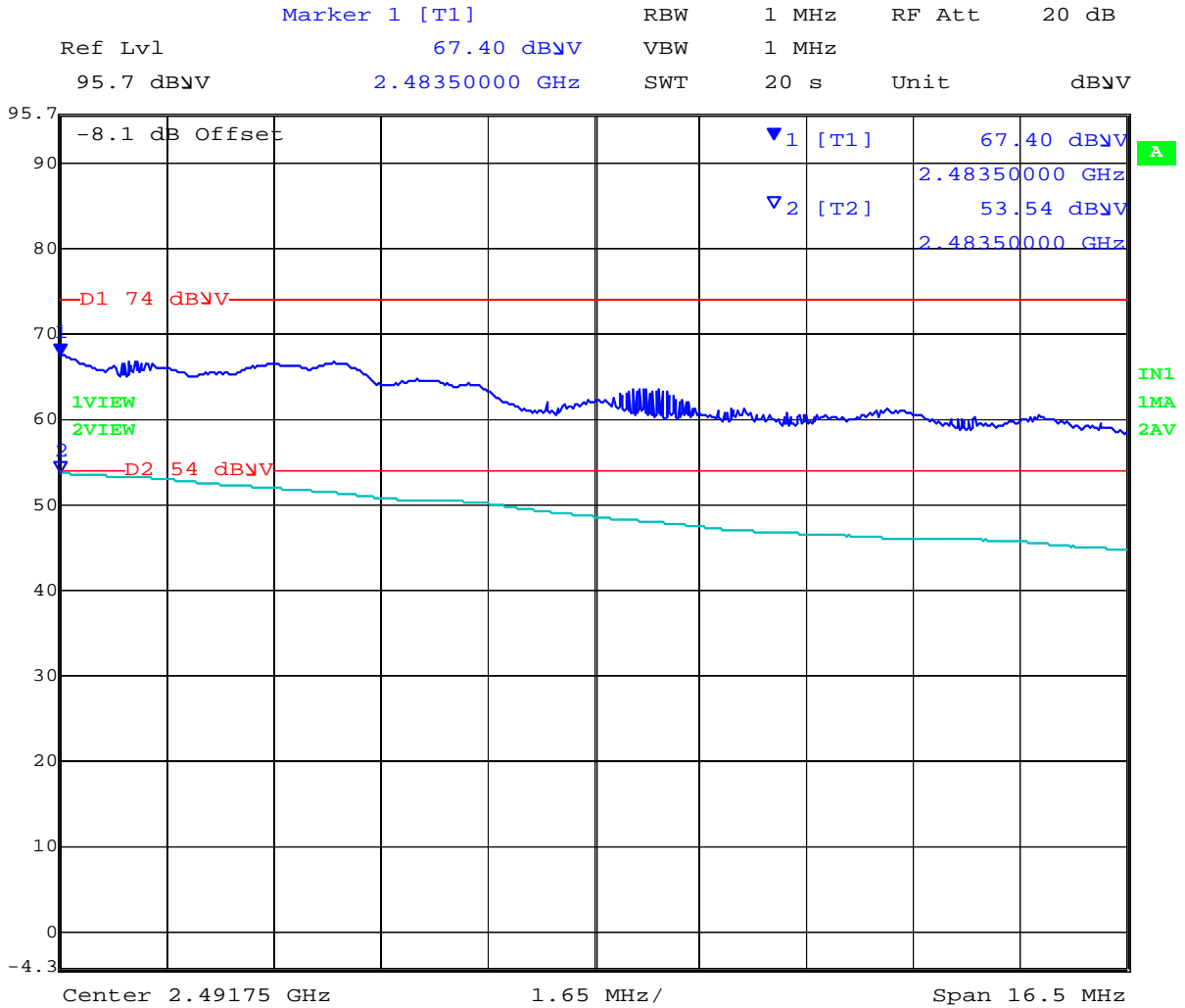

Date: 8.NOV.2012 12:26:03

Power reduction required in order to bring unit into compliance Power = 16

This test report may be reproduced in full only. The document may only be updated by MiCOM Labs personnel. Any changes will be noted in the Document History section of the report.



Title: Digi Connect Card for i.MX28 with Atheros AR6203
To: FCC 47 CFR Part 15.247 & IC RSS-210
Serial #: DIGI36-U2 Rev A
Issue Date: 22nd May 2014
Page: 99 of 261

Test Freq.	5745 MHz	Engineer	JMH
Variant	802.11a; 6.5 Mbs	Temp (°C)	24
Freq. Range	1000 MHz - 18000 MHz	Rel. Hum.(%)	32
Power Setting	20	Press. (mBars)	1001
Antenna	FXP830 x2	Duty Cycle (%)	100
Test Notes 1	Dual Port Module		
Test Notes 2			

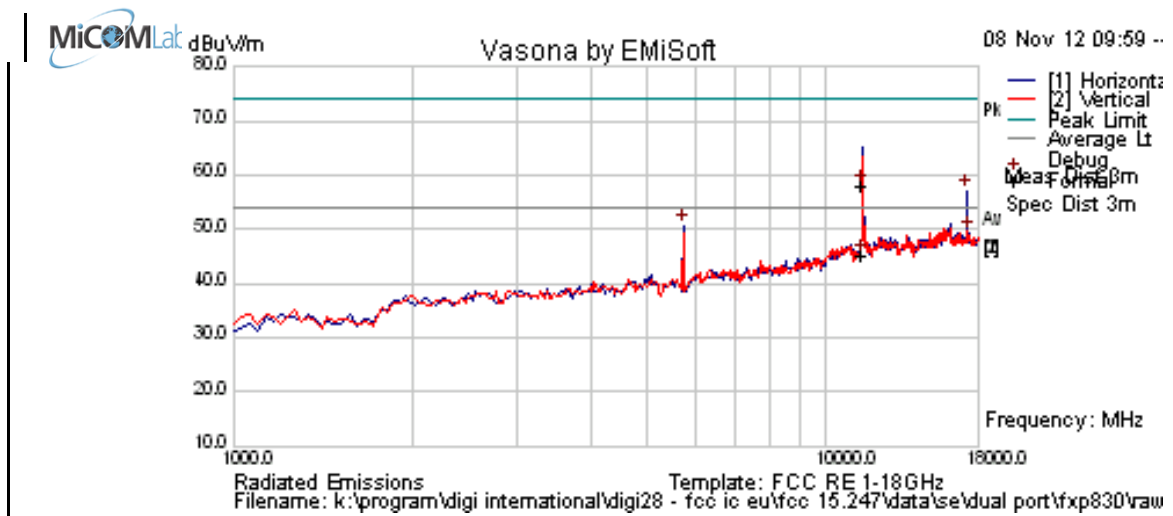

Formally measured emission peaks

Frequency MHz	Raw dBuV	Cable Loss	AF dB	Level dBuV/m	Measurement Type	Pol	Hgt cm	Azt Deg	Limit dBuV/m	Margin dB	Pass /Fail	Comments
5735.471	55.4	4.8	-9.5	50.6	Peak [Scan]	H						FUND
17386.774	39.3	8.7	1.4	49.4	Peak [Scan]	H	150	0	54	-4.6	Pass	NRB
11496.553	53.4	6.8	-2.0	58.2	Peak Max	H	98	98	74	-15.8	Pass	RB
11496.553	40.4	6.8	-2.0	45.3	Average Max	H	98	98	54	-8.8	Pass	RB
Legend: TX = Transmitter Emissions; DIG = Digital Emissions; FUND = Fundamental; WB = Wideband Emission RB = Restricted Band (15.209 Limits); NRB = Non Restricted Band, Limit is 20dB below fundamental peak												

This test report may be reproduced in full only. The document may only be updated by MiCOM Labs personnel. Any changes will be noted in the Document History section of the report.



Title: Digi Connect Card for i.MX28 with Atheros AR6203
To: FCC 47 CFR Part 15.247 & IC RSS-210
Serial #: DIGI36-U2 Rev A
Issue Date: 22nd May 2014
Page: 100 of 261

Band Edge

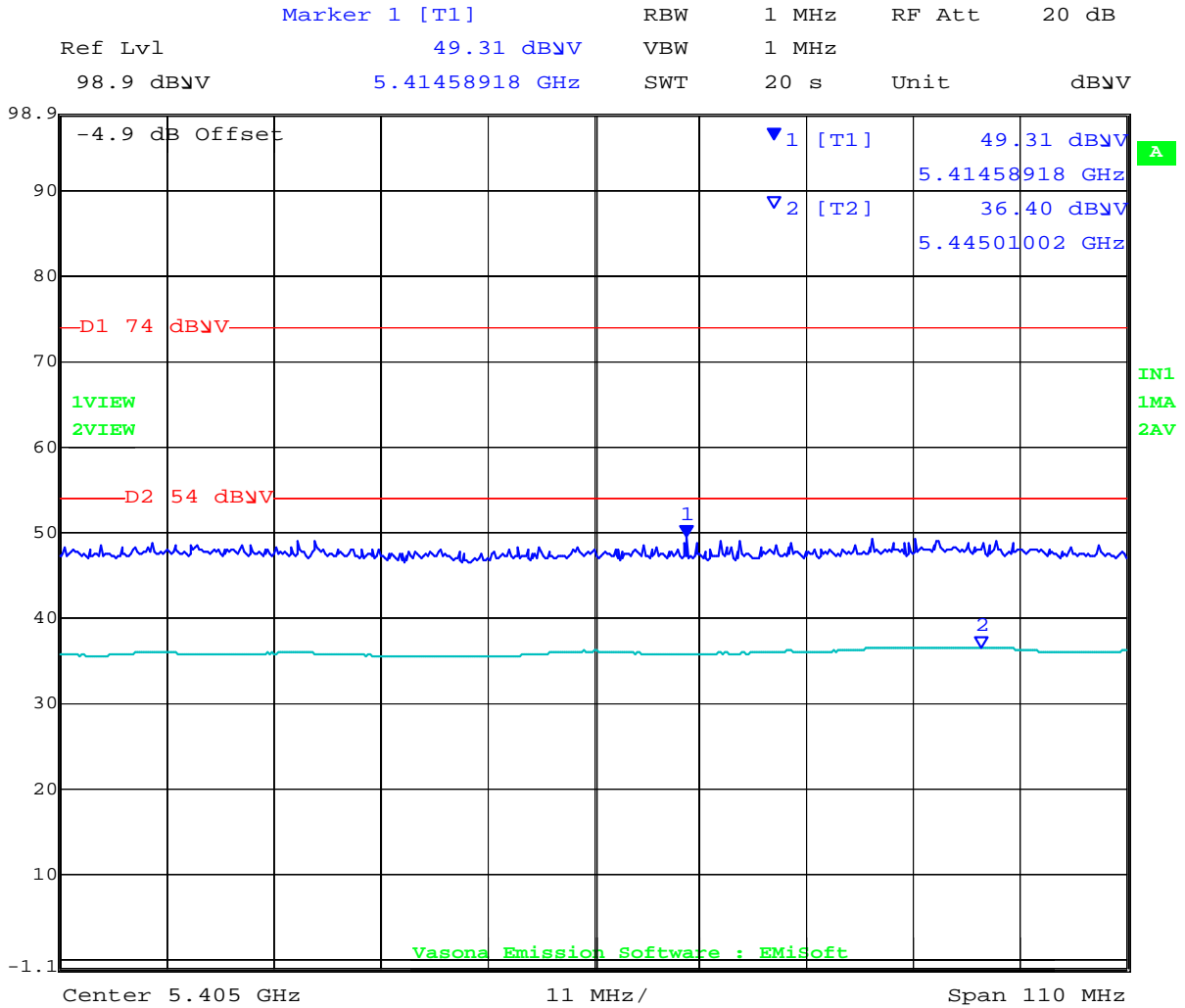

Date: 8.NOV.2012 12:13:25

This test report may be reproduced in full only. The document may only be updated by MiCOM Labs personnel. Any changes will be noted in the Document History section of the report.



Title: Digi Connect Card for i.MX28 with Atheros AR6203
To: FCC 47 CFR Part 15.247 & IC RSS-210
Serial #: DIGI36-U2 Rev A
Issue Date: 22nd May 2014
Page: 101 of 261

Band Edge 802.11n HT20 5745 MHz

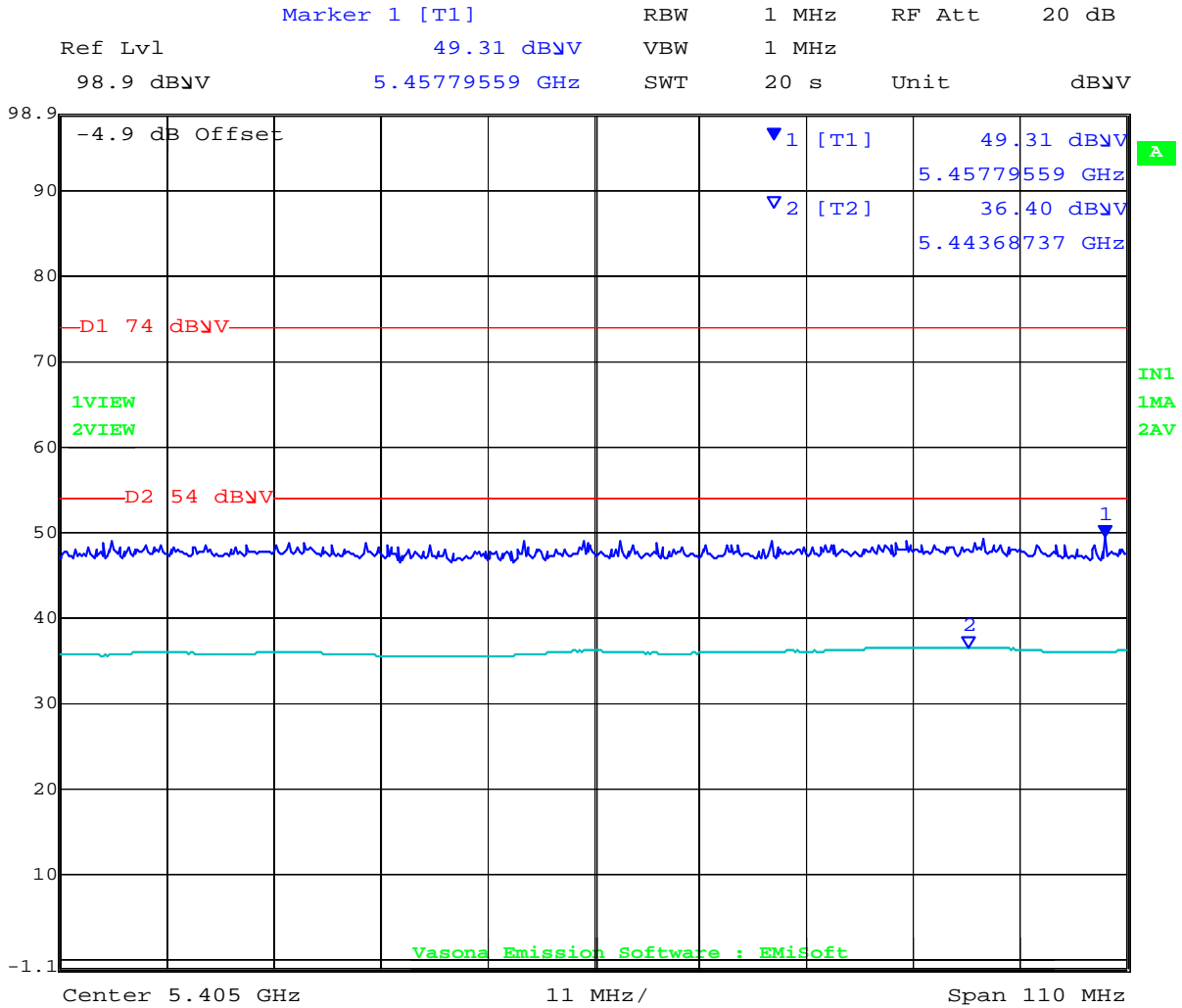

Date: 8.NOV.2012 12:12:19

This test report may be reproduced in full only. The document may only be updated by MiCOM Labs personnel. Any changes will be noted in the Document History section of the report.



Title: Digi Connect Card for i.MX28 with Atheros AR6203
To: FCC 47 CFR Part 15.247 & IC RSS-210
Serial #: DIGI36-U2 Rev A
Issue Date: 22nd May 2014
Page: 102 of 261

Band Edge 802.11n HT40 5755 MHz

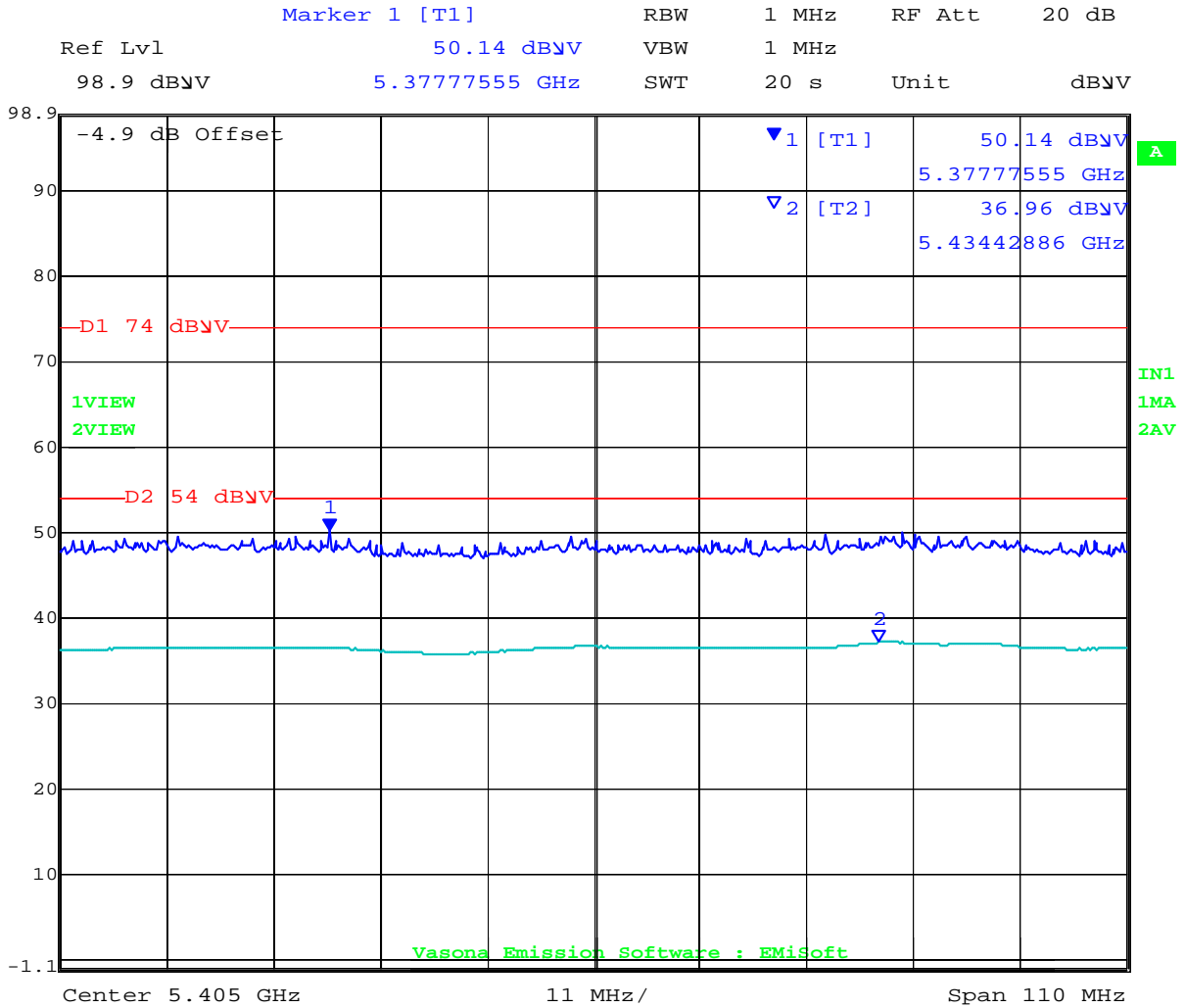

Date: 8.NOV.2012 12:15:15

This test report may be reproduced in full only. The document may only be updated by MiCOM Labs personnel. Any changes will be noted in the Document History section of the report.



Title: Digi Connect Card for i.MX28 with Atheros AR6203
To: FCC 47 CFR Part 15.247 & IC RSS-210
Serial #: DIGI36-U2 Rev A
Issue Date: 22nd May 2014
Page: 103 of 261

6.1.2.3. Dual Band Omni ANT-DB1-xxx – Dual Port Module

Test Freq.	2412 MHz	Engineer	JMH
Variant	802.11b; 1 Mbs	Temp (°C)	24
Freq. Range	1000 MHz - 18000 MHz	Rel. Hum.(%)	35
Power Setting	20	Press. (mBars)	1008
Antenna	5 dBi Monopole	Duty Cycle (%)	100
Test Notes 1	Dual Port Radio		
Test Notes 2			

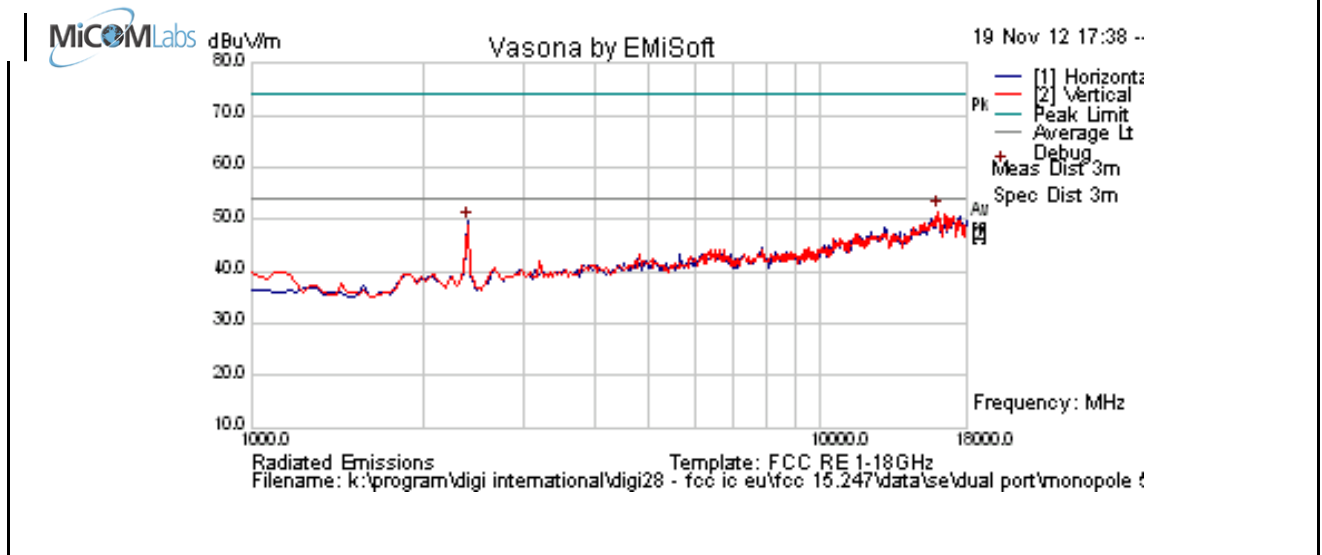

Formally measured emission peaks

Frequency MHz	Raw dBuV	Cable Loss	AF dB	Level dBuV/m	Measurement Type	Pol	Hgt cm	Azt Deg	Limit dBuV/m	Margin dB	Pass /Fail	Comments
16024.048	42.3	9.0	0.2	51.6	Peak [Scan]	V	150	0	54.0	-2.5	Pass	Noise
2396.79359	58.2	3.0	-11.7	49.5	Peak [Scan]	H						FUND

Legend: TX = Transmitter Emissions; DIG = Digital Emissions; FUND = Fundamental; WB = Wideband Emission
 RB = Restricted Band (15.209 Limits); NRB = Non Restricted Band, Limit is 20dB below fundamental peak

This test report may be reproduced in full only. The document may only be updated by MiCOM Labs personnel. Any changes will be noted in the Document History section of the report.



Band Edge

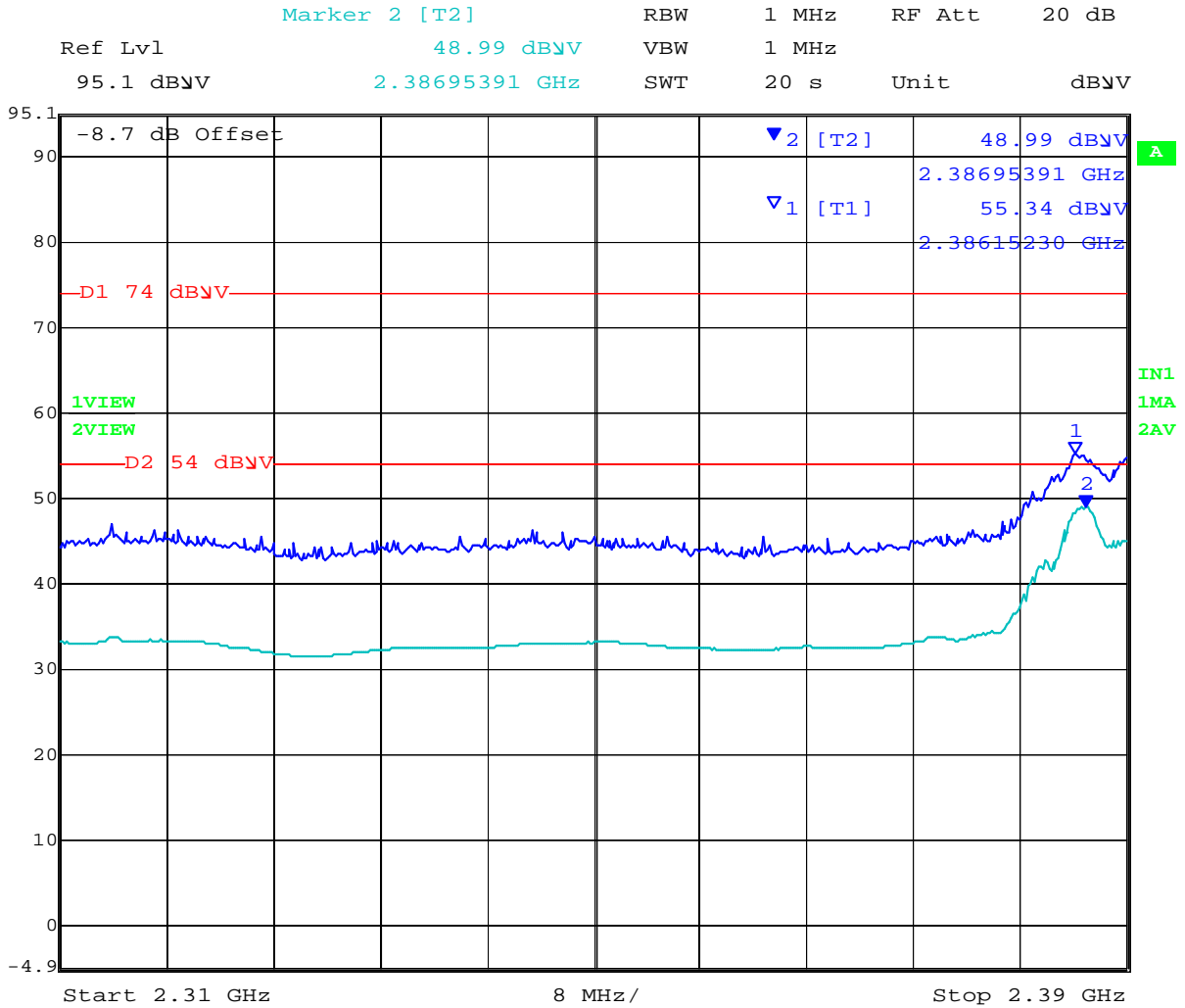

Date: 19.NOV.2012 19:53:30

This test report may be reproduced in full only. The document may only be updated by MiCOM Labs personnel. Any changes will be noted in the Document History section of the report.



Title: Digi Connect Card for i.MX28 with Atheros AR6203
To: FCC 47 CFR Part 15.247 & IC RSS-210
Serial #: DIGI36-U2 Rev A
Issue Date: 22nd May 2014
Page: 105 of 261

Test Freq.	2437 MHz	Engineer	JMH
Variant	802.11b; 1 Mbs	Temp (°C)	24
Freq. Range	1000 MHz - 18000 MHz	Rel. Hum.(%)	35
Power Setting	20	Press. (mBars)	1008
Antenna	5 dBi Monopole	Duty Cycle (%)	100
Test Notes 1	Dual Port Radio		
Test Notes 2			

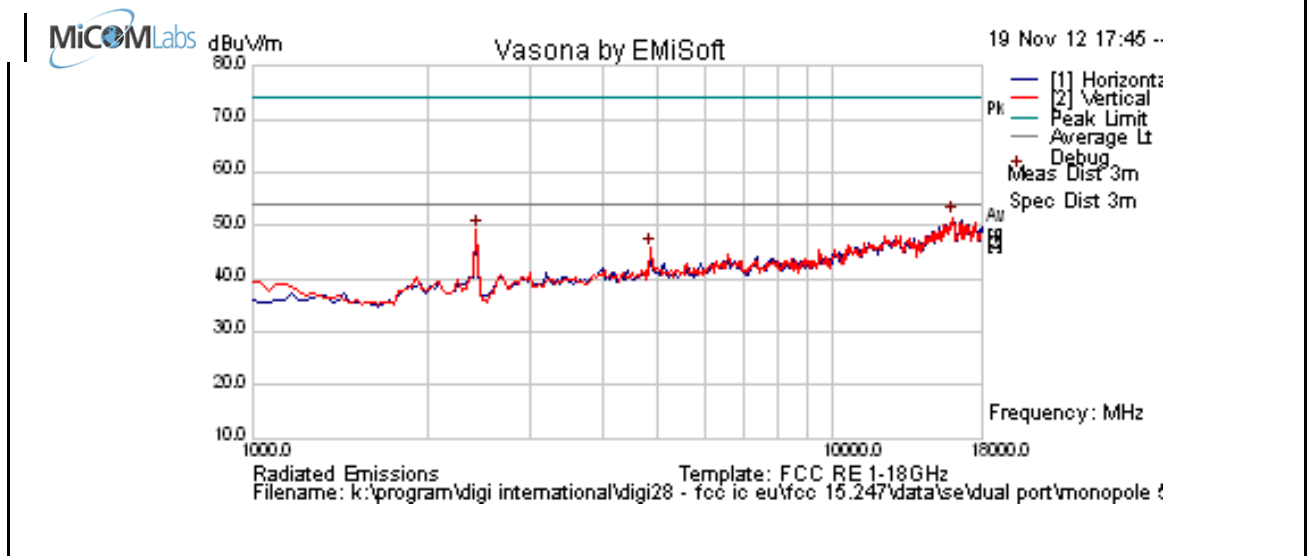

Formally measured emission peaks

Frequency MHz	Raw dBuV	Cable Loss	AF dB	Level dBuV/m	Measurement Type	Pol	Hgt cm	Azt Deg	Limit dBuV/m	Margin dB	Pass /Fail	Comments
16058.116	42.2	9.0	0.3	51.5	Peak [Scan]	V	150	0	54.0	-2.5	Pass	Noise
2430.86172	57.7	3.0	-11.6	49.2	Peak [Scan]	V						FUND
4849.094	51.0	4.5	-9.7	45.8	Peak [Scan]	V	98	360	54	-8.2	Pass	RB
Legend: TX = Transmitter Emissions; DIG = Digital Emissions; FUND = Fundamental; WB = Wideband Emission RB = Restricted Band (15.209 Limits); NRB = Non Restricted Band, Limit is 20dB below fundamental peak												

This test report may be reproduced in full only. The document may only be updated by MiCOM Labs personnel. Any changes will be noted in the Document History section of the report.



Title: Digi Connect Card for i.MX28 with Atheros AR6203
To: FCC 47 CFR Part 15.247 & IC RSS-210
Serial #: DIGI36-U2 Rev A
Issue Date: 22nd May 2014
Page: 106 of 261

Test Freq.	2462 MHz	Engineer	JMH
Variant	802.11b; 1 Mbs	Temp (°C)	24
Freq. Range	1000 MHz - 18000 MHz	Rel. Hum.(%)	35
Power Setting	20	Press. (mBars)	1008
Antenna	5 dBi Monopole	Duty Cycle (%)	100
Test Notes 1	Dual Port Radio		
Test Notes 2			

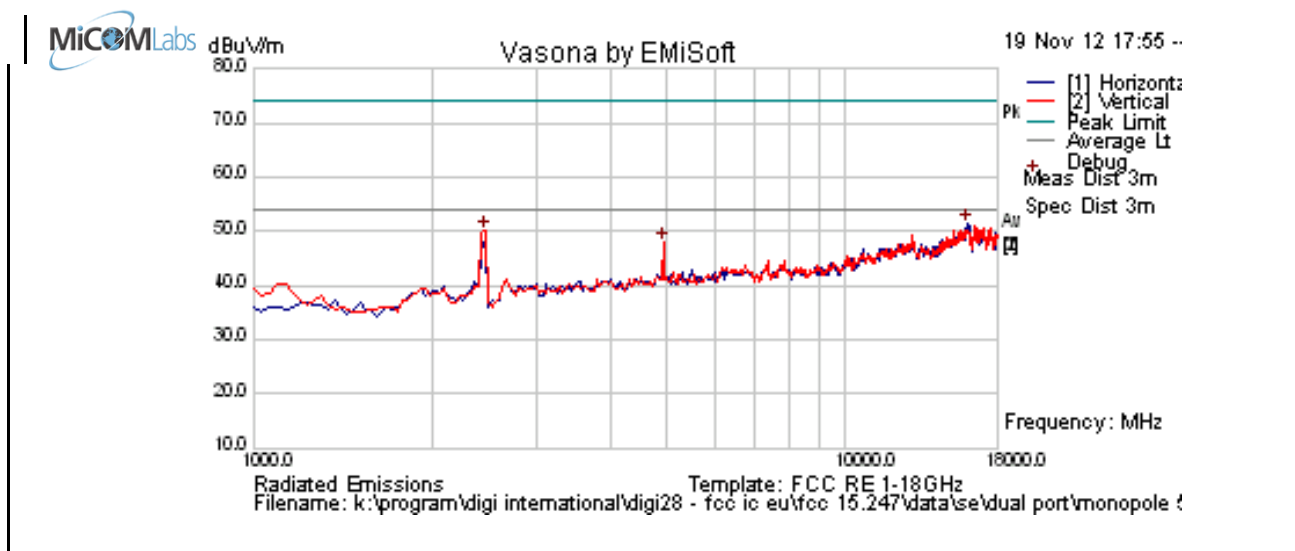

Formally measured emission peaks

Frequency MHz	Raw dBuV	Cable Loss	AF dB	Level dBuV/m	Measurement Type	Pol	Hgt cm	Azt Deg	Limit dBuV/m	Margin dB	Pass /Fail	Comments
16058.116	42.0	9.0	0.3	51.3	Peak [Scan]	H	150	0	54.0	-2.7	Pass	Noise
2464.92986	58.7	3.0	-11.5	50.2	Peak [Scan]	V						FUND
4917.520	53.0	4.6	-9.8	47.8	Peak [Scan]	V	98	360	54	-6.2	Pass	RB

Legend: TX = Transmitter Emissions; DIG = Digital Emissions; FUND = Fundamental; WB = Wideband Emission
 RB = Restricted Band (15.209 Limits); NRB = Non Restricted Band, Limit is 20dB below fundamental peak

This test report may be reproduced in full only. The document may only be updated by MiCOM Labs personnel. Any changes will be noted in the Document History section of the report.



Band Edge

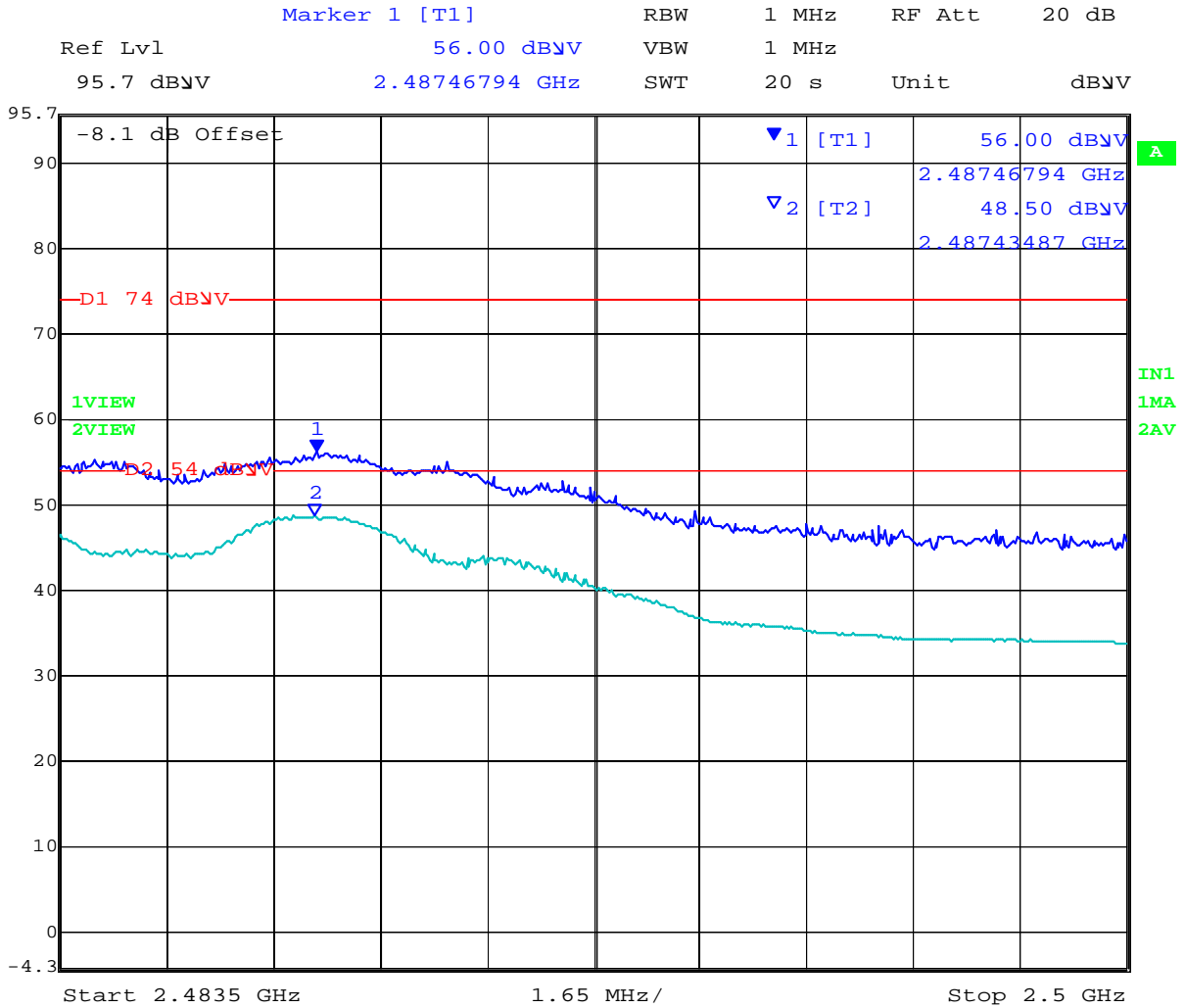

Date: 19.NOV.2012 18:53:57

Power reduction required in order to bring unit into compliance Power = 19

This test report may be reproduced in full only. The document may only be updated by MiCOM Labs personnel. Any changes will be noted in the Document History section of the report.



Title: Digi Connect Card for i.MX28 with Atheros AR6203
To: FCC 47 CFR Part 15.247 & IC RSS-210
Serial #: DIGI36-U2 Rev A
Issue Date: 22nd May 2014
Page: 108 of 261

Test Freq.	2412 MHz	Engineer	JMH
Variant	802.11g; 6 Mbs	Temp (°C)	24
Freq. Range	1000 MHz - 18000 MHz	Rel. Hum.(%)	35
Power Setting	20	Press. (mBars)	1008
Antenna	5 dBi Monopole	Duty Cycle (%)	100
Test Notes 1	Dual Port Radio Card		
Test Notes 2			

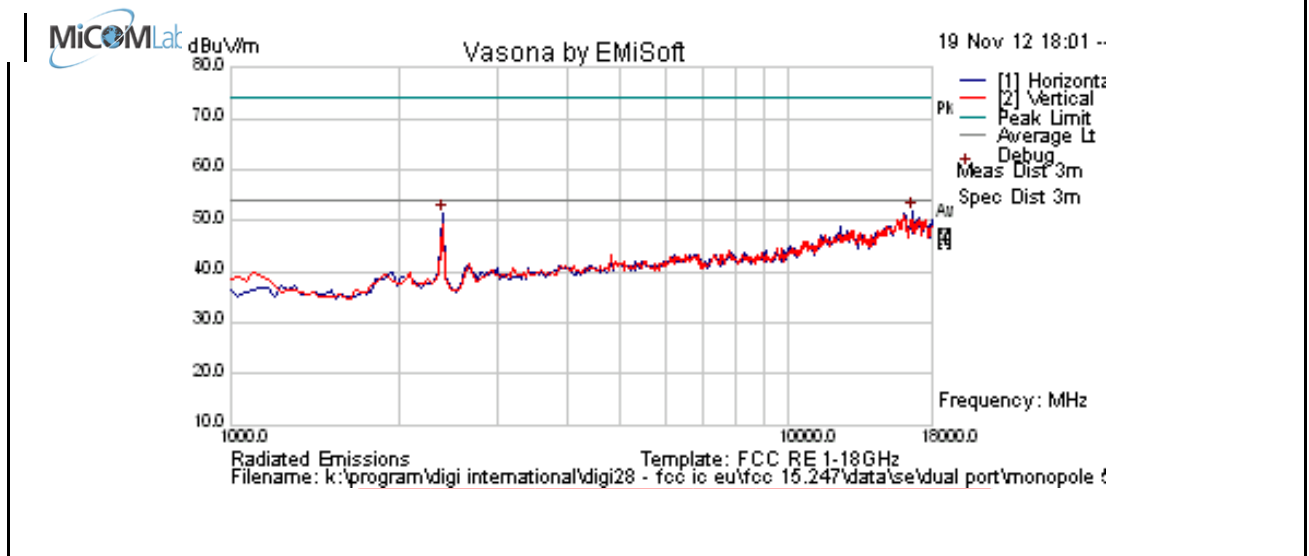

Formally measured emission peaks

Frequency MHz	Raw dBuV	Cable Loss	AF dB	Level dBuV/m	Measurement Type	Pol	Hgt cm	Azt Deg	Limit dBuV/m	Margin dB	Pass /Fail	Comments
16603.206	42.3	8.8	0.6	51.6	Peak [Scan]	H	100	0	54.0	-2.4	Pass	Noise
2396.79359	59.9	3.0	-11.7	51.2	Peak [Scan]	H						FUND

Legend: TX = Transmitter Emissions; DIG = Digital Emissions; FUND = Fundamental; WB = Wideband Emission
 RB = Restricted Band (15.209 Limits); NRB = Non Restricted Band, Limit is 20dB below fundamental peak

This test report may be reproduced in full only. The document may only be updated by MiCOM Labs personnel. Any changes will be noted in the Document History section of the report.



Band Edge

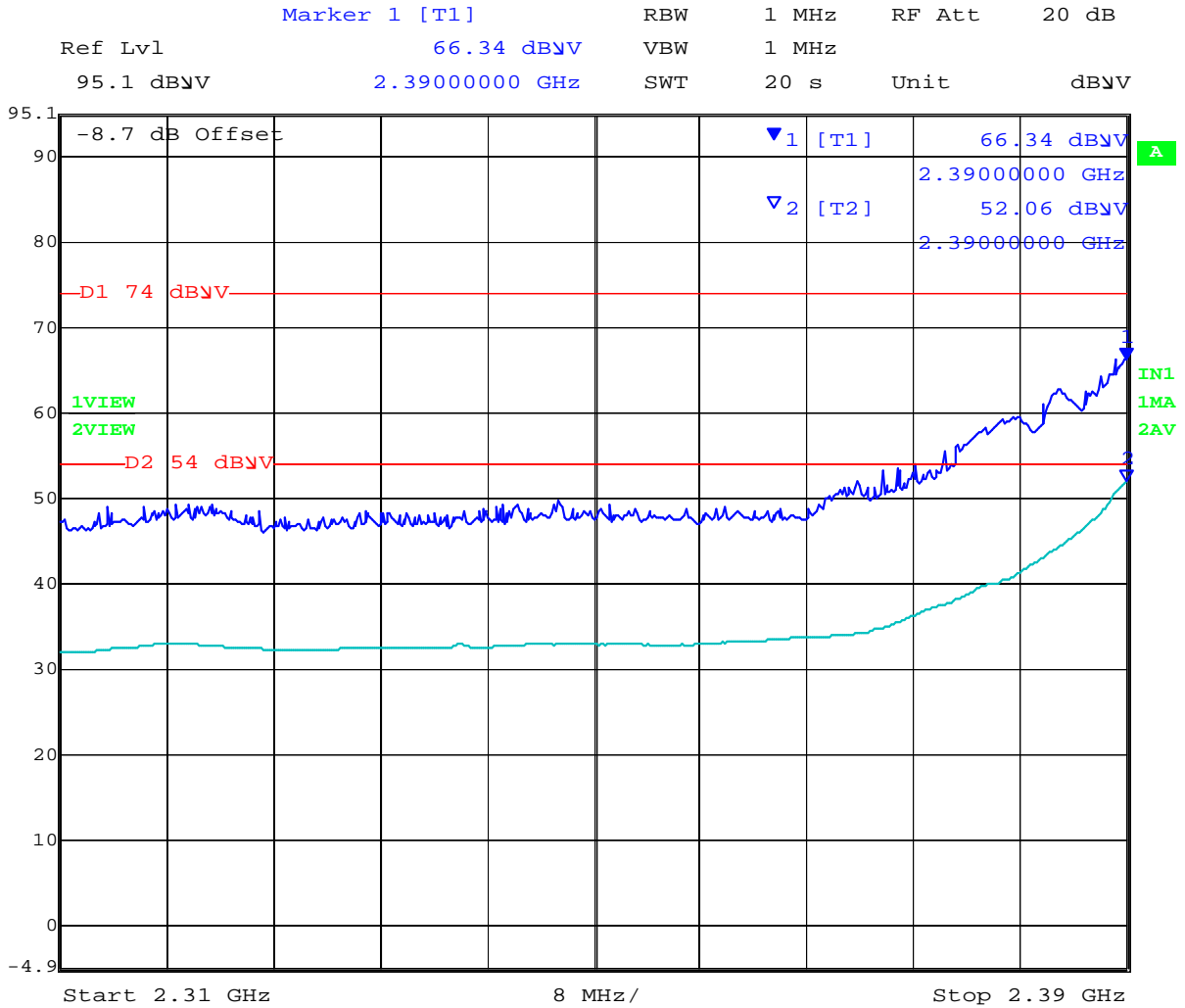

Date: 19.NOV.2012 19:47:34

Power reduction required in order to bring unit into compliance Power = 15



Title: Digi Connect Card for i.MX28 with Atheros AR6203
To: FCC 47 CFR Part 15.247 & IC RSS-210
Serial #: DIGI36-U2 Rev A
Issue Date: 22nd May 2014
Page: 110 of 261

Test Freq.	2437 MHz	Engineer	JMH
Variant	802.11g; 6 Mbs	Temp (°C)	24
Freq. Range	1000 MHz - 18000 MHz	Rel. Hum.(%)	35
Power Setting	20	Press. (mBars)	1008
Antenna	5 dBi Monopole	Duty Cycle (%)	100
Test Notes 1	Dual Port Radio Card		
Test Notes 2			

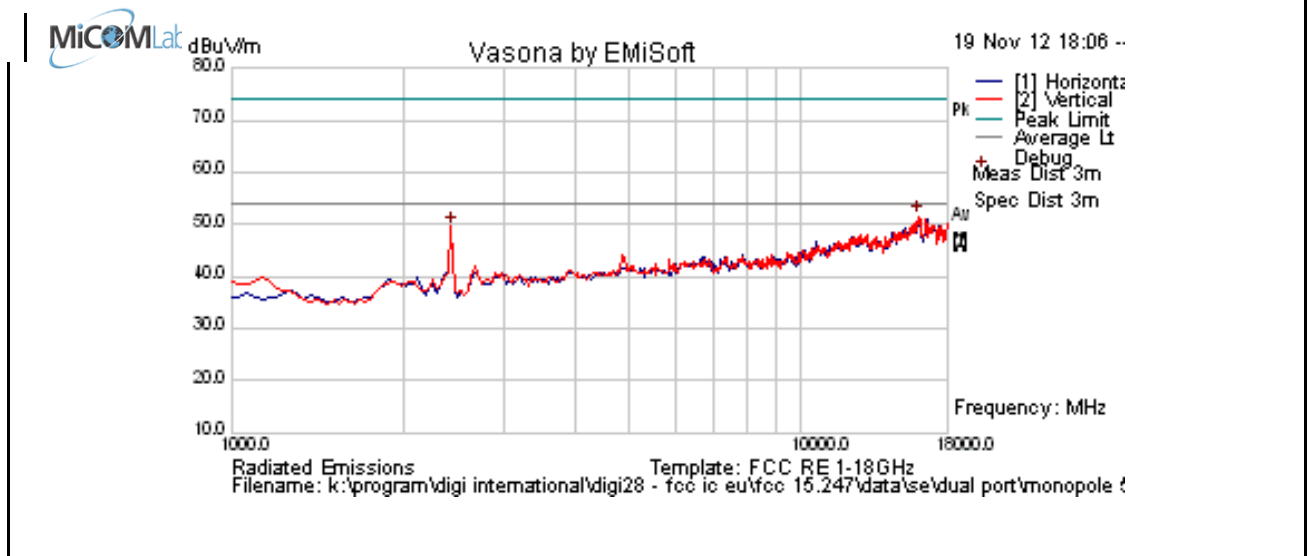

Formally measured emission peaks

Frequency MHz	Raw dBuV	Cable Loss	AF dB	Level dBuV/m	Measurement Type	Pol	Hgt cm	Azt Deg	Limit dBuV/m	Margin dB	Pass /Fail	Comments
15989.980	42.3	9.0	0.1	51.5	Peak [Scan]	V	100	0	54.0	-2.6	Pass	Noise
2430.86172	58.2	3.0	-11.6	49.6	Peak [Scan]	V						FUND

Legend:	TX = Transmitter Emissions; DIG = Digital Emissions; FUND = Fundamental; WB = Wideband Emission
	RB = Restricted Band (15.209 Limits); NRB = Non Restricted Band, Limit is 20dB below fundamental peak

This test report may be reproduced in full only. The document may only be updated by MiCOM Labs personnel. Any changes will be noted in the Document History section of the report.



Title: Digi Connect Card for i.MX28 with Atheros AR6203
To: FCC 47 CFR Part 15.247 & IC RSS-210
Serial #: DIGI36-U2 Rev A
Issue Date: 22nd May 2014
Page: 111 of 261

Test Freq.	2462 MHz	Engineer	JMH
Variant	802.11g; 6 Mbs	Temp (°C)	24
Freq. Range	1000 MHz - 18000 MHz	Rel. Hum.(%)	35
Power Setting	20	Press. (mBars)	1008
Antenna	5 dBi Monopole	Duty Cycle (%)	100
Test Notes 1	Dual Port Radio Card		
Test Notes 2			

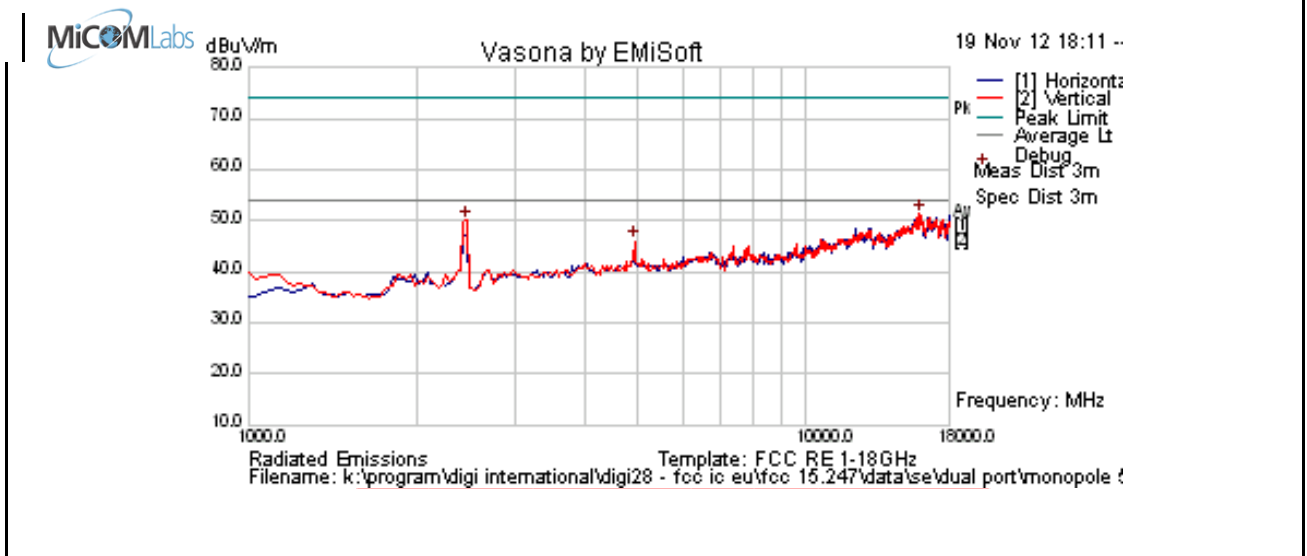

Formally measured emission peaks

Frequency MHz	Raw dBuV	Cable Loss	AF dB	Level dBuV/m	Measurement Type	Pol	Hgt cm	Azt Deg	Limit dBuV/m	Margin dB	Pass /Fail	Comments
15955.912	42.4	9.0	0.0	51.4	Peak [Scan]	V	150	0	54.0	-2.7	Pass	NOISE
2464.92986	58.5	3.0	-11.5	50.0	Peak [Scan]	V						FUND
4918.228	51.2	4.6	-9.8	46.0	Peak [Scan]	V	98	360	54	-8.0	Pass	RB

Legend: TX = Transmitter Emissions; DIG = Digital Emissions; FUND = Fundamental; WB = Wideband Emission
 RB = Restricted Band (15.209 Limits); NRB = Non Restricted Band, Limit is 20dB below fundamental peak

This test report may be reproduced in full only. The document may only be updated by MiCOM Labs personnel. Any changes will be noted in the Document History section of the report.



Band Edge

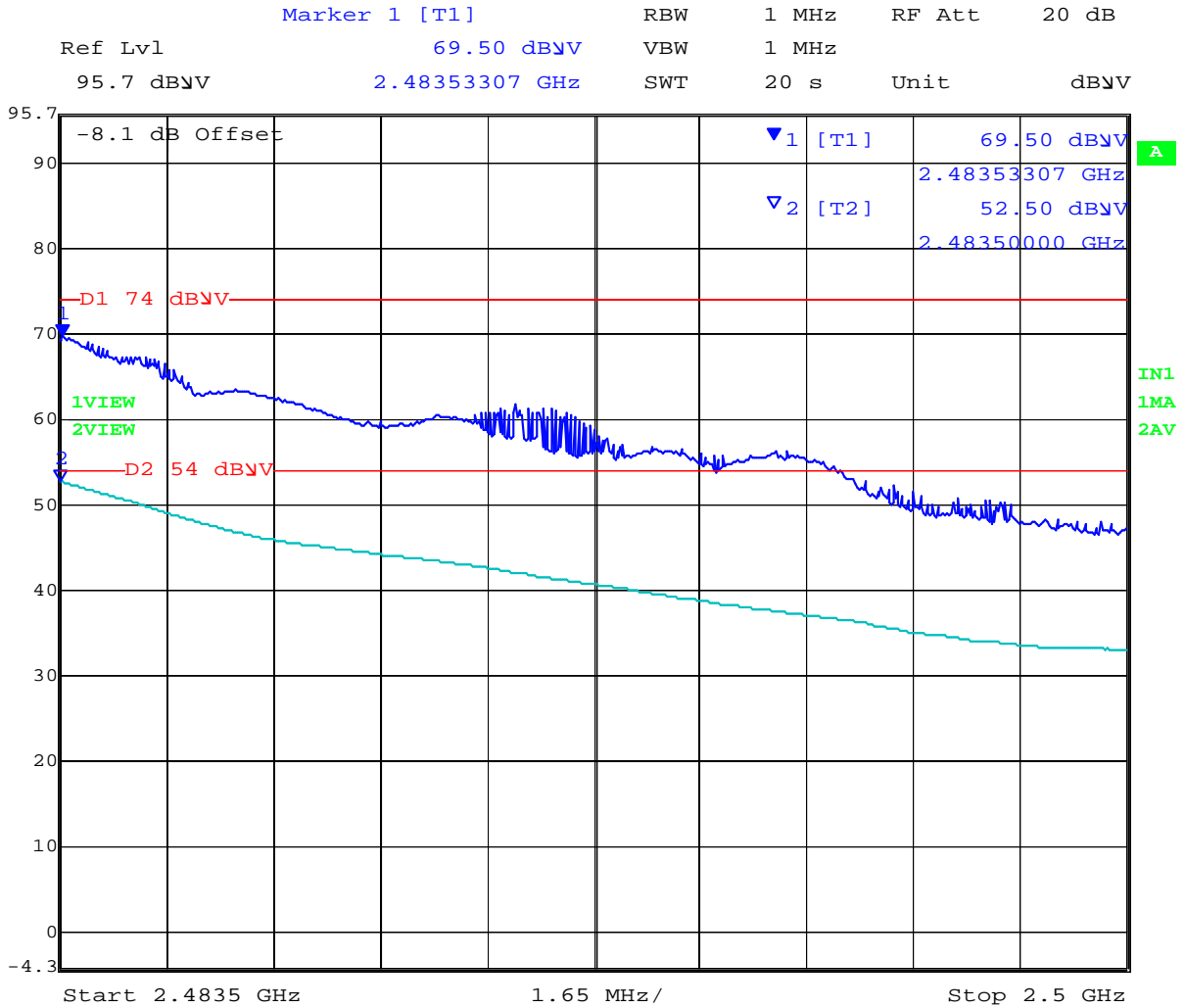

Date: 19.NOV.2012 18:41:52

Power reduction required in order to bring unit into compliance Power = 14



Band Edge 802.11n HT20 2412 MHz

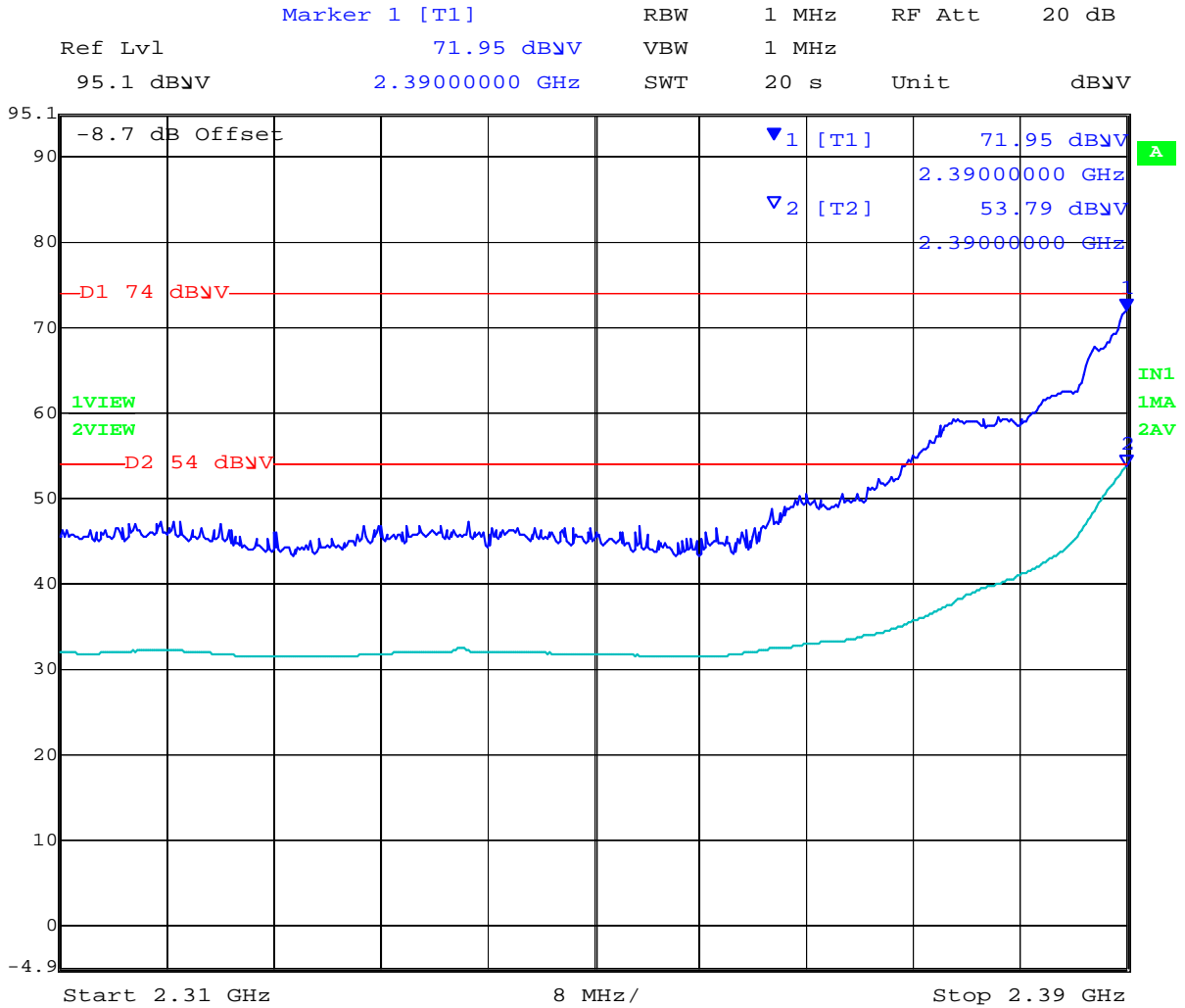

Date: 19.NOV.2012 19:40:38

Power reduction required in order to bring unit into compliance Power = 14



Band Edge 802.11n HT20 2462 MHz

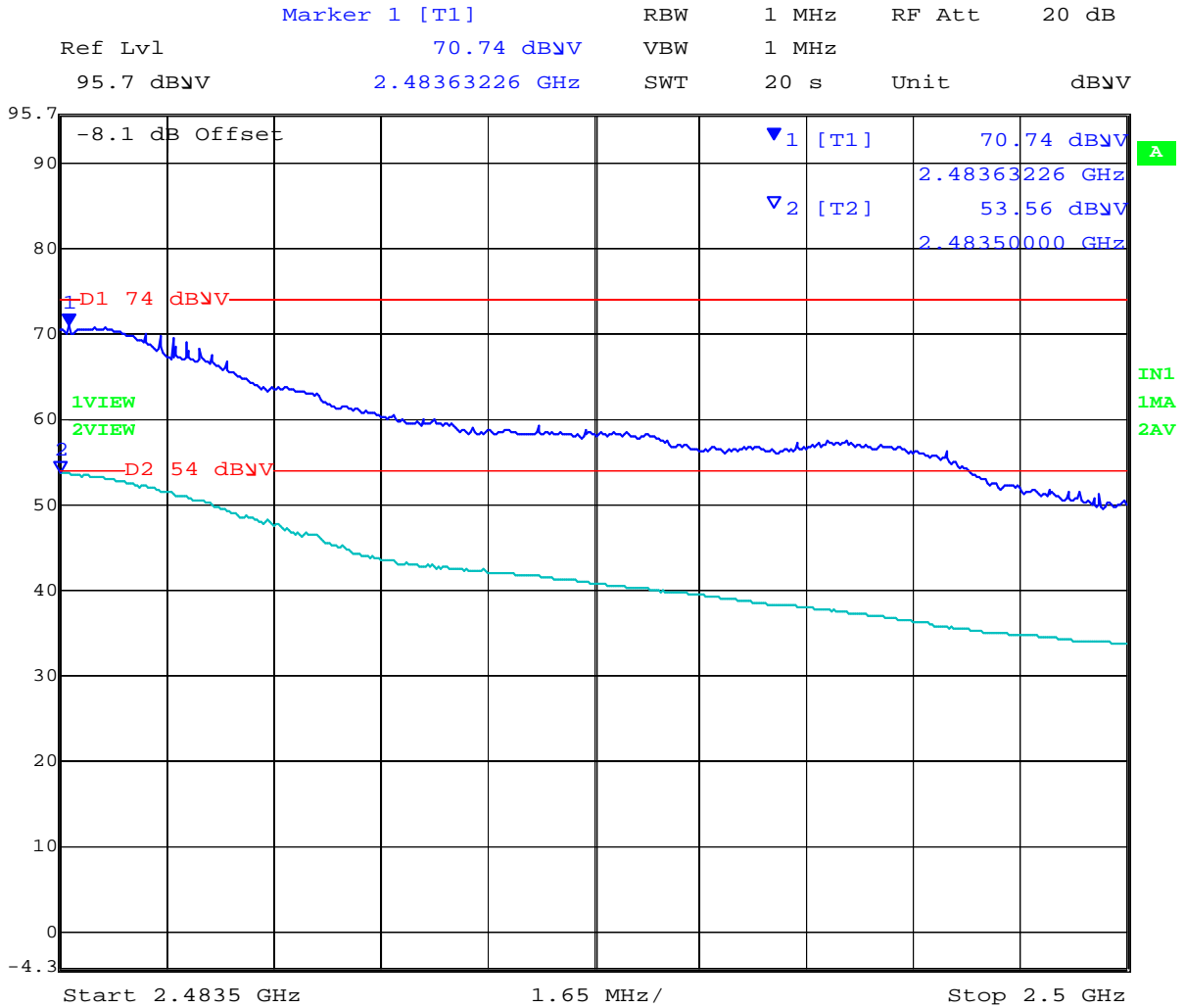

Date: 19.NOV.2012 19:04:21

Power reduction required in order to bring unit into compliance Power = 13



Title: Digi Connect Card for i.MX28 with Atheros AR6203
To: FCC 47 CFR Part 15.247 & IC RSS-210
Serial #: DIGI36-U2 Rev A
Issue Date: 22nd May 2014
Page: 115 of 261

Band Edge 802.11n HT40 2422 MHz

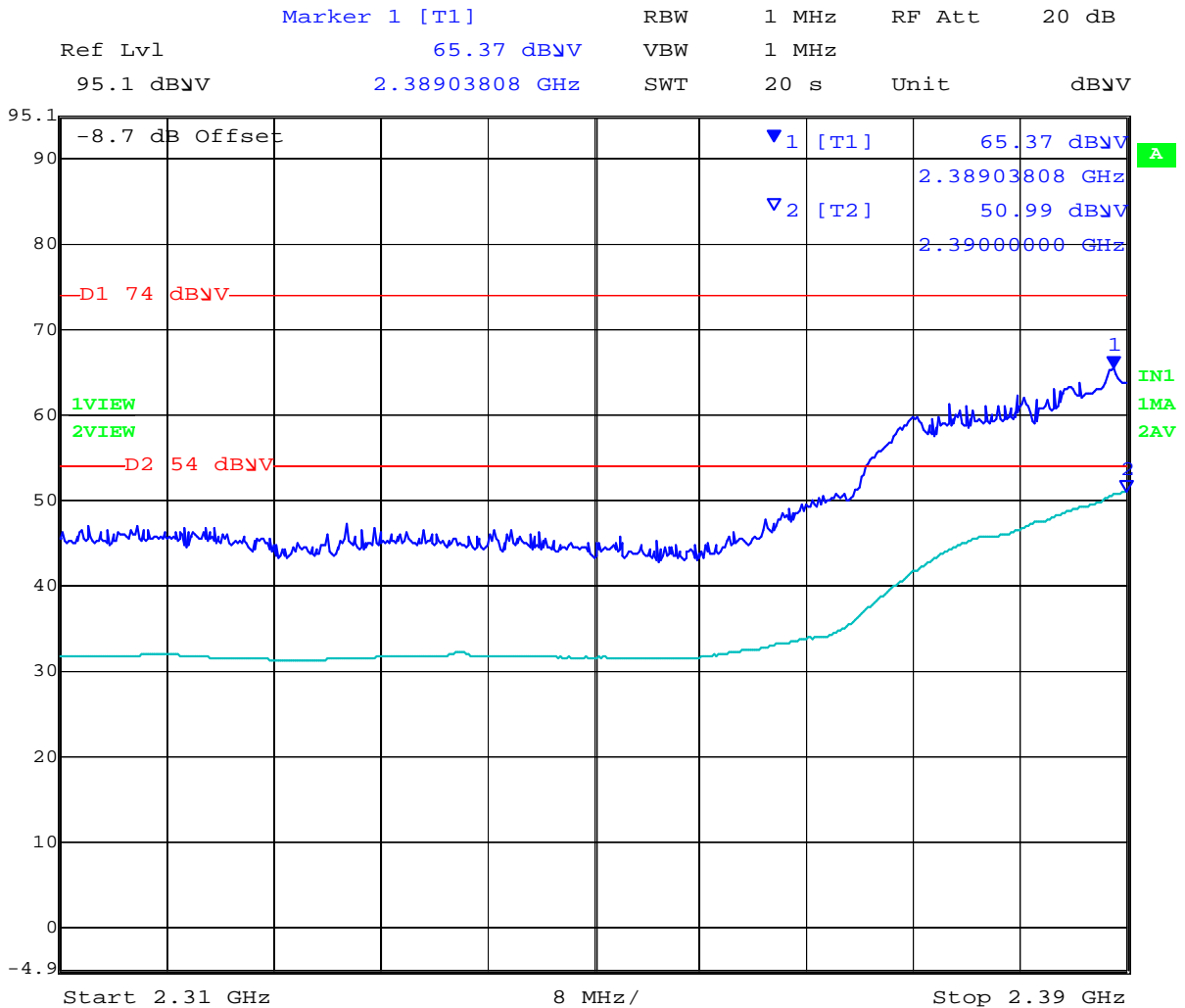

Date: 19.NOV.2012 19:32:40

Power reduction required in order to bring unit into compliance Power = 10

This test report may be reproduced in full only. The document may only be updated by MiCOM Labs personnel. Any changes will be noted in the Document History section of the report.



Title: Digi Connect Card for i.MX28 with Atheros AR6203
To: FCC 47 CFR Part 15.247 & IC RSS-210
Serial #: DIGI36-U2 Rev A
Issue Date: 22nd May 2014
Page: 116 of 261

Band Edge 802.11n HT40 2452 MHz

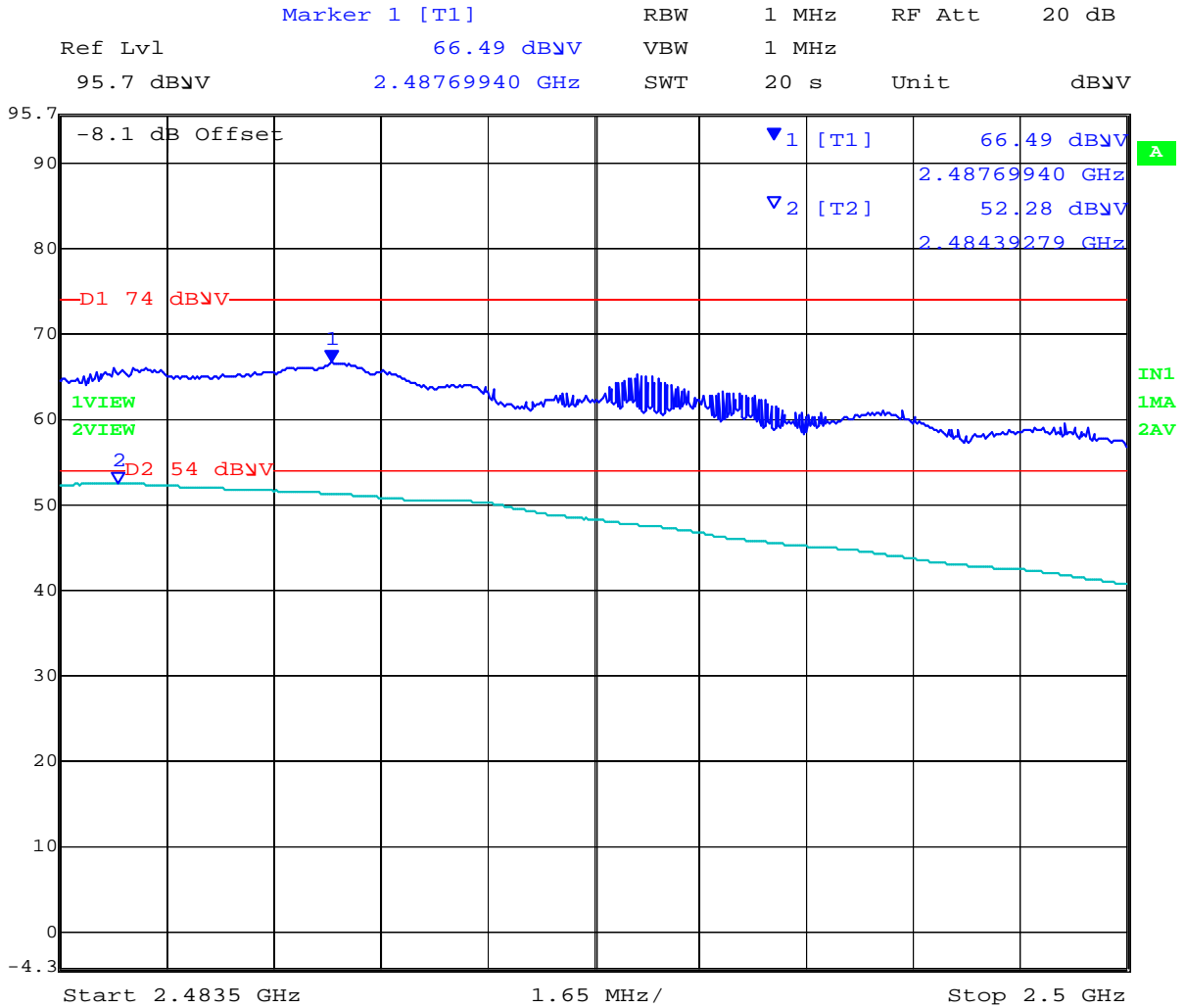

Date: 19.NOV.2012 19:15:12

Power reduction required in order to bring unit into compliance Power = 9

This test report may be reproduced in full only. The document may only be updated by MiCOM Labs personnel. Any changes will be noted in the Document History section of the report.



Title: Digi Connect Card for i.MX28 with Atheros AR6203
To: FCC 47 CFR Part 15.247 & IC RSS-210
Serial #: DIGI36-U2 Rev A
Issue Date: 22nd May 2014
Page: 117 of 261

Test Freq.	5745 MHz	Engineer	JMH
Variant	802.11a; 6.5 Mbs	Temp (°C)	24
Freq. Range	1000 MHz - 18000 MHz	Rel. Hum.(%)	39
Power Setting	13 Power Reduced	Press. (mBars)	1003
Antenna	Monopole 5 dBi	Duty Cycle (%)	100
Test Notes 1	Dual Port Radio Card		
Test Notes 2			

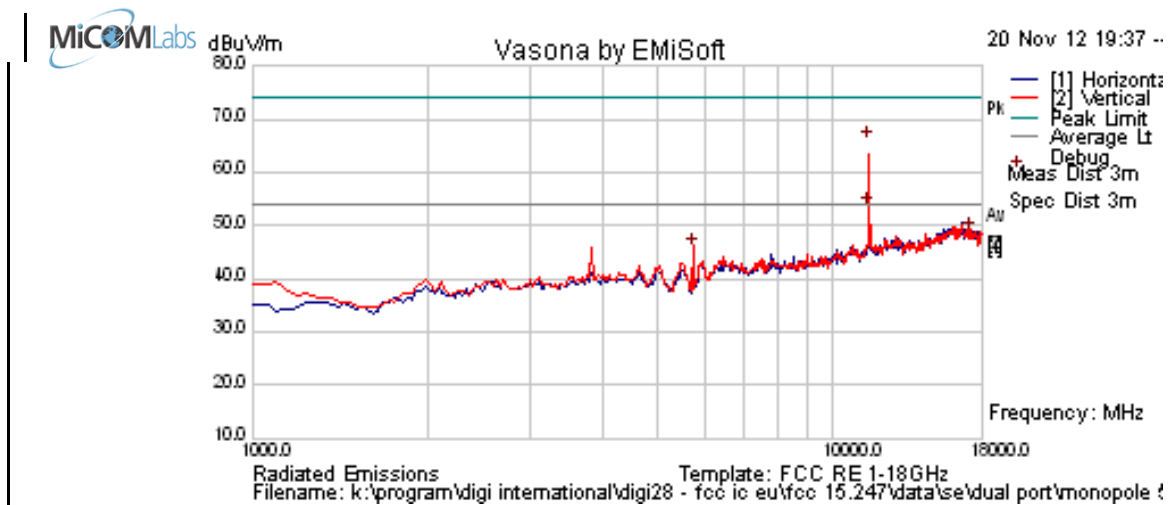

Formally measured emission peaks

Frequency MHz	Raw dBuV	Cable Loss	AF dB	Level dBuV/m	Measurement Type	Pol	Hgt cm	Azt Deg	Limit dBuV/m	Margin dB	Pass /Fail	Comments
5735.471	50.4	4.8	-9.5	45.6	Peak [Scan]	V						FUND
11496.057	48.5	6.8	-2.0	53.4	Average	V	98	30	54.0	-0.7	Pass	RB
11496.057	61.0	6.8	-2.0	65.8	Peak.	V	98	30	74	-8.2	Pass	RB
17250.501	38.9	8.6	1.0	48.5	Peak [Scan]	H	100	0	54	-5.5	Pass	Noise

Legend: TX = Transmitter Emissions; DIG = Digital Emissions; FUND = Fundamental; WB = Wideband Emission
 RB = Restricted Band (15.209 Limits); NRB = Non Restricted Band, Limit is 20dB below fundamental peak

This test report may be reproduced in full only. The document may only be updated by MiCOM Labs personnel. Any changes will be noted in the Document History section of the report.



Band Edge

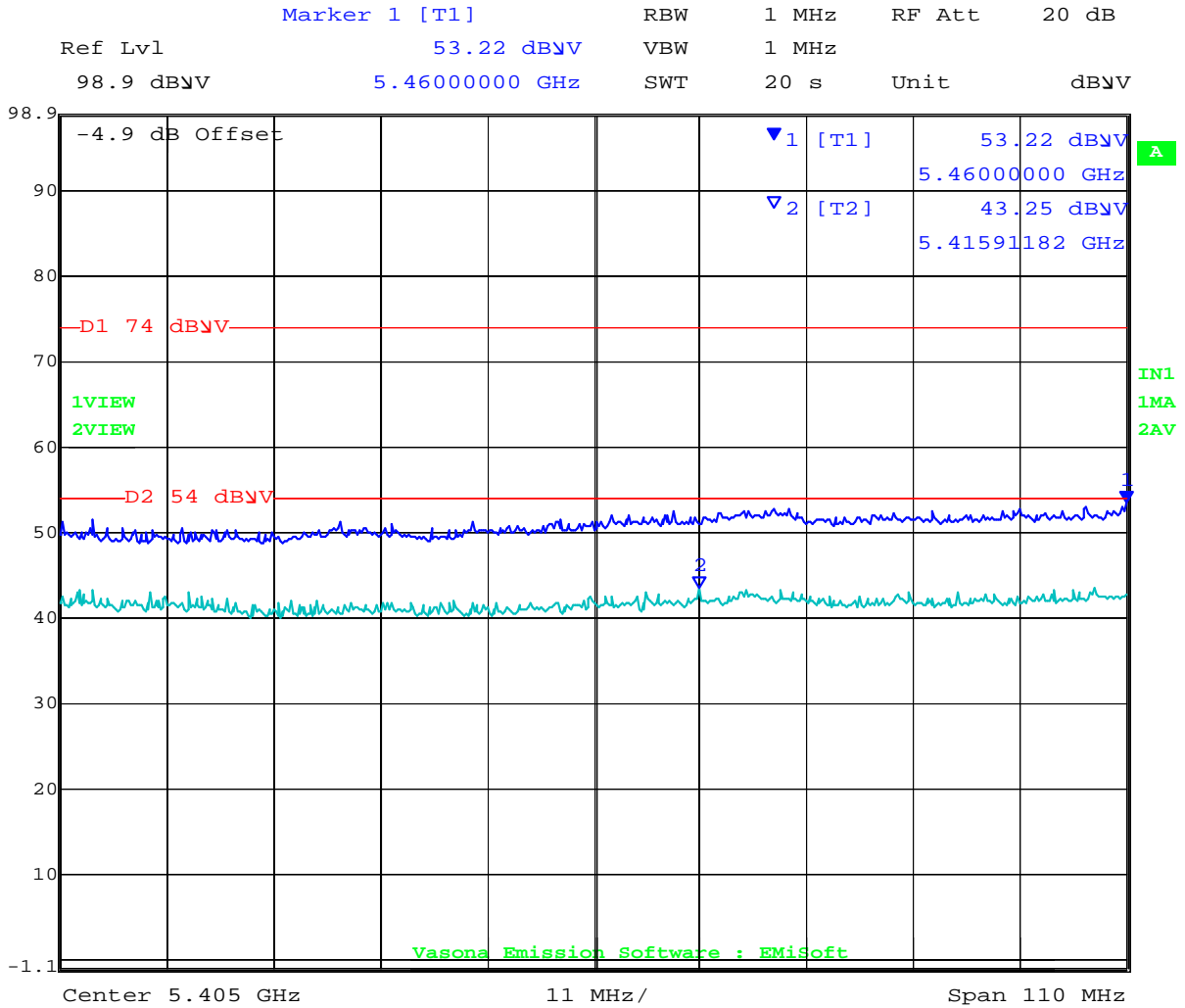

Date: 20.NOV.2012 18:50:29

This test report may be reproduced in full only. The document may only be updated by MiCOM Labs personnel. Any changes will be noted in the Document History section of the report.



Title: Digi Connect Card for i.MX28 with Atheros AR6203
To: FCC 47 CFR Part 15.247 & IC RSS-210
Serial #: DIGI36-U2 Rev A
Issue Date: 22nd May 2014
Page: 119 of 261

Test Freq.	5785 MHz	Engineer	JMH
Variant	802.11a; 6.5 Mbs	Temp (°C)	24
Freq. Range	1000 MHz - 18000 MHz	Rel. Hum.(%)	39
Power Setting	11 Pwr reduced	Press. (mBars)	1003
Antenna	Monopole 5 dBi	Duty Cycle (%)	100
Test Notes 1	Dual Port Radio Card		
Test Notes 2			

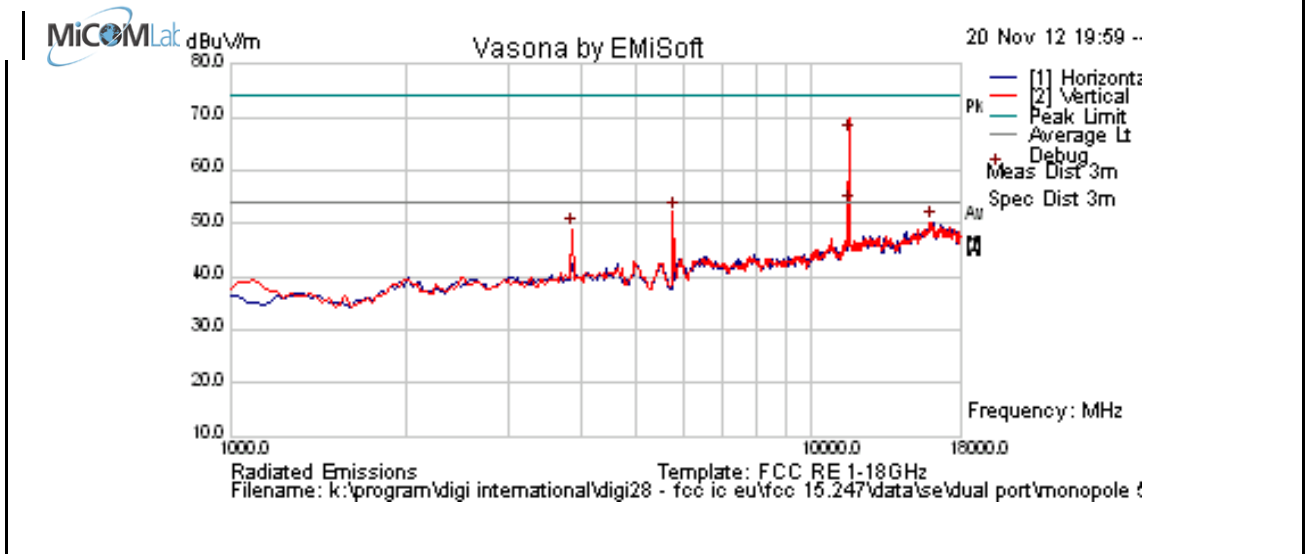

Formally measured emission peaks

Frequency MHz	Raw dBuV	Cable Loss	AF dB	Level dBuV/m	Measurement Type	Pol	Hgt cm	Azt Deg	Limit dBuV/m	Margin dB	Pass /Fail	Comments
5769.539	56.8	4.8	-9.5	52.1	Peak [Scan]	V						FUND
16024.048	41.0	9.0	0.2	50.3	Peak [Scan]	H	100	0	54.0	-3.7	Pass	Noise
3861.723	55.9	3.8	-10.8	49.0	Peak [Scan]	V	100	0	54	-5.0	Pass	RB
11570.260	61.9	6.8	-2.0	66.7	Peak Max	V	98	18	74	-7.3	Pass	RB
11570.260	48.5	6.8	-2.0	53.3	Average Max	V	98	18	54	-0.7	Pass	RB
Legend: TX = Transmitter Emissions; DIG = Digital Emissions; FUND = Fundamental; WB = Wideband Emission RB = Restricted Band (15.209 Limits); NRB = Non Restricted Band, Limit is 20dB below fundamental peak												

This test report may be reproduced in full only. The document may only be updated by MiCOM Labs personnel. Any changes will be noted in the Document History section of the report.



Title: Digi Connect Card for i.MX28 with Atheros AR6203
To: FCC 47 CFR Part 15.247 & IC RSS-210
Serial #: DIGI36-U2 Rev A
Issue Date: 22nd May 2014
Page: 120 of 261

Test Freq.	5825 MHz	Engineer	JMH
Variant	802.11a; 6.5 Mbs	Temp (°C)	24
Freq. Range	1000 MHz - 18000 MHz	Rel. Hum.(%)	39
Power Setting	9 Pwr reduced	Press. (mBars)	1003
Antenna	Monopole 5 dBi	Duty Cycle (%)	100
Test Notes 1	Dual Port Radio Card		
Test Notes 2			

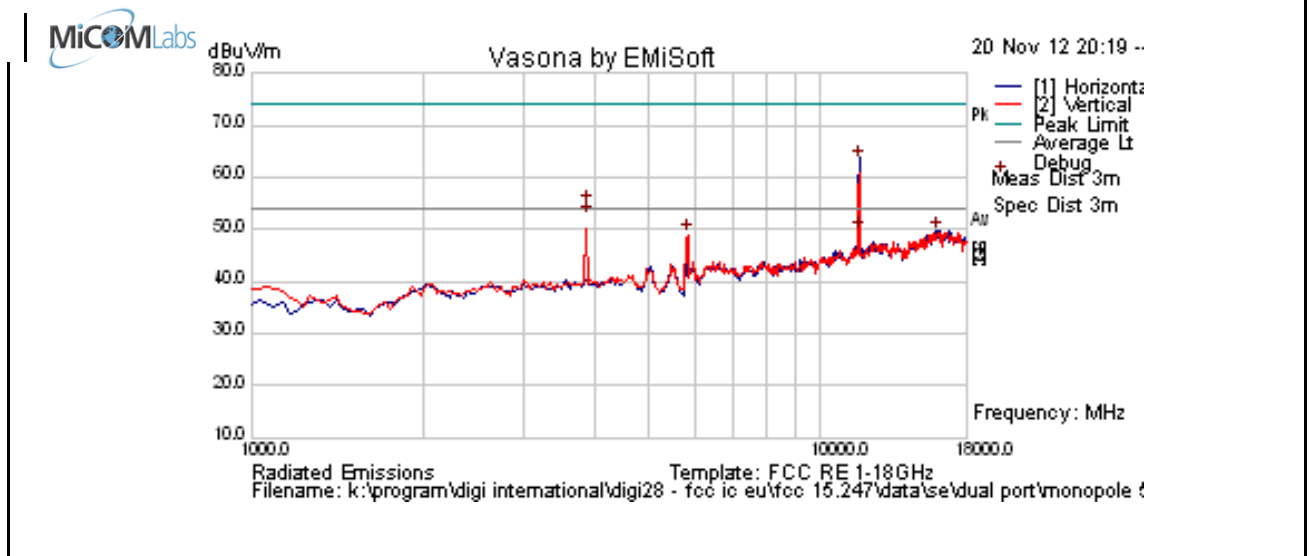

Formally measured emission peaks

Frequency MHz	Raw dBuV	Cable Loss	AF dB	Level dBuV/m	Measurement Type	Pol	Hgt cm	Azt Deg	Limit dBuV/m	Margin dB	Pass /Fail	Comments
5701.403	57.7	4.7	-9.6	52.9	Peak [Scan]	V						FUND
11398.317	61.0	6.8	-2.3	65.6	Peak Max	H	106	50	74.0	-8.5	Pass	RB
11398.317	48.9	6.8	-2.3	53.5	Average Max	H	106	50	54	-0.5	Pass	RB
16126.253	40.9	9.0	0.2	50.0	Peak [Scan]	H	100	0	54	-4.0	Pass	Noise

Legend: TX = Transmitter Emissions; DIG = Digital Emissions; FUND = Fundamental; WB = Wideband Emission
 RB = Restricted Band (15.209 Limits); NRB = Non Restricted Band, Limit is 20dB below fundamental peak

This test report may be reproduced in full only. The document may only be updated by MiCOM Labs personnel. Any changes will be noted in the Document History section of the report.



Title: Digi Connect Card for i.MX28 with Atheros AR6203
To: FCC 47 CFR Part 15.247 & IC RSS-210
Serial #: DIGI36-U2 Rev A
Issue Date: 22nd May 2014
Page: 121 of 261

Band Edge 802.11n HT20 5745 MHz

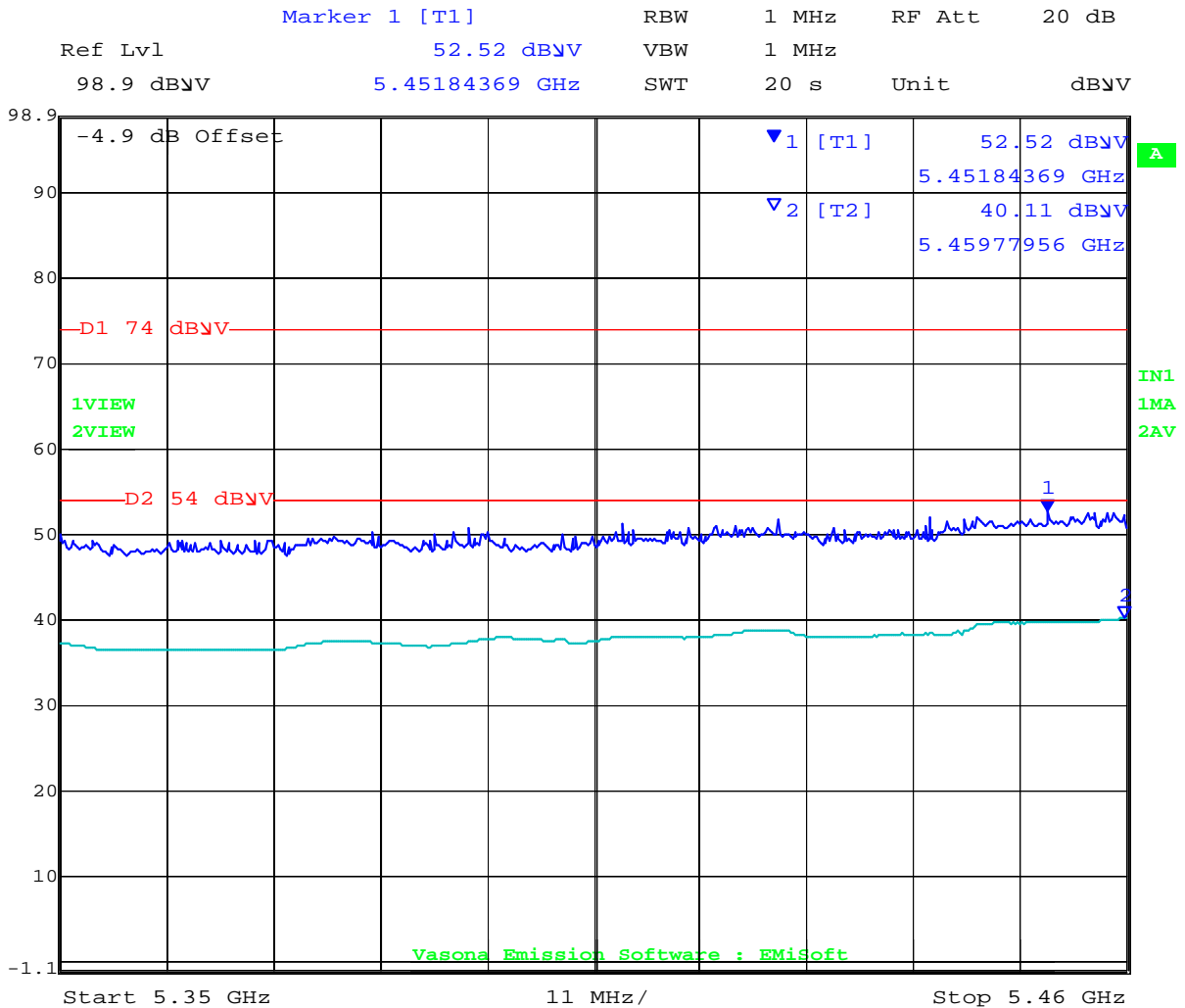

Date: 20.NOV.2012 19:04:17

This test report may be reproduced in full only. The document may only be updated by MiCOM Labs personnel. Any changes will be noted in the Document History section of the report.



Band Edge 802.11n HT40 5755 MHz

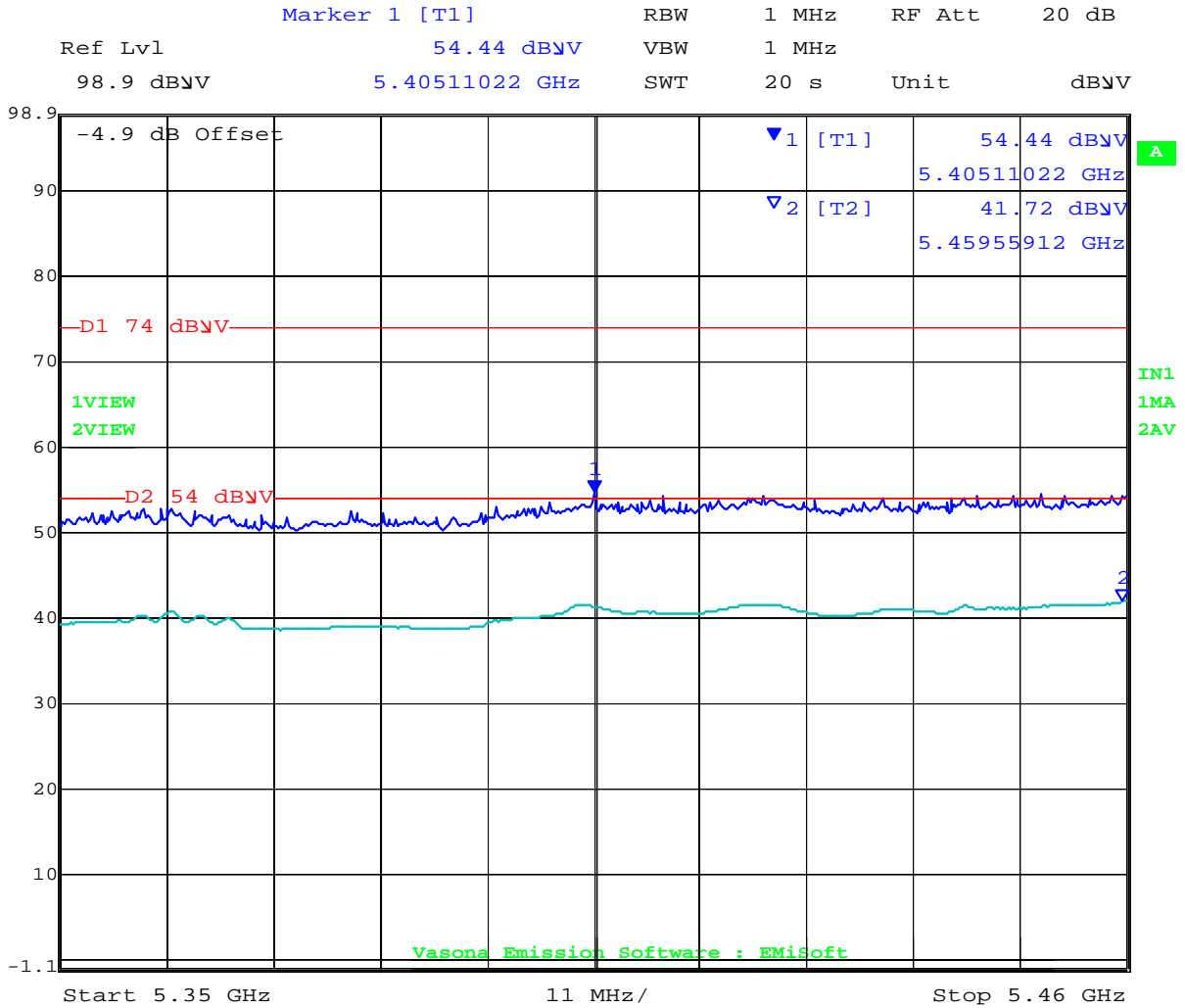

Date: 20.NOV.2012 19:09:26

This test report may be reproduced in full only. The document may only be updated by MiCOM Labs personnel. Any changes will be noted in the Document History section of the report.



Title: Digi Connect Card for i.MX28 with Atheros AR6203
To: FCC 47 CFR Part 15.247 & IC RSS-210
Serial #: DIGI36-U2 Rev A
Issue Date: 22nd May 2014
Page: 123 of 261

6.1.2.4. Single Band Omni SA-006-1 – Dual Port Module

Test Freq.	2412 MHz	Engineer	JMH
Variant	802.11b; 1 Mbs	Temp (°C)	21.5
Freq. Range	1000 MHz - 18000 MHz	Rel. Hum.(%)	35
Power Setting	20	Press. (mBars)	1004
Antenna	SA-006 Monopole	Duty Cycle (%)	100
Test Notes 1	Dual Port Module		
Test Notes 2			

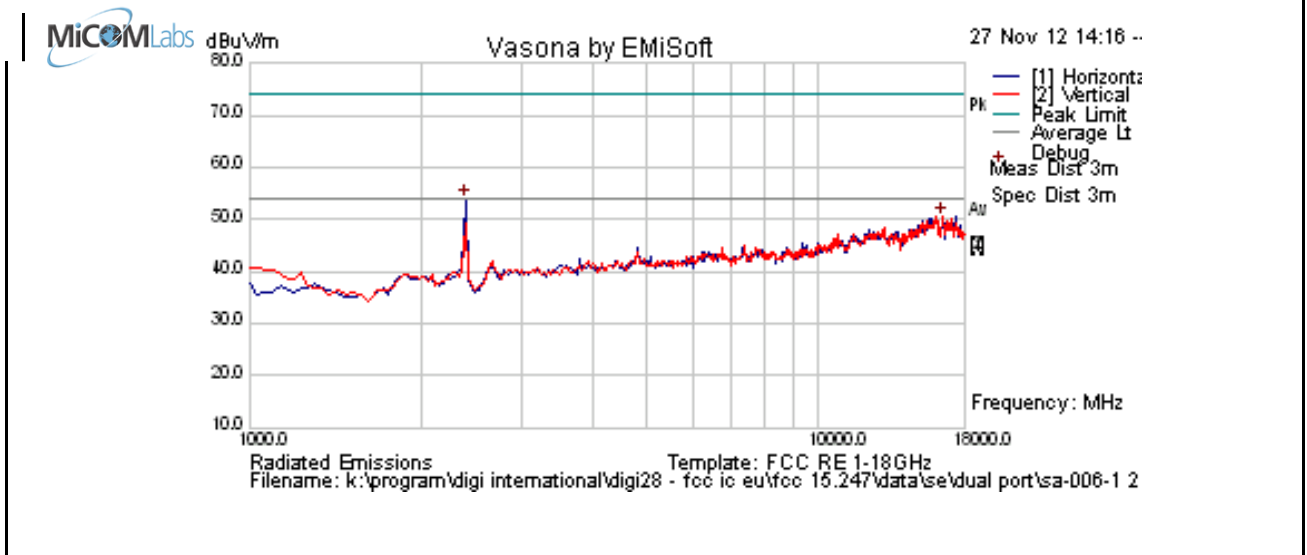

Formally measured emission peaks													
Frequency MHz	Raw dBuV	Cable Loss	AF dB	Level dBuV/m	Measurement Type	Pol	Hgt cm	Azt Deg	Limit dBuV/m	Margin dB	Pass /Fail	Comments	
2396.794	62.4	3.0	-11.7	53.7	Peak [Scan]	H							FUND
16466.934	41.4	8.8	0.3	50.5	Peak [Scan]	V	150	0	54.0	-3.5	Pass		Noise
Legend:		TX = Transmitter Emissions; DIG = Digital Emissions; FUND = Fundamental; WB = Wideband Emission											
		RB = Restricted Band (15.209 Limits); NRB = Non Restricted Band, Limit is 20dB below fundamental peak											

This test report may be reproduced in full only. The document may only be updated by MiCOM Labs personnel. Any changes will be noted in the Document History section of the report.



Band Edge

Ref Lvl	52.38 dBµV	RBW	1 MHz	RF Att	20 dB
95.1 dBµV	2.38599198 GHz	VBW	1 MHz	Unit	dBµV
		SWT	20 s		

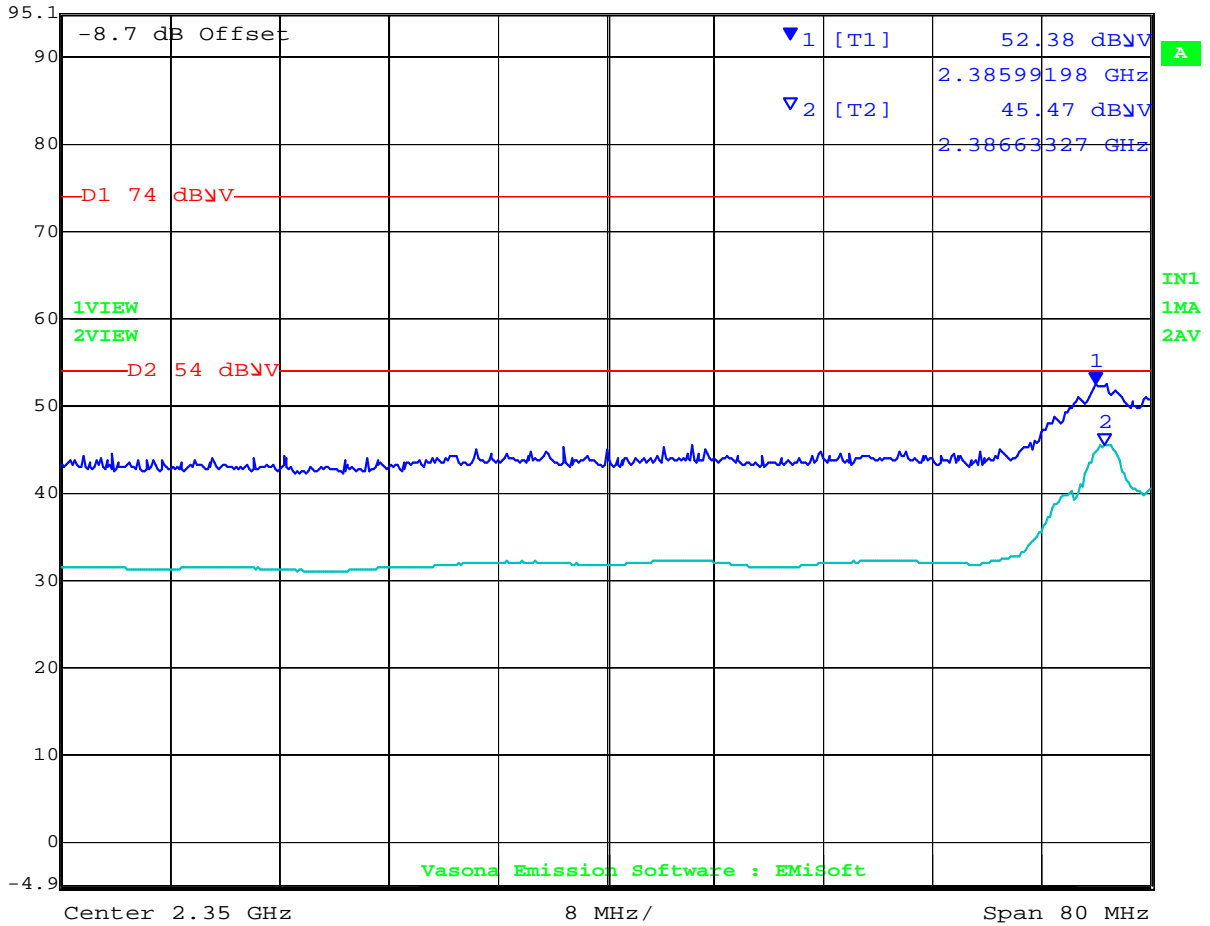

Date: 27.NOV.2012 15:59:15

This test report may be reproduced in full only. The document may only be updated by MiCOM Labs personnel. Any changes will be noted in the Document History section of the report.



Title: Digi Connect Card for i.MX28 with Atheros AR6203
To: FCC 47 CFR Part 15.247 & IC RSS-210
Serial #: DIGI36-U2 Rev A
Issue Date: 22nd May 2014
Page: 125 of 261

Test Freq.	2437 MHz	Engineer	JMH
Variant	802.11b; 1 Mbs	Temp (°C)	21.5
Freq. Range	1000 MHz - 18000 MHz	Rel. Hum.(%)	35
Power Setting	20	Press. (mBars)	1004
Antenna	SA-006 Monopole	Duty Cycle (%)	100
Test Notes 1	Dual Port Module		
Test Notes 2			

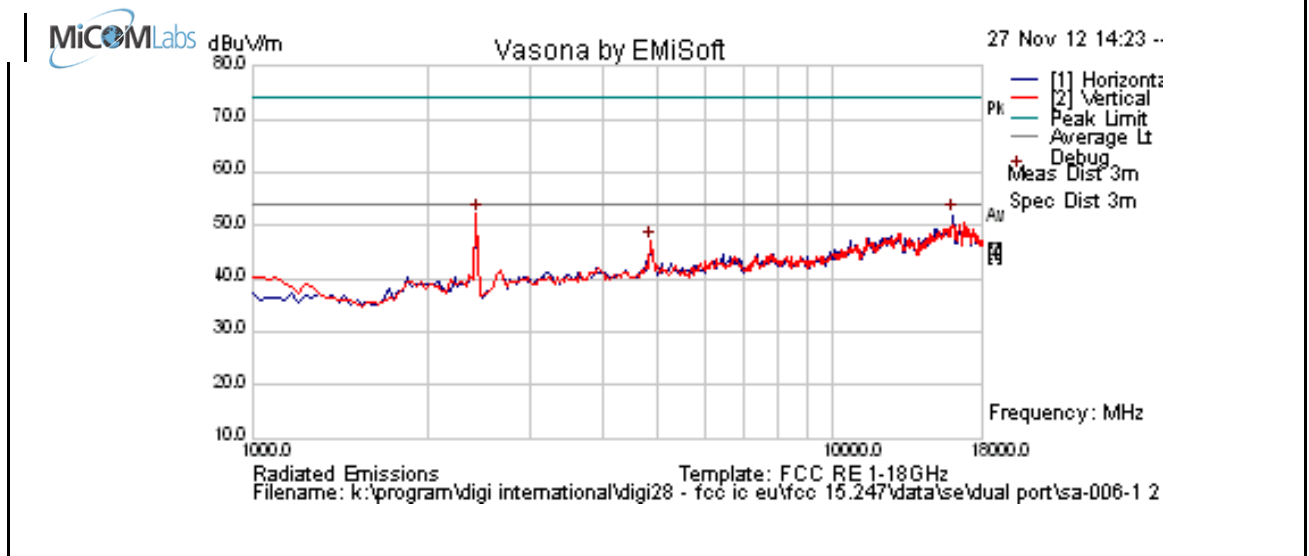

Formally measured emission peaks

Frequency MHz	Raw dBuV	Cable Loss	AF dB	Level dBuV/m	Measurement Type	Pol	Hgt cm	Azt Deg	Limit dBuV/m	Margin dB	Pass /Fail	Comments
2430.862	60.7	3.0	-11.6	52.1	Peak [Scan]	V						FUND
4848.504	52.0	4.5	-9.7	46.8	Peak [Scan]	V	98	360	54.0	-7.2	Pass	RB
16024.048	42.8	9.0	0.2	52.1	Peak [Scan]	H	100	0	54	-1.9	Pass	Noise

Legend: TX = Transmitter Emissions; DIG = Digital Emissions; FUND = Fundamental; WB = Wideband Emission
 RB = Restricted Band (15.209 Limits); NRB = Non Restricted Band, Limit is 20dB below fundamental peak

This test report may be reproduced in full only. The document may only be updated by MiCOM Labs personnel. Any changes will be noted in the Document History section of the report.



Title: Digi Connect Card for i.MX28 with Atheros AR6203
To: FCC 47 CFR Part 15.247 & IC RSS-210
Serial #: DIGI36-U2 Rev A
Issue Date: 22nd May 2014
Page: 126 of 261

Test Freq.	2462 MHz	Engineer	JMH
Variant	802.11b; 1 Mbs	Temp (°C)	21.5
Freq. Range	1000 MHz - 18000 MHz	Rel. Hum.(%)	35
Power Setting	20	Press. (mBars)	1004
Antenna	SA-006 Monopole	Duty Cycle (%)	100
Test Notes 1	Dual Port Module		
Test Notes 2			

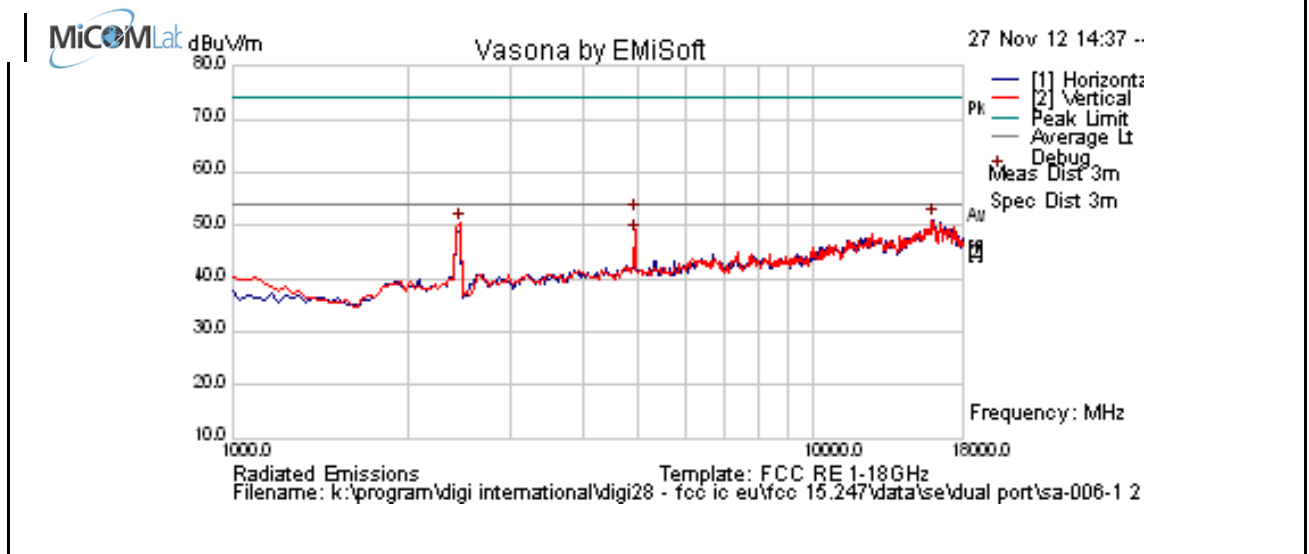

Formally measured emission peaks

Frequency MHz	Raw dBuV	Cable Loss	AF dB	Level dBuV/m	Measurement Type	Pol	Hgt cm	Azt Deg	Limit dBuV/m	Margin dB	Pass /Fail	Comments
2464.930	58.9	3.0	-11.5	50.4	Peak [Scan]	V						FUND
15955.912	42.1	9.0	0.0	51.1	Peak [Scan]	V	150	0	54.0	-2.9	Pass	Noise
4924.048	57.1	4.6	-9.8	51.9	Peak Max	V	152	210	74	-22.1	Pass	RB
4924.048	53.5	4.6	-9.8	48.3	Average Max	V	152	210	54	-5.7	Pass	RB
Legend: TX = Transmitter Emissions; DIG = Digital Emissions; FUND = Fundamental; WB = Wideband Emission RB = Restricted Band (15.209 Limits); NRB = Non Restricted Band, Limit is 20dB below fundamental peak												

This test report may be reproduced in full only. The document may only be updated by MiCOM Labs personnel. Any changes will be noted in the Document History section of the report.



Band Edge

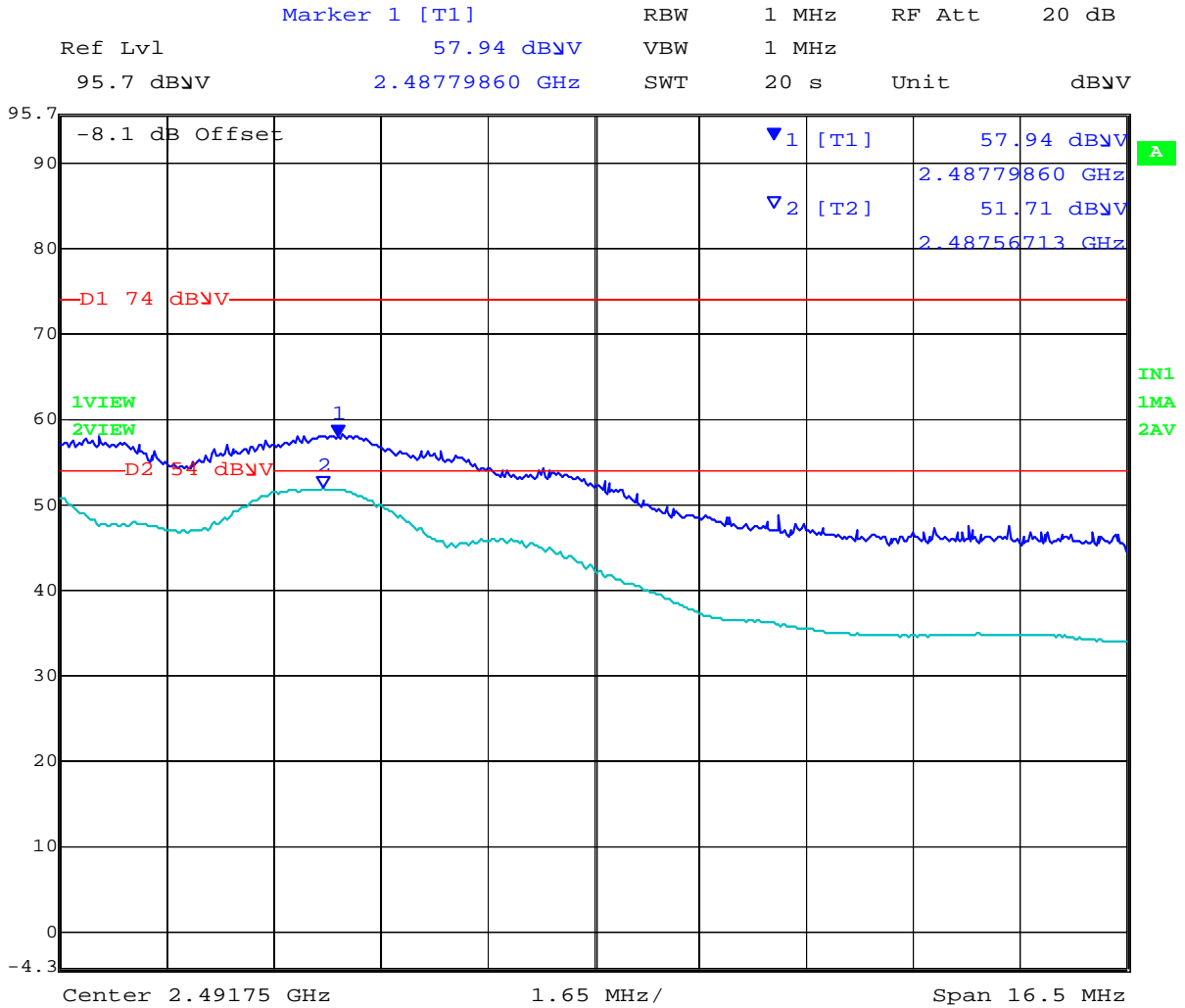

Date: 27.NOV.2012 16:35:10

This test report may be reproduced in full only. The document may only be updated by MiCOM Labs personnel. Any changes will be noted in the Document History section of the report.



Title: Digi Connect Card for i.MX28 with Atheros AR6203
To: FCC 47 CFR Part 15.247 & IC RSS-210
Serial #: DIGI36-U2 Rev A
Issue Date: 22nd May 2014
Page: 128 of 261

Test Freq.	2412 MHz	Engineer	JMH
Variant	802.11g; 6 Mbs	Temp (°C)	21.5
Freq. Range	1000 MHz - 18000 MHz	Rel. Hum.(%)	35
Power Setting	20	Press. (mBars)	1004
Antenna	SA-006 2.4 Monopole	Duty Cycle (%)	100
Test Notes 1	Dual Port Module		
Test Notes 2			

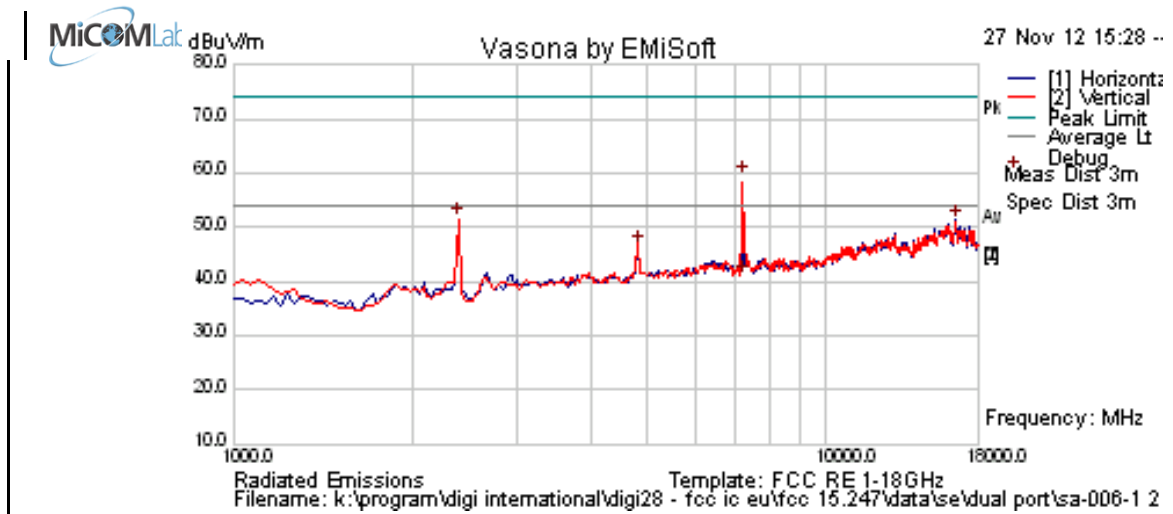

Formally measured emission peaks

Frequency MHz	Raw dBuV	Cable Loss	AF dB	Level dBuV/m	Measurement Type	Pol	Hgt cm	Azt Deg	Limit dBuV/m	Margin dB	Pass /Fail	Comments
2396.794	60.3	3.0	-11.7	51.6	Peak [Scan]	V						FUND
16535.07	42.0	8.8	0.4	51.2	Peak [Scan]	H	200	0	54.0	-2.8	Pass	Noise
4819.738	51.8	4.5	-9.7	46.6	Peak [Scan]	V	98	360	54	-7.4	Pass	RB
7233.908	60.0	5.4	-5.8	59.6	Peak Max	V	143	76	74	-14.4	Pass	RB
7233.908	41.3	5.4	-5.8	40.9	Average Max	V	143	76	54	-13.2	Pass	RB

Legend:	TX = Transmitter Emissions; DIG = Digital Emissions; FUND = Fundamental; WB = Wideband Emission
	RB = Restricted Band (15.209 Limits); NRB = Non Restricted Band, Limit is 20dB below fundamental peak

This test report may be reproduced in full only. The document may only be updated by MiCOM Labs personnel. Any changes will be noted in the Document History section of the report.



Title: Digi Connect Card for i.MX28 with Atheros AR6203
To: FCC 47 CFR Part 15.247 & IC RSS-210
Serial #: DIGI36-U2 Rev A
Issue Date: 22nd May 2014
Page: 129 of 261

Band Edge

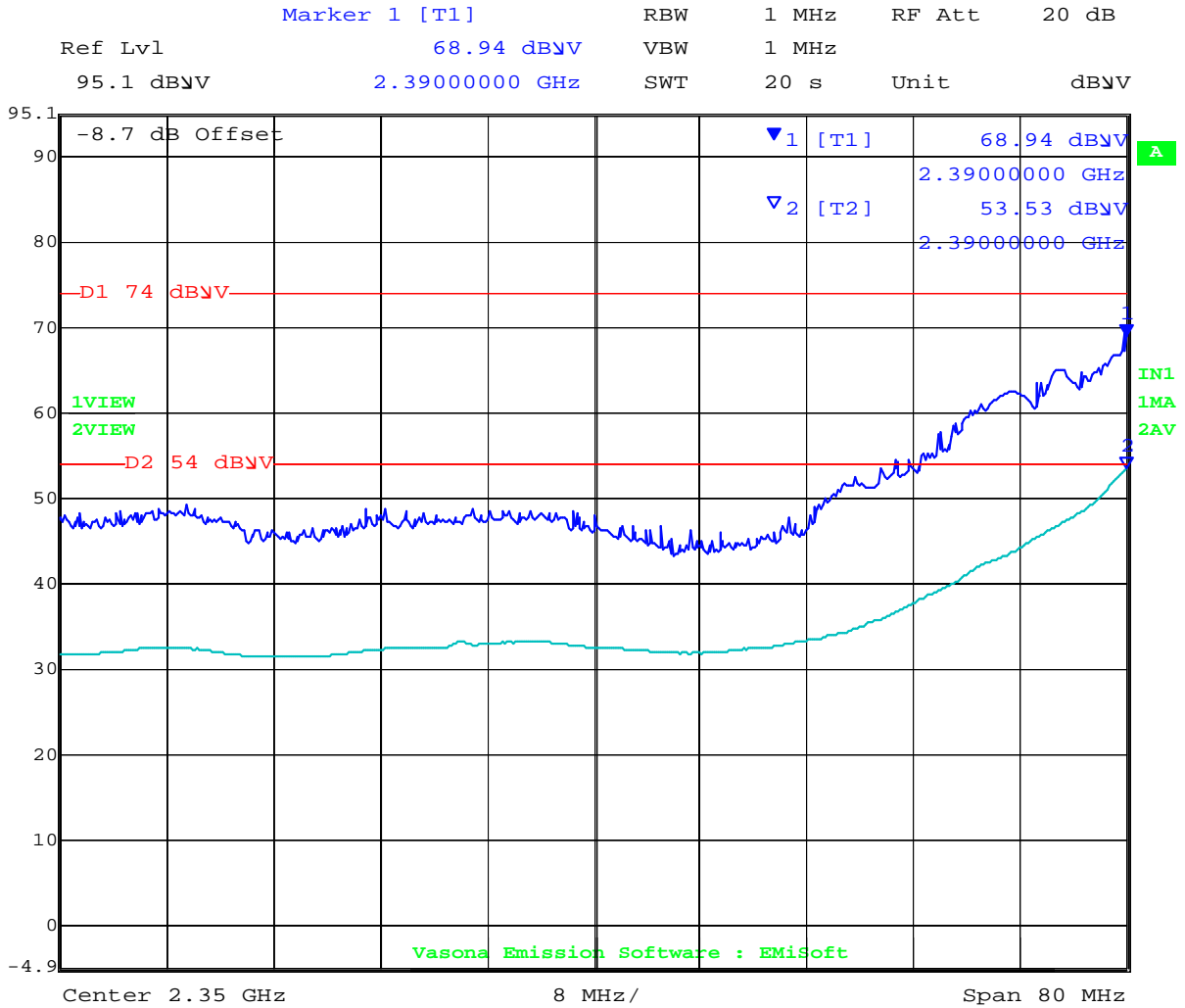

Date: 27.NOV.2012 15:52:10

Power reduction required in order to bring unit into compliance Power = 15

This test report may be reproduced in full only. The document may only be updated by MiCOM Labs personnel. Any changes will be noted in the Document History section of the report.



Title: Digi Connect Card for i.MX28 with Atheros AR6203
To: FCC 47 CFR Part 15.247 & IC RSS-210
Serial #: DIGI36-U2 Rev A
Issue Date: 22nd May 2014
Page: 130 of 261

Test Freq.	2437 MHz	Engineer	JMH
Variant	802.11g; 6 Mbs	Temp (°C)	21.5
Freq. Range	1000 MHz - 18000 MHz	Rel. Hum.(%)	35
Power Setting	20	Press. (mBars)	1004
Antenna	SA-006 2.4 Monopole	Duty Cycle (%)	100
Test Notes 1	Dual Port Module		
Test Notes 2			

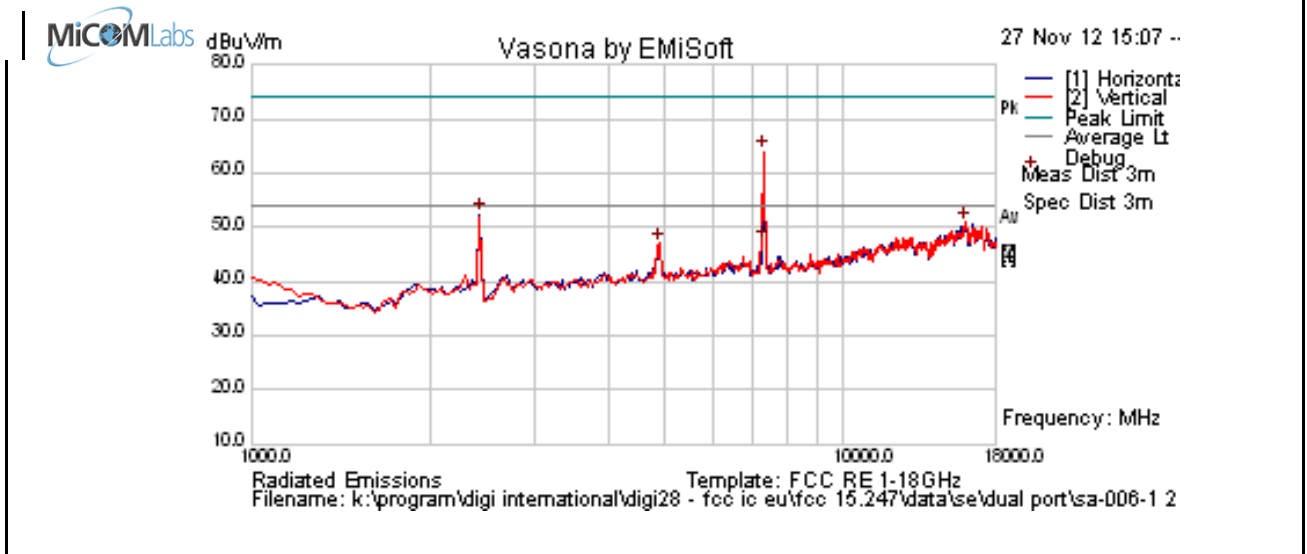

Formally measured emission peaks

Frequency MHz	Raw dBuV	Cable Loss	AF dB	Level dBuV/m	Measurement Type	Pol	Hgt cm	Azt Deg	Limit dBuV/m	Margin dB	Pass /Fail	Comments
2430.862	61.0	3.0	-11.6	52.4	Peak [Scan]	H						FUND
16024.048	41.7	9.0	0.2	50.9	Peak [Scan]	H	100	0	54.0	-3.1	Pass	Noise
4881.681	52.3	4.5	-9.7	47.1	Peak [Scan]	V	98	360	54	-6.9	Pass	RB
7312.305	64.3	5.4	-5.7	64.1	Peak Max	V	160	331	74	-9.9	Pass	RB
7312.305	47.6	5.4	-5.7	47.3	Average Max	V	160	331	54	-6.7	Pass	RB

Legend: TX = Transmitter Emissions; DIG = Digital Emissions; FUND = Fundamental; WB = Wideband Emission
 RB = Restricted Band (15.209 Limits); NRB = Non Restricted Band, Limit is 20dB below fundamental peak

This test report may be reproduced in full only. The document may only be updated by MiCOM Labs personnel. Any changes will be noted in the Document History section of the report.



Title: Digi Connect Card for i.MX28 with Atheros AR6203
To: FCC 47 CFR Part 15.247 & IC RSS-210
Serial #: DIGI36-U2 Rev A
Issue Date: 22nd May 2014
Page: 131 of 261

Test Freq.	2462 MHz	Engineer	JMH
Variant	802.11g; 6 Mbs	Temp (°C)	21.5
Freq. Range	1000 MHz - 18000 MHz	Rel. Hum.(%)	35
Power Setting	20	Press. (mBars)	1004
Antenna	SA-006 2.4 Monopole	Duty Cycle (%)	100
Test Notes 1	Dual Port Module		
Test Notes 2			

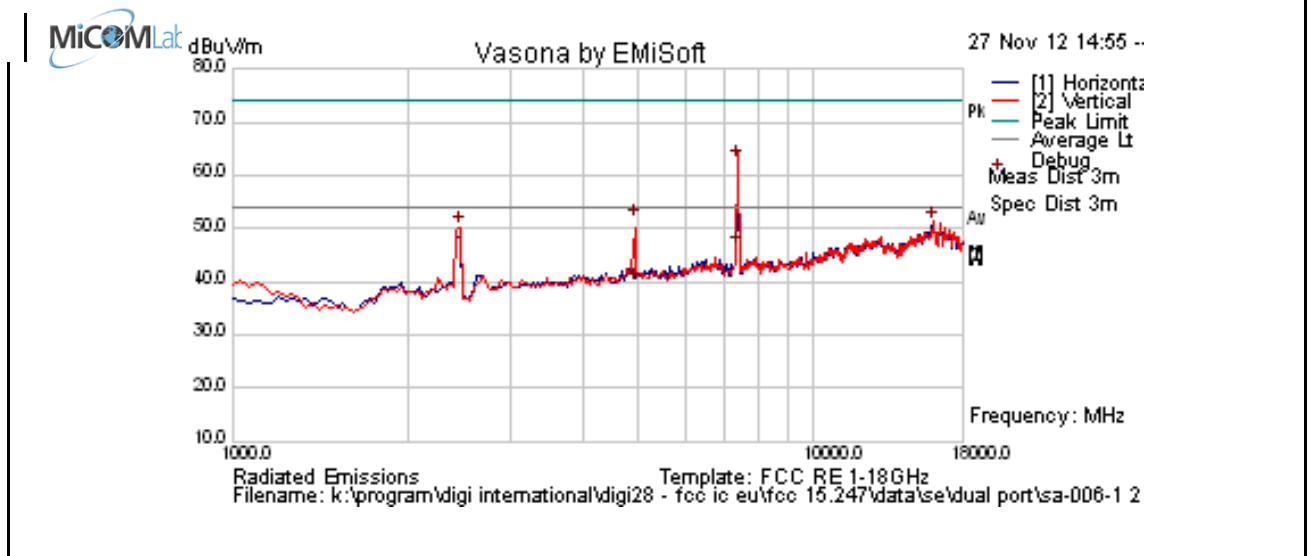

Formally measured emission peaks

Frequency MHz	Raw dBuV	Cable Loss	AF dB	Level dBuV/m	Measurement Type	Pol	Hgt cm	Azt Deg	Limit dBuV/m	Margin dB	Pass /Fail	Comments
16058.116	42.0	9.0	0.3	51.2	Peak [Scan]	V	150	0	54.0	-2.8	Pass	Noise
2464.92986	58.8	3.0	-11.5	50.3	Peak [Scan]	V						FUND
4927.214	56.7	4.6	-9.8	51.5	Peak Max	V	137	191	74	-22.5	Pass	RB
4927.214	45.0	4.6	-9.8	39.8	Average Max	V	137	191	54	-14.3	Pass	RB
7383.487	46.6	5.5	-5.5	46.6	Average Max	V	166	245	54	-7.4	Pass	RB
7383.487	63.0	5.5	-5.5	63.0	Peak Max	V	166	245	74	-11.1	Pass	RB

Legend: TX = Transmitter Emissions; DIG = Digital Emissions; FUND = Fundamental; WB = Wideband Emission
 RB = Restricted Band (15.209 Limits); NRB = Non Restricted Band, Limit is 20dB below fundamental peak

This test report may be reproduced in full only. The document may only be updated by MiCOM Labs personnel. Any changes will be noted in the Document History section of the report.



Band Edge

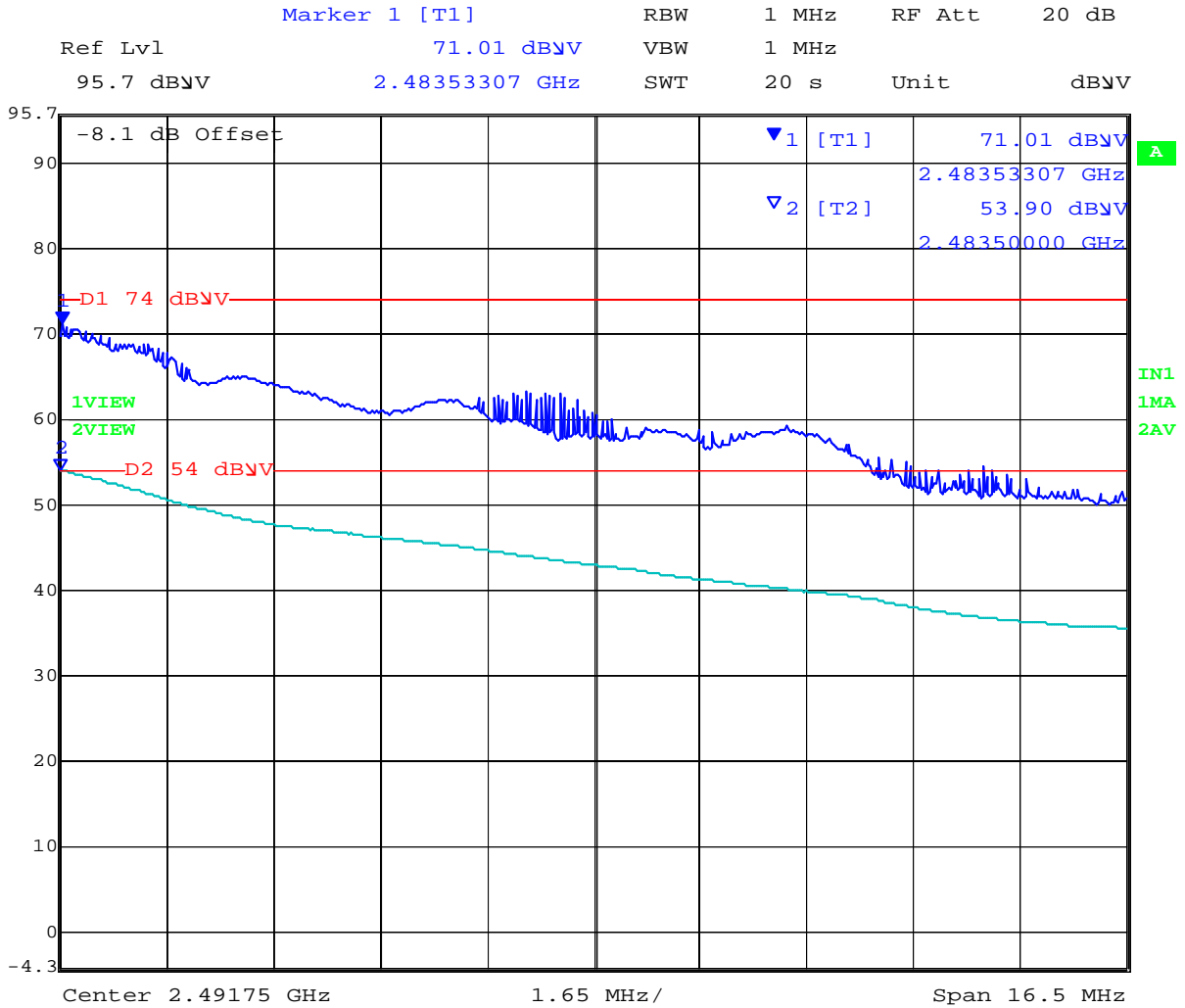

Date: 27.NOV.2012 16:30:16

Power reduction required in order to bring unit into compliance Power = 14

This test report may be reproduced in full only. The document may only be updated by MiCOM Labs personnel. Any changes will be noted in the Document History section of the report.



Title: Digi Connect Card for i.MX28 with Atheros AR6203
To: FCC 47 CFR Part 15.247 & IC RSS-210
Serial #: DIGI36-U2 Rev A
Issue Date: 22nd May 2014
Page: 133 of 261

Band Edge 802.11n HT20 2412 MHz

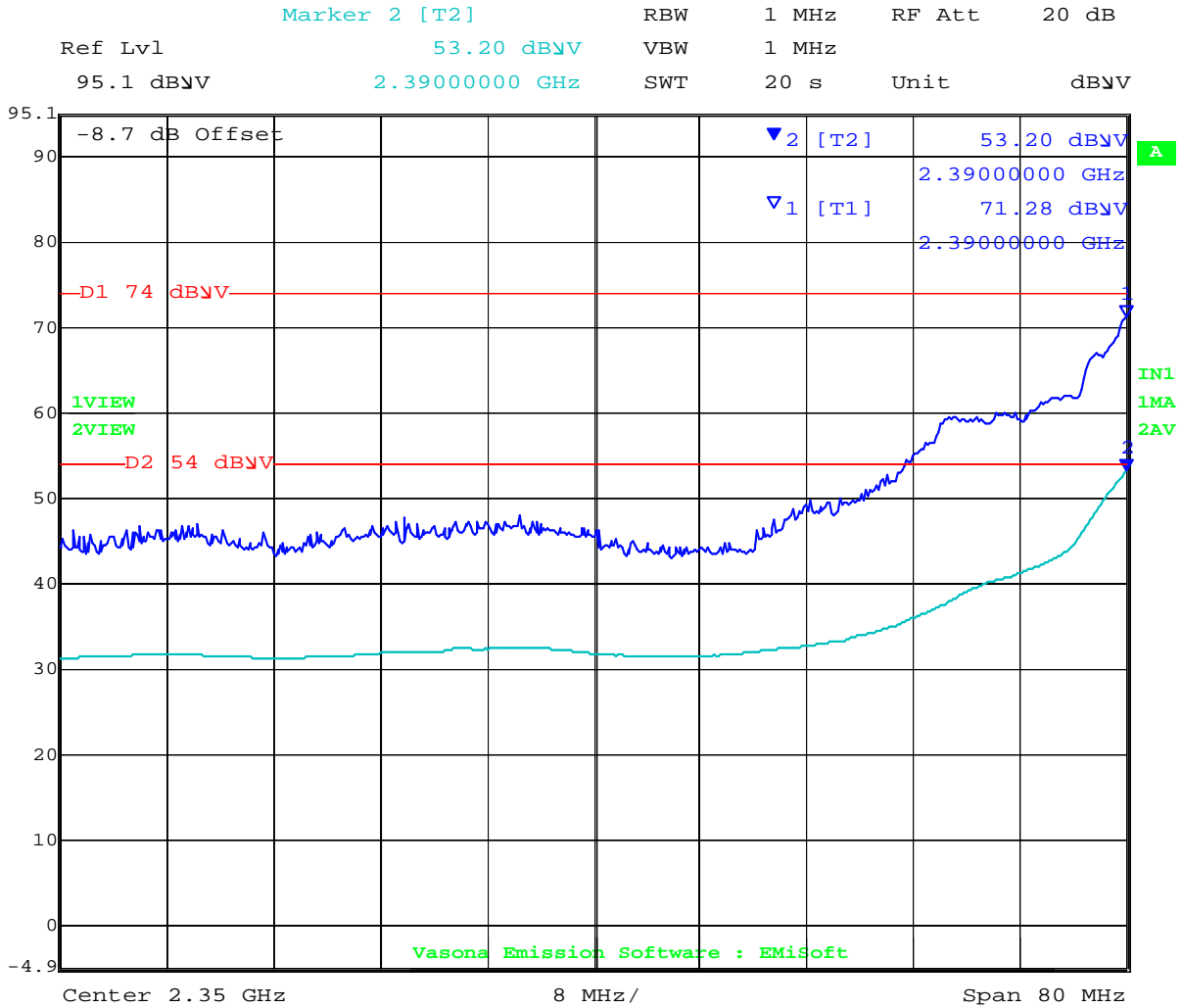

Date: 27.NOV.2012 16:03:42

Power reduction required in order to bring unit into compliance Power = 14

This test report may be reproduced in full only. The document may only be updated by MiCOM Labs personnel. Any changes will be noted in the Document History section of the report.



Title: Digi Connect Card for i.MX28 with Atheros AR6203
To: FCC 47 CFR Part 15.247 & IC RSS-210
Serial #: DIGI36-U2 Rev A
Issue Date: 22nd May 2014
Page: 134 of 261

Band Edge 802.11n HT20 2462 MHz

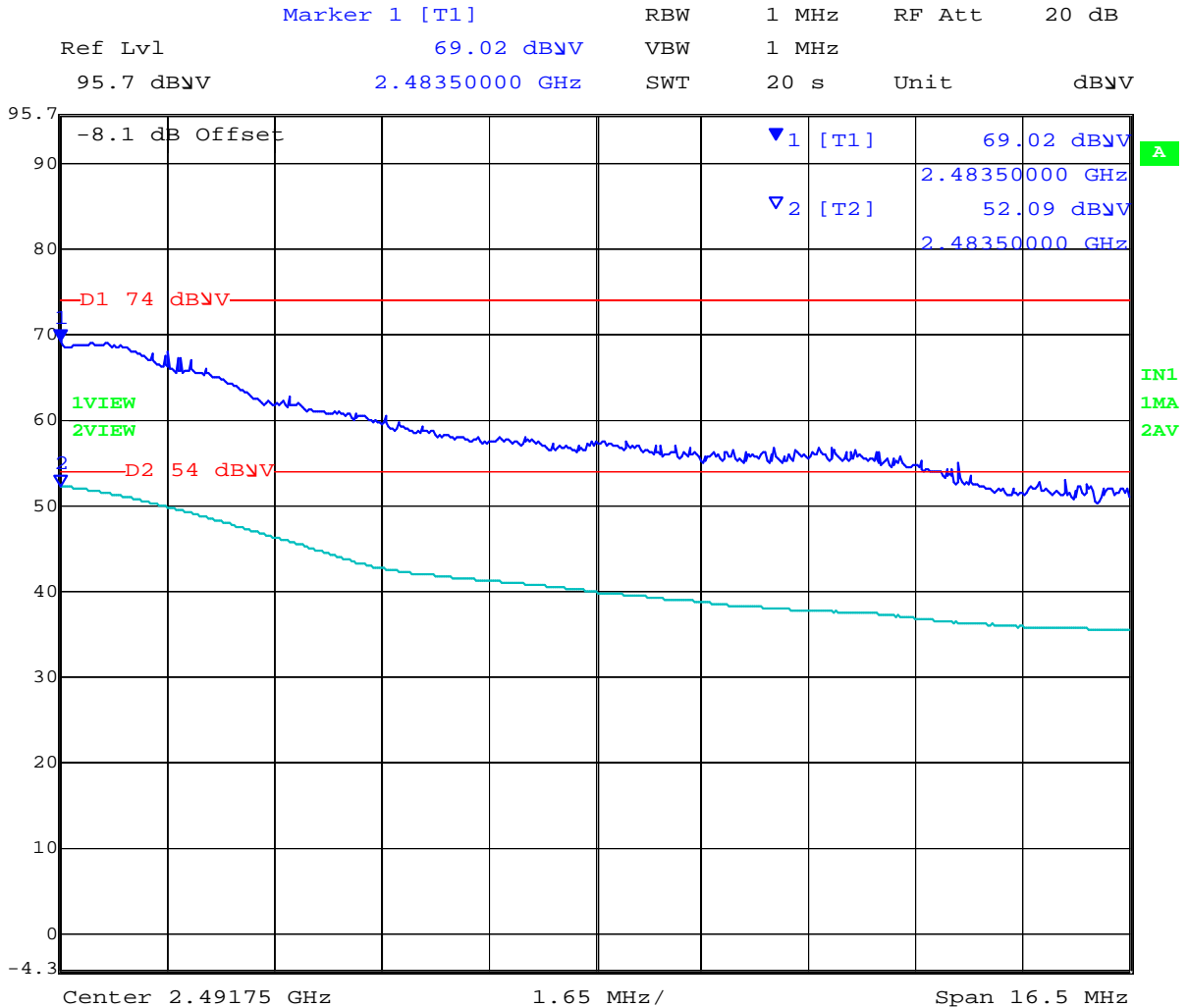

Date: 27.NOV.2012 16:24:07

Power reduction required in order to bring unit into compliance Power = 12

This test report may be reproduced in full only. The document may only be updated by MiCOM Labs personnel. Any changes will be noted in the Document History section of the report.



Title: Digi Connect Card for i.MX28 with Atheros AR6203
To: FCC 47 CFR Part 15.247 & IC RSS-210
Serial #: DIGI36-U2 Rev A
Issue Date: 22nd May 2014
Page: 135 of 261

Band Edge 802.11n HT40 2422 MHz

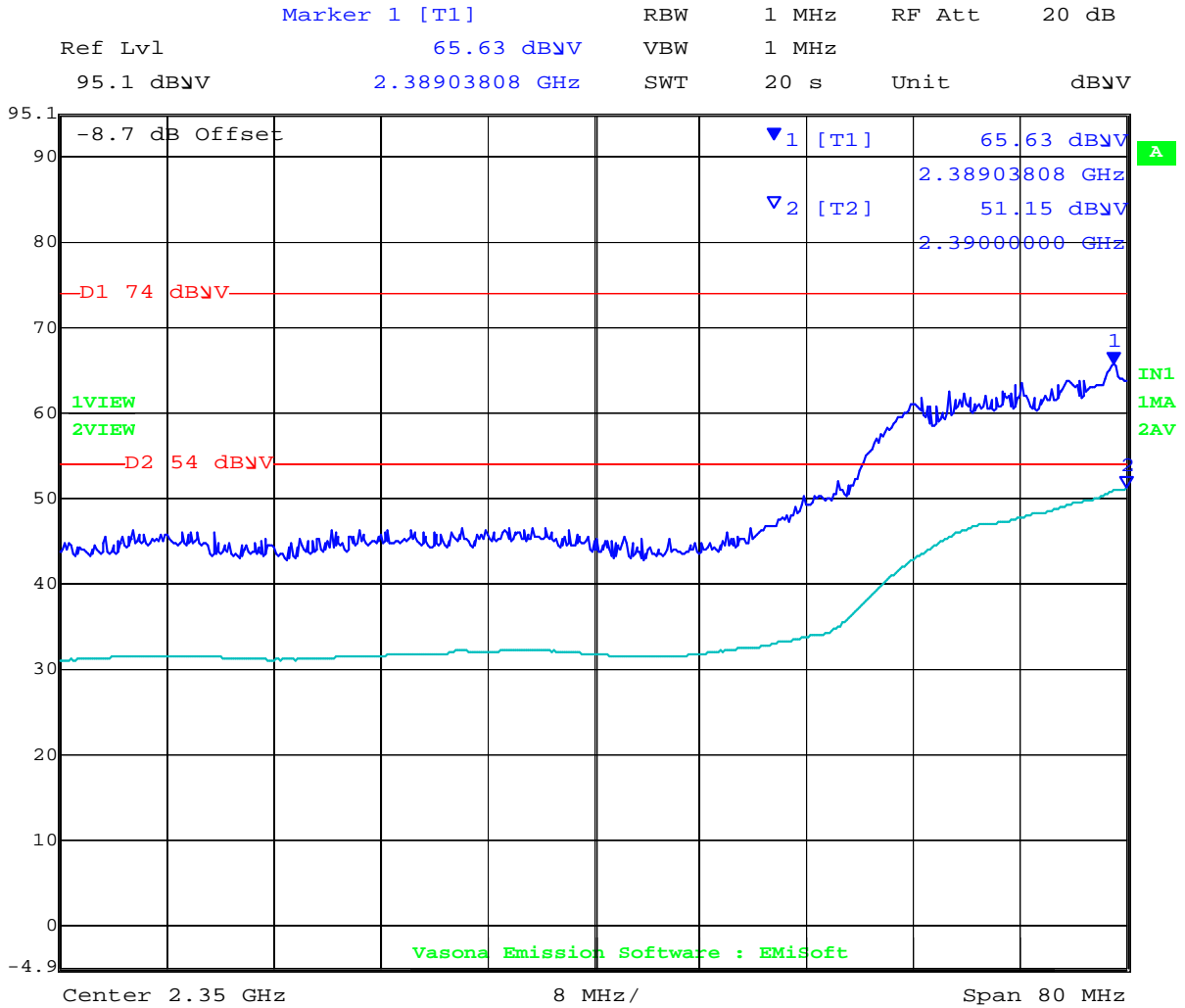

Date: 27.NOV.2012 16:09:30

Power reduction required in order to bring unit into compliance Power = 10

This test report may be reproduced in full only. The document may only be updated by MiCOM Labs personnel. Any changes will be noted in the Document History section of the report.



Title: Digi Connect Card for i.MX28 with Atheros AR6203
To: FCC 47 CFR Part 15.247 & IC RSS-210
Serial #: DIGI36-U2 Rev A
Issue Date: 22nd May 2014
Page: 136 of 261

Band Edge 802.11n HT40 2452 MHz

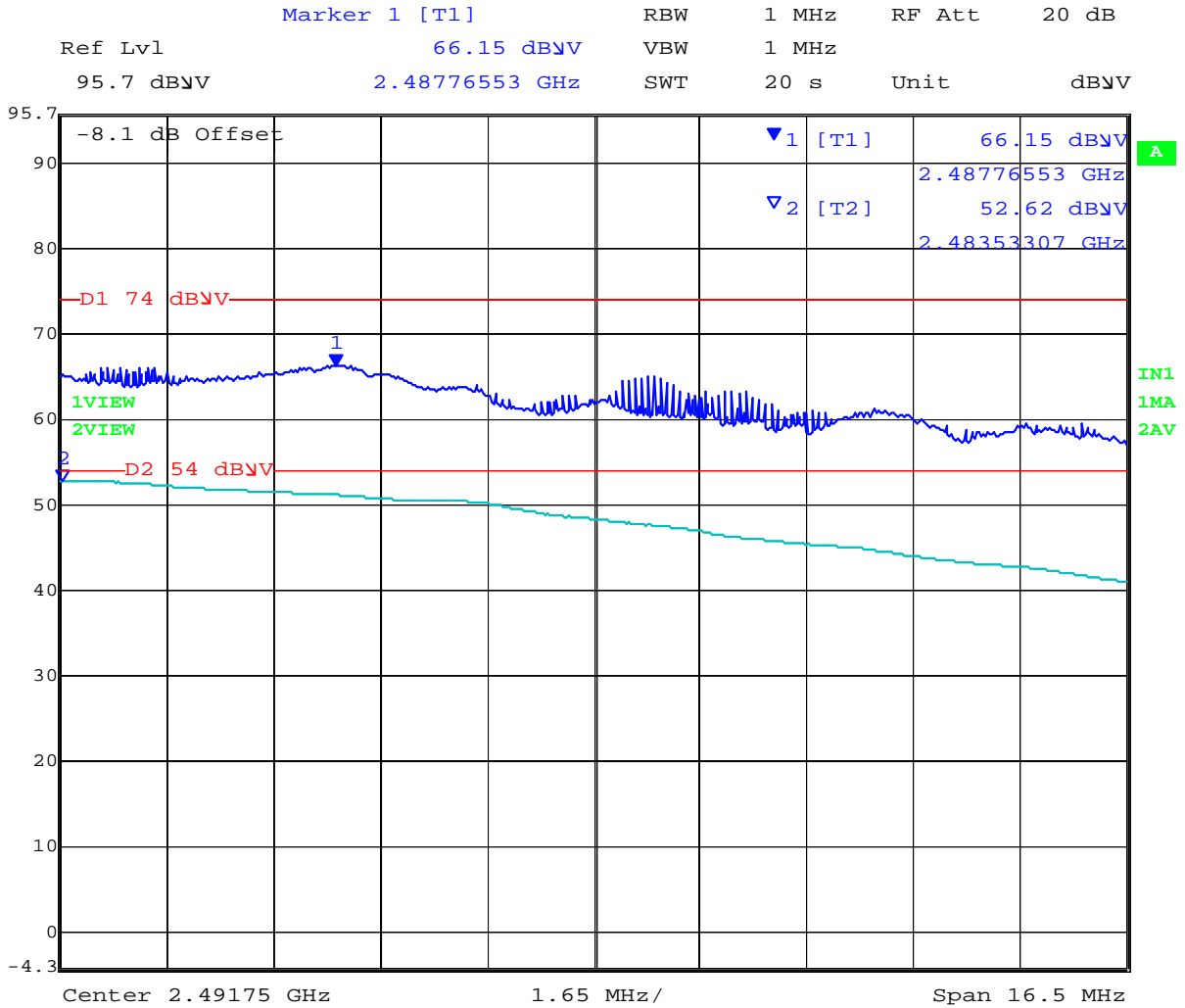

Date: 27.NOV.2012 16:20:53

Power reduction required in order to bring unit into compliance Power = 9

This test report may be reproduced in full only. The document may only be updated by MiCOM Labs personnel. Any changes will be noted in the Document History section of the report.



Title: Digi Connect Card for i.MX28 with Atheros AR6203
To: FCC 47 CFR Part 15.247 & IC RSS-210
Serial #: DIGI36-U2 Rev A
Issue Date: 22nd May 2014
Page: 137 of 261

6.1.2.5. Dual Band – Compact Balanced Dipole

Test Freq.	2412 MHz	Engineer	JMH
Variant	802.11b; 1 Mbs	Temp (°C)	25
Freq. Range	1000 MHz - 18000 MHz	Rel. Hum.(%)	38
Power Setting	20	Press. (mBars)	1004
Antenna	compactd balanced dipole x2	Duty Cycle (%)	100
Test Notes 1	Dual Port module		
Test Notes 2			

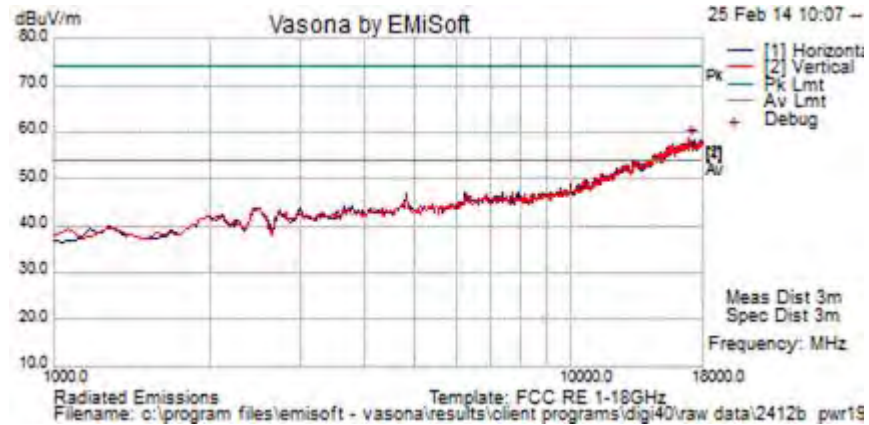

Formally measured emission peaks

Frequency MHz	Raw dBuV	Cable Loss	AF dB	Level dBuV/m	Measurement Type	Pol	Hgt cm	Azt Deg	Limit dBuV/m	Margin dB	Pass /Fail	Comments
16979.579	27.8	12.4	9.8	50.0	Average	V	201	5	54.0	-4.0	Pass	Noise Floor
4811.058	43.2	5.7	-2.6	46.3	Peak [Scan]	V	201	5	54.0	-7.7	Pass	RB
Legend: TX = Transmitter Emissions; DIG = Digital Emissions; FUND = Fundamental; WB = Wideband Emission RB = Restricted Band (15.209 Limits); NRB = Non Restricted Band, Limit is 20dB below fundamental peak												

This test report may be reproduced in full only. The document may only be updated by MiCOM Labs personnel. Any changes will be noted in the Document History section of the report.



Title: Digi Connect Card for i.MX28 with Atheros AR6203
To: FCC 47 CFR Part 15.247 & IC RSS-210
Serial #: DIGI36-U2 Rev A
Issue Date: 22nd May 2014
Page: 138 of 261

Test Freq.	2442 MHz	Engineer	JMH
Variant	802.11b; 1 Mbs	Temp (°C)	25
Freq. Range	1000 MHz - 18000 MHz	Rel. Hum.(%)	38
Power Setting	20	Press. (mBars)	1004
Antenna	compacted balanced dipole x2	Duty Cycle (%)	100
Test Notes 1	Dual Port module		
Test Notes 2			

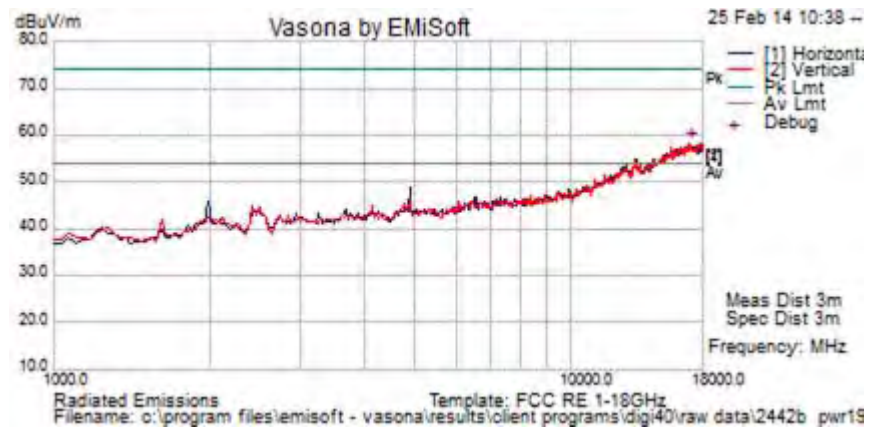

Formally measured emission peaks

Frequency MHz	Raw dBuV	Cable Loss	AF dB	Level dBuV/m	Measurement Type	Pol	Hgt cm	Azt Deg	Limit dBuV/m	Margin dB	Pass /Fail	Comments
16977.399	27.9	12.4	9.8	50.1	Average	V	197	4	54.0	-3.9	Pass	Noise Floor
4885.152	45.6	5.7	-2.6	48.7	Peak [Scan]	H	98	-1	54.0	-5.3	Pass	RB
1989.550	48.5	3.5	-6.4	45.7	Peak [Scan]	H						NRB

Legend: TX = Transmitter Emissions; DIG = Digital Emissions; FUND = Fundamental; WB = Wideband Emission
 RB = Restricted Band (15.209 Limits); NRB = Non Restricted Band, Limit is 20dB below fundamental peak

This test report may be reproduced in full only. The document may only be updated by MiCOM Labs personnel. Any changes will be noted in the Document History section of the report.



Title: Digi Connect Card for i.MX28 with Atheros AR6203
To: FCC 47 CFR Part 15.247 & IC RSS-210
Serial #: DIGI36-U2 Rev A
Issue Date: 22nd May 2014
Page: 139 of 261

Test Freq.	2472 MHz	Engineer	JMH
Variant	802.11b; 1 Mbs	Temp (°C)	25
Freq. Range	1000 MHz - 18000 MHz	Rel. Hum.(%)	38
Power Setting	20	Press. (mBars)	1004
Antenna	compacted balanced dipole x2	Duty Cycle (%)	100
Test Notes 1	Dual Port module		
Test Notes 2			

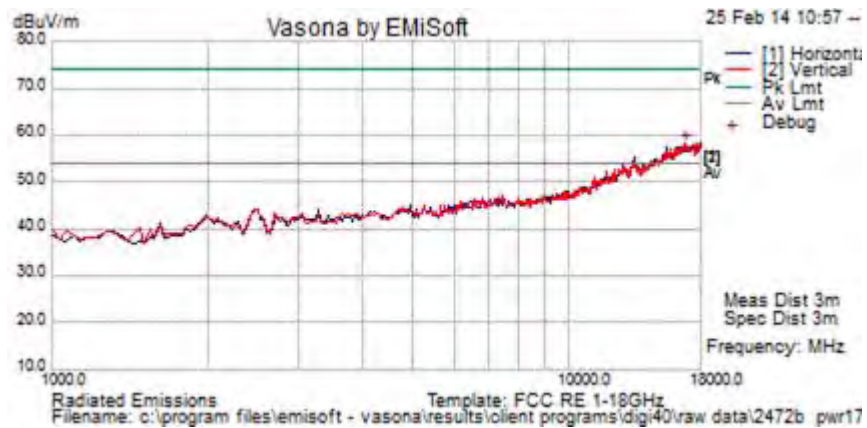

Formally measured emission peaks

Frequency MHz	Raw dBuV	Cable Loss	AF dB	Level dBuV/m	Measurement Type	Pol	Hgt cm	Azt Deg	Limit dBuV/m	Margin dB	Pass /Fail	Comments
16740.573	27.5	12.1	9.9	49.5	Average	V	150	6	54.0	-4.5	Pass	Noise Floor
Legend: TX = Transmitter Emissions; DIG = Digital Emissions; FUND = Fundamental; WB = Wideband Emission RB = Restricted Band (15.209 Limits); NRB = Non Restricted Band, Limit is 20dB below fundamental peak												

This test report may be reproduced in full only. The document may only be updated by MiCOM Labs personnel. Any changes will be noted in the Document History section of the report.



Band Edge 802.11b 2412 MHz

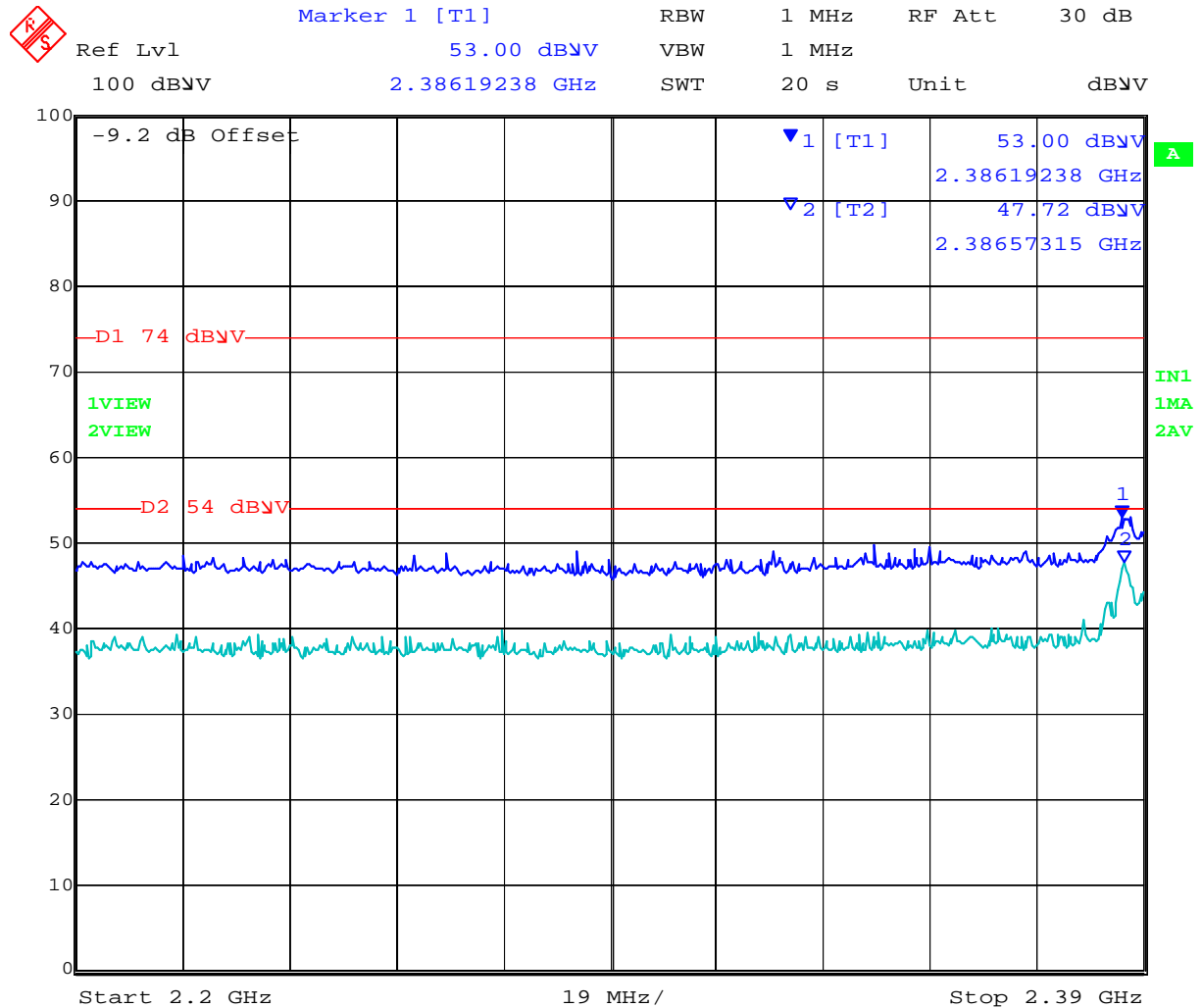

Date: 25.FEB.2014 19:11:10

This test report may be reproduced in full only. The document may only be updated by MiCOM Labs personnel. Any changes will be noted in the Document History section of the report.



Band Edge 802.11b 2462 MHz

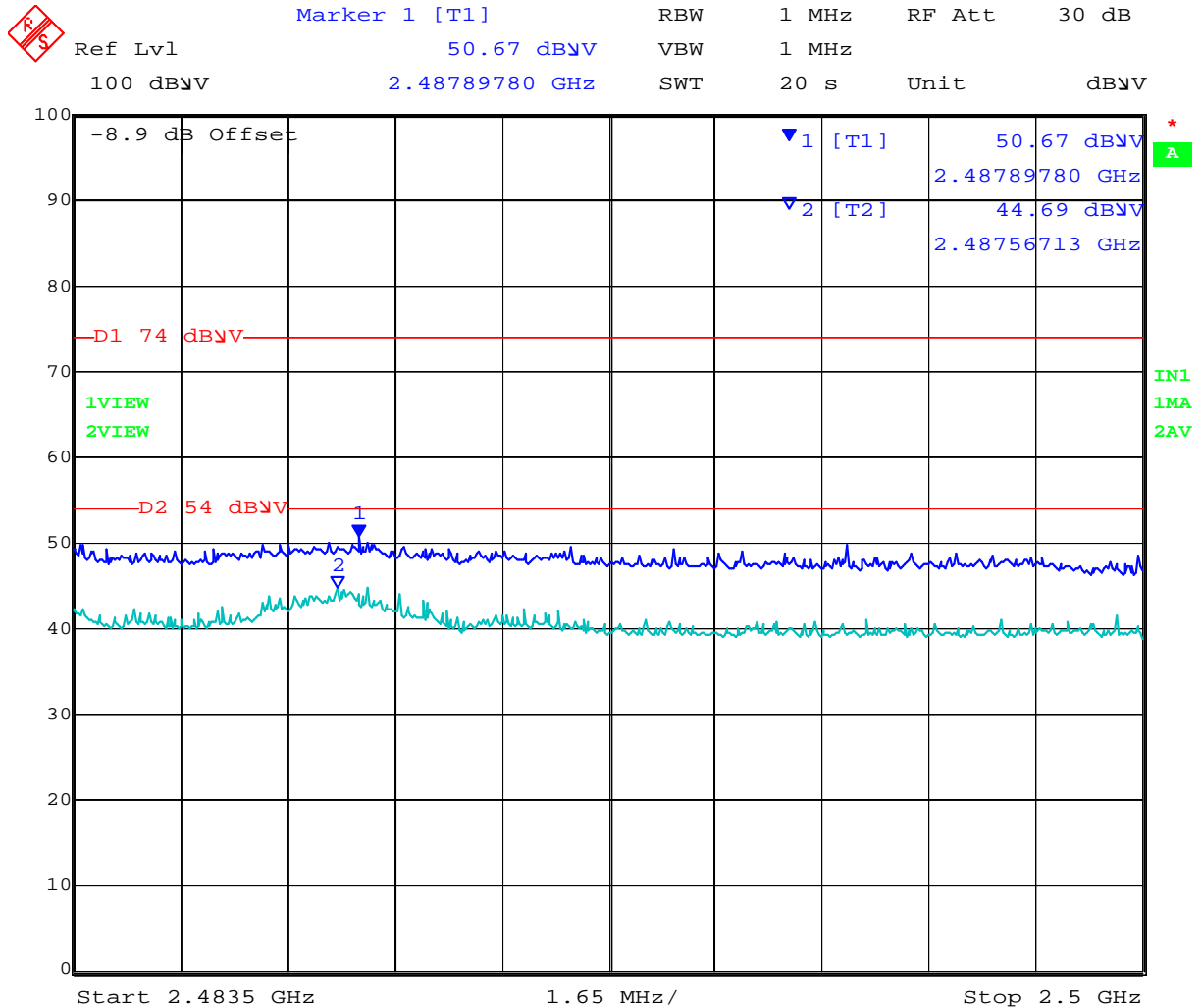

Date: 25.FEB.2014 19:33:20

This test report may be reproduced in full only. The document may only be updated by MiCOM Labs personnel. Any changes will be noted in the Document History section of the report.



Band Edge 802.11g 2412 MHz

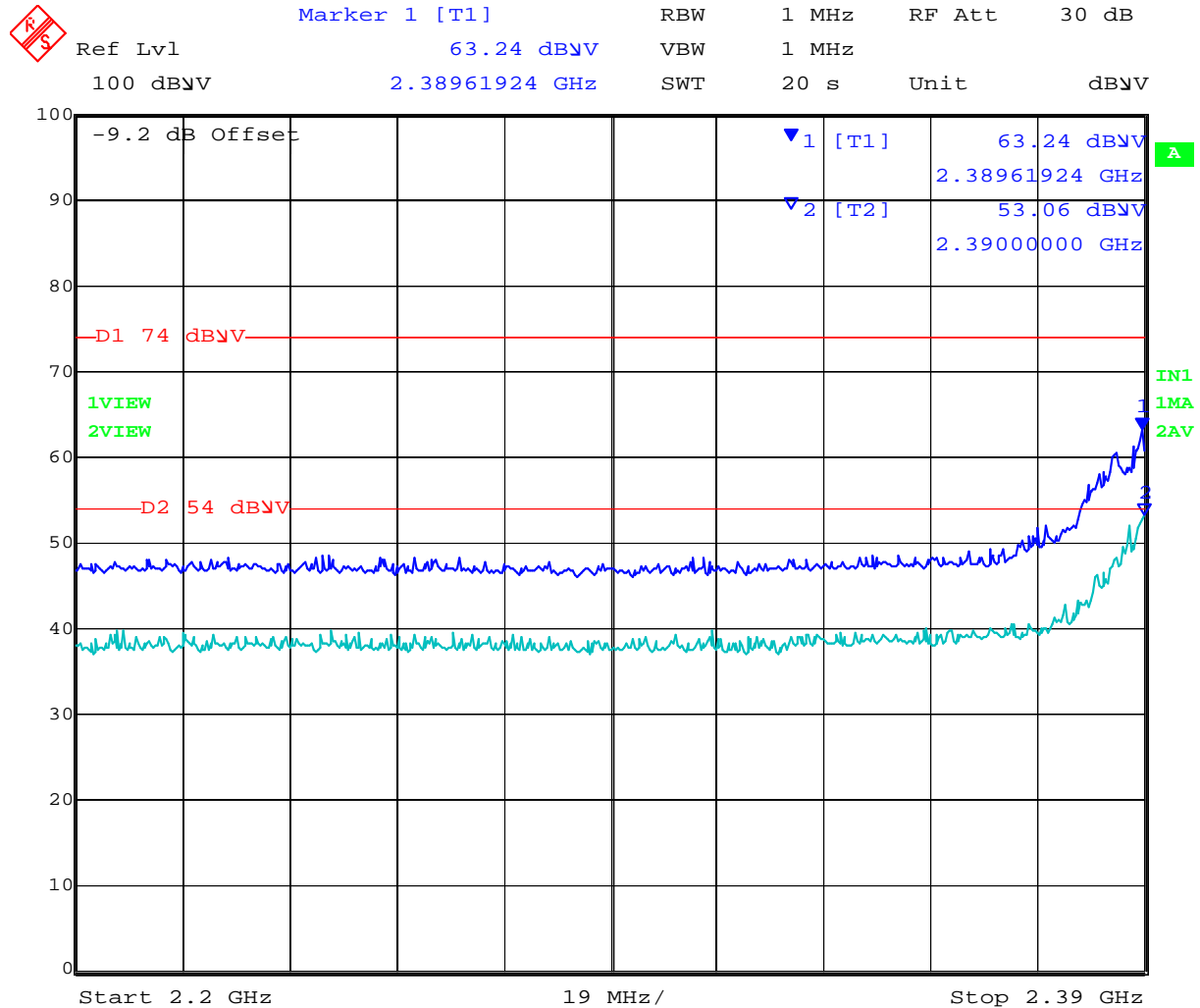

Date: 25.FEB.2014 19:17:41

Power reduction required to bring into compliance. Power now set for 16

This test report may be reproduced in full only. The document may only be updated by MiCOM Labs personnel. Any changes will be noted in the Document History section of the report.



Band Edge 802.11g 2462 MHz

 Marker 1 [T1] RBW 1 MHz RF Att 30 dB
Ref Lvl 71.65 dBμV VBW 1 MHz
100 dBμV 2.48363226 GHz SWT 20 s Unit dBμV

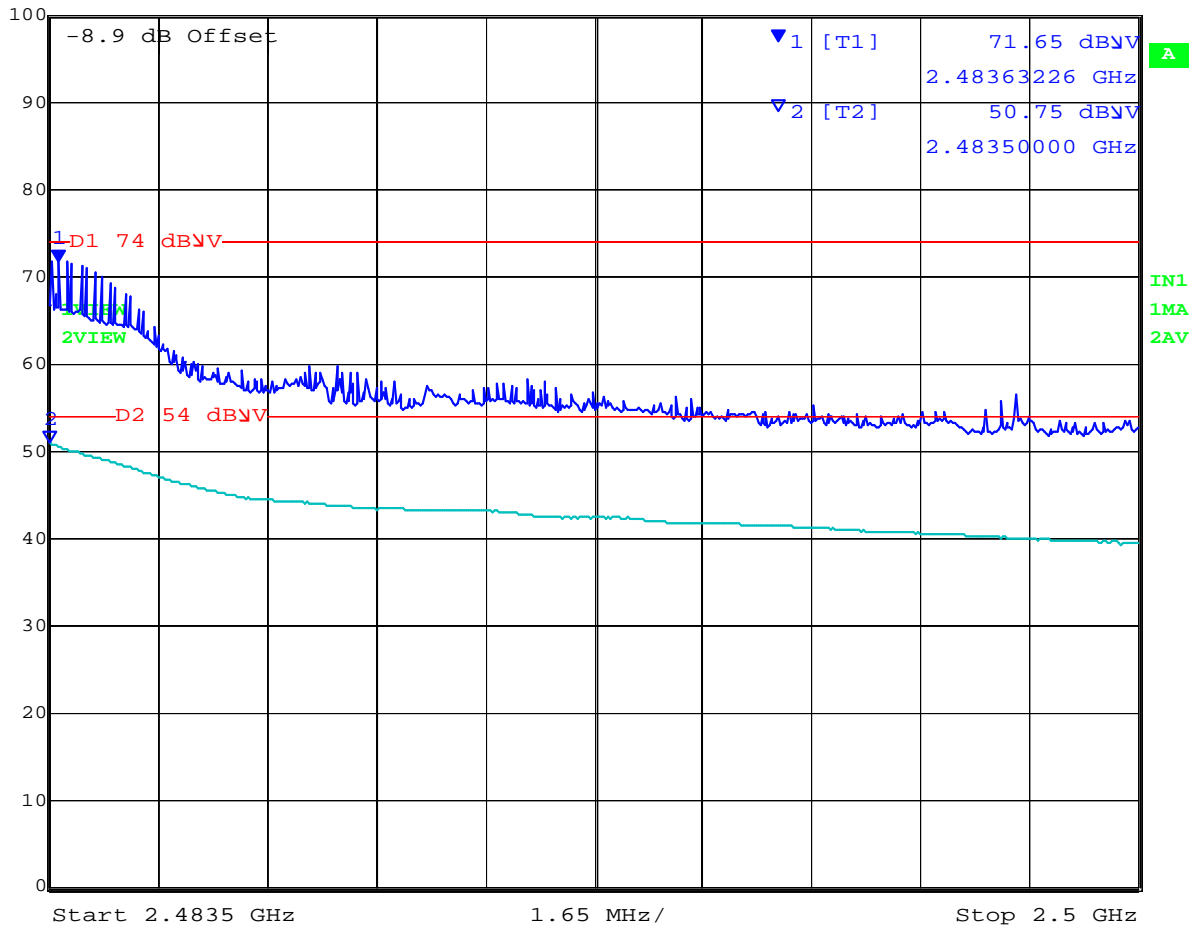

Date: 25.FEB.2014 19:40:20

This test report may be reproduced in full only. The document may only be updated by MiCOM Labs personnel. Any changes will be noted in the Document History section of the report.



Band Edge 802.11n HT20 2412 MHz

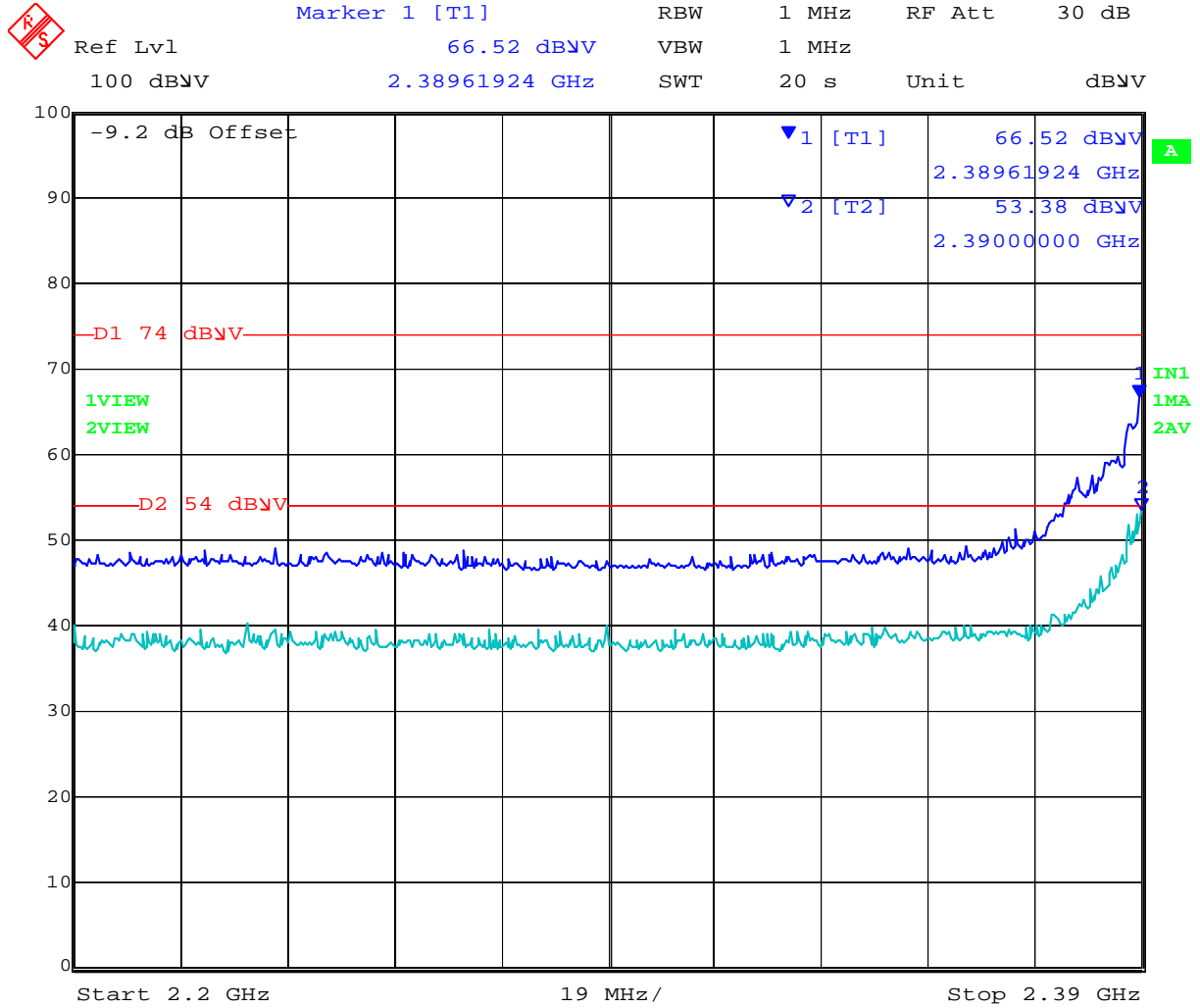

Date: 25.FEB.2014 19:22:17

Power reduction required to bring into compliance. Power now set for 15



Band Edge 802.11n HT20 2462 MHz



Date: 25.FEB.2014 19:42:38

This test report may be reproduced in full only. The document may only be updated by MiCOM Labs personnel. Any changes will be noted in the Document History section of the report.



Title: Digi Connect Card for i.MX28 with Atheros AR6203
To: FCC 47 CFR Part 15.247 & IC RSS-210
Serial #: DIGI36-U2 Rev A
Issue Date: 22nd May 2014
Page: 146 of 261

Band Edge 802.11n HT40 2422 MHz

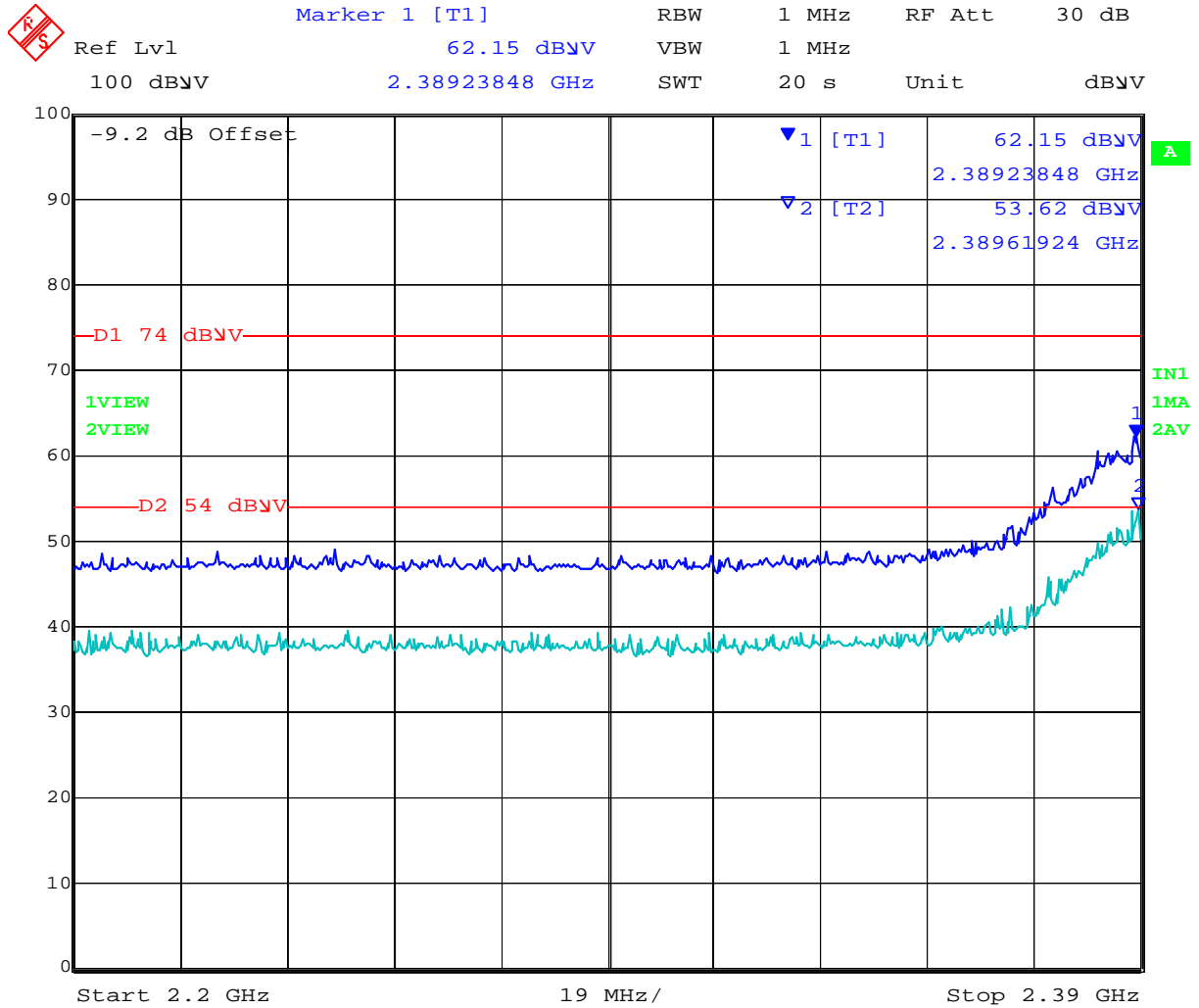

Date: 25.FEB.2014 19:26:29

Power reduction required to bring into compliance. Power now set for 18

This test report may be reproduced in full only. The document may only be updated by MiCOM Labs personnel. Any changes will be noted in the Document History section of the report.



Band Edge 802.11n HT40 2452 MHz

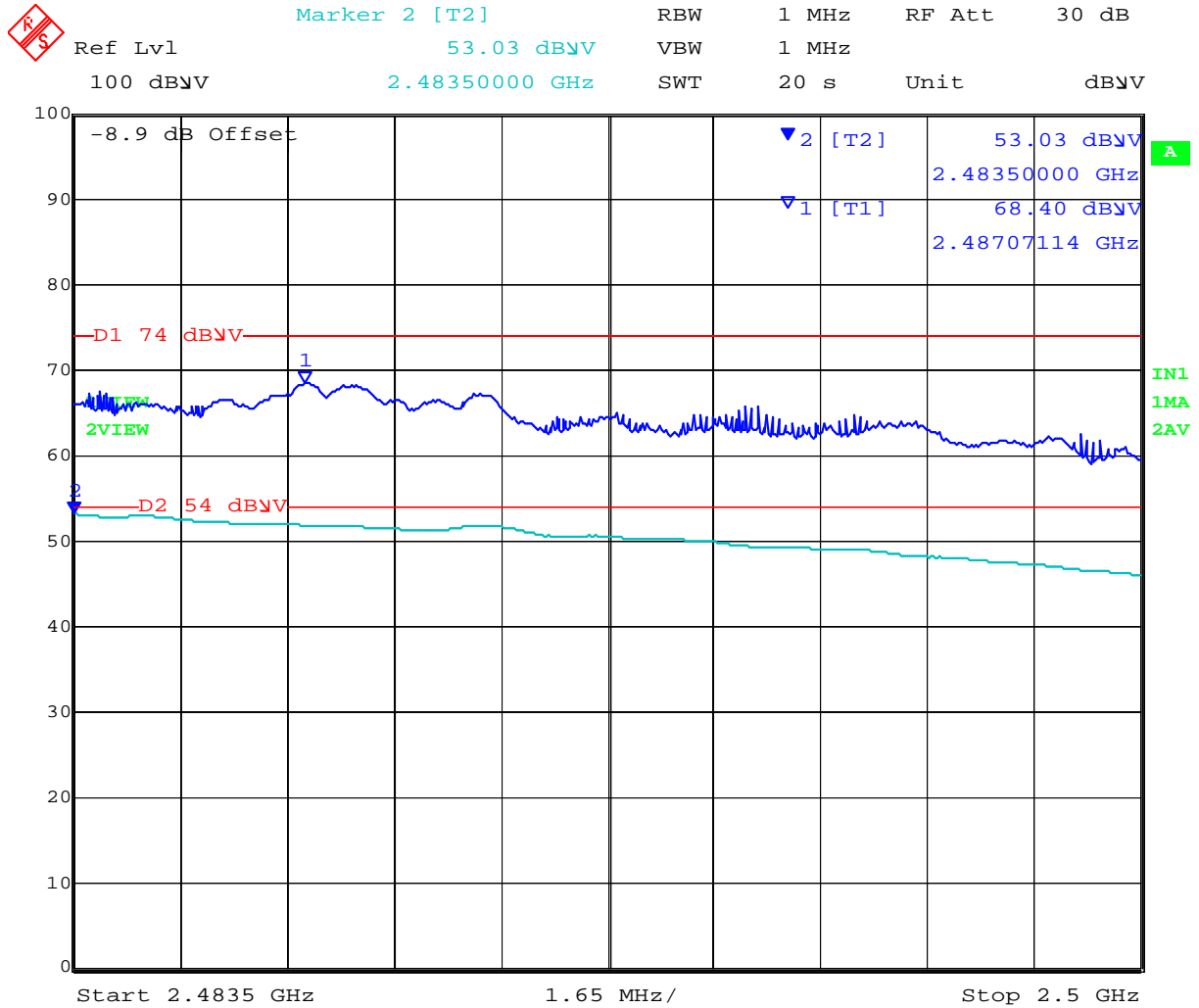

Date: 25.FEB.2014 19:48:27

Power reduction required to bring into compliance. Power now set for 18

This test report may be reproduced in full only. The document may only be updated by MiCOM Labs personnel. Any changes will be noted in the Document History section of the report.



Title: Digi Connect Card for i.MX28 with Atheros AR6203
To: FCC 47 CFR Part 15.247 & IC RSS-210
Serial #: DIGI36-U2 Rev A
Issue Date: 22nd May 2014
Page: 148 of 261

Test Freq.	5745 MHz	Engineer	JMH
Variant	802.11a; 6.5 Mbs	Temp (°C)	18
Freq. Range	1000 MHz - 18000 MHz	Rel. Hum.(%)	32
Power Setting	18	Press. (mBars)	1002
Antenna	compacted balanced dipole x2	Duty Cycle (%)	100
Test Notes 1	Dual Port Module		
Test Notes 2	Power reduced to meet limit		

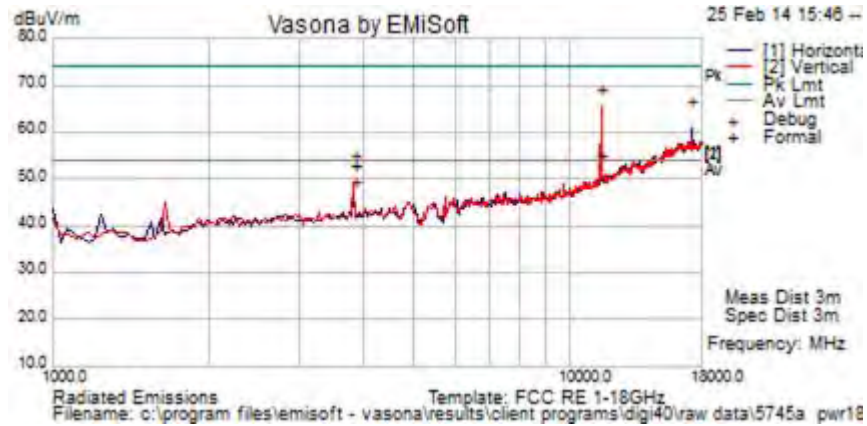

Formally measured emission peaks

Frequency MHz	Raw dBuV	Cable Loss	AF dB	Level dBuV/m	Measurement Type	Pol	Hgt cm	Azt Deg	Limit dBuV/m	Margin dB	Pass /Fail	Comments
11490.519	53.5	9.4	4.0	66.9	Peak.	V	135	5	74.0	-7.1	Pass	RB
11490.519	39.6	9.4	4.0	53.0	Average	V	135	5	54.0	-1.0	Pass	RB
17235.766	42.0	12.4	10.1	64.4	Peak.	H	128	308	74	-9.6	Pass	NRB
3830.029	51.7	5.0	-3.9	52.8	Peak.	V	147	257	74	-21.2	Pass	RB
3830.029	46.2	5.0	-3.9	47.3	Average.	V	147	257	54	-6.7	Pass	RB
Legend: TX = Transmitter Emissions; DIG = Digital Emissions; FUND = Fundamental; WB = Wideband Emission RB = Restricted Band (15.209 Limits); NRB = Non Restricted Band, Limit is 20dB below fundamental peak												

This test report may be reproduced in full only. The document may only be updated by MiCOM Labs personnel. Any changes will be noted in the Document History section of the report.



Title: Digi Connect Card for i.MX28 with Atheros AR6203
To: FCC 47 CFR Part 15.247 & IC RSS-210
Serial #: DIGI36-U2 Rev A
Issue Date: 22nd May 2014
Page: 149 of 261

Test Freq.	5785 MHz	Engineer	JMH
Variant	802.11a; 6.5 Mbs	Temp (°C)	18
Freq. Range	1000 MHz - 18000 MHz	Rel. Hum.(%)	32
Power Setting	14	Press. (mBars)	1002
Antenna	compacted balanced dipole x2	Duty Cycle (%)	100
Test Notes 1	Dual Port Module		
Test Notes 2	Power reduced to meet limit		

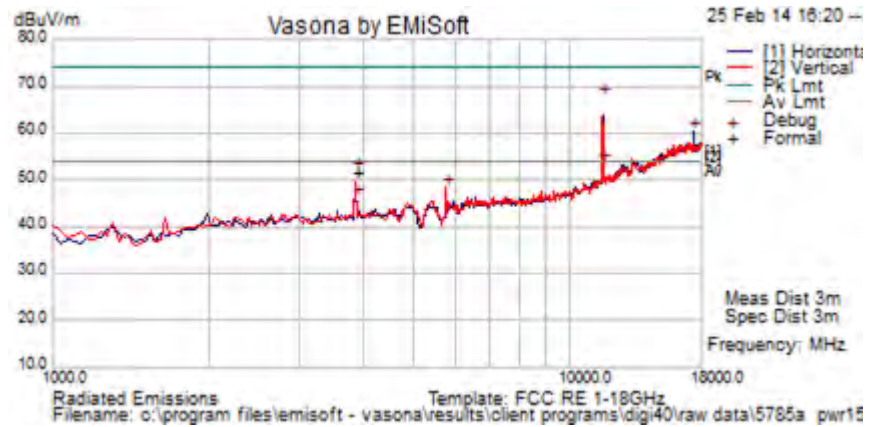

Formally measured emission peaks

Frequency MHz	Raw dBuV	Cable Loss	AF dB	Level dBuV/m	Measurement Type	Pol	Hgt cm	Azt Deg	Limit dBuV/m	Margin dB	Pass /Fail	Comments
11570.544	53.9	9.4	4.1	67.4	Peak	V	106	1	74.0	-6.6	Pass	RB
11570.588	40.0	9.4	4.1	53.5	Average	V	106	1	54.0	-0.5	Pass	RB
17352.705	37.8	12.4	10.1	60.3	Peak [Scan]	H	100	0	54	6.3	Fail	NRB
3856.663	50.3	5.0	-3.8	51.5	Peak	V	106	57	74	-22.5	Pass	RB
3856.571	44.9	5.0	-3.8	46.1	Average	V	106	57	54	-7.9	Pass	RB
5770.820	44.1	6.3	-2.4	48.0	Peak [Scan]	V	106	57	54	-6.0	Pass	FUND

Legend: TX = Transmitter Emissions; DIG = Digital Emissions; FUND = Fundamental; WB = Wideband Emission
 RB = Restricted Band (15.209 Limits); NRB = Non Restricted Band, Limit is 20dB below fundamental peak

This test report may be reproduced in full only. The document may only be updated by MiCOM Labs personnel. Any changes will be noted in the Document History section of the report.



Title: Digi Connect Card for i.MX28 with Atheros AR6203
To: FCC 47 CFR Part 15.247 & IC RSS-210
Serial #: DIGI36-U2 Rev A
Issue Date: 22nd May 2014
Page: 150 of 261

Test Freq.	5825 MHz	Engineer	JMH
Variant	802.11a; 6.5 Mbs	Temp (°C)	18
Freq. Range	1000 MHz - 18000 MHz	Rel. Hum.(%)	32
Power Setting	14	Press. (mBars)	1002
Antenna	compacted balanced dipole x2	Duty Cycle (%)	100
Test Notes 1	Dual Port Module		
Test Notes 2	Power reduced to meet limit		

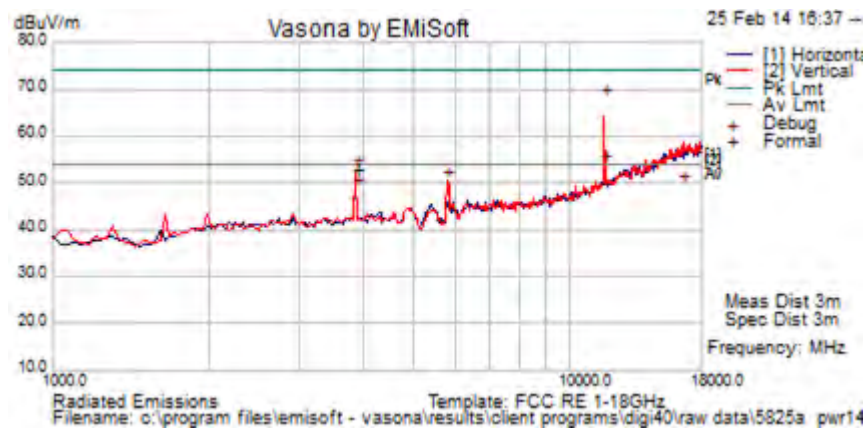

Formally measured emission peaks

Frequency MHz	Raw dBuV	Cable Loss	AF dB	Level dBuV/m	Measurement Type	Pol	Hgt cm	Azt Deg	Limit dBuV/m	Margin dB	Pass /Fail	Comments
11650.549	54.2	9.4	4.2	67.8	Peak	V	109	0	74.0	-6.2	Pass	RB
11650.521	40.0	9.4	4.2	53.6	Average	V	109	0	54.0	-0.4	Pass	RB
16568.653	27.7	11.9	9.8	49.5	Average	V	103	0	54	-4.5	Pass	Noise Floor
3883.377	51.6	5.0	-3.7	52.9	Peak	V	120	112	74	-21.1	Pass	RB
3883.293	47.3	5.0	-3.7	48.6	Average	V	120	112	54	-5.4	Pass	RB
5803.607	46.6	6.3	-2.3	50.6	Peak [Scan]							FUND

Legend: TX = Transmitter Emissions; DIG = Digital Emissions; FUND = Fundamental; WB = Wideband Emission
 RB = Restricted Band (15.209 Limits); NRB = Non Restricted Band, Limit is 20dB below fundamental peak

This test report may be reproduced in full only. The document may only be updated by MiCOM Labs personnel. Any changes will be noted in the Document History section of the report.



Title: Digi Connect Card for i.MX28 with Atheros AR6203
To: FCC 47 CFR Part 15.247 & IC RSS-210
Serial #: DIGI36-U2 Rev A
Issue Date: 22nd May 2014
Page: 151 of 261

Band Edge 802.11a 5745 MHz

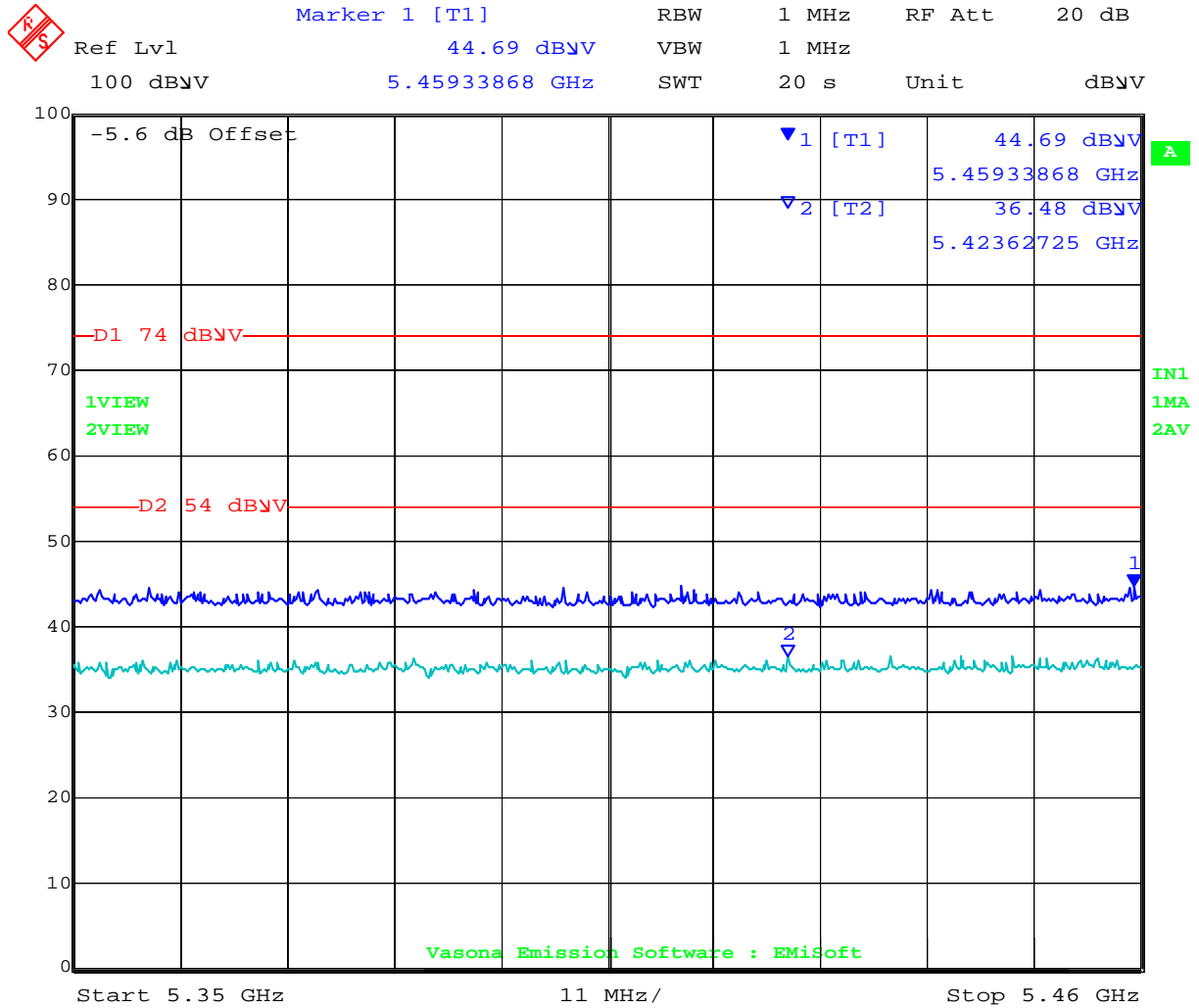

Date: 25.FEB.2014 17:07:06

This test report may be reproduced in full only. The document may only be updated by MiCOM Labs personnel. Any changes will be noted in the Document History section of the report.



Title: Digi Connect Card for i.MX28 with Atheros AR6203
To: FCC 47 CFR Part 15.247 & IC RSS-210
Serial #: DIGI36-U2 Rev A
Issue Date: 22nd May 2014
Page: 152 of 261

Band Edge 802.11n HT-20 5745 MHz

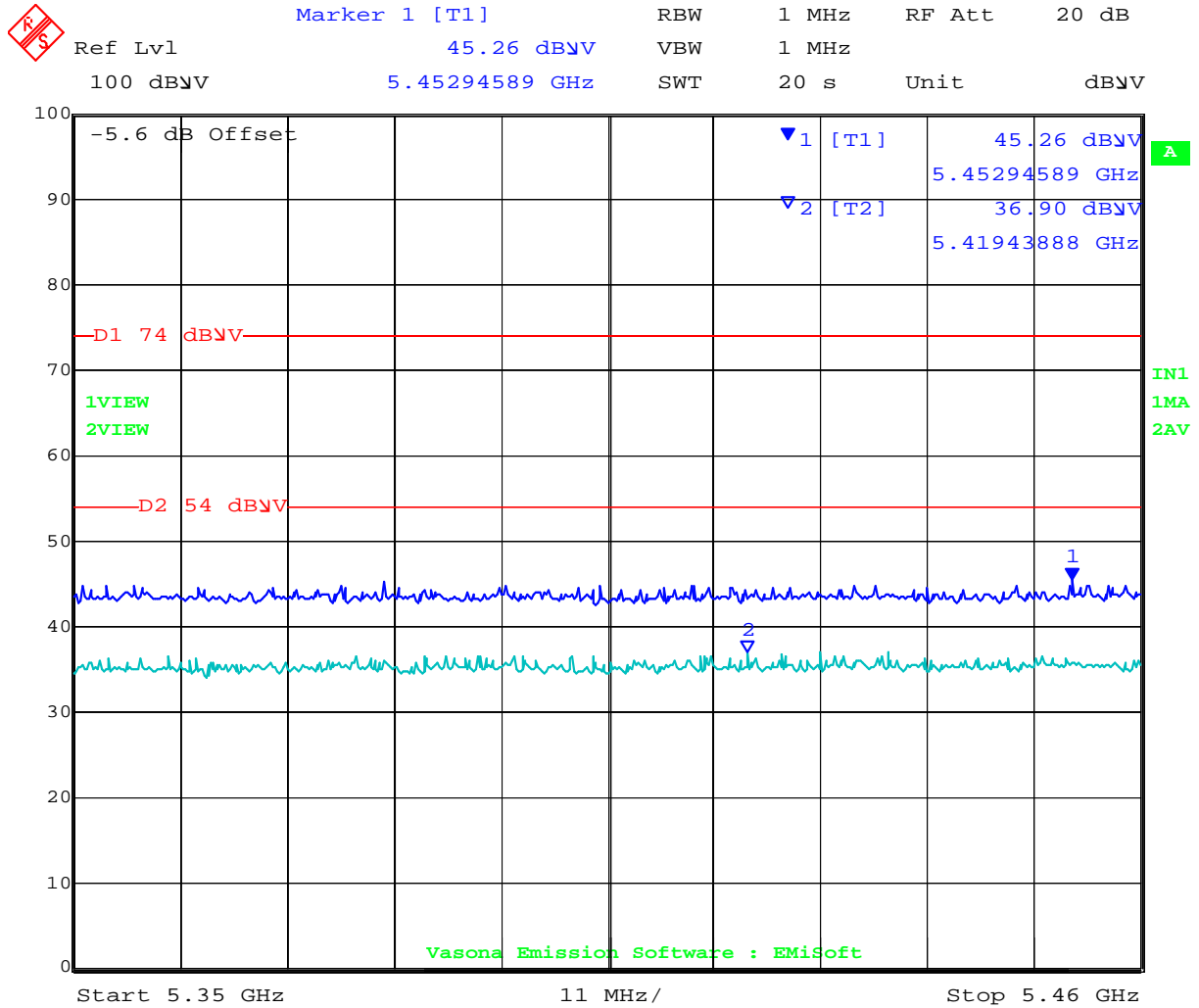

Date: 25.FEB.2014 17:19:07

This test report may be reproduced in full only. The document may only be updated by MiCOM Labs personnel. Any changes will be noted in the Document History section of the report.



Band Edge 802.11n HT-40 5755 MHz

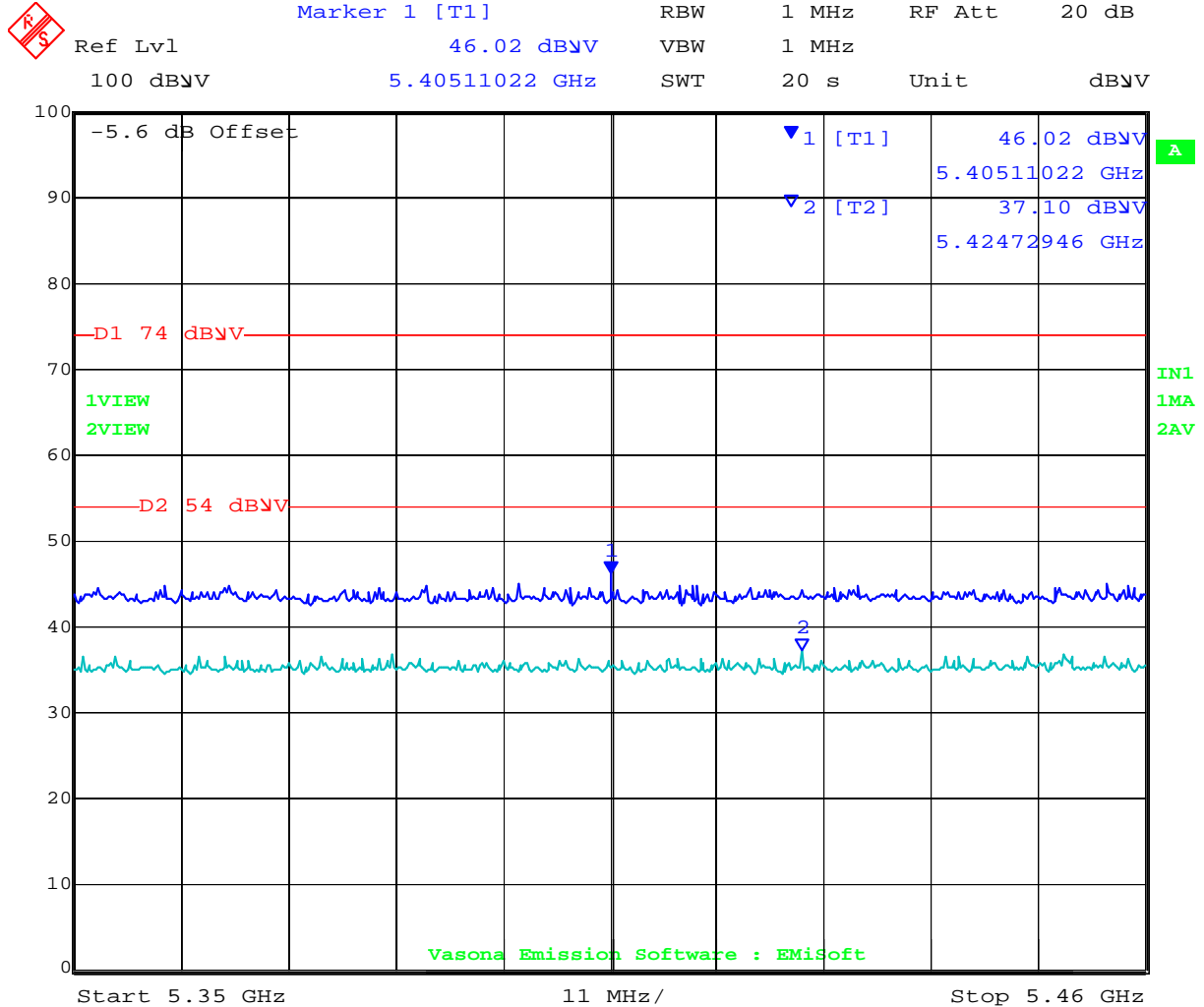

Date: 25.FEB.2014 17:27:22

This test report may be reproduced in full only. The document may only be updated by MiCOM Labs personnel. Any changes will be noted in the Document History section of the report.



Title: Digi Connect Card for i.MX28 with Atheros AR6203
To: FCC 47 CFR Part 15.247 & IC RSS-210
Serial #: DIGI36-U2 Rev A
Issue Date: 22nd May 2014
Page: 154 of 261

Specification Limits

FCC §15.247(d) and RSS-210 §A8.5 In any 100 kHz bandwidth outside the frequency band in which the spread spectrum or digitally modulated intentional radiator is operating, the radio frequency power that is produced by the intentional radiator shall be at least 20 dB below that in the 100 kHz bandwidth within the band that contains the highest level of the desired power, based on either an RF conducted or radiated measurement, provided the transmitter demonstrates compliance with the peak conducted power limits.

FCC §15.247(d)

If the transmitter complies with the conducted power limits based on the use of RMS averaging over a time interval, as permitted under paragraph (b)(3) of this section, the attenuation required under this paragraph shall be 30 dB instead of 20 dB. Attenuation below the general limits specified §15.209(a) is not required. In addition, radiated emissions which fall in the restricted bands, as defined in Section §15.205(a), must also comply with the radiated emission limits specified in Section 15.209(a) (see Section 15.205(a)).

IC RSS-210 §A8.5 If the transmitter complies with the conducted power limits based on the use of RMS averaging over a time interval, as permitted under section A8.4(4), the attenuation required shall be 30 dB instead of 20 dB. Attenuation below the general limits specified in Tables 2 and 3 is not required. In addition, radiated emissions which fall in the restricted bands of Table 1 must also comply with the radiated emission limits specified in Tables 2 and 3.

IC RSS-Gen §4.7

The search for unwanted emissions shall be from the lowest frequency internally generated or used in the device (local oscillator, intermediate or carrier frequency), or from 30 MHz, whichever is the lowest frequency, to the 5th harmonic of the highest frequency generated without exceeding 40 GHz.

FCC §15.205 (a) Except as shown in paragraph (d) of 15.205 (a), only spurious emissions are permitted in any of the frequency bands listed.

FCC §15.205 (a) Except as shown in paragraphs (d) and (e) of this section, the field strength of emissions appearing within these frequency bands shall not exceed the limits shown in Section §15.209. At frequencies equal to or less than 1000 MHz, compliance with the limits in Section 15.209 shall be demonstrated using measurement instrumentation employing a CISPR quasi-peak detector. Above 1000 MHz, compliance with the emission limits in Section 15.209 shall be demonstrated based on the average value of the measured emissions. The provisions in Section 15.35 apply to these measurements.

FCC §15.209 (a) Except as provided elsewhere in this subpart, the emissions from an intentional radiator shall not exceed the field strength levels specified in the following table.

This test report may be reproduced in full only. The document may only be updated by MiCOM Labs personnel. Any changes will be noted in the Document History section of the report.



Title: Digi Connect Card for i.MX28 with Atheros AR6203
To: FCC 47 CFR Part 15.247 & IC RSS-210
Serial #: DIGI36-U2 Rev A
Issue Date: 22nd May 2014
Page: 155 of 261

§15.209 (a) Limit Matrix

Frequency(MHz)	Field Strength ($\mu\text{V}/\text{m}$)	Field Strength ($\text{dB}\mu\text{V}/\text{m}$)	Measurement Distance (meters)
30-88	100	40.0	3
88-216	150	43.5	3
216-960	200	46.0	3
Above 960	500	54.0	3

Laboratory Measurement Uncertainty for Radiated Emissions

Measurement uncertainty	+5.6/ -4.5 dB
-------------------------	---------------

Traceability

Method	Test Equipment Used
Measurements were made per work instruction WI-03 'Measurement of Radiated Emissions'	0088, 0158, 0134, 0304, 0311, 0315, 0310, 0312

This test report may be reproduced in full only. The document may only be updated by MiCOM Labs personnel. Any changes will be noted in the Document History section of the report.



6.1.2.6. Digital Emissions (0.03-1 GHz)

FCC, Part 15 Subpart C §15.205/ §15.209
Industry Canada RSS-210 §2.2

Test Procedure

Testing 30M-1 GHz was performed in a 3-meter anechoic chamber using a CISPR compliant receiver. Preliminary radiated emissions were measured on every azimuth and with the receiving antenna in both horizontal and vertical polarizations. To further maximize emissions the receive antenna was varied between 1 and 4 meters. The emissions are recorded with receiver in peak hold mode. Emissions closest to the limits are measured in the quasi-peak mode with the tuned receiver using a bandwidth of 120 kHz. Only the highest emissions relative to the limit are listed. The anechoic chamber test set-up is identified in Section 6 Test Set-Up Photographs.

The EUT had two methods of powering on ac/dc converter and Power over Ethernet (POE). Both modes were tested for emissions below 1GHz.

Field Strength Calculation

The field strength is calculated by adding the Antenna Factor and Cable Loss, and subtracting Amplifier Gain from the measured reading. In this test facility, the Antenna Factor, Cable Loss, and Amplifier Gains are loaded into the Rohde & Schwarz Receiver and the corrected field strength can be read directly on the receiver.

$$FS = R + AF + CORR$$

where:

FS = Field Strength
R = Measured Receiver Input Amplitude
AF = Antenna Factor
CORR = Correction Factor = CL – AG + NFL
CL = Cable Loss
AG = Amplifier Gain

For example:

Given a Receiver input reading of 51.5dB μ V; Antenna Factor of 8.5dB; Cable Loss of 1.3dB; Falloff Factor of 0dB, an Amplifier Gain of 26dB and Notch Filter Loss of 1dB. The Field Strength of the measured emission is:

$$FS = 51.5 + 8.5 + 1.3 - 26.0 + 1 = 36.3\text{dB}\mu\text{V/m}$$

Conversion between dB μ V/m (or dB μ V) and μ V/m (or μ V) are done as:

$$\text{Level (dB}\mu\text{V/m)} = 20 * \text{Log (level (\mu\text{V/m}))}$$

$$40 \text{ dB}\mu\text{V/m} = 100\mu\text{V/m}$$
$$48 \text{ dB}\mu\text{V/m} = 250\mu\text{V/m}$$



Title: Digi Connect Card for i.MX28 with Atheros AR6203
To: FCC 47 CFR Part 15.247 & IC RSS-210
Serial #: DIGI36-U2 Rev A
Issue Date: 22nd May 2014
Page: 157 of 261

Test Freq.	2437 MHz	Engineer	JMH
Variant	Digital Emissions	Temp (°C)	26
Freq. Range	30 MHz - 1000 MHz	Rel. Hum.(%)	38
Power Setting	NA	Press. (mBars)	1000
Antenna	PC.11		
Test Notes 1	Dual Port Module		
Test Notes 2			

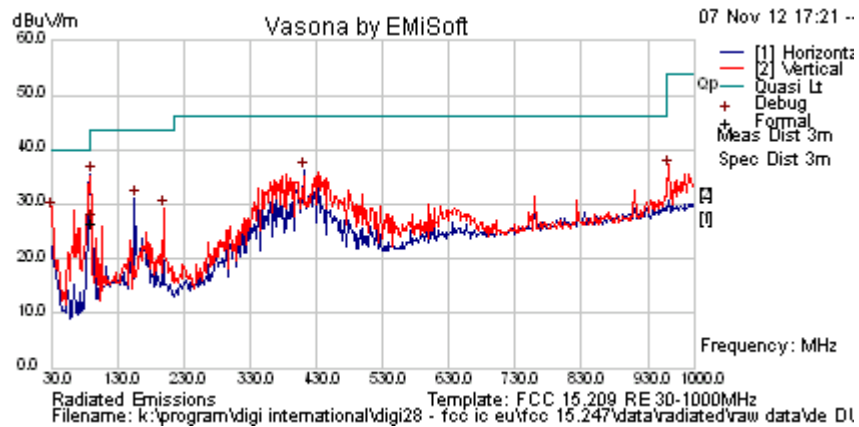

Formally measured emission peaks

Frequency MHz	Raw dBuV	Cable Loss	AF dB	Level dBuV/m	Measurement Type	Pol	Hgt cm	Azt Deg	Limit dBuV/m	Margin dB	Pass /Fail	Comments
89.431	55.2	4.0	-24.0	35.2	Peak [Scan]	H	216	0	43.5	-8.3	Pass	
411.025	45.0	5.5	-14.4	36.1	Peak [Scan]	H	98	360	46	-9.9	Pass	
30.939	35.6	3.5	-10.6	28.6	Peak [Scan]	V	98	360	40	-11.4	Pass	
156.378	45.3	4.4	-18.9	30.8	Peak [Scan]	H	98	360	43.5	-12.7	Pass	
199.149	42.8	4.6	-18.4	29.0	Peak [Scan]	V	98	360	43.5	-14.5	Pass	
89.431	46.7	4.0	-24.0	26.7	Quasi Max	H	216	0	43.5	-16.9	Pass	
961.430	36.3	7.3	-7.1	36.5	Peak [Scan]	V	98	360	54	-17.5	Pass	

Legend: DIG = Digital Device Emission; TX = Transmitter Emission; FUND = Fundamental Frequency
 NRB = Non-Restricted Band, Limit is 20 dB below Fundamental; RB = Restricted Band

This test report may be reproduced in full only. The document may only be updated by MiCOM Labs personnel. Any changes will be noted in the Document History section of the report.



Title: Digi Connect Card for i.MX28 with Atheros AR6203
To: FCC 47 CFR Part 15.247 & IC RSS-210
Serial #: DIGI36-U2 Rev A
Issue Date: 22nd May 2014
Page: 158 of 261

Specification

Limits

§15.205 (a) Except as shown in paragraph (d) of 15.205 (a), only spurious emissions are permitted in any of the frequency bands listed.

§15.205 (a) Except as shown in paragraphs (d) and (e) of this section, the field strength of emissions appearing within these frequency bands shall not exceed the limits shown in Section §15.209. At frequencies equal to or less than 1000 MHz, compliance with the limits in Section 15.209 shall be demonstrated using measurement instrumentation employing a CISPR quasi-peak detector. Above 1000 MHz, compliance with the emission limits in Section 15.209 shall be demonstrated based on the average value of the measured emissions. The provisions in Section 15.35 apply to these measurements.

§15.209 (a) Except as provided elsewhere in this subpart, the emissions from an intentional radiator shall not exceed the field strength levels specified in the following table.

§15.209 (a) and RSS-Gen §2.2 Limit Matrix

Frequency(MHz)	Field Strength ($\mu\text{V/m}$)	Field Strength ($\text{dB}\mu\text{V/m}$)	Measurement Distance (meters)
30-88	100	40.0	3
88-216	150	43.5	3
216-960	200	46.0	3
Above 960	500	54.0	3

Laboratory Measurement Uncertainty for Radiated Emissions

Measurement uncertainty	+5.6/ -4.5 dB
-------------------------	---------------

Traceability

Method	Test Equipment Used
Measurements were made per work instruction WI-03 'Measurement of Radiated Emissions'	0088, 0158, 0134, 0304, 0311, 0315, 0310, 0312

This test report may be reproduced in full only. The document may only be updated by MiCOM Labs personnel. Any changes will be noted in the Document History section of the report.

6.1.3. AC Wireline Conducted Emissions (150 kHz – 30 MHz)

FCC, Part 15 Subpart C §15.207
Industry Canada RSS-Gen §7.2.2

Test Procedure

The EUT is configured in accordance with ANSI C63.4. The conducted emissions are measured in a shielded room with a spectrum analyzer in peak hold in the first instance. Emissions closest to the limit are measured in the quasi-peak mode (QP) with the tuned receiver using a bandwidth of 9 kHz. The emissions are maximized further by cable manipulation. The highest emissions relative to the limit are listed.

Test Measurement Set up

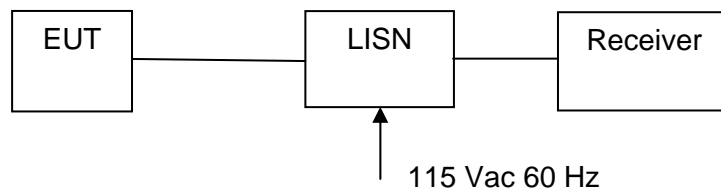

Measurement set up for AC Wireline Conducted Emissions Test

Measurement Results for AC Wireline Conducted Emissions (150 kHz – 30 MHz)

Ambient conditions.

Temperature: 17 to 23 °C Relative humidity: 31 to 57 % Pressure: 999 to 1012 mbar

Not required - EUT is power by DC only.



Specification

Limit

§15.207 (a) Except as shown in paragraphs (b) and (c) of this section, for an intentional radiator that is designed to be connected to the public utility (AC) power line, the radio frequency voltage that is conducted back onto the AC power line on any frequency or frequencies within the band 150 kHz to 30 MHz shall not exceed the limits in the following table, as measured using a 50 $\mu\Omega$ line impedance stabilization network (LISN), see §15.207 (a) matrix below. Compliance with the provisions of this paragraph shall be based on the measurement of the radio frequency voltage between each power line and ground at the power terminal.

RSS-Gen §7.2.2

The radio frequency voltage that is conducted back into the AC power lines in the frequency range of 0.15 MHz to 30 MHz shall not exceed the limits shown in the table below. The tighter limit applies at the frequency range boundaries.

§15.207 (a) and **RSS-Gen §7.2.2** Limit Matrix

The lower limit applies at the boundary between frequency ranges

Frequency of Emission (MHz)	Conducted Limit (dB μ V)	
	Quasi-peak	Average
0.15-0.5	66 to 56*	56 to 46*
0.5-5	56	46
5-30	60	50

* Decreases with the logarithm of the frequency

Laboratory Measurement Uncertainty for Conducted Emissions

Measurement uncertainty	± 2.64 dB
-------------------------	---------------

Traceability

Method	Test Equipment Used
Measurements were made per work instruction WI-EMC-01 'Measurement of Conducted Emissions'	0158, 0184, 0287, 0190, 0293, 0307

This test report may be reproduced in full only. The document may only be updated by MiCOM Labs personnel. Any changes will be noted in the Document History section of the report.

7. PHOTOGRAPHS

7.1. Conducted Test Setup



This test report may be reproduced in full only. The document may only be updated by MiCOM Labs personnel. Any changes will be noted in the Document History section of the report.

7.2. Test Setup - Digital Emissions below 1 GHz



This test report may be reproduced in full only. The document may only be updated by MiCOM Labs personnel. Any changes will be noted in the Document History section of the report.

7.3. Radiated Emissions Test Setup >1 GHz

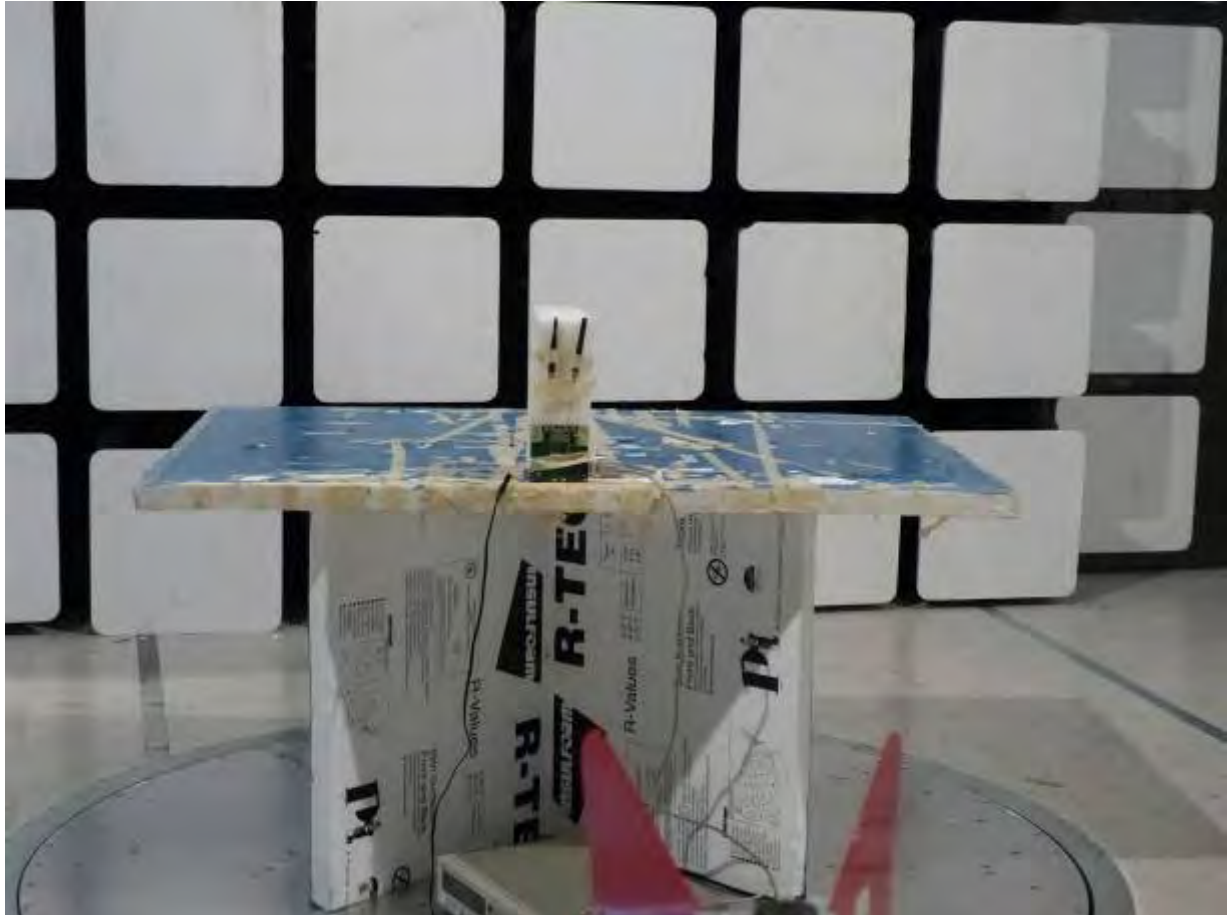

7.4. Dual Band – Compact Balanced Dipole (emissions above 1 GHz)



This test report may be reproduced in full only. The document may only be updated by MiCOM Labs personnel. Any changes will be noted in the Document History section of the report.



Title: Digi Connect Card for i.MX28 with Atheros AR6203
To: FCC 47 CFR Part 15.247 & IC RSS-210
Serial #: DIGI36-U2 Rev A
Issue Date: 22nd May 2014
Page: 165 of 261

8. TEST EQUIPMENT

Asset #	Instrument	Manufacturer	Model #	Serial #
0072	Signal Generator	Hewlett Packard	HP 83640A	2927A00105
0075	Environmental Chamber	Thermatron	SE-300-2-2	27946
0338	Antenna (30M-3GHz)	Sunol Sciences	JB3	A052907
0083	Coupler	Hewlett Packard	HP 87301D	3116A00389
0287	EMI Receiver	Rhode & Schwartz	ESIB 40	100201
0098	Oscilloscope	Hewlett Packard	54810A	US38100105
0335	Horn Antenna	The Electro-Mechanics Company	3117	00066580
0116	Power Sensor	Hewlett Packard	8485A	3318A19694
0117	Power Sensor	Hewlett Packard	8487D	3318A00371
0134	Amplifier	ComPower	PA-122	181910
0158	Barometer /Thermometer	Control Co.	4196	E2844
0193	EMI Receiver	Rhode & Schwartz	ESI 7	838496/007
0223	Power Meter	Hewlett Packard	HP EPM-442A	US37480256
0252	K-Cable	Megaphase	Sucoflex 104	Unknown
0253	K-Cable	Megaphase	Sucoflex 104	Unknown
0256	K-Cable	Megaphase	Sucoflex 104	Unknown
0251	K-Cable	Megaphase	Sucoflex 104	Unknown
0305	20M-2GHz Amplifier	ML	ML001	001
0310	2m SMA Cable	Micro-Coax	UFA210A-0-0787-3G03G0	209089-001
0312	3m SMA Cable	Micro-Coax	UFA210A-1-1181-3G0300	209092-001
0313	Coupler	Hewlett Packard	86205A	3140A01285
0314	30 dB N-Type Attenuator	ARRA	N944-30	1623
Dipole	20MHz-1GHz Dipole Antennas	EMCO	3121C	9009-505

This test report may be reproduced in full only. The document may only be updated by MiCOM Labs personnel. Any changes will be noted in the Document History section of the report.



Title: Digi Connect Card for i.MX28 with Atheros AR6203
To: FCC 47 CFR Part 15.247 & IC RSS-210
Serial #: DIGI36-U2 Rev A
Issue Date: 22nd May 2014
Page: 166 of 261

APPENDIX

A. SUPPORTING INFORMATION

A.1. CONDUCTED TEST PLOTS

This test report may be reproduced in full only. The document may only be updated by MiCOM Labs personnel. Any changes will be noted in the Document History section of the report.



A.1.1. 6 dB & 99% Bandwidth

Dual Port Module Graphs



6 dB 99%

Variant: 802.11b, Channel: 2412.00 MHz, Chain a, Temp: Ambient, Voltage: 5.00V

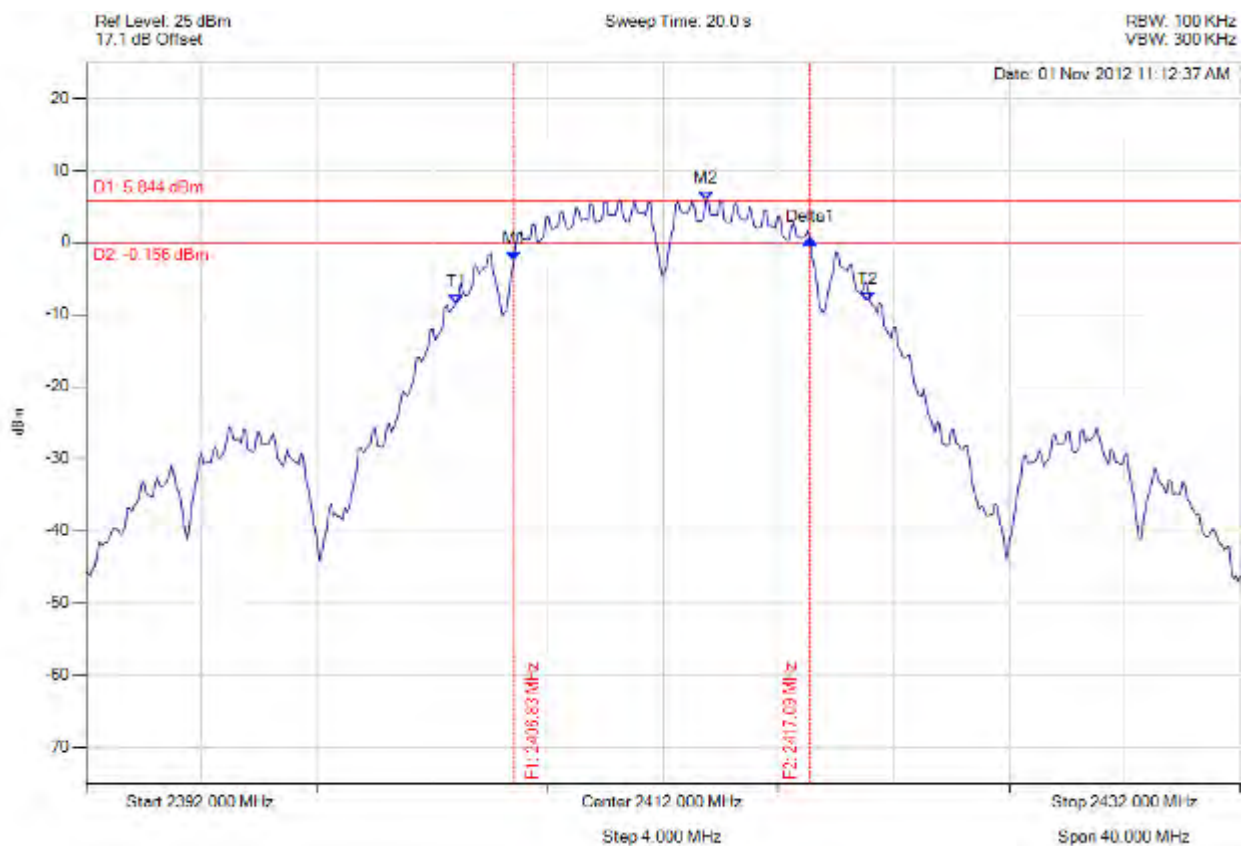

Analyser Setup	Marker : Frequency : Amplitude	Test Results
Detector = MAX PEAK Sweep Count = 0 RF Atten (dB) = 20 Trace Mode = VIEW	M1 : 2406.830 MHz : -2.563 dBm M2 : 2413.483 MHz : 5.844 dBm Delta1 : 10.261 MHz : 3.103 dB T1 : 2404.826 MHz : -8.490 dBm T2 : 2419.094 MHz : -8.193 dBm OBW : 14.349 MHz	Measured 6 dB Bandwidth: 10.261 MHz Limit: ≥ 0.5 MHz Margin: -9.76 MHz

[Back to the Matrix](#)

This test report may be reproduced in full only. The document may only be updated by MiCOM Labs personnel. Any changes will be noted in the Document History section of the report.



Title: Digi Connect Card for i.MX28 with Atheros AR6203
To: FCC 47 CFR Part 15.247 & IC RSS-210
Serial #: DIGI36-U2 Rev A
Issue Date: 22nd May 2014
Page: 168 of 261



6 dB 99%

Variant: 802.11b, Channel: 2437.00 MHz, Chain a, Temp: Ambient, Voltage: 5.00V

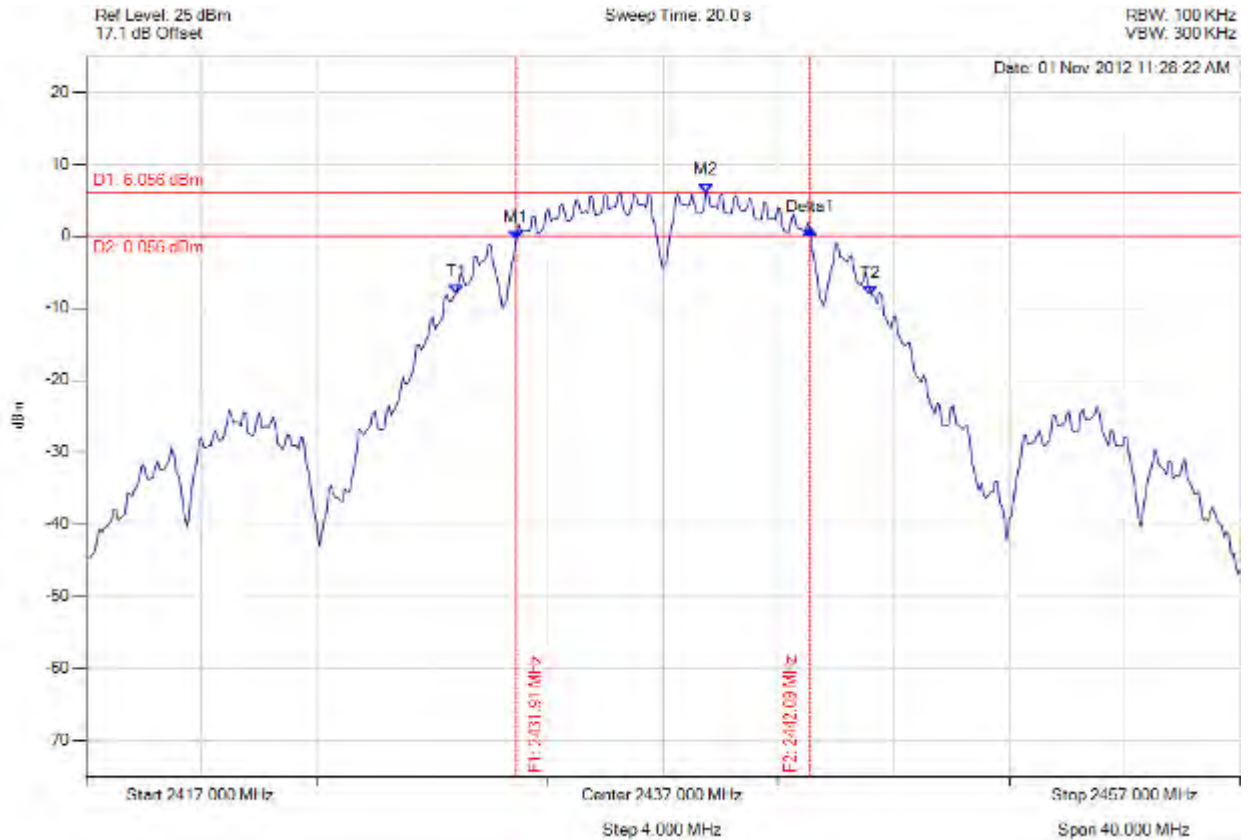

Analyser Setup	Marker : Frequency : Amplitude	Test Results
Detector = MAX PEAK Sweep Count = 0 RF Atten (dB) = 20 Trace Mode = VIEW	M1 : 2431.910 MHz : -0.540 dBm M2 : 2438.483 MHz : 6.056 dBm Delta1 : 10.180 MHz : 1.552 dB T1 : 2429.826 MHz : -8.016 dBm T2 : 2444.174 MHz : -8.187 dBm OBW : 14.429 MHz	Measured 6 dB Bandwidth: 10.180 MHz Limit: ≥ 0.5 MHz Margin: -9.68 MHz

[Back to the Matrix](#)

This test report may be reproduced in full only. The document may only be updated by MiCOM Labs personnel. Any changes will be noted in the Document History section of the report.



Title: Digi Connect Card for i.MX28 with Atheros AR6203
To: FCC 47 CFR Part 15.247 & IC RSS-210
Serial #: DIGI36-U2 Rev A
Issue Date: 22nd May 2014
Page: 169 of 261



6 dB 99%

Variant: 802.11b, Channel: 2462.00 MHz, Chain a, Temp: Ambient, Voltage: 5.00V

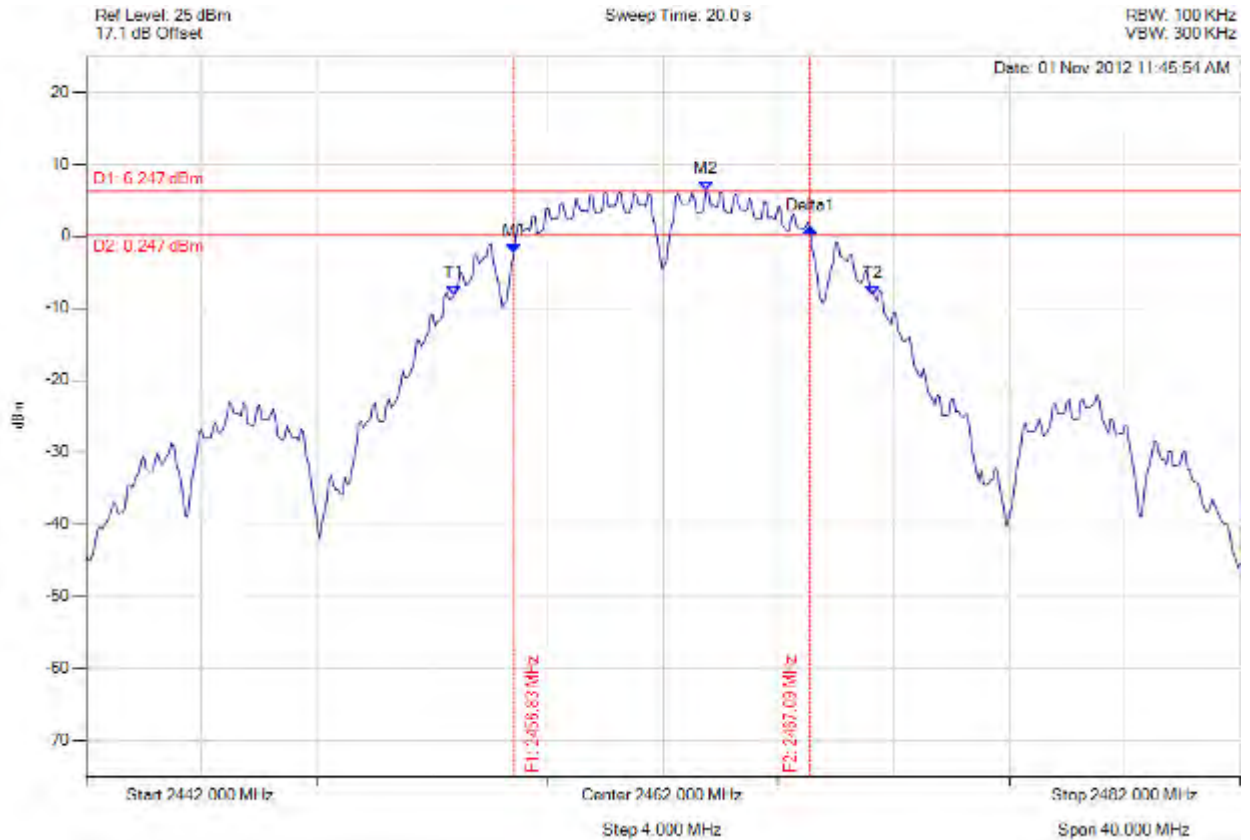

Analyser Setup	Marker : Frequency : Amplitude	Test Results
Detector = MAX PEAK Sweep Count = 0 RF Atten (dB) = 20 Trace Mode = VIEW	M1 : 2456.830 MHz : -2.411 dBm M2 : 2463.483 MHz : 6.247 dBm Delta1 : 10.261 MHz : 3.537 dB T1 : 2454.745 MHz : -8.266 dBm T2 : 2469.255 MHz : -8.280 dBm OBW : 14.589 MHz	Measured 6 dB Bandwidth: 10.261 MHz Limit: ≥ 0.5 MHz Margin: -9.76 MHz

[Back to the Matrix](#)

This test report may be reproduced in full only. The document may only be updated by MiCOM Labs personnel. Any changes will be noted in the Document History section of the report.



Title: Digi Connect Card for i.MX28 with Atheros AR6203
To: FCC 47 CFR Part 15.247 & IC RSS-210
Serial #: DIGI36-U2 Rev A
Issue Date: 22nd May 2014
Page: 170 of 261



6 dB 99%

Variant: 802.11g, Channel: 2412.00 MHz, Chain a, Temp: Ambient, Voltage: 5.00V

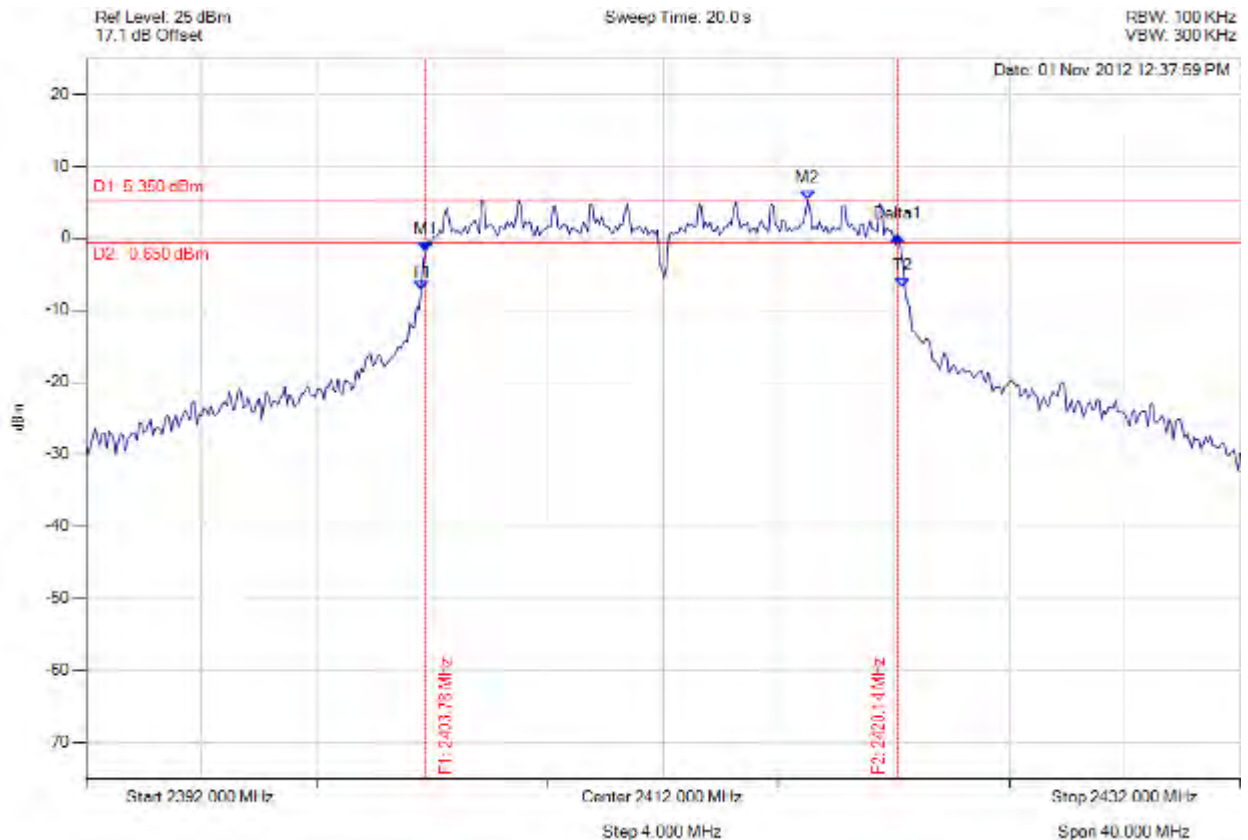

Analyser Setup	Marker : Frequency : Amplitude	Test Results
Detector = MAX PEAK Sweep Count = 0 RF Atten (dB) = 20 Trace Mode = VIEW	M1 : 2403.784 MHz : -1.911 dBm M2 : 2417.010 MHz : 5.350 dBm Delta1 : 16.353 MHz : 2.284 dB T1 : 2403.623 MHz : -7.192 dBm T2 : 2420.297 MHz : -6.932 dBm OBW : 16.754 MHz	Measured 6 dB Bandwidth: 16.353 MHz Limit: ≥ 0.5 MHz Margin: -15.85 MHz

[Back to the Matrix](#)

This test report may be reproduced in full only. The document may only be updated by MiCOM Labs personnel. Any changes will be noted in the Document History section of the report.



Title: Digi Connect Card for i.MX28 with Atheros AR6203
To: FCC 47 CFR Part 15.247 & IC RSS-210
Serial #: DIGI36-U2 Rev A
Issue Date: 22nd May 2014
Page: 171 of 261



6 dB 99%

Variant: 802.11g, Channel: 2437.00 MHz, Chain a, Temp: Ambient, Voltage: 5.00V

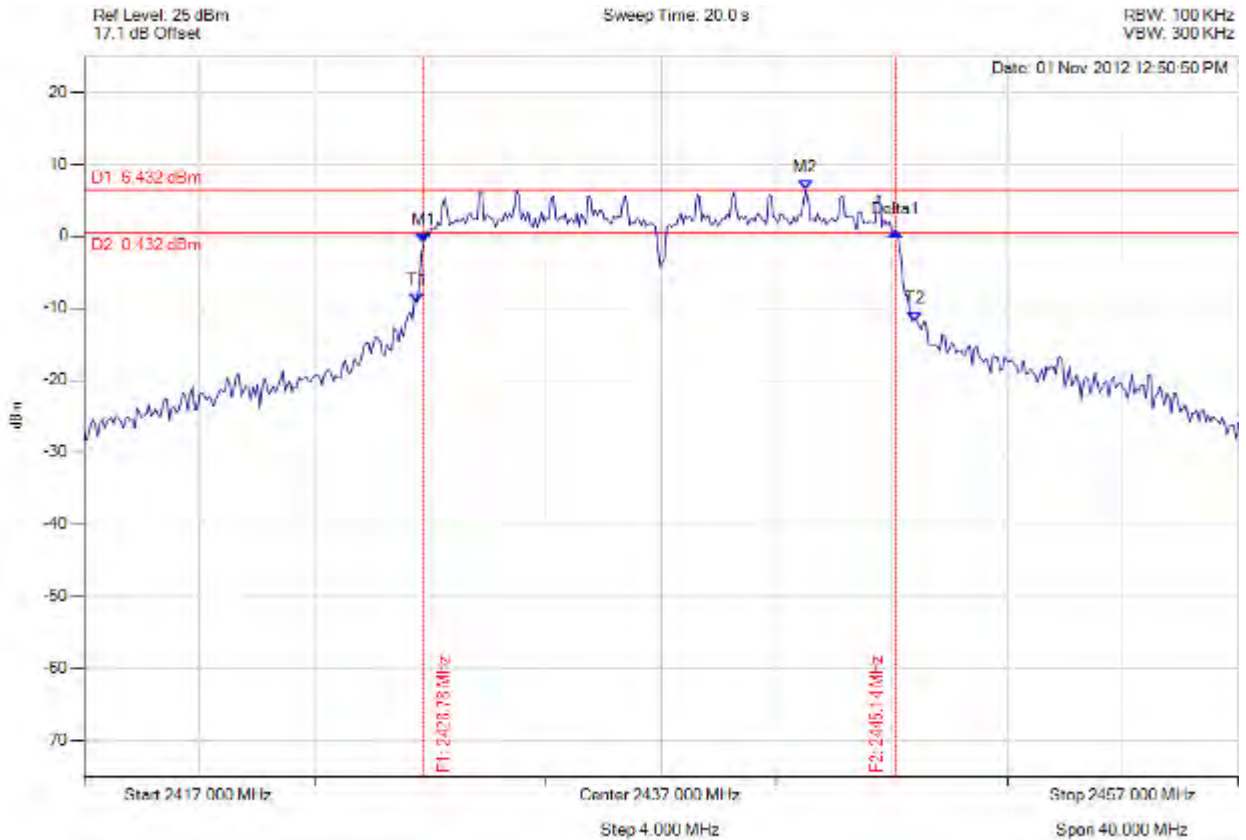

Analyser Setup	Marker : Frequency : Amplitude	Test Results
Detector = MAX PEAK Sweep Count = 0 RF Atten (dB) = 20 Trace Mode = VIEW	M1 : 2428.784 MHz : -0.877 dBm M2 : 2442.010 MHz : 6.432 dBm Delta1 : 16.353 MHz : 1.527 dB T1 : 2428.543 MHz : -9.153 dBm T2 : 2445.778 MHz : -11.788 dBm OBW : 17.315 MHz	Measured 6 dB Bandwidth: 16.353 MHz Limit: ≥ 0.5 MHz Margin: -15.85 MHz

[Back to the Matrix](#)

This test report may be reproduced in full only. The document may only be updated by MiCOM Labs personnel. Any changes will be noted in the Document History section of the report.



Title: Digi Connect Card for i.MX28 with Atheros AR6203
To: FCC 47 CFR Part 15.247 & IC RSS-210
Serial #: DIGI36-U2 Rev A
Issue Date: 22nd May 2014
Page: 172 of 261



6 dB 99%

Variant: 802.11g, Channel: 2462.00 MHz, Chain a, Temp: Ambient, Voltage: 5.00V

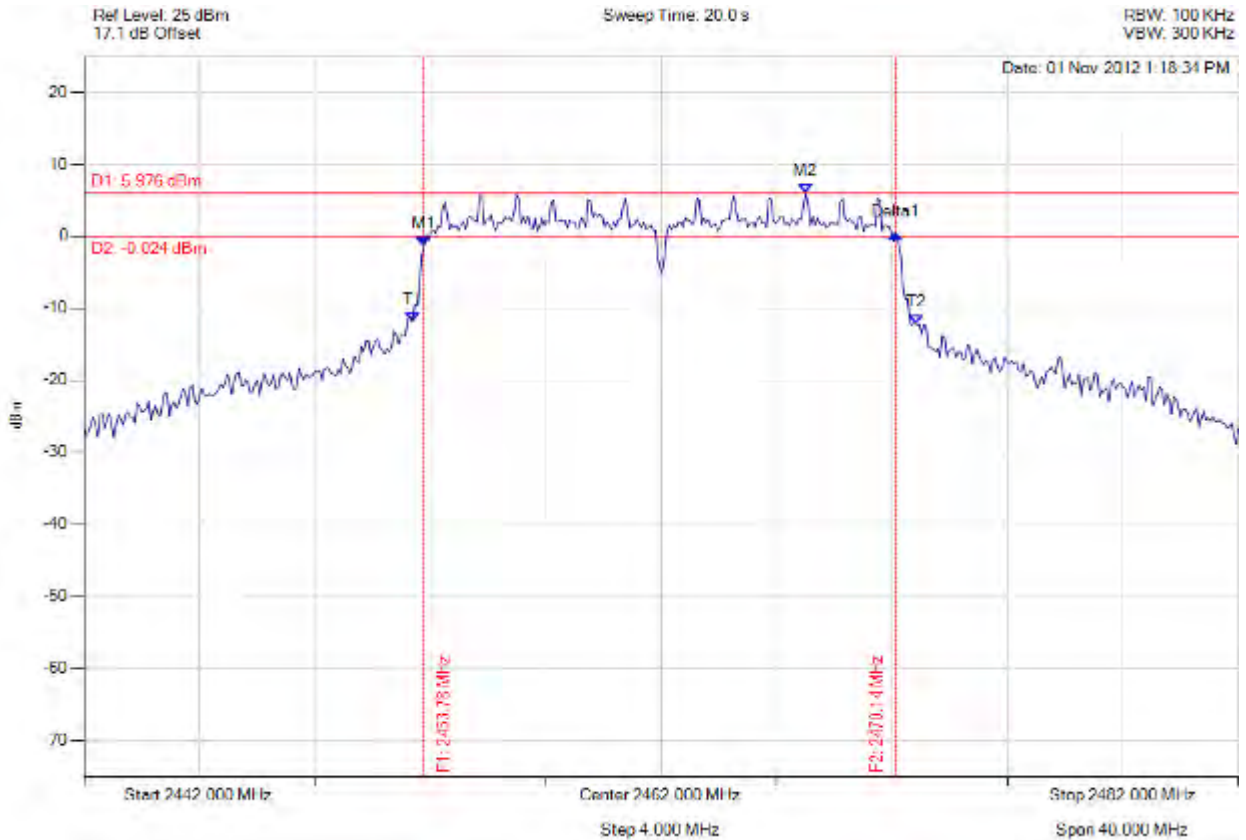

Analyser Setup	Marker : Frequency : Amplitude	Test Results
Detector = MAX PEAK Sweep Count = 0 RF Atten (dB) = 20 Trace Mode = VIEW	M1 : 2453.784 MHz : -1.431 dBm M2 : 2467.010 MHz : 5.976 dBm Delta1 : 16.353 MHz : 1.771 dB T1 : 2453.383 MHz : -11.929 dBm T2 : 2470.858 MHz : -12.181 dBm OBW : 17.555 MHz	Measured 6 dB Bandwidth: 16.353 MHz Limit: ≥ 0.5 MHz Margin: -15.85 MHz

[Back to the Matrix](#)

This test report may be reproduced in full only. The document may only be updated by MiCOM Labs personnel. Any changes will be noted in the Document History section of the report.



Title: Digi Connect Card for i.MX28 with Atheros AR6203
To: FCC 47 CFR Part 15.247 & IC RSS-210
Serial #: DIGI36-U2 Rev A
Issue Date: 22nd May 2014
Page: 173 of 261



6 dB 99%

Variant: 802.11n HT-20, Channel: 2412.00 MHz, Chain a, Temp: Ambient, Voltage: 5.00V

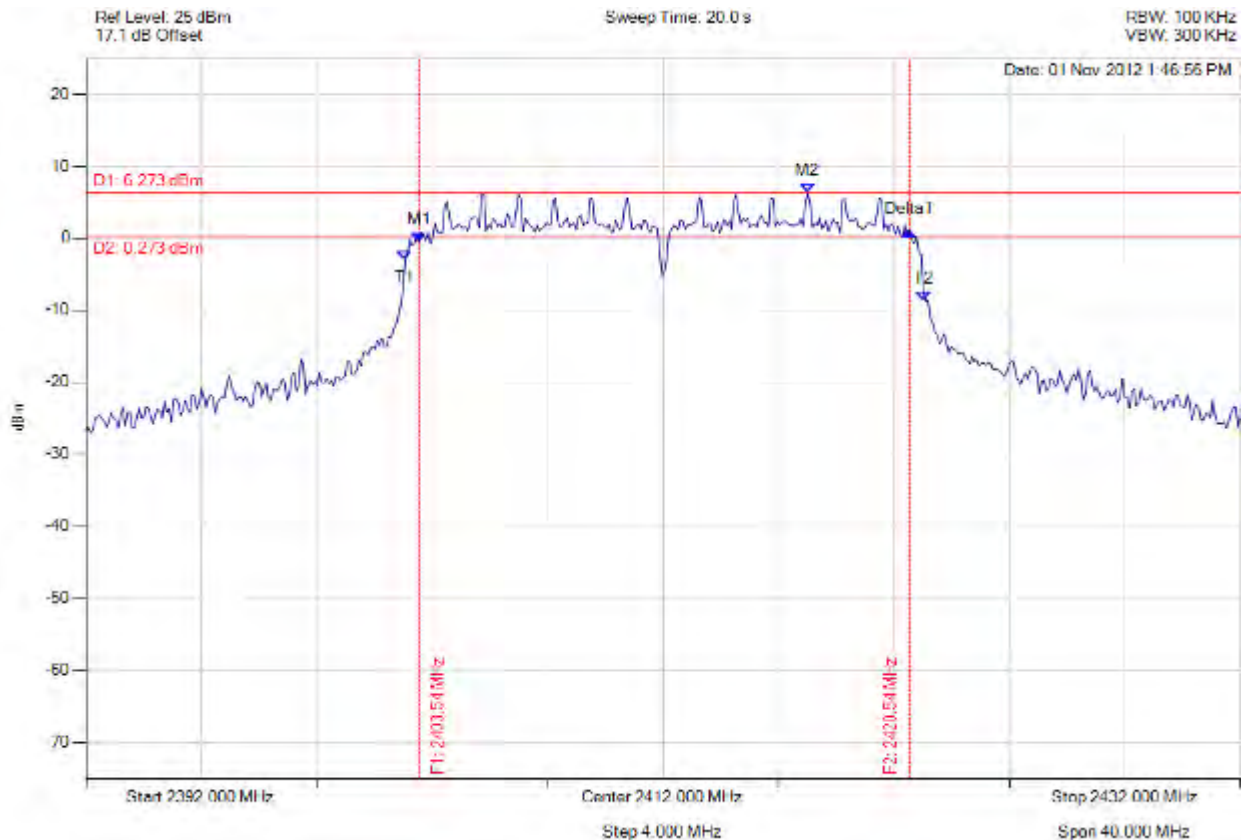

Analyser Setup	Marker : Frequency : Amplitude	Test Results
Detector = MAX PEAK Sweep Count = 0 RF Atten (dB) = 20 Trace Mode = VIEW	M1 : 2403.543 MHz : -0.505 dBm M2 : 2417.010 MHz : 6.273 dBm Delta1 : 16.994 MHz : 1.454 dB T1 : 2403.062 MHz : -2.980 dBm T2 : 2421.018 MHz : -8.703 dBm OBW : 18.036 MHz	Measured 6 dB Bandwidth: 16.994 MHz Limit: ≥ 0.5 MHz Margin: -16.49 MHz

[Back to the Matrix](#)

This test report may be reproduced in full only. The document may only be updated by MiCOM Labs personnel. Any changes will be noted in the Document History section of the report.



Title: Digi Connect Card for i.MX28 with Atheros AR6203
To: FCC 47 CFR Part 15.247 & IC RSS-210
Serial #: DIGI36-U2 Rev A
Issue Date: 22nd May 2014
Page: 174 of 261



6 dB 99%

Variant: 802.11n HT-20, Channel: 2437.00 MHz, Chain a, Temp: Ambient, Voltage: 5.00V

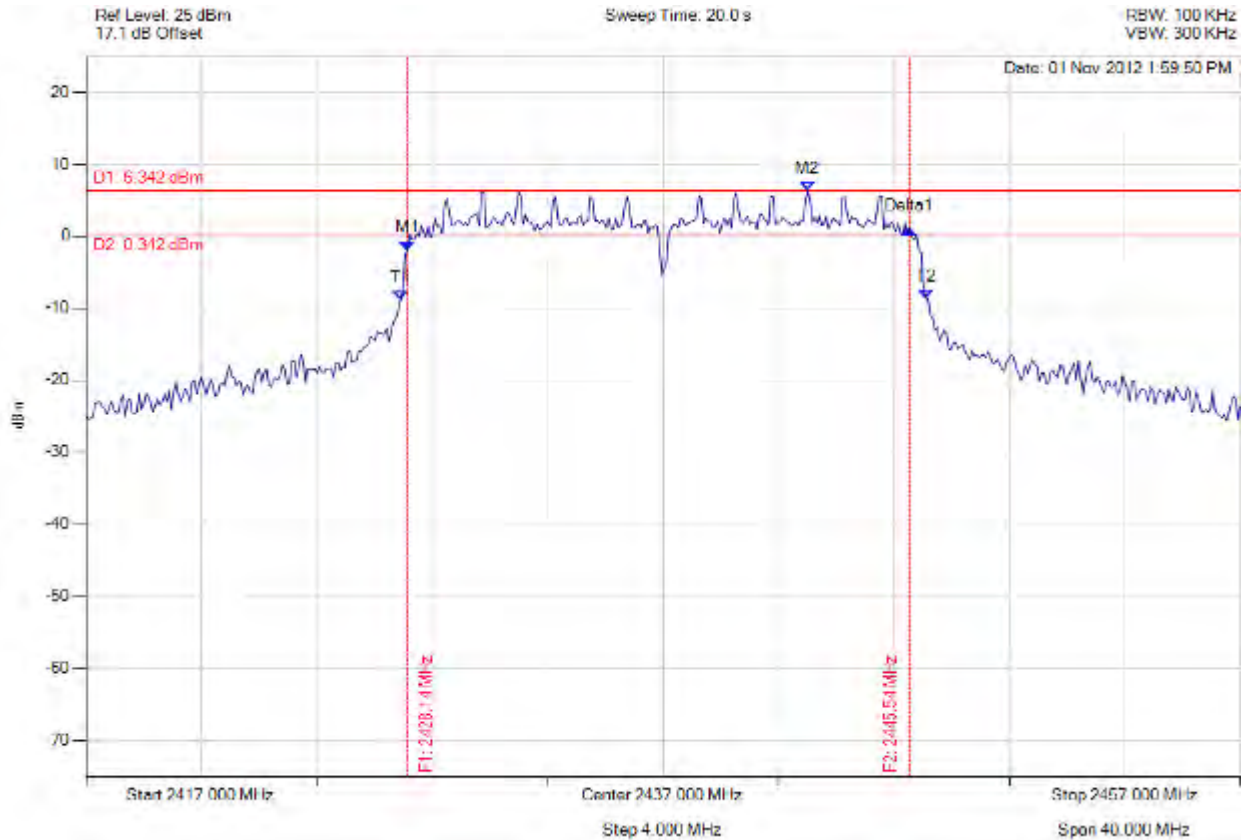

Analyser Setup	Marker : Frequency : Amplitude	Test Results
Detector = MAX PEAK Sweep Count = 0 RF Atten (dB) = 20 Trace Mode = VIEW	M1 : 2428.142 MHz : -1.955 dBm M2 : 2442.010 MHz : 6.342 dBm Delta1 : 17.395 MHz : 3.002 dB T1 : 2427.902 MHz : -8.854 dBm T2 : 2446.098 MHz : -8.689 dBm OBW : 18.277 MHz	Measured 6 dB Bandwidth: 17.395 MHz Limit: ≥ 0.5 MHz Margin: -16.90 MHz

[Back to the Matrix](#)

This test report may be reproduced in full only. The document may only be updated by MiCOM Labs personnel. Any changes will be noted in the Document History section of the report.



Title: Digi Connect Card for i.MX28 with Atheros AR6203
To: FCC 47 CFR Part 15.247 & IC RSS-210
Serial #: DIGI36-U2 Rev A
Issue Date: 22nd May 2014
Page: 175 of 261



6 dB 99%

Variant: 802.11n HT-20, Channel: 2462.00 MHz, Chain a, Temp: Ambient, Voltage: 5.00V

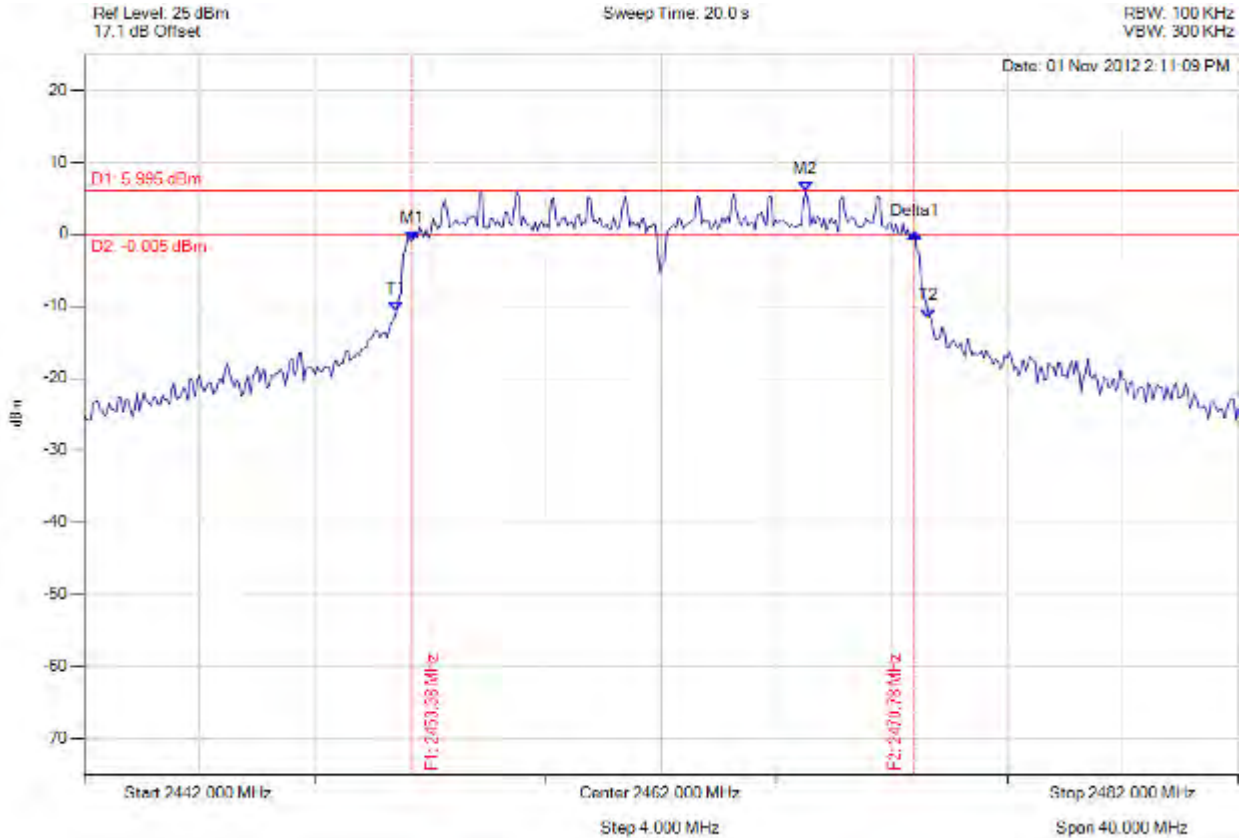

Analyser Setup	Marker : Frequency : Amplitude	Test Results
Detector = MAX PEAK Sweep Count = 0 RF Atten (dB) = 20 Trace Mode = VIEW	M1 : 2453.383 MHz : -0.875 dBm M2 : 2467.010 MHz : 5.995 dBm Delta1 : 17.395 MHz : 0.938 dB T1 : 2452.822 MHz : -10.780 dBm T2 : 2471.259 MHz : -11.624 dBm OBW : 18.517 MHz	Measured 6 dB Bandwidth: 17.395 MHz Limit: ≥ 0.5 MHz Margin: -16.90 MHz

[Back to the Matrix](#)

This test report may be reproduced in full only. The document may only be updated by MiCOM Labs personnel. Any changes will be noted in the Document History section of the report.



Title: Digi Connect Card for i.MX28 with Atheros AR6203
To: FCC 47 CFR Part 15.247 & IC RSS-210
Serial #: DIGI36-U2 Rev A
Issue Date: 22nd May 2014
Page: 176 of 261



6 dB 99%

Variant: 802.11n HT-40, Channel: 2422.00 MHz, Chain a, Temp: Ambient, Voltage: 5.00V

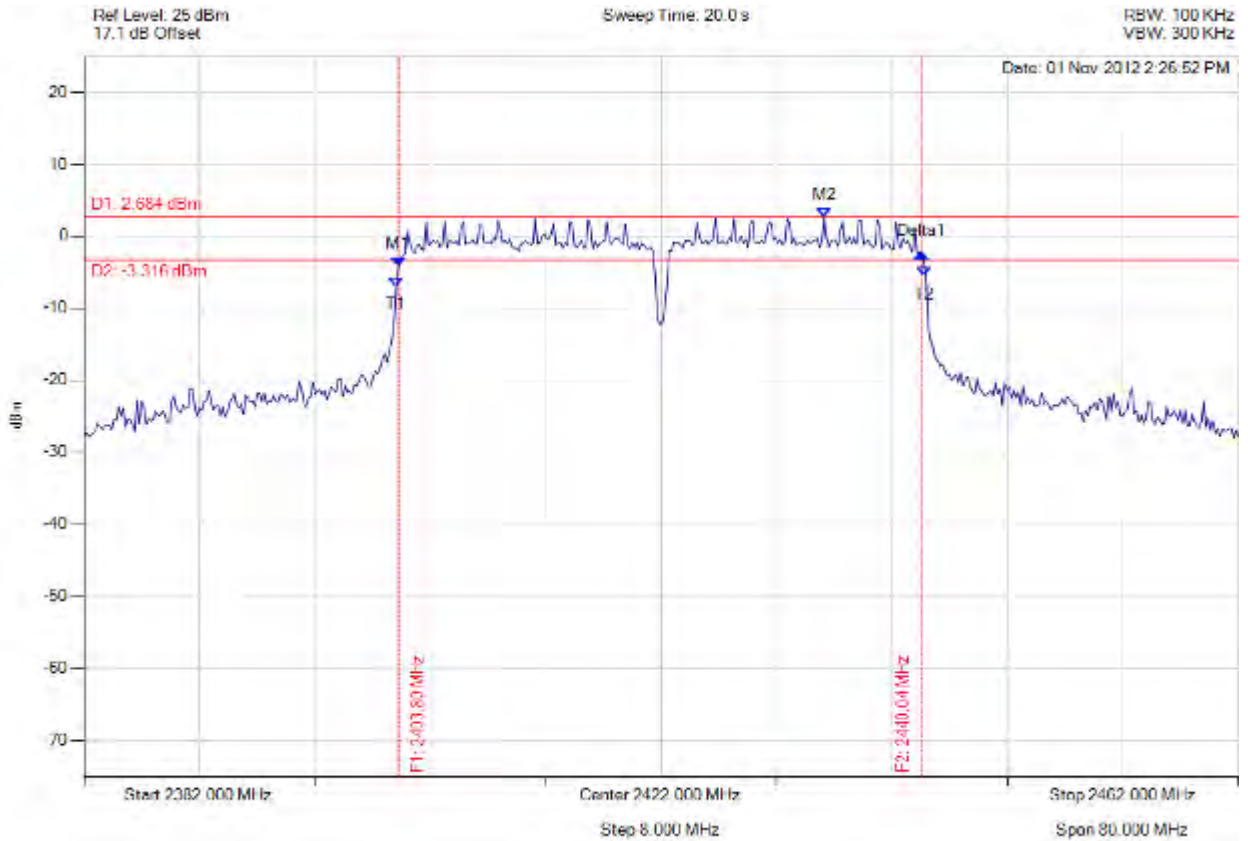

Analyser Setup	Marker : Frequency : Amplitude	Test Results
Detector = MAX PEAK Sweep Count = 0 RF Atten (dB) = 20 Trace Mode = VIEW	M1 : 2403.804 MHz : -4.217 dBm M2 : 2433.303 MHz : 2.684 dBm Delta1 : 36.232 MHz : 1.826 dB T1 : 2403.643 MHz : -6.979 dBm T2 : 2440.196 MHz : -5.559 dBm OBW : 36.713 MHz	Measured 6 dB Bandwidth: 36.232 MHz Limit: ≥ 0.5 MHz Margin: -35.73 MHz

[Back to the Matrix](#)

This test report may be reproduced in full only. The document may only be updated by MiCOM Labs personnel. Any changes will be noted in the Document History section of the report.



Title: Digi Connect Card for i.MX28 with Atheros AR6203
To: FCC 47 CFR Part 15.247 & IC RSS-210
Serial #: DIGI36-U2 Rev A
Issue Date: 22nd May 2014
Page: 177 of 261



6 dB 99%

Variant: 802.11n HT-40, Channel: 2437.00 MHz, Chain a, Temp: Ambient, Voltage: 5.00V

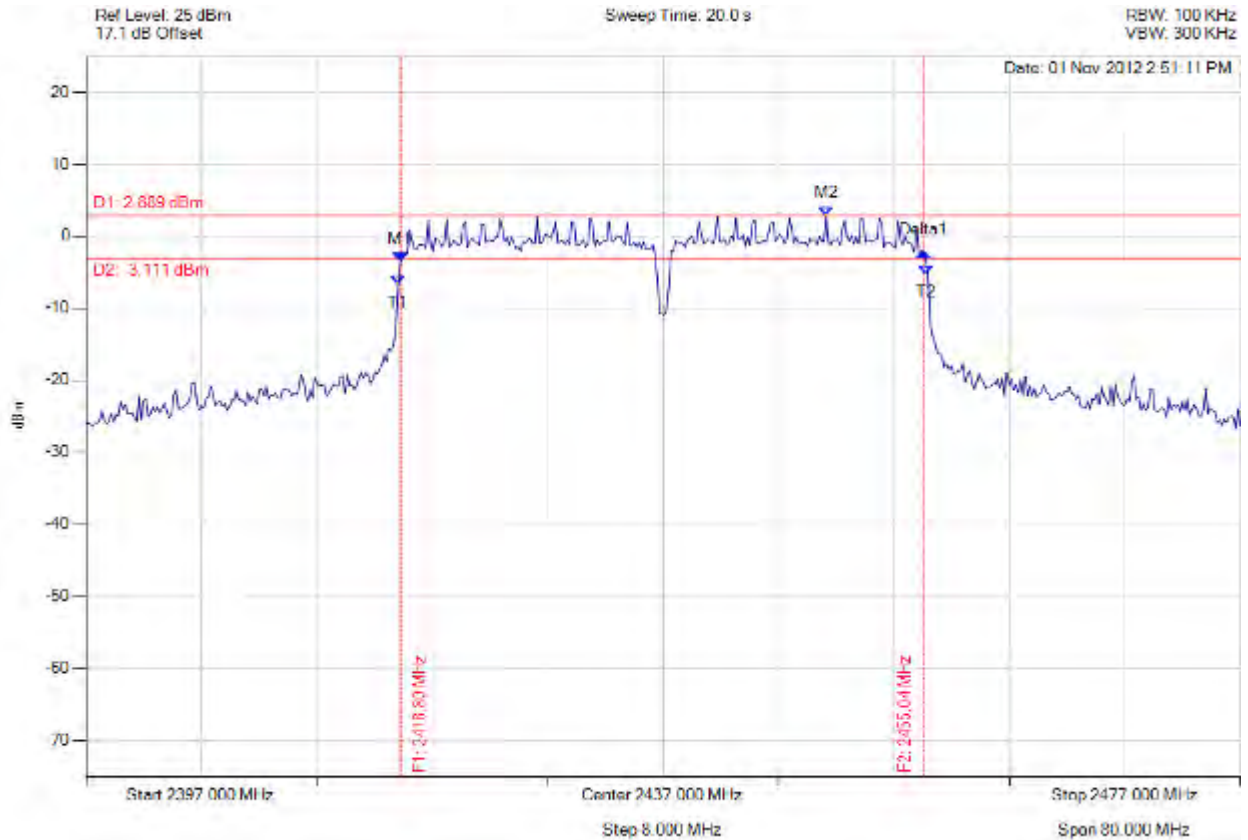

Analyser Setup	Marker : Frequency : Amplitude	Test Results
Detector = MAX PEAK Sweep Count = 0 RF Atten (dB) = 20 Trace Mode = VIEW	M1 : 2418.804 MHz : -3.521 dBm M2 : 2448.303 MHz : 2.889 dBm Delta1 : 36.232 MHz : 1.295 dB T1 : 2418.643 MHz : -6.702 dBm T2 : 2455.196 MHz : -5.297 dBm OBW : 36.713 MHz	Measured 6 dB Bandwidth: 36.232 MHz Limit: ≥ 0.5 MHz Margin: -35.73 MHz

[Back to the Matrix](#)

This test report may be reproduced in full only. The document may only be updated by MiCOM Labs personnel. Any changes will be noted in the Document History section of the report.



Title: Digi Connect Card for i.MX28 with Atheros AR6203
To: FCC 47 CFR Part 15.247 & IC RSS-210
Serial #: DIGI36-U2 Rev A
Issue Date: 22nd May 2014
Page: 178 of 261



6 dB 99%

Variant: 802.11n HT-40, Channel: 2452.00 MHz, Chain a, Temp: Ambient, Voltage: 5.00V

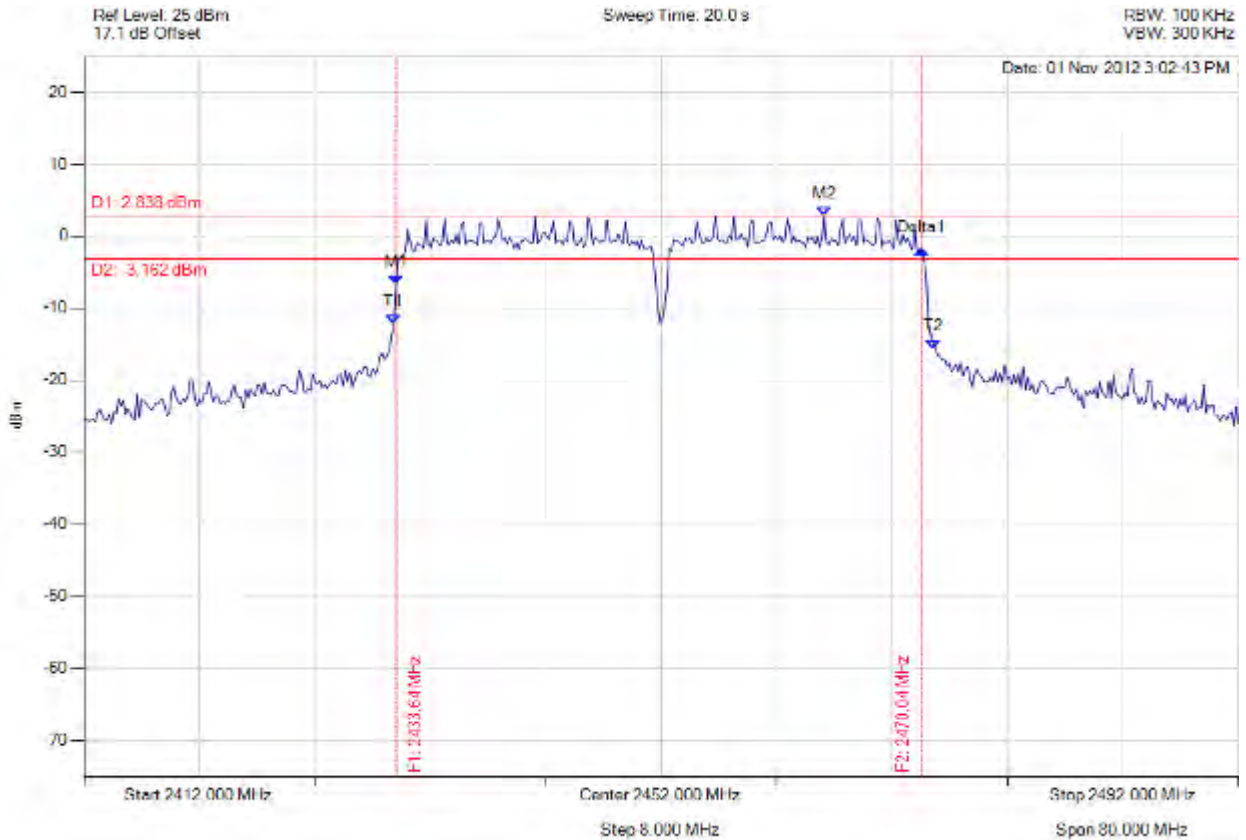

Analyser Setup	Marker : Frequency : Amplitude	Test Results
Detector = MAX PEAK Sweep Count = 0 RF Atten (dB) = 20 Trace Mode = VIEW	M1 : 2433.643 MHz : -6.653 dBm M2 : 2463.303 MHz : 2.838 dBm Delta1 : 36.393 MHz : 4.708 dB T1 : 2433.483 MHz : -12.179 dBm T2 : 2470.838 MHz : -15.626 dBm OBW : 37.515 MHz	Measured 6 dB Bandwidth: 36.393 MHz Limit: ≥ 0.5 MHz Margin: -35.89 MHz

[Back to the Matrix](#)

This test report may be reproduced in full only. The document may only be updated by MiCOM Labs personnel. Any changes will be noted in the Document History section of the report.



Title: Digi Connect Card for i.MX28 with Atheros AR6203
To: FCC 47 CFR Part 15.247 & IC RSS-210
Serial #: DIGI36-U2 Rev A
Issue Date: 22nd May 2014
Page: 179 of 261



6 dB 99%

Variant: 802.11a, Channel: 5745.00 MHz, Chain a, Temp: Ambient, Voltage: 5.00V

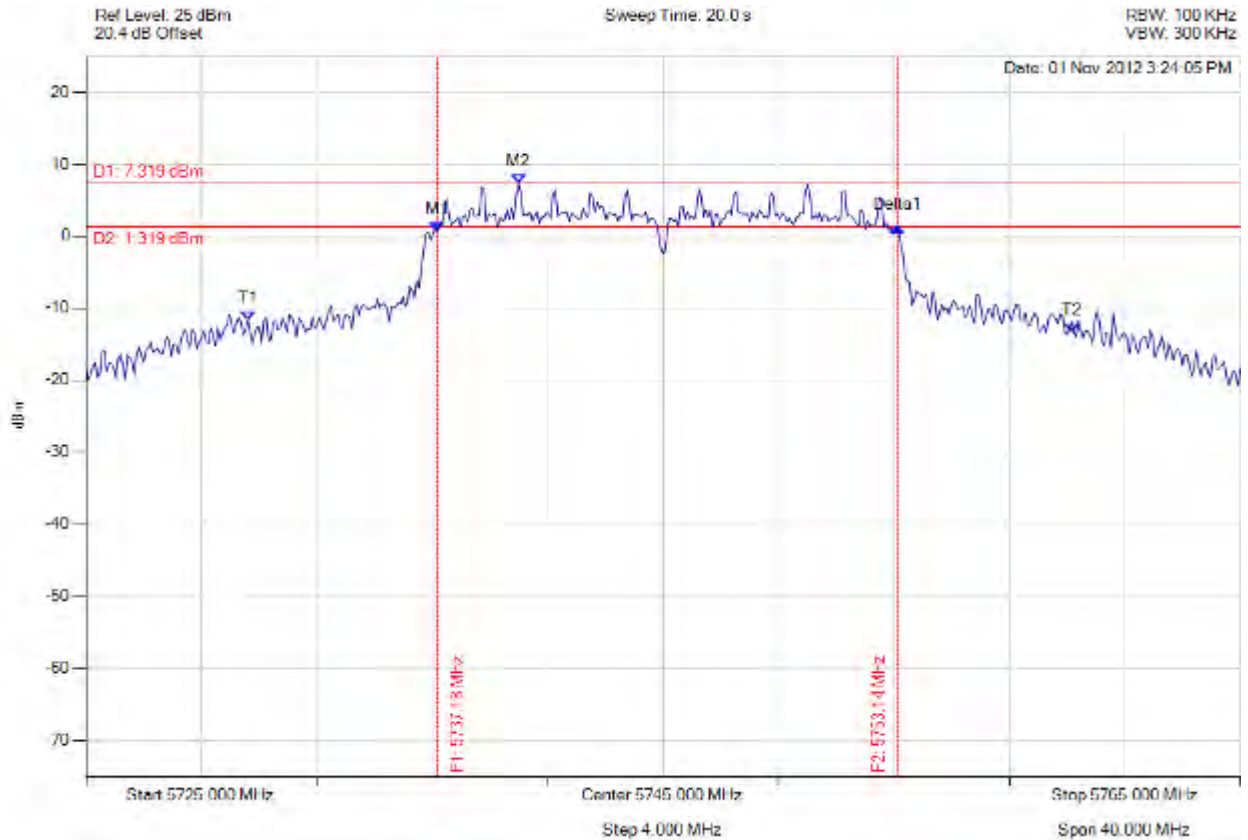

Analyser Setup	Marker : Frequency : Amplitude	Test Results
Detector = MAX PEAK Sweep Count = 0 RF Atten (dB) = 20 Trace Mode = VIEW	M1 : 5737.184 MHz : 0.691 dBm M2 : 5739.990 MHz : 7.319 dBm Delta1 : 15.952 MHz : 0.673 dB T1 : 5730.611 MHz : -11.650 dBm T2 : 5759.148 MHz : -13.422 dBm OBW : 28.617 MHz	Measured 6 dB Bandwidth: 15.952 MHz Limit: ≥ 0.5 MHz Margin: -15.45 MHz

[Back to the Matrix](#)

This test report may be reproduced in full only. The document may only be updated by MiCOM Labs personnel. Any changes will be noted in the Document History section of the report.



Title: Digi Connect Card for i.MX28 with Atheros AR6203
To: FCC 47 CFR Part 15.247 & IC RSS-210
Serial #: DIGI36-U2 Rev A
Issue Date: 22nd May 2014
Page: 180 of 261



6 dB 99%

Variant: 802.11a, Channel: 5785.00 MHz, Chain a, Temp: Ambient, Voltage: 5.00V

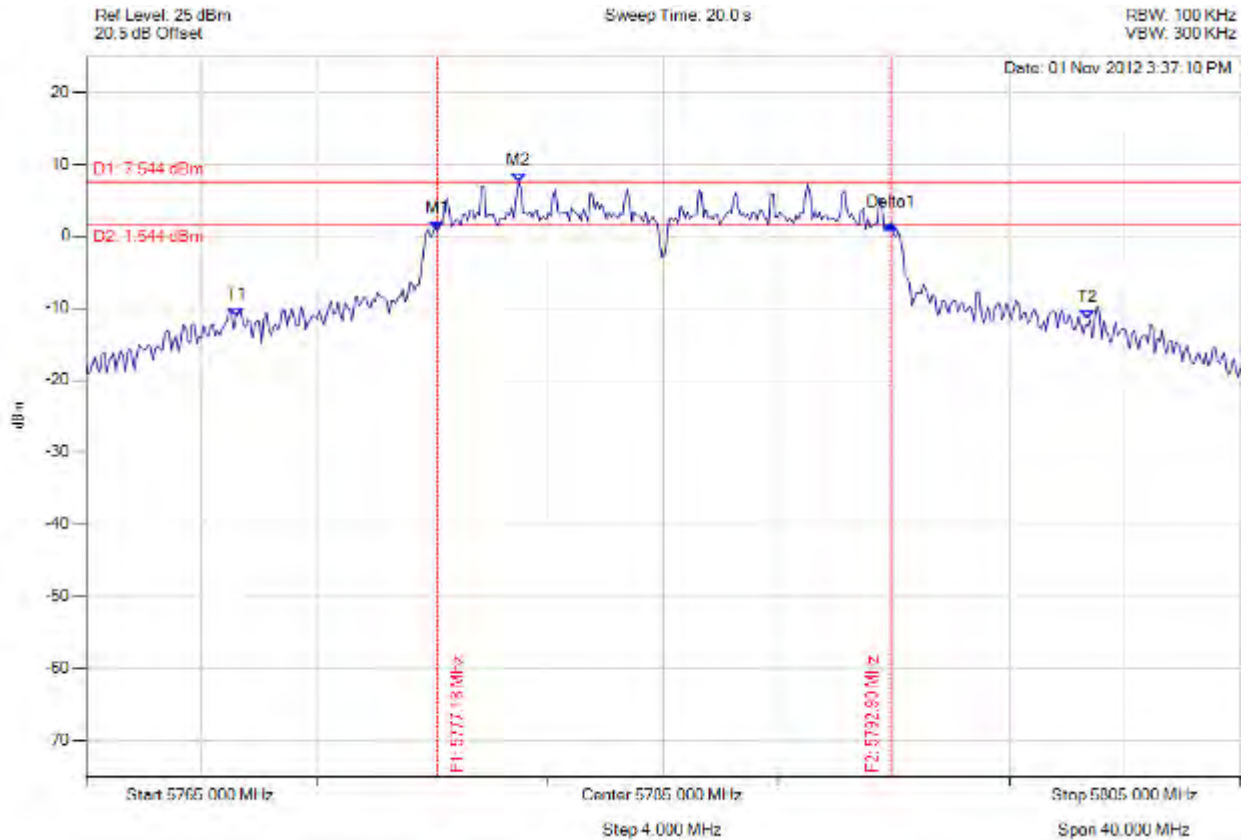

Analyser Setup	Marker : Frequency : Amplitude	Test Results
Detector = MAX PEAK Sweep Count = 0 RF Atten (dB) = 20 Trace Mode = VIEW	M1 : 5777.184 MHz : 0.737 dBm M2 : 5779.990 MHz : 7.544 dBm Delta1 : 15.711 MHz : 0.834 dB T1 : 5770.210 MHz : -11.266 dBm T2 : 5799.709 MHz : -11.573 dBm OBW : 29.579 MHz	Measured 6 dB Bandwidth: 15.711 MHz Limit: ≥ 0.5 MHz Margin: -15.21 MHz

[Back to the Matrix](#)

This test report may be reproduced in full only. The document may only be updated by MiCOM Labs personnel. Any changes will be noted in the Document History section of the report.



Title: Digi Connect Card for i.MX28 with Atheros AR6203
To: FCC 47 CFR Part 15.247 & IC RSS-210
Serial #: DIGI36-U2 Rev A
Issue Date: 22nd May 2014
Page: 181 of 261



6 dB 99%

Variant: 802.11a, Channel: 5825.00 MHz, Chain a, Temp: Ambient, Voltage: 5.00V

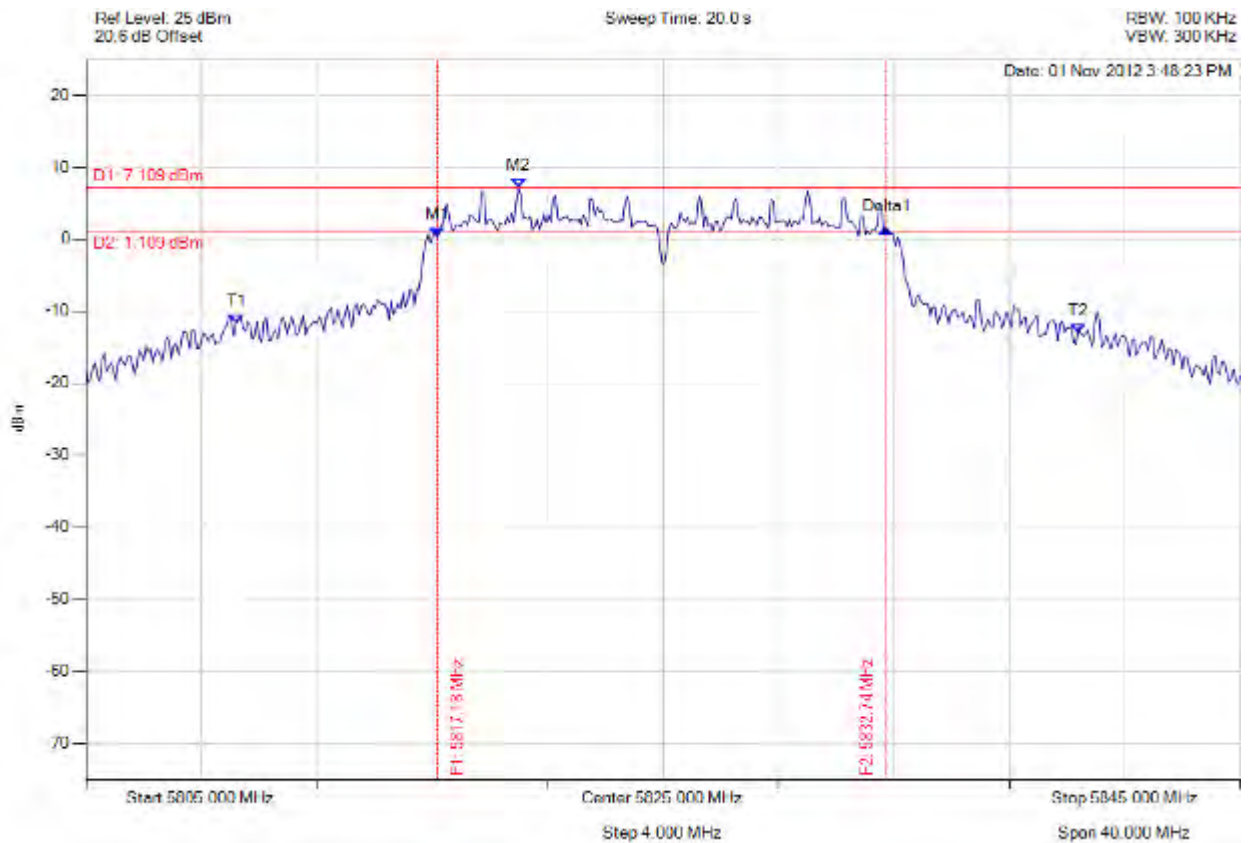

Analyser Setup	Marker : Frequency : Amplitude	Test Results
Detector = MAX PEAK Sweep Count = 0 RF Atten (dB) = 20 Trace Mode = VIEW	M1 : 5817.184 MHz : 0.243 dBm M2 : 5819.990 MHz : 7.109 dBm Delta1 : 15.551 MHz : 1.204 dB T1 : 5810.210 MHz : -11.662 dBm T2 : 5839.389 MHz : -13.070 dBm OBW : 29.259 MHz	Measured 6 dB Bandwidth: 15.551 MHz Limit: ≥ 0.5 MHz Margin: -15.05 MHz

[Back to the Matrix](#)

This test report may be reproduced in full only. The document may only be updated by MiCOM Labs personnel. Any changes will be noted in the Document History section of the report.



Title: Digi Connect Card for i.MX28 with Atheros AR6203
To: FCC 47 CFR Part 15.247 & IC RSS-210
Serial #: DIGI36-U2 Rev A
Issue Date: 22nd May 2014
Page: 182 of 261



6 dB 99%

Variant: 802.11n HT-20, Channel: 5745.00 MHz, Chain a, Temp: Ambient, Voltage: 5.00V

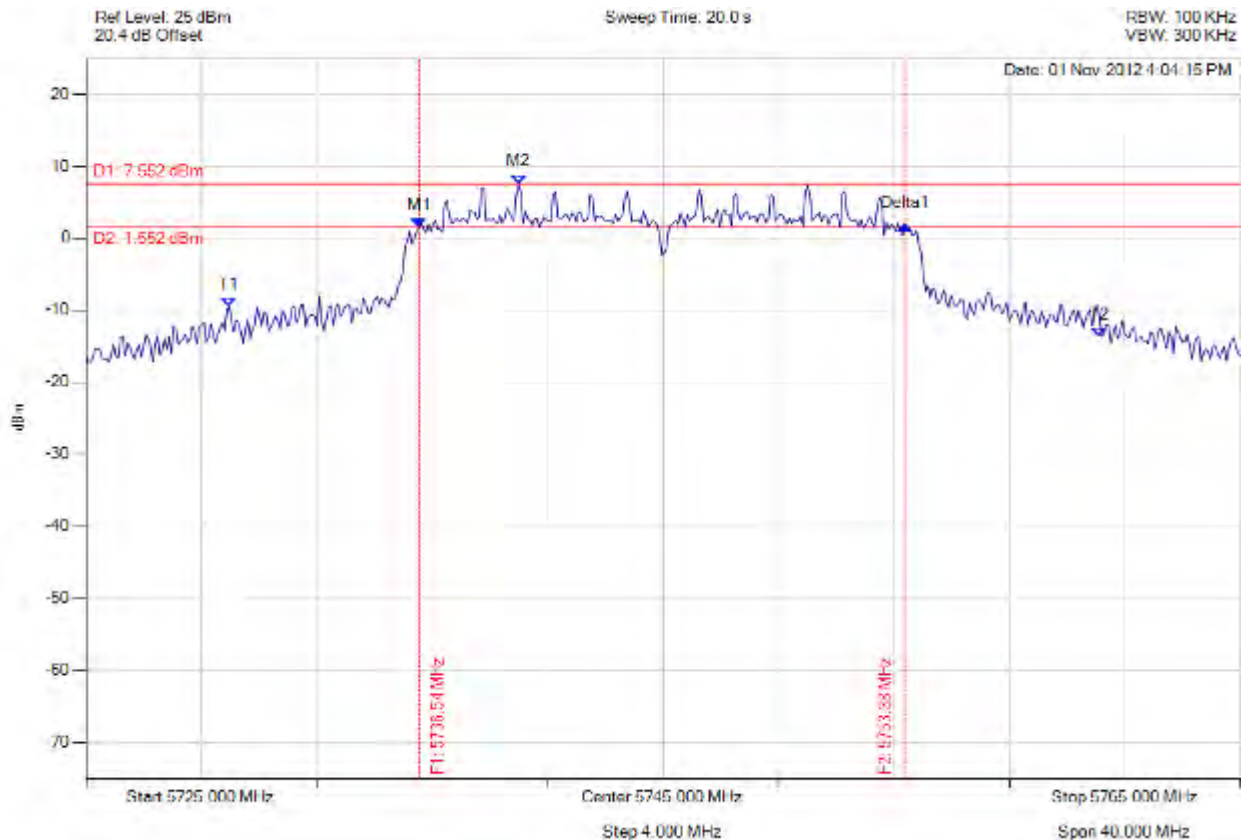

Analyser Setup	Marker : Frequency : Amplitude	Test Results
Detector = MAX PEAK Sweep Count = 0 RF Atten (dB) = 20 Trace Mode = VIEW	M1 : 5736.543 MHz : 1.524 dBm M2 : 5739.990 MHz : 7.552 dBm Delta1 : 16.834 MHz : 0.240 dB T1 : 5729.970 MHz : -9.521 dBm T2 : 5760.110 MHz : -13.645 dBm OBW : 30.220 MHz	Measured 6 dB Bandwidth: 16.834 MHz Limit: ≥ 0.5 MHz Margin: -16.33 MHz

[Back to the Matrix](#)

This test report may be reproduced in full only. The document may only be updated by MiCOM Labs personnel. Any changes will be noted in the Document History section of the report.



Title: Digi Connect Card for i.MX28 with Atheros AR6203
To: FCC 47 CFR Part 15.247 & IC RSS-210
Serial #: DIGI36-U2 Rev A
Issue Date: 22nd May 2014
Page: 183 of 261



6 dB 99%

Variant: 802.11n HT-20, Channel: 5785.00 MHz, Chain a, Temp: Ambient, Voltage: 5.00V

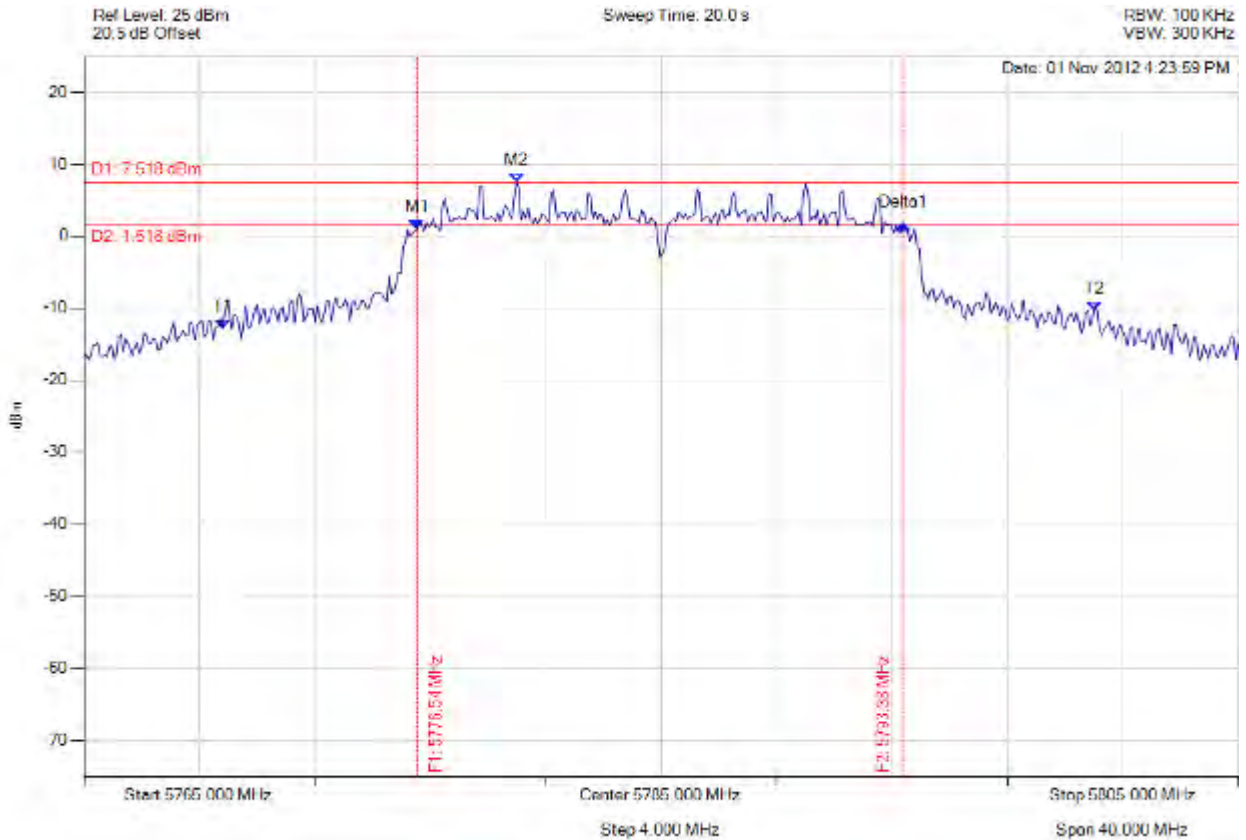

Analyser Setup	Marker : Frequency : Amplitude	Test Results
Detector = MAX PEAK Sweep Count = 0 RF Atten (dB) = 20 Trace Mode = VIEW	M1 : 5776.543 MHz : 0.998 dBm M2 : 5779.990 MHz : 7.518 dBm Delta1 : 16.834 MHz : 0.580 dB T1 : 5769.810 MHz : -12.815 dBm T2 : 5800.030 MHz : -10.428 dBm OBW : 30.301 MHz	Measured 6 dB Bandwidth: 16.834 MHz Limit: ≥ 0.5 MHz Margin: -16.33 MHz

[Back to the Matrix](#)

This test report may be reproduced in full only. The document may only be updated by MiCOM Labs personnel. Any changes will be noted in the Document History section of the report.



Title: Digi Connect Card for i.MX28 with Atheros AR6203
To: FCC 47 CFR Part 15.247 & IC RSS-210
Serial #: DIGI36-U2 Rev A
Issue Date: 22nd May 2014
Page: 184 of 261



6 dB 99%

Variant: 802.11n HT-20, Channel: 5825.00 MHz, Chain a, Temp: Ambient, Voltage: 5.00V

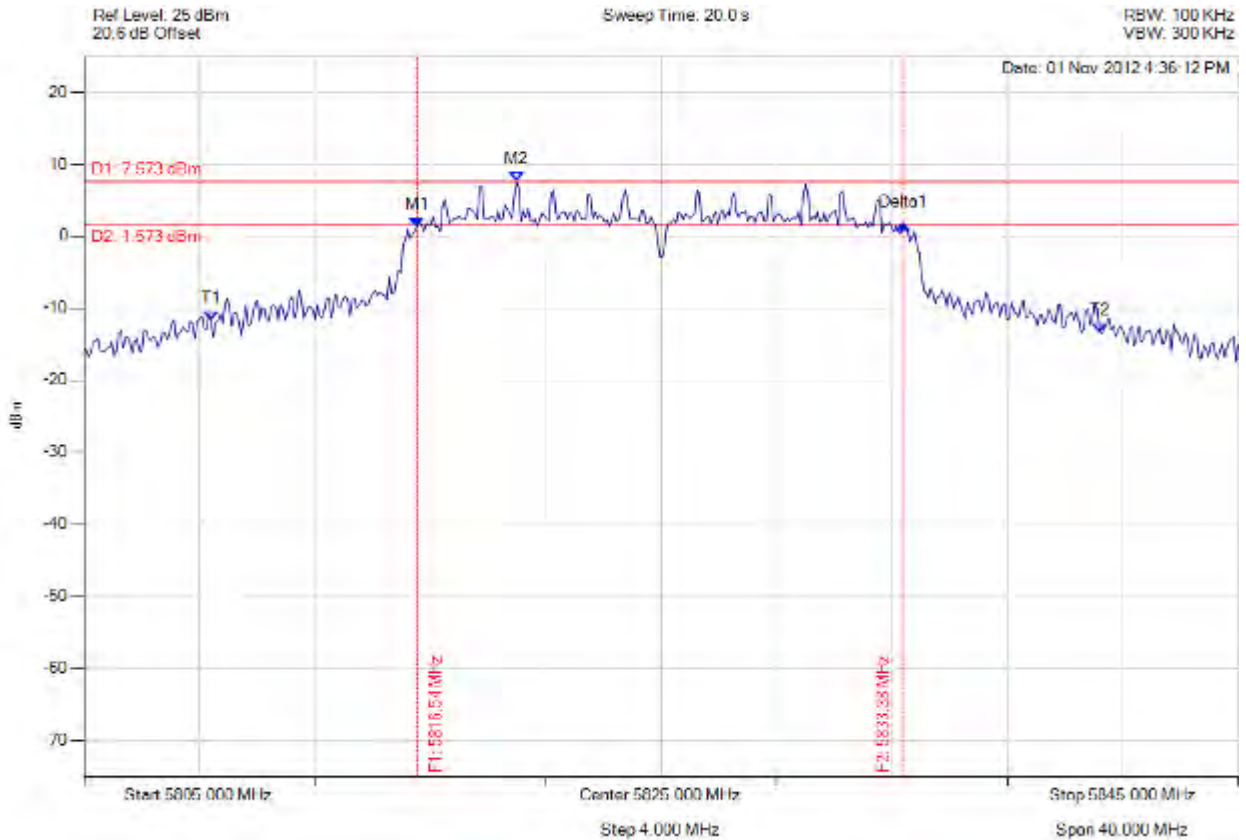

Analyser Setup	Marker : Frequency : Amplitude	Test Results
Detector = MAX PEAK Sweep Count = 0 RF Atten (dB) = 20 Trace Mode = VIEW	M1 : 5816.543 MHz : 1.356 dBm M2 : 5819.990 MHz : 7.573 dBm Delta1 : 16.834 MHz : 0.218 dB T1 : 5809.409 MHz : -11.689 dBm T2 : 5840.190 MHz : -13.448 dBm OBW : 30.862 MHz	Measured 6 dB Bandwidth: 16.834 MHz Limit: ≥ 0.5 MHz Margin: -16.33 MHz

[Back to the Matrix](#)

This test report may be reproduced in full only. The document may only be updated by MiCOM Labs personnel. Any changes will be noted in the Document History section of the report.



Title: Digi Connect Card for i.MX28 with Atheros AR6203
To: FCC 47 CFR Part 15.247 & IC RSS-210
Serial #: DIGI36-U2 Rev A
Issue Date: 22nd May 2014
Page: 185 of 261



6 dB 99%

Variant: 802.11n HT-40, Channel: 5755.00 MHz, Chain a, Temp: Ambient, Voltage: 5.00V

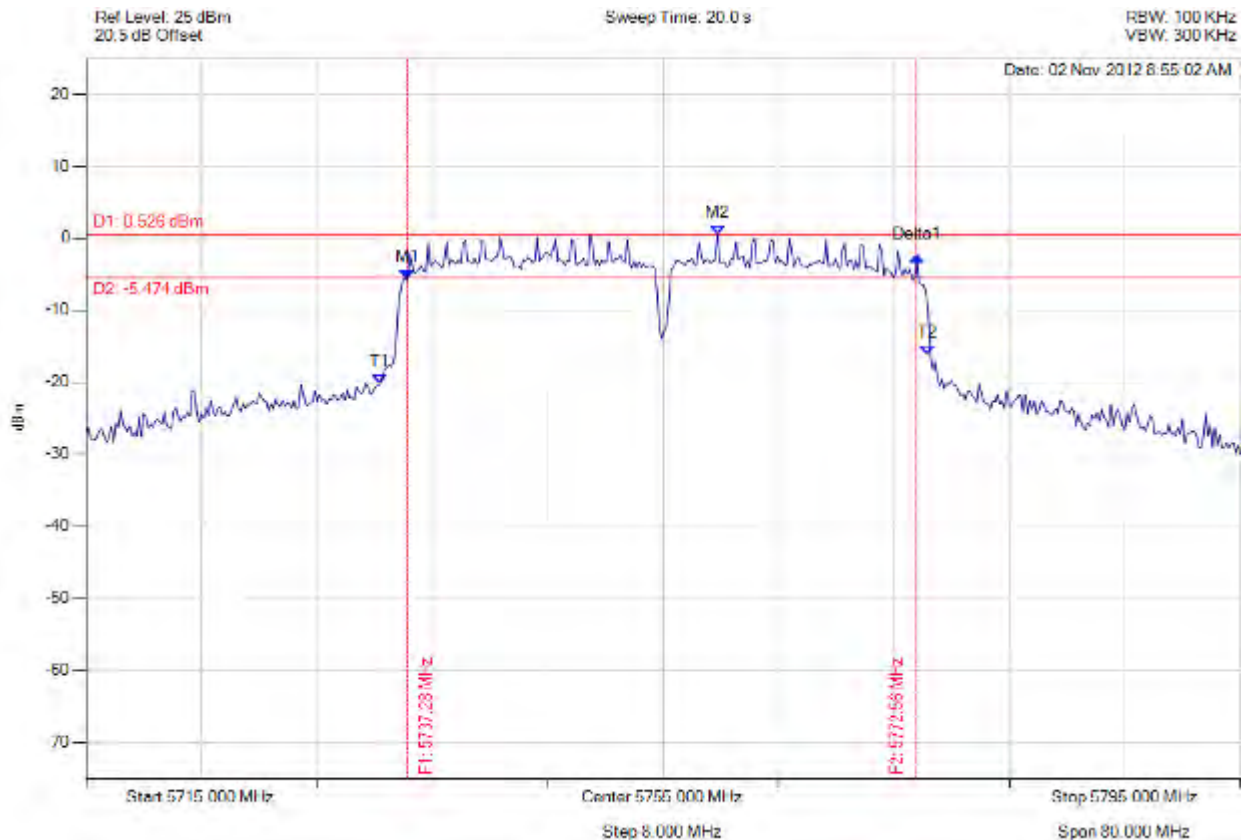

Analyser Setup	Marker : Frequency : Amplitude	Test Results
Detector = MAX PEAK Sweep Count = 0 RF Atten (dB) = 20 Trace Mode = VIEW	M1 : 5737.285 MHz : -5.777 dBm M2 : 5758.768 MHz : 0.526 dBm Delta1 : 35.271 MHz : 3.226 dB T1 : 5735.361 MHz : -20.275 dBm T2 : 5773.357 MHz : -16.216 dBm OBW : 38.156 MHz	Measured 6 dB Bandwidth: 35.271 MHz Limit: ≥ 0.5 MHz Margin: -34.77 MHz

[Back to the Matrix](#)

This test report may be reproduced in full only. The document may only be updated by MiCOM Labs personnel. Any changes will be noted in the Document History section of the report.



Title: Digi Connect Card for i.MX28 with Atheros AR6203
To: FCC 47 CFR Part 15.247 & IC RSS-210
Serial #: DIGI36-U2 Rev A
Issue Date: 22nd May 2014
Page: 186 of 261



6 dB 99%

Variant: 802.11n HT-40, Channel: 5795.00 MHz, Chain a, Temp: Ambient, Voltage: 5.00V

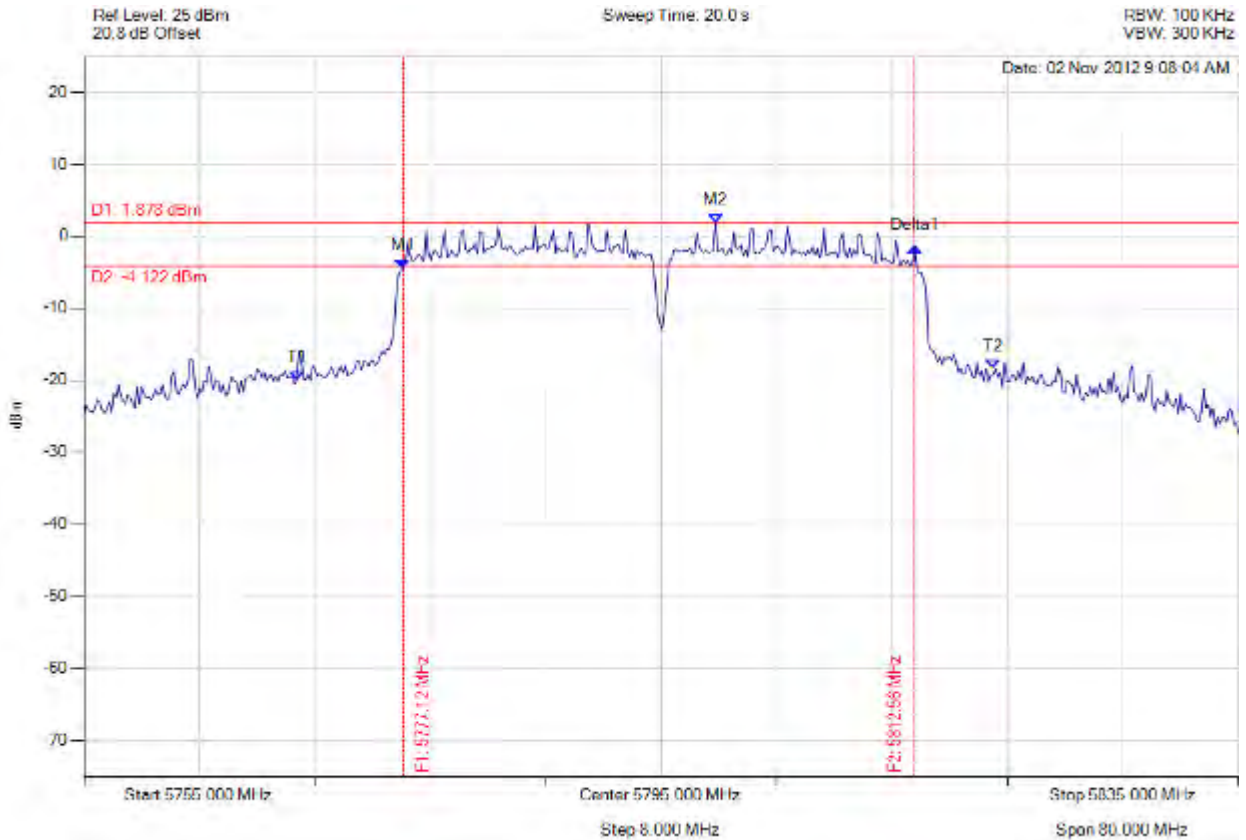

Analyser Setup	Marker : Frequency : Amplitude	Test Results
Detector = MAX PEAK Sweep Count = 0 RF Atten (dB) = 20 Trace Mode = VIEW	M1 : 5777.124 MHz : -4.461 dBm M2 : 5798.768 MHz : 1.878 dBm Delta1 : 35.431 MHz : 2.973 dB T1 : 5769.749 MHz : -19.972 dBm T2 : 5818.006 MHz : -18.327 dBm OBW : 48.417 MHz	Measured 6 dB Bandwidth: 35.431 MHz Limit: ≥ 0.5 MHz Margin: -34.93 MHz

[Back to the Matrix](#)

This test report may be reproduced in full only. The document may only be updated by MiCOM Labs personnel. Any changes will be noted in the Document History section of the report.



A.1.2. Peak Output Power

Dual Port Module:



peak output power

Variant: 802.11b, Channel: 2412.00 MHz, Chain a, Temp: Ambient, Voltage: 5.00V

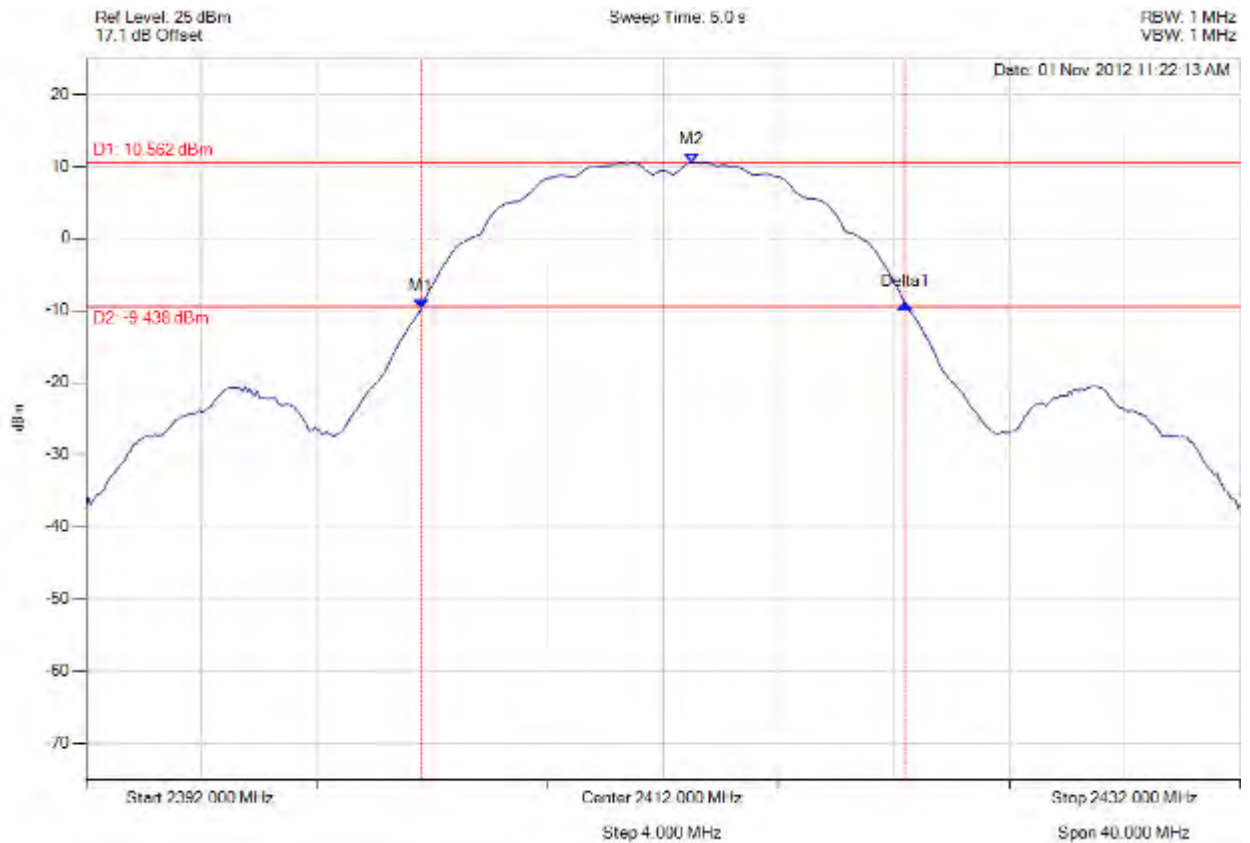

Analyser Setup	Marker : Frequency : Amplitude	Test Results
Detector = MAX PEAK Sweep Count = 0 RF Atten (dB) = 20 Trace Mode = VIEW	M1 : 2403.623 MHz : -9.637 dBm M2 : 2413.002 MHz : 10.562 dBm Delta1 : 16.754 MHz : 0.655 dB	Channel Power: 19.15 dBm Limit: 30.00 dBm Margin: -10.85 dB

[Back to the Matrix](#)

This test report may be reproduced in full only. The document may only be updated by MiCOM Labs personnel. Any changes will be noted in the Document History section of the report.



Title: Digi Connect Card for i.MX28 with Atheros AR6203
To: FCC 47 CFR Part 15.247 & IC RSS-210
Serial #: DIGI36-U2 Rev A
Issue Date: 22nd May 2014
Page: 189 of 261



peak output power

Variant: 802.11b, Channel: 2462.00 MHz, Chain a, Temp: Ambient, Voltage: 5.00V

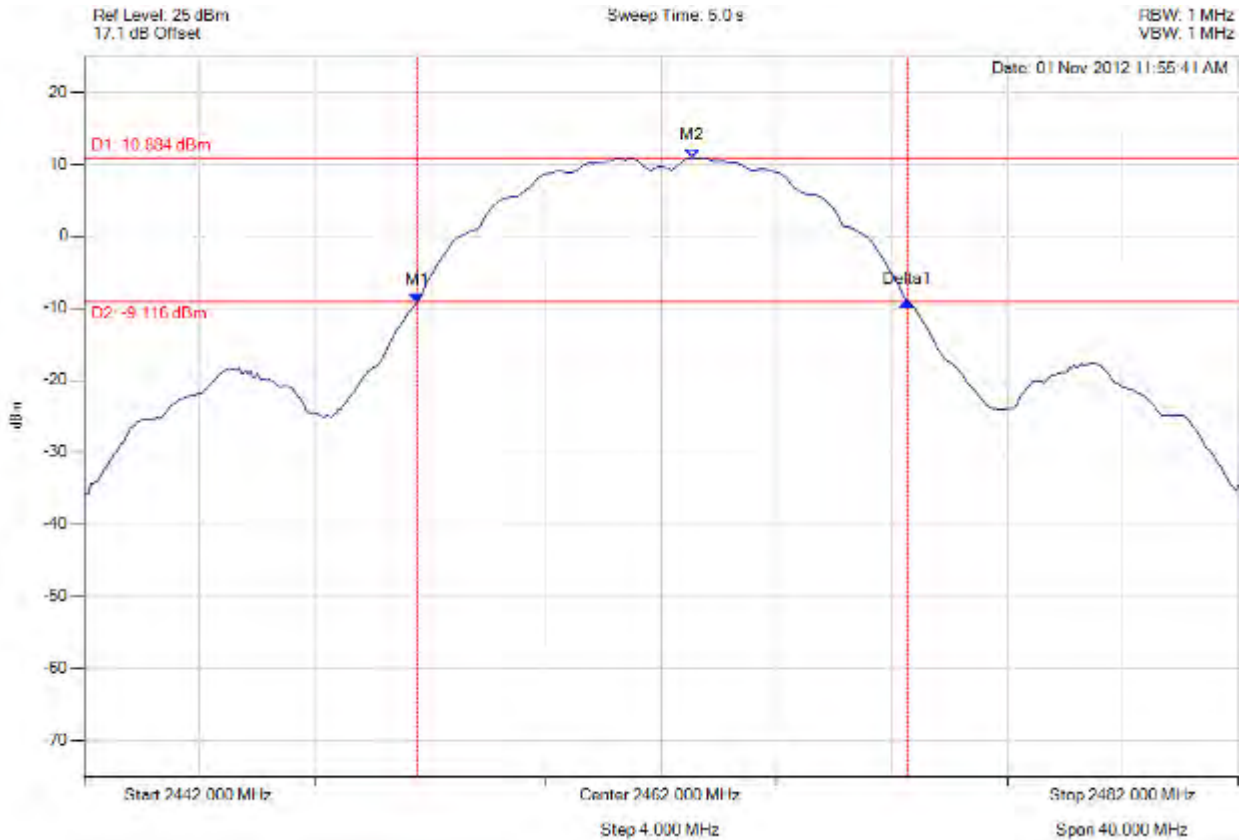

Analyser Setup	Marker : Frequency : Amplitude	Test Results
Detector = MAX PEAK Sweep Count = 0 RF Atten (dB) = 20 Trace Mode = VIEW	M1 : 2453.543 MHz : -9.151 dBm M2 : 2463.082 MHz : 10.884 dBm Delta1 : 16.994 MHz : 0.104 dB	Channel Power: 19.47 dBm Limit: 30.00 dBm Margin: -10.53 dB

[Back to the Matrix](#)

This test report may be reproduced in full only. The document may only be updated by MiCOM Labs personnel. Any changes will be noted in the Document History section of the report.



Title: Digi Connect Card for i.MX28 with Atheros AR6203
To: FCC 47 CFR Part 15.247 & IC RSS-210
Serial #: DIGI36-U2 Rev A
Issue Date: 22nd May 2014
Page: 190 of 261



peak output power

Variant: 802.11g, Channel: 2412.00 MHz, Chain a, Temp: Ambient, Voltage: 5.00V

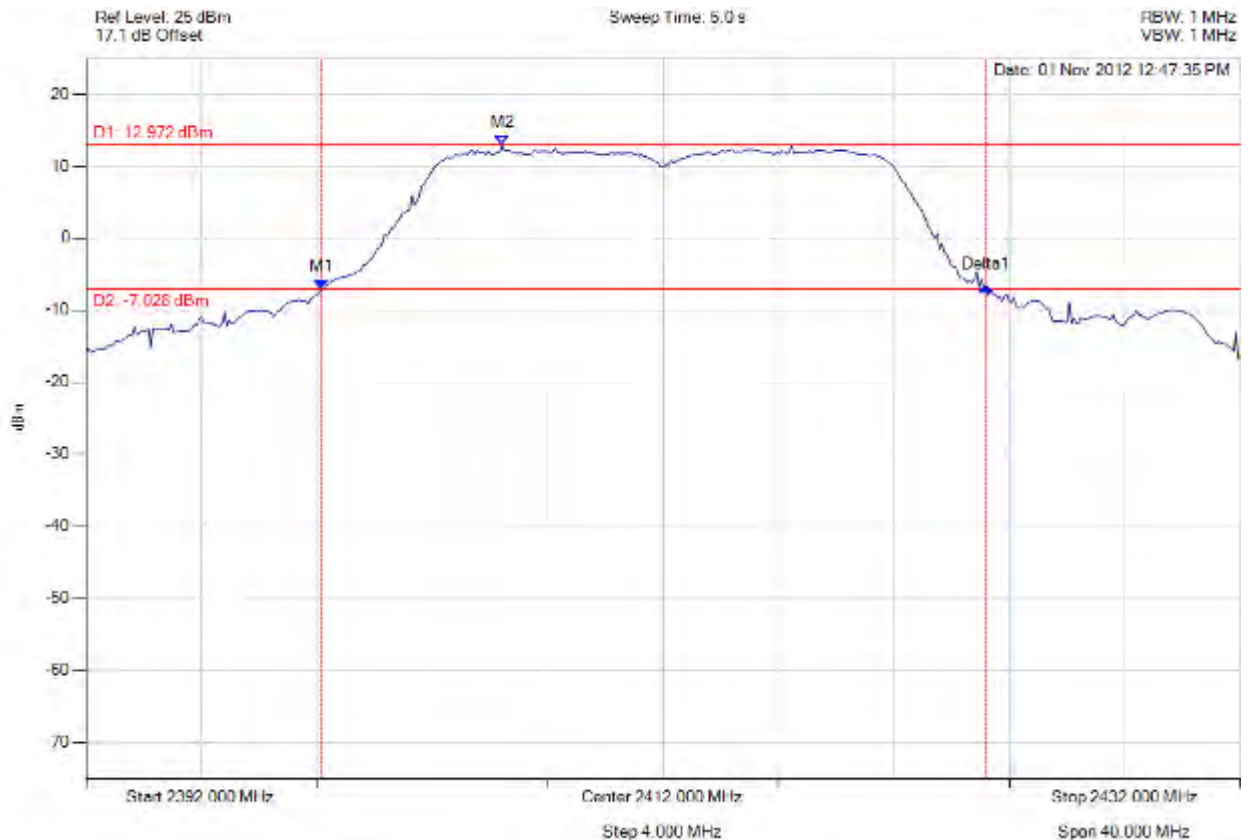

Analyser Setup	Marker : Frequency : Amplitude	Test Results
Detector = MAX PEAK Sweep Count = 0 RF Atten (dB) = 20 Trace Mode = VIEW	M1 : 2400.176 MHz : -7.107 dBm M2 : 2406.429 MHz : 12.972 dBm Delta1 : 23.006 MHz : 0.329 dB	Channel Power: 23.44 dBm Limit: 30.00 dBm Margin: -6.56 dB

[Back to the Matrix](#)

This test report may be reproduced in full only. The document may only be updated by MiCOM Labs personnel. Any changes will be noted in the Document History section of the report.



Title: Digi Connect Card for i.MX28 with Atheros AR6203
To: FCC 47 CFR Part 15.247 & IC RSS-210
Serial #: DIGI36-U2 Rev A
Issue Date: 22nd May 2014
Page: 191 of 261



peak output power

Variant: 802.11g, Channel: 2437.00 MHz, Chain a, Temp: Ambient, Voltage: 5.00V

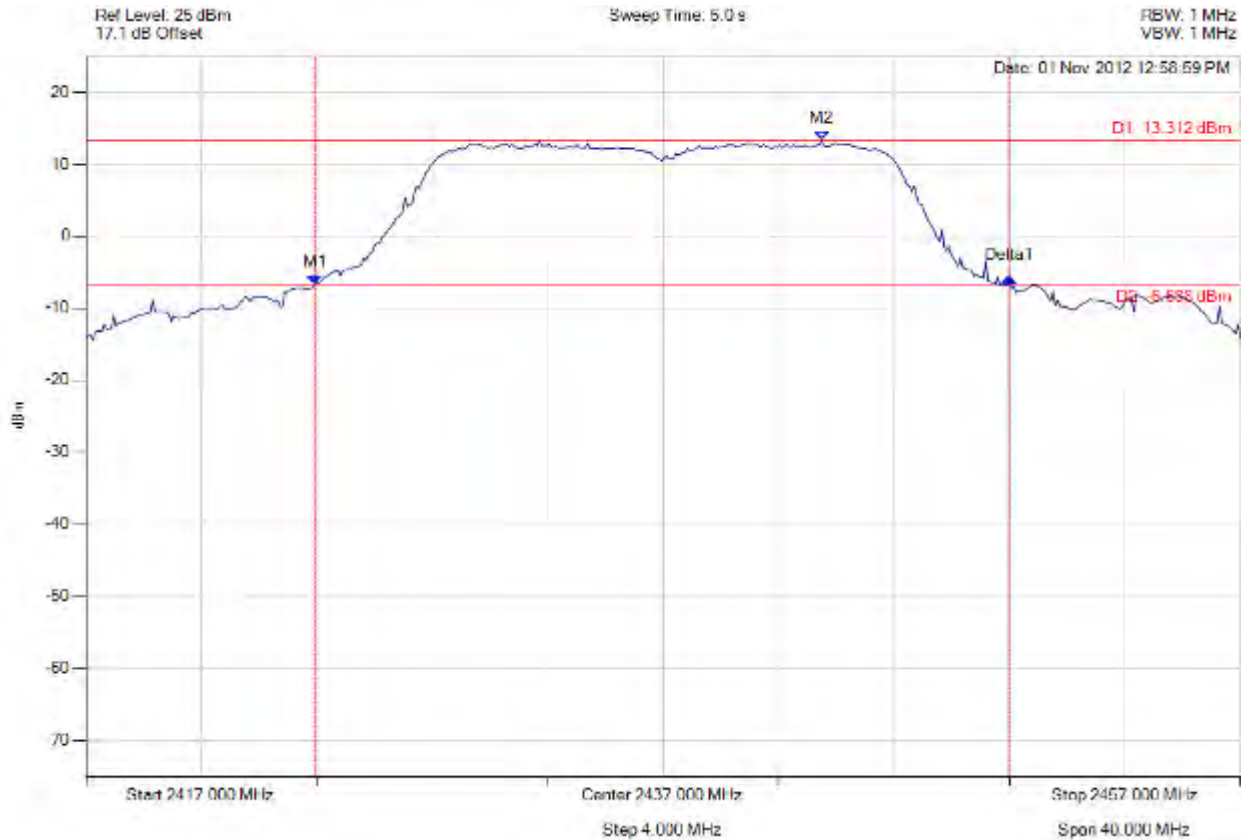

Analyser Setup	Marker : Frequency : Amplitude	Test Results
Detector = MAX PEAK Sweep Count = 0 RF Atten (dB) = 20 Trace Mode = VIEW	M1 : 2424.936 MHz : -6.690 dBm M2 : 2442.491 MHz : 13.312 dBm Delta1 : 24.048 MHz : 0.933 dB	Channel Power: 23.98 dBm Limit: 30.00 dBm Margin: -6.02 dB

[Back to the Matrix](#)

This test report may be reproduced in full only. The document may only be updated by MiCOM Labs personnel. Any changes will be noted in the Document History section of the report.



Title: Digi Connect Card for i.MX28 with Atheros AR6203
To: FCC 47 CFR Part 15.247 & IC RSS-210
Serial #: DIGI36-U2 Rev A
Issue Date: 22nd May 2014
Page: 192 of 261



peak output power

Variant: 802.11g, Channel: 2462.00 MHz, Chain a, Temp: Ambient, Voltage: 5.00V

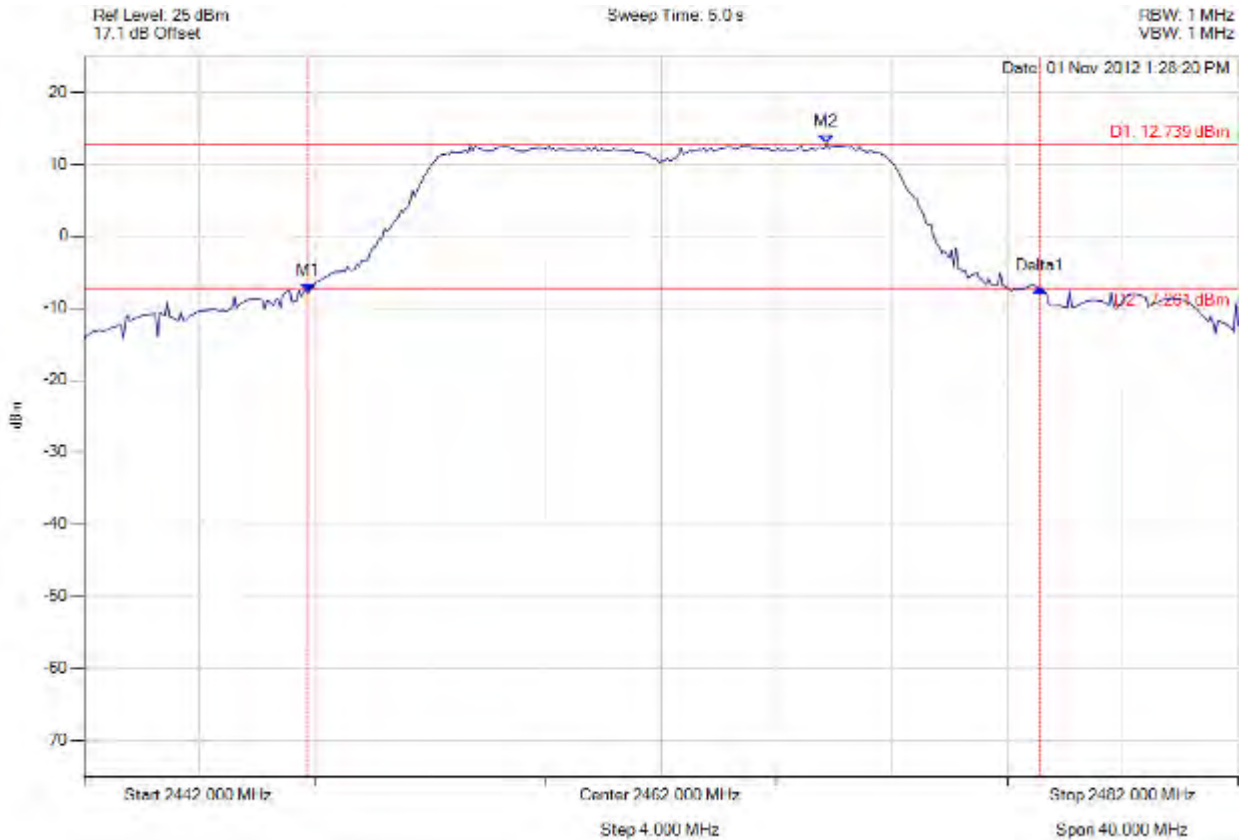

Analyser Setup	Marker : Frequency : Amplitude	Test Results
Detector = MAX PEAK Sweep Count = 0 RF Atten (dB) = 20 Trace Mode = VIEW	M1 : 2449.776 MHz : -7.888 dBm M2 : 2467.731 MHz : 12.739 dBm Delta1 : 25.331 MHz : 0.641 dB	Channel Power: 23.66 dBm Limit: 30.00 dBm Margin: -6.34 dB

[Back to the Matrix](#)

This test report may be reproduced in full only. The document may only be updated by MiCOM Labs personnel. Any changes will be noted in the Document History section of the report.



Title: Digi Connect Card for i.MX28 with Atheros AR6203
To: FCC 47 CFR Part 15.247 & IC RSS-210
Serial #: DIGI36-U2 Rev A
Issue Date: 22nd May 2014
Page: 193 of 261



peak output power

Variant: 802.11n HT-20, Channel: 2412.00 MHz, Chain a, Temp: Ambient, Voltage: 5.00V

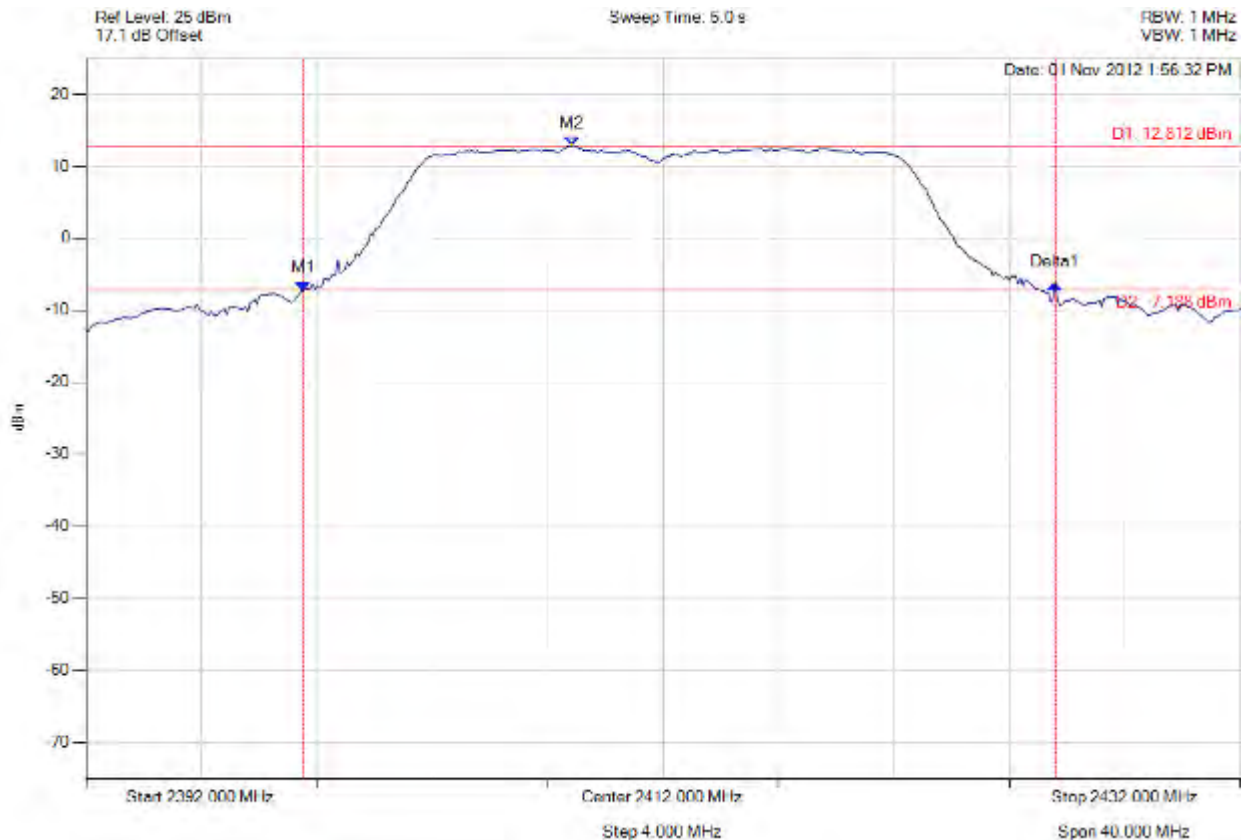

Analyser Setup	Marker : Frequency : Amplitude	Test Results
Detector = MAX PEAK Sweep Count = 0 RF Atten (dB) = 20 Trace Mode = VIEW	M1 : 2399.535 MHz : -7.286 dBm M2 : 2408.834 MHz : 12.812 dBm Delta1 : 26.052 MHz : 0.956 dB	Channel Power: 23.95 dBm Limit: 30.00 dBm Margin: -6.05 dB

[Back to the Matrix](#)

This test report may be reproduced in full only. The document may only be updated by MiCOM Labs personnel. Any changes will be noted in the Document History section of the report.



Title: Digi Connect Card for i.MX28 with Atheros AR6203
To: FCC 47 CFR Part 15.247 & IC RSS-210
Serial #: DIGI36-U2 Rev A
Issue Date: 22nd May 2014
Page: 194 of 261



peak output power

Variant: 802.11n HT-20, Channel: 2437.00 MHz, Chain a, Temp: Ambient, Voltage: 5.00V

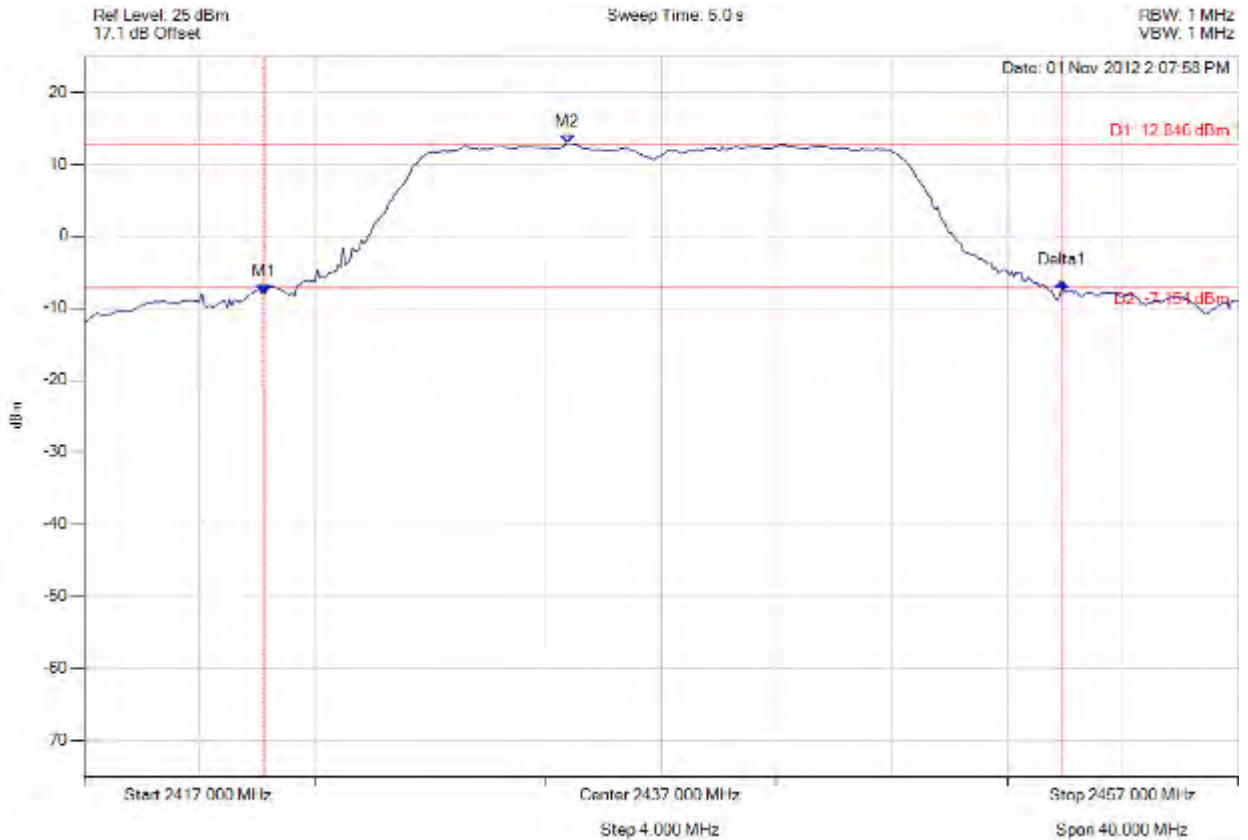

Analyser Setup	Marker : Frequency : Amplitude	Test Results
Detector = MAX PEAK Sweep Count = 0 RF Atten (dB) = 20 Trace Mode = VIEW	M1 : 2423.253 MHz : -7.993 dBm M2 : 2433.754 MHz : 12.846 dBm Delta1 : 27.655 MHz : 1.570 dB	Channel Power: 24.08 dBm Limit: 30.00 dBm Margin: -5.92 dB

[Back to the Matrix](#)

This test report may be reproduced in full only. The document may only be updated by MiCOM Labs personnel. Any changes will be noted in the Document History section of the report.



Title: Digi Connect Card for i.MX28 with Atheros AR6203
To: FCC 47 CFR Part 15.247 & IC RSS-210
Serial #: DIGI36-U2 Rev A
Issue Date: 22nd May 2014
Page: 195 of 261



peak output power

Variant: 802.11n HT-20, Channel: 2462.00 MHz, Chain a, Temp: Ambient, Voltage: 5.00V

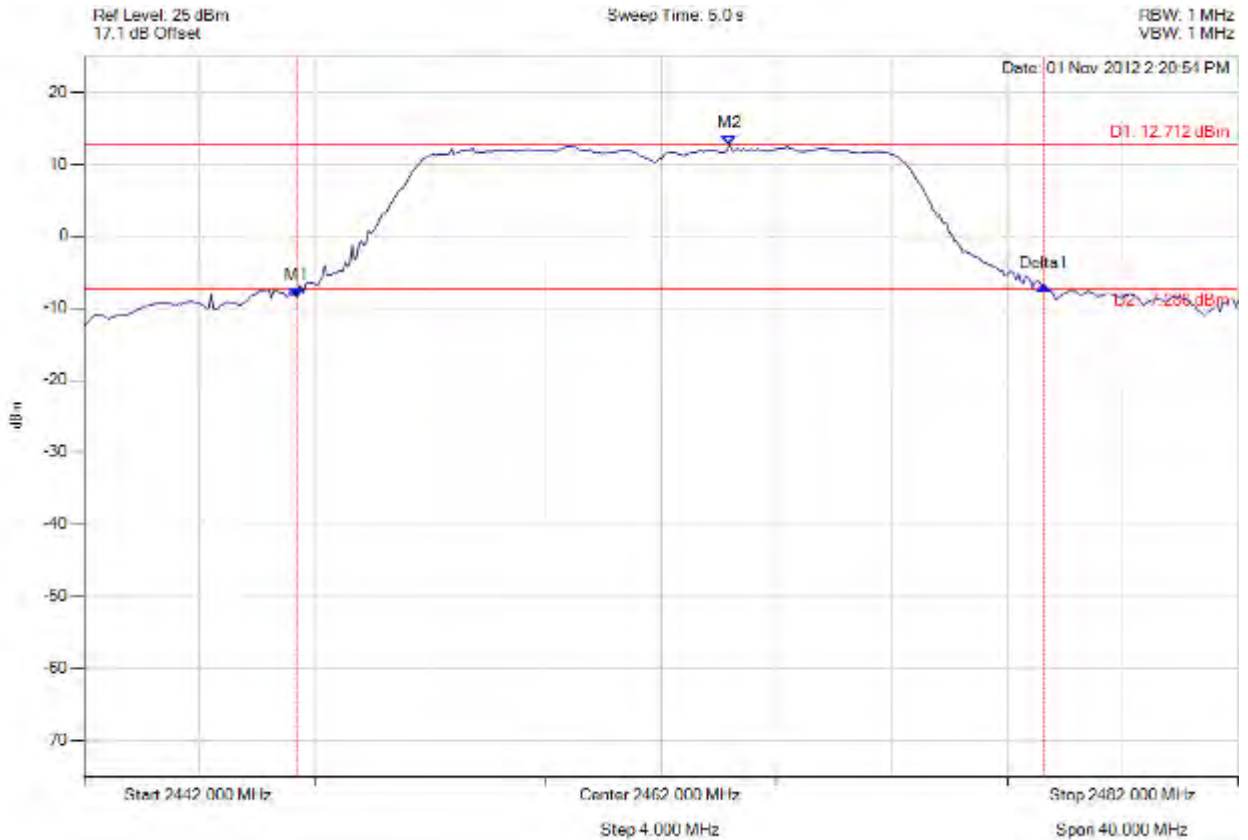

Analyser Setup	Marker : Frequency : Amplitude	Test Results
Detector = MAX PEAK Sweep Count = 0 RF Atten (dB) = 20 Trace Mode = VIEW	M1 : 2449.375 MHz : -8.482 dBm M2 : 2464.365 MHz : 12.712 dBm Delta1 : 25.892 MHz : 1.670 dB	Channel Power: 23.74 dBm Limit: 30.00 dBm Margin: -6.26 dB

[Back to the Matrix](#)

This test report may be reproduced in full only. The document may only be updated by MiCOM Labs personnel. Any changes will be noted in the Document History section of the report.



Title: Digi Connect Card for i.MX28 with Atheros AR6203
To: FCC 47 CFR Part 15.247 & IC RSS-210
Serial #: DIGI36-U2 Rev A
Issue Date: 22nd May 2014
Page: 196 of 261



peak output power

Variant: 802.11n HT-40, Channel: 2422.00 MHz, Chain a, Temp: Ambient, Voltage: 5.00V

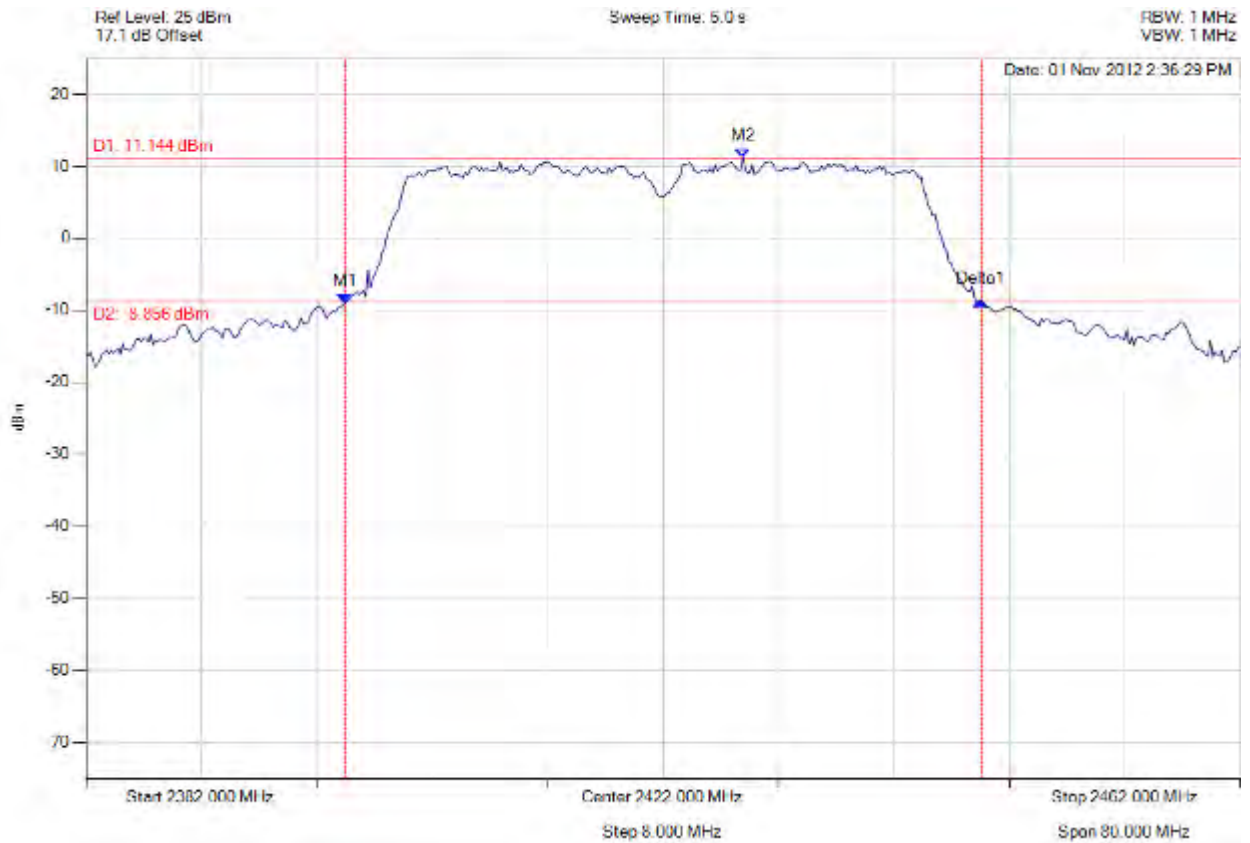

Analyser Setup	Marker : Frequency : Amplitude	Test Results
Detector = MAX PEAK Sweep Count = 0 RF Atten (dB) = 20 Trace Mode = VIEW	M1 : 2399.956 MHz : -9.027 dBm M2 : 2427.531 MHz : 11.144 dBm Delta1 : 44.088 MHz : 0.350 dB	Channel Power: 24.53 dBm Limit: 30.00 dBm Margin: -5.47 dB

[Back to the Matrix](#)

This test report may be reproduced in full only. The document may only be updated by MiCOM Labs personnel. Any changes will be noted in the Document History section of the report.



Title: Digi Connect Card for i.MX28 with Atheros AR6203
To: FCC 47 CFR Part 15.247 & IC RSS-210
Serial #: DIGI36-U2 Rev A
Issue Date: 22nd May 2014
Page: 197 of 261



peak output power

Variante: 802.11n HT-40, Channel: 2437.00 MHz, Chain a, Temp: Ambient, Voltage: 5.00V

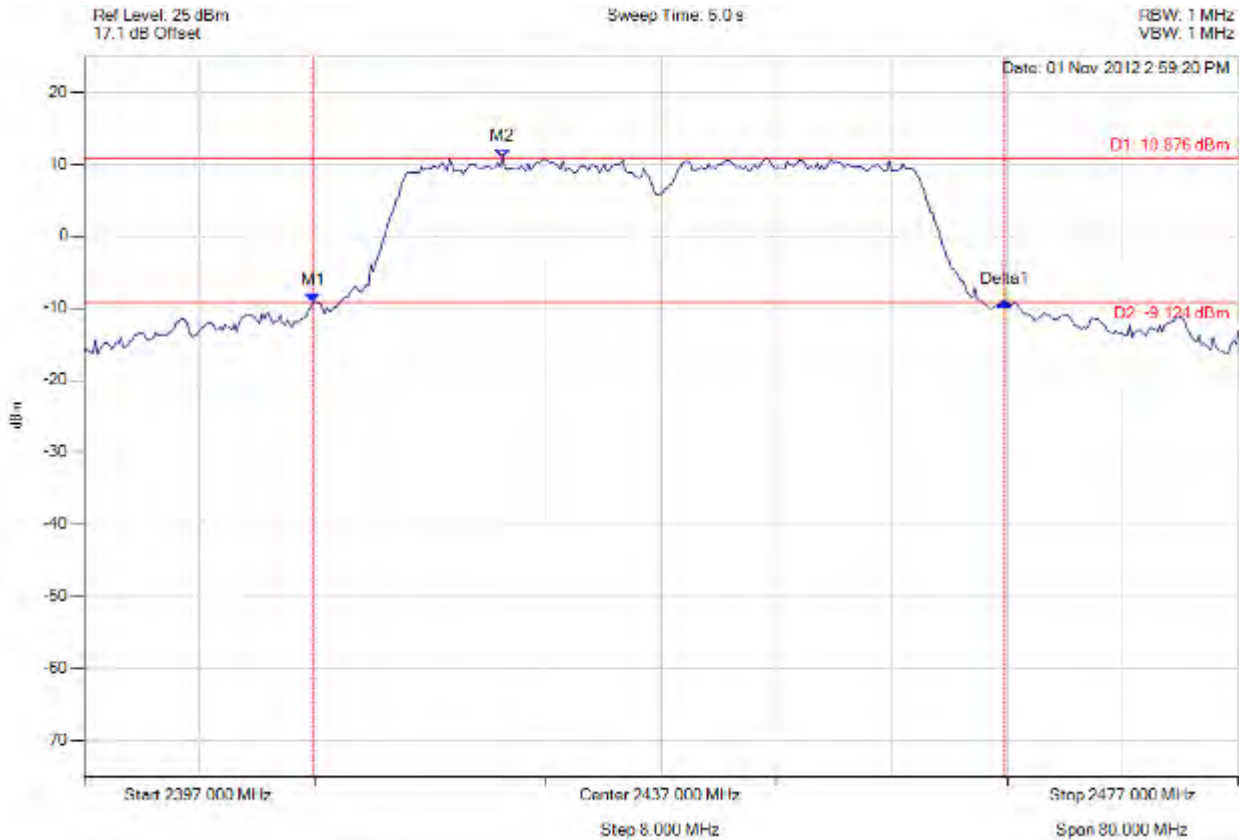

Analyser Setup	Marker : Frequency : Amplitude	Test Results
Detector = MAX PEAK Sweep Count = 0 RF Atten (dB) = 20 Trace Mode = VIEW	M1 : 2412.872 MHz : -9.250 dBm M2 : 2426.018 MHz : 10.876 dBm Delta1 : 47.936 MHz : 0.161 dB	Channel Power: 24.65 dBm Limit: 30.00 dBm Margin: -5.35 dB

[Back to the Matrix](#)

This test report may be reproduced in full only. The document may only be updated by MiCOM Labs personnel. Any changes will be noted in the Document History section of the report.



Title: Digi Connect Card for i.MX28 with Atheros AR6203
To: FCC 47 CFR Part 15.247 & IC RSS-210
Serial #: DIGI36-U2 Rev A
Issue Date: 22nd May 2014
Page: 198 of 261



peak output power

Variant: 802.11n HT-40, Channel: 2452.00 MHz, Chain a, Temp: Ambient, Voltage: 5.00V

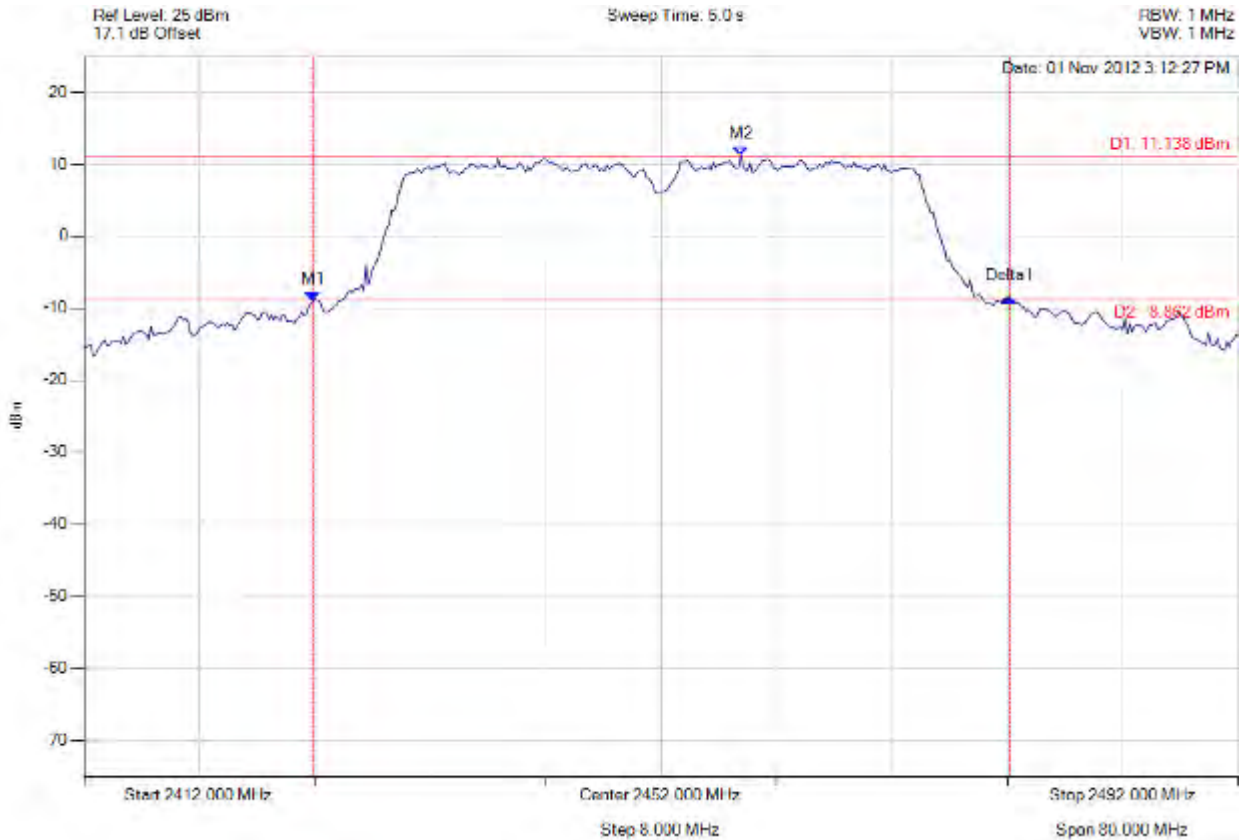

Analyser Setup	Marker : Frequency : Amplitude	Test Results
Detector = MAX PEAK Sweep Count = 0 RF Atten (dB) = 20 Trace Mode = VIEW	M1 : 2427.872 MHz : -9.012 dBm M2 : 2457.531 MHz : 11.138 dBm Delta1 : 48.257 MHz : 0.447 dB	Channel Power: 24.64 dBm Limit: 30.00 dBm Margin: -5.36 dB

[Back to the Matrix](#)

This test report may be reproduced in full only. The document may only be updated by MiCOM Labs personnel. Any changes will be noted in the Document History section of the report.



Title: Digi Connect Card for i.MX28 with Atheros AR6203
To: FCC 47 CFR Part 15.247 & IC RSS-210
Serial #: DIGI36-U2 Rev A
Issue Date: 22nd May 2014
Page: 199 of 261



peak output power

Variant: 802.11a, Channel: 5745.00 MHz, Chain a, Temp: Ambient, Voltage: 5.00V

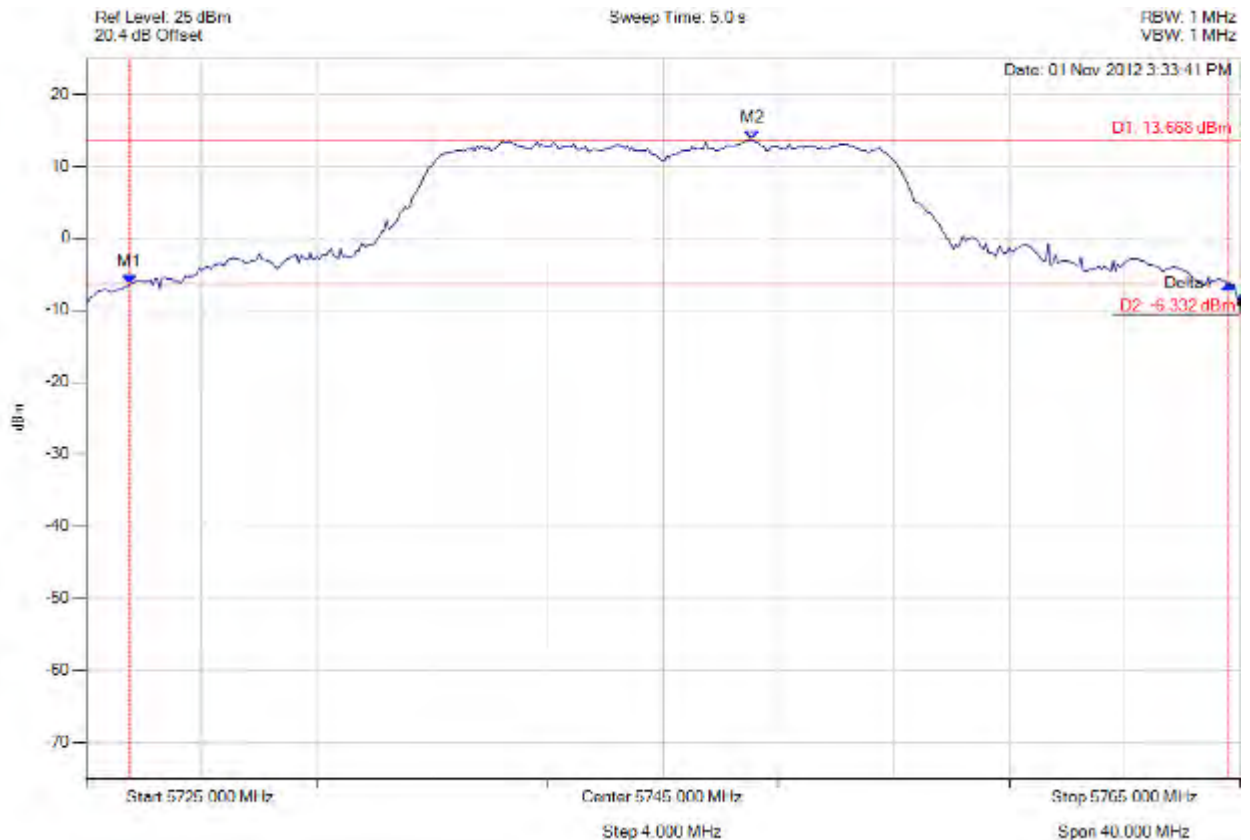

Analyser Setup	Marker : Frequency : Amplitude	Test Results
Detector = MAX PEAK Sweep Count = 0 RF Atten (dB) = 20 Trace Mode = VIEW	M1 : 5726.523 MHz : -6.411 dBm M2 : 5748.086 MHz : 13.668 dBm Delta1 : 38.076 MHz : 0.079 dB	Channel Power: 24.34 dBm Limit: 30.00 dBm Margin: -5.66 dB

[Back to the Matrix](#)

This test report may be reproduced in full only. The document may only be updated by MiCOM Labs personnel. Any changes will be noted in the Document History section of the report.



Title: Digi Connect Card for i.MX28 with Atheros AR6203
To: FCC 47 CFR Part 15.247 & IC RSS-210
Serial #: DIGI36-U2 Rev A
Issue Date: 22nd May 2014
Page: 200 of 261



peak output power

Variant: 802.11a, Channel: 5785.00 MHz, Chain a, Temp: Ambient, Voltage: 5.00V

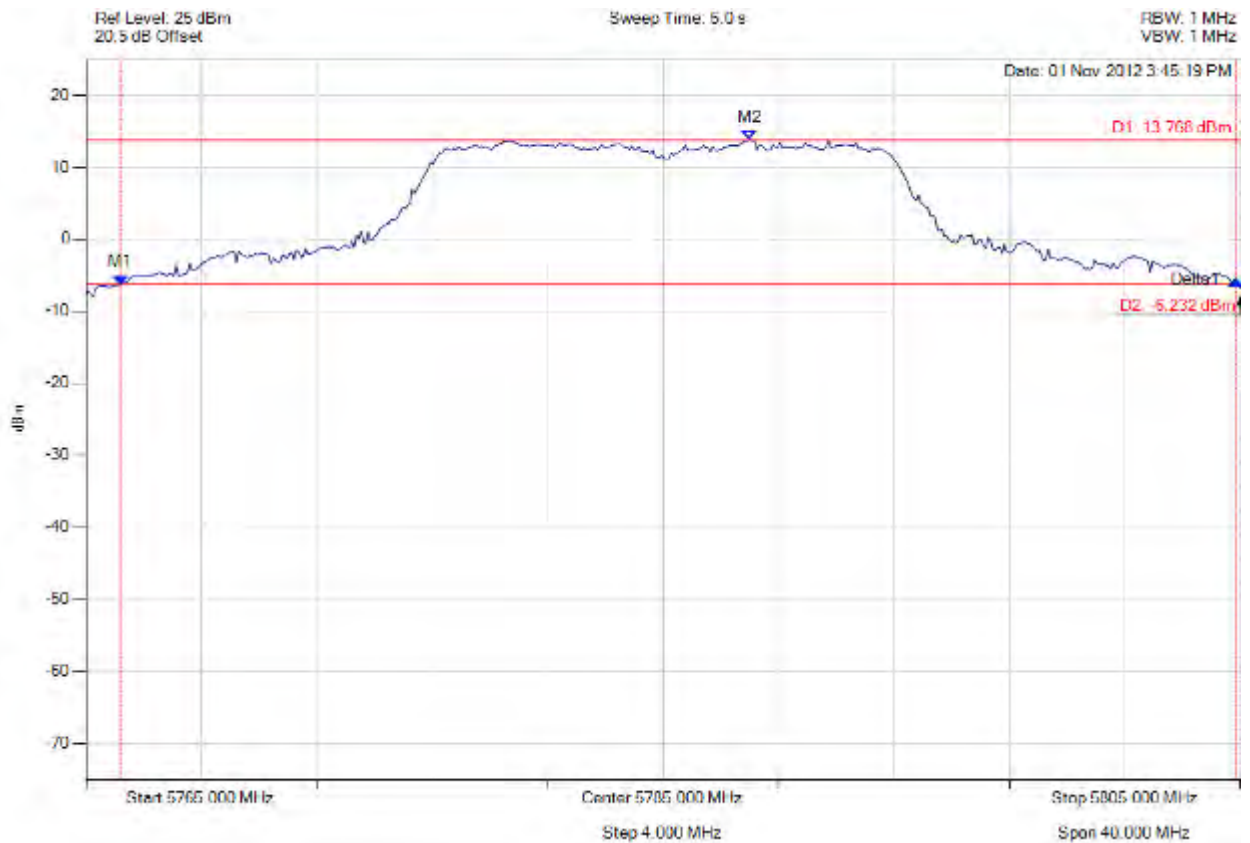

Analyser Setup	Marker : Frequency : Amplitude	Test Results
Detector = MAX PEAK Sweep Count = 0 RF Atten (dB) = 20 Trace Mode = VIEW	M1 : 5766.202 MHz : -6.285 dBm M2 : 5788.006 MHz : 13.768 dBm Delta1 : 38.637 MHz : 0.628 dB	Channel Power: 24.60 dBm Limit: 30.00 dBm Margin: -5.40 dB

[Back to the Matrix](#)

This test report may be reproduced in full only. The document may only be updated by MiCOM Labs personnel. Any changes will be noted in the Document History section of the report.



Title: Digi Connect Card for i.MX28 with Atheros AR6203
To: FCC 47 CFR Part 15.247 & IC RSS-210
Serial #: DIGI36-U2 Rev A
Issue Date: 22nd May 2014
Page: 201 of 261



peak output power

Variant: 802.11a, Channel: 5825.00 MHz, Chain a, Temp: Ambient, Voltage: 5.00V

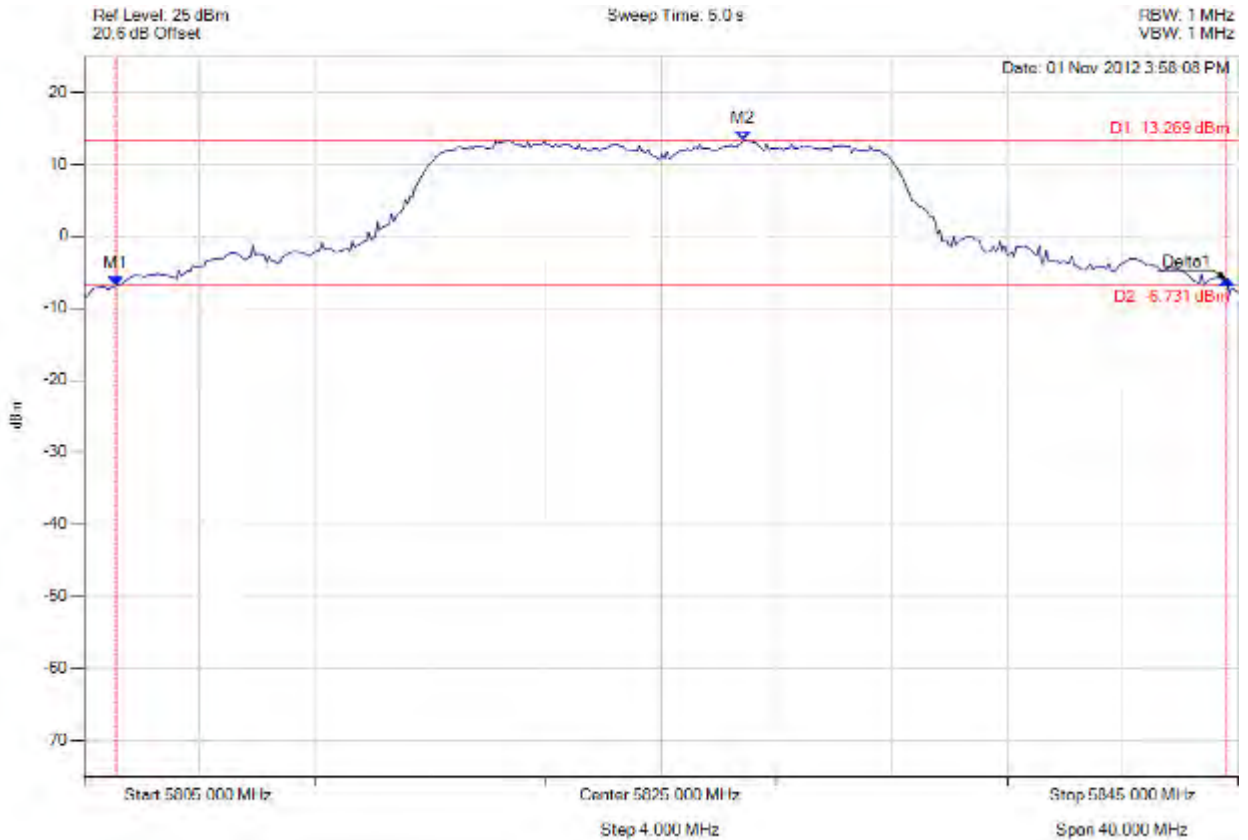

Analyser Setup	Marker : Frequency : Amplitude	Test Results
Detector = MAX PEAK Sweep Count = 0 RF Atten (dB) = 20 Trace Mode = VIEW	M1 : 5806.122 MHz : -6.838 dBm M2 : 5827.846 MHz : 13.269 dBm Delta1 : 38.477 MHz : 0.836 dB	Channel Power: 24.11 dBm Limit: 30.00 dBm Margin: -5.89 dB

[Back to the Matrix](#)

This test report may be reproduced in full only. The document may only be updated by MiCOM Labs personnel. Any changes will be noted in the Document History section of the report.



Title: Digi Connect Card for i.MX28 with Atheros AR6203
To: FCC 47 CFR Part 15.247 & IC RSS-210
Serial #: DIGI36-U2 Rev A
Issue Date: 22nd May 2014
Page: 202 of 261



PEAK OUTPUT POWER

Variant: 802.11a, Channel: 5745.00 MHz, Chain a, Temp: Ambient, Voltage: 5 Vdc

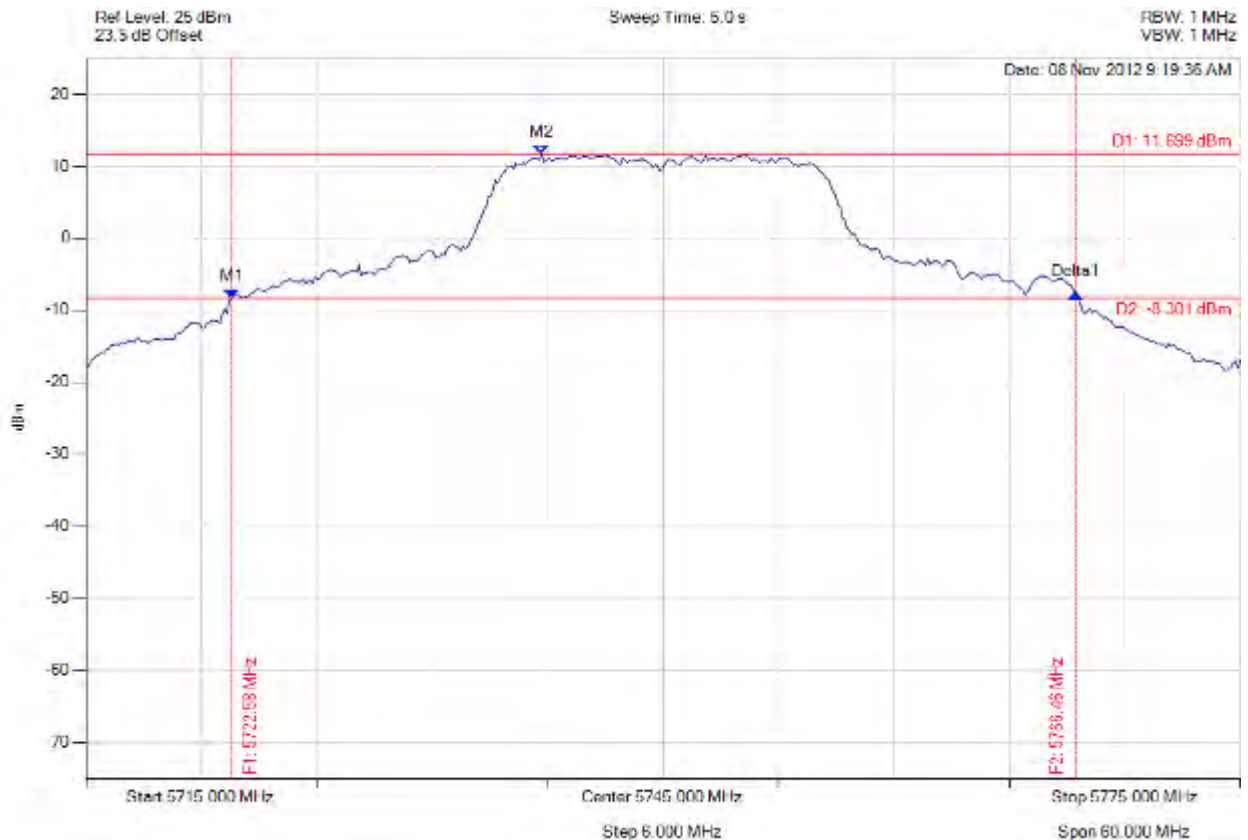

Analyser Setup	Marker : Frequency : Amplitude	Test Results
Detector = MAX PEAK Sweep Count = 0 RF Atten (dB) = 20 Trace Mode = VIEW	M1 : 5722.575 MHz : -8.307 dBm M2 : 5738.687 MHz : 11.699 dBm Delta1 : 43.888 MHz : 0.600 dB	Channel Power: 22.90 dBm Limit: 30.00 dBm Margin: -7.10 dB

[Back to the Matrix](#)

This test report may be reproduced in full only. The document may only be updated by MiCOM Labs personnel. Any changes will be noted in the Document History section of the report.



Title: Digi Connect Card for i.MX28 with Atheros AR6203
To: FCC 47 CFR Part 15.247 & IC RSS-210
Serial #: DIGI36-U2 Rev A
Issue Date: 22nd May 2014
Page: 203 of 261



PEAK OUTPUT POWER

Variant: 802.11n HT-20, Channel: 5785.00 MHz, Chain a, Temp: Ambient, Voltage: 5 Vdc

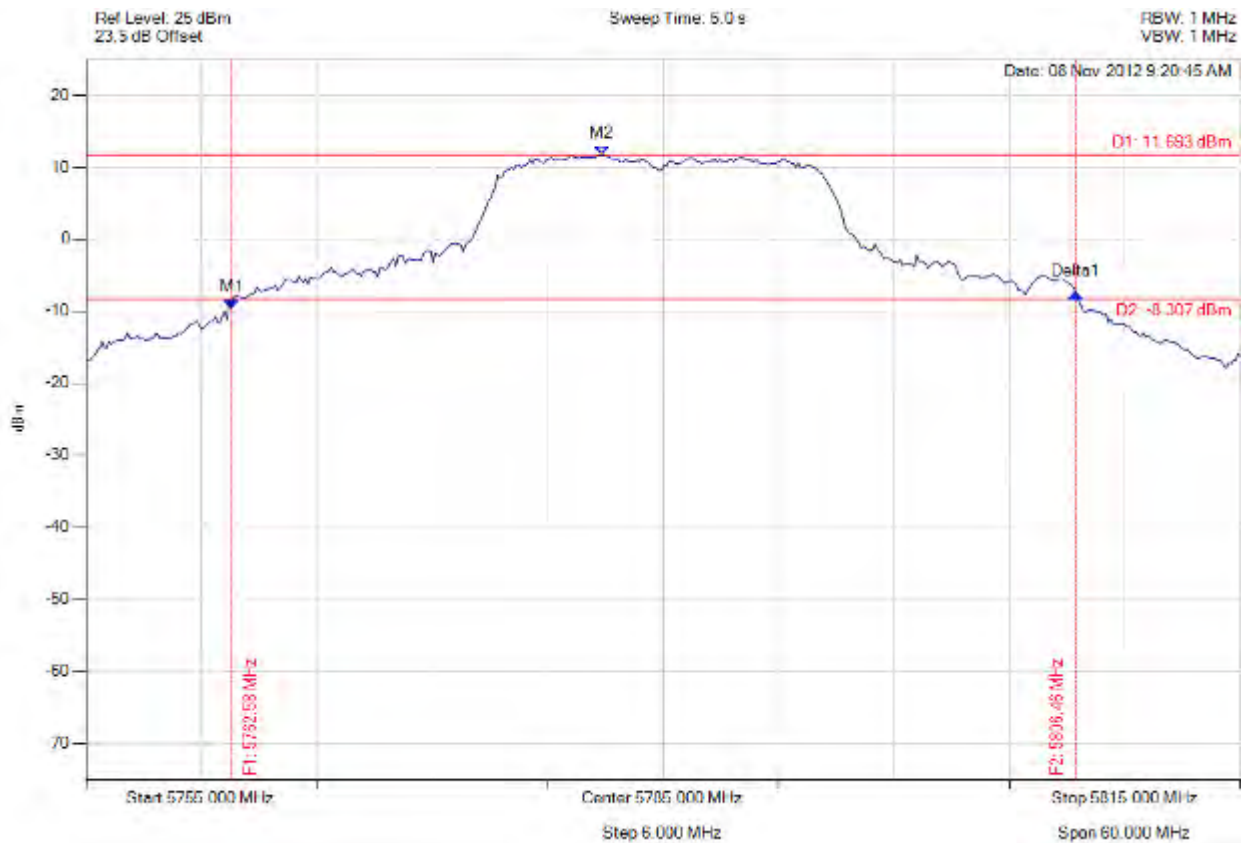

Analyser Setup	Marker : Frequency : Amplitude	Test Results
Detector = MAX PEAK Sweep Count = 0 RF Atten (dB) = 20 Trace Mode = VIEW	M1 : 5762.575 MHz : -9.635 dBm M2 : 5781.814 MHz : 11.693 dBm Delta1 : 43.888 MHz : 2.066 dB	Channel Power: 22.89 dBm Limit: 30.00 dBm Margin: -7.11 dB

[Back to the Matrix](#)

This test report may be reproduced in full only. The document may only be updated by MiCOM Labs personnel. Any changes will be noted in the Document History section of the report.



Title: Digi Connect Card for i.MX28 with Atheros AR6203
To: FCC 47 CFR Part 15.247 & IC RSS-210
Serial #: DIGI36-U2 Rev A
Issue Date: 22nd May 2014
Page: 204 of 261



PEAK OUTPUT POWER

Variant: 802.11n HT-20, Channel: 5825.00 MHz, Chain a, Temp: Ambient, Voltage: 5 Vdc

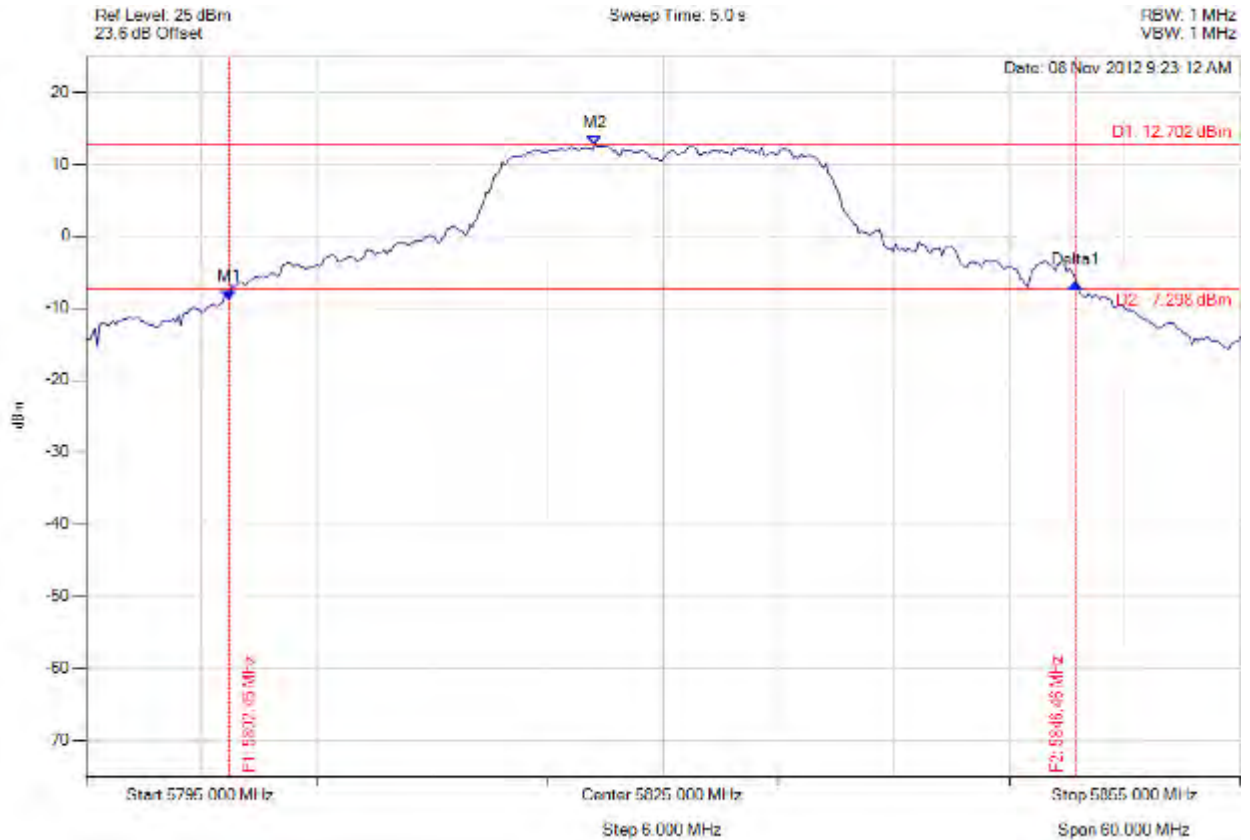

Analyser Setup	Marker : Frequency : Amplitude	Test Results
Detector = MAX PEAK Sweep Count = 0 RF Atten (dB) = 20 Trace Mode = VIEW	M1 : 5802.455 MHz : -8.787 dBm M2 : 5821.453 MHz : 12.702 dBm Delta1 : 44.008 MHz : 2.337 dB	Channel Power: 23.84 dBm Limit: 30.00 dBm Margin: -6.16 dB

[Back to the Matrix](#)

This test report may be reproduced in full only. The document may only be updated by MiCOM Labs personnel. Any changes will be noted in the Document History section of the report.



Title: Digi Connect Card for i.MX28 with Atheros AR6203
To: FCC 47 CFR Part 15.247 & IC RSS-210
Serial #: DIGI36-U2 Rev A
Issue Date: 22nd May 2014
Page: 205 of 261



peak output power

Variant: 802.11n HT-40, Channel: 5755.00 MHz, Chain a, Temp: Ambient, Voltage: 5.00V

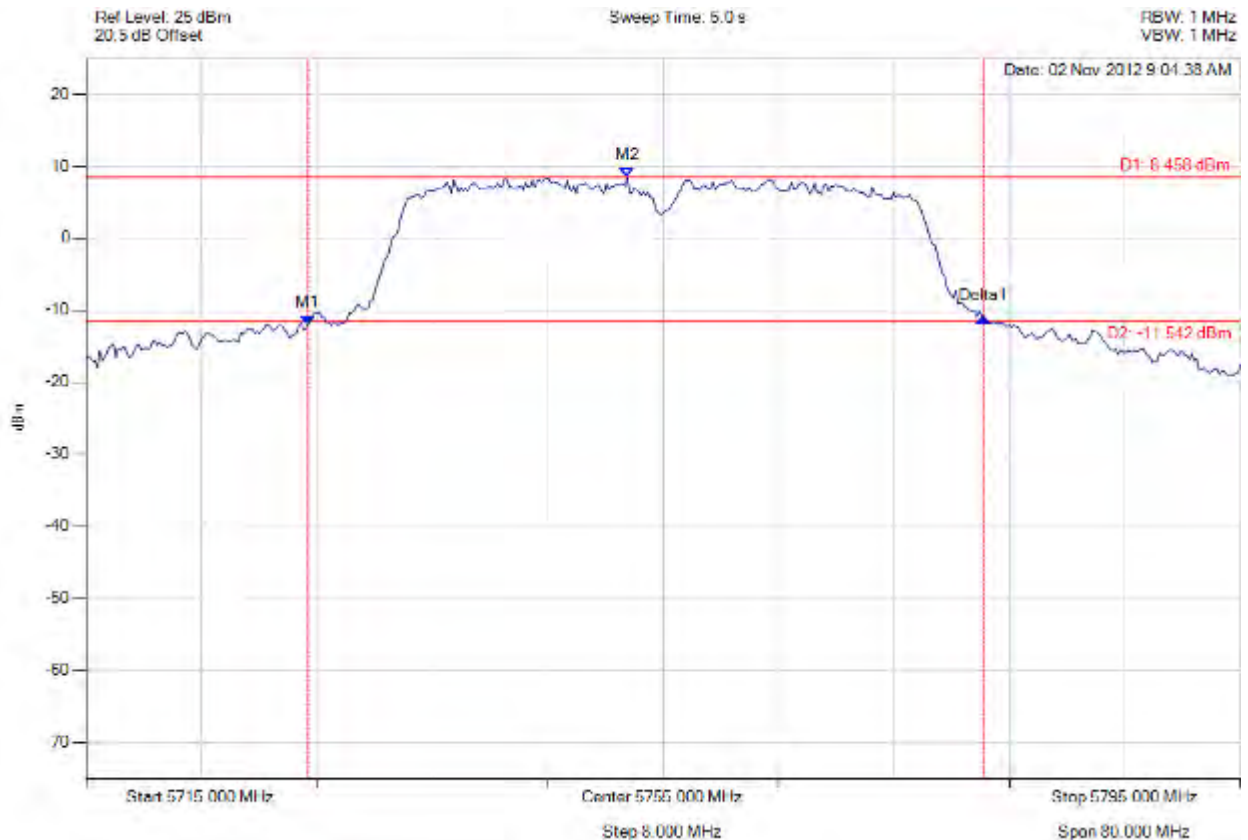

Analyser Setup	Marker : Frequency : Amplitude	Test Results
Detector = MAX PEAK Sweep Count = 0 RF Atten (dB) = 20 Trace Mode = VIEW	M1 : 5730.391 MHz : -12.016 dBm M2 : 5752.515 MHz : 8.458 dBm Delta1 : 46.814 MHz : 0.946 dB	Channel Power: 21.96 dBm Limit: 30.00 dBm Margin: -8.04 dB

[Back to the Matrix](#)

This test report may be reproduced in full only. The document may only be updated by MiCOM Labs personnel. Any changes will be noted in the Document History section of the report.



Title: Digi Connect Card for i.MX28 with Atheros AR6203
To: FCC 47 CFR Part 15.247 & IC RSS-210
Serial #: DIGI36-U2 Rev A
Issue Date: 22nd May 2014
Page: 206 of 261



peak output power

Variant: 802.11n HT-40, Channel: 5795.00 MHz, Chain a, Temp: Ambient, Voltage: 5.00V

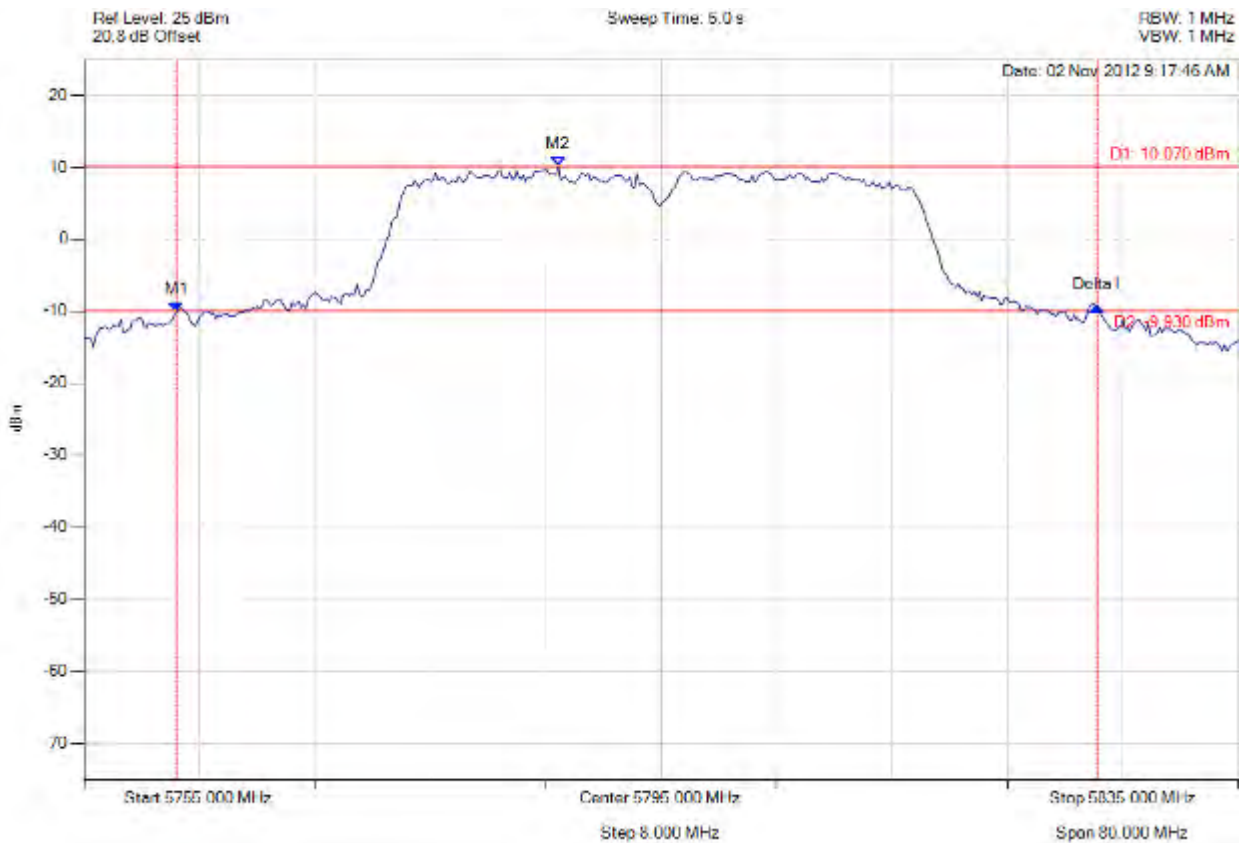

Analyser Setup	Marker : Frequency : Amplitude	Test Results
Detector = MAX PEAK Sweep Count = 0 RF Atten (dB) = 20 Trace Mode = VIEW	M1 : 5761.413 MHz : -10.102 dBm M2 : 5787.866 MHz : 10.070 dBm Delta1 : 63.808 MHz : 0.712 dB	Channel Power: 23.47 dBm Limit: 30.00 dBm Margin: -6.53 dB

[Back to the Matrix](#)

This test report may be reproduced in full only. The document may only be updated by MiCOM Labs personnel. Any changes will be noted in the Document History section of the report.



A.1.3. Power Spectral Density



power density

Variant: 802.11b, Channel: 2412.00 MHz, Chain a, Temp: Ambient, Voltage: 5.00V

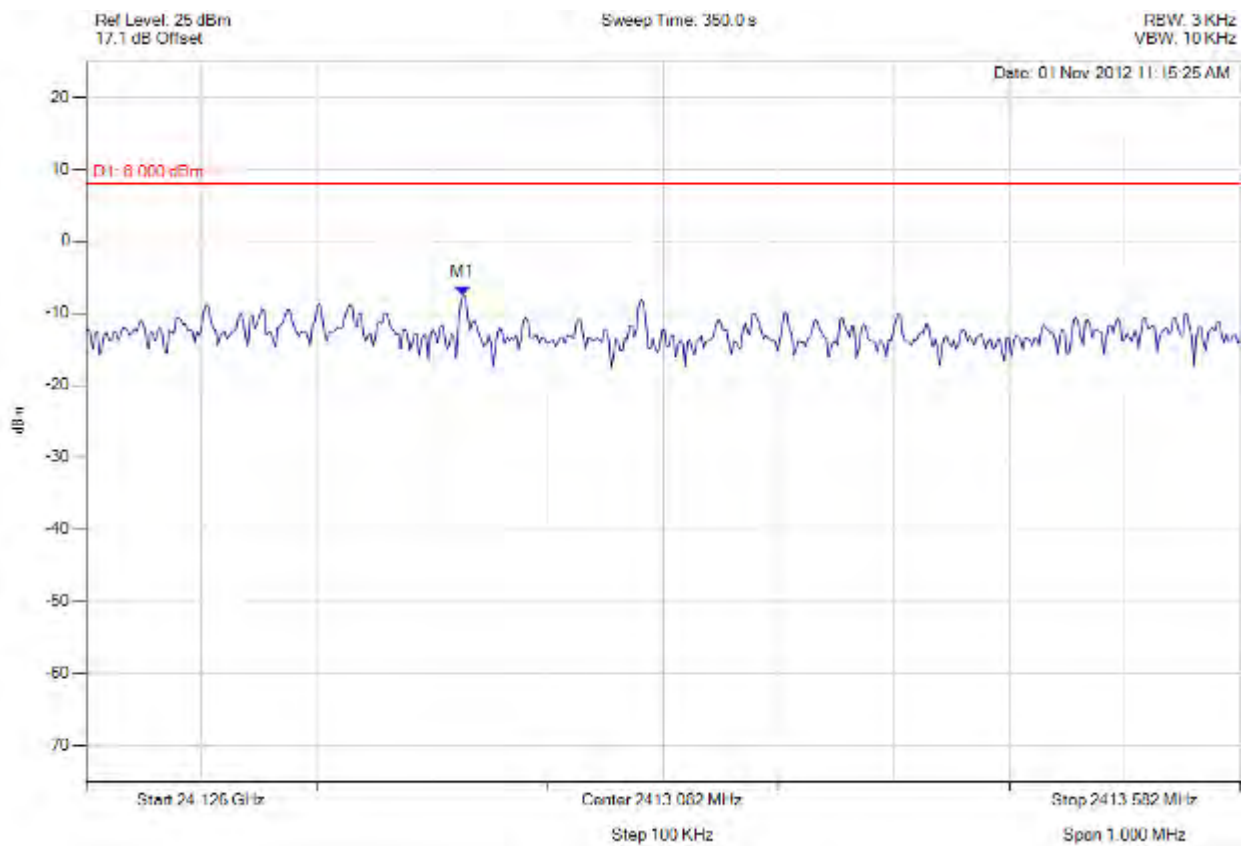

Analyser Setup	Marker : Frequency : Amplitude	Test Results
Detector = MAX PEAK Sweep Count = 0 RF Atten (dB) = 20 Trace Mode = VIEW	M1 : 2412.909 MHz : -7.459 dBm	Limit: ≤8.00 dBm Margin: -15.46 dB

[Back to the Matrix](#)

This test report may be reproduced in full only. The document may only be updated by MiCOM Labs personnel. Any changes will be noted in the Document History section of the report.



Title: Digi Connect Card for i.MX28 with Atheros AR6203
To: FCC 47 CFR Part 15.247 & IC RSS-210
Serial #: DIGI36-U2 Rev A
Issue Date: 22nd May 2014
Page: 208 of 261



power density

Variant: 802.11b, Channel: 2437.00 MHz, Chain a, Temp: Ambient, Voltage: 5.00V

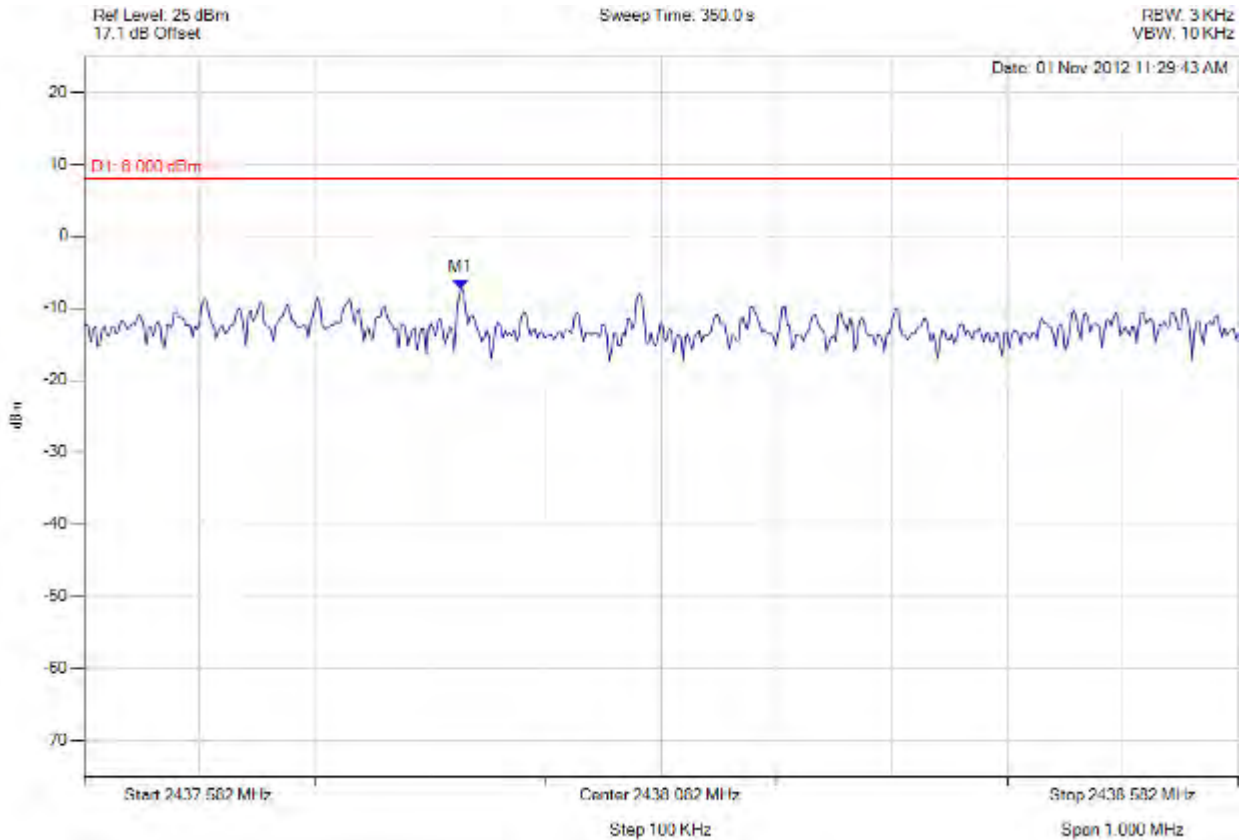

Analyser Setup	Marker : Frequency : Amplitude	Test Results
Detector = MAX PEAK Sweep Count = 0 RF Atten (dB) = 20 Trace Mode = VIEW	M1 : 2437.909 MHz : -7.367 dBm	Limit: ≤8.00 dBm Margin: -15.37 dB

[Back to the Matrix](#)

This test report may be reproduced in full only. The document may only be updated by MiCOM Labs personnel. Any changes will be noted in the Document History section of the report.



Title: Digi Connect Card for i.MX28 with Atheros AR6203
To: FCC 47 CFR Part 15.247 & IC RSS-210
Serial #: DIGI36-U2 Rev A
Issue Date: 22nd May 2014
Page: 209 of 261



power density

Variant: 802.11b, Channel: 2462.00 MHz, Chain a, Temp: Ambient, Voltage: 5.00V

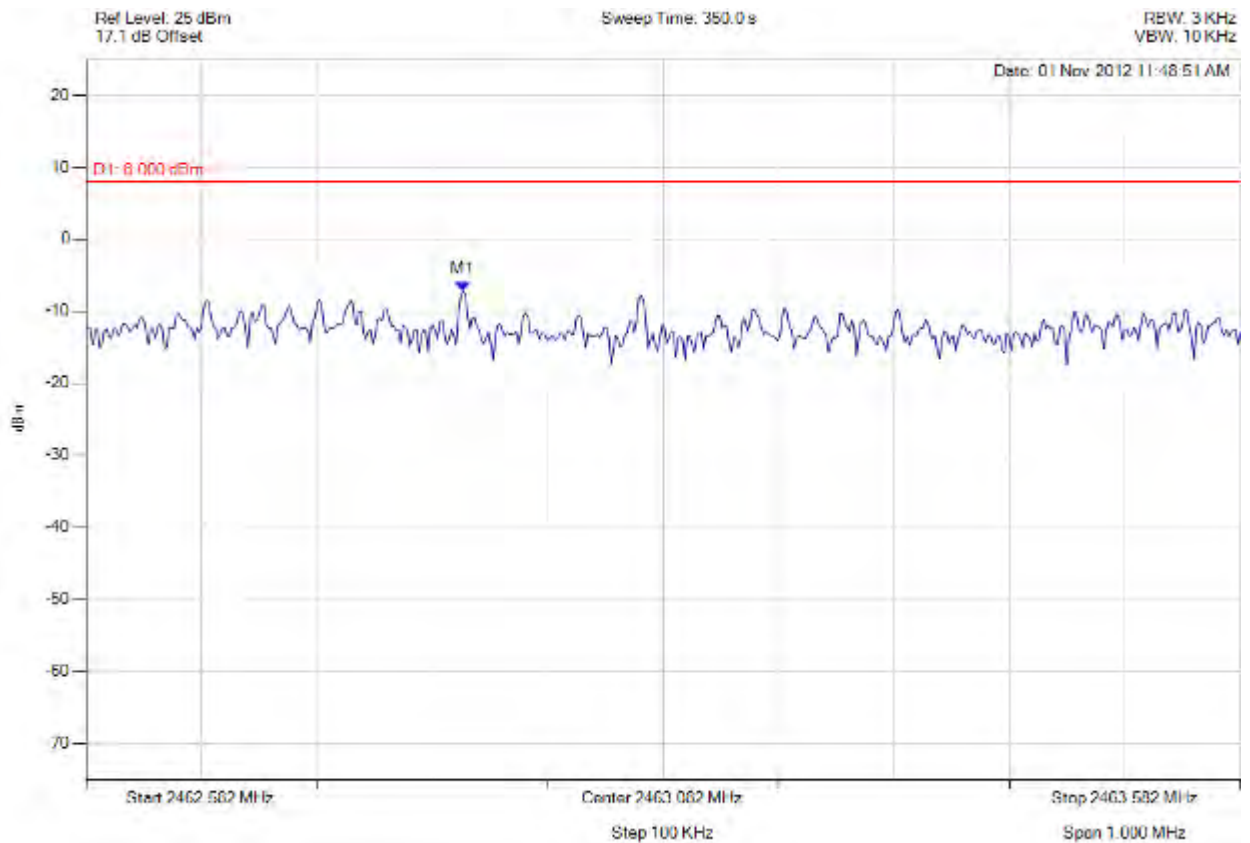

Analyser Setup	Marker : Frequency : Amplitude	Test Results
Detector = MAX PEAK Sweep Count = 0 RF Atten (dB) = 20 Trace Mode = VIEW	M1 : 2462.909 MHz : -7.172 dBm	Limit: ≤8.00 dBm Margin: -15.17 dB

[Back to the Matrix](#)

This test report may be reproduced in full only. The document may only be updated by MiCOM Labs personnel. Any changes will be noted in the Document History section of the report.



Title: Digi Connect Card for i.MX28 with Atheros AR6203
To: FCC 47 CFR Part 15.247 & IC RSS-210
Serial #: DIGI36-U2 Rev A
Issue Date: 22nd May 2014
Page: 210 of 261



power density

Variant: 802.11g, Channel: 2412.00 MHz, Chain a, Temp: Ambient, Voltage: 5.00V

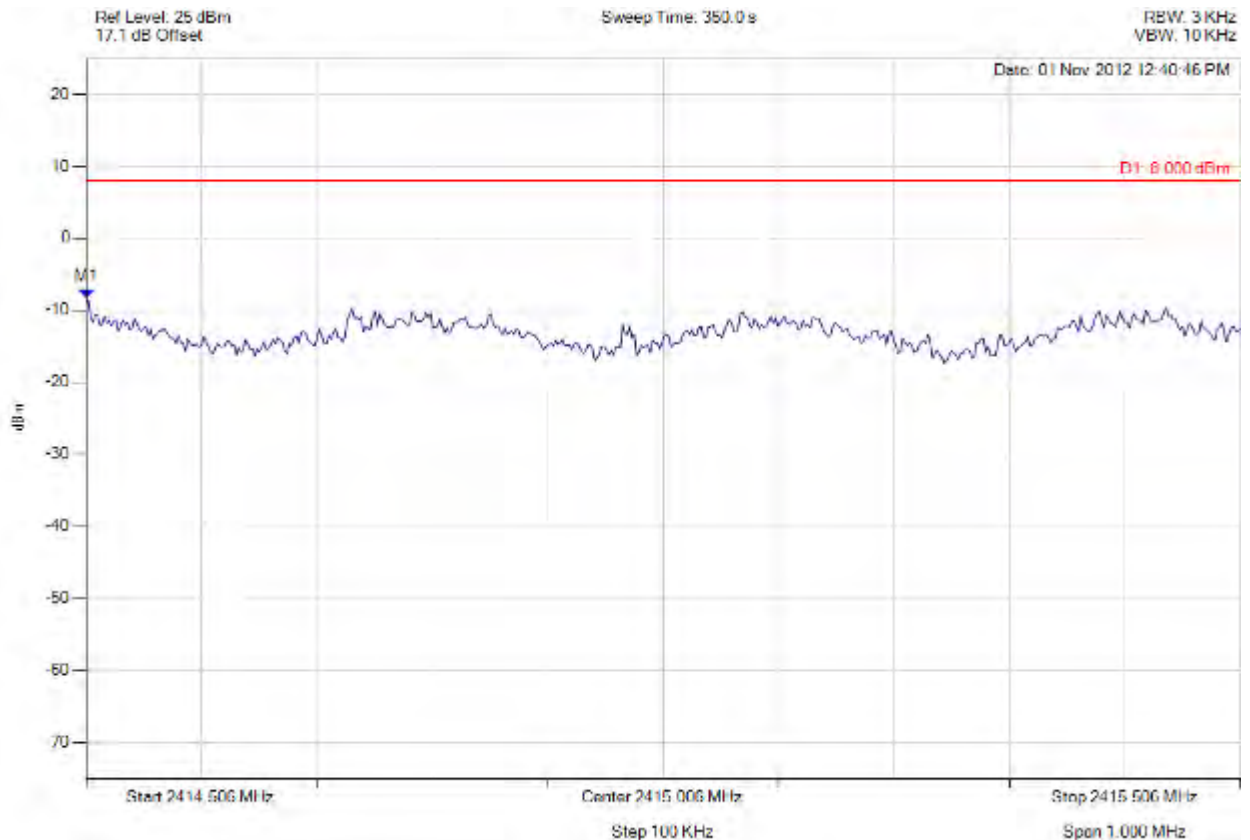

Analyser Setup	Marker : Frequency : Amplitude	Test Results
Detector = MAX PEAK Sweep Count = 0 RF Atten (dB) = 20 Trace Mode = VIEW	M1 : 2414.507 MHz : -8.337 dBm	Limit: ≤8.00 dBm Margin: -16.34 dB

[Back to the Matrix](#)

This test report may be reproduced in full only. The document may only be updated by MiCOM Labs personnel. Any changes will be noted in the Document History section of the report.



Title: Digi Connect Card for i.MX28 with Atheros AR6203
To: FCC 47 CFR Part 15.247 & IC RSS-210
Serial #: DIGI36-U2 Rev A
Issue Date: 22nd May 2014
Page: 211 of 261



power density

Variant: 802.11g, Channel: 2437.00 MHz, Chain a, Temp: Ambient, Voltage: 5.00V

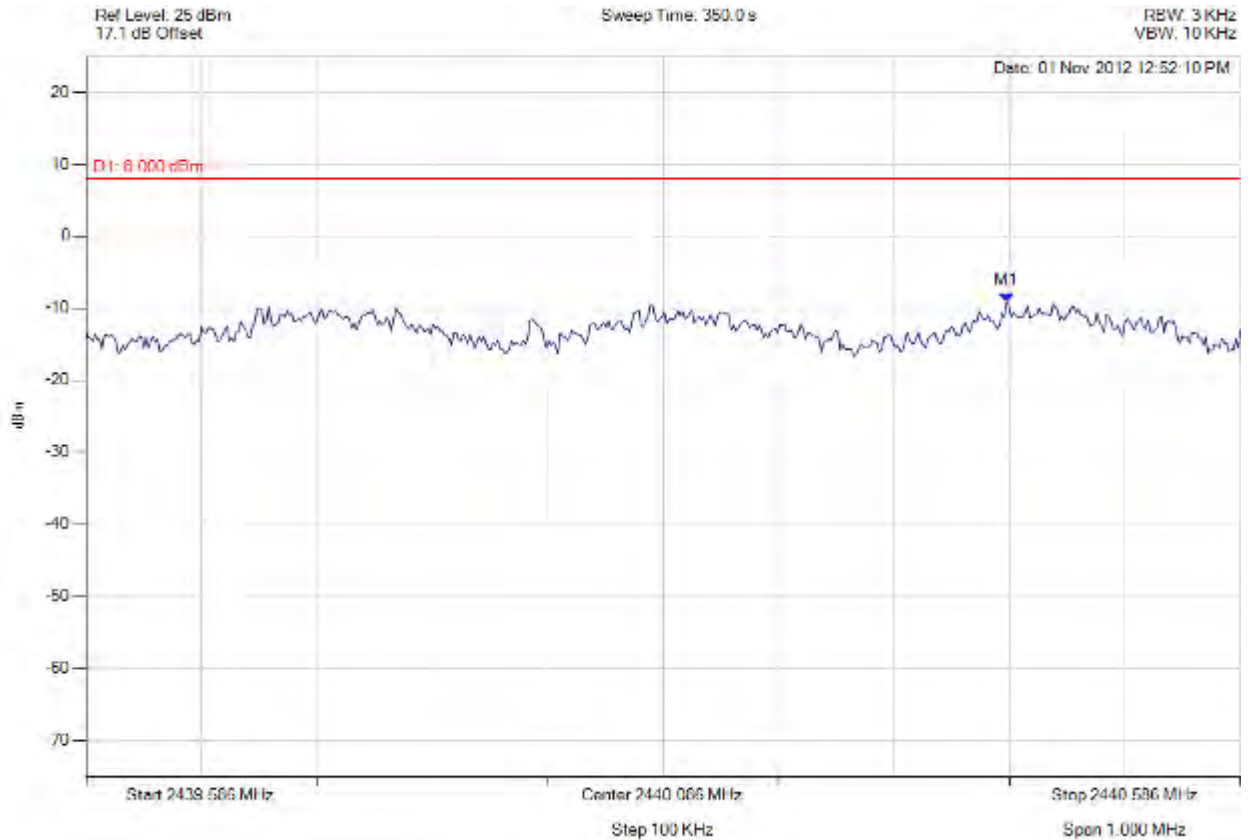

Analyser Setup	Marker : Frequency : Amplitude	Test Results
Detector = MAX PEAK Sweep Count = 0 RF Atten (dB) = 20 Trace Mode = VIEW	M1 : 2440.384 MHz : -9.185 dBm	Limit: ≤8.00 dBm Margin: -17.19 dB

[Back to the Matrix](#)

This test report may be reproduced in full only. The document may only be updated by MiCOM Labs personnel. Any changes will be noted in the Document History section of the report.



Title: Digi Connect Card for i.MX28 with Atheros AR6203
To: FCC 47 CFR Part 15.247 & IC RSS-210
Serial #: DIGI36-U2 Rev A
Issue Date: 22nd May 2014
Page: 212 of 261



power density

Variant: 802.11g, Channel: 2462.00 MHz, Chain a, Temp: Ambient, Voltage: 5.00V

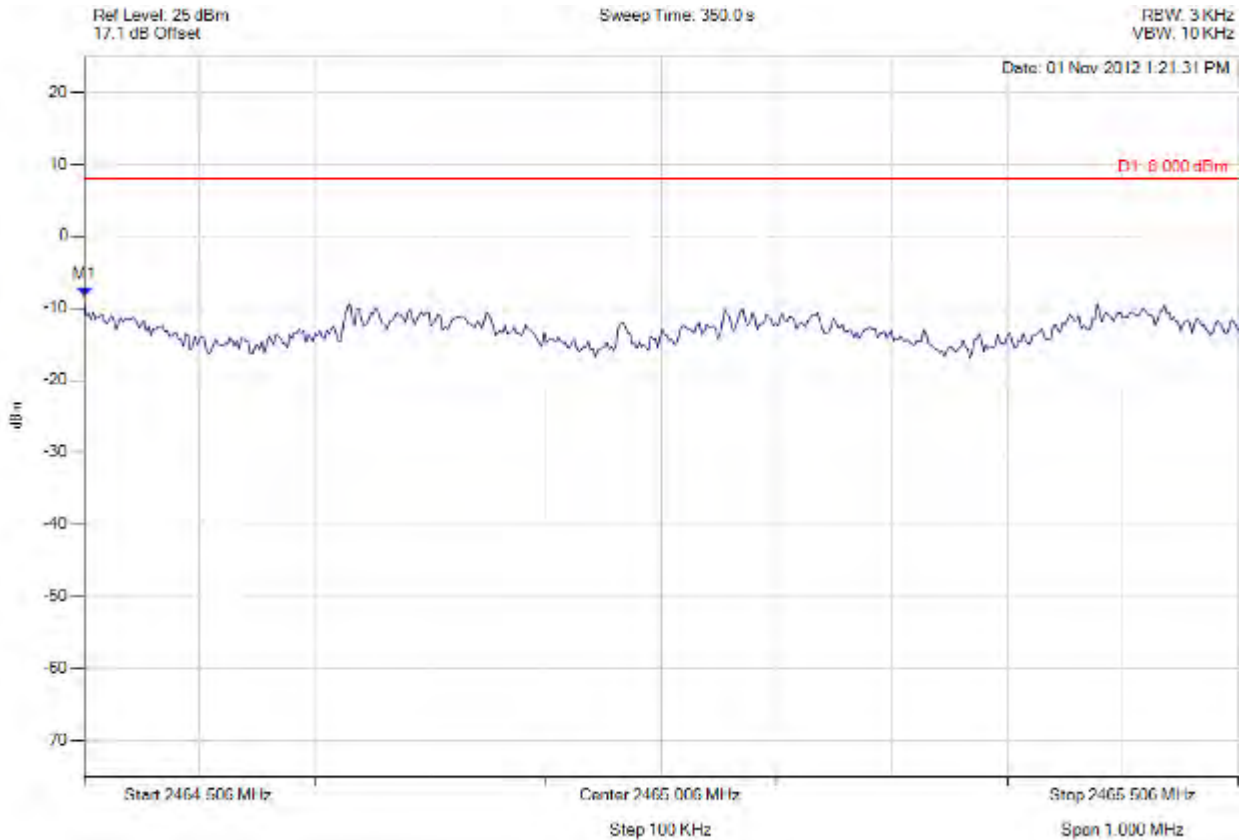

Analyser Setup	Marker : Frequency : Amplitude	Test Results
Detector = MAX PEAK Sweep Count = 0 RF Atten (dB) = 20 Trace Mode = VIEW	M1 : 2464.507 MHz : -8.427 dBm	Limit: ≤8.00 dBm Margin: -16.43 dB

[Back to the Matrix](#)

This test report may be reproduced in full only. The document may only be updated by MiCOM Labs personnel. Any changes will be noted in the Document History section of the report.



Title: Digi Connect Card for i.MX28 with Atheros AR6203
To: FCC 47 CFR Part 15.247 & IC RSS-210
Serial #: DIGI36-U2 Rev A
Issue Date: 22nd May 2014
Page: 213 of 261



power density

Variant: 802.11n HT-20, Channel: 2412.00 MHz, Chain a, Temp: Ambient, Voltage: 5.00V

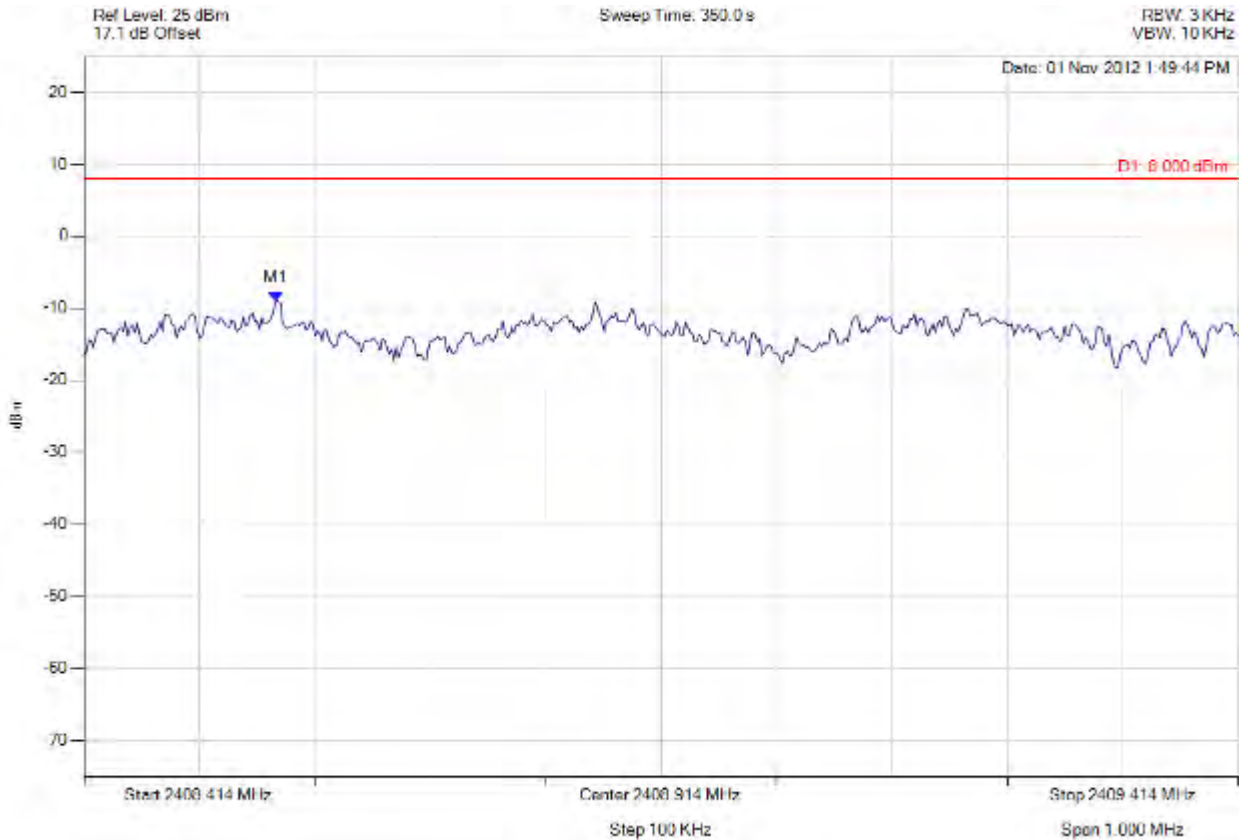

Analyser Setup	Marker : Frequency : Amplitude	Test Results
Detector = MAX PEAK Sweep Count = 0 RF Atten (dB) = 20 Trace Mode = VIEW	M1 : 2408.580 MHz : -8.964 dBm	Limit: ≤8.00 dBm Margin: -16.96 dB

[Back to the Matrix](#)

This test report may be reproduced in full only. The document may only be updated by MiCOM Labs personnel. Any changes will be noted in the Document History section of the report.



Title: Digi Connect Card for i.MX28 with Atheros AR6203
To: FCC 47 CFR Part 15.247 & IC RSS-210
Serial #: DIGI36-U2 Rev A
Issue Date: 22nd May 2014
Page: 214 of 261



power density

Variant: 802.11n HT-20, Channel: 2437.00 MHz, Chain a, Temp: Ambient, Voltage: 5.00V

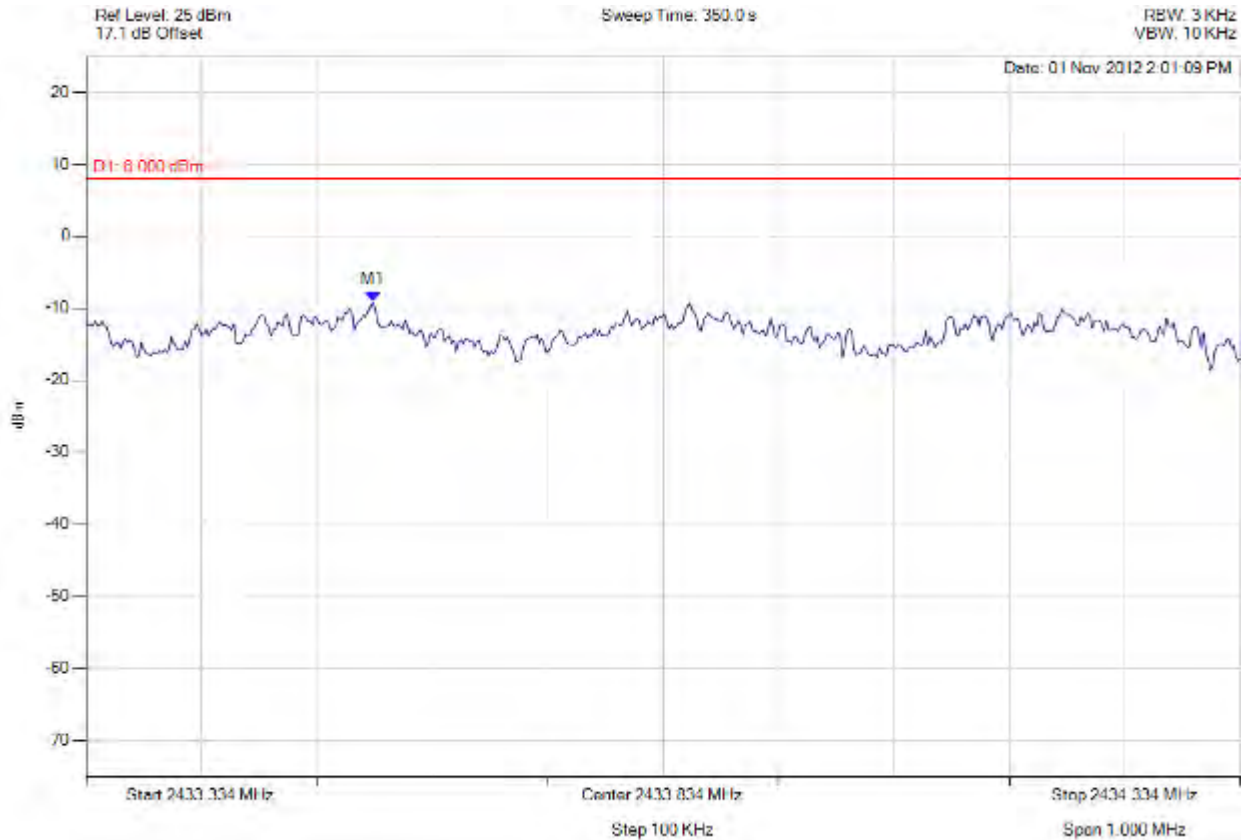

Analyser Setup	Marker : Frequency : Amplitude	Test Results
Detector = MAX PEAK Sweep Count = 0 RF Atten (dB) = 20 Trace Mode = VIEW	M1 : 2433.582 MHz : -9.094 dBm	Limit: ≤8.00 dBm Margin: -17.09 dB

[Back to the Matrix](#)

This test report may be reproduced in full only. The document may only be updated by MiCOM Labs personnel. Any changes will be noted in the Document History section of the report.



Title: Digi Connect Card for i.MX28 with Atheros AR6203
To: FCC 47 CFR Part 15.247 & IC RSS-210
Serial #: DIGI36-U2 Rev A
Issue Date: 22nd May 2014
Page: 215 of 261



power density

Variant: 802.11n HT-20, Channel: 2462.00 MHz, Chain a, Temp: Ambient, Voltage: 5.00V

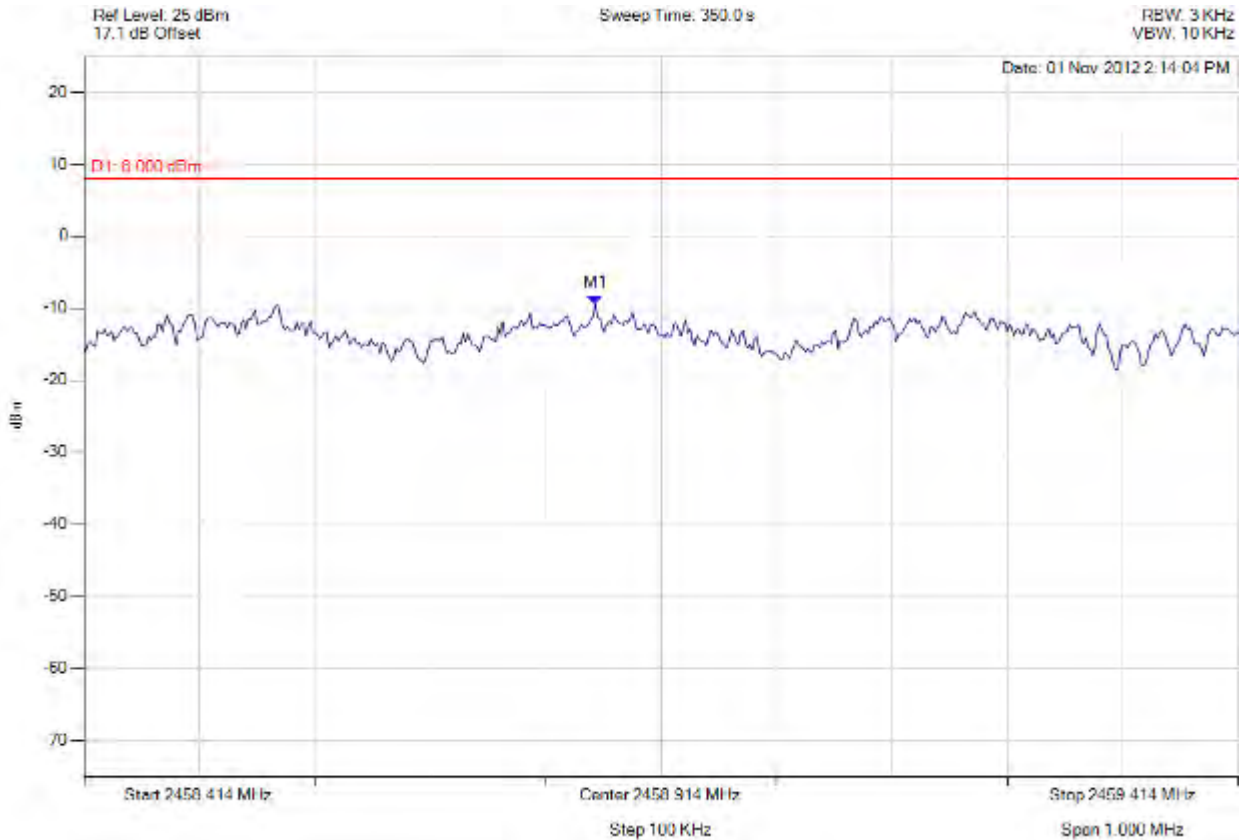

Analyser Setup	Marker : Frequency : Amplitude	Test Results
Detector = MAX PEAK Sweep Count = 0 RF Atten (dB) = 20 Trace Mode = VIEW	M1 : 2458.857 MHz : -9.494 dBm	Limit: ≤8.00 dBm Margin: -17.49 dB

[Back to the Matrix](#)

This test report may be reproduced in full only. The document may only be updated by MiCOM Labs personnel. Any changes will be noted in the Document History section of the report.



Title: Digi Connect Card for i.MX28 with Atheros AR6203
To: FCC 47 CFR Part 15.247 & IC RSS-210
Serial #: DIGI36-U2 Rev A
Issue Date: 22nd May 2014
Page: 216 of 261



power density

Variant: 802.11n HT-40, Channel: 2422.00 MHz, Chain a, Temp: Ambient, Voltage: 5.00V

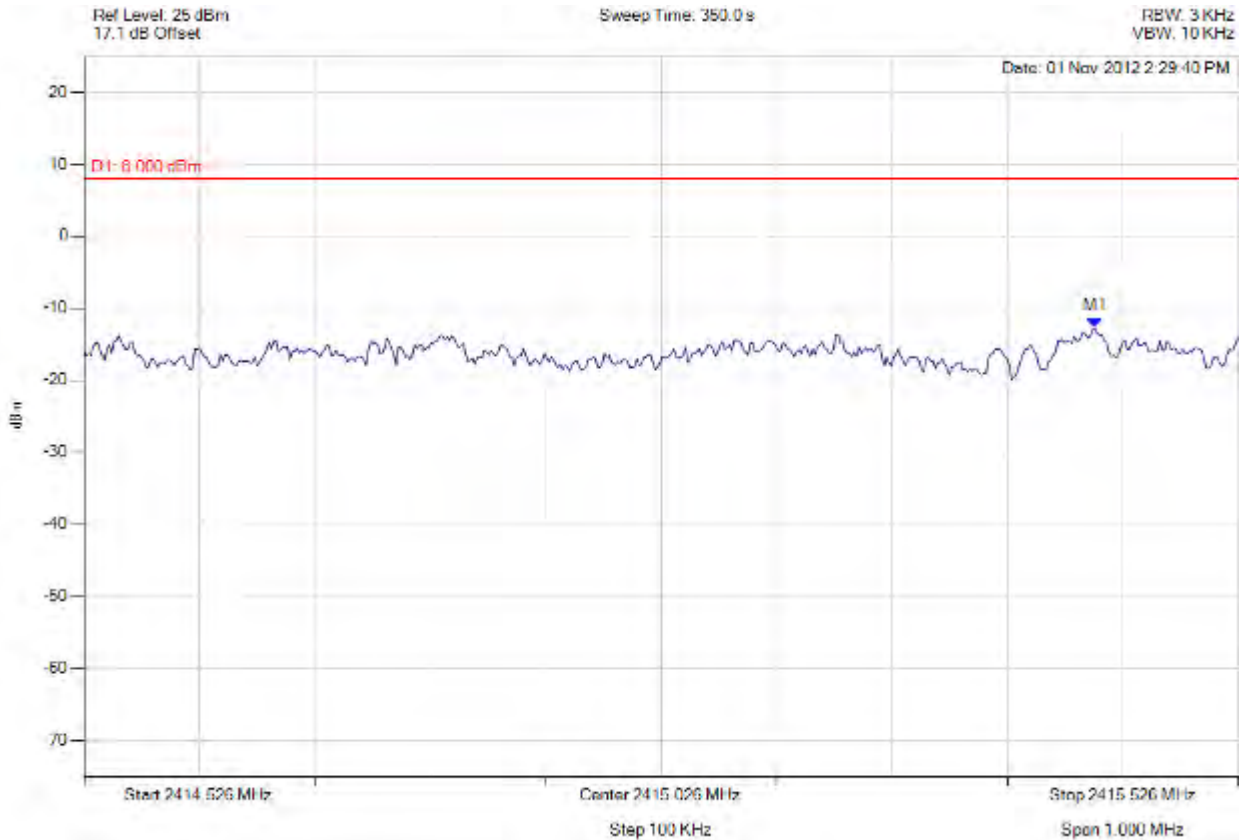

Analyser Setup	Marker : Frequency : Amplitude	Test Results
Detector = MAX PEAK Sweep Count = 0 RF Atten (dB) = 20 Trace Mode = VIEW	M1 : 2415.402 MHz : -12.775 dBm	Limit: ≤8.00 dBm Margin: -20.77 dB

[Back to the Matrix](#)

This test report may be reproduced in full only. The document may only be updated by MiCOM Labs personnel. Any changes will be noted in the Document History section of the report.



Title: Digi Connect Card for i.MX28 with Atheros AR6203
To: FCC 47 CFR Part 15.247 & IC RSS-210
Serial #: DIGI36-U2 Rev A
Issue Date: 22nd May 2014
Page: 217 of 261



power density

Variant: 802.11n HT-40, Channel: 2437.00 MHz, Chain a, Temp: Ambient, Voltage: 5.00V

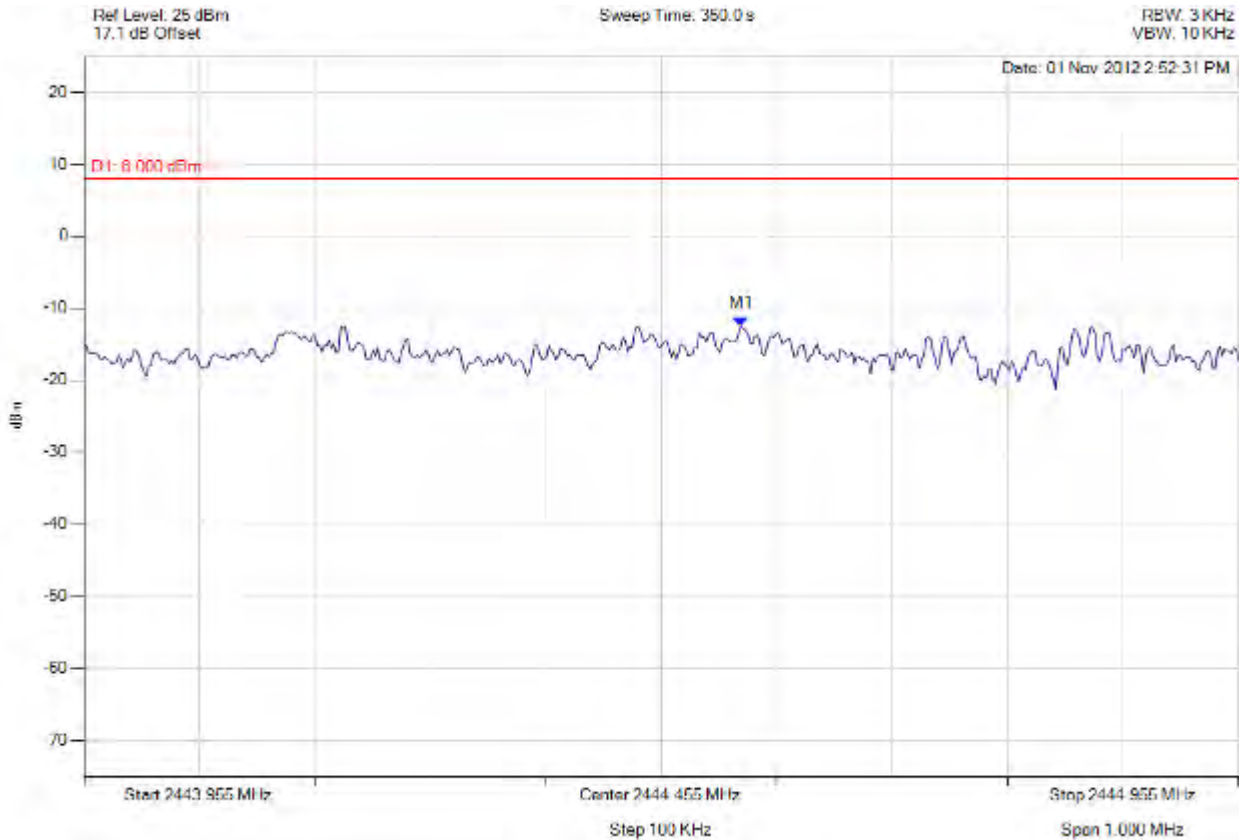

Analyser Setup	Marker : Frequency : Amplitude	Test Results
Detector = MAX PEAK Sweep Count = 0 RF Atten (dB) = 20 Trace Mode = VIEW	M1 : 2444.524 MHz : -12.466 dBm	Limit: ≤8.00 dBm Margin: -20.47 dB

[Back to the Matrix](#)

This test report may be reproduced in full only. The document may only be updated by MiCOM Labs personnel. Any changes will be noted in the Document History section of the report.



Title: Digi Connect Card for i.MX28 with Atheros AR6203
To: FCC 47 CFR Part 15.247 & IC RSS-210
Serial #: DIGI36-U2 Rev A
Issue Date: 22nd May 2014
Page: 218 of 261



power density

Variant: 802.11n HT-40, Channel: 2452.00 MHz, Chain a, Temp: Ambient, Voltage: 5.00V

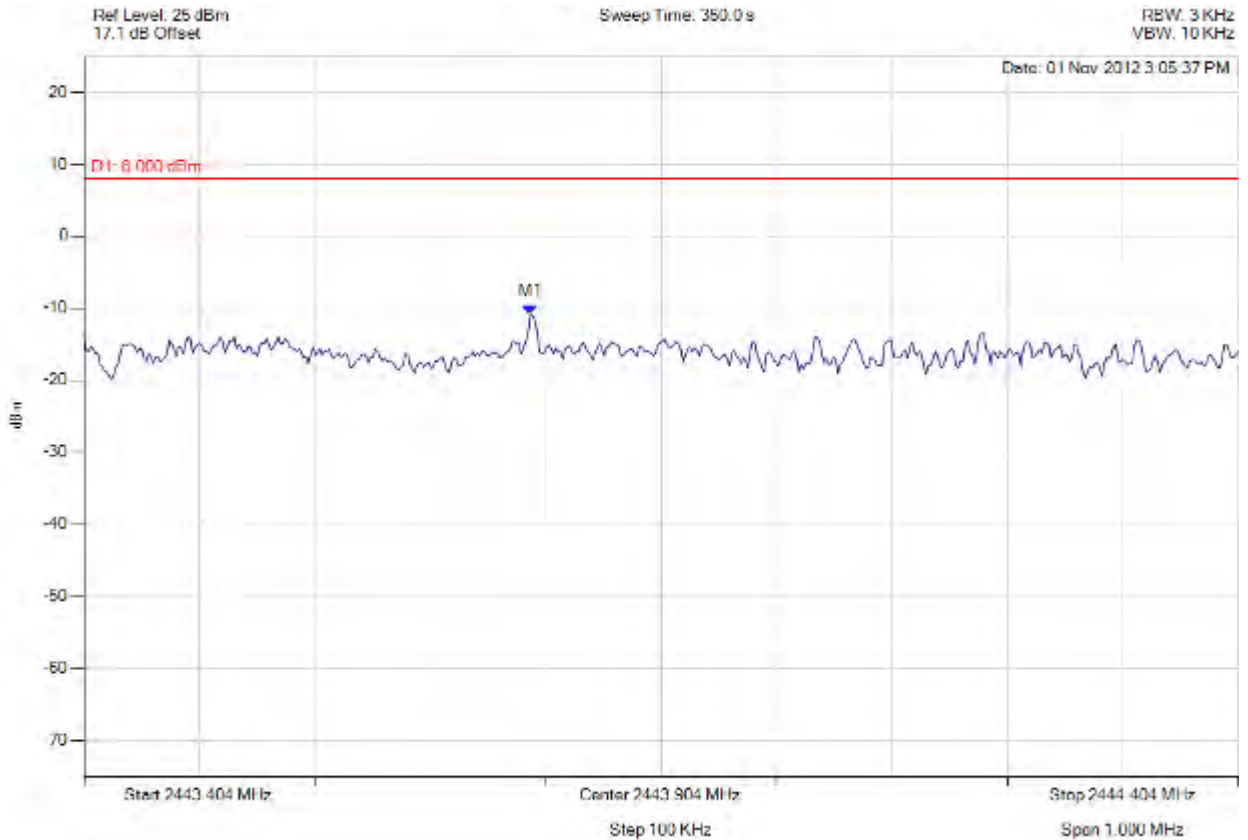

Analyser Setup	Marker : Frequency : Amplitude	Test Results
Detector = MAX PEAK Sweep Count = 0 RF Atten (dB) = 20 Trace Mode = VIEW	M1 : 2443.791 MHz : -10.790 dBm	Limit: ≤8.00 dBm Margin: -18.79 dB

[Back to the Matrix](#)

This test report may be reproduced in full only. The document may only be updated by MiCOM Labs personnel. Any changes will be noted in the Document History section of the report.



Title: Digi Connect Card for i.MX28 with Atheros AR6203
To: FCC 47 CFR Part 15.247 & IC RSS-210
Serial #: DIGI36-U2 Rev A
Issue Date: 22nd May 2014
Page: 219 of 261



power density

Variant: 802.11a, Channel: 5745.00 MHz, Chain a, Temp: Ambient, Voltage: 5.00V

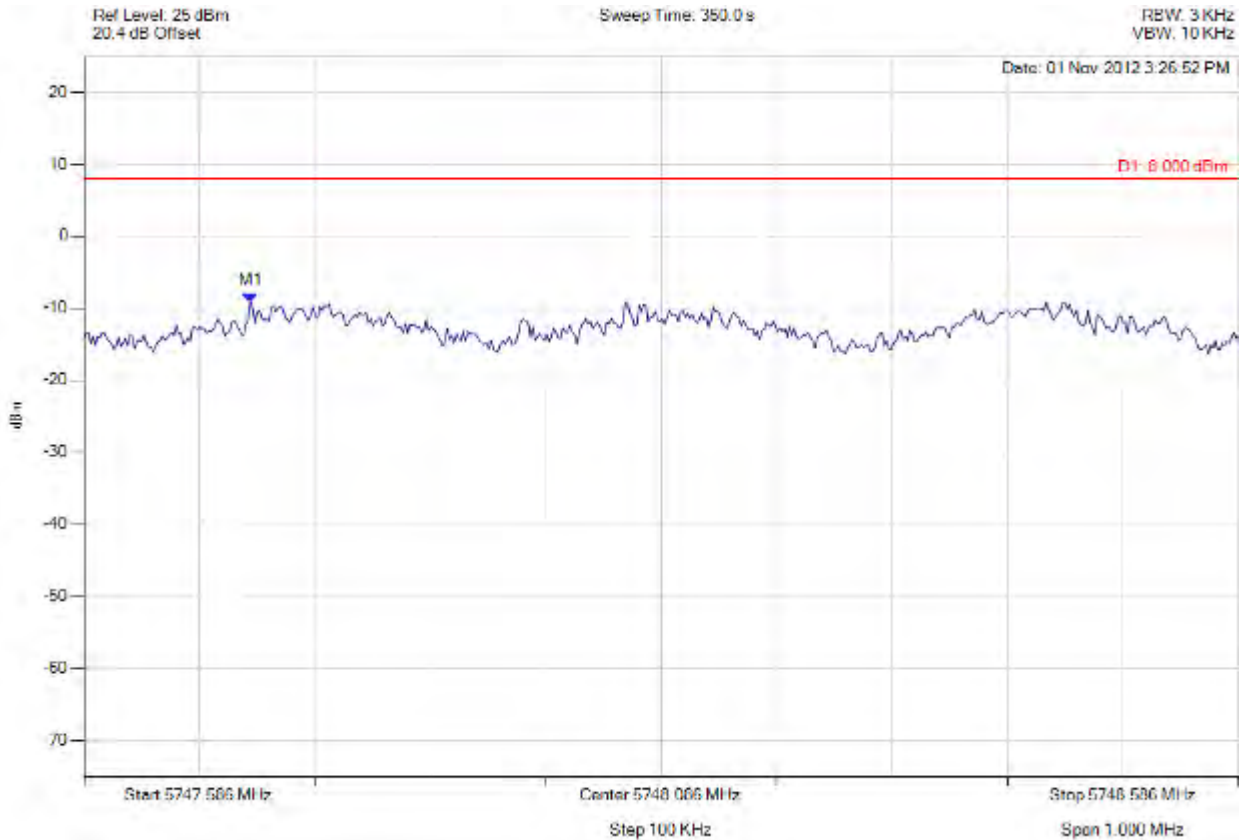

Analyser Setup	Marker : Frequency : Amplitude	Test Results
Detector = MAX PEAK Sweep Count = 0 RF Atten (dB) = 20 Trace Mode = VIEW	M1 : 5747.730 MHz : -9.153 dBm	Limit: ≤8.00 dBm Margin: -17.15 dB

[Back to the Matrix](#)

This test report may be reproduced in full only. The document may only be updated by MiCOM Labs personnel. Any changes will be noted in the Document History section of the report.



Title: Digi Connect Card for i.MX28 with Atheros AR6203
To: FCC 47 CFR Part 15.247 & IC RSS-210
Serial #: DIGI36-U2 Rev A
Issue Date: 22nd May 2014
Page: 220 of 261



power density

Variant: 802.11a, Channel: 5785.00 MHz, Chain a, Temp: Ambient, Voltage: 5.00V

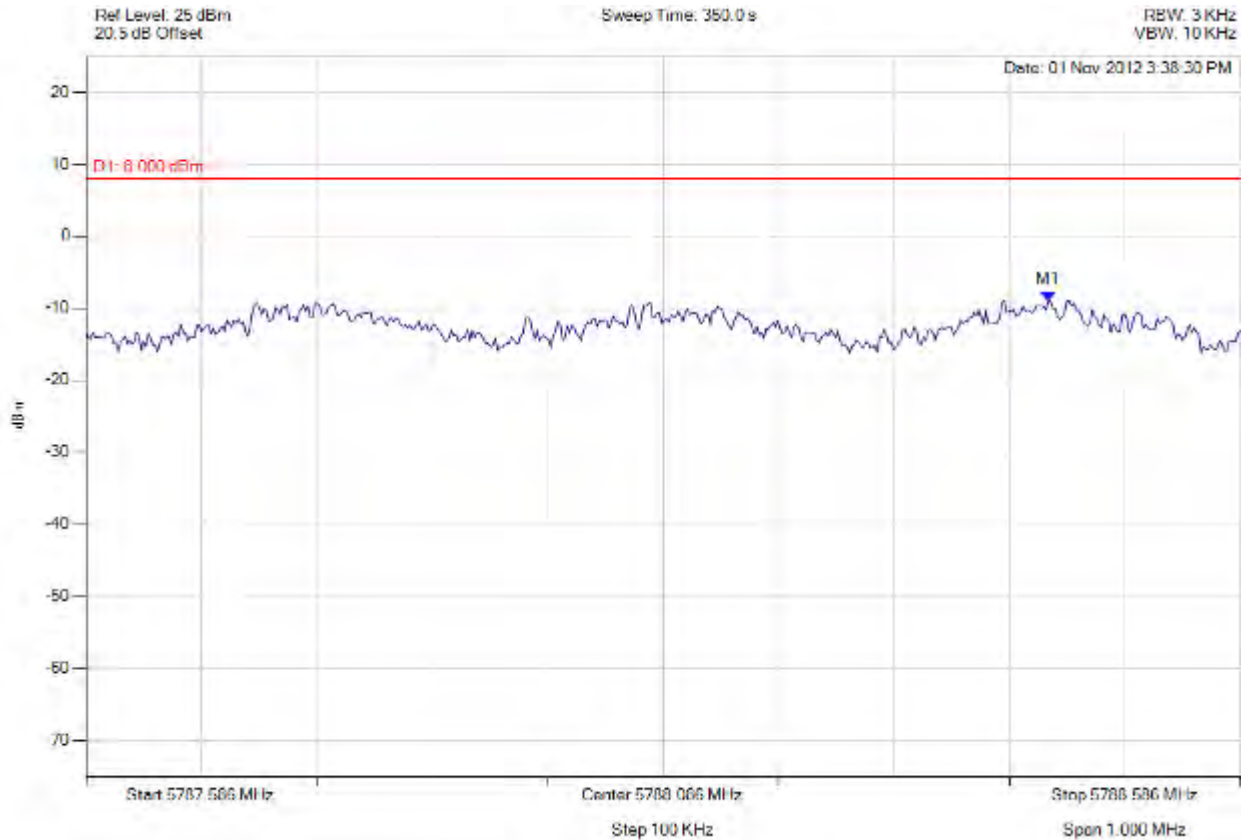

Analyser Setup	Marker : Frequency : Amplitude	Test Results
Detector = MAX PEAK Sweep Count = 0 RF Atten (dB) = 20 Trace Mode = VIEW	M1 : 5788.420 MHz : -8.978 dBm	Limit: ≤8.00 dBm Margin: -16.98 dB

[Back to the Matrix](#)

This test report may be reproduced in full only. The document may only be updated by MiCOM Labs personnel. Any changes will be noted in the Document History section of the report.



Title: Digi Connect Card for i.MX28 with Atheros AR6203
To: FCC 47 CFR Part 15.247 & IC RSS-210
Serial #: DIGI36-U2 Rev A
Issue Date: 22nd May 2014
Page: 221 of 261



power density

Variant: 802.11a, Channel: 5825.00 MHz, Chain a, Temp: Ambient, Voltage: 5.00V

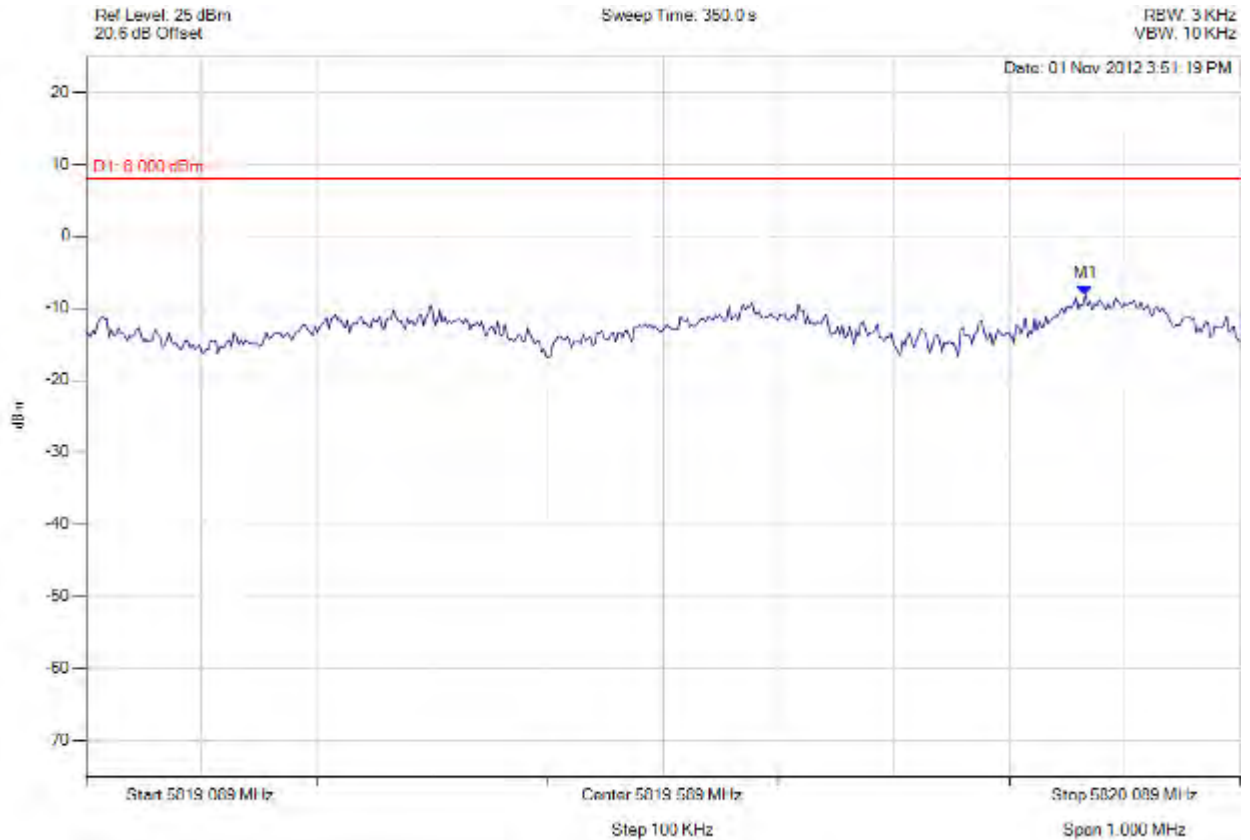

Analyser Setup	Marker : Frequency : Amplitude	Test Results
Detector = MAX PEAK Sweep Count = 0 RF Atten (dB) = 20 Trace Mode = VIEW	M1 : 5819.955 MHz : -8.227 dBm	Limit: ≤8.00 dBm Margin: -16.23 dB

[Back to the Matrix](#)

This test report may be reproduced in full only. The document may only be updated by MiCOM Labs personnel. Any changes will be noted in the Document History section of the report.



Title: Digi Connect Card for i.MX28 with Atheros AR6203
To: FCC 47 CFR Part 15.247 & IC RSS-210
Serial #: DIGI36-U2 Rev A
Issue Date: 22nd May 2014
Page: 222 of 261



power density

Variant: 802.11n HT-20, Channel: 5745.00 MHz, Chain a, Temp: Ambient, Voltage: 5.00V

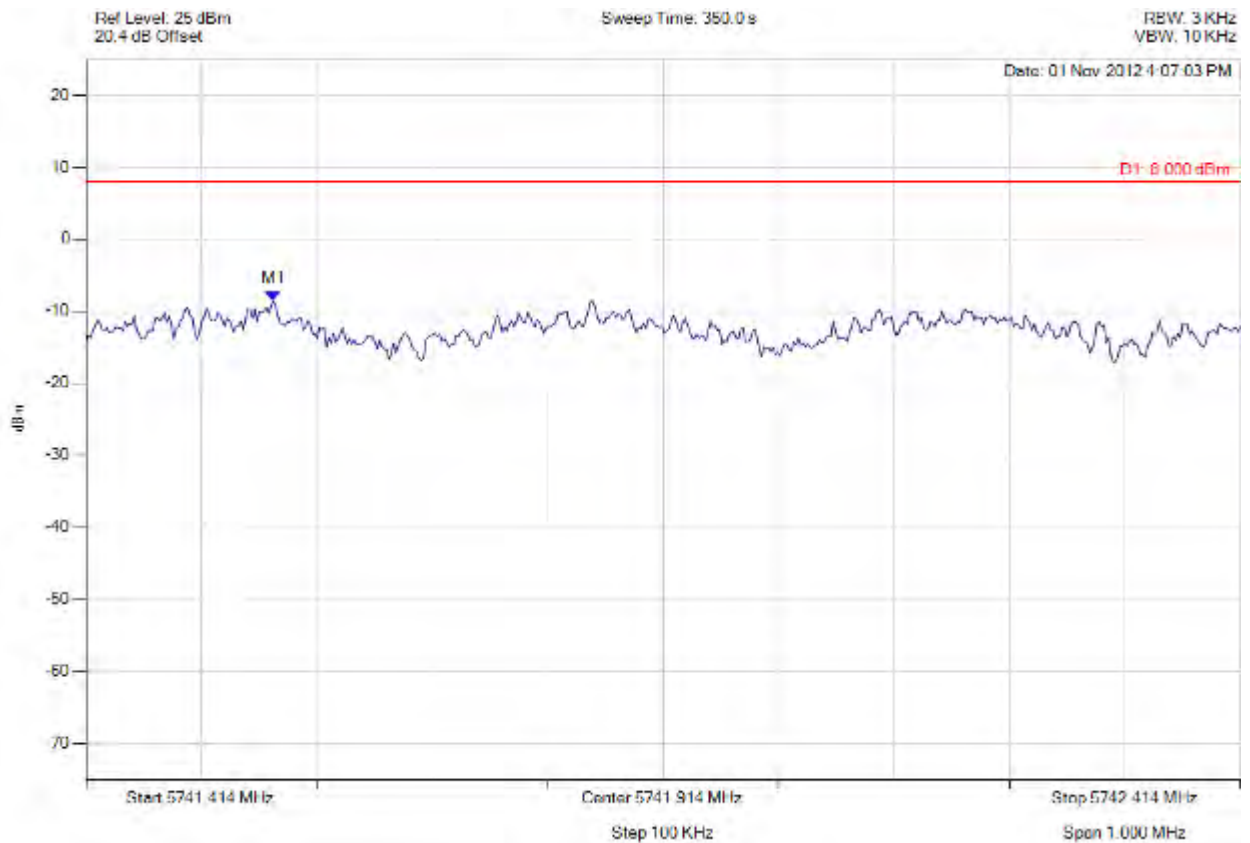

Analyser Setup	Marker : Frequency : Amplitude	Test Results
Detector = MAX PEAK Sweep Count = 0 RF Atten (dB) = 20 Trace Mode = VIEW	M1 : 5741.576 MHz : -8.532 dBm	Limit: ≤8.00 dBm Margin: -16.53 dB

[Back to the Matrix](#)

This test report may be reproduced in full only. The document may only be updated by MiCOM Labs personnel. Any changes will be noted in the Document History section of the report.



Title: Digi Connect Card for i.MX28 with Atheros AR6203
To: FCC 47 CFR Part 15.247 & IC RSS-210
Serial #: DIGI36-U2 Rev A
Issue Date: 22nd May 2014
Page: 223 of 261



power density

Variant: 802.11n HT-20, Channel: 5785.00 MHz, Chain a, Temp: Ambient, Voltage: 5.00V

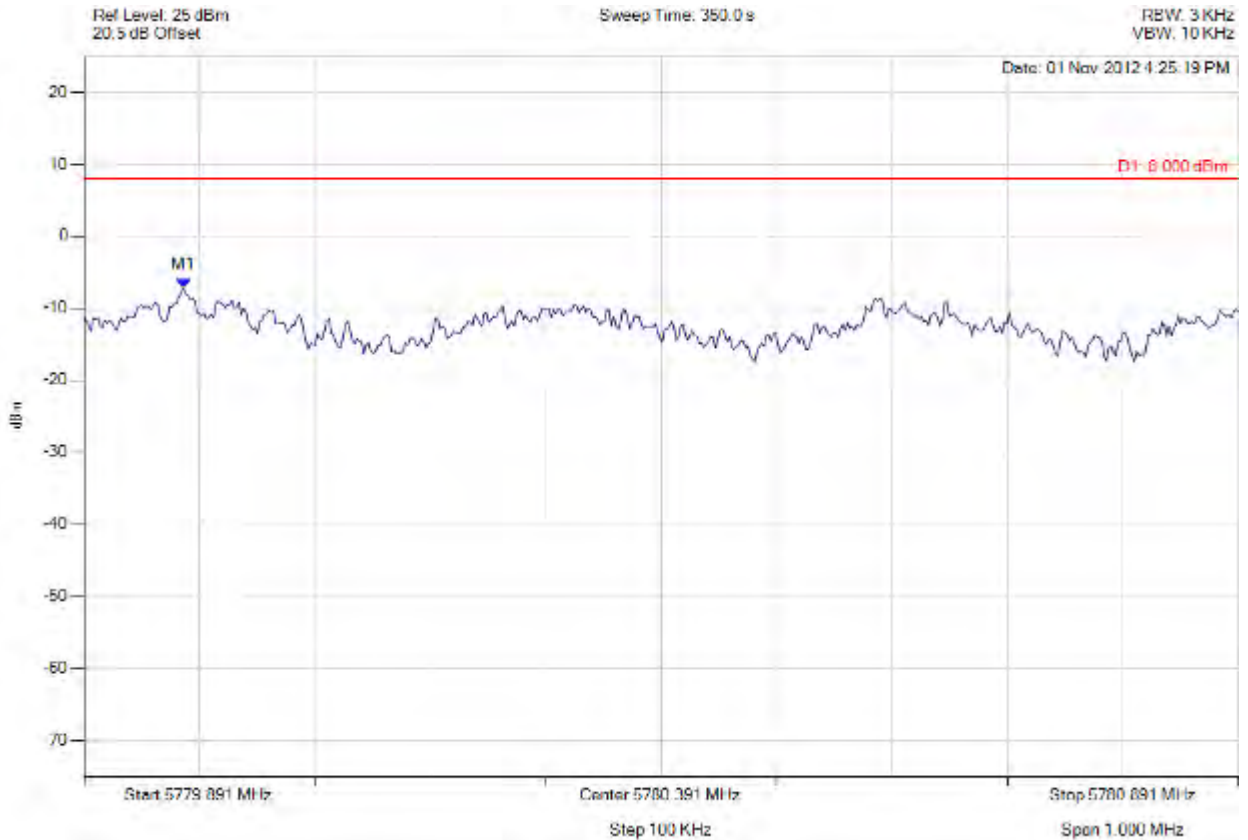

Analyser Setup	Marker : Frequency : Amplitude	Test Results
Detector = MAX PEAK Sweep Count = 0 RF Atten (dB) = 20 Trace Mode = VIEW	M1 : 5779.977 MHz : -7.127 dBm	Limit: ≤8.00 dBm Margin: -15.13 dB

[Back to the Matrix](#)

This test report may be reproduced in full only. The document may only be updated by MiCOM Labs personnel. Any changes will be noted in the Document History section of the report.



Title: Digi Connect Card for i.MX28 with Atheros AR6203
To: FCC 47 CFR Part 15.247 & IC RSS-210
Serial #: DIGI36-U2 Rev A
Issue Date: 22nd May 2014
Page: 224 of 261



power density

Variant: 802.11n HT-20, Channel: 5825.00 MHz, Chain a, Temp: Ambient, Voltage: 5.00V

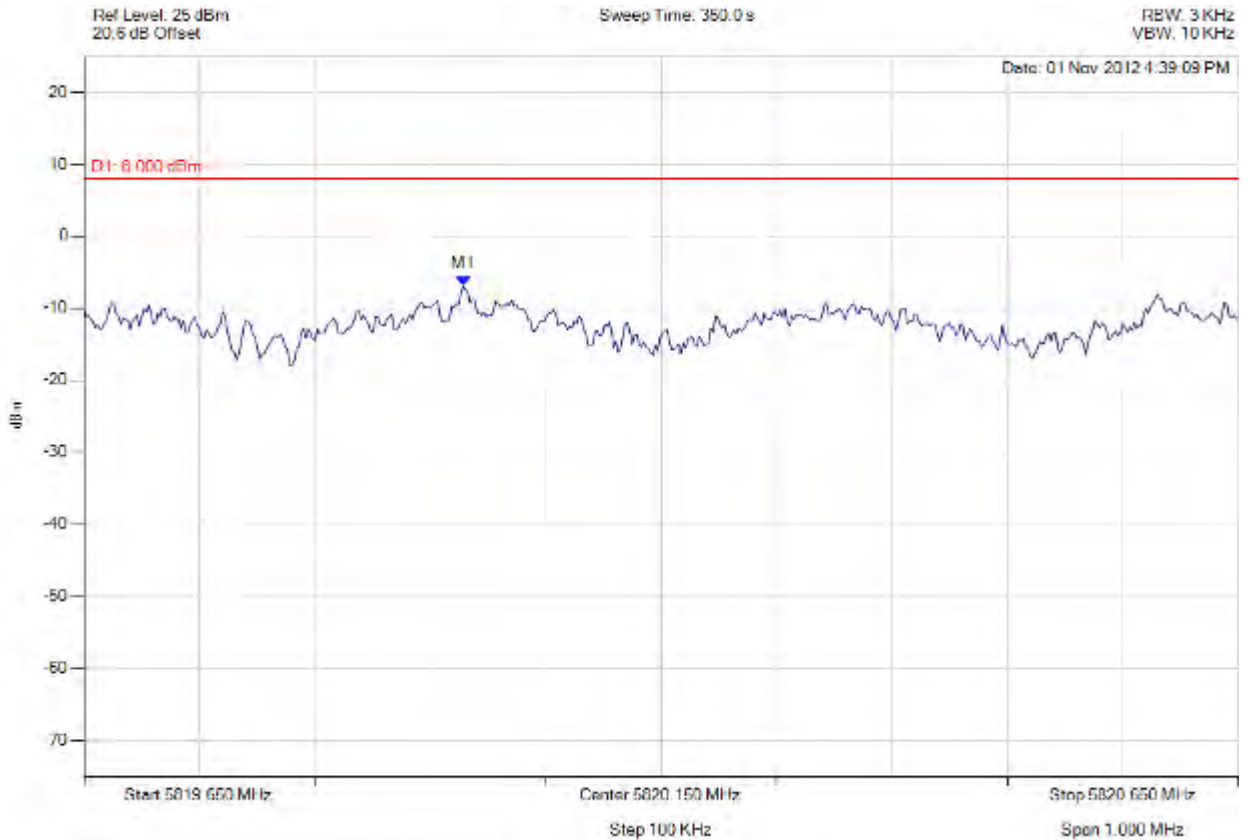

Analyser Setup	Marker : Frequency : Amplitude	Test Results
Detector = MAX PEAK Sweep Count = 0 RF Atten (dB) = 20 Trace Mode = VIEW	M1 : 5819.979 MHz : -6.881 dBm	Limit: ≤8.00 dBm Margin: -14.88 dB

[Back to the Matrix](#)

This test report may be reproduced in full only. The document may only be updated by MiCOM Labs personnel. Any changes will be noted in the Document History section of the report.



Title: Digi Connect Card for i.MX28 with Atheros AR6203
To: FCC 47 CFR Part 15.247 & IC RSS-210
Serial #: DIGI36-U2 Rev A
Issue Date: 22nd May 2014
Page: 225 of 261



power density

Variant: 802.11n HT-40, Channel: 5755.00 MHz, Chain a, Temp: Ambient, Voltage: 5.00V

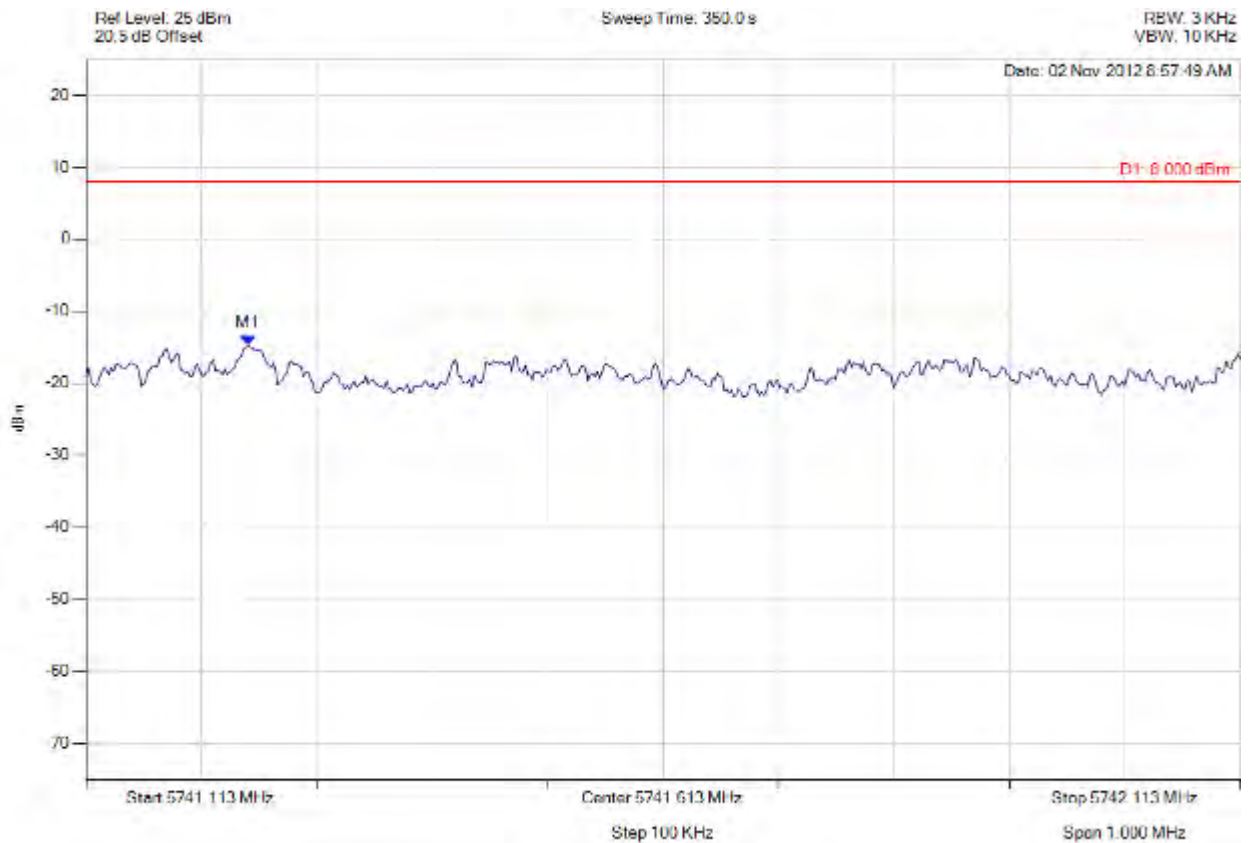

Analyser Setup	Marker : Frequency : Amplitude	Test Results
Detector = MAX PEAK Sweep Count = 0 RF Atten (dB) = 20 Trace Mode = VIEW	M1 : 5741.254 MHz : -14.691 dBm	Limit: ≤8.00 dBm Margin: -22.69 dB

[Back to the Matrix](#)

This test report may be reproduced in full only. The document may only be updated by MiCOM Labs personnel. Any changes will be noted in the Document History section of the report.



Title: Digi Connect Card for i.MX28 with Atheros AR6203
To: FCC 47 CFR Part 15.247 & IC RSS-210
Serial #: DIGI36-U2 Rev A
Issue Date: 22nd May 2014
Page: 226 of 261



power density

Variant: 802.11n HT-40, Channel: 5795.00 MHz, Chain a, Temp: Ambient, Voltage: 5.00V

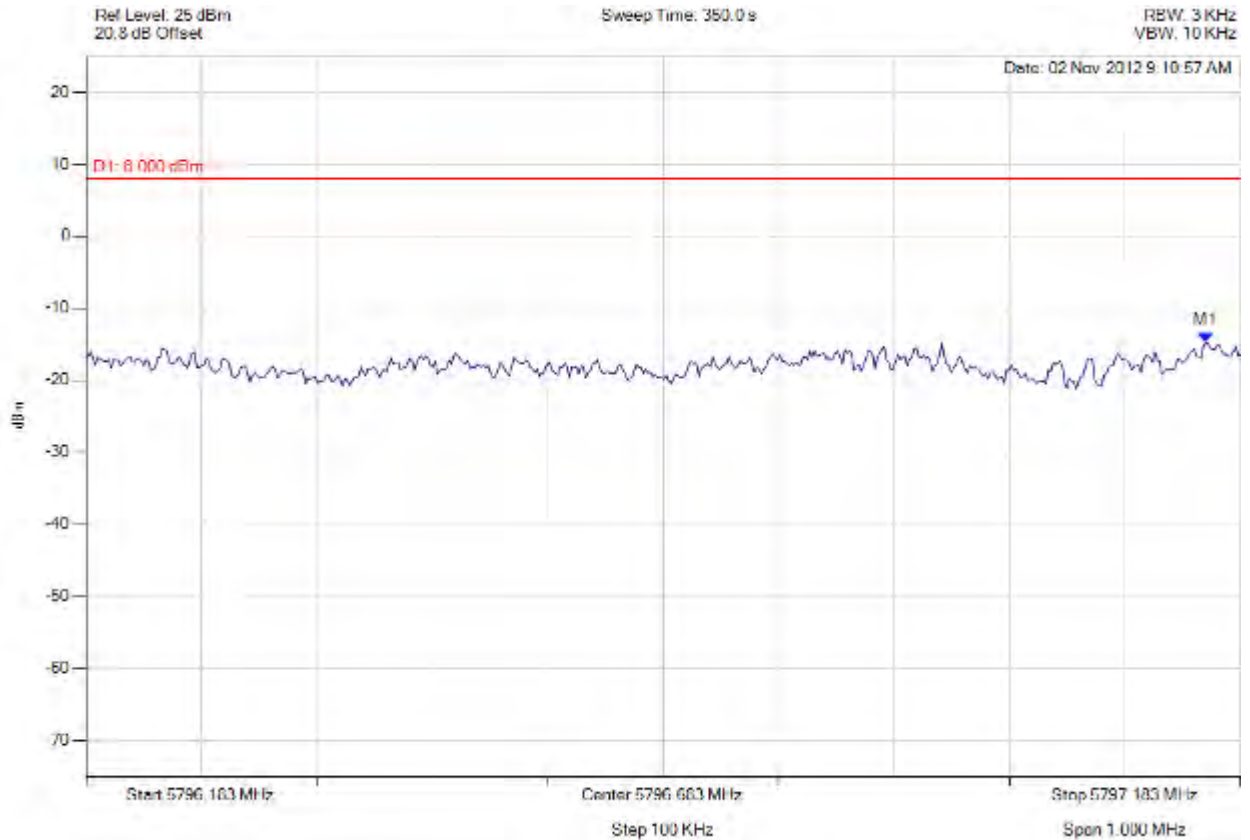

Analyser Setup	Marker : Frequency : Amplitude	Test Results
Detector = MAX PEAK Sweep Count = 0 RF Atten (dB) = 20 Trace Mode = VIEW	M1 : 5797.153 MHz : -14.725 dBm	Limit: ≤8.00 dBm Margin: -22.73 dB

[Back to the Matrix](#)

This test report may be reproduced in full only. The document may only be updated by MiCOM Labs personnel. Any changes will be noted in the Document History section of the report.



Title: Digi Connect Card for i.MX28 with Atheros AR6203
To: FCC 47 CFR Part 15.247 & IC RSS-210
Serial #: DIGI36-U2 Rev A
Issue Date: 22nd May 2014
Page: 227 of 261

A.1.4. Conducted Spurious Emissions

Dual Port Module:



band-edge

Variant: 802.11b, Channel: 2412.00 MHz, Chain a, Temp: Ambient, Voltage: 5.00V

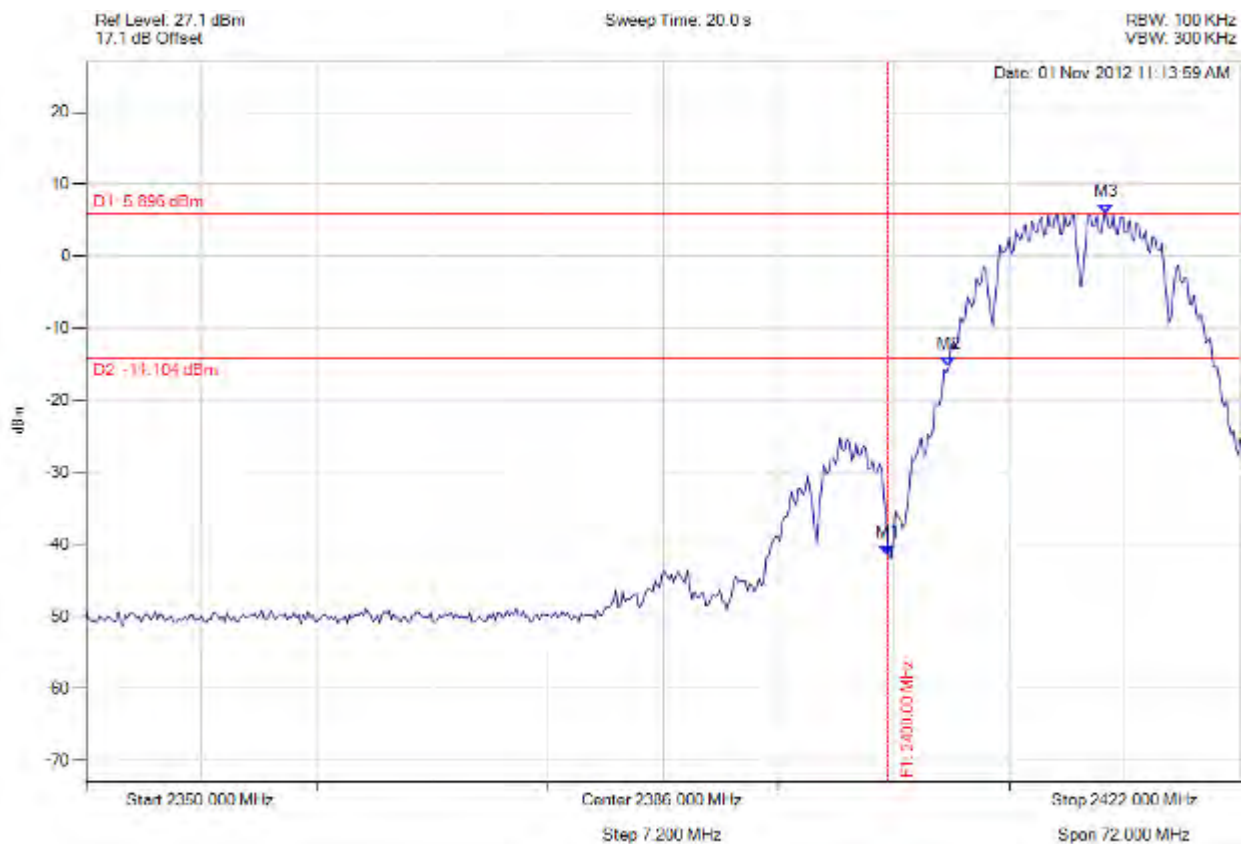

Analyser Setup	Marker : Frequency : Amplitude	Test Results
Detector = MAX PEAK Sweep Count = 0 RF Atten (dB) = 20 Trace Mode = VIEW	M1 : 2400.000 MHz : -41.392 dBm M2 : 2403.820 MHz : -15.239 dBm M3 : 2413.631 MHz : 5.896 dBm	Limit: -14.10 dBm Margin: -27.29 dB

[Back to the Matrix](#)

This test report may be reproduced in full only. The document may only be updated by MiCOM Labs personnel. Any changes will be noted in the Document History section of the report.



Title: Digi Connect Card for i.MX28 with Atheros AR6203
To: FCC 47 CFR Part 15.247 & IC RSS-210
Serial #: DIGI36-U2 Rev A
Issue Date: 22nd May 2014
Page: 228 of 261



band-edge

Variant: 802.11b, Channel: 2462.00 MHz, Chain a, Temp: Ambient, Voltage: 5.00V

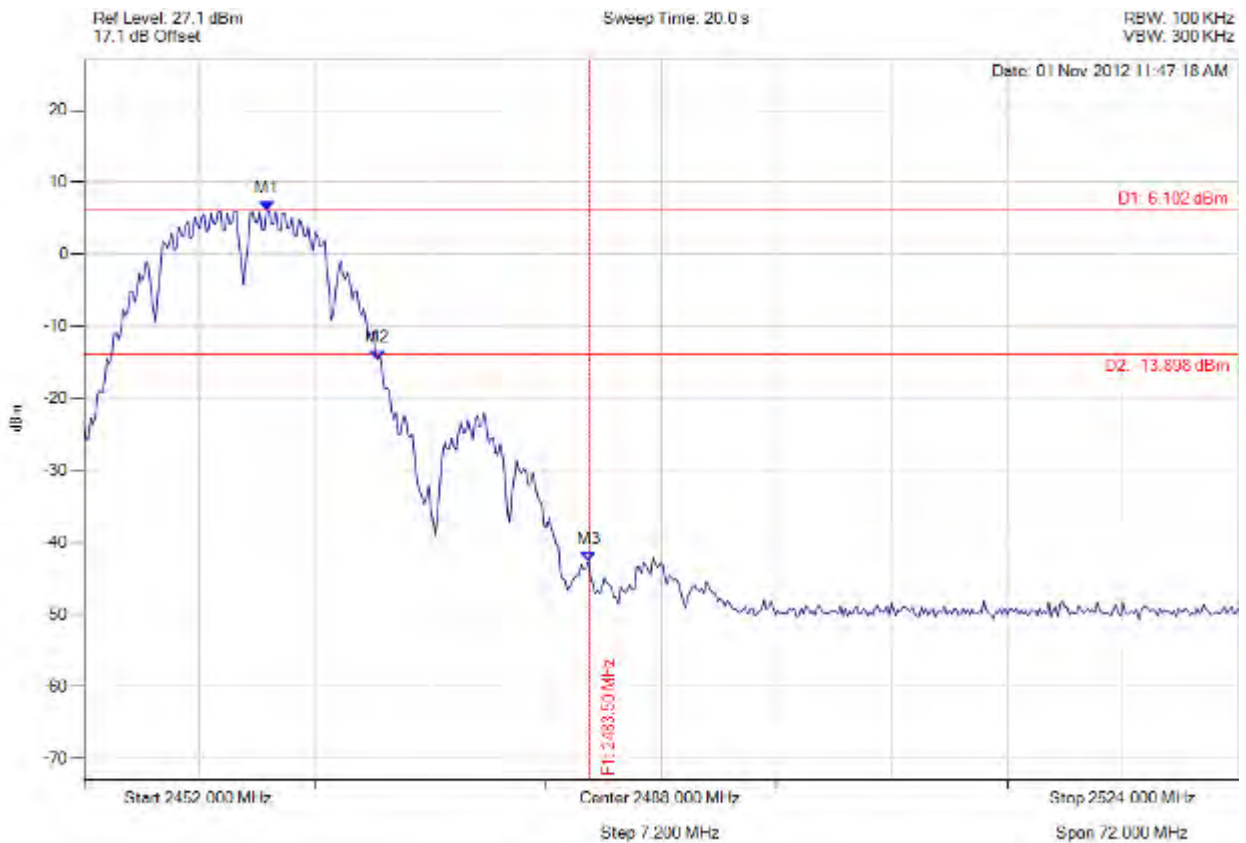

Analyser Setup	Marker : Frequency : Amplitude	Test Results
Detector = MAX PEAK Sweep Count = 0 RF Atten (dB) = 20 Trace Mode = VIEW	M1 : 2463.399 MHz : 6.102 dBm M2 : 2470.325 MHz : -14.600 dBm M3 : 2483.500 MHz : -42.706 dBm	Limit: -13.90 dBm Margin: -28.81 dB

[Back to the Matrix](#)

This test report may be reproduced in full only. The document may only be updated by MiCOM Labs personnel. Any changes will be noted in the Document History section of the report.



Title: Digi Connect Card for i.MX28 with Atheros AR6203
To: FCC 47 CFR Part 15.247 & IC RSS-210
Serial #: DIGI36-U2 Rev A
Issue Date: 22nd May 2014
Page: 229 of 261



spurious

Variant: 802.11b, Channel: 2412.00 MHz, Chain a, Temp: Ambient, Voltage: 5.00V

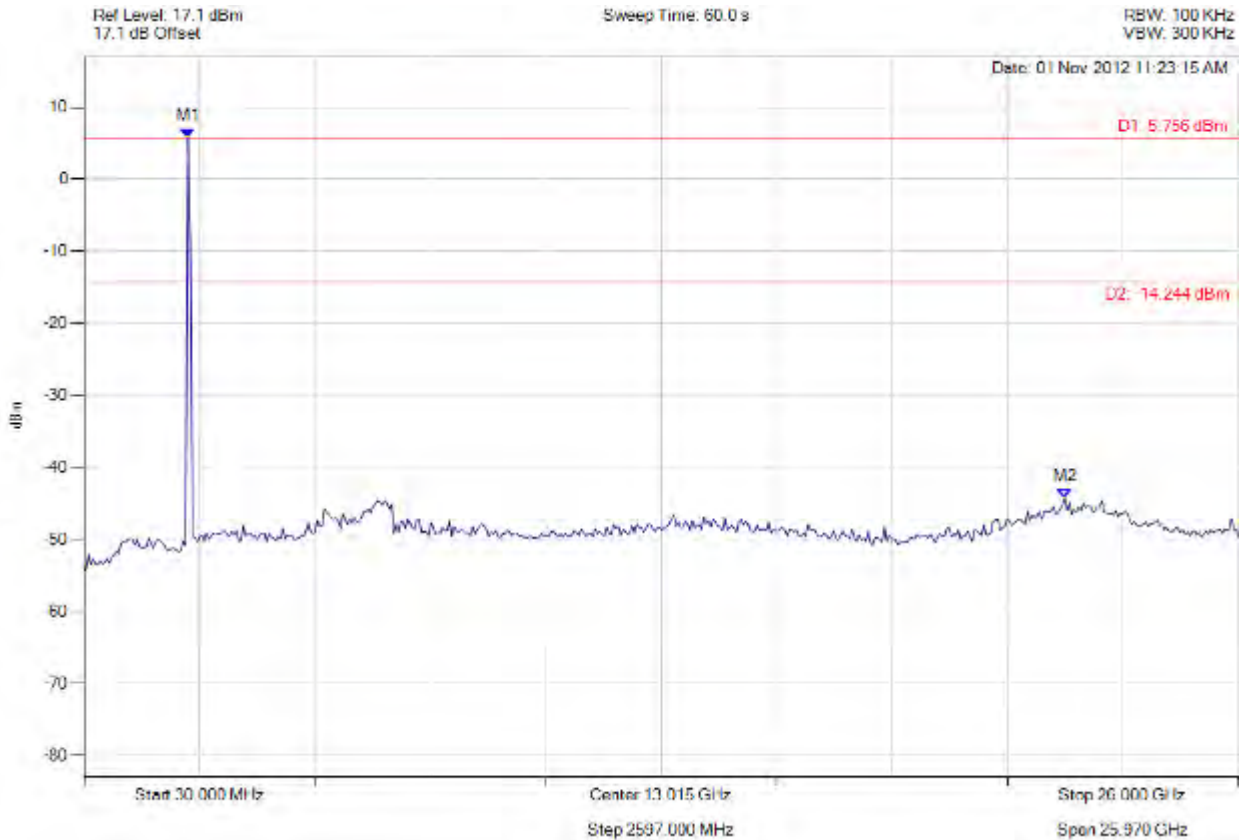

Analyser Setup	Marker : Frequency : Amplitude	Test Results
Detector = MAX PEAK Sweep Count = 0 RF Atten (dB) = 20 Trace Mode = VIEW	M1 : 2371.984 MHz : 5.756 dBm M2 : 22.097 GHz : -44.278 dBm	Limit: -14.24 dBm Margin: -30.04 dB

[Back to the Matrix](#)

This test report may be reproduced in full only. The document may only be updated by MiCOM Labs personnel. Any changes will be noted in the Document History section of the report.



Title: Digi Connect Card for i.MX28 with Atheros AR6203
To: FCC 47 CFR Part 15.247 & IC RSS-210
Serial #: DIGI36-U2 Rev A
Issue Date: 22nd May 2014
Page: 230 of 261



spurious

Variant: 802.11b, Channel: 2437.00 MHz, Chain a, Temp: Ambient, Voltage: 5.00V

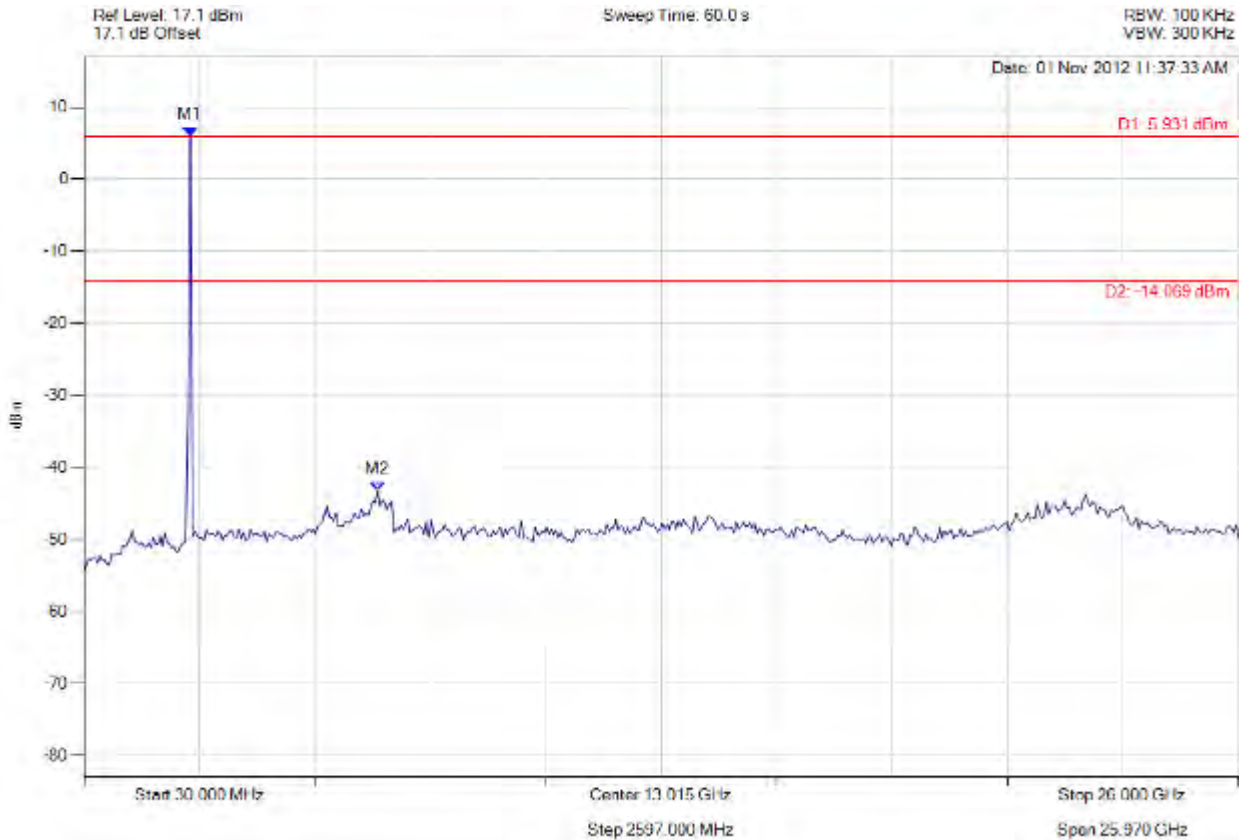

Analyser Setup	Marker : Frequency : Amplitude	Test Results
Detector = MAX PEAK Sweep Count = 0 RF Atten (dB) = 20 Trace Mode = VIEW	M1 : 2424.028 MHz : 5.931 dBm M2 : 6639.599 MHz : -43.229 dBm	Limit: -14.07 dBm Margin: -29.16 dB

[Back to the Matrix](#)

This test report may be reproduced in full only. The document may only be updated by MiCOM Labs personnel. Any changes will be noted in the Document History section of the report.



spurious

Variant: 802.11b, Channel: 2462.00 MHz, Chain a, Temp: Ambient, Voltage: 5.00V

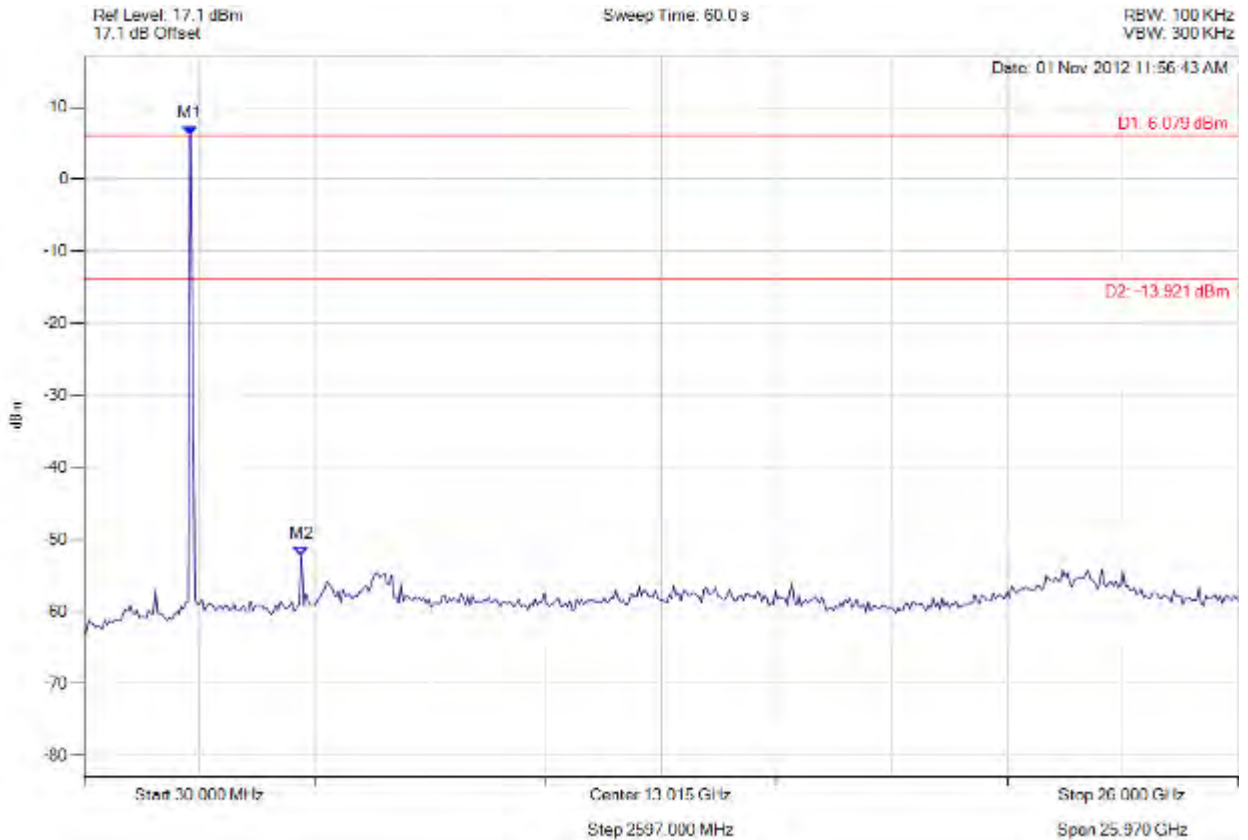

Analyser Setup	Marker : Frequency : Amplitude	Test Results
Detector = MAX PEAK Sweep Count = 0 RF Atten (dB) = 10 Trace Mode = VIEW	M1 : 2424.028 MHz : 6.079 dBm M2 : 4922.144 MHz : -52.295 dBm	Limit: -13.92 dBm Margin: -38.38 dB

[Back to the Matrix](#)

This test report may be reproduced in full only. The document may only be updated by MiCOM Labs personnel. Any changes will be noted in the Document History section of the report.



Title: Digi Connect Card for i.MX28 with Atheros AR6203
To: FCC 47 CFR Part 15.247 & IC RSS-210
Serial #: DIGI36-U2 Rev A
Issue Date: 22nd May 2014
Page: 232 of 261



band-edge

Variant: 802.11g, Channel: 2412.00 MHz, Chain a, Temp: Ambient, Voltage: 5.00V

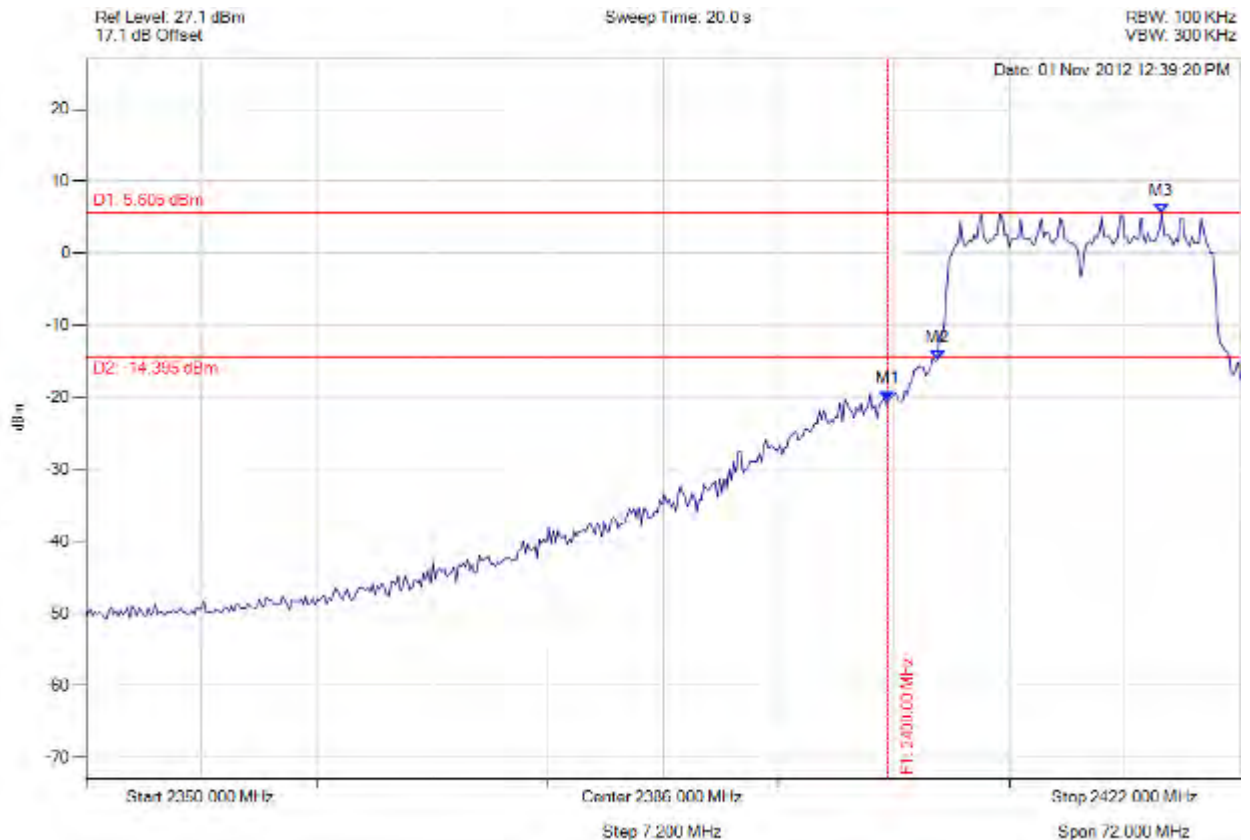

Analyser Setup	Marker : Frequency : Amplitude	Test Results
Detector = MAX PEAK Sweep Count = 0 RF Atten (dB) = 20 Trace Mode = VIEW	M1 : 2400.000 MHz : -20.484 dBm M2 : 2403.098 MHz : -14.773 dBm M3 : 2417.094 MHz : 5.605 dBm	Limit: -14.40 dBm Margin: -6.08 dB

[Back to the Matrix](#)

This test report may be reproduced in full only. The document may only be updated by MiCOM Labs personnel. Any changes will be noted in the Document History section of the report.



Title: Digi Connect Card for i.MX28 with Atheros AR6203
To: FCC 47 CFR Part 15.247 & IC RSS-210
Serial #: DIGI36-U2 Rev A
Issue Date: 22nd May 2014
Page: 233 of 261



band-edge

Variant: 802.11g, Channel: 2462.00 MHz, Chain a, Temp: Ambient, Voltage: 5.00V

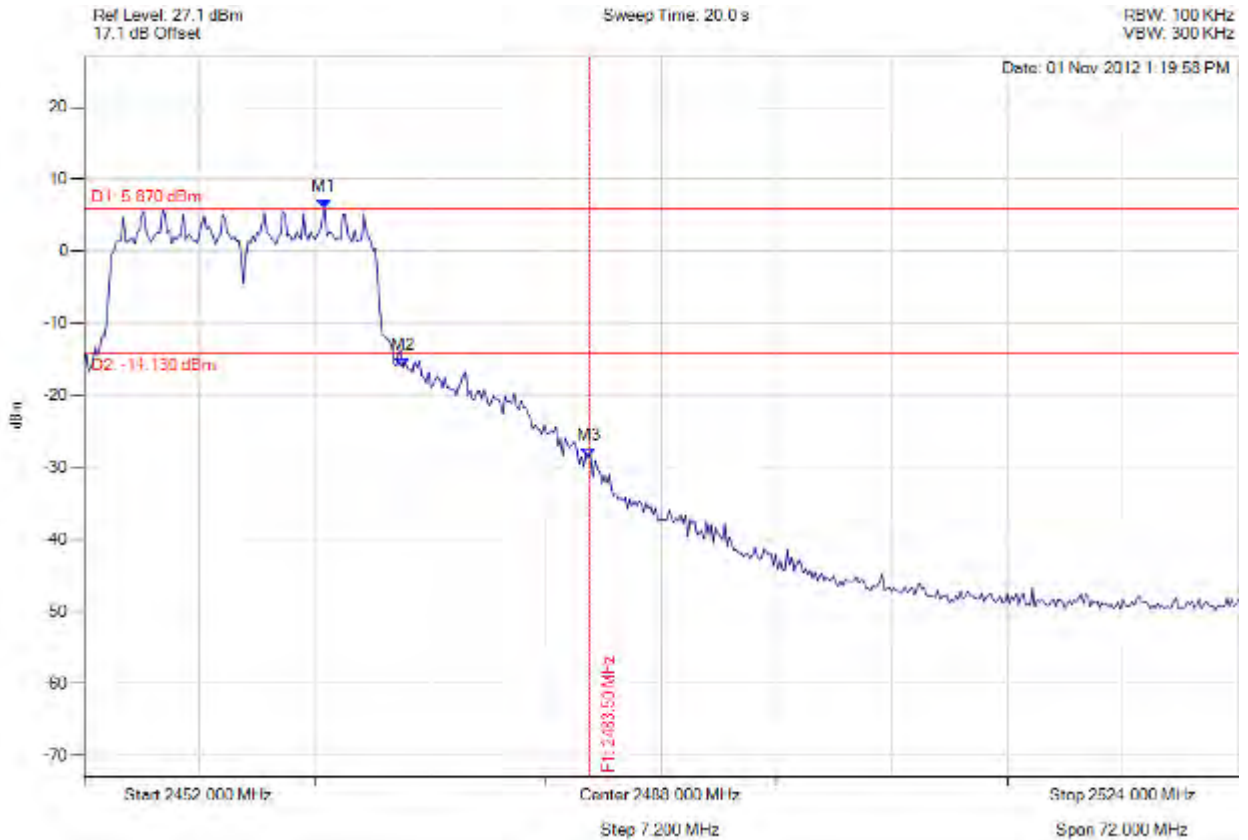

Analyser Setup	Marker : Frequency : Amplitude	Test Results
Detector = MAX PEAK Sweep Count = 0 RF Atten (dB) = 20 Trace Mode = VIEW	M1 : 2467.006 MHz : 5.870 dBm M2 : 2471.912 MHz : -16.050 dBm M3 : 2483.500 MHz : -28.604 dBm	Limit: -14.13 dBm Margin: -14.47 dB

[Back to the Matrix](#)

This test report may be reproduced in full only. The document may only be updated by MiCOM Labs personnel. Any changes will be noted in the Document History section of the report.



Title: Digi Connect Card for i.MX28 with Atheros AR6203
To: FCC 47 CFR Part 15.247 & IC RSS-210
Serial #: DIGI36-U2 Rev A
Issue Date: 22nd May 2014
Page: 234 of 261



spurious

Variant: 802.11g, Channel: 2412.00 MHz, Chain a, Temp: Ambient, Voltage: 5.00V

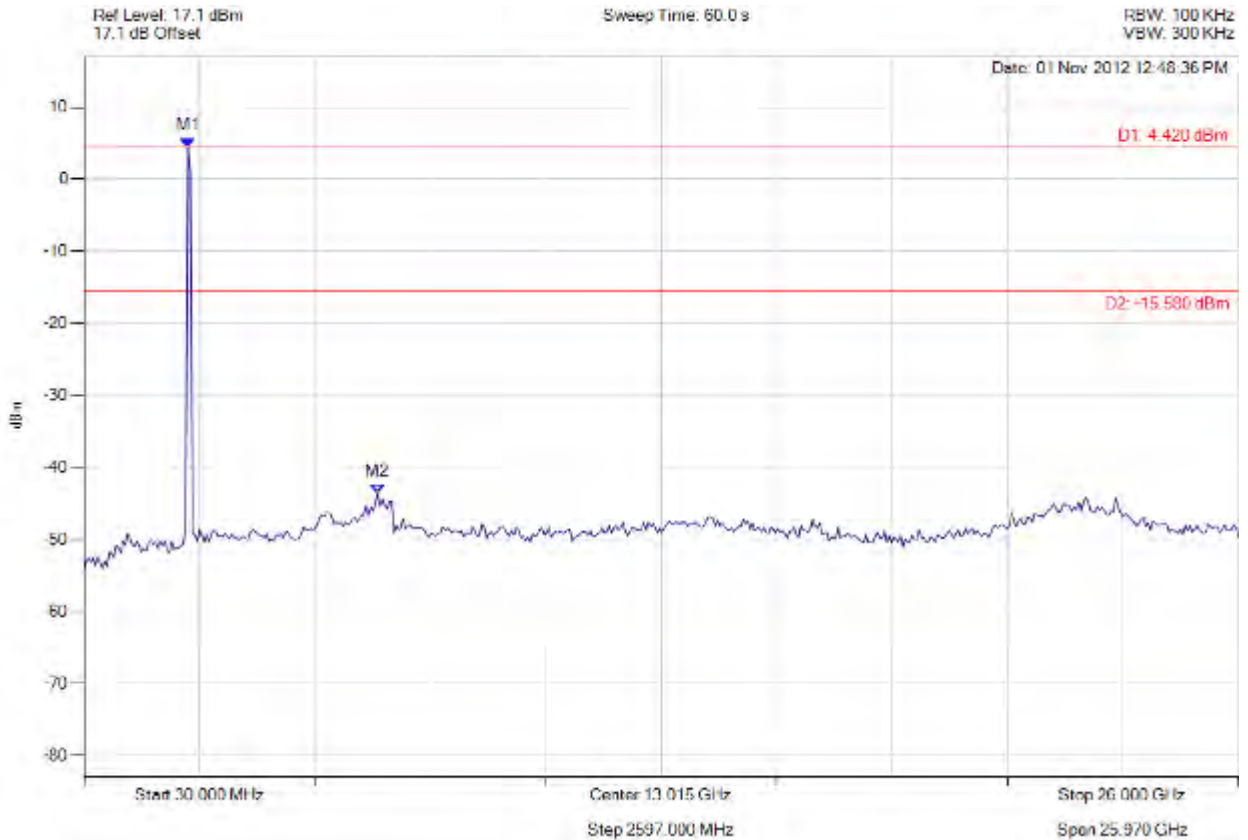

Analyser Setup	Marker : Frequency : Amplitude	Test Results
Detector = MAX PEAK Sweep Count = 0 RF Atten (dB) = 20 Trace Mode = VIEW	M1 : 2371.984 MHz : 4.420 dBm M2 : 6639.599 MHz : -43.585 dBm	Limit: -15.58 dBm Margin: -28.01 dB

[Back to the Matrix](#)

This test report may be reproduced in full only. The document may only be updated by MiCOM Labs personnel. Any changes will be noted in the Document History section of the report.



Title: Digi Connect Card for i.MX28 with Atheros AR6203
To: FCC 47 CFR Part 15.247 & IC RSS-210
Serial #: DIGI36-U2 Rev A
Issue Date: 22nd May 2014
Page: 235 of 261



spurious

Variant: 802.11g, Channel: 2437.00 MHz, Chain a, Temp: Ambient, Voltage: 5.00V

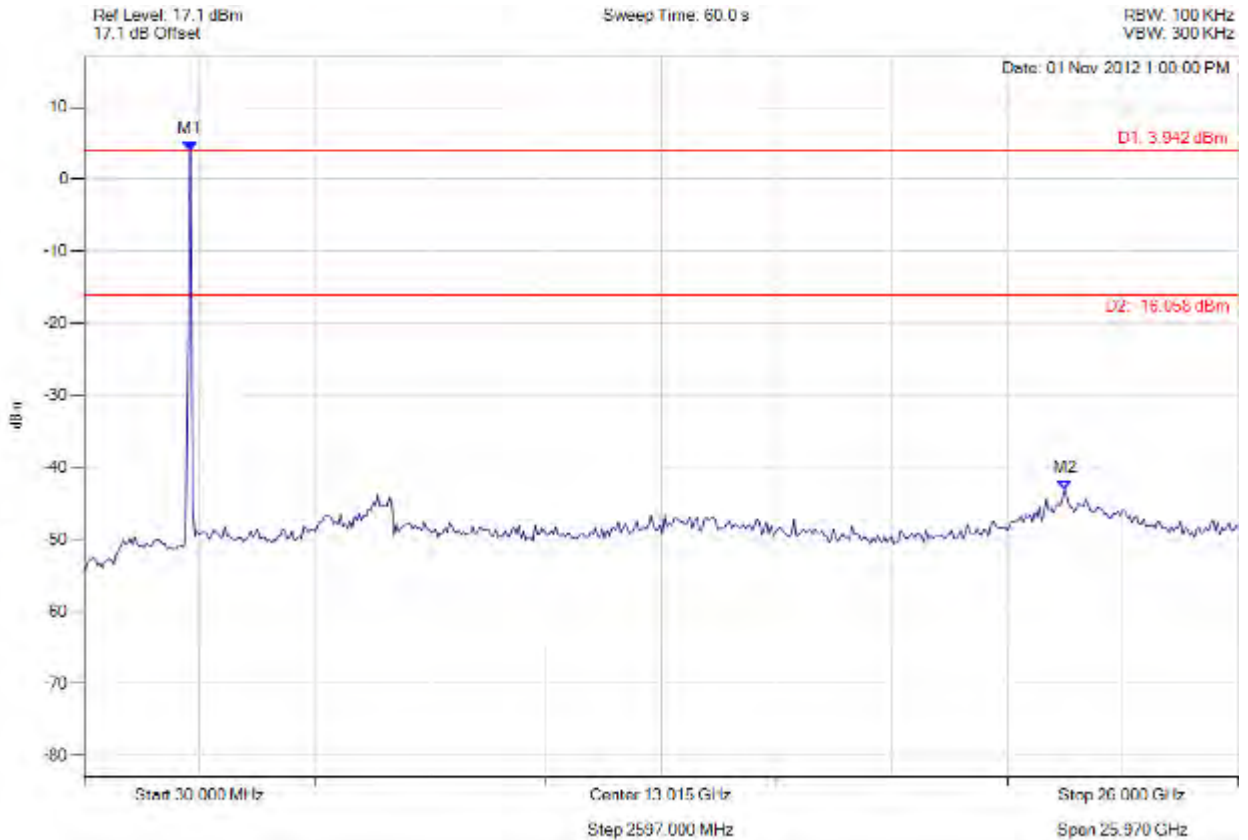

Analyser Setup	Marker : Frequency : Amplitude	Test Results
Detector = MAX PEAK Sweep Count = 0 RF Atten (dB) = 20 Trace Mode = VIEW	M1 : 2424.028 MHz : 3.942 dBm M2 : 22.097 GHz : -43.060 dBm	Limit: -16.06 dBm Margin: -27.00 dB

[Back to the Matrix](#)

This test report may be reproduced in full only. The document may only be updated by MiCOM Labs personnel. Any changes will be noted in the Document History section of the report.



Title: Digi Connect Card for i.MX28 with Atheros AR6203
To: FCC 47 CFR Part 15.247 & IC RSS-210
Serial #: DIGI36-U2 Rev A
Issue Date: 22nd May 2014
Page: 236 of 261



spurious

Variant: 802.11g, Channel: 2462.00 MHz, Chain a, Temp: Ambient, Voltage: 5.00V

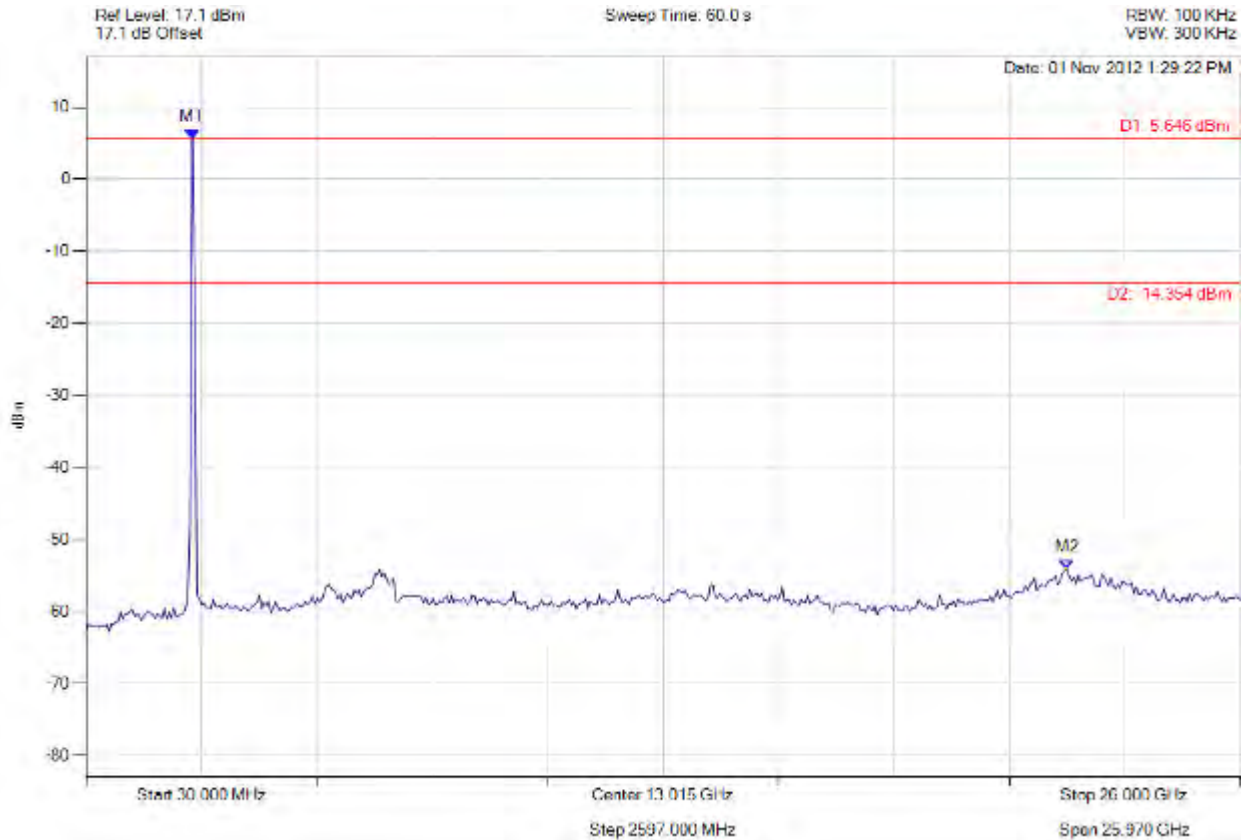

Analyser Setup	Marker : Frequency : Amplitude	Test Results
Detector = MAX PEAK Sweep Count = 0 RF Atten (dB) = 10 Trace Mode = VIEW	M1 : 2424.028 MHz : 5.646 dBm M2 : 22.097 GHz : -54.134 dBm	Limit: -14.35 dBm Margin: -39.78 dB

[Back to the Matrix](#)

This test report may be reproduced in full only. The document may only be updated by MiCOM Labs personnel. Any changes will be noted in the Document History section of the report.



Title: Digi Connect Card for i.MX28 with Atheros AR6203
To: FCC 47 CFR Part 15.247 & IC RSS-210
Serial #: DIGI36-U2 Rev A
Issue Date: 22nd May 2014
Page: 237 of 261



band-edge

Variant: 802.11n HT-20, Channel: 2412.00 MHz, Chain a, Temp: Ambient, Voltage: 5.00V

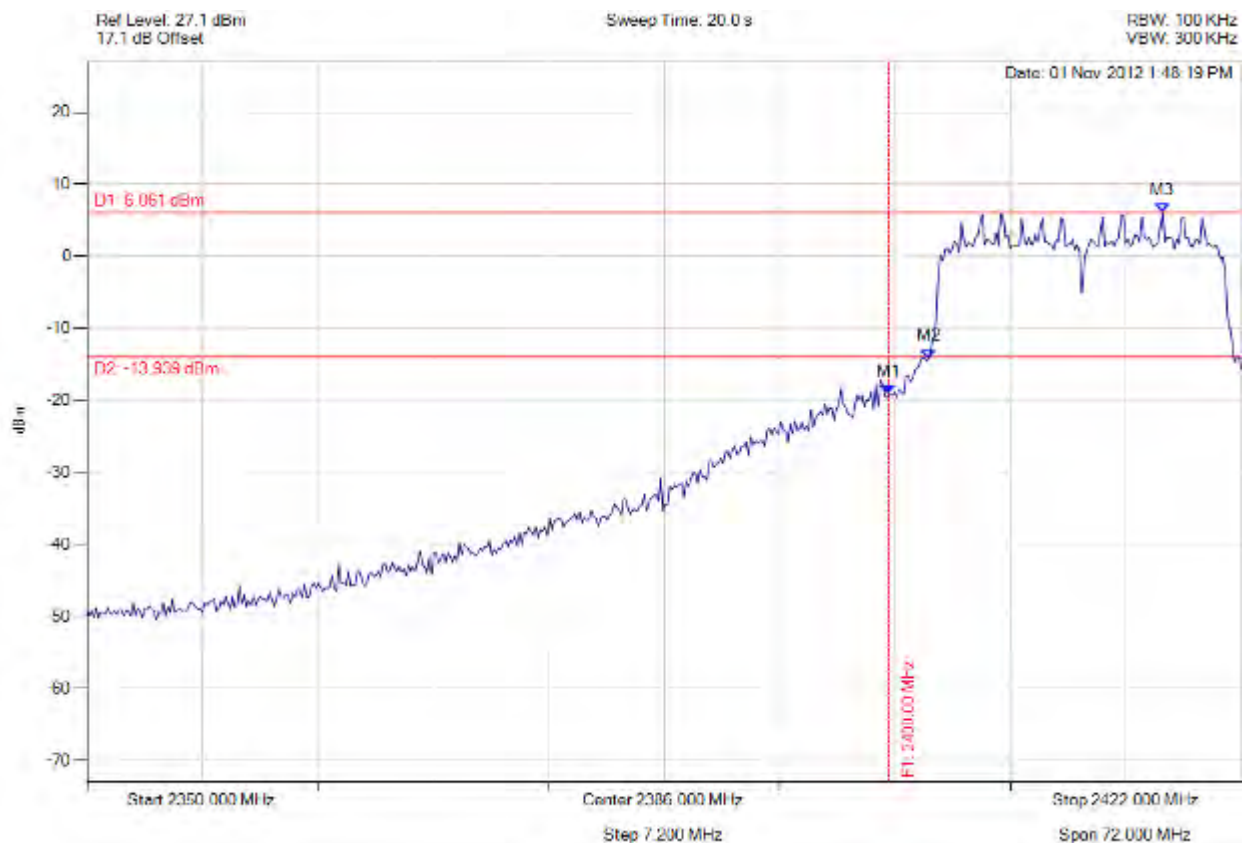

Analyser Setup	Marker : Frequency : Amplitude	Test Results
Detector = MAX PEAK Sweep Count = 0 RF Atten (dB) = 20 Trace Mode = VIEW	M1 : 2400.000 MHz : -19.153 dBm M2 : 2402.521 MHz : -14.199 dBm M3 : 2417.094 MHz : 6.061 dBm	Limit: -13.94 dBm Margin: -5.21 dB

[Back to the Matrix](#)

This test report may be reproduced in full only. The document may only be updated by MiCOM Labs personnel. Any changes will be noted in the Document History section of the report.



Title: Digi Connect Card for i.MX28 with Atheros AR6203
To: FCC 47 CFR Part 15.247 & IC RSS-210
Serial #: DIGI36-U2 Rev A
Issue Date: 22nd May 2014
Page: 238 of 261



band-edge

Variant: 802.11n HT-20, Channel: 2462.00 MHz, Chain a, Temp: Ambient, Voltage: 5.00V

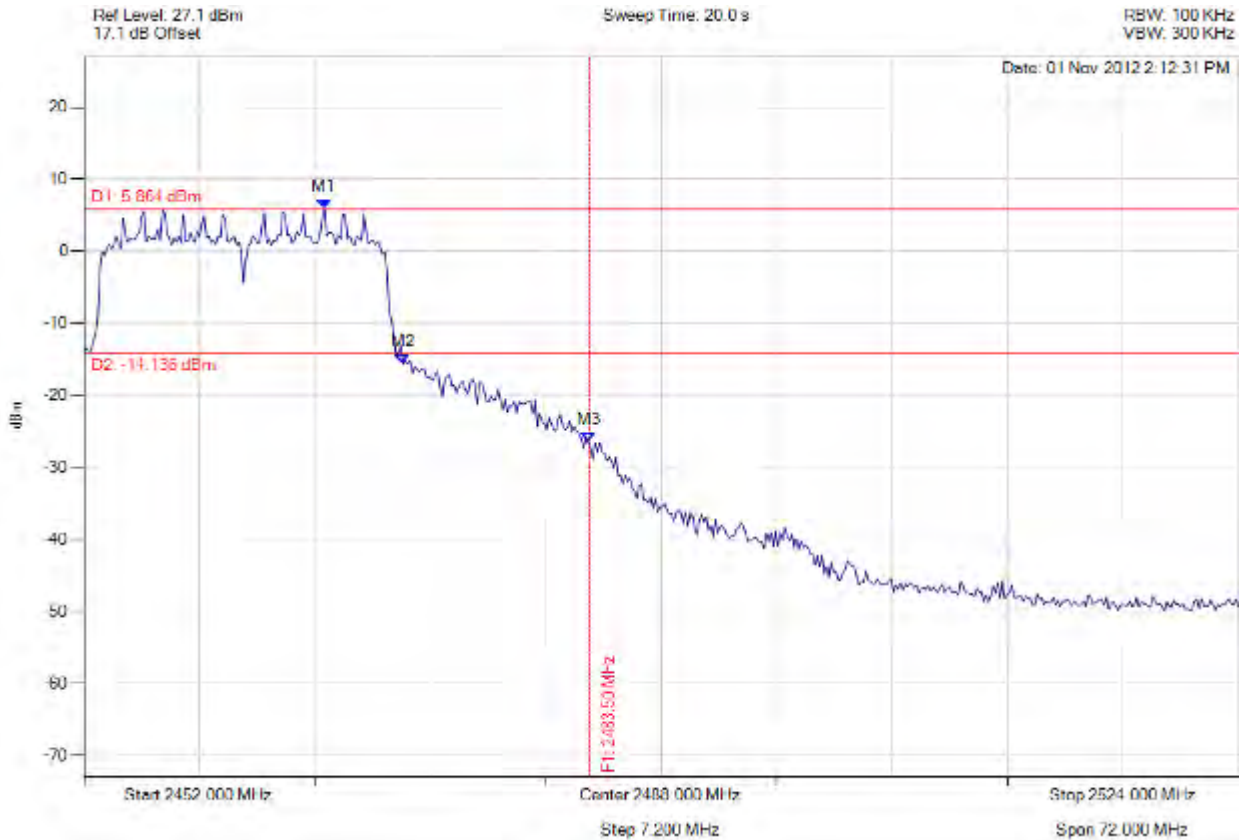

Analyser Setup	Marker : Frequency : Amplitude	Test Results
Detector = MAX PEAK Sweep Count = 0 RF Atten (dB) = 20 Trace Mode = VIEW	M1 : 2467.006 MHz : 5.864 dBm M2 : 2471.912 MHz : -15.657 dBm M3 : 2483.500 MHz : -26.518 dBm	Limit: -14.14 dBm Margin: -12.38 dB

[Back to the Matrix](#)

This test report may be reproduced in full only. The document may only be updated by MiCOM Labs personnel. Any changes will be noted in the Document History section of the report.



Title: Digi Connect Card for i.MX28 with Atheros AR6203
To: FCC 47 CFR Part 15.247 & IC RSS-210
Serial #: DIGI36-U2 Rev A
Issue Date: 22nd May 2014
Page: 239 of 261



spurious

Variant: 802.11n HT-20, Channel: 2412.00 MHz, Chain a, Temp: Ambient, Voltage: 5.00V

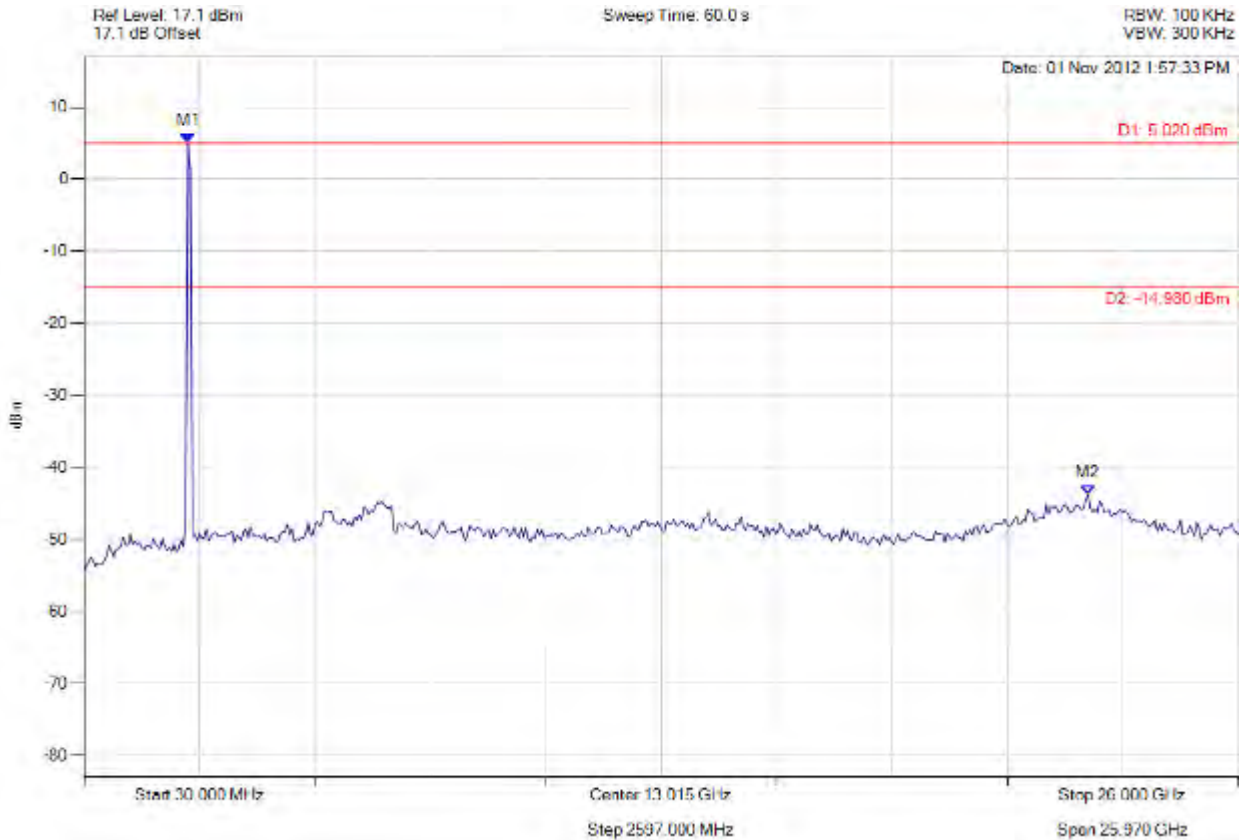

Analyser Setup	Marker : Frequency : Amplitude	Test Results
Detector = MAX PEAK Sweep Count = 0 RF Atten (dB) = 20 Trace Mode = VIEW	M1 : 2371.984 MHz : 5.020 dBm M2 : 22.617 GHz : -43.719 dBm	Limit: -14.98 dBm Margin: -28.74 dB

[Back to the Matrix](#)

This test report may be reproduced in full only. The document may only be updated by MiCOM Labs personnel. Any changes will be noted in the Document History section of the report.



Title: Digi Connect Card for i.MX28 with Atheros AR6203
To: FCC 47 CFR Part 15.247 & IC RSS-210
Serial #: DIGI36-U2 Rev A
Issue Date: 22nd May 2014
Page: 240 of 261



spurious

Variant: 802.11n HT-20, Channel: 2437.00 MHz, Chain a, Temp: Ambient, Voltage: 5.00V

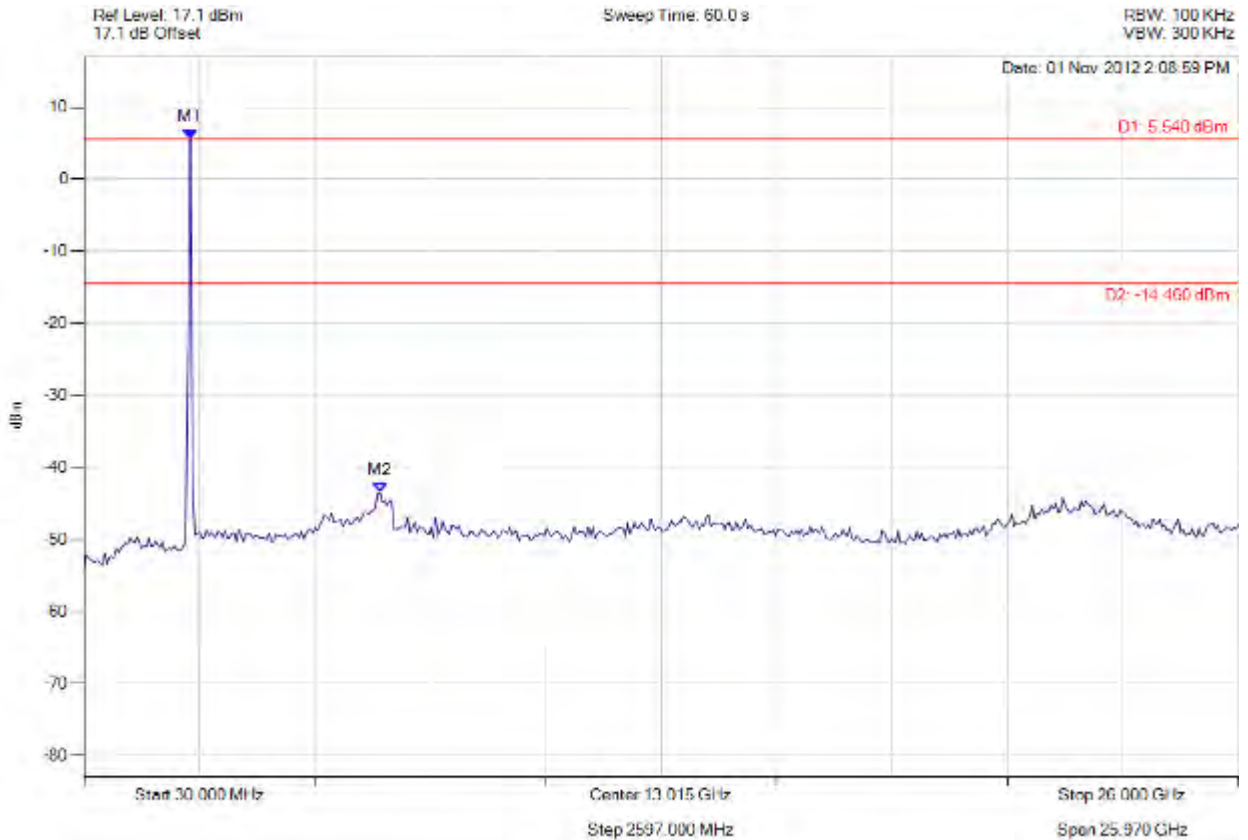

Analyser Setup	Marker : Frequency : Amplitude	Test Results
Detector = MAX PEAK Sweep Count = 0 RF Atten (dB) = 20 Trace Mode = VIEW	M1 : 2424.028 MHz : 5.540 dBm M2 : 6691.643 MHz : -43.502 dBm	Limit: -14.46 dBm Margin: -29.04 dB

[Back to the Matrix](#)

This test report may be reproduced in full only. The document may only be updated by MiCOM Labs personnel. Any changes will be noted in the Document History section of the report.



Title: Digi Connect Card for i.MX28 with Atheros AR6203
To: FCC 47 CFR Part 15.247 & IC RSS-210
Serial #: DIGI36-U2 Rev A
Issue Date: 22nd May 2014
Page: 241 of 261



spurious

Variant: 802.11n HT-20, Channel: 2462.00 MHz, Chain a, Temp: Ambient, Voltage: 5.00V

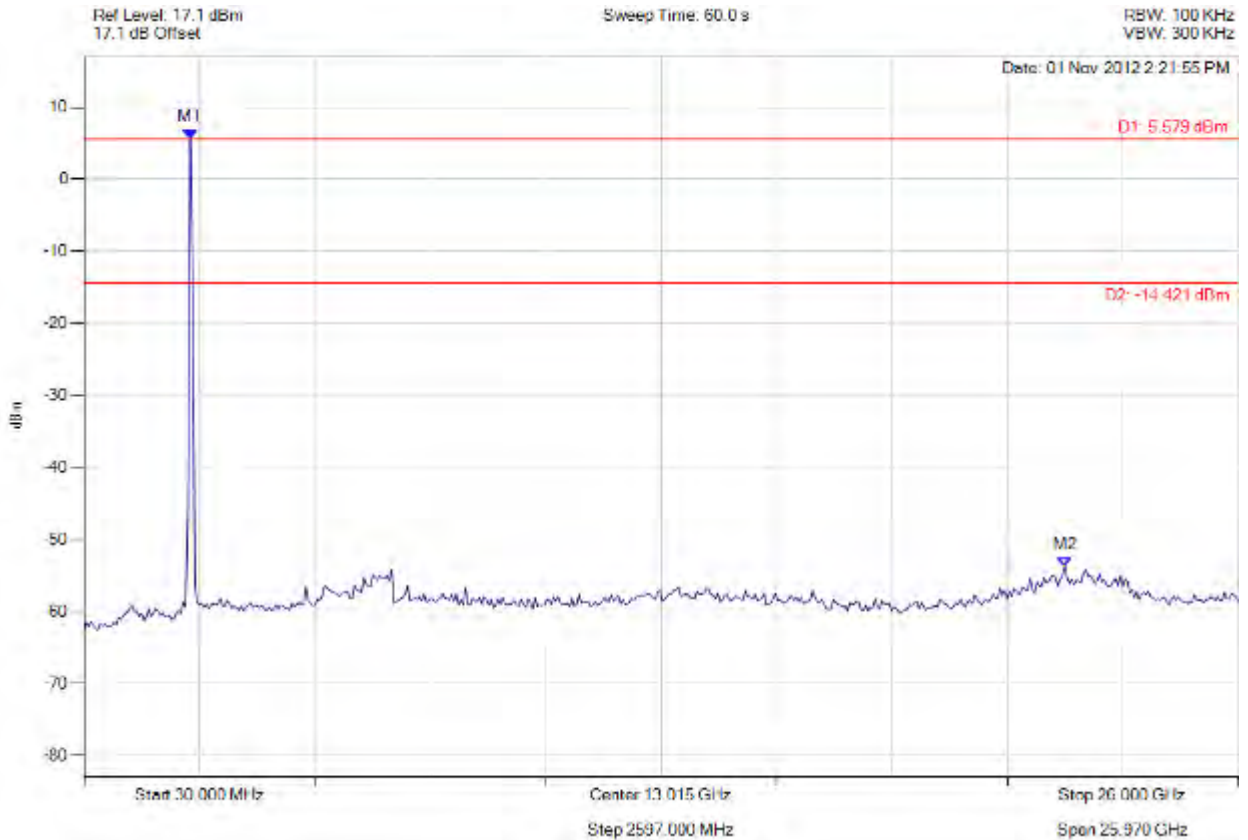

Analyser Setup	Marker : Frequency : Amplitude	Test Results
Detector = MAX PEAK Sweep Count = 0 RF Atten (dB) = 10 Trace Mode = VIEW	M1 : 2424.028 MHz : 5.579 dBm M2 : 22.097 GHz : -53.754 dBm	Limit: -14.42 dBm Margin: -39.33 dB

[Back to the Matrix](#)

This test report may be reproduced in full only. The document may only be updated by MiCOM Labs personnel. Any changes will be noted in the Document History section of the report.



Title: Digi Connect Card for i.MX28 with Atheros AR6203
To: FCC 47 CFR Part 15.247 & IC RSS-210
Serial #: DIGI36-U2 Rev A
Issue Date: 22nd May 2014
Page: 242 of 261



band-edge

Variant: 802.11n HT-40, Channel: 2422.00 MHz, Chain a, Temp: Ambient, Voltage: 5.00V

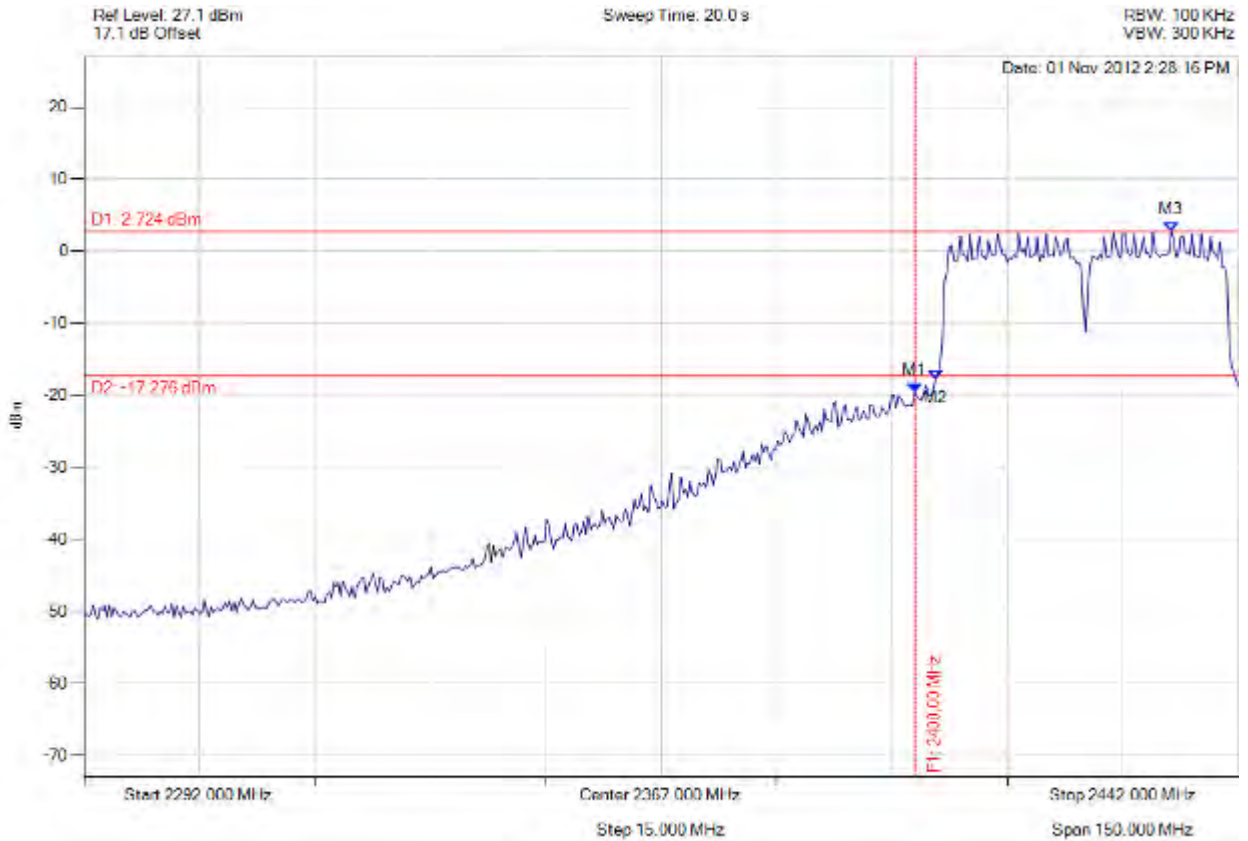

Analyser Setup	Marker : Frequency : Amplitude	Test Results
Detector = MAX PEAK Sweep Count = 0 RF Atten (dB) = 20 Trace Mode = VIEW	M1 : 2400.000 MHz : -19.542 dBm M2 : 2402.621 MHz : -17.854 dBm M3 : 2433.283 MHz : 2.724 dBm	Limit: -17.28 dBm Margin: -2.26 dB

[Back to the Matrix](#)

This test report may be reproduced in full only. The document may only be updated by MiCOM Labs personnel. Any changes will be noted in the Document History section of the report.



Title: Digi Connect Card for i.MX28 with Atheros AR6203
To: FCC 47 CFR Part 15.247 & IC RSS-210
Serial #: DIGI36-U2 Rev A
Issue Date: 22nd May 2014
Page: 243 of 261



band-edge

Variant: 802.11n HT-40, Channel: 2452.00 MHz, Chain a, Temp: Ambient, Voltage: 5.00V

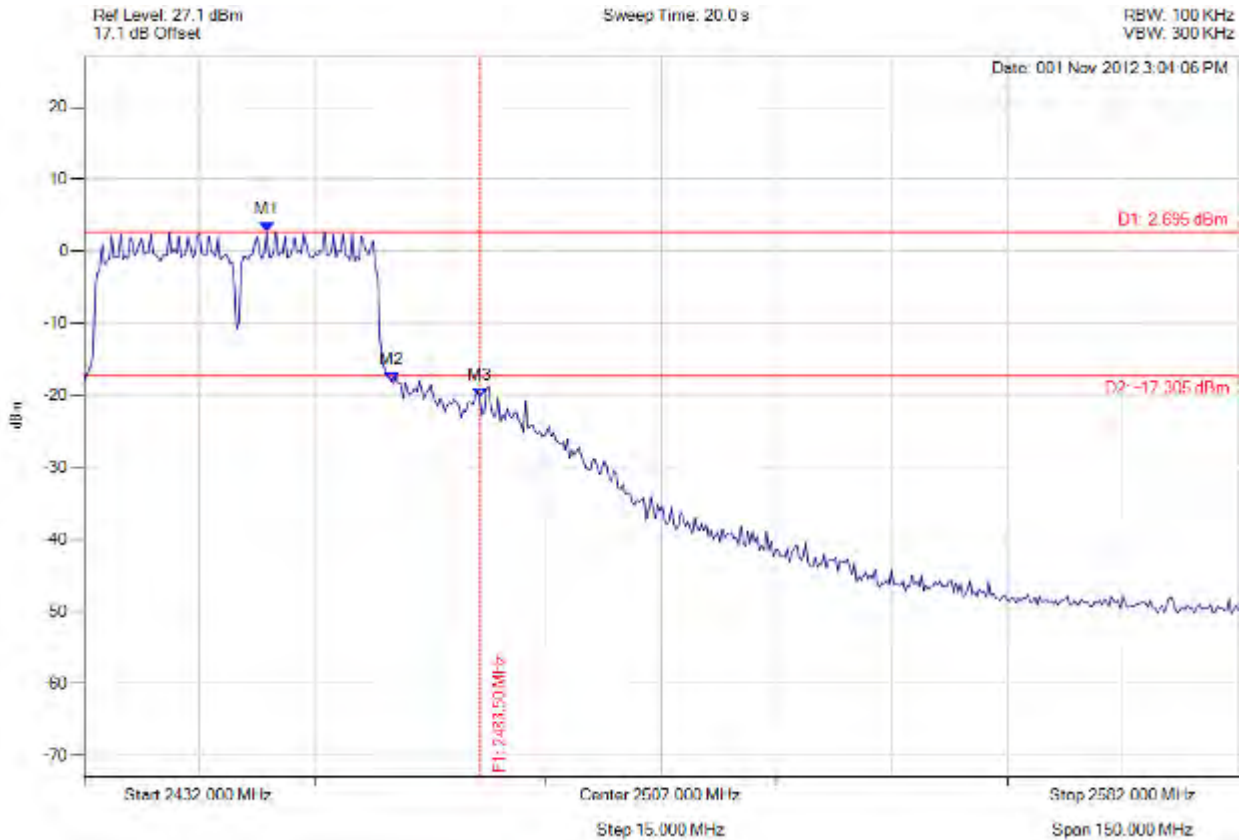

Analyser Setup	Marker : Frequency : Amplitude	Test Results
Detector = MAX PEAK Sweep Count = 0 RF Atten (dB) = 20 Trace Mode = VIEW	M1 : 2455.747 MHz : 2.695 dBm M2 : 2471.980 MHz : -18.112 dBm M3 : 2483.500 MHz : -20.217 dBm	Limit: -17.31 dBm Margin: -2.91 dB

[Back to the Matrix](#)

This test report may be reproduced in full only. The document may only be updated by MiCOM Labs personnel. Any changes will be noted in the Document History section of the report.



Title: Digi Connect Card for i.MX28 with Atheros AR6203
To: FCC 47 CFR Part 15.247 & IC RSS-210
Serial #: DIGI36-U2 Rev A
Issue Date: 22nd May 2014
Page: 244 of 261



spurious

Variant: 802.11n HT-40, Channel: 2422.00 MHz, Chain a, Temp: Ambient, Voltage: 5.00V

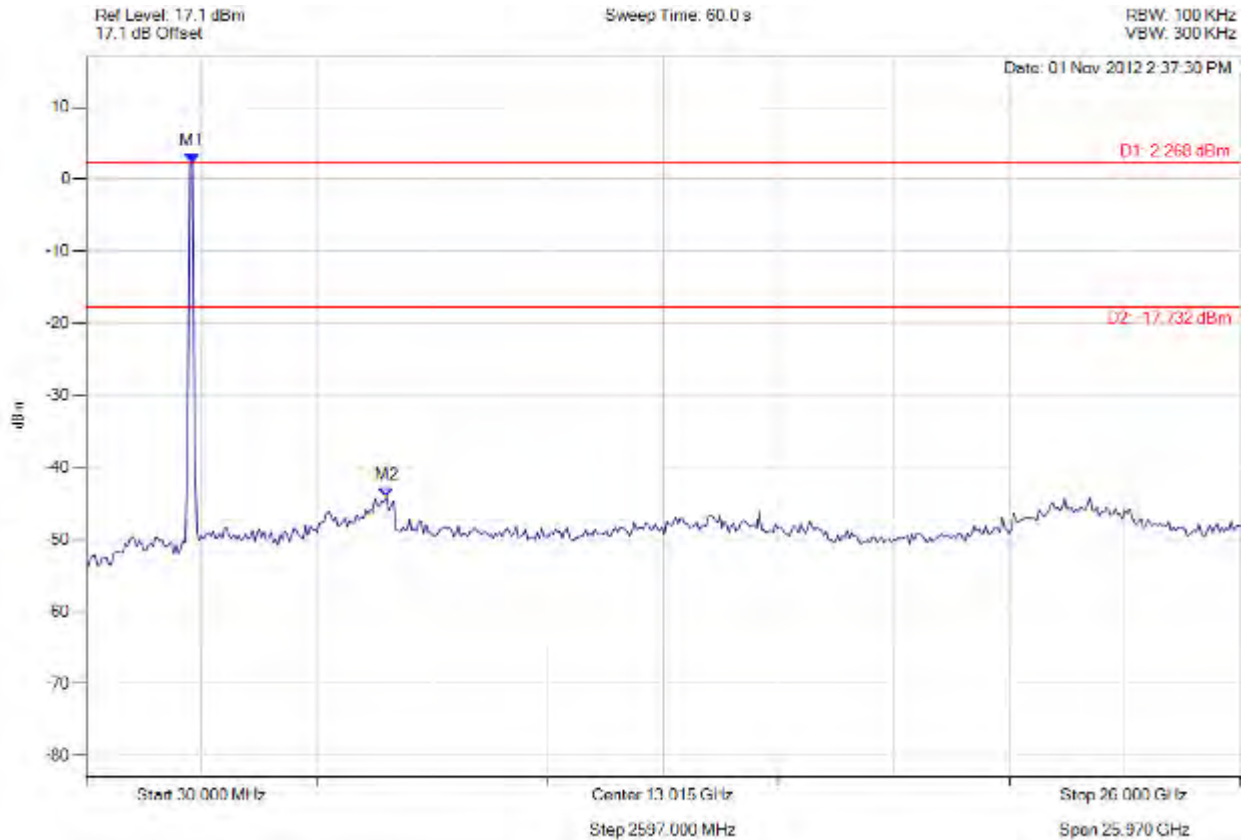

Analyser Setup	Marker : Frequency : Amplitude	Test Results
Detector = MAX PEAK Sweep Count = 0 RF Atten (dB) = 20 Trace Mode = VIEW	M1 : 2424.028 MHz : 2.268 dBm M2 : 6795.731 MHz : -44.132 dBm	Limit: -17.73 dBm Margin: -26.40 dB

[Back to the Matrix](#)

This test report may be reproduced in full only. The document may only be updated by MiCOM Labs personnel. Any changes will be noted in the Document History section of the report.



Title: Digi Connect Card for i.MX28 with Atheros AR6203
To: FCC 47 CFR Part 15.247 & IC RSS-210
Serial #: DIGI36-U2 Rev A
Issue Date: 22nd May 2014
Page: 245 of 261



spurious

Variant: 802.11n HT-40, Channel: 2437.00 MHz, Chain a, Temp: Ambient, Voltage: 5.00V

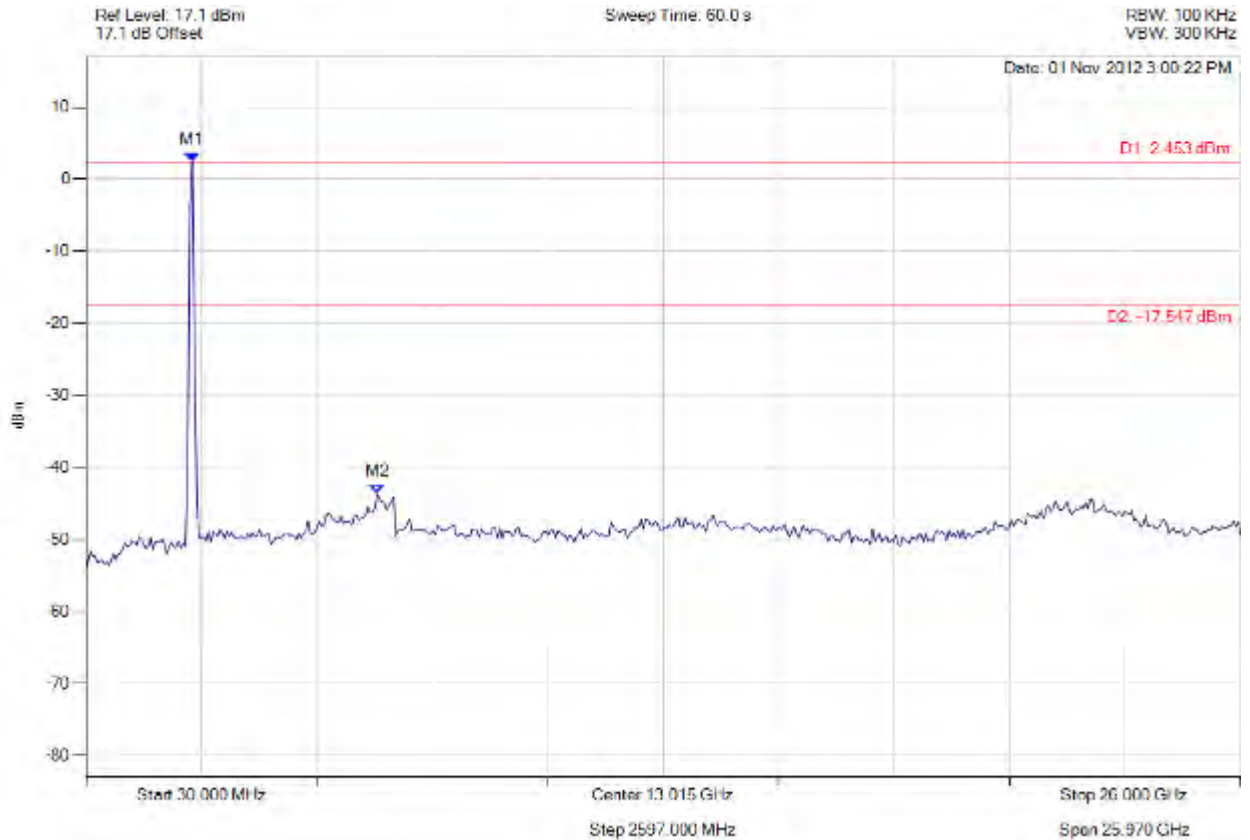

Analyser Setup	Marker : Frequency : Amplitude	Test Results
Detector = MAX PEAK Sweep Count = 0 RF Atten (dB) = 20 Trace Mode = VIEW	M1 : 2424.028 MHz : 2.453 dBm M2 : 6587.555 MHz : -43.662 dBm	Limit: -17.55 dBm Margin: -26.11 dB

[Back to the Matrix](#)

This test report may be reproduced in full only. The document may only be updated by MiCOM Labs personnel. Any changes will be noted in the Document History section of the report.



Title: Digi Connect Card for i.MX28 with Atheros AR6203
To: FCC 47 CFR Part 15.247 & IC RSS-210
Serial #: DIGI36-U2 Rev A
Issue Date: 22nd May 2014
Page: 246 of 261



spurious

Variant: 802.11n HT-40, Channel: 2452.00 MHz, Chain a, Temp: Ambient, Voltage: 5.00V

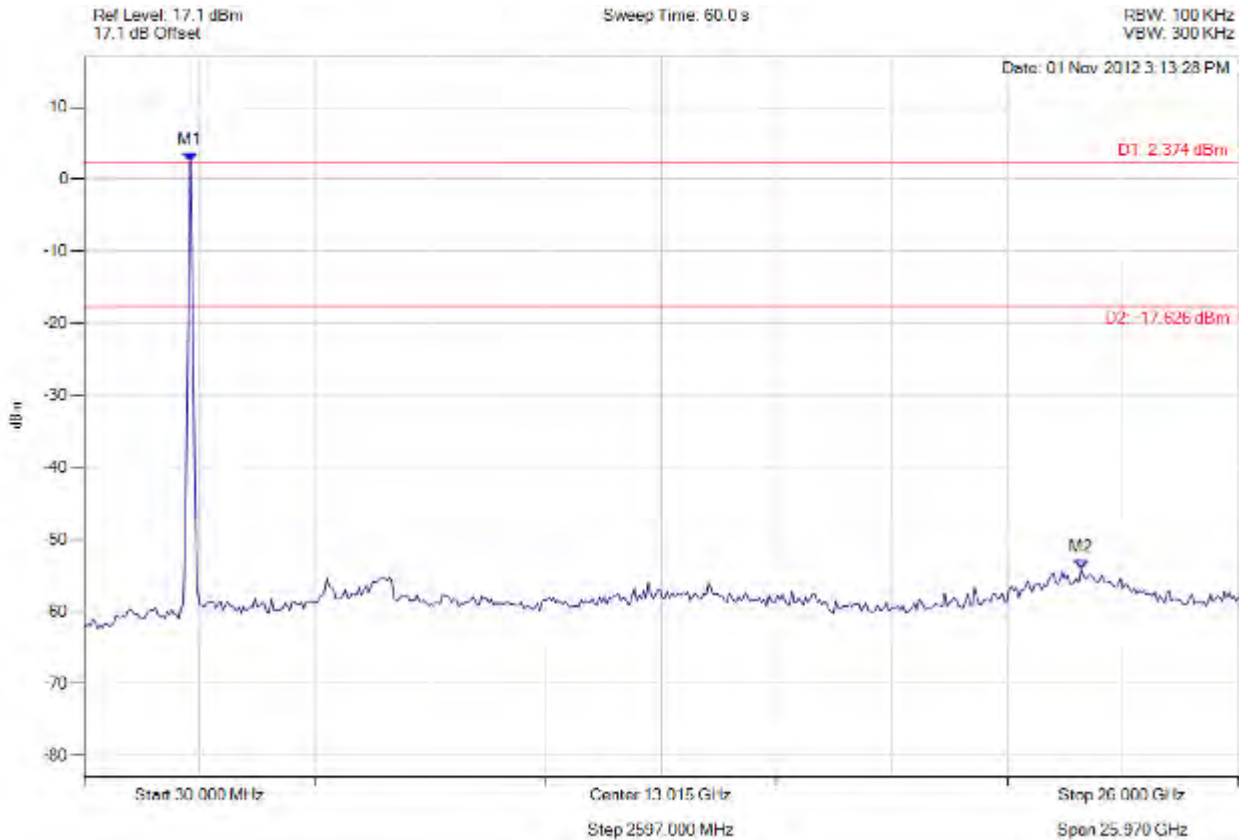

Analyser Setup	Marker : Frequency : Amplitude	Test Results
Detector = MAX PEAK Sweep Count = 0 RF Atten (dB) = 10 Trace Mode = VIEW	M1 : 2424.028 MHz : 2.374 dBm M2 : 22.461 GHz : -54.167 dBm	Limit: -17.63 dBm Margin: -36.54 dB

[Back to the Matrix](#)

This test report may be reproduced in full only. The document may only be updated by MiCOM Labs personnel. Any changes will be noted in the Document History section of the report.



Title: Digi Connect Card for i.MX28 with Atheros AR6203
To: FCC 47 CFR Part 15.247 & IC RSS-210
Serial #: DIGI36-U2 Rev A
Issue Date: 22nd May 2014
Page: 247 of 261



band-edge

Variant: 802.11a, Channel: 5745.00 MHz, Chain a, Temp: Ambient, Voltage: 5.00V

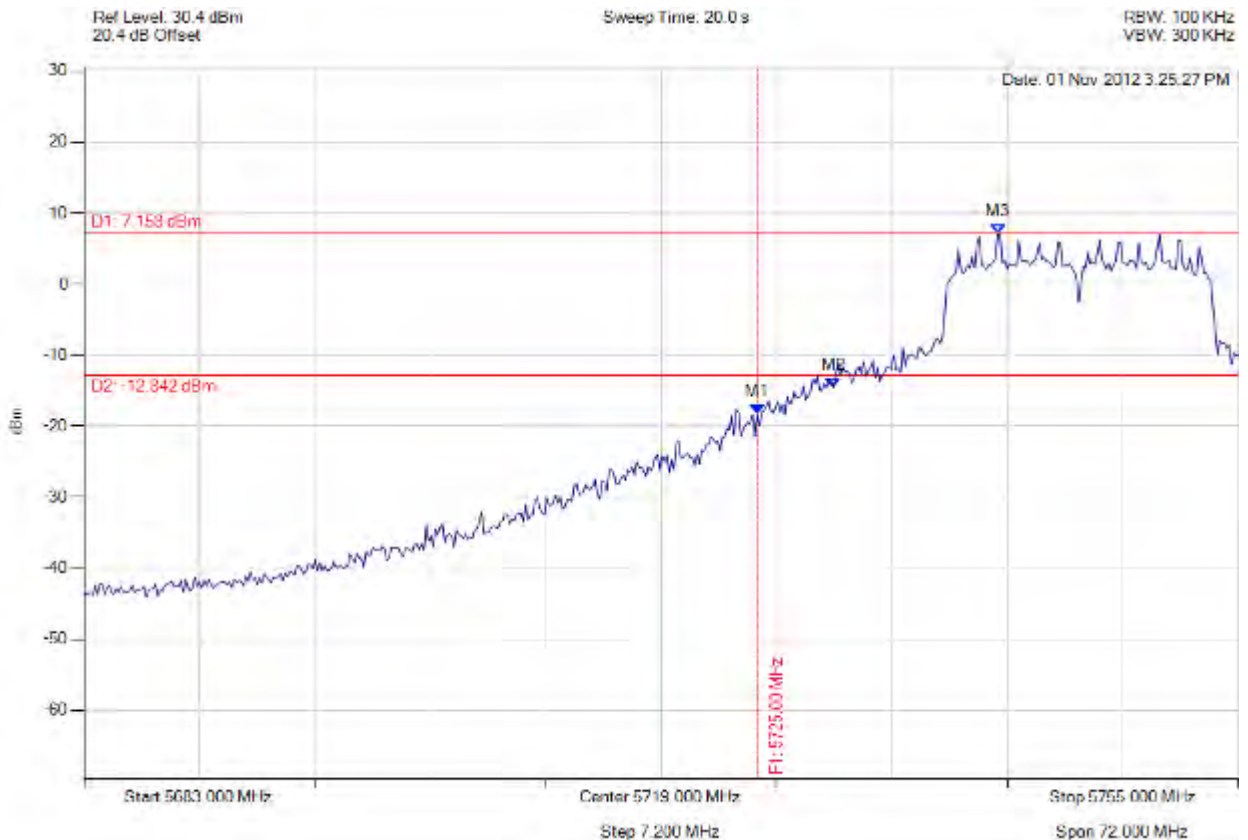

Analyser Setup	Marker : Frequency : Amplitude	Test Results
Detector = MAX PEAK Sweep Count = 0 RF Atten (dB) = 20 Trace Mode = VIEW	M1 : 5725.000 MHz : -18.270 dBm M2 : 5729.749 MHz : -14.495 dBm M3 : 5739.994 MHz : 7.158 dBm	Limit: -12.84 dBm Margin: -5.43 dB

[Back to the Matrix](#)

This test report may be reproduced in full only. The document may only be updated by MiCOM Labs personnel. Any changes will be noted in the Document History section of the report.



Title: Digi Connect Card for i.MX28 with Atheros AR6203
To: FCC 47 CFR Part 15.247 & IC RSS-210
Serial #: DIGI36-U2 Rev A
Issue Date: 22nd May 2014
Page: 248 of 261



band-edge

Variant: 802.11a, Channel: 5825.00 MHz, Chain a, Temp: Ambient, Voltage: 5.00V

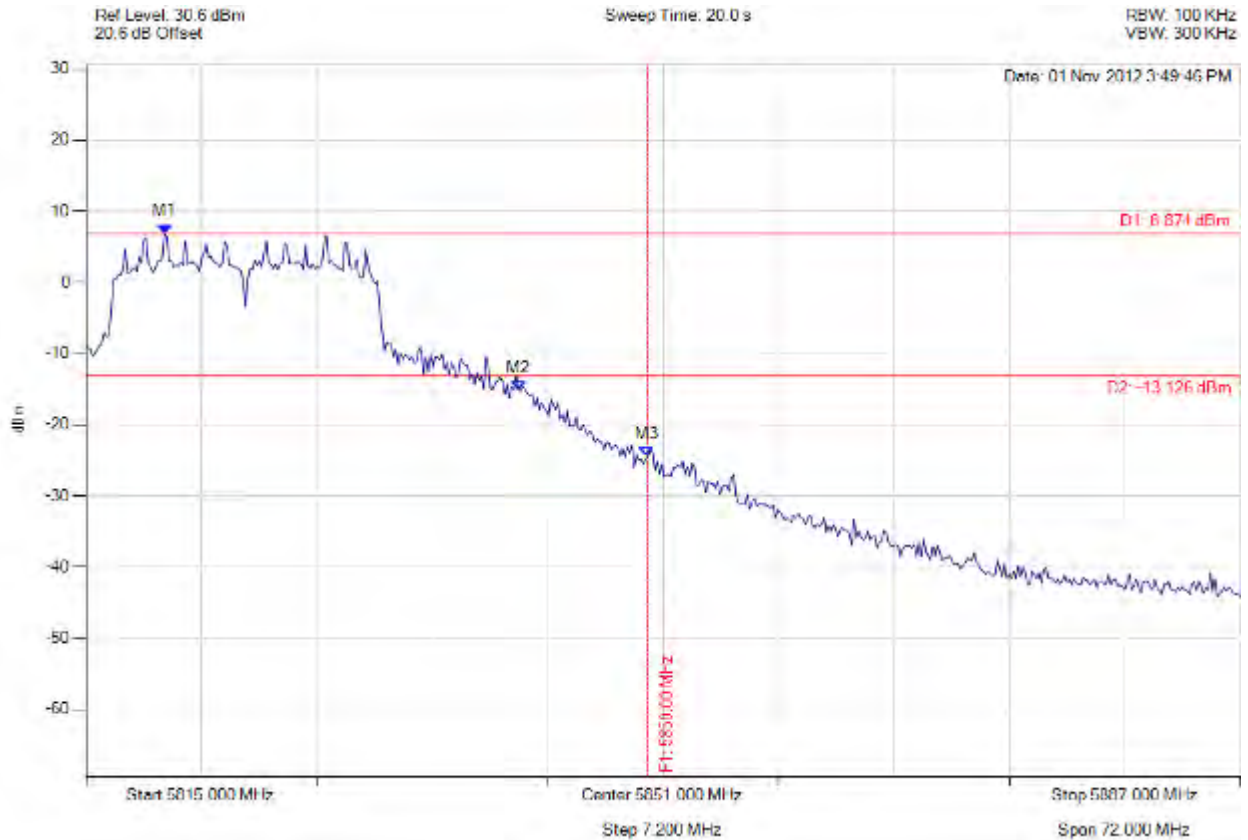

Analyser Setup	Marker : Frequency : Amplitude	Test Results
Detector = MAX PEAK Sweep Count = 0 RF Atten (dB) = 20 Trace Mode = VIEW	M1 : 5819.906 MHz : 6.874 dBm M2 : 5841.982 MHz : -15.127 dBm M3 : 5850.000 MHz : -24.464 dBm	Limit: -13.13 dBm Margin: -11.33 dB

[Back to the Matrix](#)

This test report may be reproduced in full only. The document may only be updated by MiCOM Labs personnel. Any changes will be noted in the Document History section of the report.



Title: Digi Connect Card for i.MX28 with Atheros AR6203
To: FCC 47 CFR Part 15.247 & IC RSS-210
Serial #: DIGI36-U2 Rev A
Issue Date: 22nd May 2014
Page: 249 of 261



spurious

Variant: 802.11a, Channel: 5745.00 MHz, Chain a, Temp: Ambient, Voltage: 5.00V

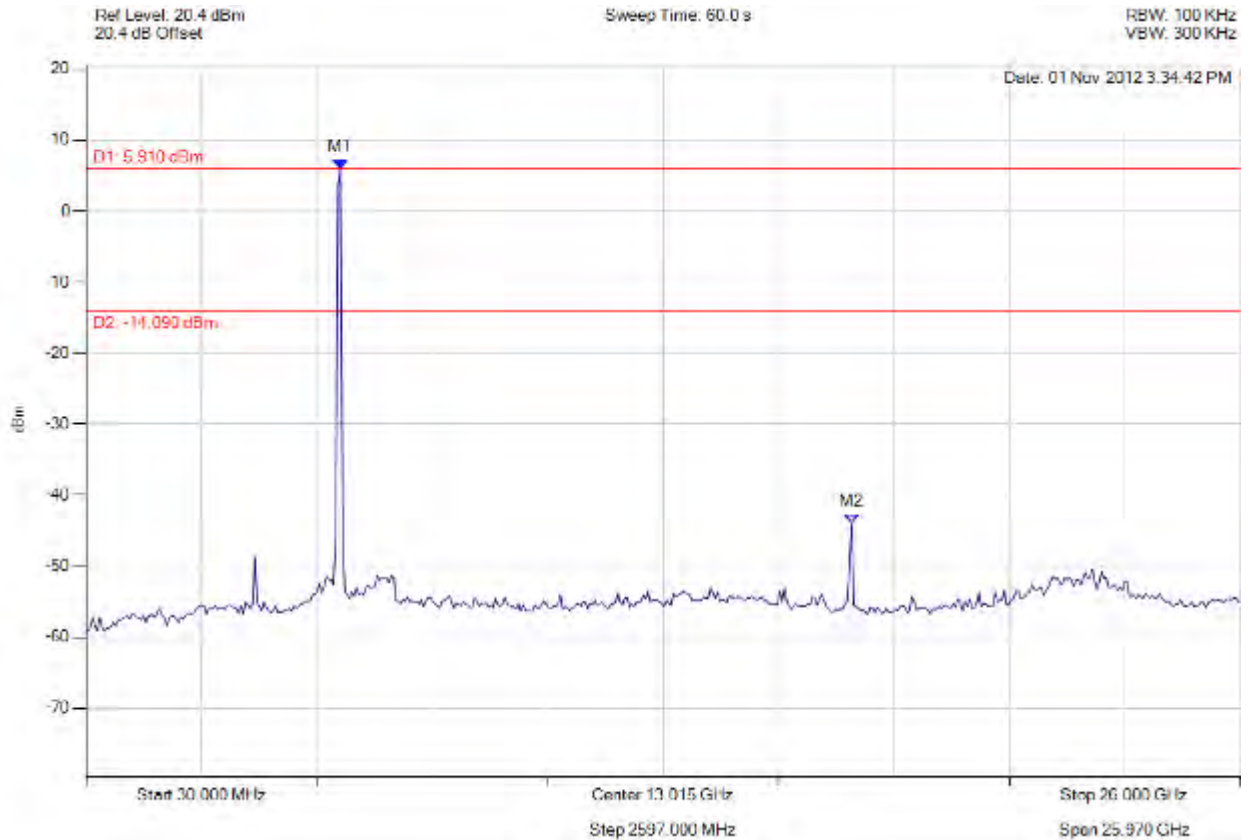

Analyser Setup	Marker : Frequency : Amplitude	Test Results
Detector = MAX PEAK Sweep Count = 0 RF Atten (dB) = 10 Trace Mode = VIEW	M1 : 5754.850 MHz : 5.910 dBm M2 : 17.257 GHz : -44.062 dBm	Limit: -14.09 dBm Margin: -29.97 dB

[Back to the Matrix](#)

This test report may be reproduced in full only. The document may only be updated by MiCOM Labs personnel. Any changes will be noted in the Document History section of the report.



Title: Digi Connect Card for i.MX28 with Atheros AR6203
To: FCC 47 CFR Part 15.247 & IC RSS-210
Serial #: DIGI36-U2 Rev A
Issue Date: 22nd May 2014
Page: 250 of 261



spurious

Variant: 802.11a, Channel: 5785.00 MHz, Chain a, Temp: Ambient, Voltage: 5.00V

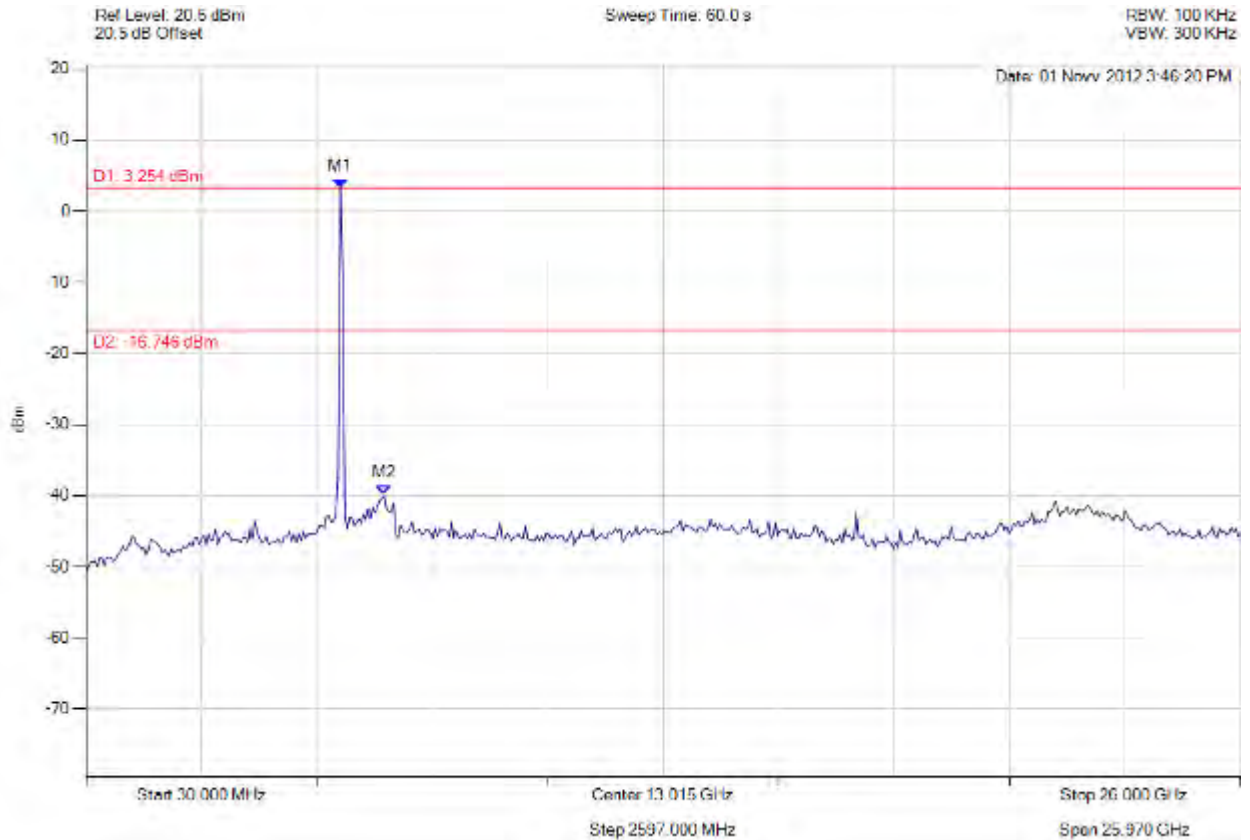

Analyser Setup	Marker : Frequency : Amplitude	Test Results
Detector = MAX PEAK Sweep Count = 0 RF Atten (dB) = 20 Trace Mode = VIEW	M1 : 5754.850 MHz : 3.254 dBm M2 : 6743.687 MHz : -39.953 dBm	Limit: -16.75 dBm Margin: -23.20 dB

[Back to the Matrix](#)

This test report may be reproduced in full only. The document may only be updated by MiCOM Labs personnel. Any changes will be noted in the Document History section of the report.



Title: Digi Connect Card for i.MX28 with Atheros AR6203
To: FCC 47 CFR Part 15.247 & IC RSS-210
Serial #: DIGI36-U2 Rev A
Issue Date: 22nd May 2014
Page: 251 of 261



spurious

Variant: 802.11a, Channel: 5825.00 MHz, Chain a, Temp: Ambient, Voltage: 5.00V

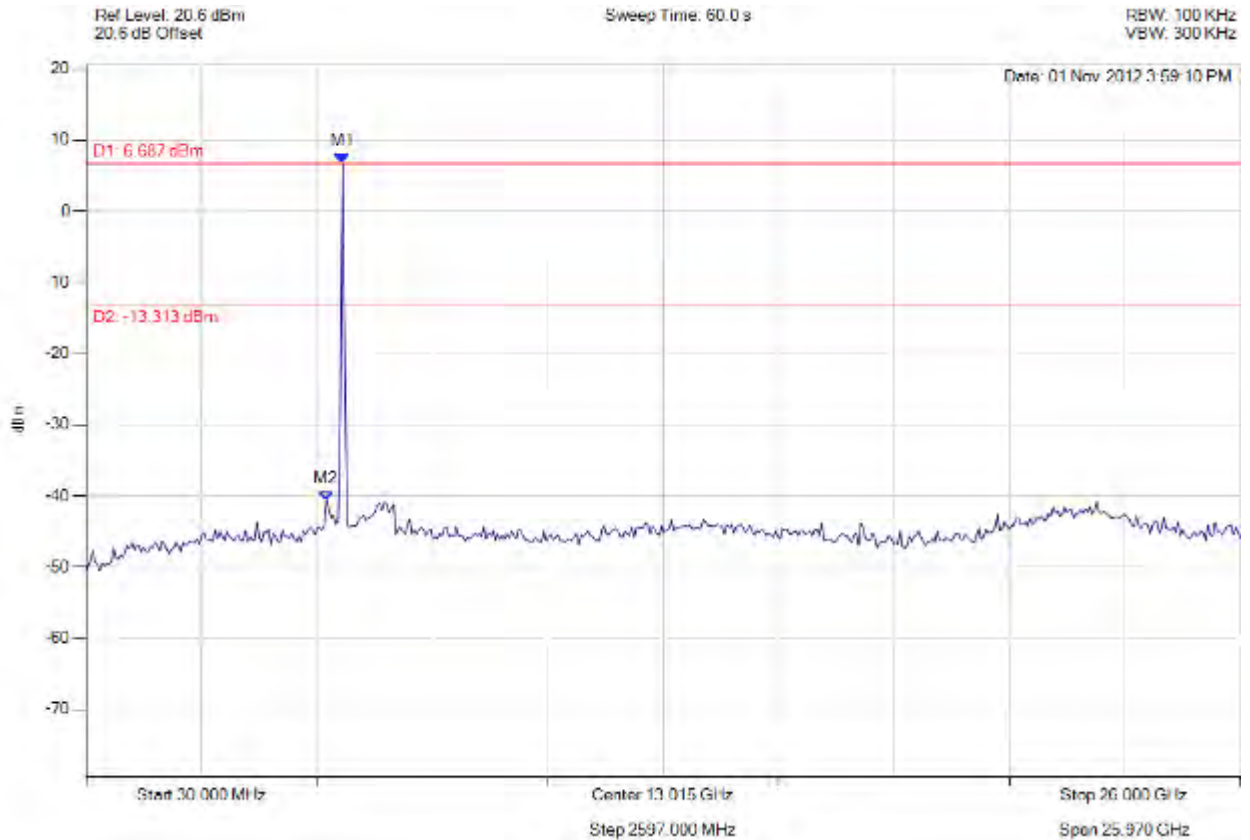

Analyser Setup	Marker : Frequency : Amplitude	Test Results
Detector = MAX PEAK Sweep Count = 0 RF Atten (dB) = 20 Trace Mode = VIEW	M1 : 5806.894 MHz : 6.687 dBm M2 : 5442.585 MHz : -40.695 dBm	Limit: -13.31 dBm Margin: -27.38 dB

[Back to the Matrix](#)

This test report may be reproduced in full only. The document may only be updated by MiCOM Labs personnel. Any changes will be noted in the Document History section of the report.



Title: Digi Connect Card for i.MX28 with Atheros AR6203
To: FCC 47 CFR Part 15.247 & IC RSS-210
Serial #: DIGI36-U2 Rev A
Issue Date: 22nd May 2014
Page: 252 of 261



band-edge

Variant: 802.11n HT-20, Channel: 5745.00 MHz, Chain a, Temp: Ambient, Voltage: 5.00V

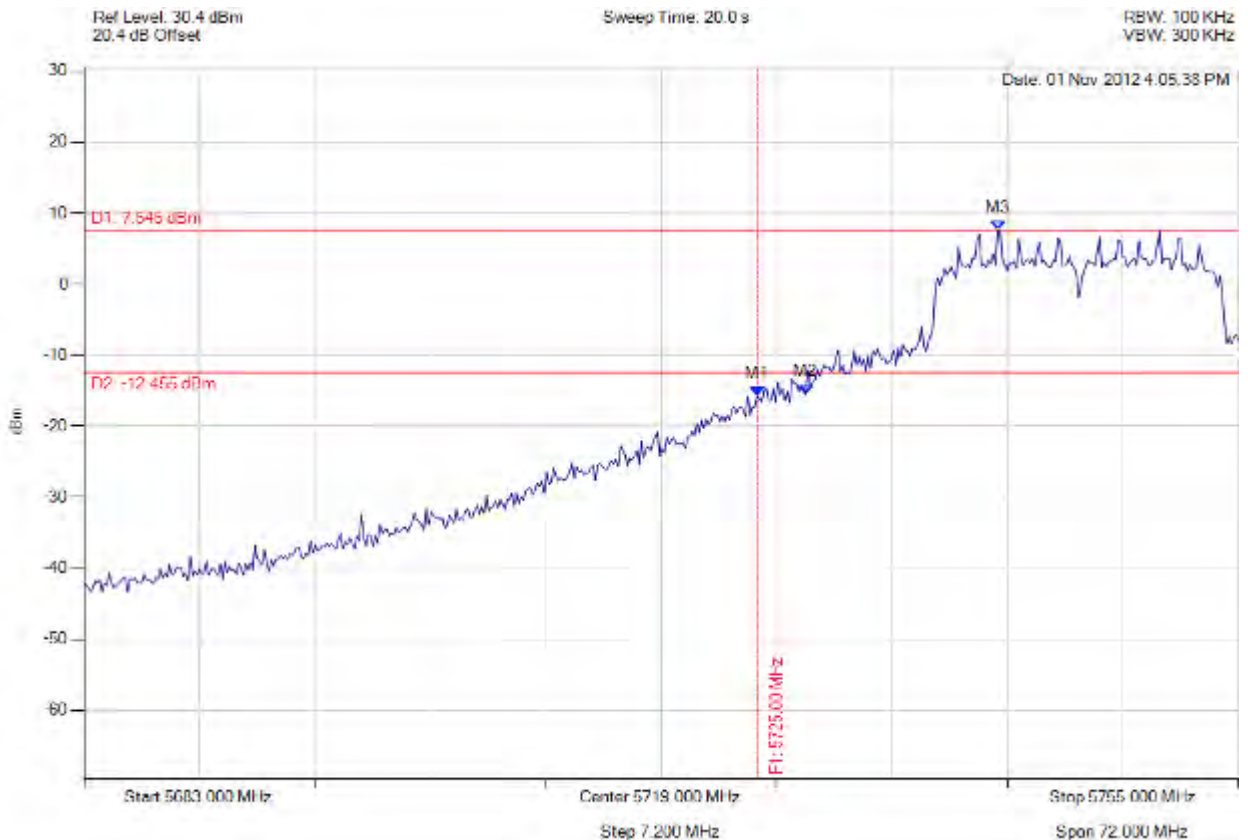

Analyser Setup	Marker : Frequency : Amplitude	Test Results
Detector = MAX PEAK Sweep Count = 0 RF Atten (dB) = 20 Trace Mode = VIEW	M1 : 5725.000 MHz : -15.697 dBm M2 : 5728.018 MHz : -15.475 dBm M3 : 5739.994 MHz : 7.545 dBm	Limit: -12.46 dBm Margin: -3.24 dB

[Back to the Matrix](#)

This test report may be reproduced in full only. The document may only be updated by MiCOM Labs personnel. Any changes will be noted in the Document History section of the report.



Title: Digi Connect Card for i.MX28 with Atheros AR6203
To: FCC 47 CFR Part 15.247 & IC RSS-210
Serial #: DIGI36-U2 Rev A
Issue Date: 22nd May 2014
Page: 253 of 261



band-edge

Variant: 802.11n HT-20, Channel: 5825.00 MHz, Chain a, Temp: Ambient, Voltage: 5.00V

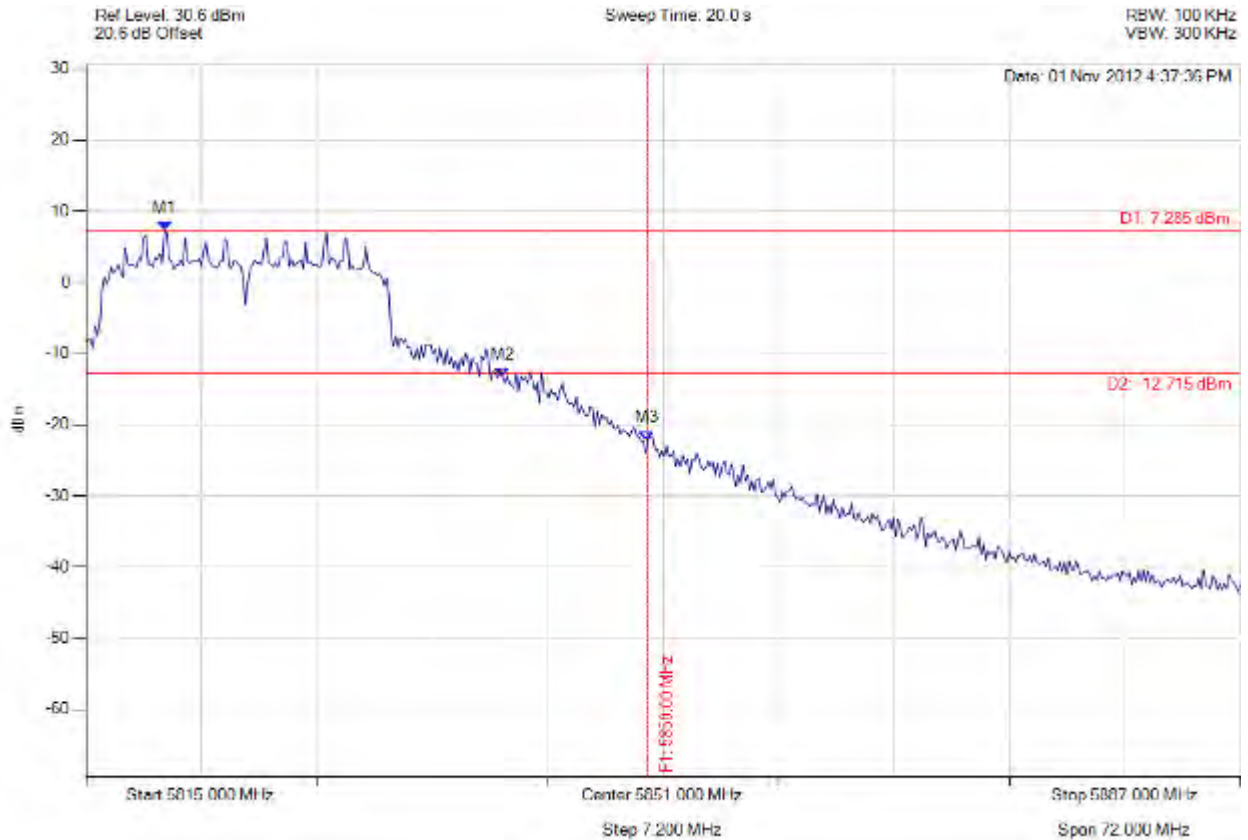

Analyser Setup	Marker : Frequency : Amplitude	Test Results
Detector = MAX PEAK Sweep Count = 0 RF Atten (dB) = 20 Trace Mode = VIEW	M1 : 5819.906 MHz : 7.285 dBm M2 : 5840.972 MHz : -13.290 dBm M3 : 5850.000 MHz : -22.151 dBm	Limit: -12.72 dBm Margin: -9.43 dB

[Back to the Matrix](#)

This test report may be reproduced in full only. The document may only be updated by MiCOM Labs personnel. Any changes will be noted in the Document History section of the report.



Title: Digi Connect Card for i.MX28 with Atheros AR6203
To: FCC 47 CFR Part 15.247 & IC RSS-210
Serial #: DIGI36-U2 Rev A
Issue Date: 22nd May 2014
Page: 254 of 261



spurious

Variant: 802.11n HT-20, Channel: 5745.00 MHz, Chain a, Temp: Ambient, Voltage: 5.00V

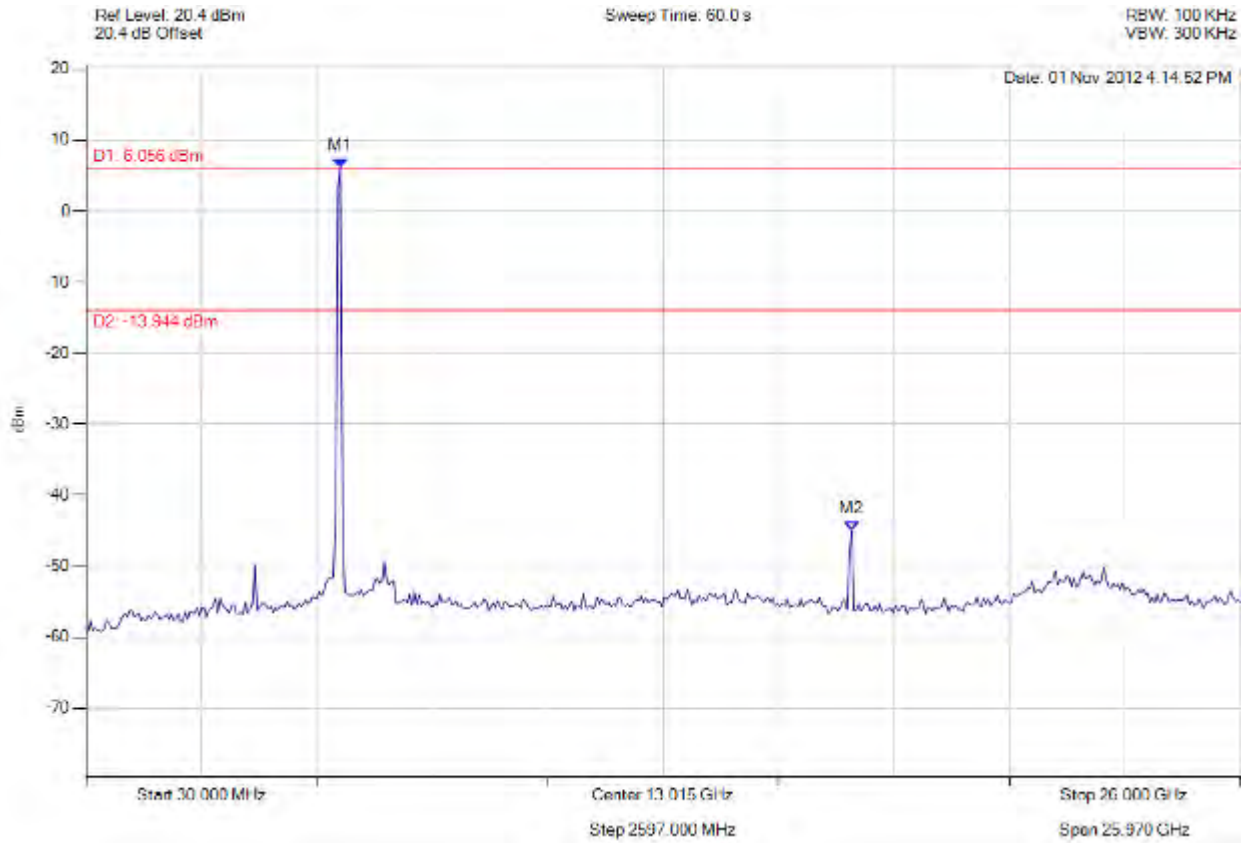

Analyser Setup	Marker : Frequency : Amplitude	Test Results
Detector = MAX PEAK Sweep Count = 0 RF Atten (dB) = 10 Trace Mode = VIEW	M1 : 5754.850 MHz : 6.056 dBm M2 : 17.257 GHz : -44.938 dBm	Limit: -13.94 dBm Margin: -31.00 dB

[Back to the Matrix](#)

This test report may be reproduced in full only. The document may only be updated by MiCOM Labs personnel. Any changes will be noted in the Document History section of the report.



Title: Digi Connect Card for i.MX28 with Atheros AR6203
To: FCC 47 CFR Part 15.247 & IC RSS-210
Serial #: DIGI36-U2 Rev A
Issue Date: 22nd May 2014
Page: 255 of 261



spurious

Variant: 802.11n HT-20, Channel: 5785.00 MHz, Chain a, Temp: Ambient, Voltage: 5.00V

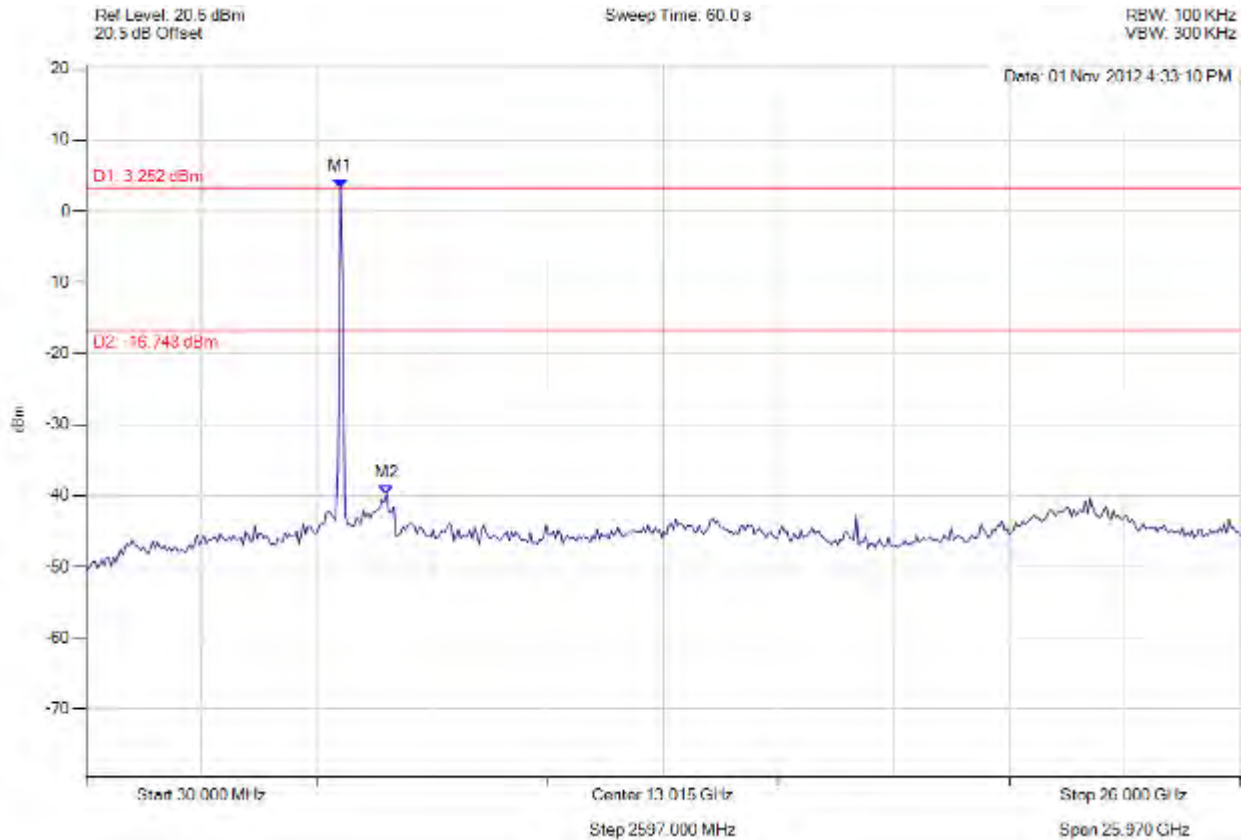

Analyser Setup	Marker : Frequency : Amplitude	Test Results
Detector = MAX PEAK Sweep Count = 0 RF Atten (dB) = 20 Trace Mode = VIEW	M1 : 5754.850 MHz : 3.252 dBm M2 : 6795.731 MHz : -39.825 dBm	Limit: -16.75 dBm Margin: -23.08 dB

[Back to the Matrix](#)

This test report may be reproduced in full only. The document may only be updated by MiCOM Labs personnel. Any changes will be noted in the Document History section of the report.



Title: Digi Connect Card for i.MX28 with Atheros AR6203
To: FCC 47 CFR Part 15.247 & IC RSS-210
Serial #: DIGI36-U2 Rev A
Issue Date: 22nd May 2014
Page: 256 of 261



spurious

Variant: 802.11n HT-20, Channel: 5825.00 MHz, Chain a, Temp: Ambient, Voltage: 5.00V

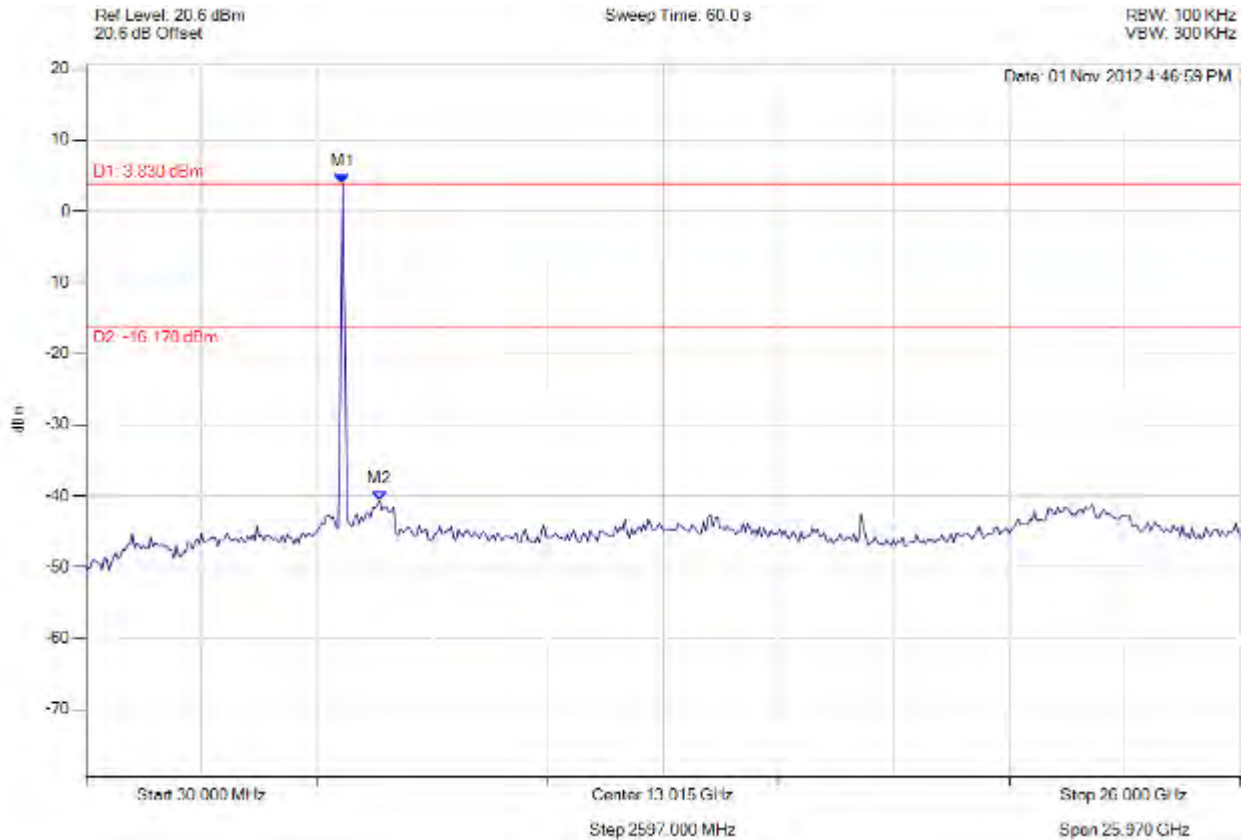

Analyser Setup	Marker : Frequency : Amplitude	Test Results
Detector = MAX PEAK Sweep Count = 0 RF Atten (dB) = 20 Trace Mode = VIEW	M1 : 5806.894 MHz : 3.830 dBm M2 : 6639.599 MHz : -40.642 dBm	Limit: -16.17 dBm Margin: -24.47 dB

[Back to the Matrix](#)

This test report may be reproduced in full only. The document may only be updated by MiCOM Labs personnel. Any changes will be noted in the Document History section of the report.



Title: Digi Connect Card for i.MX28 with Atheros AR6203
To: FCC 47 CFR Part 15.247 & IC RSS-210
Serial #: DIGI36-U2 Rev A
Issue Date: 22nd May 2014
Page: 257 of 261



band-edge

Variant: 802.11n HT-40, Channel: 5755.00 MHz, Chain a, Temp: Ambient, Voltage: 5.00V

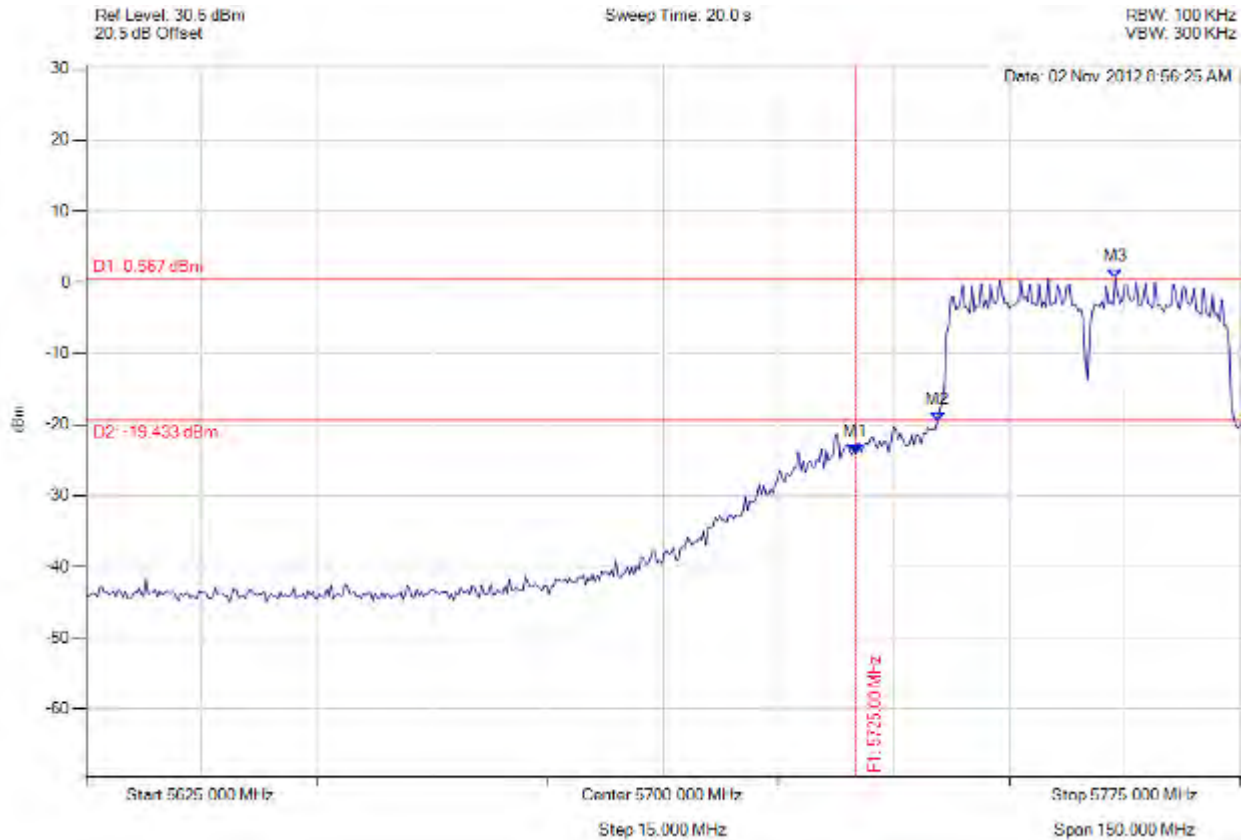

Analyser Setup	Marker : Frequency : Amplitude	Test Results
Detector = MAX PEAK Sweep Count = 0 RF Atten (dB) = 20 Trace Mode = VIEW	M1 : 5725.000 MHz : -24.169 dBm M2 : 5735.621 MHz : -19.646 dBm M3 : 5758.768 MHz : 0.567 dBm	Limit: -19.43 dBm Margin: -4.74 dB

[Back to the Matrix](#)

This test report may be reproduced in full only. The document may only be updated by MiCOM Labs personnel. Any changes will be noted in the Document History section of the report.



Title: Digi Connect Card for i.MX28 with Atheros AR6203
To: FCC 47 CFR Part 15.247 & IC RSS-210
Serial #: DIGI36-U2 Rev A
Issue Date: 22nd May 2014
Page: 258 of 261



band-edge

Variant: 802.11n HT-40, Channel: 5795.00 MHz, Chain a, Temp: Ambient, Voltage: 5.00V

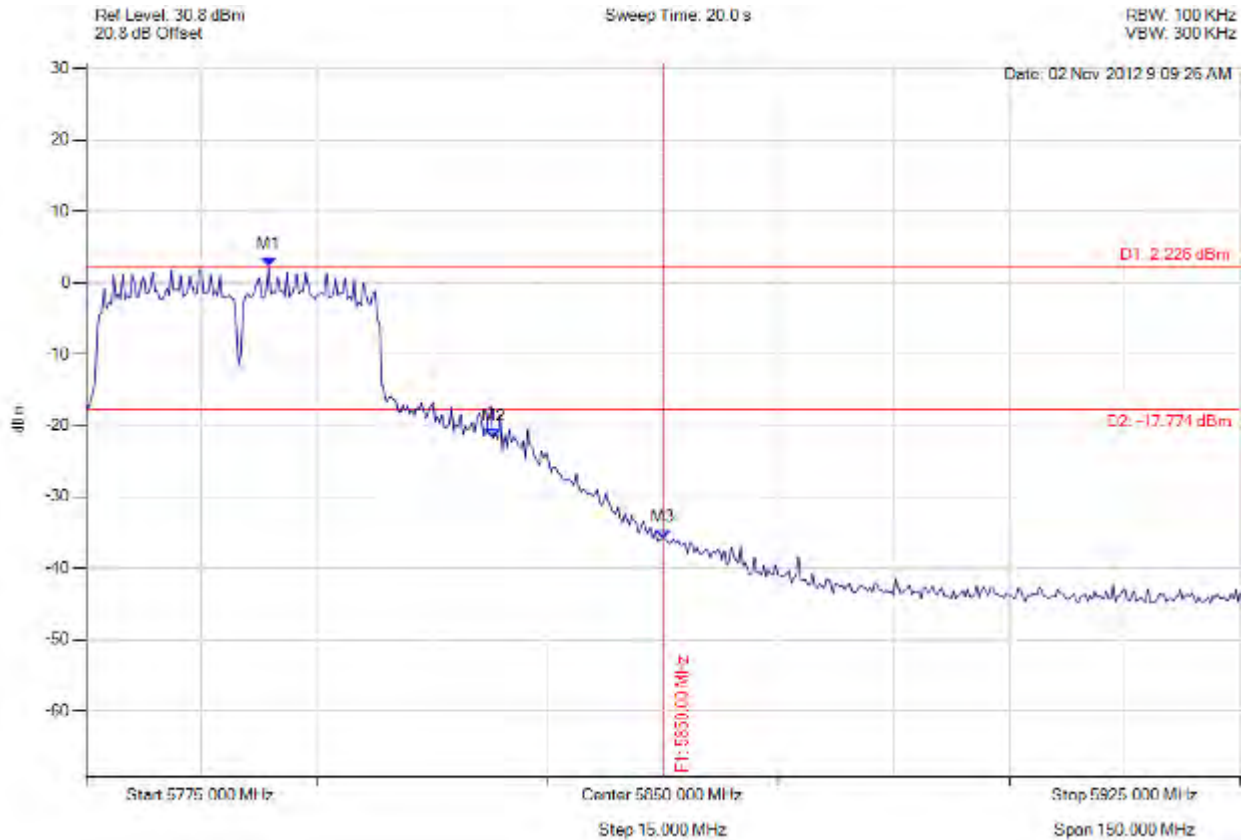

Analyser Setup	Marker : Frequency : Amplitude	Test Results
Detector = MAX PEAK Sweep Count = 0 RF Atten (dB) = 20 Trace Mode = VIEW	M1 : 5798.747 MHz : 2.226 dBm M2 : 5827.906 MHz : -21.817 dBm M3 : 5850.000 MHz : -35.958 dBm	Limit: -17.77 dBm Margin: 20.00 dB

[Back to the Matrix](#)

This test report may be reproduced in full only. The document may only be updated by MiCOM Labs personnel. Any changes will be noted in the Document History section of the report.



Title: Digi Connect Card for i.MX28 with Atheros AR6203
To: FCC 47 CFR Part 15.247 & IC RSS-210
Serial #: DIGI36-U2 Rev A
Issue Date: 22nd May 2014
Page: 259 of 261



spurious

Variant: 802.11n HT-40, Channel: 5755.00 MHz, Chain a, Temp: Ambient, Voltage: 5.00V

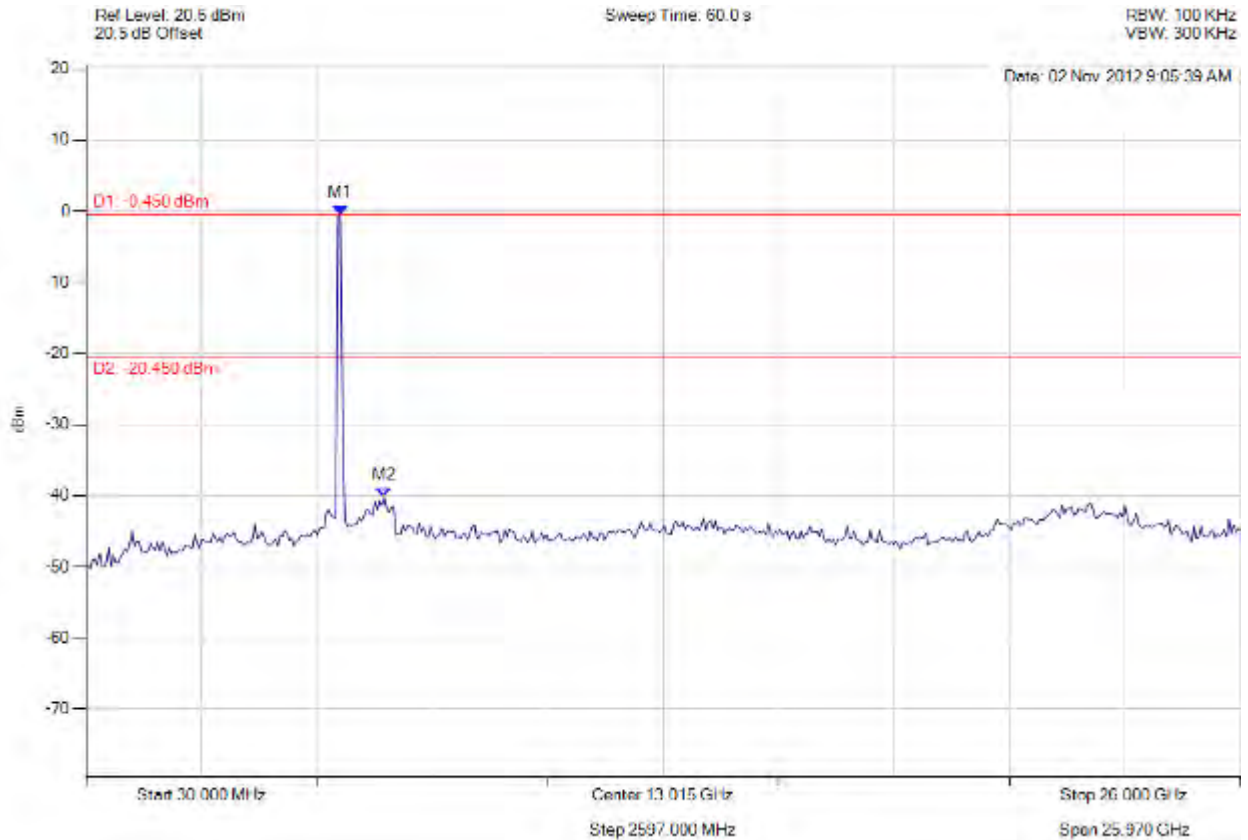

Analyser Setup	Marker : Frequency : Amplitude	Test Results
Detector = MAX PEAK Sweep Count = 0 RF Atten (dB) = 20 Trace Mode = VIEW	M1 : 5754.850 MHz : -0.450 dBm M2 : 6743.687 MHz : -40.220 dBm	Limit: -20.45 dBm Margin: -19.77 dB

[Back to the Matrix](#)

This test report may be reproduced in full only. The document may only be updated by MiCOM Labs personnel. Any changes will be noted in the Document History section of the report.



Title: Digi Connect Card for i.MX28 with Atheros AR6203
To: FCC 47 CFR Part 15.247 & IC RSS-210
Serial #: DIGI36-U2 Rev A
Issue Date: 22nd May 2014
Page: 260 of 261



spurious

Variant: 802.11n HT-40, Channel: 5795.00 MHz, Chain a, Temp: Ambient, Voltage: 5.00V

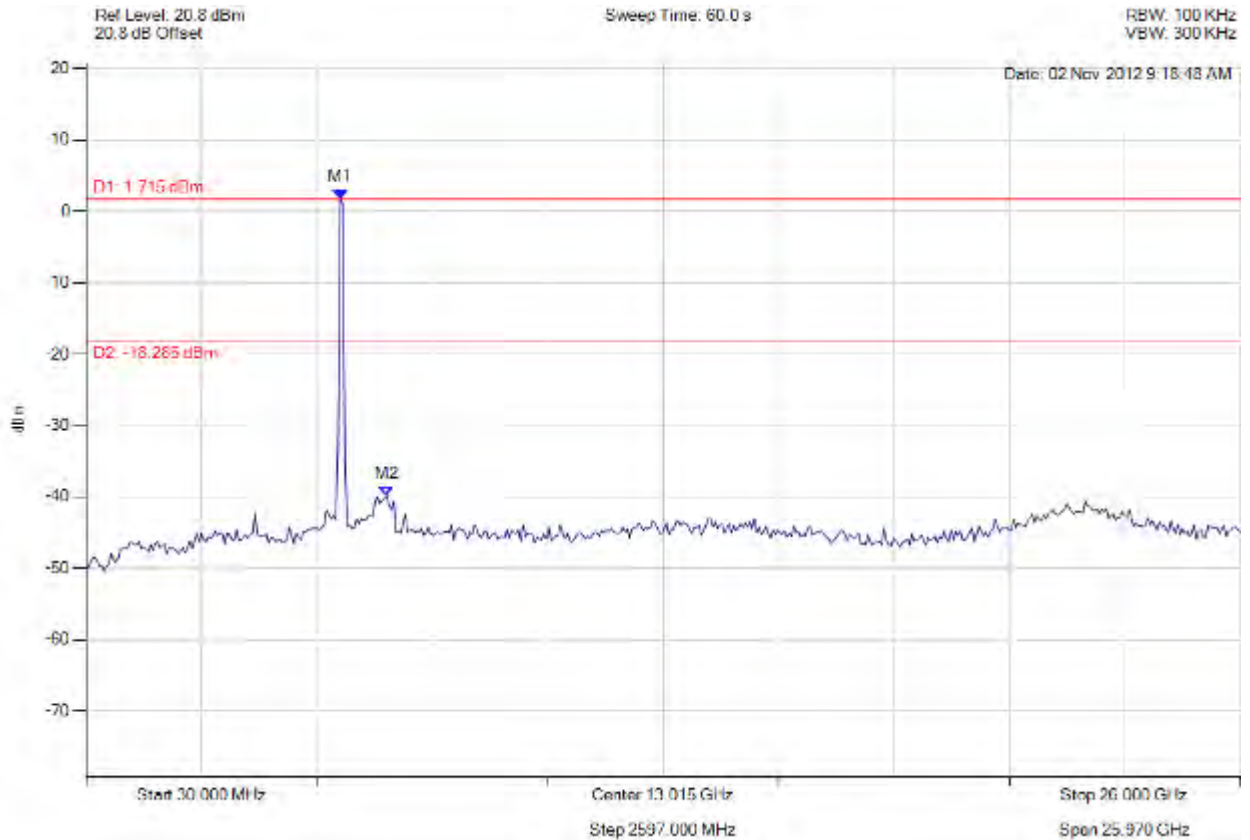

Analyser Setup	Marker : Frequency : Amplitude	Test Results
Detector = MAX PEAK Sweep Count = 0 RF Atten (dB) = 20 Trace Mode = VIEW	M1 : 5754.850 MHz : 1.715 dBm M2 : 6795.731 MHz : -39.844 dBm	Limit: -18.29 dBm Margin: -21.55 dB

[Back to the Matrix](#)

This test report may be reproduced in full only. The document may only be updated by MiCOM Labs personnel. Any changes will be noted in the Document History section of the report.



440 Boulder Court, Suite 200
Pleasanton, CA 94566, USA
Tel: 1.925.462.0304
Fax: 1.925.462.0306
www.micomlabs.com