

Test of
Digi ConnectCard for i.MX28 with Atheros AR6233
Wi-Fi Mode
To: FCC 47 CFR Part 15.247 & IC RSS-210

Test Report Serial No.: DIGI28-U2A Rev A



TEST REPORT

FROM



Test of Digi ConnectCard for i.MX28 with Atheros AR6233
Wi-Fi Mode

To FCC 47 CFR Part 15.247 & IC RSS-210

Test Report Serial No.: DIGI28-U2A Rev A

Note: this report contains data with regard to the 2400 to 2483.5 MHz and 5725 to 5850 MHz operational modes of the Digi ConnectCard for i.MX28 with Atheros AR6233. Test data for the 5,150 - 5,350 and 5,470 – 5,725 MHz is reported in MiCOM Labs test report DIGI28-U3A

This report supersedes: NONE

Applicant: Digi International
355 South 520 West, Suite 180
Lindon
Utah, 84042 USA

Product Function: 802.11 a/b/g/n Wireless Module

Copy No: pdf Issue Date: 29th March 2013

This Test Report is Issued Under the Authority of:

MiCOM Labs, Inc.

440 Boulder Court, Suite 200

Pleasanton, CA 94566 USA

Phone: +1 (925) 462-0304

Fax: +1 (925) 462-0306

www.micomlabs.com



TEST CERTIFICATE #2381.01

MiCOM Labs is an ISO 17025 Accredited Testing Laboratory



Title: Digi ConnectCard for i.MX28 with Atheros AR6233
To: FCC 47 CFR Part 15.247 & IC RSS-210
Serial #: DIGI28-U2A Rev A
Issue Date: 29th March 2013
Page: 3 of 245

This page has been left intentionally blank



TABLE OF CONTENTS

ACCREDITATION, LISTINGS & RECOGNITION	5
TESTING ACCREDITATION	5
RECOGNITION	6
PRODUCT CERTIFICATION	7
1. TEST RESULT CERTIFICATE	9
2. REFERENCES AND MEASUREMENT UNCERTAINTY	10
2.1. Normative References	10
2.2. Test and Uncertainty Procedures	11
3. PRODUCT DETAILS AND TEST CONFIGURATIONS	12
3.1. Technical Details	12
3.2. Scope of Test Program	14
3.3. Equipment Model(s) and Serial Number(s)	16
3.4. Antenna Details	16
3.5. Cabling and I/O Ports	16
3.6. Test Configurations	17
3.7. Equipment Modifications	19
3.8. Deviations from the Test Standard	19
4. TEST EQUIPMENT CONFIGURATION(S)	20
4.1. Conducted RF Emission Test Set-up	20
4.2. Radiated Spurious Emission Test Set-up > 1 GHz	21
4.3. Digital Emissions Test Set-up (0.03 – 1 GHz)	22
4.4. ac Wireline Emission Test Set-up	23
5. TEST SUMMARY	24
6. TEST RESULTS	26
6.1. Device Characteristics	26
6.1.1. <i>Conducted Testing</i>	26
6.1.2. <i>Radiated Emission Testing</i>	64
6.1.3. <i>AC Wireline Conducted Emissions (150 kHz – 30 MHz)</i>	144
7. PHOTOGRAPHS	146
7.1. Conducted Test Setup	146
7.2. Test Setup - Digital Emissions below 1 GHz	147
7.3. Radiated Emissions Test Setup >1 GHz	148
8. TEST EQUIPMENT	149
APPENDIX	150
A. SUPPORTING INFORMATION	150
A.1. CONDUCTED TEST PLOTS	150
A.1.1. <i>6 dB & 99% Bandwidth</i>	151
A.1.2. <i>Peak Output Power</i>	171
A.1.3. <i>Power Spectral Density</i>	191
A.1.4. <i>Conducted Spurious Emissions</i>	211

This test report may be reproduced in full only. The document may only be updated by MiCOM Labs personnel. Any changes will be noted in the Document History section of the report.



Title: Digi ConnectCard for i.MX28 with Atheros AR6233
To: FCC 47 CFR Part 15.247 & IC RSS-210
Serial #: DIGI28-U2A Rev A
Issue Date: 29th March 2013
Page: 5 of 245

ACCREDITATION, LISTINGS & RECOGNITION

TESTING ACCREDITATION

MiCOM Labs, Inc. is an accredited Electrical testing laboratory per the international standard EN ISO/IEC 17025. The company is accredited by the American Association for Laboratory Accreditation (A2LA) www.a2la.org test laboratory number 2381.01. MiCOM Labs test schedule is available at the following URL; <http://www.a2la.org/scopepdf/2381-01.pdf>



The American Association for Laboratory Accreditation

World Class Accreditation

Accredited Laboratory

A2LA has accredited

MICOM LABS

Pleasanton, CA

for technical competence in the field of

Electrical Testing

This laboratory is accredited in accordance with the recognized International Standard ISO/IEC 17025:2005 *General Requirements for the Competence of Testing and Calibration Laboratories*. This accreditation demonstrates technical competence for a defined scope and the operation of a laboratory quality management system (refer to joint ISO-ILAC-IAF Communiqué dated 8 January 2009).

Presented this 27th day of March 2012.



President & CEO
For the Accreditation Council
Certificate Number 2381.01
Valid to November 30, 2013

For the tests or types of tests to which this accreditation applies, please refer to the laboratory's Electrical Scope of Accreditation.

This test report may be reproduced in full only. The document may only be updated by MiCOM Labs personnel. Any changes will be noted in the Document History section of the report.



Title: Digi ConnectCard for i.MX28 with Atheros AR6233
To: FCC 47 CFR Part 15.247 & IC RSS-210
Serial #: DIGI28-U2A Rev A
Issue Date: 29th March 2013
Page: 6 of 245

RECOGNITION

MiCOM Labs, Inc has widely recognized Electrical testing capabilities. Our international recognition includes Conformity Assessment Body designation by APEC MRA** countries. Our test reports are widely accepted for global type approvals.

Country	Recognition Body	Status	Phase	Identification No.
USA	Federal Communications Commission (FCC)	TCB	-	US0159 Listing #: 102167
Canada	Industry Canada (IC)	FCB	APEC MRA 2	US0159 Listing #: 4143A-2
Japan	MIC (Ministry of Internal Affairs and Communication)	CAB	APEC MRA 2	RCB 210
	VCCI	--	--	A-0012
Europe	European Commission	NB	EU MRA	NB 2280
Australia	Australian Communications and Media Authority (ACMA)	CAB	APEC MRA 1	US0159
Hong Kong	Office of the Telecommunication Authority (OFTA)	CAB	APEC MRA 1	
Korea	Ministry of Information and Communication Radio Research Laboratory (RRL)	CAB	APEC MRA 1	
Singapore	Infocomm Development Authority (IDA)	CAB	APEC MRA 1	
Taiwan	National Communications Commission (NCC) Bureau of Standards, Metrology and Inspection (BSMI)	CAB	APEC MRA 1	
Vietnam	Ministry of Communication (MIC)	CAB	APEC MRA 1	

**APEC MRA – Asia Pacific Economic Community Mutual Recognition Agreement.

Is a recognition agreement under which test lab is accredited to regulatory standards of the APEC member countries.

Phase I - recognition for product testing

Phase II – recognition for both product testing and certification

N/A – Not Applicable

**EU MRA – European Union Mutual Recognition Agreement.

Is a recognition agreement under which test lab is accredited to regulatory standards of the EU member countries.

**NB – Notified Body

This test report may be reproduced in full only. The document may only be updated by MiCOM Labs personnel. Any changes will be noted in the Document History section of the report.



Title: Digi ConnectCard for i.MX28 with Atheros AR6233
To: FCC 47 CFR Part 15.247 & IC RSS-210
Serial #: DIGI28-U2A Rev A
Issue Date: 29th March 2013
Page: 7 of 245

PRODUCT CERTIFICATION

MiCOM Labs, Inc. is an accredited Product Certification Body per the international standard EN ISO/IEC Guide 65. The company is accredited by the American Association for Laboratory Accreditation (A2LA) www.a2la.org test laboratory number 2381.02. MiCOM Labs test schedule is available at the following URL; <http://www.a2la.org/scopepdf/2381-02.pdf>



The American Association for Laboratory Accreditation

"World Class Accreditation"

Accredited Product Certification Body

A2LA has accredited

MICOM LABS

Pleasanton, CA

for technical competence as a

Product Certification Body

This product certification body is accredited in accordance with the recognized International Standard ISO/IEC Guide 65:1996 *General requirements for bodies operating product certification systems*. This accreditation demonstrates technical competence for a defined scope and the operation of a quality management system.

Presented this 27th day of March 2012.



President & CEO
For the Accreditation Council
Certificate Number 2381.02
Valid to November 30, 2013

For the product certification schemes to which this accreditation applies, please refer to the organization's Product Certification Scope of Accreditation

United States of America – Telecommunication Certification Body (TCB)

TCB Identifier – US0159

Industry Canada – Certification Body

CAB Identifier – US0159

Europe – Notified Body

Notified Body Identifier - 2280

Japan – Recognized Certification Body (RCB)

RCB Identifier - 210

This test report may be reproduced in full only. The document may only be updated by MiCOM Labs personnel. Any changes will be noted in the Document History section of the report.



Title: Digi ConnectCard for i.MX28 with Atheros AR6233
To: FCC 47 CFR Part 15.247 & IC RSS-210
Serial #: DIGI28-U2A Rev A
Issue Date: 29th March 2013
Page: 8 of 245

DOCUMENT HISTORY

Document History		
Revision	Date	Comments
Draft		
Rev A	29 th March 2013	Initial release.

This test report may be reproduced in full only. The document may only be updated by MiCOM Labs personnel. Any changes will be noted in the Document History section of the report.



Title: Digi ConnectCard for i.MX28 with Atheros AR6233
To: FCC 47 CFR Part 15.247 & IC RSS-210
Serial #: DIGI28-U2A Rev A
Issue Date: 29th March 2013
Page: 9 of 245

1. TEST RESULT CERTIFICATE

Manufacturer:	Digi International 355 South 520 West, Suite 180 Lindon Utah, 84042 USA	Tested By:	MiCOM Labs, Inc. 440 Boulder Court Suite 200 Pleasanton California, 94566, USA
EUT:	Atheros AR6233 802.11 a/b/g/n + BT Module (Operating in Wi-Fi mode)	Telephone:	+1 925 462 0304
Model:	CCWMX28	Fax:	+1 925 462 0306
S/N's:	55001667.01		
Test Date(s):	26th September to 27th November '12	Website:	www.micomlabs.com

STANDARD(S)	TEST RESULTS
FCC 47 CFR Part 15.247 & IC RSS-210	EQUIPMENT COMPLIES

MiCOM Labs, Inc. tested the equipment mentioned in accordance with the requirements set forth in the above standards. Test results indicate that the equipment tested is capable of demonstrating compliance with the requirements as documented within this report.

Notes:

1. This document reports conditions under which testing was conducted and the results of testing performed.
2. Details of test methods used have been recorded and kept on file by the laboratory.
3. Test results apply only to the item(s) tested.

Approved & Released for MiCOM Labs, Inc. by:



Γ CERTIFICATE #2381.01



Graeme Grieve
Quality Manager MiCOM Labs,

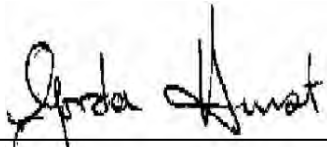

Gordon Hurst
President & CEO MiCOM Labs, Inc.

This test report may be reproduced in full only. The document may only be updated by MiCOM Labs personnel. Any changes will be noted in the Document History section of the report.

2. REFERENCES AND MEASUREMENT UNCERTAINTY

2.1. Normative References

REF.	PUBLICATION	YEAR	TITLE
i.	FCC 47 CFR Part 15, Subpart C	2012	Title 47: Telecommunication PART 15—RADIO FREQUENCY DEVICES Subpart C—Intentional Radiators
ii.	RSS-210 Annex 8	2010	Radio Standards Specification 210, Issue 8, Low-power Licence-exempt Radiocommunication Devices (All Frequency Bands): Category I Equipment
iii.	FCC OET KDB 662911	4 th April 2011	Emissions Testing of Transmitters with Multiple Outputs in the Same Band
iv.	DA 00-705	2000	FCC DA 00-705 "Filing and Measurement Guidelines for Frequency Hopping Spread Spectrum Systems" released March 30, 2000
v.	RSS-GEN	2010	Radio Standards Specification-Gen, Issue 3, General Requirements and Information for the Certification of Radiocommunication Equipment
vi.	FCC 47 CFR Part 15, Subpart B	2012	47 CFR Part 15, SubPart B; Unintentional Radiators
vii.	ICES-003	2004	Spectrum Management and Telecommunications Policy Interference-Causing Equipment Standard Digital Apparatus; Issue 4
viii.	ANSI C63.4	2009	American National Standards for Methods of Measurement of Radio-Noise Emissions from Low-Voltage Electrical and Electronic Equipment in the Range of 9 kHz to 40 GHz
ix.	CISPR 22/ EN 55022	2008 2006+A1:2007	Limits and Methods of Measurements of Radio Disturbance Characteristics of Information Technology Equipment
x.	M 3003	Edition 1 Dec. 1997	Expression of Uncertainty and Confidence in Measurements
xi.	LAB34	Edition 1 Aug 2002	The expression of uncertainty in EMC Testing
xii.	ETSI TR 100 028	2001	Parts 1 and 2 Electromagnetic compatibility and Radio Spectrum Matters (ERM); Uncertainties in the measurement of mobile radio equipment characteristics
xiii.	A2LA	July 2012	Reference to A2LA Accreditation Status – A2LA Advertising Policy

This test report may be reproduced in full only. The document may only be updated by MiCOM Labs personnel. Any changes will be noted in the Document History section of the report.



Title: Digi ConnectCard for i.MX28 with Atheros AR6233
To: FCC 47 CFR Part 15.247 & IC RSS-210
Serial #: DIGI28-U2A Rev A
Issue Date: 29th March 2013
Page: 11 of 245

2.2. Test and Uncertainty Procedures

Conducted and radiated emission measurements were conducted in accordance with American National Standards Institute ANSI C63.4, listed in the Normative References section of this report.

Measurement uncertainty figures are calculated in accordance with ETSI TR 100 028 Parts 1 and 2.

Measurement uncertainties stated are based on a standard uncertainty multiplied by a coverage factor $k = 2$, providing a level of confidence of approximately 95 % in accordance with UKAS document M 3003 listed in the Normative References section of this report.

This test report may be reproduced in full only. The document may only be updated by MiCOM Labs personnel. Any changes will be noted in the Document History section of the report.



Title: Digi ConnectCard for i.MX28 with Atheros AR6233
To: FCC 47 CFR Part 15.247 & IC RSS-210
Serial #: DIGI28-U2A Rev A
Issue Date: 29th March 2013
Page: 12 of 245

3. PRODUCT DETAILS AND TEST CONFIGURATIONS

3.1. Technical Details

Details	Description
Purpose:	Test of the Digi ConnectCard for i.MX28 with Atheros AR6233 operating in W-Fi mode to FCC Part 15.247 and Industry Canada RSS-210 regulations.
Applicant:	Digi International 355 South 520 West, Suite 180 Lindon Utah, 84042 USA
Manufacturer:	As applicant.
Laboratory performing the tests:	MiCOM Labs, Inc. 440 Boulder Court, Suite 200 Pleasanton, California 94566 USA
Test report reference number:	DIGI28-U2A Rev A
Date EUT received:	26 th September 2012
Standard(s) applied:	FCC 47 CFR Part 15.247 & IC RSS-210
Dates of test (from - to):	26th September to 27th November '12
No of Units Tested:	One
Type of Equipment:	802.11a/b/g/n Wi-Fi and BT Module
Manufacturers Trade Name:	Digi International
Model(s):	CCWMX28
Location for use:	Indoor
Declared Frequency Range(s):	2400 - 2483.5 MHz; 5725 - 5850 MHz
Hardware Rev	30013772-04
Software Rev	DEL-5.9 Rev B
Type of Modulation:	Per 802.11 –CCK, BPSK, QPSK, DSSS, OFDM
Declared Nominal Average Output Power:	2400 – 2483.5 MHz 802.11b: +19 dBm; 802.11g: +23 dBm; HT-20 +24 dBm; HT-40 +24 dBm 5725 - 5850 MHz 802.11a:+24 dBm,HT-20 +23 dBm,HT-40 +23 dBm
EUT Modes of Operation:	Legacy 802.11a/b/g, 802.11n HT-20, HT-40
Transmit/Receive Operation:	Time Division Duplex
System Beam Forming:	EUT has no capability for antenna beam forming
Rated Input Voltage and Current:	5 Vdc 0.625 A
Operating Temperature Range:	Declared range -40° to +75°C at 95% humidity non condensing
ITU Emission Designator:	2400 – 2483.5 MHz 802.11b 13M9G1D 2400 – 2483.5 MHz 802.11g 17M6D1D 2400 – 2483.5 MHz 802.11n – HT-20 18M3D1D 2400 – 2483.5 MHz 802.11n – HT-40 36M9D1D 5725 – 5850 MHz 802.11a 16M8D1D 5725 – 5850 MHz 802.11n – HT-20 17M9D1D 5725 – 5850 MHz 802.11n – HT-40 36M6D1D
Equipment Dimensions:	2" (L) x 1.375 (W) x 0.162" (H) inches

This test report may be reproduced in full only. The document may only be updated by MiCOM Labs personnel. Any changes will be noted in the Document History section of the report.



Title: Digi ConnectCard for i.MX28 with Atheros AR6233
To: FCC 47 CFR Part 15.247 & IC RSS-210
Serial #: DIGI28-U2A Rev A
Issue Date: 29th March 2013
Page: 13 of 245

Weight:	< 0.5 oz
Primary function of equipment:	802.11 a/b/g/n + BT module

This test report may be reproduced in full only. The document may only be updated by MiCOM Labs personnel. Any changes will be noted in the Document History section of the report.



Title: Digi ConnectCard for i.MX28 with Atheros AR6233
To: FCC 47 CFR Part 15.247 & IC RSS-210
Serial #: DIGI28-U2A Rev A
Issue Date: 29th March 2013
Page: 14 of 245

3.2. Scope of Test Program

Digi ConnectCard for i.MX28 with Atheros AR6233 RF Testing

The scope of the test program was to test the Digi ConnectCard for i.MX28 with Atheros AR6233 operating in Wi-Fi mode in the frequency ranges 2400 - 2483.5 MHz and 5725 – 5850 MHz for compliance against FCC 47 CFR Part 15.247 and Industry Canada RSS-210 specifications.

Wi-Fi and Bluetooth Single Port Module: 55001667.01

The following operational description of the module was provided by the customer.

The ConnectCard for i.MX28 module set contains a full 802.11 a b g n and Bluetooth radio with a programmable Freescale i.MX28 Processor. The RF section of the part is handled by a Qualcomm Atheros Wi-Fi/BT module with a 5GHz RF front end module. Data is entered into the processor through a variety of interfaces including Ethernet, CAN, UART, SPI, I2C, I2S, USB, SDIO, etc. Data is sent to the Wi-Fi/BT module where it is processed and sent to the RF Antenna(s). Likewise data is received in the Wi-Fi/BT module and converted to baseband data where it is sent to the processor for baseband processing and sent out of the module using one of the interface ports.

The module is comprised of a Freescale i.MX28 processor, a Qualcomm Atheros Wi-Fi/Bluetooth Module, an RFMD 5GHz front end module, Diplex filter, and either a BT-2.4GHz Wi-Fi switch or Diversity antenna switch (if no BT). The ConnectCard for i.MX28 functions in both the 2.4 to 2.5GHz, and 4.9 to 6 GHz ISM bands.

The module uses an efficient architecture in which data streams directly from the processor (at baseband) to the Wi-Fi/BT module through data lines. The processor also controls the transceiver's modes within the 802.11 a, b, g, and n modes. The Wi-Fi module includes LNA's for the receive modes and a power amplifier for the transmit mode within the 2.4GHz band. Further there are transmit-receive switches within the module for the 2.4GHz bands. The antenna(s) are connected to the module through u.FL connectors. With BT capable modules there is a single u.FL connector for a single antenna. For modules without BT, there is a diversity antenna switch and 2 u.FL antenna connectors. The module is available with different amounts of FLASH, and RAM, as well as various processors within the i.MX28 family for customers to store their programs.

This test report may be reproduced in full only. The document may only be updated by MiCOM Labs personnel. Any changes will be noted in the Document History section of the report.

Digi ConnectCard for i.MX28 with Atheros AR6233 – Single Port

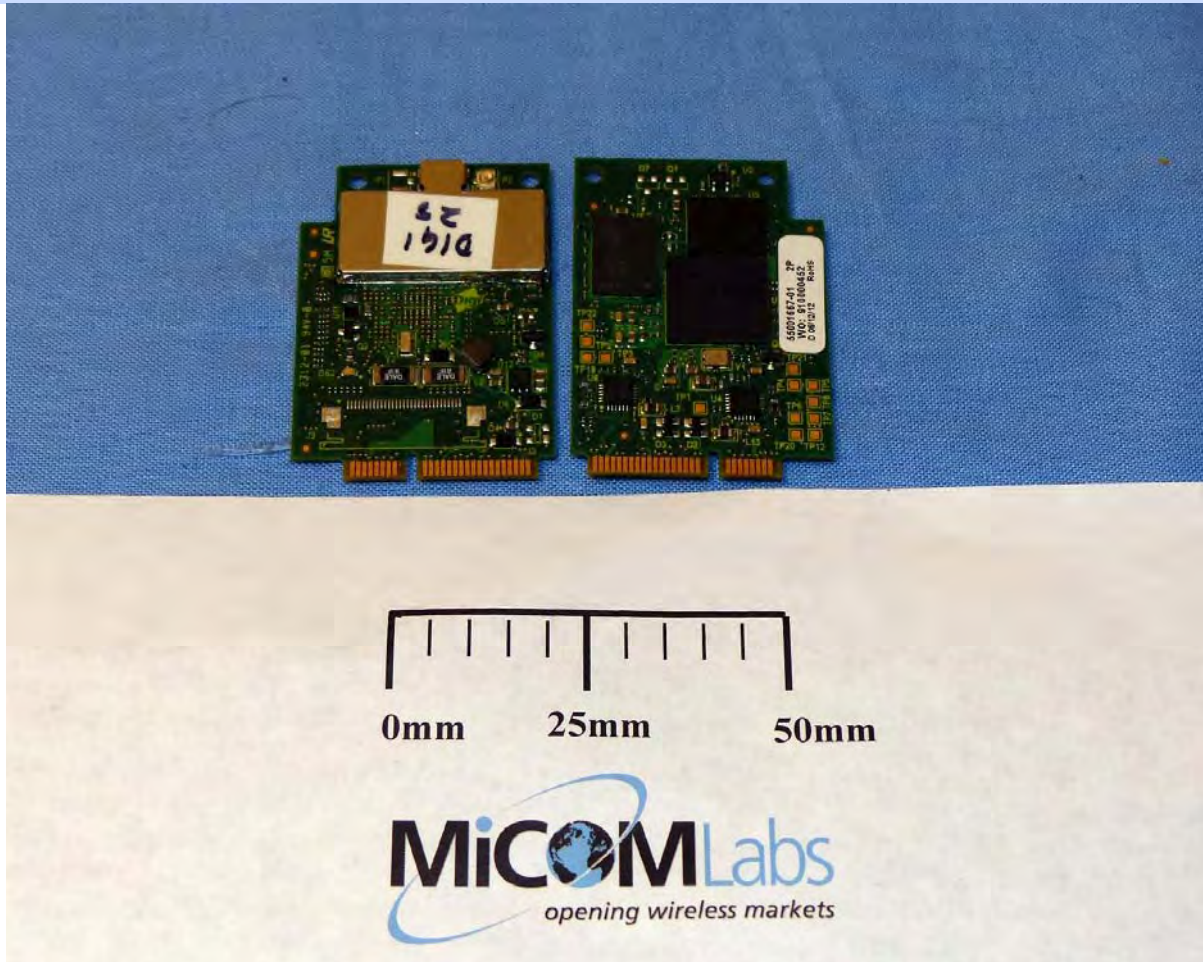



Title: Digi ConnectCard for i.MX28 with Atheros AR6233
To: FCC 47 CFR Part 15.247 & IC RSS-210
Serial #: DIGI28-U2A Rev A
Issue Date: 29th March 2013
Page: 16 of 245

3.3. Equipment Model(s) and Serial Number(s)

Equipment Type	Equipment Description (Including Brand Name)	Mfr	Model No.	Serial No.
EUT	802.11a/b/g/n Module – Single Port	Digi International	CCWMX28	55001667.01
Support	Laptop PC	IBM	Thinkpad	None

3.4. Antenna Details

Antenna Type	Manufacturer	Model Number	Antenna Gain (dBi)	
			2.4 GHz	5 GHz
Patch	Taoglas	PC.11	3.0	4.5
Patch	Taoglas	FXP.830	1.8	4
Dual Band Omni	Antenna Factor	ANT-DB1-xxx	-3.10	4.30
Single Band Omni	Bobbintron Electrical Corp.	SA-006-1	1.8	---

3.5. Cabling and I/O Ports

Number and type of I/O ports

1. 1 x DB9 control port on interface card
2. 2 x 2.5 mm DC Power ports on interface card

This test report may be reproduced in full only. The document may only be updated by MiCOM Labs personnel. Any changes will be noted in the Document History section of the report.



Title: Digi ConnectCard for i.MX28 with Atheros AR6233
To: FCC 47 CFR Part 15.247 & IC RSS-210
Serial #: DIGI28-U2A Rev A
Issue Date: 29th March 2013
Page: 17 of 245

3.6. Test Configurations

Testing was performed to determine the highest power level versus bit rate. The variant with the highest power was used to exercise the product.

Operational Mode(s) (802.11a/b/g/n)	Variant	Data Rate with Highest Power	Frequencies (MHz)
b	Legacy	1 MBit/s	2,412
g	Legacy	6 MBit/s	2,437
n	HT-20	6.5 (MCS 0)	2,462
	HT-40	13.5 (MCS 0)	2,422 2,437 2,452
a	Legacy	6 MBit/s	5,745
n	HT-20	6.5 (MCS 0)	5,785
	HT-40	13.5 (MCS 0)	5,825 5,755 5,795

Legacy – data rates for 802.11abg products

Results for the above configurations are provided in this report.

This test report may be reproduced in full only. The document may only be updated by MiCOM Labs personnel. Any changes will be noted in the Document History section of the report.



Antenna Test Configurations for Radiated Emissions

Results for the following configurations are provided in this report.

Modes with the highest spectral density will have the highest spurious emissions, only those modes were tested for this test program.

2,400 – 2483.5 MHz

5,725 – 5850 MHz

15.247	
802.11b	b SE 2412
	b SE 2437
	b SE 2462
	BE b 2390
	BE b 2483.5
802.11g	g SE 2412
	g SE 2437
	g SE 2462
	BE g 2390
	BE g 2483.5
802.11n HT-20	BE n HT-20 2390
	BE n HT-20 2483.5
802.11n HT-40	BE n HT-40 2390
	BE n HT-40 2483.5

15.247	
802.11a	a SE 5745
	a SE 5785
	a SE 5825
	BE a 5490
802.11n HT-20	BE a 5490
802.11n HT-40	BE a 5490

KEY;-

SE – Spurious Emission
BE – Band-Edge

This test report may be reproduced in full only. The document may only be updated by MiCOM Labs personnel. Any changes will be noted in the Document History section of the report.



3.7. Equipment Modifications

The following modifications were required to bring the equipment into compliance:

1. Band-Edge and Radiated Spurious Power Reduction

All conducted spurious emission testing was performed with the device set for maximum power at all times. During radiated spurious and band-edge emission testing the output power was reduced in order to comply with the Restricted Band limit criteria.

Single Port Module		PC.11	FXP.830	ANT-DB1-xxx	SA-006-1
	Channel (MHz)	Maximum Power Level			
2.4 GHz	b	2412	20	20	20
		2437	20	20	20
		2462	20	20	20
	g	2412	13	14	16
		2437	20	20	20
		2462	13	17	15
	HT-20	2412	12	13	14
		2437	20	20	20
		2462	11	16	14
	HT-40	2422	8	10	11
		2437	11	15	16
	2452	8	10	12	
5.8 GHz	a	5745	20	20	20
		5785	20	20	20
		5825	20	20	20
	HT-20	5745	20	20	20
		5785	20	20	20
		5825	20	20	20
	HT-40	5755	20	20	20
		5795	20	20	20

*Antenna is 2.4 GHz Only

3.8. Deviations from the Test Standard

The following deviations from the test standard were required in order to complete the test program:

1. NONE

4. TEST EQUIPMENT CONFIGURATION(S)

4.1. Conducted RF Emission Test Set-up

The following tests were performed using the conducted test set-up shown in the diagram below.

1. Section 6.1.1.1. 6 dB and 99% Bandwidth
2. Section 6.1.1.2. Peak Output Power
3. Section 6.1.1.3. Power Spectral Density
4. Section 6.1.1.4. Conducted Spurious Emissions

Conducted Test Set-Up Pictorial Representation

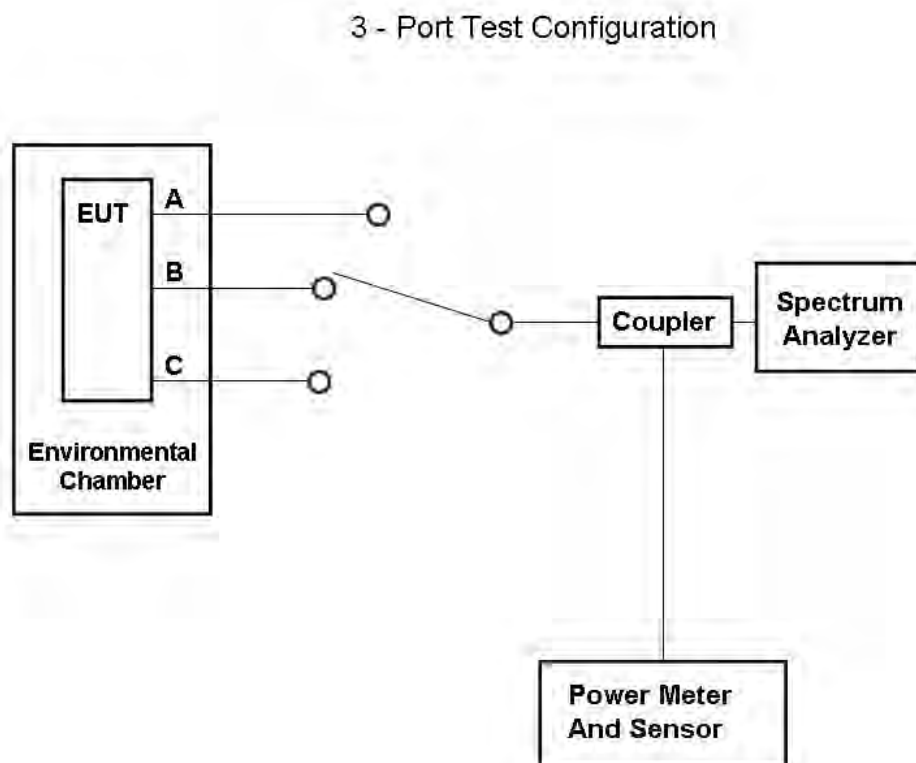

This test report may be reproduced in full only. The document may only be updated by MiCOM Labs personnel. Any changes will be noted in the Document History section of the report.

4.2. Radiated Spurious Emission Test Set-up > 1 GHz

The following tests were performed using the conducted test set-up shown in the diagram below.

1. Section 6.1.2.1. Dual Band Patch PC.11 - Single Port Module
2. Section 6.1.2.3. Dual Band Patch FXP.830 - Single Port Module
3. Section 6.1.2.5. Dual Band Omni ANT-DB1-xxx - Single Port Module
4. Section 6.1.2.7 Single Band Omni SA-006-1- Single Port Module

Radiated Emission Measurement Setup – Above 1 GHz

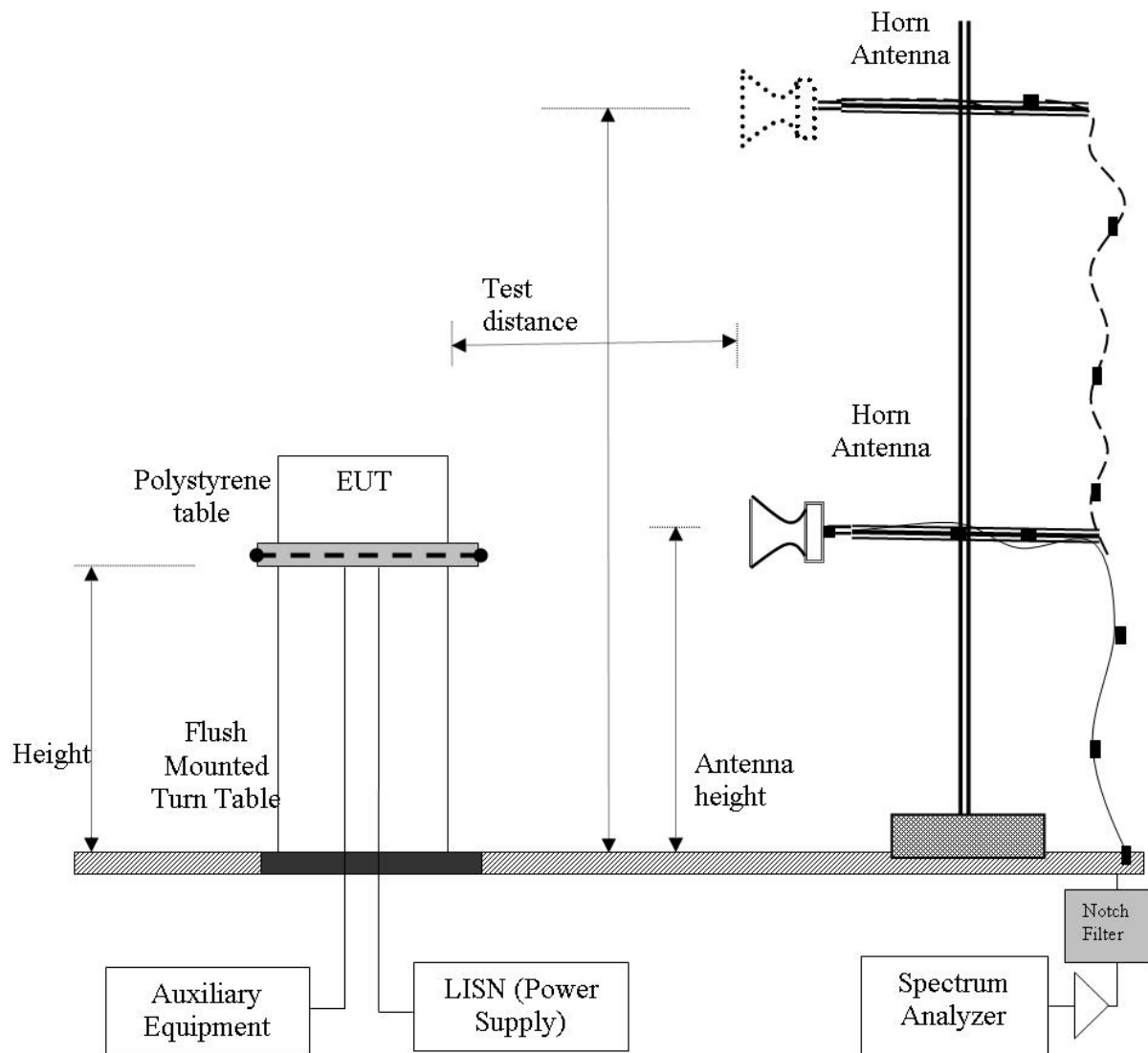

This test report may be reproduced in full only. The document may only be updated by MiCOM Labs personnel. Any changes will be noted in the Document History section of the report.

4.3. Digital Emissions Test Set-up (0.03 – 1 GHz)

The following tests were performed using the conducted test set-up shown in the diagram below.

1. Section 6.1.2.9. Dual Band OMNI ANT-DB1-xxx

Digital Emission Measurement Setup – Below 1 GHz

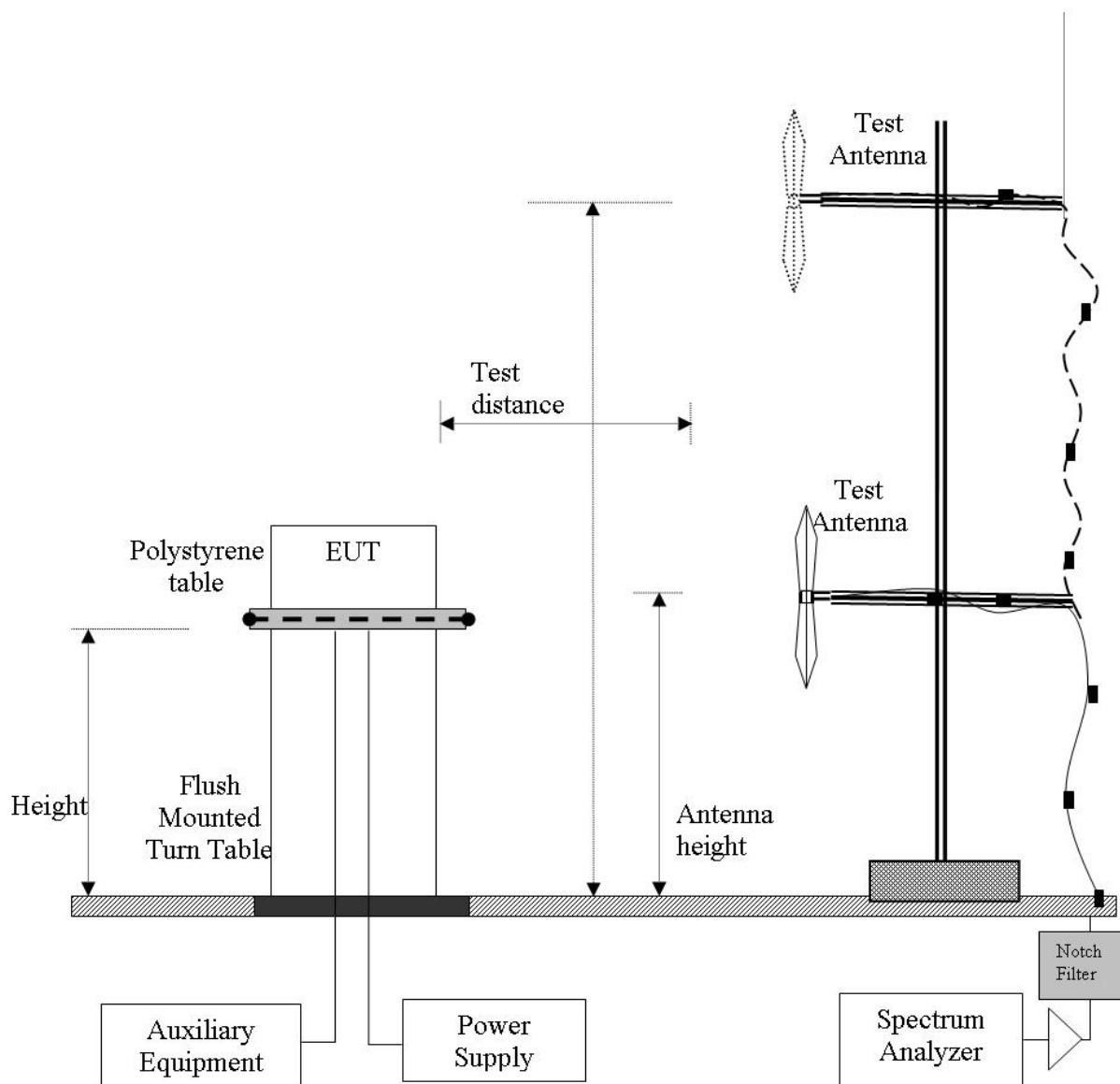

This test report may be reproduced in full only. The document may only be updated by MiCOM Labs personnel. Any changes will be noted in the Document History section of the report.

4.4. ac Wireline Emission Test Set-up

The following tests were performed using the conducted test set-up shown in the diagram below.

Refer to MiCOM Labs test report DIGI28-U4.

1. Section 6.1.3 ac Wireline Conducted Emissions

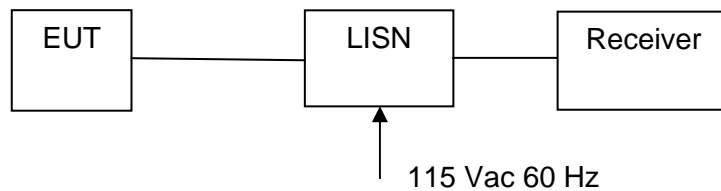

Measurement Setup for Conducted Emissions Test



Title: Digi ConnectCard for i.MX28 with Atheros AR6233
To: FCC 47 CFR Part 15.247 & IC RSS-210
Serial #: DIGI28-U2A Rev A
Issue Date: 29th March 2013
Page: 24 of 245

5. TEST SUMMARY

List of Measurements

The following table represents the list of measurements required under the **FCC CFR47 Part 15.247** and **Industry Canada RSS-210** and **Industry Canada RSS-Gen**.

Section(s)	Test Items	Description	Condition	Result	Test Report Section
15.247(a)(2) A8.2(1) 4.4	6 dB and 99 % Bandwidths	≥500 kHz	Conducted	Complies	6.1.1
15.247(b)(3) 15.31(e) A8.4(4)	Peak Output Power Voltage Variation	Shall not exceed 1W Variation of supply voltage 85 % -115 %	Conducted	Complies	6.1.2
15.247(e) A8.2	Peak Power Spectral Density	Shall not be greater than +8 dBm in any 3 kHz band	Conducted	Complies	6.1.3
15.247(i) 5.5	Maximum Permissible Exposure	Exposure to radio frequency energy levels	Conducted	Complies	6.1.4
15.247(d) 15.205 / 15.209 A8.5 2.2 4.7	Spurious Emissions (30MHz - 26 GHz b/g and 30 MHz – 40 GHz a)	The radiated emission in any 100 kHz of out-band shall be at least 20 dB below the highest in-band spectral density	Conducted	Complies	6.1.5

This test report may be reproduced in full only. The document may only be updated by MiCOM Labs personnel. Any changes will be noted in the Document History section of the report.



Title: Digi ConnectCard for i.MX28 with Atheros AR6233
To: FCC 47 CFR Part 15.247 & IC RSS-210
Serial #: DIGI28-U2A Rev A
Issue Date: 29th March 2013
Page: 25 of 245

List of Measurements (continued)

The following table represents the list of measurements required under the **FCC CFR47 Part 15.247**, **Industry Canada RSS-210**, and **Industry Canada RSS-Gen**.

Section(s)	Test Items	Description	Condition	Result	Test Report Section
15.247(d) 15.205 / 15.209 A8.5 2.2 2.6 4.7	Radiated Emissions	Restricted Bands	Radiated	Complies	6.1.2.1- 6.1.2.8
	Transmitter Radiated Spurious Emissions	Emissions above 1 GHz		Complies	6.1.2.1- 6.1.2.8
	Radiated Band Edge	Band-edge results Peak Emissions		Complies	6.1.2.1- 6.1.2.8
15.205 / 15.209 2.2	Radiated Spurious Emissions	Emissions <1 GHz (30M-1 GHz)	Radiated	Complies	6.1.2.9
15.207 7.2.2	AC Wireline Conducted Emissions 150 kHz– 30 MHz	Conducted Emissions	Conducted	N/A EUT is DC powered	6.1.3

Note 1: Test results reported in this document relate only to the items tested

Note 2: The required tests demonstrated compliance as per client declaration of test configuration, monitoring methodology and associated pass/fail criteria

Note 3: Section 3.7 Equipment Modifications highlights the equipment modifications that were required to bring the product into compliance with the above test matrix

This test report may be reproduced in full only. The document may only be updated by MiCOM Labs personnel. Any changes will be noted in the Document History section of the report.



Title: Digi ConnectCard for i.MX28 with Atheros AR6233
To: FCC 47 CFR Part 15.247 & IC RSS-210
Serial #: DIGI28-U2A Rev A
Issue Date: 29th March 2013
Page: 26 of 245

6. TEST RESULTS

6.1. Device Characteristics

6.1.1. Conducted Testing

6.1.1.1. 6 dB and 99 % Bandwidth

Conducted Test Conditions for 6 dB and 99% Bandwidth			
Standard:	FCC CFR 47:15.247	Ambient Temp. (°C):	24.0 - 27.5
Test Heading:	6 dB and 99 % Bandwidth	Rel. Humidity (%):	32 - 45
Standard Section(s):	15.247 (a)(2)	Pressure (mBars):	999 - 1001
Reference Document(s):	KDB 558074 - D01 DTS Measurement Guidance v01: Section 5.1 Emission Bandwidth		

Test Procedure for 6 dB and 99% Bandwidth Measurement
The bandwidth at 6 dB and 99 % was measured with a spectrum analyzer connected to the antenna terminal, while EUT is operating in transmission mode at the appropriate centre frequency.

This test report may be reproduced in full only. The document may only be updated by MiCOM Labs personnel. Any changes will be noted in the Document History section of the report.



Title: Digi ConnectCard for i.MX28 with Atheros AR6233
To: FCC 47 CFR Part 15.247 & IC RSS-210
Serial #: DIGI28-U2A Rev A
Issue Date: 29th March 2013
Page: 27 of 245

Single Port Module:

Equipment Configuration for 6 dB & 99% Bandwidth			
Variant:	802.11b	Duty Cycle (%):	100%
Data Rate:	1 Mbit/s	Antenna Gain (dBi):	Not Applicable
Modulation:	CCK	Beam Forming Gain (Y):	Not Applicable
TPC:	N/A		
Engineering Test Notes:			

Test Measurement Results								
Test Frequency	Measured 6 dB Bandwidth (MHz)				6 dB Bandwidth (MHz)		Limit	Lowest Margin
	Port(s)				Highest	Lowest		
MHz	a	b	c	d			MHz	MHz
2412.0	10.261	--	--	--	10.261	10.261	≥ 0.5	-9.76
2437.0	10.180	--	--	--	10.180	10.180	≥ 0.5	-9.68
2462.0	10.180	--	--	--	10.180	10.180	≥ 0.5	-9.68

Test Frequency	Measured 99% Bandwidth (MHz)				Maximum 99% Bandwidth (MHz)		
	Port(s)						
MHz	a	b	c	d			
2412.0	14.188	--	--	--	14.188		
2437.0	14.188	--	--	--	14.188		
2462.0	14.269	--	--	--	14.269		

Traceability to Industry Recognized Test Methodologies	
Work Instruction:	WI-03 MEASURING RF SPECTRUM MASK
Measurement Uncertainty:	±2.81 dB

Note: click the link in the above results matrix to view the plot

This test report may be reproduced in full only. The document may only be updated by MiCOM Labs personnel. Any changes will be noted in the Document History section of the report.



Title: Digi ConnectCard for i.MX28 with Atheros AR6233
To: FCC 47 CFR Part 15.247 & IC RSS-210
Serial #: DIGI28-U2A Rev A
Issue Date: 29th March 2013
Page: 28 of 245

Single Port Module:

Equipment Configuration for 6 dB & 99% Bandwidth			
Variant:	802.11g	Duty Cycle (%):	100%
Data Rate:	6 Mbit/s	Antenna Gain (dBi):	Not Applicable
Modulation:	OFDM	Beam Forming Gain (Y):	Not Applicable
TPC:	N/A		
Engineering Test Notes:			

Test Measurement Results								
Test Frequency	Measured 6 dB Bandwidth (MHz)				6 dB Bandwidth (MHz)		Limit	Lowest Margin
	Port(s)				Highest	Lowest		
MHz	a	b	c	d			MHz	MHz
2412.0	16.353	--	--	--	16.353	16.353	≥ 0.5	-15.85
2437.0	16.353	--	--	--	16.353	16.353	≥ 0.5	-15.85
2462.0	16.112	--	--	--	16.112	16.112	≥ 0.5	-15.61

Test Frequency	Measured 99% Bandwidth (MHz)				Maximum 99% Bandwidth (MHz)		
	Port(s)						
MHz	a	b	c	d			
2412.0	16.593	--	--	--	16.593		
2437.0	16.914	--	--	--	16.914		
2462.0	18.196	--	--	--	18.196		

Traceability to Industry Recognized Test Methodologies	
Work Instruction:	WI-03 MEASURING RF SPECTRUM MASK
Measurement Uncertainty:	±2.81 dB

Note: click the link in the above results matrix to view the plot

This test report may be reproduced in full only. The document may only be updated by MiCOM Labs personnel. Any changes will be noted in the Document History section of the report.



Title: Digi ConnectCard for i.MX28 with Atheros AR6233
To: FCC 47 CFR Part 15.247 & IC RSS-210
Serial #: DIGI28-U2A Rev A
Issue Date: 29th March 2013
Page: 29 of 245

Single Port Module:

Equipment Configuration for 6 dB & 99% Bandwidth

Variant:	802.11n HT-20	Duty Cycle (%):	100%
Data Rate:	6.5 MCS	Antenna Gain (dBi):	Not Applicable
Modulation:	OFDM	Beam Forming Gain (Y):	Not Applicable
TPC:	N/A		
Engineering Test Notes:			

Test Measurement Results

Test Frequency	Measured 6 dB Bandwidth (MHz)				6 dB Bandwidth (MHz)		Limit	Lowest Margin
	Port(s)				Highest	Lowest		
	a	b	c	d				
MHz							MHz	MHz
2412.0	17.154	--	--	--	17.154	17.154	≥ 0.5	-16.65
2437.0	17.234	--	--	--	17.234	17.234	≥ 0.5	-16.73
2462.0	16.994	--	--	--	16.994	16.994	≥ 0.5	-16.49

Test Frequency	Measured 99% Bandwidth (MHz)				Maximum 99% Bandwidth (MHz)		
	Port(s)						
	a	b	c	D			
MHz							
2412.0	17.876	--	--	--	17.876		
2437.0	17.956	--	--	--	17.956		
2462.0	18.998	--	--	--	18.998		

Traceability to Industry Recognized Test Methodologies	
Work Instruction:	WI-03 MEASURING RF SPECTRUM MASK
Measurement Uncertainty:	±2.81 dB

Note: [click the link in the above results matrix to view the plot](#)

This test report may be reproduced in full only. The document may only be updated by MiCOM Labs personnel. Any changes will be noted in the Document History section of the report.



Title: Digi ConnectCard for i.MX28 with Atheros AR6233
To: FCC 47 CFR Part 15.247 & IC RSS-210
Serial #: DIGI28-U2A Rev A
Issue Date: 29th March 2013
Page: 30 of 245

Single Port Module:

Equipment Configuration for 6 dB & 99% Bandwidth

Variant:	802.11n HT-40	Duty Cycle (%):	100%
Data Rate:	13.5 MCS	Antenna Gain (dBi):	Not Applicable
Modulation:	OFDM	Beam Forming Gain (Y):	Not Applicable
TPC:	N/A		
Engineering Test Notes:			

Test Measurement Results

Test Frequency MHz	Measured 6 dB Bandwidth (MHz)				6 dB Bandwidth (MHz)		Limit MHz	Lowest Margin MHz
	Port(s)				Highest	Lowest		
	a	b	c	d				
2422.0	36.232	--	--	--	36.232	36.232	≥ 0.5	-35.73
2437.0	36.232	--	--	--	36.232	36.232	≥ 0.5	-35.73
2452.0	35.912	--	--	--	35.912	35.912	≥ 0.5	-35.41

Test Frequency MHz	Measured 99% Bandwidth (MHz)				Maximum 99% Bandwidth (MHz)		
	Port(s)						
	a	b	c	d			
2422.0	36.393	--	--	--	36.393		
2437.0	36.553	--	--	--	36.553		
2452.0	37.034	--	--	--	37.034		

Traceability to Industry Recognized Test Methodologies	
Work Instruction:	WI-03 MEASURING RF SPECTRUM MASK
Measurement Uncertainty:	±2.81 dB

Note: [click the link in the above results matrix to view the plot](#)

This test report may be reproduced in full only. The document may only be updated by MiCOM Labs personnel. Any changes will be noted in the Document History section of the report.



Title: Digi ConnectCard for i.MX28 with Atheros AR6233
To: FCC 47 CFR Part 15.247 & IC RSS-210
Serial #: DIGI28-U2A Rev A
Issue Date: 29th March 2013
Page: 31 of 245

Single Port Module:

Equipment Configuration for 6 dB & 99% Bandwidth

Variant:	802.11a	Duty Cycle (%):	100%
Data Rate:	6 Mbit/s	Antenna Gain (dBi):	Not Applicable
Modulation:	OFDM	Beam Forming Gain (Y):	Not Applicable
TPC:	N/A		
Engineering Test Notes:			

Test Measurement Results

Test Frequency	Measured 6 dB Bandwidth (MHz)				6 dB Bandwidth (MHz)		Limit	Lowest Margin
	Port(s)				Highest	Lowest		
	a	b	c	d				
MHz							MHz	MHz
5745.0	15.711	--	--	--	15.711	15.711	≥ 0.5	-15.21
5785.0	15.551	--	--	--	15.551	15.551	≥ 0.5	-15.05
5825.0	15.631	--	--	--	15.631	15.631	≥ 0.5	-15.13

Test Frequency	Measured 99% Bandwidth (MHz)				Maximum 99% Bandwidth (MHz)		
	Port(s)						
	a	b	c	d			
MHz							
5745.0	17.715	--	--	--	17.715		
5785.0	21.242	--	--	--	21.242		
5825.0	20.762	--	--	--	20.762		

Traceability to Industry Recognized Test Methodologies	
Work Instruction:	WI-03 MEASURING RF SPECTRUM MASK
Measurement Uncertainty:	±2.81 dB

Note: [click the link in the above results matrix to view the plot](#)

This test report may be reproduced in full only. The document may only be updated by MiCOM Labs personnel. Any changes will be noted in the Document History section of the report.



Title: Digi ConnectCard for i.MX28 with Atheros AR6233
To: FCC 47 CFR Part 15.247 & IC RSS-210
Serial #: DIGI28-U2A Rev A
Issue Date: 29th March 2013
Page: 32 of 245

Single Port Module:

Equipment Configuration for 6 dB & 99% Bandwidth			
Variant:	802.11n HT-20	Duty Cycle (%):	100%
Data Rate:	6.5 MCS	Antenna Gain (dBi):	Not Applicable
Modulation:	OFDM	Beam Forming Gain (Y):	Not Applicable
TPC:	N/A		
Engineering Test Notes:			

Test Measurement Results								
Test Frequency	Measured 6 dB Bandwidth (MHz)				6 dB Bandwidth (MHz)		Limit	Lowest Margin
	Port(s)				Highest	Lowest		
	a	b	c	d				
MHz							MHz	MHz
5745.0	16.593	--	--	--	16.593	16.593	≥ 0.5	-16.09
5785.0	16.593	--	--	--	16.593	16.593	≥ 0.5	-16.09
5825.0	16.192	--	--	--	16.192	16.192	≥ 0.5	-15.69

Test Frequency	Measured 99% Bandwidth (MHz)				Maximum 99% Bandwidth (MHz)		
	Port(s)						
	a	b	c	d			
MHz							
5745.0	18.277	--	--	--	18.277		
5785.0	22.044	--	--	--	22.044		
5825.0	21.082	--	--	--	21.082		

Traceability to Industry Recognized Test Methodologies	
Work Instruction:	WI-03 MEASURING RF SPECTRUM MASK
Measurement Uncertainty:	±2.81 dB

Note: [click the link in the above results matrix to view the plot](#)

This test report may be reproduced in full only. The document may only be updated by MiCOM Labs personnel. Any changes will be noted in the Document History section of the report.



Title: Digi ConnectCard for i.MX28 with Atheros AR6233
To: FCC 47 CFR Part 15.247 & IC RSS-210
Serial #: DIGI28-U2A Rev A
Issue Date: 29th March 2013
Page: 33 of 245

Single Port Module:

Equipment Configuration for 6 dB & 99% Bandwidth

Variant:	802.11n HT-40	Duty Cycle (%):	100%
Data Rate:	13.5 MCS	Antenna Gain (dBi):	Not Applicable
Modulation:	OFDM	Beam Forming Gain (Y):	Not Applicable
TPC:	N/A		
Engineering Test Notes:			

Test Measurement Results

Test Frequency MHz	Measured 6 dB Bandwidth (MHz)				6 dB Bandwidth (MHz)		Limit MHz	Lowest Margin MHz
	Port(s)				Highest	Lowest		
	a	b	c	d				
5755.0	35.271	--	--	--	35.271	35.271	≥ 0.5	-34.77
5795.0	35.271	--	--	--	35.271	35.271	≥ 0.5	-34.77

Test Frequency MHz	Measured 99% Bandwidth (MHz)				Maximum 99% Bandwidth (MHz)		
	Port(s)						
	a	b	c	d			
5755.0	42.645	--	--	--	42.645		
5795.0	47.615	--	--	--	47.615		

Traceability to Industry Recognized Test Methodologies

Work Instruction:	WI-03 MEASURING RF SPECTRUM MASK
Measurement Uncertainty:	±2.81 dB

Note: [click the link in the above results matrix to view the plot](#)

This test report may be reproduced in full only. The document may only be updated by MiCOM Labs personnel. Any changes will be noted in the Document History section of the report.



Title: Digi ConnectCard for i.MX28 with Atheros AR6233
To: FCC 47 CFR Part 15.247 & IC RSS-210
Serial #: DIGI28-U2A Rev A
Issue Date: 29th March 2013
Page: 34 of 245

Specification

Limits

§15.247 (a)(2) & RSS-210 §A8.2(1)

The minimum 6 dB bandwidth shall be at least 500 kHz.

§ IC RSS-Gen 4.4.1 Occupied Bandwidth When an occupied bandwidth value is not specified in the applicable RSS, the transmitted signal bandwidth to be reported is to be its 99% emission bandwidth, as calculated or measured.

§ IC RSS-Gen 4.4.2 6 dB Bandwidth Where indicated, the 6 dB bandwidth is measured at the points when the spectral density of the signal is 6 dB down from the in-band spectral density of the modulated signal, with the transmitter modulated by a representative signal.

Traceability

Test Equipment Used
0158, 0287, 0252, 0313, 0314, 0070, 0116, 0117

This test report may be reproduced in full only. The document may only be updated by MiCOM Labs personnel. Any changes will be noted in the Document History section of the report.



Title: Digi ConnectCard for i.MX28 with Atheros AR6233
To: FCC 47 CFR Part 15.247 & IC RSS-210
Serial #: DIGI28-U2A Rev A
Issue Date: 29th March 2013
Page: 35 of 245

6.1.1.2. Peak Output Power

Conducted Test Conditions for Fundamental Emission Output Power			
Standard:	FCC CFR 47:15.247	Ambient Temp. (°C):	24.0 - 27.5
Test Heading:	Emission Output Power	Rel. Humidity (%):	32 - 45
Standard Section(s):	15.247 (a)(2)	Pressure (mBars):	999 - 1004
Reference Document(s):	KDB 558074 - D01 DTS Measurement Guidance v01: Section 5.2 Fundamental Emission Output Power KDB 662911 was implemented for In-band power measurements. The measure and sum technique was implemented in all cases.		

Test Procedure for Fundamental Emission Output Power Measurement

The transmitter terminal of EUT was connected to the input of the spectrum analyzer set to measure peak power. The resolution filter bandwidth was set to 6 dB, peak detector selected and the analyzer built-in power function was used to integrate peak power over the 20 dB bandwidth.

Supporting Information

Calculated Power = A + G + 10 log (1/x) dBm

A = Total Power [10 Log₁₀ (10^{a/10} + 10^{b/10} + 10^{c/10} + 10^{d/10})], G = Antenna Gain,

x = Duty Cycle

This test report may be reproduced in full only. The document may only be updated by MiCOM Labs personnel. Any changes will be noted in the Document History section of the report.



Title: Digi ConnectCard for i.MX28 with Atheros AR6233
To: FCC 47 CFR Part 15.247 & IC RSS-210
Serial #: DIGI28-U2A Rev A
Issue Date: 29th March 2013
Page: 36 of 245

The following Peak Power Matrix(s) was tested using the system maximum power setting dBm = 20, see Section 3.7 Equipment Modifications

Single Port Module:

Equipment Configuration for Peak Output Power

Variant:	802.11b	Duty Cycle (%):	100%
Data Rate:	1 Mbit/s	Antenna Gain (dBi):	Not Applicable
Modulation:	CCK	Beam Forming Gain (Y):	Not Applicable
TPC:	N/A		
Engineering Test Notes:			

Test Measurement Results

Test Frequency	Measured Output Power (dBm)				Calculated Total Power (dBm)	Limit	Margin	EUT Power Setting
	Port(s)							
MHz	a	b	c	d	Σ Port(s)	dBm	dBm	
2412.0	15.94	--	--	--	15.94	30.00	-14.06	20.00
2437.0	15.95	--	--	--	15.95	30.00	-14.05	20.00
2462.0	16.68	--	--	--	16.68	30.00	-13.32	20.00

Traceability to Industry Recognized Test Methodologies

Work Instruction:	WI-01 MEASURING RF OUTPUT POWER
Measurement Uncertainty:	±1.33 dB

Note: [click the link in the above results matrix to view the plot](#)

This test report may be reproduced in full only. The document may only be updated by MiCOM Labs personnel. Any changes will be noted in the Document History section of the report.



Title: Digi ConnectCard for i.MX28 with Atheros AR6233
To: FCC 47 CFR Part 15.247 & IC RSS-210
Serial #: DIGI28-U2A Rev A
Issue Date: 29th March 2013
Page: 37 of 245

Single Port Module:

Equipment Configuration for Peak Output Power			
---	--	--	--

Variant:	802.11g	Duty Cycle (%):	100%
Data Rate:	6 Mbit/s	Antenna Gain (dBi):	Not Applicable
Modulation:	OFDM	Beam Forming Gain (Y):	Not Applicable
TPC:	N/A		
Engineering Test Notes:			

Test Measurement Results								
--------------------------	--	--	--	--	--	--	--	--

Test Frequency	Measured Output Power (dBm)				Calculated Total Power (dBm)	Limit	Margin	EUT Power Setting
	Port(s)							
MHz	a	b	c	d	Σ Port(s)	dBm	dBm	
2412.0	20.92	--	--	--	20.92	30.00	-9.08	20.00
2437.0	21.30	--	--	--	21.30	30.00	-8.70	20.00
2462.0	21.94	--	--	--	21.94	30.00	-8.06	20.00

Traceability to Industry Recognized Test Methodologies	
--	--

Work Instruction:	WI-01 MEASURING RF OUTPUT POWER
Measurement Uncertainty:	±1.33 dB

Note: [click the link in the above results matrix to view the plot](#)

This test report may be reproduced in full only. The document may only be updated by MiCOM Labs personnel. Any changes will be noted in the Document History section of the report.



Title: Digi ConnectCard for i.MX28 with Atheros AR6233
To: FCC 47 CFR Part 15.247 & IC RSS-210
Serial #: DIGI28-U2A Rev A
Issue Date: 29th March 2013
Page: 38 of 245

Single Port Module:

Equipment Configuration for Peak Output Power			
---	--	--	--

Variant:	802.11n HT-20	Duty Cycle (%):	100%
Data Rate:	6.5 MCS	Antenna Gain (dBi):	Not Applicable
Modulation:	OFDM	Beam Forming Gain (Y):	Not Applicable
TPC:	N/A		
Engineering Test Notes:			

Test Measurement Results								
--------------------------	--	--	--	--	--	--	--	--

Test Frequency	Measured Output Power (dBm)				Calculated Total Power (dBm)	Limit	Margin	EUT Power Setting
	Port(s)							
MHz	a	b	c	d	Σ Port(s)	dBm	dBm	
2412.0	21.10	--	--	--	21.10	30.00	-8.90	20.00
2437.0	21.41	--	--	--	21.41	30.00	-8.59	20.00
2462.0	21.98	--	--	--	21.98	30.00	-8.02	20.00

Traceability to Industry Recognized Test Methodologies	
--	--

Work Instruction:	WI-01 MEASURING RF OUTPUT POWER
Measurement Uncertainty:	± 1.33 dB

Note: [click the link in the above results matrix to view the plot](#)

This test report may be reproduced in full only. The document may only be updated by MiCOM Labs personnel. Any changes will be noted in the Document History section of the report.



Title: Digi ConnectCard for i.MX28 with Atheros AR6233
To: FCC 47 CFR Part 15.247 & IC RSS-210
Serial #: DIGI28-U2A Rev A
Issue Date: 29th March 2013
Page: 39 of 245

Single Port Module:

Equipment Configuration for Peak Output Power
--

Variant:	802.11n HT-40	Duty Cycle (%):	100%
Data Rate:	13.5 MCS	Antenna Gain (dBi):	Not Applicable
Modulation:	OFDM	Beam Forming Gain (Y):	Not Applicable
TPC:	N/A		
Engineering Test Notes:			

Test Measurement Results

Test Frequency	Measured Output Power (dBm)				Calculated Total Power (dBm)	Limit	Margin	EUT Power Setting
	Port(s)							
MHz	a	b	c	d	Σ Port(s)	dBm	dBm	
2422.0	21.85	--	--	--	21.85	30.00	-8.15	20.00
2437.0	22.05	--	--	--	22.05	30.00	-7.95	20.00
2452.0	22.49	--	--	--	22.49	30.00	-7.51	20.00

Traceability to Industry Recognized Test Methodologies

Work Instruction:	WI-01 MEASURING RF OUTPUT POWER
Measurement Uncertainty:	±1.33 dB

Note: [click the link in the above results matrix to view the plot](#)

This test report may be reproduced in full only. The document may only be updated by MiCOM Labs personnel. Any changes will be noted in the Document History section of the report.



Title: Digi ConnectCard for i.MX28 with Atheros AR6233
To: FCC 47 CFR Part 15.247 & IC RSS-210
Serial #: DIGI28-U2A Rev A
Issue Date: 29th March 2013
Page: 40 of 245

Single Port Module:

Equipment Configuration for Peak Output Power			
Variant:	802.11a	Duty Cycle (%):	100%
Data Rate:	6 Mbit/s	Antenna Gain (dBi):	Not Applicable
Modulation:	OFDM	Beam Forming Gain (Y):	Not Applicable
TPC:	N/A		
Engineering Test Notes:			

Test Measurement Results								
Test Frequency	Measured Output Power (dBm)				Calculated Total Power (dBm)	Limit	Margin	EUT Power Setting
	Port(s)							
MHz	a	b	c	d	Σ Port(s)	dBm	dBm	
5745.0	22.36	--	--	--	22.36	30.00	-7.64	20.00
5785.0	22.71	--	--	--	22.71	30.00	-7.29	20.00
5825.0	22.81	--	--	--	22.81	30.00	-7.19	20.00

Traceability to Industry Recognized Test Methodologies	
Work Instruction:	WI-01 MEASURING RF OUTPUT POWER
Measurement Uncertainty:	±1.33 dB

Note: [click the link in the above results matrix to view the plot](#)

This test report may be reproduced in full only. The document may only be updated by MiCOM Labs personnel. Any changes will be noted in the Document History section of the report.



Title: Digi ConnectCard for i.MX28 with Atheros AR6233
To: FCC 47 CFR Part 15.247 & IC RSS-210
Serial #: DIGI28-U2A Rev A
Issue Date: 29th March 2013
Page: 41 of 245

Single Port Module:

Equipment Configuration for Peak Output Power			
---	--	--	--

Variant:	802.11n HT-20	Duty Cycle (%):	100%
Data Rate:	6.5 MCS	Antenna Gain (dBi):	Not Applicable
Modulation:	OFDM	Beam Forming Gain (Y):	Not Applicable
TPC:	N/A		
Engineering Test Notes:			

Test Measurement Results								
--------------------------	--	--	--	--	--	--	--	--

Test Frequency	Measured Output Power (dBm)				Calculated Total Power (dBm)	Limit	Margin	EUT Power Setting
	Port(s)							
MHz	a	b	c	d	Σ Port(s)	dBm	dBm	
5745.0	21.83	--	--	--	21.83	30.00	-8.17	20.00
5785.0	22.81	--	--	--	22.81	30.00	-7.19	20.00
5825.0	23.05	--	--	--	23.05	30.00	-6.95	20.00

Traceability to Industry Recognized Test Methodologies	
--	--

Work Instruction:	WI-01 MEASURING RF OUTPUT POWER
Measurement Uncertainty:	±1.33 dB

Note: [click the link in the above results matrix to view the plot](#)

This test report may be reproduced in full only. The document may only be updated by MiCOM Labs personnel. Any changes will be noted in the Document History section of the report.



Title: Digi ConnectCard for i.MX28 with Atheros AR6233
To: FCC 47 CFR Part 15.247 & IC RSS-210
Serial #: DIGI28-U2A Rev A
Issue Date: 29th March 2013
Page: 42 of 245

Single Port Module:

Equipment Configuration for Peak Output Power
--

Variant:	802.11n HT-40	Duty Cycle (%):	100%
Data Rate:	13.5 MCS	Antenna Gain (dBi):	Not Applicable
Modulation:	OFDM	Beam Forming Gain (Y):	Not Applicable
TPC:	N/A		
Engineering Test Notes:			

Test Measurement Results

Test Frequency	Measured Output Power (dBm)				Calculated Total Power (dBm)	Limit	Margin	EUT Power Setting
	Port(s)							
MHz	a	b	c	d	Σ Port(s)	dBm	dBm	
5755.0	23.35	--	--	--	23.35	30.00	-6.65	20.00
5795.0	23.84	--	--	--	23.84	30.00	-6.16	20.00

Traceability to Industry Recognized Test Methodologies

Work Instruction:	WI-01 MEASURING RF OUTPUT POWER
Measurement Uncertainty:	±1.33 dB

Note: [click the link in the above results matrix to view the plot](#)

This test report may be reproduced in full only. The document may only be updated by MiCOM Labs personnel. Any changes will be noted in the Document History section of the report.



Title: Digi ConnectCard for i.MX28 with Atheros AR6233
To: FCC 47 CFR Part 15.247 & IC RSS-210
Serial #: DIGI28-U2A Rev A
Issue Date: 29th March 2013
Page: 43 of 245

Specification

Limits

§15.247 (b) The maximum peak output power of the intentional radiator shall not exceed the following:

§15.247 (b) (3) For systems using digital modulation in the 902-928 MHz, 2400-2483.5 MHz and 5725-5850 MHz bands: 1.0 watt.

15.247 (b) (4) The conducted output power limit specified in paragraph (b) of this section is based on the use of antennas with directional gains that do not exceed 6 dBi. Except as shown in paragraph (c) of this section, if transmitting antennas of directional gain greater than 6 dBi are used, the conducted output power from the intentional radiator shall be reduced below the stated values in paragraphs (b)(1), (b)(2), and (b)(3) of this section, as appropriate, by the amount in dB that the directional gain of the antenna exceeds 6 dBi.

15.247 (c) Operation with directional antenna gains greater than 6 dBi.

(1) Fixed point-to-point operation:

(i) Systems operating in the 2400–2483.5 MHz band that are used exclusively for fixed, point-to-point operations may employ transmitting antennas with directional gain greater than 6 dBi provided the maximum conducted output power of the intentional radiator is reduced by 1 dB for every 3 dB that the directional gain of the antenna exceeds 6 dBi.

(ii) Systems operating in the 5725–5850 MHz band that are used exclusively for fixed, point-to-point operations may employ transmitting antennas with directional gain greater than 6 dBi without any corresponding reduction in transmitter conducted output power.

§15.31 (e) For intentional radiators, measurements of the variation of the input power or the radiated signal level of the fundamental frequency component of the emission, as appropriate, shall be performed with the supply voltage varied between 85% and 115% of the nominal rated supply voltage. For battery operated equipment, the equipment tests shall be performed using a new battery.

§ RSS-210 A8.4(4) For systems employing digital modulation techniques operating in the 902-928 MHz, 2400-2483.5 MHz and 5725-5850 MHz bands the maximum peak conducted power shall not exceed 1 watt.

Traceability

Method	Test Equipment Used
Measurements were made per work instruction WI-01 'Measuring RF Output Power'	0158, 0287, 0252, 0313, 0314, 0070, 0116, 0117

This test report may be reproduced in full only. The document may only be updated by MiCOM Labs personnel. Any changes will be noted in the Document History section of the report.



Title: Digi ConnectCard for i.MX28 with Atheros AR6233
To: FCC 47 CFR Part 15.247 & IC RSS-210
Serial #: DIGI28-U2A Rev A
Issue Date: 29th March 2013
Page: 44 of 245

6.1.1.3. Power Spectral Density

Conducted Test Conditions for Power Spectral Density			
Standard:	FCC CFR 47:15.247	Ambient Temp. (°C):	24.0 - 27.5
Test Heading:	Power Spectral Density	Rel. Humidity (%):	32 - 45
Standard Section(s):	15.247 (e)	Pressure (mBars):	999 - 1001
Reference Document(s):	KDB 558074 - D01 DTS Measurement Guidance v01: Section 5.3 Maximum Power Spectral Density Level in the Emission Bandwidth		
Test Procedure for Power Spectral Density The transmitter output was connected to a spectrum analyzer and the maximum level in a 3 kHz bandwidth was measured. A peak value was found over the full emission bandwidth and the frequency span reduced to obtain enhanced resolution. Sweep time \geq span / 3 kHz with video averaging turned off. The Peak Power Spectral Density is the highest level found across the emission in a 3 kHz resolution bandwidth.			
Supporting Information Calculated Power = $A + 10 \log (1/x)$ dBm $A = \text{Total Power Spectral Density } [10 \text{ Log}_{10} (10^{a/10} + 10^{b/10} + 10^{c/10} + 10^{d/10})]$ $x = \text{Duty Cycle}$ Limit Line: KDB 662911 was implemented for In-band power spectral density (PSD) measurements - Option (2) measure and subtract $10 \log (N)$ dB from the limit for devices with multiple RF ports			

This test report may be reproduced in full only. The document may only be updated by MiCOM Labs personnel. Any changes will be noted in the Document History section of the report.



Title: Digi ConnectCard for i.MX28 with Atheros AR6233
To: FCC 47 CFR Part 15.247 & IC RSS-210
Serial #: DIGI28-U2A Rev A
Issue Date: 29th March 2013
Page: 45 of 245

Single Port Module:

Equipment Configuration for Power Spectral Density

Variant:	802.11b	Duty Cycle (%):	100%
Data Rate:	1 Mbit/s	Antenna Gain (dBi):	Not Applicable
Modulation:	CCK	Beam Forming Gain (Y):	Not Applicable
TPC:	N/A		
Engineering Test Notes:			

Test Measurement Results

Test Frequency	Measured Power Spectral Density (dBm)				Calculated Total Power Spectral Density		Limit	Margin
	Port(s)				dBm			
MHz	a	b	c	d	Σ Port(s)	Conversion to 3 kHz RBW	dBm	dB
2412.0	-10.257	--	--	--	-10.257	N/A	≤8.0	-18.26
2437.0	-10.310	--	--	--	-10.310	N/A	≤8.0	-18.31
2462.0	-9.507	--	--	--	-9.507	N/A	≤8.0	-17.51

Traceability to Industry Recognized Test Methodologies

Work Instruction:	WI-03 MEASURING RF SPECTRUM MASK
Measurement Uncertainty:	±2.81 dB

Note: [click the link in the above results matrix to view the plot](#)

This test report may be reproduced in full only. The document may only be updated by MiCOM Labs personnel. Any changes will be noted in the Document History section of the report.



Title: Digi ConnectCard for i.MX28 with Atheros AR6233
To: FCC 47 CFR Part 15.247 & IC RSS-210
Serial #: DIGI28-U2A Rev A
Issue Date: 29th March 2013
Page: 46 of 245

Single Port Module:

Equipment Configuration for Power Spectral Density			
--	--	--	--

Variant:	802.11g	Duty Cycle (%):	100%
Data Rate:	6 Mbit/s	Antenna Gain (dBi):	Not Applicable
Modulation:	OFDM	Beam Forming Gain (Y):	Not Applicable
TPC:	N/A		
Engineering Test Notes:			

Test Measurement Results								
--------------------------	--	--	--	--	--	--	--	--

Test Frequency	Measured Power Spectral Density (dBm)				Calculated Total Power Spectral Density		Limit	Margin
	Port(s)				dBm			
MHz	a	b	c	d	Σ Port(s)	Conversion to 3 kHz RBW	dBm	dB
2412.0	-11.986	--	--	--	-11.986	N/A	≤8.0	-19.99
2437.0	-10.643	--	--	--	-10.643	N/A	≤8.0	-18.64
2462.0	-10.603	--	--	--	-10.603	N/A	≤8.0	-18.60

Traceability to Industry Recognized Test Methodologies	
--	--

Work Instruction:	WI-03 MEASURING RF SPECTRUM MASK
Measurement Uncertainty:	±2.81 dB

Note: [click the link in the above results matrix to view the plot](#)

This test report may be reproduced in full only. The document may only be updated by MiCOM Labs personnel. Any changes will be noted in the Document History section of the report.



Title: Digi ConnectCard for i.MX28 with Atheros AR6233
To: FCC 47 CFR Part 15.247 & IC RSS-210
Serial #: DIGI28-U2A Rev A
Issue Date: 29th March 2013
Page: 47 of 245

Single Port Module:

Equipment Configuration for Power Spectral Density

Variant:	802.11n HT-20	Duty Cycle (%):	100%
Data Rate:	6.5 MCS	Antenna Gain (dBi):	Not Applicable
Modulation:	OFDM	Beam Forming Gain (Y):	Not Applicable
TPC:	N/A		
Engineering Test Notes:			

Test Measurement Results

Test Frequency	Measured Power Spectral Density (dBm)				Calculated Total Power Spectral Density		Limit	Margin
	Port(s)				dBm			
MHz	a	b	c	d	Σ Port(s)	Conversion to 3 kHz RBW	dBm	dB
2412.0	-10.879	--	--	--	-10.879	N/A	≤8.0	-18.88
2437.0	-10.855	--	--	--	-10.855	N/A	≤8.0	-18.86
2462.0	-10.025	--	--	--	-10.025	N/A	≤8.0	-18.03

Traceability to Industry Recognized Test Methodologies

Work Instruction:	WI-03 MEASURING RF SPECTRUM MASK
Measurement Uncertainty:	±2.81 dB

Note: [click the link in the above results matrix to view the plot](#)

This test report may be reproduced in full only. The document may only be updated by MiCOM Labs personnel. Any changes will be noted in the Document History section of the report.



Title: Digi ConnectCard for i.MX28 with Atheros AR6233
To: FCC 47 CFR Part 15.247 & IC RSS-210
Serial #: DIGI28-U2A Rev A
Issue Date: 29th March 2013
Page: 48 of 245

Single Port Module:

Equipment Configuration for Power Spectral Density

Variant:	802.11n HT-40	Duty Cycle (%):	100%
Data Rate:	13.5 MCS	Antenna Gain (dBi):	Not Applicable
Modulation:	OFDM	Beam Forming Gain (Y):	Not Applicable
TPC:	N/A		
Engineering Test Notes:			

Test Measurement Results

Test Frequency	Measured Power Spectral Density (dBm)				Calculated Total Power Spectral Density		Limit	Margin
	Port(s)				dBm			
MHz	a	b	c	d	Σ Port(s)	Conversion to 3 kHz RBW	dBm	dB
2422.0	-13.411	--	--	--	-13.411	N/A	≤8.0	-21.41
2437.0	-14.471	--	--	--	-14.471	N/A	≤8.0	-22.47
2452.0	-14.369	--	--	--	-14.369	N/A	≤8.0	-22.37

Traceability to Industry Recognized Test Methodologies

Work Instruction:	WI-03 MEASURING RF SPECTRUM MASK
Measurement Uncertainty:	±2.81 dB

Note: [click the link in the above results matrix to view the plot](#)

This test report may be reproduced in full only. The document may only be updated by MiCOM Labs personnel. Any changes will be noted in the Document History section of the report.



Title: Digi ConnectCard for i.MX28 with Atheros AR6233
To: FCC 47 CFR Part 15.247 & IC RSS-210
Serial #: DIGI28-U2A Rev A
Issue Date: 29th March 2013
Page: 49 of 245

Single Port Module:

Equipment Configuration for Power Spectral Density

Variant:	802.11a	Duty Cycle (%):	100%
Data Rate:	6 Mbit/s	Antenna Gain (dBi):	Not Applicable
Modulation:	OFDM	Beam Forming Gain (Y):	Not Applicable
TPC:	N/A		
Engineering Test Notes:			

Test Measurement Results

Test Frequency	Measured Power Spectral Density (dBm)				Calculated Total Power Spectral Density		Limit	Margin
	Port(s)				dBm			
MHz	a	b	c	d	Σ Port(s)	Conversion to 3 kHz RBW	dBm	dB
5745.0	-8.886	--	--	--	-8.886	N/A	≤8.0	-16.89
5785.0	-10.039	--	--	--	-10.039	N/A	≤8.0	-18.04
5825.0	-10.288	--	--	--	-10.288	N/A	≤8.0	-18.29

Traceability to Industry Recognized Test Methodologies

Work Instruction:	WI-03 MEASURING RF SPECTRUM MASK
Measurement Uncertainty:	±2.81 dB

Note: [click the link in the above results matrix to view the plot](#)

This test report may be reproduced in full only. The document may only be updated by MiCOM Labs personnel. Any changes will be noted in the Document History section of the report.



Title: Digi ConnectCard for i.MX28 with Atheros AR6233
To: FCC 47 CFR Part 15.247 & IC RSS-210
Serial #: DIGI28-U2A Rev A
Issue Date: 29th March 2013
Page: 50 of 245

Single Port Module:

Equipment Configuration for Power Spectral Density			
--	--	--	--

Variant:	802.11n HT-20	Duty Cycle (%):	100%
Data Rate:	6.5 MCS	Antenna Gain (dBi):	Not Applicable
Modulation:	OFDM	Beam Forming Gain (Y):	Not Applicable
TPC:	N/A		
Engineering Test Notes:			

Test Measurement Results								
--------------------------	--	--	--	--	--	--	--	--

Test Frequency	Measured Power Spectral Density (dBm)				Calculated Total Power Spectral Density		Limit	Margin
	Port(s)				dBm			
MHz	a	b	c	D	Σ Port(s)	Conversion to 3 kHz RBW	dBm	dB
5745.0	-9.201	--	--	--	-9.201	N/A	≤ 8.0	-17.20
5785.0	-9.378	--	--	--	-9.378	N/A	≤ 8.0	-17.38
5825.0	-8.150	--	--	--	-8.150	N/A	≤ 8.0	-16.15

Traceability to Industry Recognized Test Methodologies	
--	--

Work Instruction:	WI-03 MEASURING RF SPECTRUM MASK
Measurement Uncertainty:	± 2.81 dB

Note: [click the link in the above results matrix to view the plot](#)

This test report may be reproduced in full only. The document may only be updated by MiCOM Labs personnel. Any changes will be noted in the Document History section of the report.



Title: Digi ConnectCard for i.MX28 with Atheros AR6233
To: FCC 47 CFR Part 15.247 & IC RSS-210
Serial #: DIGI28-U2A Rev A
Issue Date: 29th March 2013
Page: 51 of 245

Single Port Module:

Equipment Configuration for Power Spectral Density

Variant:	802.11n HT-40	Duty Cycle (%):	100%
Data Rate:	13.5 MCS	Antenna Gain (dBi):	Not Applicable
Modulation:	OFDM	Beam Forming Gain (Y):	Not Applicable
TPC:	N/A		
Engineering Test Notes:			

Test Measurement Results

Test Frequency	Measured Power Spectral Density (dBm)				Calculated Total Power Spectral Density		Limit	Margin
	Port(s)				dBm			
MHz	a	b	c	d	Σ Port(s)	Conversion to 3 kHz RBW	dBm	dB
5755.0	-11.402	--	--	--	-11.402	N/A	≤8.0	-19.40
5795.0	-11.156	--	--	--	-11.156	N/A	≤8.0	-19.16

Traceability to Industry Recognized Test Methodologies

Work Instruction:	WI-03 MEASURING RF SPECTRUM MASK
Measurement Uncertainty:	±2.81 dB

Note: [click the link in the above results matrix to view the plot](#)

This test report may be reproduced in full only. The document may only be updated by MiCOM Labs personnel. Any changes will be noted in the Document History section of the report.



Title: Digi ConnectCard for i.MX28 with Atheros AR6233
To: FCC 47 CFR Part 15.247 & IC RSS-210
Serial #: DIGI28-U2A Rev A
Issue Date: 29th March 2013
Page: 52 of 245

Specification
Peak Power Spectral Density Limits

§15.247(e) For digitally modulated systems, the power spectral density conducted from the intentional radiator to the antenna shall not be greater than +8 dBm in any 3 kHz band during any time interval of continuous transmission

RSS-210 §A8.2(2) The transmitter power spectral density (into the antenna) shall not be greater than +8 dBm in any 3 kHz band during any time interval of continuous transmission or over 1.0 second if the transmission exceeds 1.0 second duration.

Traceability

Method	Test Equipment Used
Measurements were made per work instruction WI-01 'Measuring RF Output Power'	0158, 0287, 0252, 0313, 0314, 0070, 0116, 0117

This test report may be reproduced in full only. The document may only be updated by MiCOM Labs personnel. Any changes will be noted in the Document History section of the report.



Title: Digi ConnectCard for i.MX28 with Atheros AR6233
To: FCC 47 CFR Part 15.247 & IC RSS-210
Serial #: DIGI28-U2A Rev A
Issue Date: 29th March 2013
Page: 53 of 245

6.1.1.4. Conducted Spurious Emissions

Conducted Test Conditions for Transmitter Conducted Spurious and Band-Edge Emissions			
Standard:	FCC CFR 47:15.247	Ambient Temp. (°C):	24.0 - 27.5
Test Heading:	Max Unwanted Emission Levels	Rel. Humidity (%):	32 - 45
Standard Section(s):	15.247 (d)	Pressure (mBars):	999 - 1001
Reference Document(s):	KDB 558074 - D01 DTS Measurement Guidance v01: Section 5.4 Maximum Unwanted Emission Levels		

Test Procedure for Transmitter Conducted Spurious and Band-Edge Emissions Measurement
Transmitter Conducted Spurious and Band-Edge emissions were measured at a limit of 20 dB below the highest in-band spectral density measured with a spectrum analyzer connected to the antenna terminal. Measurements were made while EUT was operating in transmit mode of operation at the appropriate centre frequency closest to the band-edge. Emissions were maximized during the measurement and limits derived from the peak spectral power and drawn on each plot.

This test report may be reproduced in full only. The document may only be updated by MiCOM Labs personnel. Any changes will be noted in the Document History section of the report.



Title: Digi ConnectCard for i.MX28 with Atheros AR6233
To: FCC 47 CFR Part 15.247 & IC RSS-210
Serial #: DIGI28-U2A Rev A
Issue Date: 29th March 2013
Page: 54 of 245

Single Port Module:

Equipment Configuration for Transmitter Conducted Spurious and Band-Edge Emissions

Variant:	802.11b	Duty Cycle (%):	100%
Data Rate:	1 Mbit/s	Antenna Gain (dBi):	Not Applicable
Modulation:	CCK	Beam Forming Gain (Y):	Not Applicable
TPC:	N/A		
Engineering Test Notes:			

Test Measurement Results									
---------------------------------	--	--	--	--	--	--	--	--	--

Test Frequency	Frequency Range	Transmitter Conducted Spurious Emissions (dBm)							
		Port a		Port b		Port c		Port d	
		SE	Limit	SE	Limit	SE	Limit	SE	Limit
2412.0	30.0 - 26000.0	-49.485	-17.28	--	--	--	--	--	--
2437.0	30.0 - 26000.0	-49.787	-17.32	--	--	--	--	--	--
2462.0	30.0 - 26000.0	-49.478	-16.89	--	--	--	--	--	--

SE - Maximum spurious emission found

Test Frequency	Band-Edge Frequency	Transmitter Conducted Band-Edge Emissions (dBm)							
		Port a		Port b		Port c		Port d	
		BE	Limit	BE	Limit	BE	Limit	BE	Limit
2412.0	2400.0	-43.788	-17.44	--	--	--	--	--	--
2462.0	2483.5	-17.540	-16.63	--	--	--	--	--	--

BE - Maximum band-edge emission found

Traceability to Industry Recognized Test Methodologies	
---	--

Work Instruction:	WI-05 MEASUREMENT OF SPURIOUS EMISSIONS
Measurement Uncertainty:	= 40 GHz \pm 2.37 dB, > 40 GHz \pm 4.6 dB

Note: [click the link in the above results matrix to view the plot](#)

This test report may be reproduced in full only. The document may only be updated by MiCOM Labs personnel. Any changes will be noted in the Document History section of the report.



Title: Digi ConnectCard for i.MX28 with Atheros AR6233
To: FCC 47 CFR Part 15.247 & IC RSS-210
Serial #: DIGI28-U2A Rev A
Issue Date: 29th March 2013
Page: 55 of 245

Single Port Module:

Equipment Configuration for Transmitter Conducted Spurious and Band-Edge Emissions
--

Variant:	802.11g	Duty Cycle (%):	100%
Data Rate:	6 Mbit/s	Antenna Gain (dBi):	Not Applicable
Modulation:	OFDM	Beam Forming Gain (Y):	Not Applicable
TPC:	N/A		
Engineering Test Notes:			

Test Measurement Results									
--------------------------	--	--	--	--	--	--	--	--	--

Test Frequency	Frequency Range	Transmitter Conducted Spurious Emissions (dBm)							
		Port a		Port b		Port c		Port d	
		SE	Limit	SE	Limit	SE	Limit	SE	Limit
2412.0	30.0 - 26000.0	-49.546	-18.08	--	--	--	--	--	--
2437.0	30.0 - 26000.0	-49.102	-19.36	--	--	--	--	--	--
2462.0	30.0 - 26000.0	-49.534	-17.13	--	--	--	--	--	--

SE - Maximum spurious emission found

Test Frequency	Band-Edge Frequency	Transmitter Conducted Band-Edge Emissions (dBm)							
		Port a		Port b		Port c		Port d	
		BE	Limit	BE	Limit	BE	Limit	BE	Limit
2412.0	2400.0	-23.902	-16.78	--	--	--	--	--	--
2462.0	2483.5	-16.805	-15.49	--	--	--	--	--	--

BE - Maximum band-edge emission found

Traceability to Industry Recognized Test Methodologies	
--	--

Work Instruction:	WI-05 MEASUREMENT OF SPURIOUS EMISSIONS
Measurement Uncertainty:	= 40 GHz \pm 2.37 dB, > 40 GHz \pm 4.6 dB

Note: [click the link in the above results matrix to view the plot](#)

This test report may be reproduced in full only. The document may only be updated by MiCOM Labs personnel. Any changes will be noted in the Document History section of the report.



Title: Digi ConnectCard for i.MX28 with Atheros AR6233
To: FCC 47 CFR Part 15.247 & IC RSS-210
Serial #: DIGI28-U2A Rev A
Issue Date: 29th March 2013
Page: 56 of 245

Single Port Module:

Equipment Configuration for Transmitter Conducted Spurious and Band-Edge Emissions

Variant:	802.11n HT-20	Duty Cycle (%):	100%
Data Rate:	6.5 MCS	Antenna Gain (dBi):	Not Applicable
Modulation:	OFDM	Beam Forming Gain (Y):	Not Applicable
TPC:	N/A		
Engineering Test Notes:			

Test Measurement Results

Test Frequency	Frequency Range	Transmitter Conducted Spurious Emissions (dBm)							
		Port a		Port b		Port c		Port d	
		SE	Limit	SE	Limit	SE	Limit	SE	Limit
2412.0	30.0 - 26000.0	-49.621	-17.37	--	--	--	--	--	--
2437.0	30.0 - 26000.0	-49.651	-16.85	--	--	--	--	--	--
2462.0	30.0 - 26000.0	-49.122	-19.14	--	--	--	--	--	--

SE - Maximum spurious emission found

Test Frequency	Band-Edge Frequency	Transmitter Conducted Band-Edge Emissions (dBm)							
		Port a		Port b		Port c		Port d	
		BE	Limit	BE	Limit	BE	Limit	BE	Limit
2412.0	2400.0	-23.209	-16.70	--	--	--	--	--	--
2462.0	2483.5	-17.560	-15.46	--	--	--	--	--	--

BE - Maximum band-edge emission found

Traceability to Industry Recognized Test Methodologies

Work Instruction:	WI-05 MEASUREMENT OF SPURIOUS EMISSIONS
Measurement Uncertainty:	= 40 GHz \pm 2.37 dB, > 40 GHz \pm 4.6 dB

Note: [click the link in the above results matrix to view the plot](#)

This test report may be reproduced in full only. The document may only be updated by MiCOM Labs personnel. Any changes will be noted in the Document History section of the report.



Title: Digi ConnectCard for i.MX28 with Atheros AR6233
To: FCC 47 CFR Part 15.247 & IC RSS-210
Serial #: DIGI28-U2A Rev A
Issue Date: 29th March 2013
Page: 57 of 245

Single Port Module:

Equipment Configuration for Transmitter Conducted Spurious and Band-Edge Emissions

Variant:	802.11n HT-40	Duty Cycle (%):	100%
Data Rate:	13.5 MCS	Antenna Gain (dBi):	Not Applicable
Modulation:	OFDM	Beam Forming Gain (Y):	Not Applicable
TPC:	N/A		
Engineering Test Notes:			

Test Measurement Results									
---------------------------------	--	--	--	--	--	--	--	--	--

Test Frequency	Frequency Range	Transmitter Conducted Spurious Emissions (dBm)							
		Port a		Port b		Port c		Port d	
		SE	Limit	SE	Limit	SE	Limit	SE	Limit
2422.0	30.0 - 26000.0	-50.481	-20.03	--	--	--	--	--	--
2437.0	30.0 - 26000.0	-49.523	-19.84	--	--	--	--	--	--
2452.0	30.0 - 26000.0	-49.219	-19.81	--	--	--	--	--	--

SE - Maximum spurious emission found

Test Frequency	Band-Edge Frequency	Transmitter Conducted Band-Edge Emissions (dBm)							
		Port a		Port b		Port c		Port d	
		BE	Limit	BE	Limit	BE	Limit	BE	Limit
2422.0	2400.0	-26.139	-20.03	--	--	--	--	--	--
2452.0	2483.5	-17.327	-19.18	--	--	--	--	--	--

BE - Maximum band-edge emission found

Traceability to Industry Recognized Test Methodologies	
---	--

Work Instruction:	WI-05 MEASUREMENT OF SPURIOUS EMISSIONS
Measurement Uncertainty:	= 40 GHz \pm 2.37 dB, > 40 GHz \pm 4.6 dB

Note: [click the link in the above results matrix to view the plot](#)

This test report may be reproduced in full only. The document may only be updated by MiCOM Labs personnel. Any changes will be noted in the Document History section of the report.



Title: Digi ConnectCard for i.MX28 with Atheros AR6233
To: FCC 47 CFR Part 15.247 & IC RSS-210
Serial #: DIGI28-U2A Rev A
Issue Date: 29th March 2013
Page: 58 of 245

Single Port Module:

Equipment Configuration for Transmitter Conducted Spurious and Band-Edge Emissions

Variant:	802.11a	Duty Cycle (%):	100%
Data Rate:	6 Mbit/s	Antenna Gain (dBi):	Not Applicable
Modulation:	OFDM	Beam Forming Gain (Y):	Not Applicable
TPC:	N/A		
Engineering Test Notes:			

Test Measurement Results									
---------------------------------	--	--	--	--	--	--	--	--	--

Test Frequency	Frequency Range	Transmitter Conducted Spurious Emissions (dBm)							
		Port a		Port b		Port c		Port d	
		SE	Limit	SE	Limit	SE	Limit	SE	Limit
5745.0	30.0 - 40000.0	-27.195	-15.54	--	--	--	--	--	--
5785.0	30.0 - 40000.0	-36.451	-15.58	--	--	--	--	--	--
5825.0	30.0 - 40000.0	-36.672	-15.35	--	--	--	--	--	--

SE - Maximum spurious emission found

Test Frequency	Band-Edge Frequency	Transmitter Conducted Band-Edge Emissions (dBm)							
		Port a		Port b		Port c		Port d	
		BE	Limit	BE	Limit	BE	Limit	BE	Limit
5745.0	5725.0	-27.211	-14.98	--	--	--	--	--	--
5825.0	5850.0	-14.699	-14.06	--	--	--	--	--	--

BE - Maximum band-edge emission found

Traceability to Industry Recognized Test Methodologies	
---	--

Work Instruction:	WI-05 MEASUREMENT OF SPURIOUS EMISSIONS
Measurement Uncertainty:	= 40 GHz ±2.37 dB, > 40 GHz ±4.6 dB

Note: [click the link in the above results matrix to view the plot](#)

This test report may be reproduced in full only. The document may only be updated by MiCOM Labs personnel. Any changes will be noted in the Document History section of the report.



Title: Digi ConnectCard for i.MX28 with Atheros AR6233
To: FCC 47 CFR Part 15.247 & IC RSS-210
Serial #: DIGI28-U2A Rev A
Issue Date: 29th March 2013
Page: 59 of 245

Single Port Module:

Equipment Configuration for Transmitter Conducted Spurious and Band-Edge Emissions

Variant:	802.11n HT-20	Duty Cycle (%):	100%
Data Rate:	6.5 MCS	Antenna Gain (dBi):	Not Applicable
Modulation:	OFDM	Beam Forming Gain (Y):	Not Applicable
TPC:	N/A		
Engineering Test Notes:			

Test Measurement Results									
Test Frequency	Frequency Range	Transmitter Conducted Spurious Emissions (dBm)							
		Port a		Port b		Port c		Port d	
		SE	Limit	SE	Limit	SE	Limit	SE	Limit
5745.0	30.0 - 40000.0	-27.360	-15.73	--	--	--	--	--	--
5785.0	30.0 - 40000.0	-36.792	-18.87	--	--	--	--	--	--
5825.0	30.0 - 40000.0	-36.847	-18.84	--	--	--	--	--	--

SE - Maximum spurious emission found

Test Frequency	Band-Edge Frequency	Transmitter Conducted Band-Edge Emissions (dBm)							
		Port a		Port b		Port c		Port d	
		BE	Limit	BE	Limit	BE	Limit	BE	Limit
5745.0	5725.0	-26.573	-15.09	--	--	--	--	--	--
5825.0	5850.0	-14.807	-13.98	--	--	--	--	--	--

BE - Maximum band-edge emission found

Traceability to Industry Recognized Test Methodologies	
Work Instruction:	WI-05 MEASUREMENT OF SPURIOUS EMISSIONS
Measurement Uncertainty:	= 40 GHz \pm 2.37 dB, > 40 GHz \pm 4.6 dB

Note: [click the link in the above results matrix to view the plot](#)

This test report may be reproduced in full only. The document may only be updated by MiCOM Labs personnel. Any changes will be noted in the Document History section of the report.



Title: Digi ConnectCard for i.MX28 with Atheros AR6233
To: FCC 47 CFR Part 15.247 & IC RSS-210
Serial #: DIGI28-U2A Rev A
Issue Date: 29th March 2013
Page: 60 of 245

Single Port Module:

Equipment Configuration for Transmitter Conducted Spurious and Band-Edge

Variant:	802.11n HT-40	Duty Cycle (%):	100%
Data Rate:	13.5 MCS	Antenna Gain (dBi):	Not Applicable
Modulation:	OFDM	Beam Forming Gain (Y):	Not Applicable
TPC:	N/A		
Engineering Test Notes:			

Test Measurement Results									
---------------------------------	--	--	--	--	--	--	--	--	--

Test Frequency	Frequency Range	Transmitter Conducted Spurious Emissions (dBm)							
		Port a		Port b		Port c		Port d	
		SE	Limit	SE	Limit	SE	Limit	SE	Limit
5755.0	30.0 - 40000.0	-36.691	-18.73	--	--	--	--	--	--
5795.0	30.0 - 40000.0	-26.768	-18.24	--	--	--	--	--	--

SE - Maximum spurious emission found

Test Frequency	Band-Edge Frequency	Transmitter Conducted Band-Edge Emissions (dBm)							
		Port a		Port b		Port c		Port d	
		BE	Limit	BE	Limit	BE	Limit	BE	Limit
5755.0	5725.0	-23.333	-17.48	--	--	--	--	--	--
5795.0	5850.0	-35.613	-17.29	--	--	--	--	--	--

BE - Maximum band-edge emission found

Traceability to Industry Recognized Test Methodologies	
---	--

Work Instruction:	WI-05 MEASUREMENT OF SPURIOUS EMISSIONS
Measurement Uncertainty:	= 40 GHz ±2.37 dB, > 40 GHz ±4.6 dB

Note: [click the link in the above results matrix to view the plot](#)

This test report may be reproduced in full only. The document may only be updated by MiCOM Labs personnel. Any changes will be noted in the Document History section of the report.



Title: Digi ConnectCard for i.MX28 with Atheros AR6233
To: FCC 47 CFR Part 15.247 & IC RSS-210
Serial #: DIGI28-U2A Rev A
Issue Date: 29th March 2013
Page: 61 of 245

Specification

Limits Band-Edge

Lower Limit Band-edge	Upper Limit Band-edge	Limit below highest level of desired power
2,400 MHz	2,483.5 MHz	≥ 20 dB
5725 MHz	5850 MHz	

§15.247(d) and RSS-210 §A8.5 In any 100 kHz bandwidth outside the frequency band in which the spread spectrum or digitally modulated intentional radiator is operating, the radio frequency power that is produced by the intentional radiator shall be at least 20 dB below that in the 100 kHz bandwidth within the band that contains the highest level of the desired power, based on either an RF conducted or radiated measurement, provided the transmitter demonstrates compliance with the peak conducted power limits.

§15.247(d)

If the transmitter complies with the conducted power limits based on the use of RMS averaging over a time interval, as permitted under paragraph (b)(3) of this section, the attenuation required under this paragraph shall be 30 dB instead of 20 dB. Attenuation below the general limits specified §15.209(a) is not required. In addition, radiated emissions which fall in the restricted bands, as defined in Section §15.205(a), must also comply with the radiated emission limits specified in Section 15.209(a) (see Section 15.205(a)).

RSS-210 §A8.5 If the transmitter complies with the conducted power limits based on the use of RMS averaging over a time interval, as permitted under section A8.4(4), the attenuation required shall be 30 dB instead of 20 dB. Attenuation below the general limits specified in Tables 2 and 3 is not required. In addition, radiated emissions which fall in the restricted bands of Table 1 must also comply with the radiated emission limits specified in Tables 2 and 3.

RSS-Gen §4.7

The search for unwanted emissions shall be from the lowest frequency internally generated or used in the device (local oscillator, intermediate of carrier frequency), or from 30 MHz , whichever is the lowest frequency, to the 5th harmonic of the highest frequency generated without exceeding 40 GHz.

Laboratory Measurement Uncertainty for Conducted Spurious Emissions

Measurement uncertainty	±2.37 dB
-------------------------	----------

Traceability

Method	Test Equipment Used
Measurements were made per work instruction WI-05 'Measurement of Spurious Emissions'	0088, 0158, 0287, 0252, 0313, 0314, 0070, 0116, 0117.

This test report may be reproduced in full only. The document may only be updated by MiCOM Labs personnel. Any changes will be noted in the Document History section of the report.



6.1.1.5. Maximum Permissible Exposure

FCC, Part 15 Subpart C §15.247(i)
Industry Canada RSS-Gen §5.6

Calculations for Maximum Permissible Exposure Levels

$$\text{Power Density} = P_d \text{ (mW/cm}^2\text{)} = \text{EIRP}/(4\pi d^2)$$

$$\text{EIRP} = P * G$$

P = Peak output power (mW)

G = Antenna numeric gain (numeric)

d = Separation distance (cm)

$$\text{Numeric Gain} = 10^{(G \text{ (dBi)}/10)}$$

Because the EUT belongs to the General Population/Uncontrolled Exposure the limit of power density is 1.0 mW/cm²

Single Port Module:

Antenna	Freq. Band (GHz)	Antenna Gain (dBi)	Numeric Gain (numeric)	Peak Output Power (dBm)	Peak Output Power (mW)	Calculated Safe Distance @ 1mW/cm ² Limit(cm)	Minimum Separation Distance (cm)
PC.11	2.4	3	2	22.5	177.83	5.31	20.0*
	5.8	4.5	3	23.84	242.10	7.37	20.0*
FXP.830	2.4	1.8	2	22.5	177.83	4.63	20.0*
	5.8	4	3	23.84	242.10	6.96	20.0*
ANT-DB1-xxx	2.4	-3.1	0	22.5	177.83	2.63	20.0*
	5.8	4.3	3	23.84	242.10	7.20	20.0*
SA-006-1	2.4	1.8	2	22.5	177.83	4.63	20.0*
	5.8						

*Note: for mobile or fixed location transmitters the minimum separation distance is 20cm, even if calculations indicate the MPE distance to be less.



Title: Digi ConnectCard for i.MX28 with Atheros AR6233
To: FCC 47 CFR Part 15.247 & IC RSS-210
Serial #: DIGI28-U2A Rev A
Issue Date: 29th March 2013
Page: 63 of 245

Specification

Maximum Permissible Exposure Limits

§15.247(i) Systems operating under the provisions of this section shall be operated in a manner that ensures that the public is not exposed to radio frequency levels in excess of the Commission's guidelines.

FCC §1.1310 Limit = $1\text{mW} / \text{cm}^2$ from 1.310 Table 1

RSS-Gen §5.6 Category I and Category II equipment shall comply with the applicable requirements of RSS-102.

Laboratory Measurement Uncertainty for Power Measurements

Measurement uncertainty	±1.33 dB
-------------------------	----------

This test report may be reproduced in full only. The document may only be updated by MiCOM Labs personnel. Any changes will be noted in the Document History section of the report.



Title: Digi ConnectCard for i.MX28 with Atheros AR6233
To: FCC 47 CFR Part 15.247 & IC RSS-210
Serial #: DIGI28-U2A Rev A
Issue Date: 29th March 2013
Page: 64 of 245

6.1.2. Radiated Emission Testing

Transmitter Radiated Spurious Emissions (above 1 GHz); Peak Field Strength Measurements; and Radiated Band Edge Measurements – Restricted Bands

FCC, Part 15 Subpart C §15.247(d) 15.205; 15.209
Industry Canada RSS-210 §A8.5, §2.2, §2.6
Industry Canada RSS-Gen §4.7

Test Procedure

The worst case highest spectral density radiated emissions above 1 GHz are measured in the anechoic chamber at a 3-meter distance on every azimuth in both horizontal and vertical polarities. The emissions are recorded and maximized as a function of azimuth by rotation through 360° with a spectrum analyzer in peak hold mode. Depending on the frequency band spanned a notch filter and waveguide filter was used to remove the fundamental frequency. The highest emissions relative to the limit are listed for each frequency spanned.

All measurements on any frequency or frequencies over 1 MHz are based on the use of measurement instrumentation employing an average detector function. All measurements above 1 GHz were performed using a minimum resolution bandwidth of 1 MHz.

Field Strength Calculation

The field strength is calculated by adding the Antenna Factor and Cable Loss, and subtracting Amplifier Gain from the measured reading. All factors are included in the reported data.

$$FS = R + AF + CORR - FO$$

where: FS = Field Strength

R = Measured Spectrum analyzer Input Amplitude

AF = Antenna Factor

CORR = Correction Factor = CL – AG + NFL

CL = Cable Loss

AG = Amplifier Gain

FO = Distance Falloff Factor

NFL = Notch Filter Loss or Waveguide Loss

For example:

Given receiver input reading of 51.5 dB μ V; Antenna Factor of 8.5 dB; Cable Loss of 1.3 dB; Falloff Factor of 0 dB, an Amplifier Gain of 26 dB and Notch Filter Loss of 1 dB. The Field Strength of the measured emission is:

$$FS = 51.5 + 8.5 + 1.3 - 26.0 + 1 = 36.3 \text{ dB}\mu\text{V/m}$$

Conversion between dB μ V/m (or dB μ V) and μ V/m (or μ V) are done as:

$$\text{Level (dB}\mu\text{V/m)} = 20 * \text{Log (level (\mu\text{V/m}))}$$

$$40 \text{ dB}\mu\text{V/m} = 100 \mu\text{V/m}$$

$$48 \text{ dB}\mu\text{V/m} = 250 \mu\text{V/m}$$

This test report may be reproduced in full only. The document may only be updated by MiCOM Labs personnel. Any changes will be noted in the Document History section of the report.



Title: Digi ConnectCard for i.MX28 with Atheros AR6233
To: FCC 47 CFR Part 15.247 & IC RSS-210
Serial #: DIGI28-U2A Rev A
Issue Date: 29th March 2013
Page: 65 of 245

6.1.2.1. Dual Band Patch PC.11 – Single Port Module

Test Freq.	2412 MHz	Engineer	JMH
Variant	802.11b; 1 Mbs	Temp (°C)	27
Freq. Range	1000 MHz - 18000 MHz	Rel. Hum.(%)	33
Power Setting	30	Press. (mBars)	1000
Antenna	pc.11	Duty Cycle (%)	100
Test Notes 1	3 dBi gain		
Test Notes 2	Single Port Module		

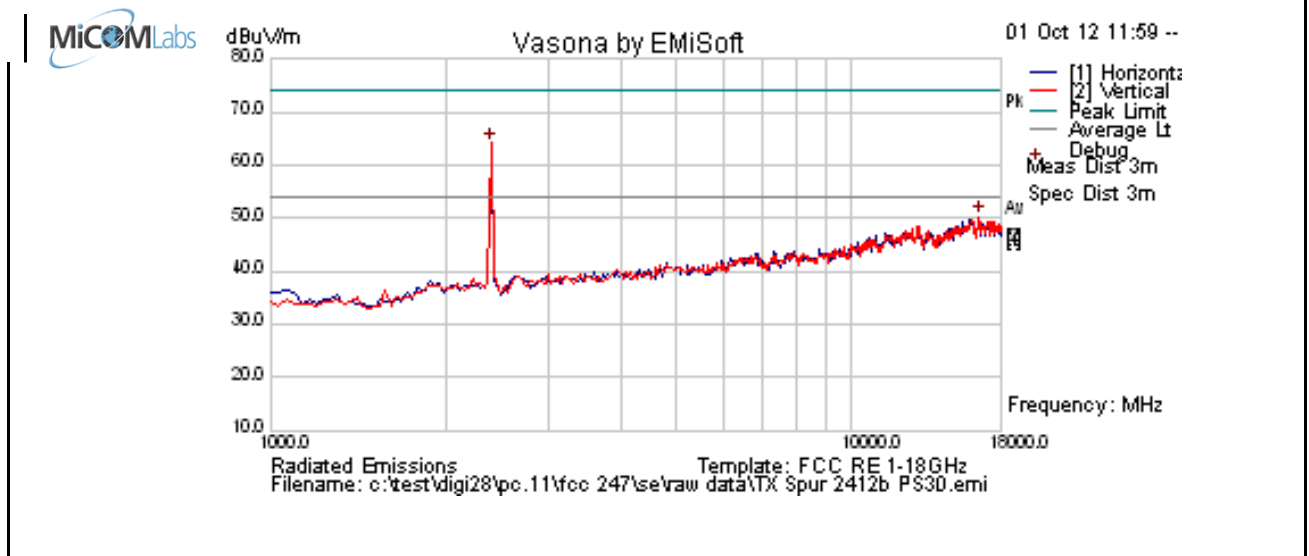

Formally measured emission peaks

Frequency MHz	Raw dBuV	Cable Loss	AF dB	Level dBuV/m	Measurement Type	Pol	Hgt cm	Azt Deg	Limit dBuV/m	Margin dB	Pass /Fail	Comments
2396.794	73.9	3.0	11.7	65.2	Peak [Scan]	H	100					FUND
16092.184	41.2	9.0	0.3	50.4	Peak [Scan]	V	100	0	54.0	-3.6	Pass	Noise

Legend: TX = Transmitter Emissions; DIG = Digital Emissions; FUND = Fundamental; WB = Wideband Emission
 RB = Restricted Band (15.209 Limits); NRB = Non Restricted Band, Limit is 20dB below fundamental peak

This test report may be reproduced in full only. The document may only be updated by MiCOM Labs personnel. Any changes will be noted in the Document History section of the report.



Title: Digi ConnectCard for i.MX28 with Atheros AR6233
To: FCC 47 CFR Part 15.247 & IC RSS-210
Serial #: DIGI28-U2A Rev A
Issue Date: 29th March 2013
Page: 66 of 245

Band Edge

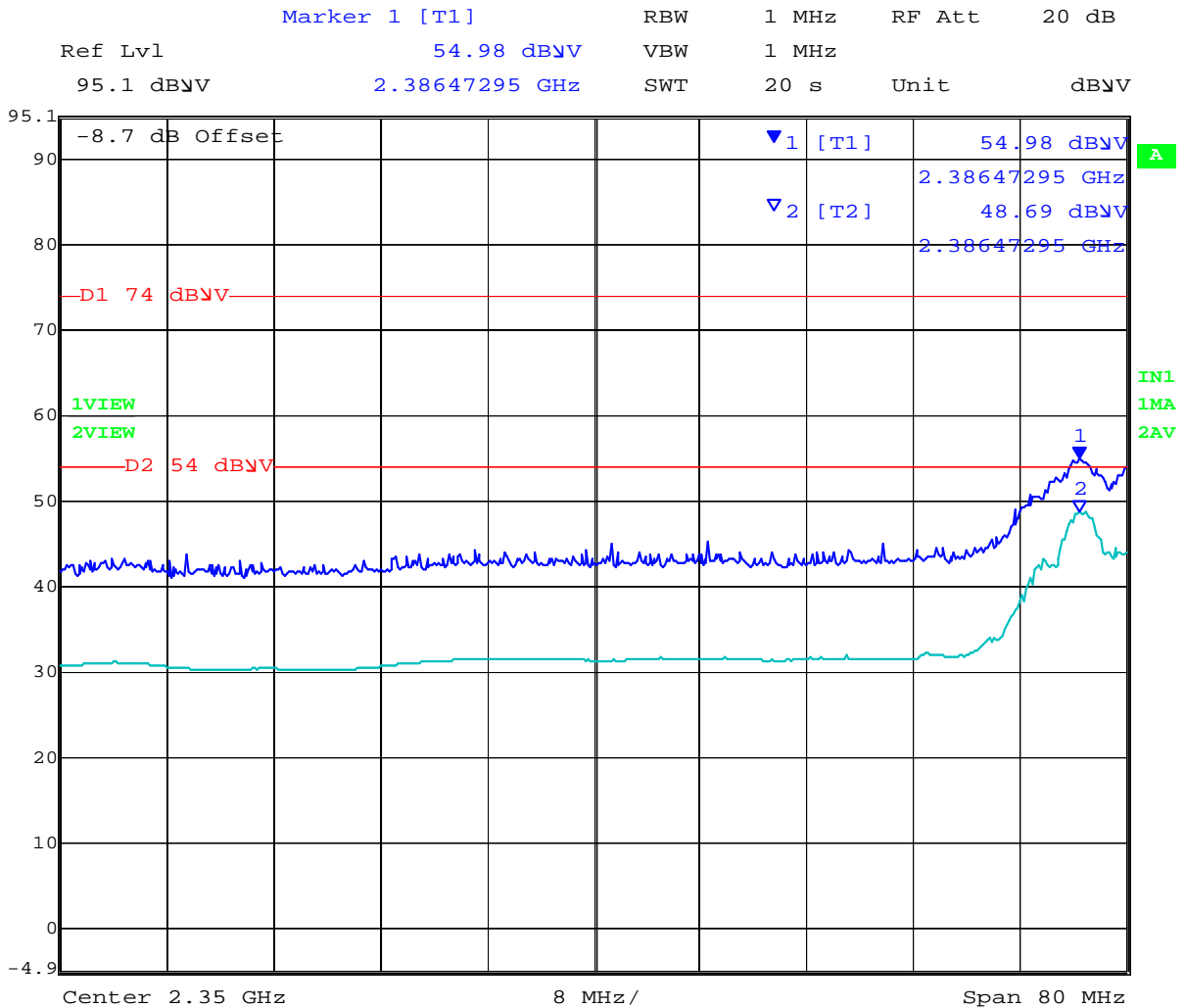

Date: 1.OCT.2012 15:22:48

This test report may be reproduced in full only. The document may only be updated by MiCOM Labs personnel. Any changes will be noted in the Document History section of the report.



Title: Digi ConnectCard for i.MX28 with Atheros AR6233
To: FCC 47 CFR Part 15.247 & IC RSS-210
Serial #: DIGI28-U2A Rev A
Issue Date: 29th March 2013
Page: 67 of 245

Test Freq.	2437 MHz	Engineer	JMH
Variant	802.11b; 1 Mbs	Temp (°C)	27
Freq. Range	1000 MHz - 18000 MHz	Rel. Hum.(%)	33
Power Setting	30	Press. (mBars)	1000
Antenna	pc.11	Duty Cycle (%)	100
Test Notes 1	3 dBi gain		
Test Notes 2	Single Port Module		

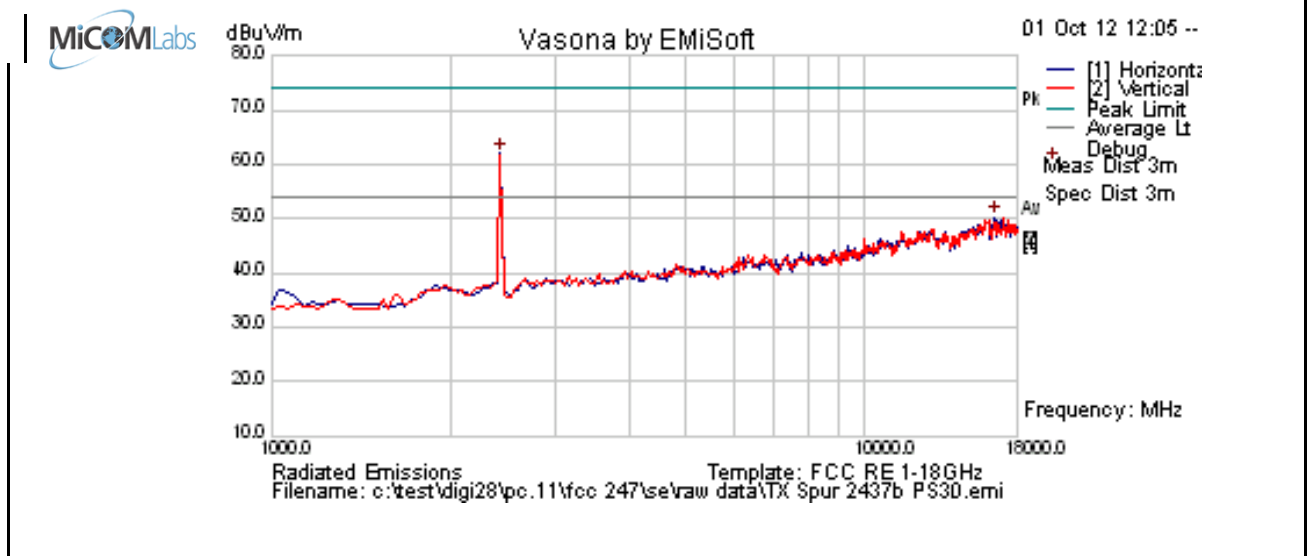

Formally measured emission peaks

Frequency MHz	Raw dBuV	Cable Loss	AF dB	Level dBuV/m	Measurement Type	Pol	Hgt cm	Azt Deg	Limit dBuV/m	Margin dB	Pass /Fail	Comments
2430.862	70.7	3.0	-11.6	62.1	Peak [Scan]	H	100					FUND
16535.07	41.1	8.8	0.4	50.3	Peak [Scan]	H	150	0	54.0	-3.7	Pass	Noise

Legend:	TX = Transmitter Emissions; DIG = Digital Emissions; FUND = Fundamental; WB = Wideband Emission
	RB = Restricted Band (15.209 Limits); NRB = Non Restricted Band, Limit is 20dB below fundamental peak

This test report may be reproduced in full only. The document may only be updated by MiCOM Labs personnel. Any changes will be noted in the Document History section of the report.



Title: Digi ConnectCard for i.MX28 with Atheros AR6233
To: FCC 47 CFR Part 15.247 & IC RSS-210
Serial #: DIGI28-U2A Rev A
Issue Date: 29th March 2013
Page: 68 of 245

Test Freq.	2462 MHz	Engineer	JMH
Variant	802.11b; 1 Mbs	Temp (°C)	27
Freq. Range	1000 MHz - 18000 MHz	Rel. Hum.(%)	33
Power Setting	30	Press. (mBars)	1000
Antenna	pc.11	Duty Cycle (%)	100
Test Notes 1	3 dBi gain		
Test Notes 2	Single Port Module		

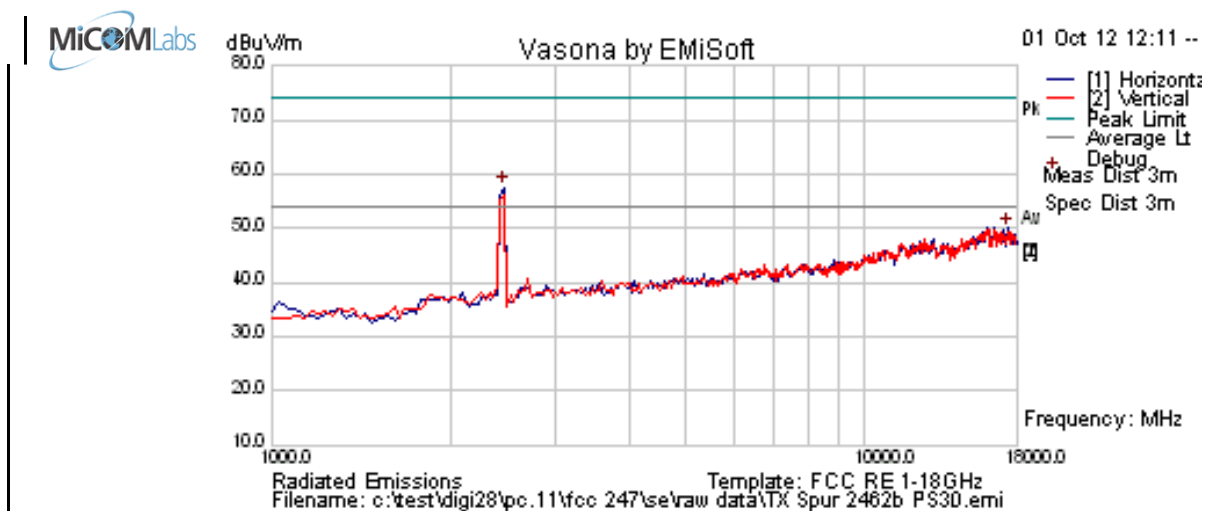

Formally measured emission peaks

Frequency MHz	Raw dBuV	Cable Loss	AF dB	Level dBuV/m	Measurement Type	Pol	Hgt cm	Azt Deg	Limit dBuV/m	Margin dB	Pass /Fail	Comments
2464.930	66.0	3.0	-11.5	57.5	Peak [Scan]	H	100					FUND
17420.842	40.0	8.7	1.3	50.0	Peak [Scan]	H	150	0	54.0	-4.0	Pass	Noise

Legend: TX = Transmitter Emissions; DIG = Digital Emissions; FUND = Fundamental; WB = Wideband Emission
 RB = Restricted Band (15.209 Limits); NRB = Non Restricted Band, Limit is 20dB below fundamental peak

This test report may be reproduced in full only. The document may only be updated by MiCOM Labs personnel. Any changes will be noted in the Document History section of the report.



Title: Digi ConnectCard for i.MX28 with Atheros AR6233
To: FCC 47 CFR Part 15.247 & IC RSS-210
Serial #: DIGI28-U2A Rev A
Issue Date: 29th March 2013
Page: 69 of 245

Band Edge

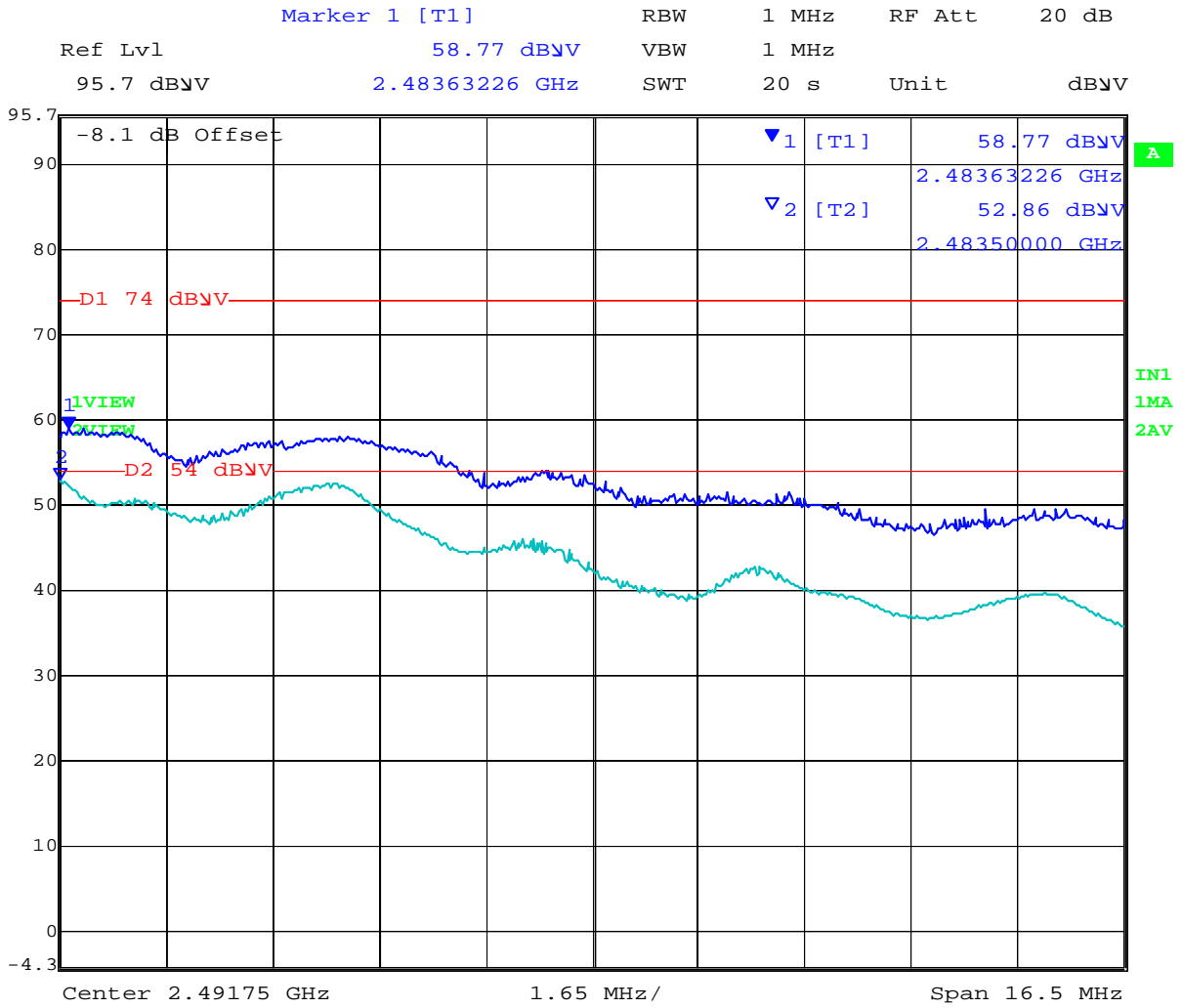

Date: 1.OCT.2012 15:27:36

This test report may be reproduced in full only. The document may only be updated by MiCOM Labs personnel. Any changes will be noted in the Document History section of the report.



Title: Digi ConnectCard for i.MX28 with Atheros AR6233
To: FCC 47 CFR Part 15.247 & IC RSS-210
Serial #: DIGI28-U2A Rev A
Issue Date: 29th March 2013
Page: 70 of 245

Test Freq.	2412 MHz	Engineer	JMH
Variant	802.11g; 6 Mbs	Temp (°C)	27
Freq. Range	1000 MHz - 18000 MHz	Rel. Hum.(%)	33
Power Setting	30	Press. (mBars)	1000
Antenna	pc.11	Duty Cycle (%)	100
Test Notes 1	Single Port Module		
Test Notes 2			

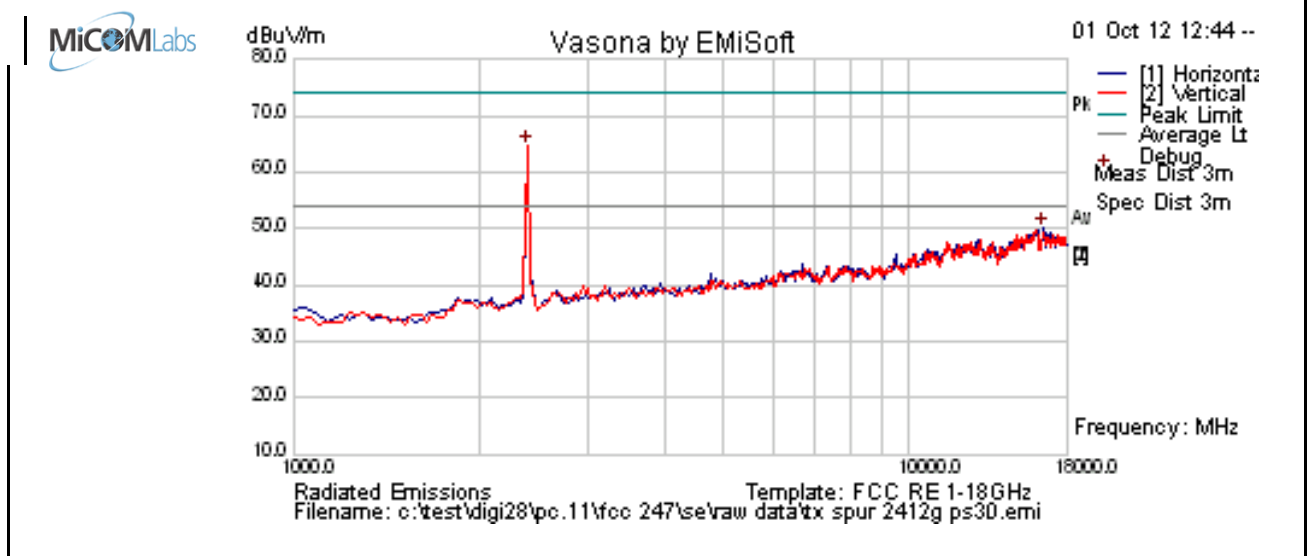

Formally measured emission peaks

Frequency MHz	Raw dBuV	Cable Loss	AF dB	Level dBuV/m	Measurement Type	Pol	Hgt cm	Azt Deg	Limit dBuV/m	Margin dB	Pass /Fail	Comments
2396.794	73.4	3.0	11.7	64.7	Peak [Scan]	V	100					FUND
16501.002	40.9	8.8	0.3	50.1	Peak [Scan]	H	100	0	54.0	-4.0	Pass	Noise

Legend: TX = Transmitter Emissions; DIG = Digital Emissions; FUND = Fundamental; WB = Wideband Emission
 RB = Restricted Band (15.209 Limits); NRB = Non Restricted Band, Limit is 20dB below fundamental peak

This test report may be reproduced in full only. The document may only be updated by MiCOM Labs personnel. Any changes will be noted in the Document History section of the report.



Title: Digi ConnectCard for i.MX28 with Atheros AR6233
To: FCC 47 CFR Part 15.247 & IC RSS-210
Serial #: DIGI28-U2A Rev A
Issue Date: 29th March 2013
Page: 71 of 245

Band Edge

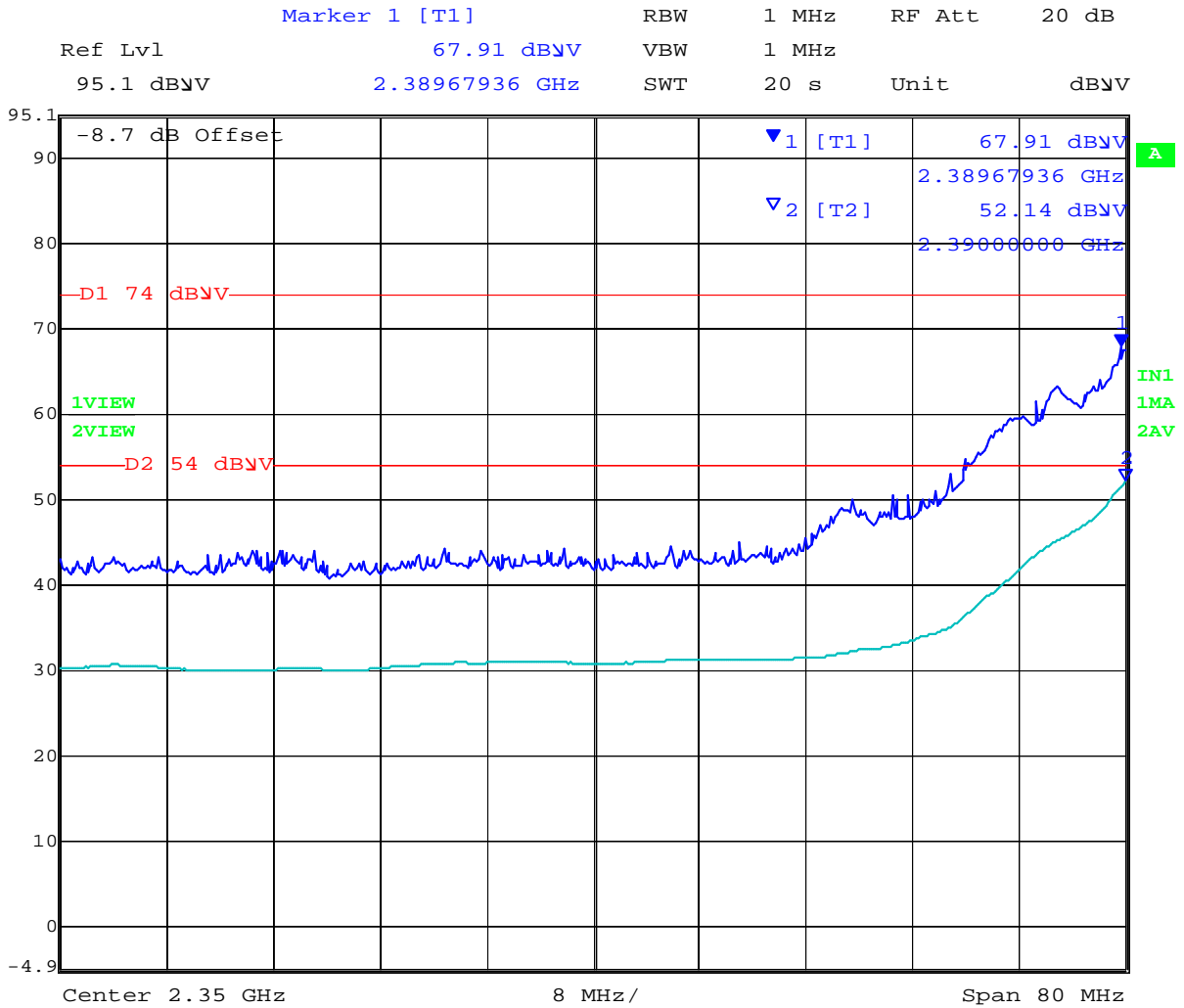

Date: 1.OCT.2012 15:20:12

Power reduction required in order to bring unit into compliance Power = 13

This test report may be reproduced in full only. The document may only be updated by MiCOM Labs personnel. Any changes will be noted in the Document History section of the report.



Title: Digi ConnectCard for i.MX28 with Atheros AR6233
To: FCC 47 CFR Part 15.247 & IC RSS-210
Serial #: DIGI28-U2A Rev A
Issue Date: 29th March 2013
Page: 72 of 245

Test Freq.	2437 MHz	Engineer	JMH
Variant	802.11g; 6 Mbs	Temp (°C)	27
Freq. Range	1000 MHz - 18000 MHz	Rel. Hum.(%)	33
Power Setting	30	Press. (mBars)	1000
Antenna	pc.11	Duty Cycle (%)	100
Test Notes 1	3 dBi gain		
Test Notes 2	Single Port Module		

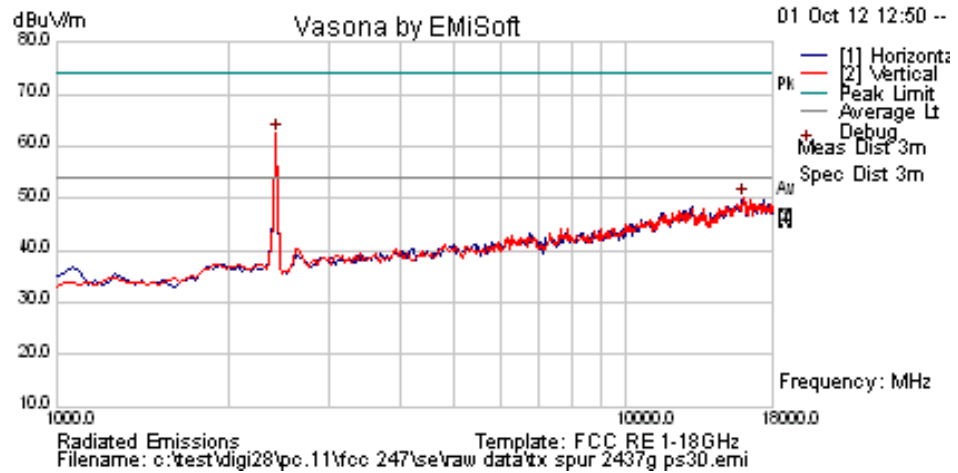

Formally measured emission peaks

Frequency MHz	Raw dBuV	Cable Loss	AF dB	Level dBuV/m	Measurement Type	Pol	Hgt cm	Azt Deg	Limit dBuV/m	Margin dB	Pass /Fail	Comments
2430.862	70.9	3.0	-11.6	62.4	Peak [Scan]	V	100					FUND
16024.048	40.8	9.0	0.2	50.1	Peak [Scan]	V	100	0	54.0	-3.9	Pass	Noise

Legend: TX = Transmitter Emissions; DIG = Digital Emissions; FUND = Fundamental; WB = Wideband Emission
 RB = Restricted Band (15.209 Limits); NRB = Non Restricted Band, Limit is 20dB below fundamental peak

This test report may be reproduced in full only. The document may only be updated by MiCOM Labs personnel. Any changes will be noted in the Document History section of the report.



Title: Digi ConnectCard for i.MX28 with Atheros AR6233
To: FCC 47 CFR Part 15.247 & IC RSS-210
Serial #: DIGI28-U2A Rev A
Issue Date: 29th March 2013
Page: 73 of 245

Test Freq.	2462 MHz	Engineer	JMH
Variant	802.11g; 6 Mbs	Temp (°C)	27
Freq. Range	1000 MHz - 18000 MHz	Rel. Hum.(%)	33
Power Setting	30	Press. (mBars)	1000
Antenna	pc.11	Duty Cycle (%)	100
Test Notes 1	3 dBi gain		
Test Notes 2	Single Port Module		

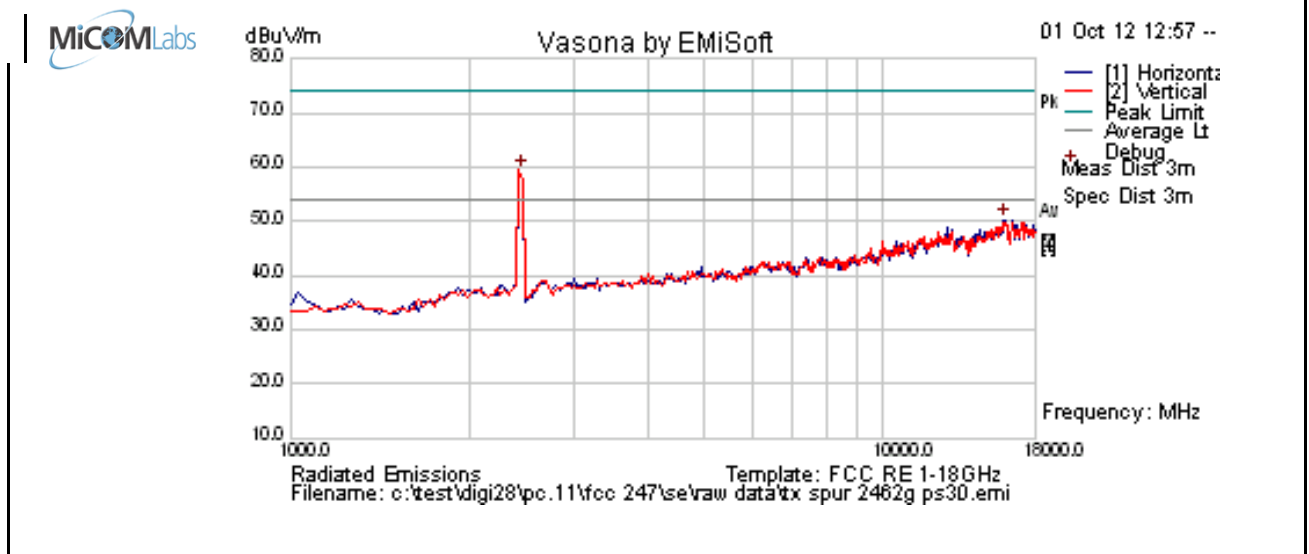

Formally measured emission peaks

Frequency MHz	Raw dBuV	Cable Loss	AF dB	Level dBuV/m	Measurement Type	Pol	Hgt cm	Azt Deg	Limit dBuV/m	Margin dB	Pass /Fail	Comments
2455.071	68.1	3.0	-11.5	59.5	Peak [Scan]	V	100					FUND
16024.048	41.0	9.0	0.2	50.2	Peak [Scan]	H	100	0	54.0	-3.8	Pass	Noise

Legend:	TX = Transmitter Emissions; DIG = Digital Emissions; FUND = Fundamental; WB = Wideband Emission
	RB = Restricted Band (15.209 Limits); NRB = Non Restricted Band, Limit is 20dB below fundamental peak

This test report may be reproduced in full only. The document may only be updated by MiCOM Labs personnel. Any changes will be noted in the Document History section of the report.



Title: Digi ConnectCard for i.MX28 with Atheros AR6233
To: FCC 47 CFR Part 15.247 & IC RSS-210
Serial #: DIGI28-U2A Rev A
Issue Date: 29th March 2013
Page: 74 of 245

Band Edge

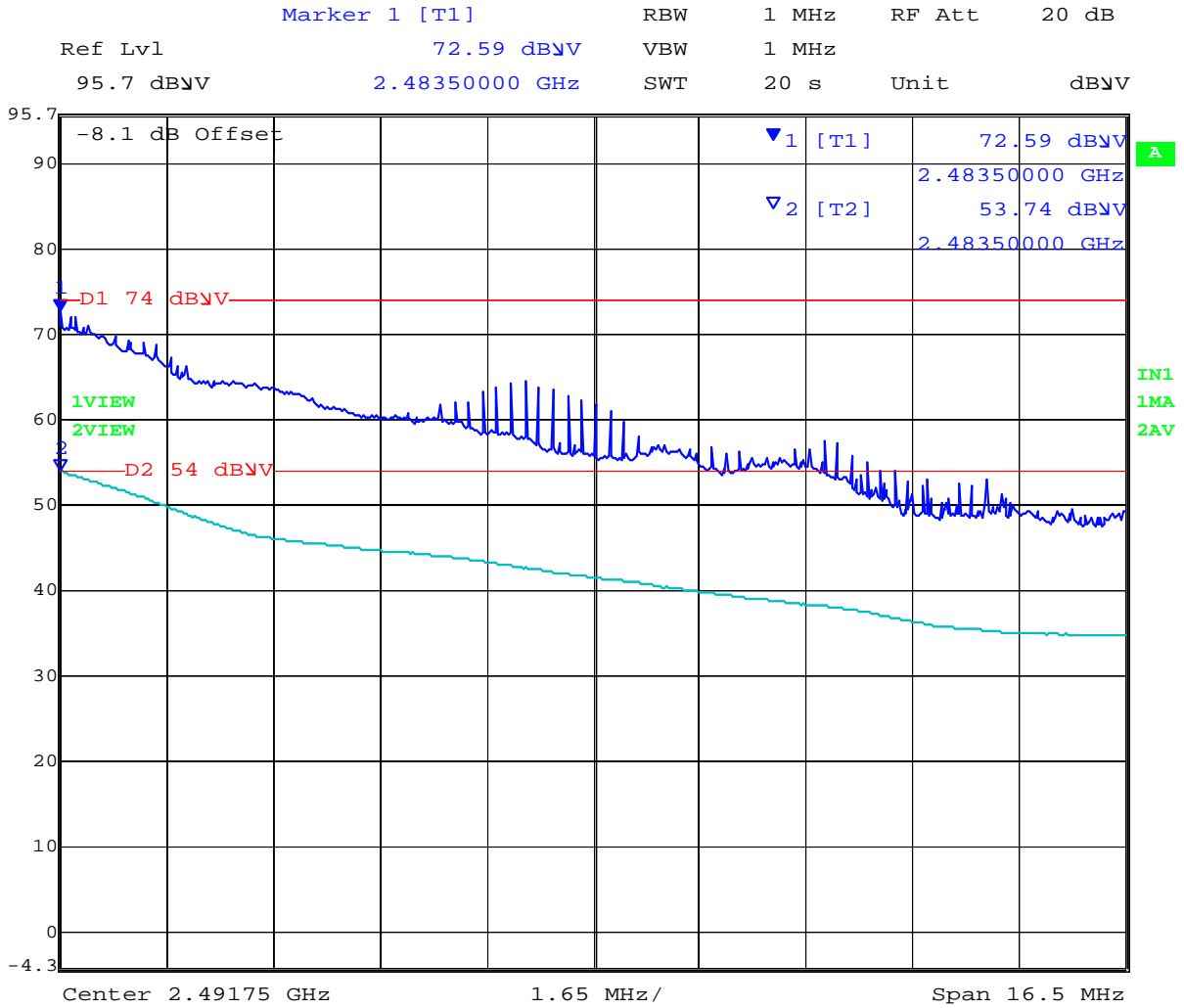

Date: 1.OCT.2012 15:33:20

Power reduction required in order to bring unit into compliance Power = 13

This test report may be reproduced in full only. The document may only be updated by MiCOM Labs personnel. Any changes will be noted in the Document History section of the report.



Title: Digi ConnectCard for i.MX28 with Atheros AR6233
To: FCC 47 CFR Part 15.247 & IC RSS-210
Serial #: DIGI28-U2A Rev A
Issue Date: 29th March 2013
Page: 75 of 245

Band Edge 802.11n HT20 2412

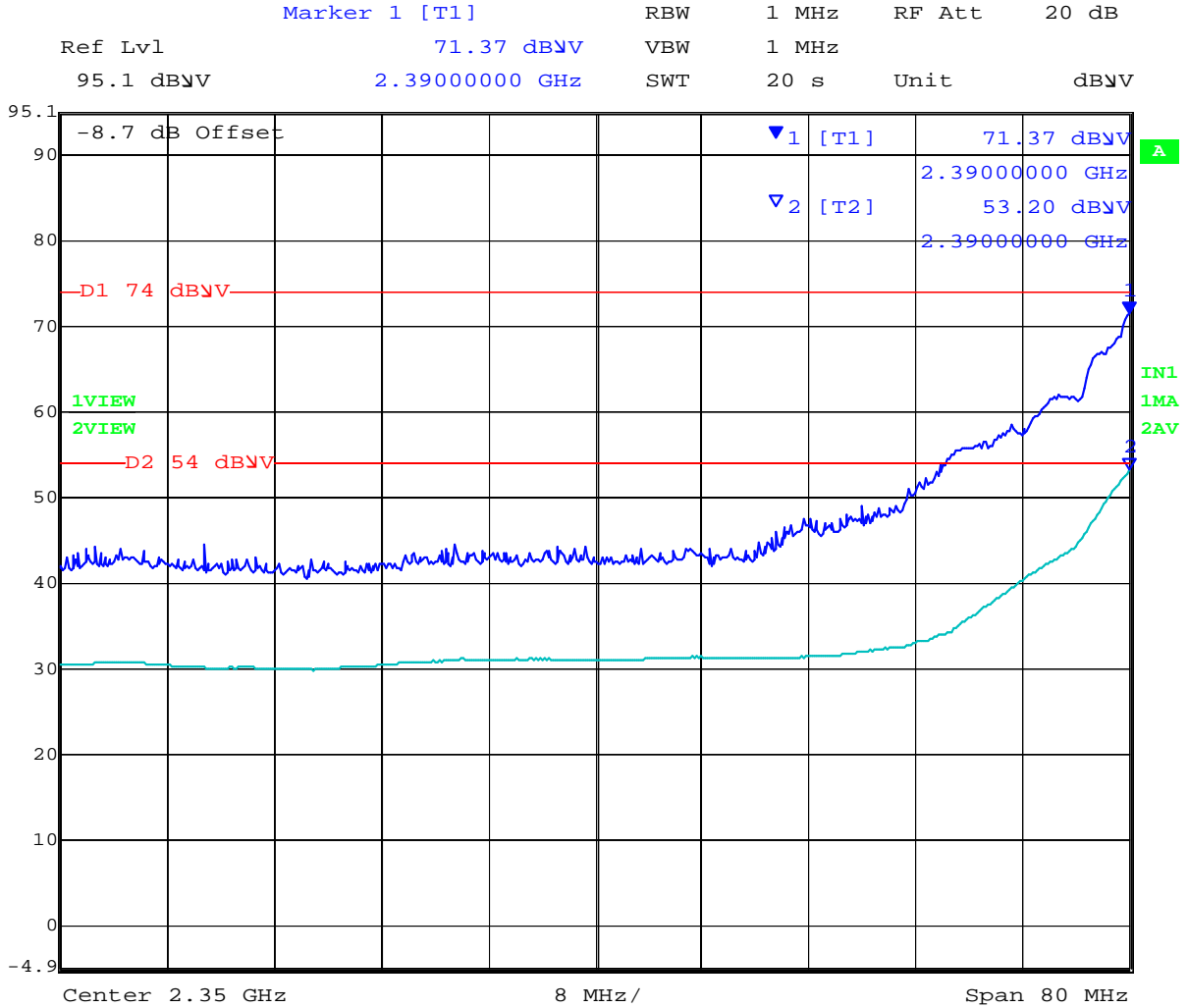

Date: 1.OCT.2012 15:17:05

Power reduction required in order to bring unit into compliance Power = 12

This test report may be reproduced in full only. The document may only be updated by MiCOM Labs personnel. Any changes will be noted in the Document History section of the report.



Title: Digi ConnectCard for i.MX28 with Atheros AR6233
To: FCC 47 CFR Part 15.247 & IC RSS-210
Serial #: DIGI28-U2A Rev A
Issue Date: 29th March 2013
Page: 76 of 245

Band Edge 802.11n HT20 2462

Marker 1 [T1] RBW 1 MHz RF Att 20 dB
Ref Lvl 70.87 dBμV VBW 1 MHz
95.7 dBμV 2.48366533 GHz SWT 20 s Unit dBμV

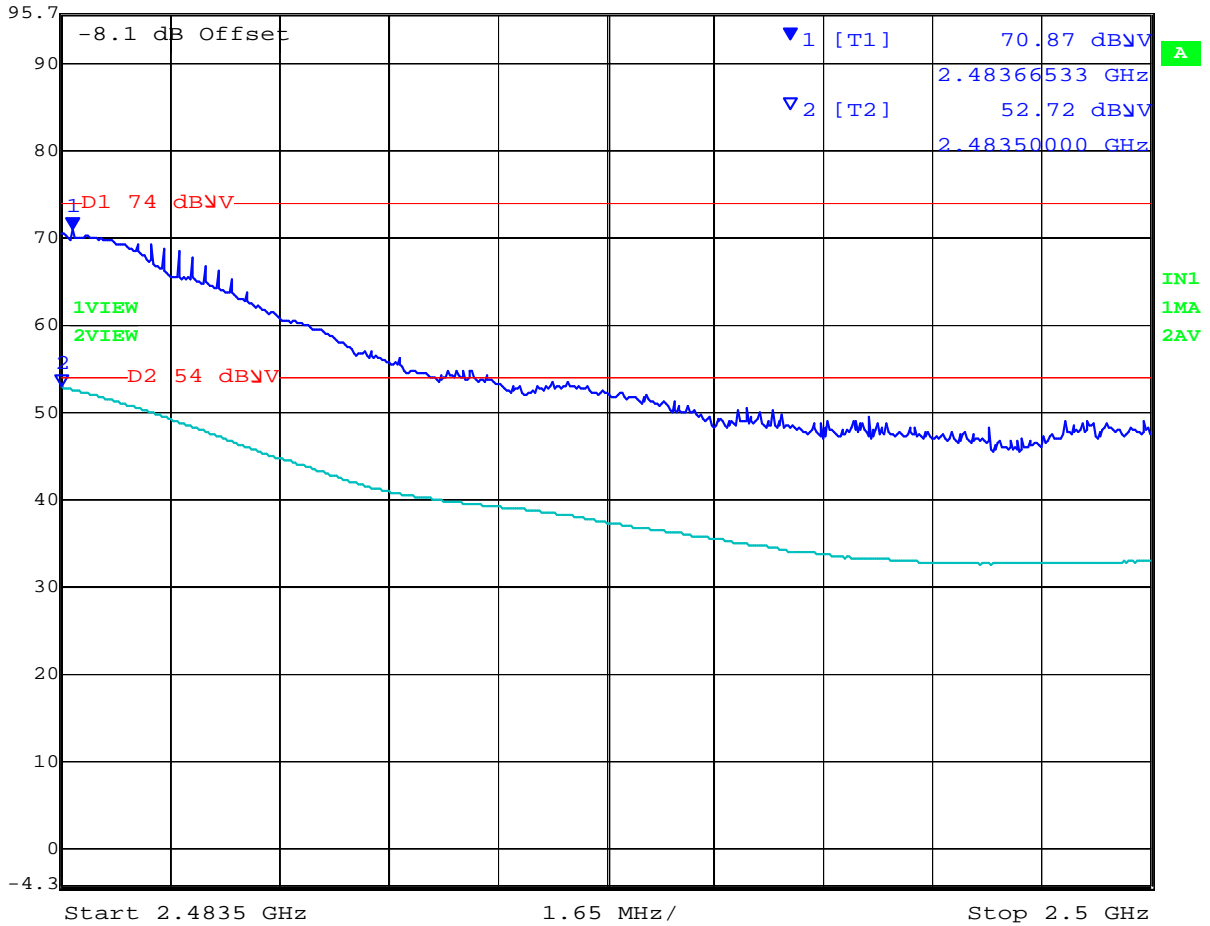

Date: 3.OCT.2012 11:42:00

Power reduction required in order to bring unit into compliance Power = 11

This test report may be reproduced in full only. The document may only be updated by MiCOM Labs personnel. Any changes will be noted in the Document History section of the report.



Title: Digi ConnectCard for i.MX28 with Atheros AR6233
To: FCC 47 CFR Part 15.247 & IC RSS-210
Serial #: DIGI28-U2A Rev A
Issue Date: 29th March 2013
Page: 77 of 245

Band Edge 802.11n HT40 2422

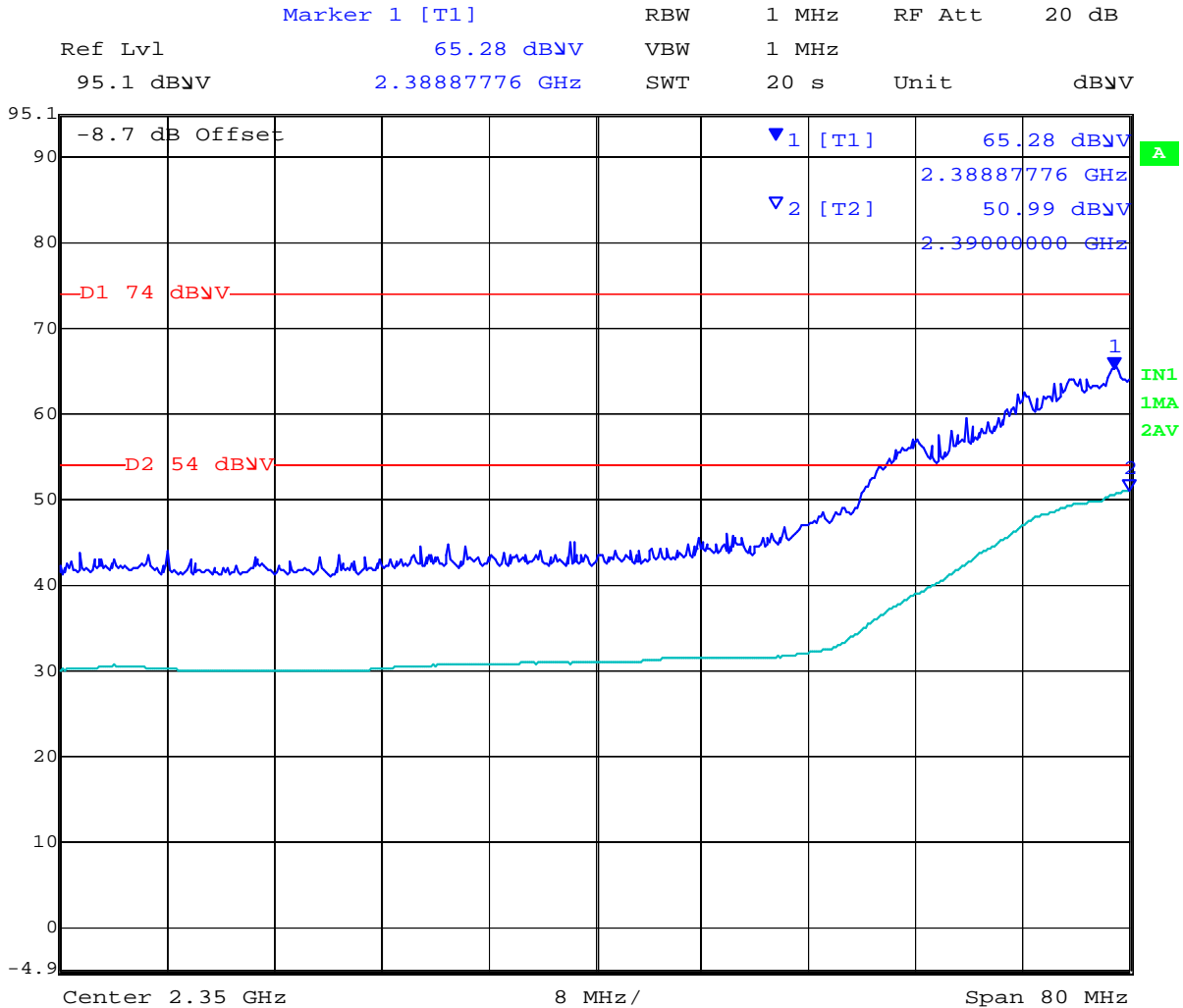

Date: 1.OCT.2012 15:05:12

Power reduction required in order to bring unit into compliance Power = 8

This test report may be reproduced in full only. The document may only be updated by MiCOM Labs personnel. Any changes will be noted in the Document History section of the report.



Title: Digi ConnectCard for i.MX28 with Atheros AR6233
To: FCC 47 CFR Part 15.247 & IC RSS-210
Serial #: DIGI28-U2A Rev A
Issue Date: 29th March 2013
Page: 78 of 245

Band Edge 802.11n HT40 2452

Marker 1 [T1] RBW 1 MHz RF Att 20 dB
Ref Lvl 66.39 dBµV VBW 1 MHz
95.7 dBµV 2.48779860 GHz SWT 20 s Unit dBµV

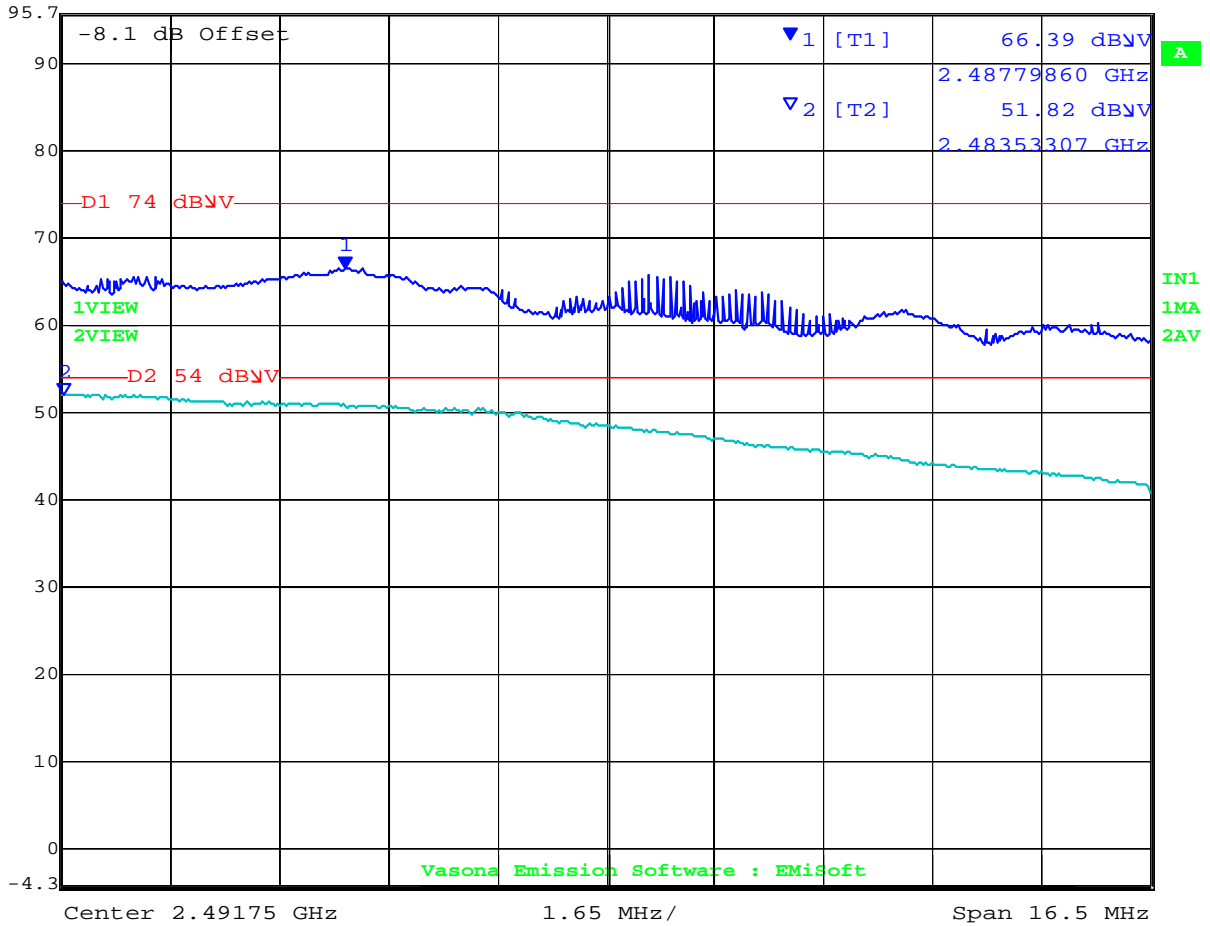

Date: 1.OCT.2012 14:17:15

Power reduction required in order to bring unit into compliance Power = 8

This test report may be reproduced in full only. The document may only be updated by MiCOM Labs personnel. Any changes will be noted in the Document History section of the report.



Title: Digi ConnectCard for i.MX28 with Atheros AR6233
To: FCC 47 CFR Part 15.247 & IC RSS-210
Serial #: DIGI28-U2A Rev A
Issue Date: 29th March 2013
Page: 79 of 245

Test Freq.	5745 MHz	Engineer	JMH
Variant	802.11a; 6.5 Mbs	Temp (°C)	27
Freq. Range	1000 MHz - 18000 MHz	Rel. Hum.(%)	33
Power Setting	30	Press. (mBars)	1000
Antenna	pc.11 patch	Duty Cycle (%)	100
Test Notes 1	4.5 dBi Gain		
Test Notes 2	Single Port Module		

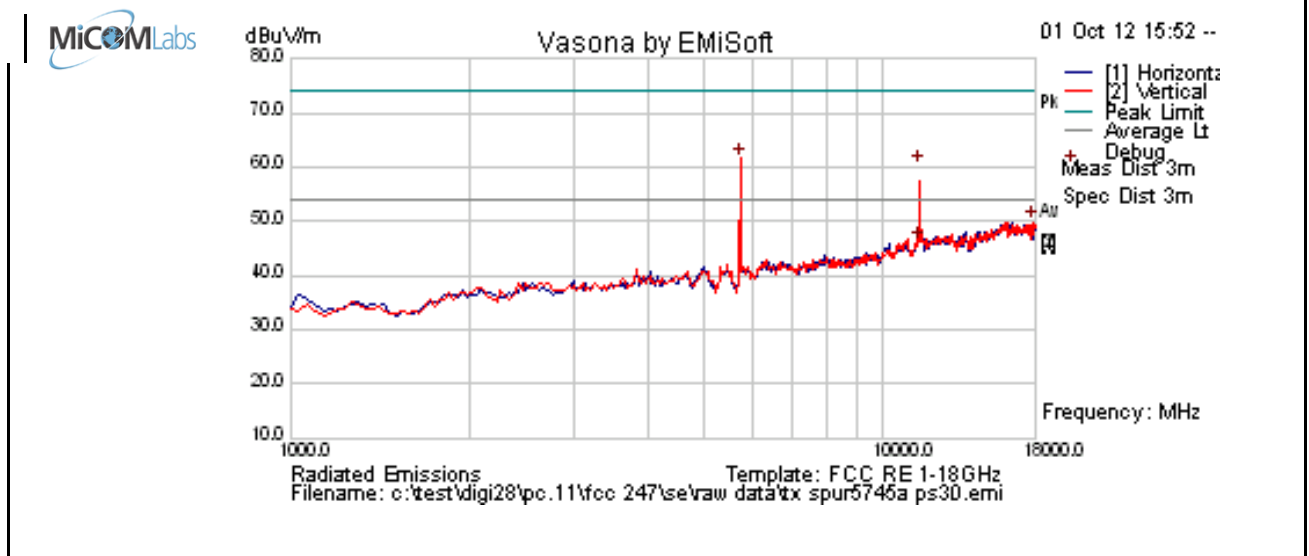

Formally measured emission peaks

Frequency MHz	Raw dBuV	Cable Loss	AF dB	Level dBuV/m	Measurement Type	Pol	Hgt cm	Azt Deg	Limit dBuV/m	Margin dB	Pass /Fail	Comments
5735.471	66.5	4.8	-9.5	61.7	Peak [Scan]	V	150					FUND
17863.727	40.7	8.8	0.3	49.8	Peak [Scan]	V	150	0	54.0	-4.2	Pass	Noise
11492.986	55.2	6.8	-2.0	60.0	Peak Max	V	108	12	74	-14.0	Pass	RB
11492.986	41.1	6.8	-2.0	45.9	Average Max	V	108	12	54	-8.1	Pass	RB

Legend: TX = Transmitter Emissions; DIG = Digital Emissions; FUND = Fundamental; WB = Wideband Emission
 RB = Restricted Band (15.209 Limits); NRB = Non Restricted Band, Limit is 20dB below fundamental peak

This test report may be reproduced in full only. The document may only be updated by MiCOM Labs personnel. Any changes will be noted in the Document History section of the report.



Title: Digi ConnectCard for i.MX28 with Atheros AR6233
To: FCC 47 CFR Part 15.247 & IC RSS-210
Serial #: DIGI28-U2A Rev A
Issue Date: 29th March 2013
Page: 80 of 245

Band Edge

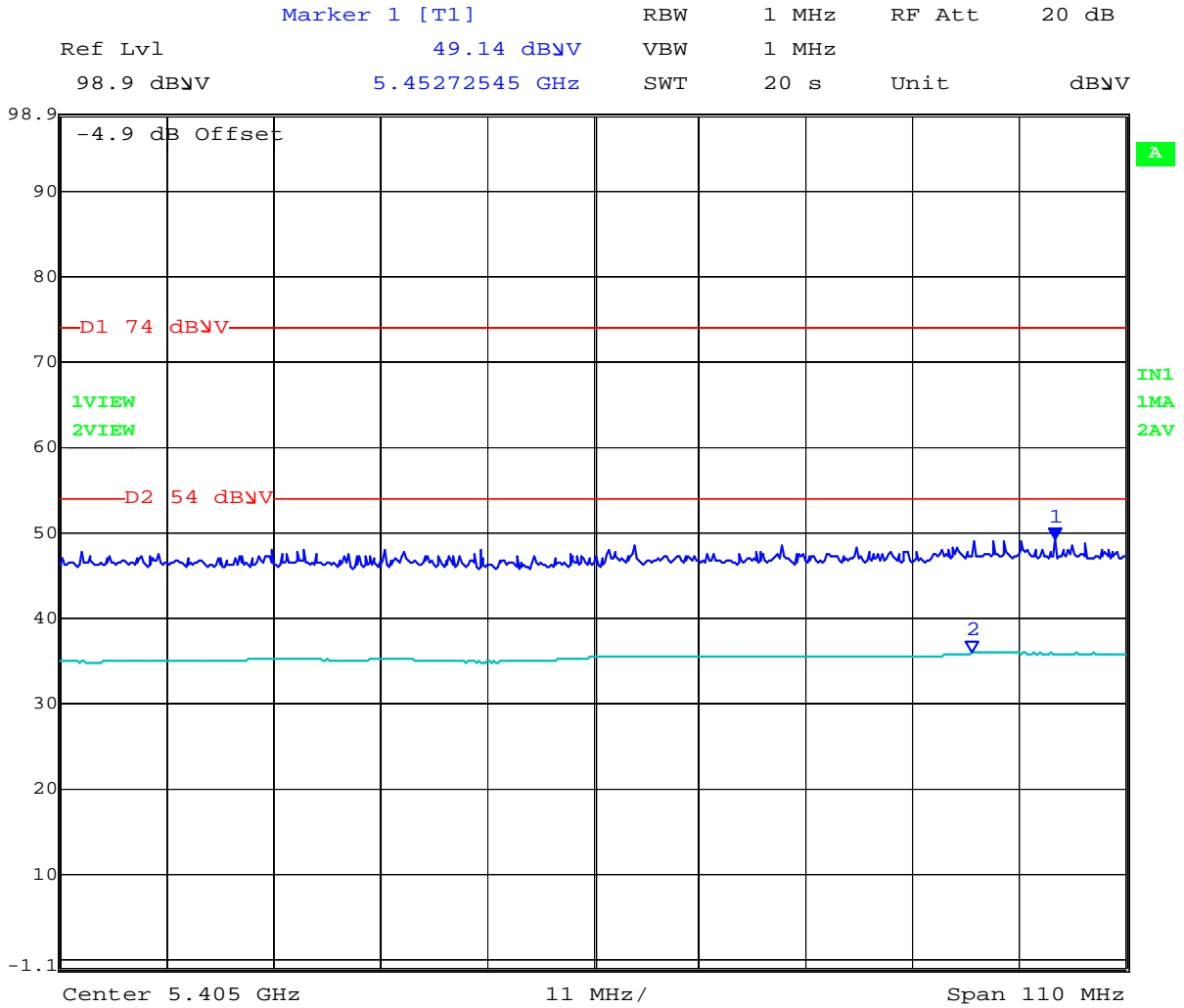

Date: 6.NOV.2012 12:45:46

This test report may be reproduced in full only. The document may only be updated by MiCOM Labs personnel. Any changes will be noted in the Document History section of the report.



Title: Digi ConnectCard for i.MX28 with Atheros AR6233
To: FCC 47 CFR Part 15.247 & IC RSS-210
Serial #: DIGI28-U2A Rev A
Issue Date: 29th March 2013
Page: 81 of 245

Test Freq.	5785 MHz	Engineer	JMH
Variant	802.11a; 6.5 Mbs	Temp (°C)	27
Freq. Range	1000 MHz - 18000 MHz	Rel. Hum.(%)	33
Power Setting	30	Press. (mBars)	1000
Antenna	pc.11 patch	Duty Cycle (%)	100
Test Notes 1	4.5 dBi Gain		
Test Notes 2	Single Port Module		

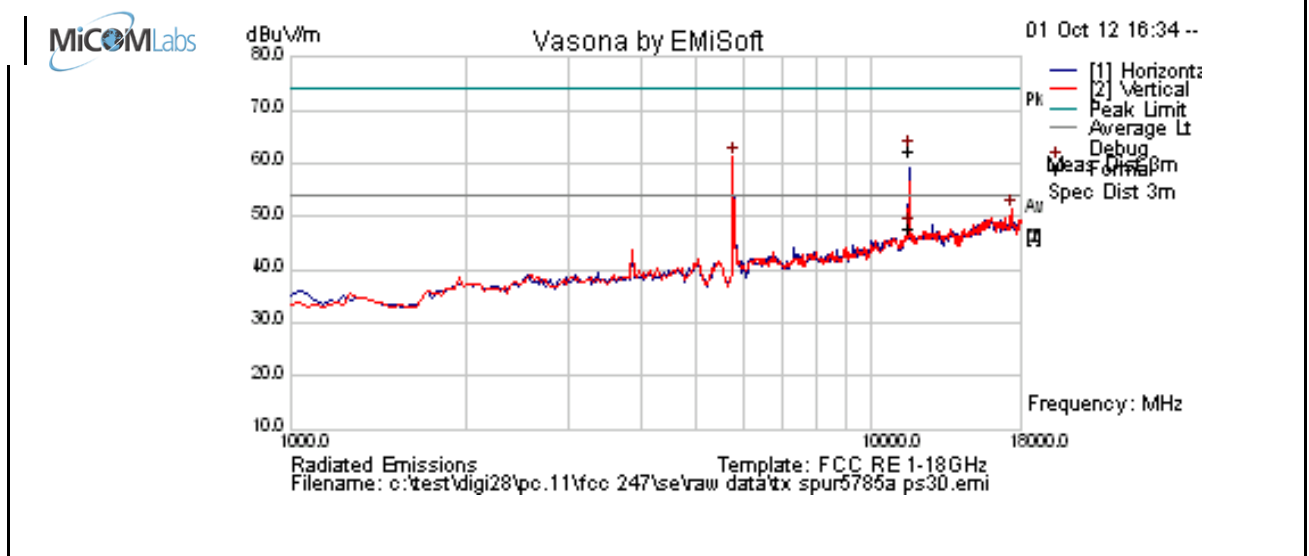

Formally measured emission peaks

Frequency MHz	Raw dBuV	Cable Loss	AF dB	Level dBuV/m	Measurement Type	Pol	Hgt cm	Azt Deg	Limit dBuV/m	Margin dB	Pass /Fail	Comments
5769.539	66.0	4.8	-9.5	61.3	Peak [Scan]	V	150					FUND
17352.705	41.3	8.7	1.3	51.4	Peak [Scan]	V	100	0	54.0	-2.6	Pass	Noise
11570.850	57.4	6.8	-2.0	62.2	Peak Max	H	98	16	74	-11.8	Pass	RB
11570.850	42.8	6.8	-2.0	47.6	Average Max	H	98	16	54	-6.4	Pass	RB

Legend: TX = Transmitter Emissions; DIG = Digital Emissions; FUND = Fundamental; WB = Wideband Emission
 RB = Restricted Band (15.209 Limits); NRB = Non Restricted Band, Limit is 20dB below fundamental peak

This test report may be reproduced in full only. The document may only be updated by MiCOM Labs personnel. Any changes will be noted in the Document History section of the report.



Title: Digi ConnectCard for i.MX28 with Atheros AR6233
To: FCC 47 CFR Part 15.247 & IC RSS-210
Serial #: DIGI28-U2A Rev A
Issue Date: 29th March 2013
Page: 82 of 245

Test Freq.	5825 MHz	Engineer	JMH
Variant	802.11a; 6.5 Mbs	Temp (°C)	27
Freq. Range	1000 MHz - 18000 MHz	Rel. Hum.(%)	33
Power Setting	30	Press. (mBars)	1000
Antenna	pc.11 patch	Duty Cycle (%)	100
Test Notes 1	4.5 dBi Gain		
Test Notes 2	Single Port Module		

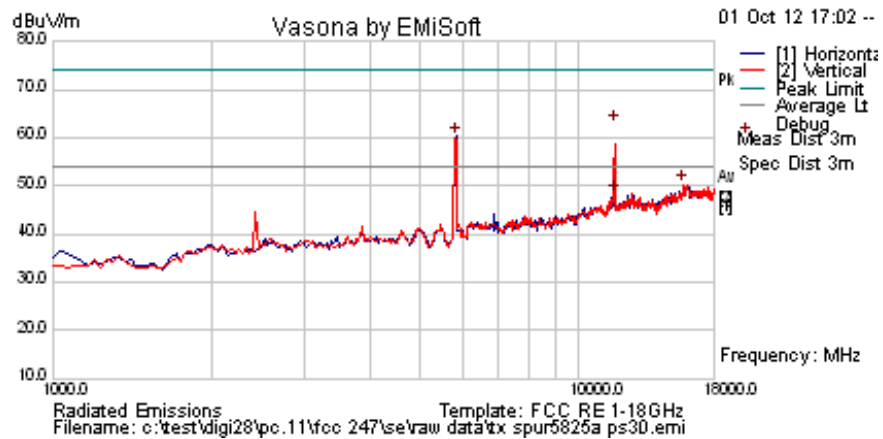

Formally measured emission peaks

Frequency MHz	Raw dBuV	Cable Loss	AF dB	Level dBuV/m	Measurement Type	Pol	Hgt cm	Azt Deg	Limit dBuV/m	Margin dB	Pass /Fail	Comments
5837.675	64.8	4.8	-9.3	60.4	Peak [Scan]	H	150					FUND
15785.571	41.8	8.7	-0.3	50.2	Peak [Scan]	V	150	0	54.0	-3.8	Pass	Noise
11650.742	58.3	6.8	-2.3	62.9	Peak Max	V	118	11	74	-11.1	Pass	RB
11650.742	43.5	6.8	-2.3	48.1	Average Max	V	118	11	54	-5.9	Pass	RB

Legend: TX = Transmitter Emissions; DIG = Digital Emissions; FUND = Fundamental; WB = Wideband Emission
 RB = Restricted Band (15.209 Limits); NRB = Non Restricted Band, Limit is 20dB below fundamental peak

This test report may be reproduced in full only. The document may only be updated by MiCOM Labs personnel. Any changes will be noted in the Document History section of the report.



Title: Digi ConnectCard for i.MX28 with Atheros AR6233
To: FCC 47 CFR Part 15.247 & IC RSS-210
Serial #: DIGI28-U2A Rev A
Issue Date: 29th March 2013
Page: 83 of 245

Band Edge: 802.11n; HT-20 5745

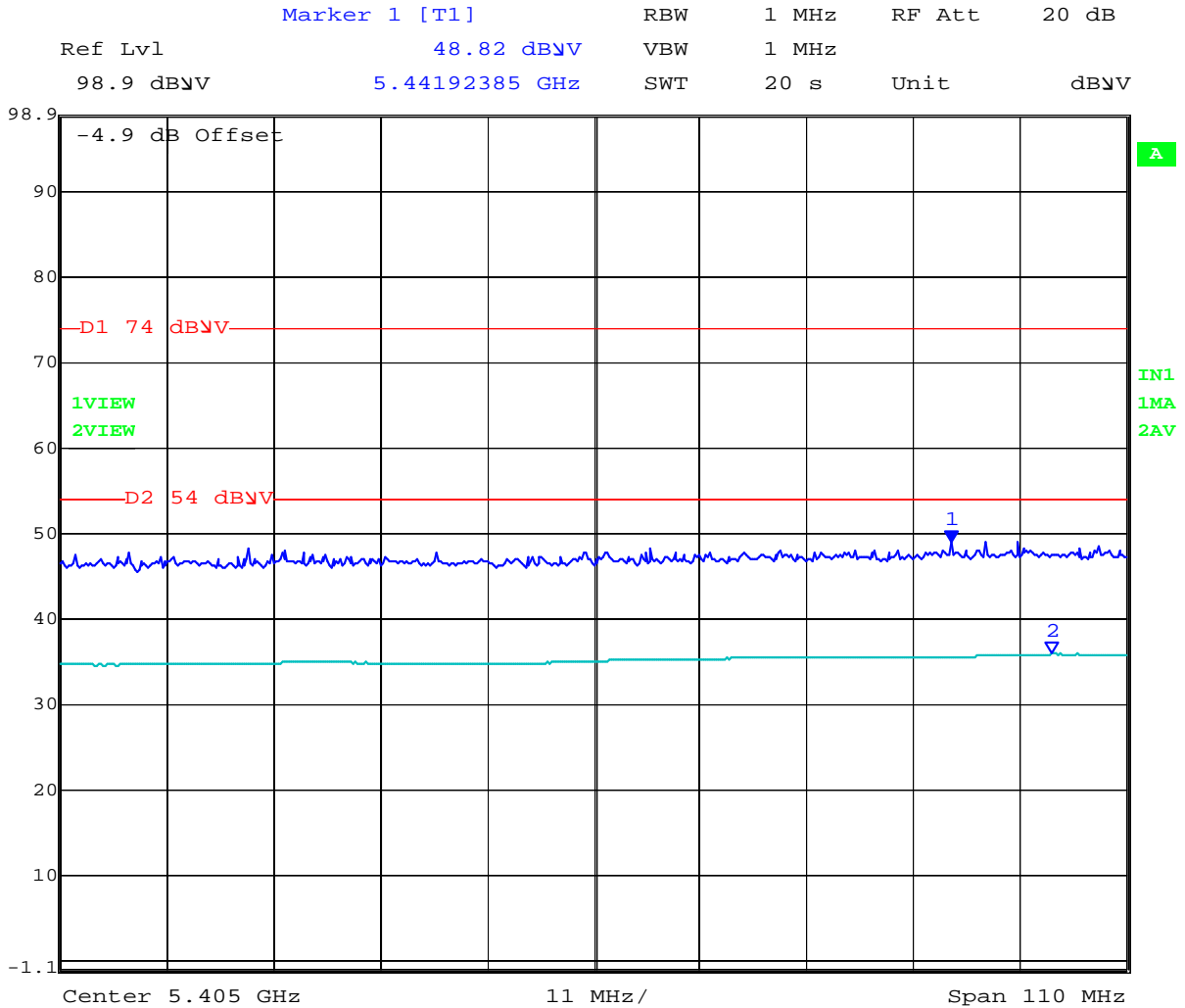

Date: 6.NOV.2012 12:49:37

This test report may be reproduced in full only. The document may only be updated by MiCOM Labs personnel. Any changes will be noted in the Document History section of the report.



Title: Digi ConnectCard for i.MX28 with Atheros AR6233
To: FCC 47 CFR Part 15.247 & IC RSS-210
Serial #: DIGI28-U2A Rev A
Issue Date: 29th March 2013
Page: 84 of 245

Band Edge: 802.11n; HT-40 5755

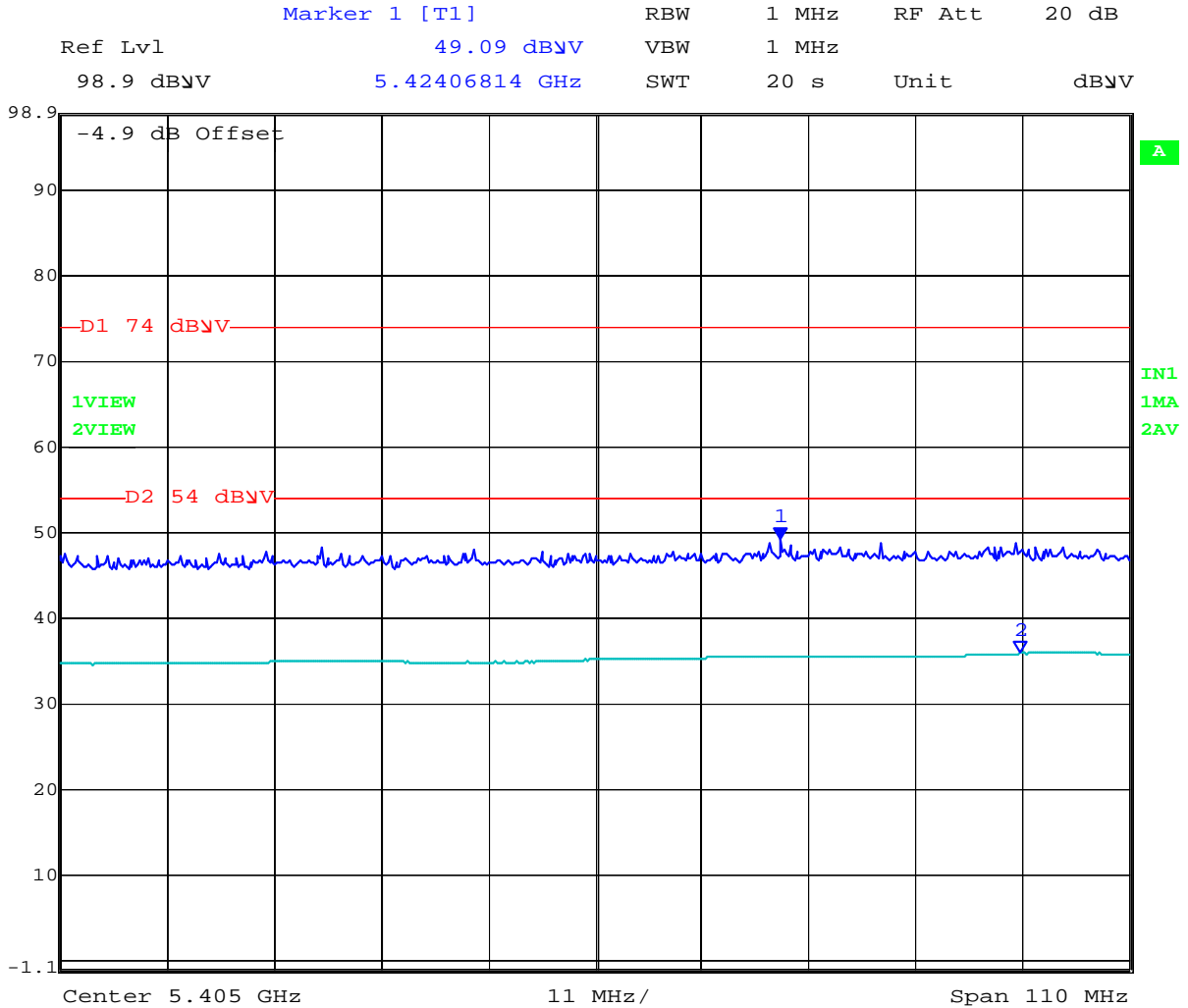

Date: 6.NOV.2012 12:52:03

This test report may be reproduced in full only. The document may only be updated by MiCOM Labs personnel. Any changes will be noted in the Document History section of the report.



Title: Digi ConnectCard for i.MX28 with Atheros AR6238
To: FCC 47 CFR Part 15.247 & IC RSS-210
Serial #: DIGI28-U2A Rev A
Issue Date: 29th March 2013
Page: 85 of 245

6.1.2.2. Dual Band Patch FXP.830 – Single Port Module

Test Freq.	2412 MHz	Engineer	JMH
Variant	802.11b; 1 Mbs	Temp (°C)	26
Freq. Range	1000 MHz - 18000 MHz	Rel. Hum.(%)	33
Power Setting	30	Press. (mBars)	1002
Antenna	FXP.830	Duty Cycle (%)	100
Test Notes 1	1.8 dBi gain		
Test Notes 2	Single Port Module		

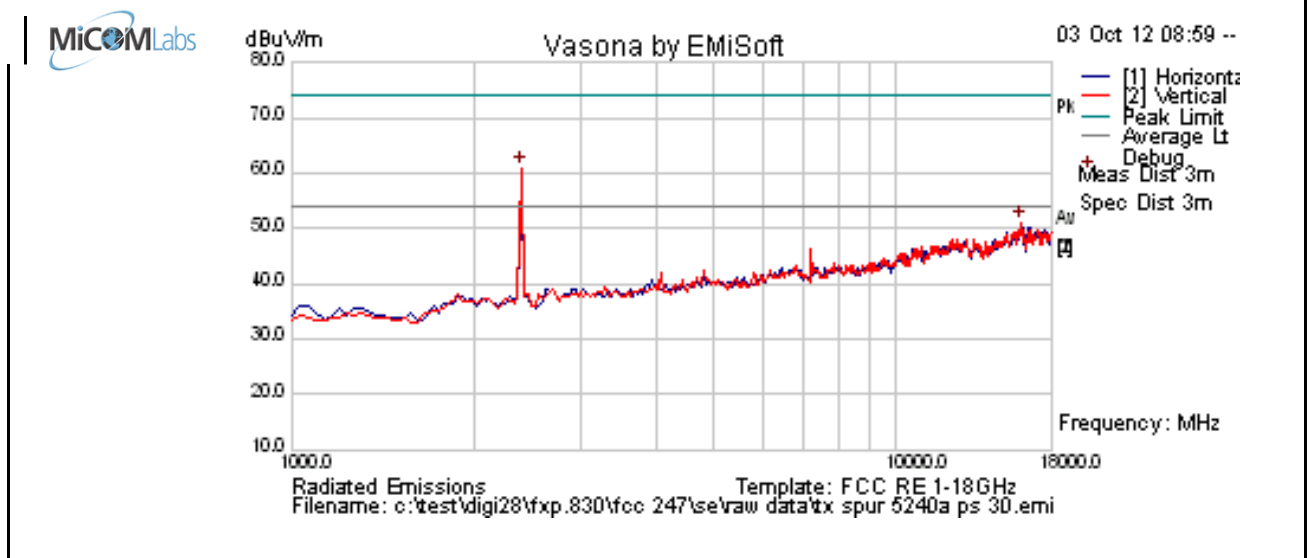

Formally measured emission peaks

Frequency MHz	Raw dBuV	Cable Loss	AF dB	Level dBuV/m	Measurement Type	Pol	Hgt cm	Azt Deg	Limit dBuV/m	Margin dB	Pass /Fail	Comments
2396.794	69.8	3.0	11.7	61.1	Peak [Scan]	V						FUND
15989.98	42.0	9.0	0.1	51.1	Peak [Scan]	H	150	0	54.0	-2.9	Pass	Noise

Legend: TX = Transmitter Emissions; DIG = Digital Emissions; FUND = Fundamental; WB = Wideband Emission
 RB = Restricted Band (15.209 Limits); NRB = Non Restricted Band, Limit is 20dB below fundamental peak

This test report may be reproduced in full only. The document may only be updated by MiCOM Labs personnel. Any changes will be noted in the Document History section of the report.



Title: Digi ConnectCard for i.MX28 with Atheros AR6233
To: FCC 47 CFR Part 15.247 & IC RSS-210
Serial #: DIGI28-U2A Rev A
Issue Date: 29th March 2013
Page: 86 of 245

Band Edge

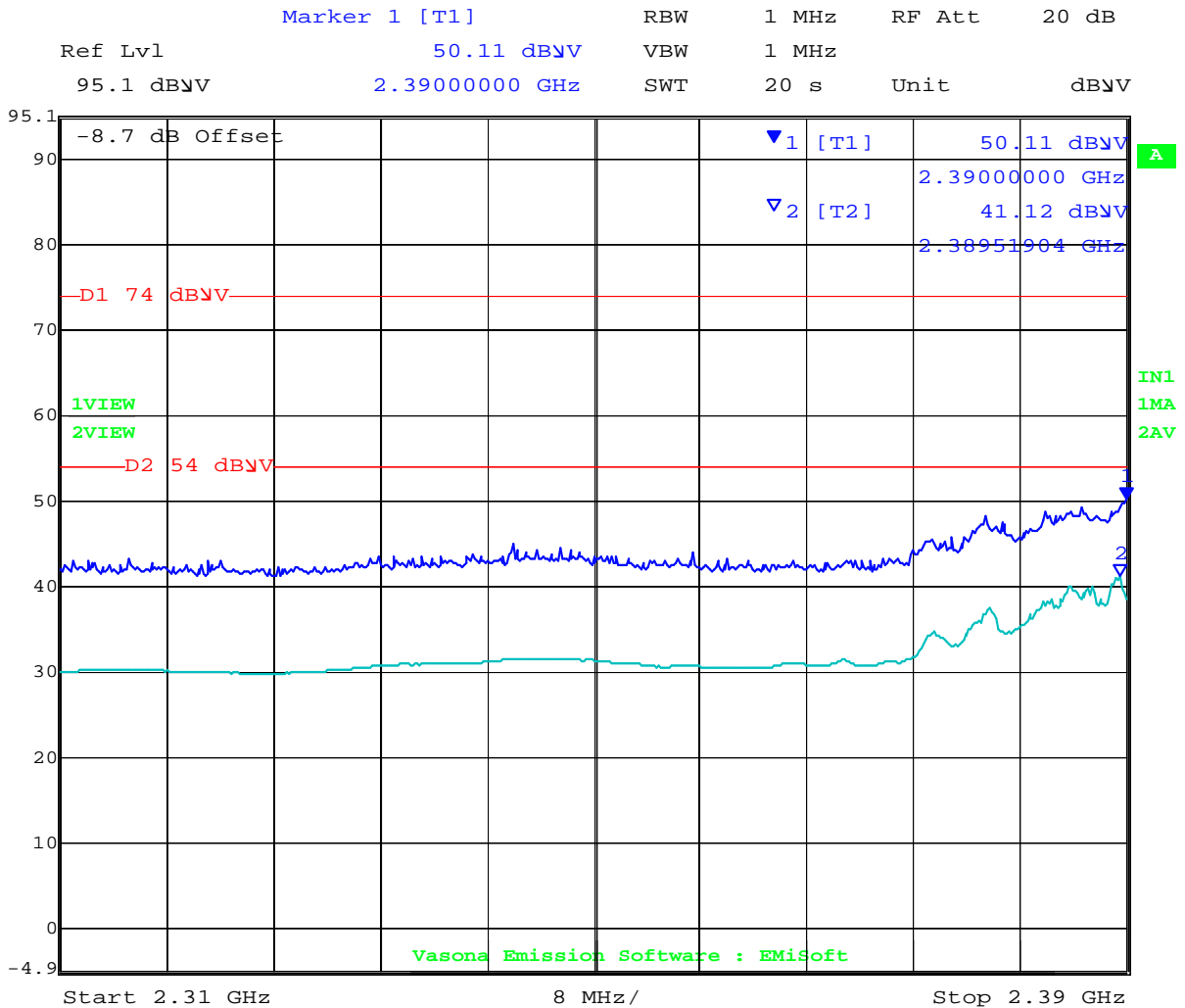

Date: 3.OCT.2012 11:27:26

This test report may be reproduced in full only. The document may only be updated by MiCOM Labs personnel. Any changes will be noted in the Document History section of the report.



Title: Digi ConnectCard for i.MX28 with Atheros AR6233
To: FCC 47 CFR Part 15.247 & IC RSS-210
Serial #: DIGI28-U2A Rev A
Issue Date: 29th March 2013
Page: 87 of 245

Test Freq.	2437 MHz	Engineer	JMH
Variant	802.11b; 1 Mbs	Temp (°C)	26
Freq. Range	1000 MHz - 18000 MHz	Rel. Hum.(%)	33
Power Setting	30	Press. (mBars)	1002
Antenna	FXP.830	Duty Cycle (%)	100
Test Notes 1	1.8 dBi gain		
Test Notes 2	Single Port Module		

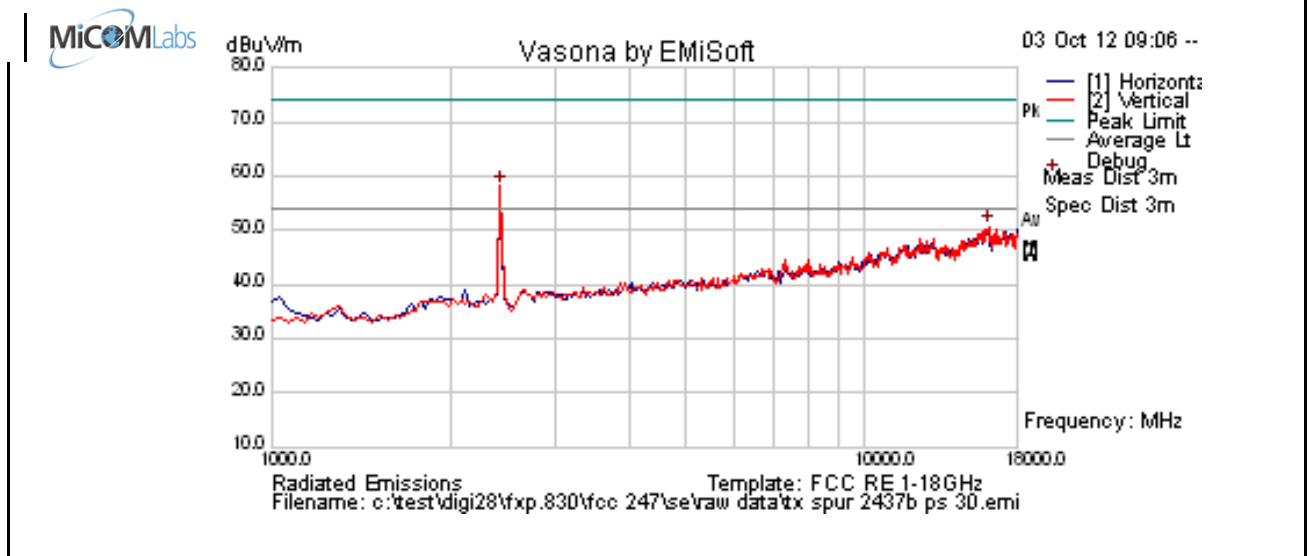

Formally measured emission peaks

Frequency MHz	Raw dBuV	Cable Loss	AF dB	Level dBuV/m	Measurement Type	Pol	Hgt cm	Azt Deg	Limit dBuV/m	Margin dB	Pass /Fail	Comments
2430.862	66.7	3.0	-11.6	58.1	Peak [Scan]	V						FUND
16160.321	41.6	9.0	0.2	50.7	Peak [Scan]	V	150	0	54.0	-3.3	Pass	Noise

Legend: TX = Transmitter Emissions; DIG = Digital Emissions; FUND = Fundamental; WB = Wideband Emission
 RB = Restricted Band (15.209 Limits); NRB = Non Restricted Band, Limit is 20dB below fundamental peak

This test report may be reproduced in full only. The document may only be updated by MiCOM Labs personnel. Any changes will be noted in the Document History section of the report.



Title: Digi ConnectCard for i.MX28 with Atheros AR6233
To: FCC 47 CFR Part 15.247 & IC RSS-210
Serial #: DIGI28-U2A Rev A
Issue Date: 29th March 2013
Page: 88 of 245

Test Freq.	2462 MHz	Engineer	JMH
Variant	802.11b; 1 Mbs	Temp (°C)	26
Freq. Range	1000 MHz - 18000 MHz	Rel. Hum.(%)	33
Power Setting	30	Press. (mBars)	1002
Antenna	FXP.830	Duty Cycle (%)	100
Test Notes 1	1.8 dBi gain		
Test Notes 2	Single Port Module		

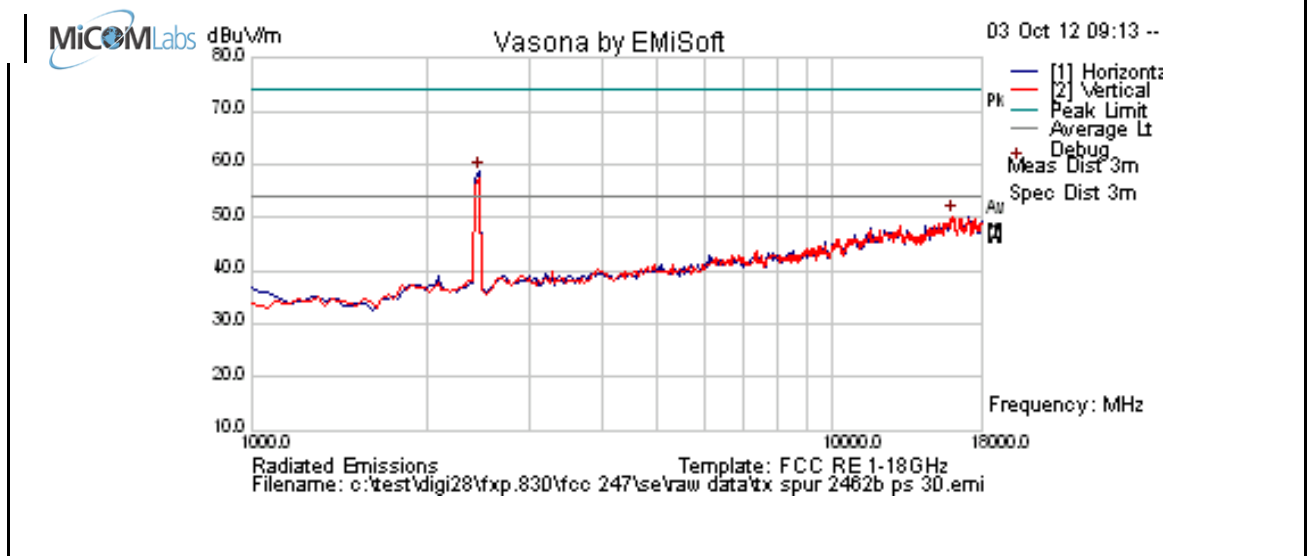

Formally measured emission peaks

Frequency MHz	Raw dBuV	Cable Loss	AF dB	Level dBuV/m	Measurement Type	Pol	Hgt cm	Azt Deg	Limit dBuV/m	Margin dB	Pass /Fail	Comments
2464.930	67.1	3.0	-11.5	58.6	Peak [Scan]	H	100					FUND
16058.116	41.0	9.0	0.3	50.2	Peak [Scan]	H	150	0	54.0	-3.8	Pass	

Legend:	TX = Transmitter Emissions; DIG = Digital Emissions; FUND = Fundamental; WB = Wideband Emission
	RB = Restricted Band (15.209 Limits); NRB = Non Restricted Band, Limit is 20dB below fundamental peak

This test report may be reproduced in full only. The document may only be updated by MiCOM Labs personnel. Any changes will be noted in the Document History section of the report.



Title: Digi ConnectCard for i.MX28 with Atheros AR6233
To: FCC 47 CFR Part 15.247 & IC RSS-210
Serial #: DIGI28-U2A Rev A
Issue Date: 29th March 2013
Page: 89 of 245

Band Edge

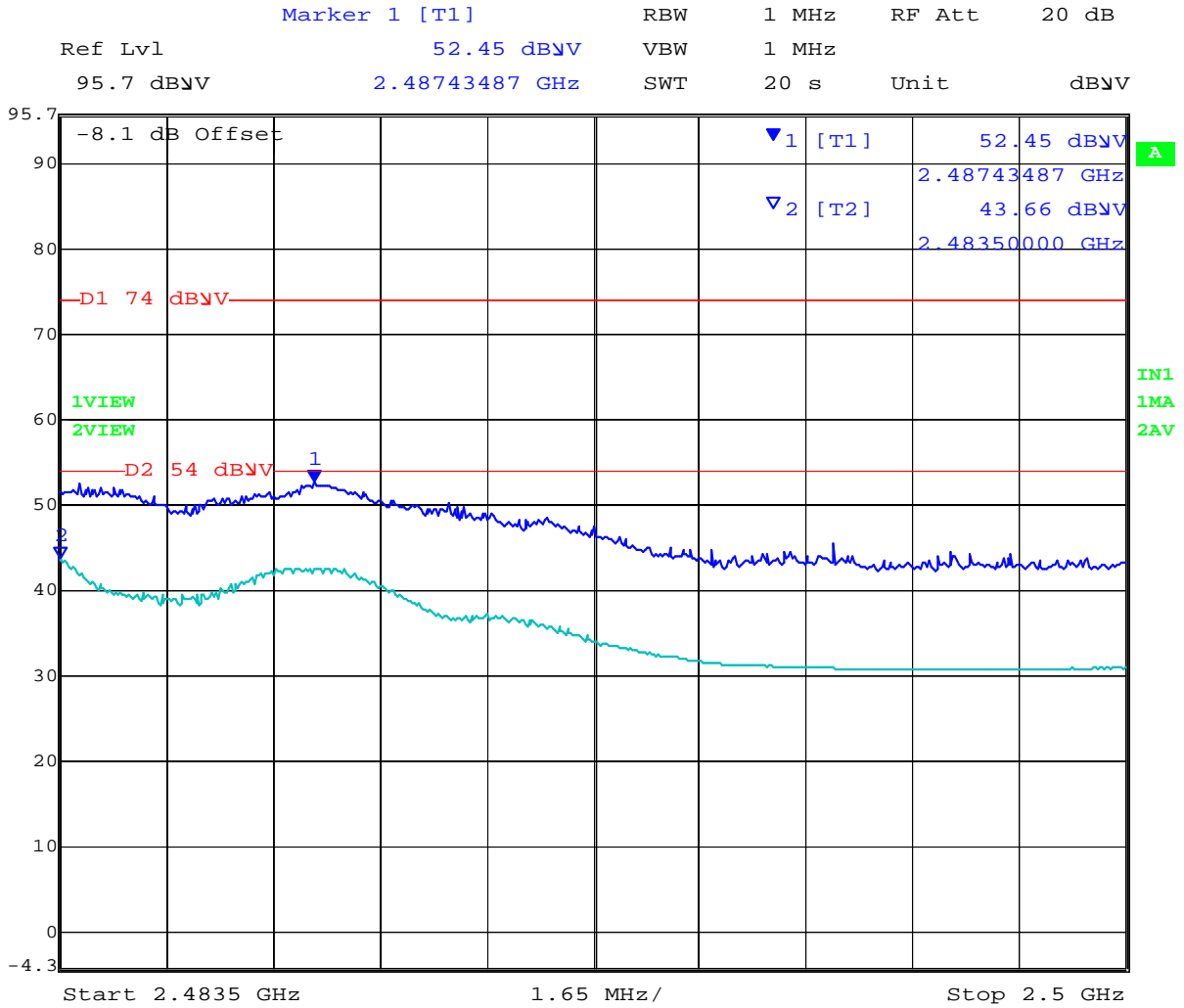

Date: 3.OCT.2012 11:35:32

This test report may be reproduced in full only. The document may only be updated by MiCOM Labs personnel. Any changes will be noted in the Document History section of the report.



Title: Digi ConnectCard for i.MX28 with Atheros AR6233
To: FCC 47 CFR Part 15.247 & IC RSS-210
Serial #: DIGI28-U2A Rev A
Issue Date: 29th March 2013
Page: 90 of 245

Test Freq.	2412 MHz	Engineer	JMH
Variant	802.11g; 6 Mbs	Temp (°C)	26
Freq. Range	1000 MHz - 18000 MHz	Rel. Hum.(%)	33
Power Setting	30	Press. (mBars)	1002
Antenna	FXP.830	Duty Cycle (%)	100
Test Notes 1	1.8 dBi		
Test Notes 2	Single Port Module		

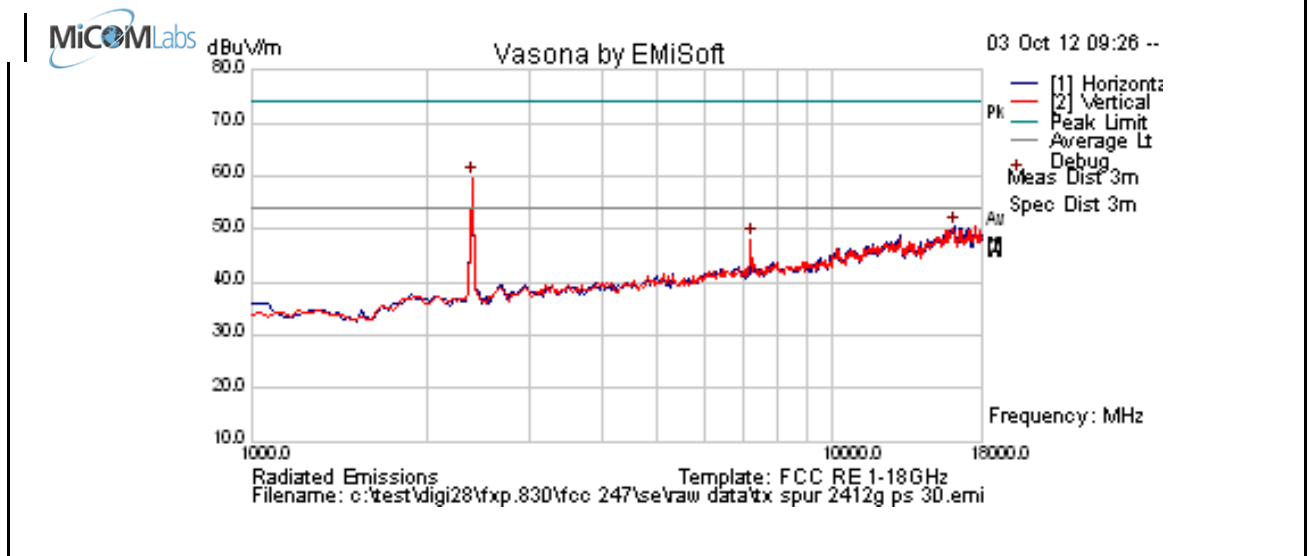

Formally measured emission peaks

Frequency MHz	Raw dBuV	Cable Loss	AF dB	Level dBuV/m	Measurement Type	Pol	Hgt cm	Azt Deg	Limit dBuV/m	Margin dB	Pass /Fail	Comments
2396.794	68.3	3.0	-11.7	59.6	Peak [Scan]	V						FUND
16126.253	41.3	9.0	0.2	50.4	Peak [Scan]	H	100	0	54.0	-3.6	Pass	Noise
7234.469	48.5	5.4	-5.8	48.1	Peak [Scan]	V					Pass	NRB

Legend: TX = Transmitter Emissions; DIG = Digital Emissions; FUND = Fundamental; WB = Wideband Emission
 RB = Restricted Band (15.209 Limits); NRB = Non Restricted Band, Limit is 20dB below fundamental peak

This test report may be reproduced in full only. The document may only be updated by MiCOM Labs personnel. Any changes will be noted in the Document History section of the report.



Title: Digi ConnectCard for i.MX28 with Atheros AR6233
To: FCC 47 CFR Part 15.247 & IC RSS-210
Serial #: DIGI28-U2A Rev A
Issue Date: 29th March 2013
Page: 91 of 245

Band Edge

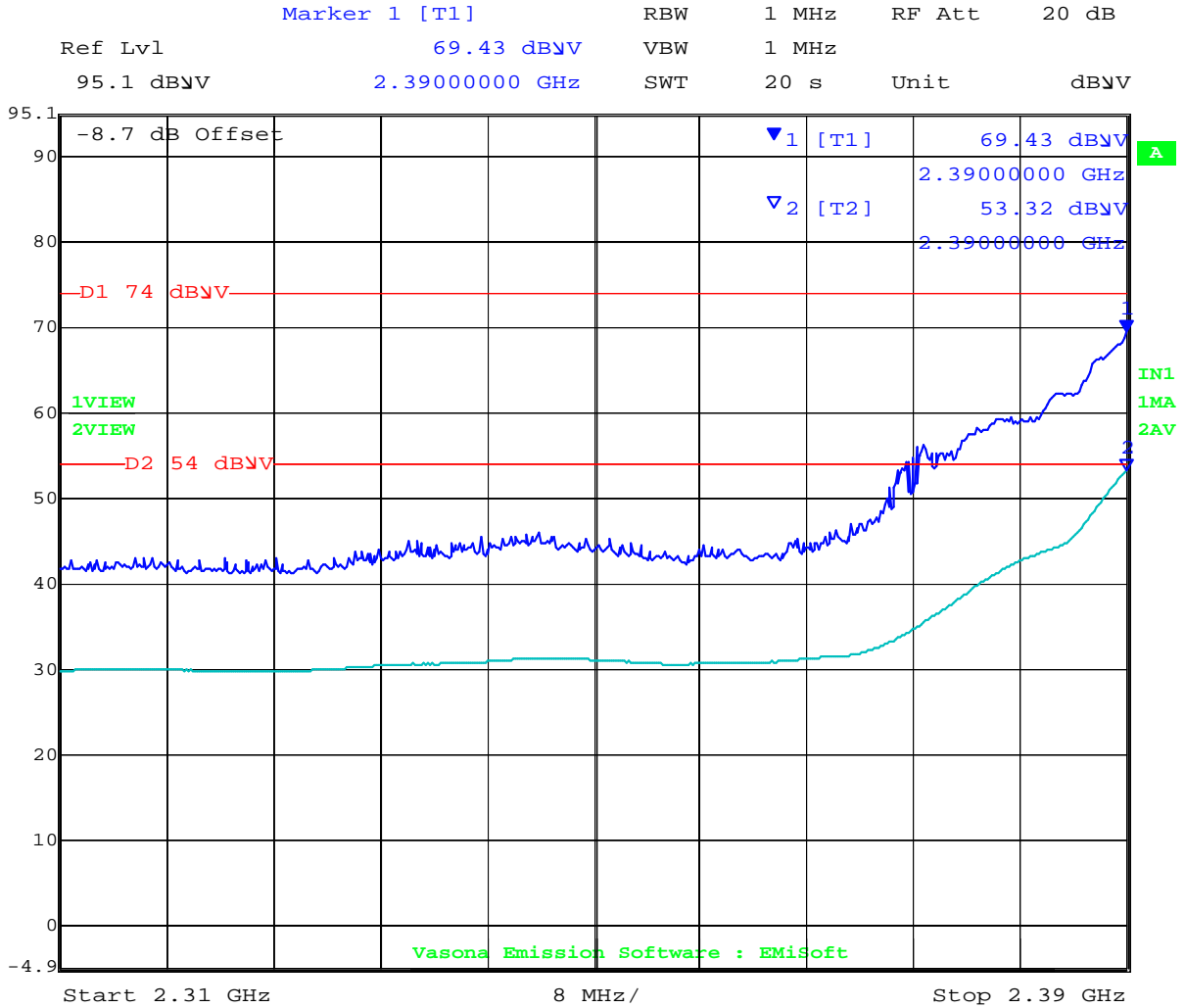

Date: 3.OCT.2012 11:25:05

Power reduction required in order to bring unit into compliance Power = 14

This test report may be reproduced in full only. The document may only be updated by MiCOM Labs personnel. Any changes will be noted in the Document History section of the report.



Title: Digi ConnectCard for i.MX28 with Atheros AR6233
To: FCC 47 CFR Part 15.247 & IC RSS-210
Serial #: DIGI28-U2A Rev A
Issue Date: 29th March 2013
Page: 92 of 245

Test Freq.	2437 MHz	Engineer	JMH
Variant	802.11g; 6 Mbs	Temp (°C)	26
Freq. Range	1000 MHz - 18000 MHz	Rel. Hum.(%)	33
Power Setting	30	Press. (mBars)	1002
Antenna	FXP.830	Duty Cycle (%)	100
Test Notes 1	1.8 dBi		
Test Notes 2	Single Port Module		

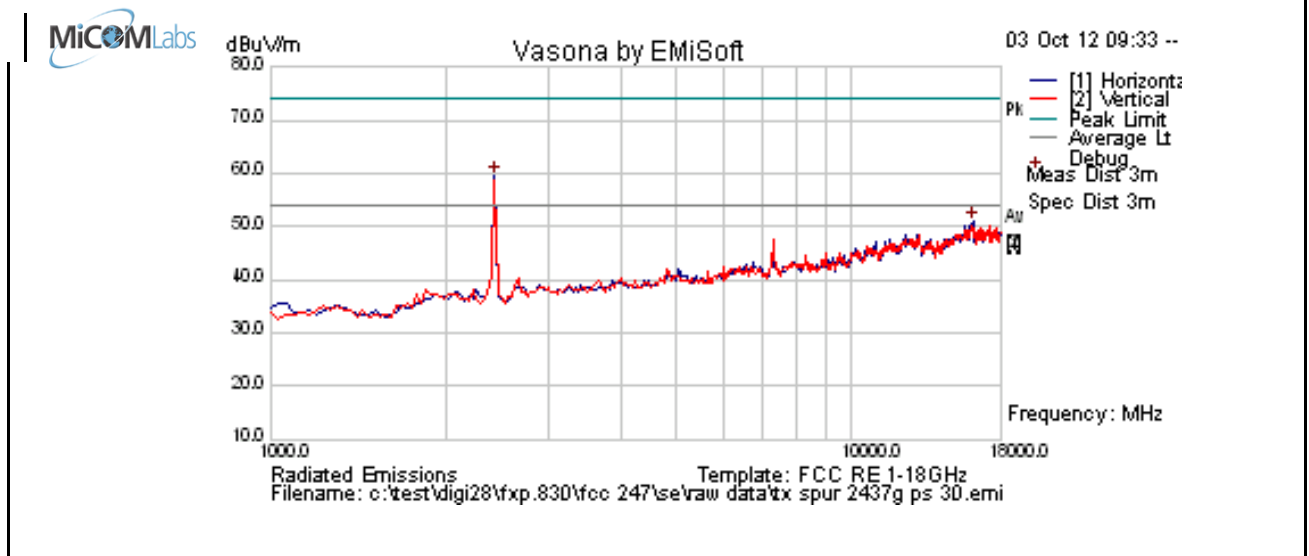

Formally measured emission peaks

Frequency MHz	Raw dBuV	Cable Loss	AF dB	Level dBuV/m	Measurement Type	Pol	Hgt cm	Azt Deg	Limit dBuV/m	Margin dB	Pass /Fail	Comments
2430.862	67.9	3.0	-11.6	59.4	Peak [Scan]	H						FUND
16126.253	41.8	9.0	0.2	51.0	Peak [Scan]	H	100	0	54.0	-3.0	Pass	Noise

Legend: TX = Transmitter Emissions; DIG = Digital Emissions; FUND = Fundamental; WB = Wideband Emission
 RB = Restricted Band (15.209 Limits); NRB = Non Restricted Band, Limit is 20dB below fundamental peak

This test report may be reproduced in full only. The document may only be updated by MiCOM Labs personnel. Any changes will be noted in the Document History section of the report.



Title: Digi ConnectCard for i.MX28 with Atheros AR6233
To: FCC 47 CFR Part 15.247 & IC RSS-210
Serial #: DIGI28-U2A Rev A
Issue Date: 29th March 2013
Page: 93 of 245

Test Freq.	2462 MHz	Engineer	JMH
Variant	802.11g; 6 Mbs	Temp (°C)	26
Freq. Range	1000 MHz - 18000 MHz	Rel. Hum.(%)	33
Power Setting	30	Press. (mBars)	1000
Antenna	FXP.830	Duty Cycle (%)	100
Test Notes 1	1.8 dBi gain		
Test Notes 2	Single Port Module		

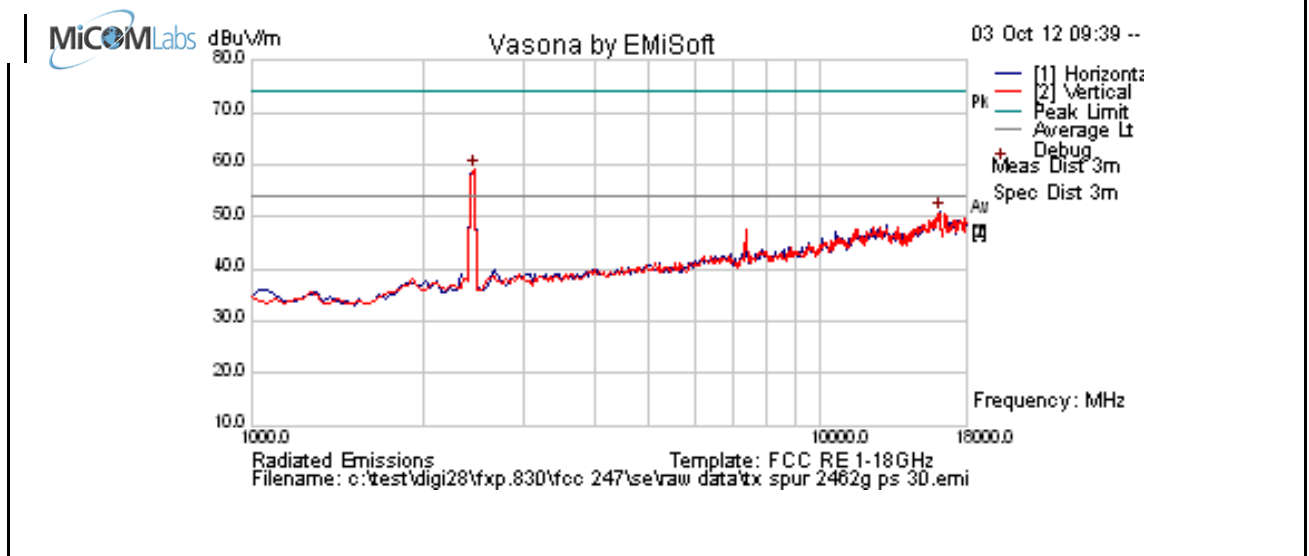

Formally measured emission peaks

Frequency MHz	Raw dBuV	Cable Loss	AF dB	Level dBuV/m	Measurement Type	Pol	Hgt cm	Azt Deg	Limit dBuV/m	Margin dB	Pass /Fail	Comments
2464.930	67.5	3.0	-11.5	59.0	Peak [Scan]	V						FUND
16126.253	41.8	9.0	0.2	51.0	Peak [Scan]	H	100	0	54.0	-3.0	Pass	Noise

Legend:	TX = Transmitter Emissions; DIG = Digital Emissions; FUND = Fundamental; WB = Wideband Emission
	RB = Restricted Band (15.209 Limits); NRB = Non Restricted Band, Limit is 20dB below fundamental peak

This test report may be reproduced in full only. The document may only be updated by MiCOM Labs personnel. Any changes will be noted in the Document History section of the report.



Title: Digi ConnectCard for i.MX28 with Atheros AR6233
To: FCC 47 CFR Part 15.247 & IC RSS-210
Serial #: DIGI28-U2A Rev A
Issue Date: 29th March 2013
Page: 94 of 245

Band Edge

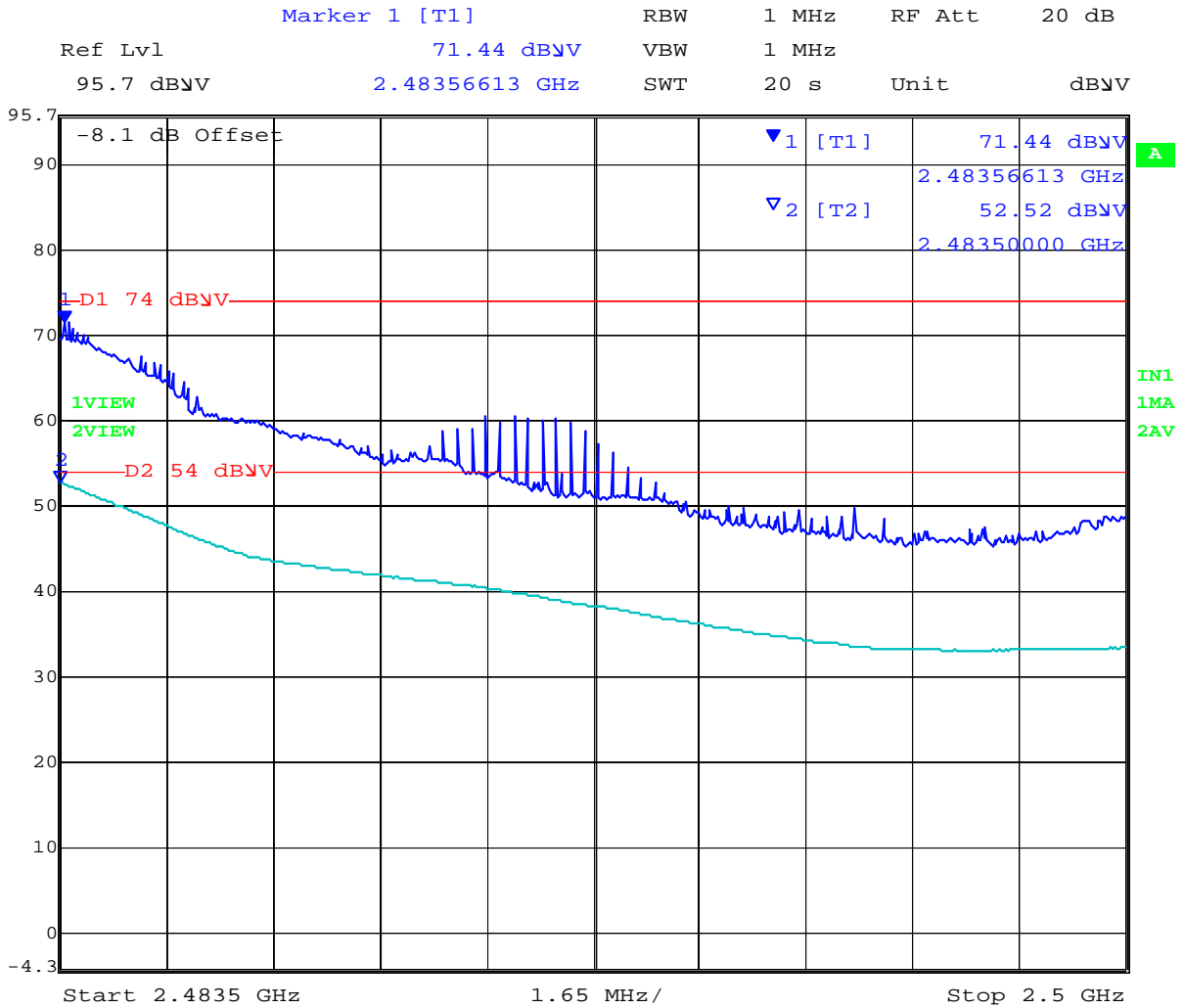

Date: 3.OCT.2012 11:39:31

Power reduction required in order to bring unit into compliance Power = 17

This test report may be reproduced in full only. The document may only be updated by MiCOM Labs personnel. Any changes will be noted in the Document History section of the report.



Title: Digi ConnectCard for i.MX28 with Atheros AR6233
To: FCC 47 CFR Part 15.247 & IC RSS-210
Serial #: DIGI28-U2A Rev A
Issue Date: 29th March 2013
Page: 95 of 245

Band Edge 802.11n HT20 2412 MHz

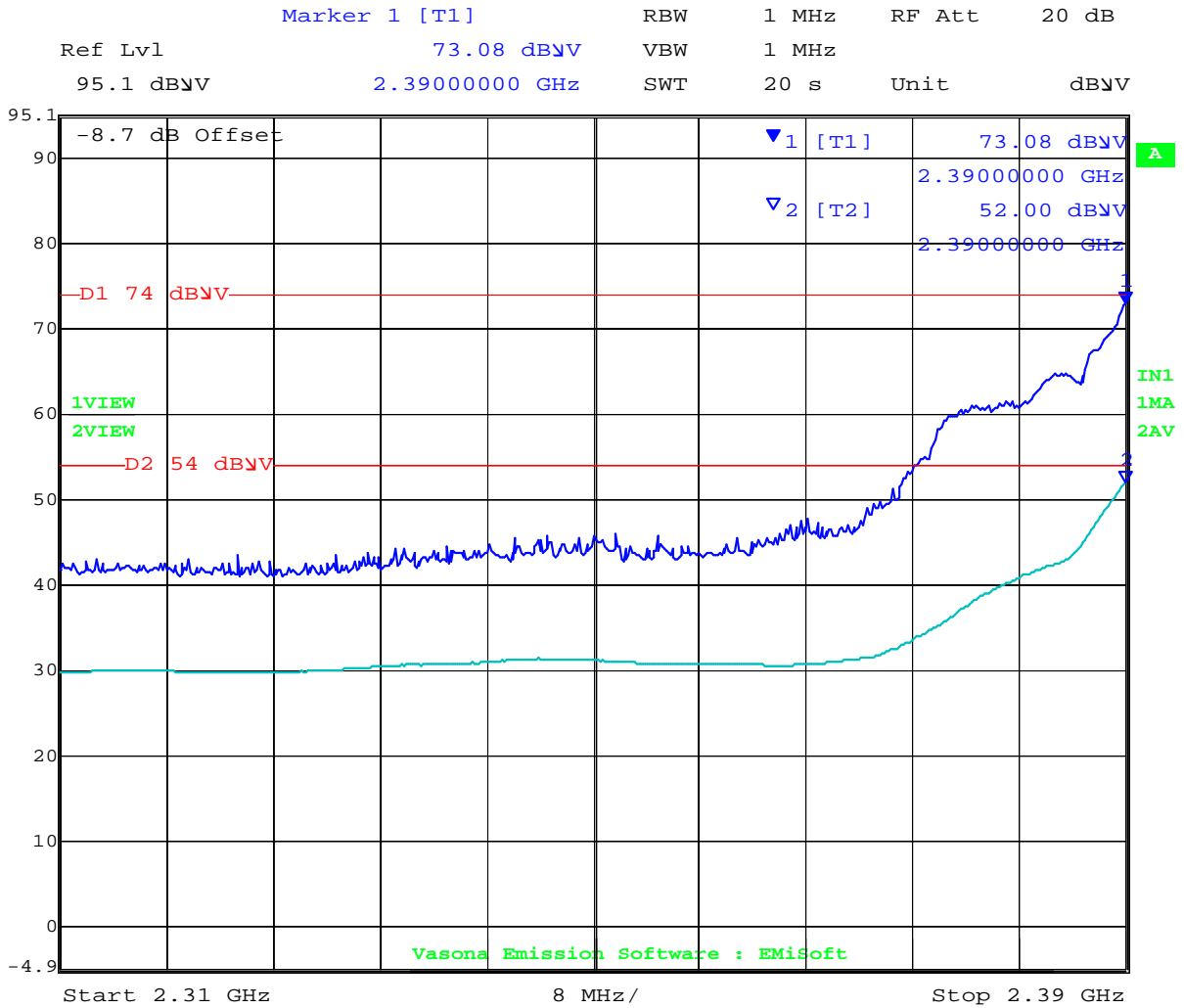

Date: 3.OCT.2012 11:21:02

Power reduction required in order to bring unit into compliance Power = 13

This test report may be reproduced in full only. The document may only be updated by MiCOM Labs personnel. Any changes will be noted in the Document History section of the report.



Title: Digi ConnectCard for i.MX28 with Atheros AR6233
To: FCC 47 CFR Part 15.247 & IC RSS-210
Serial #: DIGI28-U2A Rev A
Issue Date: 29th March 2013
Page: 96 of 245

Band Edge 802.11n HT20 2462 MHz

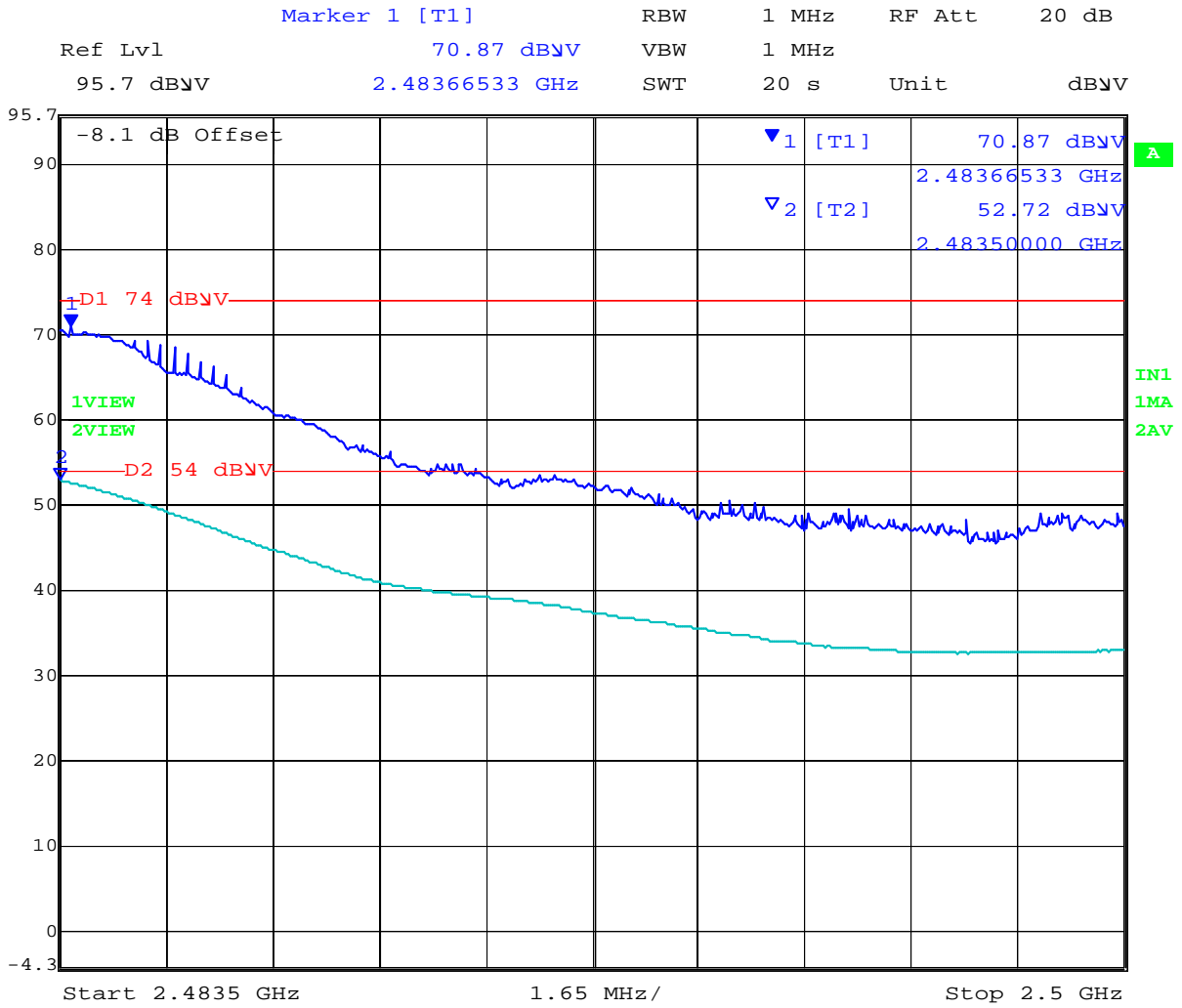

Date: 3.OCT.2012 11:42:00

Power reduction required in order to bring unit into compliance Power = 16

This test report may be reproduced in full only. The document may only be updated by MiCOM Labs personnel. Any changes will be noted in the Document History section of the report.



Title: Digi ConnectCard for i.MX28 with Atheros AR6233
To: FCC 47 CFR Part 15.247 & IC RSS-210
Serial #: DIGI28-U2A Rev A
Issue Date: 29th March 2013
Page: 97 of 245

Band Edge 802.11n HT40 2422 MHz

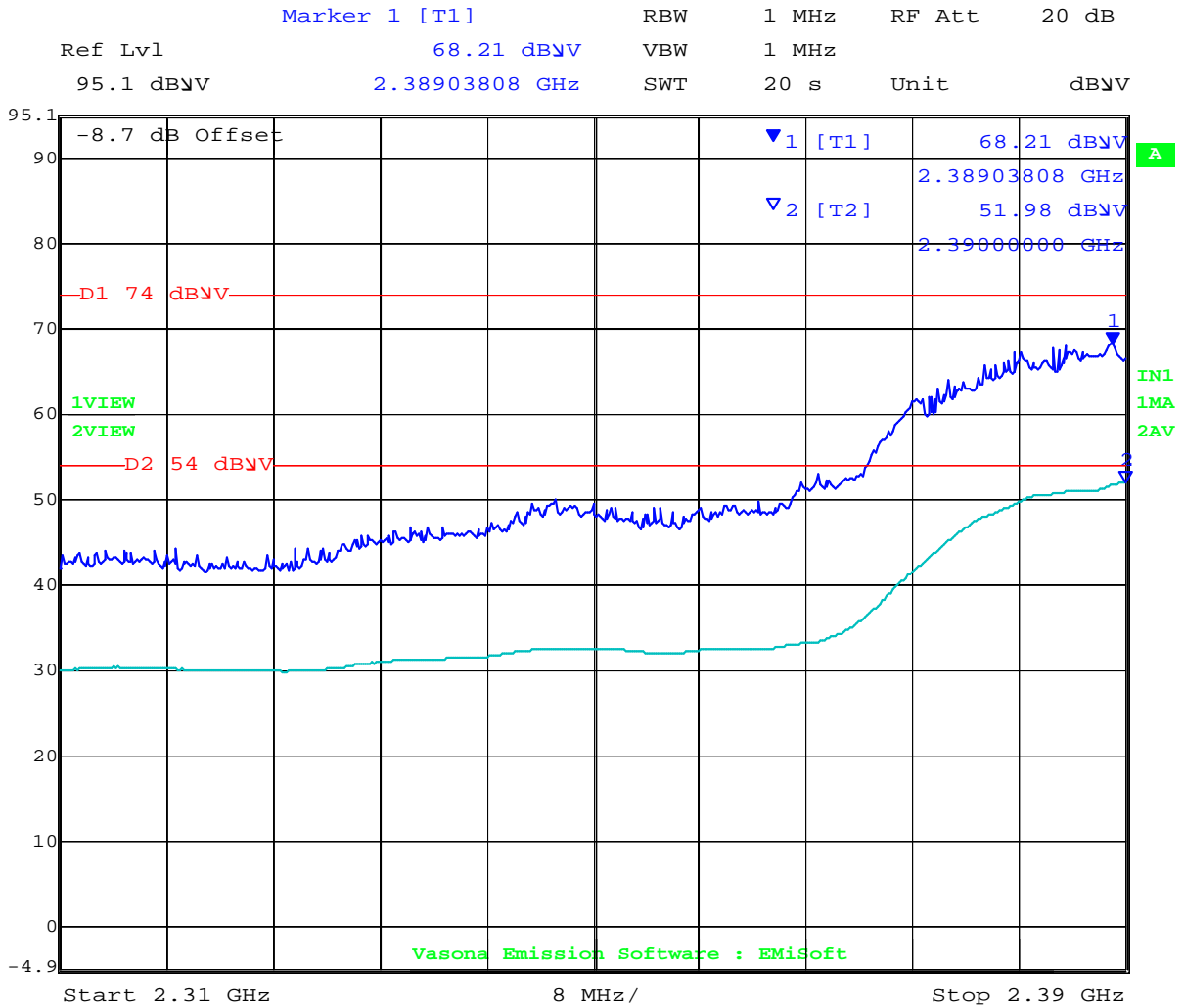

Date: 3.OCT.2012 11:11:51

Power reduction required in order to bring unit into compliance Power = 10

This test report may be reproduced in full only. The document may only be updated by MiCOM Labs personnel. Any changes will be noted in the Document History section of the report.



Title: Digi ConnectCard for i.MX28 with Atheros AR6233
To: FCC 47 CFR Part 15.247 & IC RSS-210
Serial #: DIGI28-U2A Rev A
Issue Date: 29th March 2013
Page: 98 of 245

Band Edge 802.11n HT40 2452 MHz

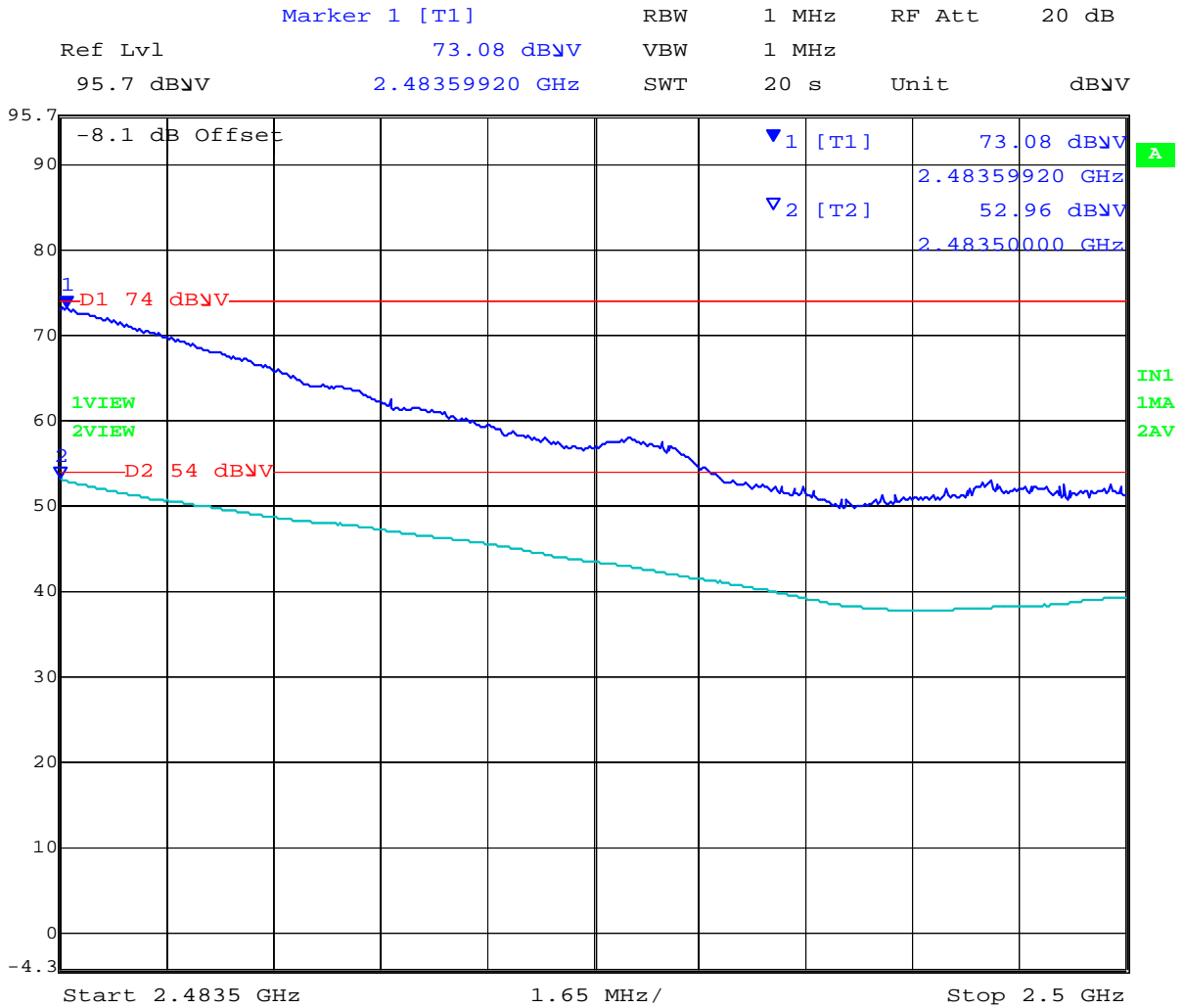

Date: 3.OCT.2012 11:44:39

Power reduction required in order to bring unit into compliance Power = 10

This test report may be reproduced in full only. The document may only be updated by MiCOM Labs personnel. Any changes will be noted in the Document History section of the report.



Title: Digi ConnectCard for i.MX28 with Atheros AR6233
To: FCC 47 CFR Part 15.247 & IC RSS-210
Serial #: DIGI28-U2A Rev A
Issue Date: 29th March 2013
Page: 99 of 245

Test Freq.	5745 MHz	Engineer	JMH
Variant	802.11a; 6.5 Mbs	Temp (°C)	27
Freq. Range	1000 MHz - 18000 MHz	Rel. Hum.(%)	33
Power Setting	30	Press. (mBars)	1000
Antenna	FXP.830	Duty Cycle (%)	100
Test Notes 1	3.6 dBi Gain		
Test Notes 2			

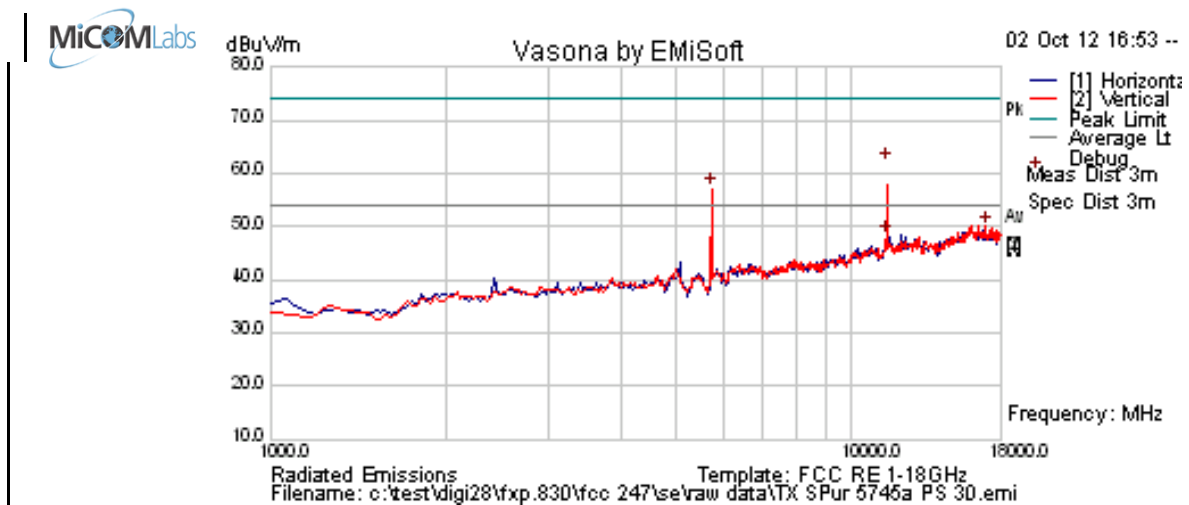

Formally measured emission peaks

Frequency MHz	Raw dBuV	Cable Loss	AF dB	Level dBuV/m	Measurement Type	Pol	Hgt cm	Azt Deg	Limit dBuV/m	Margin dB	Pass /Fail	Comments
5735.471	61.8	4.8	-9.5	57.0	Peak [Scan]	V	100					FUND
16977.956	41.2	8.5	0.4	50.1	Peak [Scan]	V	150	0	54.0	-3.9	Pass	Noise
11492.986	56.9	6.8	-2.0	61.8	Peak Max	V	120	14	74	-12.2	Pass	RB
11492.986	43.3	6.8	-2.0	48.1	Average Max	V	120	14	54	-5.9	Pass	RB

Legend: TX = Transmitter Emissions; DIG = Digital Emissions; FUND = Fundamental; WB = Wideband Emission
 RB = Restricted Band (15.209 Limits); NRB = Non Restricted Band, Limit is 20dB below fundamental peak

This test report may be reproduced in full only. The document may only be updated by MiCOM Labs personnel. Any changes will be noted in the Document History section of the report.



Band Edge

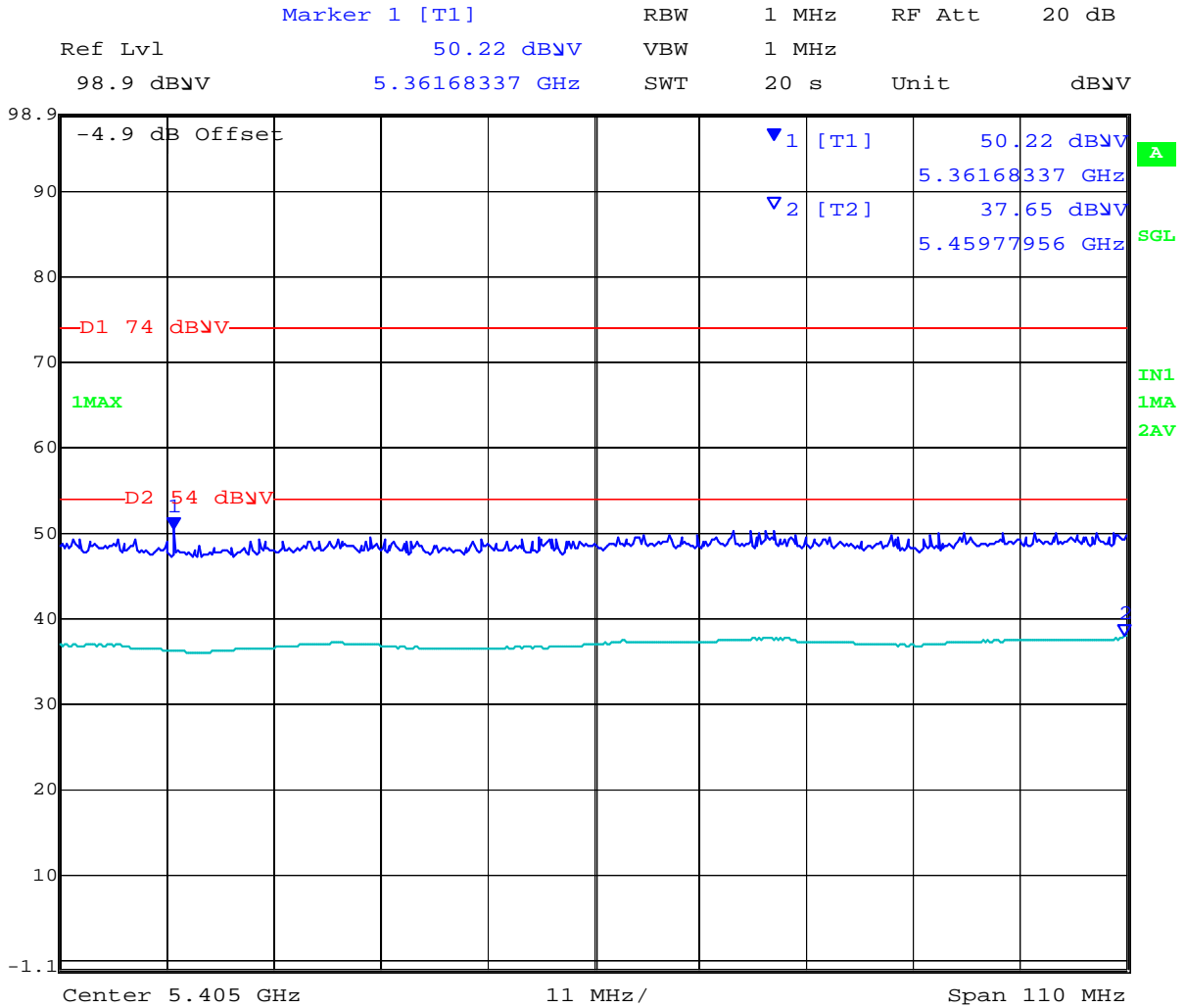

Date: 2.OCT.2012 14:31:42

This test report may be reproduced in full only. The document may only be updated by MiCOM Labs personnel. Any changes will be noted in the Document History section of the report.



Title: Digi ConnectCard for i.MX28 with Atheros AR6233
To: FCC 47 CFR Part 15.247 & IC RSS-210
Serial #: DIGI28-U2A Rev A
Issue Date: 29th March 2013
Page: 101 of 245

Test Freq.	5785 MHz	Engineer	JMH
Variant	802.11a; 6.5 Mbs	Temp (°C)	27
Freq. Range	1000 MHz - 18000 MHz	Rel. Hum.(%)	33
Power Setting	30	Press. (mBars)	1000
Antenna	FXP.830	Duty Cycle (%)	100
Test Notes 1	3.6 dBi Gain		
Test Notes 2			

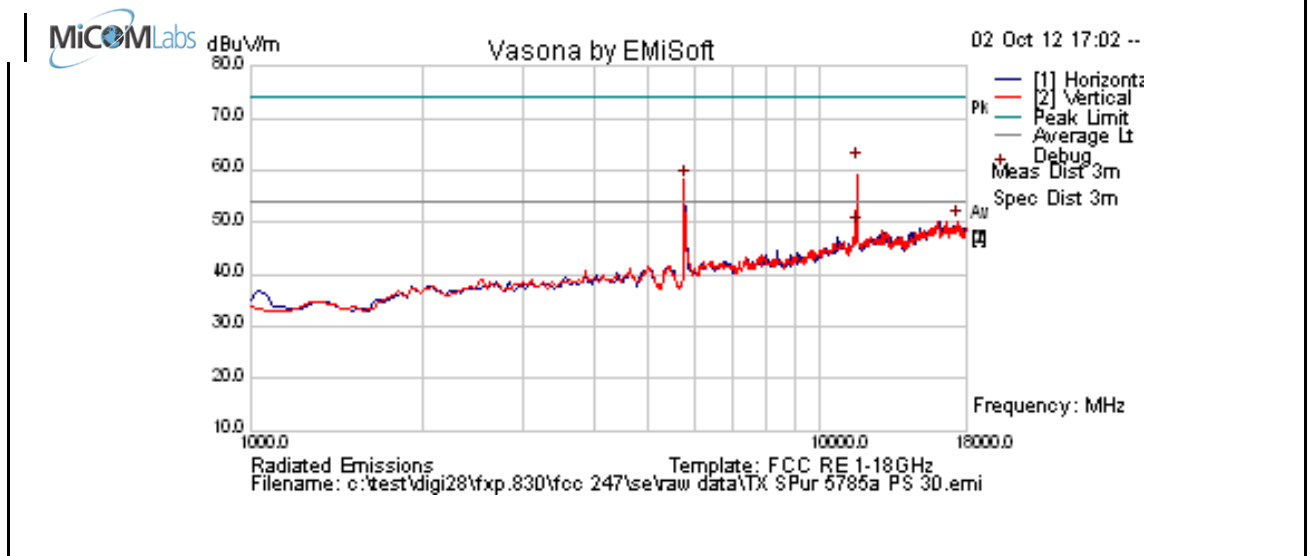

Formally measured emission peaks

Frequency MHz	Raw dBuV	Cable Loss	AF dB	Level dBuV/m	Measurement Type	Pol	Hgt cm	Azt Deg	Limit dBuV/m	Margin dB	Pass /Fail	Comments
5769.539	62.9	4.8	-9.5	58.2	Peak [Scan]	V	100					FUND
17386.774	40.2	8.7	1.4	50.3	Peak [Scan]	H	100	0	54.0	-3.7	Pass	Noise
11572.104	56.6	6.8	-2.0	61.4	Peak Max	V	120	6	74	-12.7	Pass	RB
11572.104	44.3	6.8	-2.0	49.1	Average Max	V	120	6	54	-4.9	Pass	RB
Legend: TX = Transmitter Emissions; DIG = Digital Emissions; FUND = Fundamental; WB = Wideband Emission RB = Restricted Band (15.209 Limits); NRB = Non Restricted Band, Limit is 20dB below fundamental peak												

This test report may be reproduced in full only. The document may only be updated by MiCOM Labs personnel. Any changes will be noted in the Document History section of the report.



Title: Digi ConnectCard for i.MX28 with Atheros AR6233
To: FCC 47 CFR Part 15.247 & IC RSS-210
Serial #: DIGI28-U2A Rev A
Issue Date: 29th March 2013
Page: 102 of 245

Test Freq.	5825 MHz	Engineer	JMH
Variant	802.11a; 6.5 Mbs	Temp (°C)	27
Freq. Range	1000 MHz - 18000 MHz	Rel. Hum.(%)	33
Power Setting	30	Press. (mBars)	1000
Antenna	FXP.830	Duty Cycle (%)	100
Test Notes 1	3.6 dBi Gain		
Test Notes 2			

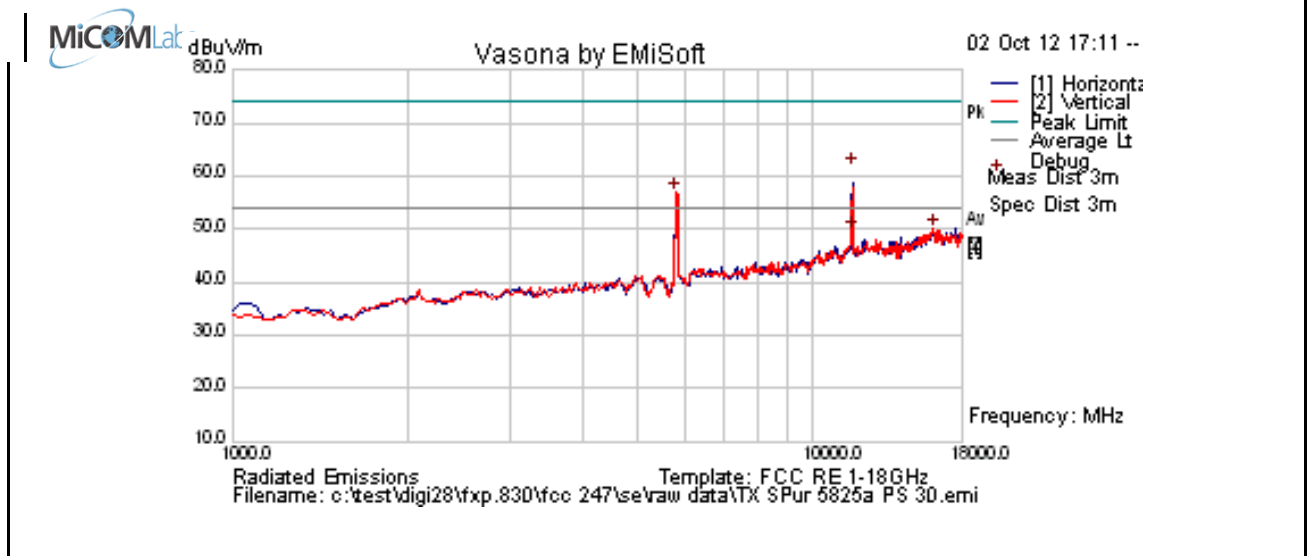

Formally measured emission peaks

Frequency MHz	Raw dBuV	Cable Loss	AF dB	Level dBuV/m	Measurement Type	Pol	Hgt cm	Azt Deg	Limit dBuV/m	Margin dB	Pass /Fail	Comments
5803.607	61.5	4.8	-9.4	56.9	Peak [Scan]	V	100					FUND
16092.184	40.9	9.0	0.3	50.2	Peak [Scan]	V	100	0	54.0	-3.9	Pass	Noise
11647.856	57.0	6.8	-2.3	61.5	Peak Max	H	114	13	74	-12.5	Pass	RB
11647.856	44.8	6.8	-2.3	49.3	Average Max	H	114	13	54	-4.7	Pass	RB

Legend: TX = Transmitter Emissions; DIG = Digital Emissions; FUND = Fundamental; WB = Wideband Emission
 RB = Restricted Band (15.209 Limits); NRB = Non Restricted Band, Limit is 20dB below fundamental peak

This test report may be reproduced in full only. The document may only be updated by MiCOM Labs personnel. Any changes will be noted in the Document History section of the report.



Title: Digi ConnectCard for i.MX28 with Atheros AR6233
To: FCC 47 CFR Part 15.247 & IC RSS-210
Serial #: DIGI28-U2A Rev A
Issue Date: 29th March 2013
Page: 103 of 245

Band Edge 802.11n HT20 5745 Mhz

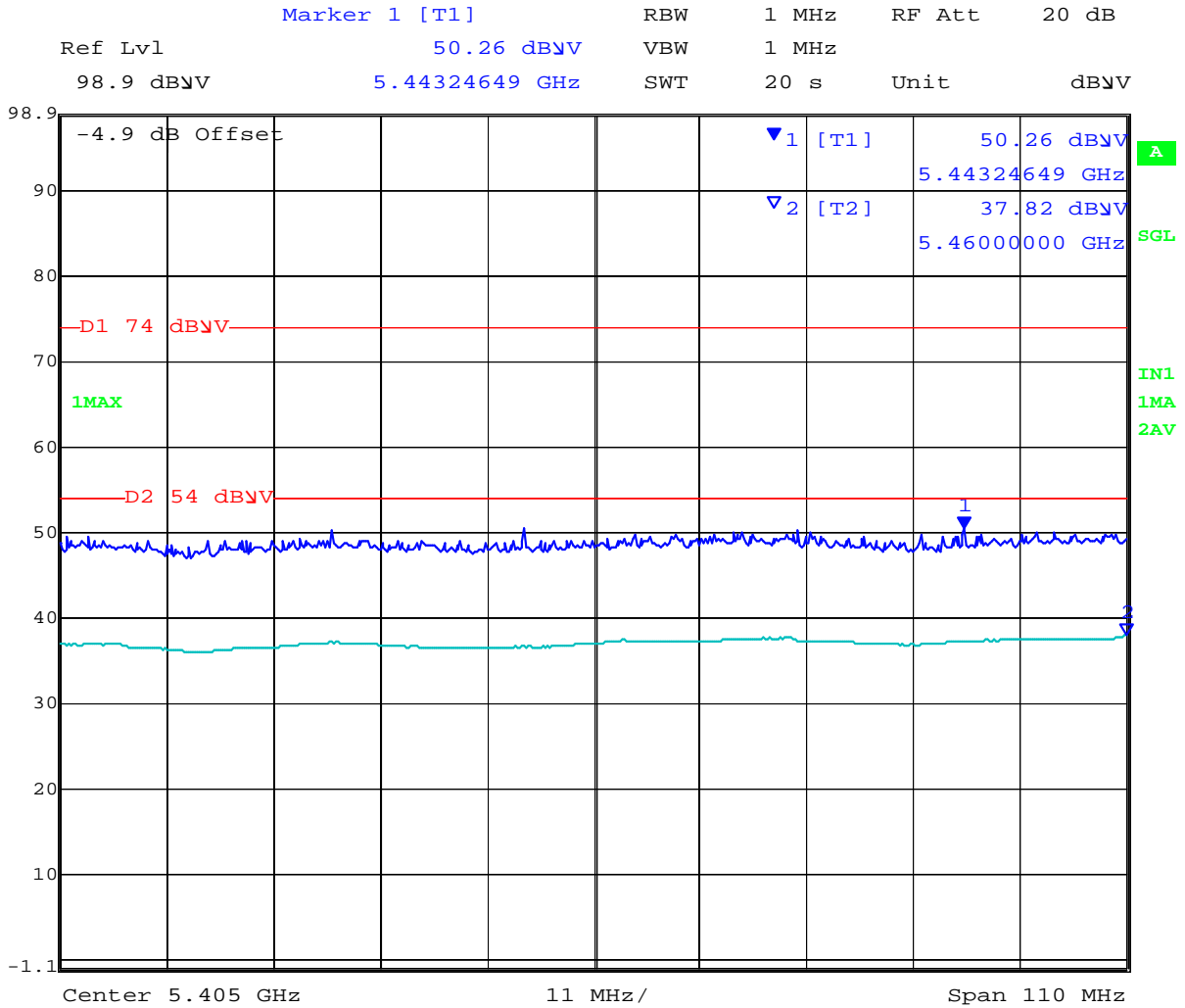

Date: 2.OCT.2012 14:30:43

This test report may be reproduced in full only. The document may only be updated by MiCOM Labs personnel. Any changes will be noted in the Document History section of the report.



Title: Digi ConnectCard for i.MX28 with Atheros AR6233
To: FCC 47 CFR Part 15.247 & IC RSS-210
Serial #: DIGI28-U2A Rev A
Issue Date: 29th March 2013
Page: 104 of 245

Band Edge 802.11n HT40 5755 Mhz

Marker 1 [T1] RBW 1 MHz RF Att 20 dB
Ref Lvl 50.42 dBμV VBW 1 MHz
98.9 dBμV 5.41172345 GHz SWT 20 s Unit dBμV

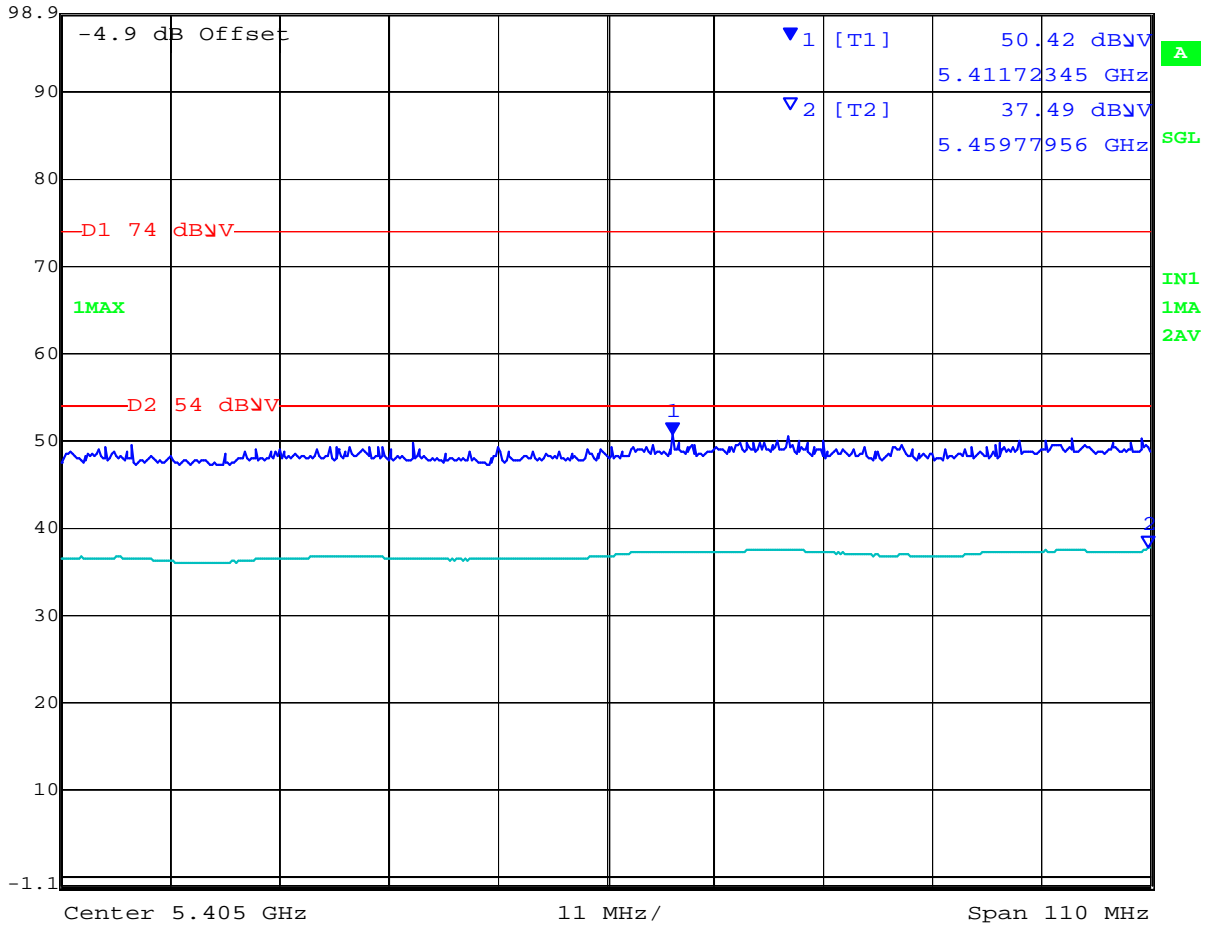

Date: 2.OCT.2012 14:28:03

This test report may be reproduced in full only. The document may only be updated by MiCOM Labs personnel. Any changes will be noted in the Document History section of the report.



Title: Digi ConnectCard for i.MX28 with Atheros AR6233
To: FCC 47 CFR Part 15.247 & IC RSS-210
Serial #: DIGI28-U2A Rev A
Issue Date: 29th March 2013
Page: 105 of 245

6.1.2.3. Dual Band Omni ANT-DB1-xxx – Single Port Module

Test Freq.	2412 MHz	Engineer	JMH
Variant	802.11b; 1 Mbs	Temp (°C)	26
Freq. Range	1000 MHz - 18000 MHz	Rel. Hum.(%)	32
Power Setting	30	Press. (mBars)	996
Antenna	5 dBi Monopole	Duty Cycle (%)	100
Test Notes 1			
Test Notes 2			

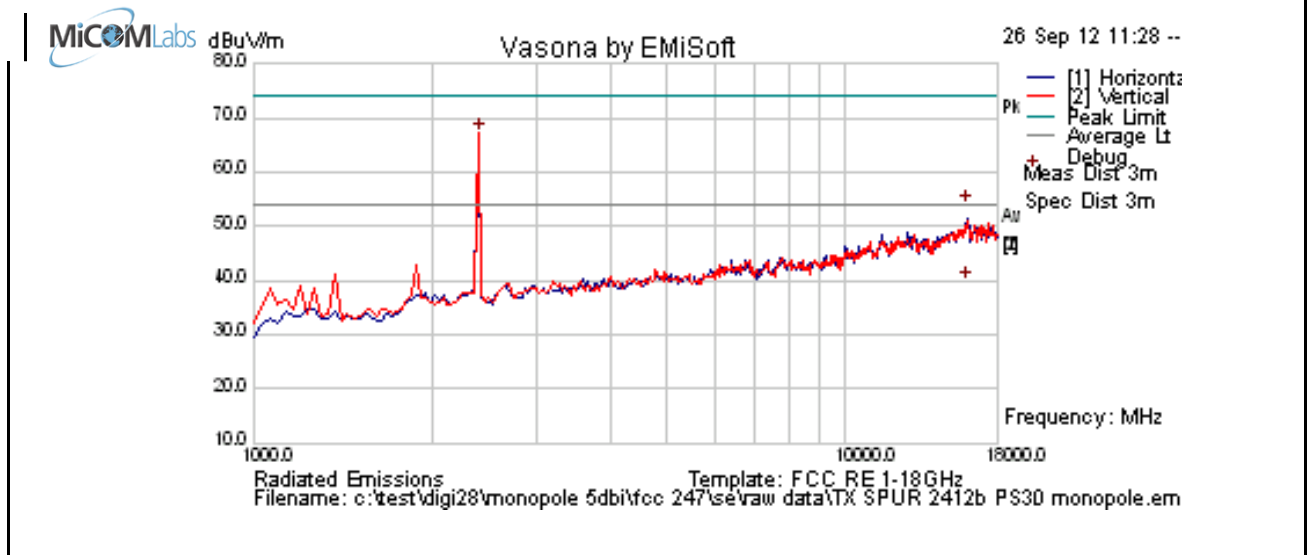

Formally measured emission peaks													
Frequency MHz	Raw dBuV	Cable Loss	AF dB	Level dBuV/m	Measurement Type	Pol	Hgt cm	Azt Deg	Limit dBuV/m	Margin dB	Pass /Fail	Comments	
2412.104	75.9	3.0	-11.6	67.3	Peak [Scan]	V	100					FUND	
15992.95	44.5	9.0	0.1	53.6	Peak Max	H	145	190	74.0	-20.4	Pass	RB	
15992.950	30.5	9.0	0.1	39.7	Average Max	H	145	190	54	-14.3	Pass	RB	
Legend:		TX = Transmitter Emissions; DIG = Digital Emissions; FUND = Fundamental; WB = Wideband Emission											
		RB = Restricted Band (15.209 Limits); NRB = Non Restricted Band, Limit is 20dB below fundamental peak											

This test report may be reproduced in full only. The document may only be updated by MiCOM Labs personnel. Any changes will be noted in the Document History section of the report.



Title: Digi ConnectCard for i.MX28 with Atheros AR6233
To: FCC 47 CFR Part 15.247 & IC RSS-210
Serial #: DIGI28-U2A Rev A
Issue Date: 29th March 2013
Page: 106 of 245

Band Edge

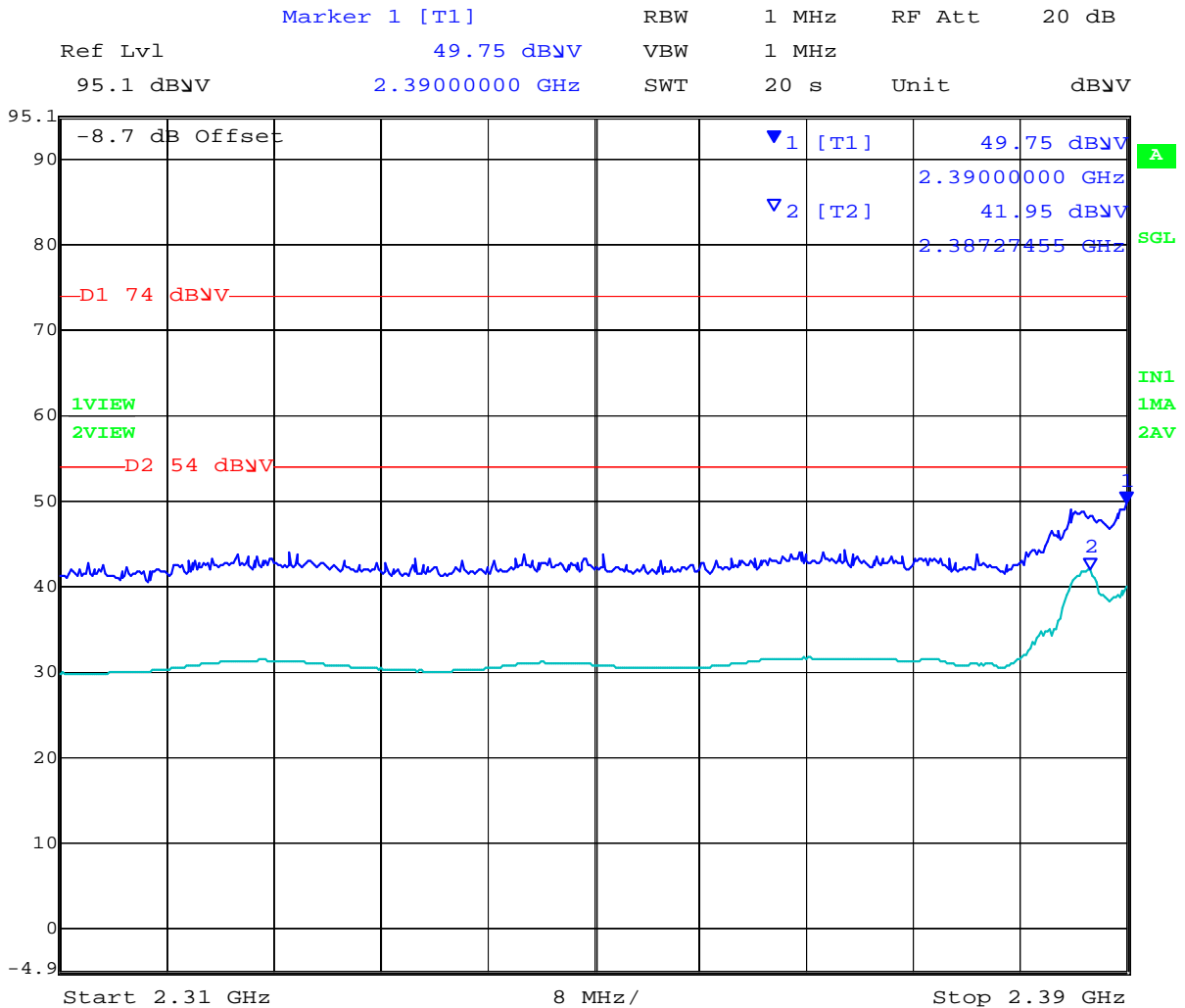

Date: 26.SEP.2012 17:24:54

This test report may be reproduced in full only. The document may only be updated by MiCOM Labs personnel. Any changes will be noted in the Document History section of the report.



Title: Digi ConnectCard for i.MX28 with Atheros AR6233
To: FCC 47 CFR Part 15.247 & IC RSS-210
Serial #: DIGI28-U2A Rev A
Issue Date: 29th March 2013
Page: 107 of 245

Test Freq.	2437 MHz	Engineer	JMH
Variant	802.11b; 1 Mbs	Temp (°C)	26
Freq. Range	1000 MHz - 18000 MHz	Rel. Hum.(%)	32
Power Setting	30	Press. (mBars)	996
Antenna	5 dBi Monopole	Duty Cycle (%)	100
Test Notes 1			
Test Notes 2			

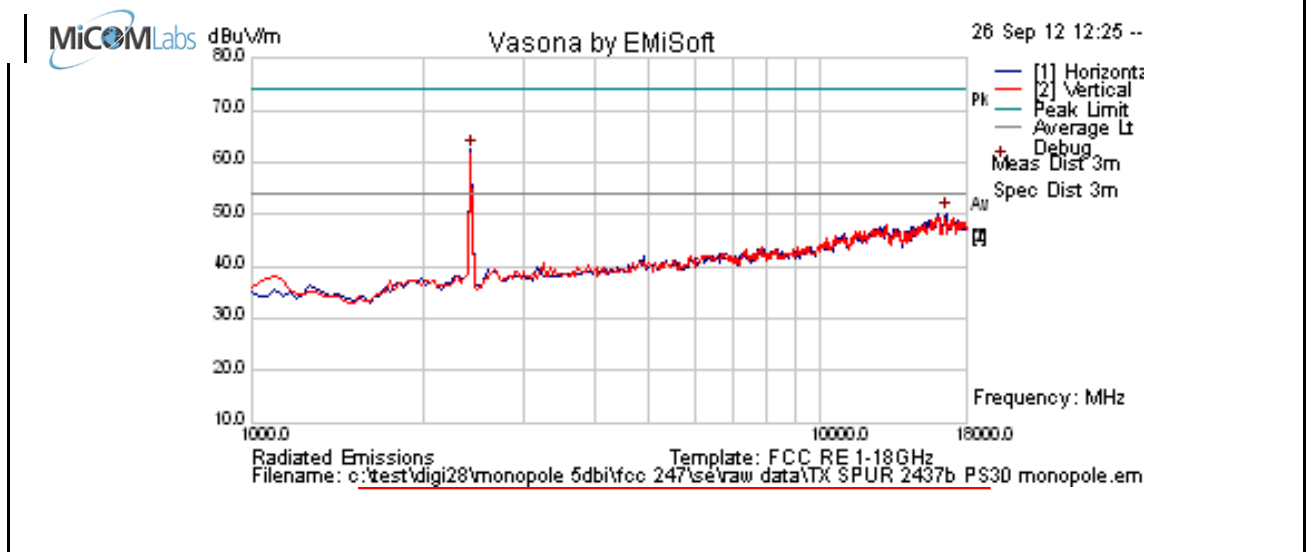

Formally measured emission peaks

Frequency MHz	Raw dBuV	Cable Loss	AF dB	Level dBuV/m	Measurement Type	Pol	Hgt cm	Azt Deg	Limit dBuV/m	Margin dB	Pass /Fail	Comments
2430.862	71.0	3.0	-11.6	62.4	Peak [Scan]	H	100					FUND
16569.138	40.9	8.8	0.5	50.2	Peak [Scan]	H	100					NRB

Legend: TX = Transmitter Emissions; DIG = Digital Emissions; FUND = Fundamental; WB = Wideband Emission
 RB = Restricted Band (15.209 Limits); NRB = Non Restricted Band, Limit is 20dB below fundamental peak

This test report may be reproduced in full only. The document may only be updated by MiCOM Labs personnel. Any changes will be noted in the Document History section of the report.



Title: Digi ConnectCard for i.MX28 with Atheros AR6233
To: FCC 47 CFR Part 15.247 & IC RSS-210
Serial #: DIGI28-U2A Rev A
Issue Date: 29th March 2013
Page: 108 of 245

Test Freq.	2462 MHz	Engineer	JMH
Variant	802.11b; 1 Mbs	Temp (°C)	26
Freq. Range	1000 MHz - 18000 MHz	Rel. Hum.(%)	32
Power Setting	30	Press. (mBars)	996
Antenna	5 dBi Monopole	Duty Cycle (%)	100
Test Notes 1			
Test Notes 2			

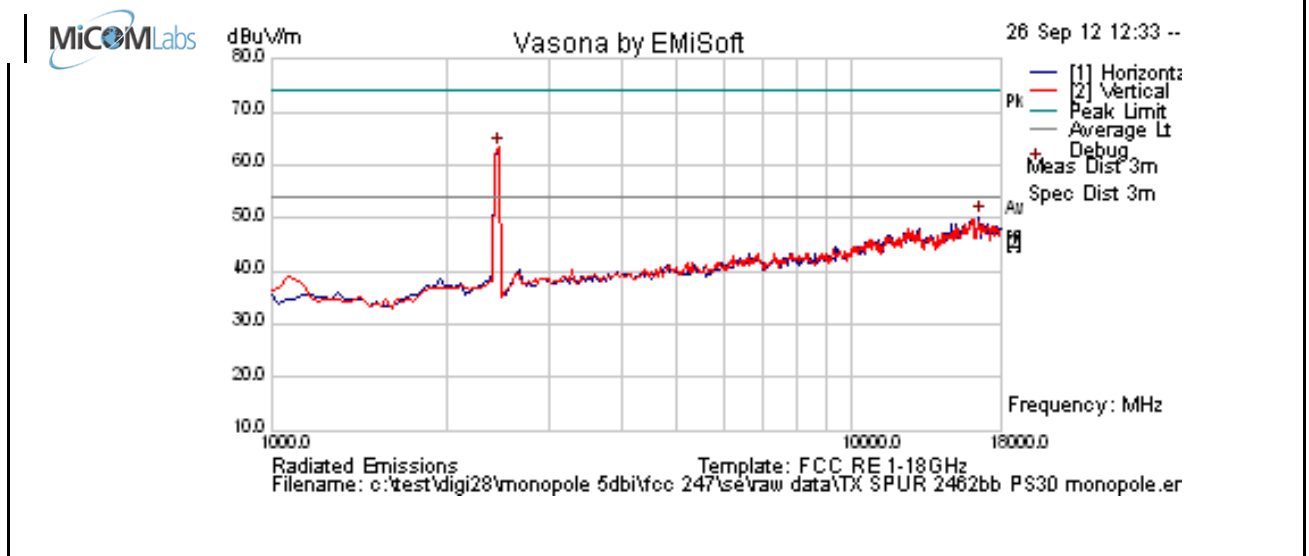

Formally measured emission peaks

Frequency MHz	Raw dBuV	Cable Loss	AF dB	Level dBuV/m	Measurement Type	Pol	Hgt cm	Azt Deg	Limit dBuV/m	Margin dB	Pass /Fail	Comments
2464.930	71.7	3.0	-11.5	63.2	Peak [Scan]	V	100					FUND
16535.07	41.1	8.8	0.4	50.3	Peak [Scan]	H	100					NRB

Legend: TX = Transmitter Emissions; DIG = Digital Emissions; FUND = Fundamental; WB = Wideband Emission
 RB = Restricted Band (15.209 Limits); NRB = Non Restricted Band, Limit is 20dB below fundamental peak

This test report may be reproduced in full only. The document may only be updated by MiCOM Labs personnel. Any changes will be noted in the Document History section of the report.



Title: Digi ConnectCard for i.MX28 with Atheros AR6233
To: FCC 47 CFR Part 15.247 & IC RSS-210
Serial #: DIGI28-U2A Rev A
Issue Date: 29th March 2013
Page: 109 of 245

Band Edge

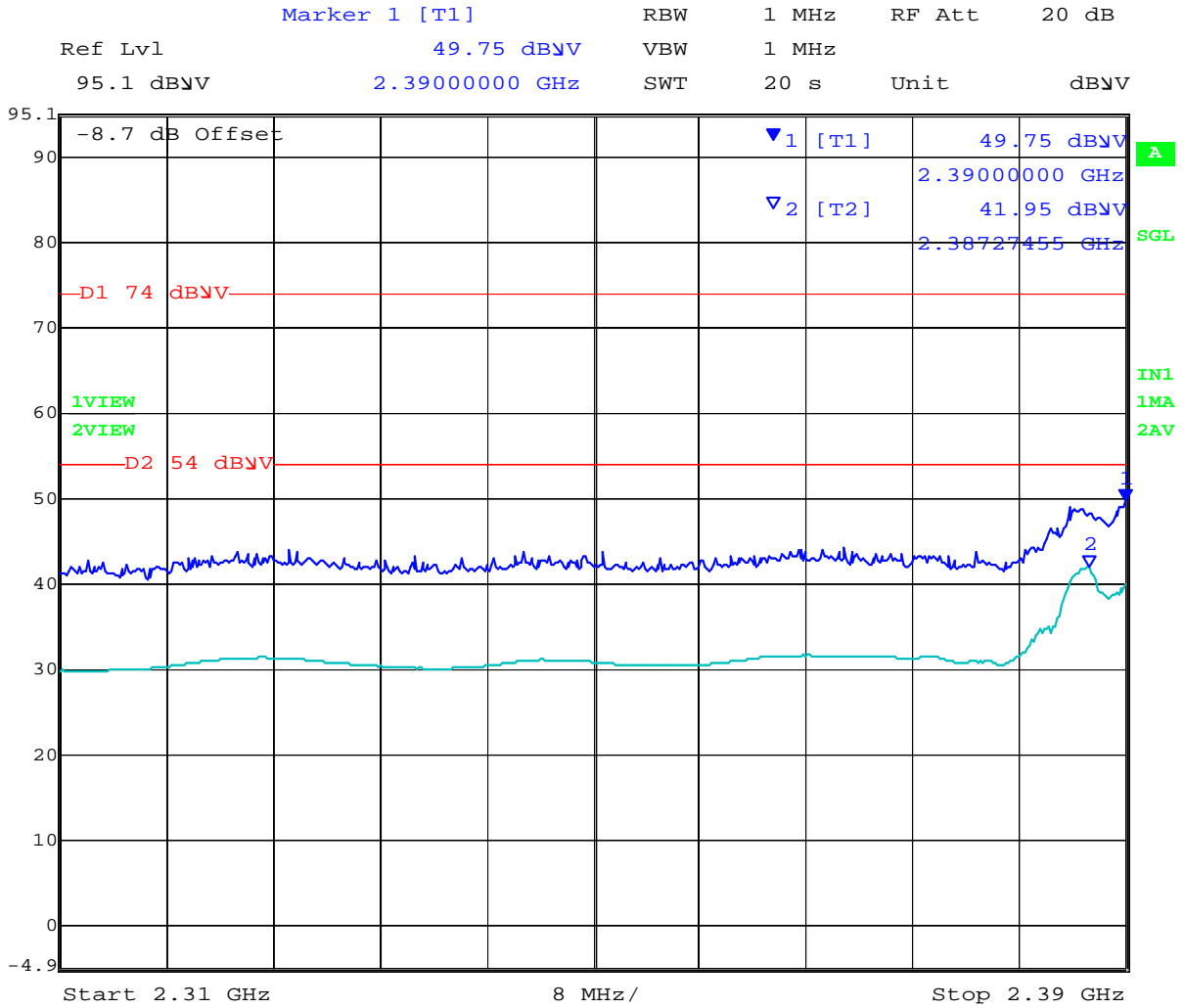

Date: 26.SEP.2012 17:23:27

This test report may be reproduced in full only. The document may only be updated by MiCOM Labs personnel. Any changes will be noted in the Document History section of the report.



Title: Digi ConnectCard for i.MX28 with Atheros AR6233
To: FCC 47 CFR Part 15.247 & IC RSS-210
Serial #: DIGI28-U2A Rev A
Issue Date: 29th March 2013
Page: 110 of 245

Test Freq.	2412 MHz	Engineer	JMH
Variant	802.11g; 6 Mbs	Temp (°C)	26
Freq. Range	1000 MHz - 18000 MHz	Rel. Hum.(%)	32
Power Setting	30	Press. (mBars)	996
Antenna	5 dBi Monopole	Duty Cycle (%)	100
Test Notes 1			
Test Notes 2			

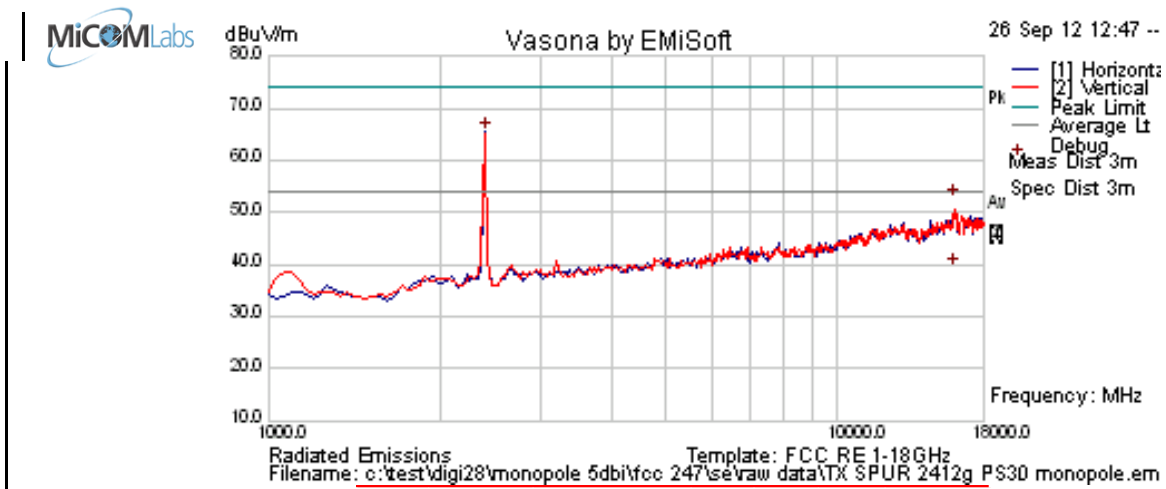

Formally measured emission peaks

Frequency MHz	Raw dBuV	Cable Loss	AF dB	Level dBuV/m	Measurement Type	Pol	Hgt cm	Azt Deg	Limit dBuV/m	Margin dB	Pass /Fail	Comments
2415.230	74.1	3.0	-11.6	65.4	Peak [Scan]	H	100					FUND
16023.659	43.3	9.0	0.2	52.6	Peak Max	V	169	282	74.0	-21.5	Pass	RB
16023.659	29.8	9.0	0.2	39.1	Average Max	V	169	282	54	-15.0	Pass	RB

Legend: TX = Transmitter Emissions; DIG = Digital Emissions; FUND = Fundamental; WB = Wideband Emission
 RB = Restricted Band (15.209 Limits); NRB = Non Restricted Band, Limit is 20dB below fundamental peak

This test report may be reproduced in full only. The document may only be updated by MiCOM Labs personnel. Any changes will be noted in the Document History section of the report.



Title: Digi ConnectCard for i.MX28 with Atheros AR6233
To: FCC 47 CFR Part 15.247 & IC RSS-210
Serial #: DIGI28-U2A Rev A
Issue Date: 29th March 2013
Page: 111 of 245

Band Edge

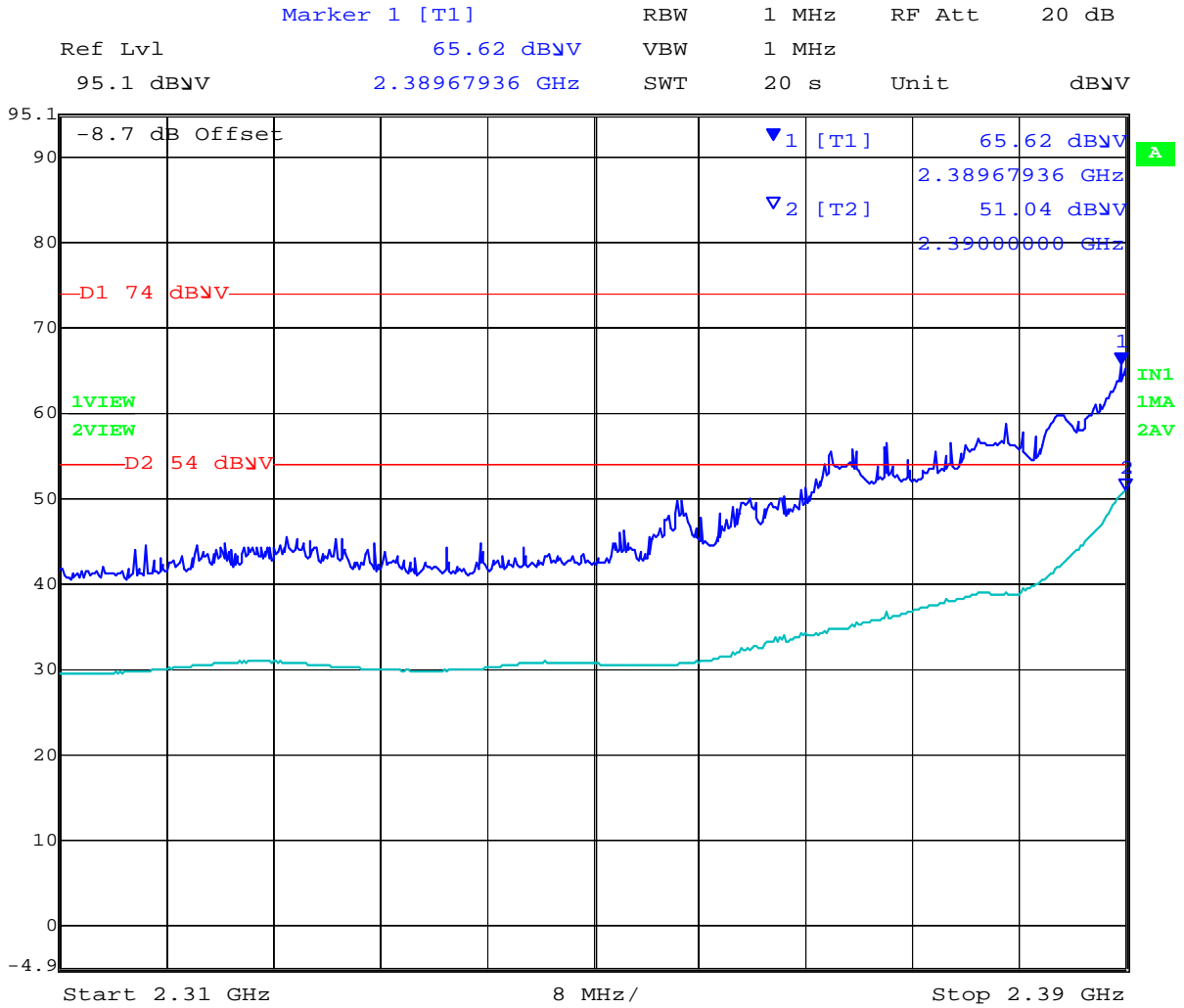

Date: 26.SEP.2012 17:27:59

Power reduction required in order to bring unit into compliance Power = 16

This test report may be reproduced in full only. The document may only be updated by MiCOM Labs personnel. Any changes will be noted in the Document History section of the report.



Title: Digi ConnectCard for i.MX28 with Atheros AR6233
To: FCC 47 CFR Part 15.247 & IC RSS-210
Serial #: DIGI28-U2A Rev A
Issue Date: 29th March 2013
Page: 112 of 245

Test Freq.	2437 MHz	Engineer	JMH
Variant	802.11g; 6 Mbs	Temp (°C)	26
Freq. Range	1000 MHz - 18000 MHz	Rel. Hum.(%)	32
Power Setting	30	Press. (mBars)	996
Antenna	5 dBi Monopole	Duty Cycle (%)	100
Test Notes 1			
Test Notes 2			

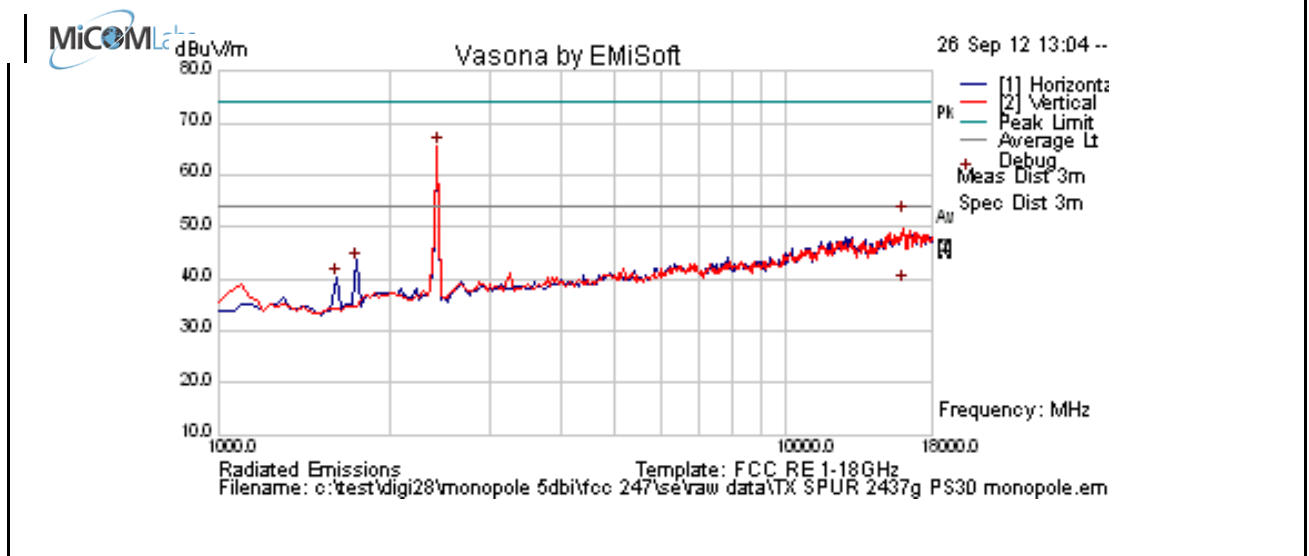

Formally measured emission peaks

Frequency MHz	Raw dBuV	Cable Loss	AF dB	Level dBuV/m	Measurement Type	Pol	Hgt cm	Azt Deg	Limit dBuV/m	Margin dB	Pass /Fail	Comments
2430.862	74.1	3.0	-11.6	65.5	Peak [Scan]	H	100					FUND
1615.754	52.6	2.5	-15.1	40.0	Peak [Scan]	V	98	360	54.0	-14.0	Pass	RB
1751.955	54.0	2.6	-13.5	43.1	Peak [Scan]	V	98					NRB
16025.046	43.0	9.0	0.2	52.3	Peak Max	H	180	44	74	-21.7	Pass	RB
16025.046	29.7	9.0	0.2	39.0	Average Max	H	180	44	54	-15.0	Pass	RB

Legend: TX = Transmitter Emissions; DIG = Digital Emissions; FUND = Fundamental; WB = Wideband Emission
 RB = Restricted Band (15.209 Limits); NRB = Non Restricted Band, Limit is 20dB below fundamental peak

This test report may be reproduced in full only. The document may only be updated by MiCOM Labs personnel. Any changes will be noted in the Document History section of the report.



Title: Digi ConnectCard for i.MX28 with Atheros AR6233
To: FCC 47 CFR Part 15.247 & IC RSS-210
Serial #: DIGI28-U2A Rev A
Issue Date: 29th March 2013
Page: 113 of 245

Test Freq.	2462 MHz	Engineer	JMH
Variant	802.11g; 6 Mbs	Temp (°C)	26
Freq. Range	1000 MHz - 18000 MHz	Rel. Hum.(%)	32
Power Setting	30	Press. (mBars)	996
Antenna	5 dBi Monopole	Duty Cycle (%)	100
Test Notes 1			
Test Notes 2			

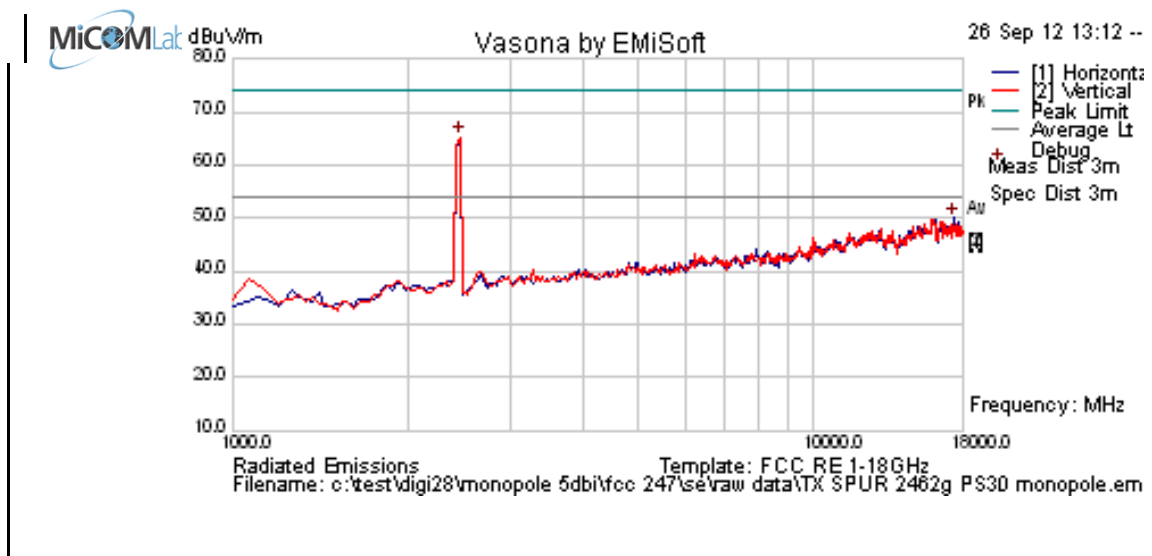

Formally measured emission peaks

Frequency MHz	Raw dBuV	Cable Loss	AF dB	Level dBuV/m	Measurement Type	Pol	Hgt cm	Azt Deg	Limit dBuV/m	Margin dB	Pass /Fail	Comments
2464.930	73.7	3.0	-11.5	65.2	Peak [Scan]	V	100					FUND
17420.842	40.1	8.7	1.3	50.1	Peak [Scan]	H	150					NRB

Legend:	TX = Transmitter Emissions; DIG = Digital Emissions; FUND = Fundamental; WB = Wideband Emission
	RB = Restricted Band (15.209 Limits); NRB = Non Restricted Band, Limit is 20dB below fundamental peak

This test report may be reproduced in full only. The document may only be updated by MiCOM Labs personnel. Any changes will be noted in the Document History section of the report.



Title: Digi ConnectCard for i.MX28 with Atheros AR6233
To: FCC 47 CFR Part 15.247 & IC RSS-210
Serial #: DIGI28-U2A Rev A
Issue Date: 29th March 2013
Page: 114 of 245

Band Edge

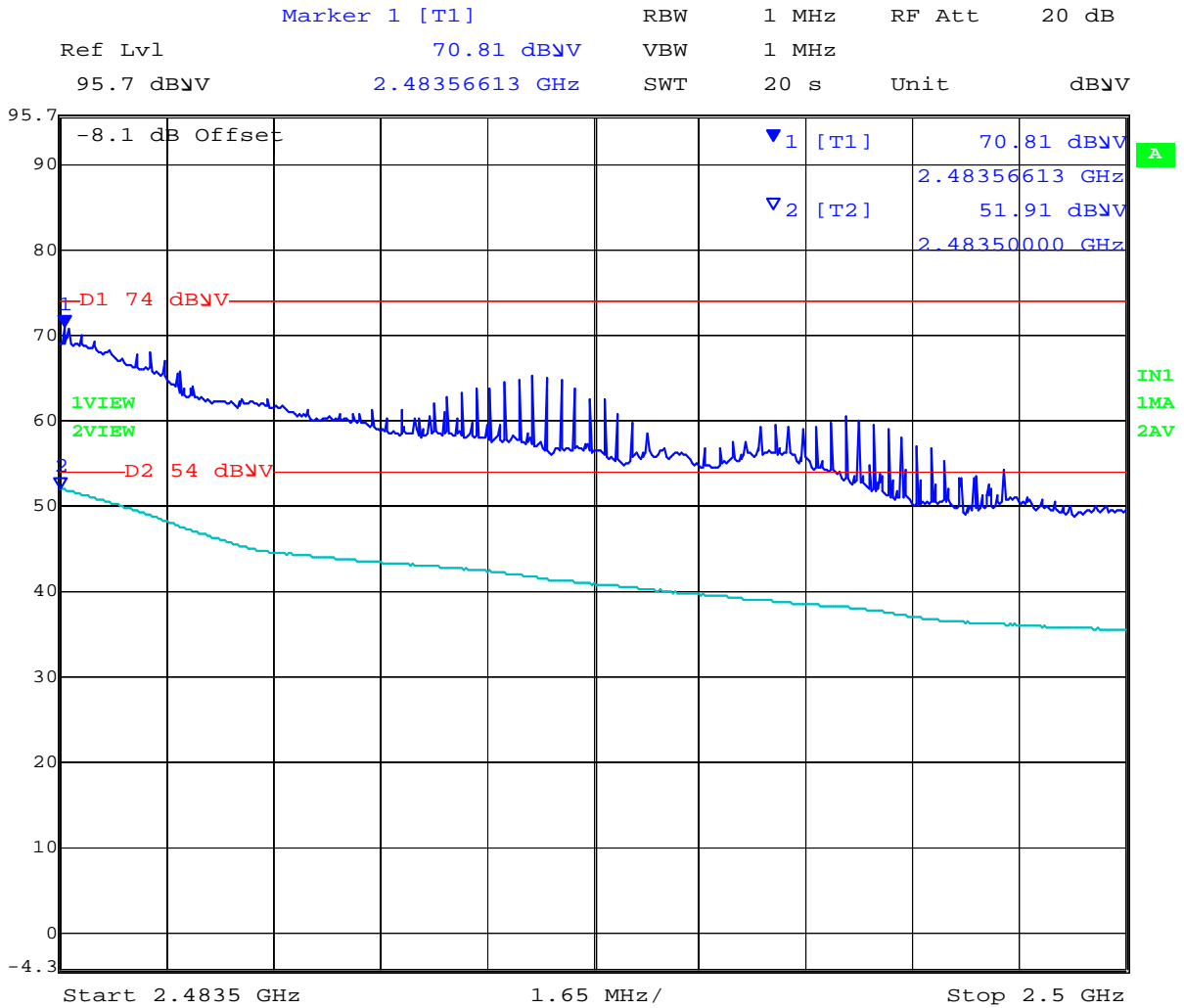

Date: 26.SEP.2012 17:16:00

Power reduction required in order to bring unit into compliance Power = 15

This test report may be reproduced in full only. The document may only be updated by MiCOM Labs personnel. Any changes will be noted in the Document History section of the report.



Title: Digi ConnectCard for i.MX28 with Atheros AR6233
To: FCC 47 CFR Part 15.247 & IC RSS-210
Serial #: DIGI28-U2A Rev A
Issue Date: 29th March 2013
Page: 115 of 245

Band Edge 802.11n HT20 2412 MHz

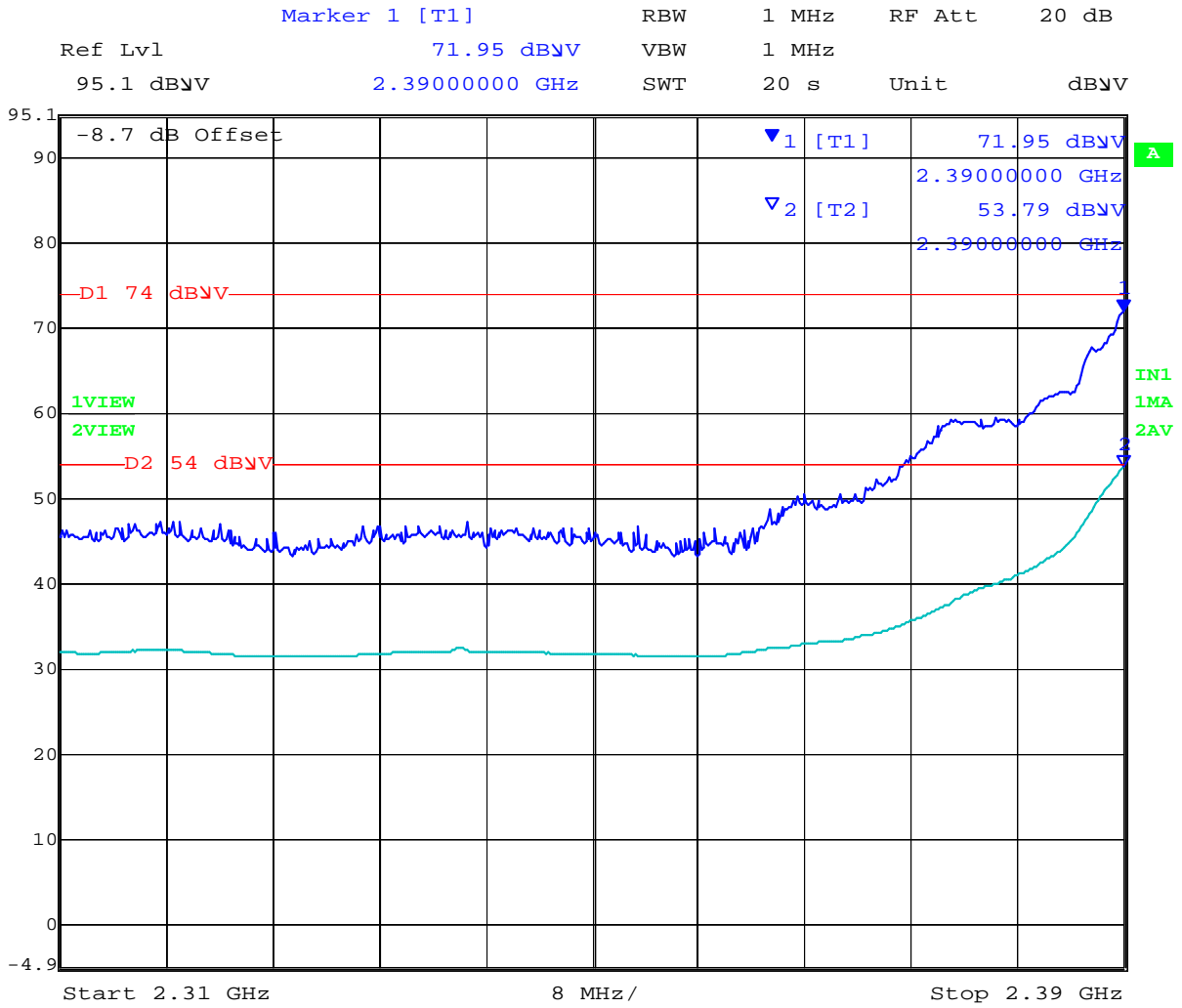

Date: 19.NOV.2012 19:40:38

Power reduction required in order to bring unit into compliance Power = 14

This test report may be reproduced in full only. The document may only be updated by MiCOM Labs personnel. Any changes will be noted in the Document History section of the report.



Title: Digi ConnectCard for i.MX28 with Atheros AR6233
To: FCC 47 CFR Part 15.247 & IC RSS-210
Serial #: DIGI28-U2A Rev A
Issue Date: 29th March 2013
Page: 116 of 245

Band Edge 802.11n HT20 2462 MHz

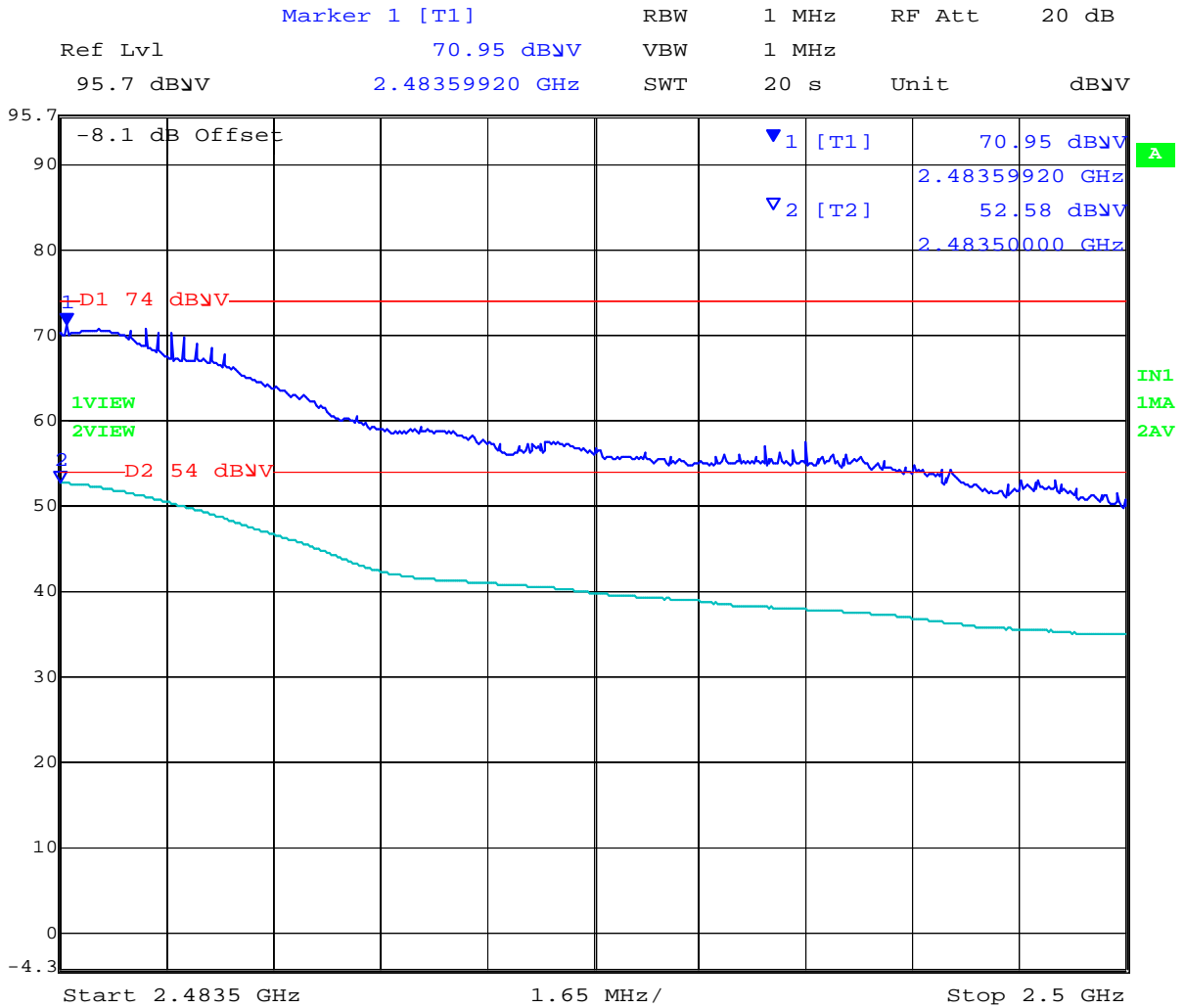

Date: 26.SEP.2012 17:12:13

Power reduction required in order to bring unit into compliance Power = 14

This test report may be reproduced in full only. The document may only be updated by MiCOM Labs personnel. Any changes will be noted in the Document History section of the report.



Title: Digi ConnectCard for i.MX28 with Atheros AR6233
To: FCC 47 CFR Part 15.247 & IC RSS-210
Serial #: DIGI28-U2A Rev A
Issue Date: 29th March 2013
Page: 117 of 245

Band Edge 802.11n HT40 2422 MHz

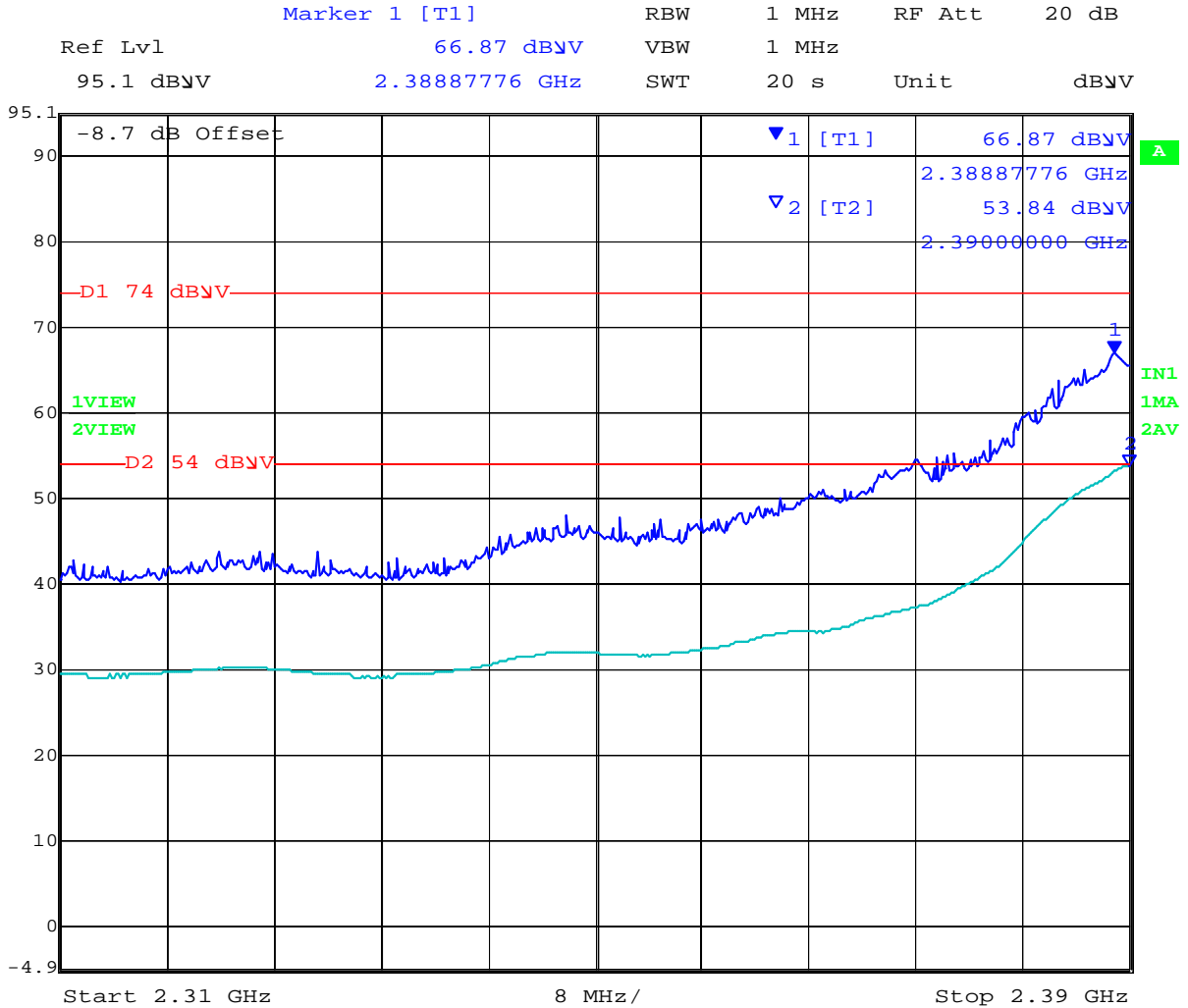

Date: 26.SEP.2012 16:38:58

Power reduction required in order to bring unit into compliance Power = 11

This test report may be reproduced in full only. The document may only be updated by MiCOM Labs personnel. Any changes will be noted in the Document History section of the report.



Title: Digi ConnectCard for i.MX28 with Atheros AR6233
To: FCC 47 CFR Part 15.247 & IC RSS-210
Serial #: DIGI28-U2A Rev A
Issue Date: 29th March 2013
Page: 118 of 245

Band Edge 802.11n HT40 2452 MHz

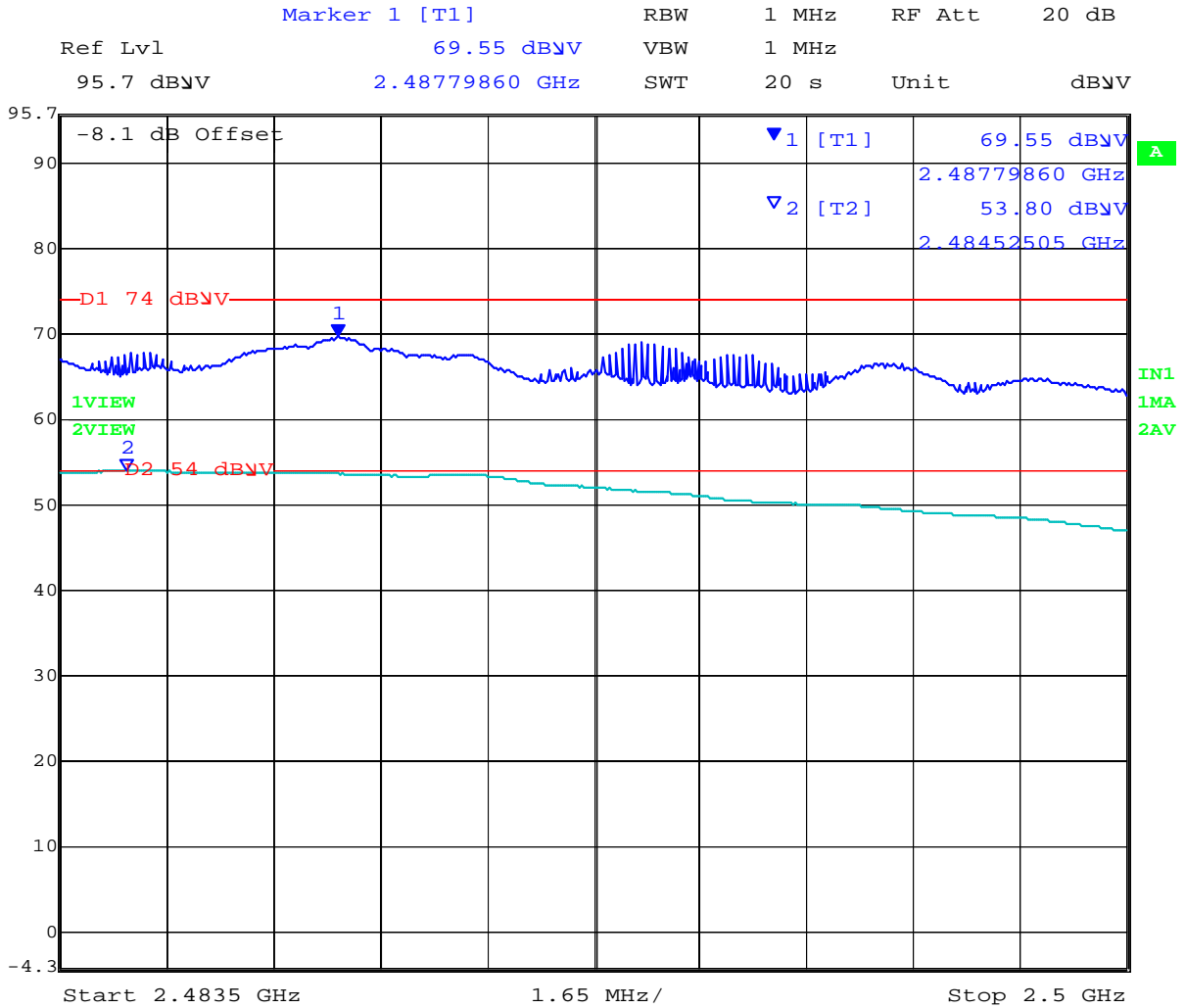

Date: 26.SEP.2012 15:55:23

Power reduction required in order to bring unit into compliance Power = 12

This test report may be reproduced in full only. The document may only be updated by MiCOM Labs personnel. Any changes will be noted in the Document History section of the report.



Title: Digi ConnectCard for i.MX28 with Atheros AR6233
To: FCC 47 CFR Part 15.247 & IC RSS-210
Serial #: DIGI28-U2A Rev A
Issue Date: 29th March 2013
Page: 119 of 245

Test Freq.	5745 MHz	Engineer	SB
Variant	802.11a; 6.5 Mbs	Temp (°C)	25
Freq. Range	1000 MHz - 18000 MHz	Rel. Hum.(%)	33
Power Setting	30	Press. (mBars)	1008
Antenna	Monopole 5 dBi	Duty Cycle (%)	100
Test Notes 1			
Test Notes 2			

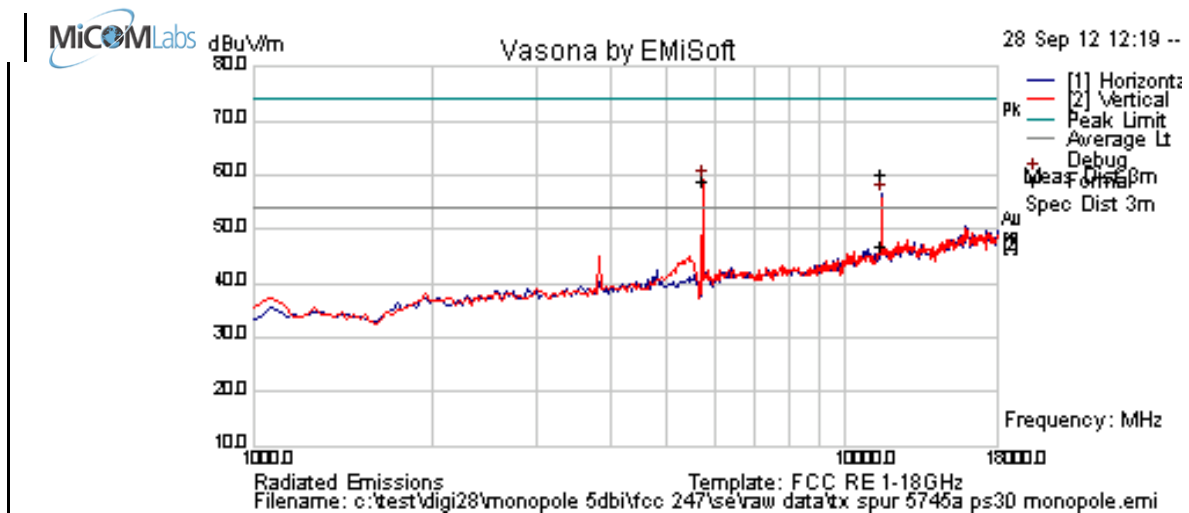

Formally measured emission peaks

Frequency MHz	Raw dBuV	Cable Loss	AF dB	Level dBuV/m	Measurement Type	Pol	Hgt cm	Azt Deg	Limit dBuV/m	Margin dB	Pass /Fail	Comments
11491.543	55.2	6.8	-2.0	60.0	Peak Max	H	143	29	74.0	-14.0	Pass	RB
11491.543	42.0	6.8	-2.0	46.9	Average Max	H	143	29	54.0	-7.2	Pass	RB
5735.471	63.8	4.8	-9.5	59.0	Peak [Scan]	V	100					FUND

Legend: TX = Transmitter Emissions; DIG = Digital Emissions; FUND = Fundamental; WB = Wideband Emission
 RB = Restricted Band (15.209 Limits); NRB = Non Restricted Band, Limit is 20dB below fundamental peak

This test report may be reproduced in full only. The document may only be updated by MiCOM Labs personnel. Any changes will be noted in the Document History section of the report.



Title: Digi ConnectCard for i.MX28 with Atheros AR6233
To: FCC 47 CFR Part 15.247 & IC RSS-210
Serial #: DIGI28-U2A Rev A
Issue Date: 29th March 2013
Page: 120 of 245

Band Edge

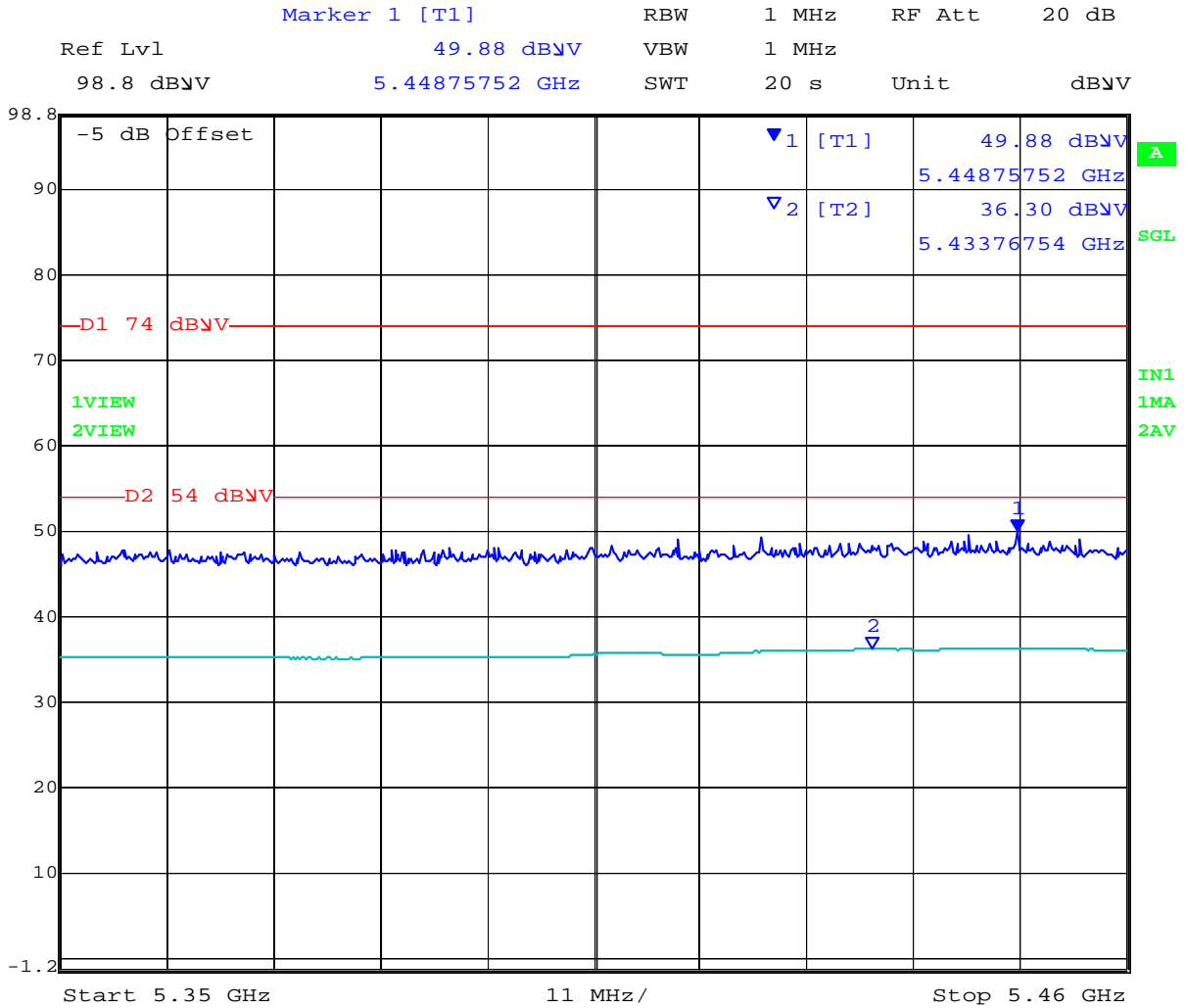

Date: 28.SEP.2012 12:03:33

This test report may be reproduced in full only. The document may only be updated by MiCOM Labs personnel. Any changes will be noted in the Document History section of the report.



Title: Digi ConnectCard for i.MX28 with Atheros AR6233
To: FCC 47 CFR Part 15.247 & IC RSS-210
Serial #: DIGI28-U2A Rev A
Issue Date: 29th March 2013
Page: 121 of 245

Test Freq.	5785 MHz	Engineer	SB
Variant	802.11a; 6.5 Mbs	Temp (°C)	25
Freq. Range	1000 MHz - 18000 MHz	Rel. Hum.(%)	33
Power Setting	30	Press. (mBars)	1008
Antenna	Monopole 5 dBi	Duty Cycle (%)	100
Test Notes 1			
Test Notes 2			

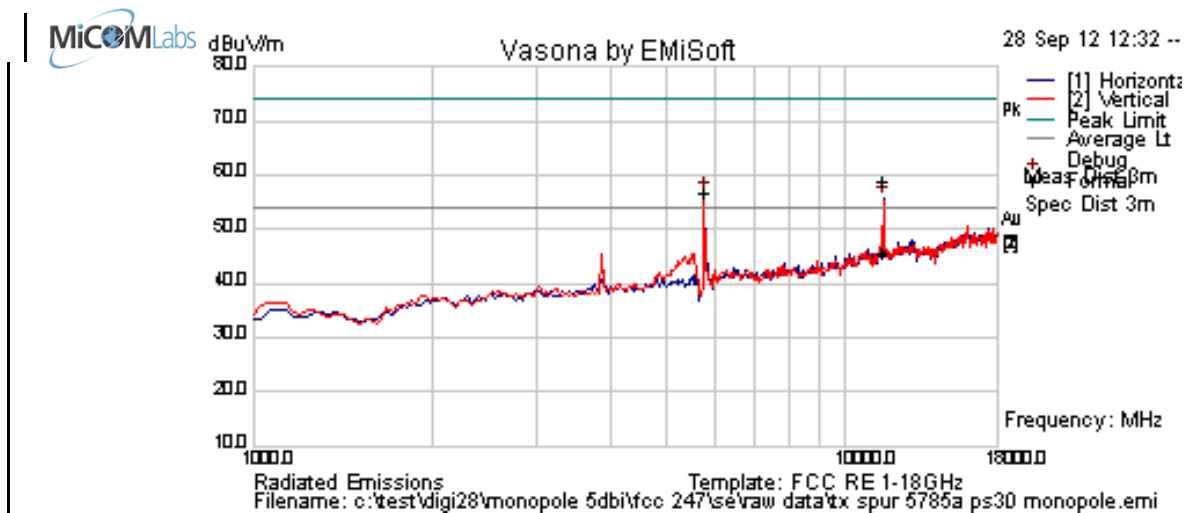

Formally measured emission peaks

Frequency MHz	Raw dBuV	Cable Loss	AF dB	Level dBuV/m	Measurement Type	Pol	Hgt cm	Azt Deg	Limit dBuV/m	Margin dB	Pass /Fail	Comments
11567.375	53.9	6.8	-2.0	58.7	Peak Max	H	134	362	74.0	-15.3	Pass	
11567.375	40.7	6.8	-2.0	45.5	Average Max	H	134	362	54.0	-8.5	Pass	
5769.539	61.3	4.8	-9.5	56.6	Peak [Scan]	V	200					FUND
Legend: TX = Transmitter Emissions; DIG = Digital Emissions; FUND = Fundamental; WB = Wideband Emission RB = Restricted Band (15.209 Limits); NRB = Non Restricted Band, Limit is 20dB below fundamental peak												

This test report may be reproduced in full only. The document may only be updated by MiCOM Labs personnel. Any changes will be noted in the Document History section of the report.



Title: Digi ConnectCard for i.MX28 with Atheros AR6233
To: FCC 47 CFR Part 15.247 & IC RSS-210
Serial #: DIGI28-U2A Rev A
Issue Date: 29th March 2013
Page: 122 of 245

Test Freq.	5825 MHz	Engineer	SB
Variant	802.11a; 6.5 Mbs	Temp (°C)	25
Freq. Range	1000 MHz - 18000 MHz	Rel. Hum.(%)	33
Power Setting	30	Press. (mBars)	1008
Antenna	Monopole 5 dBi	Duty Cycle (%)	100
Test Notes 1			
Test Notes 2			

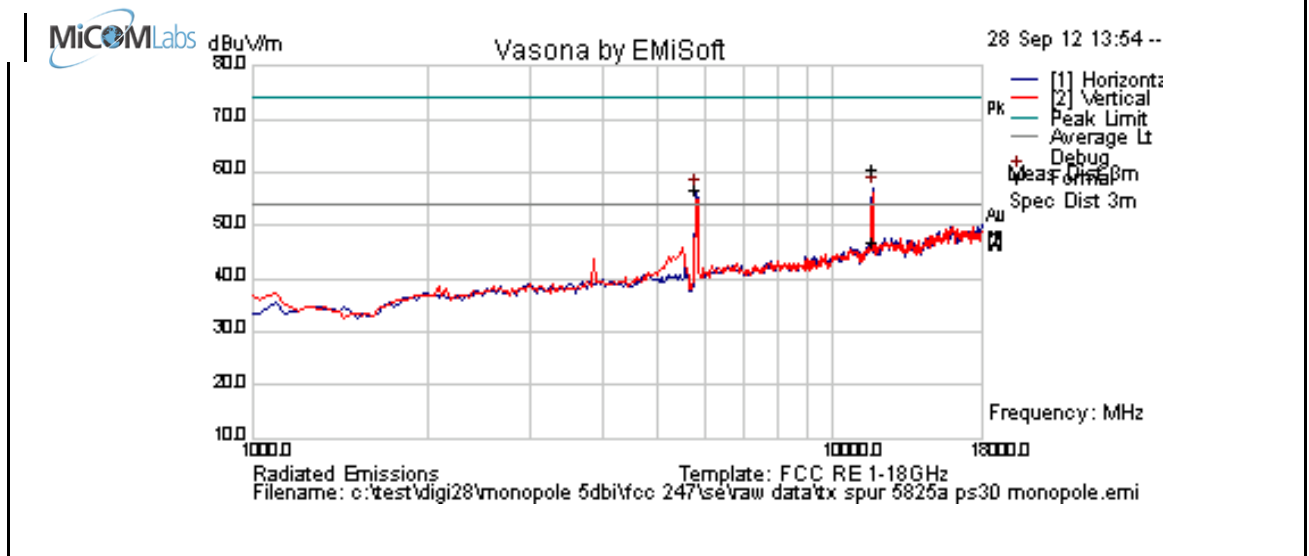

Formally measured emission peaks

Frequency MHz	Raw dBuV	Cable Loss	AF dB	Level dBuV/m	Measurement Type	Pol	Hgt cm	Azt Deg	Limit dBuV/m	Margin dB	Pass /Fail	Comments
11650.662	56.1	6.8	-2.3	60.6	Peak Max	H	135	26	74.0	-13.4	Pass	
11650.662	42.4	6.8	-2.3	46.9	Average Max	H	135	26	54.0	-7.1	Pass	
5803.607	61.3	4.8	-9.4	56.7	Peak [Scan]	H	150					FUND

Legend: TX = Transmitter Emissions; DIG = Digital Emissions; FUND = Fundamental; WB = Wideband Emission
 RB = Restricted Band (15.209 Limits); NRB = Non Restricted Band, Limit is 20dB below fundamental peak

This test report may be reproduced in full only. The document may only be updated by MiCOM Labs personnel. Any changes will be noted in the Document History section of the report.



Title: Digi ConnectCard for i.MX28 with Atheros AR6233
To: FCC 47 CFR Part 15.247 & IC RSS-210
Serial #: DIGI28-U2A Rev A
Issue Date: 29th March 2013
Page: 123 of 245

Band Edge 802.11n HT20 5745 MHz

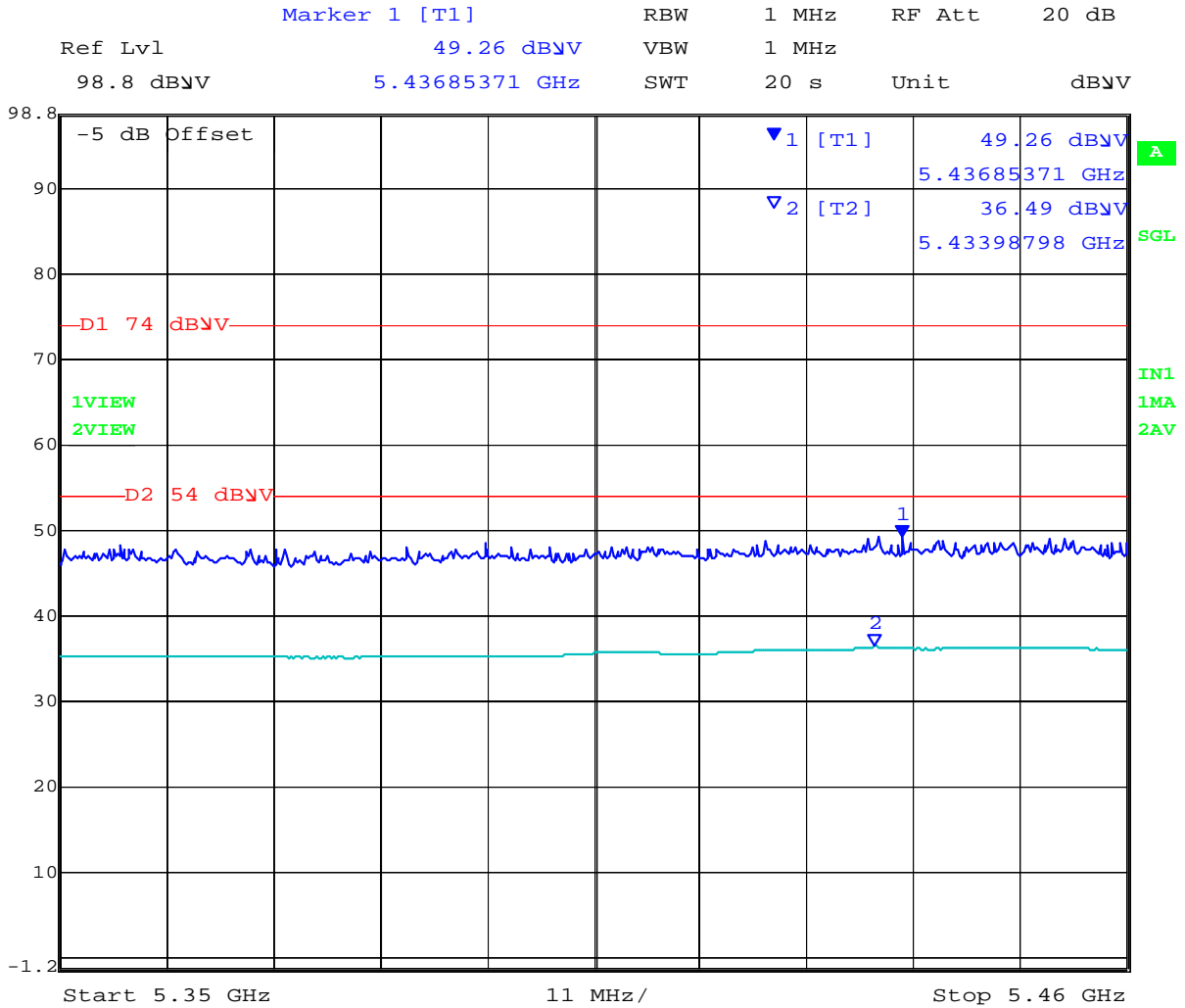

Date: 28.SEP.2012 11:59:26

This test report may be reproduced in full only. The document may only be updated by MiCOM Labs personnel. Any changes will be noted in the Document History section of the report.



Title: Digi ConnectCard for i.MX28 with Atheros AR6233
To: FCC 47 CFR Part 15.247 & IC RSS-210
Serial #: DIGI28-U2A Rev A
Issue Date: 29th March 2013
Page: 124 of 245

Band Edge 802.11n HT40 5755 MHz

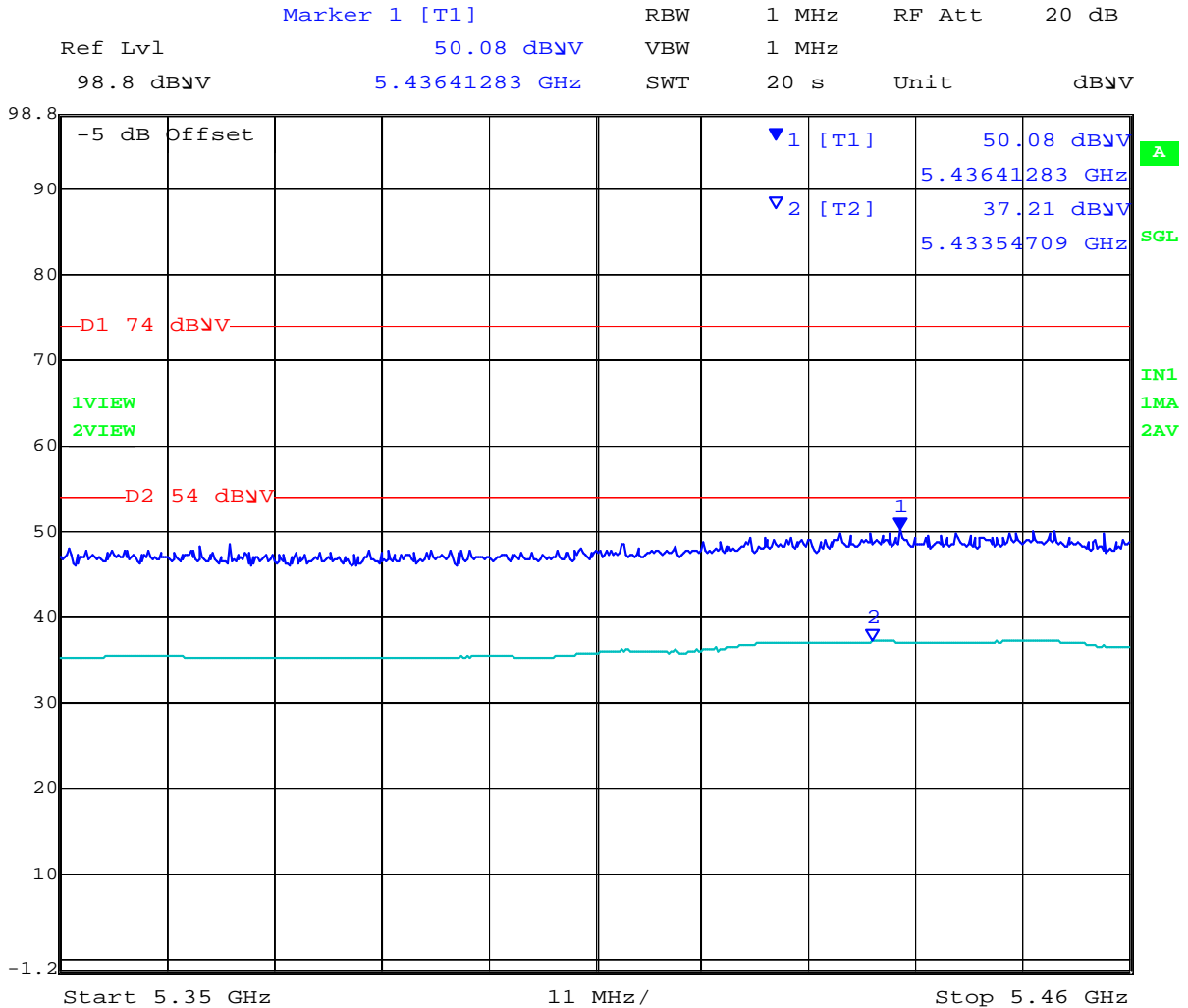

Date: 28.SEP.2012 11:55:39

This test report may be reproduced in full only. The document may only be updated by MiCOM Labs personnel. Any changes will be noted in the Document History section of the report.



Title: Digi ConnectCard for i.MX28 with Atheros AR6233
To: FCC 47 CFR Part 15.247 & IC RSS-210
Serial #: DIGI28-U2A Rev A
Issue Date: 29th March 2013
Page: 125 of 245

6.1.2.4. Single Band Omni SA-006-1 – Single Port Module

Test Freq.	2412 MHz	Engineer	JMH
Variant	802.11b; 1 Mbs	Temp (°C)	27
Freq. Range	1000 MHz - 18000 MHz	Rel. Hum.(%)	33
Power Setting	30	Press. (mBars)	1002
Antenna	SA-006 monopole	Duty Cycle (%)	100
Test Notes 1	1.8 dBi		
Test Notes 2			

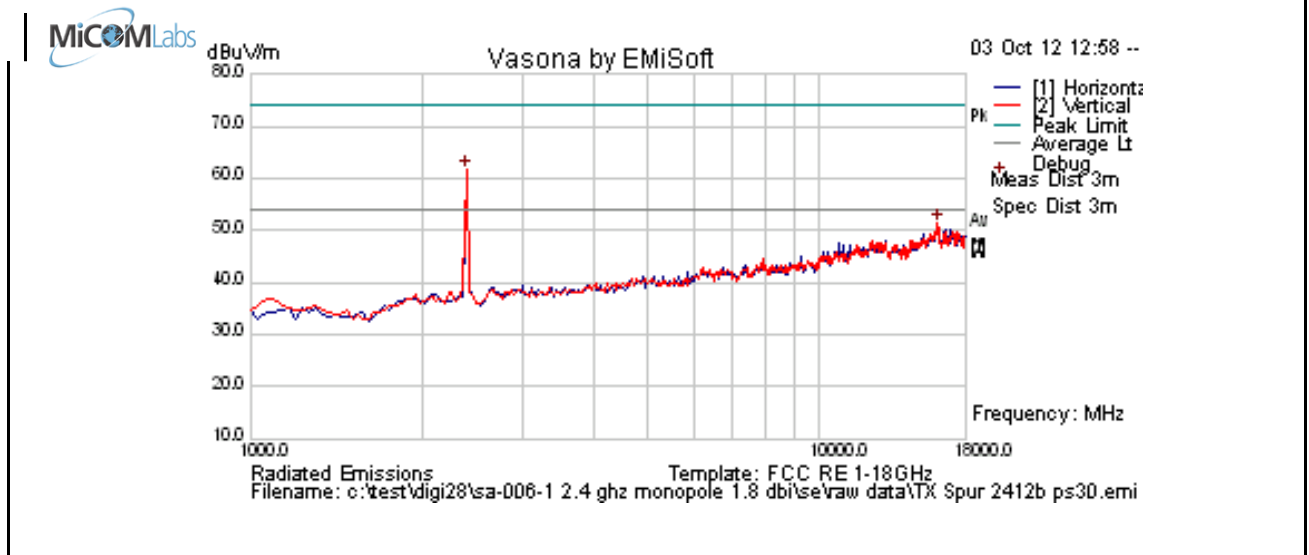

Formally measured emission peaks

Frequency MHz	Raw dBuV	Cable Loss	AF dB	Level dBuV/m	Measurement Type	Pol	Hgt cm	Azt Deg	Limit dBuV/m	Margin dB	Pass /Fail	Comments
2396.794	70.4	3.0	11.7	61.7	Peak [Scan]	H						FUND
16092.184	42.0	9.0	0.3	51.3	Peak [Scan]	V	100	0	54.0	-2.7	Pass	Noise

Legend: TX = Transmitter Emissions; DIG = Digital Emissions; FUND = Fundamental; WB = Wideband Emission
 RB = Restricted Band (15.209 Limits); NRB = Non Restricted Band, Limit is 20dB below fundamental peak

This test report may be reproduced in full only. The document may only be updated by MiCOM Labs personnel. Any changes will be noted in the Document History section of the report.



Title: Digi ConnectCard for i.MX28 with Atheros AR6233
To: FCC 47 CFR Part 15.247 & IC RSS-210
Serial #: DIGI28-U2A Rev A
Issue Date: 29th March 2013
Page: 126 of 245

Band Edge

Marker 2 [T2] RBW 1 MHz RF Att 20 dB
Ref Lvl 48.99 dBμV VBW 1 MHz
95.1 dBμV 2.38695391 GHz SWT 20 s Unit dBμV

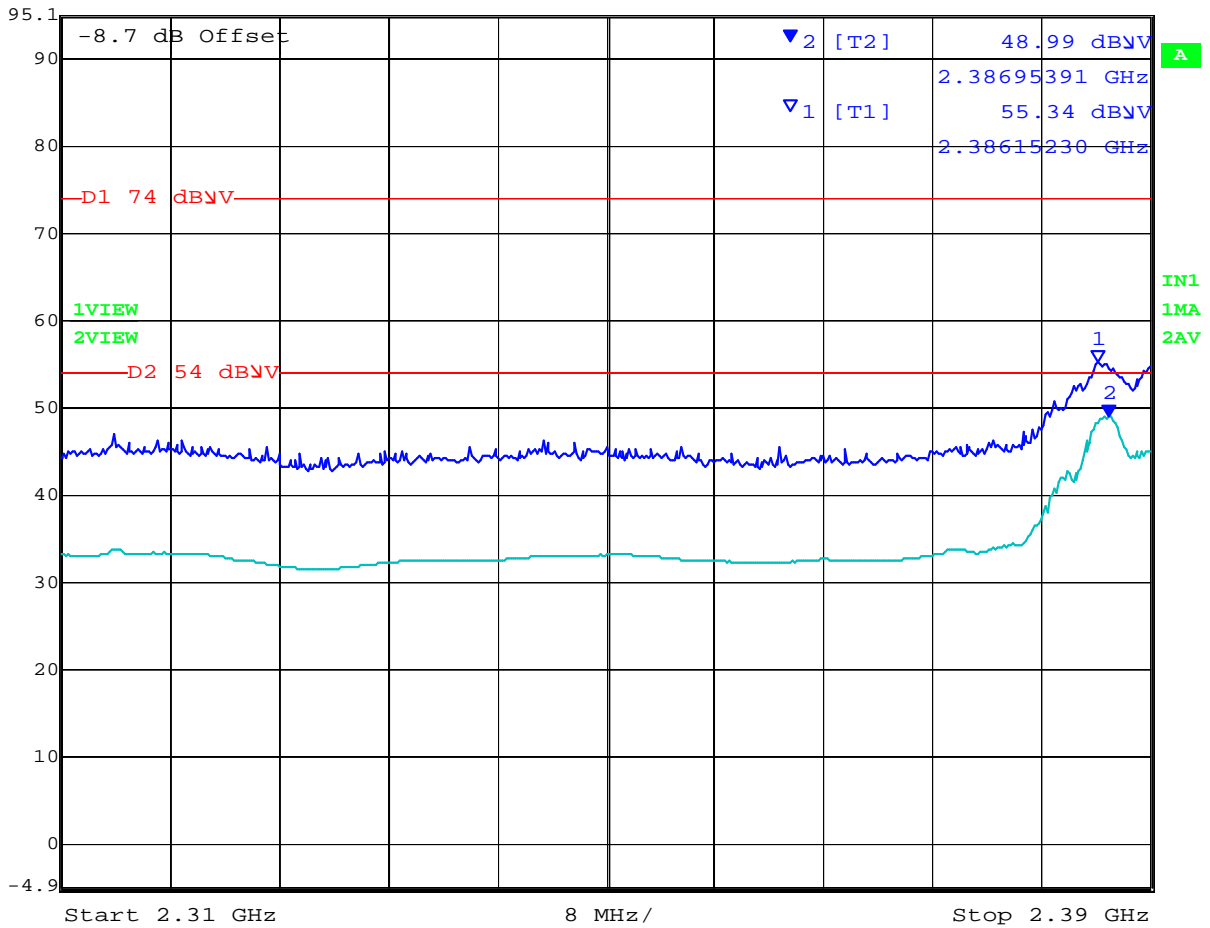

Date: 19.NOV.2012 19:53:30

This test report may be reproduced in full only. The document may only be updated by MiCOM Labs personnel. Any changes will be noted in the Document History section of the report.



Title: Digi ConnectCard for i.MX28 with Atheros AR6233
To: FCC 47 CFR Part 15.247 & IC RSS-210
Serial #: DIGI28-U2A Rev A
Issue Date: 29th March 2013
Page: 127 of 245

Test Freq.	2437 MHz	Engineer	JMH
Variant	802.11b; 1 Mbs	Temp (°C)	27
Freq. Range	1000 MHz - 18000 MHz	Rel. Hum.(%)	33
Power Setting	30	Press. (mBars)	1002
Antenna	SA-006 monopole	Duty Cycle (%)	100
Test Notes 1	1.8 dBi		
Test Notes 2			

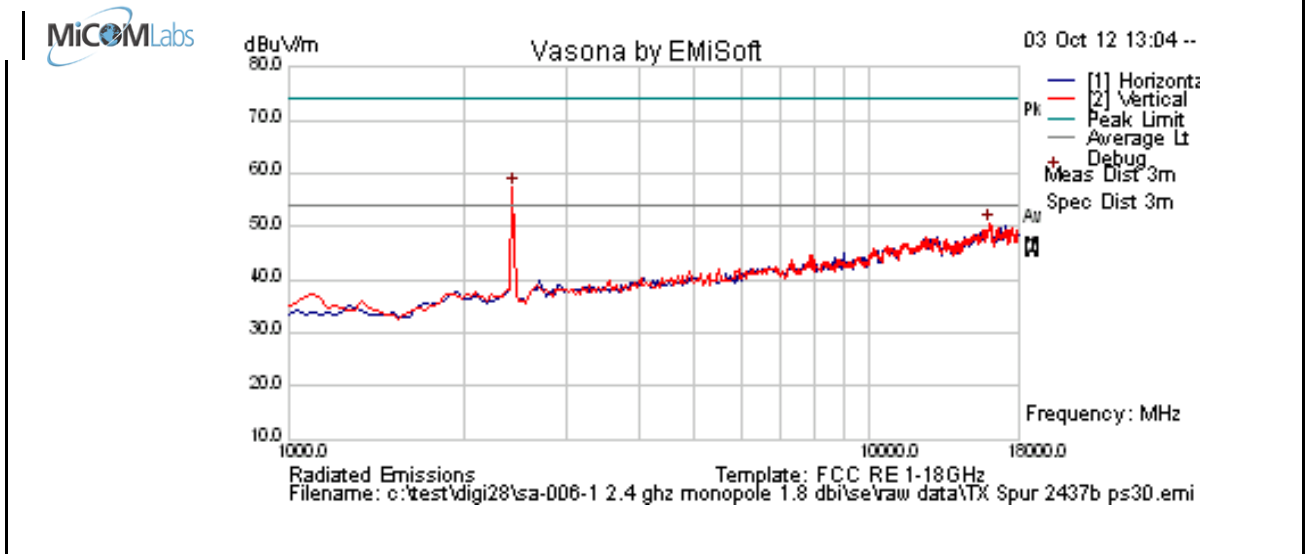

Formally measured emission peaks

Frequency MHz	Raw dBuV	Cable Loss	AF dB	Level dBuV/m	Measurement Type	Pol	Hgt cm	Azt Deg	Limit dBuV/m	Margin dB	Pass /Fail	Comments
2430.862	66.0	3.0	-11.6	57.4	Peak [Scan]	V						FUND
16024.048	41.1	9.0	0.2	50.4	Peak [Scan]	V	100	0	54.0	-3.6	Pass	Noise

Legend:	TX = Transmitter Emissions; DIG = Digital Emissions; FUND = Fundamental; WB = Wideband Emission
	RB = Restricted Band (15.209 Limits); NRB = Non Restricted Band, Limit is 20dB below fundamental peak

This test report may be reproduced in full only. The document may only be updated by MiCOM Labs personnel. Any changes will be noted in the Document History section of the report.



Title: Digi ConnectCard for i.MX28 with Atheros AR6233
To: FCC 47 CFR Part 15.247 & IC RSS-210
Serial #: DIGI28-U2A Rev A
Issue Date: 29th March 2013
Page: 128 of 245

Test Freq.	2462 MHz	Engineer	JMH
Variant	802.11b; 1 Mbs	Temp (°C)	27
Freq. Range	1000 MHz - 18000 MHz	Rel. Hum.(%)	33
Power Setting	30	Press. (mBars)	1002
Antenna	SA-006 monopole	Duty Cycle (%)	100
Test Notes 1	1.8 dBi		
Test Notes 2			

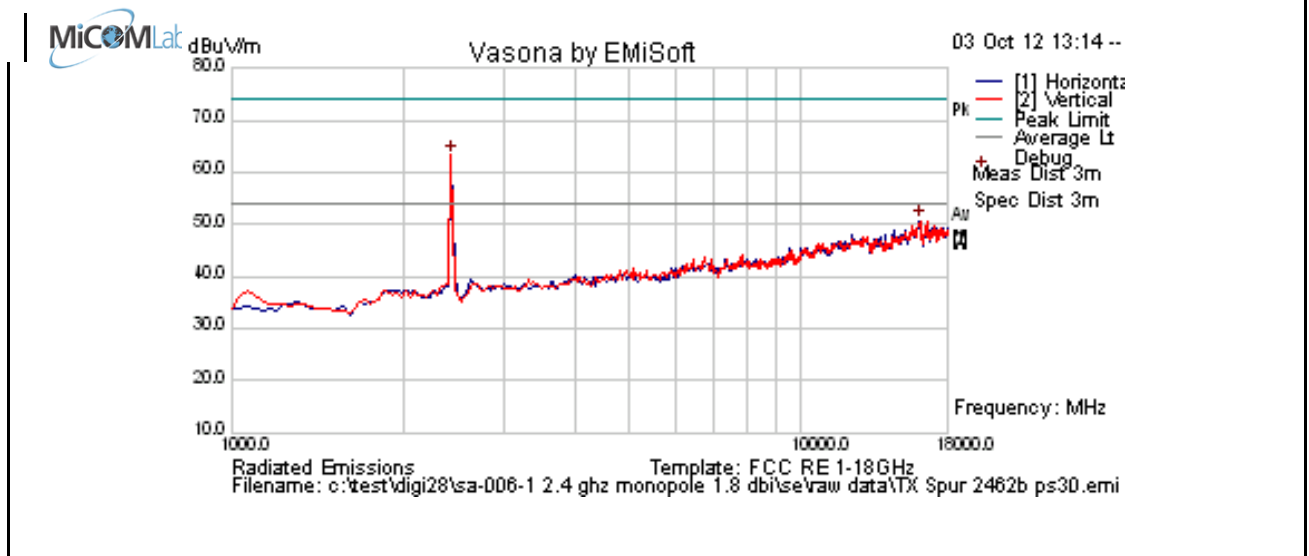

Formally measured emission peaks

Frequency MHz	Raw dBuV	Cable Loss	AF dB	Level dBuV/m	Measurement Type	Pol	Hgt cm	Azt Deg	Limit dBuV/m	Margin dB	Pass /Fail	Comments
2430.862	72.0	3.0	-11.6	63.4	Peak [Scan]	V						FUND
16126.253	41.6	9.0	0.2	50.8	Peak [Scan]	V	100	0	54.0	-3.2	Pass	Noise

Legend: TX = Transmitter Emissions; DIG = Digital Emissions; FUND = Fundamental; WB = Wideband Emission
 RB = Restricted Band (15.209 Limits); NRB = Non Restricted Band, Limit is 20dB below fundamental peak

This test report may be reproduced in full only. The document may only be updated by MiCOM Labs personnel. Any changes will be noted in the Document History section of the report.



Title: Digi ConnectCard for i.MX28 with Atheros AR6233
To: FCC 47 CFR Part 15.247 & IC RSS-210
Serial #: DIGI28-U2A Rev A
Issue Date: 29th March 2013
Page: 129 of 245

Band Edge

Marker 1 [T1]	RBW	1 MHz	RF Att	20 dB
Ref Lvl	52.92 dB μ V	VBW	1 MHz	
95.1 dB μ V	2.38615230 GHz	SWT	20 s	Unit dB μ V

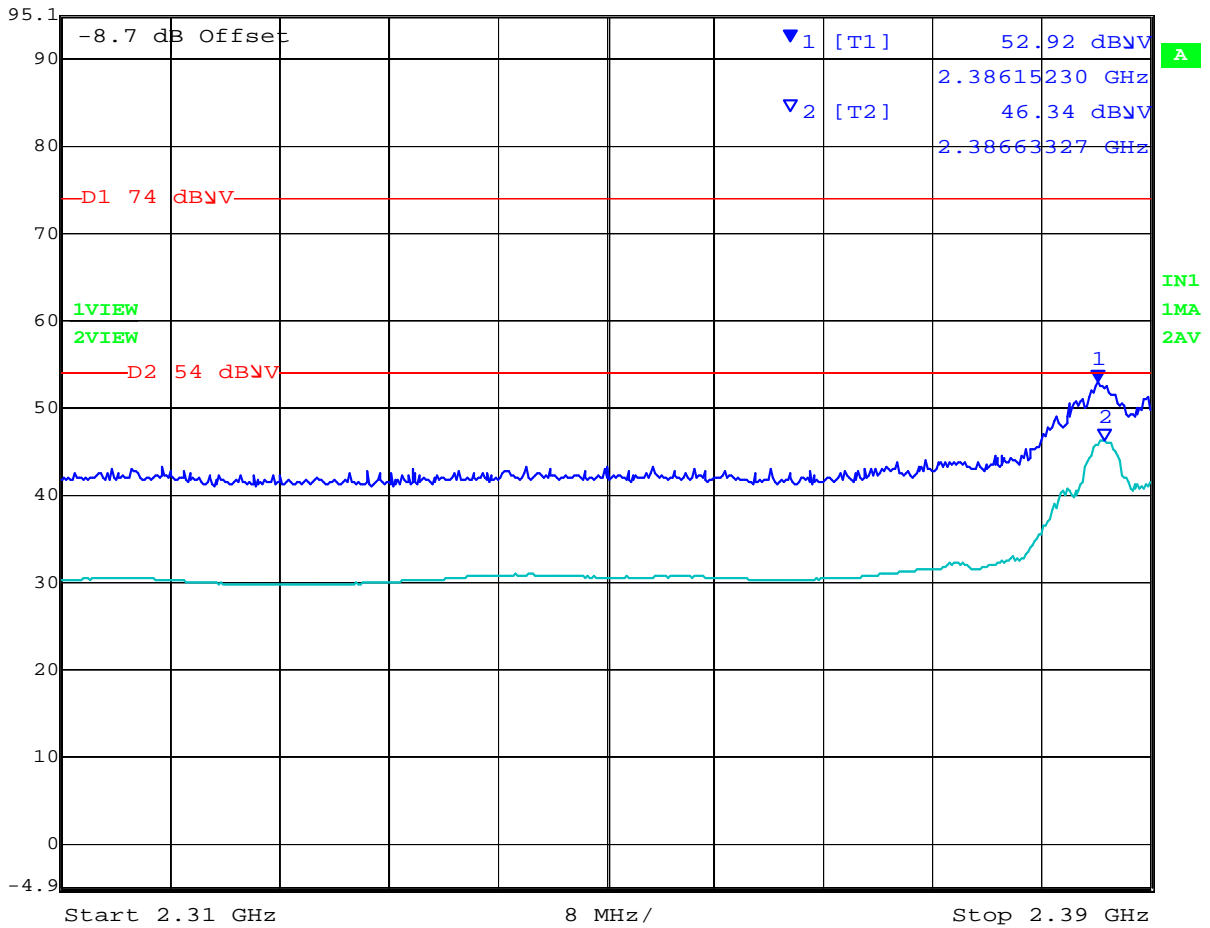

Date: 3.OCT.2012 12:52:19

This test report may be reproduced in full only. The document may only be updated by MiCOM Labs personnel. Any changes will be noted in the Document History section of the report.



Title: Digi ConnectCard for i.MX28 with Atheros AR6233
To: FCC 47 CFR Part 15.247 & IC RSS-210
Serial #: DIGI28-U2A Rev A
Issue Date: 29th March 2013
Page: 130 of 245

Test Freq.	2412 MHz	Engineer	JMH
Variant	802.11g; 6 Mbs	Temp (°C)	27
Freq. Range	1000 MHz - 18000 MHz	Rel. Hum.(%)	33
Power Setting	30	Press. (mBars)	1002
Antenna	SA-006 Monopole	Duty Cycle (%)	100
Test Notes 1	1.8 dBi		
Test Notes 2			

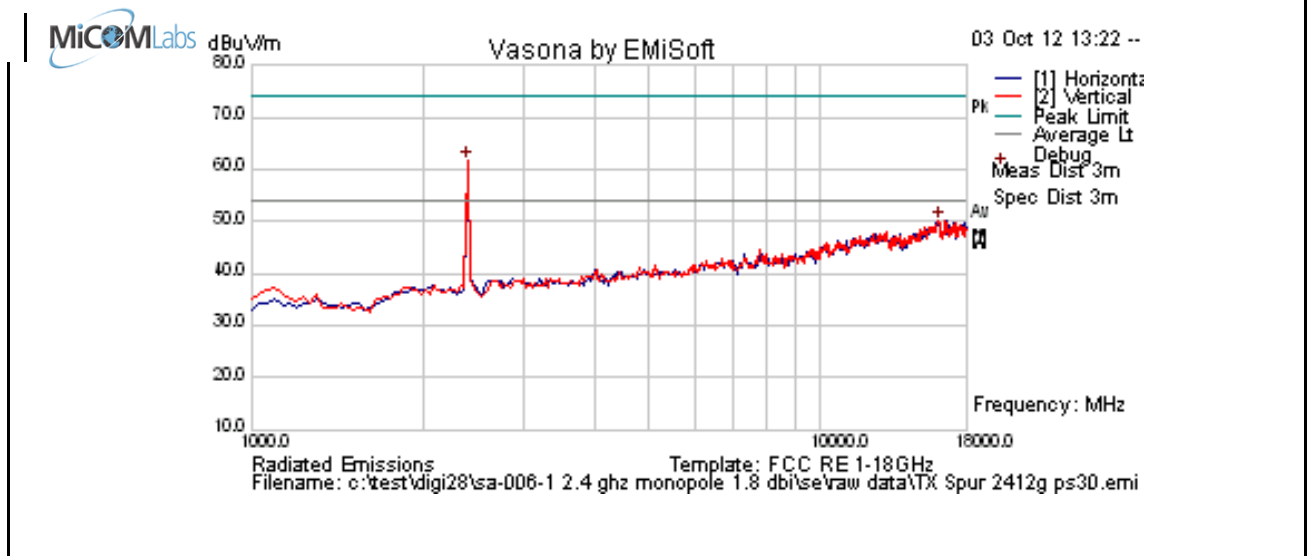

Formally measured emission peaks

Frequency MHz	Raw dBuV	Cable Loss	AF dB	Level dBuV/m	Measurement Type	Pol	Hgt cm	Azt Deg	Limit dBuV/m	Margin dB	Pass /Fail	Comments
2396.794	70.3	3.0	-11.7	61.6	Peak [Scan]	V						FUND
16092.184	40.9	9.0	0.3	50.2	Peak [Scan]	H	150	0	54.0	-3.9	Pass	Noise

Legend:	TX = Transmitter Emissions; DIG = Digital Emissions; FUND = Fundamental; WB = Wideband Emission
	RB = Restricted Band (15.209 Limits); NRB = Non Restricted Band, Limit is 20dB below fundamental peak

This test report may be reproduced in full only. The document may only be updated by MiCOM Labs personnel. Any changes will be noted in the Document History section of the report.



Title: Digi ConnectCard for i.MX28 with Atheros AR6233
To: FCC 47 CFR Part 15.247 & IC RSS-210
Serial #: DIGI28-U2A Rev A
Issue Date: 29th March 2013
Page: 131 of 245

Band Edge

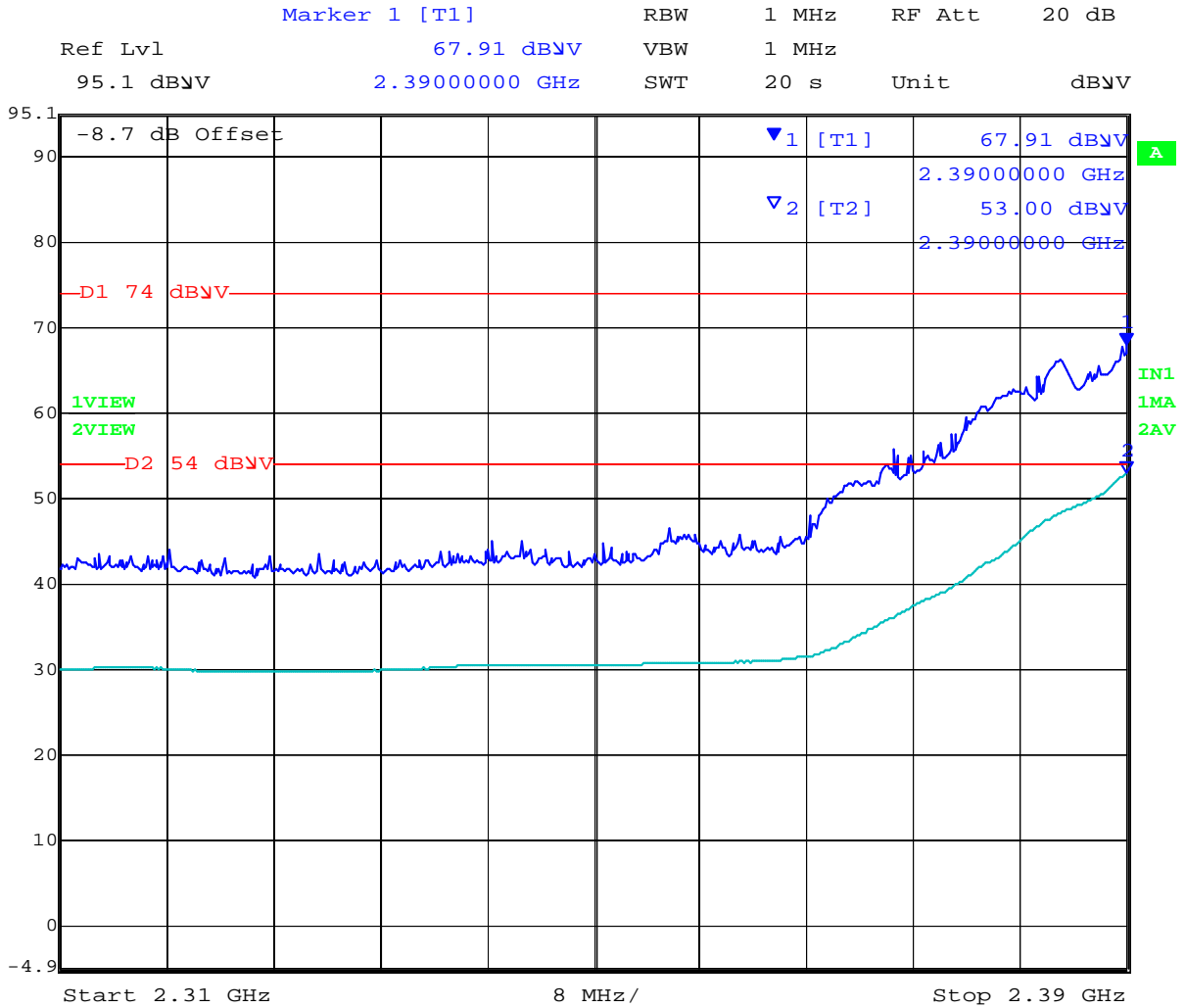

Date: 3.OCT.2012 12:50:49

Power reduction required in order to bring unit into compliance Power = 16

This test report may be reproduced in full only. The document may only be updated by MiCOM Labs personnel. Any changes will be noted in the Document History section of the report.



Title: Digi ConnectCard for i.MX28 with Atheros AR6233
To: FCC 47 CFR Part 15.247 & IC RSS-210
Serial #: DIGI28-U2A Rev A
Issue Date: 29th March 2013
Page: 132 of 245

Test Freq.	2437 MHz	Engineer	JMH
Variant	802.11g; 6 Mbs	Temp (°C)	27
Freq. Range	1000 MHz - 18000 MHz	Rel. Hum.(%)	33
Power Setting	30	Press. (mBars)	1002
Antenna	SA-006 Monopole	Duty Cycle (%)	100
Test Notes 1	1.8 dBi		
Test Notes 2			

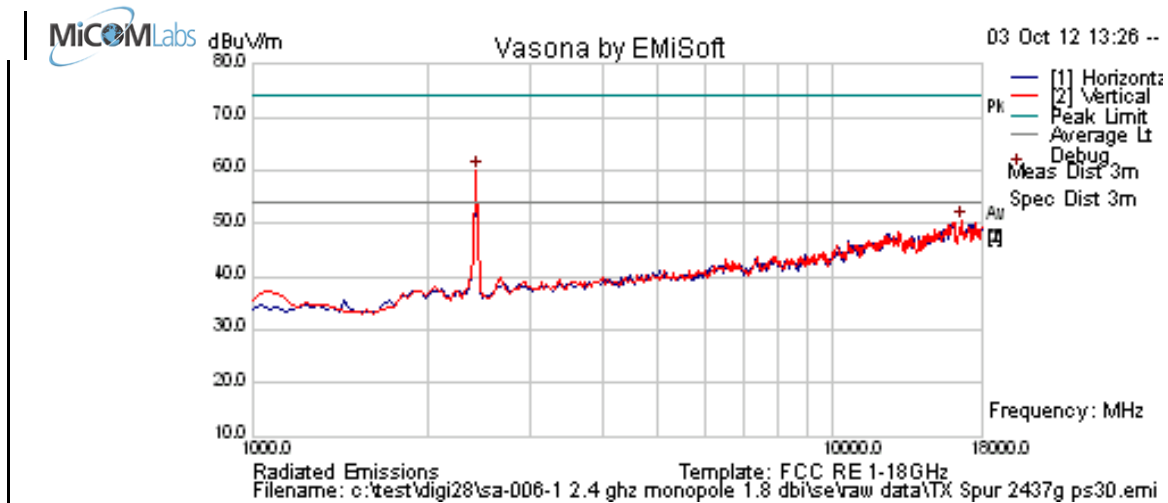

Formally measured emission peaks

Frequency MHz	Raw dBuV	Cable Loss	AF dB	Level dBuV/m	Measurement Type	Pol	Hgt cm	Azt Deg	Limit dBuV/m	Margin dB	Pass /Fail	Comments
2430.862	68.5	3.0	-11.6	59.9	Peak [Scan]	V						FUND
16637.275	41.1	8.7	0.6	50.4	Peak [Scan]	V	100	0	54.0	-3.6	Pass	Noise

Legend: TX = Transmitter Emissions; DIG = Digital Emissions; FUND = Fundamental; WB = Wideband Emission
 RB = Restricted Band (15.209 Limits); NRB = Non Restricted Band, Limit is 20dB below fundamental peak

This test report may be reproduced in full only. The document may only be updated by MiCOM Labs personnel. Any changes will be noted in the Document History section of the report.



Title: Digi ConnectCard for i.MX28 with Atheros AR6233
To: FCC 47 CFR Part 15.247 & IC RSS-210
Serial #: DIGI28-U2A Rev A
Issue Date: 29th March 2013
Page: 133 of 245

Test Freq.	2462 MHz	Engineer	JMH
Variant	802.11g; 6 Mbs	Temp (°C)	27
Freq. Range	1000 MHz - 18000 MHz	Rel. Hum.(%)	33
Power Setting	30	Press. (mBars)	1002
Antenna	SA-006 Monopole	Duty Cycle (%)	100
Test Notes 1	1.8 dBi		
Test Notes 2			

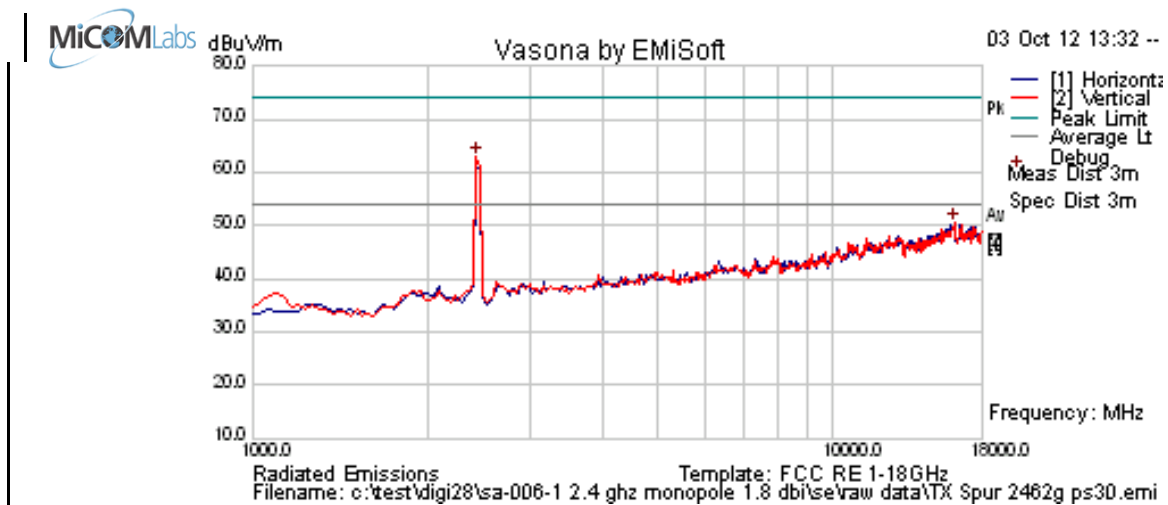

Formally measured emission peaks

Frequency MHz	Raw dBuV	Cable Loss	AF dB	Level dBuV/m	Measurement Type	Pol	Hgt cm	Azt Deg	Limit dBuV/m	Margin dB	Pass /Fail	Comments
2430.862	71.5	3.0	-11.6	62.9	Peak [Scan]	V						FUND
16126.253	41.2	9.0	0.2	50.4	Peak [Scan]	V	100	0	54.0	-3.6	Pass	Noise

Legend: TX = Transmitter Emissions; DIG = Digital Emissions; FUND = Fundamental; WB = Wideband Emission
 RB = Restricted Band (15.209 Limits); NRB = Non Restricted Band, Limit is 20dB below fundamental peak

This test report may be reproduced in full only. The document may only be updated by MiCOM Labs personnel. Any changes will be noted in the Document History section of the report.



Title: Digi ConnectCard for i.MX28 with Atheros AR6233
To: FCC 47 CFR Part 15.247 & IC RSS-210
Serial #: DIGI28-U2A Rev A
Issue Date: 29th March 2013
Page: 134 of 245

Band Edge

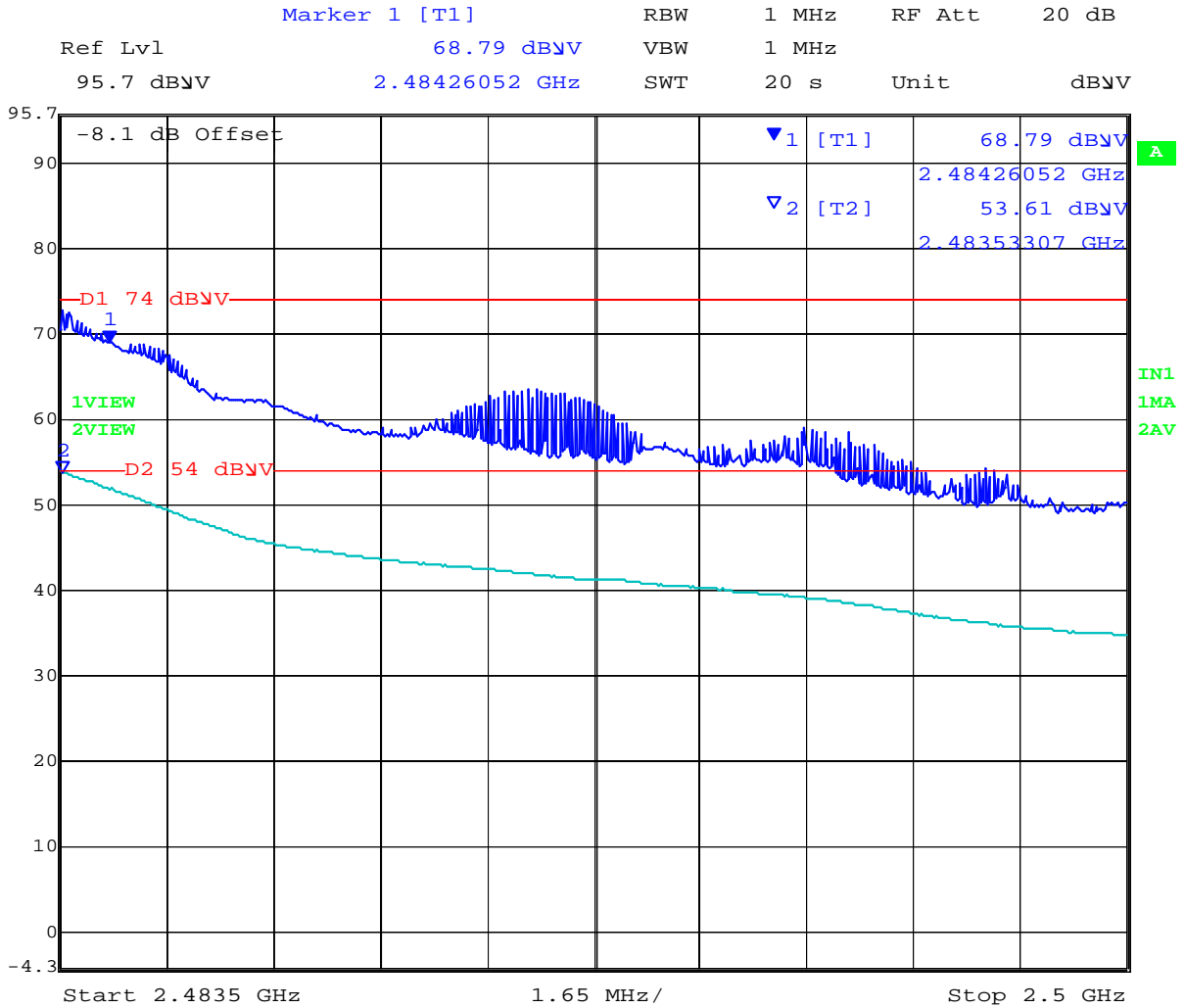

Date: 3.OCT.2012 12:20:36

Power reduction required in order to bring unit into compliance Power = 15

This test report may be reproduced in full only. The document may only be updated by MiCOM Labs personnel. Any changes will be noted in the Document History section of the report.



Title: Digi ConnectCard for i.MX28 with Atheros AR6233
To: FCC 47 CFR Part 15.247 & IC RSS-210
Serial #: DIGI28-U2A Rev A
Issue Date: 29th March 2013
Page: 135 of 245

Band Edge 802.11n HT20 2412 MHz

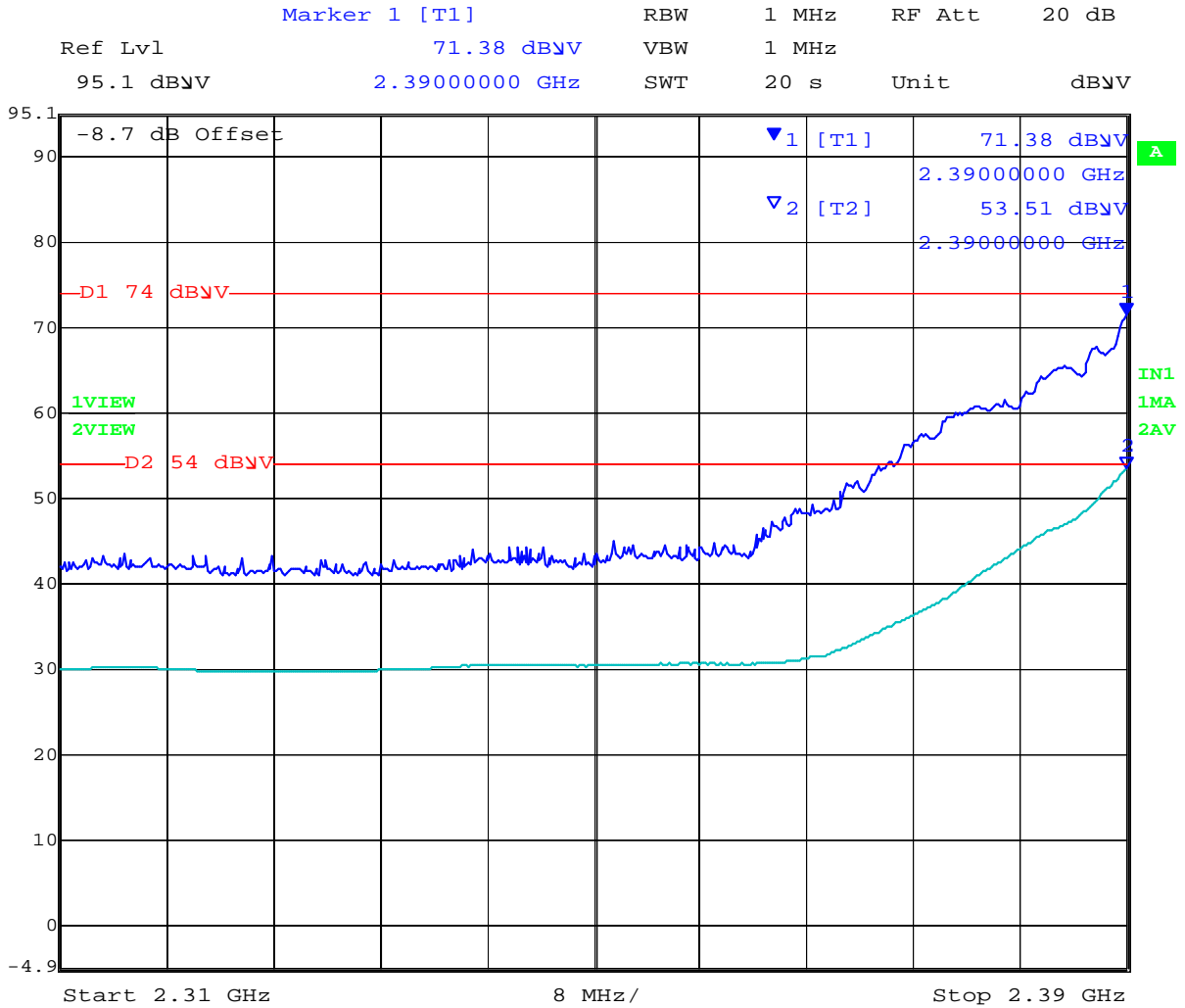

Date: 3.OCT.2012 12:48:55

Power reduction required in order to bring unit into compliance Power = 15

This test report may be reproduced in full only. The document may only be updated by MiCOM Labs personnel. Any changes will be noted in the Document History section of the report.



Title: Digi ConnectCard for i.MX28 with Atheros AR6233
To: FCC 47 CFR Part 15.247 & IC RSS-210
Serial #: DIGI28-U2A Rev A
Issue Date: 29th March 2013
Page: 136 of 245

Band Edge 802.11n HT20 2462 MHz

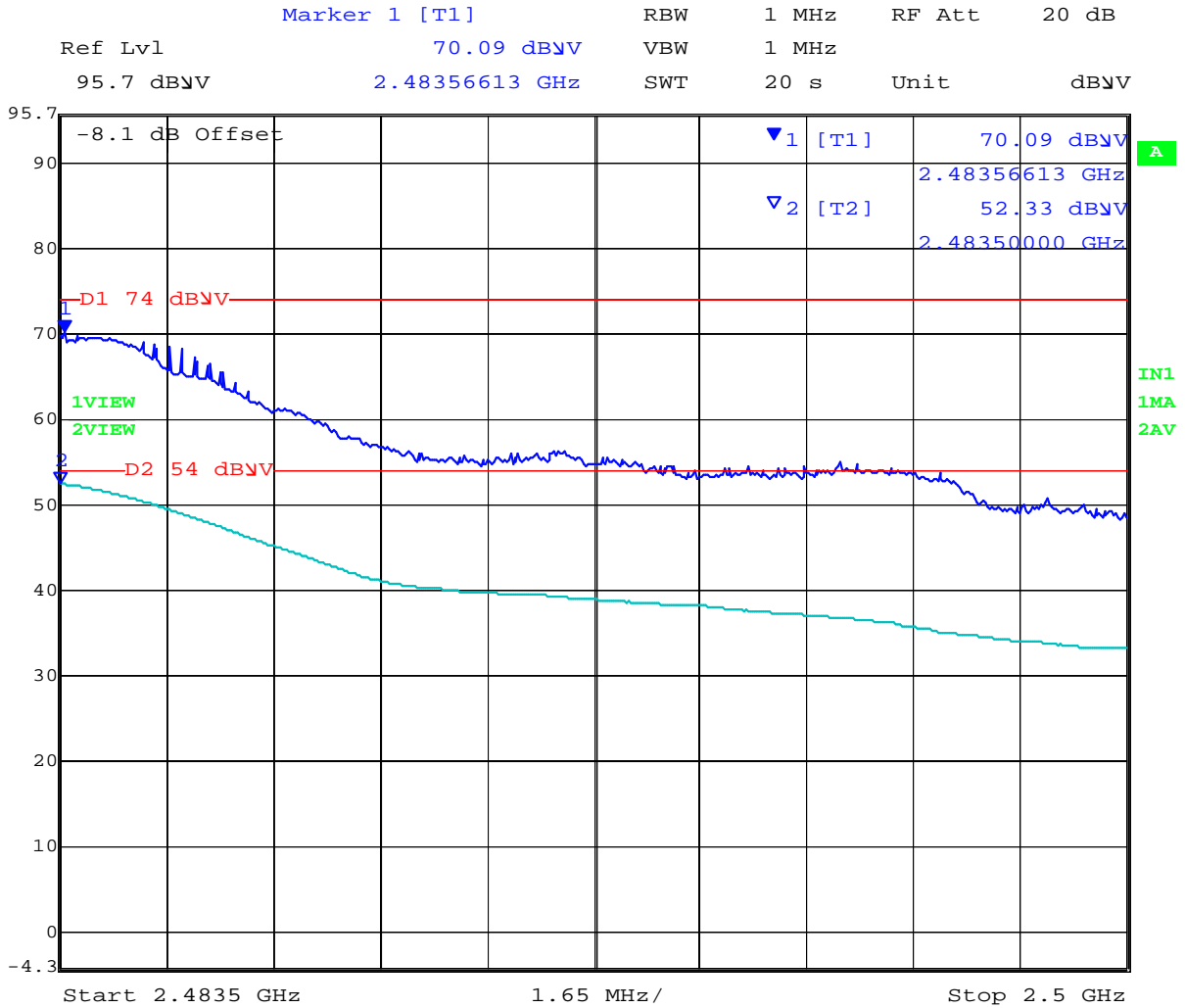

Date: 3.OCT.2012 12:22:44

Power reduction required in order to bring unit into compliance Power = 13

This test report may be reproduced in full only. The document may only be updated by MiCOM Labs personnel. Any changes will be noted in the Document History section of the report.



Title: Digi ConnectCard for i.MX28 with Atheros AR6233
To: FCC 47 CFR Part 15.247 & IC RSS-210
Serial #: DIGI28-U2A Rev A
Issue Date: 29th March 2013
Page: 137 of 245

Band Edge 802.11n HT40 2422 MHz

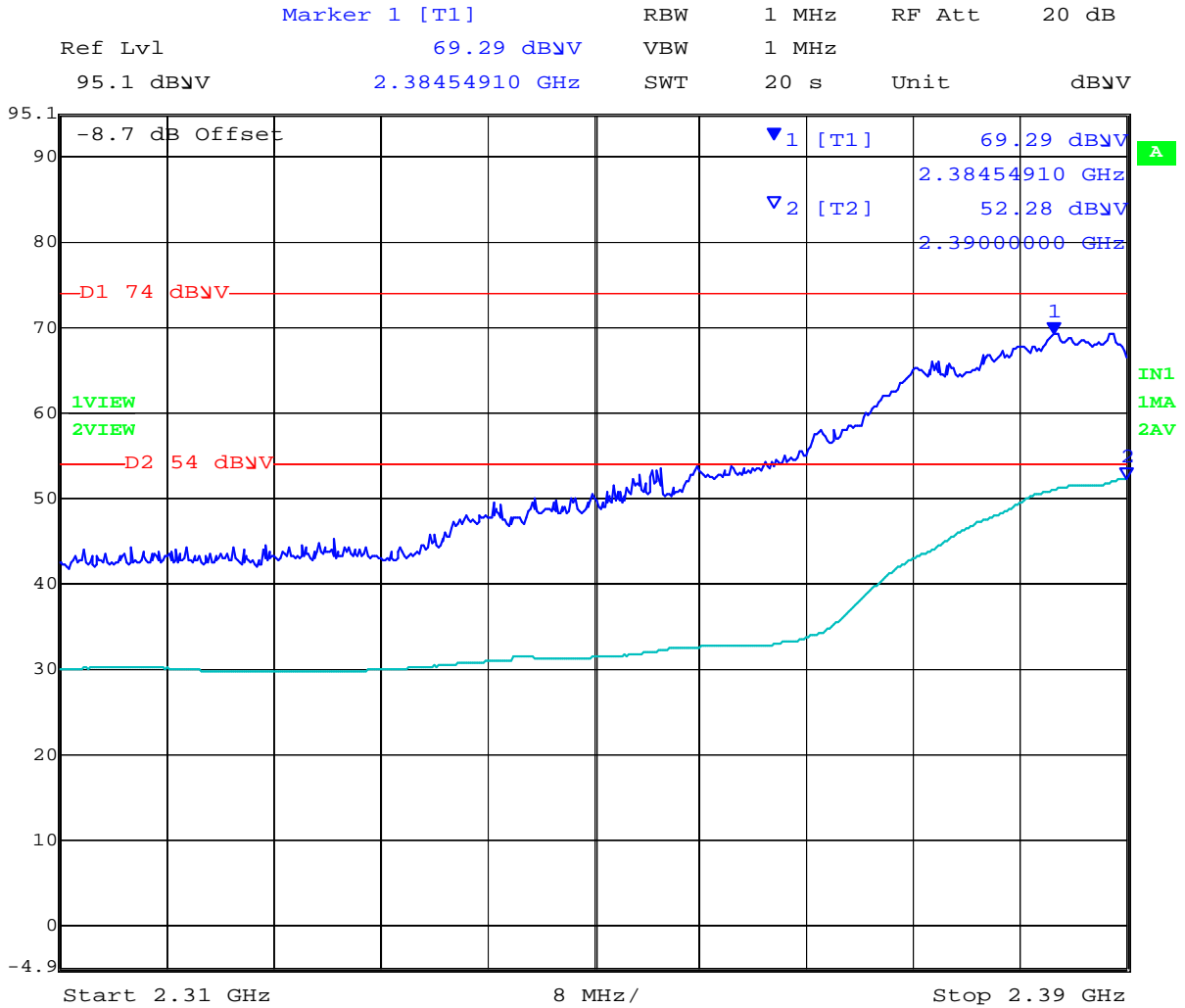

Date: 3.OCT.2012 12:46:39

Power reduction required in order to bring unit into compliance Power = 11

This test report may be reproduced in full only. The document may only be updated by MiCOM Labs personnel. Any changes will be noted in the Document History section of the report.



Title: Digi ConnectCard for i.MX28 with Atheros AR6233
To: FCC 47 CFR Part 15.247 & IC RSS-210
Serial #: DIGI28-U2A Rev A
Issue Date: 29th March 2013
Page: 138 of 245

Band Edge 802.11n HT40 2452 MHz

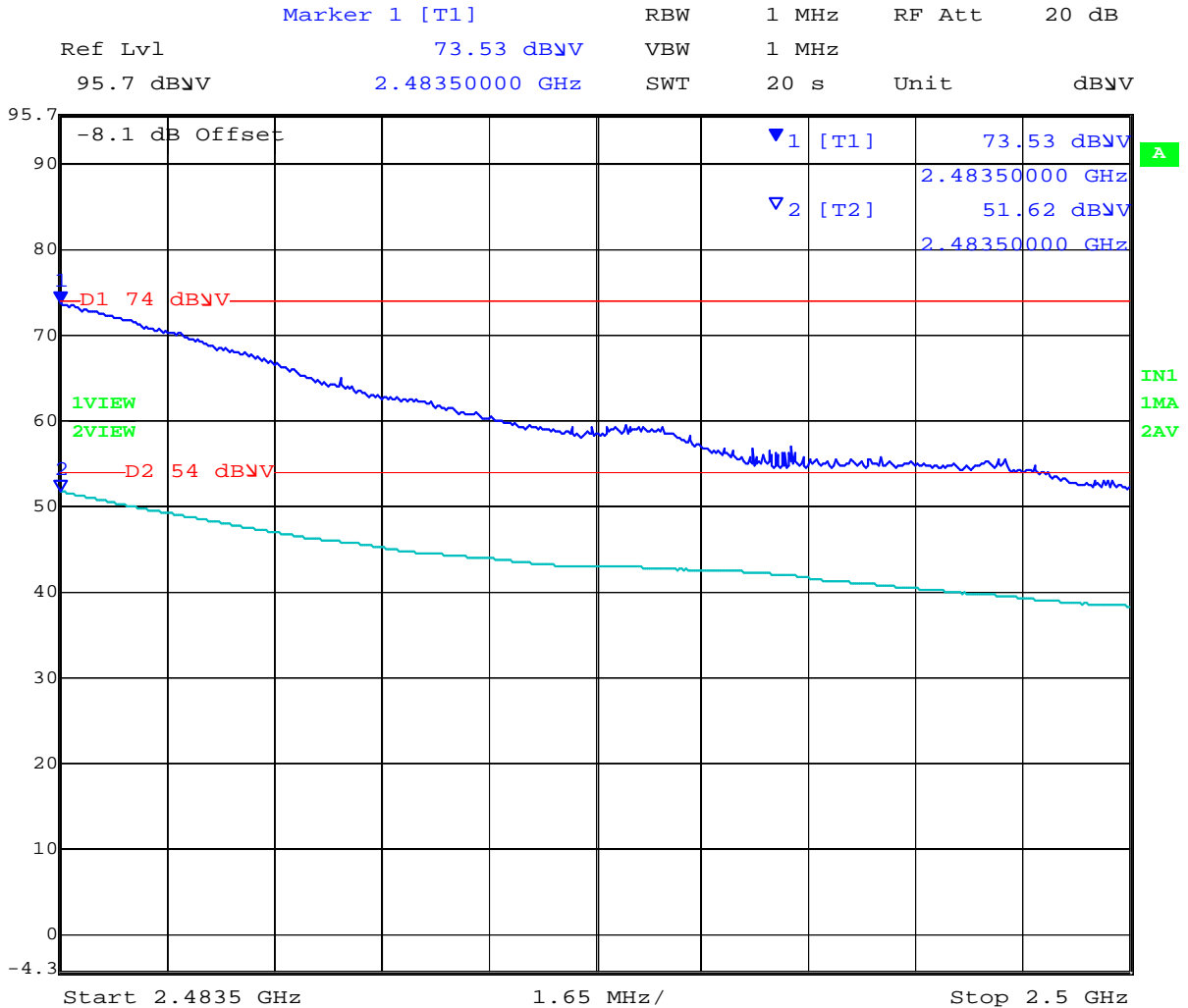

Date: 3.OCT.2012 12:25:28

Power reduction required in order to bring unit into compliance Power = 8

This test report may be reproduced in full only. The document may only be updated by MiCOM Labs personnel. Any changes will be noted in the Document History section of the report.



Title: Digi ConnectCard for i.MX28 with Atheros AR6233
To: FCC 47 CFR Part 15.247 & IC RSS-210
Serial #: DIGI28-U2A Rev A
Issue Date: 29th March 2013
Page: 139 of 245

Specification Limits

FCC §15.247(d) and RSS-210 §A8.5 In any 100 kHz bandwidth outside the frequency band in which the spread spectrum or digitally modulated intentional radiator is operating, the radio frequency power that is produced by the intentional radiator shall be at least 20 dB below that in the 100 kHz bandwidth within the band that contains the highest level of the desired power, based on either an RF conducted or radiated measurement, provided the transmitter demonstrates compliance with the peak conducted power limits.

FCC §15.247(d)

If the transmitter complies with the conducted power limits based on the use of RMS averaging over a time interval, as permitted under paragraph (b)(3) of this section, the attenuation required under this paragraph shall be 30 dB instead of 20 dB. Attenuation below the general limits specified §15.209(a) is not required. In addition, radiated emissions which fall in the restricted bands, as defined in Section §15.205(a), must also comply with the radiated emission limits specified in Section 15.209(a) (see Section 15.205(a)).

IC RSS-210 §A8.5 If the transmitter complies with the conducted power limits based on the use of RMS averaging over a time interval, as permitted under section A8.4(4), the attenuation required shall be 30 dB instead of 20 dB. Attenuation below the general limits specified in Tables 2 and 3 is not required. In addition, radiated emissions which fall in the restricted bands of Table 1 must also comply with the radiated emission limits specified in Tables 2 and 3.

IC RSS-Gen §4.7

The search for unwanted emissions shall be from the lowest frequency internally generated or used in the device (local oscillator, intermediate or carrier frequency), or from 30 MHz, whichever is the lowest frequency, to the 5th harmonic of the highest frequency generated without exceeding 40 GHz.

FCC §15.205 (a) Except as shown in paragraph (d) of 15.205 (a), only spurious emissions are permitted in any of the frequency bands listed.

FCC §15.205 (a) Except as shown in paragraphs (d) and (e) of this section, the field strength of emissions appearing within these frequency bands shall not exceed the limits shown in Section §15.209. At frequencies equal to or less than 1000 MHz, compliance with the limits in Section 15.209 shall be demonstrated using measurement instrumentation employing a CISPR quasi-peak detector. Above 1000 MHz, compliance with the emission limits in Section 15.209 shall be demonstrated based on the average value of the measured emissions. The provisions in Section 15.35 apply to these measurements.

FCC §15.209 (a) Except as provided elsewhere in this subpart, the emissions from an intentional radiator shall not exceed the field strength levels specified in the following table.

This test report may be reproduced in full only. The document may only be updated by MiCOM Labs personnel. Any changes will be noted in the Document History section of the report.



Title: Digi ConnectCard for i.MX28 with Atheros AR6233
To: FCC 47 CFR Part 15.247 & IC RSS-210
Serial #: DIGI28-U2A Rev A
Issue Date: 29th March 2013
Page: 140 of 245

§15.209 (a) Limit Matrix

Frequency(MHz)	Field Strength ($\mu\text{V/m}$)	Field Strength ($\text{dB}\mu\text{V/m}$)	Measurement Distance (meters)
30-88	100	40.0	3
88-216	150	43.5	3
216-960	200	46.0	3
Above 960	500	54.0	3

Laboratory Measurement Uncertainty for Radiated Emissions

Measurement uncertainty	+5.6/ -4.5 dB
-------------------------	---------------

Traceability

Method	Test Equipment Used
Measurements were made per work instruction WI-03 'Measurement of Radiated Emissions'	0088, 0158, 0134, 0304, 0311, 0315, 0310, 0312

This test report may be reproduced in full only. The document may only be updated by MiCOM Labs personnel. Any changes will be noted in the Document History section of the report.



Title: Digi ConnectCard for i.MX28 with Atheros AR6233
To: FCC 47 CFR Part 15.247 & IC RSS-210
Serial #: DIGI28-U2A Rev A
Issue Date: 29th March 2013
Page: 141 of 245

6.1.2.5. Digital Emissions (0.03-1 GHz)

FCC, Part 15 Subpart C §15.205/ §15.209
Industry Canada RSS-210 §2.2

Test Procedure

Testing 30M-1 GHz was performed in a 3-meter anechoic chamber using a CISPR compliant receiver. Preliminary radiated emissions were measured on every azimuth and with the receiving antenna in both horizontal and vertical polarizations. To further maximize emissions the receive antenna was varied between 1 and 4 meters. The emissions are recorded with receiver in peak hold mode. Emissions closest to the limits are measured in the quasi-peak mode with the tuned receiver using a bandwidth of 120 kHz. Only the highest emissions relative to the limit are listed. The anechoic chamber test set-up is identified in Section 6 Test Set-Up Photographs.

The EUT had two methods of powering on ac/dc converter and Power over Ethernet (POE). Both modes were tested for emissions below 1GHz.

Field Strength Calculation

The field strength is calculated by adding the Antenna Factor and Cable Loss, and subtracting Amplifier Gain from the measured reading. In this test facility, the Antenna Factor, Cable Loss, and Amplifier Gains are loaded into the Rohde & Schwarz Receiver and the corrected field strength can be read directly on the receiver.

$$FS = R + AF + CORR$$

where:

FS = Field Strength
R = Measured Receiver Input Amplitude
AF = Antenna Factor
CORR = Correction Factor = CL – AG + NFL
CL = Cable Loss
AG = Amplifier Gain

For example:

Given a Receiver input reading of 51.5dB μ V; Antenna Factor of 8.5dB; Cable Loss of 1.3dB; Falloff Factor of 0dB, an Amplifier Gain of 26dB and Notch Filter Loss of 1dB. The Field Strength of the measured emission is:

$$FS = 51.5 + 8.5 + 1.3 - 26.0 + 1 = 36.3\text{dB}\mu\text{V/m}$$

Conversion between dB μ V/m (or dB μ V) and μ V/m (or μ V) are done as:

$$\text{Level (dB}\mu\text{V/m)} = 20 * \text{Log (level (\mu\text{V/m}))}$$

$$40 \text{ dB}\mu\text{V/m} = 100\mu\text{V/m}$$

$$48 \text{ dB}\mu\text{V/m} = 250\mu\text{V/m}$$

This test report may be reproduced in full only. The document may only be updated by MiCOM Labs personnel. Any changes will be noted in the Document History section of the report.



Title: Digi ConnectCard for i.MX28 with Atheros AR6233
To: FCC 47 CFR Part 15.247 & IC RSS-210
Serial #: DIGI28-U2A Rev A
Issue Date: 29th March 2013
Page: 142 of 245

Test Freq.	2437 MHz	Engineer	
Variant	Digital Emissions	Temp (°C)	
Freq. Range	30 MHz - 1000 MHz	Rel. Hum.(%)	
Power Setting	20	Press. (mBars)	
Antenna	SA-006-1		
Test Notes 1	Single Port Module		
Test Notes 2			

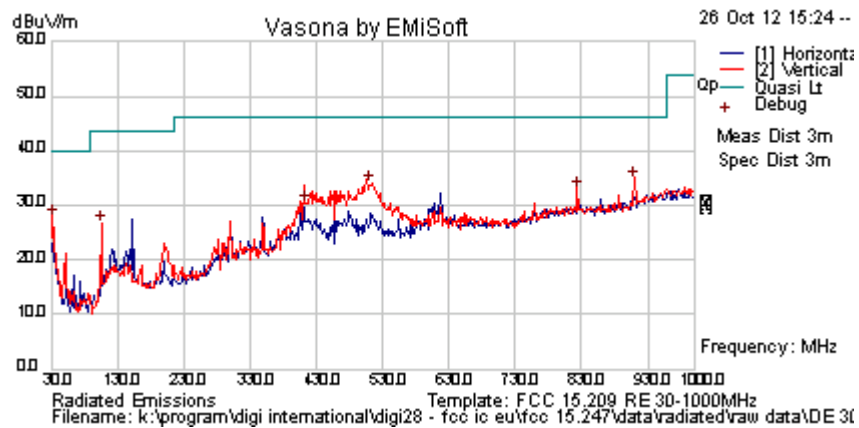

Formally measured emission peaks

Frequency MHz	Raw dBuV	Cable Loss	AF dB	Level dBuV/m	Measurement Type	Pol	Hgt cm	Azt Deg	Limit dBuV/m	Margin dB	Pass /Fail	Comments
32.169	35.5	3.5	-11.4	27.7	Peak [Scan]	V	98	0	40	-12.3	Pass	
414.605	39.1	5.5	-14.3	30.3	Peak [Scan]	V	98	0	46	-15.8	Pass	
511.605	40.6	5.9	-12.8	33.7	Peak [Scan]	V	98	0	46	-12.3	Pass	
823.383	34.2	6.9	-8.4	32.8	Peak [Scan]	V	98	0	46	-13.2	Pass	
910.770	35.1	7.1	-7.7	34.5	Peak [Scan]	V	98	0	46	-11.5	Pass	
105.767	42.0	4.1	-19.7	26.4	Peak [Scan]	V	98	0	43.5	-17.1	Pass	

Legend: DIG = Digital Device Emission; TX = Transmitter Emission; FUND = Fundamental Frequency
 NRB = Non-Restricted Band, Limit is 20 dB below Fundamental; RB = Restricted Band

This test report may be reproduced in full only. The document may only be updated by MiCOM Labs personnel. Any changes will be noted in the Document History section of the report.



Title: Digi ConnectCard for i.MX28 with Atheros AR6233
To: FCC 47 CFR Part 15.247 & IC RSS-210
Serial #: DIGI28-U2A Rev A
Issue Date: 29th March 2013
Page: 143 of 245

Specification

Limits

§15.205 (a) Except as shown in paragraph (d) of 15.205 (a), only spurious emissions are permitted in any of the frequency bands listed.

§15.205 (a) Except as shown in paragraphs (d) and (e) of this section, the field strength of emissions appearing within these frequency bands shall not exceed the limits shown in Section §15.209. At frequencies equal to or less than 1000 MHz, compliance with the limits in Section 15.209 shall be demonstrated using measurement instrumentation employing a CISPR quasi-peak detector. Above 1000 MHz, compliance with the emission limits in Section 15.209 shall be demonstrated based on the average value of the measured emissions. The provisions in Section 15.35 apply to these measurements.

§15.209 (a) Except as provided elsewhere in this subpart, the emissions from an intentional radiator shall not exceed the field strength levels specified in the following table.

§15.209 (a) and RSS-Gen §2.2 Limit Matrix

Frequency(MHz)	Field Strength ($\mu\text{V}/\text{m}$)	Field Strength ($\text{dB}\mu\text{V}/\text{m}$)	Measurement Distance (meters)
30-88	100	40.0	3
88-216	150	43.5	3
216-960	200	46.0	3
Above 960	500	54.0	3

Laboratory Measurement Uncertainty for Radiated Emissions

Measurement uncertainty	+5.6/ -4.5 dB
-------------------------	---------------

Traceability

Method	Test Equipment Used
Measurements were made per work instruction WI-03 'Measurement of Radiated Emissions'	0088, 0158, 0134, 0304, 0311, 0315, 0310, 0312

This test report may be reproduced in full only. The document may only be updated by MiCOM Labs personnel. Any changes will be noted in the Document History section of the report.

6.1.3. AC Wireline Conducted Emissions (150 kHz – 30 MHz)

FCC, Part 15 Subpart C §15.207
Industry Canada RSS-Gen §7.2.2

Test Procedure

The EUT is configured in accordance with ANSI C63.4. The conducted emissions are measured in a shielded room with a spectrum analyzer in peak hold in the first instance. Emissions closest to the limit are measured in the quasi-peak mode (QP) with the tuned receiver using a bandwidth of 9 kHz. The emissions are maximized further by cable manipulation. The highest emissions relative to the limit are listed.

Test Measurement Set up

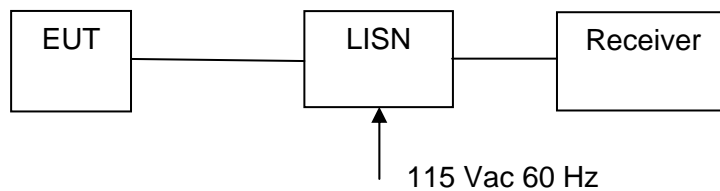

Measurement set up for AC Wireline Conducted Emissions Test

Measurement Results for AC Wireline Conducted Emissions (150 kHz – 30 MHz)

Ambient conditions.

Temperature: 17 to 23 °C Relative humidity: 31 to 57 % Pressure: 999 to 1012 mbar

Not required - EUT is power by DC only.



Title: Digi ConnectCard for i.MX28 with Atheros AR6233
To: FCC 47 CFR Part 15.247 & IC RSS-210
Serial #: DIGI28-U2A Rev A
Issue Date: 29th March 2013
Page: 145 of 245

Specification

Limit

§15.207 (a) Except as shown in paragraphs (b) and (c) of this section, for an intentional radiator that is designed to be connected to the public utility (AC) power line, the radio frequency voltage that is conducted back onto the AC power line on any frequency or frequencies within the band 150 kHz to 30 MHz shall not exceed the limits in the following table, as measured using a 50 $\mu\Omega$ line impedance stabilization network (LISN), see §15.207 (a) matrix below. Compliance with the provisions of this paragraph shall be based on the measurement of the radio frequency voltage between each power line and ground at the power terminal.

RSS-Gen §7.2.2

The radio frequency voltage that is conducted back into the AC power lines in the frequency range of 0.15 MHz to 30 MHz shall not exceed the limits shown in the table below. The tighter limit applies at the frequency range boundaries.

§15.207 (a) and RSS-Gen §7.2.2 Limit Matrix

The lower limit applies at the boundary between frequency ranges

Frequency of Emission (MHz)	Conducted Limit (dB μ V)	
	Quasi-peak	Average
0.15-0.5	66 to 56*	56 to 46*
0.5-5	56	46
5-30	60	50

* Decreases with the logarithm of the frequency

Laboratory Measurement Uncertainty for Conducted Emissions

Measurement uncertainty	± 2.64 dB
-------------------------	---------------

Traceability

Method	Test Equipment Used
Measurements were made per work instruction WI-EMC-01 'Measurement of Conducted Emissions'	0158, 0184, 0287, 0190, 0293, 0307

This test report may be reproduced in full only. The document may only be updated by MiCOM Labs personnel. Any changes will be noted in the Document History section of the report.

7. PHOTOGRAPHS

7.1. Conducted Test Setup



This test report may be reproduced in full only. The document may only be updated by MiCOM Labs personnel. Any changes will be noted in the Document History section of the report.

7.2. Test Setup - Digital Emissions below 1 GHz



This test report may be reproduced in full only. The document may only be updated by MiCOM Labs personnel. Any changes will be noted in the Document History section of the report.

7.3. Radiated Emissions Test Setup >1 GHz



This test report may be reproduced in full only. The document may only be updated by MiCOM Labs personnel. Any changes will be noted in the Document History section of the report.



Title: Digi ConnectCard for i.MX28 with Atheros AR6233
To: FCC 47 CFR Part 15.247 & IC RSS-210
Serial #: DIGI28-U2A Rev A
Issue Date: 29th March 2013
Page: 149 of 245

8. TEST EQUIPMENT

Asset #	Instrument	Manufacturer	Part #	Serial #	Calibration Due Date
0070	Power Meter	Hewlett Packard	437B	3125U11552	28 th Nov 13
0117	Power Sensor	Hewlett Packard	8487D	3318A00371	15 th Nov 13
0223	Power Meter	Hewlett Packard	EPM-442A	US37480256	15 th Nov 13
0374	Power Sensor	Hewlett Packard	8485A	3318A19694	29 th Nov 13
0376	Power Sensor	Agilent	U2000A	MY51440005	8 th Dec 13
0158	Barometer /Thermometer	Control Co.	4196	E2846	8 th Dec 13
0193	EMI Receiver	Rhode & Schwartz	ESI 7	838496/007	2 nd Dec 13
0287	EMI Receiver	Rhode & Schwartz	ESIB40	100201	16 th Nov 13
0338	30 - 3000 MHz Antenna	Sunol	JB3	A052907	8 th Nov 13
0335	1-18 GHz Horn Antenna	EMCO	3117	00066580	7 th Nov 13
0252	SMA Cable	Megaphase	Sucoflex 104	None	N/A
0293	BNC Cable	Megaphase	1689 1GVT4	15F50B001	N/A
0307	BNC Cable	Megaphase	1689 1GVT4	15F50B002	N/A
0310	2m SMA Cable	Micro-Coax	UFA210A-0-0787-3G03G0	209089-001	N/A
0312	3m SMA Cable	Micro-Coax	UFA210A-1-1181-3G0300	209092-001	N/A
0314	30dB N-Type Attenuator	ARRA	N9444-30	1623	N/A
	EMC Test Software	EMISoft	Vasona	5.0051	N/A
	RF Conducted Test Software	National Instruments	Labview	Version 8.2	N/A
	RF Conducted Test Software	MiCOM Labs ATS		Version 1.5	N/A

This test report may be reproduced in full only. The document may only be updated by MiCOM Labs personnel. Any changes will be noted in the Document History section of the report.



Title: Digi ConnectCard for i.MX28 with Atheros AR6233
To: FCC 47 CFR Part 15.247 & IC RSS-210
Serial #: DIGI28-U2A Rev A
Issue Date: 29th March 2013
Page: 150 of 245

APPENDIX

A. SUPPORTING INFORMATION

A.1. CONDUCTED TEST PLOTS

This test report may be reproduced in full only. The document may only be updated by MiCOM Labs personnel. Any changes will be noted in the Document History section of the report.



A.1.1.1. 6 dB & 99% Bandwidth



6 dB & 99% BANDWIDTH

Variant: 802.11b, Channel: 2412.00 MHz, Chain a, Temp: Ambient, Voltage: 5 Vdc

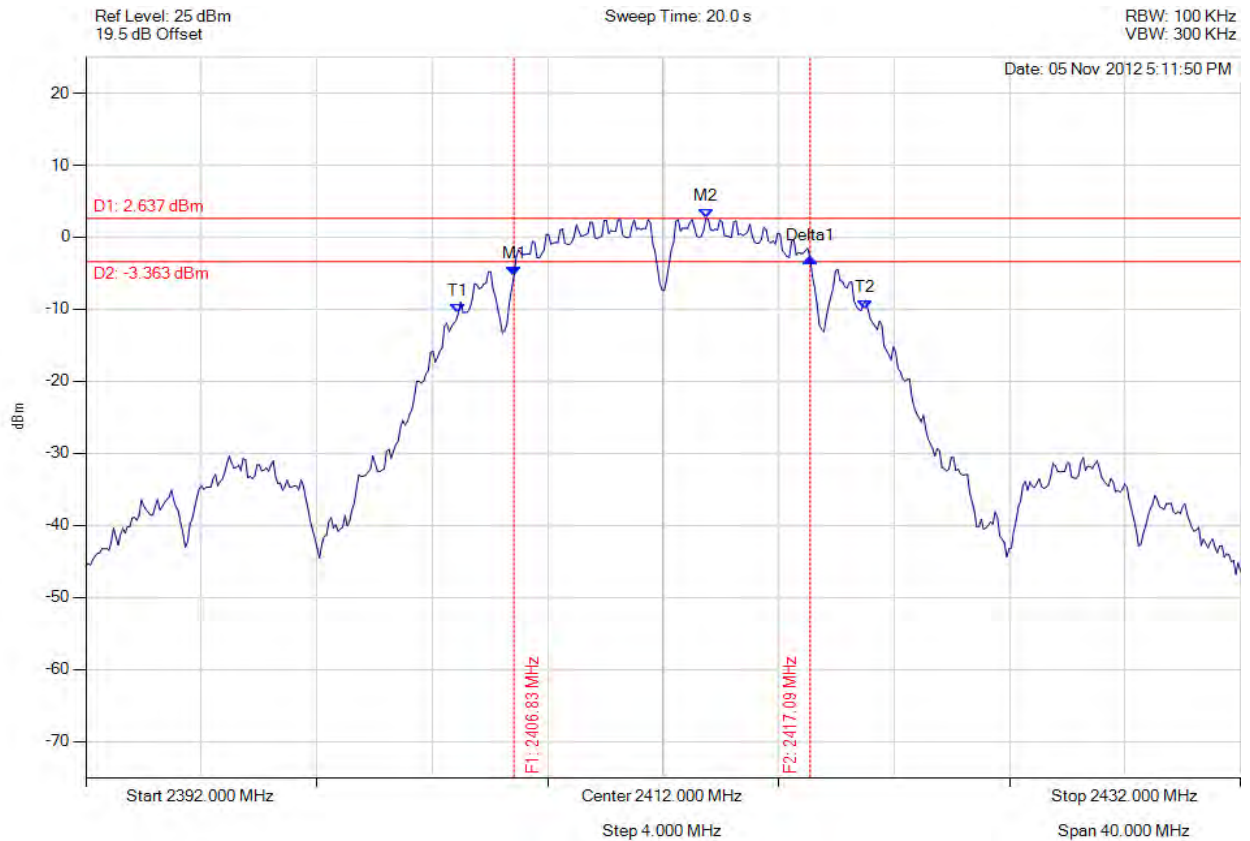

Analyser Setup	Marker : Frequency : Amplitude	Test Results
Detector = MAX PEAK Sweep Count = 0 RF Atten (dB) = 20 Trace Mode = VIEW	M1 : 2406.830 MHz : -5.388 dBm M2 : 2413.483 MHz : 2.637 dBm Delta1 : 10.261 MHz : 2.556 dB T1 : 2404.906 MHz : -10.548 dBm T2 : 2419.014 MHz : -10.005 dBm OBW : 14.188 MHz	Measured 6 dB Bandwidth: 10.261 MHz Limit: ≥ 0.5 MHz Margin: -9.76 MHz

[Back to the Matrix](#)

This test report may be reproduced in full only. The document may only be updated by MiCOM Labs personnel. Any changes will be noted in the Document History section of the report.



Title: Digi ConnectCard for i.MX28 with Atheros AR6233
To: FCC 47 CFR Part 15.247 & IC RSS-210
Serial #: DIGI28-U2A Rev A
Issue Date: 29th March 2013
Page: 152 of 245



6 dB & 99% BANDWIDTH

Variant: 802.11b, Channel: 2437.00 MHz, Chain a, Temp: Ambient, Voltage: 5 Vdc

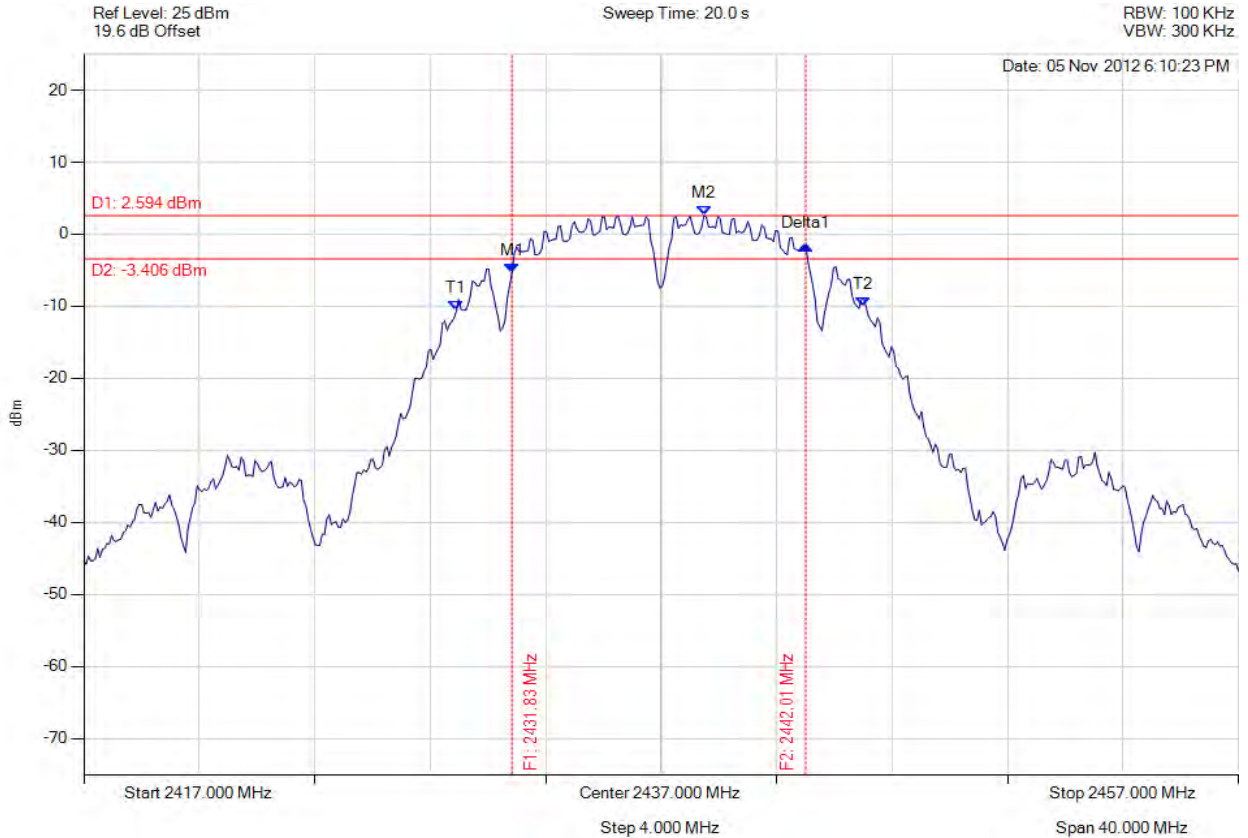

Analyser Setup	Marker : Frequency : Amplitude	Test Results
Detector = MAX PEAK Sweep Count = 0 RF Atten (dB) = 20 Trace Mode = VIEW	M1 : 2431.830 MHz : -5.356 dBm M2 : 2438.483 MHz : 2.594 dBm Delta1 : 10.180 MHz : 3.764 dB T1 : 2429.906 MHz : -10.609 dBm T2 : 2444.014 MHz : -9.972 dBm OBW : 14.188 MHz	Measured 6 dB Bandwidth: 10.180 MHz Limit: ≥ 0.5 MHz Margin: -9.68 MHz

[Back to the Matrix](#)

This test report may be reproduced in full only. The document may only be updated by MiCOM Labs personnel. Any changes will be noted in the Document History section of the report.



Title: Digi ConnectCard for i.MX28 with Atheros AR6233
To: FCC 47 CFR Part 15.247 & IC RSS-210
Serial #: DIGI28-U2A Rev A
Issue Date: 29th March 2013
Page: 153 of 245



6 dB & 99% BANDWIDTH

Variant: 802.11b, Channel: 2462.00 MHz, Chain a, Temp: Ambient, Voltage: 5 Vdc

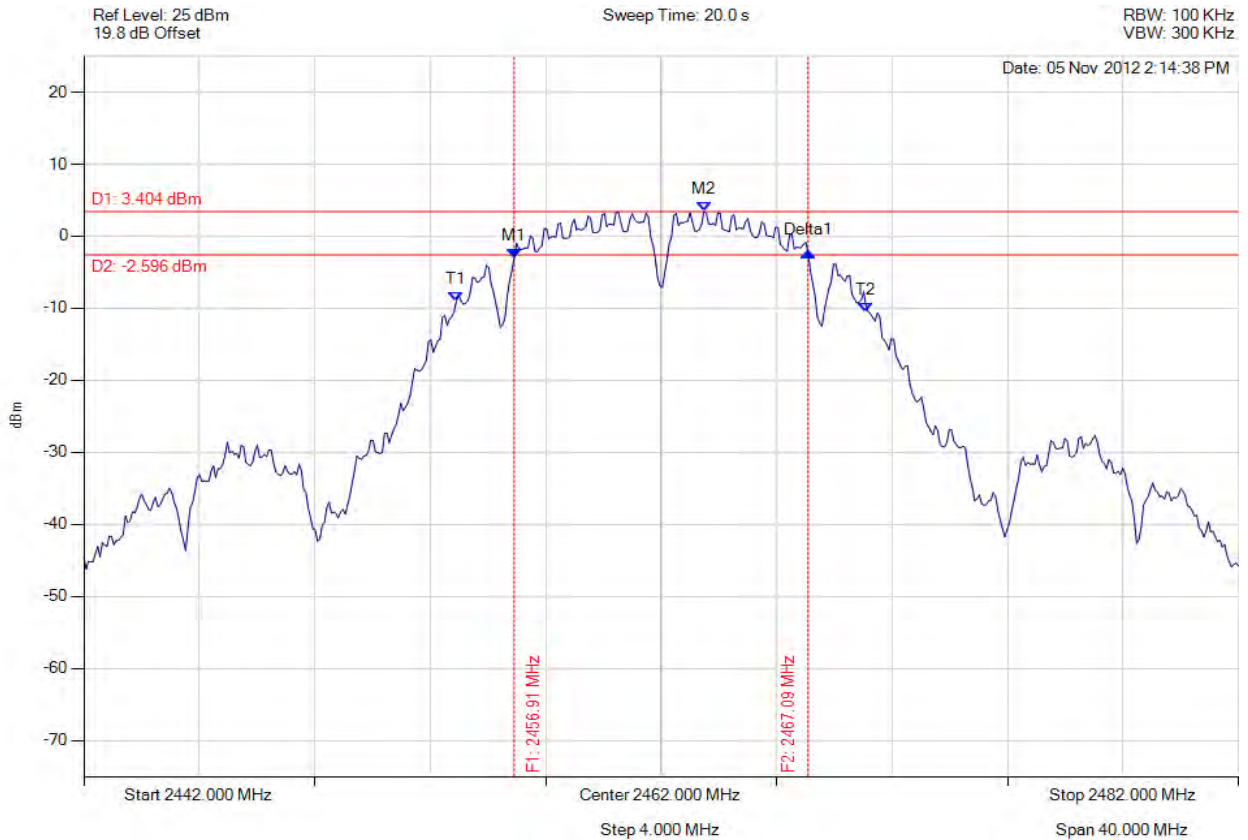

Analyser Setup	Marker : Frequency : Amplitude	Test Results
Detector = MAX PEAK Sweep Count = 0 RF Atten (dB) = 20 Trace Mode = VIEW	M1 : 2456.910 MHz : -2.988 dBm M2 : 2463.483 MHz : 3.404 dBm Delta1 : 10.180 MHz : 0.765 dB T1 : 2454.906 MHz : -8.986 dBm T2 : 2469.094 MHz : -10.471 dBm OBW : 14.269 MHz	Measured 6 dB Bandwidth: 10.180 MHz Limit: ≥ 0.5 MHz Margin: -9.68 MHz

[Back to the Matrix](#)

This test report may be reproduced in full only. The document may only be updated by MiCOM Labs personnel. Any changes will be noted in the Document History section of the report.



Title: Digi ConnectCard for i.MX28 with Atheros AR6233
To: FCC 47 CFR Part 15.247 & IC RSS-210
Serial #: DIGI28-U2A Rev A
Issue Date: 29th March 2013
Page: 154 of 245



6 dB & 99% BANDWIDTH

Variant: 802.11g, Channel: 2412.00 MHz, Chain a, Temp: Ambient, Voltage: 5 Vdc

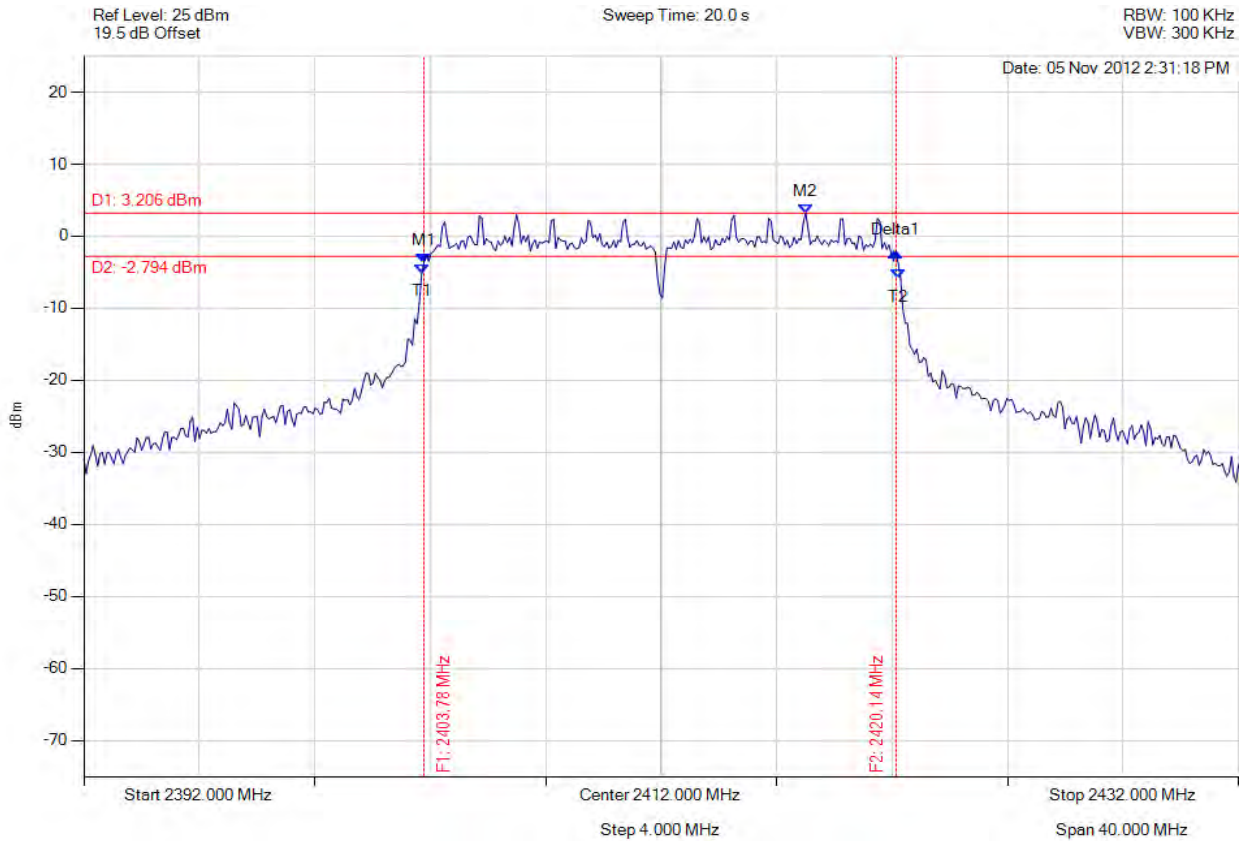

Analyser Setup	Marker : Frequency : Amplitude	Test Results
Detector = MAX PEAK Sweep Count = 0 RF Atten (dB) = 20 Trace Mode = VIEW	M1 : 2403.784 MHz : -3.629 dBm M2 : 2417.010 MHz : 3.206 dBm Delta1 : 16.353 MHz : 1.440 dB T1 : 2403.703 MHz : -5.167 dBm T2 : 2420.216 MHz : -5.891 dBm OBW : 16.593 MHz	Measured 6 dB Bandwidth: 16.353 MHz Limit: ≥ 0.5 MHz Margin: -15.85 MHz

[Back to the Matrix](#)

This test report may be reproduced in full only. The document may only be updated by MiCOM Labs personnel. Any changes will be noted in the Document History section of the report.



Title: Digi ConnectCard for i.MX28 with Atheros AR6233
To: FCC 47 CFR Part 15.247 & IC RSS-210
Serial #: DIGI28-U2A Rev A
Issue Date: 29th March 2013
Page: 155 of 245



6 dB & 99% BANDWIDTH

Variant: 802.11g, Channel: 2437.00 MHz, Chain a, Temp: Ambient, Voltage: 5 Vdc

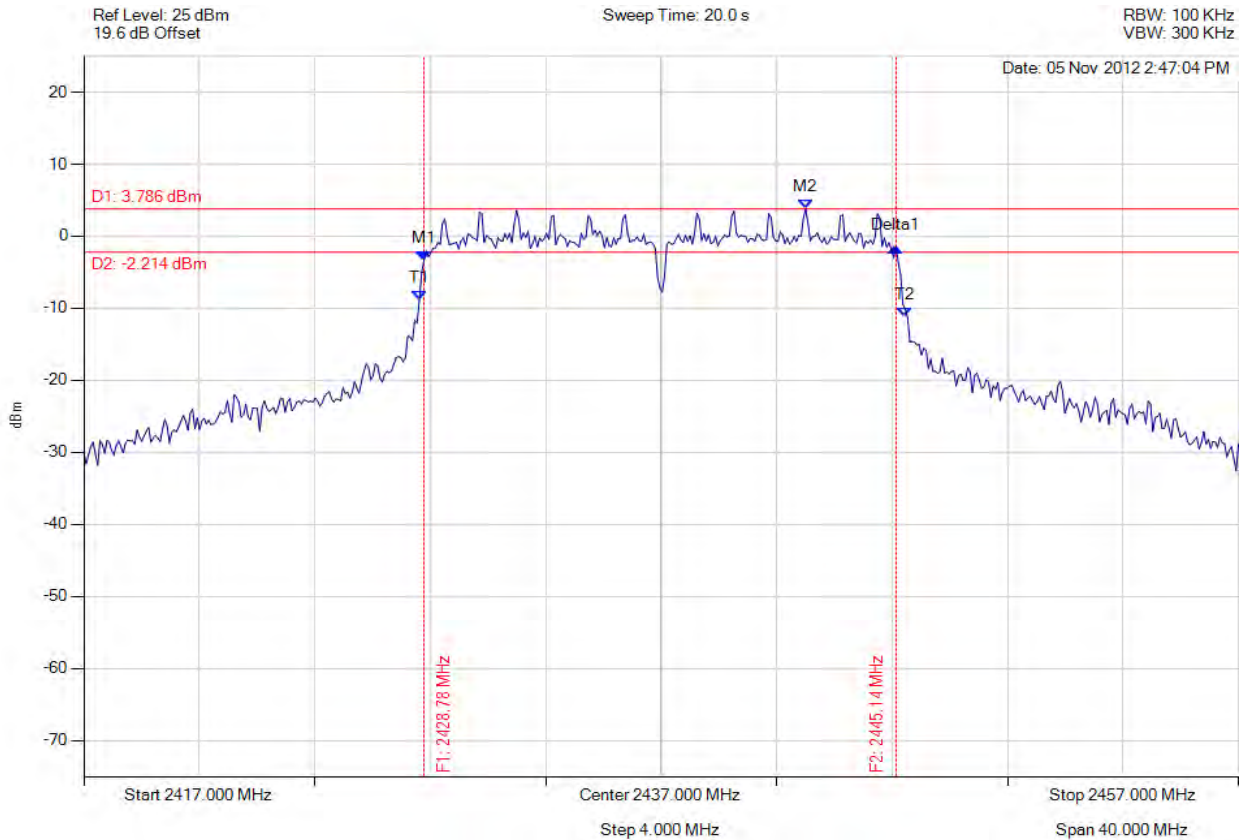

Analyser Setup	Marker : Frequency : Amplitude	Test Results
Detector = MAX PEAK Sweep Count = 0 RF Atten (dB) = 20 Trace Mode = VIEW	M1 : 2428.784 MHz : -3.379 dBm M2 : 2442.010 MHz : 3.786 dBm Delta1 : 16.353 MHz : 1.881 dB T1 : 2428.623 MHz : -8.941 dBm T2 : 2445.457 MHz : -11.203 dBm OBW : 16.914 MHz	Measured 6 dB Bandwidth: 16.353 MHz Limit: ≥ 0.5 MHz Margin: -15.85 MHz

[Back to the Matrix](#)

This test report may be reproduced in full only. The document may only be updated by MiCOM Labs personnel. Any changes will be noted in the Document History section of the report.



Title: Digi ConnectCard for i.MX28 with Atheros AR6233
To: FCC 47 CFR Part 15.247 & IC RSS-210
Serial #: DIGI28-U2A Rev A
Issue Date: 29th March 2013
Page: 157 of 245



6 dB & 99% BANDWIDTH

Variant: 802.11n HT-20, Channel: 2412.00 MHz, Chain a, Temp: Ambient, Voltage: 5 Vdc

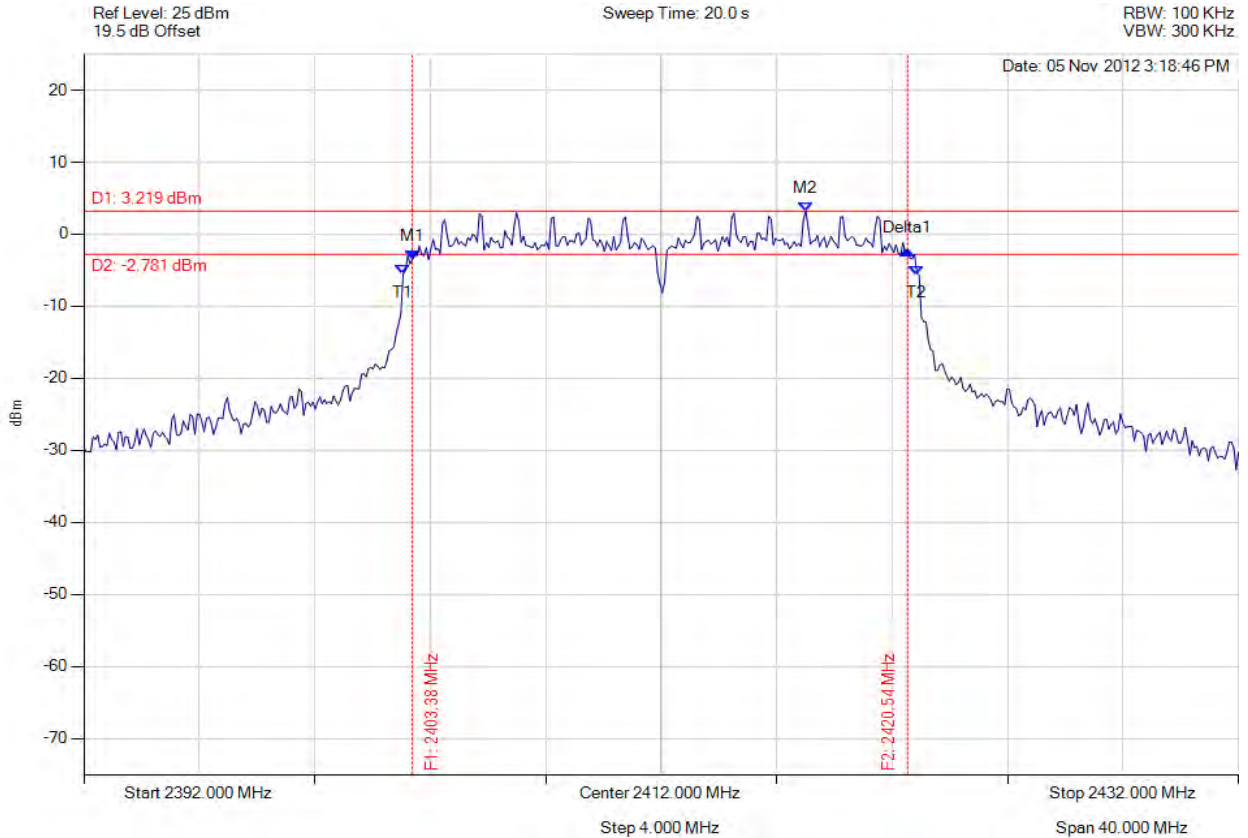

Analyser Setup	Marker : Frequency : Amplitude	Test Results
Detector = MAX PEAK Sweep Count = 0 RF Atten (dB) = 20 Trace Mode = VIEW	M1 : 2403.383 MHz : -3.456 dBm M2 : 2417.010 MHz : 3.219 dBm Delta1 : 17.154 MHz : 1.326 dB T1 : 2403.062 MHz : -5.557 dBm T2 : 2420.858 MHz : -5.659 dBm OBW : 17.876 MHz	Measured 6 dB Bandwidth: 17.154 MHz Limit: ≥ 0.5 MHz Margin: -16.65 MHz

[Back to the Matrix](#)

This test report may be reproduced in full only. The document may only be updated by MiCOM Labs personnel. Any changes will be noted in the Document History section of the report.



Title: Digi ConnectCard for i.MX28 with Atheros AR6233
To: FCC 47 CFR Part 15.247 & IC RSS-210
Serial #: DIGI28-U2A Rev A
Issue Date: 29th March 2013
Page: 158 of 245



6 dB & 99% BANDWIDTH

Variant: 802.11n HT-20, Channel: 2437.00 MHz, Chain a, Temp: Ambient, Voltage: 5 Vdc

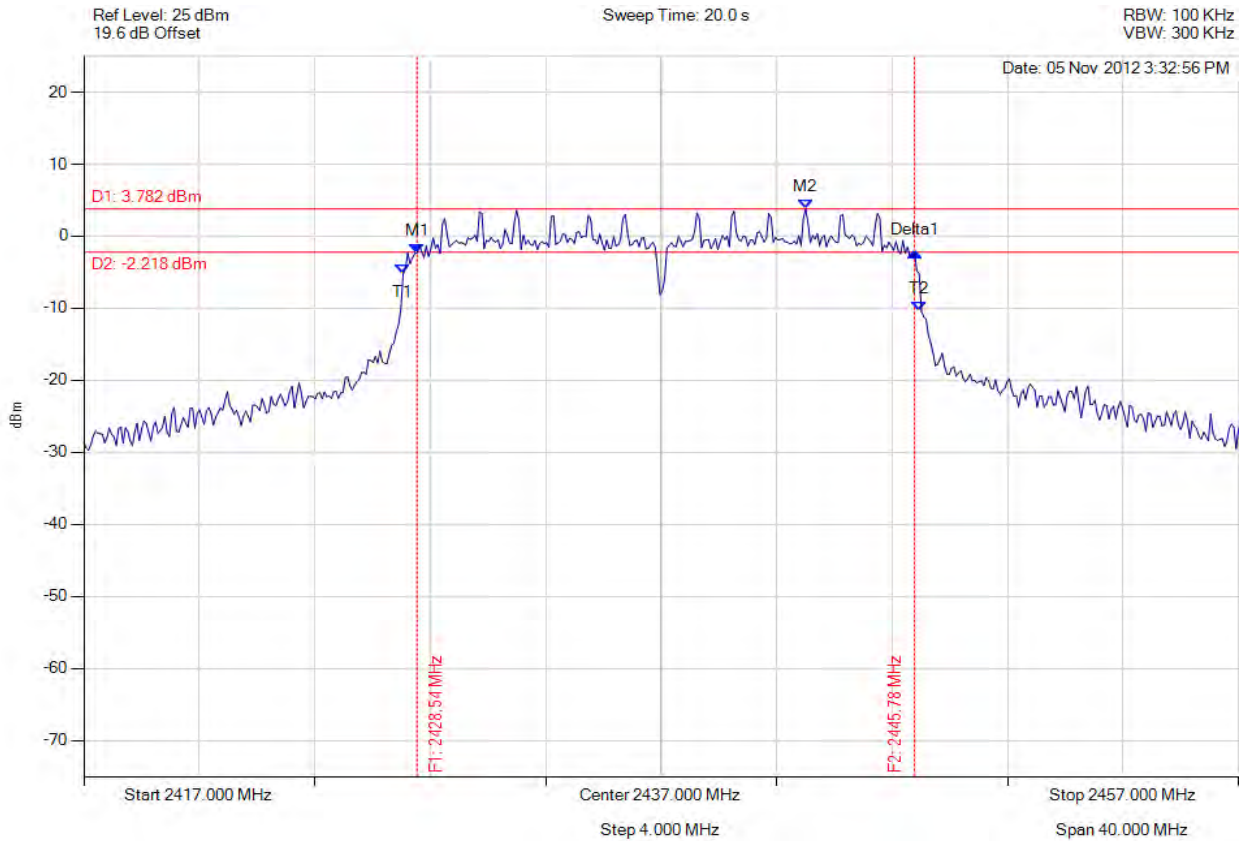

Analyser Setup	Marker : Frequency : Amplitude	Test Results
Detector = MAX PEAK Sweep Count = 0 RF Atten (dB) = 20 Trace Mode = VIEW	M1 : 2428.543 MHz : -2.303 dBm M2 : 2442.010 MHz : 3.782 dBm Delta1 : 17.234 MHz : 0.106 dB T1 : 2428.062 MHz : -5.223 dBm T2 : 2445.938 MHz : -10.410 dBm OBW : 17.956 MHz	Measured 6 dB Bandwidth: 17.234 MHz Limit: ≥ 0.5 MHz Margin: -16.73 MHz

[Back to the Matrix](#)

This test report may be reproduced in full only. The document may only be updated by MiCOM Labs personnel. Any changes will be noted in the Document History section of the report.



Title: Digi ConnectCard for i.MX28 with Atheros AR6233
To: FCC 47 CFR Part 15.247 & IC RSS-210
Serial #: DIGI28-U2A Rev A
Issue Date: 29th March 2013
Page: 159 of 245



6 dB & 99% BANDWIDTH

Variant: 802.11n HT-20, Channel: 2462.00 MHz, Chain a, Temp: Ambient, Voltage: 5 Vdc

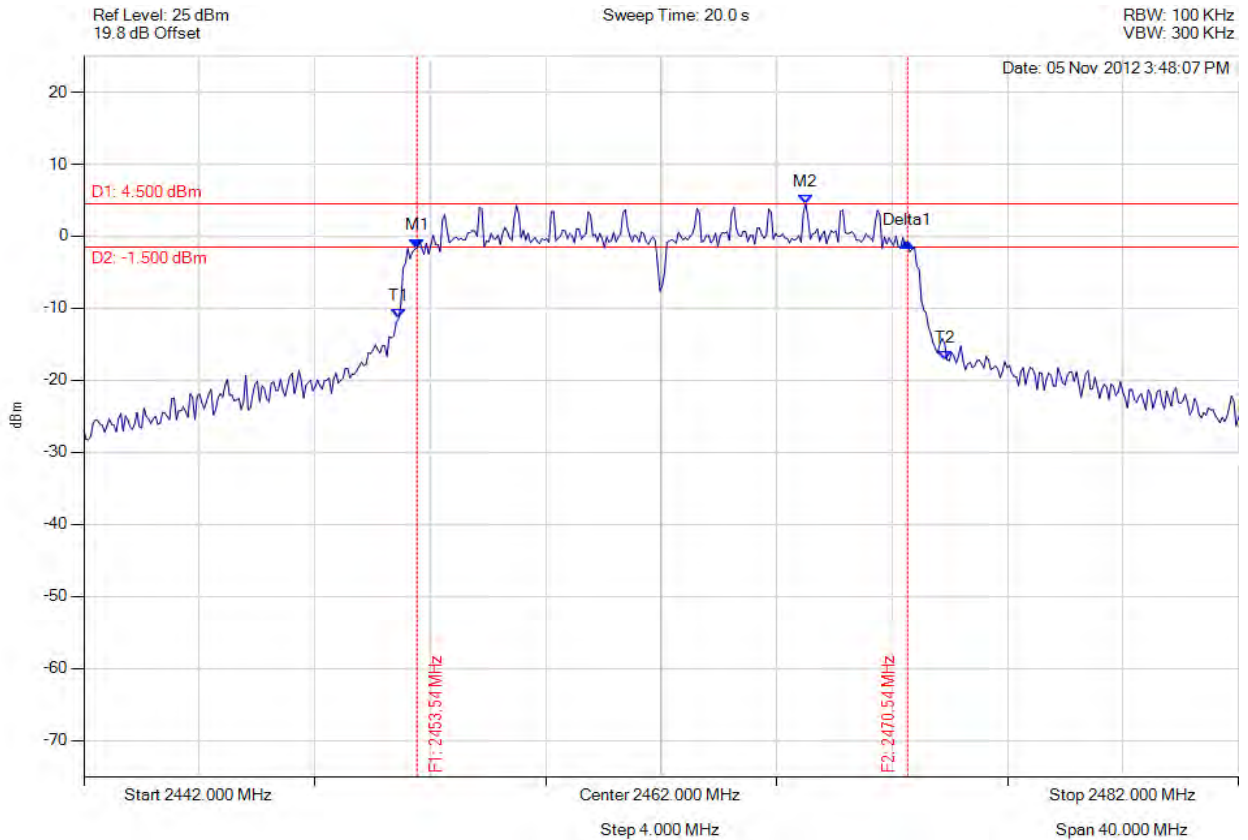

Analyser Setup	Marker : Frequency : Amplitude	Test Results
Detector = MAX PEAK Sweep Count = 0 RF Atten (dB) = 20 Trace Mode = VIEW	M1 : 2453.543 MHz : -1.626 dBm M2 : 2467.010 MHz : 4.500 dBm Delta1 : 16.994 MHz : 0.793 dB T1 : 2452.902 MHz : -11.449 dBm T2 : 2471.820 MHz : -17.153 dBm OBW : 18.998 MHz	Measured 6 dB Bandwidth: 16.994 MHz Limit: ≥ 0.5 MHz Margin: -16.49 MHz

[Back to the Matrix](#)

This test report may be reproduced in full only. The document may only be updated by MiCOM Labs personnel. Any changes will be noted in the Document History section of the report.



Title: Digi ConnectCard for i.MX28 with Atheros AR6233
To: FCC 47 CFR Part 15.247 & IC RSS-210
Serial #: DIGI28-U2A Rev A
Issue Date: 29th March 2013
Page: 160 of 245



6 dB & 99% BANDWIDTH

Variant: 802.11n HT-40, Channel: 2422.00 MHz, Chain a, Temp: Ambient, Voltage: 5 Vdc

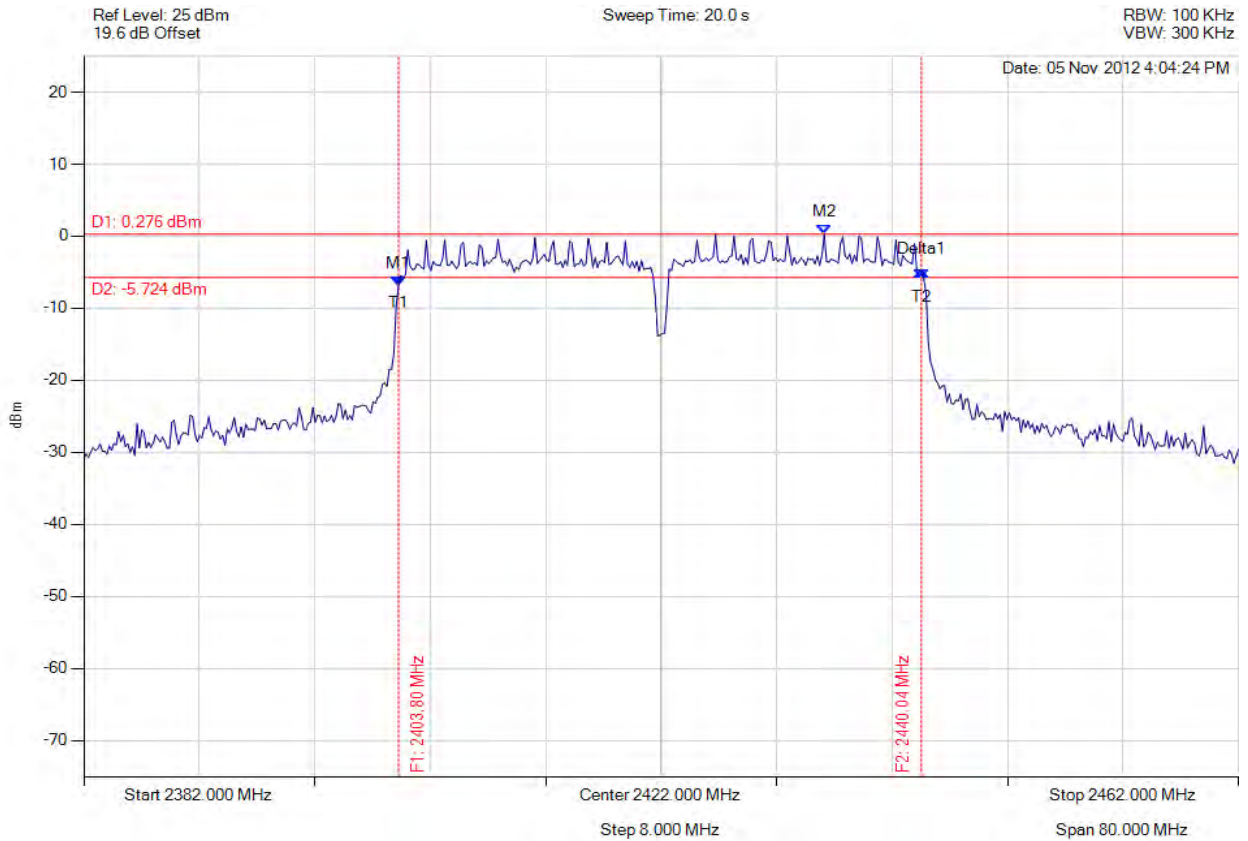

Analyser Setup	Marker : Frequency : Amplitude	Test Results
Detector = MAX PEAK Sweep Count = 0 RF Atten (dB) = 20 Trace Mode = VIEW	M1 : 2403.804 MHz : -6.840 dBm M2 : 2433.303 MHz : 0.276 dBm Delta1 : 36.232 MHz : 2.001 dB T1 : 2403.804 MHz : -6.840 dBm T2 : 2440.036 MHz : -5.844 dBm OBW : 36.393 MHz	Measured 6 dB Bandwidth: 36.232 MHz Limit: ≥ 0.5 MHz Margin: -35.73 MHz

[Back to the Matrix](#)

This test report may be reproduced in full only. The document may only be updated by MiCOM Labs personnel. Any changes will be noted in the Document History section of the report.



6 dB & 99% BANDWIDTH

Variant: 802.11n HT-40, Channel: 2437.00 MHz, Chain a, Temp: Ambient, Voltage: 5 Vdc

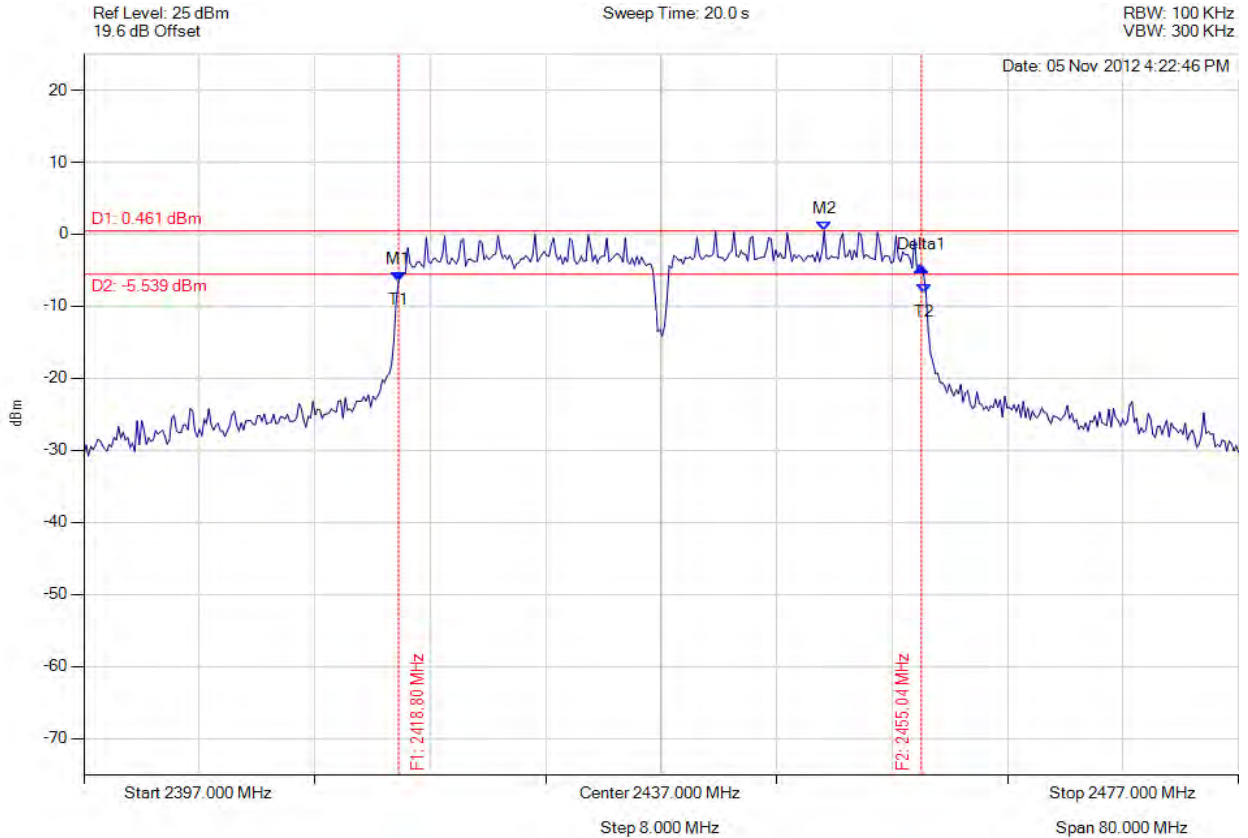

Analyser Setup	Marker : Frequency : Amplitude	Test Results
Detector = MAX PEAK Sweep Count = 0 RF Atten (dB) = 20 Trace Mode = VIEW	M1 : 2418.804 MHz : -6.606 dBm M2 : 2448.303 MHz : 0.461 dBm Delta1 : 36.232 MHz : 2.144 dB T1 : 2418.804 MHz : -6.606 dBm T2 : 2455.196 MHz : -8.256 dBm OBW : 36.553 MHz	Measured 6 dB Bandwidth: 36.232 MHz Limit: ≥ 0.5 MHz Margin: -35.73 MHz

[Back to the Matrix](#)

This test report may be reproduced in full only. The document may only be updated by MiCOM Labs personnel. Any changes will be noted in the Document History section of the report.



Title: Digi ConnectCard for i.MX28 with Atheros AR6233
To: FCC 47 CFR Part 15.247 & IC RSS-210
Serial #: DIGI28-U2A Rev A
Issue Date: 29th March 2013
Page: 162 of 245



6 dB & 99% BANDWIDTH

Variant: 802.11n HT-40, Channel: 2452.00 MHz, Chain a, Temp: Ambient, Voltage: 5 Vdc

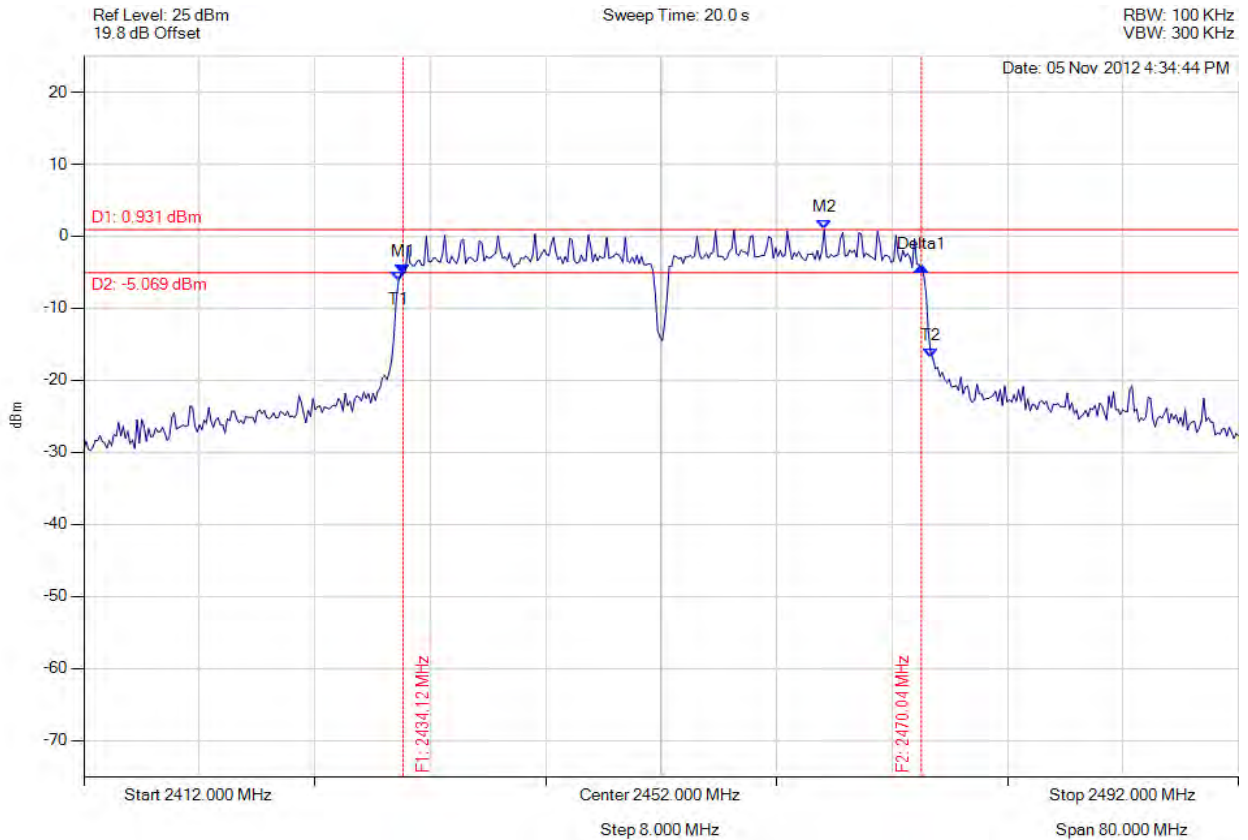

Analyser Setup	Marker : Frequency : Amplitude	Test Results
Detector = MAX PEAK Sweep Count = 0 RF Atten (dB) = 20 Trace Mode = VIEW	M1 : 2434.124 MHz : -5.130 dBm M2 : 2463.303 MHz : 0.931 dBm Delta1 : 35.912 MHz : 0.866 dB T1 : 2433.804 MHz : -6.185 dBm T2 : 2470.677 MHz : -16.956 dBm OBW : 37.034 MHz	Measured 6 dB Bandwidth: 35.912 MHz Limit: ≥ 0.5 MHz Margin: -35.41 MHz

[Back to the Matrix](#)

This test report may be reproduced in full only. The document may only be updated by MiCOM Labs personnel. Any changes will be noted in the Document History section of the report.



Title: Digi ConnectCard for i.MX28 with Atheros AR6233
To: FCC 47 CFR Part 15.247 & IC RSS-210
Serial #: DIGI28-U2A Rev A
Issue Date: 29th March 2013
Page: 163 of 245



6 dB & 99% BANDWIDTH

Variant: 802.11a, Channel: 5745.00 MHz, Chain a, Temp: Ambient, Voltage: 5 Vdc

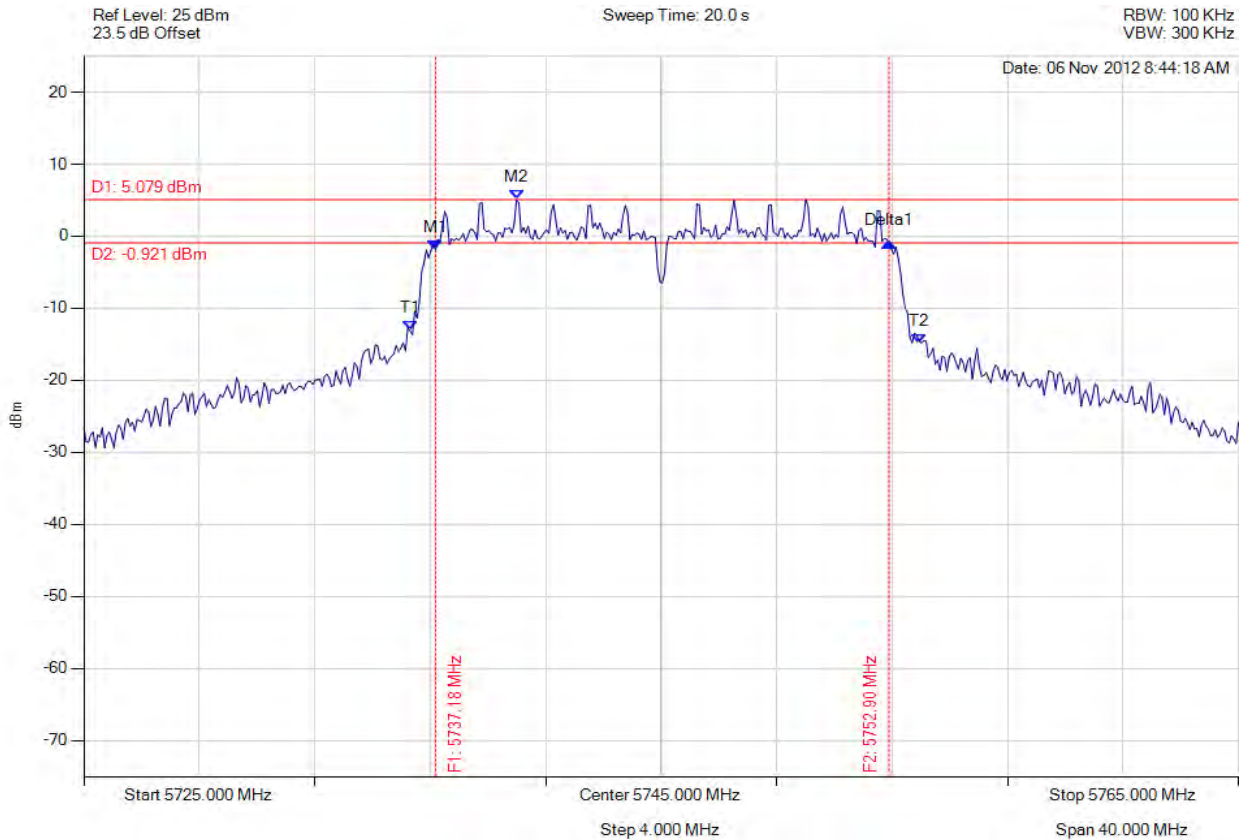

Analyser Setup	Marker : Frequency : Amplitude	Test Results
Detector = MAX PEAK Sweep Count = 0 RF Atten (dB) = 20 Trace Mode = VIEW	M1 : 5737.184 MHz : -1.886 dBm M2 : 5739.990 MHz : 5.079 dBm Delta1 : 15.711 MHz : 0.970 dB T1 : 5736.303 MHz : -13.108 dBm T2 : 5753.938 MHz : -14.819 dBm OBW : 17.715 MHz	Measured 6 dB Bandwidth: 15.711 MHz Limit: ≥ 0.5 MHz Margin: -15.21 MHz

[Back to the Matrix](#)

This test report may be reproduced in full only. The document may only be updated by MiCOM Labs personnel. Any changes will be noted in the Document History section of the report.



Title: Digi ConnectCard for i.MX28 with Atheros AR6233
To: FCC 47 CFR Part 15.247 & IC RSS-210
Serial #: DIGI28-U2A Rev A
Issue Date: 29th March 2013
Page: 164 of 245



6 dB & 99% BANDWIDTH

Variant: 802.11a, Channel: 5785.00 MHz, Chain a, Temp: Ambient, Voltage: 5 Vdc

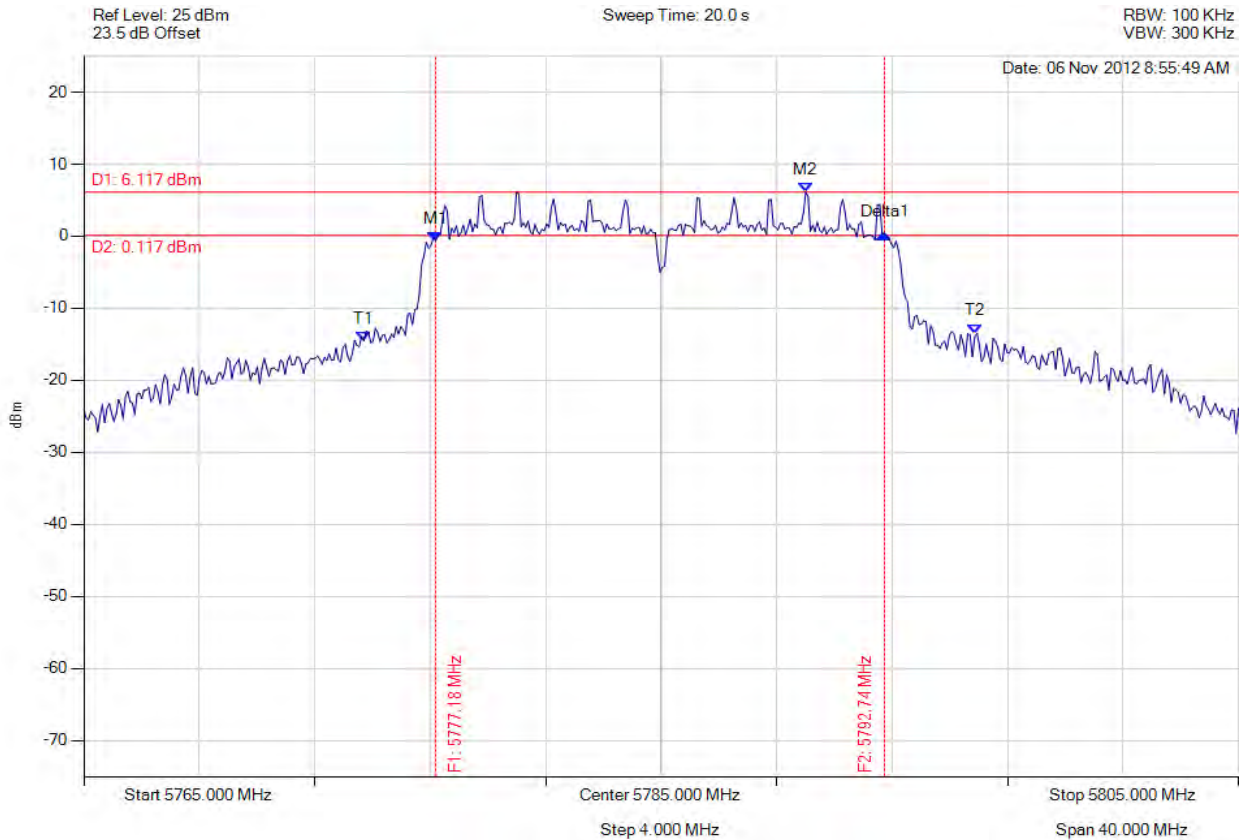

Analyser Setup	Marker : Frequency : Amplitude	Test Results
Detector = MAX PEAK Sweep Count = 0 RF Atten (dB) = 20 Trace Mode = VIEW	M1 : 5777.184 MHz : -0.652 dBm M2 : 5790.010 MHz : 6.117 dBm Delta1 : 15.551 MHz : 0.972 dB T1 : 5774.699 MHz : -14.522 dBm T2 : 5795.862 MHz : -13.458 dBm OBW : 21.242 MHz	Measured 6 dB Bandwidth: 15.551 MHz Limit: ≥ 0.5 MHz Margin: -15.05 MHz

[Back to the Matrix](#)

This test report may be reproduced in full only. The document may only be updated by MiCOM Labs personnel. Any changes will be noted in the Document History section of the report.

6 dB & 99% BANDWIDTH

Variant: 802.11a, Channel: 5825.00 MHz, Chain a, Temp: Ambient, Voltage: 5 Vdc

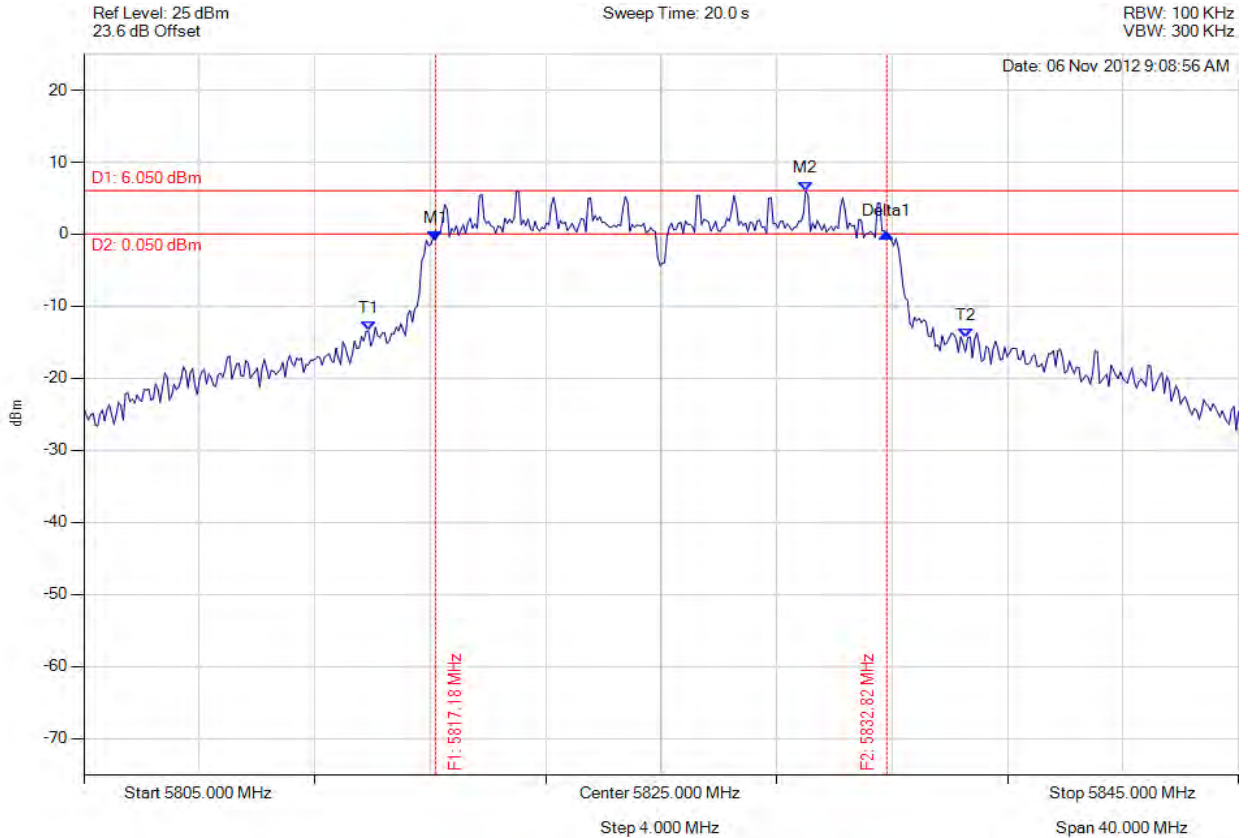

Analyser Setup	Marker : Frequency : Amplitude	Test Results
Detector = MAX PEAK Sweep Count = 0 RF Atten (dB) = 20 Trace Mode = VIEW	M1 : 5817.184 MHz : -0.869 dBm M2 : 5830.010 MHz : 6.050 dBm Delta1 : 15.631 MHz : 0.948 dB T1 : 5814.860 MHz : -13.424 dBm T2 : 5835.541 MHz : -14.383 dBm OBW : 20.762 MHz	Measured 6 dB Bandwidth: 15.631 MHz Limit: ≥ 0.5 MHz Margin: -15.13 MHz

[Back to the Matrix](#)

This test report may be reproduced in full only. The document may only be updated by MiCOM Labs personnel. Any changes will be noted in the Document History section of the report.



6 dB & 99% BANDWIDTH

Variant: 802.11n HT-20, Channel: 5745.00 MHz, Chain a, Temp: Ambient, Voltage: 5 Vdc

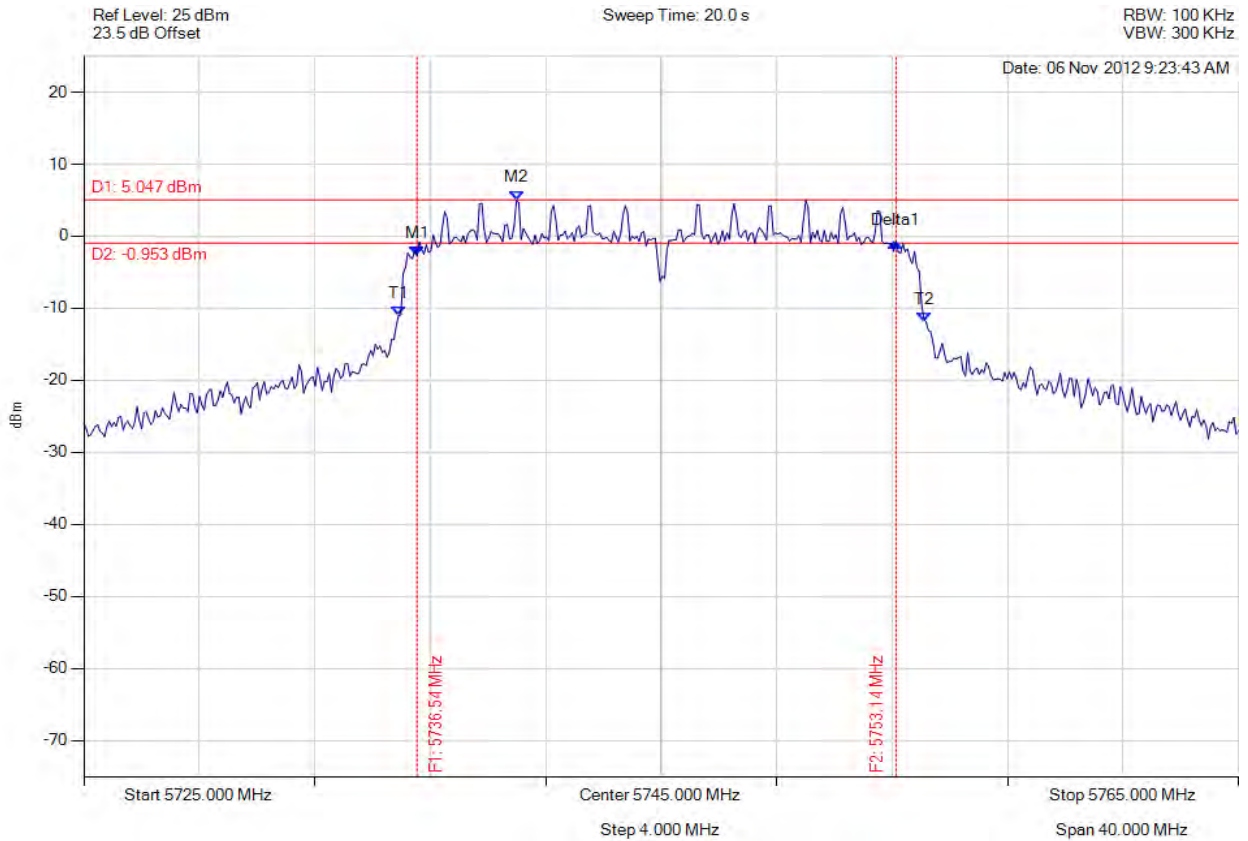

Analyser Setup	Marker : Frequency : Amplitude	Test Results
Detector = MAX PEAK Sweep Count = 0 RF Atten (dB) = 20 Trace Mode = VIEW	M1 : 5736.543 MHz : -2.675 dBm M2 : 5739.990 MHz : 5.047 dBm Delta1 : 16.593 MHz : 1.780 dB T1 : 5735.902 MHz : -11.038 dBm T2 : 5754.098 MHz : -11.872 dBm OBW : 18.277 MHz	Measured 6 dB Bandwidth: 16.593 MHz Limit: ≥ 0.5 MHz Margin: -16.09 MHz

[Back to the Matrix](#)

This test report may be reproduced in full only. The document may only be updated by MiCOM Labs personnel. Any changes will be noted in the Document History section of the report.



6 dB & 99% BANDWIDTH

Variant: 802.11n HT-20, Channel: 5785.00 MHz, Chain a, Temp: Ambient, Voltage: 5 Vdc

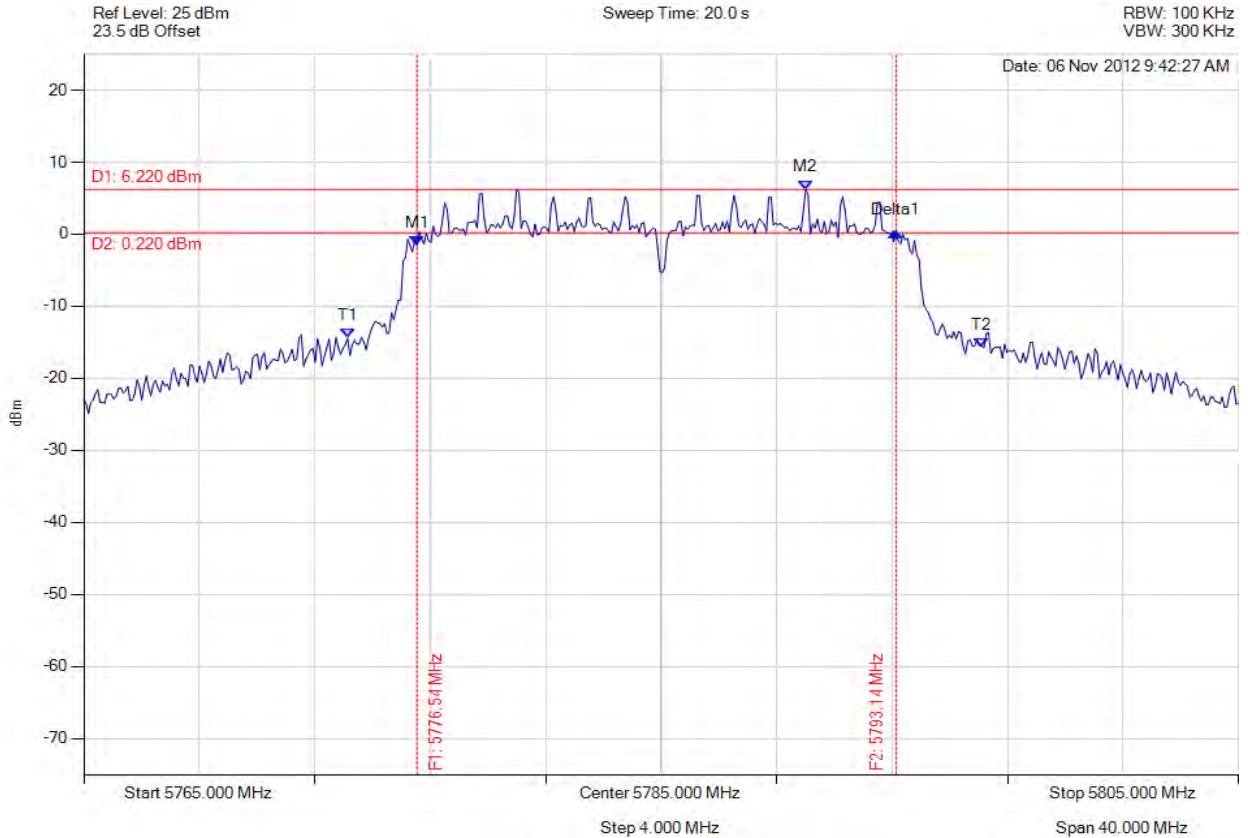

Analyser Setup	Marker : Frequency : Amplitude	Test Results
Detector = MAX PEAK Sweep Count = 0 RF Atten (dB) = 20 Trace Mode = VIEW	M1 : 5776.543 MHz : -1.585 dBm M2 : 5790.010 MHz : 6.220 dBm Delta1 : 16.593 MHz : 1.863 dB T1 : 5774.138 MHz : -14.408 dBm T2 : 5796.102 MHz : -15.750 dBm OBW : 22.044 MHz	Measured 6 dB Bandwidth: 16.593 MHz Limit: ≥ 0.5 MHz Margin: -16.09 MHz

[Back to the Matrix](#)

This test report may be reproduced in full only. The document may only be updated by MiCOM Labs personnel. Any changes will be noted in the Document History section of the report.



6 dB & 99% BANDWIDTH

Variant: 802.11n HT-20, Channel: 5825.00 MHz, Chain a, Temp: Ambient, Voltage: 5 Vdc

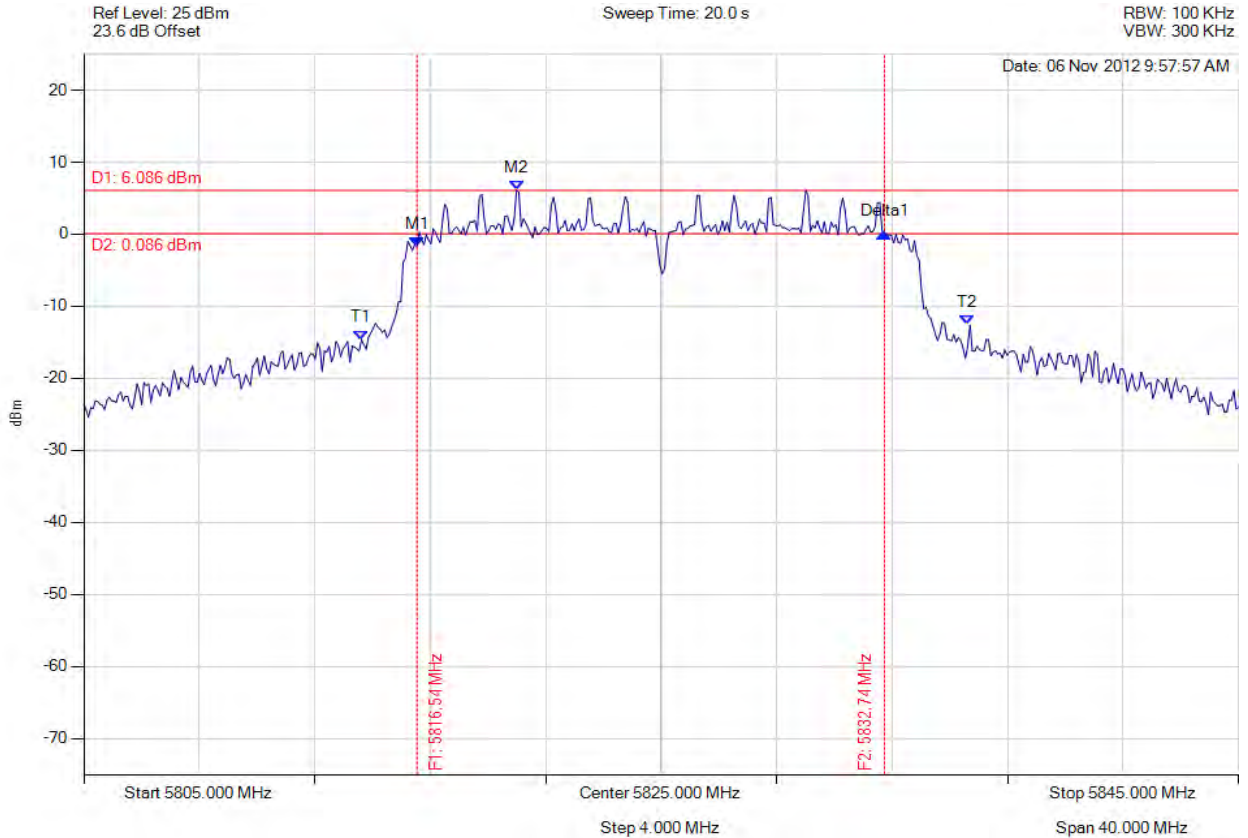

Analyser Setup	Marker : Frequency : Amplitude	Test Results
Detector = MAX PEAK Sweep Count = 0 RF Atten (dB) = 20 Trace Mode = VIEW	M1 : 5816.543 MHz : -1.699 dBm M2 : 5819.990 MHz : 6.086 dBm Delta1 : 16.192 MHz : 1.851 dB T1 : 5814.619 MHz : -14.626 dBm T2 : 5835.621 MHz : -12.604 dBm OBW : 21.082 MHz	Measured 6 dB Bandwidth: 16.192 MHz Limit: ≥ 0.5 MHz Margin: -15.69 MHz

[Back to the Matrix](#)

This test report may be reproduced in full only. The document may only be updated by MiCOM Labs personnel. Any changes will be noted in the Document History section of the report.



Title: Digi ConnectCard for i.MX28 with Atheros AR6233
To: FCC 47 CFR Part 15.247 & IC RSS-210
Serial #: DIGI28-U2A Rev A
Issue Date: 29th March 2013
Page: 169 of 245



6 dB & 99% BANDWIDTH

Variant: 802.11n HT-40, Channel: 5755.00 MHz, Chain a, Temp: Ambient, Voltage: 5 Vdc

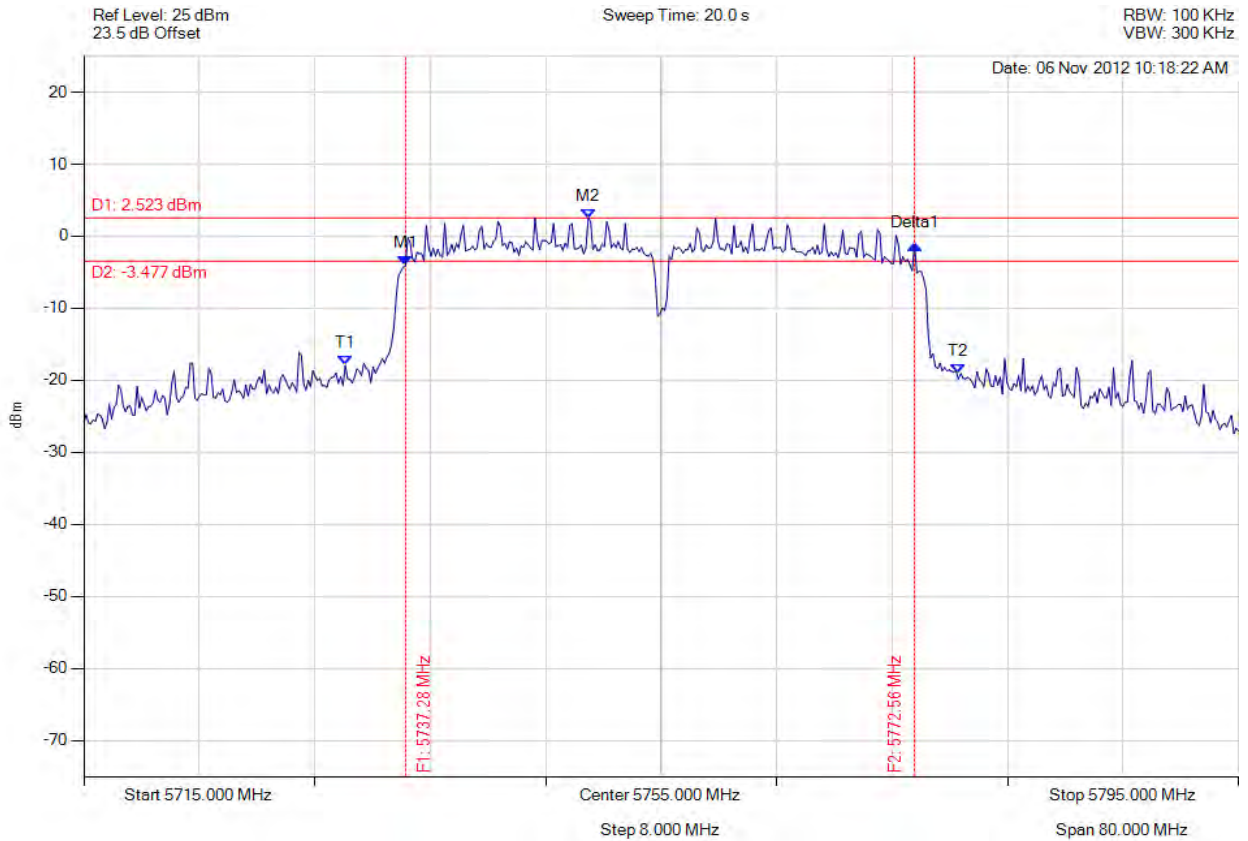

Analyser Setup	Marker : Frequency : Amplitude	Test Results
Detector = MAX PEAK Sweep Count = 0 RF Atten (dB) = 20 Trace Mode = VIEW	M1 : 5737.285 MHz : -4.091 dBm M2 : 5749.950 MHz : 2.523 dBm Delta1 : 35.271 MHz : 2.910 dB T1 : 5733.116 MHz : -17.955 dBm T2 : 5775.601 MHz : -19.069 dBm OBW : 42.645 MHz	Measured 6 dB Bandwidth: 35.271 MHz Limit: ≥ 0.5 MHz Margin: -34.77 MHz

[Back to the Matrix](#)

This test report may be reproduced in full only. The document may only be updated by MiCOM Labs personnel. Any changes will be noted in the Document History section of the report.



Title: Digi ConnectCard for i.MX28 with Atheros AR6233
To: FCC 47 CFR Part 15.247 & IC RSS-210
Serial #: DIGI28-U2A Rev A
Issue Date: 29th March 2013
Page: 170 of 245



6 dB & 99% BANDWIDTH

Variant: 802.11n HT-40, Channel: 5795.00 MHz, Chain a, Temp: Ambient, Voltage: 5 Vdc

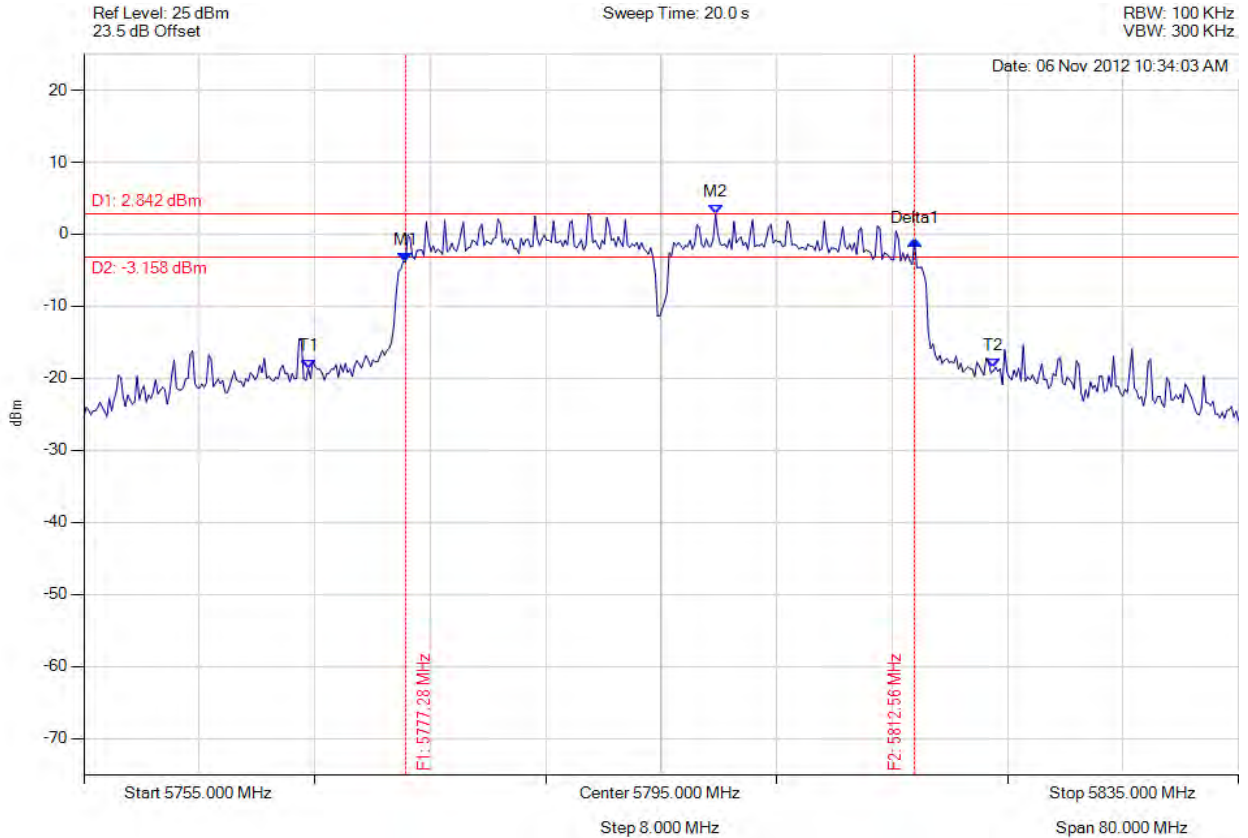

Analyser Setup	Marker : Frequency : Amplitude	Test Results
Detector = MAX PEAK Sweep Count = 0 RF Atten (dB) = 20 Trace Mode = VIEW	M1 : 5777.285 MHz : -3.841 dBm M2 : 5798.768 MHz : 2.842 dBm Delta1 : 35.271 MHz : 2.935 dB T1 : 5770.551 MHz : -18.632 dBm T2 : 5818.006 MHz : -18.477 dBm OBW : 47.615 MHz	Measured 6 dB Bandwidth: 35.271 MHz Limit: ≥ 0.5 MHz Margin: -34.77 MHz

[Back to the Matrix](#)

This test report may be reproduced in full only. The document may only be updated by MiCOM Labs personnel. Any changes will be noted in the Document History section of the report.



A.1.2. Peak Output Power

Single Port Module:



PEAK OUTPUT POWER

Variant: 802.11b, Channel: 2412.00 MHz, Chain a, Temp: Ambient, Voltage: 5 Vdc

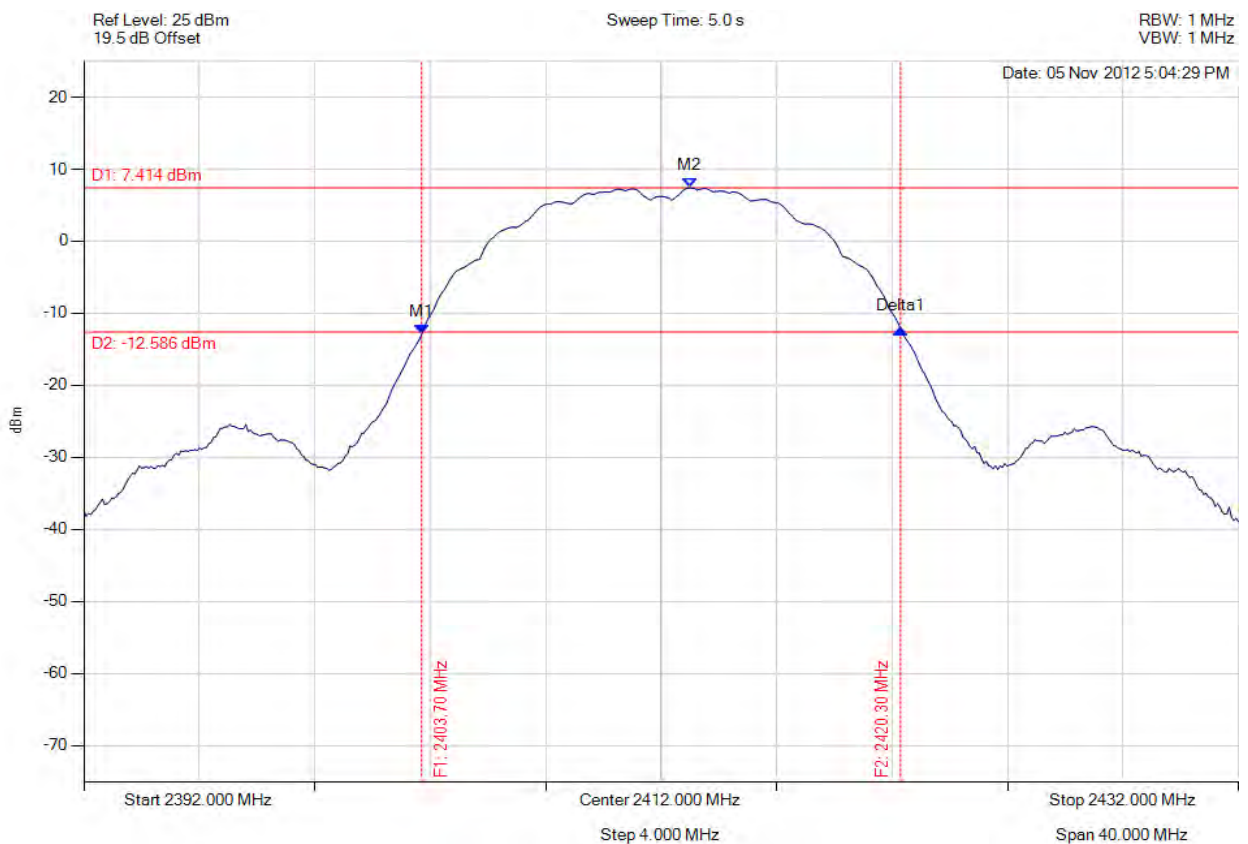

Analyser Setup	Marker : Frequency : Amplitude	Test Results
Detector = MAX PEAK Sweep Count = 0 RF Atten (dB) = 20 Trace Mode = VIEW	M1 : 2403.703 MHz : -12.885 dBm M2 : 2413.002 MHz : 7.414 dBm Delta1 : 16.593 MHz : 0.765 dB	Channel Power: 15.94 dBm Limit: 30.00 dBm Margin: -14.06 dB

[Back to the Matrix](#)

This test report may be reproduced in full only. The document may only be updated by MiCOM Labs personnel. Any changes will be noted in the Document History section of the report.



Title: Digi ConnectCard for i.MX28 with Atheros AR6233
To: FCC 47 CFR Part 15.247 & IC RSS-210
Serial #: DIGI28-U2A Rev A
Issue Date: 29th March 2013
Page: 172 of 245



PEAK OUTPUT POWER

Variant: 802.11b, Channel: 2437.00 MHz, Chain a, Temp: Ambient, Voltage: 5 Vdc

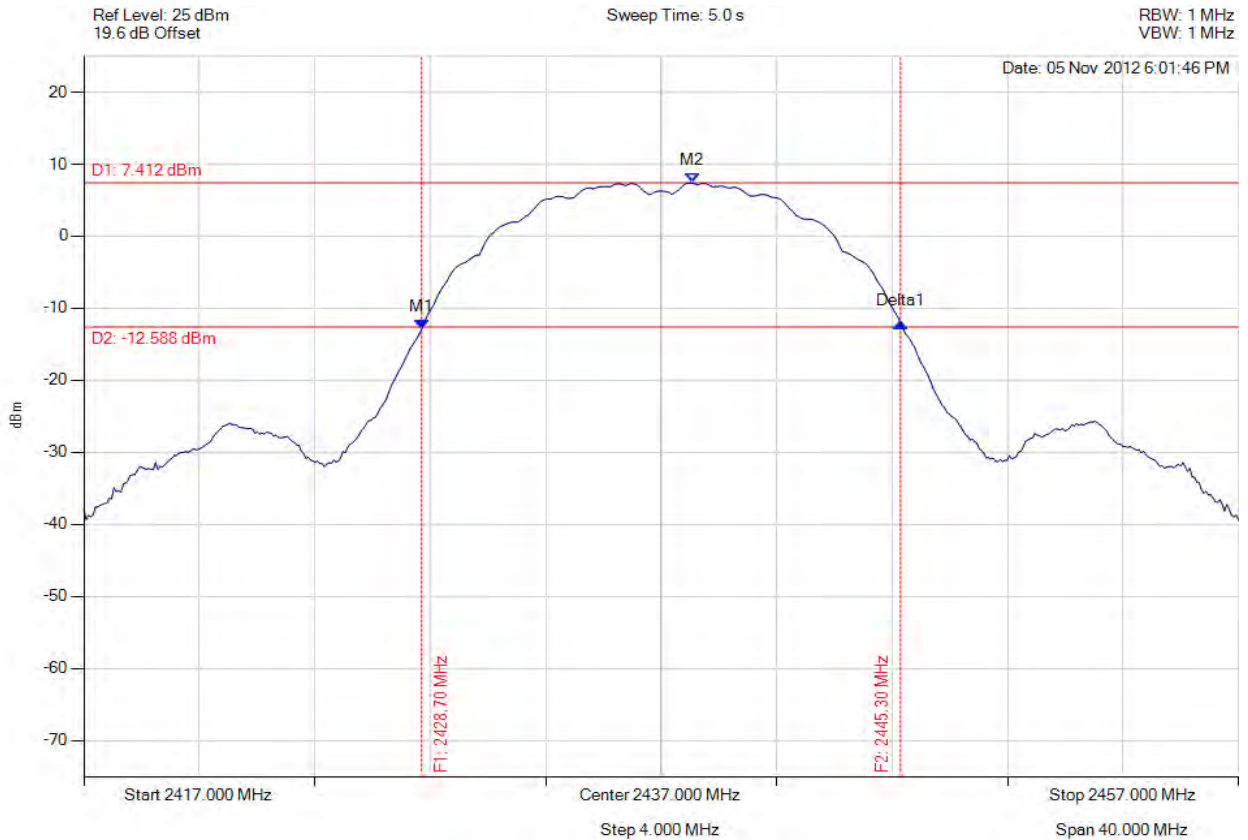

Analyser Setup	Marker : Frequency : Amplitude	Test Results
Detector = MAX PEAK Sweep Count = 0 RF Atten (dB) = 20 Trace Mode = VIEW	M1 : 2428.703 MHz : -12.889 dBm M2 : 2438.082 MHz : 7.412 dBm Delta1 : 16.593 MHz : 0.803 dB	Channel Power: 15.95 dBm Limit: 30.00 dBm Margin: -14.05 dB

[Back to the Matrix](#)

This test report may be reproduced in full only. The document may only be updated by MiCOM Labs personnel. Any changes will be noted in the Document History section of the report.



Title: Digi ConnectCard for i.MX28 with Atheros AR6233
To: FCC 47 CFR Part 15.247 & IC RSS-210
Serial #: DIGI28-U2A Rev A
Issue Date: 29th March 2013
Page: 173 of 245



PEAK OUTPUT POWER

Variant: 802.11b, Channel: 2462.00 MHz, Chain a, Temp: Ambient, Voltage: 5 Vdc

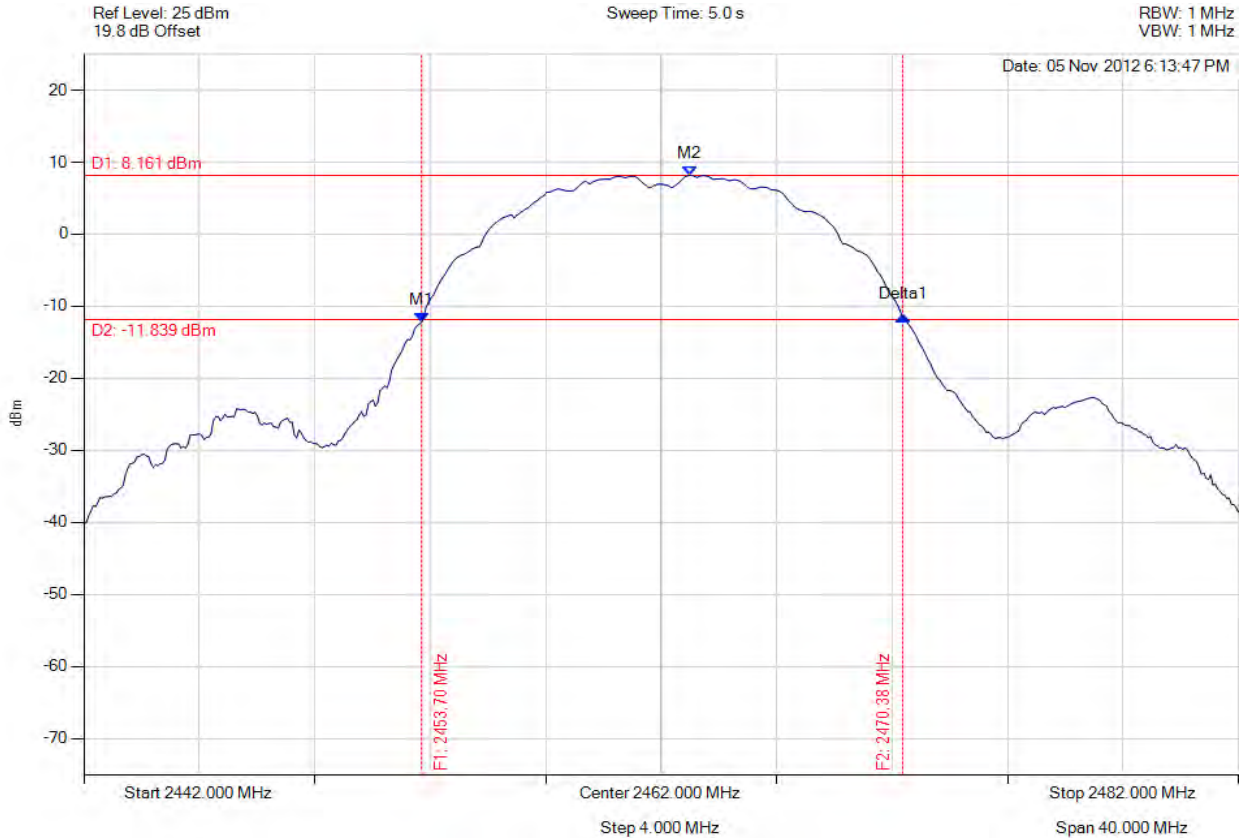

Analyser Setup	Marker : Frequency : Amplitude	Test Results
Detector = MAX PEAK Sweep Count = 0 RF Atten (dB) = 20 Trace Mode = VIEW	M1 : 2453.703 MHz : -12.201 dBm M2 : 2463.002 MHz : 8.161 dBm Delta1 : 16.673 MHz : 0.795 dB	Channel Power: 16.68 dBm Limit: 30.00 dBm Margin: -13.32 dB

[Back to the Matrix](#)

This test report may be reproduced in full only. The document may only be updated by MiCOM Labs personnel. Any changes will be noted in the Document History section of the report.



Title: Digi ConnectCard for i.MX28 with Atheros AR6233
To: FCC 47 CFR Part 15.247 & IC RSS-210
Serial #: DIGI28-U2A Rev A
Issue Date: 29th March 2013
Page: 174 of 245



PEAK OUTPUT POWER

Variant: 802.11g, Channel: 2412.00 MHz, Chain a, Temp: Ambient, Voltage: 5 Vdc

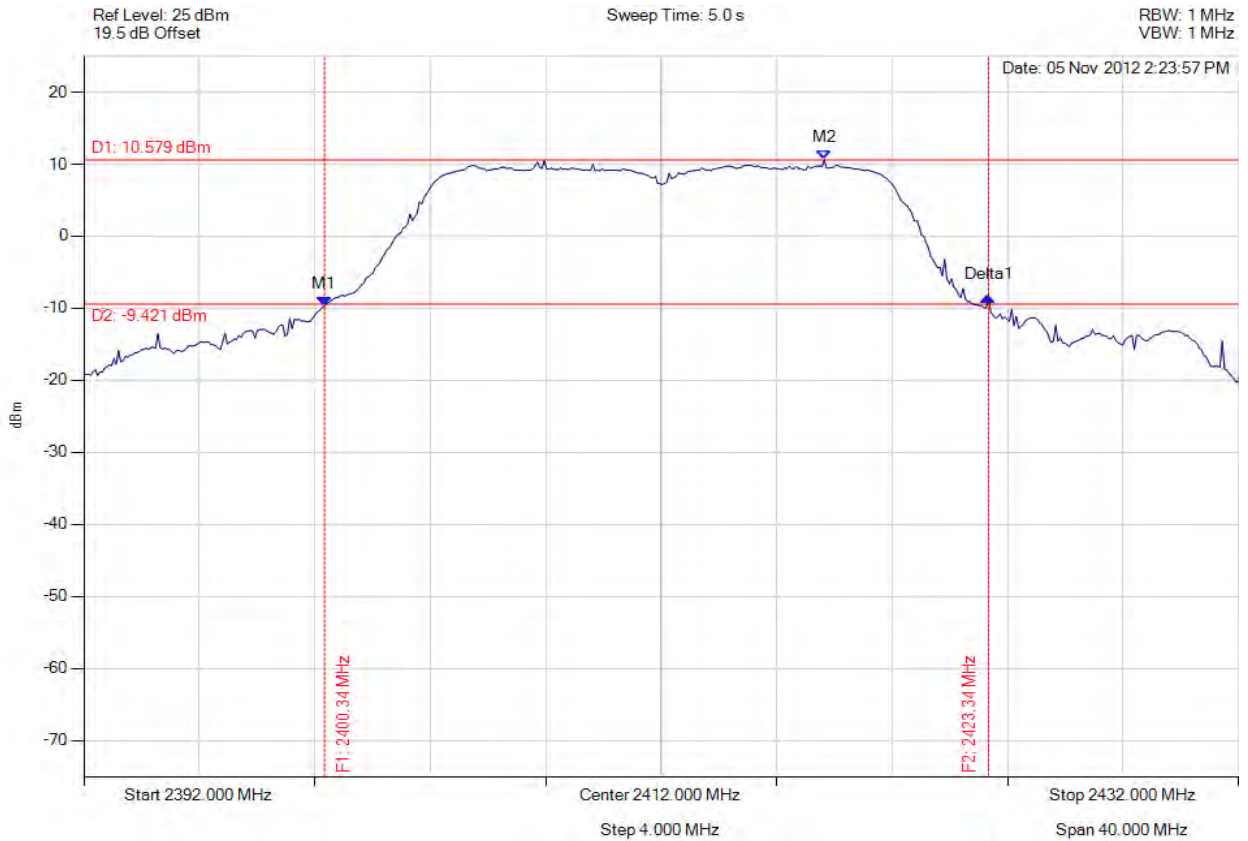

Analyser Setup	Marker : Frequency : Amplitude	Test Results
Detector = MAX PEAK Sweep Count = 0 RF Atten (dB) = 20 Trace Mode = VIEW	M1 : 2400.337 MHz : -9.651 dBm M2 : 2417.651 MHz : 10.579 dBm Delta1 : 23.006 MHz : 1.249 dB	Channel Power: 20.92 dBm Limit: 30.00 dBm Margin: -9.08 dB

[Back to the Matrix](#)

This test report may be reproduced in full only. The document may only be updated by MiCOM Labs personnel. Any changes will be noted in the Document History section of the report.



Title: Digi ConnectCard for i.MX28 with Atheros AR6233
To: FCC 47 CFR Part 15.247 & IC RSS-210
Serial #: DIGI28-U2A Rev A
Issue Date: 29th March 2013
Page: 175 of 245



PEAK OUTPUT POWER

Variant: 802.11g, Channel: 2437.00 MHz, Chain a, Temp: Ambient, Voltage: 5 Vdc

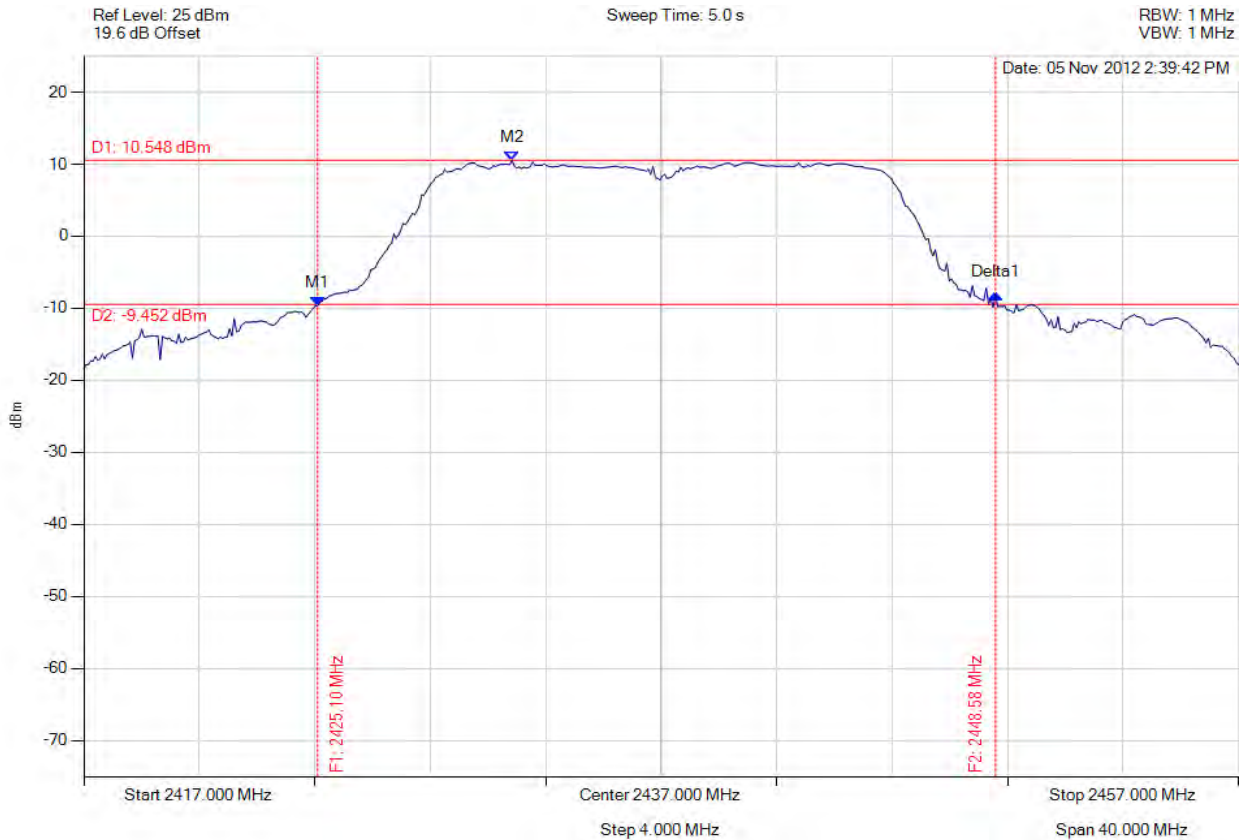

Analyser Setup	Marker : Frequency : Amplitude	Test Results
Detector = MAX PEAK Sweep Count = 0 RF Atten (dB) = 20 Trace Mode = VIEW	M1 : 2425.096 MHz : -9.631 dBm M2 : 2431.830 MHz : 10.548 dBm Delta1 : 23.487 MHz : 1.578 dB	Channel Power: 21.30 dBm Limit: 30.00 dBm Margin: -8.70 dB

[Back to the Matrix](#)

This test report may be reproduced in full only. The document may only be updated by MiCOM Labs personnel. Any changes will be noted in the Document History section of the report.



Title: Digi ConnectCard for i.MX28 with Atheros AR6233
To: FCC 47 CFR Part 15.247 & IC RSS-210
Serial #: DIGI28-U2A Rev A
Issue Date: 29th March 2013
Page: 176 of 245



PEAK OUTPUT POWER

Variant: 802.11g, Channel: 2462.00 MHz, Chain a, Temp: Ambient, Voltage: 5 Vdc

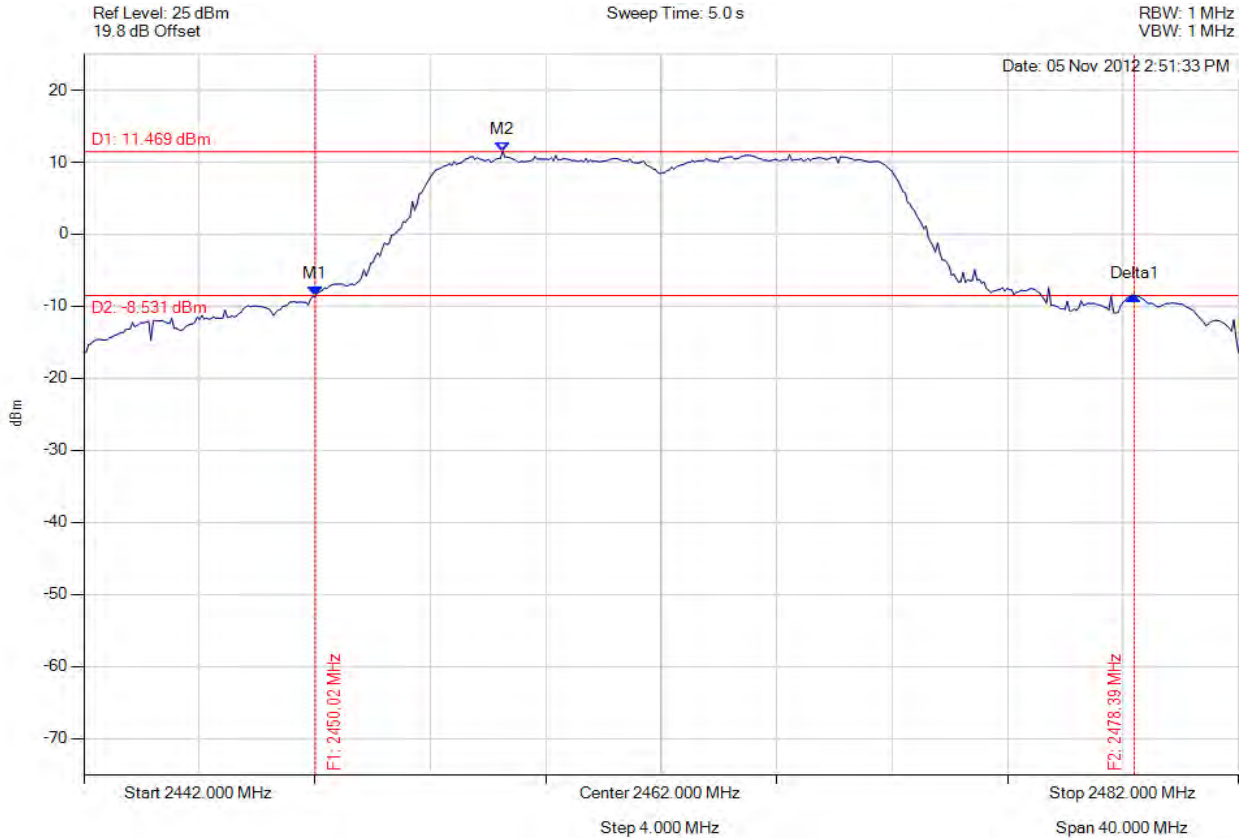

Analyser Setup	Marker : Frequency : Amplitude	Test Results
Detector = MAX PEAK Sweep Count = 0 RF Atten (dB) = 20 Trace Mode = VIEW	M1 : 2450.016 MHz : -8.608 dBm M2 : 2456.509 MHz : 11.469 dBm Delta1 : 28.377 MHz : 0.087 dB	Channel Power: 21.94 dBm Limit: 30.00 dBm Margin: -8.06 dB

[Back to the Matrix](#)

This test report may be reproduced in full only. The document may only be updated by MiCOM Labs personnel. Any changes will be noted in the Document History section of the report.



Title: Digi ConnectCard for i.MX28 with Atheros AR6233
To: FCC 47 CFR Part 15.247 & IC RSS-210
Serial #: DIGI28-U2A Rev A
Issue Date: 29th March 2013
Page: 177 of 245



PEAK OUTPUT POWER

Variant: 802.11n HT-20, Channel: 2412.00 MHz, Chain a, Temp: Ambient, Voltage: 5 Vdc

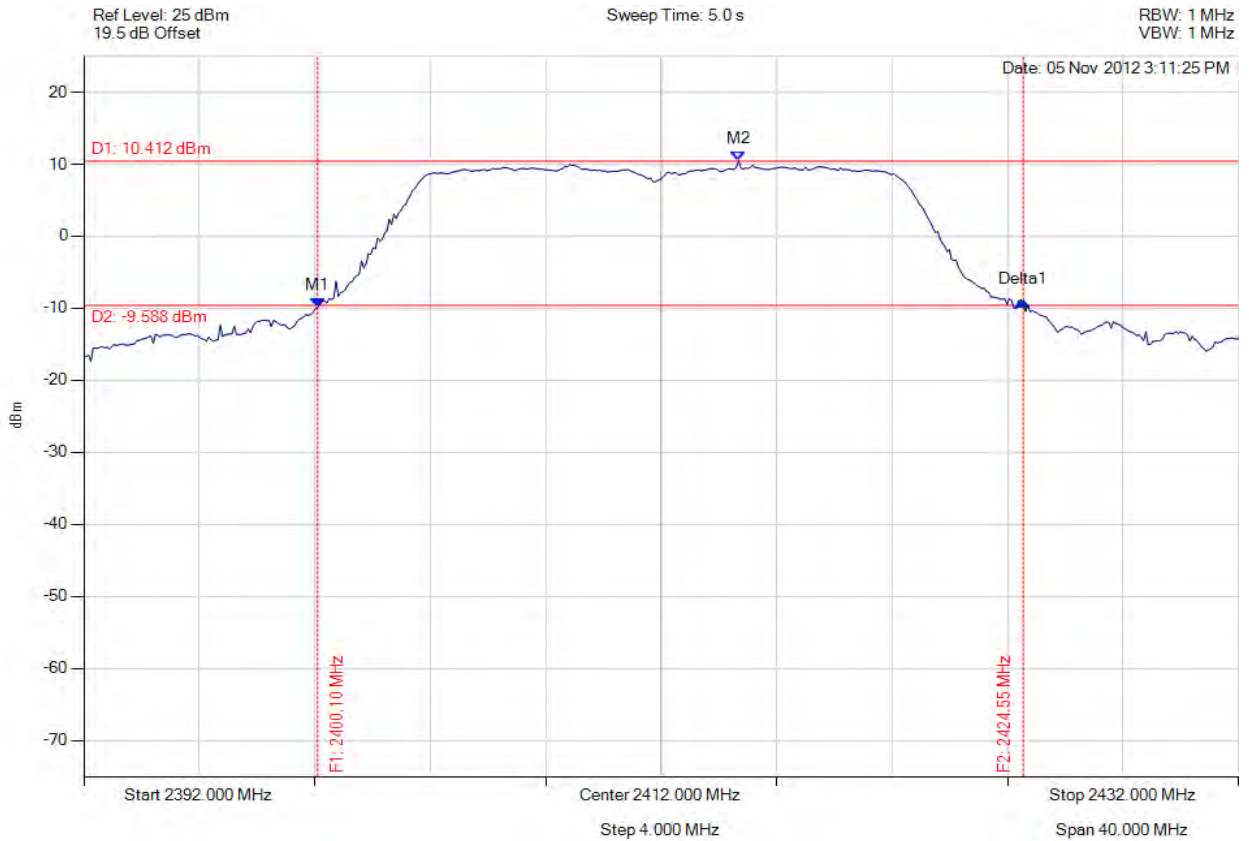

Analyser Setup	Marker : Frequency : Amplitude	Test Results
Detector = MAX PEAK Sweep Count = 0 RF Atten (dB) = 20 Trace Mode = VIEW	M1 : 2400.096 MHz : -9.873 dBm M2 : 2414.685 MHz : 10.412 dBm Delta1 : 24.449 MHz : 0.773 dB	Channel Power: 21.10 dBm Limit: 30.00 dBm Margin: -8.90 dB

[Back to the Matrix](#)

This test report may be reproduced in full only. The document may only be updated by MiCOM Labs personnel. Any changes will be noted in the Document History section of the report.



Title: Digi ConnectCard for i.MX28 with Atheros AR6233
To: FCC 47 CFR Part 15.247 & IC RSS-210
Serial #: DIGI28-U2A Rev A
Issue Date: 29th March 2013
Page: 178 of 245



PEAK OUTPUT POWER

Variant: 802.11n HT-20, Channel: 2437.00 MHz, Chain a, Temp: Ambient, Voltage: 5 Vdc

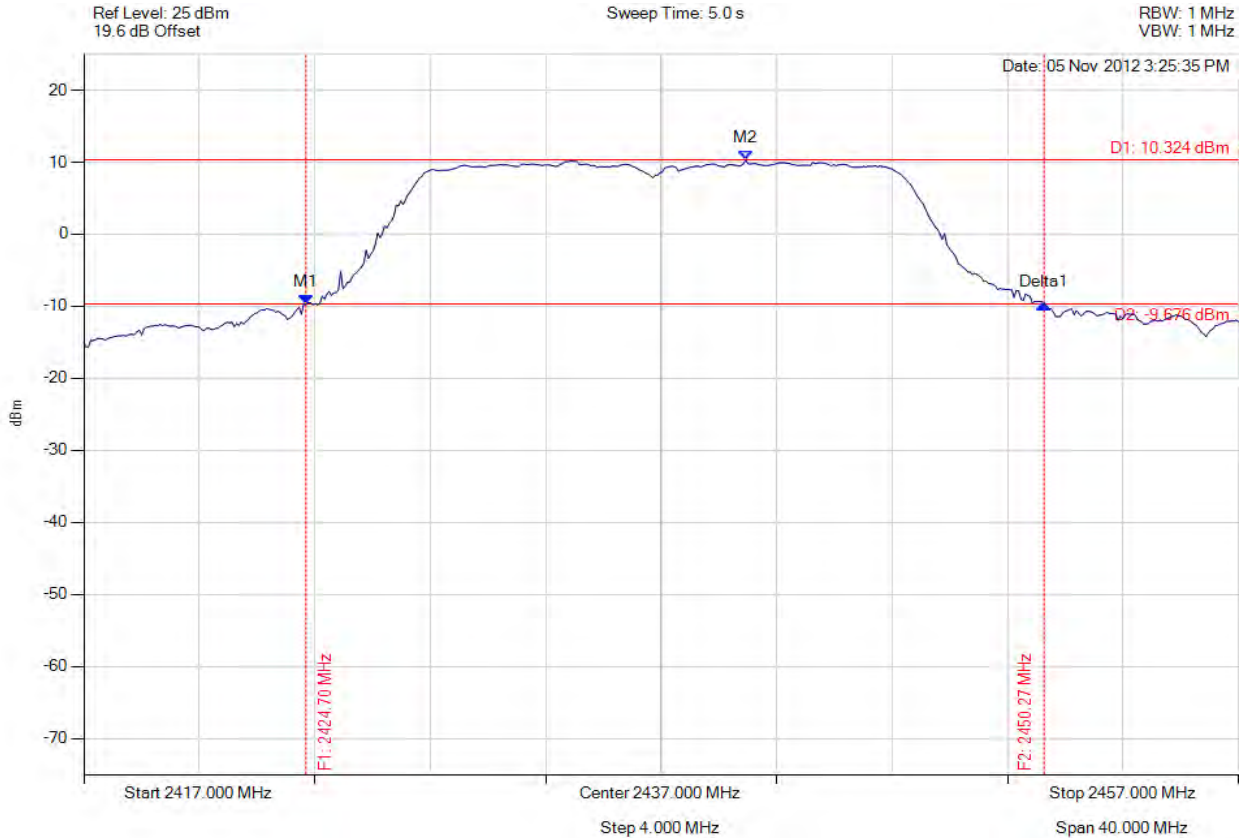

Analyser Setup	Marker : Frequency : Amplitude	Test Results
Detector = MAX PEAK Sweep Count = 0 RF Atten (dB) = 20 Trace Mode = VIEW	M1 : 2424.695 MHz : -9.728 dBm M2 : 2439.926 MHz : 10.324 dBm Delta1 : 25.571 MHz : 0.059 dB	Channel Power: 21.41 dBm Limit: 30.00 dBm Margin: -8.59 dB

[Back to the Matrix](#)

This test report may be reproduced in full only. The document may only be updated by MiCOM Labs personnel. Any changes will be noted in the Document History section of the report.



Title: Digi ConnectCard for i.MX28 with Atheros AR6233
To: FCC 47 CFR Part 15.247 & IC RSS-210
Serial #: DIGI28-U2A Rev A
Issue Date: 29th March 2013
Page: 179 of 245



PEAK OUTPUT POWER

Variant: 802.11n HT-20, Channel: 2462.00 MHz, Chain a, Temp: Ambient, Voltage: 5 Vdc

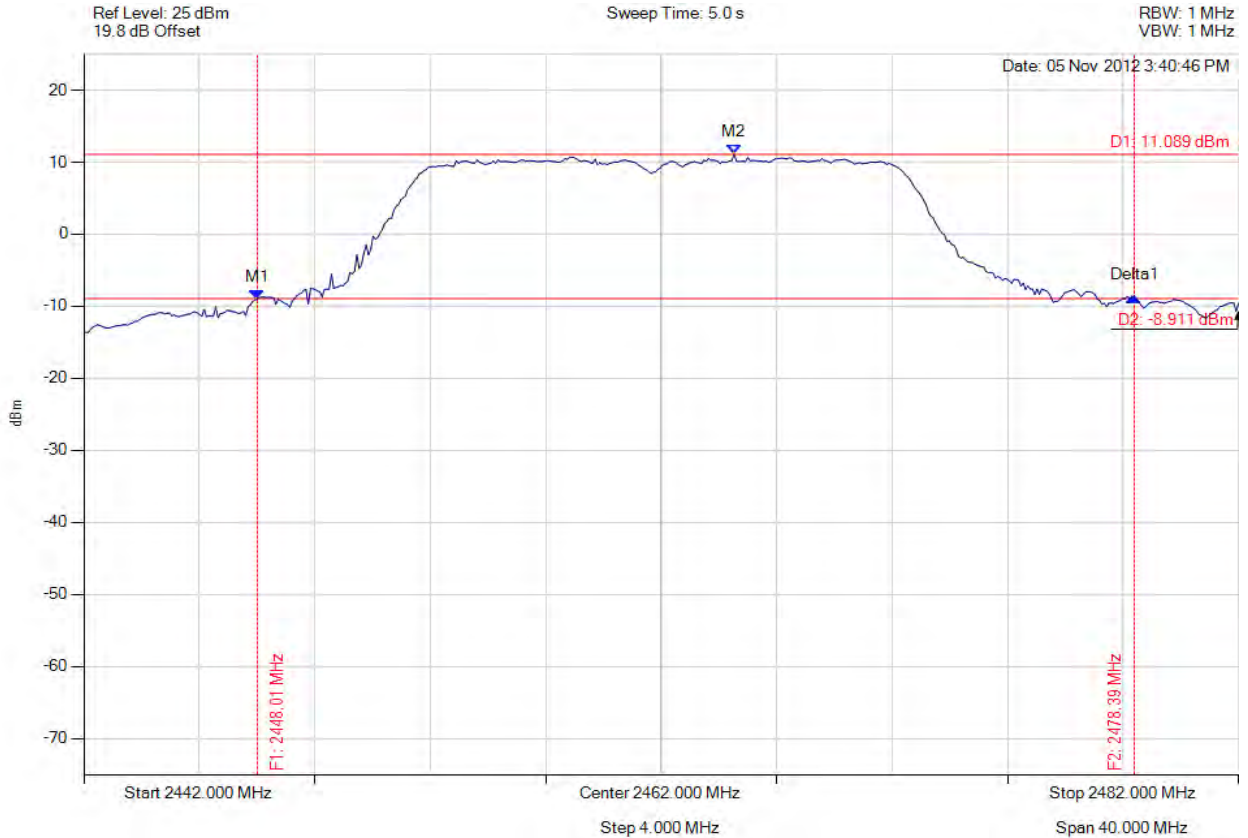

Analyser Setup	Marker : Frequency : Amplitude	Test Results
Detector = MAX PEAK Sweep Count = 0 RF Atten (dB) = 20 Trace Mode = VIEW	M1 : 2448.012 MHz : -9.039 dBm M2 : 2464.525 MHz : 11.089 dBm Delta1 : 30.381 MHz : 0.275 dB	Channel Power: 21.98 dBm Limit: 30.00 dBm Margin: -8.02 dB

[Back to the Matrix](#)

This test report may be reproduced in full only. The document may only be updated by MiCOM Labs personnel. Any changes will be noted in the Document History section of the report.



Title: Digi ConnectCard for i.MX28 with Atheros AR6233
To: FCC 47 CFR Part 15.247 & IC RSS-210
Serial #: DIGI28-U2A Rev A
Issue Date: 29th March 2013
Page: 180 of 245



PEAK OUTPUT POWER

Variant: 802.11n HT-40, Channel: 2422.00 MHz, Chain a, Temp: Ambient, Voltage: 5 Vdc

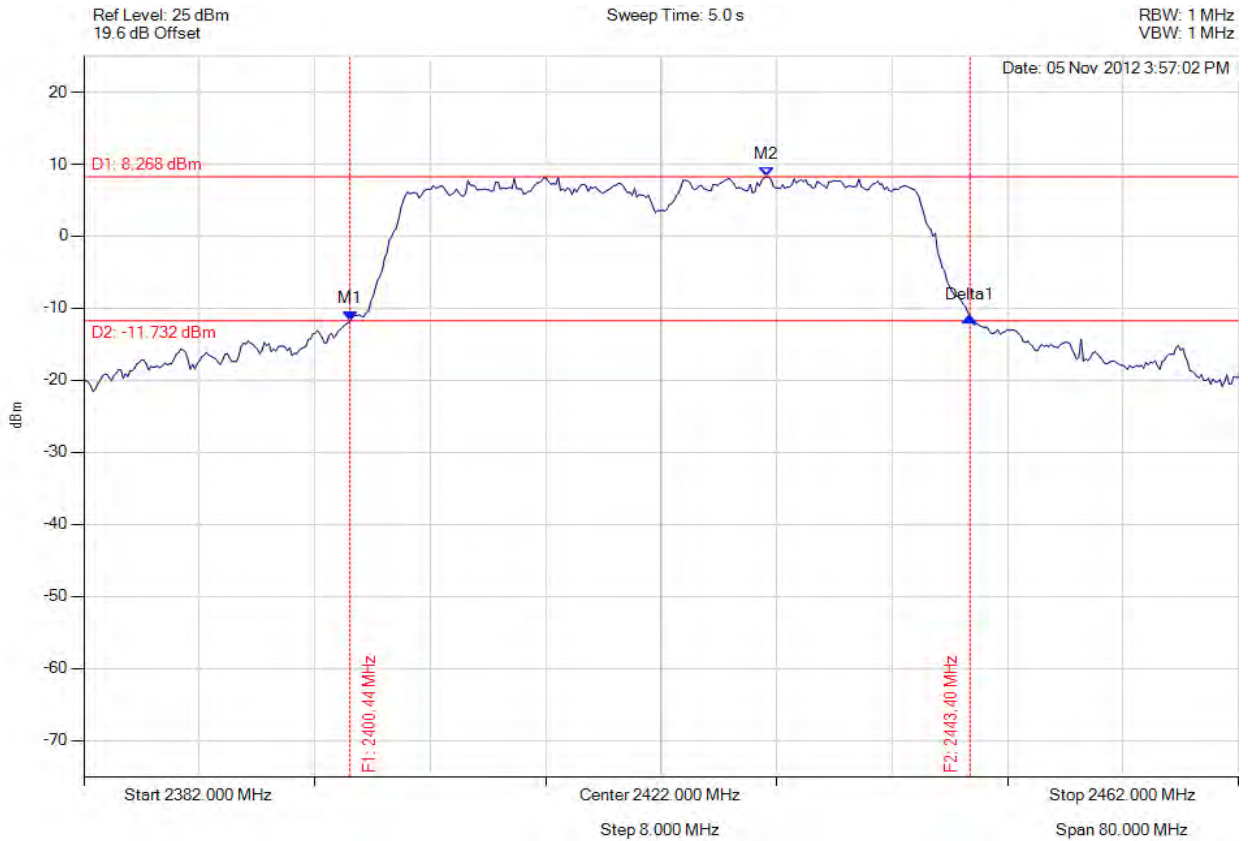

Analyser Setup	Marker : Frequency : Amplitude	Test Results
Detector = MAX PEAK Sweep Count = 0 RF Atten (dB) = 20 Trace Mode = VIEW	M1 : 2400.437 MHz : -11.764 dBm M2 : 2429.295 MHz : 8.268 dBm Delta1 : 2429.966 MHz : 0.557 dB	Channel Power: 21.85 dBm Limit: 30.00 dBm Margin: -8.15 dB

[Back to the Matrix](#)

This test report may be reproduced in full only. The document may only be updated by MiCOM Labs personnel. Any changes will be noted in the Document History section of the report.



Title: Digi ConnectCard for i.MX28 with Atheros AR6233
To: FCC 47 CFR Part 15.247 & IC RSS-210
Serial #: DIGI28-U2A Rev A
Issue Date: 29th March 2013
Page: 181 of 245



PEAK OUTPUT POWER

Variant: 802.11n HT-40, Channel: 2437.00 MHz, Chain a, Temp: Ambient, Voltage: 5 Vdc

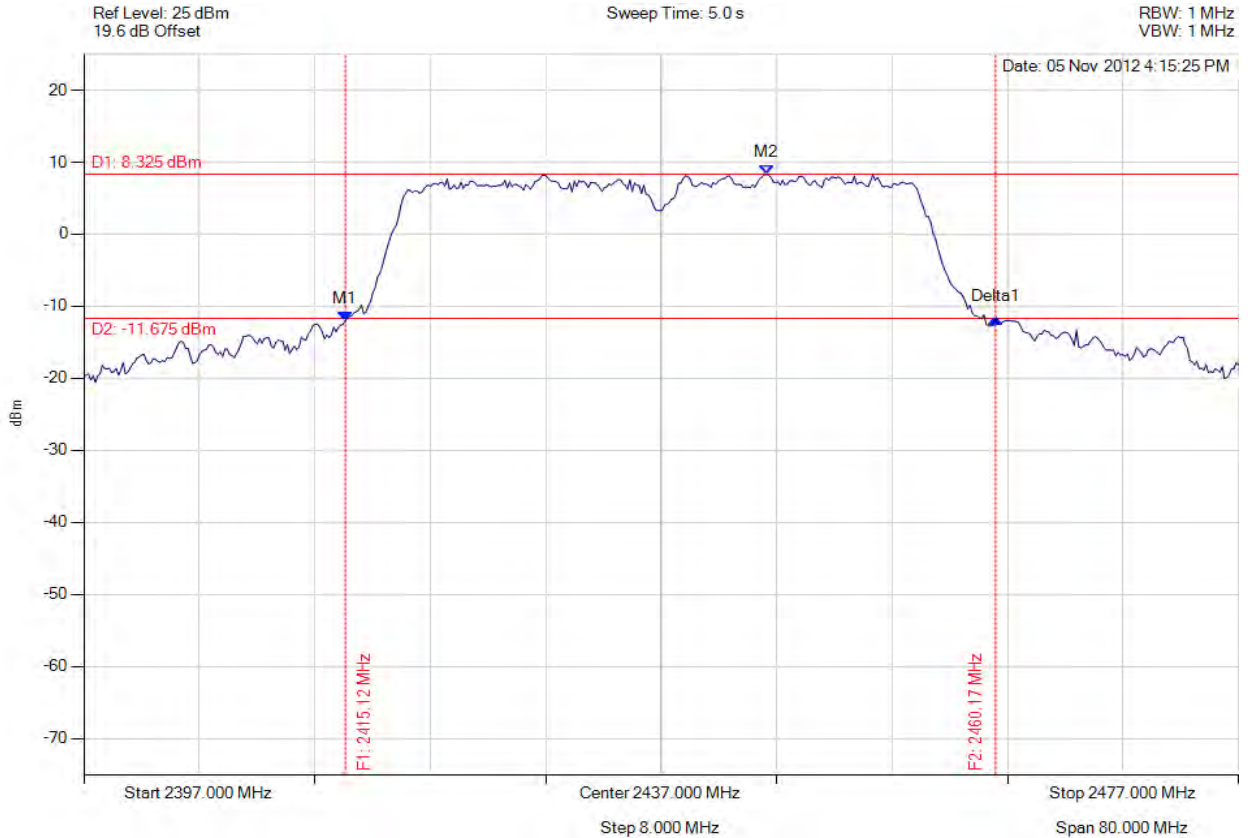

Analyser Setup	Marker : Frequency : Amplitude	Test Results
Detector = MAX PEAK Sweep Count = 0 RF Atten (dB) = 20 Trace Mode = VIEW	M1 : 2415.116 MHz : -11.992 dBm M2 : 2444.295 MHz : 8.325 dBm Delta1 : 2460.17 MHz : 0.332 dB	Channel Power: 22.05 dBm Limit: 30.00 dBm Margin: -7.95 dB

[Back to the Matrix](#)

This test report may be reproduced in full only. The document may only be updated by MiCOM Labs personnel. Any changes will be noted in the Document History section of the report.



Title: Digi ConnectCard for i.MX28 with Atheros AR6233
To: FCC 47 CFR Part 15.247 & IC RSS-210
Serial #: DIGI28-U2A Rev A
Issue Date: 29th March 2013
Page: 182 of 245



PEAK OUTPUT POWER

Variant: 802.11n HT-40, Channel: 2452.00 MHz, Chain a, Temp: Ambient, Voltage: 5 Vdc

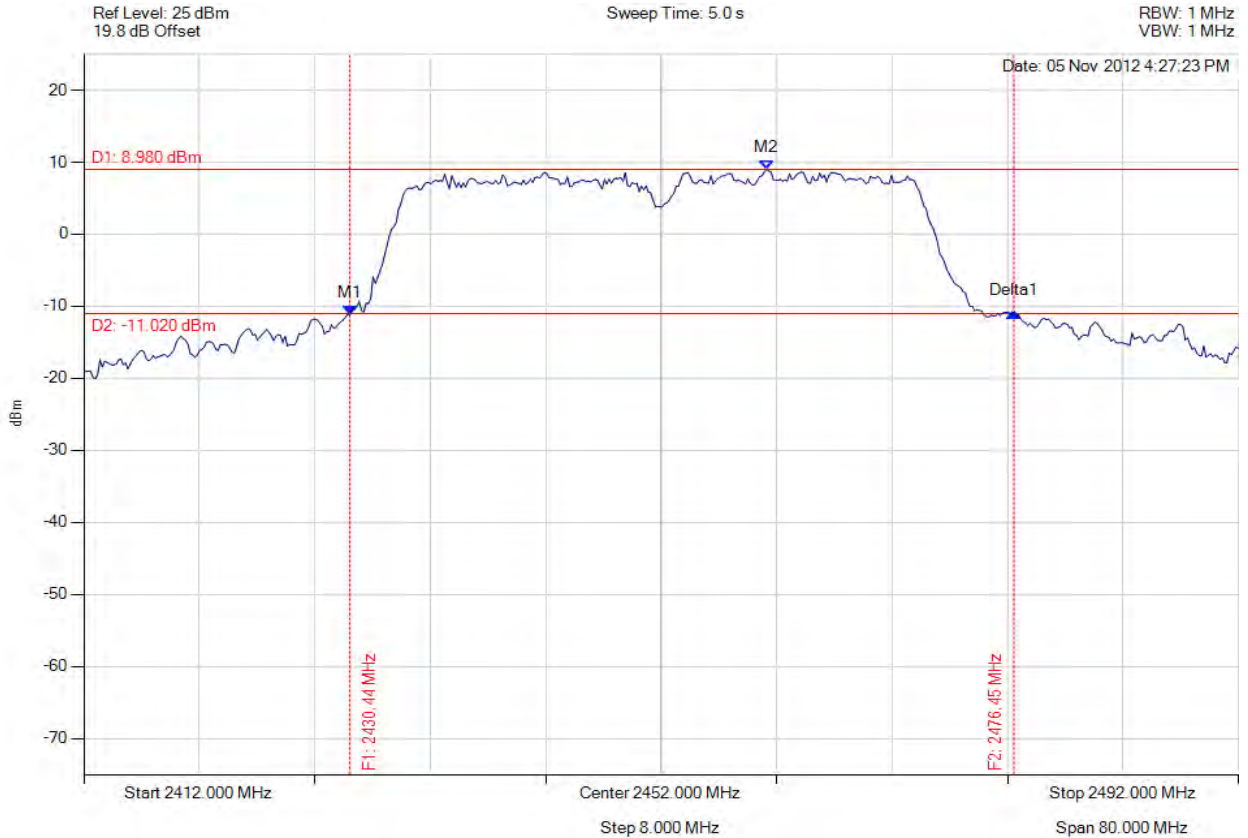

Analyser Setup	Marker : Frequency : Amplitude	Test Results
Detector = MAX PEAK Sweep Count = 0 RF Atten (dB) = 20 Trace Mode = VIEW	M1 : 2430.437 MHz : -11.152 dBm M2 : 2459.295 MHz : 8.980 dBm Delta1 : 46.012 MHz : 0.256 dB	Channel Power: 22.49 dBm Limit: 30.00 dBm Margin: -7.51 dB

[Back to the Matrix](#)

This test report may be reproduced in full only. The document may only be updated by MiCOM Labs personnel. Any changes will be noted in the Document History section of the report.



Title: Digi ConnectCard for i.MX28 with Atheros AR6233
To: FCC 47 CFR Part 15.247 & IC RSS-210
Serial #: DIGI28-U2A Rev A
Issue Date: 29th March 2013
Page: 183 of 245



PEAK OUTPUT POWER

Variant: 802.11a, Channel: 5745.00 MHz, Chain a, Temp: Ambient, Voltage: 5 Vdc

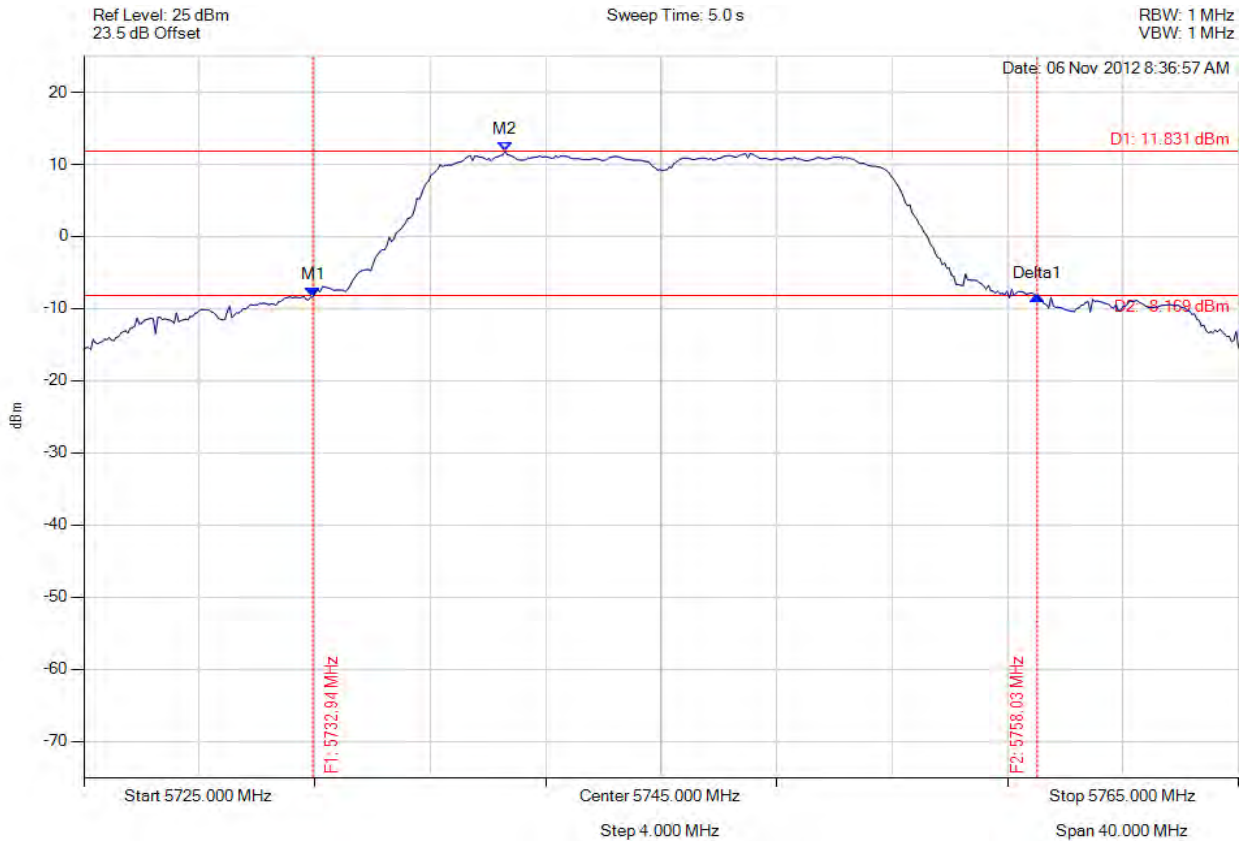

Analyser Setup	Marker : Frequency : Amplitude	Test Results
Detector = MAX PEAK Sweep Count = 0 RF Atten (dB) = 20 Trace Mode = VIEW	M1 : 5732.936 MHz : -8.386 dBm M2 : 5739.589 MHz : 11.831 dBm Delta1 : 25.090 MHz : 0.228 dB	Channel Power: 22.36 dBm Limit: 30.00 dBm Margin: -7.64 dB

[Back to the Matrix](#)

This test report may be reproduced in full only. The document may only be updated by MiCOM Labs personnel. Any changes will be noted in the Document History section of the report.



Title: Digi ConnectCard for i.MX28 with Atheros AR6233
To: FCC 47 CFR Part 15.247 & IC RSS-210
Serial #: DIGI28-U2A Rev A
Issue Date: 29th March 2013
Page: 184 of 245



PEAK OUTPUT POWER

Variant: 802.11a, Channel: 5785.00 MHz, Chain a, Temp: Ambient, Voltage: 5 Vdc

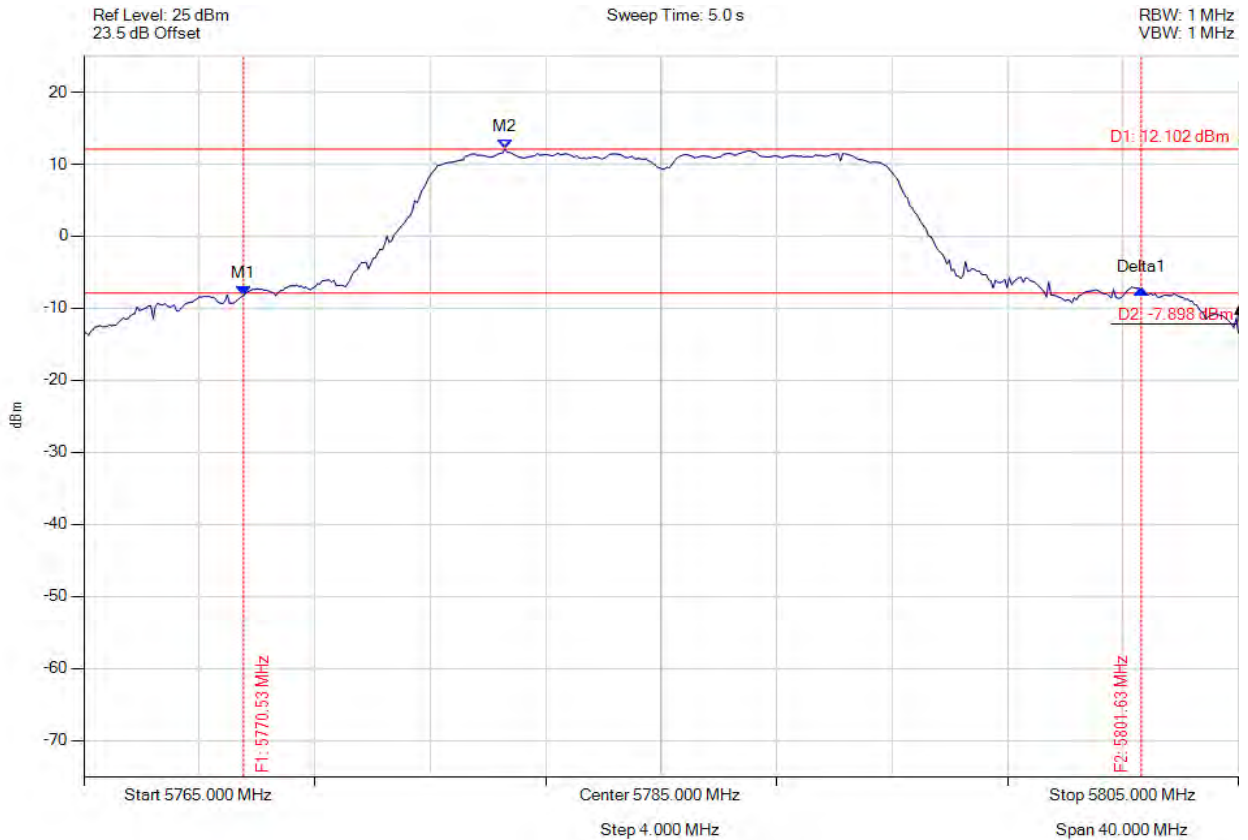

Analyser Setup	Marker : Frequency : Amplitude	Test Results
Detector = MAX PEAK Sweep Count = 0 RF Atten (dB) = 20 Trace Mode = VIEW	M1 : 5770.531 MHz : -8.264 dBm M2 : 5779.589 MHz : 12.102 dBm Delta1 : 31.102 MHz : 0.848 dB	Channel Power: 22.71 dBm Limit: 30.00 dBm Margin: -7.29 dB

[Back to the Matrix](#)

This test report may be reproduced in full only. The document may only be updated by MiCOM Labs personnel. Any changes will be noted in the Document History section of the report.



Title: Digi ConnectCard for i.MX28 with Atheros AR6233
To: FCC 47 CFR Part 15.247 & IC RSS-210
Serial #: DIGI28-U2A Rev A
Issue Date: 29th March 2013
Page: 185 of 245



PEAK OUTPUT POWER

Variant: 802.11a, Channel: 5825.00 MHz, Chain a, Temp: Ambient, Voltage: 5 Vdc

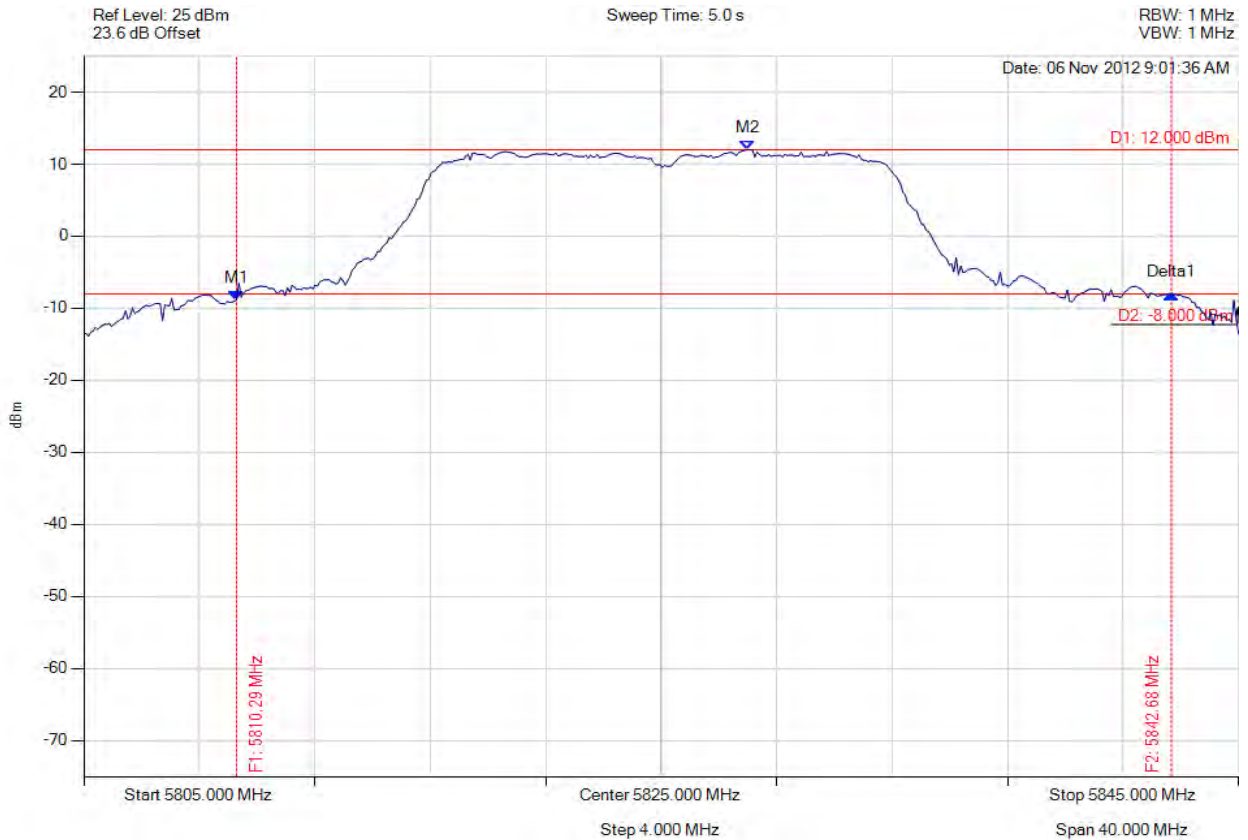

Analyser Setup	Marker : Frequency : Amplitude	Test Results
Detector = MAX PEAK Sweep Count = 0 RF Atten (dB) = 20 Trace Mode = VIEW	M1 : 5810.291 MHz : -8.844 dBm M2 : 5828.006 MHz : 12.000 dBm Delta1 : 32.385 MHz : 0.848 dB	Channel Power: 22.81 dBm Limit: 30.00 dBm Margin: -7.19 dB

[Back to the Matrix](#)

This test report may be reproduced in full only. The document may only be updated by MiCOM Labs personnel. Any changes will be noted in the Document History section of the report.



Title: Digi ConnectCard for i.MX28 with Atheros AR6233
To: FCC 47 CFR Part 15.247 & IC RSS-210
Serial #: DIGI28-U2A Rev A
Issue Date: 29th March 2013
Page: 186 of 245



PEAK OUTPUT POWER

Variant: 802.11n HT-20, Channel: 5745.00 MHz, Chain a, Temp: Ambient, Voltage: 5 Vdc

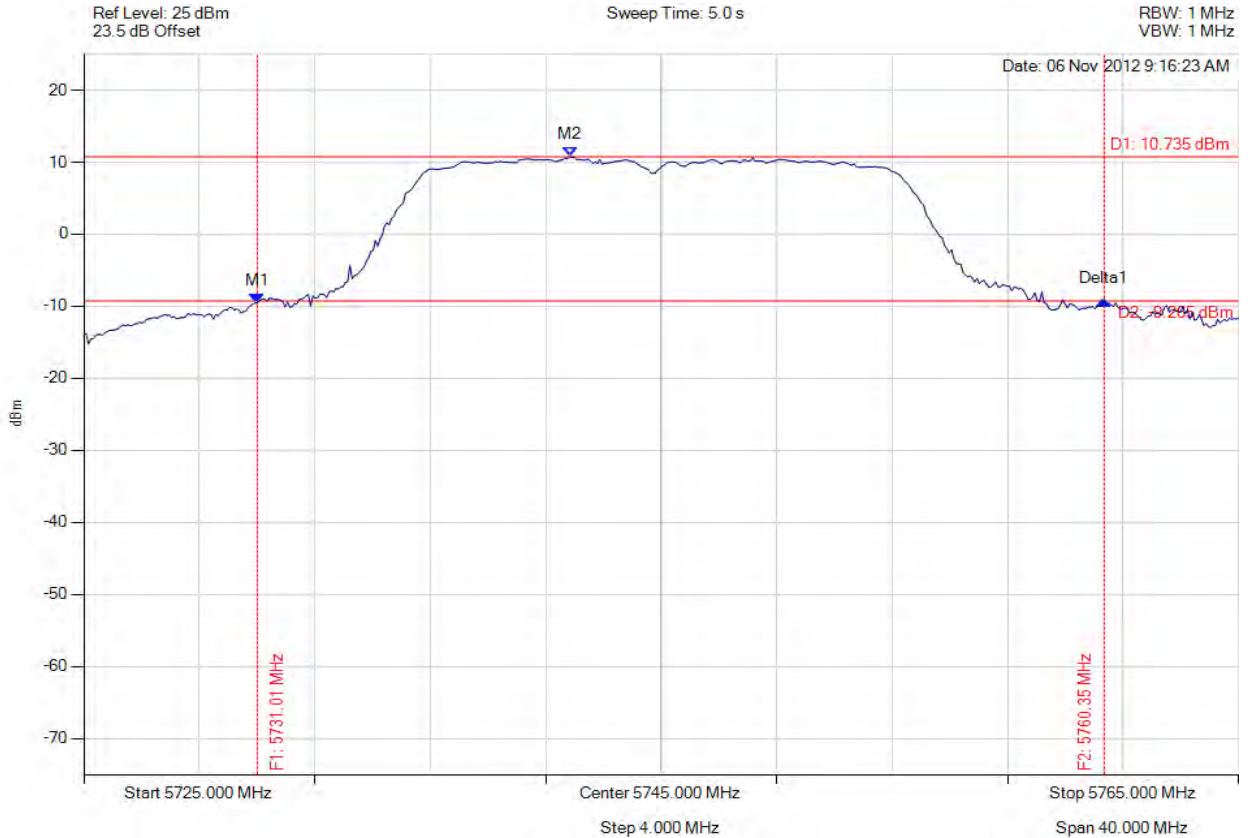

Analyser Setup	Marker : Frequency : Amplitude	Test Results
Detector = MAX PEAK Sweep Count = 0 RF Atten (dB) = 20 Trace Mode = VIEW	M1 : 5731.012 MHz : -9.568 dBm M2 : 5741.834 MHz : 10.735 dBm Delta1 : 29.339 MHz : 0.395 dB	Channel Power: 21.83 dBm Limit: 30.00 dBm Margin: -8.17 dB

[Back to the Matrix](#)

This test report may be reproduced in full only. The document may only be updated by MiCOM Labs personnel. Any changes will be noted in the Document History section of the report.



Title: Digi ConnectCard for i.MX28 with Atheros AR6233
To: FCC 47 CFR Part 15.247 & IC RSS-210
Serial #: DIGI28-U2A Rev A
Issue Date: 29th March 2013
Page: 187 of 245



PEAK OUTPUT POWER

Variant: 802.11n HT-20, Channel: 5785.00 MHz, Chain a, Temp: Ambient, Voltage: 5 Vdc

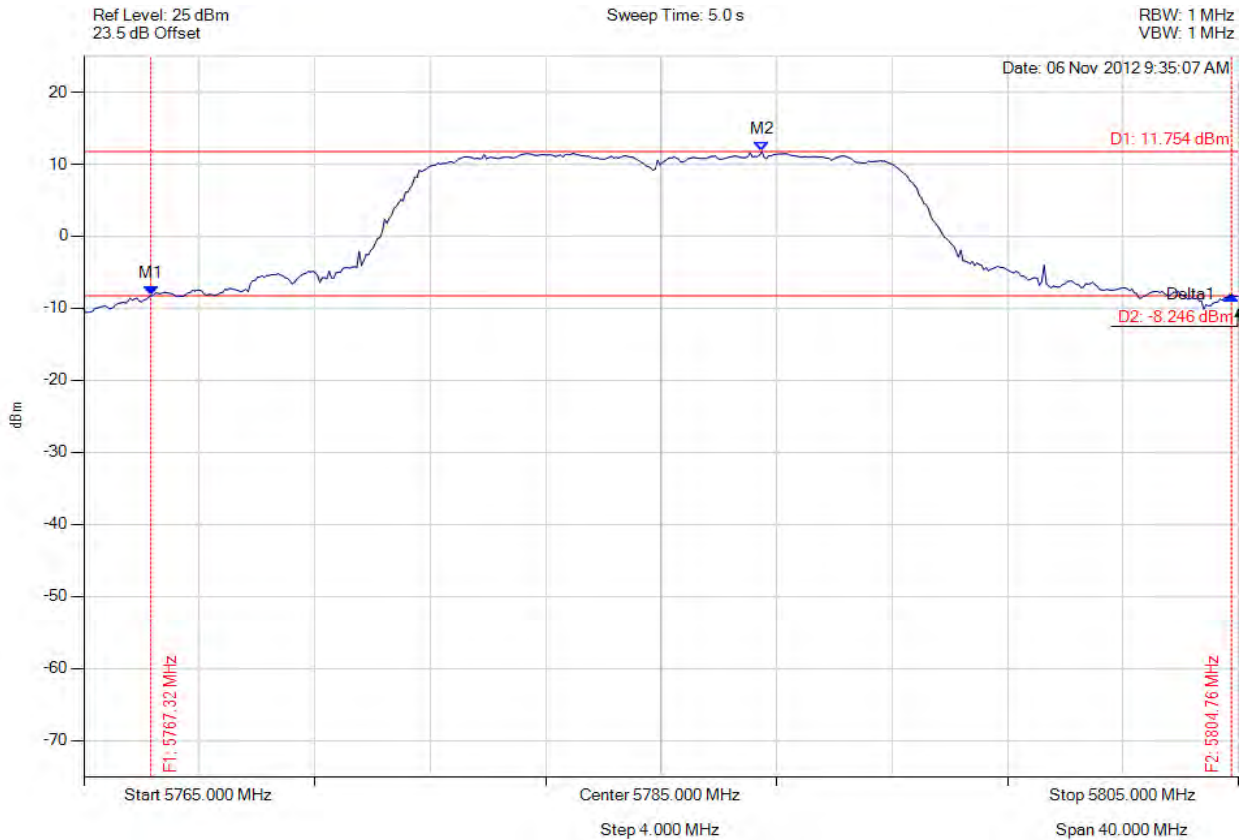

Analyser Setup	Marker : Frequency : Amplitude	Test Results
Detector = MAX PEAK Sweep Count = 0 RF Atten (dB) = 20 Trace Mode = VIEW	M1 : 5767.325 MHz : -8.268 dBm M2 : 5788.487 MHz : 11.754 dBm Delta1 : 37.435 MHz : 0.138 dB	Channel Power: 22.81 dBm Limit: 30.00 dBm Margin: -7.19 dB

[Back to the Matrix](#)

This test report may be reproduced in full only. The document may only be updated by MiCOM Labs personnel. Any changes will be noted in the Document History section of the report.



Title: Digi ConnectCard for i.MX28 with Atheros AR6233
To: FCC 47 CFR Part 15.247 & IC RSS-210
Serial #: DIGI28-U2A Rev A
Issue Date: 29th March 2013
Page: 188 of 245



PEAK OUTPUT POWER

Variante: 802.11n HT-20, Channel: 5825.00 MHz, Chain a, Temp: Ambient, Voltage: 5 Vdc

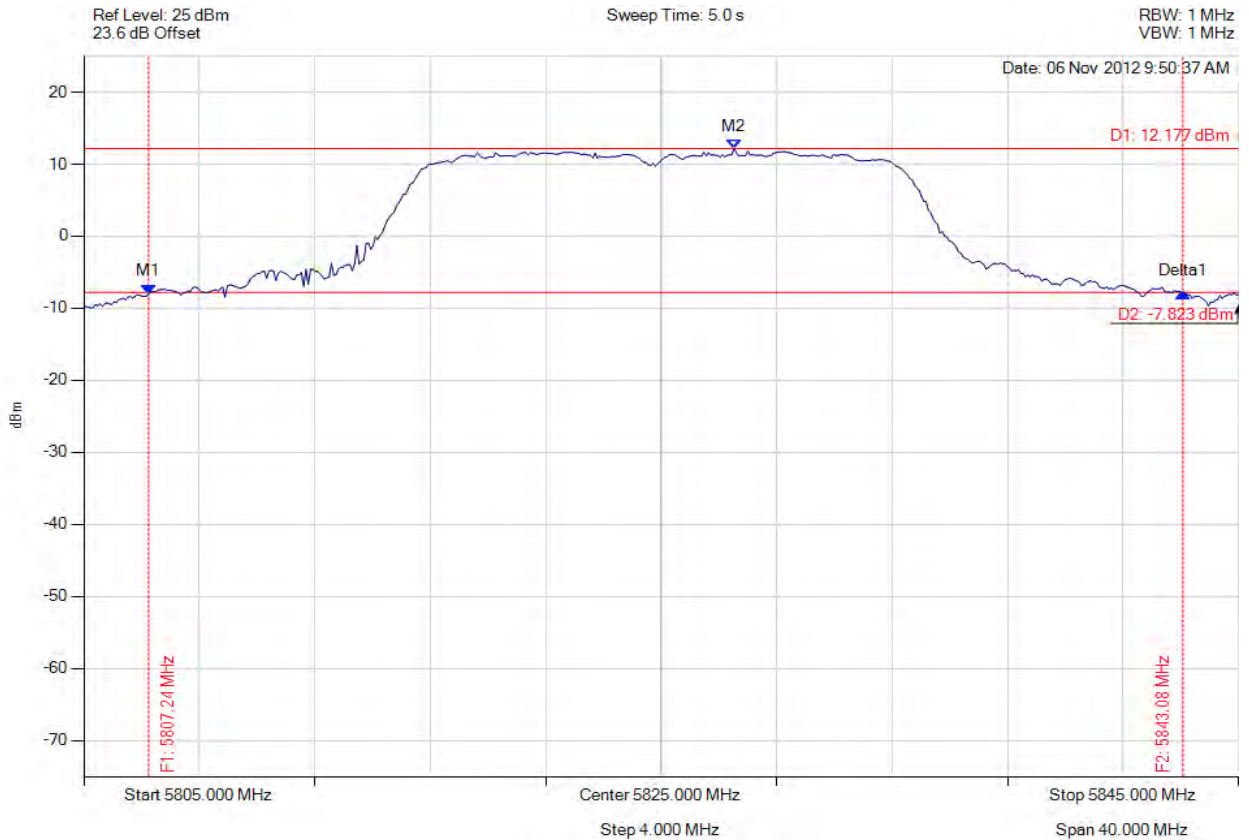

Analyser Setup	Marker : Frequency : Amplitude	Test Results
Detector = MAX PEAK Sweep Count = 0 RF Atten (dB) = 20 Trace Mode = VIEW	M1 : 5807.244 MHz : -7.953 dBm M2 : 5827.525 MHz : 12.177 dBm Delta1 : 35.832 MHz : 0.134 dB	Channel Power: 23.05 dBm Limit: 30.00 dBm Margin: -6.95 dB

[Back to the Matrix](#)

This test report may be reproduced in full only. The document may only be updated by MiCOM Labs personnel. Any changes will be noted in the Document History section of the report.



Title: Digi ConnectCard for i.MX28 with Atheros AR6233
To: FCC 47 CFR Part 15.247 & IC RSS-210
Serial #: DIGI28-U2A Rev A
Issue Date: 29th March 2013
Page: 189 of 245



PEAK OUTPUT POWER

Variant: 802.11n HT-40, Channel: 5755.00 MHz, Chain a, Temp: Ambient, Voltage: 5 Vdc

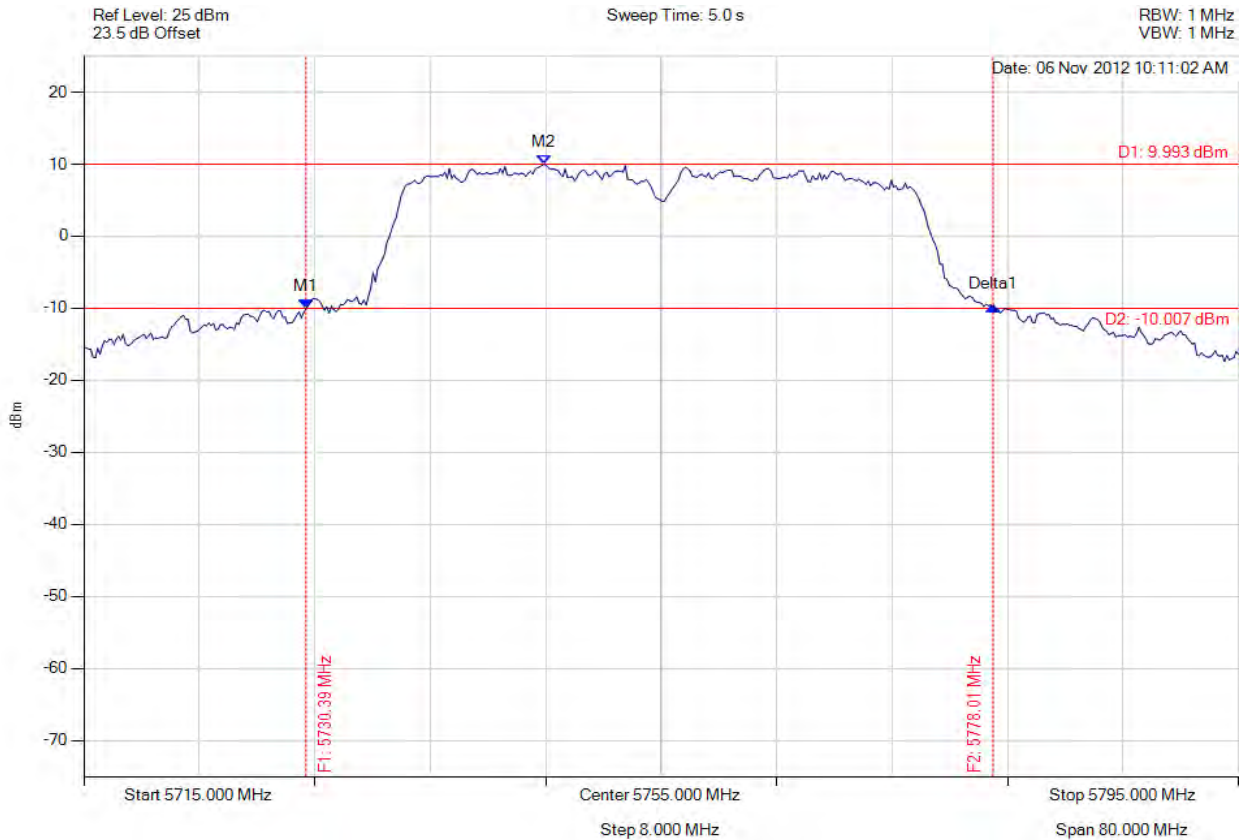

Analyser Setup	Marker : Frequency : Amplitude	Test Results
Detector = MAX PEAK Sweep Count = 0 RF Atten (dB) = 20 Trace Mode = VIEW	M1 : 5730.391 MHz : -10.062 dBm M2 : 5746.904 MHz : 9.993 dBm Delta1 : 47.615 MHz : 0.360 dB	Channel Power: 23.35 dBm Limit: 30.00 dBm Margin: -6.65 dB

[Back to the Matrix](#)

This test report may be reproduced in full only. The document may only be updated by MiCOM Labs personnel. Any changes will be noted in the Document History section of the report.



Title: Digi ConnectCard for i.MX28 with Atheros AR6233
To: FCC 47 CFR Part 15.247 & IC RSS-210
Serial #: DIGI28-U2A Rev A
Issue Date: 29th March 2013
Page: 190 of 245



PEAK OUTPUT POWER

Variant: 802.11n HT-40, Channel: 5795.00 MHz, Chain a, Temp: Ambient, Voltage: 5 Vdc

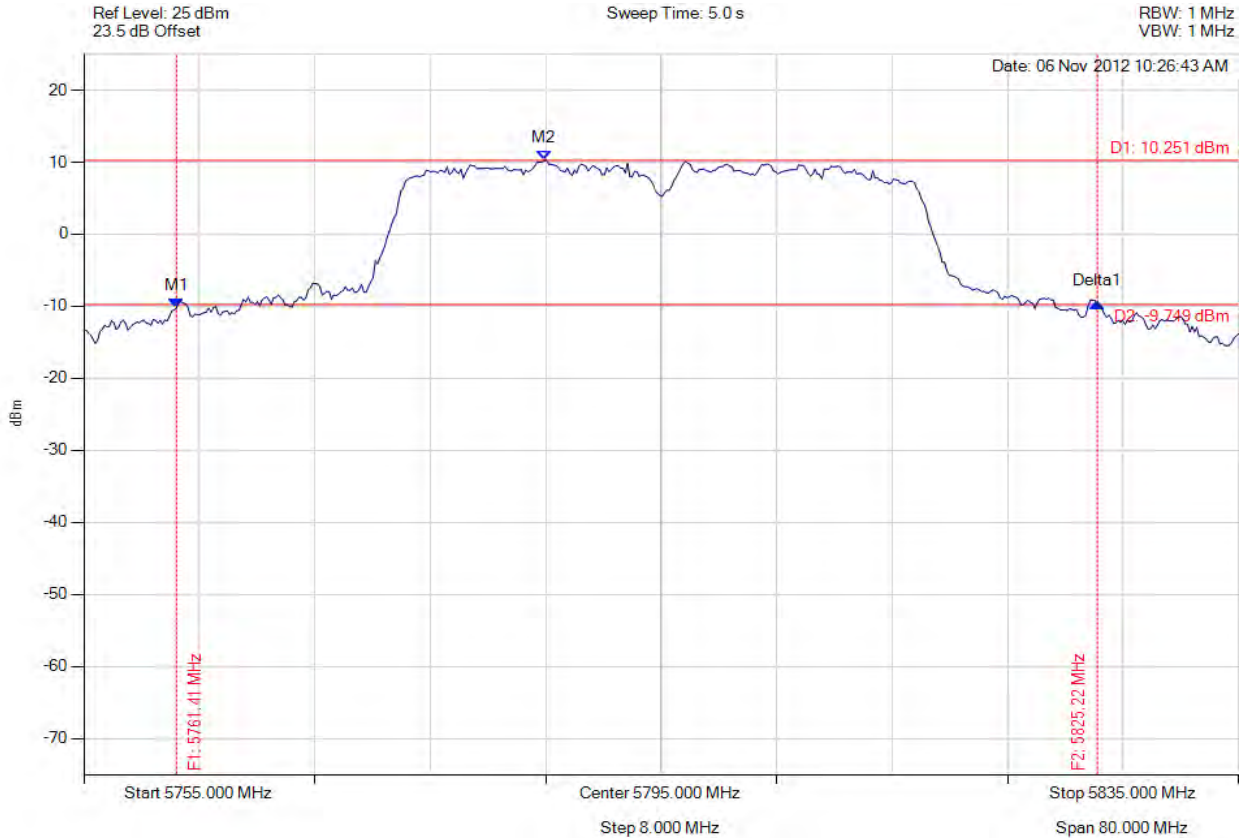

Analyser Setup	Marker : Frequency : Amplitude	Test Results
Detector = MAX PEAK Sweep Count = 0 RF Atten (dB) = 20 Trace Mode = VIEW	M1 : 5761.413 MHz : -10.277 dBm M2 : 5786.904 MHz : 10.251 dBm Delta1 : 63.808 MHz : 0.759 dB	Channel Power: 23.84 dBm Limit: 30.00 dBm Margin: -6.16 dB

[Back to the Matrix](#)

This test report may be reproduced in full only. The document may only be updated by MiCOM Labs personnel. Any changes will be noted in the Document History section of the report.



Title: Digi ConnectCard for i.MX28 with Atheros AR6233
To: FCC 47 CFR Part 15.247 & IC RSS-210
Serial #: DIGI28-U2A Rev A
Issue Date: 29th March 2013
Page: 191 of 245

A.1.3. Power Spectral Density



POWER SPECTRAL DENSITY

Variant: 802.11b, Channel: 2412.00 MHz, Chain a, Temp: Ambient, Voltage: 5 Vdc

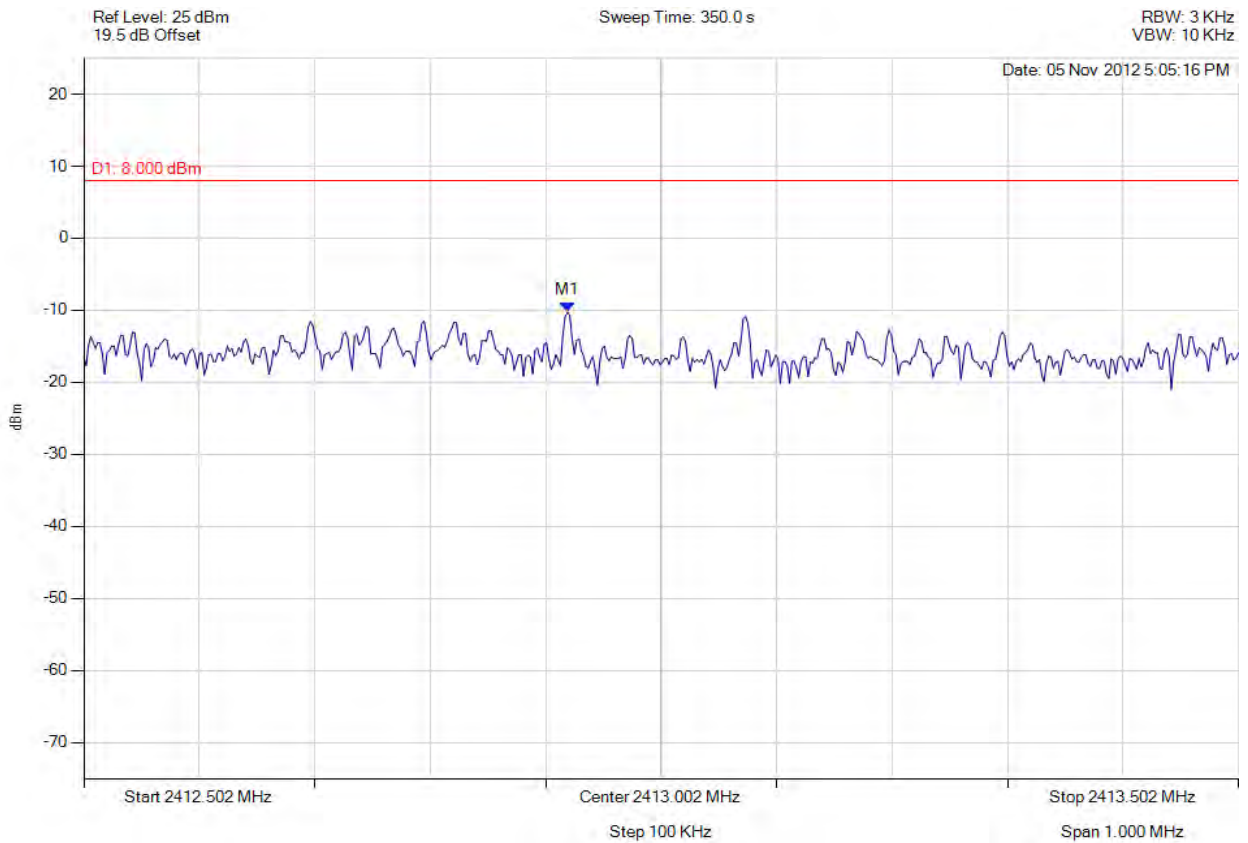

Analyser Setup	Marker : Frequency : Amplitude	Test Results
Detector = MAX PEAK Sweep Count = 0 RF Atten (dB) = 20 Trace Mode = VIEW	M1 : 2412.921 MHz : -10.257 dBm	Limit: ≤ 8.00 dBm Margin: -18.26 dB

[Back to the Matrix](#)

This test report may be reproduced in full only. The document may only be updated by MiCOM Labs personnel. Any changes will be noted in the Document History section of the report.



Title: Digi ConnectCard for i.MX28 with Atheros AR6233
To: FCC 47 CFR Part 15.247 & IC RSS-210
Serial #: DIGI28-U2A Rev A
Issue Date: 29th March 2013
Page: 192 of 245



POWER SPECTRAL DENSITY

Variant: 802.11b, Channel: 2437.00 MHz, Chain a, Temp: Ambient, Voltage: 5 Vdc

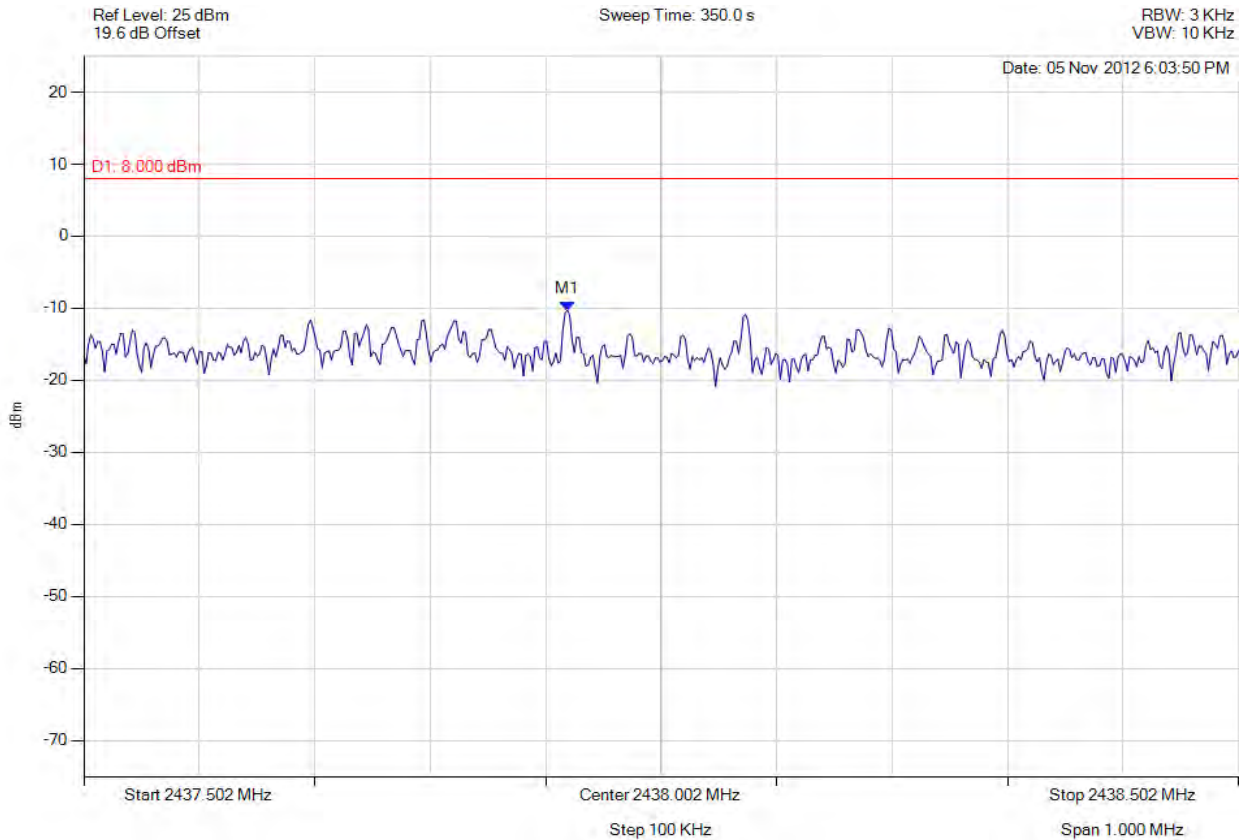

Analyser Setup	Marker : Frequency : Amplitude	Test Results
Detector = MAX PEAK Sweep Count = 0 RF Atten (dB) = 20 Trace Mode = VIEW	M1 : 2437.921 MHz : -10.310 dBm	Limit: ≤8.00 dBm Margin: -18.31 dB

[Back to the Matrix](#)

This test report may be reproduced in full only. The document may only be updated by MiCOM Labs personnel. Any changes will be noted in the Document History section of the report.



Title: Digi ConnectCard for i.MX28 with Atheros AR6233
To: FCC 47 CFR Part 15.247 & IC RSS-210
Serial #: DIGI28-U2A Rev A
Issue Date: 29th March 2013
Page: 193 of 245



POWER SPECTRAL DENSITY

Variant: 802.11b, Channel: 2462.00 MHz, Chain a, Temp: Ambient, Voltage: 5 Vdc

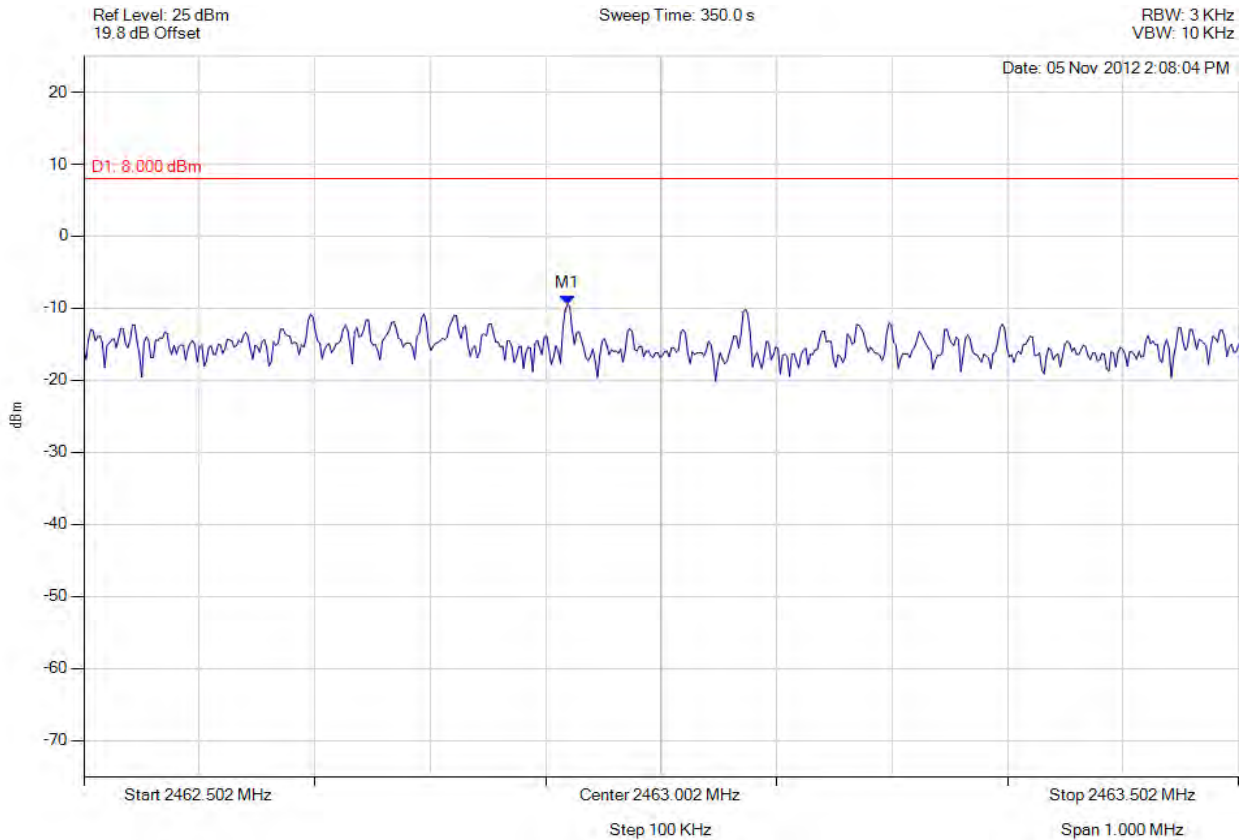

Analyser Setup	Marker : Frequency : Amplitude	Test Results
Detector = MAX PEAK Sweep Count = 0 RF Atten (dB) = 20 Trace Mode = VIEW	M1 : 2462.921 MHz : -9.507 dBm	Limit: ≤8.00 dBm Margin: -17.51 dB

[Back to the Matrix](#)

This test report may be reproduced in full only. The document may only be updated by MiCOM Labs personnel. Any changes will be noted in the Document History section of the report.



Title: Digi ConnectCard for i.MX28 with Atheros AR6233
To: FCC 47 CFR Part 15.247 & IC RSS-210
Serial #: DIGI28-U2A Rev A
Issue Date: 29th March 2013
Page: 194 of 245



POWER SPECTRAL DENSITY

Variant: 802.11g, Channel: 2412.00 MHz, Chain a, Temp: Ambient, Voltage: 5 Vdc

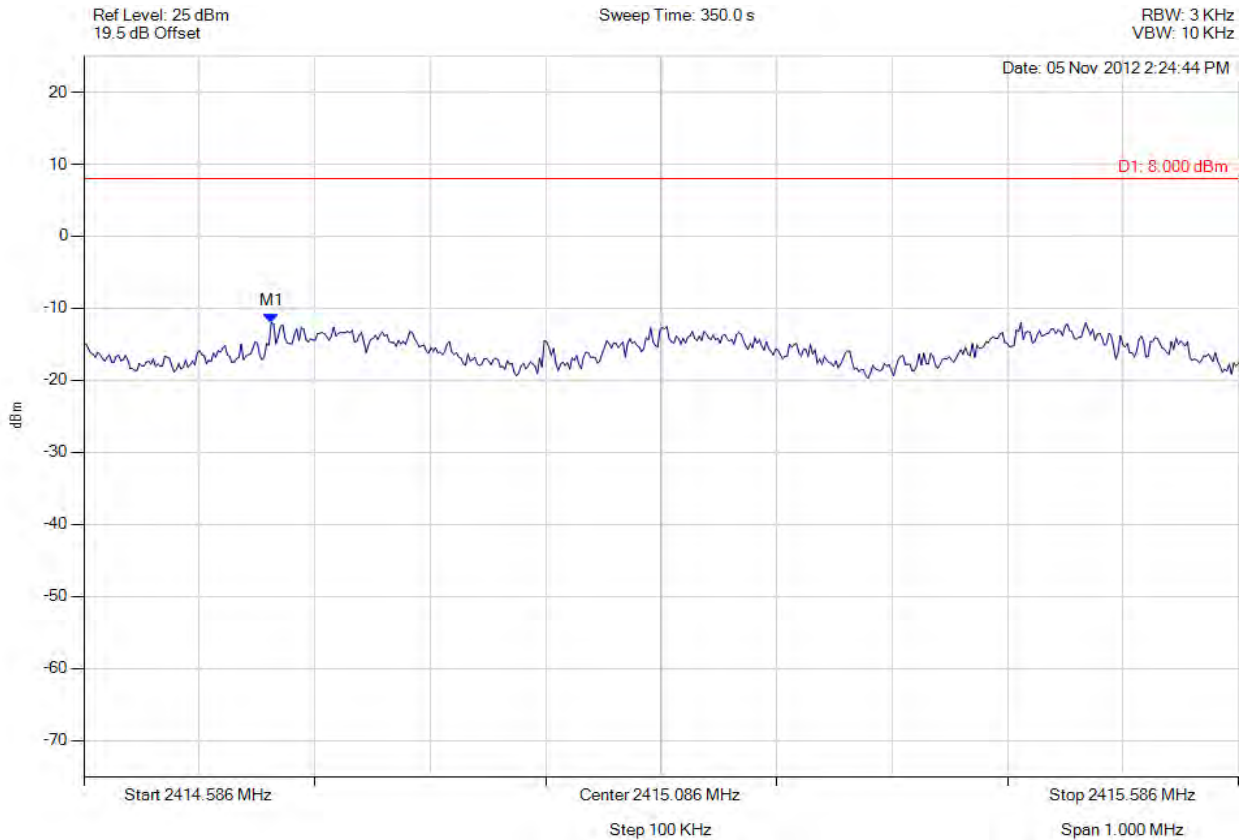

Analyser Setup	Marker : Frequency : Amplitude	Test Results
Detector = MAX PEAK Sweep Count = 0 RF Atten (dB) = 20 Trace Mode = VIEW	M1 : 2414.748 MHz : -11.986 dBm	Limit: ≤8.00 dBm Margin: -19.99 dB

[Back to the Matrix](#)

This test report may be reproduced in full only. The document may only be updated by MiCOM Labs personnel. Any changes will be noted in the Document History section of the report.



Title: Digi ConnectCard for i.MX28 with Atheros AR6233
To: FCC 47 CFR Part 15.247 & IC RSS-210
Serial #: DIGI28-U2A Rev A
Issue Date: 29th March 2013
Page: 195 of 245



POWER SPECTRAL DENSITY

Variant: 802.11g, Channel: 2437.00 MHz, Chain a, Temp: Ambient, Voltage: 5 Vdc

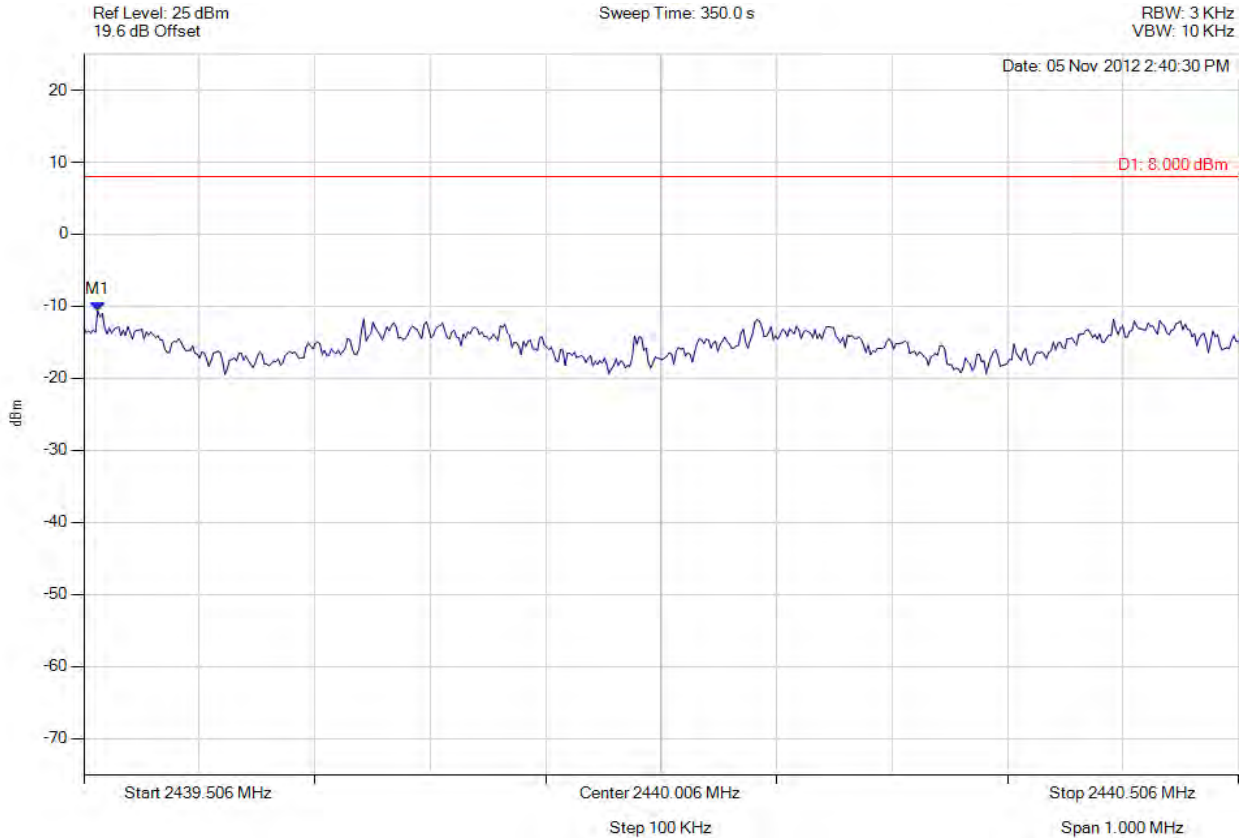

Analyser Setup	Marker : Frequency : Amplitude	Test Results
Detector = MAX PEAK Sweep Count = 0 RF Atten (dB) = 20 Trace Mode = VIEW	M1 : 2439.518 MHz : -10.643 dBm	Limit: ≤8.00 dBm Margin: -18.64 dB

[Back to the Matrix](#)

This test report may be reproduced in full only. The document may only be updated by MiCOM Labs personnel. Any changes will be noted in the Document History section of the report.



Title: Digi ConnectCard for i.MX28 with Atheros AR6233
To: FCC 47 CFR Part 15.247 & IC RSS-210
Serial #: DIGI28-U2A Rev A
Issue Date: 29th March 2013
Page: 196 of 245



POWER SPECTRAL DENSITY

Variant: 802.11g, Channel: 2462.00 MHz, Chain a, Temp: Ambient, Voltage: 5 Vdc

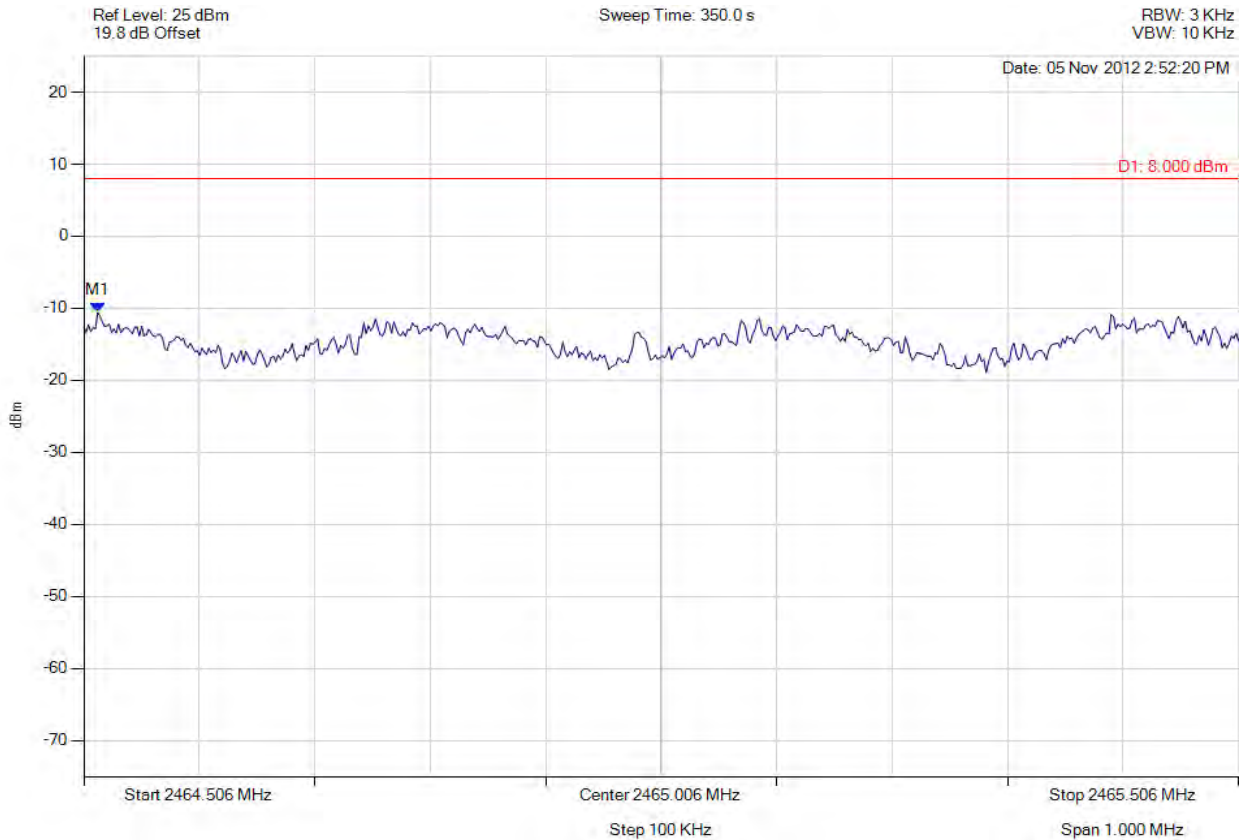

Analyser Setup	Marker : Frequency : Amplitude	Test Results
Detector = MAX PEAK Sweep Count = 0 RF Atten (dB) = 20 Trace Mode = VIEW	M1 : 2464.518 MHz : -10.603 dBm	Limit: ≤8.00 dBm Margin: -18.60 dB

[Back to the Matrix](#)

This test report may be reproduced in full only. The document may only be updated by MiCOM Labs personnel. Any changes will be noted in the Document History section of the report.



Title: Digi ConnectCard for i.MX28 with Atheros AR6233
To: FCC 47 CFR Part 15.247 & IC RSS-210
Serial #: DIGI28-U2A Rev A
Issue Date: 29th March 2013
Page: 197 of 245



POWER SPECTRAL DENSITY

Variant: 802.11n HT-20, Channel: 2412.00 MHz, Chain a, Temp: Ambient, Voltage: 5 Vdc

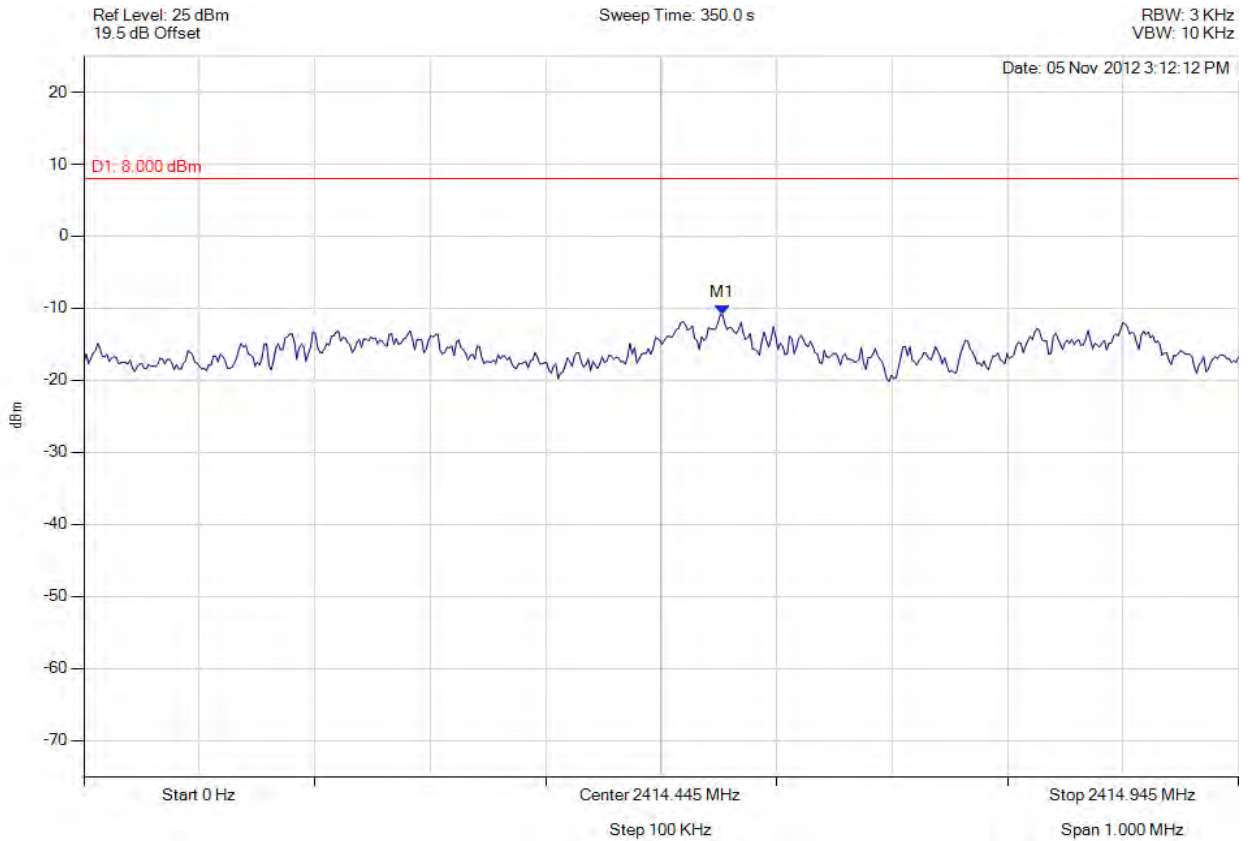

Analyser Setup	Marker : Frequency : Amplitude	Test Results
Detector = MAX PEAK Sweep Count = 0 RF Atten (dB) = 20 Trace Mode = VIEW	M1 : 2414.498 MHz : -10.879 dBm	Limit: ≤8.00 dBm Margin: -18.88 dB

[Back to the Matrix](#)

This test report may be reproduced in full only. The document may only be updated by MiCOM Labs personnel. Any changes will be noted in the Document History section of the report.



Title: Digi ConnectCard for i.MX28 with Atheros AR6233
To: FCC 47 CFR Part 15.247 & IC RSS-210
Serial #: DIGI28-U2A Rev A
Issue Date: 29th March 2013
Page: 198 of 245



POWER SPECTRAL DENSITY

Variant: 802.11n HT-20, Channel: 2437.00 MHz, Chain a, Temp: Ambient, Voltage: 5 Vdc

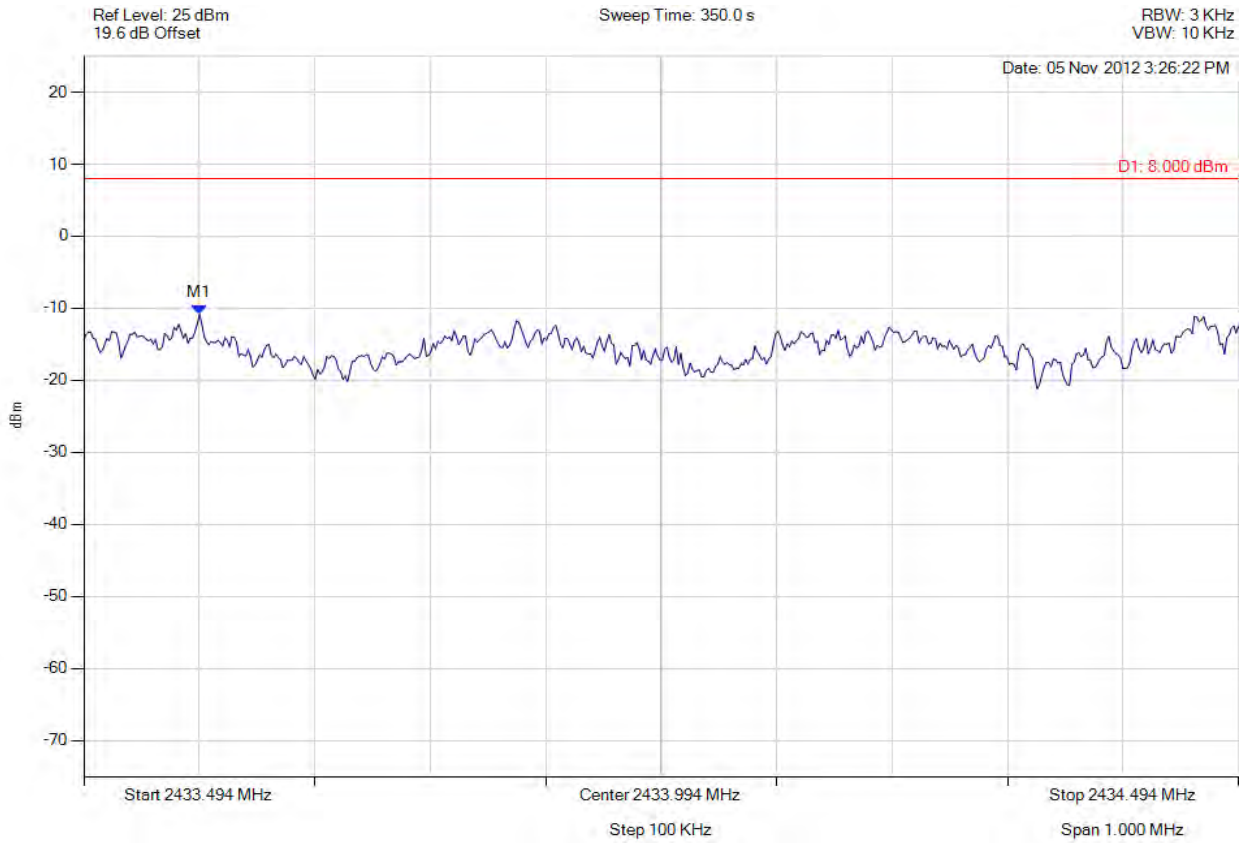

Analyser Setup	Marker : Frequency : Amplitude	Test Results
Detector = MAX PEAK Sweep Count = 0 RF Atten (dB) = 20 Trace Mode = VIEW	M1 : 2433.594 MHz : -10.855 dBm	Limit: ≤8.00 dBm Margin: -18.86 dB

[Back to the Matrix](#)

This test report may be reproduced in full only. The document may only be updated by MiCOM Labs personnel. Any changes will be noted in the Document History section of the report.



Title: Digi ConnectCard for i.MX28 with Atheros AR6233
To: FCC 47 CFR Part 15.247 & IC RSS-210
Serial #: DIGI28-U2A Rev A
Issue Date: 29th March 2013
Page: 199 of 245



POWER SPECTRAL DENSITY

Variant: 802.11n HT-20, Channel: 2462.00 MHz, Chain a, Temp: Ambient, Voltage: 5 Vdc

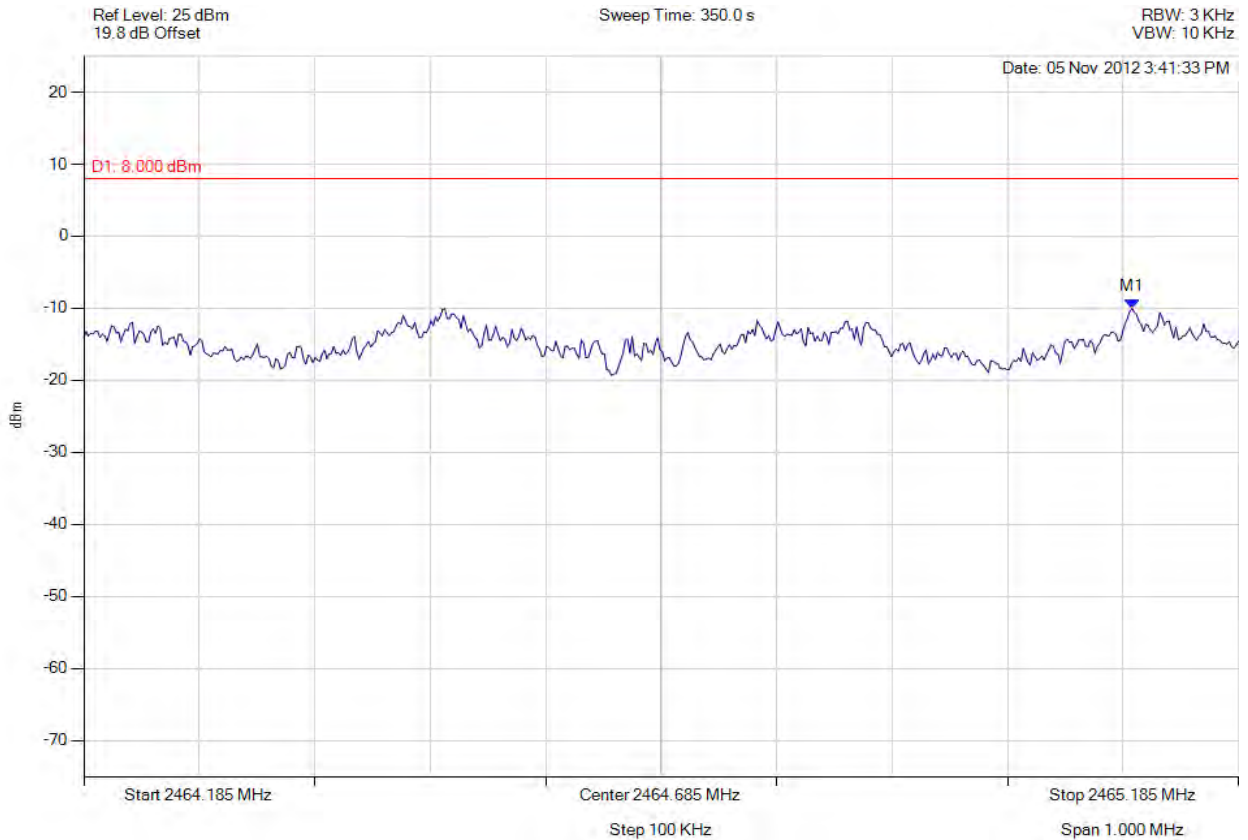

Analyser Setup	Marker : Frequency : Amplitude	Test Results
Detector = MAX PEAK Sweep Count = 0 RF Atten (dB) = 20 Trace Mode = VIEW	M1 : 2465.093 MHz : -10.025 dBm	Limit: ≤8.00 dBm Margin: -18.02 dB

[Back to the Matrix](#)

This test report may be reproduced in full only. The document may only be updated by MiCOM Labs personnel. Any changes will be noted in the Document History section of the report.



Title: Digi ConnectCard for i.MX28 with Atheros AR6233
To: FCC 47 CFR Part 15.247 & IC RSS-210
Serial #: DIGI28-U2A Rev A
Issue Date: 29th March 2013
Page: 200 of 245



POWER SPECTRAL DENSITY

Variant: 802.11n HT-40, Channel: 2422.00 MHz, Chain a, Temp: Ambient, Voltage: 5 Vdc

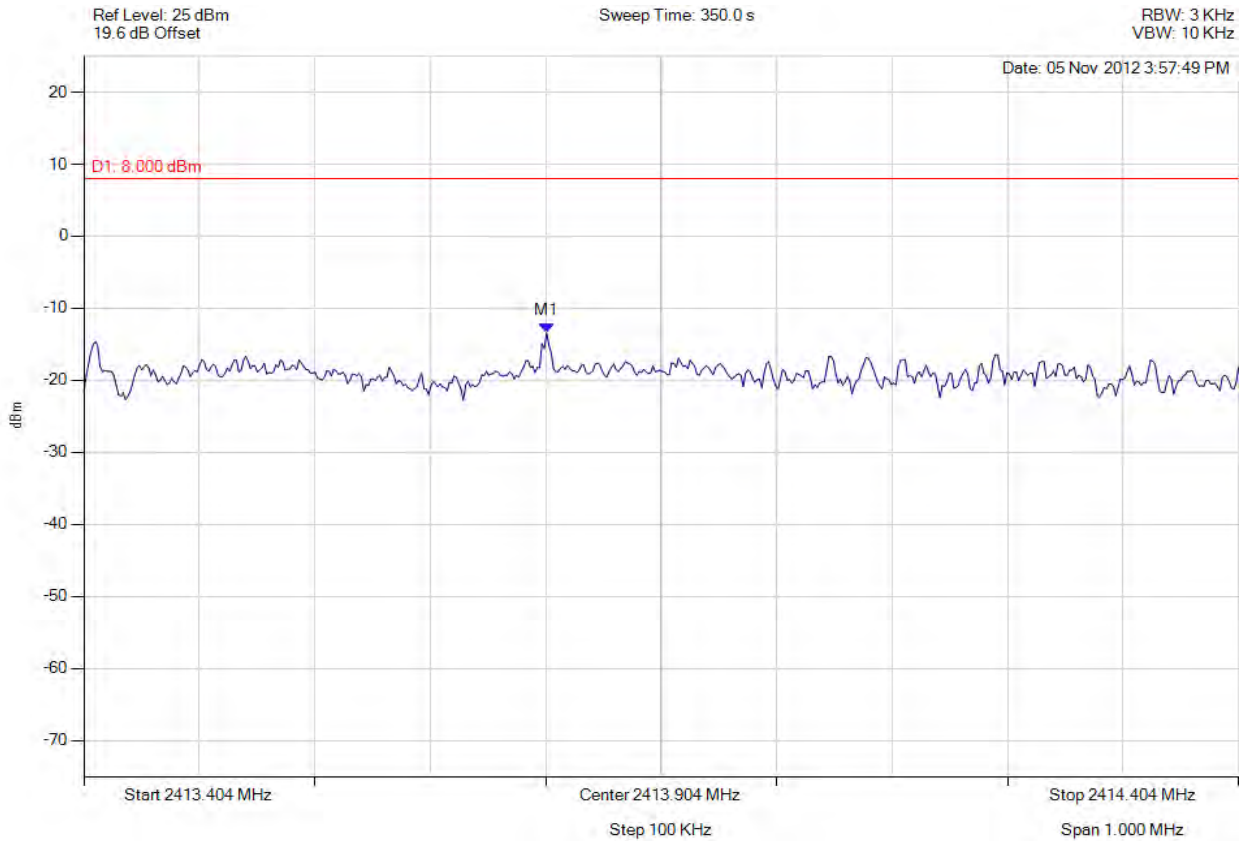

Analyser Setup	Marker : Frequency : Amplitude	Test Results
Detector = MAX PEAK Sweep Count = 0 RF Atten (dB) = 20 Trace Mode = VIEW	M1 : 2413.805 MHz : -13.411 dBm	Limit: ≤8.00 dBm Margin: -21.41 dB

[Back to the Matrix](#)

This test report may be reproduced in full only. The document may only be updated by MiCOM Labs personnel. Any changes will be noted in the Document History section of the report.



Title: Digi ConnectCard for i.MX28 with Atheros AR6233
To: FCC 47 CFR Part 15.247 & IC RSS-210
Serial #: DIGI28-U2A Rev A
Issue Date: 29th March 2013
Page: 201 of 245



POWER SPECTRAL DENSITY

Variant: 802.11n HT-40, Channel: 2437.00 MHz, Chain a, Temp: Ambient, Voltage: 5 Vdc

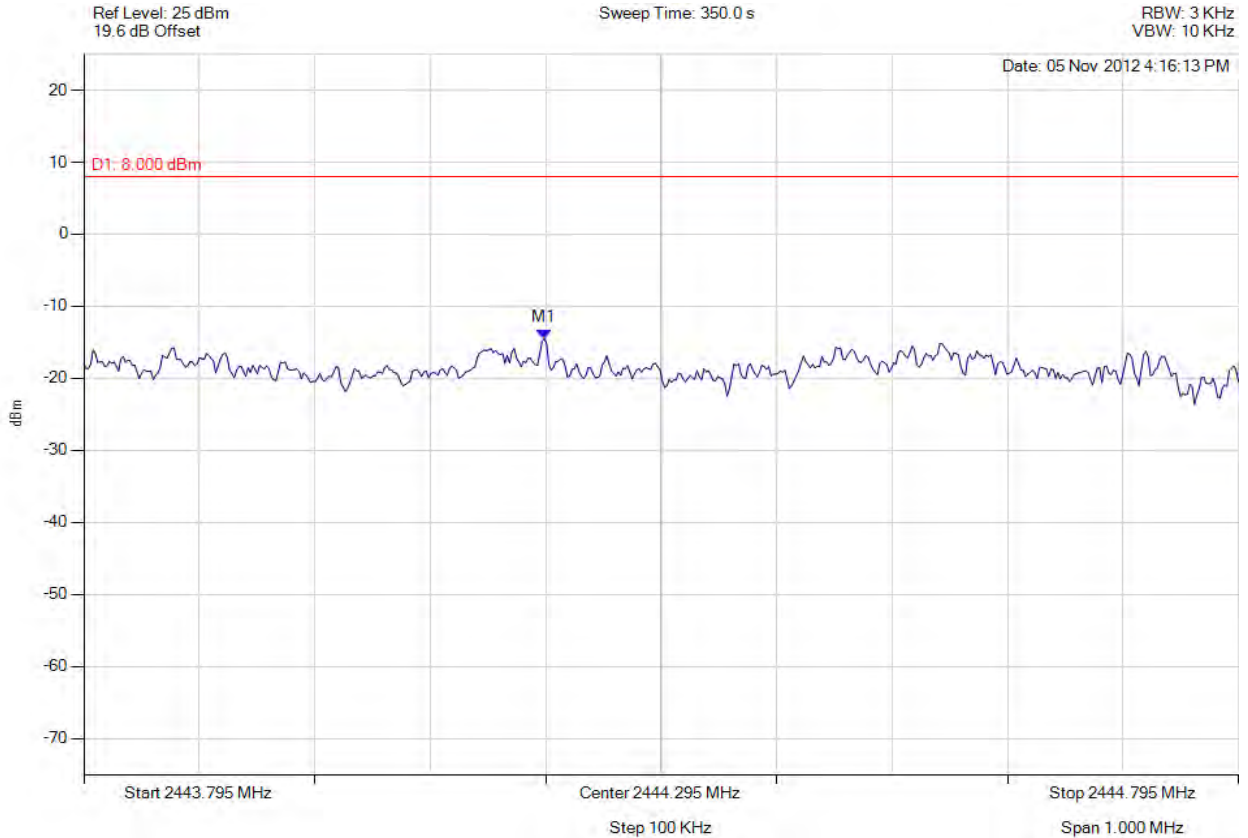

Analyser Setup	Marker : Frequency : Amplitude	Test Results
Detector = MAX PEAK Sweep Count = 0 RF Atten (dB) = 20 Trace Mode = VIEW	M1 : 2444.193 MHz : -14.471 dBm	Limit: ≤8.00 dBm Margin: -22.47 dB

[Back to the Matrix](#)

This test report may be reproduced in full only. The document may only be updated by MiCOM Labs personnel. Any changes will be noted in the Document History section of the report.



Title: Digi ConnectCard for i.MX28 with Atheros AR6233
To: FCC 47 CFR Part 15.247 & IC RSS-210
Serial #: DIGI28-U2A Rev A
Issue Date: 29th March 2013
Page: 202 of 245



POWER SPECTRAL DENSITY

Variant: 802.11n HT-40, Channel: 2452.00 MHz, Chain a, Temp: Ambient, Voltage: 5 Vdc

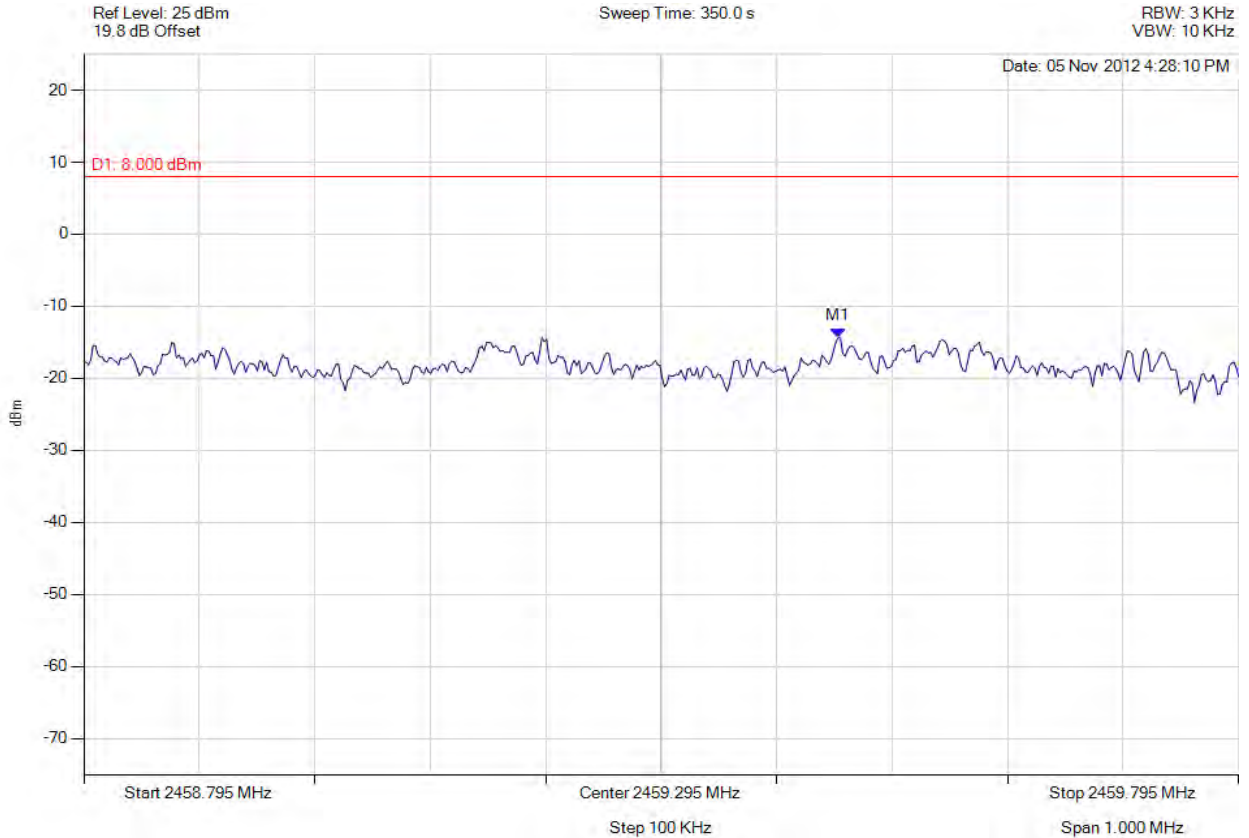

Analyser Setup	Marker : Frequency : Amplitude	Test Results
Detector = MAX PEAK Sweep Count = 0 RF Atten (dB) = 20 Trace Mode = VIEW	M1 : 2459.448 MHz : -14.369 dBm	Limit: ≤8.00 dBm Margin: -22.37 dB

[Back to the Matrix](#)

This test report may be reproduced in full only. The document may only be updated by MiCOM Labs personnel. Any changes will be noted in the Document History section of the report.



Title: Digi ConnectCard for i.MX28 with Atheros AR6233
To: FCC 47 CFR Part 15.247 & IC RSS-210
Serial #: DIGI28-U2A Rev A
Issue Date: 29th March 2013
Page: 203 of 245



POWER SPECTRAL DENSITY

Variant: 802.11a, Channel: 5745.00 MHz, Chain a, Temp: Ambient, Voltage: 5 Vdc

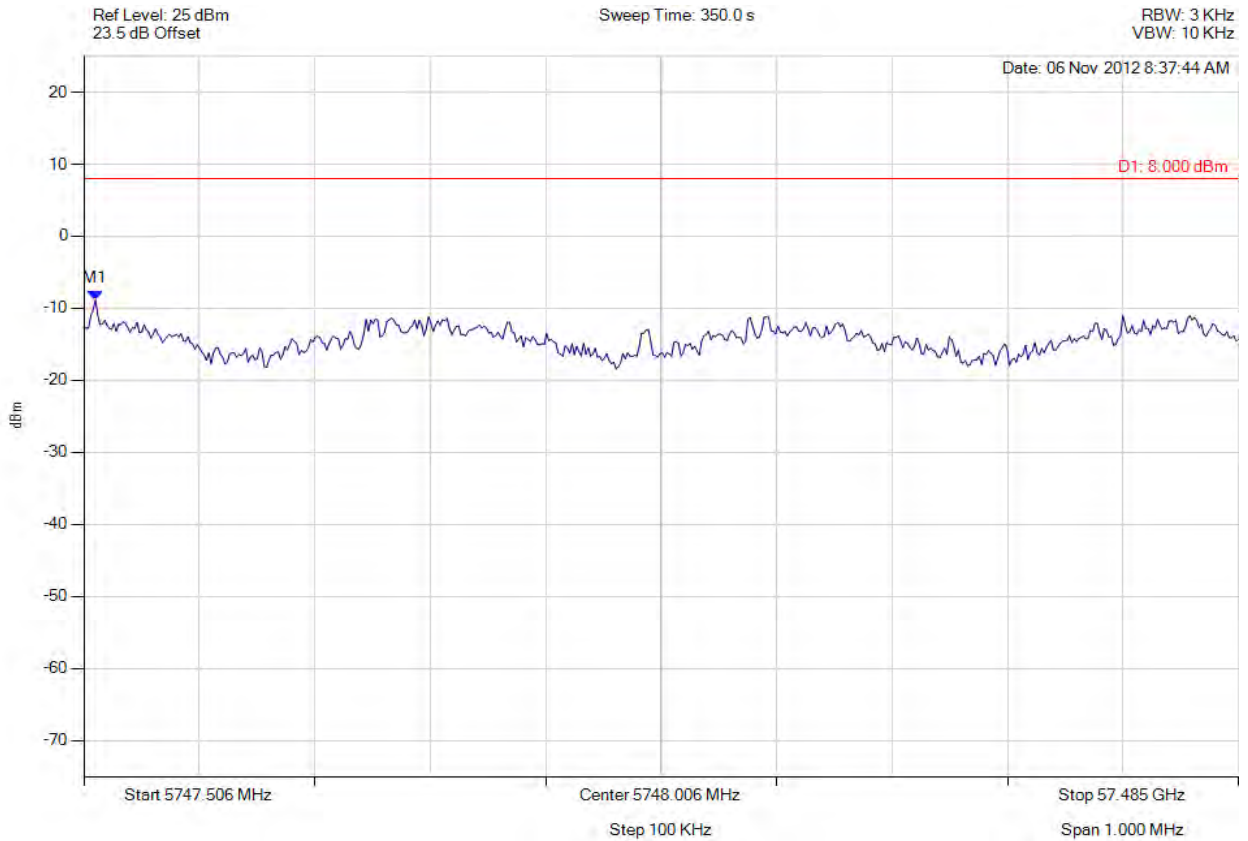

Analyser Setup	Marker : Frequency : Amplitude	Test Results
Detector = MAX PEAK Sweep Count = 0 RF Atten (dB) = 20 Trace Mode = VIEW	M1 : 5747.516 MHz : -8.886 dBm	Limit: ≤8.00 dBm Margin: -16.89 dB

[Back to the Matrix](#)

This test report may be reproduced in full only. The document may only be updated by MiCOM Labs personnel. Any changes will be noted in the Document History section of the report.



Title: Digi ConnectCard for i.MX28 with Atheros AR6233
To: FCC 47 CFR Part 15.247 & IC RSS-210
Serial #: DIGI28-U2A Rev A
Issue Date: 29th March 2013
Page: 204 of 245



POWER SPECTRAL DENSITY

Variant: 802.11a, Channel: 5785.00 MHz, Chain a, Temp: Ambient, Voltage: 5 Vdc

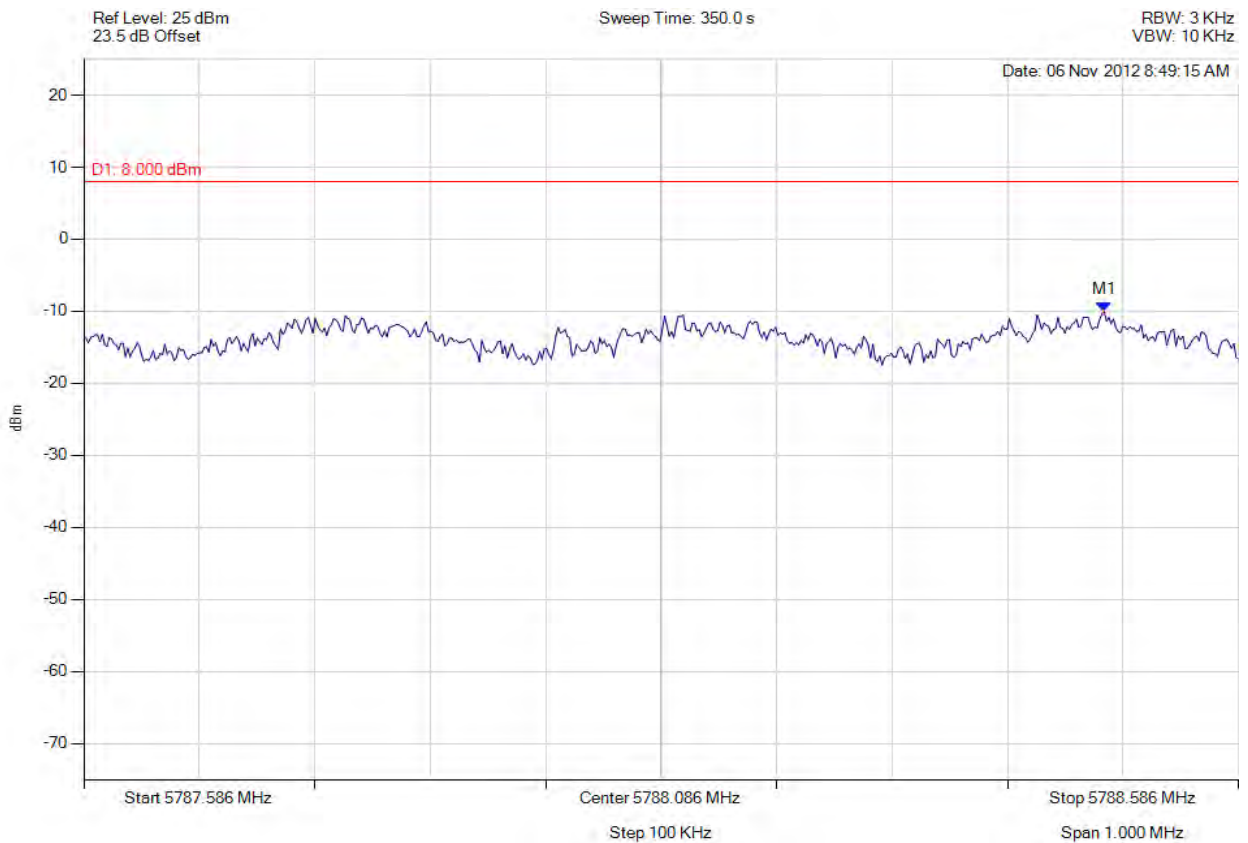

Analyser Setup	Marker : Frequency : Amplitude	Test Results
Detector = MAX PEAK Sweep Count = 0 RF Atten (dB) = 20 Trace Mode = VIEW	M1 : 5788.470 MHz : -10.039 dBm	Limit: ≤8.00 dBm Margin: -18.04 dB

[Back to the Matrix](#)

This test report may be reproduced in full only. The document may only be updated by MiCOM Labs personnel. Any changes will be noted in the Document History section of the report.



Title: Digi ConnectCard for i.MX28 with Atheros AR6233
To: FCC 47 CFR Part 15.247 & IC RSS-210
Serial #: DIGI28-U2A Rev A
Issue Date: 29th March 2013
Page: 205 of 245



POWER SPECTRAL DENSITY

Variant: 802.11a, Channel: 5825.00 MHz, Chain a, Temp: Ambient, Voltage: 5 Vdc

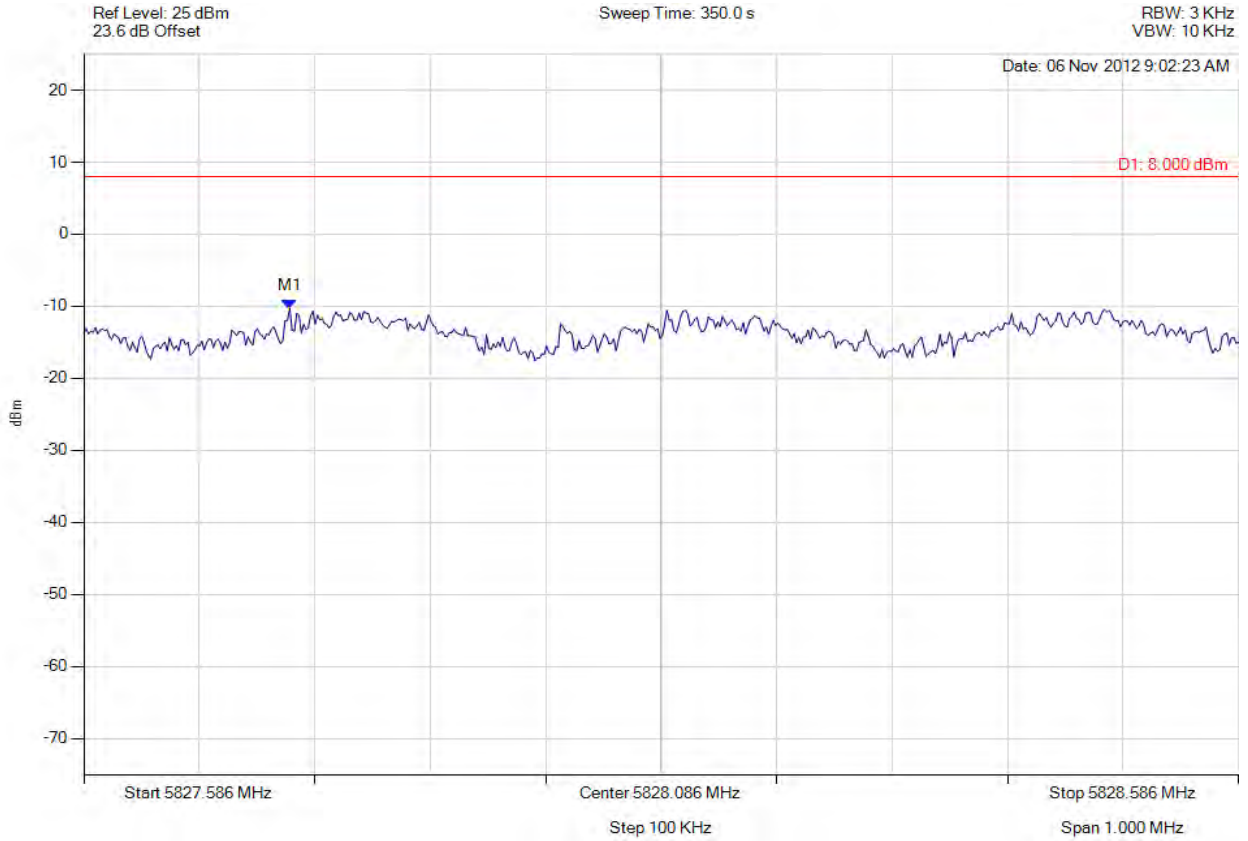

Analyser Setup	Marker : Frequency : Amplitude	Test Results
Detector = MAX PEAK Sweep Count = 0 RF Atten (dB) = 20 Trace Mode = VIEW	M1 : 5827.765 MHz : -10.288 dBm	Limit: ≤8.00 dBm Margin: -18.29 dB

[Back to the Matrix](#)

This test report may be reproduced in full only. The document may only be updated by MiCOM Labs personnel. Any changes will be noted in the Document History section of the report.



Title: Digi ConnectCard for i.MX28 with Atheros AR6233
To: FCC 47 CFR Part 15.247 & IC RSS-210
Serial #: DIGI28-U2A Rev A
Issue Date: 29th March 2013
Page: 206 of 245



POWER SPECTRAL DENSITY

Variant: 802.11n HT-20, Channel: 5745.00 MHz, Chain a, Temp: Ambient, Voltage: 5 Vdc

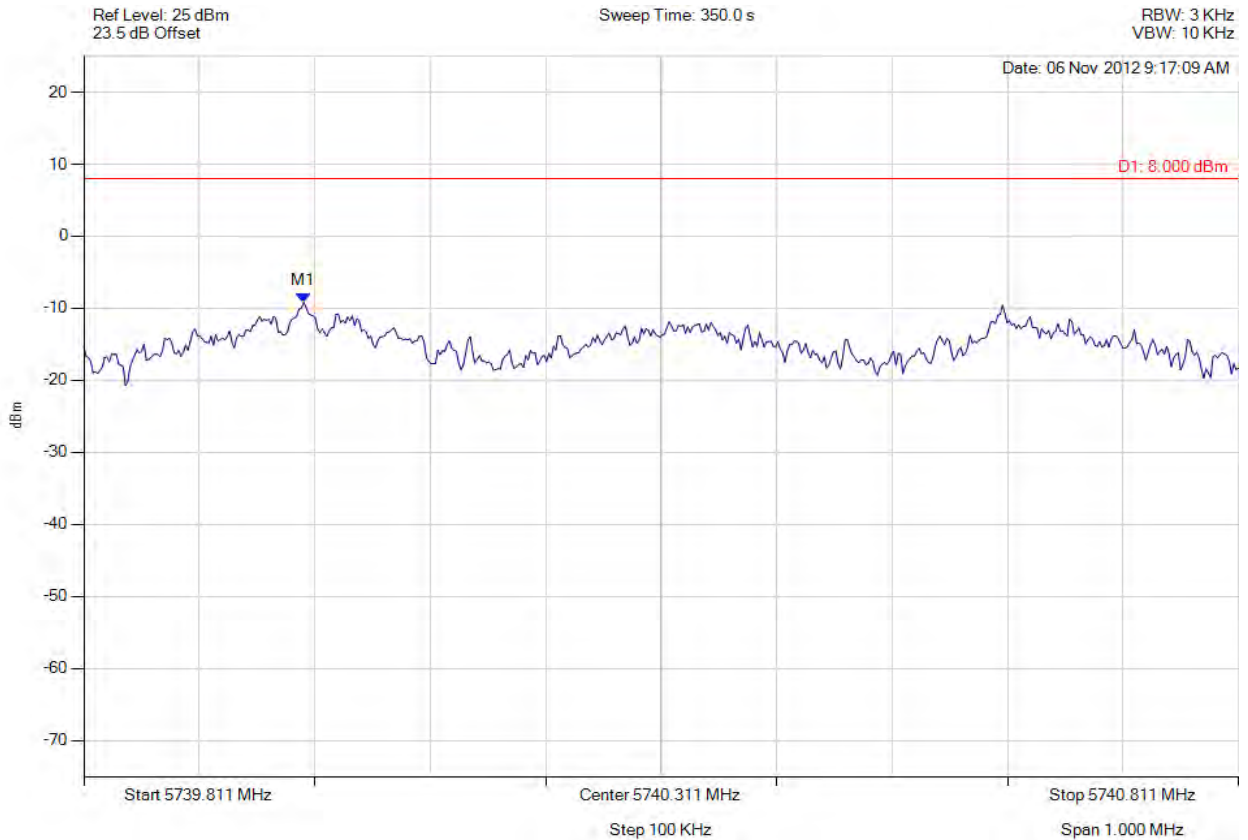

Analyser Setup	Marker : Frequency : Amplitude	Test Results
Detector = MAX PEAK Sweep Count = 0 RF Atten (dB) = 20 Trace Mode = VIEW	M1 : 5740.001 MHz : -9.201 dBm	Limit: ≤8.00 dBm Margin: -17.20 dB

[Back to the Matrix](#)

This test report may be reproduced in full only. The document may only be updated by MiCOM Labs personnel. Any changes will be noted in the Document History section of the report.



Title: Digi ConnectCard for i.MX28 with Atheros AR6233
To: FCC 47 CFR Part 15.247 & IC RSS-210
Serial #: DIGI28-U2A Rev A
Issue Date: 29th March 2013
Page: 207 of 245



POWER SPECTRAL DENSITY

Variant: 802.11n HT-20, Channel: 5785.00 MHz, Chain a, Temp: Ambient, Voltage: 5 Vdc

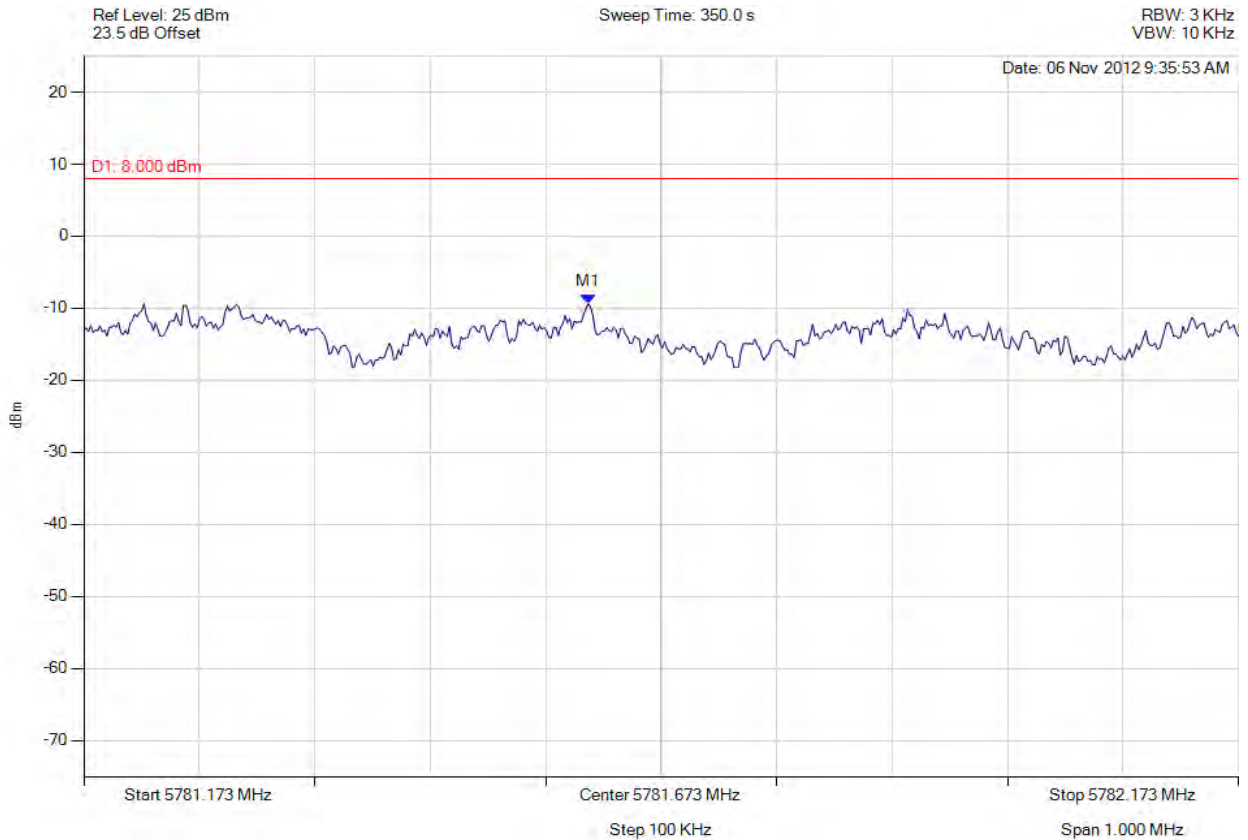

Analyser Setup	Marker : Frequency : Amplitude	Test Results
Detector = MAX PEAK Sweep Count = 0 RF Atten (dB) = 20 Trace Mode = VIEW	M1 : 5781.610 MHz : -9.378 dBm	Limit: ≤8.00 dBm Margin: -17.38 dB

[Back to the Matrix](#)

This test report may be reproduced in full only. The document may only be updated by MiCOM Labs personnel. Any changes will be noted in the Document History section of the report.



Title: Digi ConnectCard for i.MX28 with Atheros AR6233
To: FCC 47 CFR Part 15.247 & IC RSS-210
Serial #: DIGI28-U2A Rev A
Issue Date: 29th March 2013
Page: 208 of 245



POWER SPECTRAL DENSITY

Variant: 802.11n HT-20, Channel: 5825.00 MHz, Chain a, Temp: Ambient, Voltage: 5 Vdc

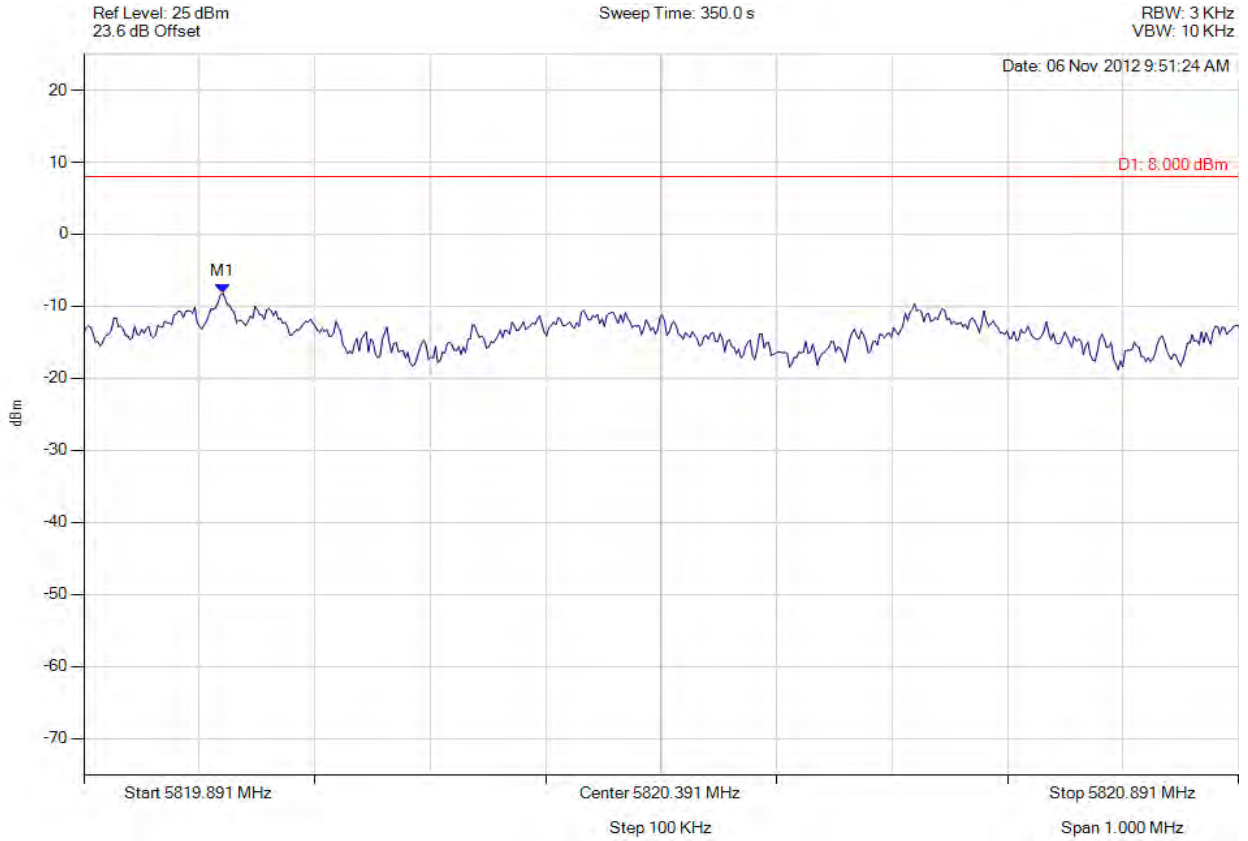

Analyser Setup	Marker : Frequency : Amplitude	Test Results
Detector = MAX PEAK Sweep Count = 0 RF Atten (dB) = 20 Trace Mode = VIEW	M1 : 5820.011 MHz : -8.150 dBm	Limit: ≤8.00 dBm Margin: -16.15 dB

[Back to the Matrix](#)

This test report may be reproduced in full only. The document may only be updated by MiCOM Labs personnel. Any changes will be noted in the Document History section of the report.



Title: Digi ConnectCard for i.MX28 with Atheros AR6233
To: FCC 47 CFR Part 15.247 & IC RSS-210
Serial #: DIGI28-U2A Rev A
Issue Date: 29th March 2013
Page: 209 of 245



POWER SPECTRAL DENSITY

Variant: 802.11n HT-40, Channel: 5755.00 MHz, Chain a, Temp: Ambient, Voltage: 5 Vdc

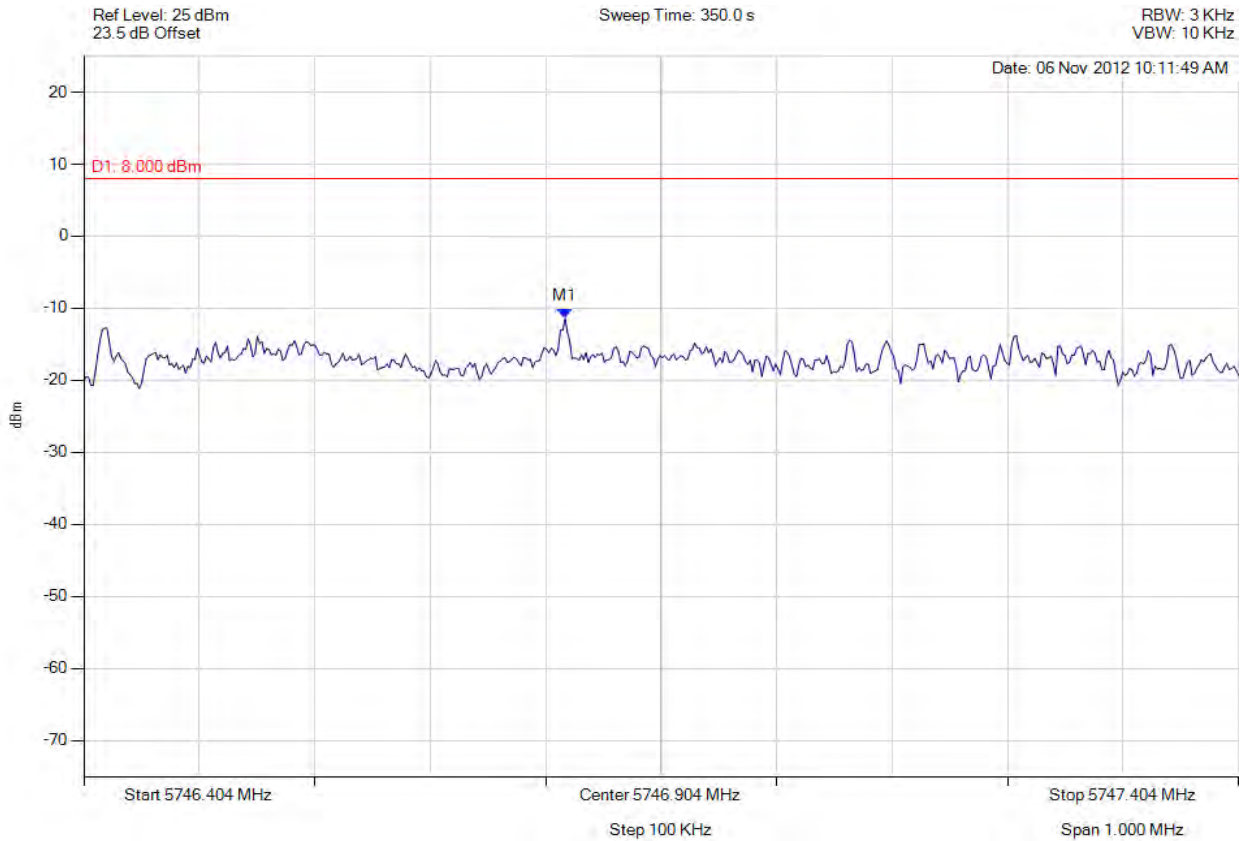

Analyser Setup	Marker : Frequency : Amplitude	Test Results
Detector = MAX PEAK Sweep Count = 0 RF Atten (dB) = 20 Trace Mode = VIEW	M1 : 5746.821 MHz : -11.402 dBm	Limit: ≤8.00 dBm Margin: -19.40 dB

[Back to the Matrix](#)

This test report may be reproduced in full only. The document may only be updated by MiCOM Labs personnel. Any changes will be noted in the Document History section of the report.



Title: Digi ConnectCard for i.MX28 with Atheros AR6233
To: FCC 47 CFR Part 15.247 & IC RSS-210
Serial #: DIGI28-U2A Rev A
Issue Date: 29th March 2013
Page: 210 of 245



POWER SPECTRAL DENSITY

Variant: 802.11n HT-40, Channel: 5795.00 MHz, Chain a, Temp: Ambient, Voltage: 5 Vdc

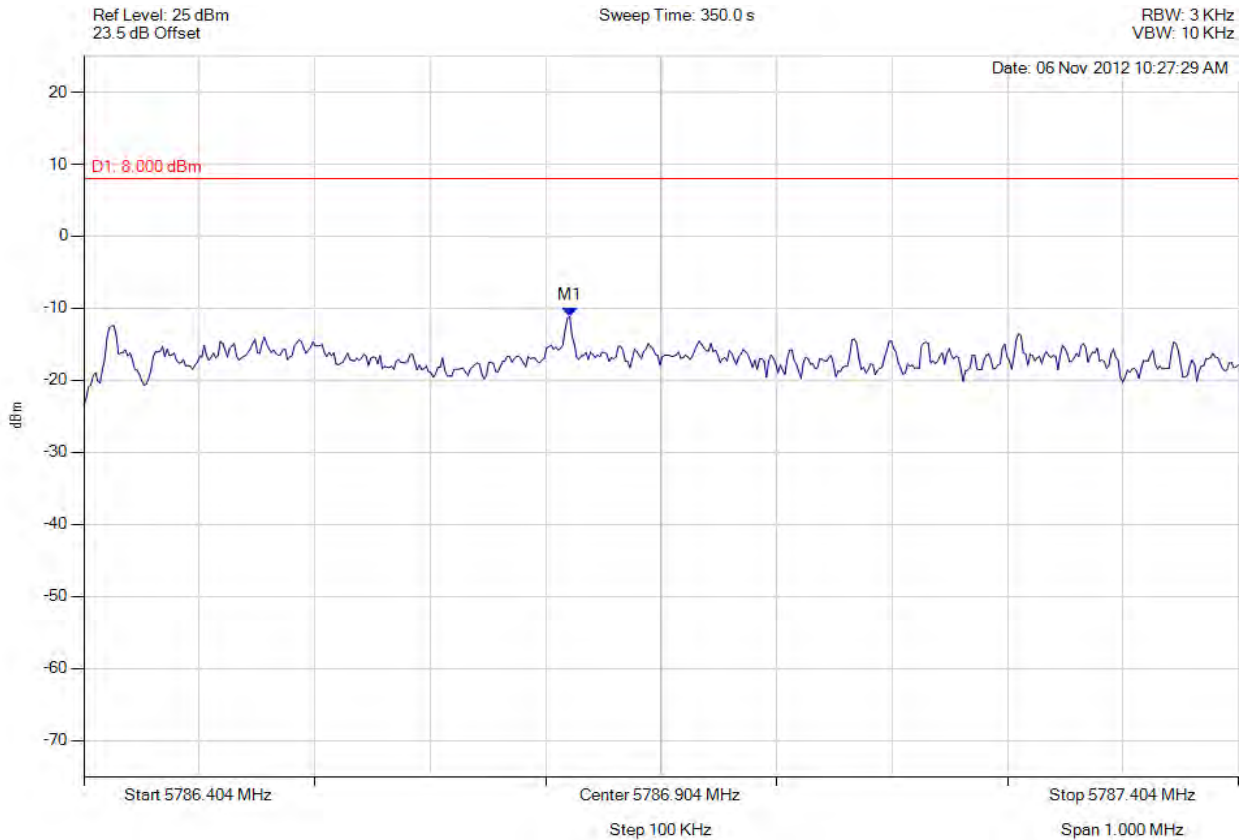

Analyser Setup	Marker : Frequency : Amplitude	Test Results
Detector = MAX PEAK Sweep Count = 0 RF Atten (dB) = 20 Trace Mode = VIEW	M1 : 5786.825 MHz : -11.156 dBm	Limit: ≤8.00 dBm Margin: -19.16 dB

[Back to the Matrix](#)

This test report may be reproduced in full only. The document may only be updated by MiCOM Labs personnel. Any changes will be noted in the Document History section of the report.



Title: Digi ConnectCard for i.MX28 with Atheros AR6233
To: FCC 47 CFR Part 15.247 & IC RSS-210
Serial #: DIGI28-U2A Rev A
Issue Date: 29th March 2013
Page: 211 of 245

A.1.4. Conducted Spurious Emissions



CONDUCTED BAND-EDGE EMISSIONS

Variant: 802.11b, Channel: 2412.00 MHz, Chain a, Temp: Ambient, Voltage: 5 Vdc

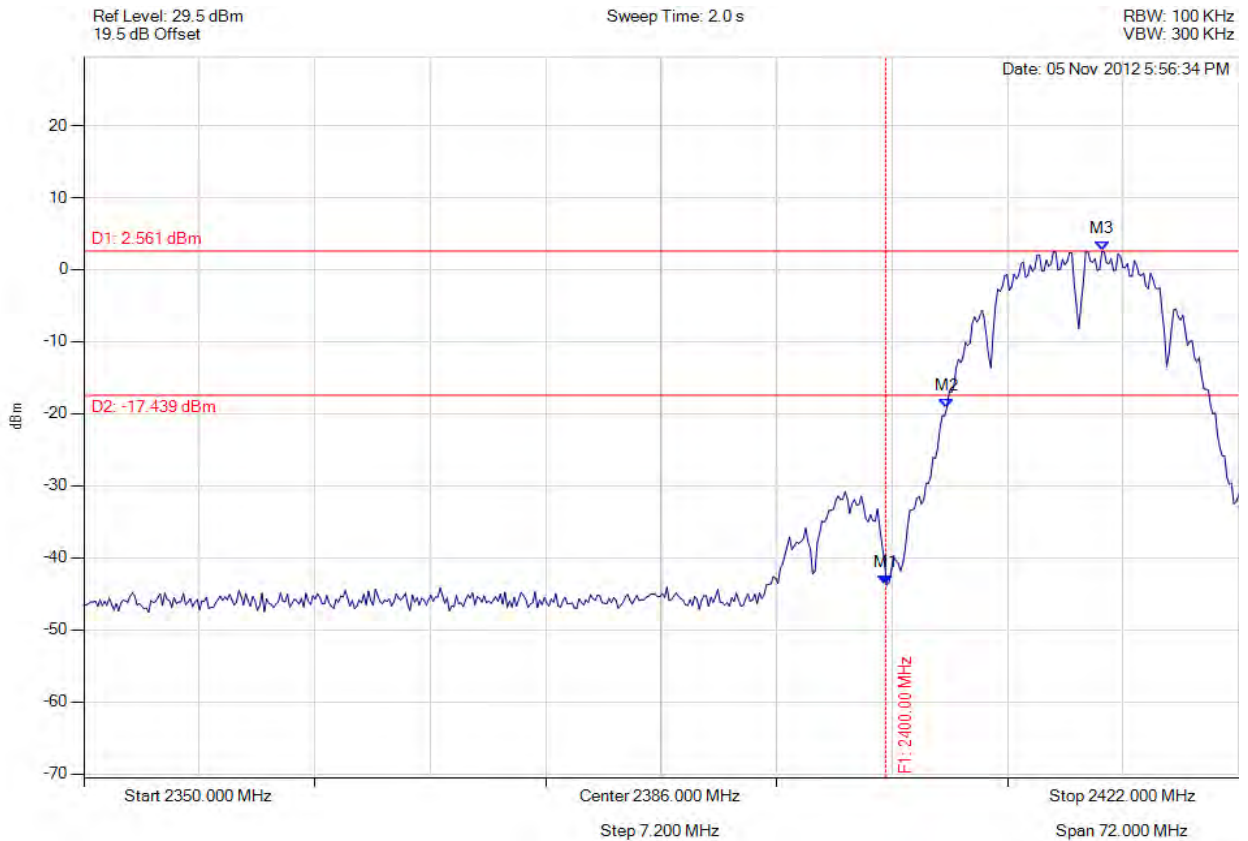

Analyser Setup	Marker : Frequency : Amplitude	Test Results
Detector = MAX PEAK Sweep Count = 0 RF Atten (dB) = 20 Trace Mode = VIEW	M1 : 2400.000 MHz : -43.788 dBm M2 : 2403.820 MHz : -19.166 dBm M3 : 2413.487 MHz : 2.561 dBm	Limit: -17.44 dBm Margin: =C20-D20 dB

[Back to the Matrix](#)

This test report may be reproduced in full only. The document may only be updated by MiCOM Labs personnel. Any changes will be noted in the Document History section of the report.



Title: Digi ConnectCard for i.MX28 with Atheros AR6233
To: FCC 47 CFR Part 15.247 & IC RSS-210
Serial #: DIGI28-U2A Rev A
Issue Date: 29th March 2013
Page: 212 of 245



CONDUCTED BAND-EDGE EMISSIONS

Variant: 802.11b, Channel: 2462.00 MHz, Chain a, Temp: Ambient, Voltage: 5 Vdc

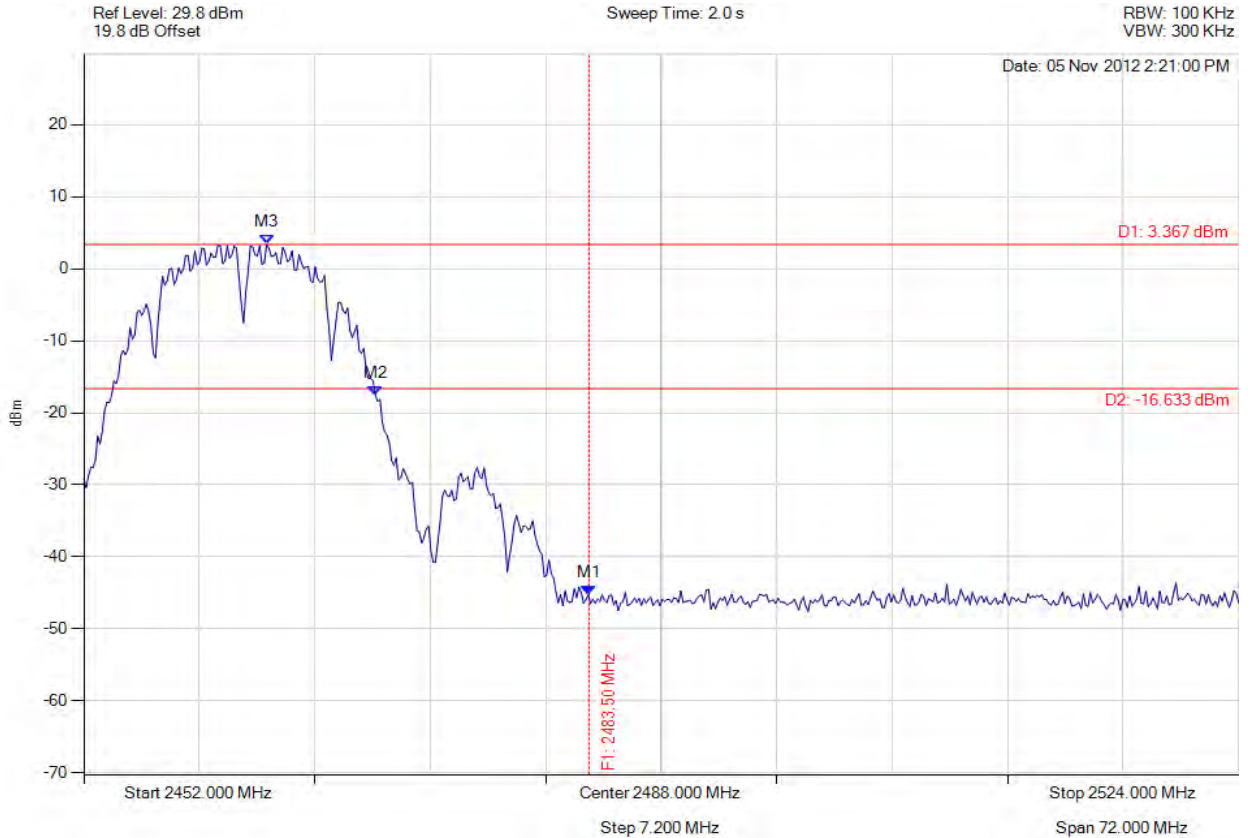

Analyser Setup	Marker : Frequency : Amplitude	Test Results
Detector = MAX PEAK Sweep Count = 0 RF Atten (dB) = 20 Trace Mode = VIEW	M1 : 2483.500 MHz : -45.288 dBm M2 : 2470.180 MHz : -17.540 dBm M3 : 2463.399 MHz : 3.367 dBm	Limit: -16.63 dBm Margin: =C22-D22 dB

[Back to the Matrix](#)

This test report may be reproduced in full only. The document may only be updated by MiCOM Labs personnel. Any changes will be noted in the Document History section of the report.



Title: Digi ConnectCard for i.MX28 with Atheros AR6233
To: FCC 47 CFR Part 15.247 & IC RSS-210
Serial #: DIGI28-U2A Rev A
Issue Date: 29th March 2013
Page: 213 of 245



CONDUCTED SPURIOUS EMISSIONS

Variant: 802.11b, Channel: 2412.00 MHz, Chain a, Temp: Ambient, Voltage: 5 Vdc

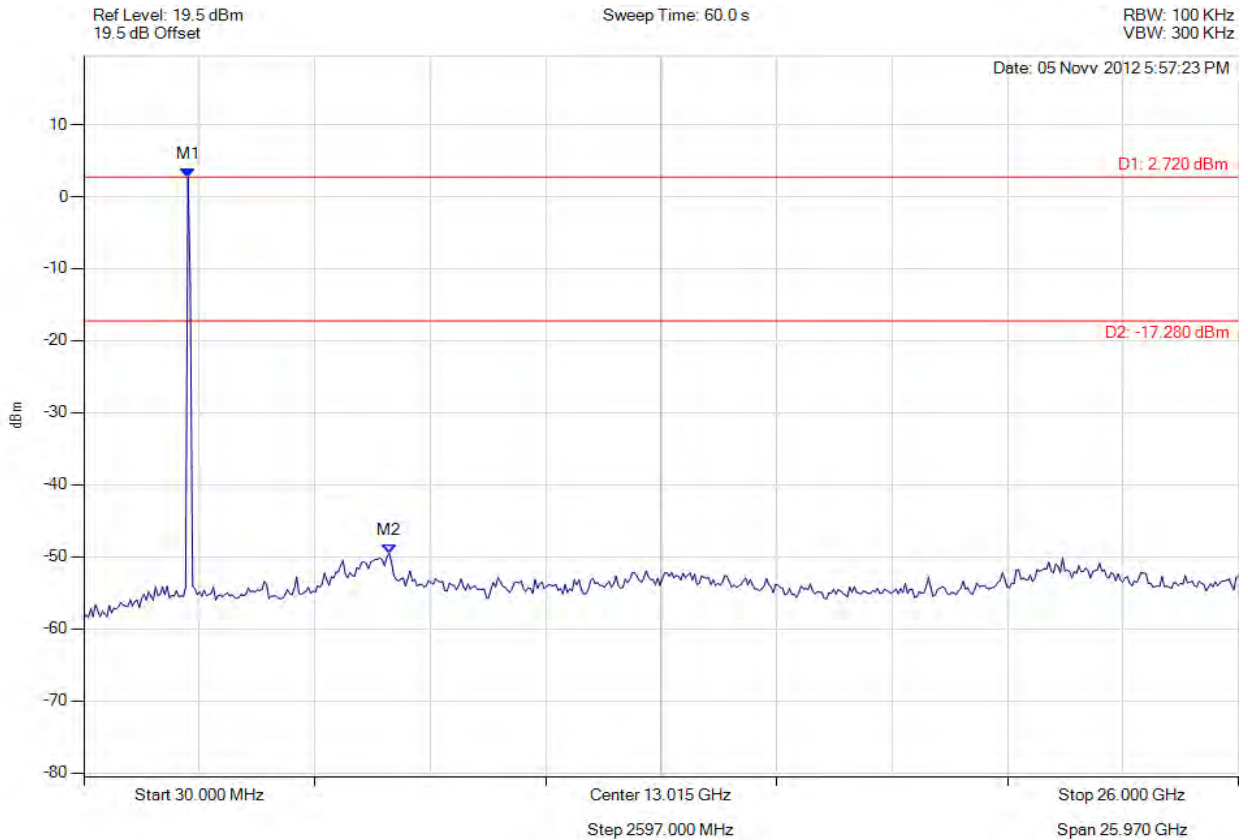

Analyser Setup	Marker : Frequency : Amplitude	Test Results
Detector = MAX PEAK Sweep Count = 0 RF Atten (dB) = 10 Trace Mode = VIEW	M1 : 2371.984 MHz : 2.720 dBm M2 : 6899.820 MHz : -49.485 dBm	Limit: -17.28 dBm Margin: =C11-D11 dB

[Back to the Matrix](#)

This test report may be reproduced in full only. The document may only be updated by MiCOM Labs personnel. Any changes will be noted in the Document History section of the report.



Title: Digi ConnectCard for i.MX28 with Atheros AR6233
To: FCC 47 CFR Part 15.247 & IC RSS-210
Serial #: DIGI28-U2A Rev A
Issue Date: 29th March 2013
Page: 214 of 245



CONDUCTED SPURIOUS EMISSIONS

Variant: 802.11b, Channel: 2437.00 MHz, Chain a, Temp: Ambient, Voltage: 5 Vdc

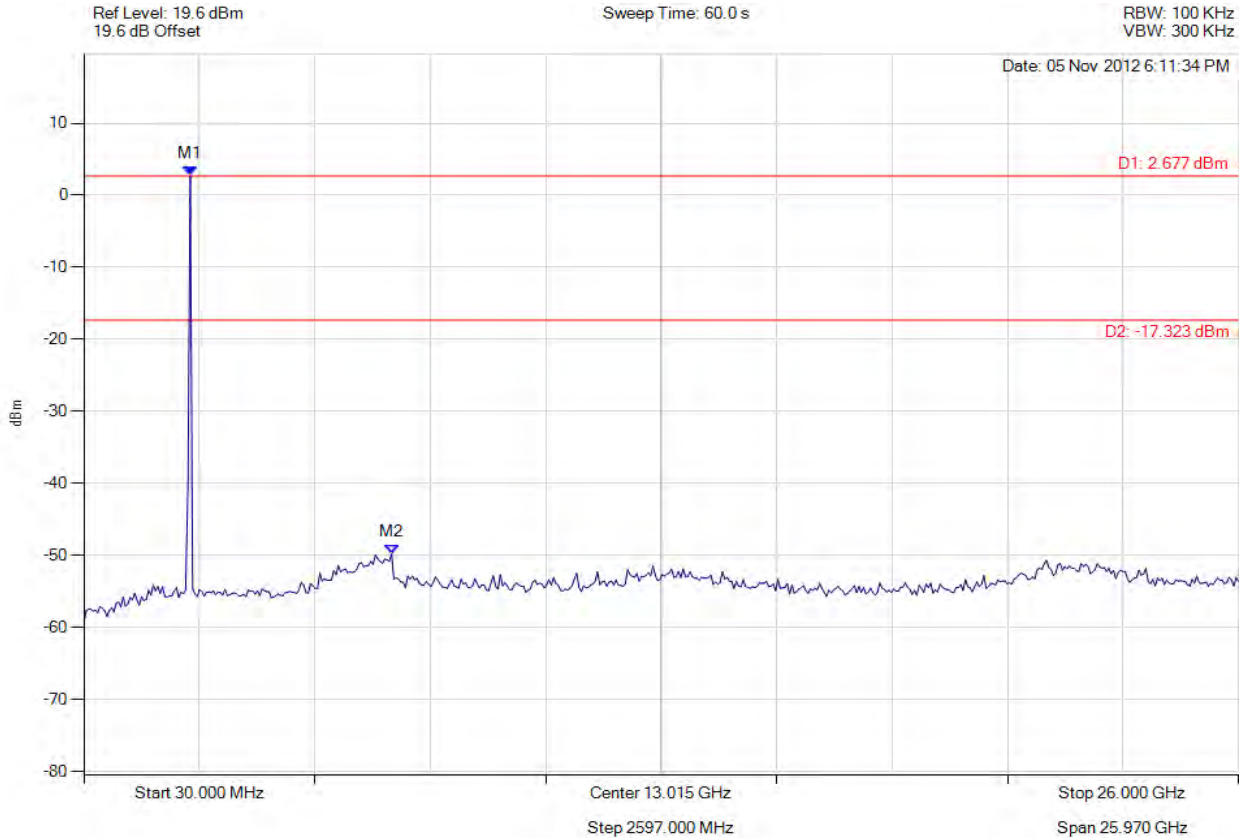

Analyser Setup	Marker : Frequency : Amplitude	Test Results
Detector = MAX PEAK Sweep Count = 0 RF Atten (dB) = 10 Trace Mode = VIEW	M1 : 2424.028 MHz : 2.677 dBm M2 : 6951.864 MHz : -49.787 dBm	Limit: -17.32 dBm Margin: =C12-D12 dB

[Back to the Matrix](#)

This test report may be reproduced in full only. The document may only be updated by MiCOM Labs personnel. Any changes will be noted in the Document History section of the report.



Title: Digi ConnectCard for i.MX28 with Atheros AR6233
To: FCC 47 CFR Part 15.247 & IC RSS-210
Serial #: DIGI28-U2A Rev A
Issue Date: 29th March 2013
Page: 215 of 245



CONDUCTED SPURIOUS EMISSIONS

Variant: 802.11b, Channel: 2462.00 MHz, Chain a, Temp: Ambient, Voltage: 5 Vdc

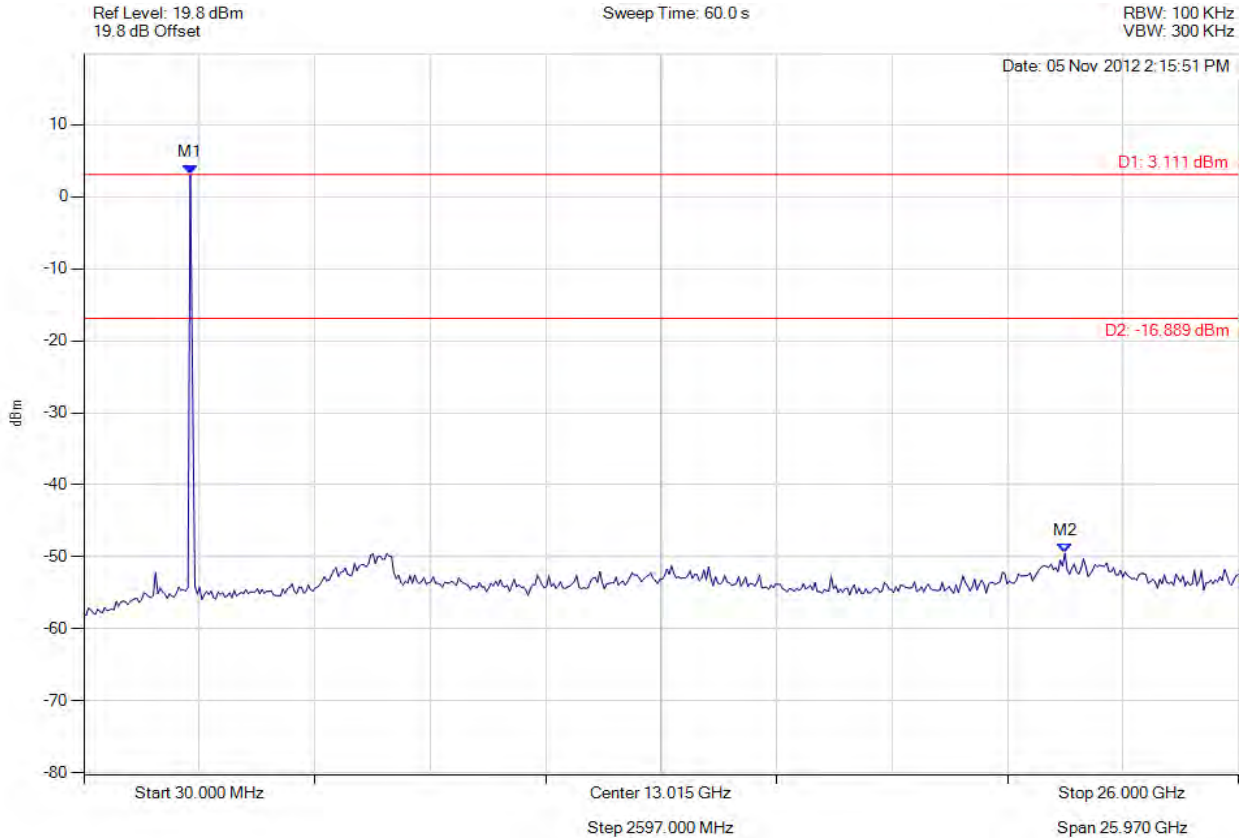

Analyser Setup	Marker : Frequency : Amplitude	Test Results
Detector = MAX PEAK Sweep Count = 0 RF Atten (dB) = 10 Trace Mode = VIEW	M1 : 2424.028 MHz : 3.111 dBm M2 : 22.097 GHz : -49.478 dBm	Limit: -16.89 dBm Margin: =C13-D13 dB

[Back to the Matrix](#)

This test report may be reproduced in full only. The document may only be updated by MiCOM Labs personnel. Any changes will be noted in the Document History section of the report.



Title: Digi ConnectCard for i.MX28 with Atheros AR6233
To: FCC 47 CFR Part 15.247 & IC RSS-210
Serial #: DIGI28-U2A Rev A
Issue Date: 29th March 2013
Page: 216 of 245



CONDUCTED BAND-EDGE EMISSIONS

Variant: 802.11g, Channel: 2412.00 MHz, Chain a, Temp: Ambient, Voltage: 5 Vdc

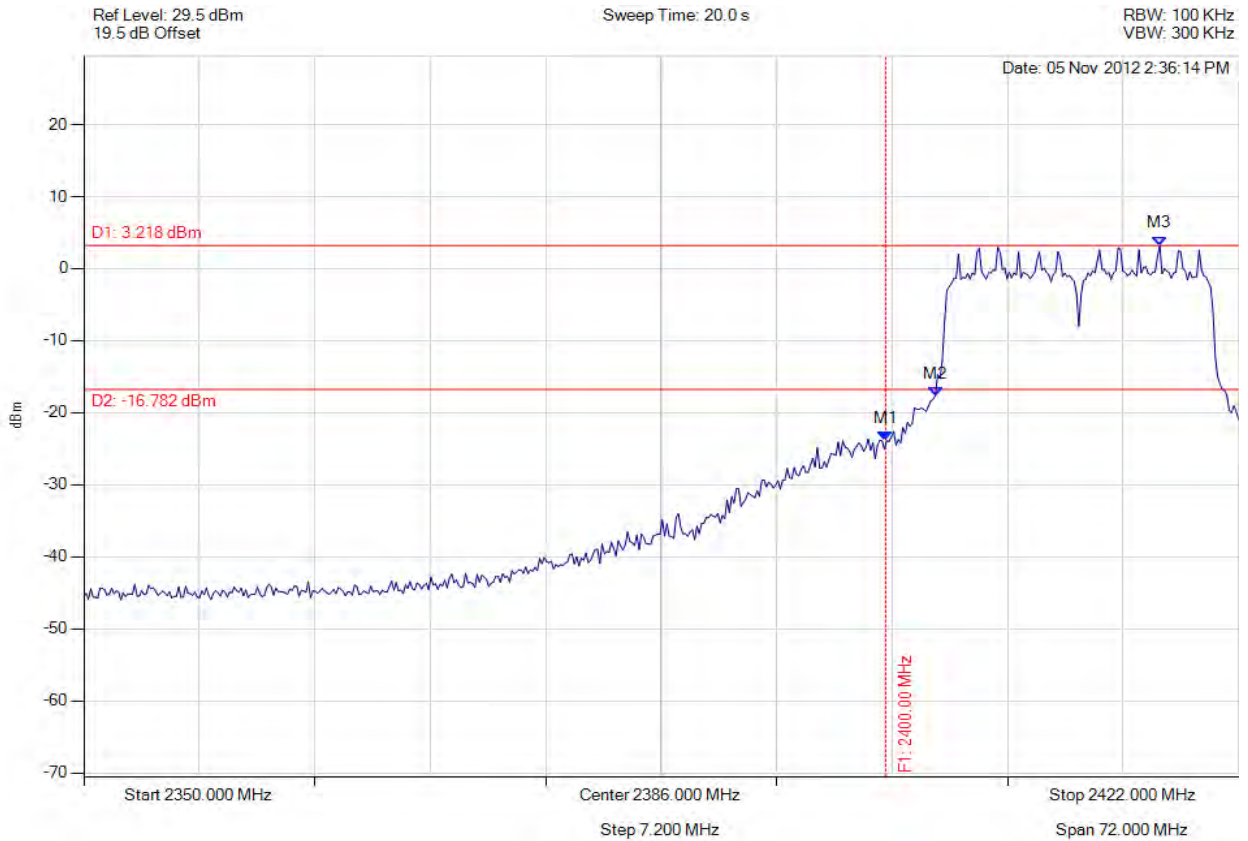

Analyser Setup	Marker : Frequency : Amplitude	Test Results
Detector = MAX PEAK Sweep Count = 0 RF Atten (dB) = 20 Trace Mode = VIEW	M1 : 2400.000 MHz : -23.902 dBm M2 : 2403.098 MHz : -17.667 dBm M3 : 2417.094 MHz : 3.218 dBm	Limit: -16.78 dBm Margin: =C20-D20 dB

[Back to the Matrix](#)

This test report may be reproduced in full only. The document may only be updated by MiCOM Labs personnel. Any changes will be noted in the Document History section of the report.



Title: Digi ConnectCard for i.MX28 with Atheros AR6233
To: FCC 47 CFR Part 15.247 & IC RSS-210
Serial #: DIGI28-U2A Rev A
Issue Date: 29th March 2013
Page: 217 of 245



CONDUCTED BAND-EDGE EMISSIONS

Variant: 802.11g, Channel: 2462.00 MHz, Chain a, Temp: Ambient, Voltage: 5 Vdc

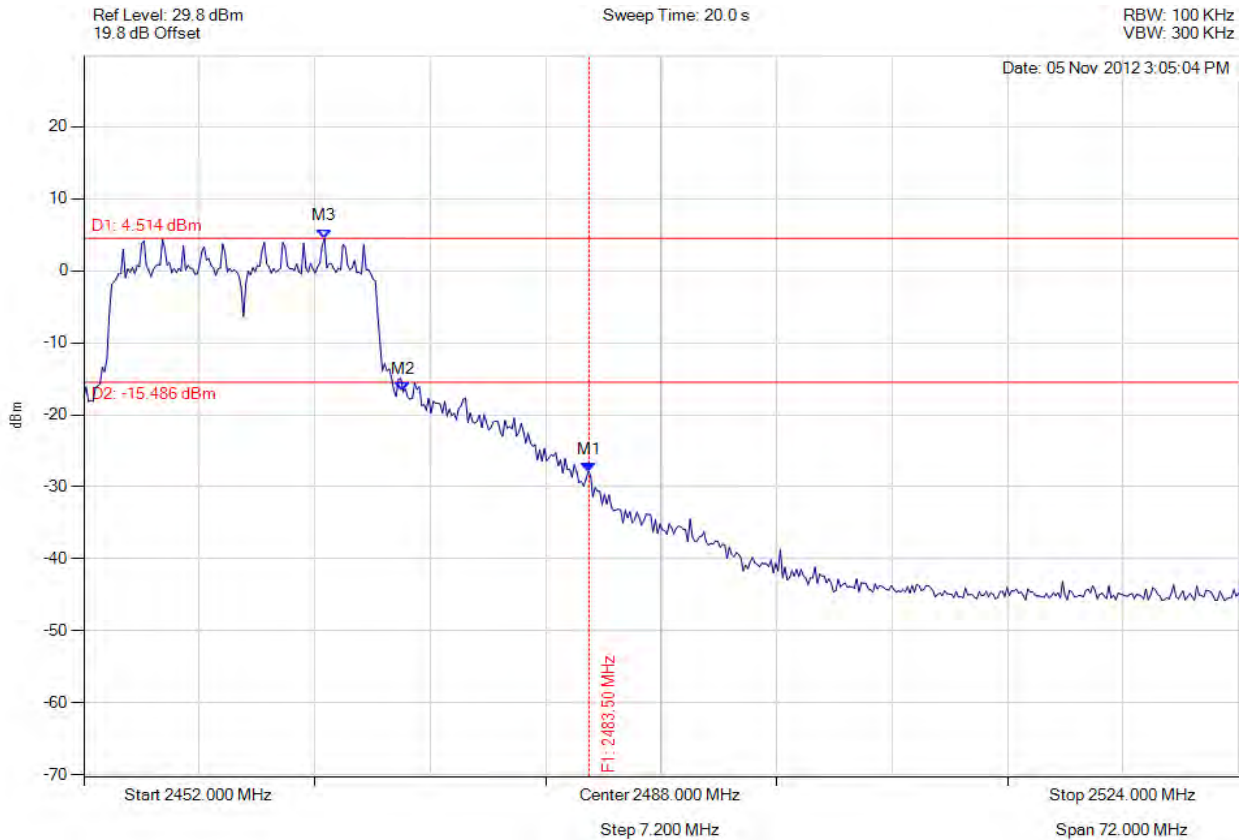

Analyser Setup	Marker : Frequency : Amplitude	Test Results
Detector = MAX PEAK Sweep Count = 0 RF Atten (dB) = 20 Trace Mode = VIEW	M1 : 2483.500 MHz : -27.849 dBm M2 : 2471.912 MHz : -16.805 dBm M3 : 2467.006 MHz : 4.514 dBm	Limit: -15.49 dBm Margin: =C22-D22 dB

[Back to the Matrix](#)

This test report may be reproduced in full only. The document may only be updated by MiCOM Labs personnel. Any changes will be noted in the Document History section of the report.



Title: Digi ConnectCard for i.MX28 with Atheros AR6233
To: FCC 47 CFR Part 15.247 & IC RSS-210
Serial #: DIGI28-U2A Rev A
Issue Date: 29th March 2013
Page: 218 of 245



CONDUCTED SPURIOUS EMISSIONS

Variant: 802.11g, Channel: 2412.00 MHz, Chain a, Temp: Ambient, Voltage: 5 Vdc

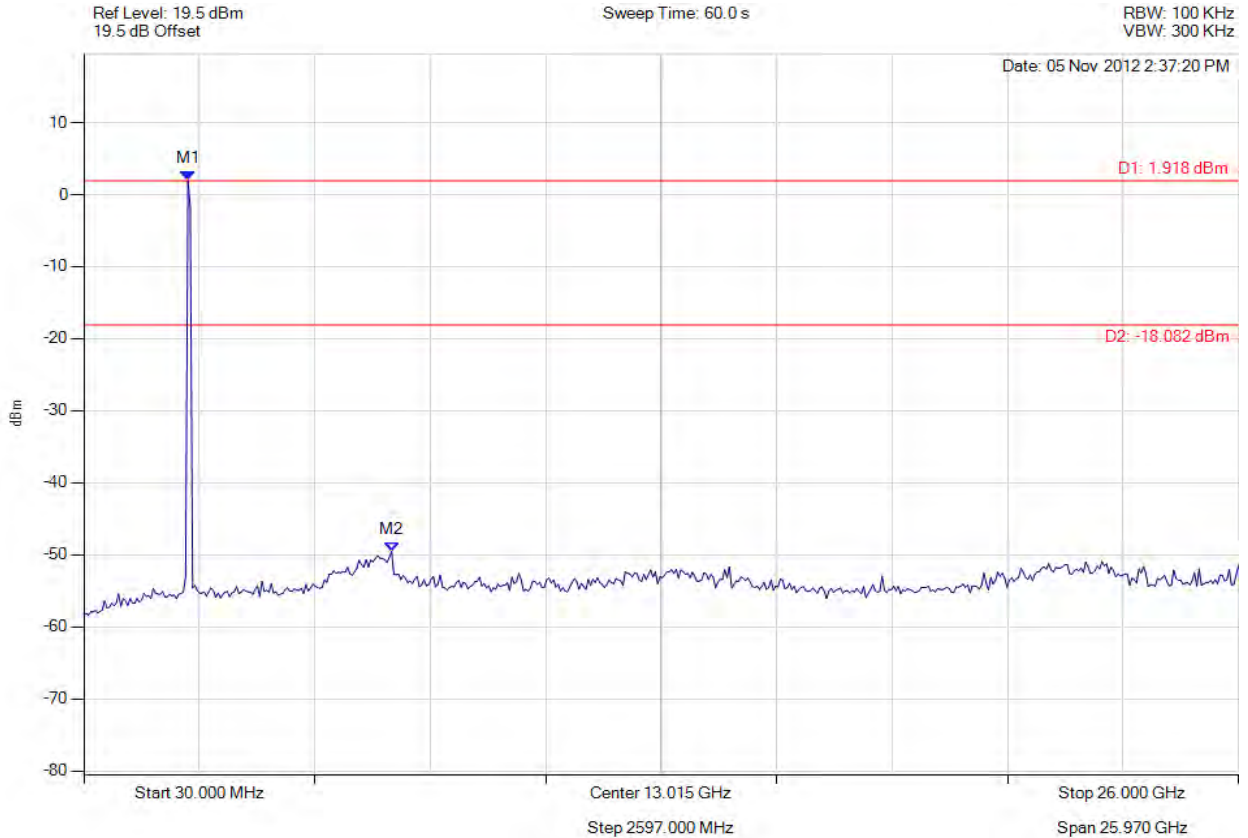

Analyser Setup	Marker : Frequency : Amplitude	Test Results
Detector = MAX PEAK Sweep Count = 0 RF Atten (dB) = 10 Trace Mode = VIEW	M1 : 2371.984 MHz : 1.918 dBm M2 : 6951.864 MHz : -49.546 dBm	Limit: -18.08 dBm Margin: =C11-D11 dB

[Back to the Matrix](#)

This test report may be reproduced in full only. The document may only be updated by MiCOM Labs personnel. Any changes will be noted in the Document History section of the report.



Title: Digi ConnectCard for i.MX28 with Atheros AR6233
To: FCC 47 CFR Part 15.247 & IC RSS-210
Serial #: DIGI28-U2A Rev A
Issue Date: 29th March 2013
Page: 219 of 245



CONDUCTED SPURIOUS EMISSIONS

Variant: 802.11g, Channel: 2437.00 MHz, Chain a, Temp: Ambient, Voltage: 5 Vdc

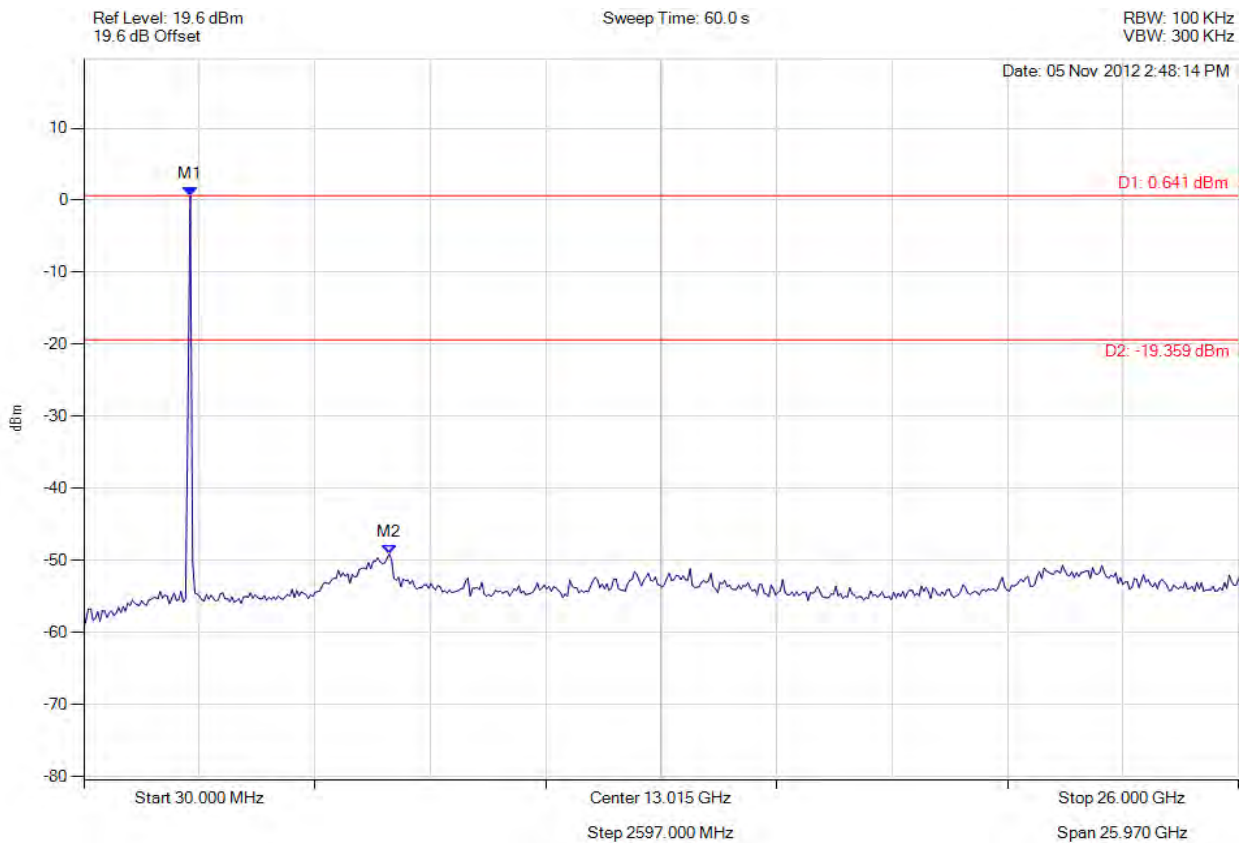

Analyser Setup	Marker : Frequency : Amplitude	Test Results
Detector = MAX PEAK Sweep Count = 0 RF Atten (dB) = 10 Trace Mode = VIEW	M1 : 2424.028 MHz : 0.641 dBm M2 : 6899.820 MHz : -49.102 dBm	Limit: -19.36 dBm Margin: =C12-D12 dB

[Back to the Matrix](#)

This test report may be reproduced in full only. The document may only be updated by MiCOM Labs personnel. Any changes will be noted in the Document History section of the report.



Title: Digi ConnectCard for i.MX28 with Atheros AR6233
To: FCC 47 CFR Part 15.247 & IC RSS-210
Serial #: DIGI28-U2A Rev A
Issue Date: 29th March 2013
Page: 220 of 245



CONDUCTED SPURIOUS EMISSIONS

Variant: 802.11g, Channel: 2462.00 MHz, Chain a, Temp: Ambient, Voltage: 5 Vdc

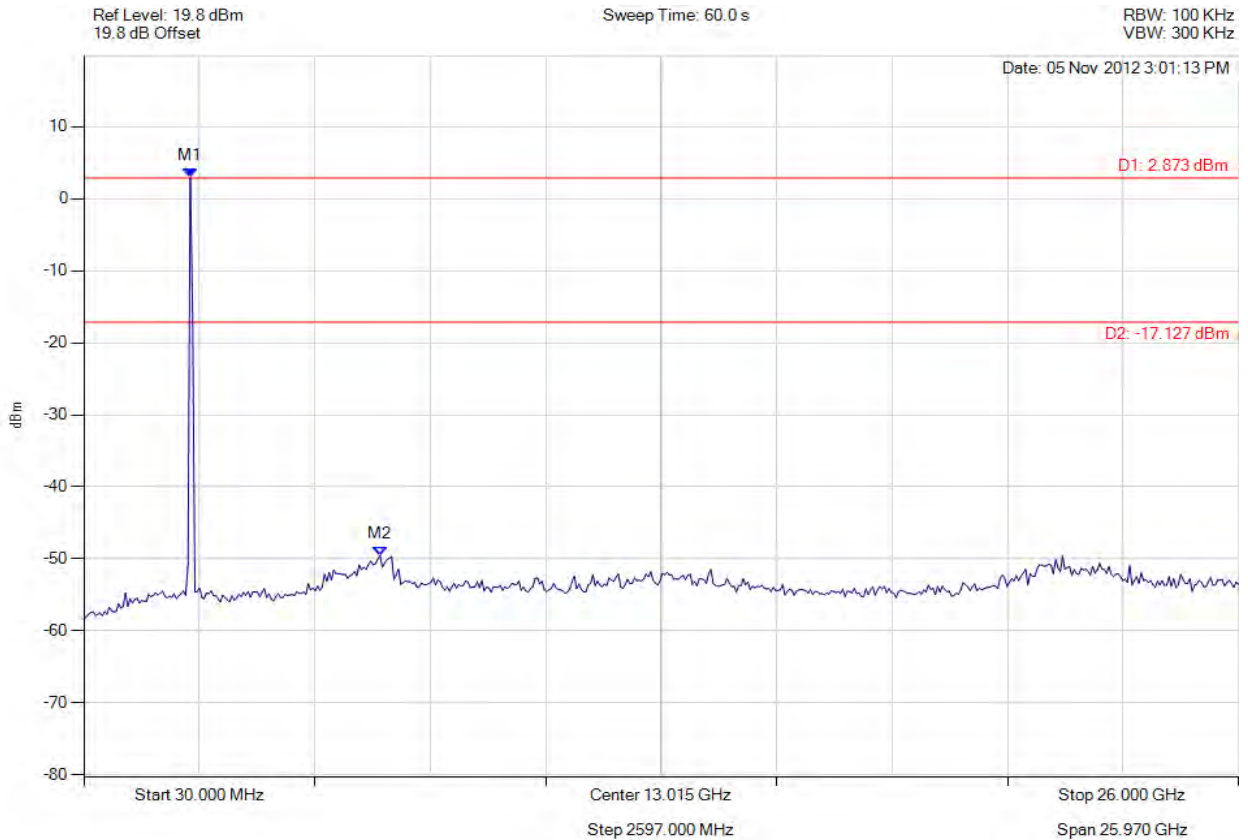

Analyser Setup	Marker : Frequency : Amplitude	Test Results
Detector = MAX PEAK Sweep Count = 0 RF Atten (dB) = 10 Trace Mode = VIEW	M1 : 2424.028 MHz : 2.873 dBm M2 : 6691.643 MHz : -49.534 dBm	Limit: -17.13 dBm Margin: =C13-D13 dB

[Back to the Matrix](#)

This test report may be reproduced in full only. The document may only be updated by MiCOM Labs personnel. Any changes will be noted in the Document History section of the report.



Title: Digi ConnectCard for i.MX28 with Atheros AR6233
To: FCC 47 CFR Part 15.247 & IC RSS-210
Serial #: DIGI28-U2A Rev A
Issue Date: 29th March 2013
Page: 221 of 245



CONDUCTED BAND-EDGE EMISSIONS

Variant: 802.11n HT-20, Channel: 2412.00 MHz, Chain a, Temp: Ambient, Voltage: 5 Vdc

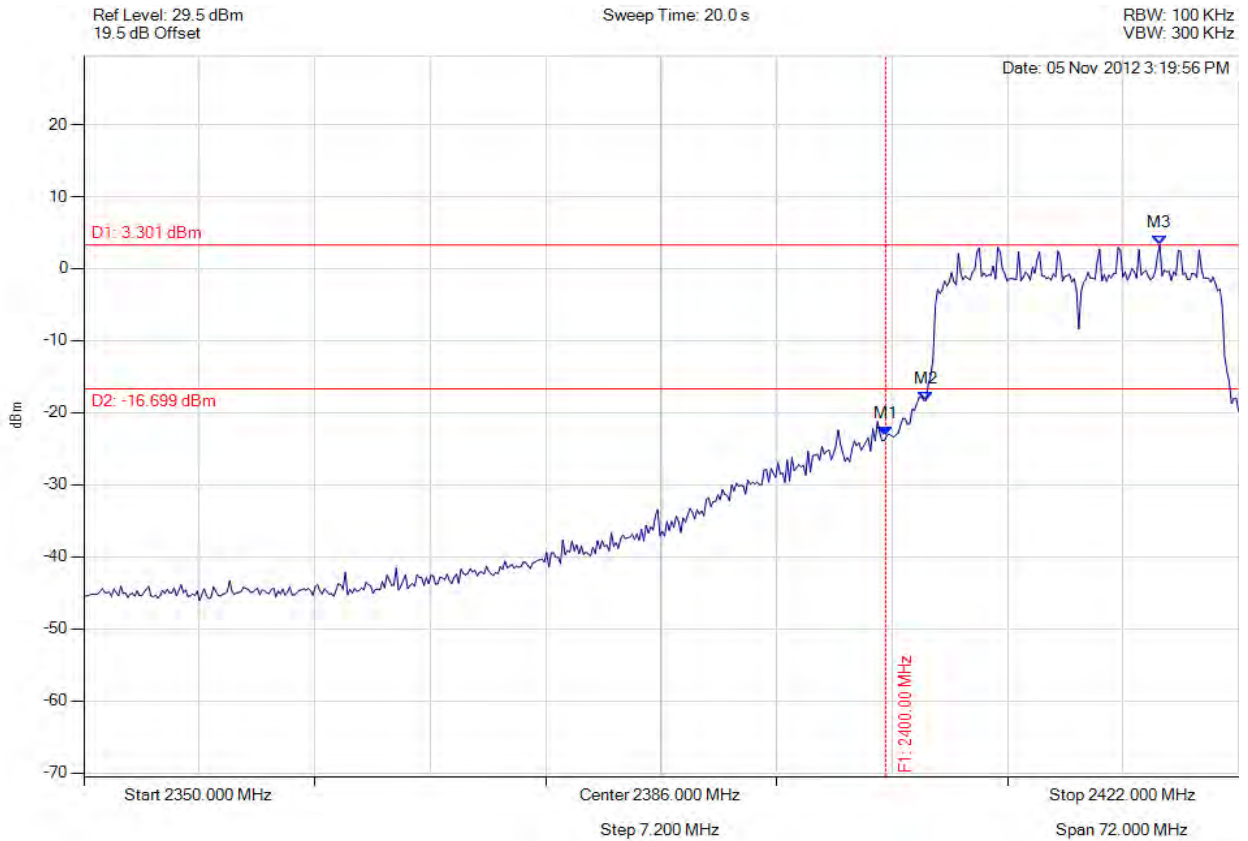

Analyser Setup	Marker : Frequency : Amplitude	Test Results
Detector = MAX PEAK Sweep Count = 0 RF Atten (dB) = 20 Trace Mode = VIEW	M1 : 2400.000 MHz : -23.209 dBm M2 : 2402.521 MHz : -18.364 dBm M3 : 2417.094 MHz : 3.301 dBm	Limit: -16.70 dBm Margin: =C20-D20 dB

[Back to the Matrix](#)

This test report may be reproduced in full only. The document may only be updated by MiCOM Labs personnel. Any changes will be noted in the Document History section of the report.



Title: Digi ConnectCard for i.MX28 with Atheros AR6233
To: FCC 47 CFR Part 15.247 & IC RSS-210
Serial #: DIGI28-U2A Rev A
Issue Date: 29th March 2013
Page: 222 of 245



CONDUCTED BAND-EDGE EMISSIONS

Variant: 802.11n HT-20, Channel: 2462.00 MHz, Chain a, Temp: Ambient, Voltage: 5 Vdc

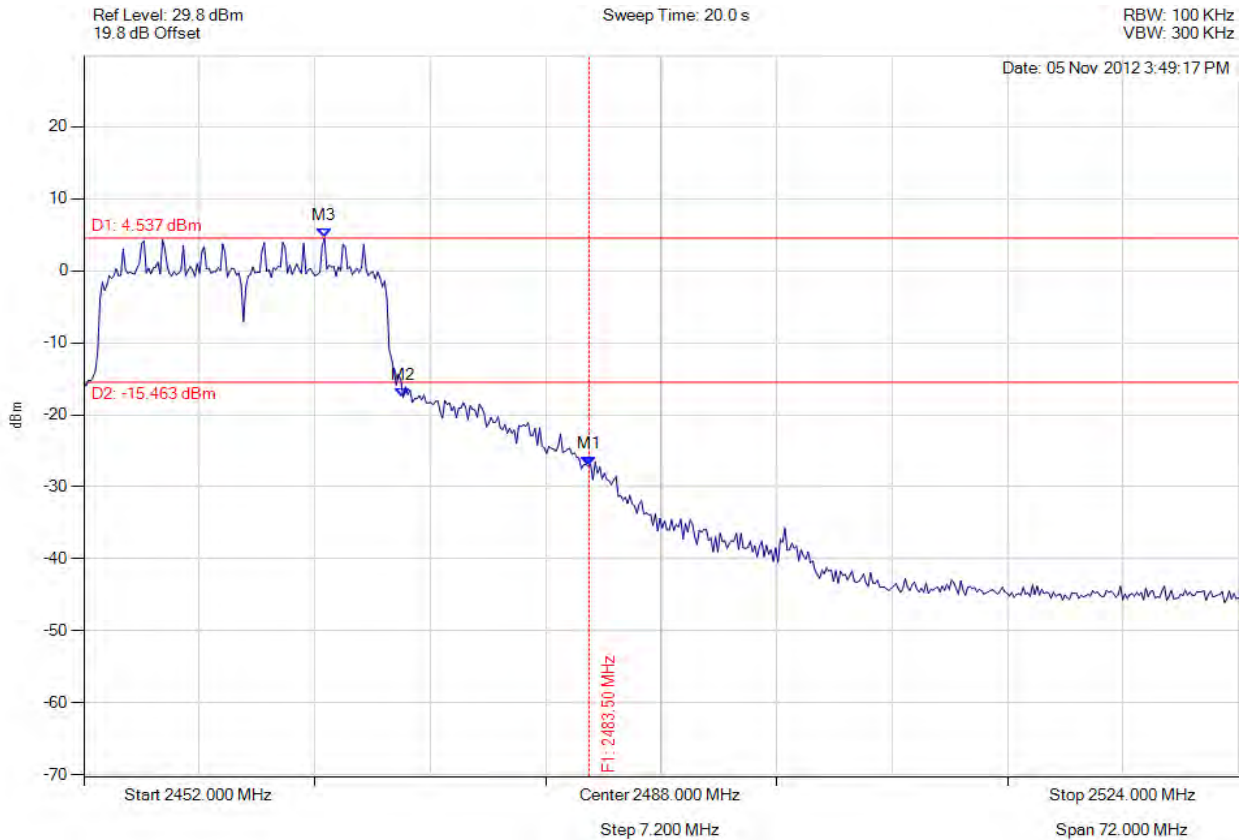

Analyser Setup	Marker : Frequency : Amplitude	Test Results
Detector = MAX PEAK Sweep Count = 0 RF Atten (dB) = 20 Trace Mode = VIEW	M1 : 2483.500 MHz : -27.155 dBm M2 : 2471.912 MHz : -17.560 dBm M3 : 2467.006 MHz : 4.537 dBm	Limit: -15.46 dBm Margin: =C22-D22 dB

[Back to the Matrix](#)

This test report may be reproduced in full only. The document may only be updated by MiCOM Labs personnel. Any changes will be noted in the Document History section of the report.



Title: Digi ConnectCard for i.MX28 with Atheros AR6233
To: FCC 47 CFR Part 15.247 & IC RSS-210
Serial #: DIGI28-U2A Rev A
Issue Date: 29th March 2013
Page: 223 of 245



CONDUCTED SPURIOUS EMISSIONS

Variant: 802.11n HT-20, Channel: 2412.00 MHz, Chain a, Temp: Ambient, Voltage: 5 Vdc

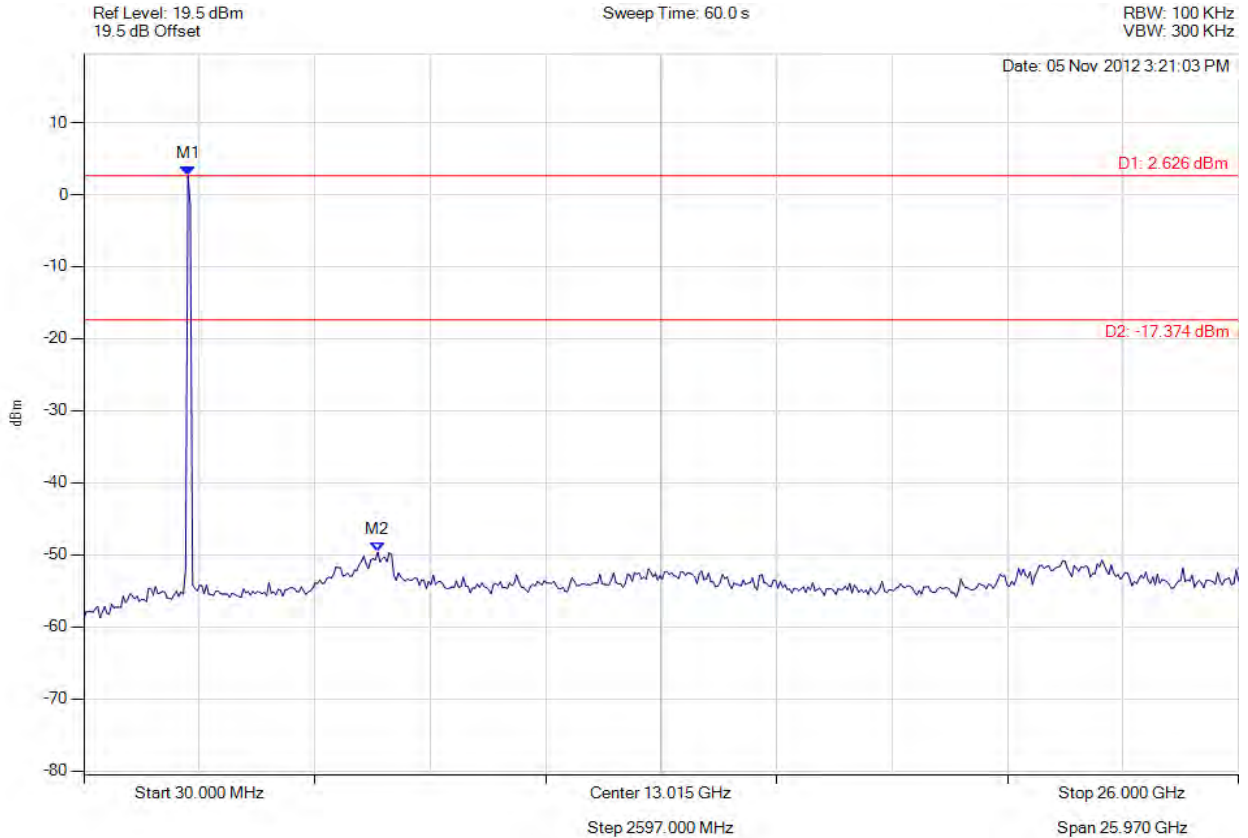

Analyser Setup	Marker : Frequency : Amplitude	Test Results
Detector = MAX PEAK Sweep Count = 0 RF Atten (dB) = 10 Trace Mode = VIEW	M1 : 2371.984 MHz : 2.626 dBm M2 : 6639.599 MHz : -49.621 dBm	Limit: -17.37 dBm Margin: =C11-D11 dB

[Back to the Matrix](#)

This test report may be reproduced in full only. The document may only be updated by MiCOM Labs personnel. Any changes will be noted in the Document History section of the report.



Title: Digi ConnectCard for i.MX28 with Atheros AR6233
To: FCC 47 CFR Part 15.247 & IC RSS-210
Serial #: DIGI28-U2A Rev A
Issue Date: 29th March 2013
Page: 224 of 245



CONDUCTED SPURIOUS EMISSIONS

Variant: 802.11n HT-20, Channel: 2437.00 MHz, Chain a, Temp: Ambient, Voltage: 5 Vdc

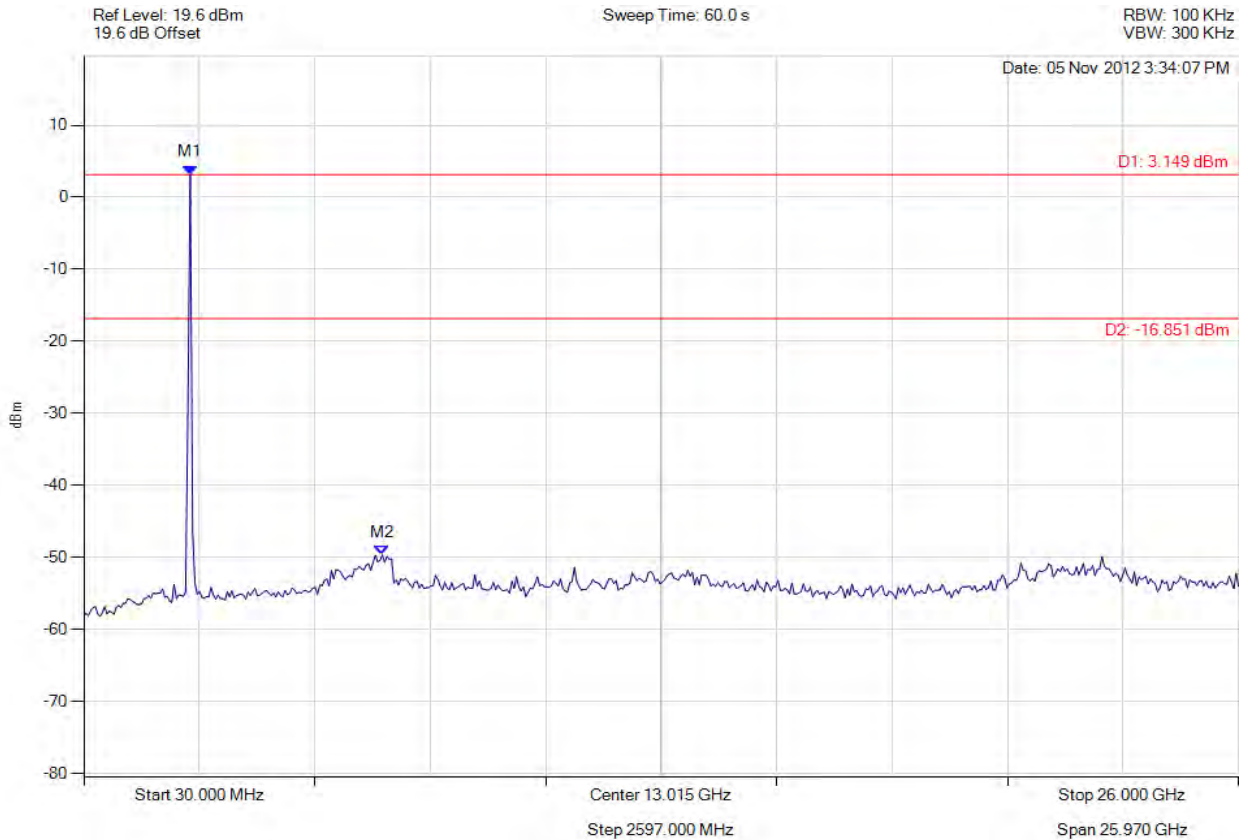

Analyser Setup	Marker : Frequency : Amplitude	Test Results
Detector = MAX PEAK Sweep Count = 0 RF Atten (dB) = 10 Trace Mode = VIEW	M1 : 2424.028 MHz : 3.149 dBm M2 : 6743.687 MHz : -49.651 dBm	Limit: -16.85 dBm Margin: =C12-D12 dB

[Back to the Matrix](#)

This test report may be reproduced in full only. The document may only be updated by MiCOM Labs personnel. Any changes will be noted in the Document History section of the report.



Title: Digi ConnectCard for i.MX28 with Atheros AR6233
To: FCC 47 CFR Part 15.247 & IC RSS-210
Serial #: DIGI28-U2A Rev A
Issue Date: 29th March 2013
Page: 225 of 245



CONDUCTED SPURIOUS EMISSIONS

Variant: 802.11n HT-20, Channel: 2462.00 MHz, Chain a, Temp: Ambient, Voltage: 5 Vdc

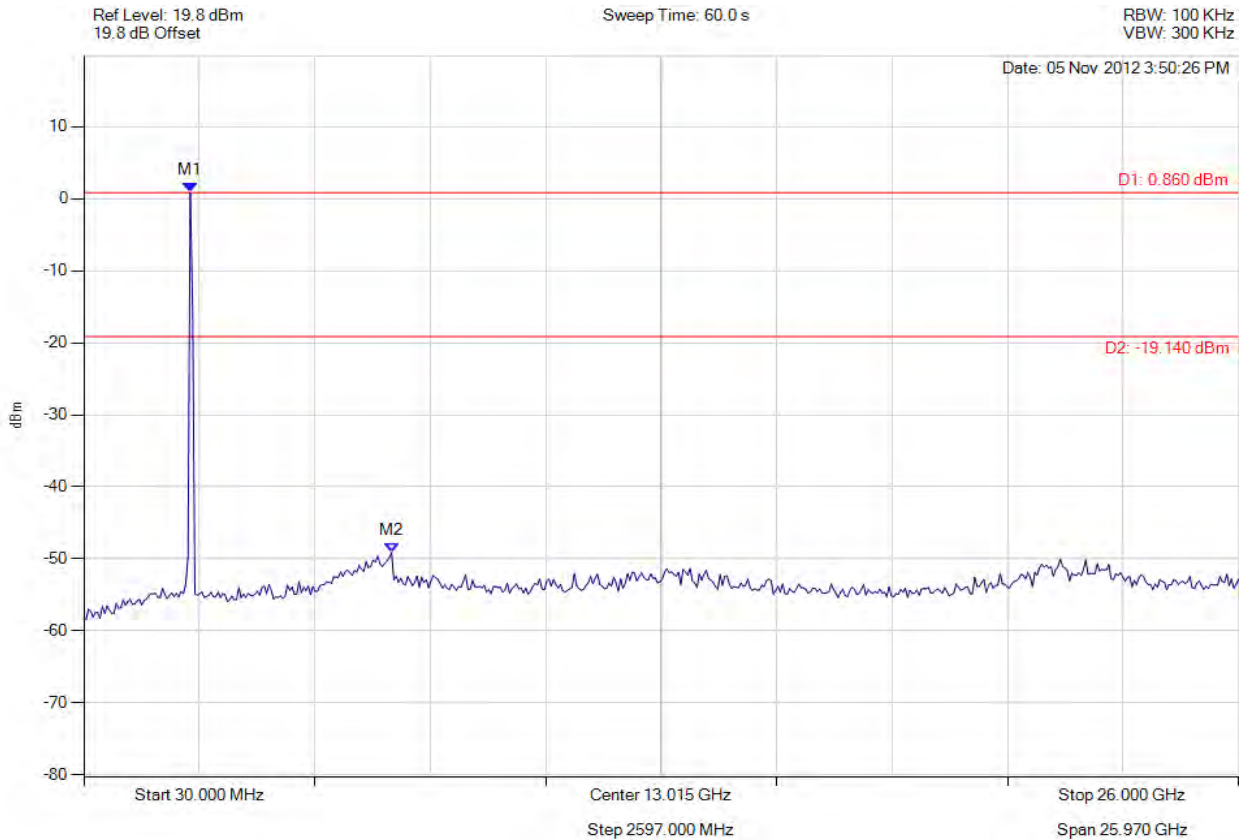

Analyser Setup	Marker : Frequency : Amplitude	Test Results
Detector = MAX PEAK Sweep Count = 0 RF Atten (dB) = 10 Trace Mode = VIEW	M1 : 2424.028 MHz : 0.860 dBm M2 : 6951.864 MHz : -49.122 dBm	Limit: -19.14 dBm Margin: =C13-D13 dB

[Back to the Matrix](#)

This test report may be reproduced in full only. The document may only be updated by MiCOM Labs personnel. Any changes will be noted in the Document History section of the report.



Title: Digi ConnectCard for i.MX28 with Atheros AR6233
To: FCC 47 CFR Part 15.247 & IC RSS-210
Serial #: DIGI28-U2A Rev A
Issue Date: 29th March 2013
Page: 226 of 245



CONDUCTED BAND-EDGE EMISSIONS

Variant: 802.11n HT-40, Channel: 2422.00 MHz, Chain a, Temp: Ambient, Voltage: 5 Vdc

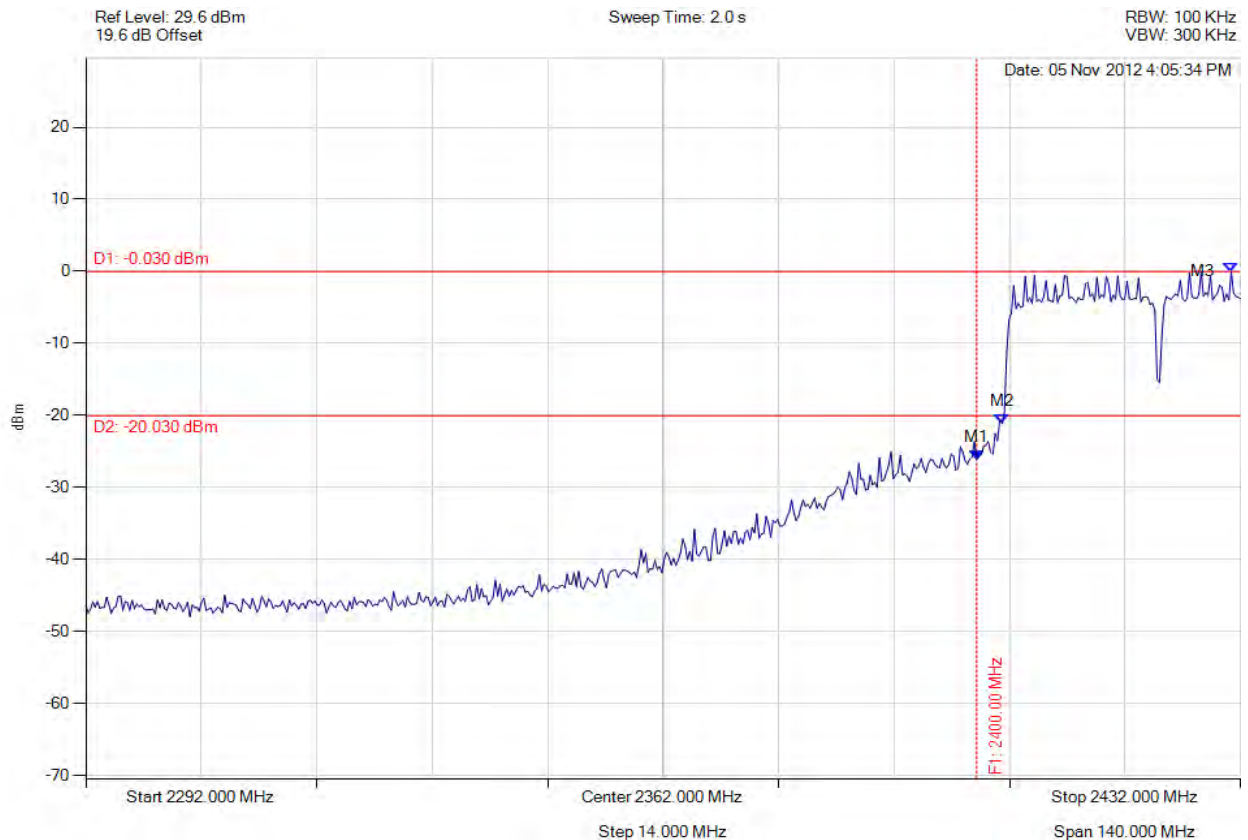

Analyser Setup	Marker : Frequency : Amplitude	Test Results
Detector = MAX PEAK Sweep Count = 0 RF Atten (dB) = 20 Trace Mode = VIEW	M1 : 2400.000 MHz : -26.139 dBm M2 : 2403.102 MHz : -21.081 dBm M3 : 2430.878 MHz : -0.030 dBm	Limit: -20.03 dBm Margin: =C20-D20 dB

[Back to the Matrix](#)

This test report may be reproduced in full only. The document may only be updated by MiCOM Labs personnel. Any changes will be noted in the Document History section of the report.



Title: Digi ConnectCard for i.MX28 with Atheros AR6233
To: FCC 47 CFR Part 15.247 & IC RSS-210
Serial #: DIGI28-U2A Rev A
Issue Date: 29th March 2013
Page: 227 of 245



CONDUCTED BAND-EDGE EMISSIONS

Variant: 802.11n HT-40, Channel: 2452.00 MHz, Chain a, Temp: Ambient, Voltage: 5 Vdc

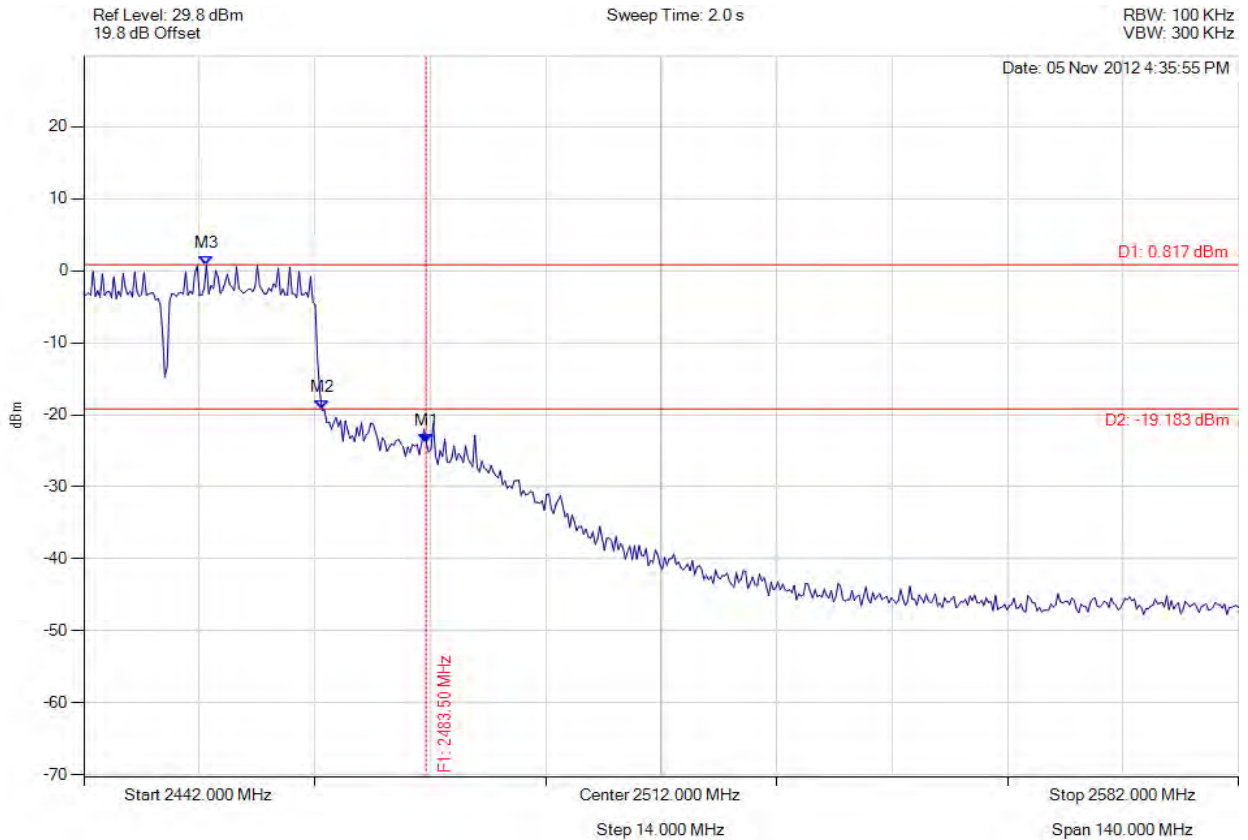

Analyser Setup	Marker : Frequency : Amplitude	Test Results
Detector = MAX PEAK Sweep Count = 0 RF Atten (dB) = 20 Trace Mode = VIEW	M1 : 2483.500 MHz : -23.907 dBm M2 : 2470.898 MHz : -19.327 dBm M3 : 2456.870 MHz : 0.817 dBm	Limit: -19.18 dBm Margin: =C22-D22 dB

[Back to the Matrix](#)

This test report may be reproduced in full only. The document may only be updated by MiCOM Labs personnel. Any changes will be noted in the Document History section of the report.



Title: Digi ConnectCard for i.MX28 with Atheros AR6233
To: FCC 47 CFR Part 15.247 & IC RSS-210
Serial #: DIGI28-U2A Rev A
Issue Date: 29th March 2013
Page: 228 of 245



CONDUCTED SPURIOUS EMISSIONS

Variant: 802.11n HT-40, Channel: 2422.00 MHz, Chain a, Temp: Ambient, Voltage: 5 Vdc

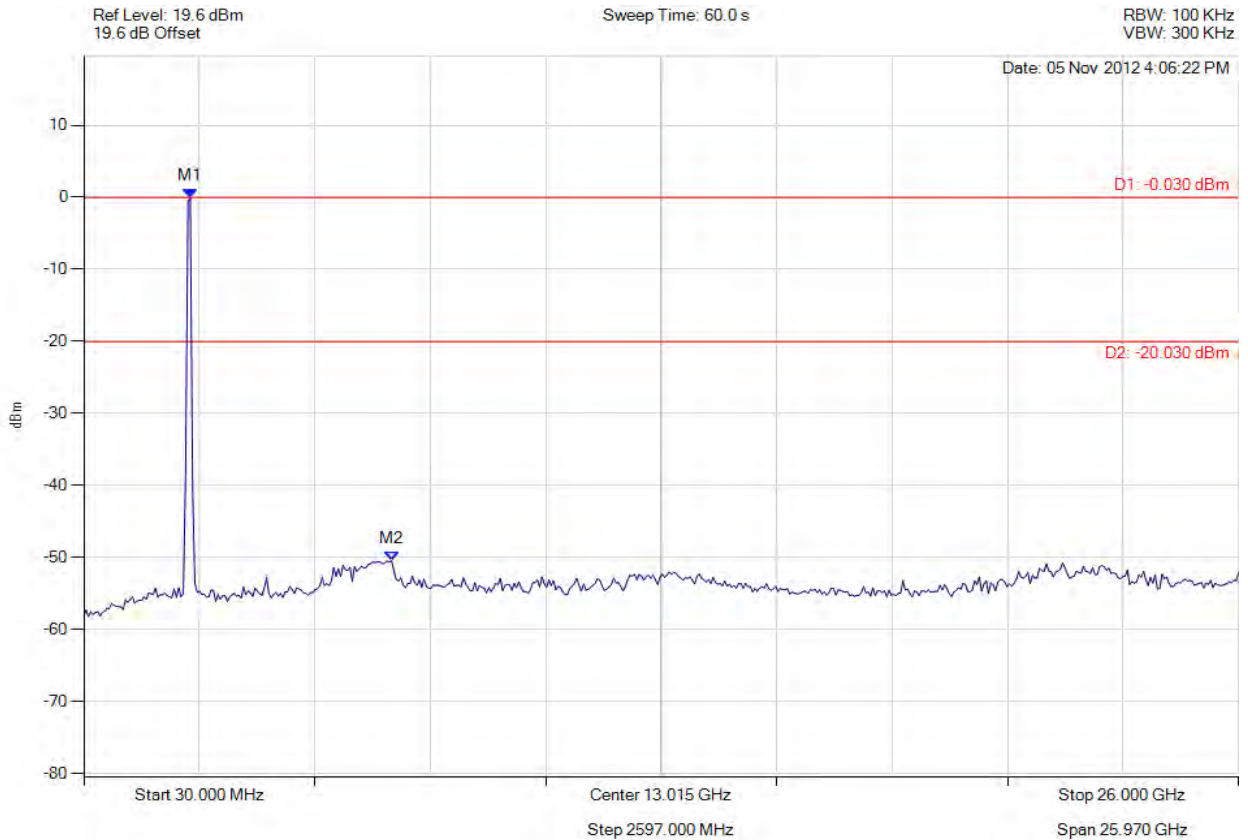

Analyser Setup	Marker : Frequency : Amplitude	Test Results
Detector = MAX PEAK Sweep Count = 0 RF Atten (dB) = 10 Trace Mode = VIEW	M1 : 2424.028 MHz : -0.030 dBm M2 : 6951.864 MHz : -50.481 dBm	Limit: -20.03 dBm Margin: =C11-D11 dB

[Back to the Matrix](#)

This test report may be reproduced in full only. The document may only be updated by MiCOM Labs personnel. Any changes will be noted in the Document History section of the report.



Title: Digi ConnectCard for i.MX28 with Atheros AR6233
To: FCC 47 CFR Part 15.247 & IC RSS-210
Serial #: DIGI28-U2A Rev A
Issue Date: 29th March 2013
Page: 229 of 245



CONDUCTED SPURIOUS EMISSIONS

Variant: 802.11n HT-40, Channel: 2437.00 MHz, Chain a, Temp: Ambient, Voltage: 5 Vdc

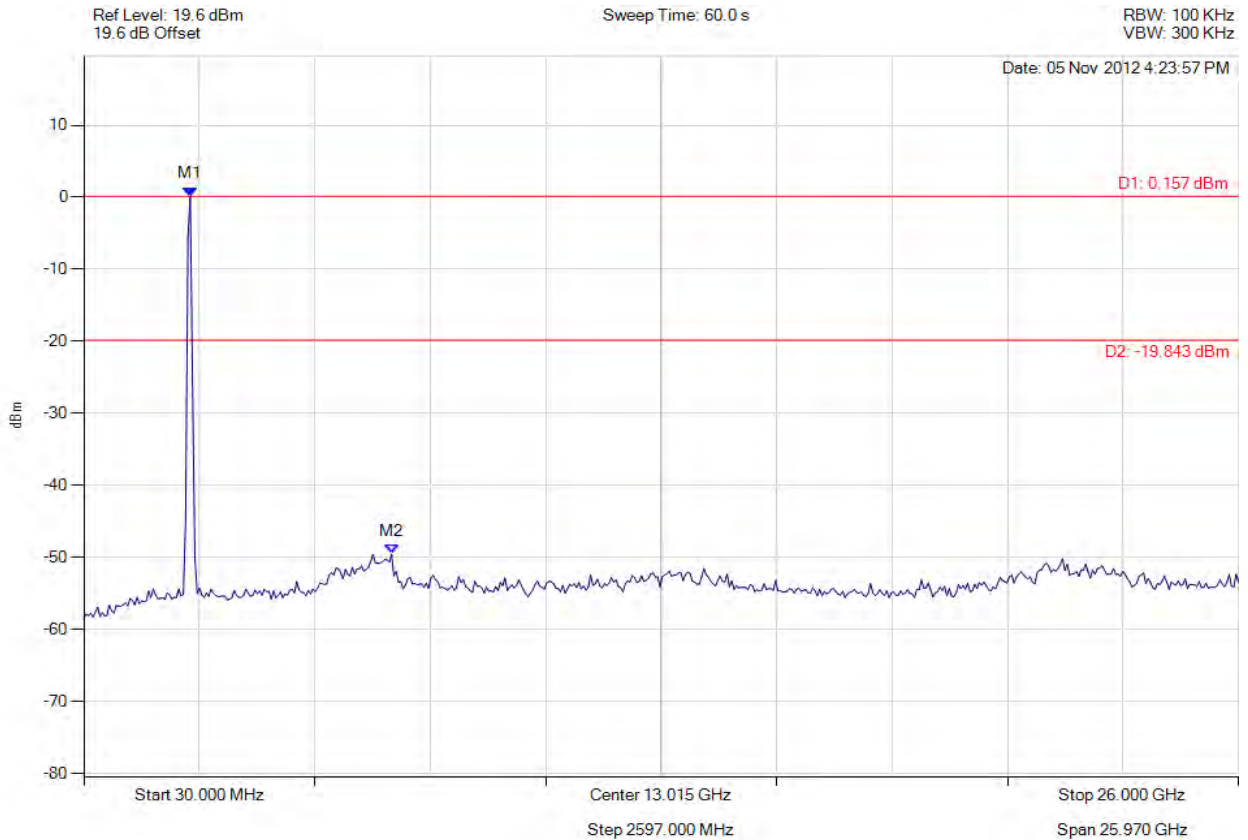

Analyser Setup	Marker : Frequency : Amplitude	Test Results
Detector = MAX PEAK Sweep Count = 0 RF Atten (dB) = 10 Trace Mode = VIEW	M1 : 2424.028 MHz : 0.157 dBm M2 : 6951.864 MHz : -49.523 dBm	Limit: -19.84 dBm Margin: =C12-D12 dB

[Back to the Matrix](#)

This test report may be reproduced in full only. The document may only be updated by MiCOM Labs personnel. Any changes will be noted in the Document History section of the report.



Title: Digi ConnectCard for i.MX28 with Atheros AR6233
To: FCC 47 CFR Part 15.247 & IC RSS-210
Serial #: DIGI28-U2A Rev A
Issue Date: 29th March 2013
Page: 230 of 245



CONDUCTED SPURIOUS EMISSIONS

Variant: 802.11n HT-40, Channel: 2452.00 MHz, Chain a, Temp: Ambient, Voltage: 5 Vdc

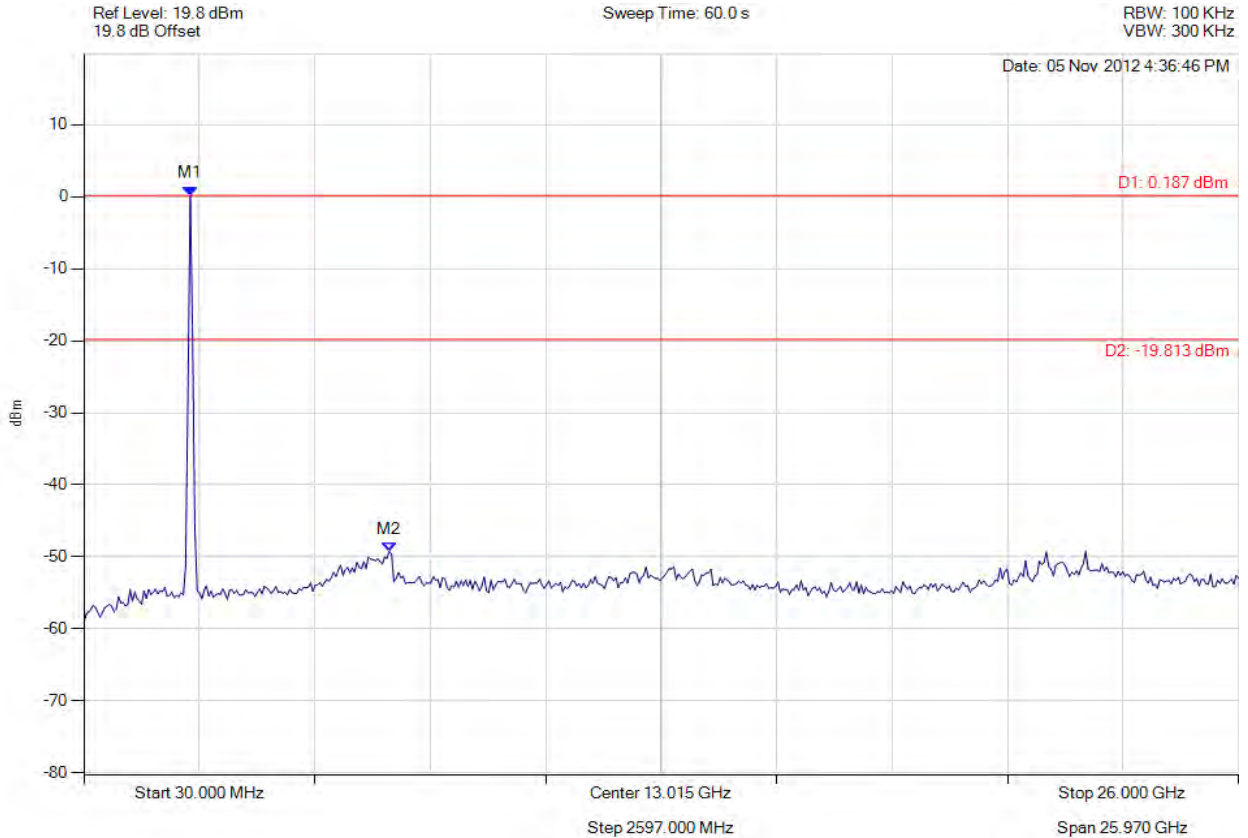

Analyser Setup	Marker : Frequency : Amplitude	Test Results
Detector = MAX PEAK Sweep Count = 0 RF Atten (dB) = 10 Trace Mode = VIEW	M1 : 2424.028 MHz : 0.187 dBm M2 : 6899.820 MHz : -49.219 dBm	Limit: -19.81 dBm Margin: =C13-D13 dB

[Back to the Matrix](#)

This test report may be reproduced in full only. The document may only be updated by MiCOM Labs personnel. Any changes will be noted in the Document History section of the report.



Title: Digi ConnectCard for i.MX28 with Atheros AR6233
To: FCC 47 CFR Part 15.247 & IC RSS-210
Serial #: DIGI28-U2A Rev A
Issue Date: 29th March 2013
Page: 231 of 245



CONDUCTED BAND-EDGE EMISSIONS

Variant: 802.11a, Channel: 5745.00 MHz, Chain a, Temp: Ambient, Voltage: 5 Vdc

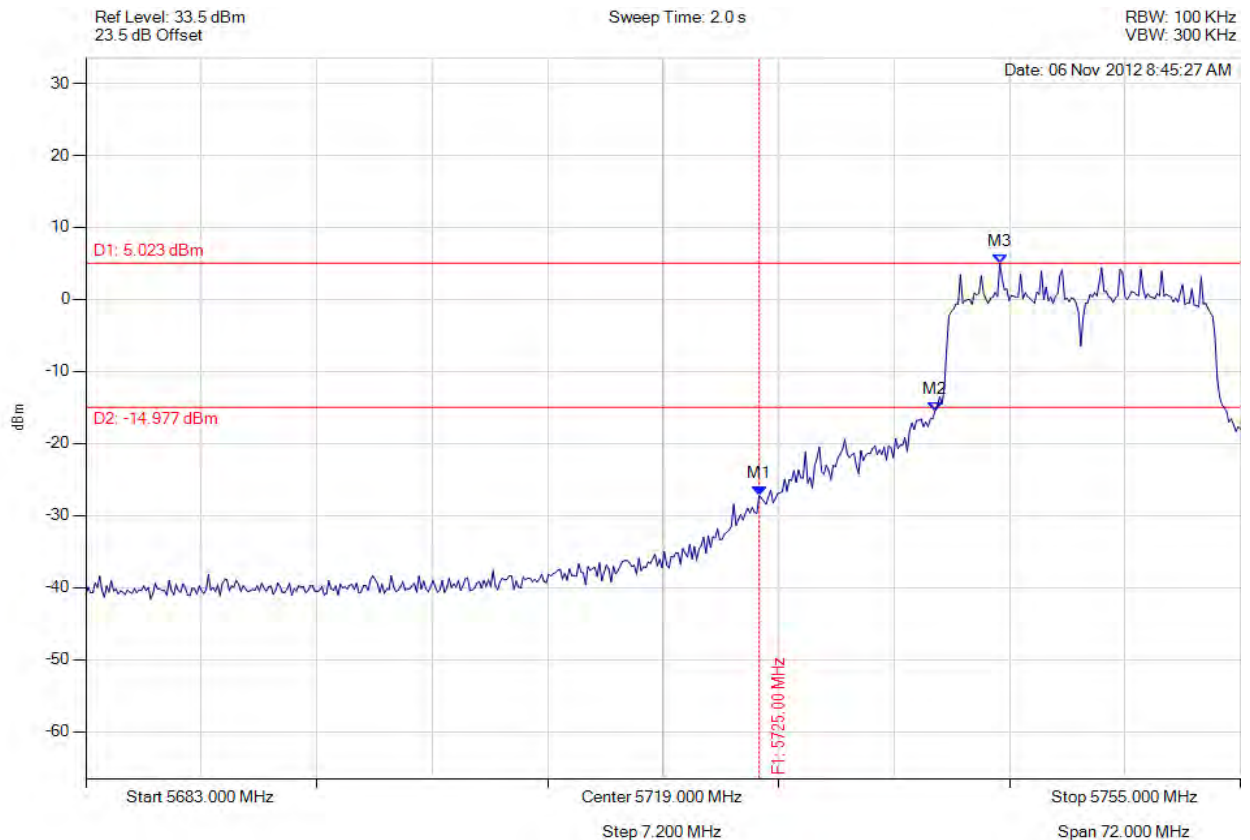

Analyser Setup	Marker : Frequency : Amplitude	Test Results
Detector = MAX PEAK Sweep Count = 0 RF Atten (dB) = 20 Trace Mode = VIEW	M1 : 5725.000 MHz : -27.211 dBm M2 : 5735.954 MHz : -15.538 dBm M3 : 5739.994 MHz : 5.023 dBm	Limit: -14.98 dBm Margin: =C20-D20 dB

[Back to the Matrix](#)

This test report may be reproduced in full only. The document may only be updated by MiCOM Labs personnel. Any changes will be noted in the Document History section of the report.



Title: Digi ConnectCard for i.MX28 with Atheros AR6233
To: FCC 47 CFR Part 15.247 & IC RSS-210
Serial #: DIGI28-U2A Rev A
Issue Date: 29th March 2013
Page: 232 of 245



CONDUCTED BAND-EDGE EMISSIONS

Variant: 802.11a, Channel: 5825.00 MHz, Chain a, Temp: Ambient, Voltage: 5 Vdc

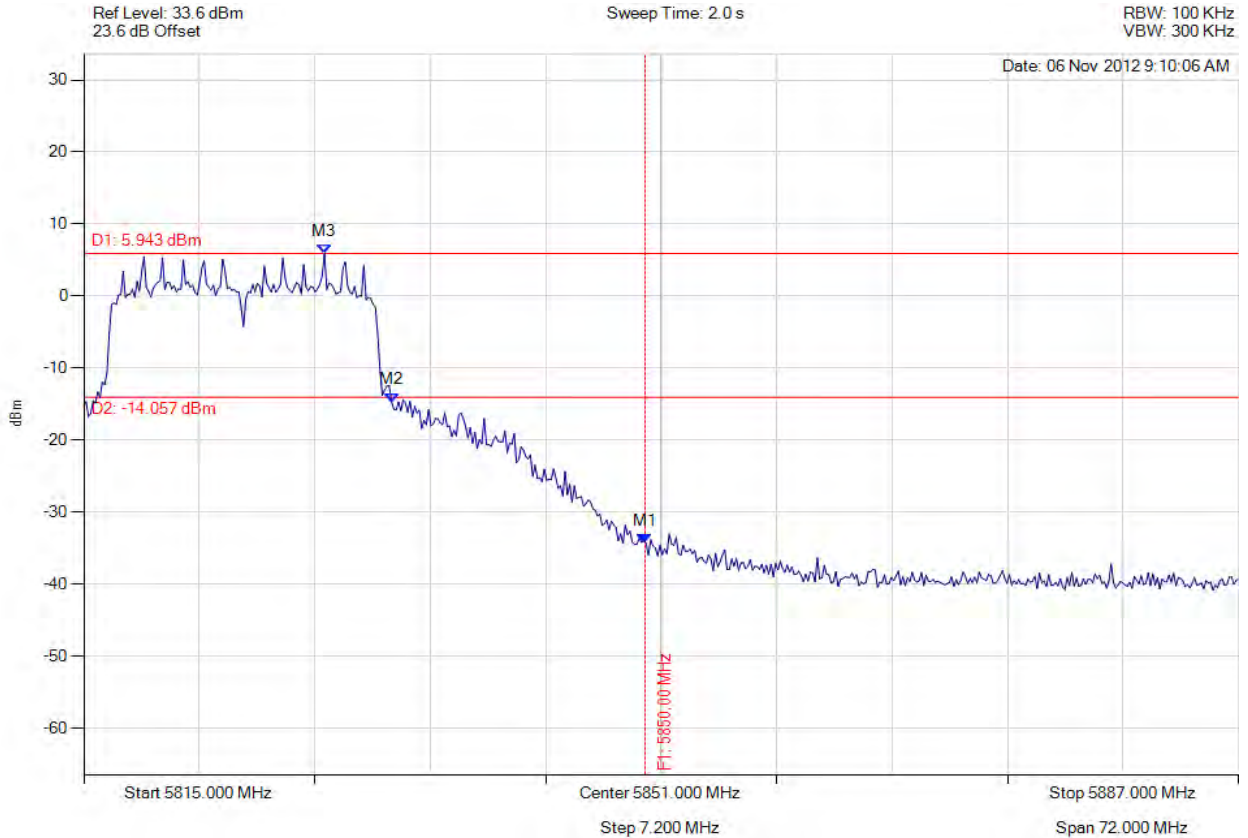

Analyser Setup	Marker : Frequency : Amplitude	Test Results
Detector = MAX PEAK Sweep Count = 0 RF Atten (dB) = 20 Trace Mode = VIEW	M1 : 5850.000 MHz : -34.240 dBm M2 : 5834.190 MHz : -14.699 dBm M3 : 5830.006 MHz : 5.943 dBm	Limit: -14.06 dBm Margin: =C22-D22 dB

[Back to the Matrix](#)

This test report may be reproduced in full only. The document may only be updated by MiCOM Labs personnel. Any changes will be noted in the Document History section of the report.



Title: Digi ConnectCard for i.MX28 with Atheros AR6233
To: FCC 47 CFR Part 15.247 & IC RSS-210
Serial #: DIGI28-U2A Rev A
Issue Date: 29th March 2013
Page: 233 of 245



CONDUCTED SPURIOUS EMISSIONS

Variant: 802.11a, Channel: 5745.00 MHz, Chain a, Temp: Ambient, Voltage: 5 Vdc

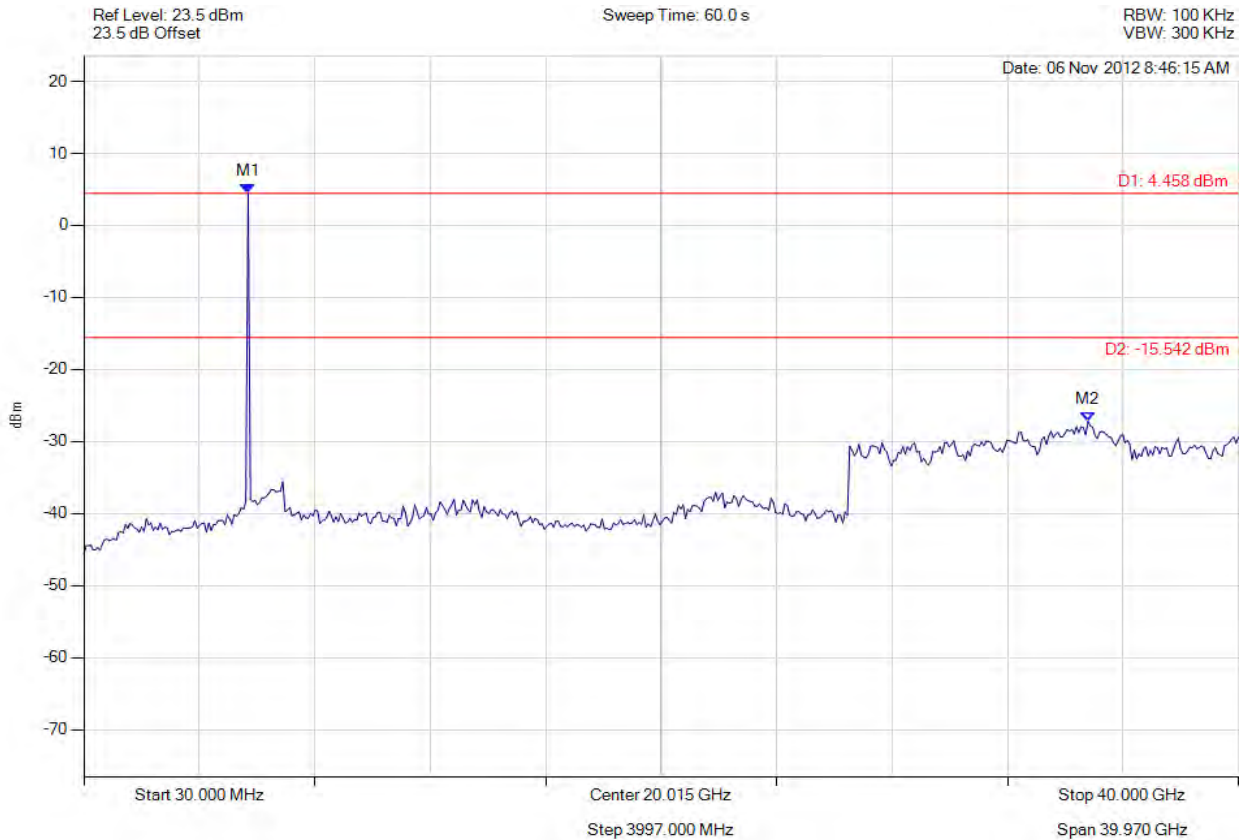

Analyser Setup	Marker : Frequency : Amplitude	Test Results
Detector = MAX PEAK Sweep Count = 0 RF Atten (dB) = 20 Trace Mode = VIEW	M1 : 5717.114 MHz : 4.458 dBm M2 : 34.793 GHz : -27.195 dBm	Limit: -15.54 dBm Margin: =C11-D11 dB

[Back to the Matrix](#)

This test report may be reproduced in full only. The document may only be updated by MiCOM Labs personnel. Any changes will be noted in the Document History section of the report.



Title: Digi ConnectCard for i.MX28 with Atheros AR6233
To: FCC 47 CFR Part 15.247 & IC RSS-210
Serial #: DIGI28-U2A Rev A
Issue Date: 29th March 2013
Page: 234 of 245



CONDUCTED SPURIOUS EMISSIONS

Variant: 802.11a, Channel: 5785.00 MHz, Chain a, Temp: Ambient, Voltage: 5 Vdc

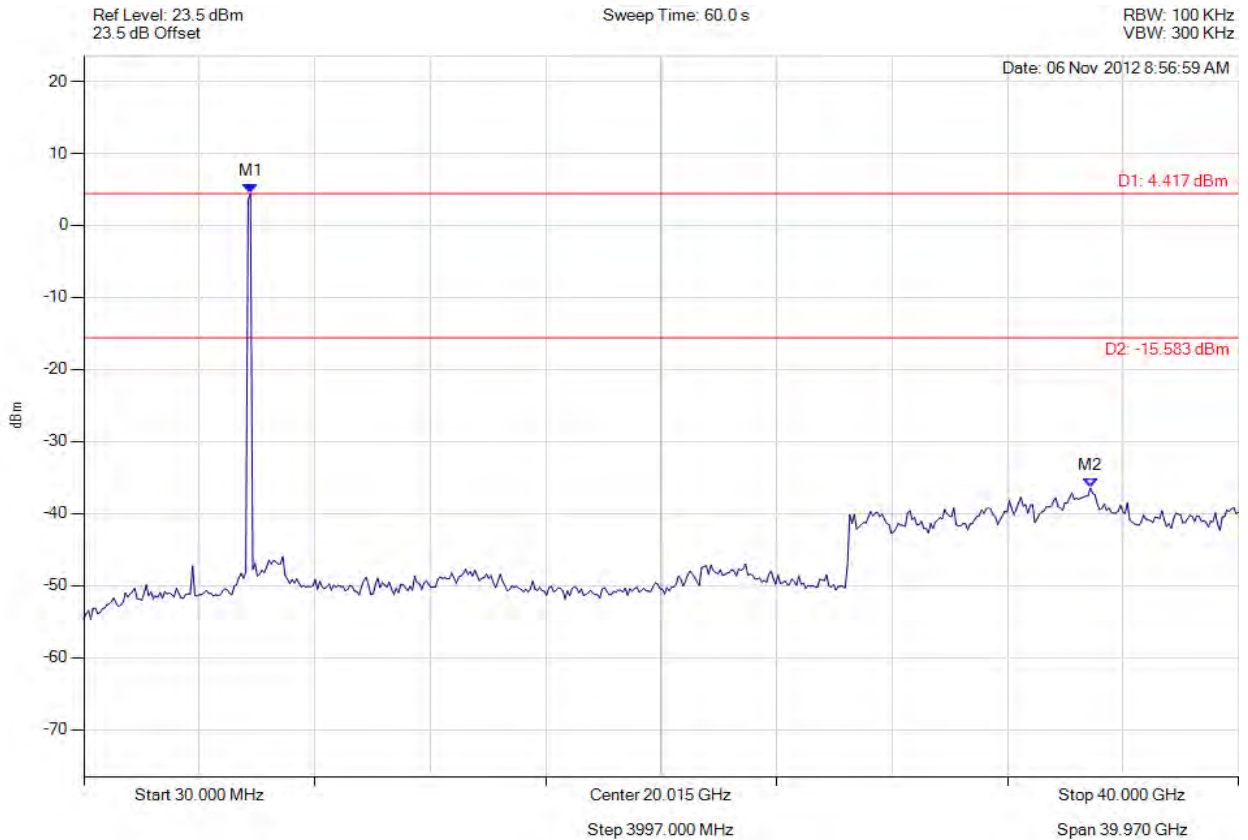

Analyser Setup	Marker : Frequency : Amplitude	Test Results
Detector = MAX PEAK Sweep Count = 0 RF Atten (dB) = 10 Trace Mode = VIEW	M1 : 5797.214 MHz : 4.417 dBm M2 : 34.874 GHz : -36.451 dBm	Limit: -15.58 dBm Margin: =C12-D12 dB

[Back to the Matrix](#)

This test report may be reproduced in full only. The document may only be updated by MiCOM Labs personnel. Any changes will be noted in the Document History section of the report.



Title: Digi ConnectCard for i.MX28 with Atheros AR6233
To: FCC 47 CFR Part 15.247 & IC RSS-210
Serial #: DIGI28-U2A Rev A
Issue Date: 29th March 2013
Page: 235 of 245



CONDUCTED SPURIOUS EMISSIONS

Variant: 802.11a, Channel: 5825.00 MHz, Chain a, Temp: Ambient, Voltage: 5 Vdc

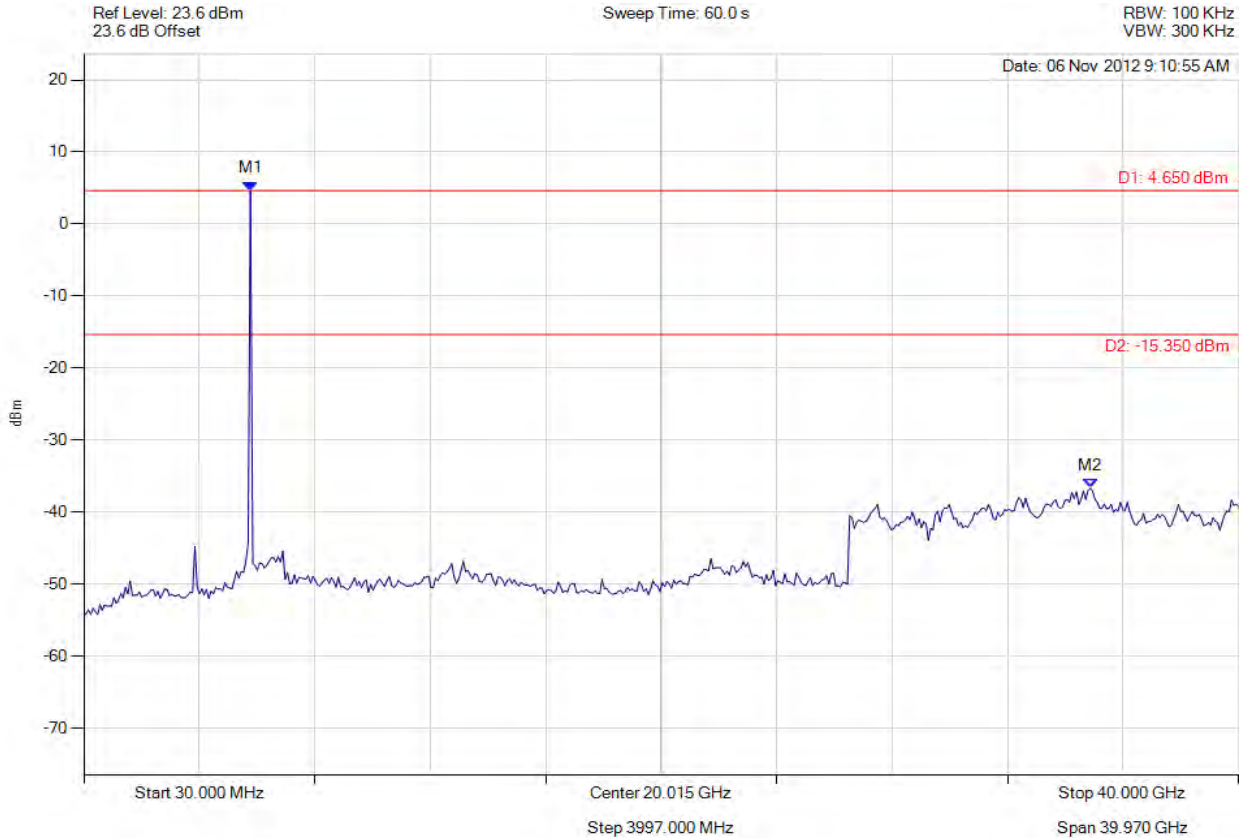

Analyser Setup	Marker : Frequency : Amplitude	Test Results
Detector = MAX PEAK Sweep Count = 0 RF Atten (dB) = 10 Trace Mode = VIEW	M1 : 5797.214 MHz : 4.650 dBm M2 : 34.874 GHz : -36.672 dBm	Limit: -15.35 dBm Margin: =C13-D13 dB

[Back to the Matrix](#)

This test report may be reproduced in full only. The document may only be updated by MiCOM Labs personnel. Any changes will be noted in the Document History section of the report.



Title: Digi ConnectCard for i.MX28 with Atheros AR6233
To: FCC 47 CFR Part 15.247 & IC RSS-210
Serial #: DIGI28-U2A Rev A
Issue Date: 29th March 2013
Page: 236 of 245



CONDUCTED BAND-EDGE EMISSIONS

Variant: 802.11n HT-20, Channel: 5745.00 MHz, Chain a, Temp: Ambient, Voltage: 5 Vdc

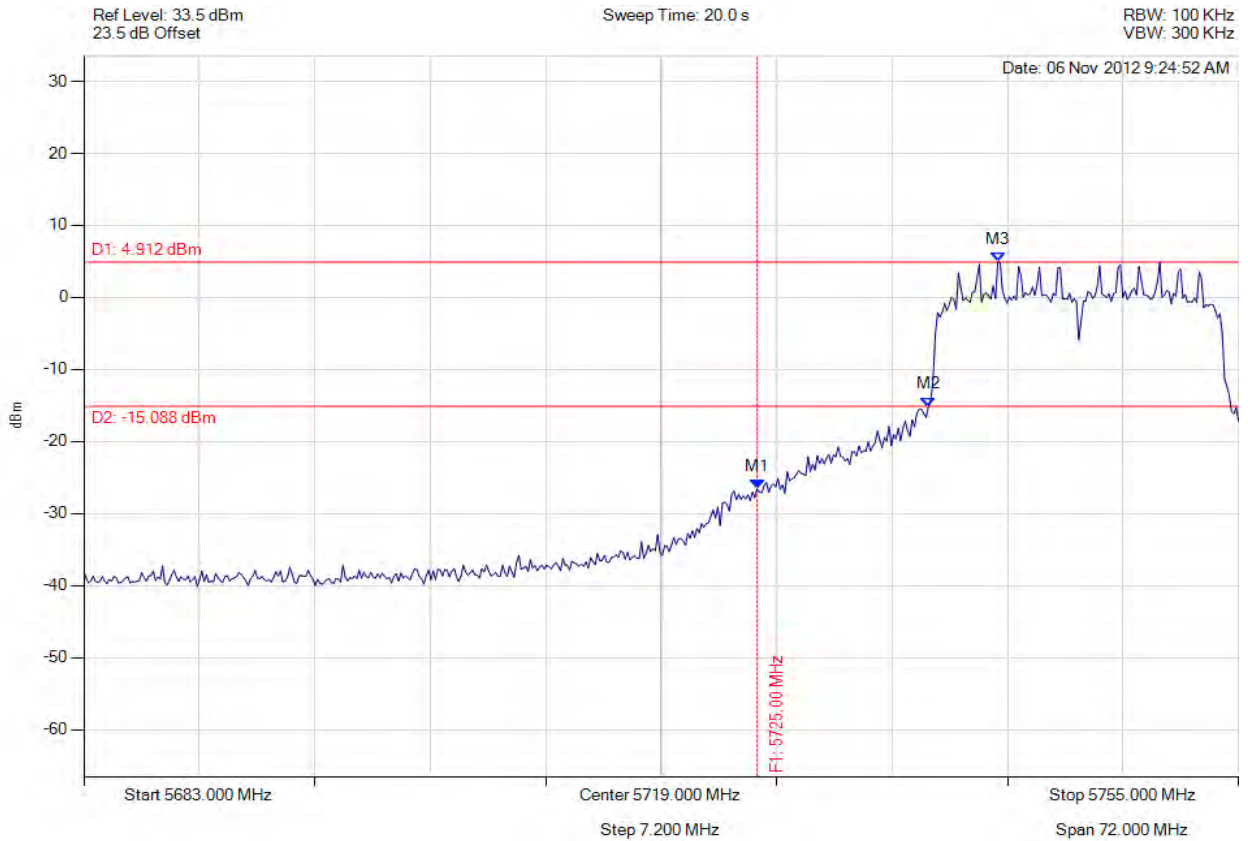

Analyser Setup	Marker : Frequency : Amplitude	Test Results
Detector = MAX PEAK Sweep Count = 0 RF Atten (dB) = 20 Trace Mode = VIEW	M1 : 5725.000 MHz : -26.573 dBm M2 : 5735.665 MHz : -15.129 dBm M3 : 5739.994 MHz : 4.912 dBm	Limit: -15.09 dBm Margin: =C20-D20 dB

[Back to the Matrix](#)

This test report may be reproduced in full only. The document may only be updated by MiCOM Labs personnel. Any changes will be noted in the Document History section of the report.



Title: Digi ConnectCard for i.MX28 with Atheros AR6233
To: FCC 47 CFR Part 15.247 & IC RSS-210
Serial #: DIGI28-U2A Rev A
Issue Date: 29th March 2013
Page: 237 of 245



CONDUCTED BAND-EDGE EMISSIONS

Variant: 802.11n HT-20, Channel: 5825.00 MHz, Chain a, Temp: Ambient, Voltage: 5 Vdc

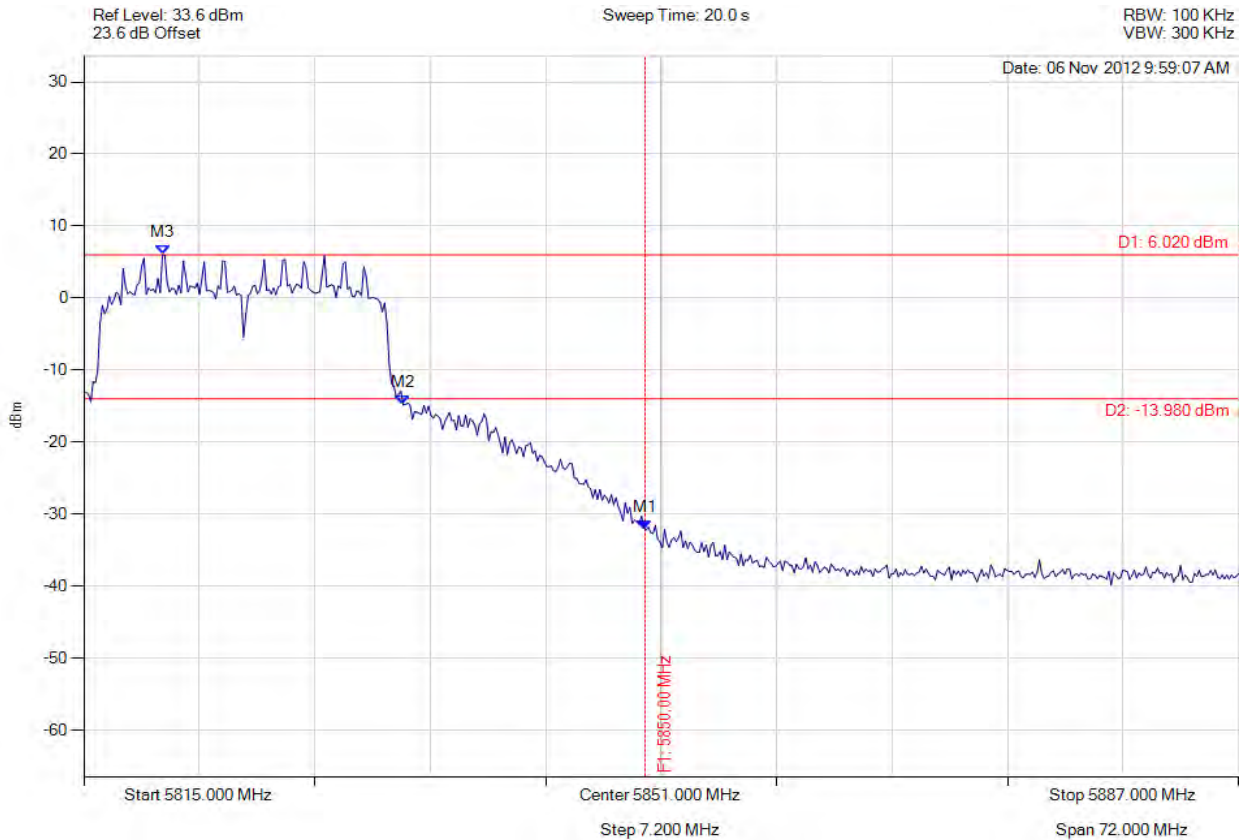

Analyser Setup	Marker : Frequency : Amplitude	Test Results
Detector = MAX PEAK Sweep Count = 0 RF Atten (dB) = 20 Trace Mode = VIEW	M1 : 5850.000 MHz : -32.167 dBm M2 : 5834.912 MHz : -14.807 dBm M3 : 5819.906 MHz : 6.020 dBm	Limit: -13.98 dBm Margin: =C22-D22 dB

[Back to the Matrix](#)

This test report may be reproduced in full only. The document may only be updated by MiCOM Labs personnel. Any changes will be noted in the Document History section of the report.



Title: Digi ConnectCard for i.MX28 with Atheros AR6233
To: FCC 47 CFR Part 15.247 & IC RSS-210
Serial #: DIGI28-U2A Rev A
Issue Date: 29th March 2013
Page: 238 of 245



CONDUCTED SPURIOUS EMISSIONS

Variant: 802.11n HT-20, Channel: 5745.00 MHz, Chain a, Temp: Ambient, Voltage: 5 Vdc

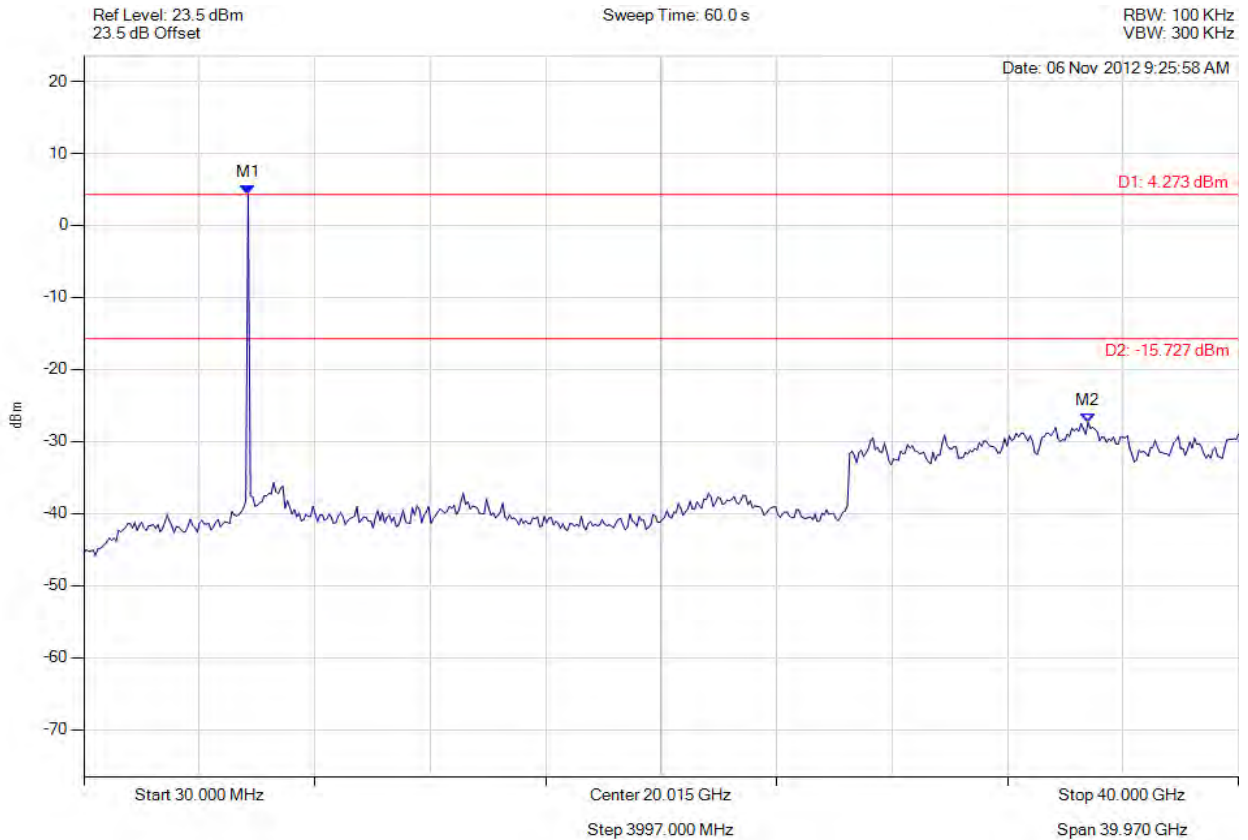

Analyser Setup	Marker : Frequency : Amplitude	Test Results
Detector = MAX PEAK Sweep Count = 0 RF Atten (dB) = 20 Trace Mode = VIEW	M1 : 5717.114 MHz : 4.273 dBm M2 : 34.793 GHz : -27.360 dBm	Limit: -15.73 dBm Margin: =C11-D11 dB

[Back to the Matrix](#)

This test report may be reproduced in full only. The document may only be updated by MiCOM Labs personnel. Any changes will be noted in the Document History section of the report.



Title: Digi ConnectCard for i.MX28 with Atheros AR6233
To: FCC 47 CFR Part 15.247 & IC RSS-210
Serial #: DIGI28-U2A Rev A
Issue Date: 29th March 2013
Page: 239 of 245



CONDUCTED SPURIOUS EMISSIONS

Variant: 802.11n HT-20, Channel: 5785.00 MHz, Chain a, Temp: Ambient, Voltage: 5 Vdc

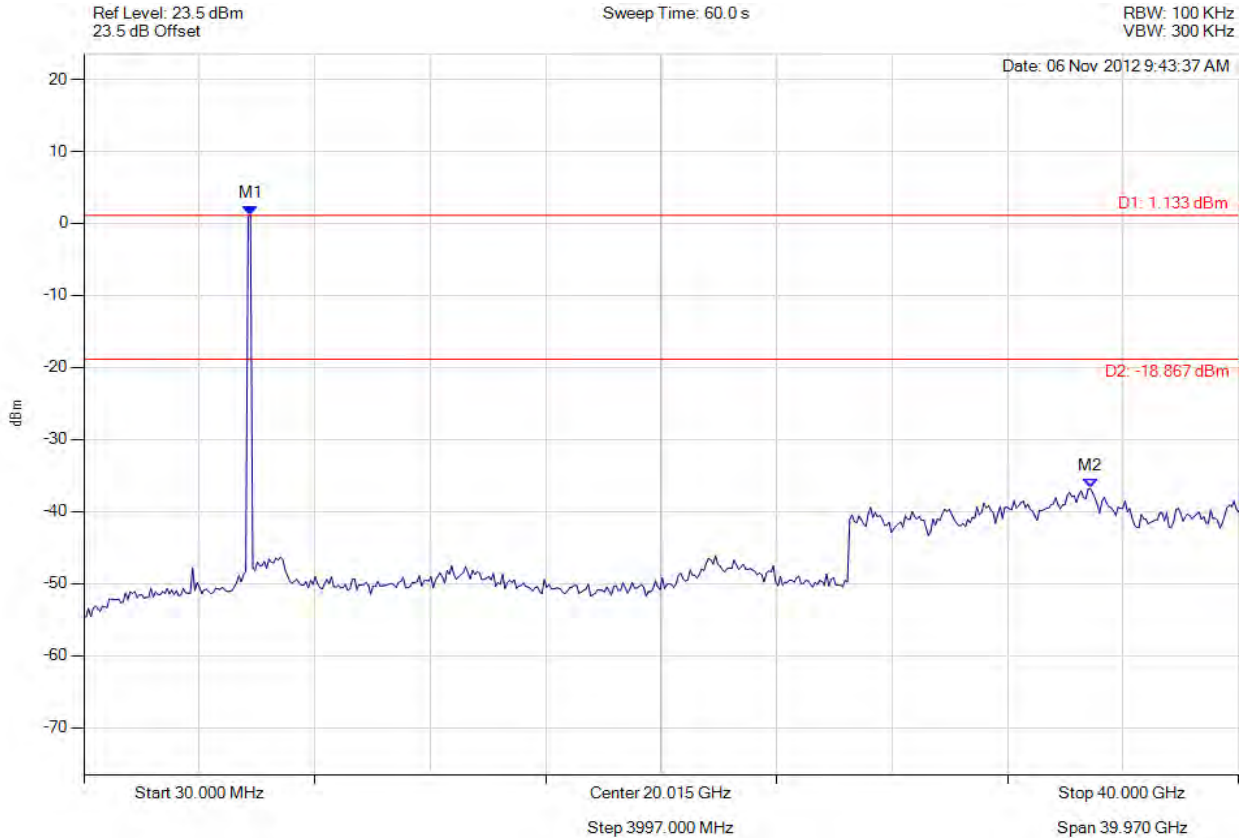

Analyser Setup	Marker : Frequency : Amplitude	Test Results
Detector = MAX PEAK Sweep Count = 0 RF Atten (dB) = 10 Trace Mode = VIEW	M1 : 5797.214 MHz : 1.133 dBm M2 : 34.874 GHz : -36.792 dBm	Limit: -18.87 dBm Margin: =C12-D12 dB

[Back to the Matrix](#)

This test report may be reproduced in full only. The document may only be updated by MiCOM Labs personnel. Any changes will be noted in the Document History section of the report.



Title: Digi ConnectCard for i.MX28 with Atheros AR6233
To: FCC 47 CFR Part 15.247 & IC RSS-210
Serial #: DIGI28-U2A Rev A
Issue Date: 29th March 2013
Page: 240 of 245



CONDUCTED SPURIOUS EMISSIONS

Variant: 802.11n HT-20, Channel: 5825.00 MHz, Chain a, Temp: Ambient, Voltage: 5 Vdc

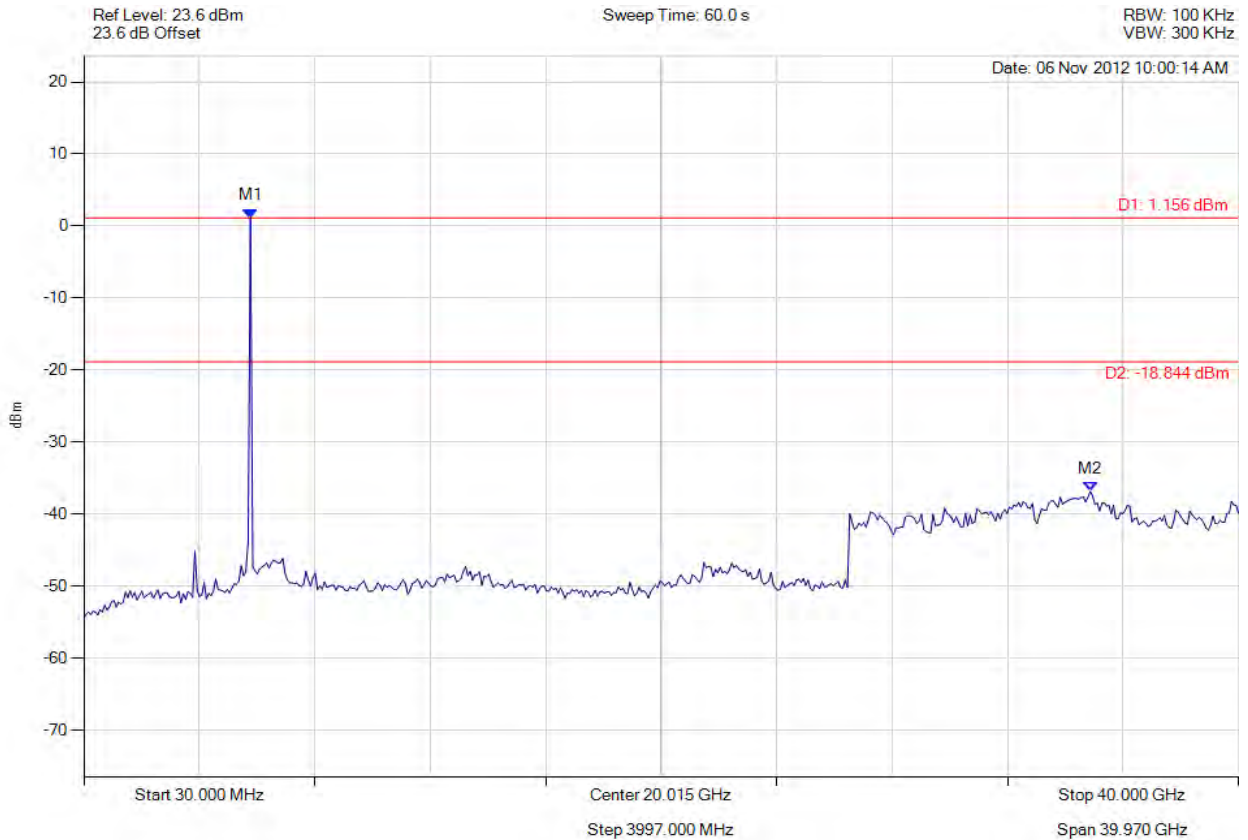

Analyser Setup	Marker : Frequency : Amplitude	Test Results
Detector = MAX PEAK Sweep Count = 0 RF Atten (dB) = 10 Trace Mode = VIEW	M1 : 5797.214 MHz : 1.156 dBm M2 : 34.874 GHz : -36.847 dBm	Limit: -18.84 dBm Margin: =C13-D13 dB

[Back to the Matrix](#)

This test report may be reproduced in full only. The document may only be updated by MiCOM Labs personnel. Any changes will be noted in the Document History section of the report.



Title: Digi ConnectCard for i.MX28 with Atheros AR6233
To: FCC 47 CFR Part 15.247 & IC RSS-210
Serial #: DIGI28-U2A Rev A
Issue Date: 29th March 2013
Page: 241 of 245



CONDUCTED BAND-EDGE EMISSIONS

Variant: 802.11n HT-40, Channel: 5755.00 MHz, Chain a, Temp: Ambient, Voltage: 5 Vdc

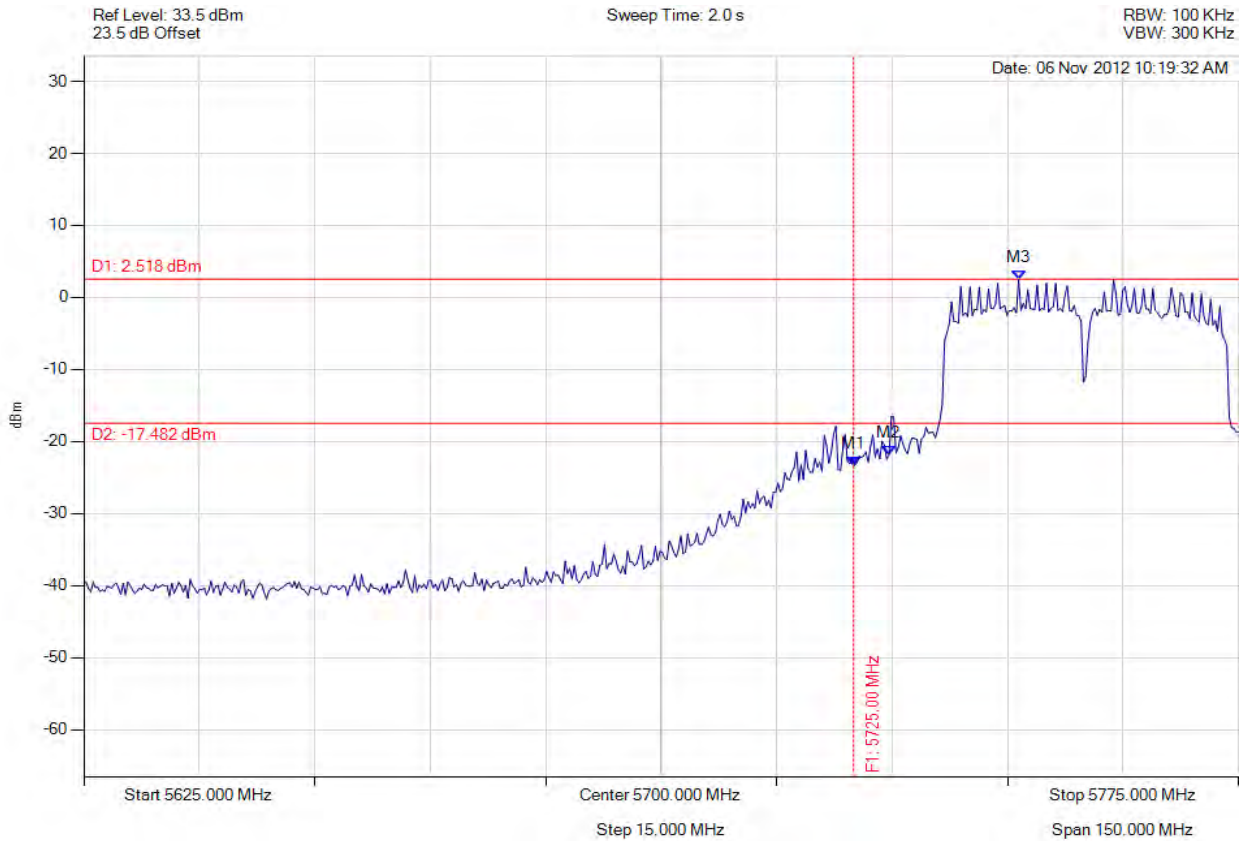

Analyser Setup	Marker : Frequency : Amplitude	Test Results
Detector = MAX PEAK Sweep Count = 0 RF Atten (dB) = 20 Trace Mode = VIEW	M1 : 5725.000 MHz : -23.333 dBm M2 : 5729.609 MHz : -21.816 dBm M3 : 5746.443 MHz : 2.518 dBm	Limit: -17.48 dBm Margin: =C20-D20 dB

[Back to the Matrix](#)

This test report may be reproduced in full only. The document may only be updated by MiCOM Labs personnel. Any changes will be noted in the Document History section of the report.



Title: Digi ConnectCard for i.MX28 with Atheros AR6233
To: FCC 47 CFR Part 15.247 & IC RSS-210
Serial #: DIGI28-U2A Rev A
Issue Date: 29th March 2013
Page: 242 of 245



CONDUCTED BAND-EDGE EMISSIONS

Variant: 802.11n HT-40, Channel: 5795.00 MHz, Chain a, Temp: Ambient, Voltage: 5 Vdc

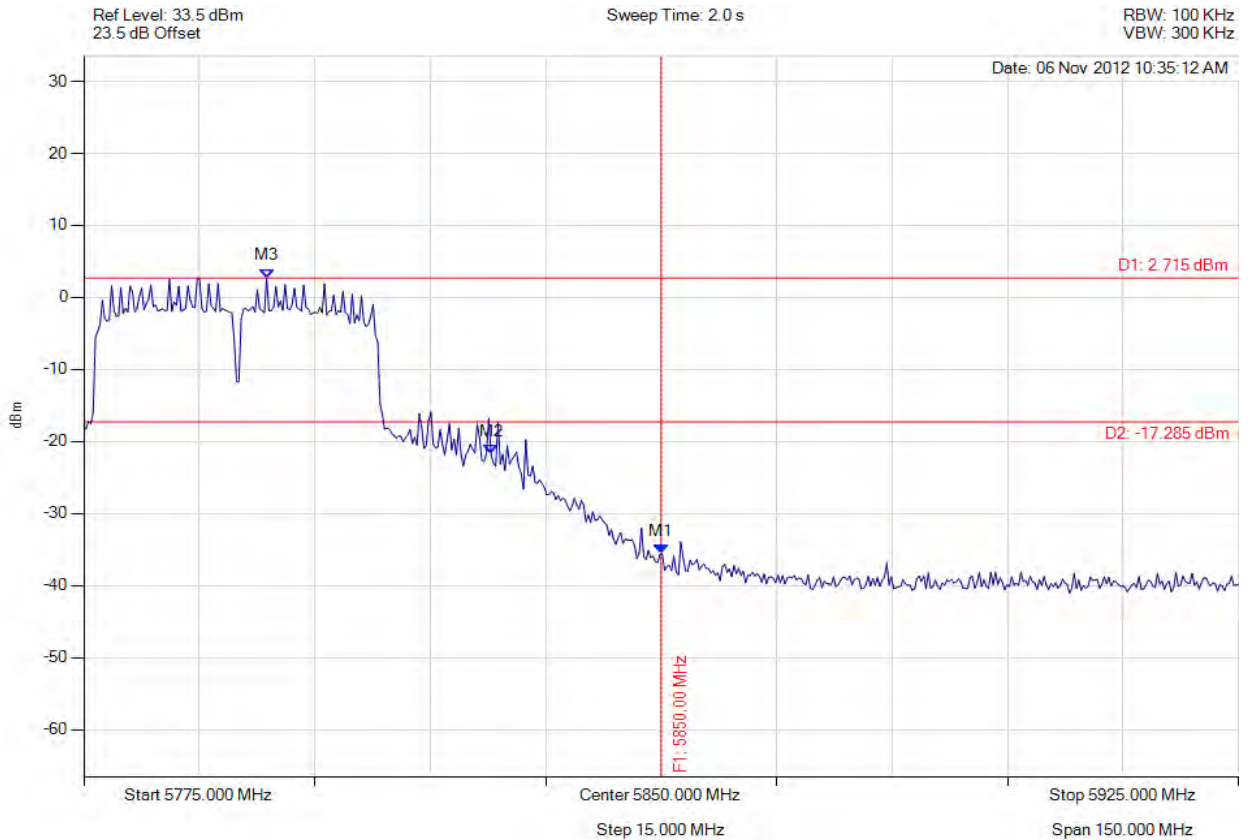

Analyser Setup	Marker : Frequency : Amplitude	Test Results
Detector = MAX PEAK Sweep Count = 0 RF Atten (dB) = 20 Trace Mode = VIEW	M1 : 5850.000 MHz : -35.613 dBm M2 : 5827.906 MHz : -21.789 dBm M3 : 5798.747 MHz : 2.715 dBm	Limit: -17.29 dBm Margin: =C21-D21 dB

[Back to the Matrix](#)

This test report may be reproduced in full only. The document may only be updated by MiCOM Labs personnel. Any changes will be noted in the Document History section of the report.



Title: Digi ConnectCard for i.MX28 with Atheros AR6233
To: FCC 47 CFR Part 15.247 & IC RSS-210
Serial #: DIGI28-U2A Rev A
Issue Date: 29th March 2013
Page: 243 of 245



CONDUCTED SPURIOUS EMISSIONS

Variant: 802.11n HT-40, Channel: 5755.00 MHz, Chain a, Temp: Ambient, Voltage: 5 Vdc

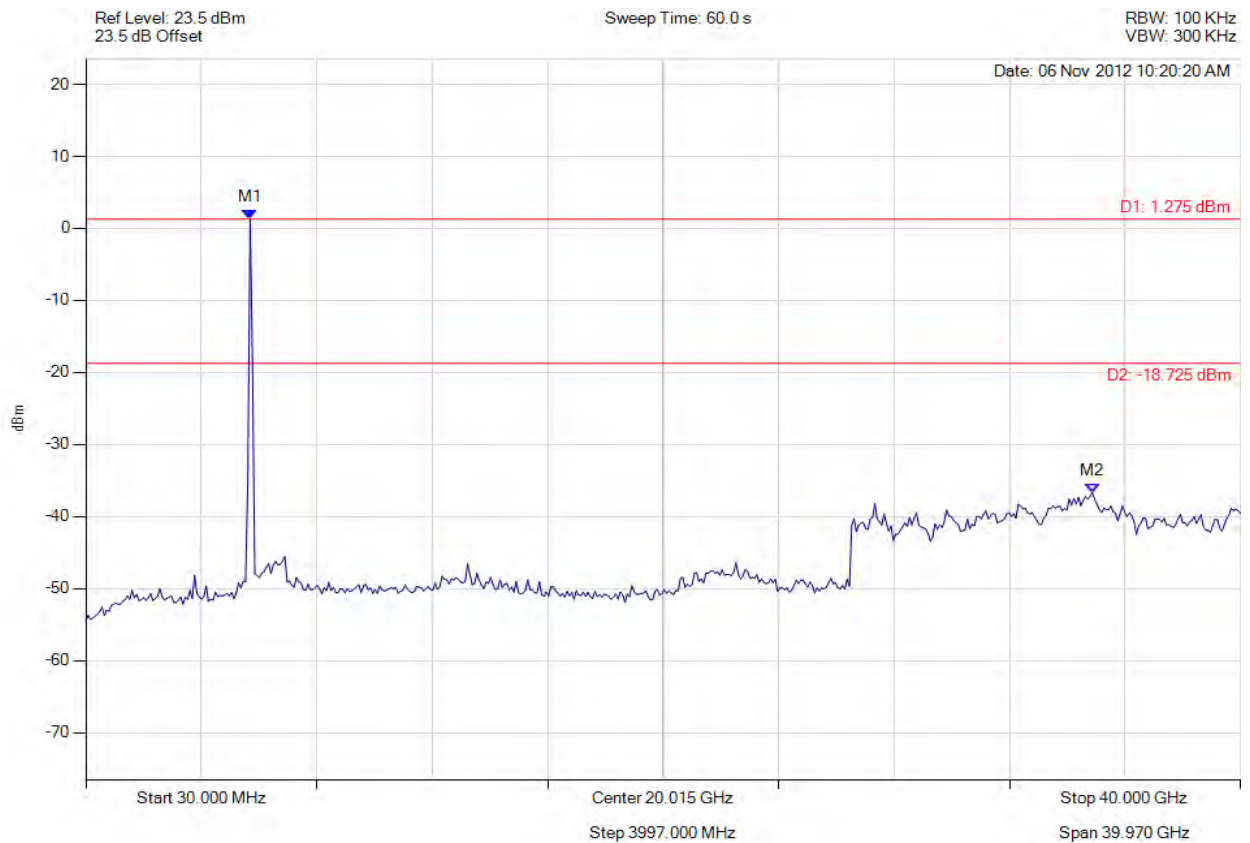

Analyser Setup	Marker : Frequency : Amplitude	Test Results
Detector = MAX PEAK Sweep Count = 0 RF Atten (dB) = 10 Trace Mode = VIEW	M1 : 5717.114 MHz : 1.275 dBm M2 : 34.874 GHz : -36.691 dBm	Limit: -18.73 dBm Margin: =C11-D11 dB

[Back to the Matrix](#)

This test report may be reproduced in full only. The document may only be updated by MiCOM Labs personnel. Any changes will be noted in the Document History section of the report.



Title: Digi ConnectCard for i.MX28 with Atheros AR6233
To: FCC 47 CFR Part 15.247 & IC RSS-210
Serial #: DIGI28-U2A Rev A
Issue Date: 29th March 2013
Page: 244 of 245



CONDUCTED SPURIOUS EMISSIONS

Variant: 802.11n HT-40, Channel: 5795.00 MHz, Chain a, Temp: Ambient, Voltage: 5 Vdc

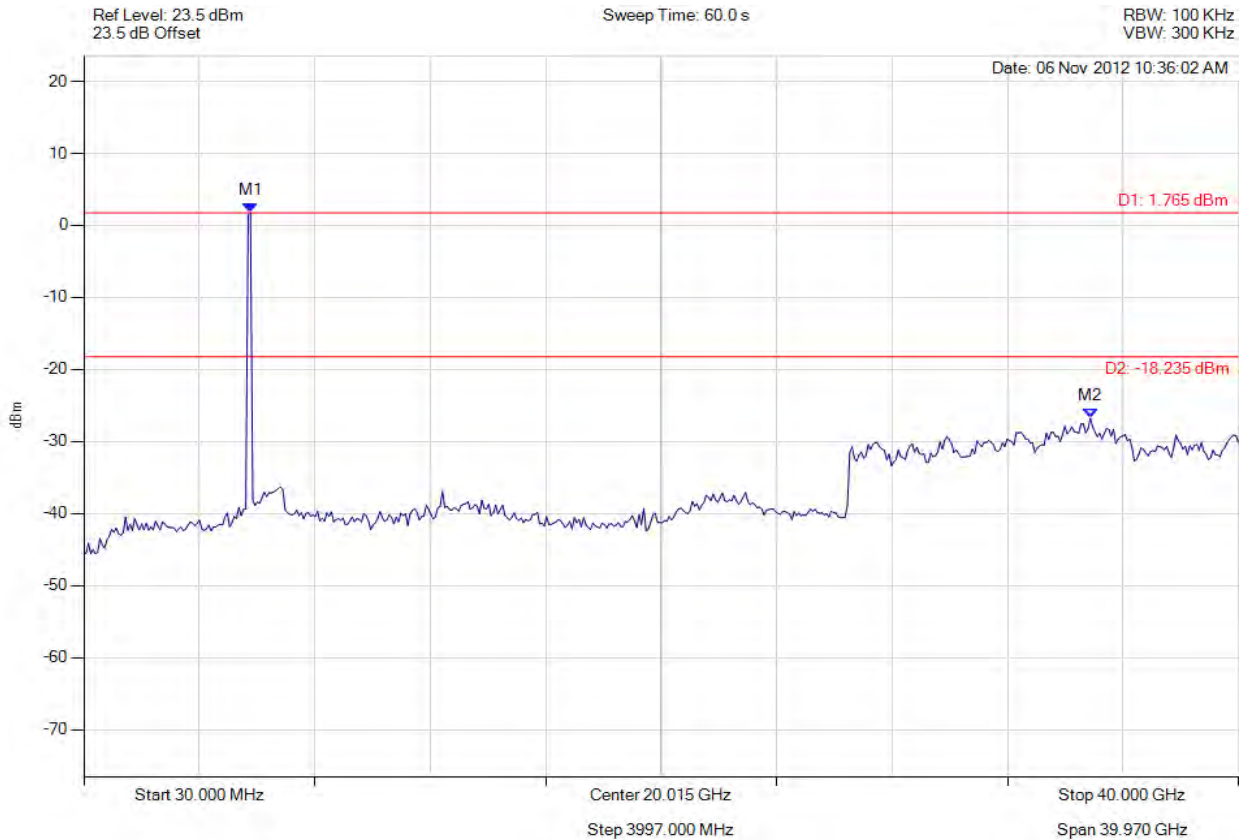

Analyser Setup	Marker : Frequency : Amplitude	Test Results
Detector = MAX PEAK Sweep Count = 0 RF Atten (dB) = 20 Trace Mode = VIEW	M1 : 5797.214 MHz : 1.765 dBm M2 : 34.874 GHz : -26.768 dBm	Limit: -18.24 dBm Margin: =C12-D12 dB

[Back to the Matrix](#)

This test report may be reproduced in full only. The document may only be updated by MiCOM Labs personnel. Any changes will be noted in the Document History section of the report.



440 Boulder Court, Suite 200
Pleasanton, CA 94566, USA
Tel: 1.925.462.0304
Fax: 1.925.462.0306
www.micomlabs.com