



*Digi Connect ME<sup>®</sup> &  
Digi Connect<sup>®</sup> Wi-ME  
Digi Connect ME<sup>®</sup> 9210  
Hardware Reference*

© Digi International Inc. 2004 -2007. All Rights Reserved.

The Digi logo is a registered trademark of Digi International, Inc.

Connectware and Digi Connect ME and Digi Connect Wi-ME are trademarks of Digi International, Inc.

NetSilicon, NET+Works, NET+OS, and NET+ are trademarks of NetSilicon, Inc.

All other trademarks mentioned in this document are the property of their respective owners.

Information in this document is subject to change without notice and does not represent a commitment on the part of Digi International.

Digi provides this document "as is," without warranty of any kind, either expressed or implied, including, but not limited to, the implied warranties of fitness or merchantability for a particular purpose. Digi may make improvements and/or changes in this manual or in the product(s) and/or the program(s) described in this manual at any time.

This product could include technical inaccuracies or typographical errors. Changes are periodically made to the information herein; these changes may be incorporated in new editions of the publication.



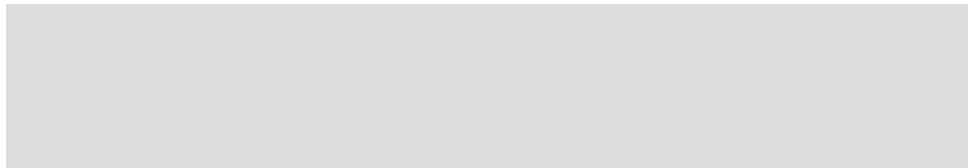

# Contents

.....

About This Document .....	6
Related Documentation .....	6
Support Information .....	7
<b>Chapter 1: About the Digi Connect ME Family of Embedded Modules .....</b>	<b>8</b>
Overview .....	8
Types of Modules .....	9
Connectors: Power and Device Interface .....	11
Connectors: Ethernet Interface .....	14
Connectors: Antenna .....	15
Module LEDs .....	16
<b>Chapter 2: About the Development Board .....</b>	<b>18</b>
Overview .....	18
Basic Description .....	19
Port Descriptions .....	22
Connectors and Blocks .....	25
Switches .....	31
Development Board LEDs .....	32
Power Jack .....	35
Test Points .....	36
<b>Chapter 3: Programming Considerations .....</b>	<b>38</b>
Overview .....	38
Module Pinout .....	39
LEDs .....	41
Reset .....	41
Memory .....	43

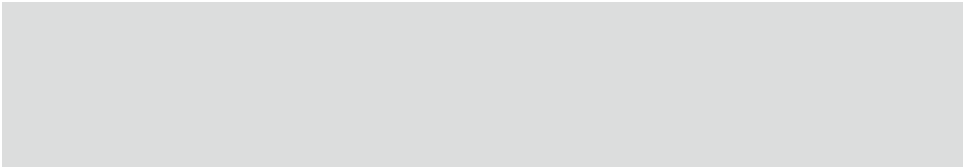

- Appendix A Module Specifications..... 46**
  - Network Interface ..... 46
  - Serial Interface ..... 47
  - Data Rates (bps)..... 47
  - Flow Control Options..... 47
  - DC Characteristics ..... 47
  - Power Management (Connect ME-9210 only) ..... 50
  - Thermal Specifications ..... 51
  - Mechanical..... 53
  - Bar Code ..... 53
  - Dimensions..... 53
  - Recommended PCB Layout..... 59
  - Antenna Information..... 61
  - RF Exposure Statement..... 65
  - Safety Statements..... 65
  
- Appendix B Certifications..... 68**
  - FCC Part 15 Class B ..... 68
  - Industry Canada ..... 69
  - Declaration of Conformity..... 70
  - International EMC Standards..... 71
  
- Appendix C Sample Application: PoE Power Supply ..... 74**
  
- Appendix D Sample Application: TTL Signals to EIA-232 ..... 76**
  
- Appendix E Change Log ..... 78**
  - Revision F ..... 78
  - Revision E ..... 78
  - Revision D..... 78
  - Revision C..... 79
  - Revision B..... 79
  - Revision 90000631\_G>90000897\_A ..... 79
  - Revision G..... 79
  - Revision F ..... 80
  - Revision E..... 80



# *About This Document*

---

## **Scope of the Reference Manual**

---

The purpose of this document is to enable developers to integrate the Digi Connect ME, Digi connect ME 9210, or Digi Connect Wi-ME embedded modules with other devices, enabling these devices to make use of the module's rich networking features.

**Note:** Unless mentioned specifically by name, the products will be referred to as the embedded modules or modules. Individual naming is used to differentiate product specific features. **Unless noted otherwise, all Digi Connect ME related technical information provided in this document also applies to the Digi Connect ME 9210 module.**

## **Related Documentation**

---

See the *NS7520 Hardware Reference* for information on the NS7520 chip.

See the *NS9210 Hardware Reference* for information on the NS9210 chip.



## Support Information

---

To get help with a question or technical problem or make comments and recommendations about Digi products and documentation, use the following contact information.

### *General*

Digi International  
11001 Bren Road East  
Minnetonka, MN 55343  
U.S.A.

### *Customer Service and Support*

United States: 1 877-912-3444  
Other Locations: 1 952-912-3444  
[www.digi.com/support/eservice/  
eservicelogin.jsp](http://www.digi.com/support/eservice/eservicelogin.jsp)



# *About the Digi Connect ME Family of Embedded Modules*

---

## C H A P T E R 1

### **Overview**

---

The embedded modules provide fully transparent device connectivity over industry-standard Ethernet connections and allows both equipment manufacturers and systems integrators to network-enable products at a fraction of the time and cost required to develop a custom solution. It is a highly flexible and compact single component solution with a serial port, GPIO, and a robust on-board TCP/IP stack and 10/100 BASE-T Ethernet support or wireless interface.

Built on Digi's leading 32-bit NET+ARM processor technology, the Digi Connect ME family of embedded modules offer serial-to-Ethernet functionality through Digi's Plug-and-Play Firmware firmware, or the freedom and flexibility of professional embedded software development provided by the easy-to-use, cost-effective and complete Digi JumpStart Kits™ for NET+OS and Microsoft .NET Micro Framework.

The Digi Connect ME and Digi Connect Wi-ME modules are utilizing the powerful Digi NS7520 processor with an ARM7TDMI core running at 55 MHz. They provide integrated wired or wireless networking and serial device connectivity in a compact connector-style form factor. The Digi Connect ME 9210 module is the latest, fully form factor and pin compatible, member of the Digi Connect ME family providing 75 MHz ARM9 core performance based on the Digi NS9210 processor. In addition to higher performance with integrated Ethernet connectivity, the Digi Connect ME 9210 offers higher serial data rates,



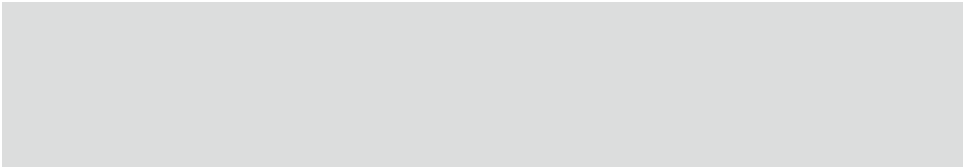

SPI functionality, as well as the unique option of application specific interfaces using the programmable FIMs on the NS9210.

From medical systems to building control and industrial automation, in virtually any application where embedded device connectivity over Ethernet or wireless connectivity is needed, embedded modules are the ideal choice, delivering high-performance functionality.

**Note:** Unless mentioned specifically by name, the products will be referred to as the embedded modules or modules. Individual naming is used to differentiate product specific features. Similarly, information about the Connect ME applies to the Connect ME 9210 as well unless stated otherwise.

This chapter provides information about the modules hardware and contains the following topics:

- "Types of Modules" on page 9
- "Connectors: Antenna" on page 15
- "Connectors: Ethernet Interface" on page 14
- "Module LEDs" on page 16

## Types of Modules

---

There are two types of modules. One module utilizes Digi Plug-and-Play Firmware, while the second is customizable with the option to develop a firmware application in .NET MF or NET+OS. If you are developing your firmware application in NET+OS, you will be using a module with a JTAG interface.

**Note:** JTAG is a commonly used term that is also referred to as IEEE 1149.1, an industry standard test protocol. JTAG is an abbreviation for the European Joint Test Action Group, which invented the first versions of the IEEE 1149.1 interface. The JTAG interface, along with the other development tools, enables you to download, run and debug programs on the module.

The following figures show the two types of modules.

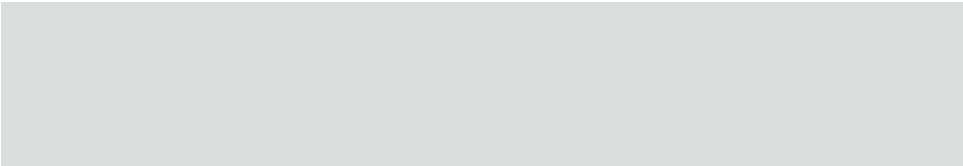

<b>Digi Connect ME Modules</b>		
<b>Model</b>	<b>Description</b>	<b>Figure</b>
Digi Connect ME DC-ME-01T-JT DC-ME4-01T-JT  Digi Connect ME 9210 DC-ME-Y401-JT DC-ME-Y402-JT	<ul style="list-style-type: none"><li>■ Used for development purposes only</li><li>■ JTAG interface</li></ul>	
Digi Connect ME DC-ME-01T-S DC-ME4-01T-S DC-ME-01T-C DC-ME4-01T-C DC-ME-01T-MF  Digi Connect ME 9210 DC-ME-Y401-C DC-ME-Y402-C	<ul style="list-style-type: none"><li>■ No JTAG interface</li><li>■ Ordered independently for use in your implementation</li></ul>	

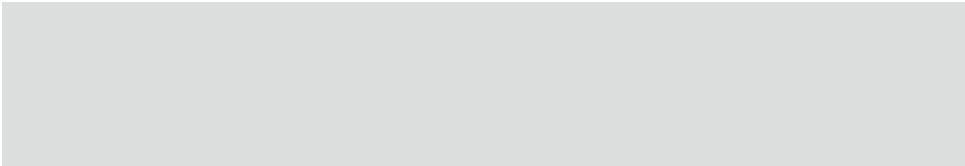

Digi Connect Wi-ME Modules		
Model	Description	Figure
DC-WME-01T-JT	<ul style="list-style-type: none"> <li>Used for development purposes only</li> <li>JTAG interface</li> </ul>	
DC-WME-01T-S DC-WME-01T-C	<ul style="list-style-type: none"> <li>No JTAG interface</li> <li>Ordered independently for use in your implementation.</li> </ul>	

**Note:** -S: No JTAG for use with Digi Plug-and-Play Firmware  
 -C: No JTAG for use with custom NET+OS applications  
 -JT: With JTAG for use with custom firmware development-  
 -MF: No JTAG for use with Microsoft .NET Micro Framework

### Connectors: Power and Device Interface



The module has a 20-pin male connector that supports a serial interface with data rates up to 230,400 (Digi Connect ME)/ 921,600 bps (Digi Connect ME 9210) and full-modem

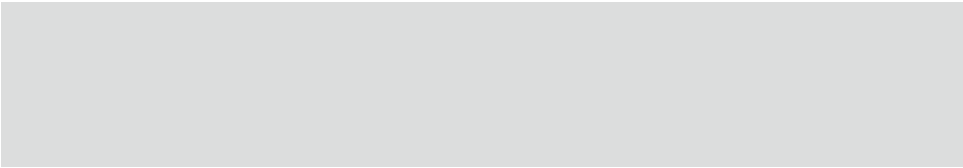

control, and GPIO ports. See the following figure for pin orientation and the table for pin assignments.

**Difference in pin assignments/availability**

Pin assignments/availability for pins 1 and 2 depend on which module you are using. Pins 1 and 2 are available for Digi Connect ME; these pins are removed for Digi Connect Wi-ME. The pin assignment table shows the appropriate values.

**Power and Device Interface Connector**

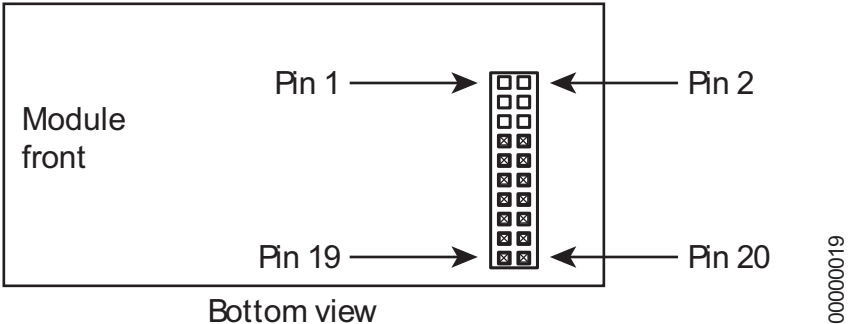

Power and Device Interface Connector Pin Assignments			
Pin	Signal		Description
	ME	Wi-ME	
1	VETH+	—	ME: Power Pass-Thru+ Wi-ME: Position Removed
2	VETH-	—	ME: Power Pass-Thru- Wi-ME: Position removed
3-6	—	—	Position removed

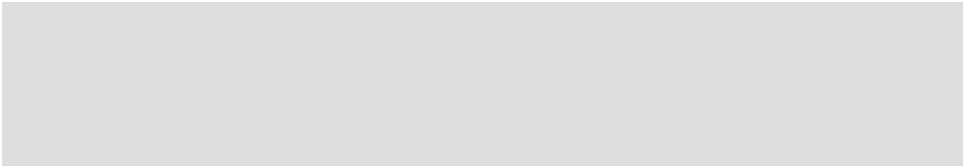

<b>Power and Device Interface Connector Pin Assignments</b>			
<b>Pin</b>	<b>Signal</b>		<b>Description</b>
	<b>ME</b>	<b>Wi-ME</b>	
7	RXD	RXD	Receive Data (Input)
8	TXD	TXD	Transmit Data (Output)
9	RTS	RTS	Request to Send (Output)
10	DTR	DTR	Data Terminal Ready (Output)
11	CTS	CTS	Clear to Send (Input)
12	DSR	DSR	Data Set Ready (Input)
13	DCD	DCD	Data Carrier Detect (Input)
14	/RESET	/RESET	Reset
15	+3.3V	+3.3V	Power
16	GND	GND	Ground
17, 18			Not accessible with Digi Plug-and-Play Firmware. If using a development kit, see "Module Pinout" on page 39 for detailed IO configuration information.
19	Reserved. Do not connect.		
20	/INIT	/INIT	Software Reset

**Note:** The development board provides connectors for an optional PoE application kit.

**Note:** Any pins not used can be left floating.

**Note:** See "Module Pinout" on page 39 for detailed IO configuration information.

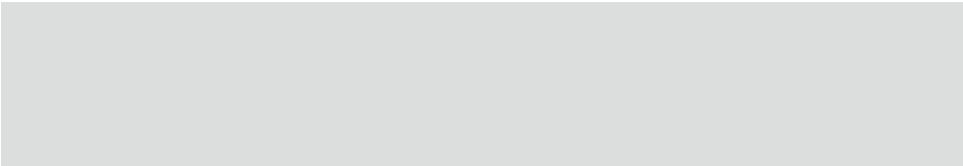

# Connectors: Ethernet Interface

---

The Ethernet connector is an 8-wire RJ-45 jack that meets the ISO 8877 requirements for 10/100BASE-T. See the following figure and table for pin orientation and pin assignments.

**Note:** Pin orientation and assignments are the same for modules with or without a JTAG connector.

## Ethernet Interface Pin Orientation

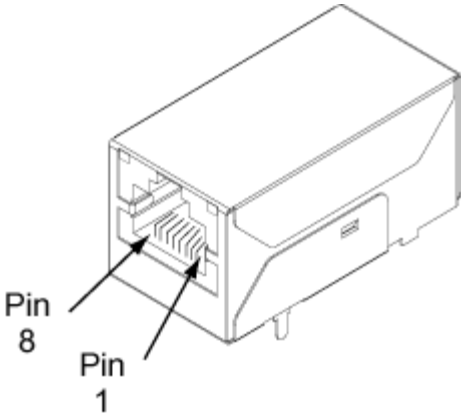

Ethernet Interface Pin Assignments							
Pin 1	Pin 2	Pin 3	Pin 4	Pin 5	Pin 6	Pin 7	Pin 8
TXD+	TXD-	RXD+	EPWR+	EPWR+	RXD-	EPWR-	EPWR-
Transmit Data +	Transmit Data -	Receive Data +	Power from Switch +	Power from Switch +	Receive Data -	Power from Switch -	Power from Switch -

## Hard Reset

The embedded modules support a hardware reset on pin 14 of the 20-pin header. Pulling pin 14 low with an open drain driver will force the module into a hard reset state. The module will remain in the reset state as long as pin 14 is held low and will leave this reset state ~250mS after pin 14 goes high. Do not actively drive pin 14 high and do not allow the rise time of the pin 14 to be longer than 100uS. When used with the development board, this pin is wired to reset button SW4, which means it acts as a hard reset button.

## Connectors: Antenna

---

The Digi Connect Wi-ME is available with 1 RP-SMA connector. The antenna is connected to the module with a reverse polarity SMA connector (sub-miniature size A). The antenna only fits on the module one way to ensure a proper connection. Another option for both signal reception and design flexibility is to use an antenna extension cord to separate the antenna from the module. This allows the module to fit inside your product but the antenna to be placed outside the device.



Caution: This Part 15 radio device operates on a non-interference basis with other devices operating at this frequency when using the antennae listed in the Antenna Specification table. Any changes or modification to the product not expressly approved by Digi International could void the user's authority to operate the device.

Antenna Specifications			
<b>Type</b>	Desktop	Dipole	30 cm Antenna Extension Cord
<b>Part number</b>	DC-ANT-24DT	DG-ANT-20DP-BG	DG-EXT-300-RR
<b>Gain</b>	1.8 dBi	2 dBi	-.5dB

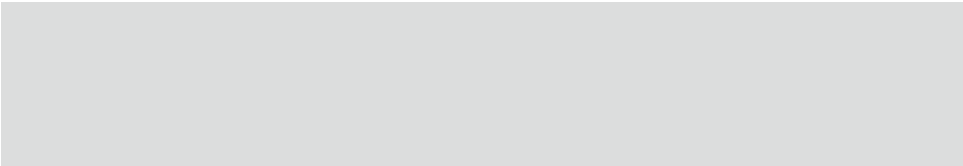

# Module LEDs

---

The module has two LEDs that are located near the upper corners of the Ethernet port (see the following figure). The following table describes the LEDs.

**Note:** The LEDs are the same for a module with or without a JTAG connector.

## LED Locations

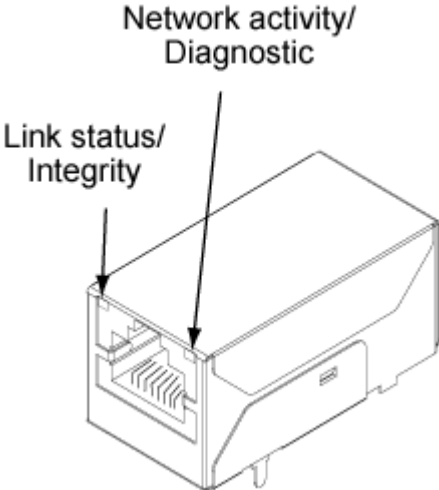



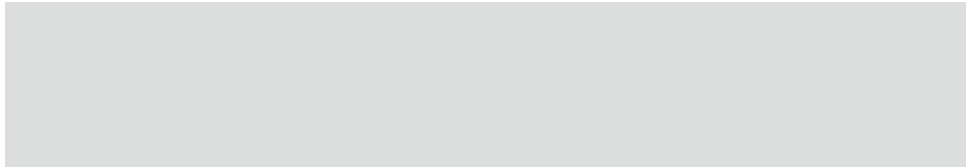

<b>LED Behaviors</b>				
<b>LED</b>	<b>Pin Header EM</b>	<b>Digi Plug-and Play Firmware Digi Connect ME</b>	<b>Digi Plug-and Play Firmware Digi Connect Wi-ME</b>	<b>Customizable Modules</b>
Top left (yellow)	5 (+) 7 (-)	Network link status: Off - no link has been detected. On - a link has been detected.	Network link status: On - unit is associated with an access point. Blinking slowly - unit is in ad hoc mode. Blinking quickly - unit is scanning for a network.	Same as Digi Plug-and Play Firmware (Network link status).
Top right (green)	1 (+) 3 (-)	Network activity: Blinking -network data is transmitted or received.		This LED is software programmable.



# *About the Development Board*

---

## C H A P T E R 2

### Overview

---

The development board is a hardware platform from which you can determine how to integrate the embedded modules into your design. The board consists of the following main features:

- Socket for connecting the embedded modules
- JTAG connection (for use with the development kit only)
- GPIO switches
- Serial and GPIO ports
- Power input

This chapter provides information on development board components and contains the topics listed below. For more detailed information on the development board, see the schematic and mechanical drawings on the CD that accompanies your kit. Once you've installed the software that comes with your kit, you can access the schematic from the Start menu.

- "Basic Description" on page 19
- "Placement of Module" on page 22
- "Connectors and Blocks" on page 25
- "Switches" on page 31
- "Development Board LEDs" on page 32
- "Power Jack" on page 35
- "Test Points" on page 36

## Basic Description

The development board contains connectors, switches, and LEDs for use while integrating the embedded module into your design. See the following figure for the location of the connectors, switches, and LEDs. Additionally, the board provides test points (not shown on the figure). For more information about test points, see "Test Points" on page 36.

### Board Layout and Connector Locations:

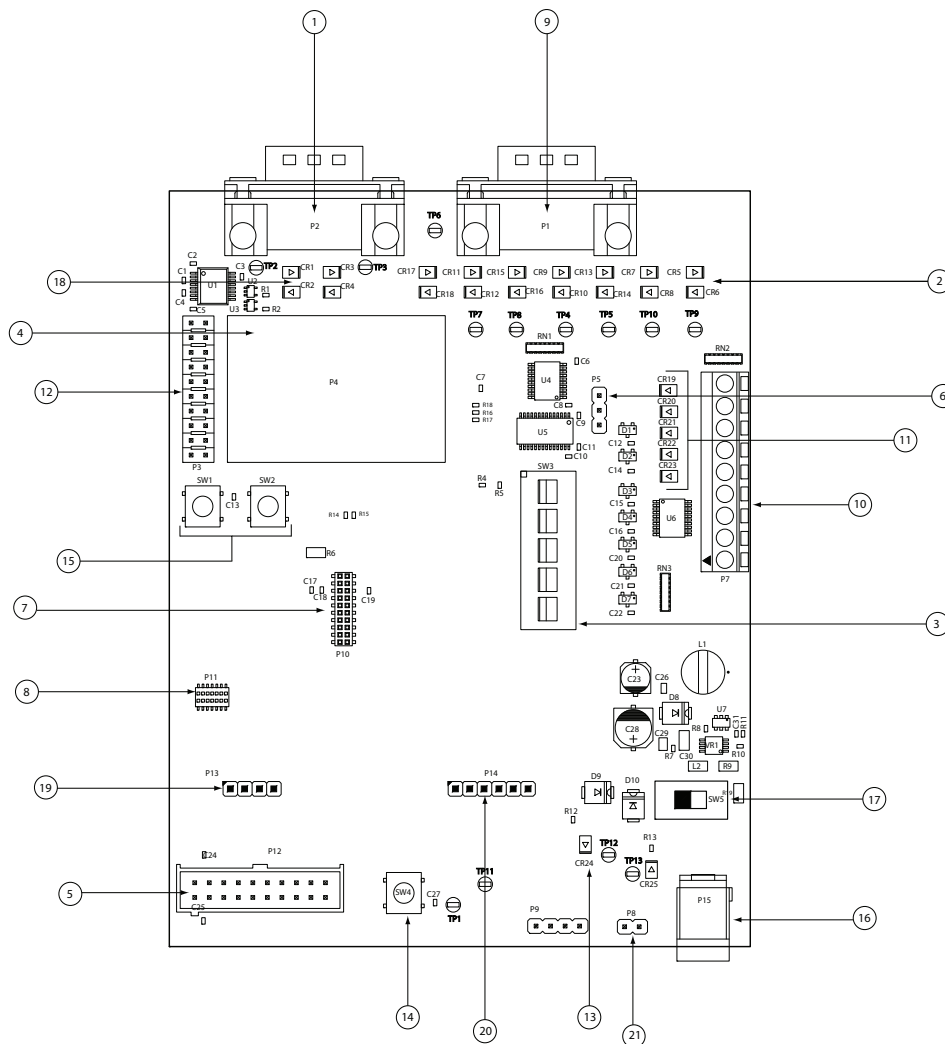

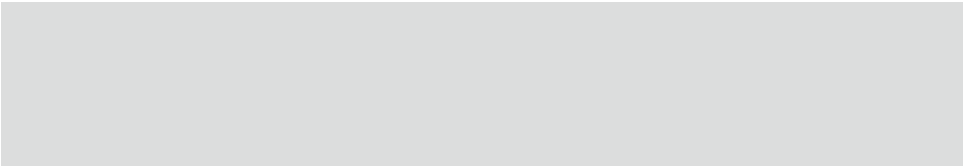

<b>Connectors, Switches and LEDs Board Description Markers 1-5</b>				
1	2	3	4	5
Secondary Serial Port, P2	Primary Port LEDs, CR5 - CR18	GPIO Switch Bank, SW3	Prototyping Area, P4	JTAG Header, P12

<b>Connectors, Switches and LEDs Board Description (continued) Markers 6-10</b>				
6	7	8	9	10
232 Enable Jumper Block, P5	Embedded Module Connector, P10	ME JTAG Connector, P11	Primary Serial Port, P1	GPIO Port, P7

<b>Connectors, Switches and LEDs Board Description (continued) Markers 11-15</b>				
11	12	13	14	15
Digital I/O LEDs, CR19 - CR23	Logic Analyzer header, P3	POE Source LED, CR24	Reset Switch, SW4	User Pushbuttons, SW1 & SW2

<b>Connectors, Switches and LEDs Board Description (continued) Markers 16-21</b>					
16	17	18	19	20	21
Power Jack, P15	On/Off switch, SW5	Secondary Port LEDs CR1-CR4	-48V DC output from ME module P13	12V output from PoE module P14	Current Measurement Option P8

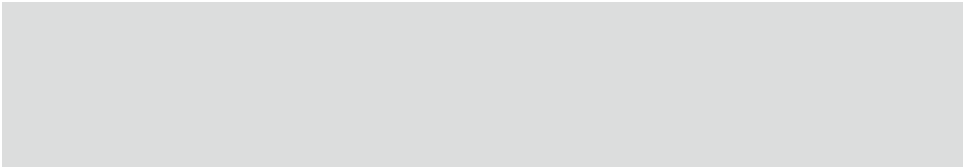

- "Port Descriptions" on page 22
- "Connectors and Blocks" on page 25
- "Switches" on page 31
- "Development Board LEDs" on page 32
- "Power Jack" on page 35

See the following figures for placement of either module onto the development board.

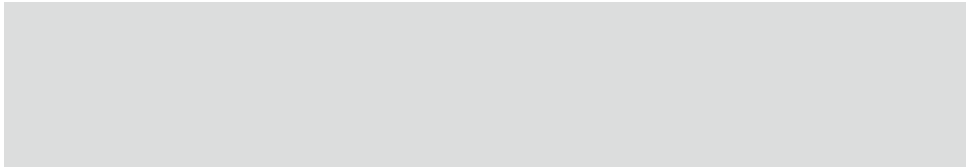

## Placement of Module

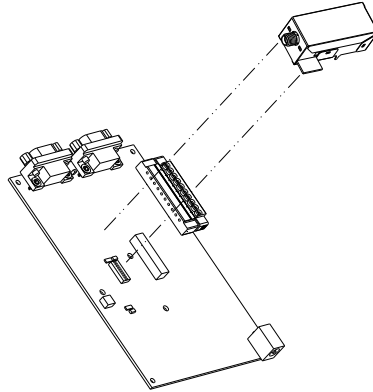

Caution: When handling the development board, wear a grounding wrist strap to avoid ESD damage to the board.

## Port Descriptions

---

The development board provides the following ports:

- Primary Serial Port, P1
- Secondary Serial Port, P2
- GPIO Port, P7

See the figure titled "Board Layout and Connector Locations:" on page 19 for the location of the ports. The following sections describe the ports.

## Primary Serial Port, P1

The Primary Serial Port is a DB-9 male connector that is labeled as P1 on the development board. See the following figure for pin orientation; see the following table for pin assignments.

### Primary Serial Port Pin Orientation

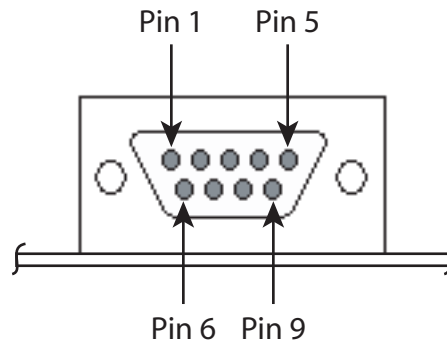

Primary Serial Port Pin Assignments								
Pin 1	Pin 2	Pin 3	Pin 4	Pin 5	Pin 6	Pin 7	Pin 8	Pin 9
DCD	RXD	TXD	DTR	GND	DSR	RTS	CTS	—
Data Carrier Detect	Receive Data	Transmit Data	Data Terminal Ready	Signal/Chassis Ground	Data Set Ready	Request To Send	Clear To Send	—

## Secondary Serial Port, P2

The Secondary Serial Port is a DB-9 male connector that is labeled as P2 on the development board. The port is used only with the Digi Connect ME modules with JTAG interfaces for debugging purposes. See the following figure for pin orientation; see the following table for pin assignments.

## Secondary Serial Port Pin Orientation

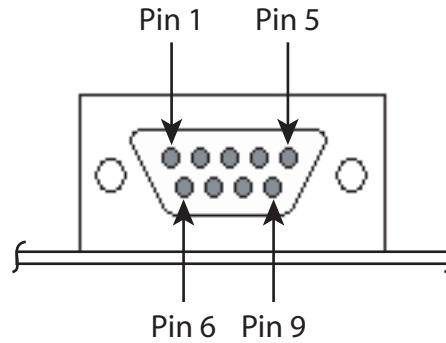

Secondary Serial Port Pin Assignments								
Pin 1	Pin 2	Pin 3	Pin 4	Pin 5	Pin 6	Pin 7	Pin 8	Pin 9
—	RXD	TXD	—	GND	—	—	—	—
—	Receive Data	Transmit Data	—	Signal/Chassis Ground	—	—	—	—

### RS232-Enable Pin Header, P5

When enabled, P5 connects the TTL signals to the RS232 transceiver allowing for RS232 communication on Serial Port 1. When the jumper is removed, the transceiver is no longer connected and the load is removed from the TTL lines.

### GPIO Port, P7

The GPIO port is a 9-pin male right-angle connector that is labeled as P7 on the development board. See the following figure for pin orientation; see the following tables for pin assignments. For input and output threshold specifications, see "DC Characteristics" on page 47.



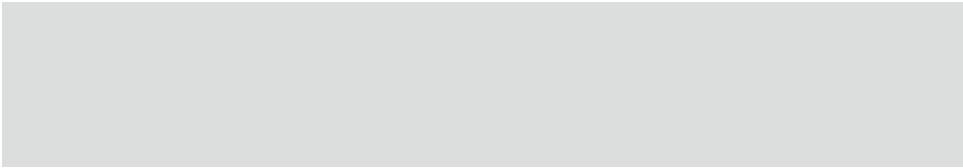

**Note:** The development board is shipped with a 9-pin screw-flange plug attached to the GPIO port.

**GPIO Port Pin Orientation**

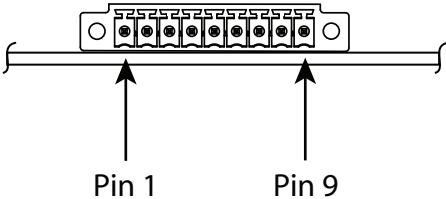

<b>GPIO Port Pin Assignments</b>									
	<b>Pin 1</b>	<b>Pin 2</b>	<b>Pin 3</b>	<b>Pin 4</b>	<b>Pin 5</b>	<b>Pin 6</b>	<b>Pin 7</b>	<b>Pin 8</b>	<b>Pin 9</b>
<b>Signal</b>	GPIO-1	GND	GPIO-2	GND	GPIO-3	TXD_TTL	GPIO-4	RXD_TTL	GPIO-5

**Connectors and Blocks**

.....

- The development board provides the following connectors and blocks:
- Embedded Module Connector, P10
  - The Digi Connect Wi-ME module does not provide pins 1-6
  - JTAG Debugger Connector, P12.
  - -48V DC input to PoE module (ME must be connected to a Powering Device for this feature.), P13
  - 12V DC output from PoE module into Dev Board Power Supply, P14
  - Logic Analyzer Header, P3

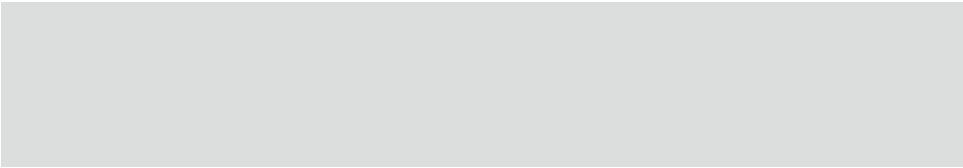

See the figure titled "Board Layout and Connector Locations:" on page 19 for the location of the connectors and blocks. The following sections describe the connectors and blocks.

**Embedded Module Connector, P10**

The Digi Connect ME embedded module Connector is a 20-pin female vertical header that is labeled P10 on the development board. See the following figure for pin orientation; see the following table for pin assignments.

**Note:** The figure shows the connector using the same orientation as shown in the figure titled "Board Layout and Connector Locations:" on page 19.

**Embedded Module Connector Pin Orientation**

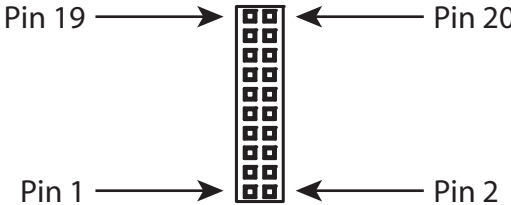

Module Connector Pin Assignments			
Pin	Signal		Description
	ME	Wi-ME	
1	VETH+	—	ME: Power Pass-Thru + Wi-ME: Position removed
2	VETH-	—	ME: Power Pass-Thru - Wi-ME: Position removed
3-6	Position Removed		
7	RXD	RXD	Receive Data (Input)
8	TXD	TXD	Transmit Data (Output)

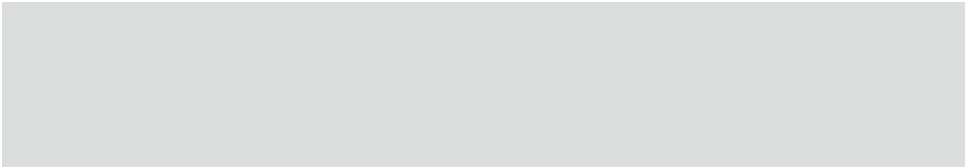

<b>Module Connector Pin Assignments</b>			
<b>Pin</b>	<b>Signal</b>		<b>Description</b>
	<b>ME</b>	<b>Wi-ME</b>	
9	RTS	RTS	Request to Send (Output)
10	DTR	DTR	Data Terminal Ready (Output)
11	CTS	CTS	Clear to Send (Input)
12	DSR	DSR	Data Set Ready (Input)
13	DCD	DCD	Data Carrier Detect (Input)
14	/RESET	/RESET	Reset
15	+3.3V	+3.3V	Power
16	GND	GND	Ground
17, 18			Not accessible with Digi Plug-and-Play Firmware. If using a development kit, see "Module Pinout" on page 39 for detailed IO configuration information.
19			Reserved
20	/INIT	/INIT	Digi Plug-and-Play Firmware Software Reset

- Note:** The Digi Connect Wi-ME module does not provide pins 1-6
- Note:** See "Module Pinout" on page 39 for detailed IO configuration information.

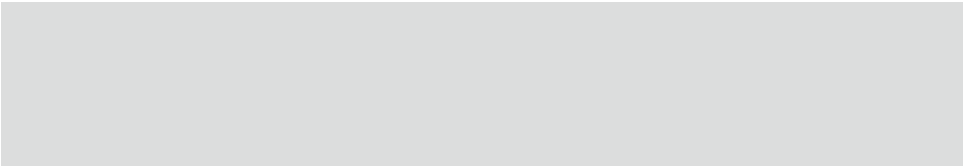

**Module JTAG Interface Connector, P11**

The Module JTAG Interface Connector is a 14-pin female vertical header that is labeled P11 on the development board. The connector mates with the JTAG connector on the Digi Connect ME embedded module. The Module JTAG Connector pins are tied to the JTAG debugger Connector (see “JTAG Debugger Connector, P12”).

**Note:** Because there is no direct connection to the Module JTAG Interface Connector, pin orientation and pin assignments are not described for the connector.

**JTAG Debugger Connector, P12**

The JTAG debugger connector is a 20-pin male vertical header that is labeled P12 on the development board. The connector mates with a JTAG debugger plug (for example, a Digi JTAG Link). The connector is used with the development kit only. See the following figure for pin orientation. See the following table for pin assignments.

**Note:** The figure shows the connector using the same orientation as shown in the figure titled "Board Layout and Connector Locations:" on page 19.

**JTAG Debugger Connector Pin Orientation**

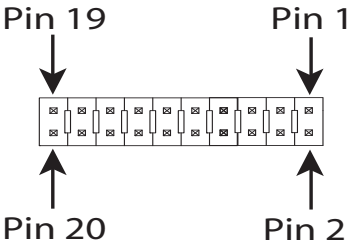

JTAG Debugger Connector Pin Assignments									
Pin 1	Pin 2	Pin 3	Pin 4	Pin 5	Pin 6	Pin 7	Pin 8	Pin 9	Pin 10
VCC+	VCC+	/TRST	GND	TDI	GND	TMS	GND	TCK	GND

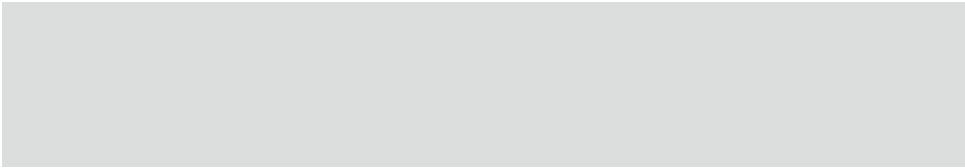

<b>JTAG Debugger Connector Pin Assignments</b>									
<b>Pin 1</b>	<b>Pin 2</b>	<b>Pin 3</b>	<b>Pin 4</b>	<b>Pin 5</b>	<b>Pin 6</b>	<b>Pin 7</b>	<b>Pin 8</b>	<b>Pin 9</b>	<b>Pin 10</b>
<b>Pin 11</b>	<b>Pin 12</b>	<b>Pin 13</b>	<b>Pin 14</b>	<b>Pin 15</b>	<b>Pin 16</b>	<b>Pin 17</b>	<b>Pin 18</b>	<b>Pin 19</b>	<b>Pin 20</b>
RTCK	GNO	TDO	GND	/SRST	GNO	N/A	GND	N/A	GND

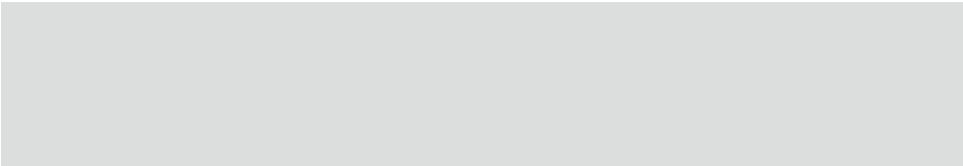

**Logic Analyzer Header, P3**

The Logic Analyzer Header is a 20-pin male vertical header that is labeled P3 on the development board. The header is for connecting a digital signal analyzer (for example, a logic analyzer) to the development board. See the following figure for pin orientation; see the following table for pin assignments.

**Note:** The figure shows the connector using the same orientation as shown in the figure titled "Board Layout and Connector Locations:" on page 19.

**Logic Analyzer Header Pin Orientation**

<b>Logic Analyzer Header Pin Assignments</b>									
<b>Pin 1</b>	<b>Pin 2</b>	<b>Pin 3</b>	<b>Pin 4</b>	<b>Pin 5</b>	<b>Pin 6</b>	<b>Pin 7</b>	<b>Pin 8</b>	<b>Pin 9</b>	<b>Pin 10</b>
V_Ether+	V_Ether-	Not Connected	Not Connected	Not Connected	Not Connected	RXD	TXD	GPIO-4	GPIO-5
<b>Pin 11</b>	<b>Pin 12</b>	<b>Pin 13</b>	<b>Pin 14</b>	<b>Pin 15</b>	<b>Pin 16</b>	<b>Pin 17</b>	<b>Pin 18</b>	<b>Pin 19</b>	<b>Pin 20</b>
GPIO-2	GPIO-3	GPIO-1	/RST	3.3v	GND	See "Power and Device Interface Connector Pin Assignments" on page 12 for details.		Reserved	/INIT

## Switches

---

The development board provides the following switches:



- GPIO Switch Bank 1, SW3
- Reset, SW4

See the figure titled "Board Layout and Connector Locations:" on page 19 for the location of the switches. The following sections describe the switches.

### GPIO Switch Bank 1, SW3

GPIO Switch Bank 1, labeled SW3, is a set of five slide switches that allows the Digi Connect ME embedded module to use either serial signals or GPIO signals to communicate with a device.

### GPIO Switch Bank 1 Settings

Switch Number	Left Position 	Right Position 
1	DCD	GPIO-1
2	CTS	GPIO-2
3	DSR	GPIO-3
4	RTS	GPIO-4
5	DTR	GPIO-5

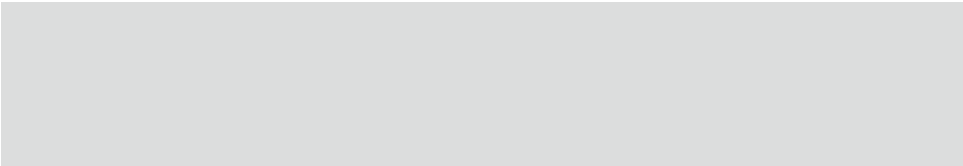

### Reset, SW4

The Reset switch is a push button switch labeled SW4 on the development board. Pressing the switch holds the Digi Connect ME embedded module in reset. When the push button is released, the module reboots.

### Development Board LEDs

---

The development board contains 25 LEDs that are labeled CR1 through CR25. The following table lists and describes the LEDs.

Development Board LED Descriptions			
Board Label	Description	Color or State	Indication
CR1	TXD, Secondary Serial Port	On	Logic 1 on TTL
		Off	Logic 0 on TTL
CR2	TXD, Secondary Serial Port	On	Logic 0 on TTL
		Off	Logic 1 on TTL
CR3	RXD, Secondary Serial Port	On	Logic 1 on TTL
		Off	Logic 0 on TTL
CR4	RXD, Secondary Serial Port	On	Logic 0 on TTL
		Off	Logic 1 on TTL
CR5	DCD, Primary Serial Port	On	Logic 0 on line side
		Off	Logic 1 on line side



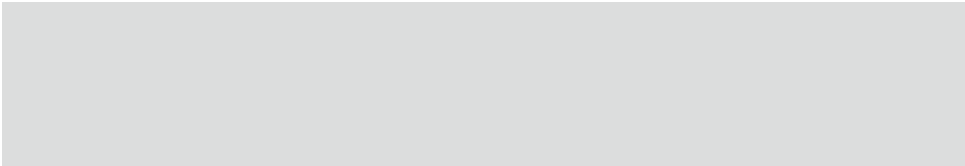

<b>Development Board LED Descriptions</b>			
<b>Board Label</b>	<b>Description</b>	<b>Color or State</b>	<b>Indication</b>
CR6	DCD, Primary Serial Port	On	Logic 1 on line side
		Off	Logic 0 on line side
CR7	DSR, Primary Serial Port	On	Logic 0 on line side
		Off	Logic 1 on line side
CR8	DSR, Primary Serial Port	On	Logic 1 on line side
		Off	Logic 0 on line side
CR9	CTS, Primary Serial Port	On	Logic 0 on line side
		Off	Logic 1 on line side
CR10	CTS, Primary Serial Port	On	Logic 1 on line side
		Off	Logic 0 on line side
CR11	RXD, Primary Serial Port	On	Logic 0 on line side
		Off	Logic 1 on line side
CR12	RXD, Primary Serial Port	On	Logic 1 on line side
		Off	Logic 0 on line side
CR13	DTR, Primary Serial Port	On	Logic 0 on line side
		Off	Logic 1 on line side



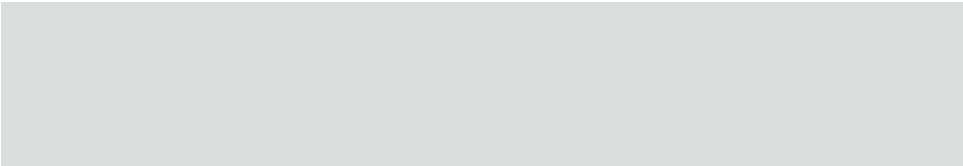

<b>Development Board LED Descriptions</b>			
<b>Board Label</b>	<b>Description</b>	<b>Color or State</b>	<b>Indication</b>
CR14	DTR, Primary Serial Port	On	Logic 1 on line side
		Off	Logic 0 on line side
CR15	RTS, Primary Serial Port	On	Logic 0 on line side
		Off	Logic 1 on line side
CR16	RTS, Primary Serial Port	On	Logic 1 on line side
		Off	Logic 0 on line side
CR17	TXD, Primary Serial Port	On	Logic 0 on line side
		Off	Logic 1 on line side
CR18	TXD Primary Serial Port	On	Logic 1 on line side
		Off	Logic 0 on line side
CR19	GPIO 1	On	Logic 1
		Off	Logic 0
CR20	GPIO 2	On	Logic 1
		Off	Logic 0
CR21	GPIO 3	On	Logic 1
		Off	Logic 0

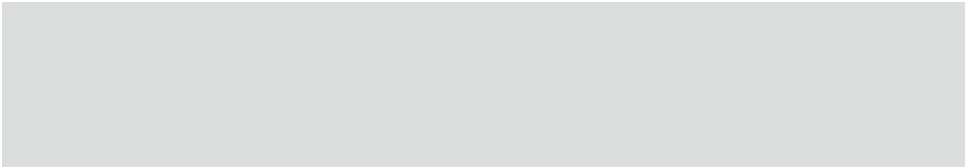

<b>Development Board LED Descriptions</b>			
<b>Board Label</b>	<b>Description</b>	<b>Color or State</b>	<b>Indication</b>
CR22	GPIO 4	On	Logic 1
		Off	Logic 0
CR23	GPIO 5	On	Logic 1
		Off	Logic 0
CR24	3.3v LED	On	3.3v present from POE
		Off	No POE present
CR25	3.3v LED	On	3.3v present
		Off	No 3.3v present

## Power Jack



The Power Jack is a barrel connector that accepts 9 to 30 VDC +/- 5%. The jack is labeled as P15 on the development board. The following table shows the polarity of the power jack.

<b>Power Jack Polarity</b>	
<b>Contact</b>	<b>Polarity</b>
Center	+9 to +30 VDC
Outer	Ground

The following figure schematically represents the polarity of the power jack.

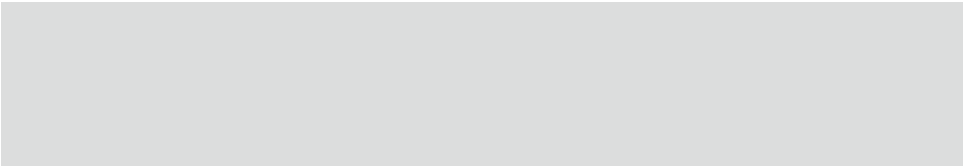

### Power Jack Polarity, Schematic

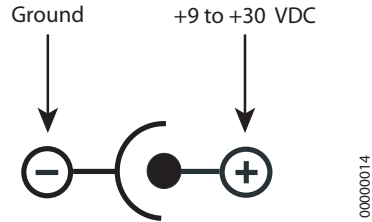

### Test Points

---

The development board provides 13 test points that can be identified by a board label . The test point numbers are in the development board schematic drawings. The following table lists the test point number, board label, and a brief description of each test point.

Test Point Descriptions		
Test Point	Board Label	Description
TP2	TXD	TXD-2, Transmit, Secondary Serial Port
TP3	RXD	RXD-2, Receive, Secondary Serial Port
TP4	CTS	CTS, Primary Serial Port
TP5	DTR	DTR, Primary Serial Port
TP6	TXD	TXD, Primary Serial Port
TP7	RXD	RXD, Primary Serial Port
TP8	RTS	RTS, Primary Serial Port

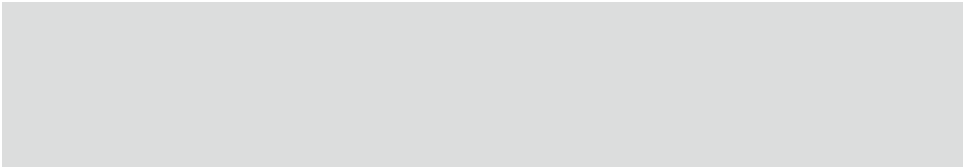

<b>Test Point Descriptions</b>		
<b>Test Point</b>	<b>Board Label</b>	<b>Description</b>
TP9	DCD	DCD, Primary Serial Port
TP10	DSR	DSR, Primary Serial Port
TP12	Reset	Reset
TP13	POE 12v	POE 12v
TP14	3.3v	3.3v Supply
TP15	GND	Ground

# *Programming Considerations*

---

## C H A P T E R 3

### **Overview**

---

This chapter provides information programmers may require to make use of some Digi Connect ME embedded module hardware resources. It provides programming information on the following topics for the Digi Connect ME-9210, the Digi Connect ME and the Digi Connect Wi-ME:

- "Module Pinout" on page 39
- "LEDs" on page 41
- "Reset" on page 41
- "Memory" on page 43
- "SDRAM" on page 43

## Module Pinout

---

### General Information

The NS7520/NS9210 processors support 16 General Purpose I/O (GPIO) lines, some of which are reserved for specific functions and some of which can be customized. For Digi Plug-and-Play Firmware users, see the Digi Connect Family Users Guide for details on what Pin configurations are available to you.

### Module Pinout

The following table provides signal header pinout information for the Digi Connect Me, Digi Connect Wi-ME and Digi Connect ME 9210 modules. Please refer to the color key below.

Key
Applies to Digi Connect ME/Wi-ME modules.
Applies to Digi Connect ME 9210 modules.
Applies to Digi Connect ME/Wi-ME and ME 9210 modules.

Pin	UART [All]	GPIO [ME/ Wi-ME]	GPIO [ME 9210]	Ext IRQ [ME/ Wi-ME]	Ext IRQ [ME 9210]	I2C [ME 9210]	SPI [ME 9210]	FIM [ME 9210]	Timer [ME 9210]	Other [All]
1										VETH+
2										VETH-
3-6	Positions Removed									
7	RXD	A3	GPIO[3]				DATA IN	PIC [3]		
8	TXD	A7	GPIO[7]				DATA OUT		Timer Out 7 Timer In 8	
9	RTS	A5	GPIO[5]		3		CLK		Timer Out 6	
10	DTR	A6	GPIO[6]						Timer In 7	
11	CTS	A1	GPIO[1]		0			PIC[1]		
12	DSR	A2	GPIO[2]		1			PIC[2]		
13	DCD	A0	GPIO[0]				EN	PIC[0]		
14										/RST
15										3.3V
16										GND
17		C4	GPIO[12]			SDA	CLK			RESET_ DONE
18		C1	GPIO[9]	1	0	SCL				
19	Reserved									
20		C5	GPIO [13]				CLK		Timer Out 9	/INIT

**Note:** A special model of the Digi Connect ME 9210 is required for CAN bus 2.0 support. The CAN bus model does not support the I2C interface. Instead, it makes GPIO[14] / PIC[0]\_CAN\_RXD available on pin 17, and GPIO [15]/ PIC[0]\_CA\_TXD on pin 18. Please contact Digi for availability information.

**Note:** The Digi Connect Wi-ME module does not provide pins 1-6.



## LEDs

---

### General Information

The embedded modules have two types of LEDs:

- An LED connected directly to GPIO pins on the processor and controlled directly in software
- An LED connected to other hardware components (normally the Ethernet hardware) and not directly programmable by the operating system

The development kit, by default, correctly configures the GPIO connected to the LED as an output and then uses this LED to represent Ethernet activity.

LED	Description
Yellow	This is wired directly to Ethernet hardware and provides an indication of link.
Green	This software-programmable LED is wired to processor GPIO register bit C6/GPIO[14] and is wired to be lit when low. The default behavior is to blink on Ethernet activity.

## Reset

---

### Hard Reset

The embedded module supports a hardware reset via pin 14 of the 20-pin header. The unit is forced into a hard reset when pulling the pin to ground, or less than 2.88v, for one microsecond. When plugged into a development board, this pin is wired to the push button at SW3. As a result, this switch acts as a hard reset button.

Reset Characteristics	
Characteristic	Specification
Delay	250 milliseconds (typical)
Threshold	2.88 V

<b>Reset Characteristics</b>	
<b>Characteristic</b>	<b>Specification</b>
Minimum Hold Time	1 microsecond pulse
Rise Time	100 microseconds

## Memory

---

### Flash

The Digi Connect ME has 2 or 4 MB of flash memory. The Digi Connect Wi-ME has 4 MB of flash memory.

On the ConnectME/ARM7 family, the flash memory is controlled by chip select 0, located at 0x02000000.

On the ConnectME-9210/ARM9 family, the flash memory is controlled by chip select 2 (default=st\_cs1) and is located at 0x50000000.

### SDRAM

The Digi Connect ME and the Digi Connect Wi-ME's SDRAM is controlled by chip select 1 and is located at 0x00000000.

The Digi Connect ME 9210's SDRAM is controlled by chip select 1 (default = dy\_cs0) and is mapped to 0x00000000.

The embedded modules have 8 MB of SDRAM memory.

The following table illustrates typical power consumptions using these power management mechanisms. These measurements were taken with all Digi NS9210 processor’s I/O clocks disabled except UART A, UART C, Ethernet MAC, I/O Hub and Memory Clock0 with the ethernet connected to a 100Mb network, using a standard module plugged into a Digi JumpStart Kit development board, with nominal voltage applied:

Mode	Power Consumption <sup>1</sup>
Normal Operational Mode <sup>2</sup>	1.14W (346mA)
Full Clock Scaling Mode <sup>3</sup>	.613W (186mA)
Sleep Mode <sup>4</sup>	.113W (34mA)

**Note 1:** This measurement was taken from the R6 current sense resistor using a 0.025 ohm shunt on the JumpStart Kit development board.

**Note 2:** This is the default power consumption mode when entering applicationStart(), as measured with the napsave sample application. The value of the NS9210 Clock Configuration register (A090017C) is 0001200B hexadecimal.

**Note 3:** This measurement was produced by selecting the “Clock Scale” menu option in the napsave sample application.

**Note 4:** This measurement was produced by selecting the “Deep Sleep/Wakeup with an External IRA” menu option in the napsave sample application.

Memory

# Module Specifications

## A P P E N D I X A

### Network Interface

#### Digi Connect ME/ME9210

- Standard: IEEE 802.3
- Physical Layer: 10/100Base-T
- Data Rate: 10/100Mbps (auto-sensing)
- Mode: Half-duplex and full-duplex support (auto-sensing)
- Connector: RJ-45

#### Digi Connect Wi-ME

- Standard: IEEE 802.11b
- Frequency: 2.4 GHz
- Data Rate: Up to 11 Mbps with automatic fallback
- Modulation: CCK (11/5 Mbps), DQPSK (2 Mbps), DBPSK (1 Mbps)
- Transmit Power: 16 dBm typical
- Receive sensitivity:
  - 1Mbps: -92 dBm
  - 2Mbps: -89 dBm
  - 5.5Mbps: -87 dBm
  - 11Mbps: -82 dBm
- Antenna Connector: 1 x RP-SMA



Caution: The Digi Connect ME and Digi Connect Wi-ME embedded modules were designed for use in no clean flux wave soldering processes. The product is not designed to support draining after a water-wash process, which can lead to water residue inside the enclosure resulting from direct entry or condensation after the wash process.

## Serial Interface

---

One TTL serial interface (CMOS 3.3v) with full modem control signals (DTR, DSR, DCD, RTS, CTS). The Connect ME 9210 also supports SPI and FIM-based application specific interfaces.

## Data Rates (bps)

---

50, 75, 110, 134, 150, 200, 300, 600, 1200, 1800, 2400, 4800, 9600, 14400, 19200, 28800, 38400, 57600, 115200, 230400, 460800 (Connect ME 9210 only), 921600 (Connect ME 9210 only)

## Flow Control Options

---

RTS/CTS, XON/XOFF, None

## DC Characteristics

---

The following tables provide DC characteristics for operating conditions, inputs, and outputs.

Operating Conditions					
Symbol	Description	Min	Typ	Max	Unit
V <sub>CC</sub>	Supply Voltage	3.14	3.3	3.45	V
n/a	Power Supply Ripple			40	mVpp

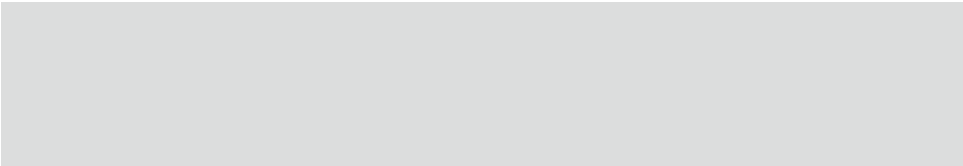

Operating Conditions						
Symbol	Description	Min	Typ	Max	Unit	
I <sub>CC</sub>	Supply Current	—	—	Digi Connect ME	270	mA
				Digi Connect ME 9210	450	
				Digi Connect Wi-ME	400	
I <sub>IL</sub>	Input Current as “0” (57K pull-up resistor)	—	—	57	μA	
	9210 (16K pull up resistor)	-10	—	200	μA	
I <sub>IH</sub>	Input Current “1” (57K pull-up resistor)	-10	—	10	μA	
	9210 (16K pull up resistor)	-10	—	10	μA	
I <sub>OZ</sub>	HighZ Leakage Current	-10	—	10	μA	
I <sub>OD</sub>	Output Drive Strength	—	—	2	mA	
C <sub>IO</sub>	Pin Capacitance (V <sub>O</sub> =0)	—	—	4	pF	



Warning: The rise time of the 3.3v power supply must be between 700 μs and 140ms and the inrush current must be limited to less than 2 A. A rise time outside of these limits may cause the device to malfunction and give a 3-1-3 diagnostic error.



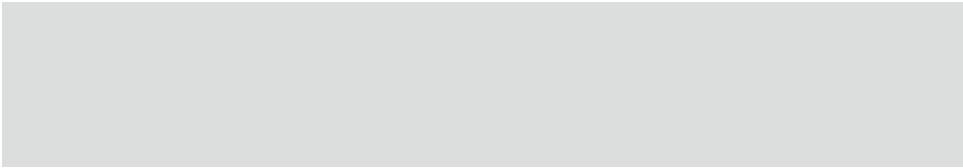

Inputs					
Symbol	Description	Min	Typ	Max	Unit
V <sub>IH</sub>	Input High Voltage	2	—	V <sub>CC</sub> +0.3	V
V <sub>IL</sub>	Input Low Voltage	V <sub>SS</sub> -0.3	—	0.2*V <sub>CC</sub>	V

Outputs					
Symbol	Description	Min	Typ	Max	Unit
V <sub>OH</sub>	Output High Voltage	2.4	—	3.45	V
V <sub>OL</sub>	Output Low Voltage	0	—	0.4	V

**Note:** The embedded modules provide an on board supervisor circuit with a 2.88V reset threshold and an internal 5k pull-up resistor. When VCC falls to the threshold voltage, a reset pulse is issued, holding the output in active state. When power rises above 2.88V, the reset remains for approximately 250 ms to allow the system clock and other circuits to stabilize.

	Digi Connect ME	Digi Connect Wi-ME
Storage Temperature	-40°F to 257°F (-40°C to 125°C)	
Humidity	5% to 90%	
Altitude	12000 feet (3657.60 meters)	

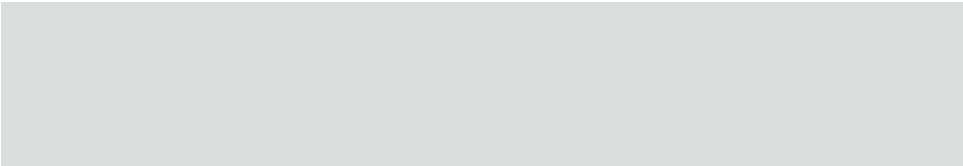

## Power Management (Connect ME-9210 only)

---

Using the Digi NET+OS development environment, applications on the Digi Connect ME 9210 are capable of operating the module in several reduced power consumption modes. These reduced power operating modes utilize the power management mechanisms for the Digi NS9210 processor for CPU clock scaling and sleep.

In the Clock Scaling mode, the system itself continues to execute instructions, but at a different clock rate, which can be changed on-the-fly, using Digi’s patented circuitry inside the NS9210 processor. The clock speed is changed programmatically to lower or raise the system clock speed, thus reducing or increasing the module’s power footprint, respectively.

Additionally, a Sleep mode is available in which the system stops executing instructions. Based on the application needs, wake-up triggers can be set up programmatically to activate the processor back to wherever it left off. In this mode, a drastic power reduction is realized by reducing the power consumption of the Digi NS9210 processor and the on-module PHY.

For sample power consumption figures for normal (typical) and power management related operation of the Digi Connect ME 9210, see below:

- 3.3VDC @ 346 mA typical (1.14W)
- UART and Ethernet activated

**Low Speed Idle Mode (approximate)**

- 3.3VDC @ 186 mA (613 mW)
- /16 clock scaling, Ethernet activated

**Sleep Mode (approximate)**

- 3.3VDC @ 34 mA (113 mW)
- Wake-up on EIRQ, Ethernet PHY off

## Thermal Specifications

---

The table below shows the standard operating temperature ranges for the entire Digi Connect ME family of embedded modules.

<b>Standard Operating Temperature Ranges</b>	
<b>Product</b>	<b>Operating Temperature Range</b>
Digi Connect ME	-40°C to +85°C
Digi Connect ME 9210	-40°C to +80°C
Digi Connect Wi-ME	-30°C to +75°C

The lower standard operating temperature ranges are specified without restrictions, except condensation must not occur.

The upper operating temperature limit depends on the host PCB layout and surrounding environmental conditions. To simplify the customer's design process, a maximum case temperature has been specified.

<b>Maximum Case Temperature</b>	
<b>Product</b>	<b>Maximum Case Temperature</b>
Digi Connect ME	96°C
Digi Connect ME 9210	93°C
Digi Connect Wi-ME	85°C

The maximum case temperature must remain below the maximum, measured at the location shown in the figure below.

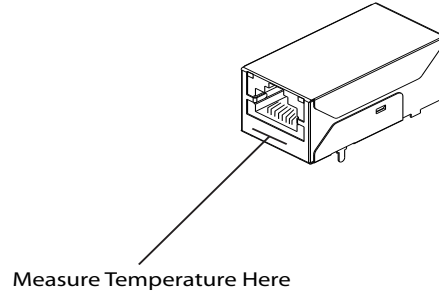
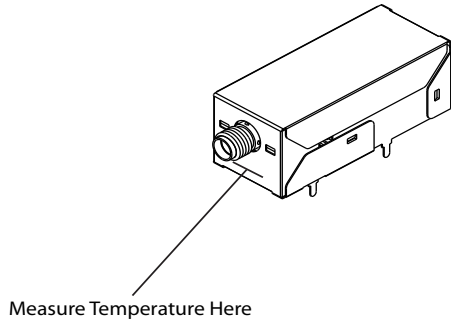
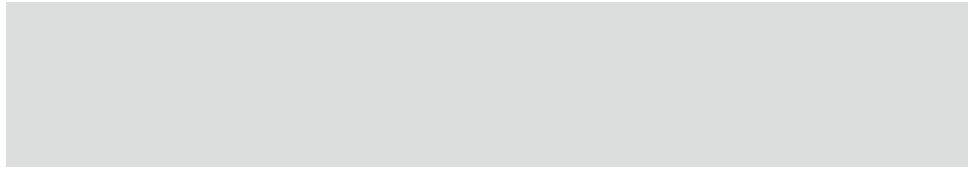

### **Additional Design Recommendations**

The following list provides additional design guidance with respect to thermal management in applications with operating temperatures at the high end or beyond the specified standard ambient temperature range.

- Providing air movement will improve heat dissipation.
- The host PCB plays a large part in dissipating the heat generated by the module. A large copper plane located under the Digi Connect ME 9210 and soldered to the module's mounting tabs will improve the heat dissipation capabilities of the PCB.
- If the design allows, added buried PCB planes will also improve heat dissipation. The copper planes create a larger surface to spread the heat into the surrounding environment.
- Adding a thermal pad or thermal compound, such as Sil-Pad<sup>®</sup>, Gap Pad<sup>®</sup> or Gap Filler products made by the Bergquist Company ([www.bergquistcompany.com](http://www.bergquistcompany.com)), between the host PCB and the underside of the module will significantly increase the thermal transfer between the module's enclosure and the host PCB. Limit the fill area to the folded metal portion of the module's underside.

## Mechanical

Dimensions	Digi Connect ME	Digi Connect Wi-ME	
Length	1.445 in. (36.703 mm)	1.85 in (46.99 mm)	
Width	0.75 in. (19.05 mm)		
Height	0.854 in. (21.69 mm)		
Weight	.616oz. 17.463g	.696 oz. 19.731 g.	Antenna- .408 oz. 11.567 g
		Total - 1.104 oz. 31.298 g	
Device/serial interface connector	20-pin micro header (10-pin double row) with .05-inch (1.27-mm) pitch (Samtec P/N FTS-110-01-F-DV-TR or similar). Positions 3 through 6 are removed.		

## Bar Code

The 50m PN is code 3 of 9 (39) and the MAC is code 128. All scanners are set up so if they read code 3 of 9 they will automatically read 128. The reason for the two different code types is to maximize the size of the bars within a given space to improved readability.

## Dimensions

The following figures show the dimensions of Digi Connect Wi-ME and Digi Connect ME embedded modules.

**Note:** These are the tolerances for the drawings shown on this and the following pages:

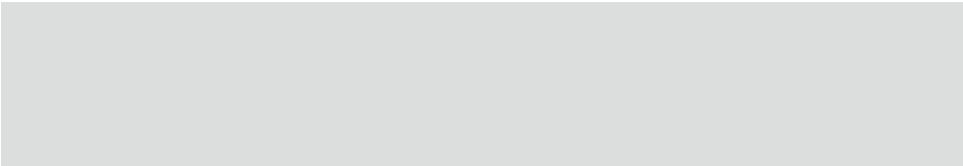

Measure	Tolerance
.XX	± .02
.XXX	± .010
Angles	± 3°

**Digi Connect Wi-ME Module**

**Front Wi-ME**

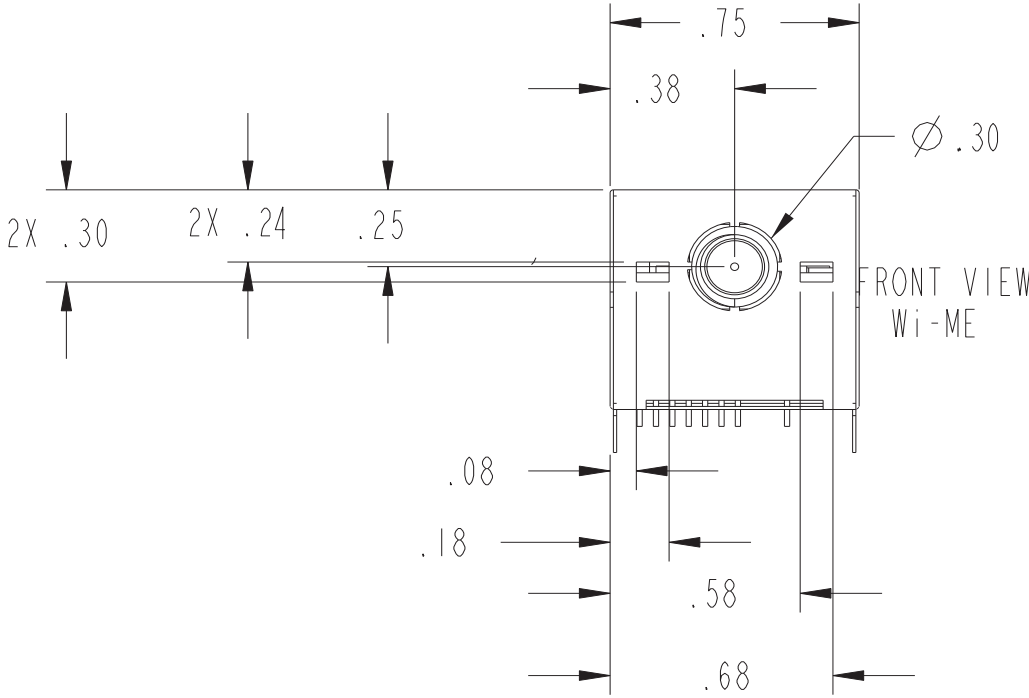

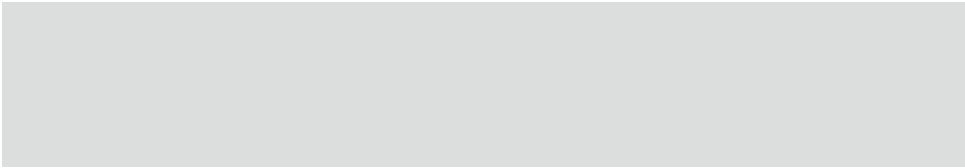

**Side Wi-ME**

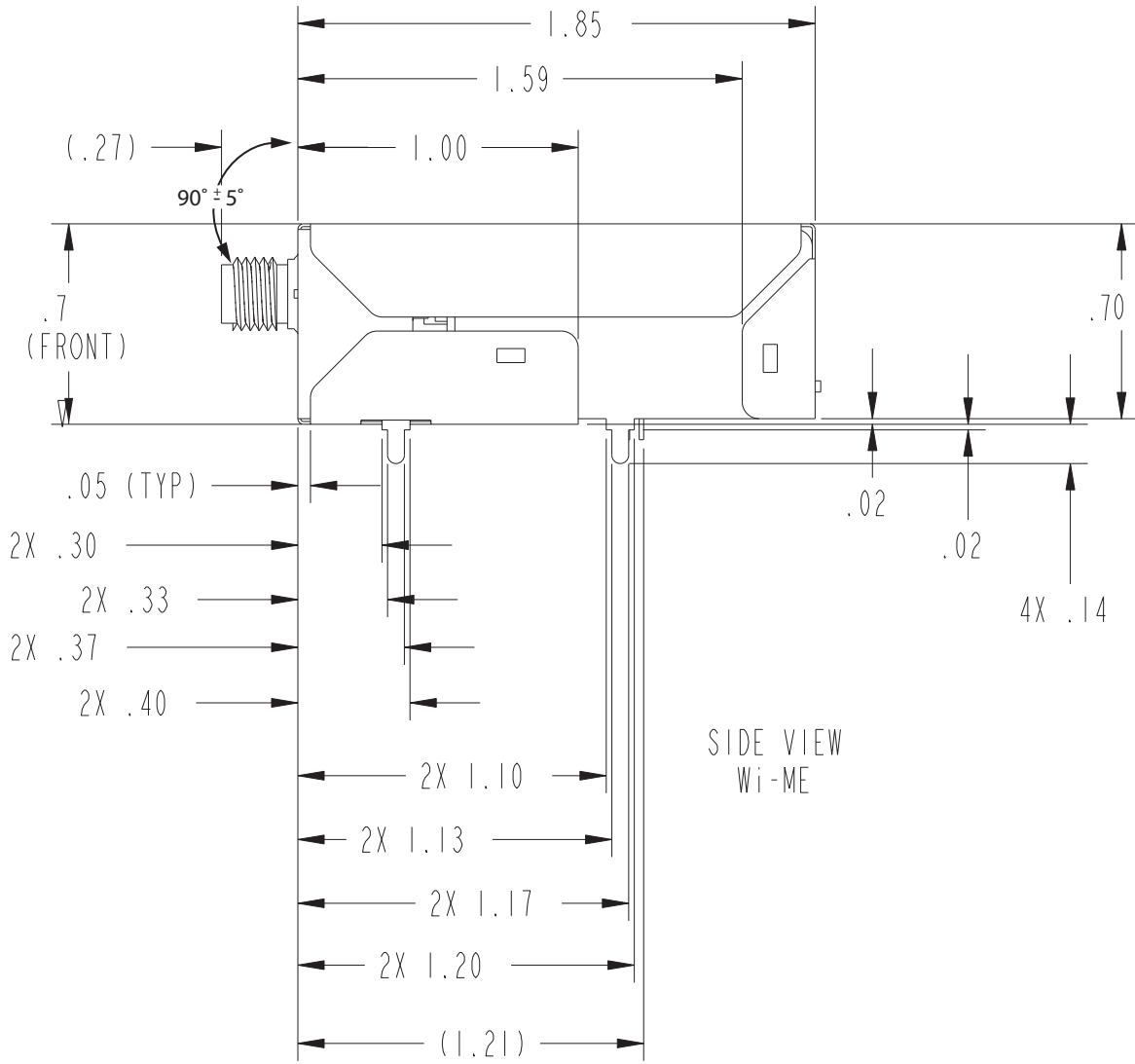

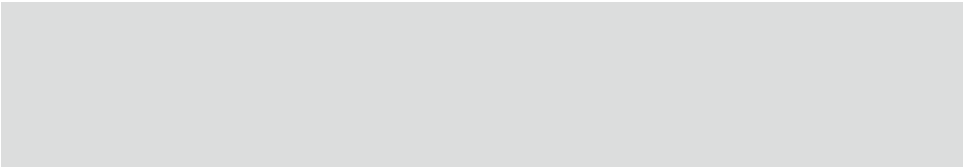

**Bottom Wi-ME**

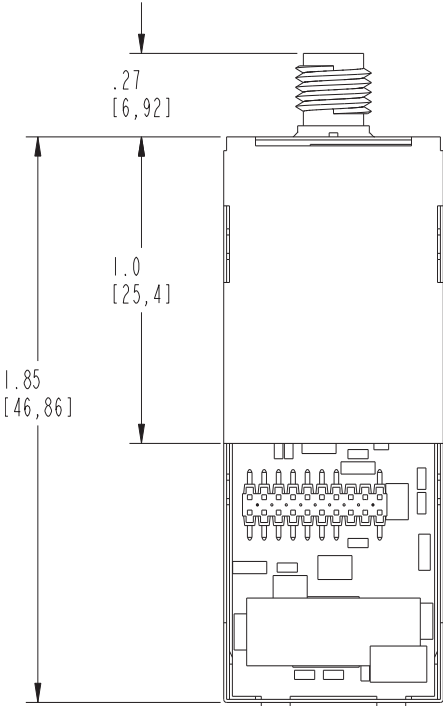



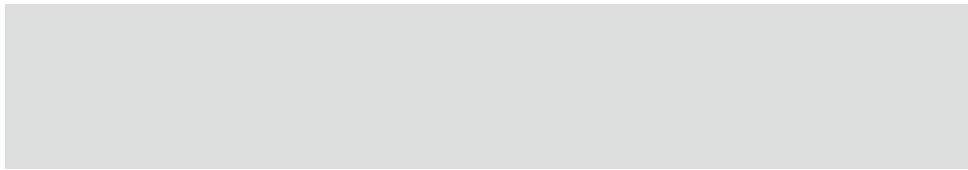

## Digi Connect ME Module

### Front View

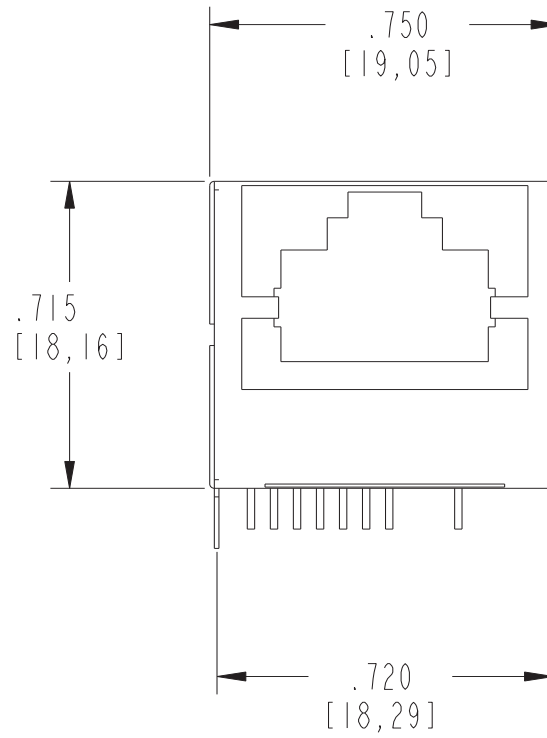

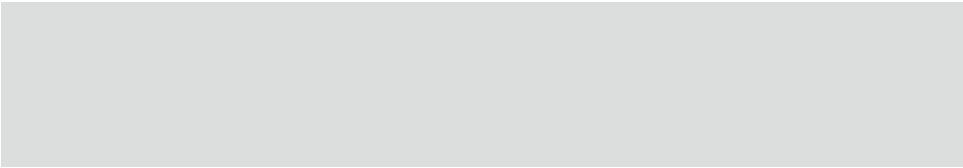

**Side**

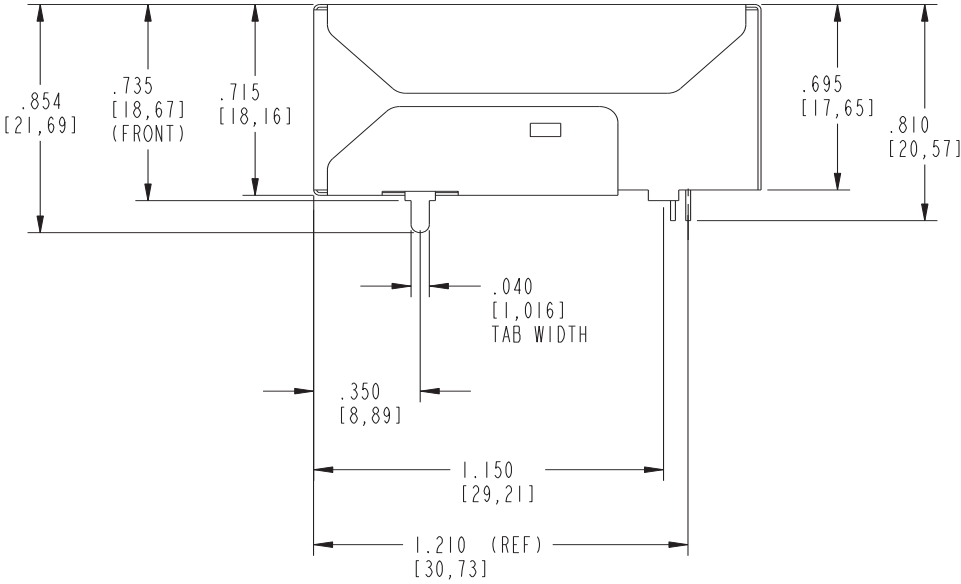

SIDE VIEW

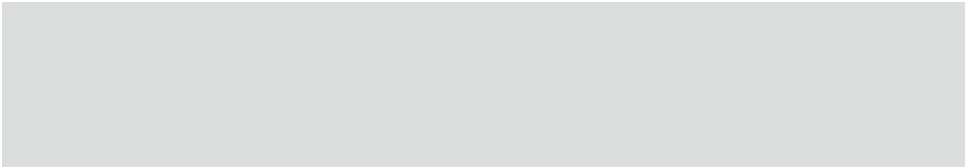

**Bottom**

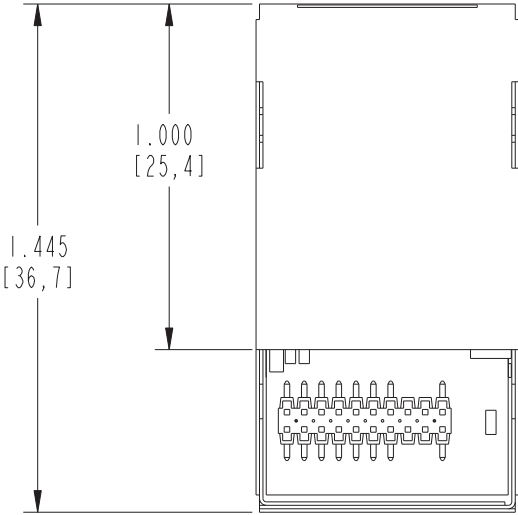

**Recommended PCB Layout**



The following figure shows the recommended PCB (printed circuit board) layout of the Digi Connect Wi-ME and Digi Connect ME. It is strongly recommended that you consider using the Digi Connect Wi-ME footprint for future flexibility.

## Digi Connect ME and Wi-ME

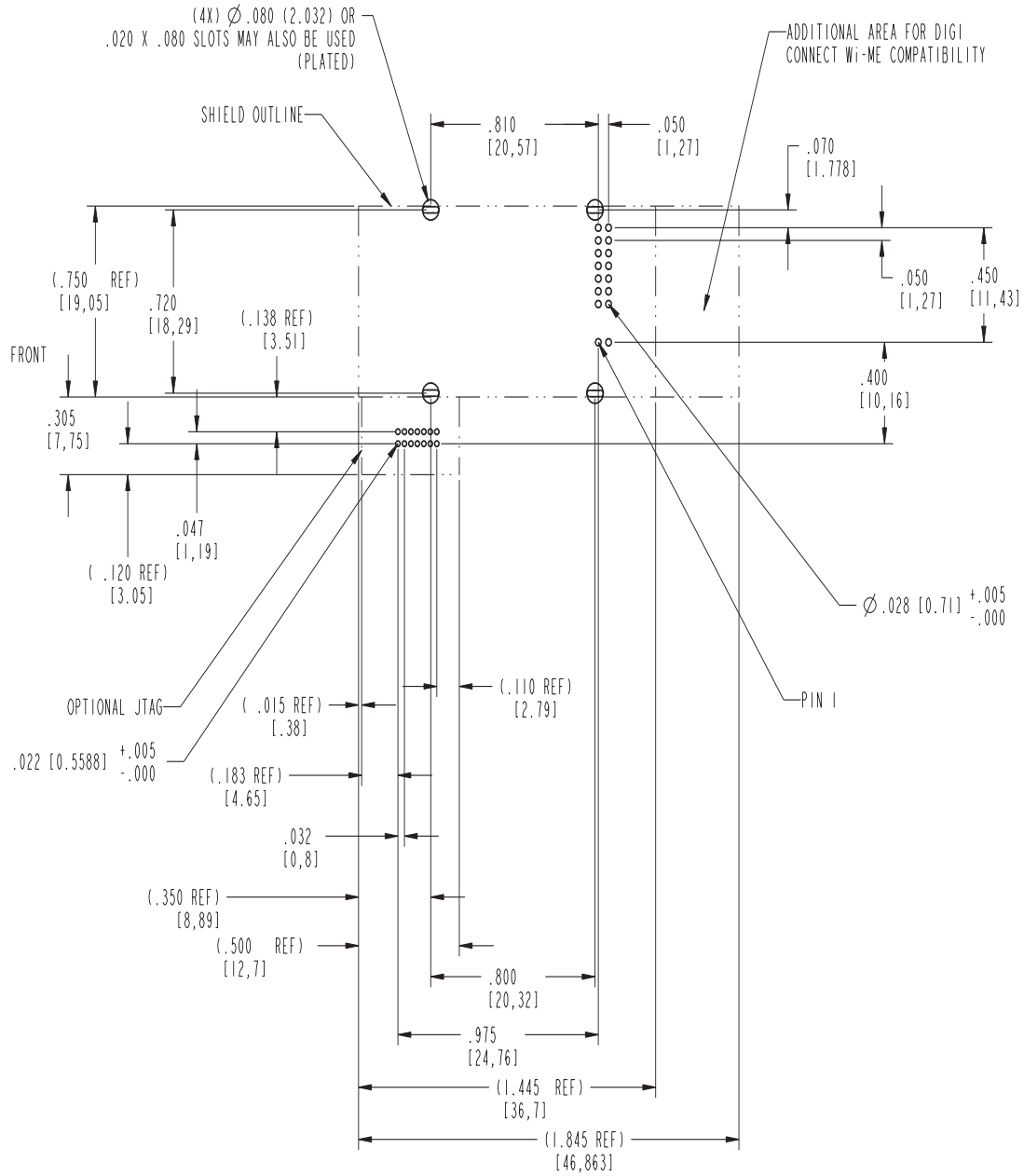

RECOMMENDED PCB LAYOUT  
 TOL.  $\pm$ .005 [0,127] NON-CUMULATIVE

## Antenna Information

---

### Antenna Strength

The following diagram demonstrates the strength of the signal received by the whip antenna on both a horizontal and vertical plane. The diagram shows the magnetic field when the antenna is in a vertical position. The outside line represents the horizontal plane and the inside dotted line represents the vertical plane.

### Radiation Patterns

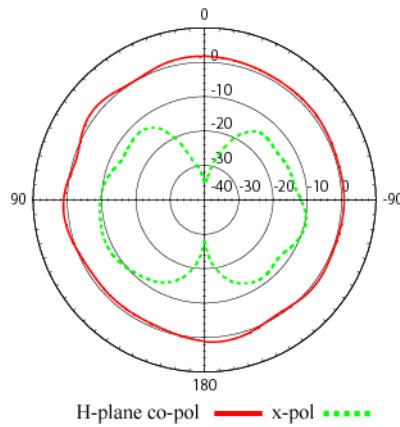

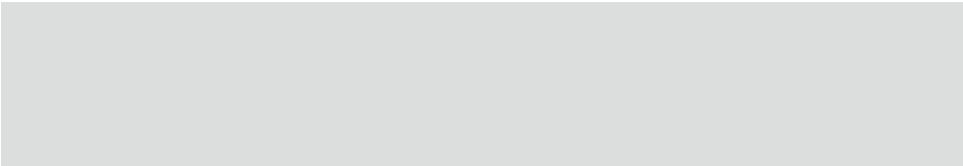

### Antenna Specifications

Antenna Description	Dipole	Desktop
Frequency	2.4~2.5 GHz	2.4~2.5 GHz
Power Output	2 W	1 W
DB Gain	2 dBi	1.8 dBi
VSWR	< or = 2.0	1.92 max.
Dimension	108.5 x 10.0 mm	105 x4.5 mm
Weight	10.5g	11 g
Connector	RP-SMA	
Part Number	DG-ANT-20DP-BG	DC-ANT-24DT

Any antenna matching the in-band and out-of-band signal patterns and strengths of the antenna, whose characteristics are given in the Antenna Description table and the Radiation Pattern graphic may be used with the Digi Connect Wi-ME.

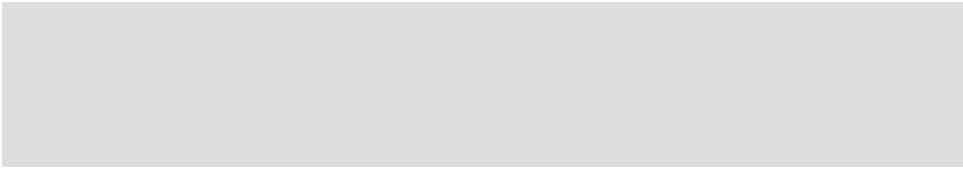

*Desktop Antenna Dimensions*

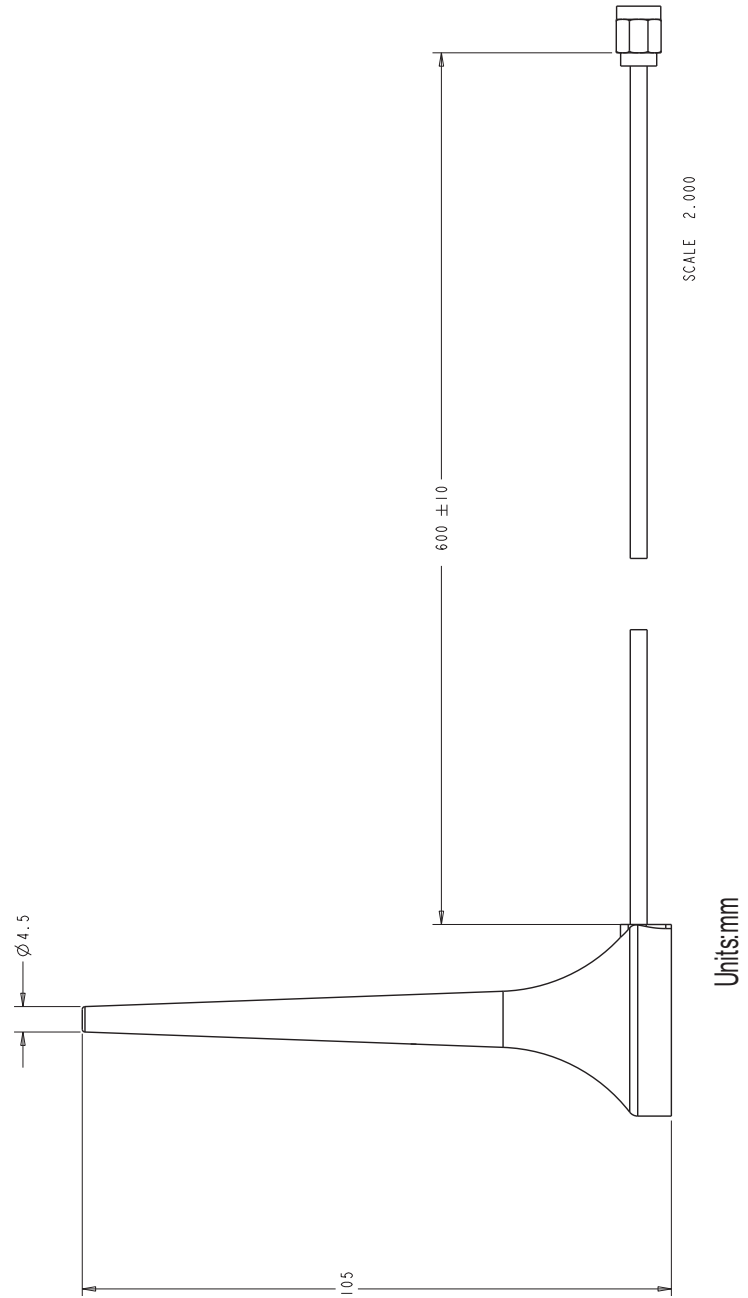

## Dipole Antenna Dimensions

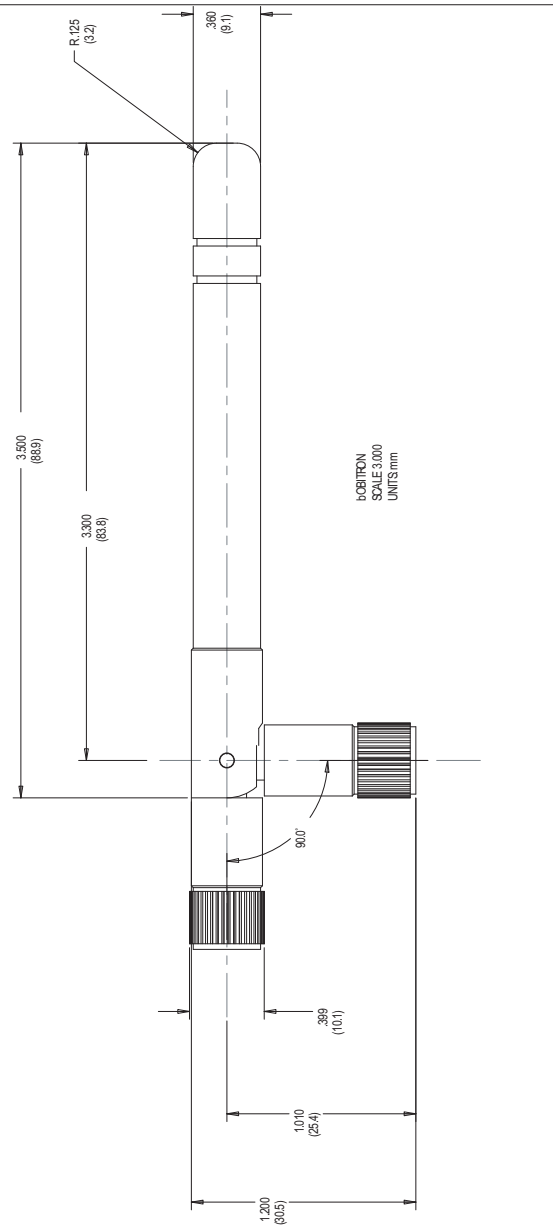





## RF Exposure Statement

---

The Digi Connect Wi-ME module complies with the RF exposure limits for humans as called out in RSS-102. It is exempt from RF evaluation based on its operating frequency of 2.4 GHz, and effective radiated power less than the 3 watt requirement for a mobile device (>20 cm separation) operating at 2.4 GHz.

## Safety Statements

---

**To avoid contact with electrical current:**

- Never install electrical wiring during an electrical storm.
- Never install an ethernet connection in wet locations unless that connector is specifically designed for wet locations.
- Use caution when installing or modifying ethernet lines.
- Use a screwdriver and other tools with insulated handles.
- You and those around you should wear safety glasses or goggles.
- Do not place ethernet wiring or connections in any conduit, outlet or junction box containing electrical wiring.
- Installation of inside wire may bring you close to electrical wire, conduit, terminals and other electrical facilities. Extreme caution must be used to avoid electrical shock from such facilities. You must avoid contact with all such facilities.
- Ethernet wiring must be at least 6 feet from bare power wiring or lightning rods and associated wires, and at least 6 inches from other wire (antenna wires, doorbell wires, wires from transformers to neon signs), steam or hot water pipes, and heating ducts.
- Do not place an ethernet connection where it would allow a person to use an ethernet device while in a bathtub, shower, swimming pool, or similar hazardous location.
- Protectors and grounding wire placed by the service provider must not be connected to, removed, or modified by the customer.

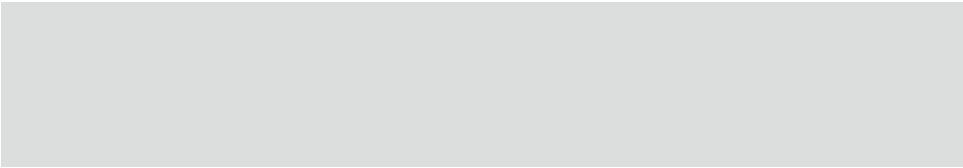

- Do not touch un-insulated ethernet wiring if lightning is likely!
- Do not touch or move the antenna(s) while the unit is transmitting or receiving.
- Do not hold any component containing a radio such that the antenna is very close to or touching any exposed parts of the body, especially the face or eyes, while transmitting.
- Do not operate a portable transmitter near unshielded blasting caps or in an explosive environment unless it is a type especially qualified for such use

Any *external* communications wiring you may install needs to be constructed to all relevant electrical codes. In the United States this is the National Electrical Code Article 800. Contact a licensed electrician for details.

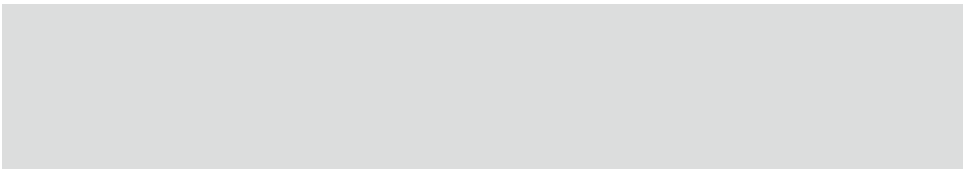



# *Certifications*

---

## A P P E N D I X B

These products comply with the following standards.

### **FCC Part 15 Class B**

---

#### **Radio Frequency Interference (RFI)(FCC 15.105)**

The Digi Connect ME and Digi Connect Wi-ME embedded modules have been tested and found to comply with the limits for Class B digital devices pursuant to Part 15 Subpart B, of the FCC Rules. These limits are designed to provide reasonable protection against harmful interference in a residential environment. This equipment generates, uses, and can radiate radio frequency energy, and if not installed and used in accordance with the instruction manual, may cause harmful interference to radio communications. However, there is no guarantee that interference will not occur in a particular installation. If this equipment does cause harmful interference to radio or television reception, which can be determined by turning the equipment off and on, the user is encouraged to try and correct the interference by one or more of the following measures:

- Reorient or relocate the receiving antenna.
- Increase the separation between the equipment and the receiver.
- Connect the equipment into an outlet on a circuit different from that to which the receiver is connected.
- Consult the dealer or an experienced radio/TV technician for help.



## **Labeling Requirements (FCC 15.19)**

This device complies with Part 15 of FCC rules. Operation is subject to the following two conditions: (1) this device may not cause harmful interference, and (2) this device must accept any interference received, including interference that may cause undesired operation.

If the FCC ID is not visible when installed inside another device, then the outside of the device into which the module is installed must also display a label referring to the enclosed module FCC ID. This exterior label can use wording such as the following: "Contains Transmitter Module FCC ID: MCQ-50M880/ IC: 1846A-50M880".

## **Modifications (FCC 15.21)**

Changes or modifications to this equipment not expressly approved by Digi may void the user's authority to operate this equipment.

## **Industry Canada**

---

This digital apparatus does not exceed the Class B limits for radio noise emissions from digital apparatus set out in the Radio Interference Regulations of the Canadian Department of Communications.

Le present appareil numerique n'emet pas de bruits radioelectriques depassant les limites applicables aux appareils numeriques de la class B prescrites dans le Reglement sur le brouillage radioelectrique edicte par le ministere des Communications du Canada."

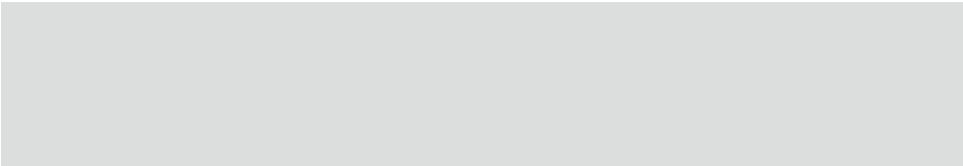

# Declaration of Conformity



(In accordance with FCC Dockets 96-208 and 95-19)

**Manufacturer's Name:** Digi International

**Corporate Headquarters:** 11001 Bren Road East  
Minnetonka MN 55343

**Manufacturing Headquarters:** 10000 West 76th Street  
Eden Prairie MN 55344

Digi International declares, that the product:

**Product Name:** Digi Connect ME embedded module

**Model Number:** 50001528-XX

**Product Name:** Digi Connect Wi-ME embedded module

**Model Number:** 50000880-XX

to which this declaration relates, meets the requirements specified by the Federal Communications Commission as detailed in the following specifications:

- Part 15, Subpart B, for Class B Equipment
- FCC Docket 96-208 as it applies to Class B personal
- Computers and Peripherals

The product listed above has been tested at an External Test Laboratory certified per FCC rules and has been found to meet the FCC, Part 15, Class B, Emission Limits. Documentation is on file and available from the Digi International Homologation Department.

## International EMC Standards

The Digi Connect ME and Digi Connect Wi-ME embedded modules meet the following standards:

Standards	Digi Connect ME	Digi Connect Wi-ME
<b>Emissions</b>	AS/NZS 3548	AS/NZS 3548 CISPR 22
		Japan IOH 003NY04115 0000 003GZ04064 0000
		FCC Part 15 Subpart C (FCC ID: MCQ-50M880)
		IC RSS 210 (IC:1846A-50M880)
	FCC Part 15 Subpart B ICES-003 EN 55022 EN 61000-4-2 EN 61000-4-3 EN 61000-4-6 EN 301 489-3 EN 300 328 VCCI	
<b>Immunity</b>		EN 55024
<b>Safety</b>		UL 60950-1 CSA 22.2 No. 60950--1 EN 60950

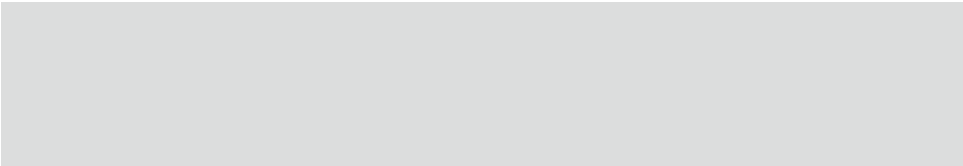

**Antenna configurations**

This device has been designed to operate with the antennas listed below, and having a maximum gain of [10] dBi. Antennas not included in this list or having a gain greater than [10] dBi are strictly prohibited for use with this device. The required antenna impedance is [50] ohms

The following antenna configurations that were tested with the Connect Wi-ME 802.11 b module.

**Digi 29000095, Bobbintron SA-006-1, +2 dBi dipole antenna (RP-SMA)**





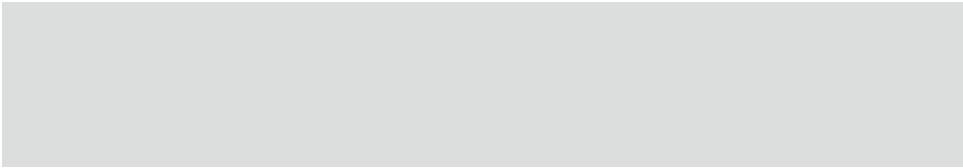

**PCTEL, MLPV2400NGP, 2.4 GHz, 3dBi gain, no ground plane, low profile antenna**



**MAXRAD, MFB24010, 2.4 GHz, 10 dBi Fiberglass OMNI antenna**

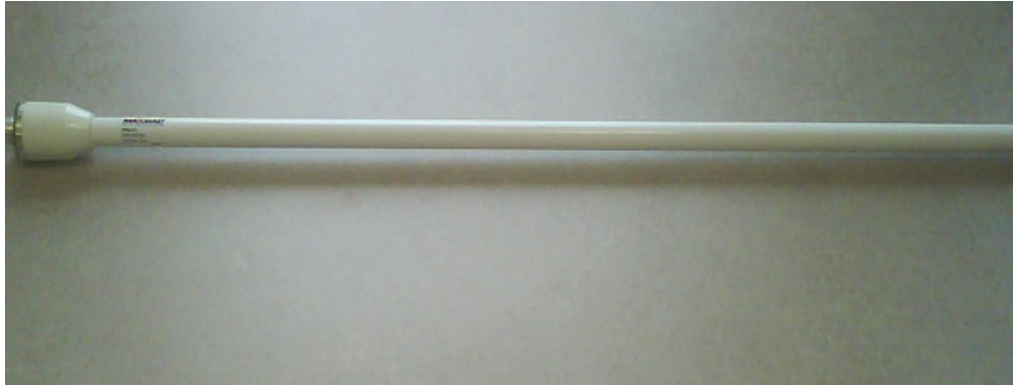

To reduce potential radio interference to other users, the antenna type and its gain should be so chosen that the equivalent isotropically radiated power (e.i.r.p.) is not more than that permitted for successful communication.

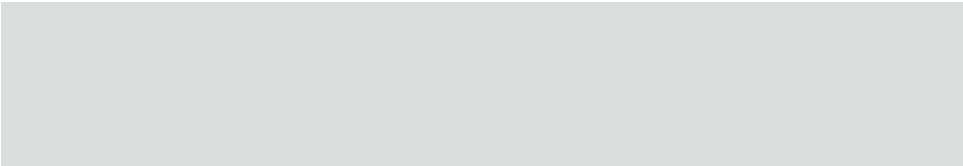

# *Sample Application: PoE Power Supply*



## A P P E N D I X C

The following schematic is an example of PoE Power Supply:

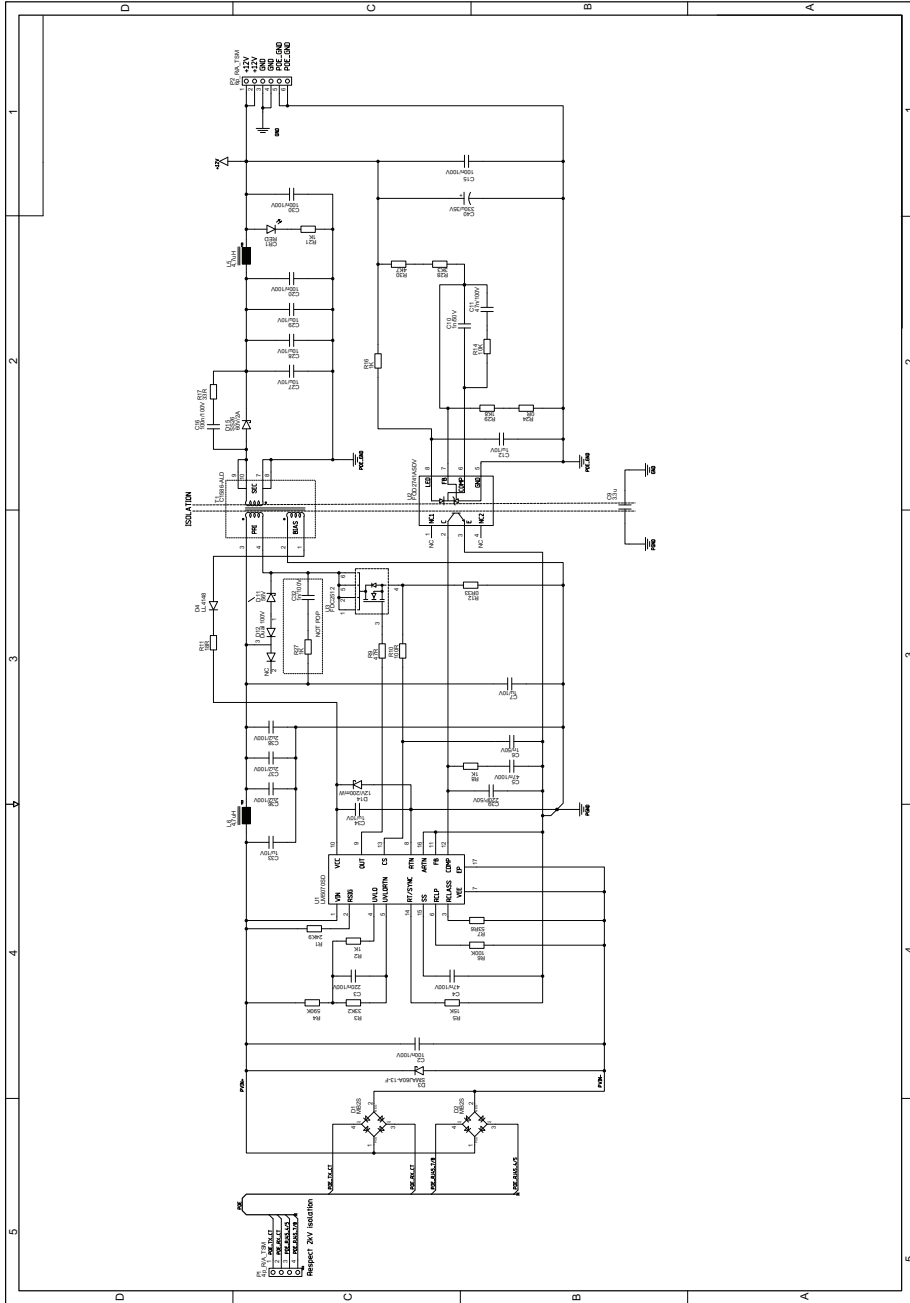
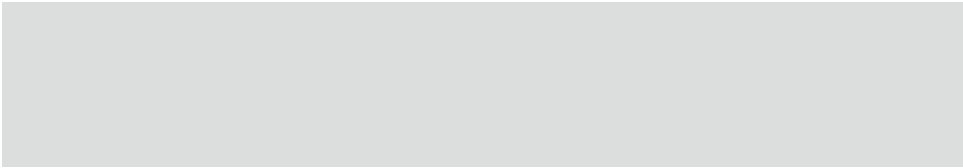

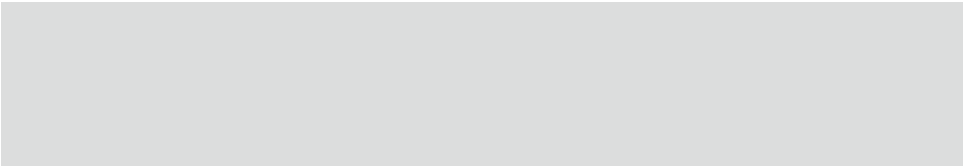

# *Sample Application: TTL Signals to EIA-232*



## A P P E N D I X D

The following schematic is an example of how to convert the modules's TTL signals to EIA-232.



# SAMPLE APPLICATION

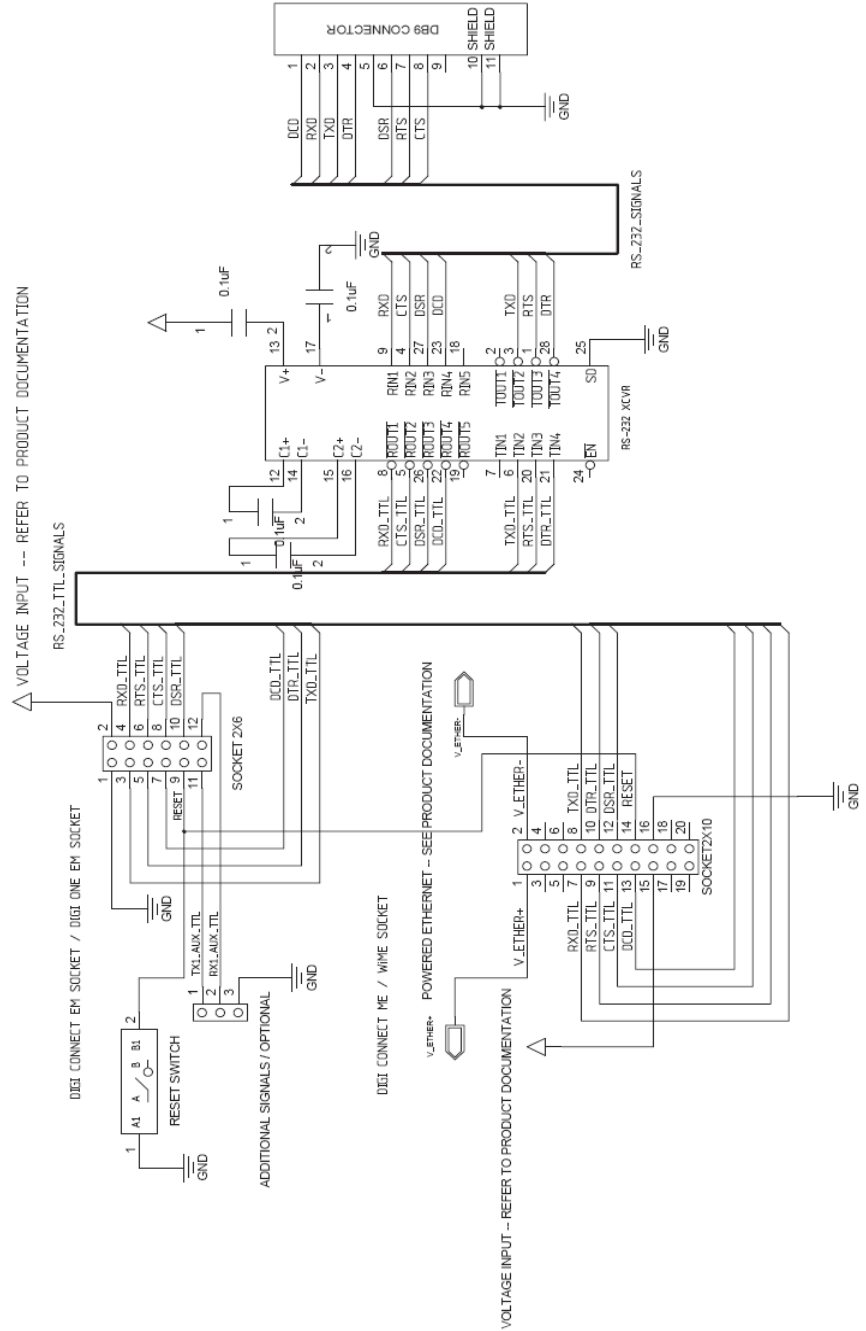

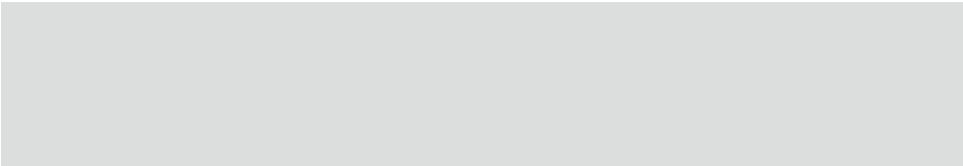

# *Change Log*



## A P P E N D I X E

The following changes have been made since the last revision of this document.

**Note: As of September 2007, the document number changed from 90000631 to 90000897.**

### **Revision F**



- Added ME sketch to Thermal Specifications.
- Added antenna configurations.

### **Revision E**



- Changed schematics in appendix A to reflect correct measurements.

### **Revision D**



- Added a new section labeled “Thermal Specifications” to the book. This section outlines the temperature ranges at which the devices specified can still function properly.



## Revision C

---

Updates to schematics in Chapter 2.  
Added/revised Module Pin-out table in Chapter 3.  
Updated GPIO tables throughout book.

## Revision B

---

Fixed page numbers to make them correspond in PDF form.  
Added components to Development Board schematics. (#19 and 20)

## Revision 90000631\_G>90000897\_A

---

Added Connect ME 9210 related information.  
Updated schematics in development board chapter to reflect 9210 changes.

## Revision G

---

Updated the Connectors: power and device interface section to say that pins 1 and 2 on the connector are available if using Connect ME, not available if using Connect Wi-ME.  
Updated the Embedded Module Connector table in Chapter 2 similarly.  
Added tolerance information for dimension drawings  
Updated Hard Reset section to clarify forcing the unit into hard reset  
Updated the ambient (operating) temperature for Connect Wi-ME  
Added information regarding reading the bar code  
Added P12 Factory reset pin

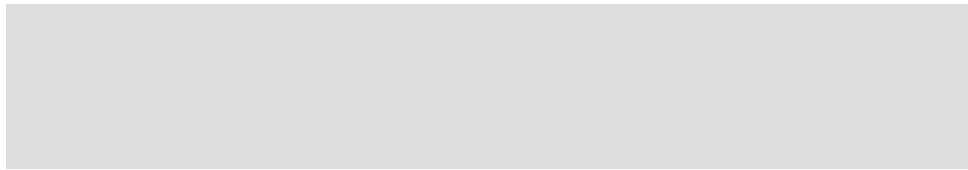

## Revision F

---

- Updated Antenna drawing
- Added product weights
- Updated UL labeling description
- Updated dimension drawings

## Revision E

---

- Added Japan certification
- Improve dipole antenna drawing
- Corrected imperial pitch measurement
- Reformatted tables for easier reading
- Added antenna extension cord information
- Added more receive sensitivity information
- Added Caution for soldering process
- Added reset hold times
- Added VCC \*absolute max\* ratings
- Combined PCB layouts with improvements



