

TEST REPORT

Test report no.: 1-2428-01-08/10-B



Testing laboratory

CETECOM ICT Services GmbH
Untertuerkheimer Straße 6 – 10
66117 Saarbruecken / Germany
Phone: + 49 681 5 98 - 0
Fax: + 49 681 5 98 - 9075
Internet: <http://www.cetecom.com>
e-mail: ict@cetecom.com

Accredited test laboratory:

The test laboratory (area of testing) is accredited according to DIN EN ISO/IEC 17025
DAR registration number: DGA-PL-176/94-D1

Area of Testing: Radio/Satellite Communications

Applicant

Digi International GmbH
Branch Breisach
Kueferstr.8
79206 Breisach / Germany
Phone: -/
Fax: +49 7667 908 200
Contact: Andreas Ortlieb
e-mail: andreas.ortlieb@digi.com
Phone: +49 7667 908 136

Manufacturer

Digi International GmbH
Branch Breisach
Kueferstr.8
79206 Breisach / Germany

Test standard/s

47 CFR Part 15

Title 47 of the Code of Federal Regulations; Chapter I-Federal Communications Commission
subchapter A - general, Part 15-Radio frequency devices

RSS - 210 Issue 8

Spectrum Management and Telecommunications - Radio Standards Specification
Low-power Licence-exempt Radiocommunication Devices (All Frequency Bands):
Category I Equipment

For further applied test standards please refer to section 3 of this test report.

Test item

Kind of test item:	WLAN module
Model name:	WLAN-Computer
FCC ID:	MCQ-50M1699
IC:	1846A-50M1699
Frequency [MHz]:	5725 MHz – 5850 MHz ISM band (lowest channel 5745MHz; highest channel 5825 MHz)
Power supply:	3.3V DC by power supply
Temperature range:	-20 °C to +55 °C

This test report is electronically signed and valid without handwriting signature. For verification of the electronic signatures, the public keys can be requested at the testing laboratory.

Test performed:

Test report authorised:

Marco Bertolino

Andreas Keller

1 Table of contents

1	Table of contents	2
2	General information	3
2.1	Notes.....	3
2.2	Application details	3
3	Test standard/s	3
4	Test environment	3
5	Test item	4
6	Test laboratories sub-contracted	4
7	Summary of measurement results	5
8	RF measurement testing	6
8.1	Description of test setup.....	6
8.1.1	Radiated measurements	6
8.1.2	Conducted measurements	7
8.2	Additional comments	7
8.3	RSP100 test report cover sheet / performance test data	8
9	Measurement results.....	9
9.1	Maximum output power (conducted).....	9
9.2	Antenna gain.....	18
9.3	Power spectral density.....	21
9.4	Spectrum bandwidth of a FHSS system – 6 dB bandwidth.....	21
9.5	Spectrum bandwidth of a FHSS system – 20 dB bandwidth.....	21
9.6	Maximum output power.....	22
9.7	Band edge compliance conducted	27
9.8	Band edge compliance radiated	27
9.9	TX spurious emissions conducted	27
9.10	TX spurious emissions radiated	28
9.11	RX spurious emissions radiated	55
9.12	TX spurious emissions radiated < 30 MHz	61
9.13	TX spurious emissions conducted < 30 MHz	66
10	Test equipment and ancillaries used for tests.....	67
Annex A	Document history	69
Annex B	Further information.....	69

2 General information

2.1 Notes

The test results of this test report relate exclusively to the test item specified in this test report. CETECOM ICT Services GmbH does not assume responsibility for any conclusions and generalisations drawn from the test results with regard to other specimens or samples of the type of the equipment represented by the test item. The test report may only be reproduced or published in full. Reproduction or publication of extracts from the report requires the prior written approval of CETECOM ICT Services GmbH. This test report is electronically signed and valid without handwriting signature. For verification of the electronic signatures, the public keys can be requested at the testing laboratory.

2.2 Application details

Date of receipt of order:	2010-09-22
Date of receipt of test item:	2010-11-11
Start of test:	2010-11-11
End of test:	2010-11-18
Person(s) present during the test:	-/-

3 Test standard/s

Test standard	Version	Test standard description
47 CFR Part 15	2009-10	Title 47 of the Code of Federal Regulations; Chapter I-Federal Communications Commission subchapter A - general, Part 15-Radio frequency devices
RSS - 210 Issue 8	2010-12	Spectrum Management and Telecommunications - Radio Standards Specification Low-power Licence-exempt Radiocommunication Devices (All Frequency Bands): Category I Equipment

4 Test environment

Temperature:	T_{nom}	+20 °C during room temperature tests
	T_{max}	+55 °C during high temperature test
	T_{min}	-20 °C during low temperature test
Relative humidity content:		39 %
Air pressure:		not relevant for this kind of testing
Power supply:	V_{nom}	3.3 V DC by power supply
	V_{max}	-/- V
	V_{min}	-/- V

5 Test item

Kind of test item	:	WLAN module
Type identification	:	WLAN-Computer
S/N serial number	:	Prototype 1 55001564-01 04 8104526044 Prototype 2 55001564-01 04 B104526040
HW hardware status	:	No information available!
SW software status	:	No information available!
Frequency band [MHz]	:	5725 MHz – 5850 MHz ISM band (lowest channel 5745MHz; highest channel 5825 MHz)
Type of modulation	:	ODFM technology with QPSK; 16- & 64-QAM modulation.
Number of channels	:	5
Antenna	:	Integrated ceramic antenna
Power supply	:	3.3 V DC by power supply
Temperature range	:	-20 °C to +55 °C

6 Test laboratories sub-contracted

None

7 Summary of measurement results



No deviations from the technical specifications were ascertained



There were deviations from the technical specifications ascertained

TC Identifier	Description	Verdict	Date	Remark
RF-Testing	CFR Part 15 RSS 210, Issue 8, Annex 8	Passed	2011-01-28	-/-

Test specification clause	Test case	Temperature conditions	Power source voltages	Mode	Pass	Fail	NA	NP	Remark
§15.247(b)(4) RSS 210 / A8.4(2)	Antenna gain	Nominal	Nominal	OFDM	<input checked="" type="checkbox"/>	<input type="checkbox"/>	<input type="checkbox"/>	<input type="checkbox"/>	complies
§15.247(e) RSS 210 / A8.2(b)	Power spectral density	Nominal	Nominal	OFDM	<input type="checkbox"/> <input type="checkbox"/>	<input type="checkbox"/> <input type="checkbox"/>	<input type="checkbox"/> <input type="checkbox"/>	<input checked="" type="checkbox"/> <input checked="" type="checkbox"/>	Delta tests only!
§15.247(a)(2) RSS 210 / A8.2(a)	Spectrum bandwidth of a FHSS system 6dB bandwidth	Nominal	Nominal	OFDM	<input type="checkbox"/> <input type="checkbox"/>	<input type="checkbox"/> <input type="checkbox"/>	<input type="checkbox"/> <input type="checkbox"/>	<input checked="" type="checkbox"/> <input checked="" type="checkbox"/>	Delta tests only!
§15.247(a)(2) RSS 210 / A8.2(a)	Spectrum bandwidth of a FHSS system 20dB bandwidth	Nominal	Nominal	OFDM	<input type="checkbox"/> <input type="checkbox"/>	<input type="checkbox"/> <input type="checkbox"/>	<input type="checkbox"/> <input type="checkbox"/>	<input checked="" type="checkbox"/> <input checked="" type="checkbox"/>	Delta tests only!
§15.247(b)(3) RSS-210 / A8.4(4)	Maximum output power	Nominal	Nominal	OFDM	<input checked="" type="checkbox"/> <input checked="" type="checkbox"/>	<input type="checkbox"/> <input type="checkbox"/>	<input type="checkbox"/> <input type="checkbox"/>	<input type="checkbox"/> <input type="checkbox"/>	complies
§15.247(d) RSS-210 / A8.5	Band edge compliance conducted	Nominal	Nominal	OFDM	<input type="checkbox"/> <input type="checkbox"/>	<input type="checkbox"/> <input type="checkbox"/>	<input type="checkbox"/> <input type="checkbox"/>	<input checked="" type="checkbox"/> <input checked="" type="checkbox"/>	Delta tests only!
§15.205 RSS-210 / A8.5	Band edge compliance radiated	Nominal	Nominal	OFDM	<input type="checkbox"/> <input type="checkbox"/>	<input type="checkbox"/> <input type="checkbox"/>	<input checked="" type="checkbox"/> <input checked="" type="checkbox"/>	<input type="checkbox"/> <input type="checkbox"/>	-/-
§15.247(d) RSS-210 / A8.5	TX spurious emissions conducted	Nominal	Nominal	OFDM	<input type="checkbox"/> <input type="checkbox"/>	<input type="checkbox"/> <input type="checkbox"/>	<input type="checkbox"/> <input type="checkbox"/>	<input checked="" type="checkbox"/> <input checked="" type="checkbox"/>	Delta tests only!
§15.247(d) RSS-210 / A8.5	TX spurious emissions radiated	Nominal	Nominal	OFDM	<input checked="" type="checkbox"/> <input checked="" type="checkbox"/>	<input type="checkbox"/> <input type="checkbox"/>	<input type="checkbox"/> <input type="checkbox"/>	<input type="checkbox"/> <input type="checkbox"/>	complies
§15.109 RSS-Gen.	RX spurious emissions radiated	Nominal	Nominal	-/-	<input checked="" type="checkbox"/>	<input type="checkbox"/>	<input type="checkbox"/>	<input type="checkbox"/>	complies
§15.209(a) RSS-Gen	TX spurious emissions radiated < 30 MHz	Nominal	Nominal	OFDM	<input checked="" type="checkbox"/> <input checked="" type="checkbox"/>	<input type="checkbox"/> <input type="checkbox"/>	<input type="checkbox"/> <input type="checkbox"/>	<input type="checkbox"/> <input type="checkbox"/>	complies
§15.107(a)	Conducted emissions < 30 MHz	Nominal	Nominal	OFDM	<input type="checkbox"/> <input type="checkbox"/>	<input type="checkbox"/> <input type="checkbox"/>	<input type="checkbox"/> <input type="checkbox"/>	<input checked="" type="checkbox"/> <input checked="" type="checkbox"/>	Delta tests only!

Note: NA = Not Applicable; NP = Not Performed

8 RF measurement testing

8.1 Description of test setup

8.1.1 Radiated measurements

The radiated measurements are performed in vertical and horizontal plane in the frequency range from 9 kHz to 25 GHz in semi-anechoic chambers. The EUT is positioned on a non-conductive support with a height of 0.80 m above a conductive ground plane that covers the whole chamber. The receiving antennas are confirmed with specifications ANSI C63.2-1996 clause 15 and ANSI C63.4-2003 clause 4.1.5. These antennas can be moved over the height range between 1.0 m and 4.0 m in order to search for maximum field strength emitted from EUT. The measurement distances between EUT and receiving antennas are indicated in the test setups for the various frequency ranges. For each measurement, the EUT is rotated in all three axes until the maximum field strength is received. The wanted and unwanted emissions are received by spectrum analysers where the detector modes and resolution bandwidths over various frequency ranges are set according to requirement ANSI C63-4-2003 clause 4.2.

Antennas are confirmed with ANSI C63.2-1996 item 15.

Semi anechoic chamber

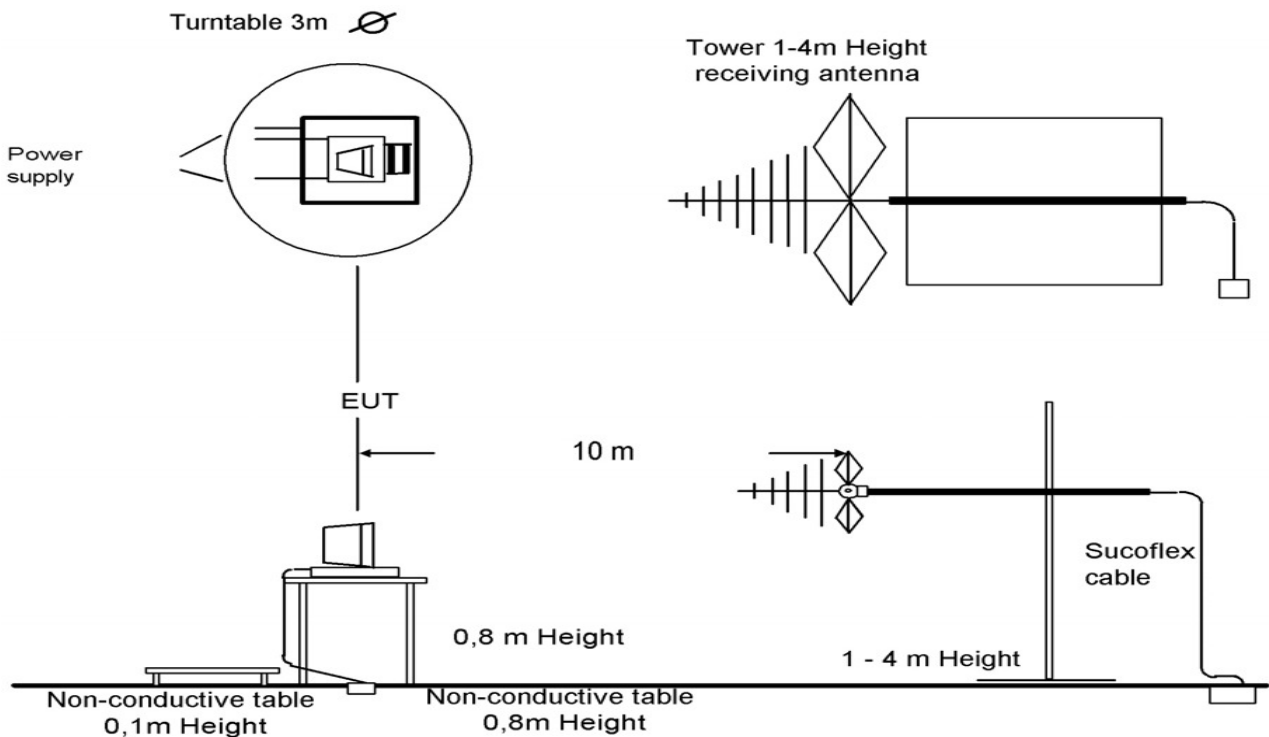

Picture 1: Diagram radiated measurements

9 kHz - 30 MHz:	active loop antenna
30 MHz – 1 GHz:	tri-log antenna
> 1 GHz:	horn antenna

The EUT is powered by an external power supply with nominal voltage. The signalling is performed from outside the chamber with a signalling unit (CMU200 or other) by air link using signalling antenna.

8.1.2 Conducted measurements

The EUT's RF signal is coupled out by the antenna connector which is supplied by the manufacturer. The signal is first 10dB attenuated before it is power divided (~6dB loss per branch). One of the signal paths is connected to the communication base Station (CMU200 or other), the other one is connected to the spectrum analyzer. The specific losses for both signal paths are first checked within a calibration. The measurement readings on the signalling unit/spectrum analyzer are corrected by the specific test set-up loss. The attenuator, power divider, signalling unit and the spectrum analyzer are impedance matched on 50 Ohm.

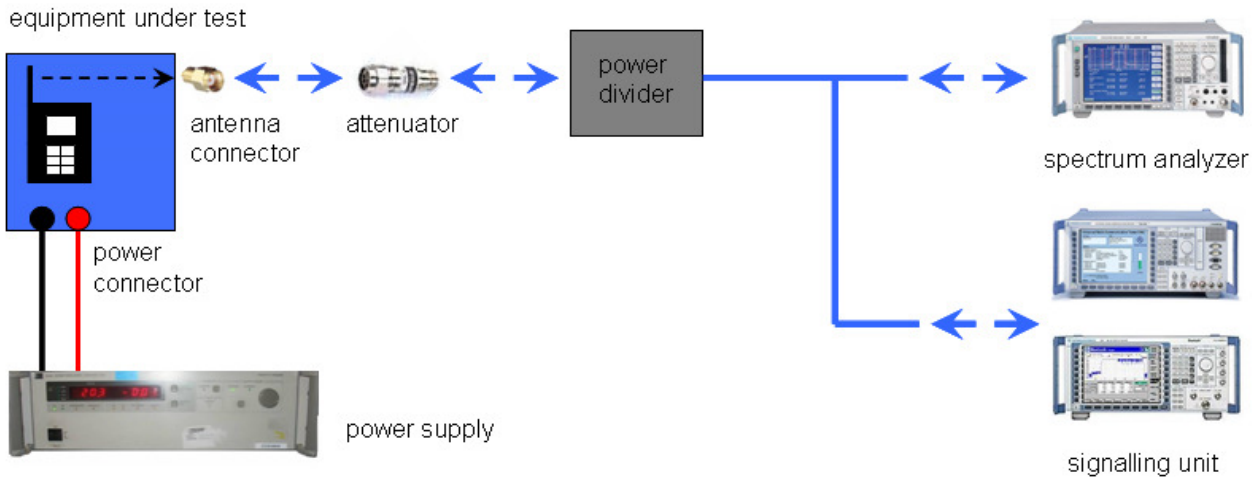

Picture 2: Diagram conducted measurements

8.2 Additional comments

Reference documents: Full module tests =>
Project number CETECOM ICT Services 1-1554/09 (i.MX module)

Special test descriptions: Additional measurement cable (assumed attenuation 1 dB @ 5 GHz)

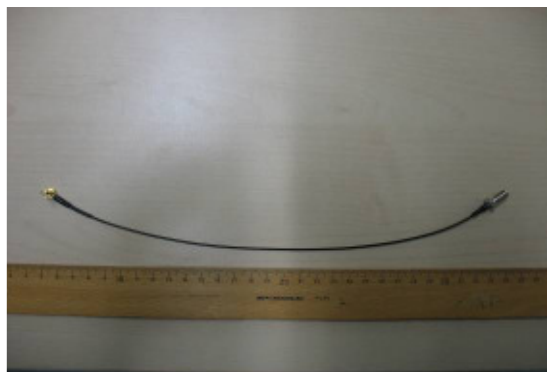

Configuration descriptions: The used power settings are configured according to the conducted output power of the i.MX module. Both samples show with there individually power settings the same output power values.

Test mode:

- No test mode available.
lperf was used to ping an other device with the largest support packet size
- Special software is used.
EUT is transmitting pseudo random data by itself

8.3 RSP100 test report cover sheet / performance test data

Test report number	:	1-2428-01-08/10-B 1-1554-01-15/09-A
Equipment model number	:	WLAN-Computer
Certification number	:	1846A-50M1699
Manufacturer (complete address)	:	Digi International GmbH Branch Breisach Kueferstr.8 79206 Breisach / Germany
Tested to radio standards specification no.	:	RSS 210, Issue 8, Annex 8
Open area test site IC No.	:	IC 3462C-1
Frequency range	:	5725 MHz – 5850 MHz ISM band (lowest channel 5745MHz; highest channel 5825 MHz)
RF-power [W] (max.)	:	cond.: 26.48 mW (OFDM a – mode) 25.47 mW (OFDM n – mode) EIRP: 18.71 mW (OFDM a – mode) 19.14 mW (OFDM n – mode)
Occupied bandwidth (99%-BW) [kHz]	:	OFDM a – mode: 19.52 MHz OFDM n – mode: 19.95 MHz
Type of modulation	:	OFDM - QPSK, 16 QAM, 64 QAM
Emission designator (TRC-43)	:	OFDM a – mode: 19M5G7D OFDM n – mode: 20M0G7D
Antenna information	:	Integrated ceramic antenna
Transmitter spurious (worst case) [dBµV/m @ 3m]:		54 .00 dBµV/m @ 3857 MHz (a – mode) 54 .00 dBµV/m @ 3883 MHz (n – mode)
Receiver spurious (worst case) [dBµV/m @ 3m]:		47.61 dBµV/m @ 9748 GHz

ATTESTATION:

DECLARATION OF COMPLIANCE:

I attest that the testing was performed or supervised by me; that the test measurements were made in accordance with the above-mentioned Industry Canada standard(s); and that the equipment identified in this application has been subjected to all the applicable test conditions specified in the Industry Canada standards and all of the requirements of the standard have been met.

Laboratory manager:

2011-01-28
Date

Marco Bertolino
Name

Signature

9 Measurement results

9.1 Maximum output power (conducted)

Description:

Measurement of the maximum output power conducted. This measurement is performed only at the middle channel in both modes and all data rates to determine the data rate per mode which results in the highest output power. This mode will be selected for all further measurements.

Measurement:

Measurement parameter	
Detector:	Peak
Sweep time:	Auto
Video bandwidth:	30 MHz
Resolution bandwidth:	50 MHz
Span:	100 MHz
Trace-Mode:	Max Hold

Result:

OFDM Data Rate [MBit/s]	Maximum Output Power Conducted [dBm]							
	6	9	12	18	24	36	48	54
Ch 157 - 5785 MHz	12.30	12.84	12.99	12.53	13.03	12.85	12.88	13.45
Measurement uncertainty	± 0.5 dB							

OFDM Data Rate [MBit/s]	Maximum Output Power Conducted [dBm]							
	mcs0	mcs1	mcs2	mcs3	mcs4	mcs5	mcs6	mcs7
Ch 157 - 5785 MHz	12.98	12.62	13.17	13.26	12.95	13.17	12.72	13.42
Measurement uncertainty	± 0.5 dB							

Result: Selected data rate for all measurements:

OFDM / a – mode: 54 MBit/s
 OFDM / n – mode: mcs 7

OFDM – mode / a – mode:

Plot 1: OFDM – mode; middle channel – 5785 MHz; power index 35; 6 MBit/s

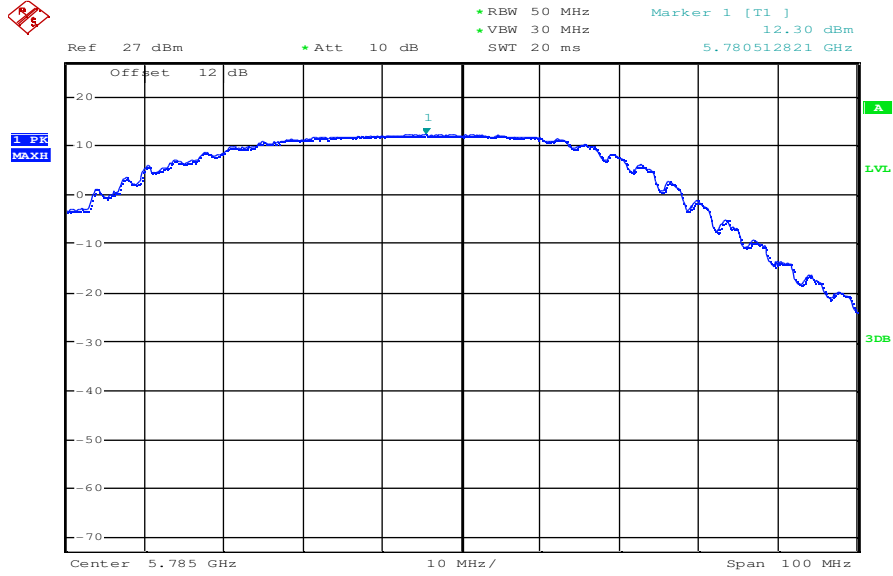

Date: 18.NOV.2010 10:07:09

Plot 2: OFDM – mode; middle channel – 5785 MHz; power index 35; 9 MBit/s

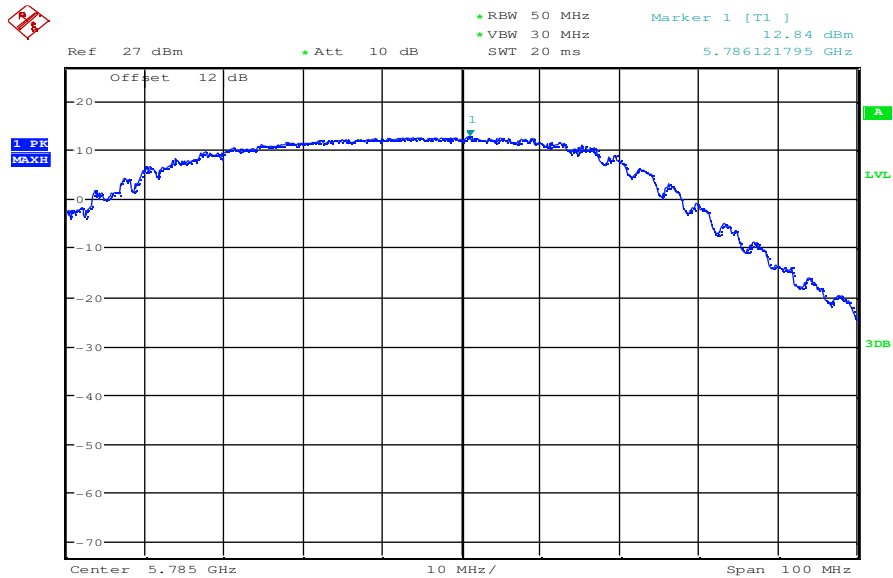

Date: 18.NOV.2010 10:08:26

Plot 3: OFDM – mode; middle channel – 5785 MHz; power index 35; 12 MBit/s

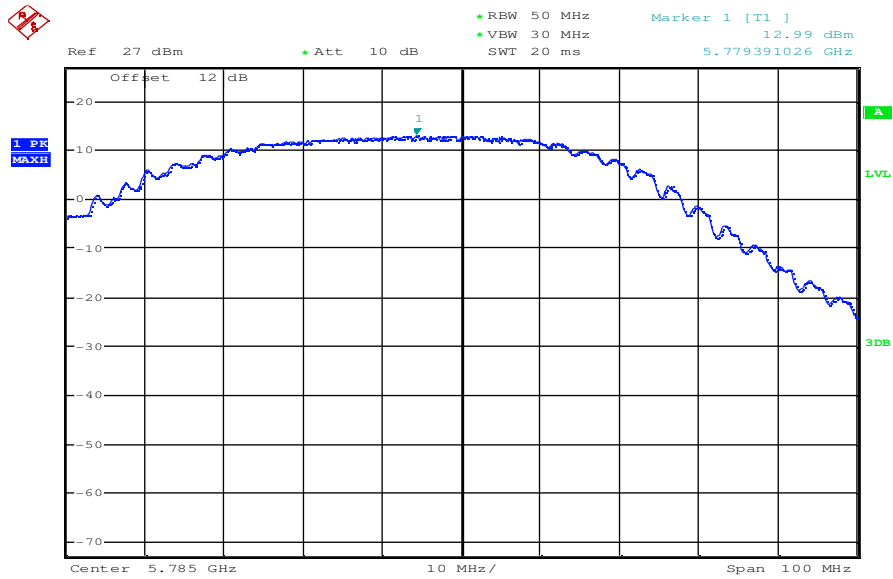

Date: 18.NOV.2010 10:09:42

Plot 4: OFDM – mode; middle channel – 5785 MHz; power index 35; 18 MBit/s

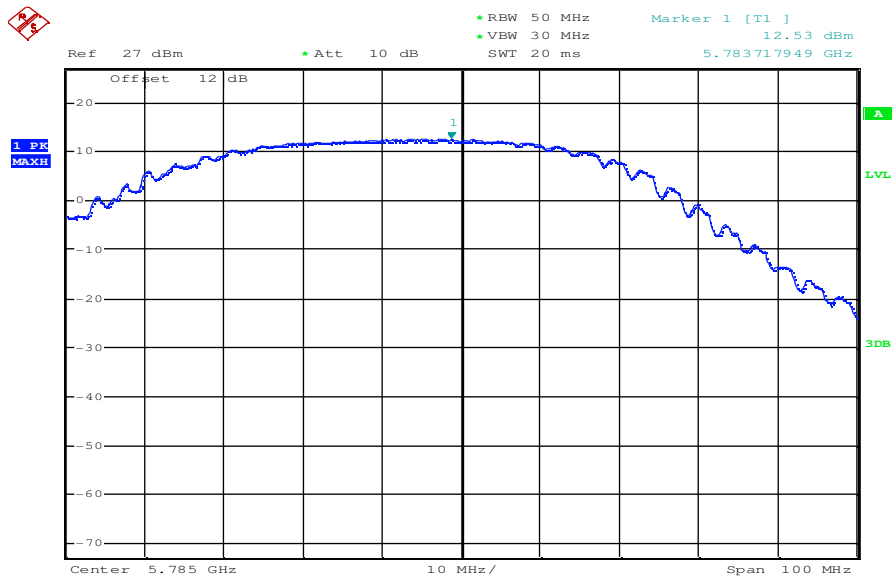

Date: 18.NOV.2010 10:11:02

Plot 5: OFDM – mode; middle channel – 5785 MHz; power index 35; 24 MBit/s

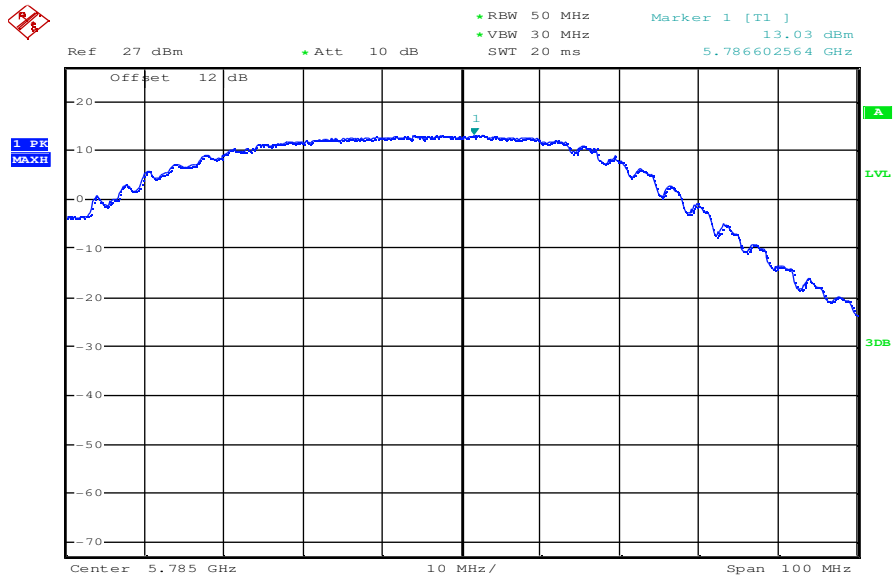

Date: 18.NOV.2010 10:12:33

Plot 6: OFDM – mode; middle channel – 5785 MHz; power index 35; 36 MBit/s

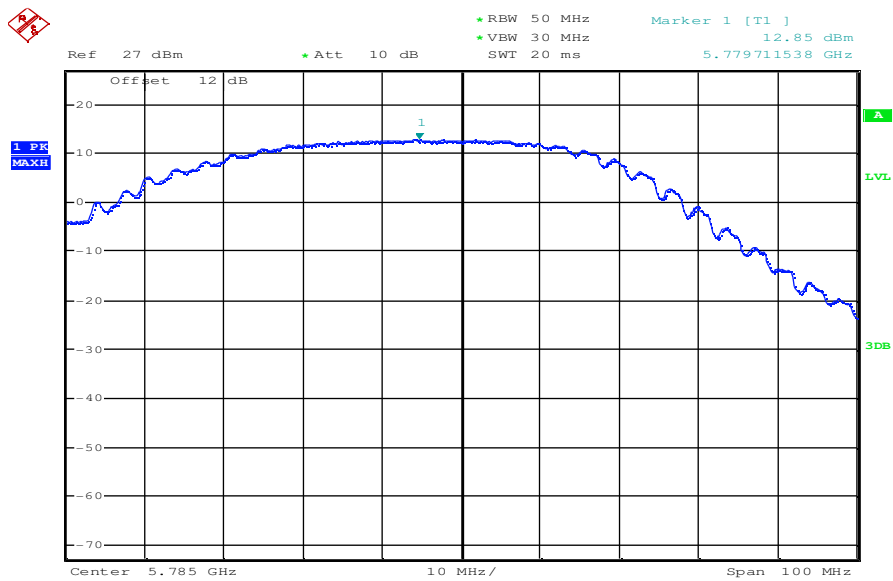

Date: 18.NOV.2010 10:14:55

Plot 7: OFDM – mode; middle channel – 5785 MHz; power index 35; 48 MBit/s

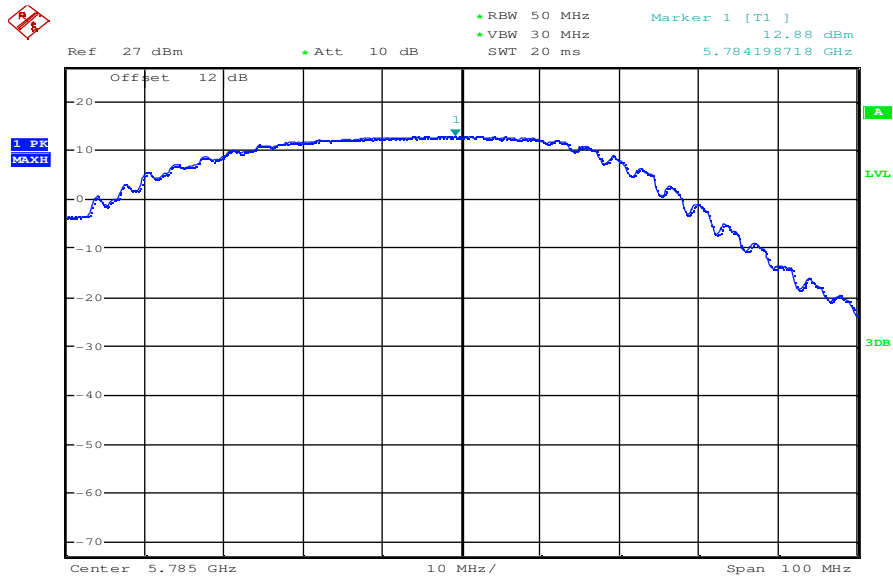

Date: 18.NOV.2010 10:16:24

Plot 8: OFDM – mode; middle channel – 5785 MHz; power index 35; 54 MBit/s

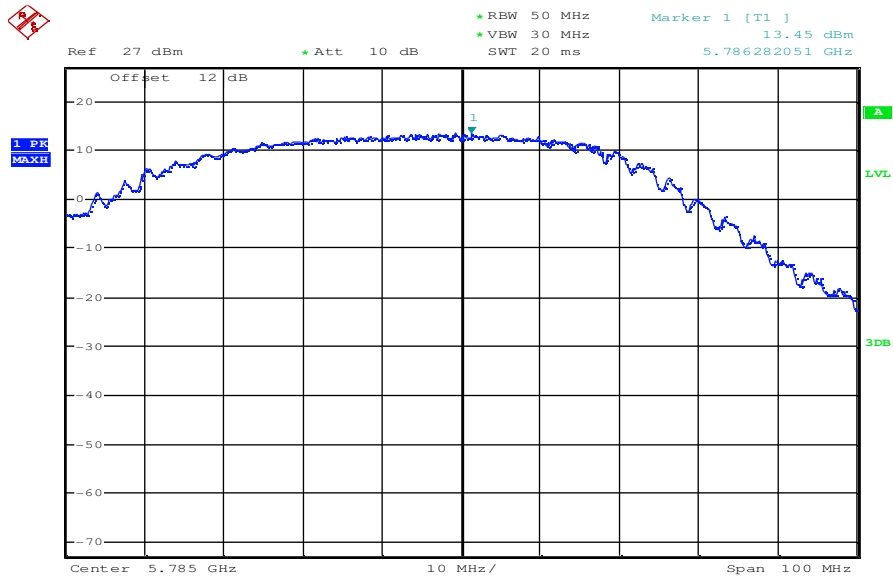

Date: 18.NOV.2010 10:19:39

OFDM – mode / n – mode:

Plot 1: OFDM – mode; middle channel – 5785 MHz; power index 35; mcs0

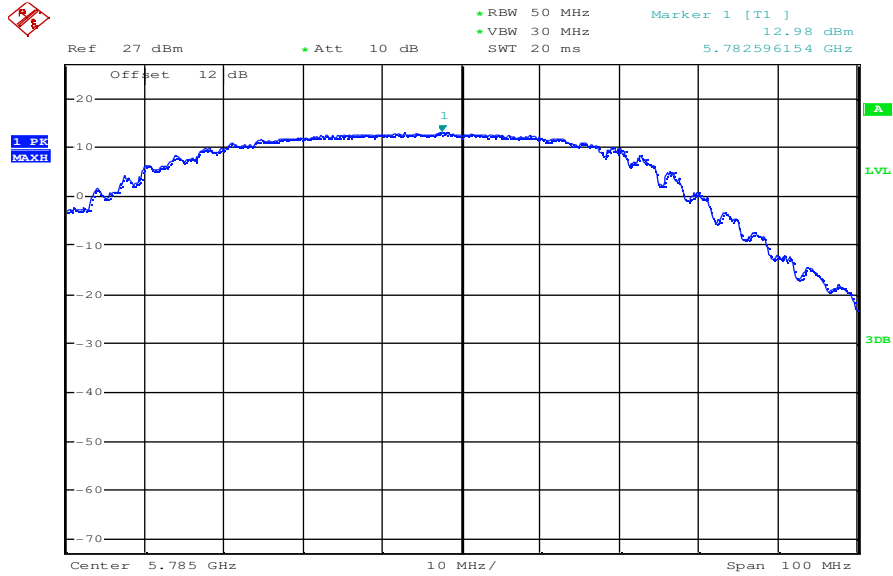

Date: 18.NOV.2010 10:31:23

Plot 2: OFDM – mode; middle channel – 5785 MHz; power index 35; mcs1

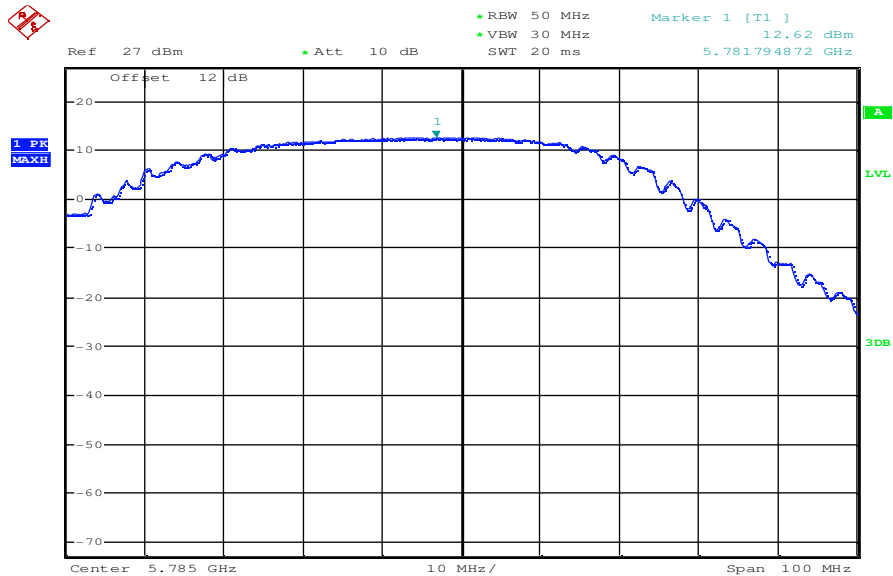

Date: 18.NOV.2010 10:32:43

Plot 3: OFDM – mode; middle channel – 5785 MHz; power index 35; mcs2

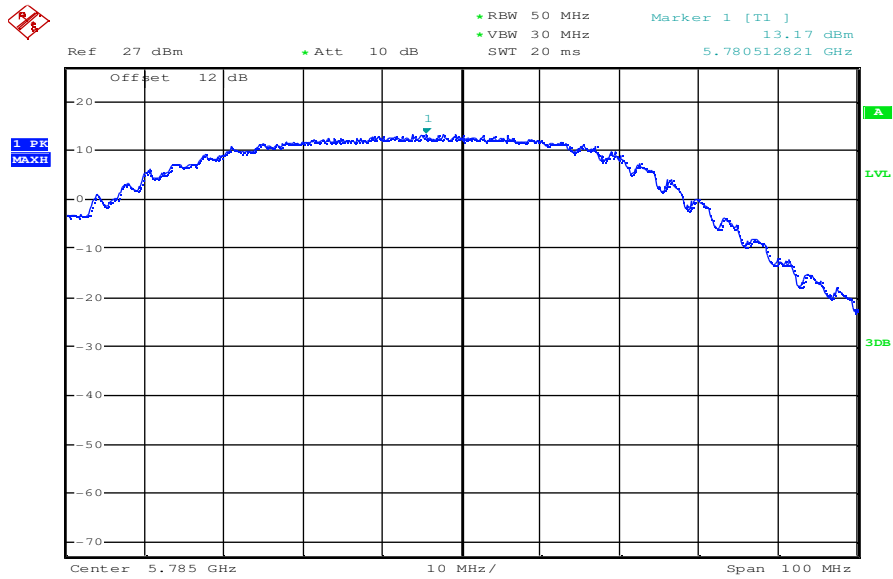

Date: 18.NOV.2010 10:33:52

Plot 4: OFDM – mode; middle channel – 5785 MHz; power index 35; mcs3

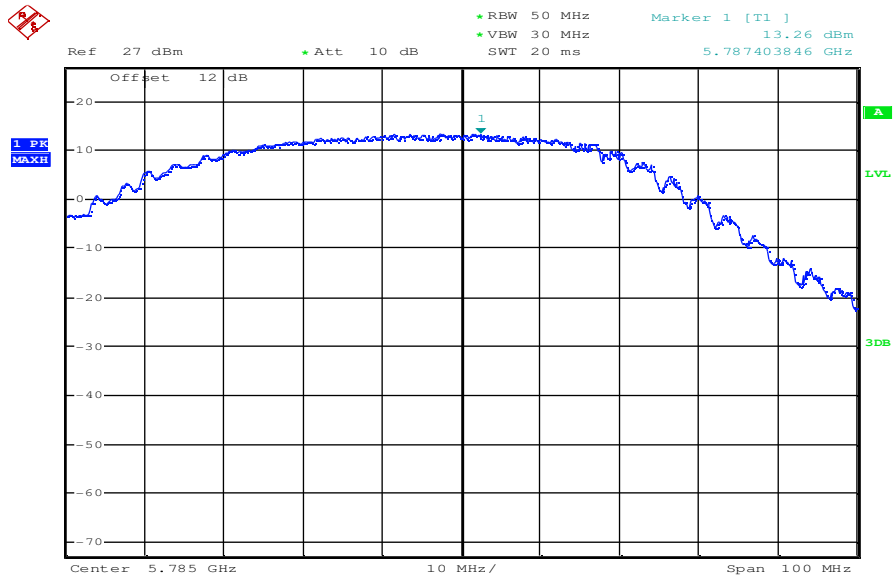

Date: 18.NOV.2010 10:34:56

Plot 5: OFDM – mode; middle channel – 5785 MHz; power index 35; mcs4

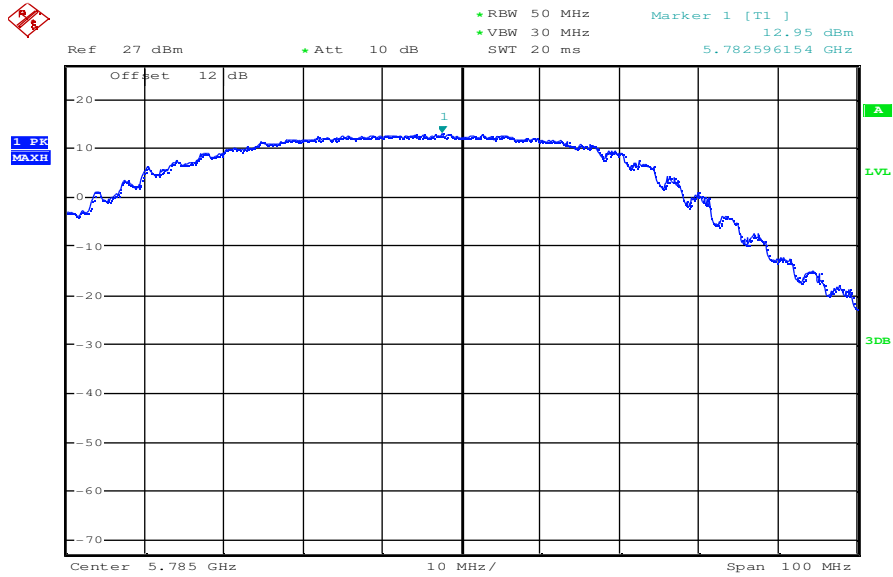

Date: 18.NOV.2010 10:35:45

Plot 6: OFDM – mode; middle channel – 5785 MHz; power index 35; mcs5

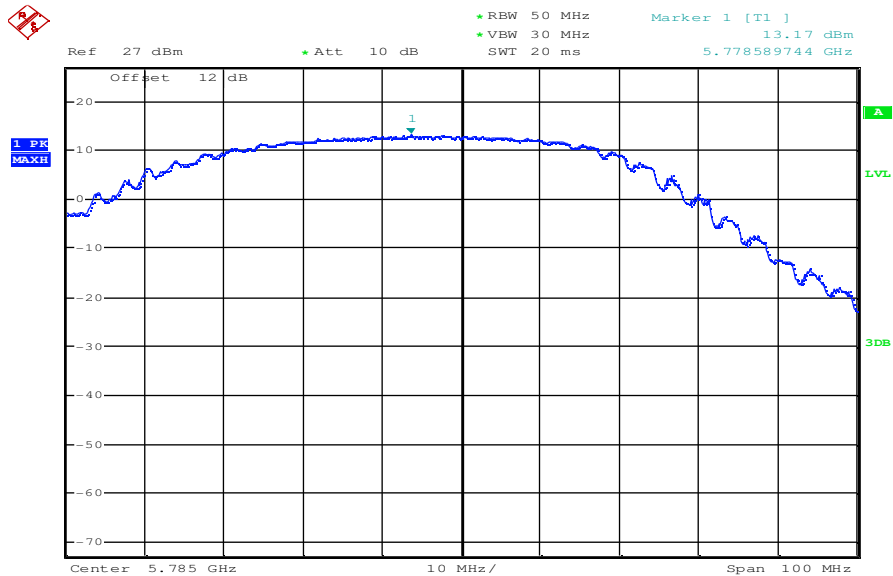

Date: 18.NOV.2010 10:39:41

Plot 7: OFDM – mode; middle channel – 5785 MHz; power index 35; mcs6

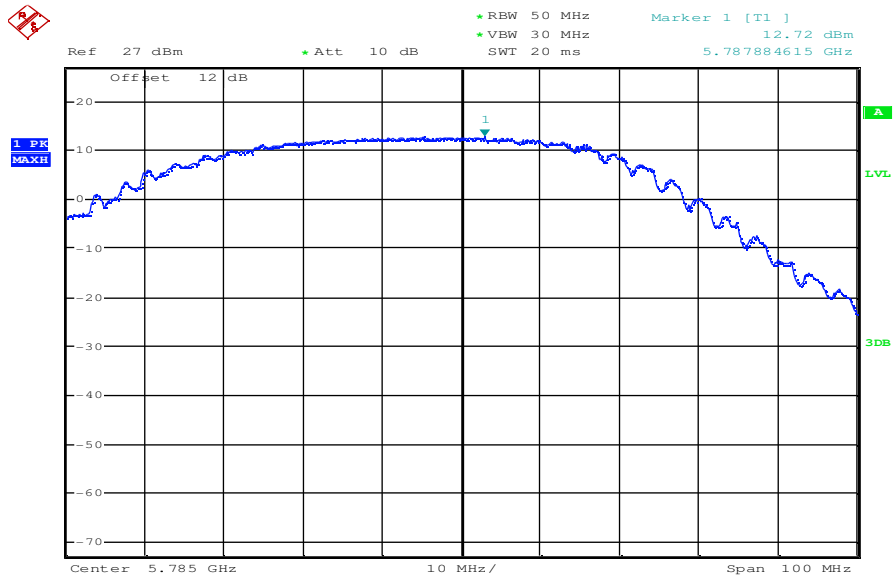

Date: 18.NOV.2010 10:42:13

Plot 8: OFDM – mode; middle channel – 5785 MHz; power index 35; mcs7

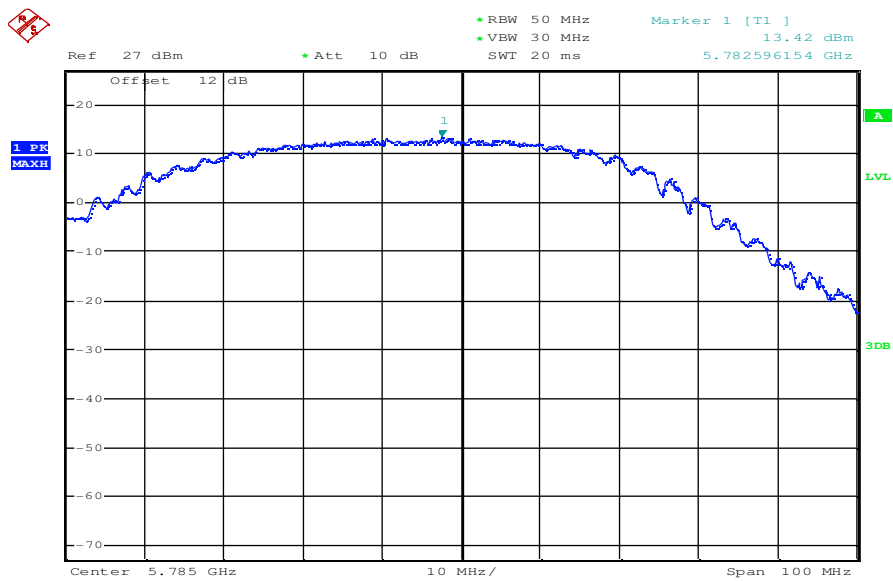

Date: 18.NOV.2010 10:40:33

9.2 Antenna gain

Measurement:

The antenna gain of the complete system is calculated by the difference of radiated power in EIRP and the conducted power of the module. For normal WLAN devices, the DSSS mode is used.

Measurement parameters:

Measurement parameter	
Detector:	Peak
Sweep time:	Auto
Video bandwidth:	3 MHz
Resolution bandwidth:	3 MHz
Span:	50 MHz
Trace-Mode:	Max hold

Limits:

FCC	IC
CFR Part 15.247 (b)(4)	RSS 210, Issue 8, A 8.4(2)
Antenna Gain	
6 dBi	

Results:

T _{nom}	V _{nom}	lowest channel 5745 MHz	middle channel 5785 MHz	highest channel 5825 MHz
Conducted power [dBm] Measured with OFDM (a – mode / 54MBit/s)		6.89	5.40	5.27
Radiated power [dBm] Measured with (a – mode / 54MBit/s)		5.12	3.42	3.03
Gain [dBi] Calculated		-1.77	-1.98	-2.24

Result: The result of the measurement is passed.

Plot 1: OFDM – mode; lowest channel – 5745 MHz; power index 35; 54 MBit/s

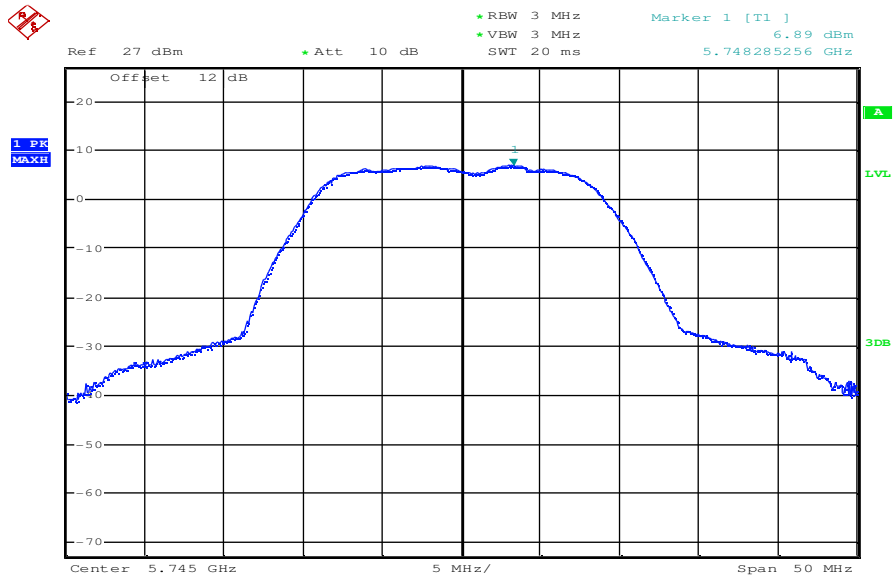

Date: 18.NOV.2010 11:19:10

Plot 2: OFDM – mode; middle channel – 5785 MHz; power index 35; 54 MBit/s

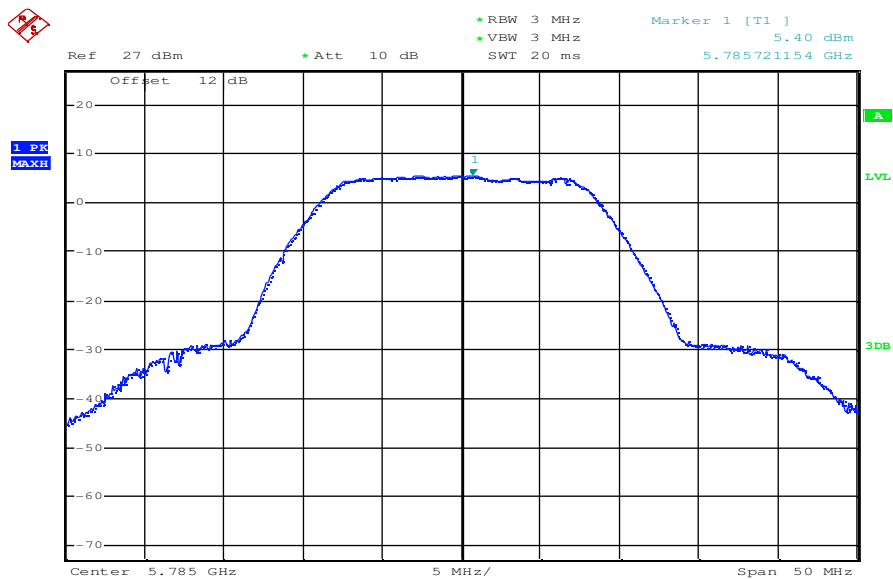

Date: 18.NOV.2010 11:20:39

Plot 3: OFDM – mode; highest channel – 5825 MHz; power index 35; 54 MBit/s

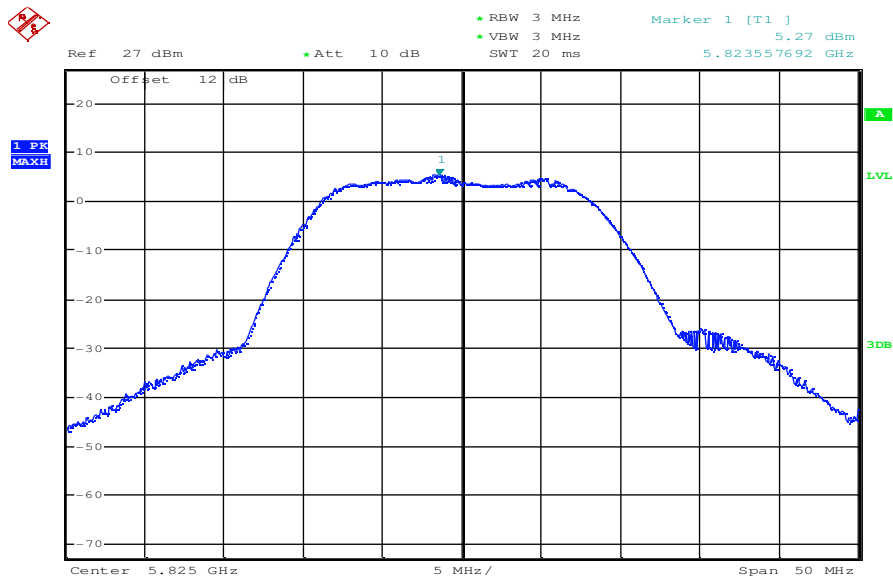

Date: 18.NOV.2010 11:21:47

9.3 Power spectral density

Not performed! Delta tests only!

9.4 Spectrum bandwidth of a FHSS system – 6 dB bandwidth

Not performed! Delta tests only!

9.5 Spectrum bandwidth of a FHSS system – 20 dB bandwidth

Not performed! Delta tests only!

9.6 Maximum output power

Description:

Measurement of the maximum output power conducted and radiated. The measurements are performed using the data rate producing the highest conducted output power. The determination of these data rates was performed at the beginning of the tests. Additionally the average power is measured using a wideband power meter.

Measurement:

Measurement parameter	
Detector:	Peak
Sweep time:	Auto
Video bandwidth:	30 MHz
Resolution bandwidth:	50 MHz
Span:	100 MHz
Trace-Mode:	Max Hold

Limits:

FCC	IC
CFR Part 15.247 (b)(3)	RSS 210, Issue 8, A 8.4(4)
Maximum Output Power	
Conducted: 1.0 W – Antenna Gain max. 6 dBi	

Results:

OFDM / a – mode Frequency	Maximum Output Power [dBm]		
	5745 MHz	5785 MHz	5825 MHz
Peak Output Power Conducted	14.49	13.45	12.47
Output Power Radiated - EIRP	12.72	11.47	10.23
Measurement uncertainty	± 0.5 dB (cond.) / ± 2 dB (rad.)		

OFDM / n – mode Frequency	Maximum Output Power [dBm]		
	5745 MHz	5785 MHz	5825 MHz
Peak Output Power Conducted	14.59	13.42	12.27
Output Power Radiated - EIRP	12.82	11.44	10.03
Measurement uncertainty	± 0.5 dB (cond.) / ± 2 dB (rad.)		

Result: The result of the measurement is passed.

OFDM – mode / q – mode:

Plot 1: OFDM – mode; lowest channel – 5745 MHz; power index 35; 54 MBit/s

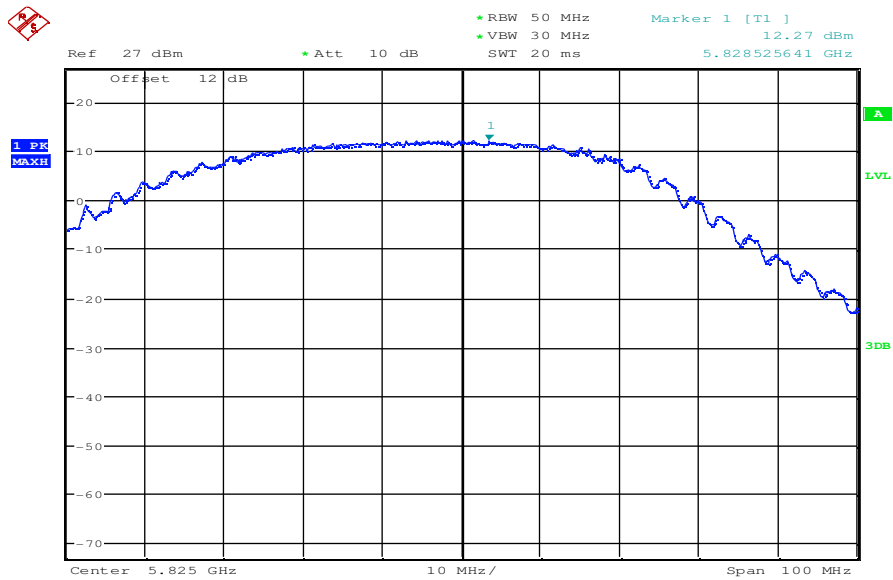

Date: 18.NOV.2010 11:06:04

Plot 2: OFDM – mode; middle channel – 5785 MHz; power index 35; 54 MBit/s

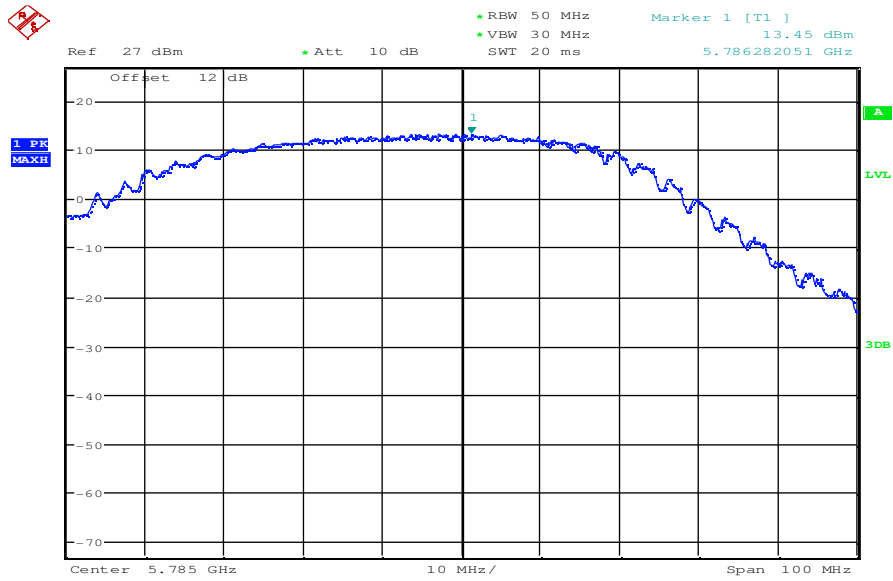

Date: 18.NOV.2010 10:19:39

Plot 3: OFDM – mode; highest channel – 5825 MHz; power index 35; 54 MBit/s

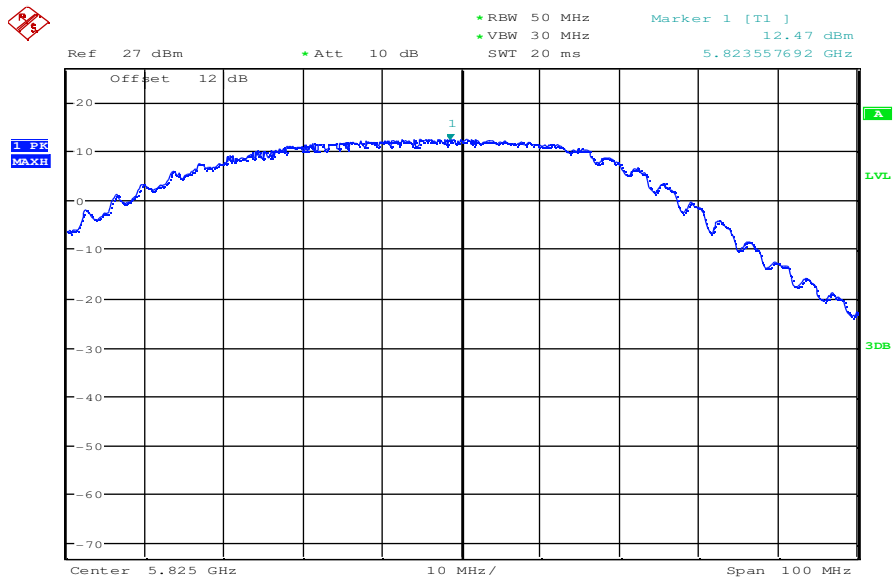

Date: 18.NOV.2010 10:29:43

OFDM – mode / n – mode:

Plot 1: OFDM – mode; lowest channel – 5745 MHz; power index 35; mcs 7

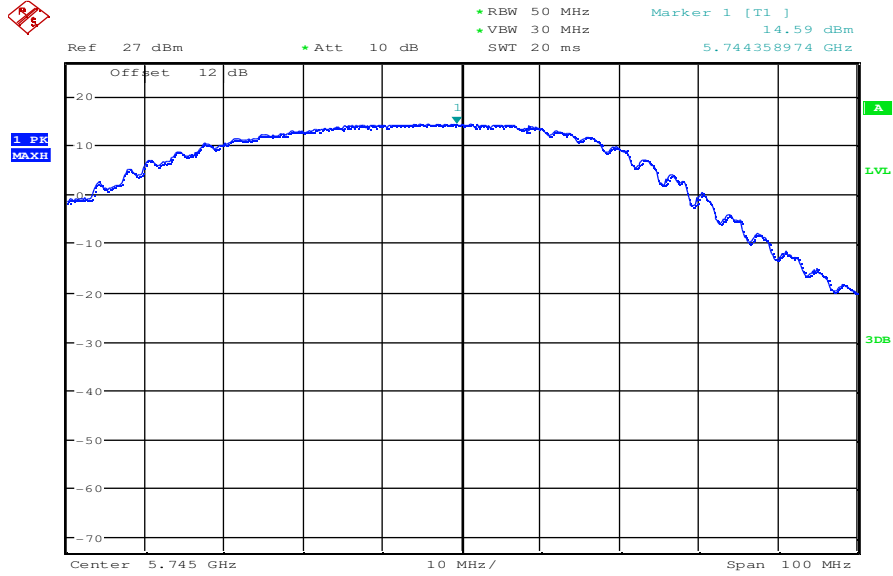

Date: 18.NOV.2010 10:43:21

Plot 2: OFDM – mode; middle channel – 5785 MHz; power index 35; mcs 7

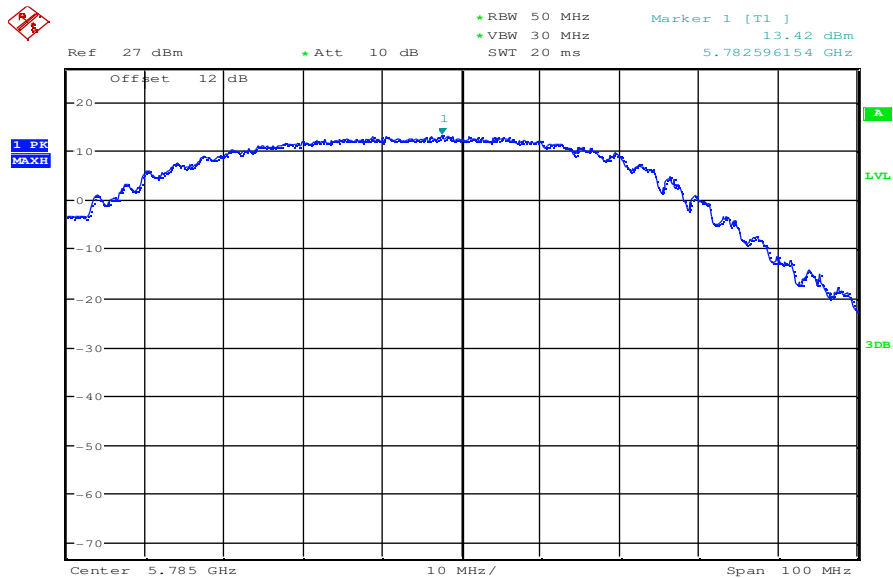

Date: 18.NOV.2010 10:40:33

Plot 3: OFDM – mode; highest channel – 5825 MHz; power index 35; mcs 7

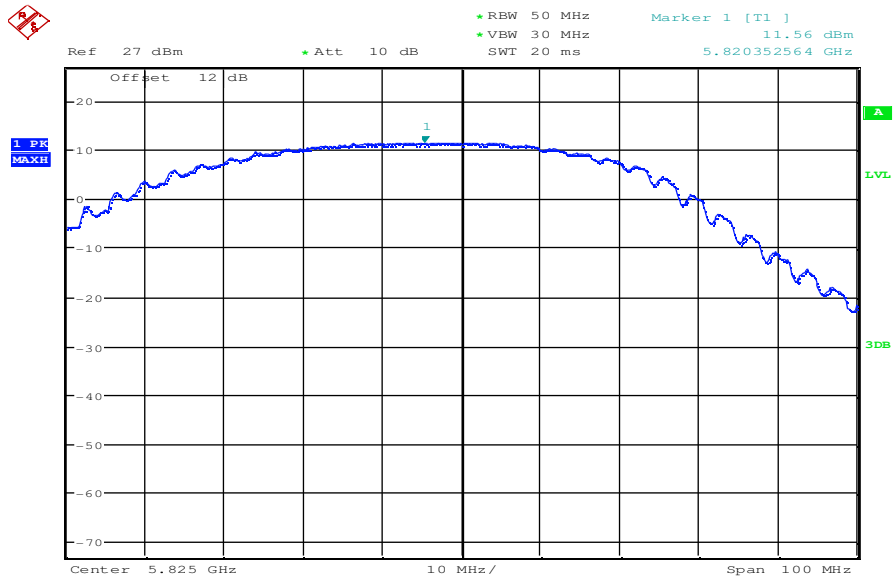

Date: 18.NOV.2010 10:44:50

9.7 Band edge compliance conducted

Not performed! Delta tests only!

9.8 Band edge compliance radiated

Not performed!

No restricted band in the range ± 2 channel bandwidths of the upper band edge of the specified emission band! (5.725 GHz – 5.850 GHz).

Note: restricted bands

MHz	MHz	MHz	GHz
0.090–0.110	16.42–16.423	399.9–410	4.5–5.15
¹ 0.495–0.505	16.69475–16.69525	608–614	5.35–5.46
2.1735–2.1905	16.80425–16.80475	960–1240	7.25–7.75
4.125–4.128	25.5–25.67	1300–1427	8.025–8.5
4.17725–4.17775	37.5–38.25	1435–1626.5	9.0–9.2
4.20725–4.20775	73–74.6	1645.5–1646.5	9.3–9.5
6.215–6.218	74.8–75.2	1660–1710	10.8–12.7
6.26775–6.26825	108–121.94	1718.8–1722.2	13.25–13.4
6.31175–6.31225	123–138	2200–2300	14.47–14.5
8.291–8.294	149.9–150.05	2310–2390	15.35–16.2
8.362–8.366	156.52475–156.52525	2483.5–2500	17.7–21.4
8.37625–8.38675	156.7–156.9	2690–2900	22.01–23.12
8.41425–8.41475	162.0125–167.17	3260–3267	23.8–24.0
12.29–12.293	167.72–173.2	3332–3339	31.2–31.8
12.51975–12.52025	240–265	3345.8–3358	36.43–36.5
12.57675–12.57725	322–335.4	3600–4400	(²)
13.36–13.41			

¹ Until February 1, 1999, this restricted band shall be 0.490–0.510 MHz.

² Above 38.6

9.9 TX spurious emissions conducted

Not performed! Delta tests only!

9.10 TX spurious emissions radiated

Description:

Measurement of the radiated spurious emissions in transmit mode. The measurement is performed at channel 1, 6 and 11. The measurement is repeated for all modulations.

Measurement:

Measurement parameter	
Detector:	Peak / Quasi Peak
Sweep time:	Auto
Video bandwidth:	Sweep: 100 kHz Remeasurement: 10 Hz
Resolution bandwidth:	F < 1 GHz: 100 kHz F > 1 GHz: 1 MHz
Span:	30 MHz to 40 GHz
Trace-Mode:	Max Hold
Measured Modulation	<input checked="" type="checkbox"/> OFDM a & n mode

The modulation with the highest output power was used to perform the transmitter spurious emissions. If spurious were detected a re-measurement was performed on the detected frequency with each modulation.

Limits:

FCC		IC	
CFR Part 15.247(d)		RSS 210, Issue 8, A 8.5	
TX Spurious Emissions Radiated			
<p>In any 100 kHz bandwidth outside the frequency band in which the spread spectrum or digitally modulated intentional radiator is operating, the radio frequency power that is produced by the intentional radiator shall be at least 20 dB below that in the 100 kHz bandwidth within the band that contains the highest level of the desired power, based on either an RF conducted or a radiated measurement. Attenuation below the general limits specified in Section 15.209(a) is not required. In addition, radiated emissions which fall in the restricted bands, as defined in §15.205(a), must also comply with the radiated emission limits specified in §15.209(a) (see §15.205(c)).</p>			
§15.209			
Frequency (MHz)	Field Strength (dBµV/m)	Measurement distance	
30 - 88	30.0	10	
88 – 216	33.5	10	
216 – 960	36.0	10	
Above 960	54.0	3	

Results:

OFDM – mode / a – mode:

TX Spurious Emissions Radiated [dBµV/m]								
OFDM – mode (a – mode)								
5745 MHz			5785 MHz			5825 MHz		
F	Detector	Level	F	Detector	Level	F	Detector	Level
3830 MHz	1 MHz / 10 Hz PP	52.81 dBµV/m vertical 49.33 dBµV/m horizontal	3857 MHz	1 MHz / 10 Hz PP	54.00 dBµV/m vertical 52.34 dBµV/m horizontal	3883 MHz	1 MHz / 10 Hz PP	53.68 dBµV/m vertical 51.02 dBµV/m horizontal
11490 MHz	1 MHz / 10 Hz PP	43.32 dBµV/m vertical 42.92 dBµV/m horizontal	11570 MHz	1 MHz / 10 Hz PP	42.85 dBµV/m vertical 42.04 dBµV/m horizontal	11650 MHz	1 MHz / 10 Hz PP	42.62 dBµV/m vertical 41.22 dBµV/m horizontal
15324.5	1 MHz / 1 MHz PP	49.60 dBµV/m vertical & horizontal	15245.5	1 MHz / 1 MHz PP	46.55 dBµV/m vertical & horizontal	15534.9	1 MHz / 1 MHz PP	47.57 dBµV/m vertical & horizontal
17234.4	1 MHz / 1 MHz PP	47.45 dBµV/m vertical & horizontal	17360.6	1 MHz / 1 MHz PP	44.18 dBµV/m vertical & horizontal	17470.0	1 MHz / 1 MHz PP	41.50 dBµV/m vertical & horizontal
22974.4	1 MHz / 1 MHz PP	48.19 dBµV/m vertical & horizontal	23141.0	1 MHz / 1 MHz PP	45.97 dBµV/m vertical & horizontal	23294.9	1 MHz / 1 MHz PP	42.05 dBµV/m vertical & horizontal
All other detected emissions are more than 20 dB below the limit. For emissions below 1 GHz – please take a look at the table below the 1 GHz plot.			All other detected emissions are more than 20 dB below the limit. For emissions below 1 GHz – please take a look at the table below the 1 GHz plot.			All other detected emissions are more than 20 dB below the limit. For emissions below 1 GHz – please take a look at the table below the 1 GHz plot.		
Measurement uncertainty			± 3 dB					

Result: The result of the measurement is passed.

OFDM – mode / n – mode:

TX Spurious Emissions Radiated [dBµV/m]								
OFDM – mode (n – mode)								
5745 MHz			5785 MHz			5825 MHz		
F	Detector	Level	F	Detector	Level	F	Detector	Level
3830 MHz	1 MHz / 10 Hz PP	51.89 dBµV/m vertical 49.77 dBµV/m horizontal	3857 MHz	1 MHz / 10 Hz PP	53.43 dBµV/m vertical 51.79 dBµV/m horizontal	3883 MHz	1 MHz / 10 Hz PP	54.00 dBµV/m vertical 52.19 dBµV/m horizontal
11490 MHz	1 MHz / 10 Hz PP	43.70 dBµV/m vertical 43.40 dBµV/m horizontal	11570 MHz	1 MHz / 10 Hz PP	43.57 dBµV/m vertical 43.07 dBµV/m horizontal	11650 MHz	1 MHz / 10 Hz PP	42.31 dBµV/m vertical 41.79 dBµV/m horizontal
15324.5	1 MHz / 1 MHz PP	48.34 dBµV/m vertical & horizontal	15425.5	1 MHz / 1 MHz PP	47.52 dBµV/m vertical & horizontal	15534.8	1 MHz / 1 MHz PP	49.29 dBµV/m vertical & horizontal
17242.8	1 MHz / 1 MHz PP	48.29 dBµV/m vertical & horizontal	17352.2	1 MHz / 1 MHz PP	45.89 dBµV/m vertical & horizontal	17478.4	1 MHz / 1 MHz PP	42.42 dBµV/m vertical & horizontal
22987.2	1 MHz / 1 MHz PP	47.23 dBµV/m vertical & horizontal	23141.0	1 MHz / 1 MHz PP	47.75 dBµV/m vertical & horizontal	23307.7	1 MHz / 1 MHz PP	46.08 dBµV/m vertical & horizontal
All other detected emissions are more than 20 dB below the limit. For emissions below 1 GHz – please take a look at the table below the 1 GHz plot.			All other detected emissions are more than 20 dB below the limit. For emissions below 1 GHz – please take a look at the table below the 1 GHz plot.			All other detected emissions are more than 20 dB below the limit. For emissions below 1 GHz – please take a look at the table below the 1 GHz plot.		
Measurement uncertainty			± 3 dB					

Result: The result of the measurement is passed.

OFDM – mode / a – mode (54 MBit/s):

Plot 1: lowest channel; power index 35; 30 MHz to 1 GHz – vertical & horizontal polarization

Common Information

EUT: WLAN computer embex
 Serial Number: Proto
 Test Description: FCC part 15 @ 10 m
 Operating Conditions: TX, 5745 MHz, channel 149, 54 Mbps, a mode
 Operator Name: HNA
 Comment: 3.3V DC

Scan Setup: STAN_Fin [EMI radiated]

Hardware Setup: Electric Field (NOS)
 Level Unit: dBµV/m

Subrange	Detectors	IF Bandwidth	Meas. Time	Receiver
30 MHz - 1,05 GHz	QuasiPeak	120 kHz	15 s	Receiver

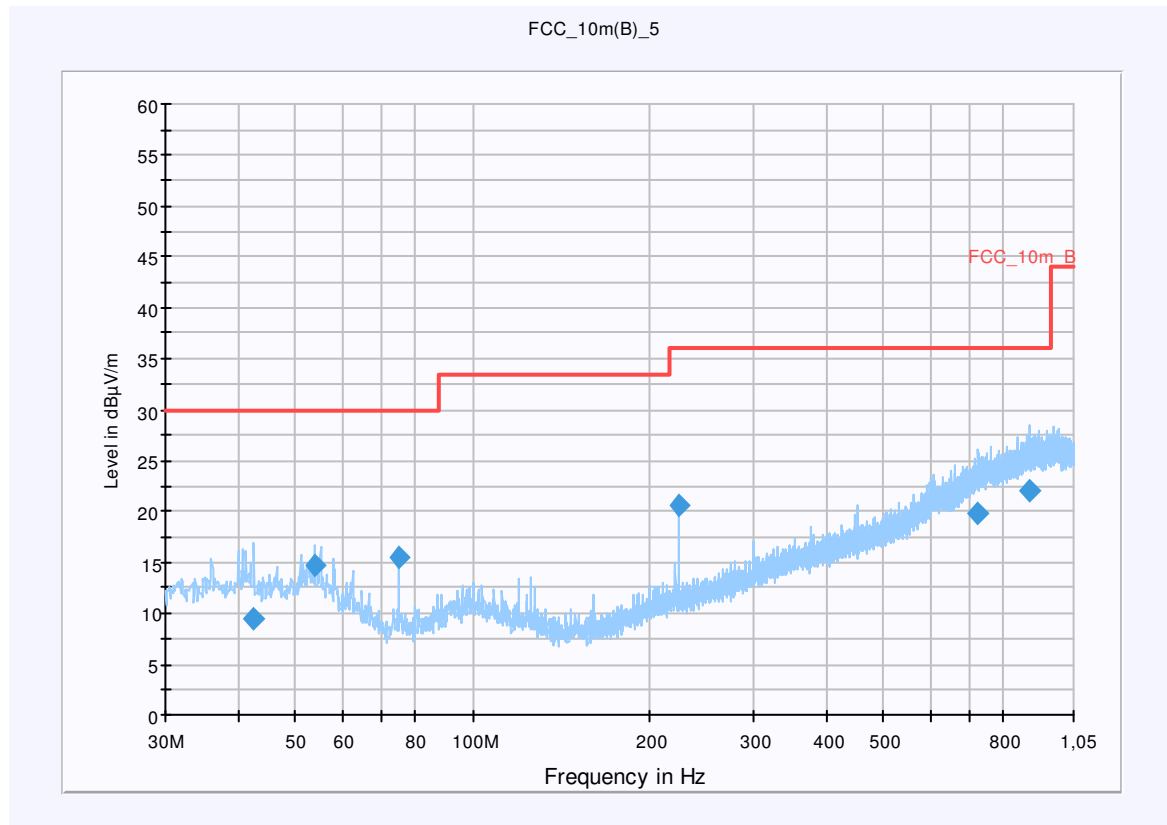

Final Result 1

Frequency (MHz)	QuasiPeak (dBµV/m)	Meas. Time (ms)	Bandwidth (kHz)	Antenna height (cm)	Polarity	Turntable position (deg)	Corr. (dB)	Margin (dB)	Limit (dBµV/m)	Comment
42.480000	9.5	15000.000	120.000	98.0	V	10.0	13.3	20.5	30.0	
54.000000	14.7	15000.000	120.000	270.0	V	267.0	13.0	15.3	30.0	
75.000000	15.5	15000.000	120.000	189.0	V	160.0	9.2	14.5	30.0	
224.880000	20.7	15000.000	120.000	119.0	V	28.0	12.5	15.3	36.0	
723.720000	19.9	15000.000	120.000	270.0	H	120.0	23.1	16.1	36.0	
886.920000	22.0	15000.000	120.000	270.0	H	219.0	25.0	14.0	36.0	

Hardware Setup: EMI radiated\Electric Field (NOS) - [EMI radiated]

Subrange 1	
Frequency Range:	30 MHz - 2 GHz
Receiver:	Receiver [ESCI 3] @ GPIB0 (ADR 20), SN 100083/003, FW 4.32
Signal Path:	without Notch FW 1.0
Antenna:	VULB 9163 SN 9163-295, FW --- Correction Table (vertical): VULP6113 Correction Table (horizontal): VULP6113 Correction Table: Cable_EN_1GHz (0909)
Antenna Tower:	Tower [EMCO 2090 Antenna Tower] @ GPIB0 (ADR 8), FW REV 3.12
Turntable:	Turntable [EMCO Turntable] @ GPIB0 (ADR 9), FW REV 3.12

EMC 32 Version 8.10.00

Plot 2: lowest channel; power index 35; 1 GHz to 12.75 GHz – vertical polarization

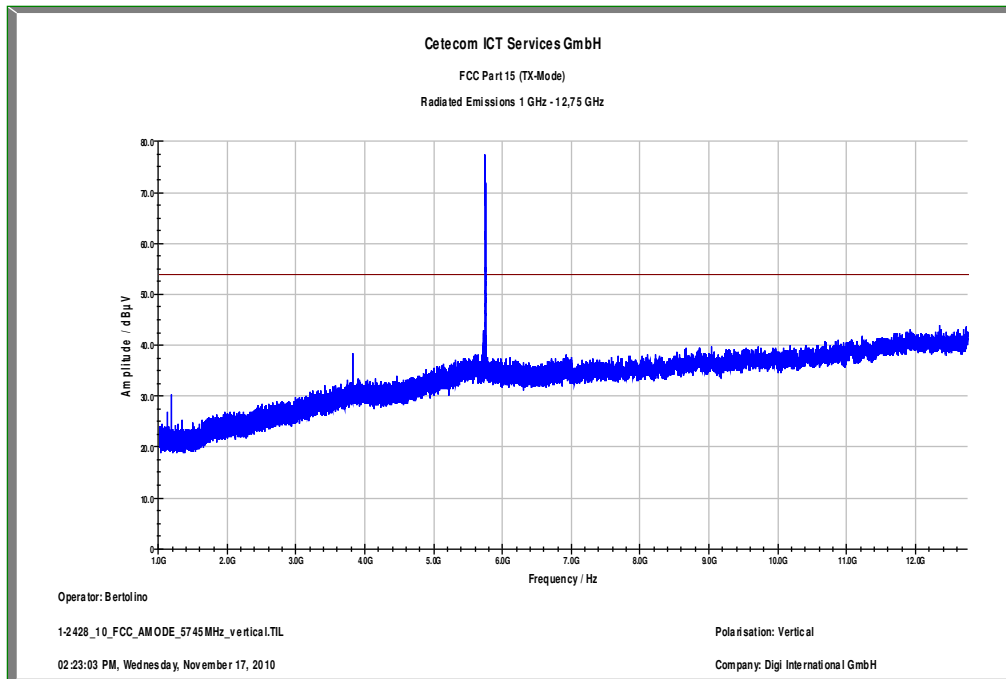

Plot 3: lowest channel; power index 35; 1 GHz to 12.75 GHz – horizontal polarization

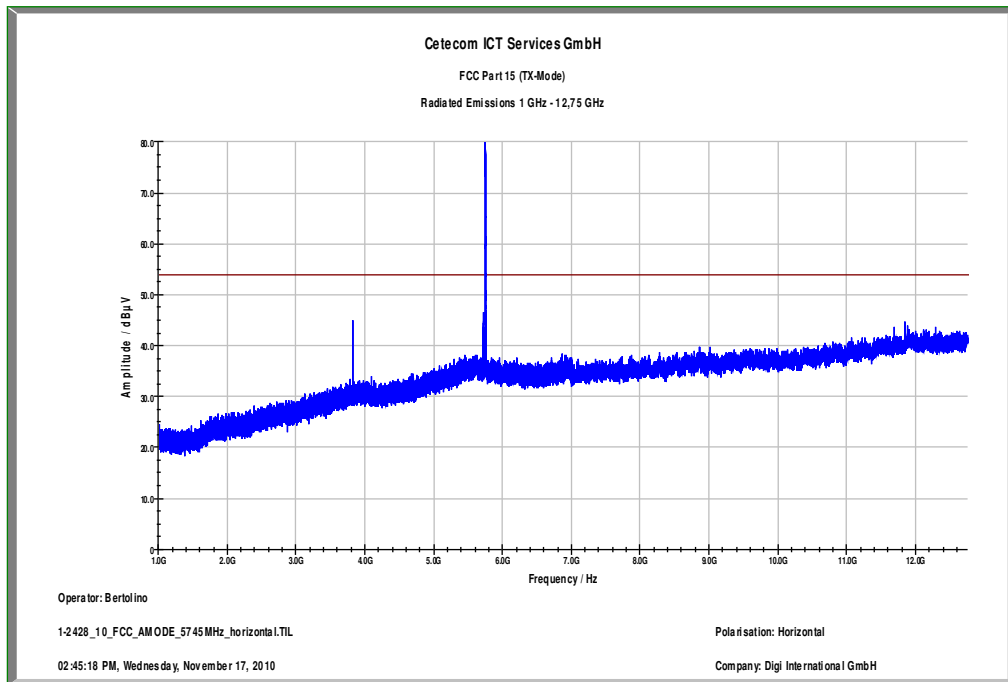

Plot 4: lowest channel; power index 35; 12.75 GHz to 18 GHz – vertical & horizontal polarization

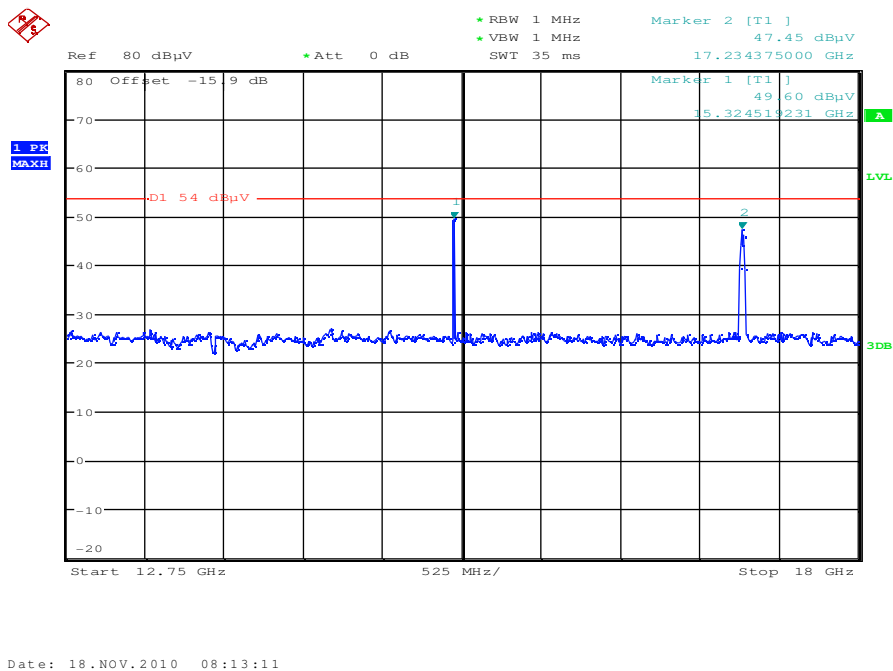

Plot 5: lowest channel; power index 35; 18 GHz to 26 GHz – vertical & horizontal polarization

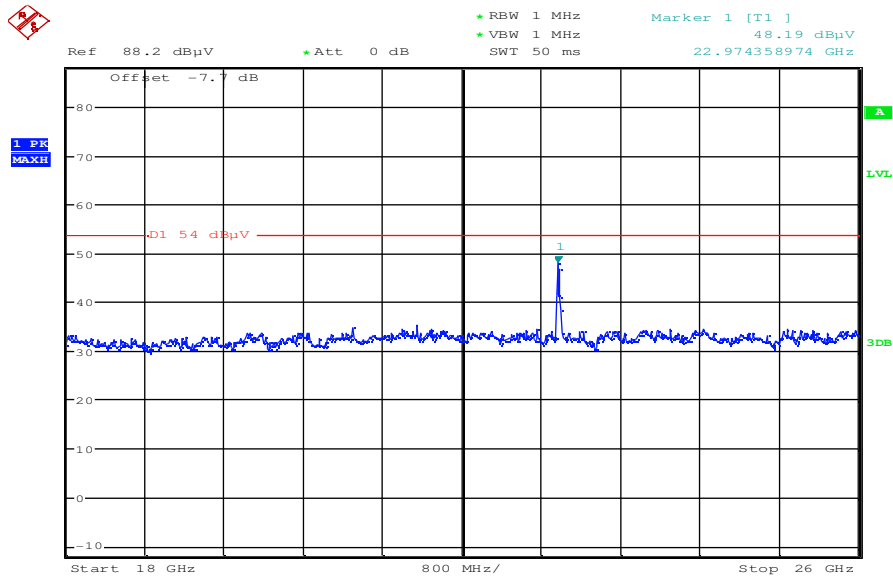

Date: 18.NOV.2010 08:29:09

Plot 6: lowest channel; power index 35; 26 GHz to 40 GHz – vertical & horizontal polarization

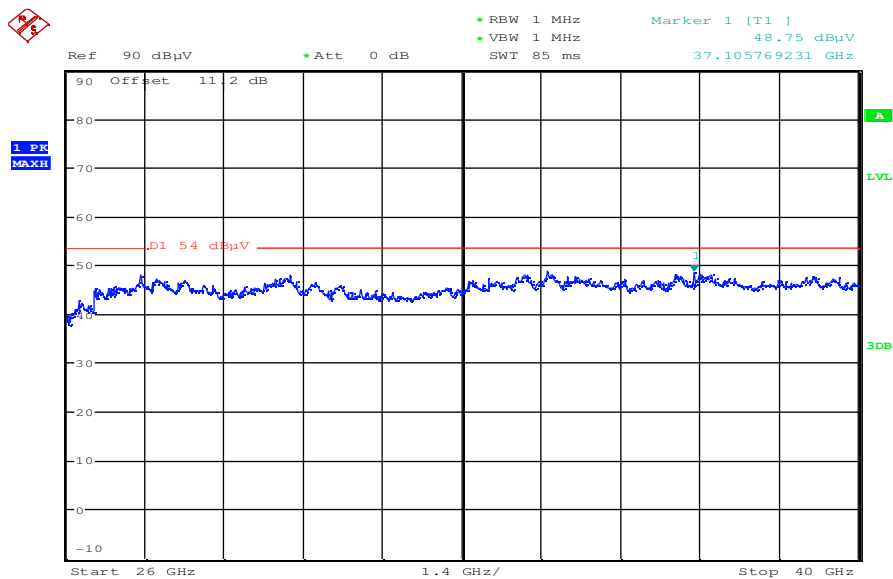

Date: 18.NOV.2010 08:59:05

Plot 7: middle channel; power index 35; 30 MHz to 1 GHz – vertical & horizontal polarization

Common Information

EUT: WLAN computer embex
 Serial Number: Proto
 Test Description: FCC part 15 @ 10 m
 Operating Conditions: TX, 5785 MHz, channel 157, 54 Mbps, a mode
 Operator Name: HNA
 Comment: 3.3V DC

Scan Setup: STAN_Fin [EMI radiated]

Hardware Setup: Electric Field (NOS)
 Level Unit: dBµV/m
Subrange **Detectors** **IF Bandwidth** **Meas. Time** **Receiver**
 30 MHz - 1,05 GHz QuasiPeak 120 kHz 15 s Receiver

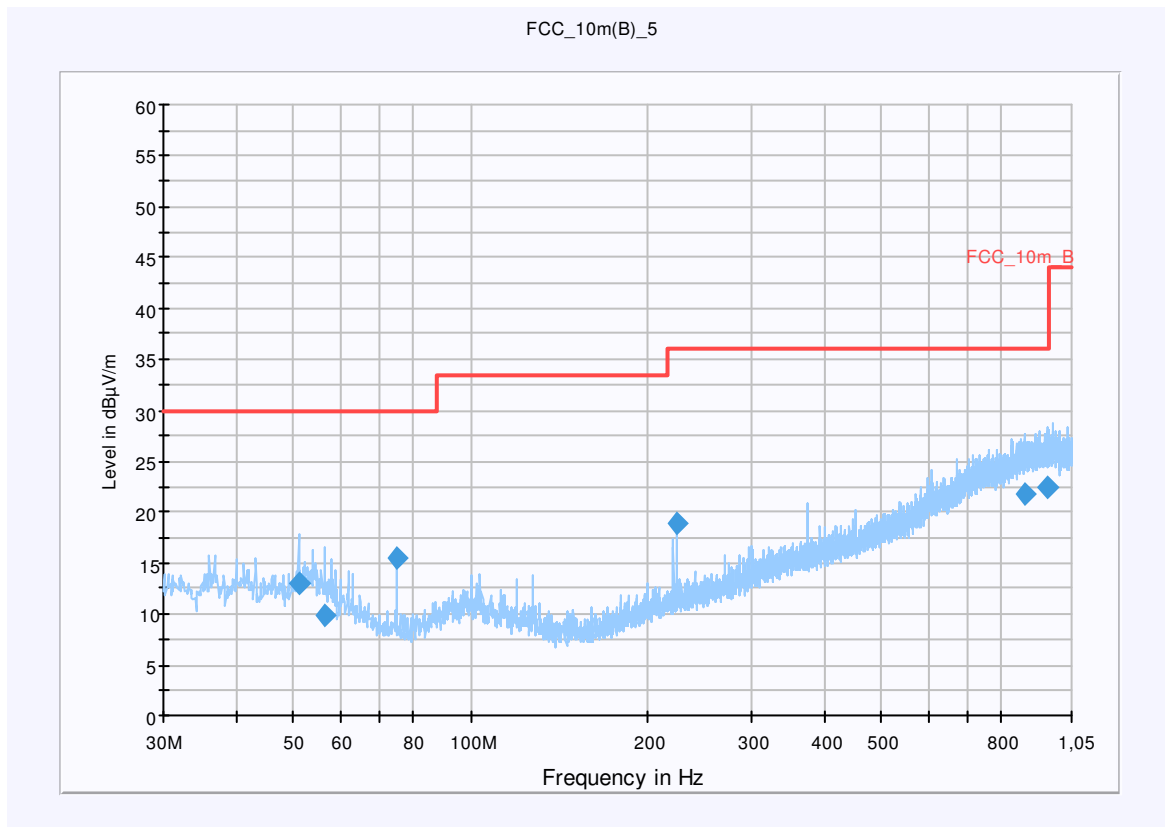

Final Result 1

Frequency (MHz)	QuasiPeak (dBµV/m)	Meas. Time (ms)	Bandwidth (kHz)	Antenna height (cm)	Polarity	Turntable position (deg)	Corr. (dB)	Margin (dB)	Limit (dBµV/m)	Comment
51.000000	12.9	15000.000	120.000	270.0	V	105.0	13.3	17.1	30.0	
56.640000	9.9	15000.000	120.000	263.0	V	181.0	12.5	20.1	30.0	
75.000000	15.6	15000.000	120.000	270.0	V	-2.0	9.2	14.4	30.0	
224.880000	19.0	15000.000	120.000	98.0	V	353.0	12.5	17.0	36.0	
877.200000	21.8	15000.000	120.000	135.0	H	119.0	24.9	14.2	36.0	
958.080000	22.3	15000.000	120.000	111.0	H	150.0	25.4	13.7	36.0	

Hardware Setup: EMI radiated\Electric Field (NOS) - [EMI radiated]

Subrange 1	
Frequency Range:	30 MHz - 2 GHz
Receiver:	Receiver [ESCI 3] @ GPIB0 (ADR 20), SN 100083/003, FW 4.32
Signal Path:	without Notch FW 1.0
Antenna:	VULB 9163 SN 9163-295, FW --- Correction Table (vertical): VULP6113 Correction Table (horizontal): VULP6113 Correction Table: Cable_EN_1GHz (0909)
Antenna Tower:	Tower [EMCO 2090 Antenna Tower] @ GPIB0 (ADR 8), FW REV 3.12
Turntable:	Turntable [EMCO Turntable] @ GPIB0 (ADR 9), FW REV 3.12

EMC 32 Version 8.10.00

Plot 8: middle channel; power index 35; 1 GHz to 12.75 GHz – vertical polarization

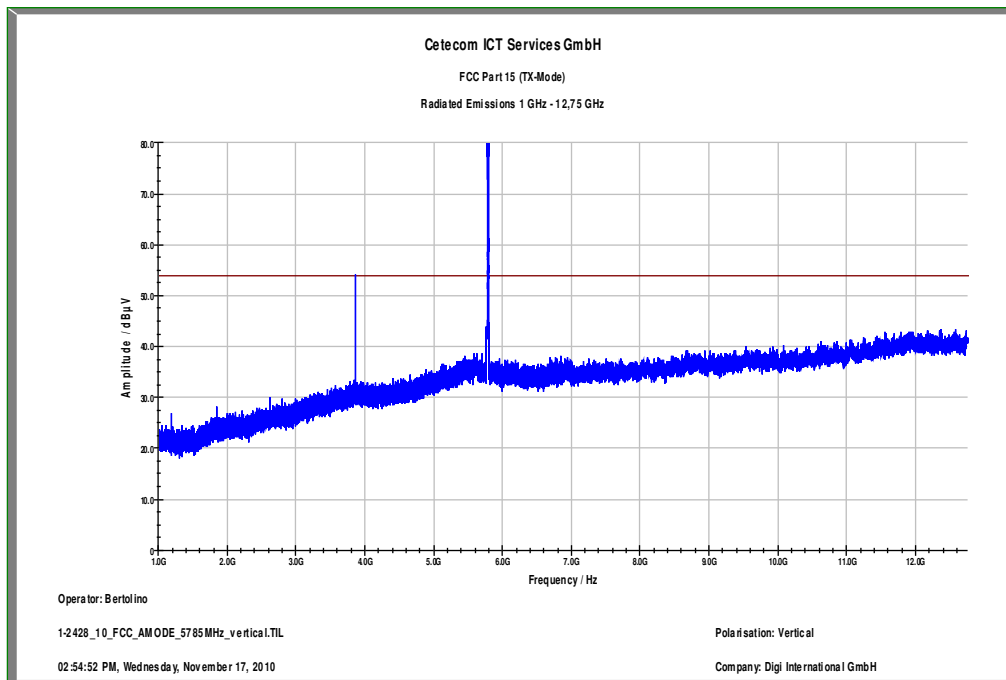

Plot 9: middle channel; power index 35; 1 GHz to 12.75 GHz – horizontal polarization

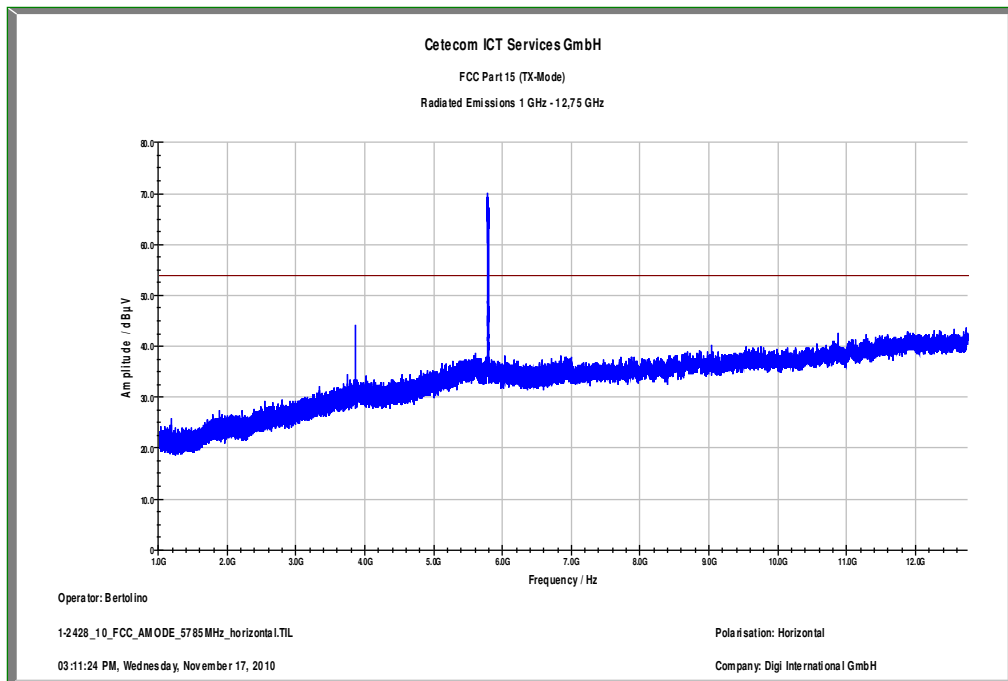

Plot 10: middle channel; power index 35; 12.75 GHz to 18 GHz – vertical & horizontal polarization

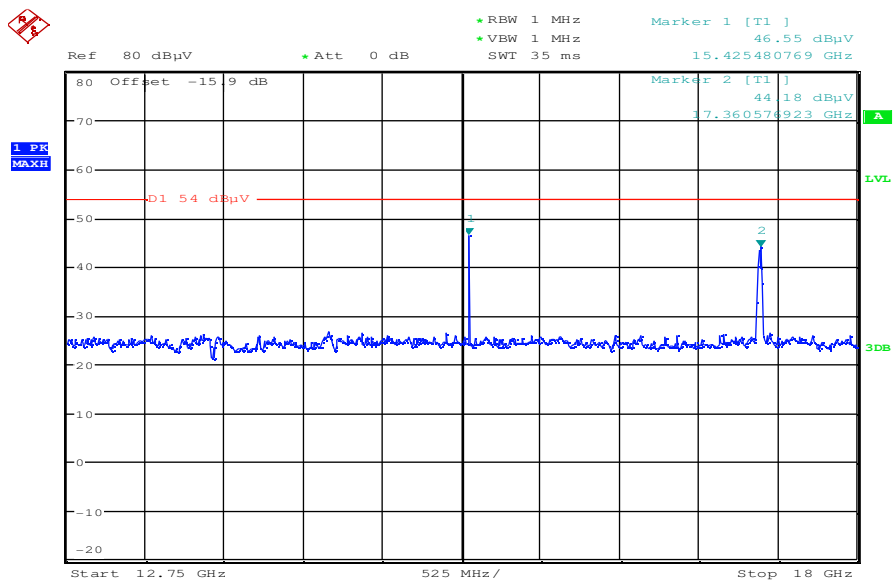

Date: 18.NOV.2010 08:16:25

Plot 11: middle channel; power index 35; 18 GHz to 26 GHz – vertical & horizontal polarization

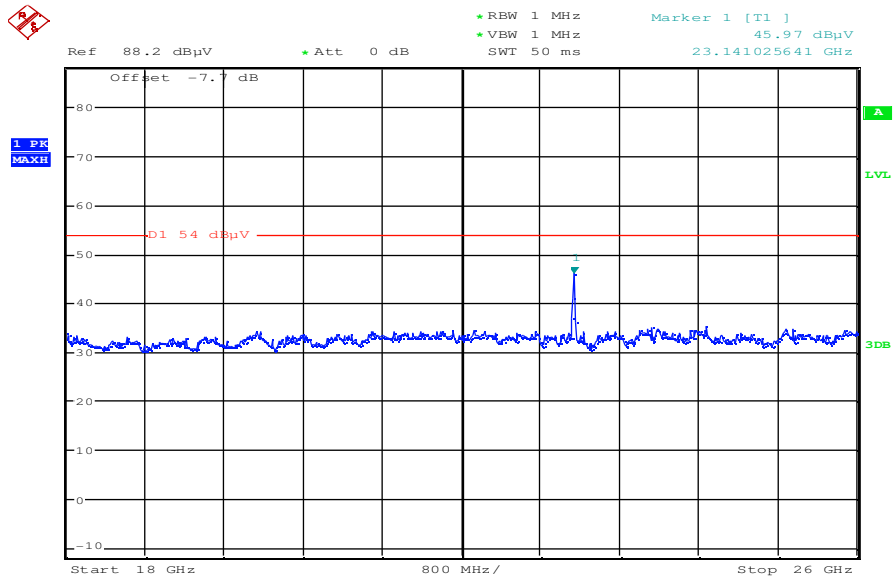

Date: 18.NOV.2010 08:33:36

Plot 12: middle channel; power index 35; 26 GHz to 40 GHz – vertical & horizontal polarization

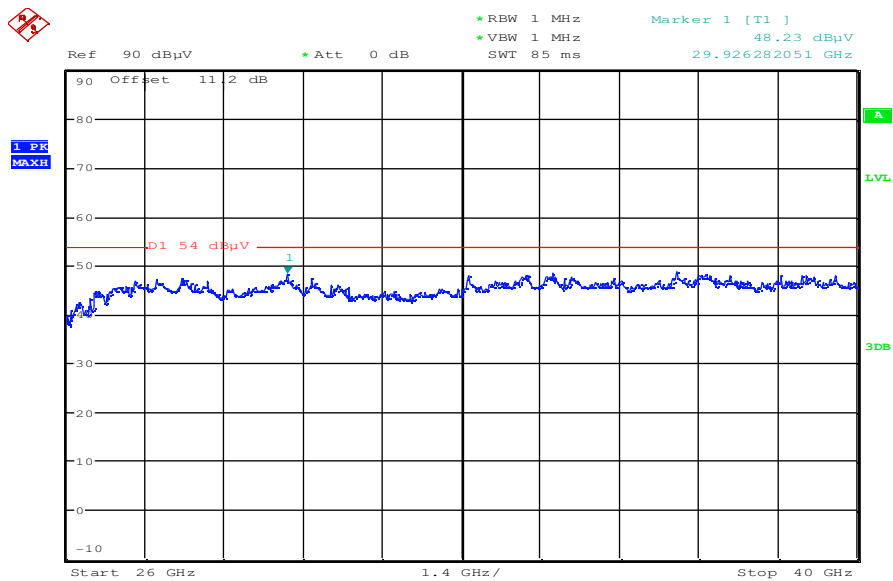

Date: 18.NOV.2010 09:00:36

Plot 13: highest channel; power index 35; 30 MHz to 1 GHz – vertical & horizontal polarization

Common Information

EUT: WLAN computer embex
 Serial Number: Proto
 Test Description: FCC part 15 @ 10 m
 Operating Conditions: TX, 5825 MHz, channel 165, 54 Mbps, a mode
 Operator Name: HNA
 Comment: 3.3V DC

Scan Setup: STAN_Fin [EMI radiated]

Hardware Setup: Electric Field (NOS)
 Level Unit: dBµV/m
Subrange **Detectors** **IF Bandwidth** **Meas. Time** **Receiver**
 30 MHz - 1,05 GHz QuasiPeak 120 kHz 15 s Receiver

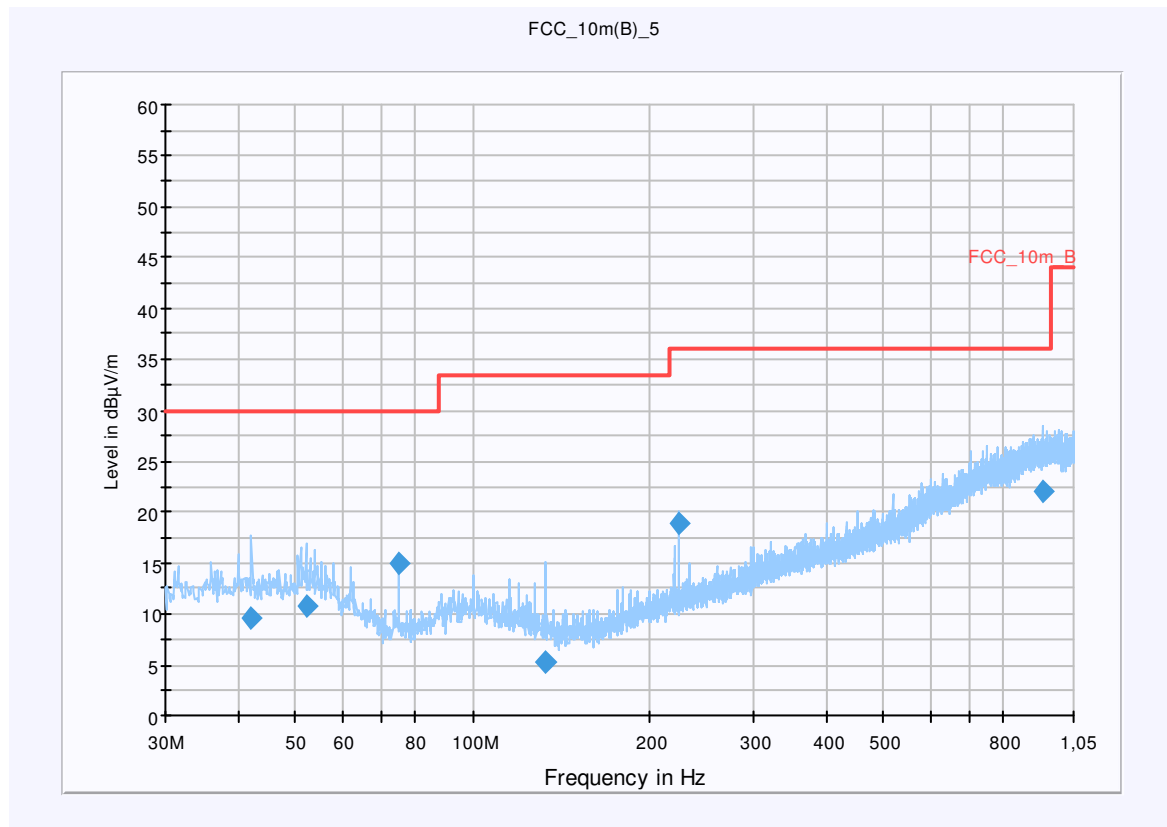

Final Result 1

Frequency (MHz)	QuasiPeak (dBµV/m)	Meas. Time (ms)	Bandwidth (kHz)	Antenna height (cm)	Polarity	Turntable position (deg)	Corr. (dB)	Margin (dB)	Limit (dBµV/m)	Comment
42.120000	9.6	15000.000	120.000	134.0	V	136.0	13.4	20.4	30.0	
52.200000	10.9	15000.000	120.000	98.0	V	203.0	13.2	19.1	30.0	
75.000000	15.0	15000.000	120.000	201.0	V	256.0	9.2	15.0	30.0	
133.080000	5.3	15000.000	120.000	270.0	V	359.0	9.2	28.2	33.5	
224.880000	18.8	15000.000	120.000	98.0	V	216.0	12.5	17.2	36.0	
934.200000	22.1	15000.000	120.000	124.0	V	96.0	25.3	13.9	36.0	

Hardware Setup: EMI radiated\Electric Field (NOS) - [EMI radiated]

Subrange 1	
Frequency Range:	30 MHz - 2 GHz
Receiver:	Receiver [ESCI 3] @ GPIB0 (ADR 20), SN 100083/003, FW 4.32
Signal Path:	without Notch FW 1.0
Antenna:	VULB 9163 SN 9163-295, FW --- Correction Table (vertical): VULP6113 Correction Table (horizontal): VULP6113 Correction Table: Cable_EN_1GHz (0909)
Antenna Tower:	Tower [EMCO 2090 Antenna Tower] @ GPIB0 (ADR 8), FW REV 3.12
Turntable:	Turntable [EMCO Turntable] @ GPIB0 (ADR 9), FW REV 3.12

EMC 32 Version 8.10.00

Plot 14: highest channel; power index 35; 1 GHz to 12.75 GHz – vertical polarization

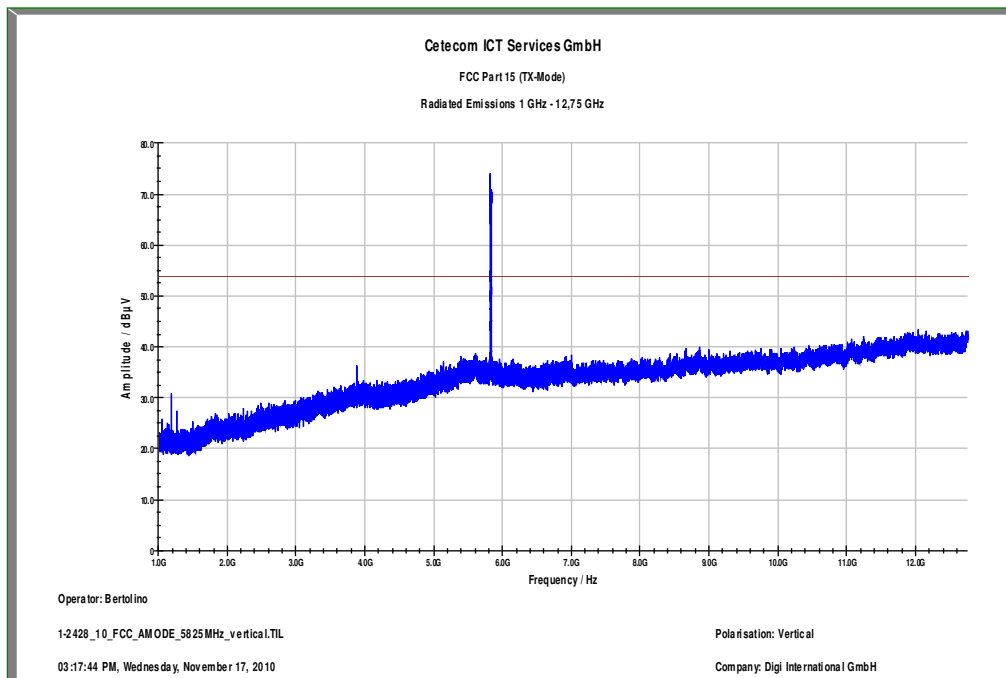

Plot 15: highest channel; power index 35; 1 GHz to 12.75 GHz – horizontal polarization

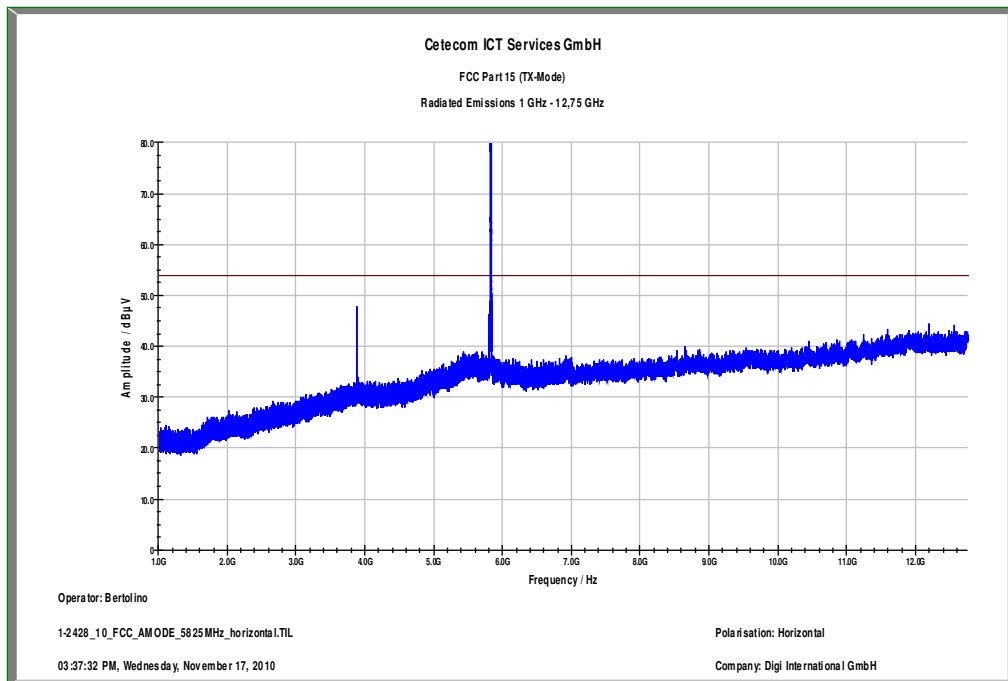

Plot 16: highest channel; power index 35; 12.75 GHz to 18 GHz – vertical & horizontal polarization

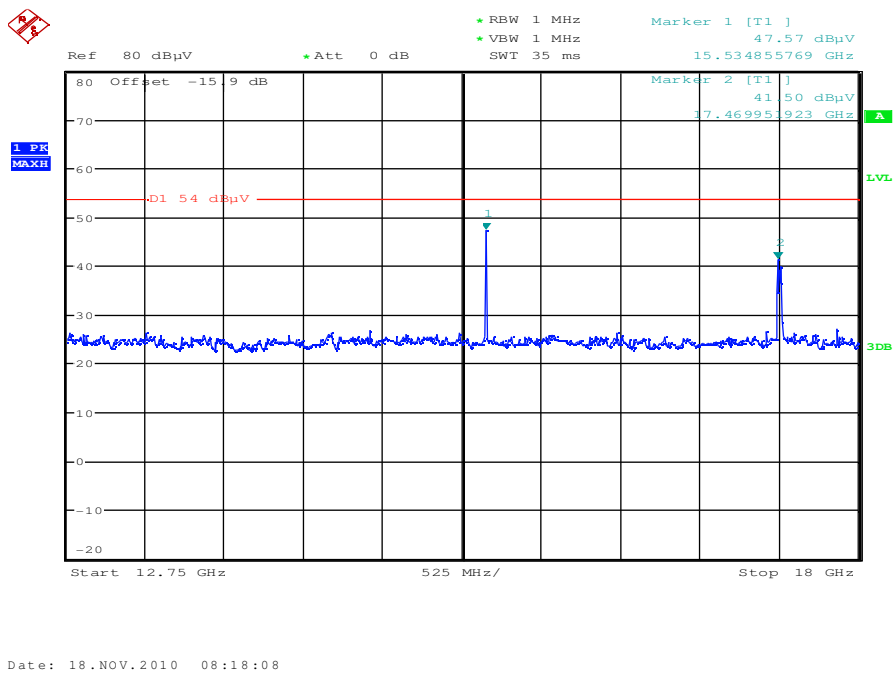

Plot 17: highest channel; power index 35; 18 GHz to 26 GHz – vertical & horizontal polarization

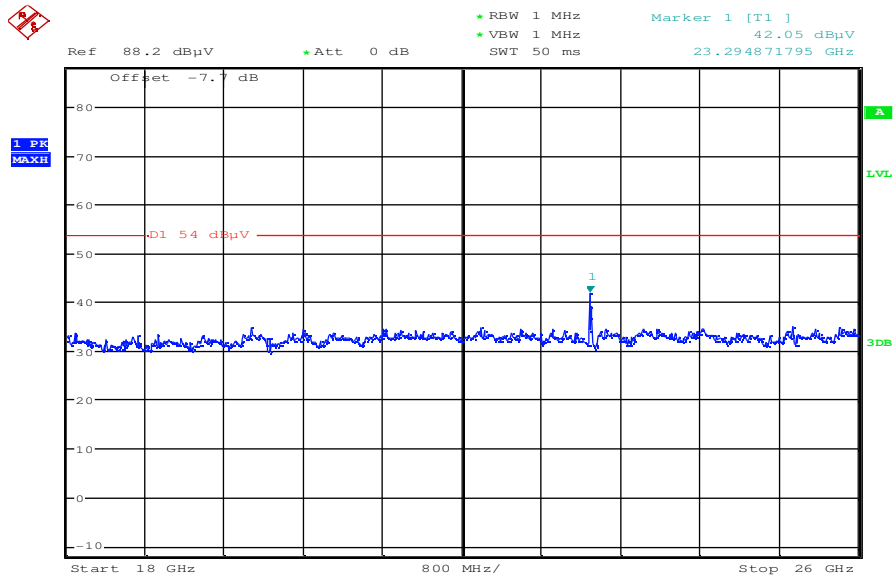

Date: 18.NOV.2010 08:35:42

Plot 18: highest channel; power index 35; 26 GHz to 40 GHz – vertical & horizontal polarization

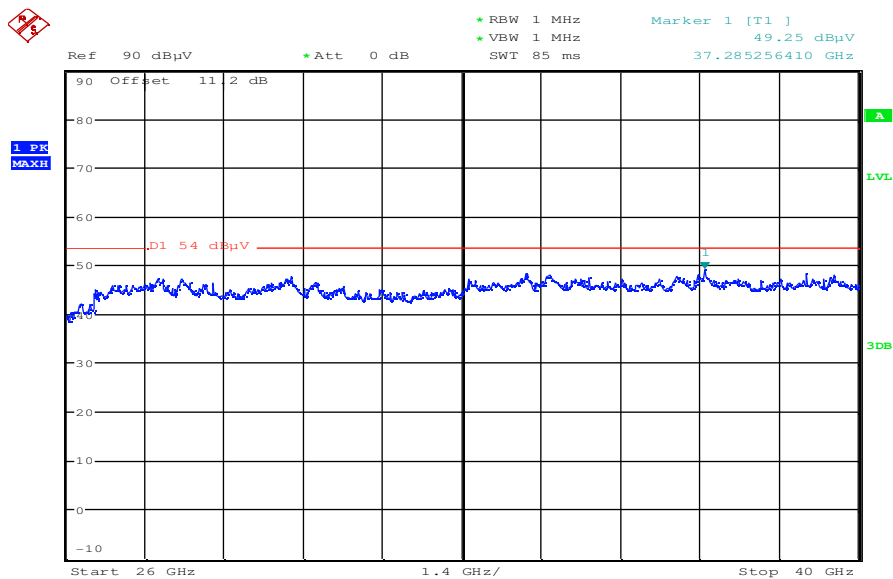

Date: 18.NOV.2010 09:01:51

OFDM – mode / n – mode (mcs 7):

Plot 1: lowest channel; power index 35; 30 MHz to 1 GHz – vertical & horizontal polarization

Common Information

EUT: WLAN computer embex
 Serial Number: Proto
 Test Description: FCC part 15 @ 10 m
 Operating Conditions: TX, 5745 MHz, channel 149, mcs7, n mode
 Operator Name: HNA
 Comment: 3.3V DC

Scan Setup: STAN_Fin [EMI radiated]

Hardware Setup: Electric Field (NOS)
 Level Unit: dBµV/m
Subrange **Detectors** **IF Bandwidth** **Meas. Time** **Receiver**
 30 MHz - 1,05 GHz QuasiPeak 120 kHz 15 s Receiver

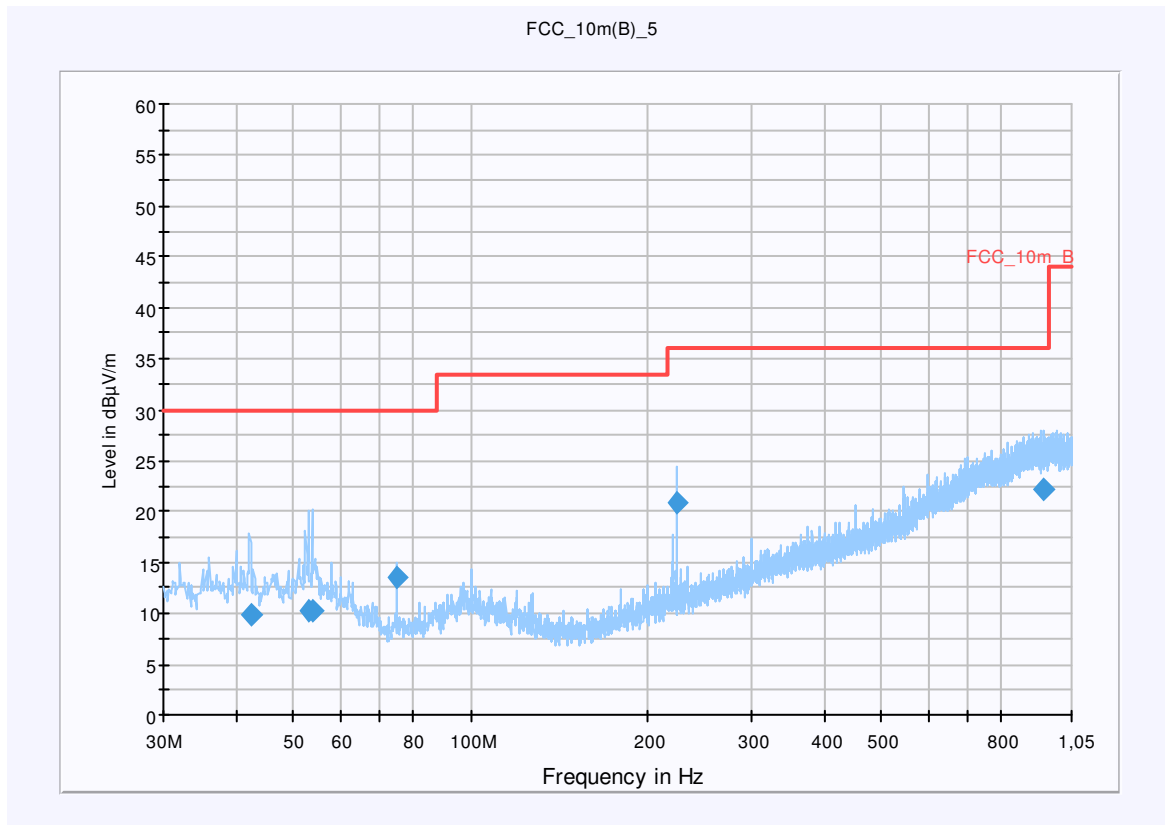

Final Result 1

Frequency (MHz)	QuasiPeak (dBµV/m)	Meas. Time (ms)	Bandwidth (kHz)	Antenna height (cm)	Polarity	Turntable position (deg)	Corr. (dB)	Margin (dB)	Limit (dBµV/m)	Comment
42.240000	9.8	15000.000	120.000	120.0	V	39.0	13.4	20.2	30.0	
53.160000	10.2	15000.000	120.000	270.0	V	173.0	13.1	19.8	30.0	
53.880000	10.3	15000.000	120.000	247.0	V	-2.0	13.0	19.7	30.0	
75.000000	13.6	15000.000	120.000	258.0	V	156.0	9.2	16.4	30.0	
224.880000	20.8	15000.000	120.000	120.0	V	-2.0	12.5	15.2	36.0	
943.560000	22.3	15000.000	120.000	254.0	V	156.0	25.3	13.7	36.0	

Hardware Setup: EMI radiated\Electric Field (NOS) - [EMI radiated]

Subrange 1	
Frequency Range:	30 MHz - 2 GHz
Receiver:	Receiver [ESCI 3] @ GPIB0 (ADR 20), SN 100083/003, FW 4.32
Signal Path:	without Notch FW 1.0
Antenna:	VULB 9163 SN 9163-295, FW --- Correction Table (vertical): VULP6113 Correction Table (horizontal): VULP6113 Correction Table: Cable_EN_1GHz (0909)
Antenna Tower:	Tower [EMCO 2090 Antenna Tower] @ GPIB0 (ADR 8), FW REV 3.12
Turntable:	Turntable [EMCO Turntable] @ GPIB0 (ADR 9), FW REV 3.12

EMC 32 Version 8.10.00

Plot 2: lowest channel; power index 35; 1 GHz to 12.75 GHz – vertical polarization

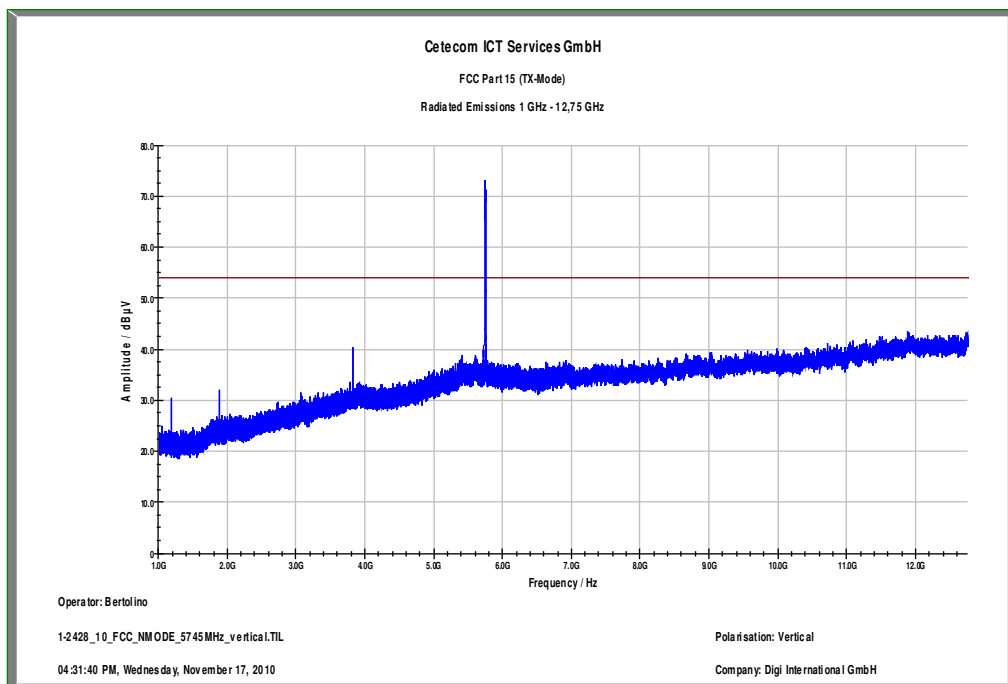

Plot 3: lowest channel; power index 35; 1 GHz to 12.75 GHz – horizontal polarization

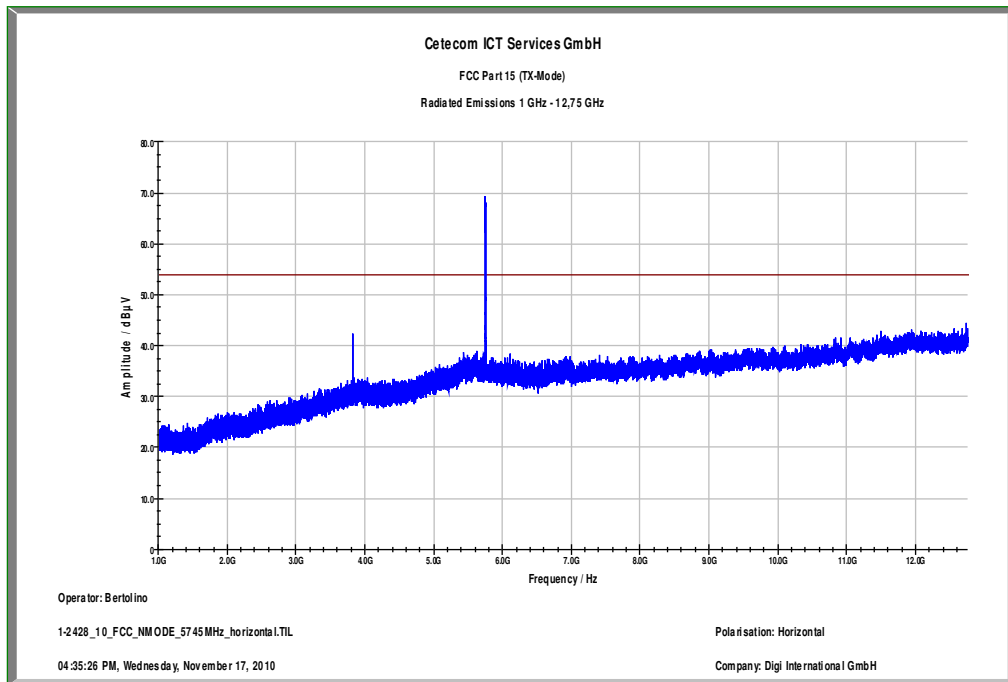

Plot 4: lowest channel; power index 35; 12.75 GHz to 18 GHz – vertical & horizontal polarization

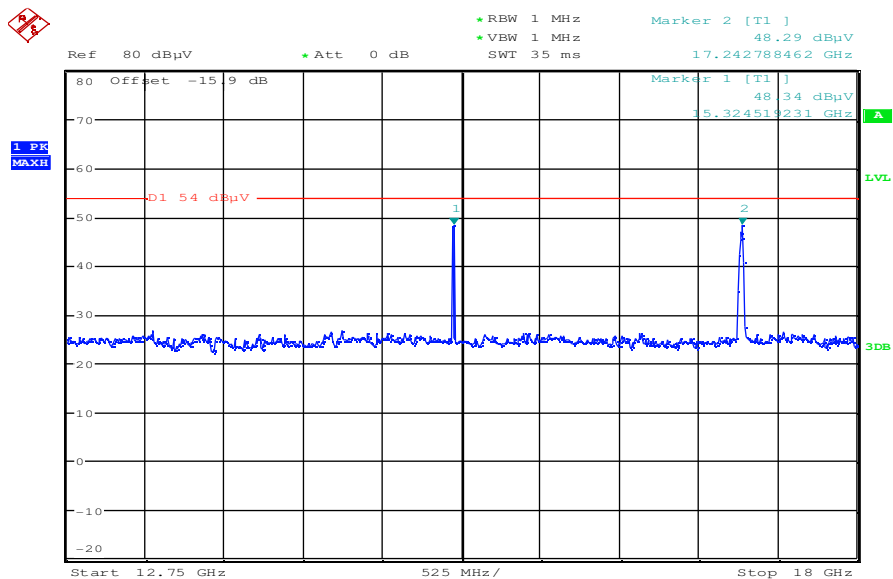

Date: 18.NOV.2010 08:20:07

Plot 5: lowest channel; power index 35; 18 GHz to 26 GHz – vertical & horizontal polarization

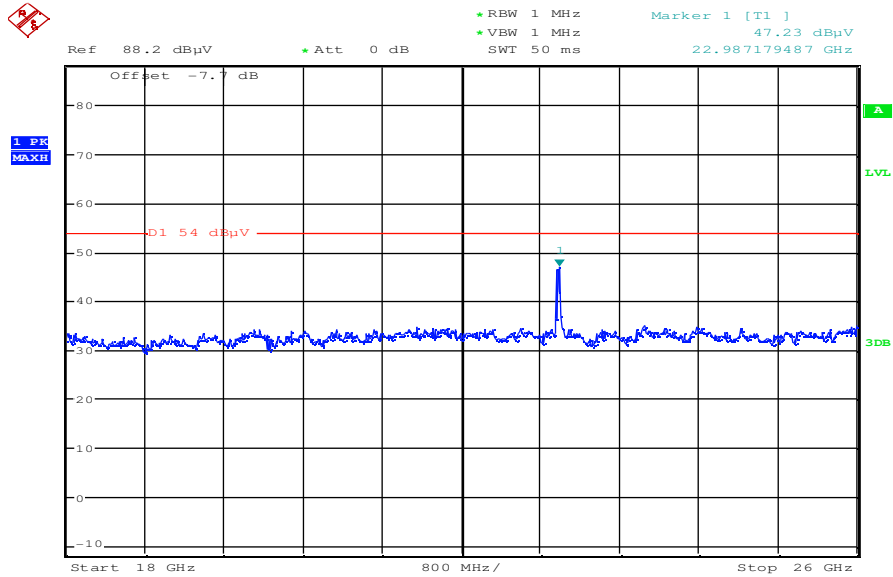

Date: 18.NOV.2010 08:37:25

Plot 6: lowest channel; power index 35; 26 GHz to 40 GHz – vertical & horizontal polarization

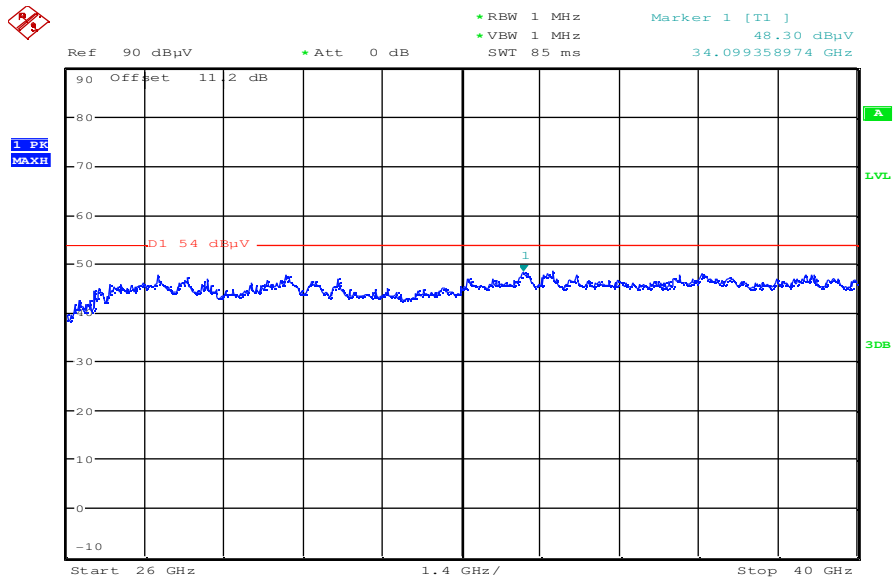

Date: 18.NOV.2010 09:03:32

Plot 7: middle channel; power index 35; 30 MHz to 1 GHz – vertical & horizontal polarization

Common Information

EUT: WLAN computer embex
 Serial Number: Proto
 Test Description: FCC part 15 @ 10 m
 Operating Conditions: TX, 5785 MHz, channel 157, mcs7, n mode
 Operator Name: HNA
 Comment: 3.3V DC

Scan Setup: STAN_Fin [EMI radiated]

Hardware Setup: Electric Field (NOS)
 Level Unit: dBµV/m

Subrange	Detectors	IF Bandwidth	Meas. Time	Receiver
30 MHz - 1,05 GHz	QuasiPeak	120 kHz	15 s	Receiver

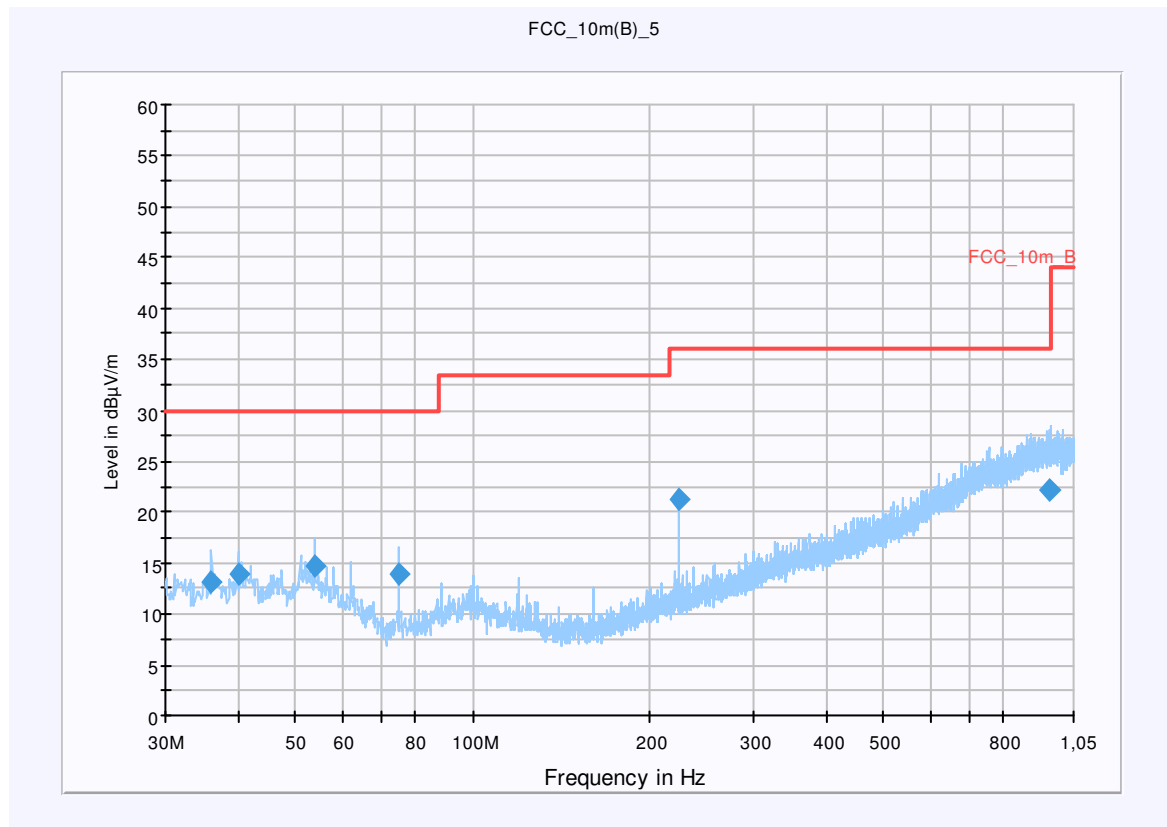

Final Result 1

Frequency (MHz)	QuasiPeak (dBµV/m)	Meas. Time (ms)	Bandwidth (kHz)	Antenna height (cm)	Polarity	Turntable position (deg)	Corr. (dB)	Margin (dB)	Limit (dBµV/m)	Comment
36.000000	13.2	15000.000	120.000	120.0	V	339.0	13.1	16.8	30.0	
39.960000	13.9	15000.000	120.000	98.0	V	256.0	13.4	16.1	30.0	
54.000000	14.7	15000.000	120.000	259.0	V	265.0	13.0	15.3	30.0	
75.000000	13.9	15000.000	120.000	270.0	V	153.0	9.2	16.1	30.0	
224.880000	21.3	15000.000	120.000	98.0	V	46.0	12.5	14.7	36.0	
952.560000	22.3	15000.000	120.000	270.0	V	90.0	25.4	13.7	36.0	

Hardware Setup: EMI radiated\Electric Field (NOS) - [EMI radiated]

Subrange 1	
Frequency Range:	30 MHz - 2 GHz
Receiver:	Receiver [ESCI 3] @ GPIB0 (ADR 20), SN 100083/003, FW 4.32
Signal Path:	without Notch FW 1.0
Antenna:	VULB 9163 SN 9163-295, FW --- Correction Table (vertical): VULP6113 Correction Table (horizontal): VULP6113 Correction Table: Cable_EN_1GHz (0909)
Antenna Tower:	Tower [EMCO 2090 Antenna Tower] @ GPIB0 (ADR 8), FW REV 3.12
Turntable:	Turntable [EMCO Turntable] @ GPIB0 (ADR 9), FW REV 3.12

EMC 32 Version 8.10.00

Plot 8: middle channel; power index 35; 1 GHz to 12.75 GHz – vertical polarization

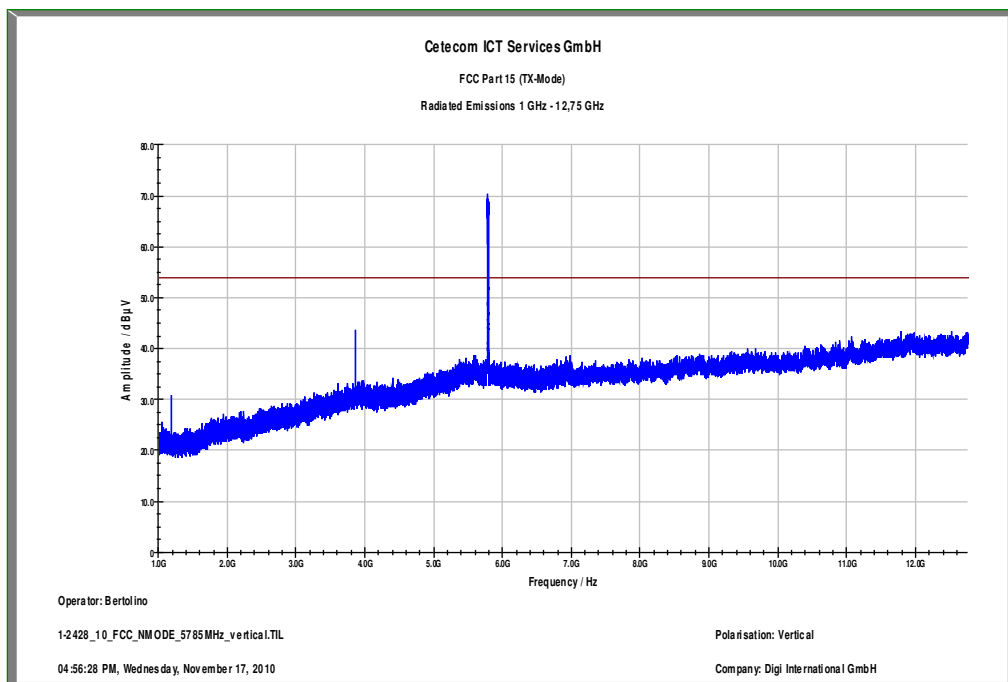

Plot 9: middle channel; power index 35; 1 GHz to 12.75 GHz – horizontal polarization

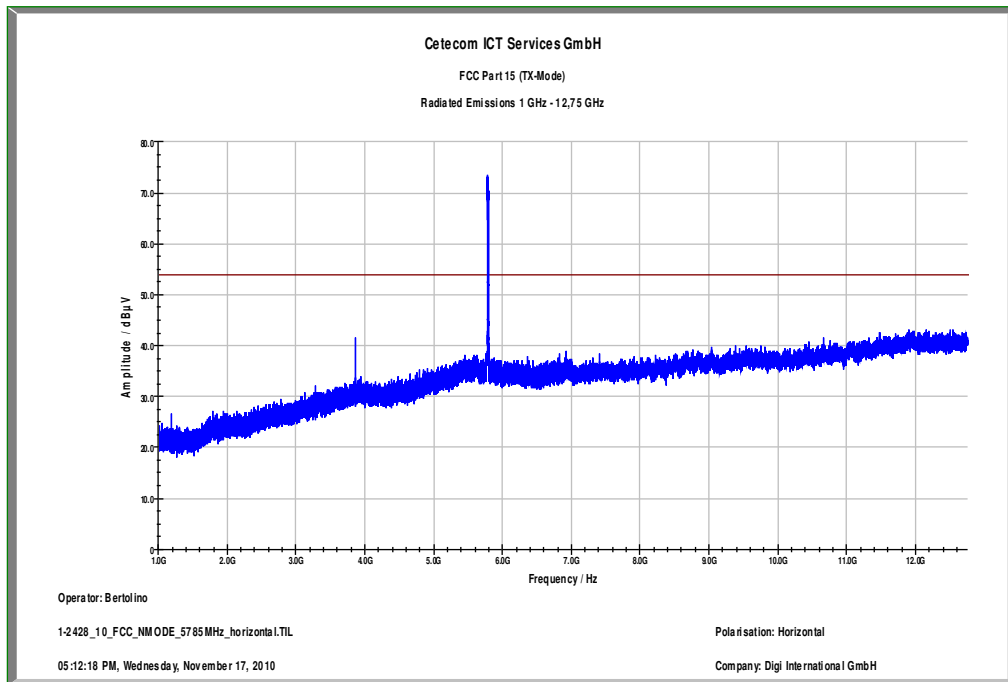

Plot 10: middle channel; power index 35; 12.75 GHz to 18 GHz – vertical & horizontal polarization

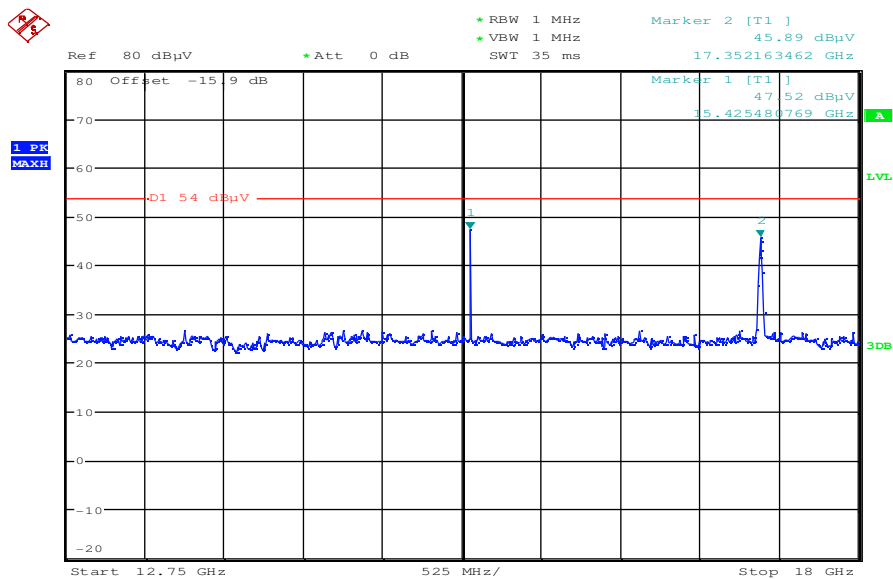

Date: 18.NOV.2010 08:21:53

Plot 11: middle channel; power index 35; 18 GHz to 26 GHz – vertical & horizontal polarization

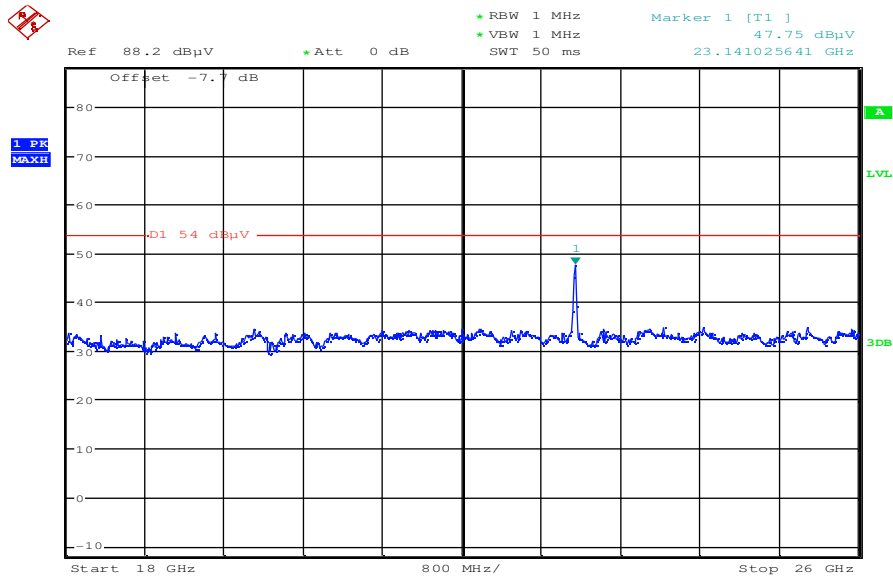

Date: 18.NOV.2010 08:39:15

Plot 12: middle channel; power index 35; 26 GHz to 40 GHz – vertical & horizontal polarization

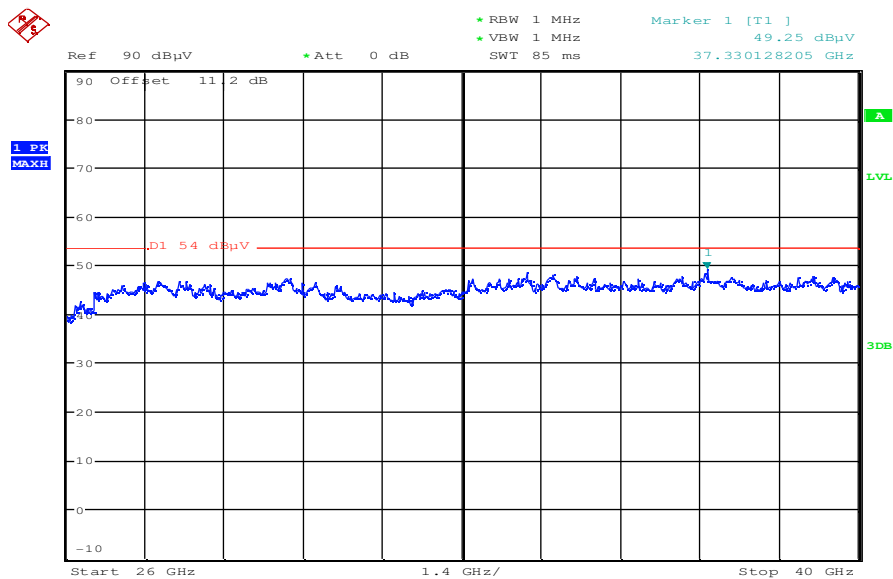

Date: 18.NOV.2010 09:05:34

Plot 13: highest channel; power index 35; 30 MHz to 1 GHz – vertical & horizontal polarization

Common Information

EUT: WLAN computer embex
 Serial Number: Proto
 Test Description: FCC part 15 @ 10 m
 Operating Conditions: TX, 5825 MHz, channel 165, mcs7, n mode
 Operator Name: HNA
 Comment: 3.3V DC

Scan Setup: STAN_Fin [EMI radiated]

Hardware Setup: Electric Field (NOS)
 Level Unit: dBµV/m
Subrange **Detectors** **IF Bandwidth** **Meas. Time** **Receiver**
 30 MHz - 1,05 GHz QuasiPeak 120 kHz 15 s Receiver

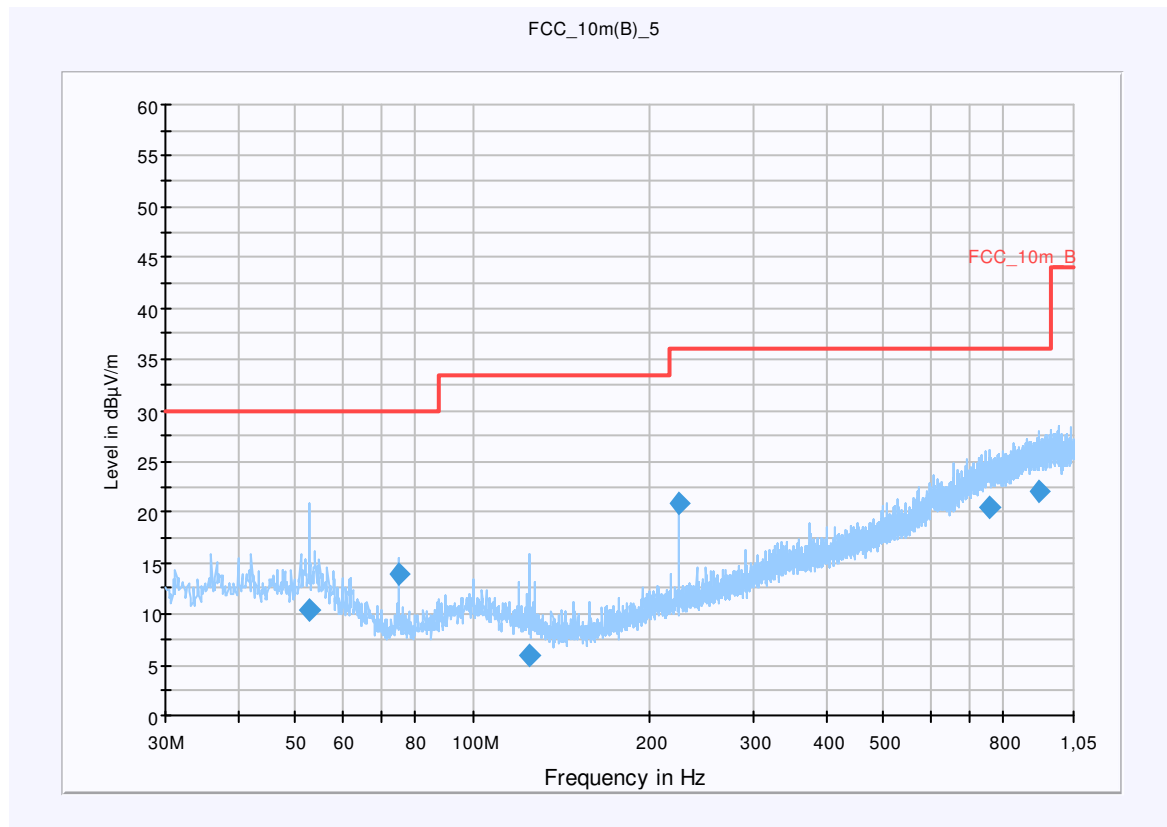

Final Result 1

Frequency (MHz)	QuasiPeak (dBµV/m)	Meas. Time (ms)	Bandwidth (kHz)	Antenna height (cm)	Polarity	Turntable position (deg)	Corr. (dB)	Margin (dB)	Limit (dBµV/m)	Comment
52.680000	10.4	15000.000	120.000	270.0	V	10.0	13.1	19.6	30.0	
75.000000	14.1	15000.000	120.000	246.0	V	162.0	9.2	15.9	30.0	
124.920000	6.0	15000.000	120.000	197.0	V	229.0	9.8	27.5	33.5	
224.880000	20.8	15000.000	120.000	109.0	V	20.0	12.5	15.2	36.0	
754.920000	20.4	15000.000	120.000	270.0	H	254.0	23.7	15.6	36.0	
922.560000	22.1	15000.000	120.000	98.0	H	120.0	25.3	13.9	36.0	

Hardware Setup: EMI radiated\Electric Field (NOS) - [EMI radiated]

Subrange 1	
Frequency Range:	30 MHz - 2 GHz
Receiver:	Receiver [ESCI 3] @ GPIB0 (ADR 20), SN 100083/003, FW 4.32
Signal Path:	without Notch FW 1.0
Antenna:	VULB 9163 SN 9163-295, FW --- Correction Table (vertical): VULP6113 Correction Table (horizontal): VULP6113 Correction Table: Cable_EN_1GHz (0909)
Antenna Tower:	Tower [EMCO 2090 Antenna Tower] @ GPIB0 (ADR 8), FW REV 3.12
Turntable:	Turntable [EMCO Turntable] @ GPIB0 (ADR 9), FW REV 3.12

EMC 32 Version 8.10.00

Plot 14: highest channel; power index 35; 1 GHz to 12.75 GHz – vertical polarization

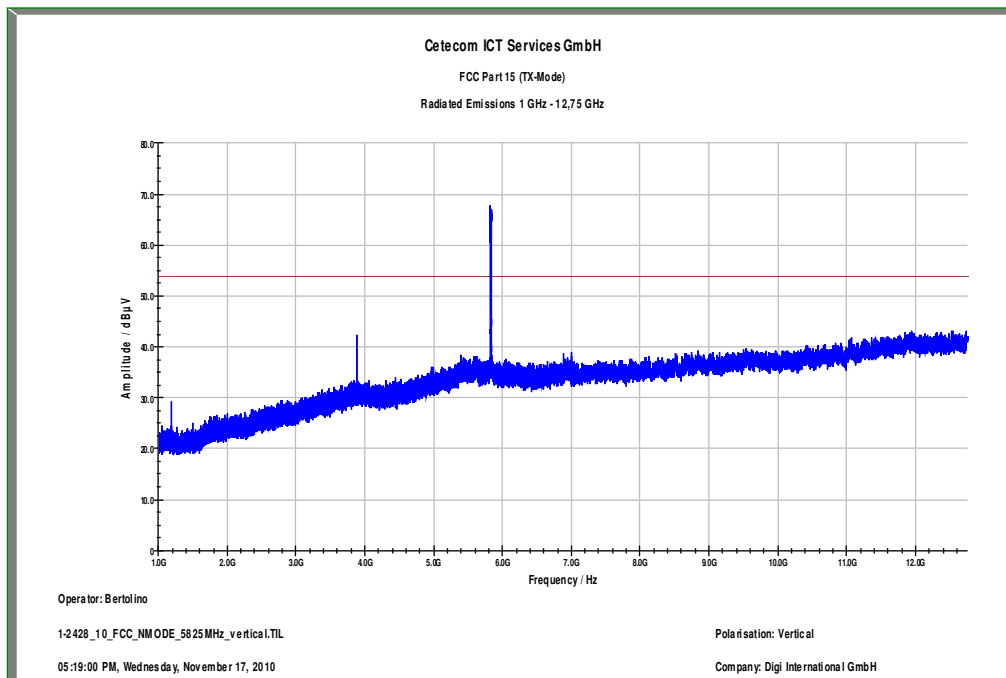

Plot 15: highest channel; power index 35; 1 GHz to 12.75 GHz – horizontal polarization

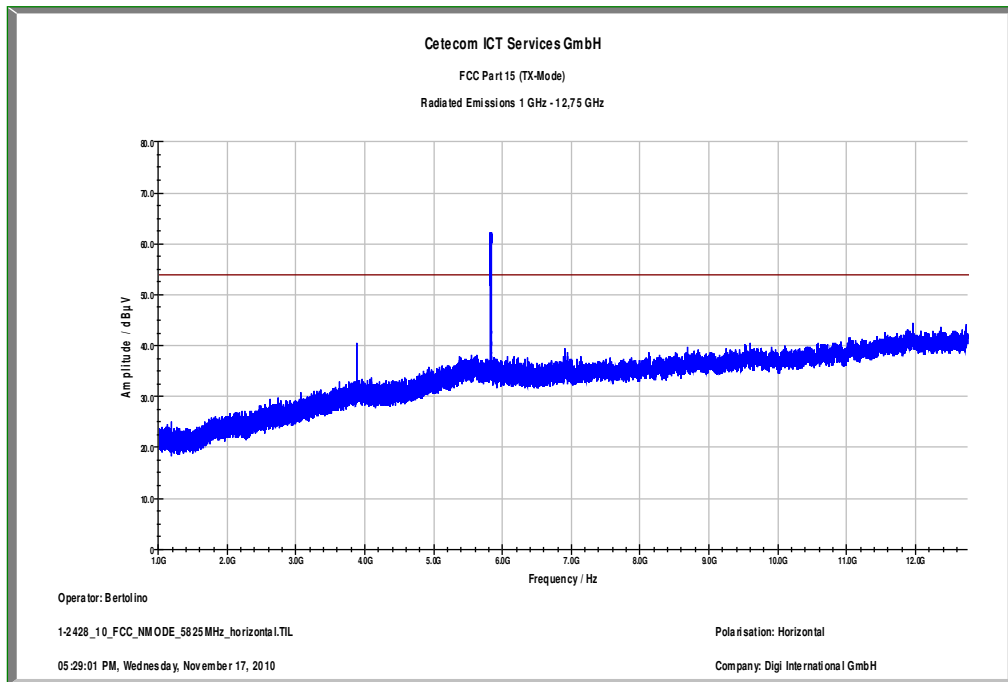

Plot 16: highest channel; power index 35; 12.75 GHz to 18 GHz – vertical & horizontal polarization

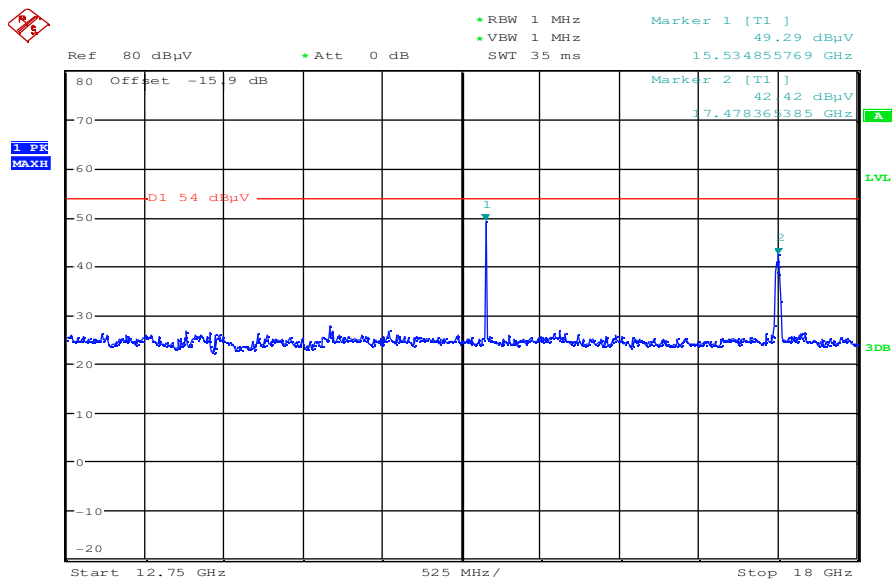

Date: 18.NOV.2010 08:23:37

Plot 17: highest channel; power index 35; 18 GHz to 26 GHz – vertical & horizontal polarization

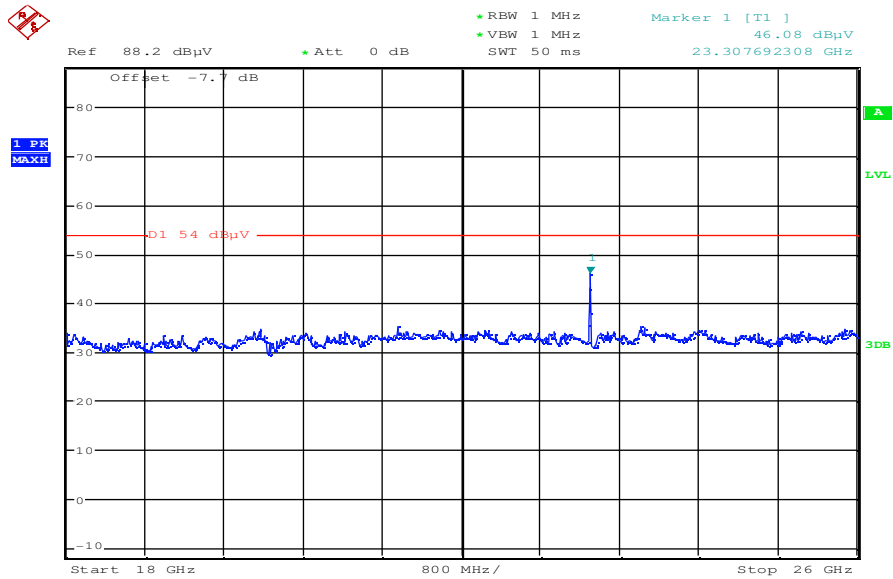

Date: 18.NOV.2010 08:40:53

Plot 18: highest channel; power index 35; 26 GHz to 40 GHz – vertical & horizontal polarization

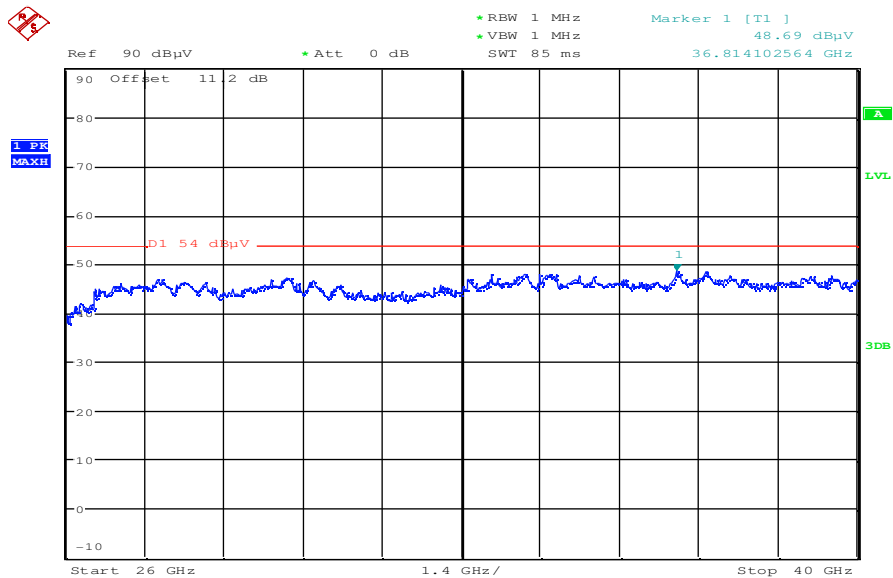

Date: 18.NOV.2010 09:06:49

9.11 RX spurious emissions radiated

Description:

Measurement of the radiated spurious emissions in idle/receive mode. The results are valid for both modes.

Measurement:

Measurement parameter	
Detector:	Peak / Quasi Peak
Sweep time:	Auto
Video bandwidth:	Sweep: 100 kHz Remeasurement: 10 Hz
Resolution bandwidth:	F < 1 GHz: 100 kHz F > 1 GHz: 1 MHz
Span:	30 MHz to 25 GHz
Trace-Mode:	Max Hold

Limits:

FCC		IC	
CFR Part 15.109		RSS Gen, Issue 2, 4.10	
RX Spurious Emissions Radiated			
Frequency (MHz)	Field Strength (dB μ V/m)	Measurement distance	
30 - 88	30.0	10	
88 - 216	33.5	10	
216 - 960	36.0	10	
Above 960	54.0	3	

Results:

RX Spurious Emissions Radiated [dB μ V/m]		
F	Detector	Level
4970.0 MHz	1 MHz / 10 Hz PP	43.19 dB μ V/m vertical 41.77 dB μ V/m horizontal
9748.0 MHz	1 MHz / 10 Hz PP	47.61 dB μ V/m vertical 44.58 dB μ V/m horizontal
19487.2 MHz	1 MHz / 1 MHz PP	42.19 dB μ V/m vertical & horizontal
Measurement uncertainty		± 3 dB

Result: The result of the measurement is passed.

Plot 1: RX – mode; 30 MHz to 1 GHz – vertical & horizontal polarization

Common Information

EUT: WLAN computer embex
 Serial Number: Proto
 Test Description: FCC part 15 @ 10 m
 Operating Conditions: RX
 Operator Name: HNA
 Comment: 3.3V DC

Scan Setup: STAN_Fin [EMI radiated]

Hardware Setup: Electric Field (NOS)
 Level Unit: dBµV/m
Subrange **Detectors** **IF Bandwidth** **Meas. Time** **Receiver**
 30 MHz - 1,05 GHz QuasiPeak 120 kHz 15 s Receiver

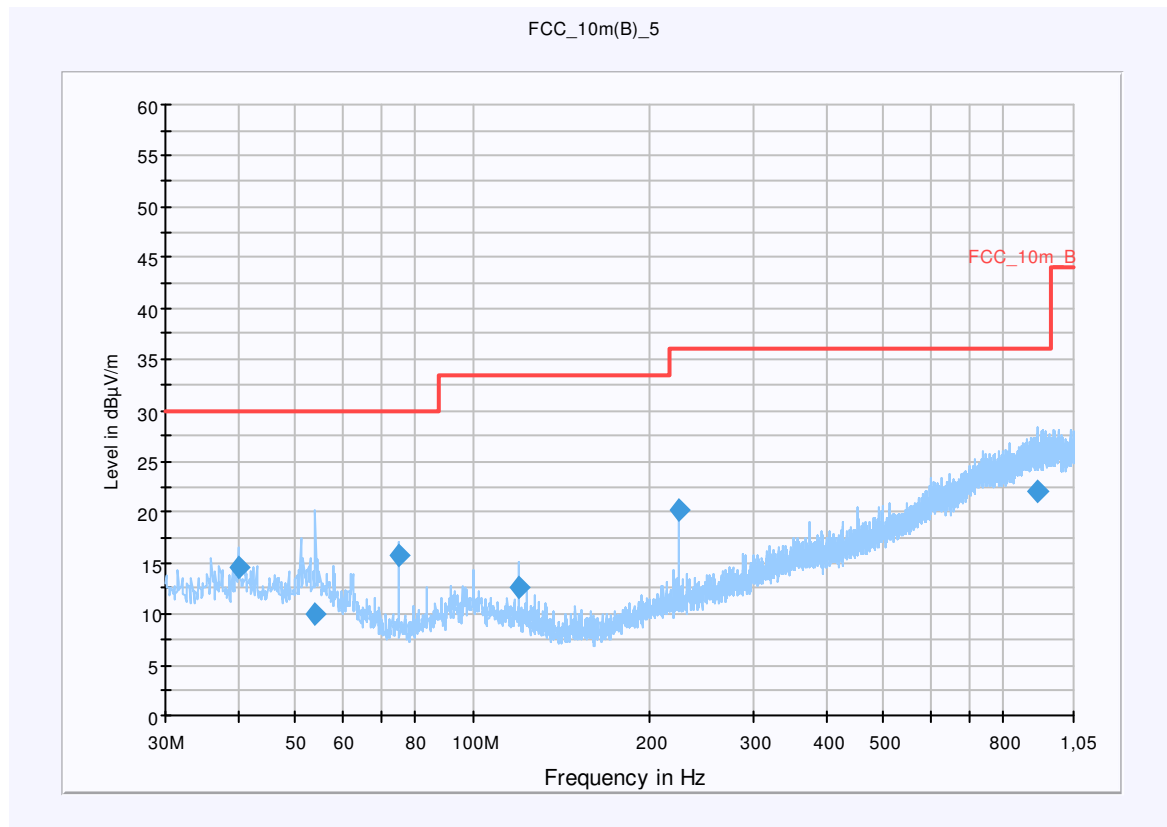

Final Result 1

Frequency (MHz)	QuasiPeak (dBµV/m)	Meas. Time (ms)	Bandwidth (kHz)	Antenna height (cm)	Polarity	Turntable position (deg)	Corr. (dB)	Margin (dB)	Limit (dBµV/m)	Comment
39.960000	14.6	15000.000	120.000	98.0	V	91.0	13.4	15.4	30.0	
54.120000	10.0	15000.000	120.000	133.0	V	345.0	13.0	20.0	30.0	
75.000000	15.8	15000.000	120.000	186.0	V	118.0	9.2	14.2	30.0	
120.000000	12.6	15000.000	120.000	135.0	V	28.0	10.2	20.9	33.5	
224.880000	20.3	15000.000	120.000	105.0	V	37.0	12.5	15.7	36.0	
911.880000	22.1	15000.000	120.000	212.0	V	118.0	25.2	13.9	36.0	

Hardware Setup: EMI radiated\Electric Field (NOS) - [EMI radiated]

Subrange 1	
Frequency Range:	30 MHz - 2 GHz
Receiver:	Receiver [ESCI 3] @ GPIB0 (ADR 20), SN 100083/003, FW 4.32
Signal Path:	without Notch FW 1.0
Antenna:	VULB 9163 SN 9163-295, FW --- Correction Table (vertical): VULP6113 Correction Table (horizontal): VULP6113 Correction Table: Cable_EN_1GHz (0909)
Antenna Tower:	Tower [EMCO 2090 Antenna Tower] @ GPIB0 (ADR 8), FW REV 3.12
Turntable:	Turntable [EMCO Turntable] @ GPIB0 (ADR 9), FW REV 3.12

EMC 32 Version 8.10.00

Plot 2: RX – mode; 1 GHz to 12.75 GHz – vertical polarization

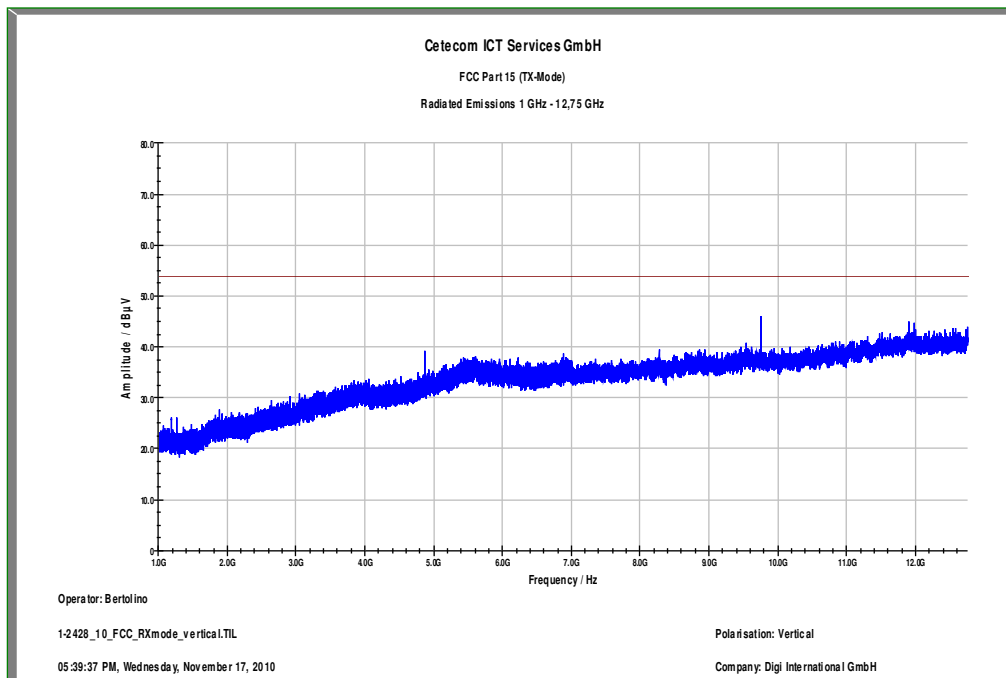

Plot 3: RX – mode; 1 GHz to 12.75 GHz – horizontal polarization

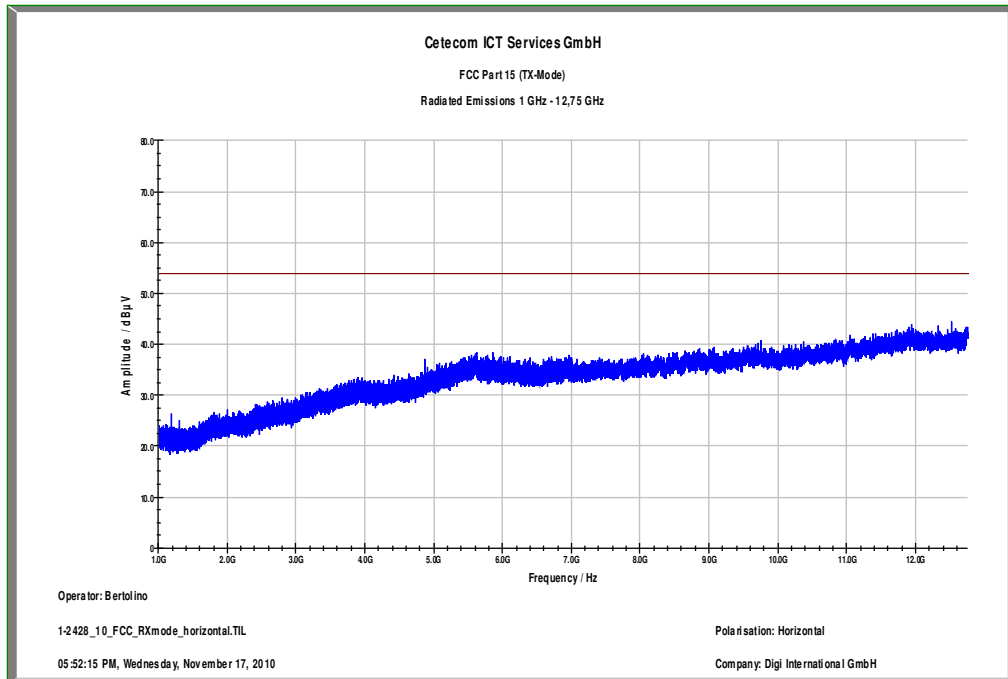

Plot 4: RX – mode; 12.75 GHz to 18 GHz – vertical & horizontal polarization

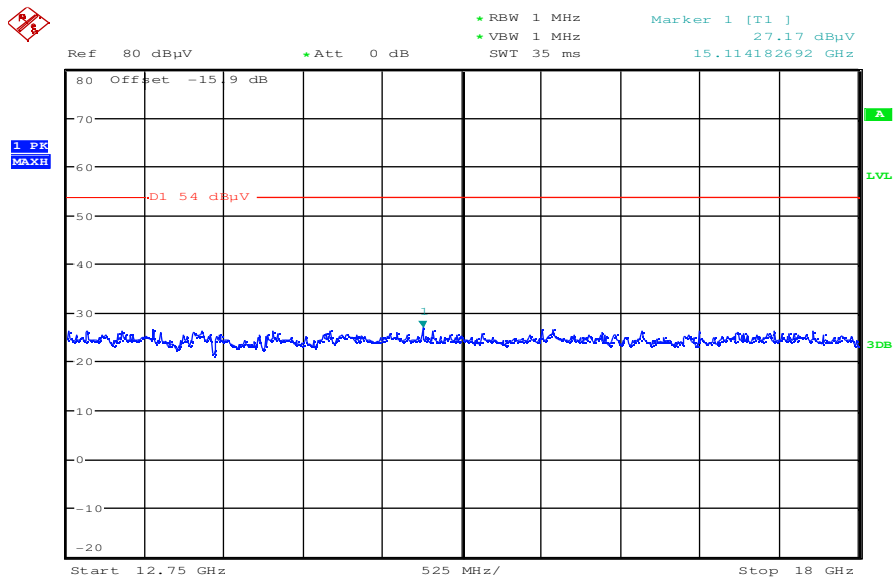

Date: 18.NOV.2010 08:24:56

Plot 5: RX – mode; 18 GHz to 26 GHz – vertical & horizontal polarization

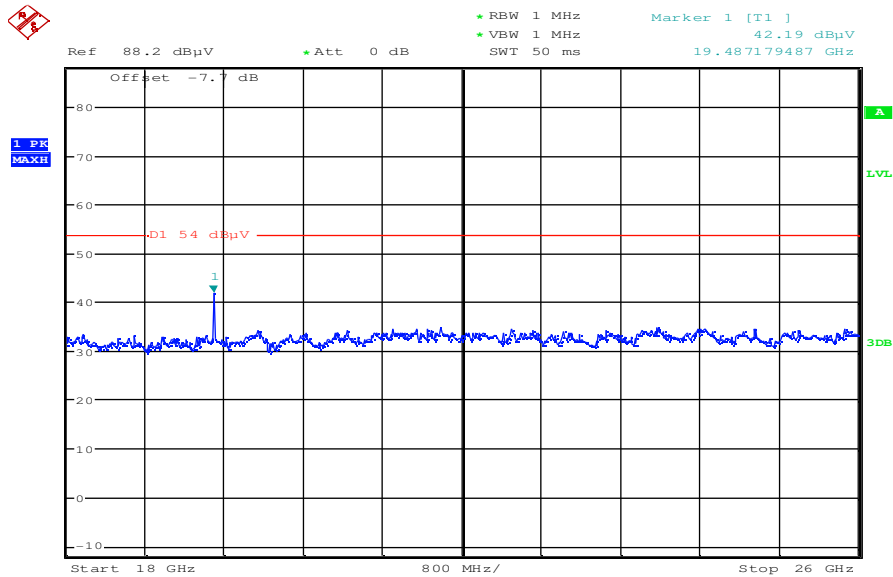

Date: 18.NOV.2010 08:27:24

Plot 6: RX – mode; 26 GHz to 40 GHz – vertical & horizontal polarization

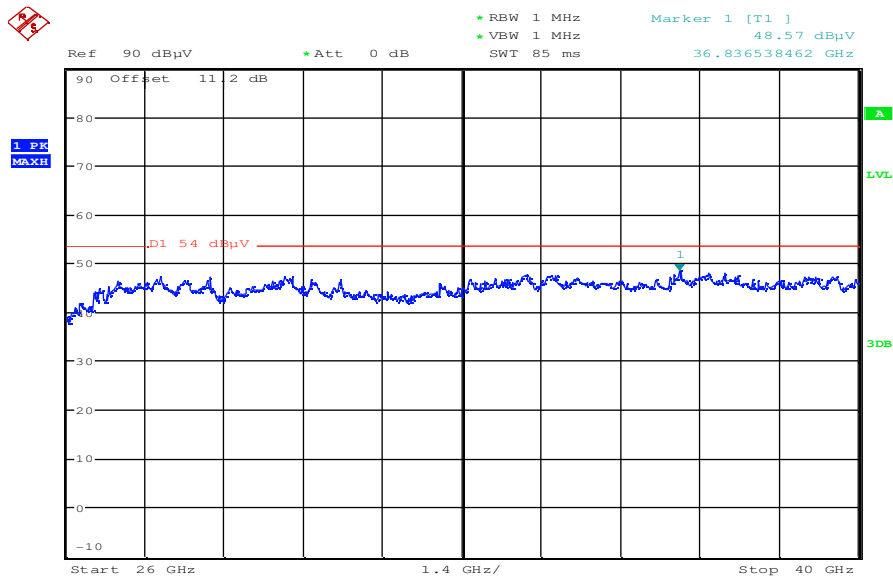

Date: 18.NOV.2010 09:07:25

9.12 TX spurious emissions radiated < 30 MHz

Description:

Measurement of the radiated spurious emissions in transmit mode below 30 MHz. The EUT is set to channel 6. This measurement is representative for all channels and modes. If critical peaks are found channel 1 and channel 11 will be measured too. The measurement is performed with the data rate producing the highest output power. The limits are recalculated to a measurement distance of 3 m with 40 dB/decade according CFR Part 2.

Measurement:

Measurement parameter	
Detector:	Peak / Quasi Peak
Sweep time:	Auto
Video bandwidth:	F < 150 kHz: 200 Hz F > 150 kHz: 9 kHz
Resolution bandwidth:	F < 150 kHz: 1 kHz F > 150 kHz: 100 kHz
Span:	9 kHz to 30 MHz
Trace-Mode:	Max Hold

Limits:

FCC		IC	
CFR Part 15.209(a)		RSS -Gen	
TX Spurious Emissions Radiated < 30 MHz			
Frequency (MHz)	Field Strength (dB μ V/m)	Measurement distance	
0.009 – 0.490	2400/F(kHz)	300	
0.490 – 1.705	24000/F(kHz)	30	
1.705 – 30.0	30	30	

Result: Also see plots

TX Spurious Emissions Radiated < 30 MHz [dBµV/m]		
F [MHz]	Detector	Level [dBµV/m]
No peaks found!		
Measurement uncertainty	± 3 dB	

Result: The result of the measurement is passed.

OFDM – mode / a – mode:

Plot 1: lowest channel; power index 35; 9 kHz to 30 MHz – magnetic

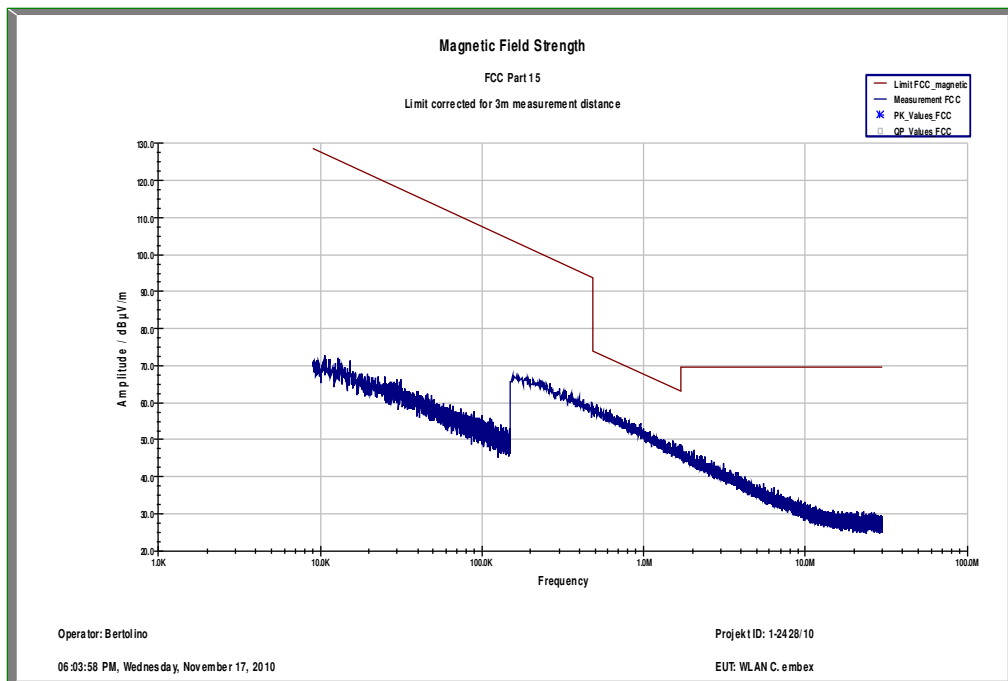

Plot 2: middle channel; power index 35; 9 kHz to 30 MHz – magnetic

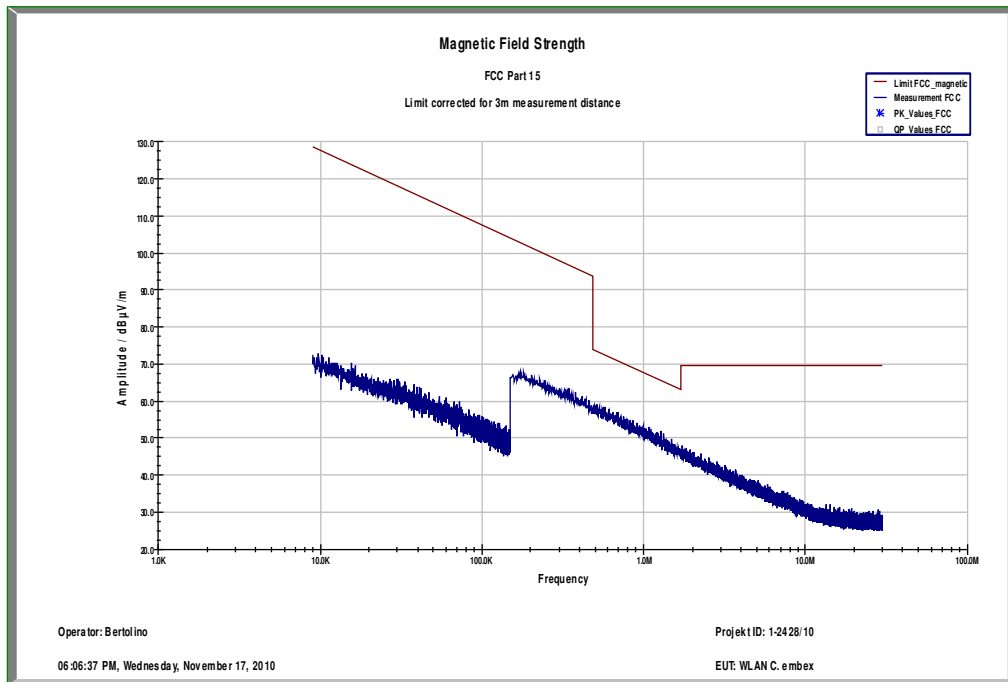

Plot 3: highest channel; power index 35; 9 kHz to 30 MHz – magnetic

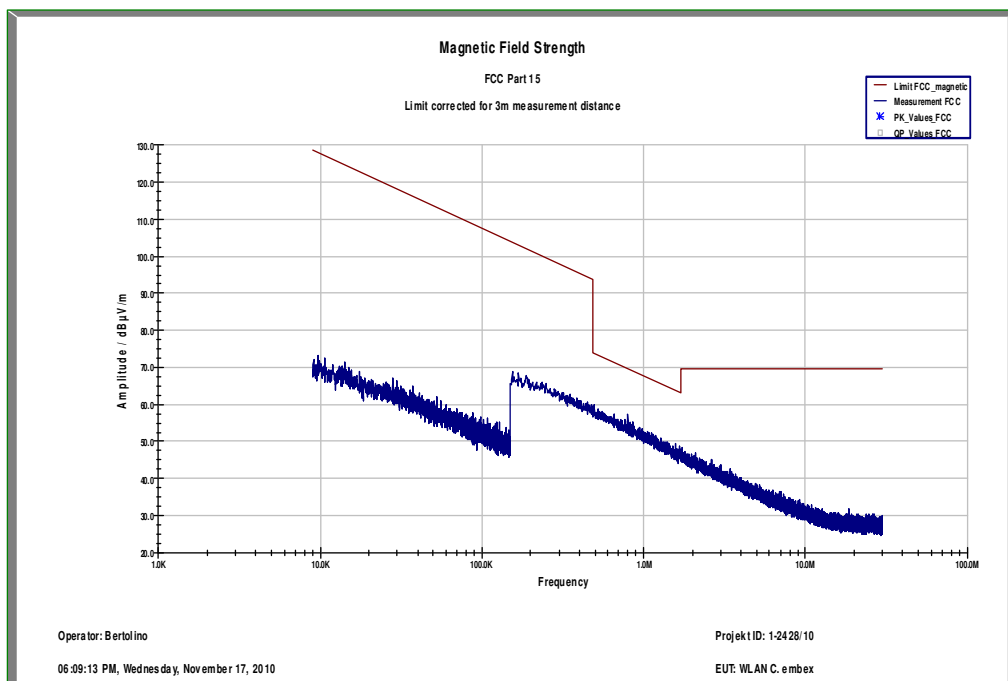

OFDM – mode / n – mode:

Plot 1: lowest channel; power index 35; 9 kHz to 30 MHz – magnetic

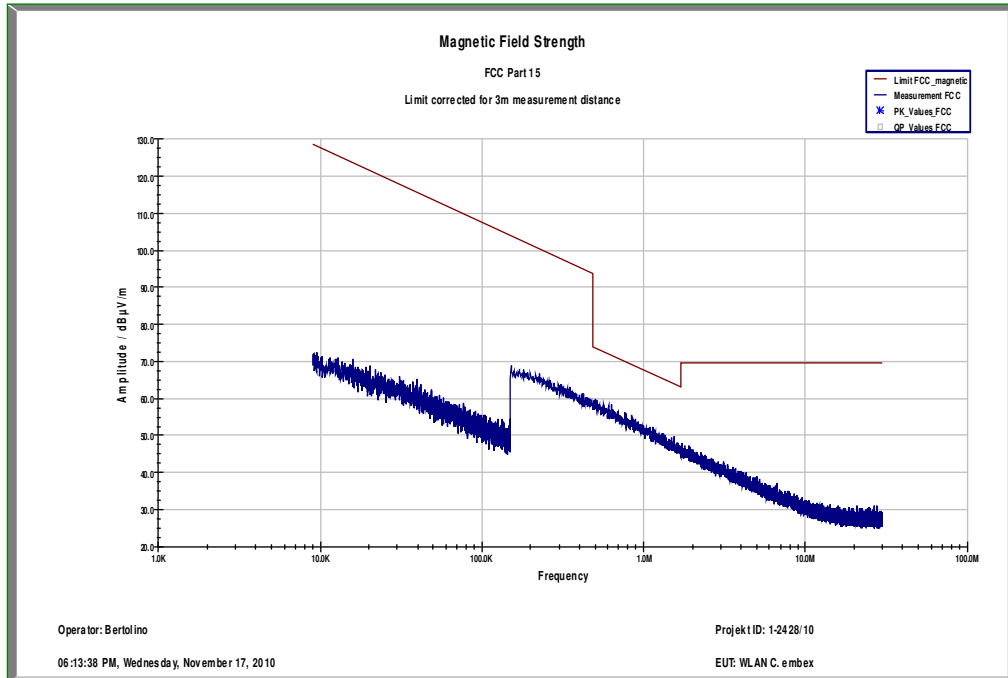

Plot 2: middle channel; power index 35; 9 kHz to 30 MHz – magnetic

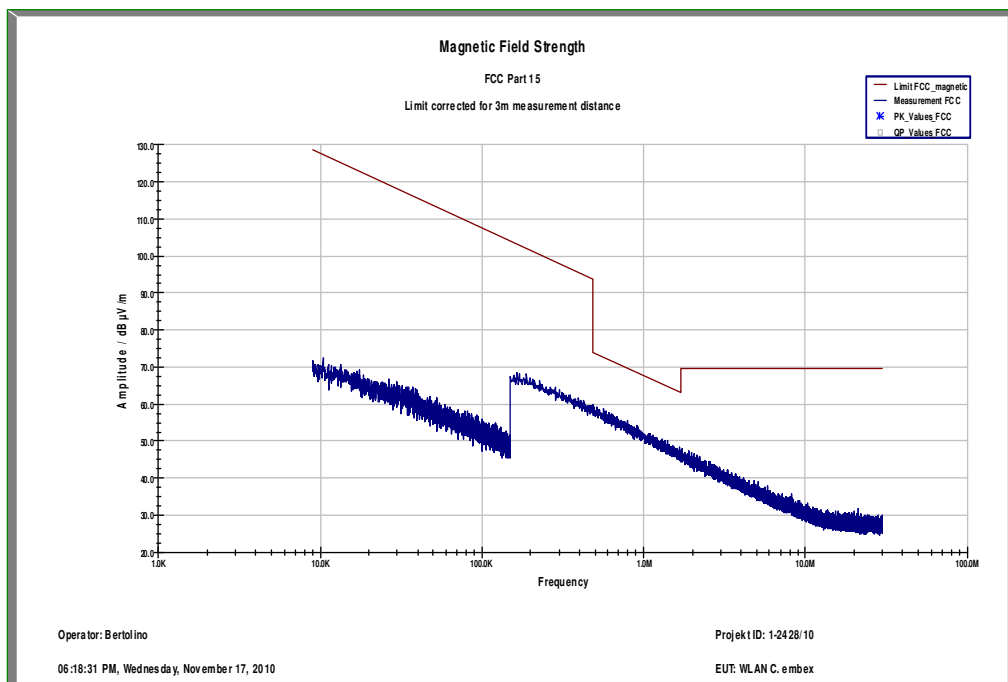

Plot 3: highest channel; power index 35; 9 kHz to 30 MHz – magnetic

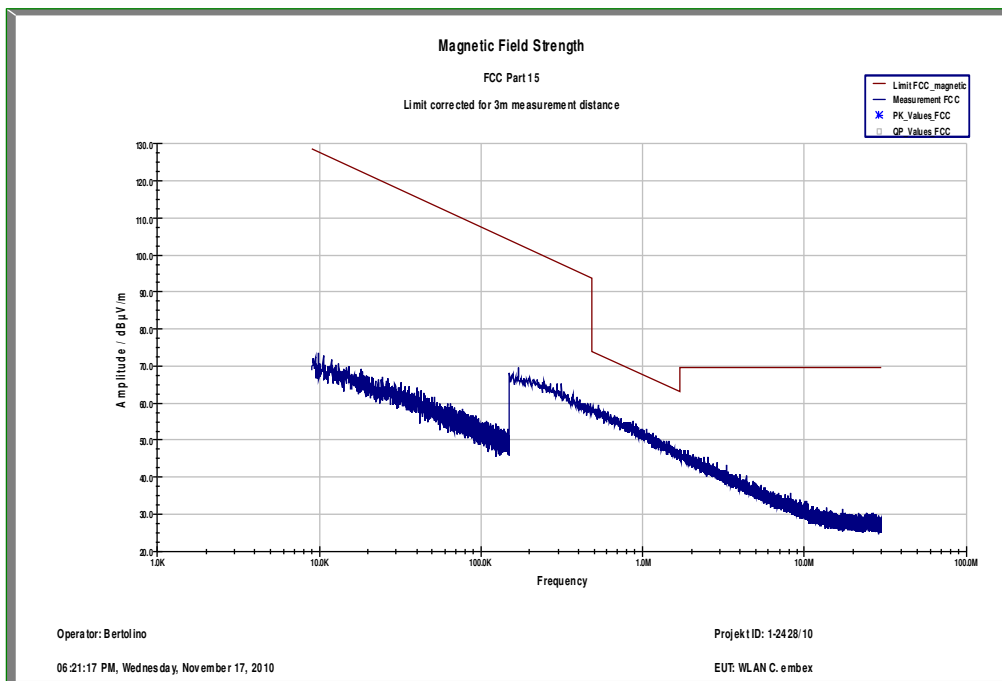

RX – mode / idle – mode:

Plot 1: RX mode; 9 kHz to 30 MHz – magnetic

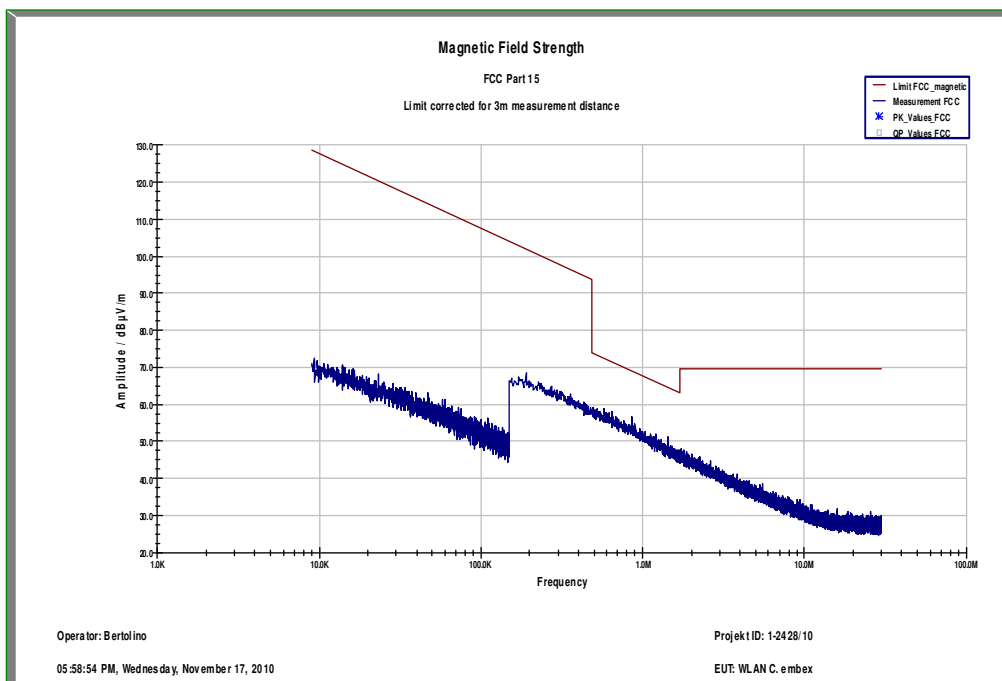

9.13 TX spurious emissions conducted < 30 MHz

Not performed! Delta tests only!

10 Test equipment and ancillaries used for tests

Typically, the calibrations of the test apparatus are commissioned to and performed by an accredited calibration laboratory. The calibration intervals are determined in accordance with the DIN EN ISO/IEC 17025. In addition to the external calibrations, the laboratory executes comparison measurements with other calibrated test systems or effective verifications. Weekly chamber inspections and range calibrations are performed. Where possible, rf-generating and signalling equipment as well as measuring receivers and analyzers are connected to an external high-precision 10 MHz reference (GPS-based or rubidium frequency standard).

In order to simplify the identification of the equipment used at some special tests, some items of test equipment and ancillaries can be provided with an identifier or number in the equipment list below (Labor/Item).

No.	Labor / Item	Equipment	Type	Manufact.	Serial No.	INV. No Cetecom	Kind of Calibration	Last Calibration	Next Calibration
1	n. a.	PowerAttenuator	8325	Byrd	1530	300001595	ev		
2	n. a.	Double-Ridged Waveguide Horn Antenna 1-18.0GHz	3115	EMCO	8812-3088	300001032	viKI!	05.03.2009	05.03.2011
3	n. a.	Active Loop Antenna	6502	EMCO	2210	300001015	ne		
4	n. a.	Anechoic chamber	FAC 3/5m	MWB / TDK	87400/02	300000996		23.03.2009	
5	9	Artificial Mains 9 kHz to 30 MHz	ESH3-Z5	R&S	828576/020	300001210	Ve	06.01.2010	06.01.2012
6	n. a.	Relais Matrix	PSU	R&S	890167/024	300001168	ne		
7	n. a.	Isolating Transformer	RT5A	Grundig	9242	300001263	ne		
8	n. a.	Three-Way Power Splitter, 50 Ohm	11850C	HP Meßtechnik		300000997	ne		
9	n. a.	Switch / Control Unit	3488A	HP	2605e08770	300001443	ne		
10	n. a.	Amplifier	js42-00502650-28-5a	Parzich GMBH	928979	300003143	ne		
11	n. a.	Band Reject filter	WRCG2400/2483-2375/2505-50/10SS	Wainwright	11	300003351	ev		
12	n. a.	TILE-Software Emission	Quantum Change, Modell TILE-ICS/FULL	EMCO	none	300003451	ne		
13	n. a.	Highpass Filter	WHKX2.9/18G-12SS	Wainwright	1	300003492	ev		
14	n. a.	Highpass Filter	WHK1.1/15G-10SS	Wainwright	3	300003255	ev		
15	n. a.	Highpass Filter	WHKX7.0/18G-8SS	Wainwright	18	300003789	ne		
16	n. a.	PSA Spectrum Analyzer 3 Hz - 26.5 GHz	E4440A	Agilent Technologies	MY48250080	300003812	k	08.09.2010	08.09.2012
17	n. a.	RF Filter Section 9kHz - 1GHz	N9039A	Agilent Technologies	MY48260003	300003825	viKI!	08.09.2010	08.09.2012
18	n. a.	TRILOG Broadband Test-Antenna 30 MHz - 3 GHz	VULB9163	Schwarzbeck	371	300003854	viKI!	17.12.2008	17.12.2010
19	45	Switch-Unit	3488A	HP Meßtechnik	2719A14505	300000368	g		
20	50	DC power supply, 60Vdc, 50A, 1200 W	6032A	HP Meßtechnik	2920A04466	300000580	k	06.01.2009	06.01.2011
21	n. a.	software	SPS_PHE 1.4f	Spitzberger & Spieß	B5981; 5D1081; B5979	300000210	ne		
22	n. a.	EMI Test Receiver	ESCI 1166.5950.03	R&S	100083	300003312	k	08.01.2010	08.01.2012
23	n. a.	Analyzer-Reference-System (Harmonics and Flicker)	ARS 16/1	SPS	A3509 07/0 0205	300003314	k	01.06.2009	01.06.2011
24	n. a.	Amplifier	JS42-00502650-28-5A	MITEQ	1084532	300003379	ev		
25	n. a.	Antenna Tower	Model 2175	ETS-LINDGREN	64762	300003745	izw		

26	n. a.	Positioning Controller	Model 2090	ETS-LINDGREN	64672	300003746	izw		
27	n. a.	Turntable Interface-Box	Model 105637	ETS-LINDGREN	44583	300003747	izw		
28	n. a.	TRILOG Broadband Test-Antenna 30 MHz - 3 GHz	VULB9163	Schwarzbeck	295	300003787	k	01.04.2010	01.04.2012
29	n. a.	Spectrum-Analyzer	FSU26	R&S	200809	300003874	k	08.01.2010	08.01.2012
30	A026	Std. Gain Horn Antenna 12.4 to 18.0 GHz	639	Narda		300000787	ne		
31	A029	Std. Gain Horn Antenna 18.0 to 26.5 GHz	638	Narda		300002442	ne		
32	n. a.	Power Supply	LA30/5GA	Zentro Elektronik	2046	300000711	NK!		
33	n. a.	Spectrum Analyzer 20 Hz - 50 GHz	FSU50	R&S	200012	300003443	ve	01.07.2010	01.07.2012
34	n. a.	Spectrum Analyzer 9kHz to 30GHz - 140..+30dBm	FSP30	R&S	100886	300003575	k	07.09.2010	07.09.2012
35	11b	Microwave System Amplifier, 0.5-26.5 GHz; 25 dB gain	83017A	HP Meßtechnik	3123A00105	300002268	ev		

Agenda: Kind of Calibration

k calibration / calibrated
 ne not required (k, ev, izw, zw not required)
 ev periodic self verification
 Ve long-term stability recognized
 vlk! Attention: extended calibration interval
 NK! Attention: not calibrated

EK limited calibration
 zw cyclical maintenance (external cyclical maintenance)
 izw internal cyclical maintenance
 g blocked for accredited testing
 *) next calibration ordered / currently in progress

Annex A Document history

Version	Applied changes	Date of release
1.0	Initial release	2010-11-18
1.0-A	Additional cover sheet information	2011-01-27
1.0-B	Photos removed	2011-01-28

Annex B Further information

Glossary

DUT	-	Device under Test
EMC	-	Electromagnetic Compatibility
EUT	-	Equipment under Test
FCC	-	Federal Communication Commission
FCC ID	-	Company Identifier at FCC
HW	-	Hardware
IC	-	Industry Canada
Inv. No.	-	Inventory number
N/A	-	not applicable
S/N	-	Serial Number
SW	-	Software