



Accredited testing-laboratory

DAR registration number: DAT-P-176/94-D1

**Federal Motor Transport Authority (KBA)
DAR registration number: KBA-P 00070-97**

Recognized by the Federal Communications Commission

Anechoic chamber registration no.: 90462 (FCC)

Anechoic chamber registration no.: 3462C-1 (IC)

Certification ID: DE 0001

Accreditation ID: DE 0002

Accredited Bluetooth® Test Facility (BQTF)

*The Bluetooth word mark and logos are owned by the Bluetooth SIG,
Inc. and any use of such marks by Cetecom ICT is under license*

Test report no. : 1-1121-01-12/09
Type identification : CCW9M2443
Applicant : Digi International GmbH
FCC ID : MCQ-50M1663
IC Certification No : 1846A-50M1663
Test standards : 47 CFR Part 15
RSS - 210 Issue 7

Table of contents

1	General information	3
1.1	Notes	3
1.2	Testing laboratory	4
1.3	Details of applicant	4
1.4	Application details	4
2	Test standard/s	5
3	Technical tests	6
3.1	Details of manufacturer.....	6
3.1.1	Test item.....	6
3.1.2	Additional EUT information For IC Canada (appendix 2).....	7
3.1.3	RF Technical Brief Cover Sheet acc. To RSS-102	8
3.1.4	EUT operating modes.....	9
3.1.5	Extreme conditions testing values	9
4	Summary of Measurement Results and list of all performed test cases	10
5	RF measurement testing	11
5.1	Description of test set-up.....	11
5.1.1	Radiated measurements.....	11
5.1.2	Conducted measurements.....	11
5.2	Referenced Documents	12
5.3	Additional comments	13
5.4	Peak Power Spectral density (digitally modulated systems) §15.247(e).....	14
5.5	Spectrum Bandwidth of a DSSS System / 6 dB Bandwidth §15.247(a)(2).....	18
5.6	Spectrum Bandwidth of a DSSS System / 20 dB Bandwidth.....	22
5.7	Maximum output power (conducted) §15.247 (b)(3).....	26
5.8	Max. peak output power (radiated) §15.247 (b)(3)	30
5.9	Band-edge compliance of conducted emissions §15.247 (d)	32
5.10	Band-edge compliance of radiated emissions §15.205	35
5.11	Spurious Emissions - conducted (Transmitter) §15.247 (d).....	37
5.12	Spurious Emissions - radiated (Transmitter) §15.209	41
5.13	Spurious Emissions - radiated (Receiver) §15.109 / 209	57
5.14	Spurious Emissions - radiated <30 MHz §15.209	60
5.15	Conducted Emissions <30 MHz §15.107/207.....	61
6	Test equipment and ancillaries used for tests	62
7	Photographs of the Test Set-up	65
8	Photographs of the EUT	67

1 General information

1.1 Notes

The test results of this test report relate exclusively to the test item specified in 3.1.1. The CETECOM ICT Services GmbH does not assume responsibility for any conclusions and generalisations drawn from the test results with regard to other specimens or samples of the type of the equipment represented by the test item. The test report may only be reproduced or published in full. Reproduction or publication of extracts from the report requires the prior written approval of the CETECOM ICT Services GmbH.

Test laboratory manager:

2009-07-24 Daniel Muyunga

Date

Name

Signature

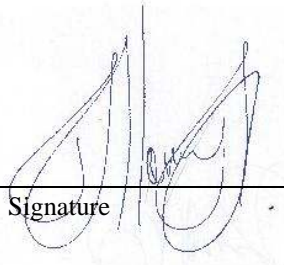

Technical responsibility for area of testing:

2009-07-24 Stefan Bös

Date

Name

Signature



1.2 Testing laboratory

CETECOM ICT Services GmbH

Untertürkheimer Straße 6 - 10

66117 Saarbrücken

Germany

Phone: + 49 681 5 98 - 0

Fax: + 49 681 5 98 - 9075

e-mail: info@ICT.cetecom.de

Internet: <http://www.cetecom-ict.de>

State of accreditation: The test laboratory (area of testing) is accredited according to
DIN EN ISO/IEC 17025
DAR registration number: DAT-P-176/94-D1

Accredited by: Federal Motor Transport Authority (KBA)
DAR registration number: KBA-P 00070-97

Testing location, if different from CETECOM ICT Services GmbH:

Name :
Street :
Town :
Country :
Phone :
Fax :

1.3 Details of applicant

Name:	Digi International GmbH Branch Breisach
Street:	Kueferstr.8
Town:	79206 Breisach
Country:	Germany
Telephone:	
Fax:	+49 7667 908 200
Contact:	Andreas Ortlieb
E-mail:	andreas.ortlieb@digi.com
Telephone:	+49 7667 908 136

1.4 Application details

Date of receipt of order:	2009-06-05
Date of receipt of test item:	2009-07-13
Date of start test:	2009-07-13
Date of end test:	2009-07-24
Persons(s) who have been present during the test:	Mr. Andreas Ortlieb

2 Test standard/s

47 CFR Part 15	2008-07	Title 47 of the Code of Federal Regulations; Chapter I- Federal Communications Commission subchapter A - general, Part 15-Radio frequency devices
RSS - 210 Issue 7	2007-06	Spectrum Management and Telecommunications - Radio Standards Specification Low-power Licence-exempt Radiocommunication Devices (All Frequency Bands): Category I Equipment

3 Technical tests

3.1 Details of manufacturer

Name:	Digi International GmbH Branch Breisach
Street:	Kueferstr.8
Town:	79206 Breisach
Country:	Germany

3.1.1 Test item

Kind of test item	:	WLAN Modul
Type identification	:	CCW9M2443
S/N serial number	:	B92834248, B92834249, B92834250
HW hardware status	:	-/-
SW software status	:	-/-
Frequency Band [MHz]	:	2412 – 2462 MHz
Type of Modulation	:	DSSS & OFDM
Number of channels	:	11
Antenna	:	External rod. antenna
Power Supply	:	Developer board: 115 V AC/60 Hz to 12 V DC by power adaptor TR10R0120
Temperature Range	:	-20 °C to +55 °C

DSSS – mode:

Conducted power [dBm]: 15.62

Radiated power [dBm]: 18.31

OFDM – mode:

Conducted power [dBm]: 19.26

Radiated power [dBm]: 22.30

FCC ID : MCQ-50M1663

IC Certification No : 1846A-50M1663

3.1.2 Additional EUT information For IC Canada (appendix 2)

IC Registration Number:	1846A-50M1663
Model Name:	CCW9M2443
Manufacturer (complete Address):	Digi International GmbH Kueferstr.8 79206 Breisach Germany
Tested to Radio Standards Specification (RSS) No.:	RSS-210 Issue 7
Open Area Test Site Industry Canada Number:	IC 3462C-1
Frequency Range (or fixed frequency) [MHz]:	2412 – 2462 MHz
RF: Power [W] (max):	DSSS: Rad. EIRP: 54.33 mW Conducted : 36.48 mW OFDM: Rad. EIRP: 125.60 mW Conducted : 84.33 mW
Antenna Type:	External rod. antenna
Occupied Bandwidth (99% BW) [MHz]:	DSSS: 15.53 OFDM: 18.74
Type of Modulation:	DSSS & OFDM
Emission Designator (TRC-43):	15M5G1D (DSSS) 18M7G7D (OFDM)
Transmitter Spurious (worst case) [dBµV/m in 3m]:	DSSS: 40.25 OFDM: 39.71
Receiver Spurious (worst case) [dBµV/m in 3m]:	39.05

ATTESTATION:

I attest that the testing was performed or supervised by me; that the test measurements were made in accordance with the above-mentioned departmental standard(s), and that the radio equipment identified in this application has been subject to all applicable test conditions specified in the departmental standards and all of the requirements of the standards have been met.

Signature:

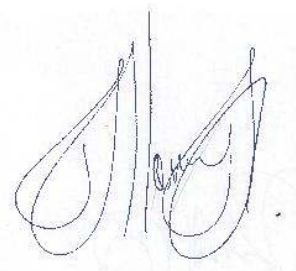

Test engineer: Daniel Muyunga

Date: 2009-07-24

3.1.3 RF Technical Brief Cover Sheet acc. To RSS-102

All Fields must be completed with the requested information or the following codes: N/A for Not Applicable, N/P for Not Performed or N/V for Not Available. Where applicable, check appropriate box.

1. COMPANY NUMBER: **1846A-50M1663**
2. MODEL NUMBER: **CCW9M2443**
3. MANUFACTURER: **Digi International GmbH**
4. TYPE OF EVALUATION: **(c) RF Evaluation**

- Evaluated against exposure limits: General Public Use Controlled Use
- Duty cycle used in evaluation: 100 %
- Standard used for evaluation: RSS-102 Issue 2 (2005-11)
- Measurement distance: 0.20 m
- RF value: 0.25 V/m A/m W/m²
- Measured Computed Calculated

Declaration of RF Exposure Compliance

ATTESTATION:

I attest that the information provided in this test report is correct; that a Technical Brief was prepared and the information it contains is correct; that the device evaluation was performed or supervised by me; that applicable measurement methods and evaluation methodologies have been followed and that the device meets the SAR and/or RF exposure limits of RSS-102.

Name: Dipl.-Ing. (FH) Daniel Muyunga
Title: Engineer
Company: Cetecom ICT Services GmbH

Signature:

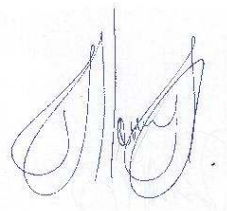

Date: 2009-07-24

3.1.4 EUT operating modes

EUT operating mode no.*)	Description of operating modes	Additional information
Op. 0	normal mode	normal temperature and power source conditions
Op. 1		low temperature, low power source conditions
Op. 2		low temperature, high power source conditions
Op. 3		high temperature, low power source conditions
Op. 4		high temperature, high power source conditions

*) EUT operating mode no. is used to simplify the test plan

3.1.5 Extreme conditions testing values

Description	Shortcut	Unit	Value
Nominal Temperature	T _{nom}	°C	20
Nominal Humidity	H _{nom}	%	49
Nominal Power Source	V _{nom}	V	115 V AC/60 Hz to 12 V DC

Type of power source: **by power adaptor TR10R0120**

4 Summary of Measurement Results and list of all performed test cases

- No deviations from the technical specifications were ascertained
- There were deviations from the technical specifications ascertained

TC identifier	Description	verdict	date	Remark
RF-Testing	FCC Part 15 §15.247 - CANADA RSS-210	PASS	2009-07-24	-/-

Test Specification Clause	Test Case	Pass	Fail	Not applicable	Not performed
§15.247 (e)	Peak power spectral density	Yes			
§15.247(a)(2)	Spectrum Bandwidth of a DSSS System / 6dB BW	Yes			
§15.247(a)(2)	Spectrum Bandwidth of a DSSS System / 20dB BW	Yes			
§ 15.247 (b)(3)	Maximum output power (conducted)	Yes			
§ 15.247 (b)(3)	Max. peak output power (radiated)	Yes			
§15.247 (d)	Band-edge compliance of conducted emissions	Yes			
§15.205	Band-edge compliance of radiated emissions	Yes			
§15.247 (d)	Spurious Emission - conducted (Transmitter)	Yes			
§ 15.209	Spurious Emission -radiated (Transmitter)	Yes			
§ 15.109	Spurious Emissions-radiated (Receiver)	Yes			
§ 15.209	Spurious Emissions-radiated <30 MHz	Yes			
§ 15.107/207	Conducted Emissions <30 MHz	Yes			

5 RF measurement testing

5.1 Description of test set-up

5.1.1 Radiated measurements

The radiated measurements are performed in vertical and horizontal plane in the frequency range from 9 kHz to 20 GHz in semi-anechoic chambers. The EUT is positioned on a non-conductive support with a height of 0.80 m above a conductive ground plane that covers the whole chamber.

The receiving antennas are confirmed with specifications ANSI C63.2-1996 clause 15 and ANSI C63.4-2003 clause 4.1.5. These antennas can be moved over the height range between 1.0 m and 4.0 m in order to search for maximum field strength emitted from EUT. The measurement distances between EUT and receiving antennas are indicated in the test set-ups for the various frequency ranges. For each measurement, the EUT is rotated in all three axes until the maximum field strength is received.

The wanted and unwanted emissions are received by spectrum analysers where the detector modes and resolution bandwidths over various frequency ranges are set according to requirement ANSI C63.4-2003 clause 4.2.

Antennas are confirmed with ANSI C63.2-1996 item 15.

9 kHz - 150 MHz: Quasi Peak measurement, 200 Hz Bandwidth, passive loop antenna.

150 kHz - 30 MHz: Quasi Peak measurement, 9 kHz Bandwidth, passive loop antenna.

30 MHz - 200 MHz: Quasi Peak measurement, 120 kHz Bandwidth, trilob antenna

200MHz - 1GHz: Quasi Peak measurement, 120 kHz Bandwidth, trilob antenna

>1GHz: Average, RBW 1MHz, VBW 10 Hz, wave guide horn

All measurement settings are according to FCC 15.209 and 15.207

5.1.2 Conducted measurements

The EUT's RF signal is coupled out by the antenna connector which is supplied by the manufacturer. The signal is connected to the spectrum analyzer. The specific losses for signal path are first checked within a calibration. The measurement readings on the spectrum analyzer are corrected by the specific test set-up loss. The attenuator, power divider, signalling unit and the spectrum analyzer are impedance matched on 50 Ohm.

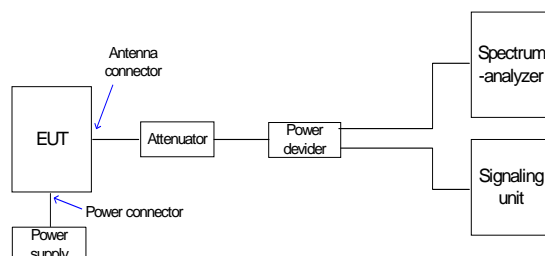

5.2 Referenced Documents

Antenna specification: 802.11a/b/g antenna

Attributes

Attribute	Band 1	Band 2
Frequency	2.4-2.483.5GHz	5.15GHz~6GHz
Bandwidth	120MHz	875MHz
Wavelength	¼ Wave	¼ Wave
Impedance	50 Ohm	50 Ohm
VSWR	< 1.9 typ. Center	< 1.9 typ. Center
Connector	RP-SMA	RP-SMA
Gain	2.3dBi	3.6dBi
Dimension	See measurements in the drawing after the table.	
Maximum Power level	TBD	TBD
Operating temperature	TBD	TBD
Storage temperature	TBD	TBD
Part number	ANT-DB1-RAF-RPS	

Dimensions

Note: Dimensions are provided for reference purposes only. The actual antenna might vary.

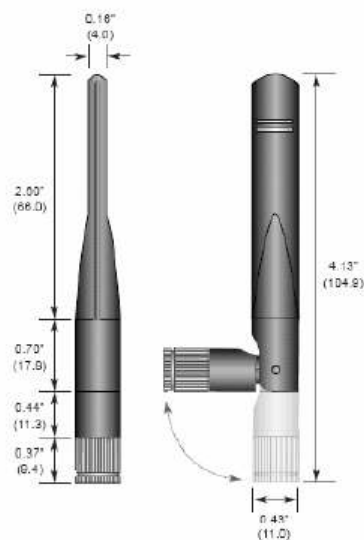

Cable specification : U.FL/W.FL to RP-SMA FEMALE

Attributes

Attribute	Property
Impedance	50 Ohm
Frequency Range	0 to 6 GHz
Length	150 mm /
Temperature Range	-40 to +90°C
Loss	3.8dB/m (3 GHz) 5.6dB/m (6 GHz)

Dimensions

Note: Dimensions are provided for reference purposes only. The actual cable might vary.

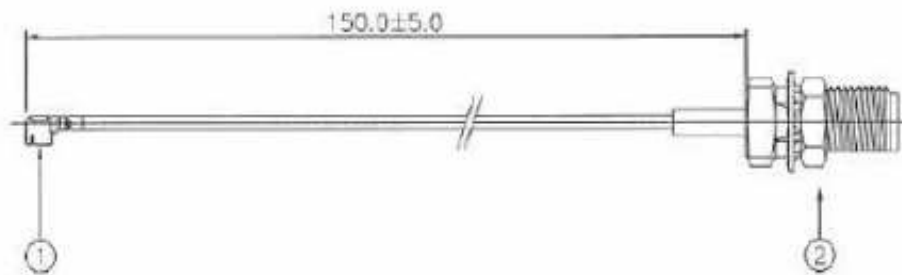

- 1 = U.FL
- 2 = RP-SMA

Note: This module obtained its complete certification by using the cable described here. End users in North America should use a cable that matches these specs to maintain the module's certification.

5.3 Additional comments

None

5.4 Peak Power Spectral density (digitally modulated systems) §15.247(e)

DSSS – mode:

Plot 1:

Max.Power Index: 35

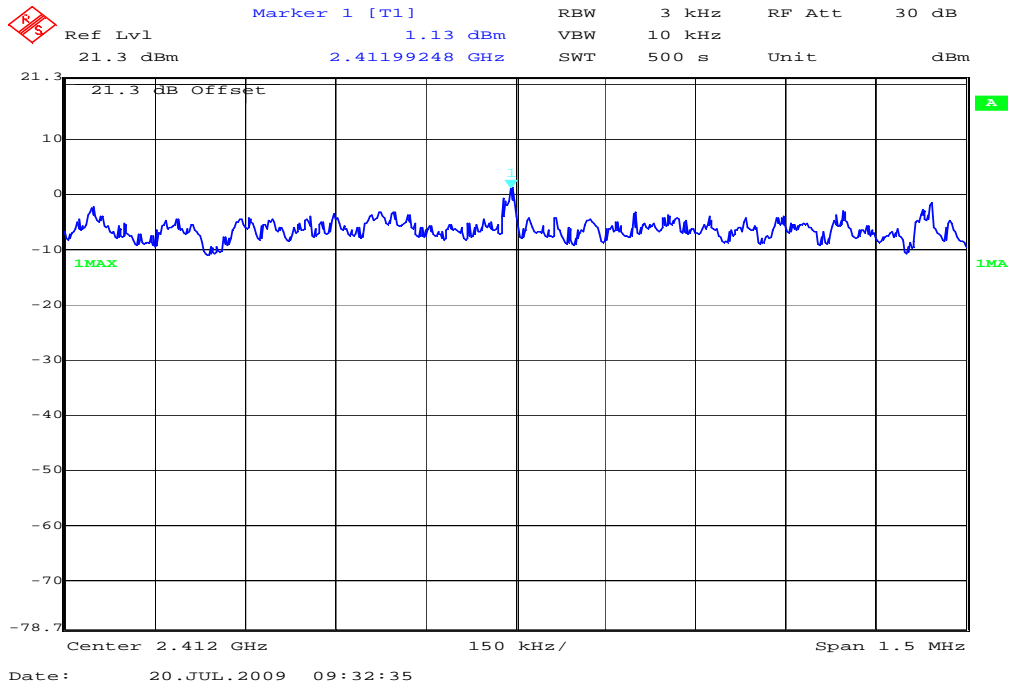

Plot 2:

Max.Power Index: 35

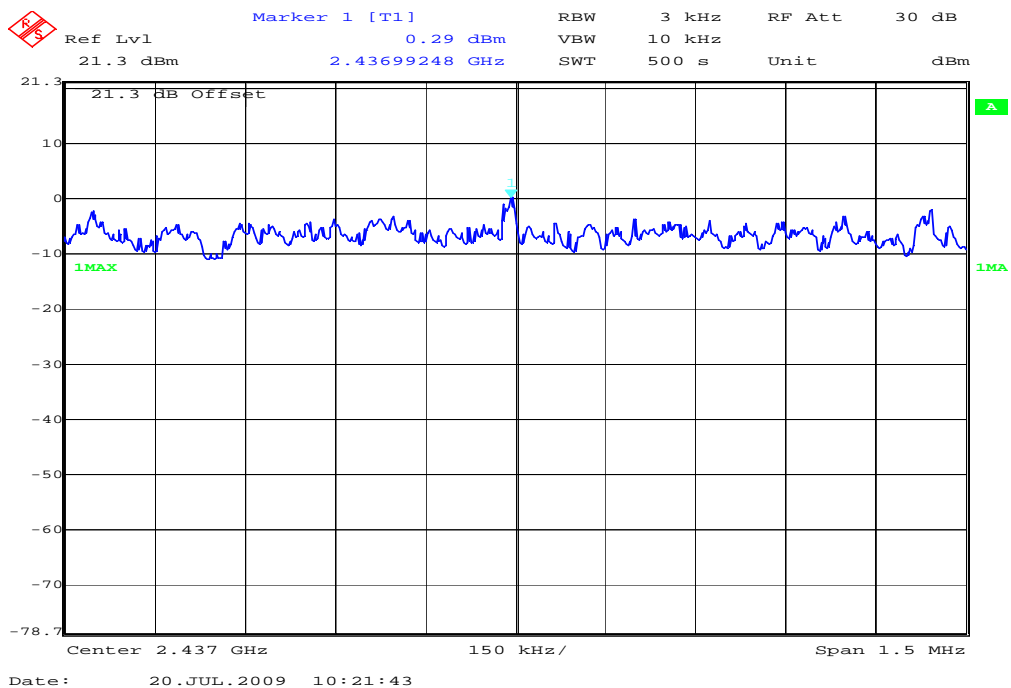

Plot 3:

Max.Power Index: 35

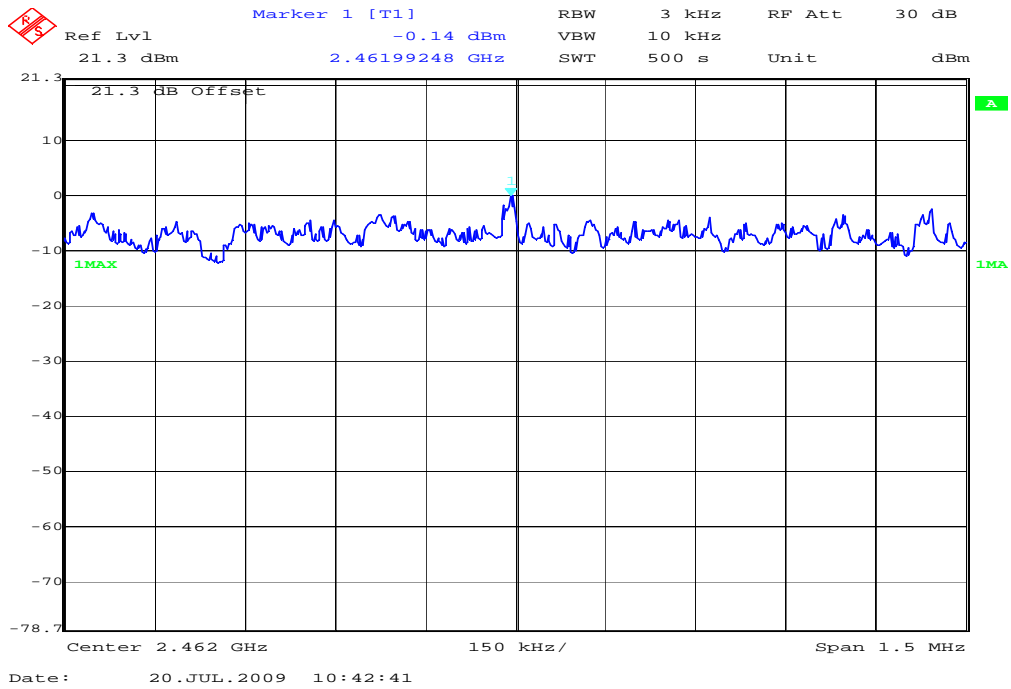

Results:

Plot 1: Power density: 1.13 dBm / 3 kHz

Plot 2: Power density: 0.29 dBm / 3 kHz

Plot 3: Power density: -0.14 dBm / 3 kHz

Limits:

<p>Under normal test conditions only</p>	<p>For digitally modulated systems, the peak power spectral density conducted from the intentional radiator to the antenna shall not be greater than 8 dBm in any 3 kHz band during any time interval of continuous transmission</p>
--	--

OFDM – mode:

Plot 1:

Max.Power Index: 35

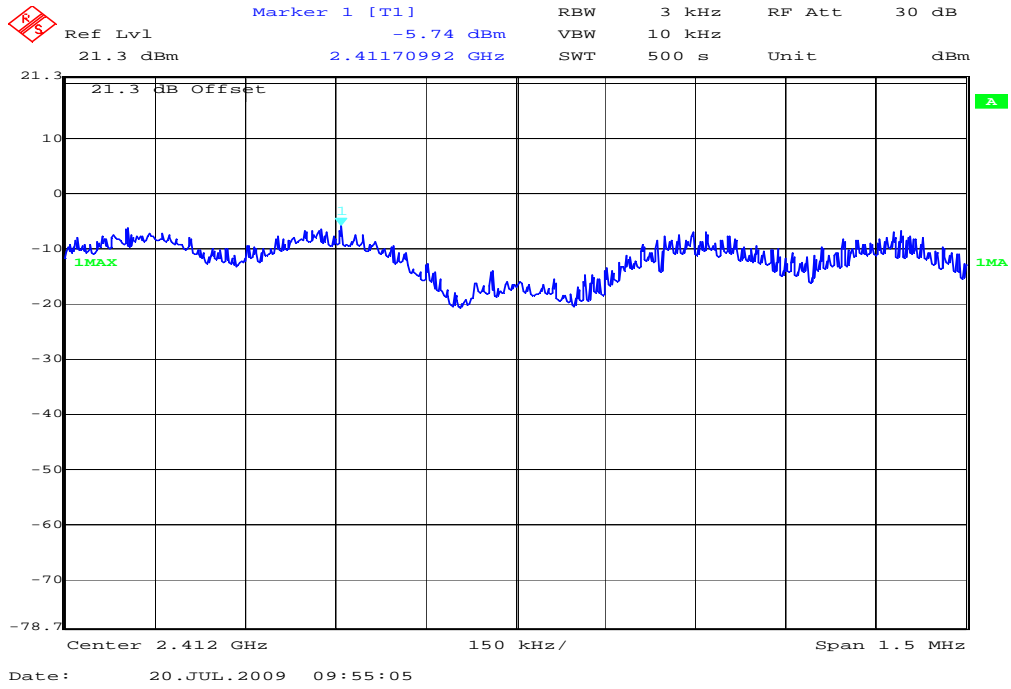

Plot 2:

Max.Power Index: 35

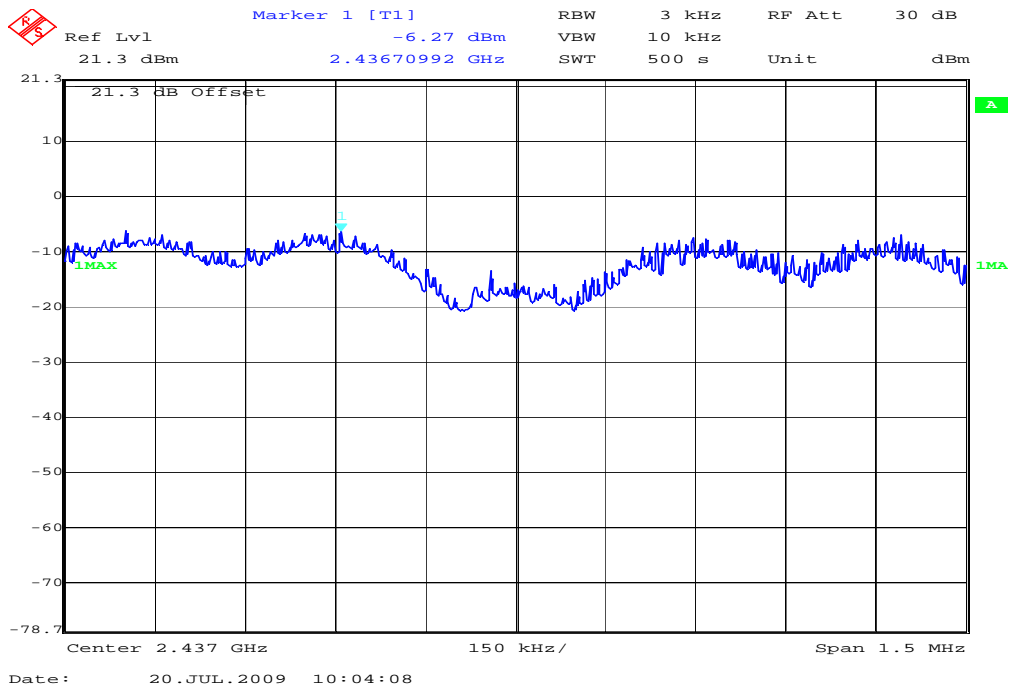

Plot 3:

Max.Power Index: 35

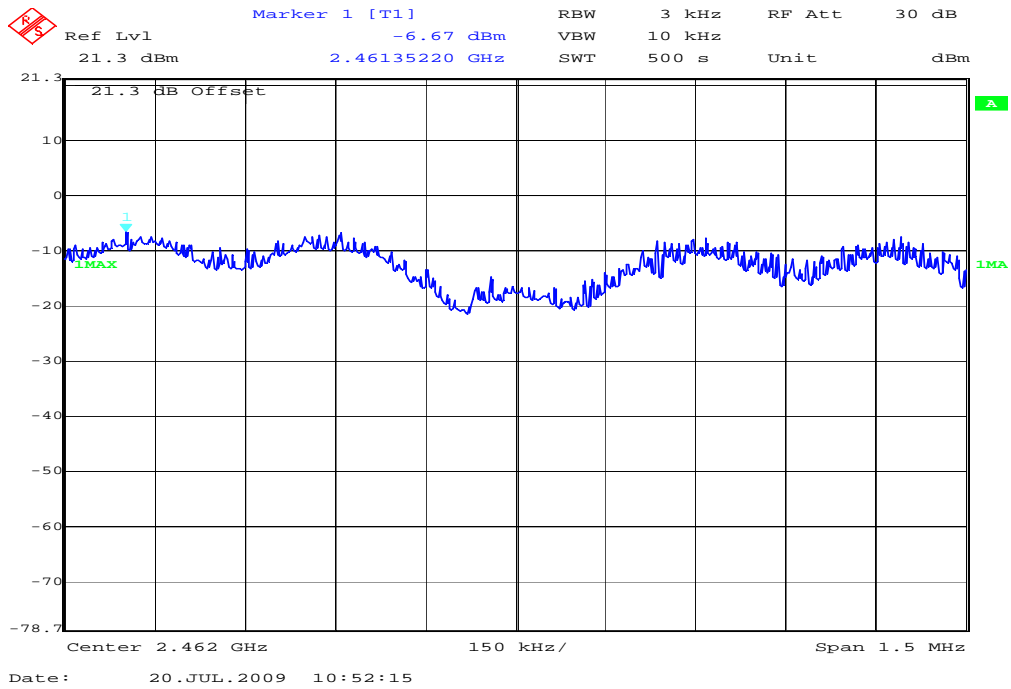

Results:

Plot 1: Power density: -5.74 dBm / 3 kHz

Plot 2: Power density: -6.27 dBm / 3 kHz

Plot 3: Power density: -6.67 dBm / 3 kHz

Limits:

Under normal test conditions only	For digitally modulated systems, the peak power spectral density conducted from the intentional radiator to the antenna shall not be greater than 8 dBm in any 3 kHz band during any time interval of continuous transmission
-----------------------------------	---

5.5 Spectrum Bandwidth of a DSSS System / 6 dB Bandwidth §15.247(a)(2)

DSSS – mode:

Plot 1:

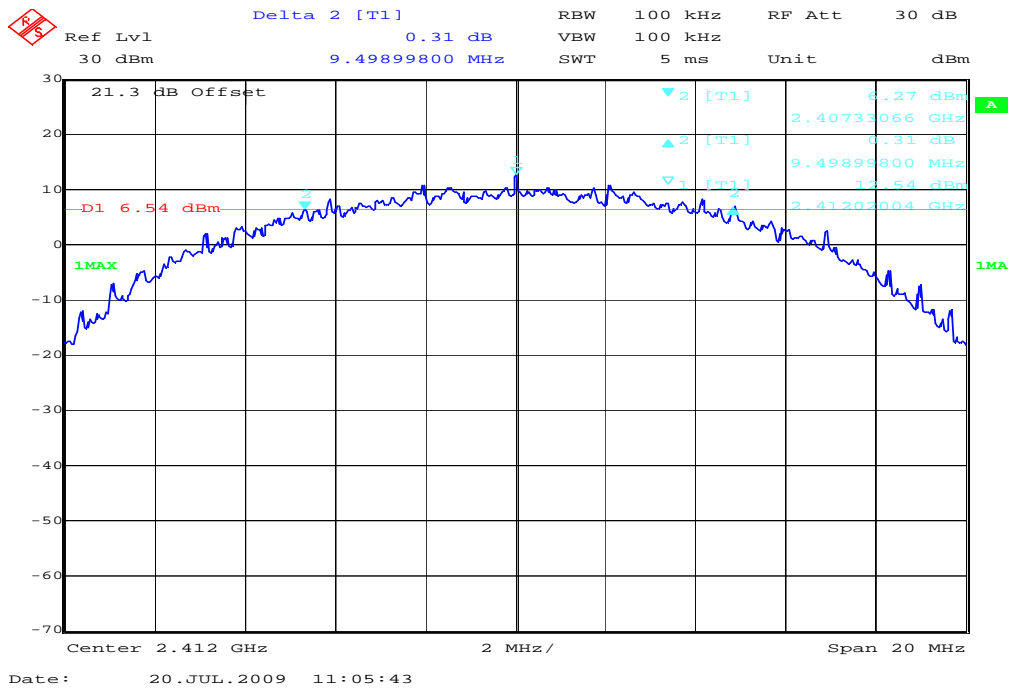

Plot 2:

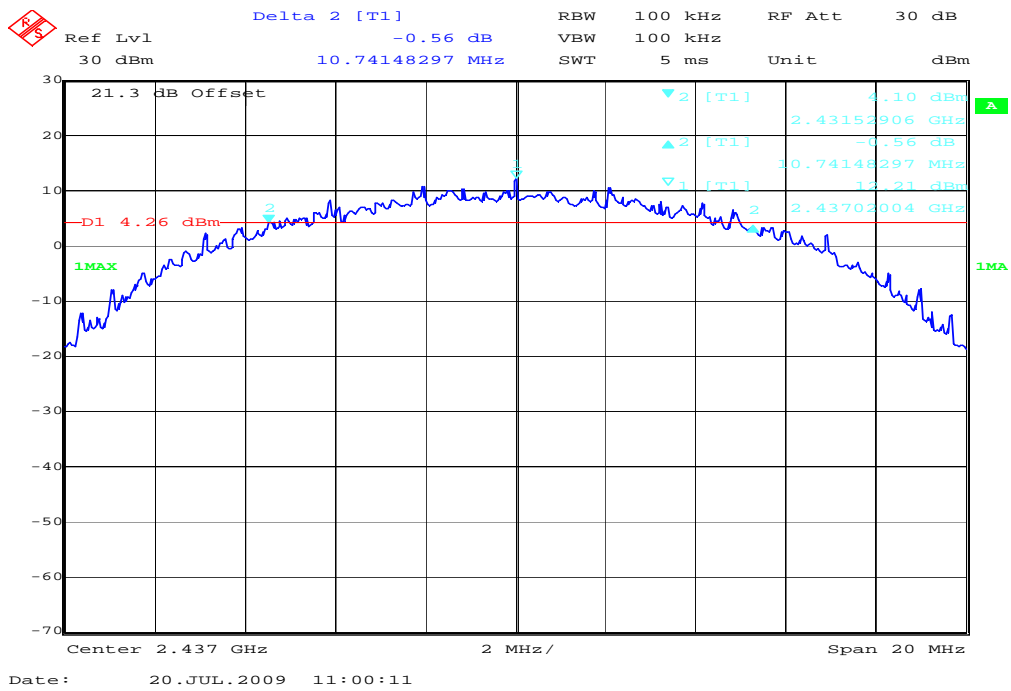

Plot 3:

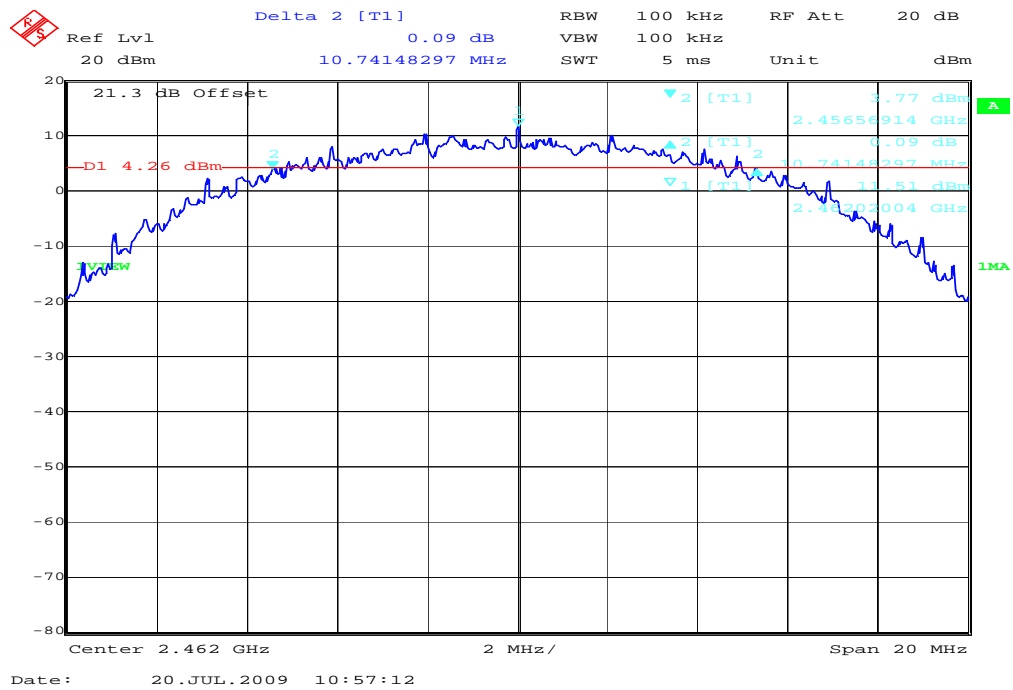

Results:

Test conditions		6 dB BANDWIDTH [MHz]		
Frequency [MHz]		2412	2437	2462
T _{nom}	V _{nom}	9.50	10.74	10.74
Measurement uncertainty		±100 kHz		

RBW: 100 kHz / VBW 100 kHz

Limits:

Under normal test conditions only	> 500 kHz
-----------------------------------	-----------

OFDM – mode:

Plot 1:

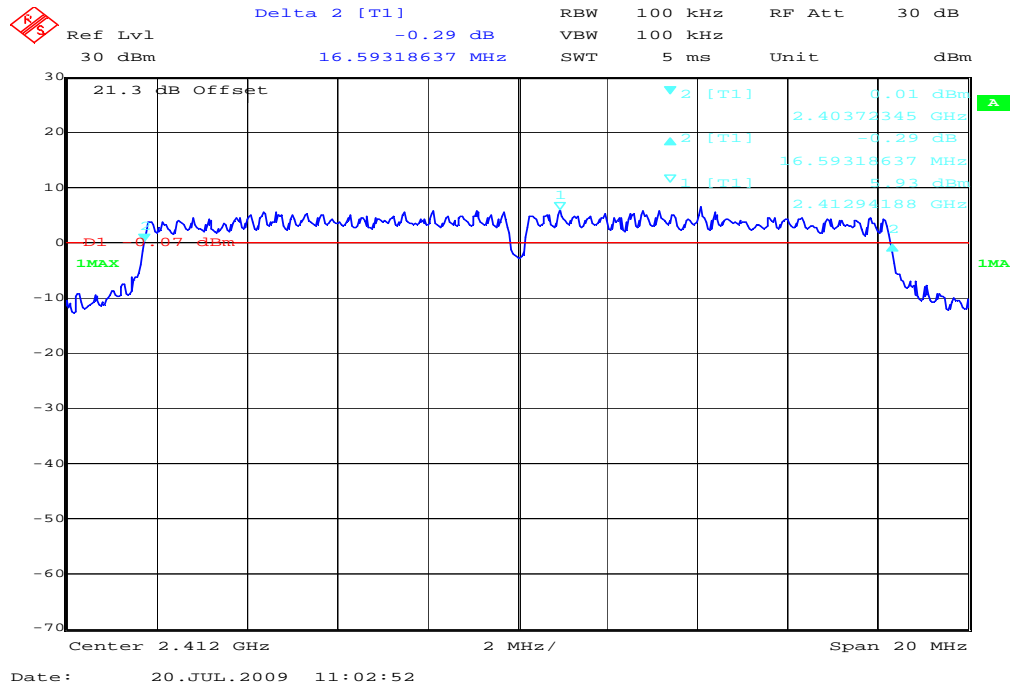

Plot 2:

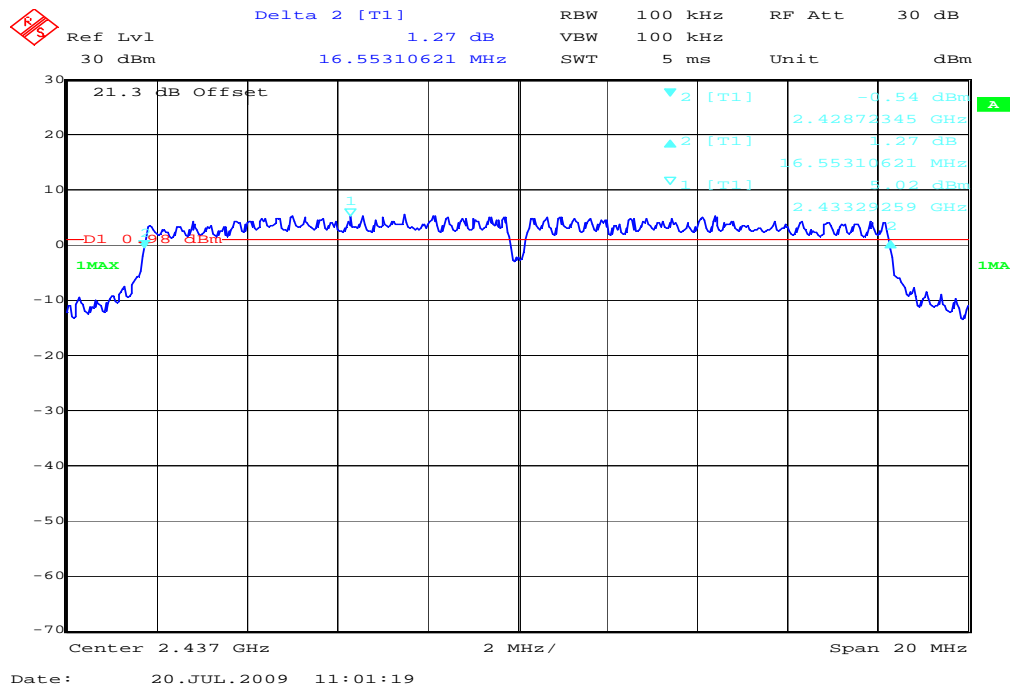

Plot 3:

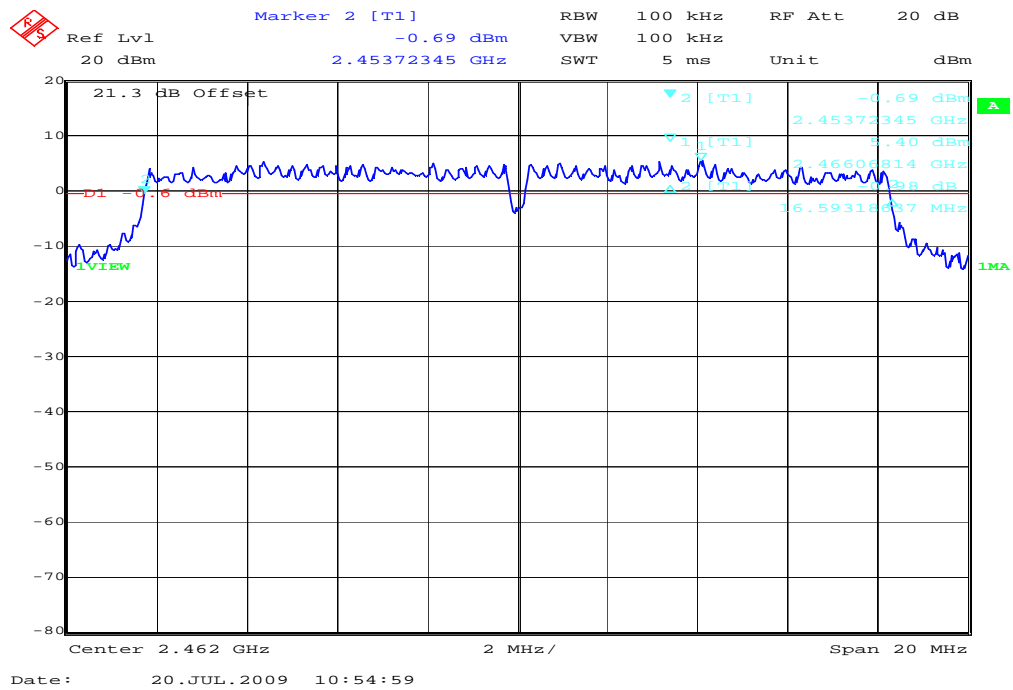

Results:

Test conditions		6 dB BANDWIDTH [MHz]		
		2412	2437	2462
Frequency [MHz]		2412	2437	2462
T _{nom}	V _{nom}	16.59	16.55	16.59
Measurement uncertainty		±100 kHz		

RBW: 100 kHz / VBW 100 kHz

Limits:

Under normal test conditions only	> 500 kHz
-----------------------------------	-----------

5.6 Spectrum Bandwidth of a DSSS System / 20 dB Bandwidth

DSSS – mode:

Plot 1:

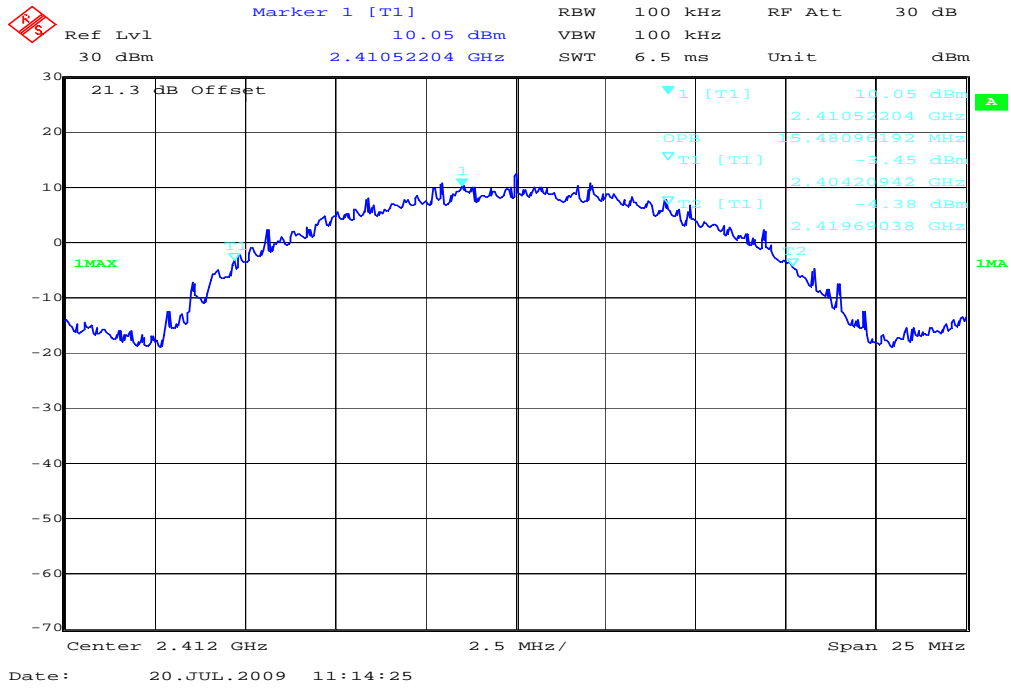

Plot 2:

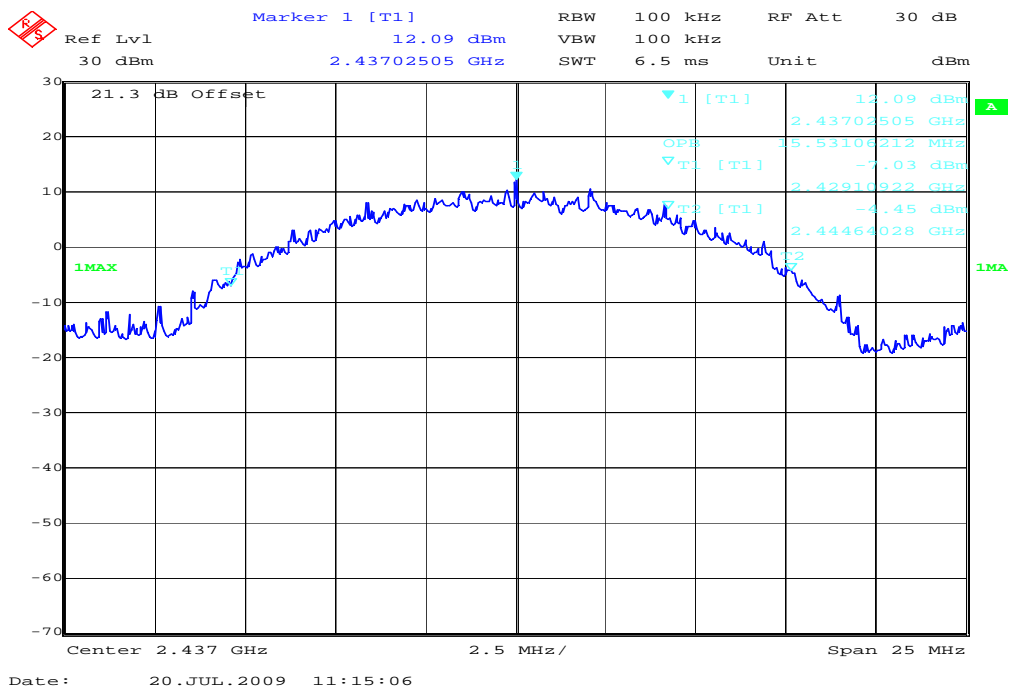

Plot 3:

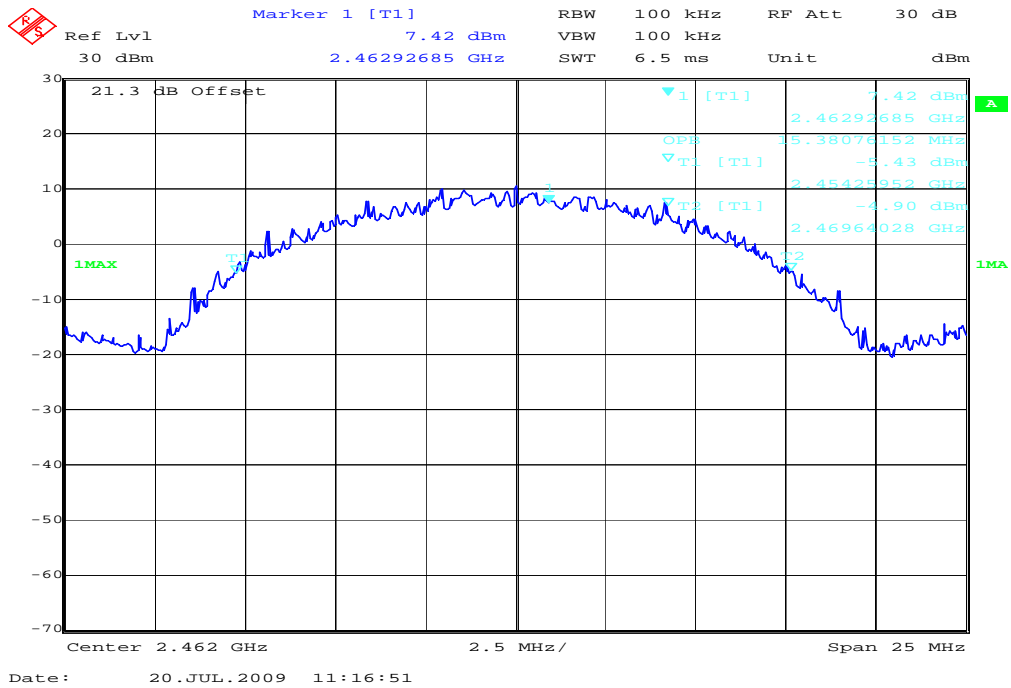

Results:

Test conditions		20 dB BANDWIDTH [MHz]		
		2412	2437	2462
Frequency [MHz]		2412	2437	2462
T _{nom}	V _{nom}	15.48	15.53	15.38
Measurement uncertainty		±100 kHz		

RBW: 100 kHz / VBW 100 kHz

OFDM – mode:

Plot 1:

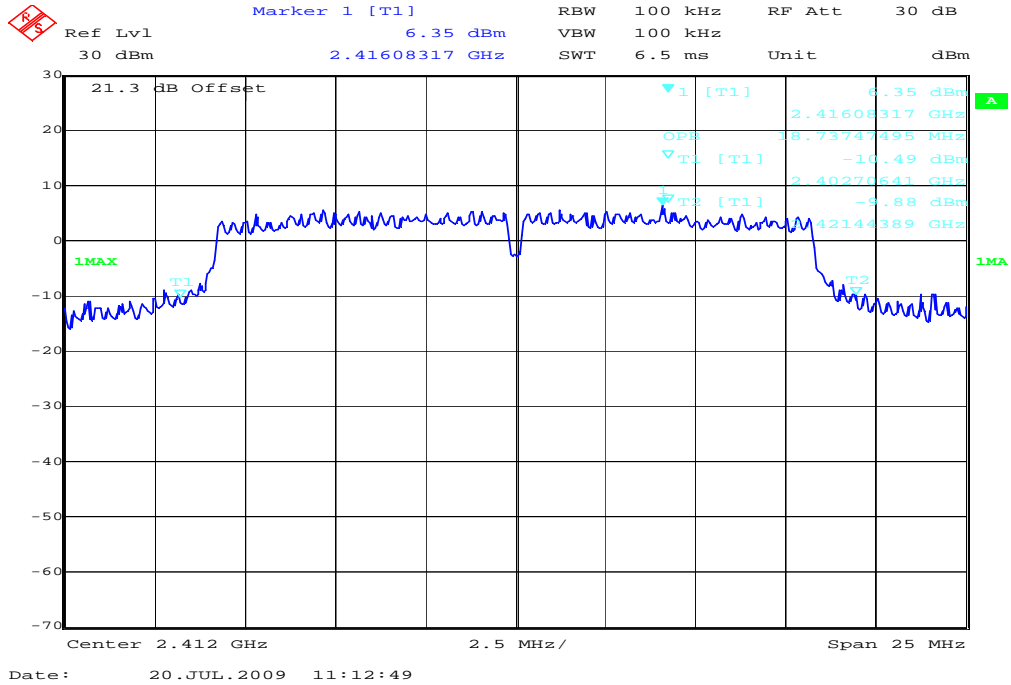

Plot 2:

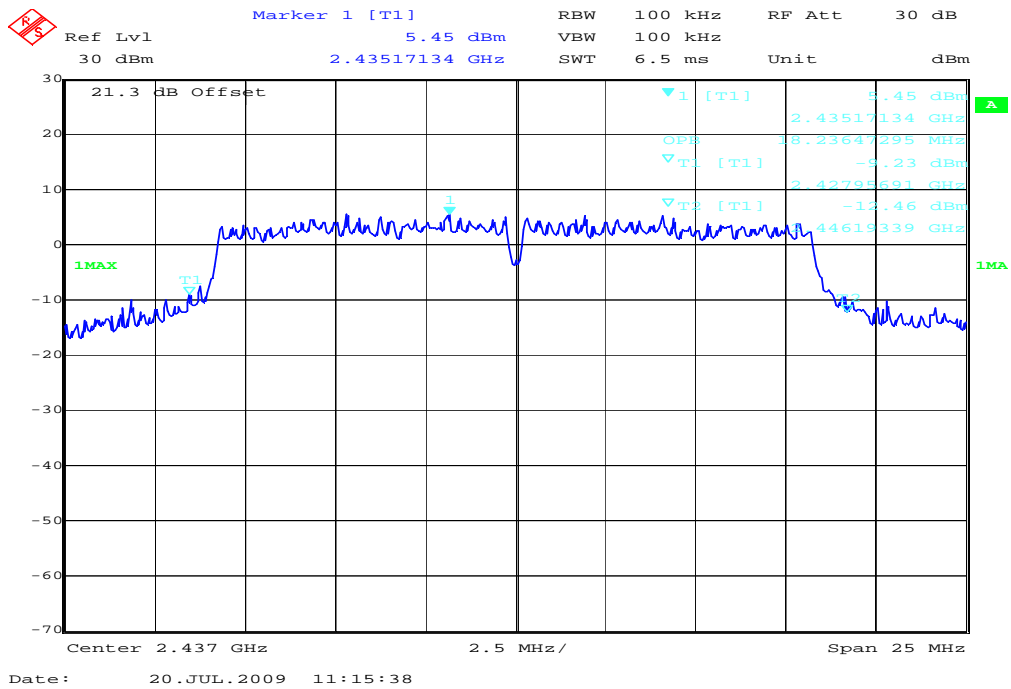

Plot 3:

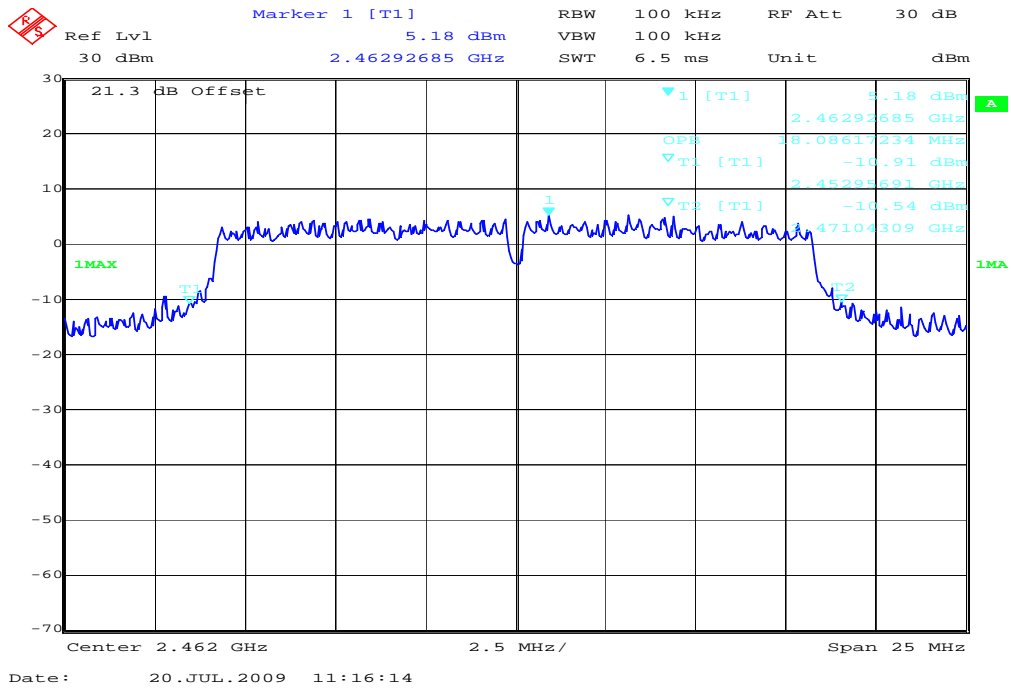

Results:

Test conditions		20 dB BANDWIDTH [MHz]		
		2412	2437	2462
Frequency [MHz]		2412	2437	2462
T _{nom}	V _{nom}	18.74	18.24	18.07
Measurement uncertainty		±100 kHz		

RBW: 100 kHz / VBW 100 kHz

5.7 Maximum output power (conducted) §15.247 (b)(3)

DSSS – mode:

Plot 1:
Power Index: 35

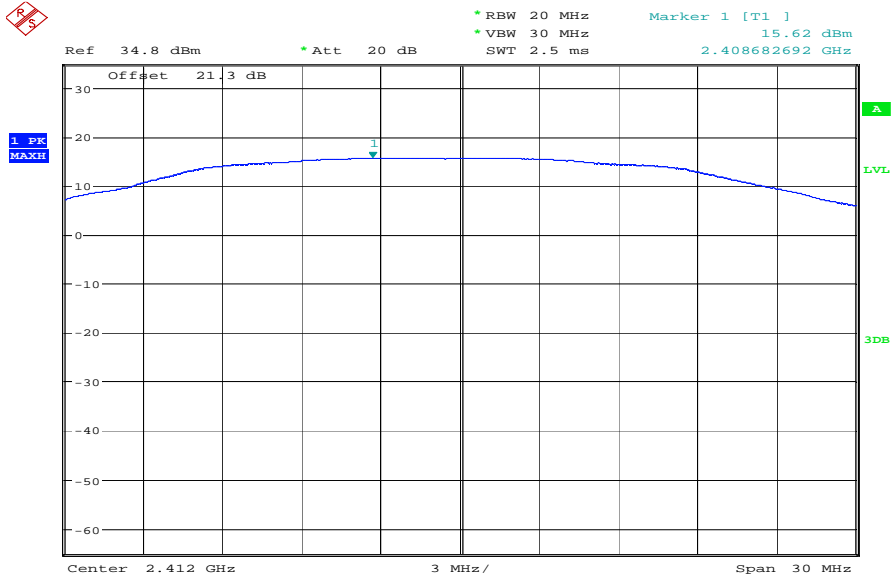

Date: 22.JUL.2009 10:33:22

Plot 2:
Power Index: 35

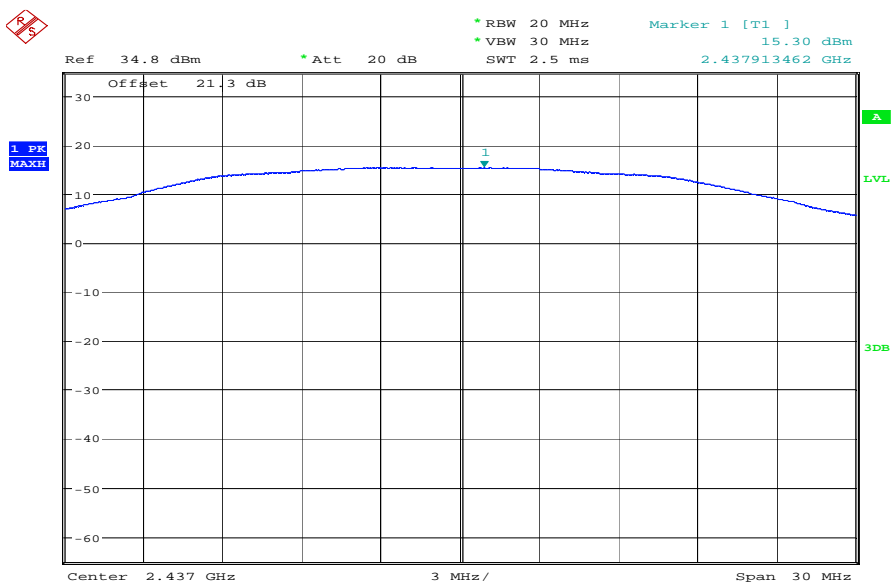

Date: 22.JUL.2009 10:34:13

Plot 3:
Power Index: 35

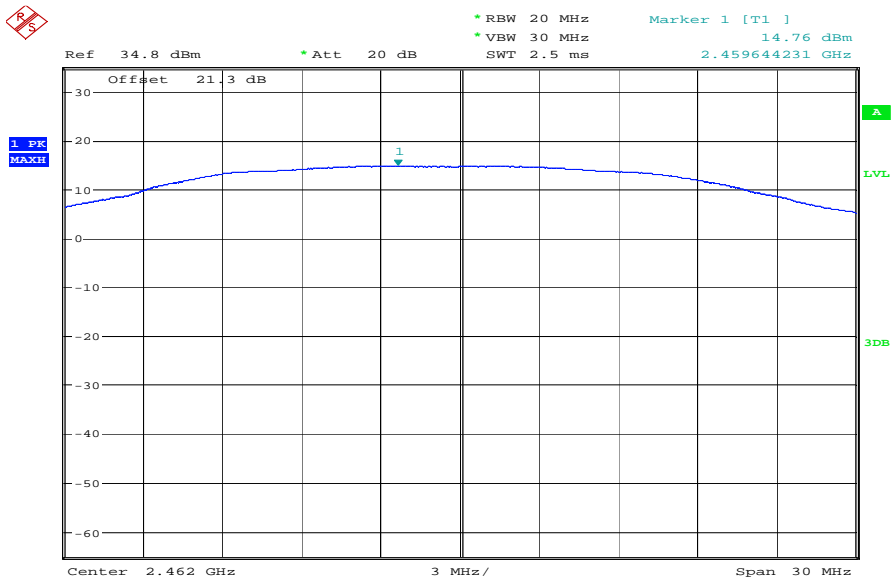

Date: 22.JUL.2009 10:36:21

Results:

Test conditions		Max. peak output power [dBm]		
		2412	2437	2462
Frequency [MHz]		2412	2437	2462
T _{nom}	V _{nom}	15.62	15.30	14.76
Measurement uncertainty		±3dB		

RBW / VBW: 20 MHz / 30 MHz

Limits:

Under normal test conditions only, for frequency range 2400-2483.5 MHz	Max. 1.0 Watt / 30 dBm
--	------------------------

OFDM – mode:

Plot 1:

Power Index: 35

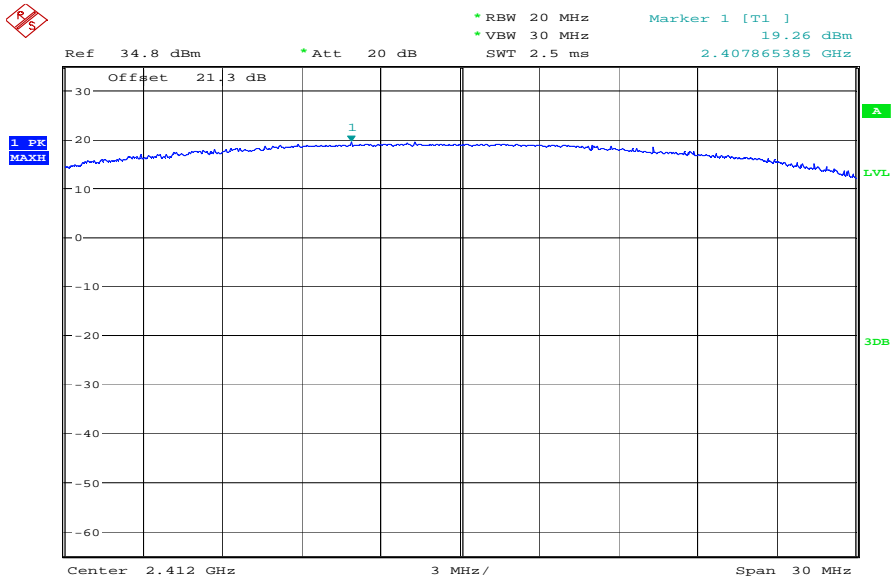

Date: 22.JUL.2009 10:33:01

Plot 2:

Power Index: 35

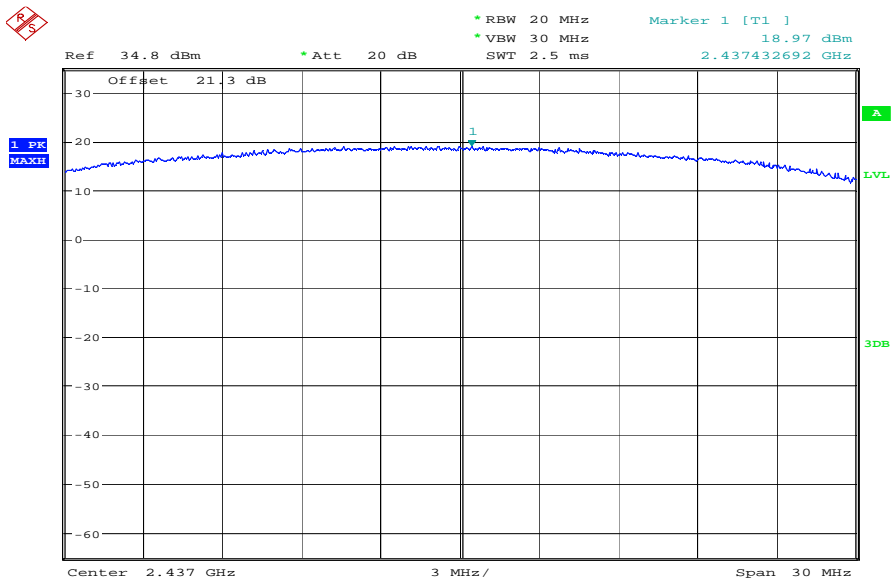

Date: 22.JUL.2009 10:34:49

Plot 3:
Power Index: 35

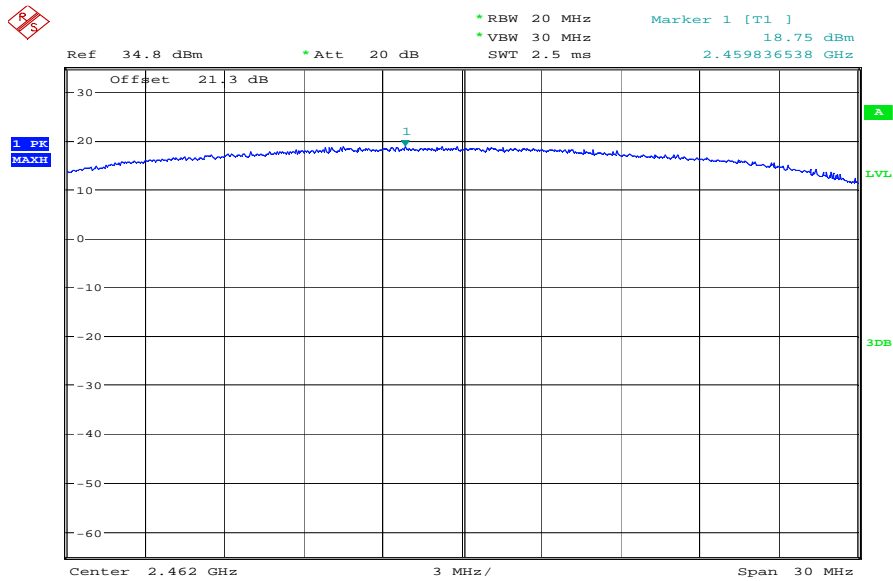

Date: 22.JUL.2009 10:35:58

Results:

Test conditions		Max. peak output power [dBm]		
		2412	2437	2462
Frequency [MHz]				
T _{nom}	V _{nom}	19.26	18.97	18.75
Measurement uncertainty		±3dB		

RBW / VBW: 20 MHz / 30 MHz

Limits:

Under normal test conditions only, for frequency range 2400-2483.5 MHz	Max. 1.0 Watt / 30 dBm
--	------------------------

5.8 Max. peak output power (radiated) §15.247 (b)(3)

DSSS – mode:

Results:

Power Index: 35

Test conditions Frequency [MHz]	Max. peak output power EIRP [dBm]		
	2412	2437	2462
Conducted output power	15.62	15.30	14.76
- Cable attenuation	0.57	0.57	0.57
+ Antenna gain	2.3	2.3	2.3
= Peak output power radiated (EIRP)	17.35	17.03	16.49
Measurement uncertainty	±3dB		

RBW / VBW: 20 MHz / 30 MHz

OFDM – mode:

Results:

Power Index: 35

Test conditions Frequency [MHz]	Max. peak output power EIRP [dBm]		
	2412	2437	2462
Conducted output power	19.26	18.97	18.75
- Cable attenuation	0.57	0.57	0.57
+ Antenna gain	2.3	2.3	2.3
= Peak output power radiated (EIRP)	20.99	20.70	20.48
Measurement uncertainty	±3dB		

RBW / VBW: 20 MHz / 30 MHz

Limits:

Under normal test conditions only, for frequency range 2400-2483.5 MHz	Max. 1.0 Watt
--	---------------

MPE calculation

These equations are generally accurate in the far field of an antenna but will over predict power density in the near field, where they could be used for making a “worst case” prediction.

$$S = PG/4\pi R^2$$

where S = power density (in appropriate units, e.g. mW/cm²)
P = power input to the antenna (in appropriate units e.g. mW)
G = power gain of the antenna in the direction of interest relative to the isotropic radiator
R = distance to the centre of radiation of the antenna (appropriate units e.g. cm)

Or

$$S = EIRP/4\pi R^2$$

where EIRP = equivalent isotropically radiated power

Calculation:

(Calculated for max. EIRP)

EIRP: 20.99 dBm (125.60 mW)

calculated at distance of 20 cm:

power density = $125.60 / 4\pi 20^2 = 0.025 \text{ mW/ cm}^2$

Limit:

1mW/ cm ² is the reference level for general public exposure according to the OET Bulletin 65, Edition 97-01 Table 1.

5.9 Band-edge compliance of conducted emissions §15.247 (d)

DSSS – mode:

Plot 1: lowest channel
Max. Power Index: 35

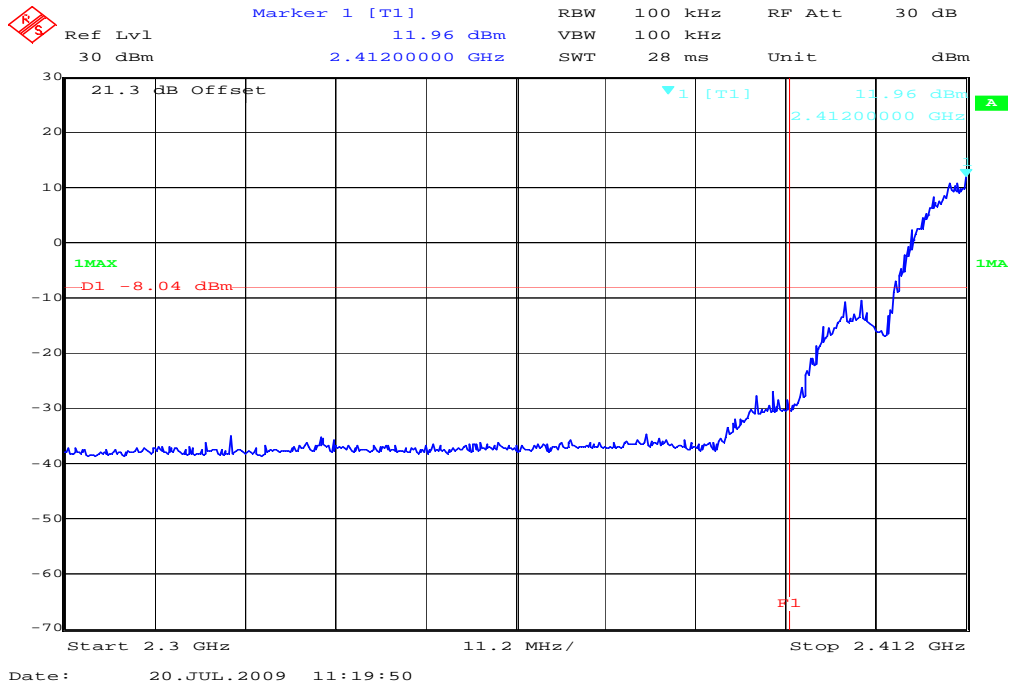

Plot 2: highest channel
Max. Power Index: 35



OFDM – mode:

Plot 1: lowest channel

Max. Power Index: 35

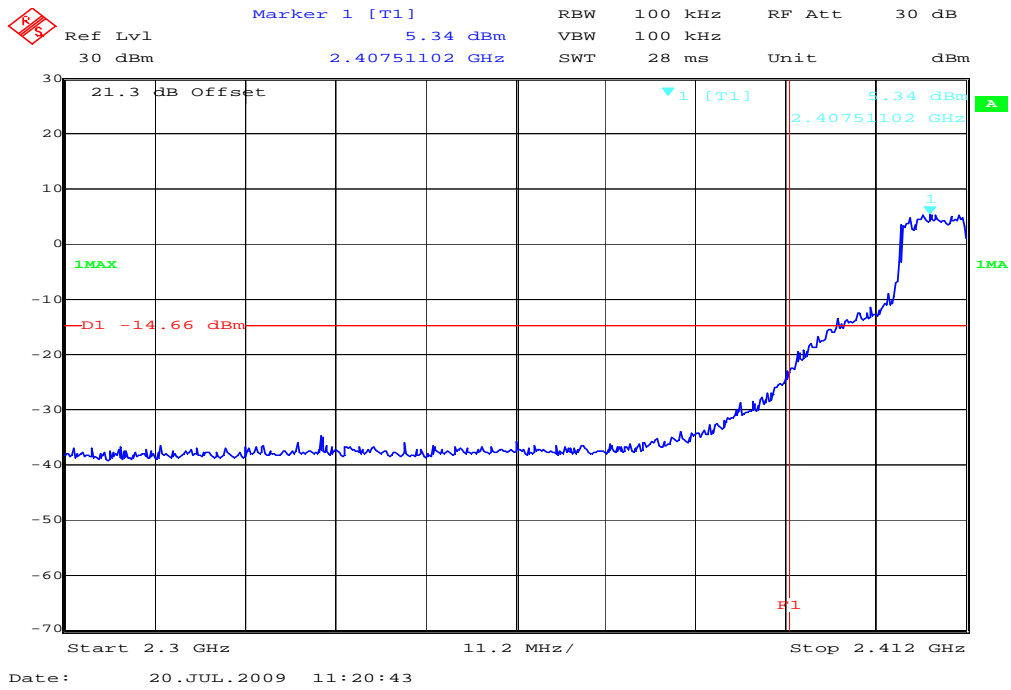

Plot 2: highest channel

Max. Power Index: 35

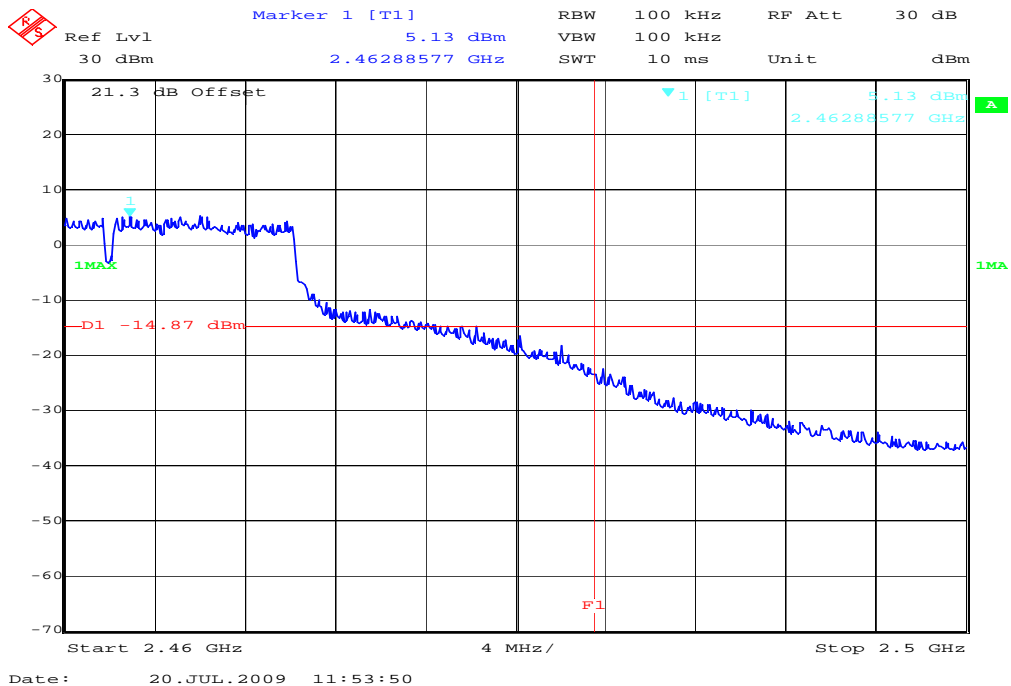

Limits:

Under normal test conditions only	In any 100 kHz bandwidth outside the frequency band in which the spread spectrum or digitally modulated intentional radiator is operating, the radio frequency power that is produced by the intentional radiator shall be at least 20 dB below that in the 100 kHz bandwidth within the band that contains the highest level of the desired power, based on either an RF conducted or a radiated measurement. Attenuation below the general limits specified in Section 15.209(a) is not required. In addition, radiated emissions which fall in the restricted bands, as defined in Section 15.205(a), must also comply with the radiated emission limits specified in Section 15.209(a) (see Section 5.205(c)).
-----------------------------------	--

5.10 Band-edge compliance of radiated emissions §15.205

DSSS – mode:

Plot 1: lowest channel
Max. Power Index: 35

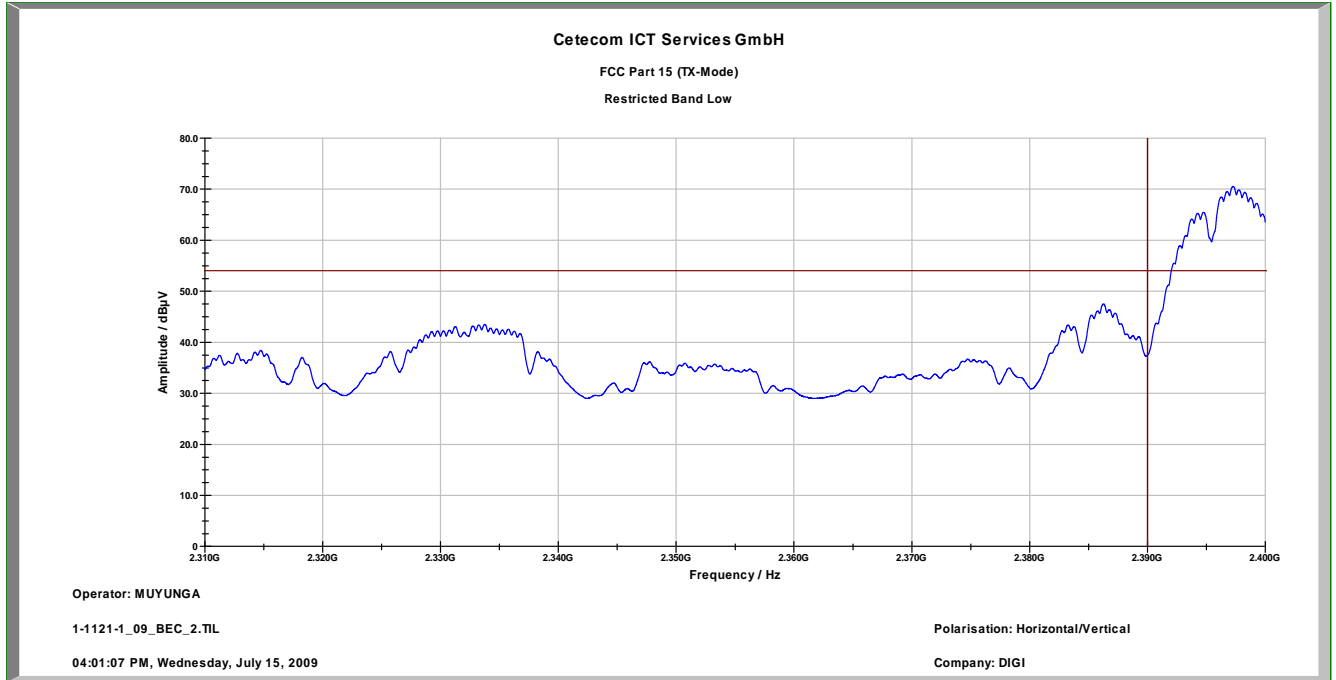

Plot 2: highest channel
Max. Power Index: 35

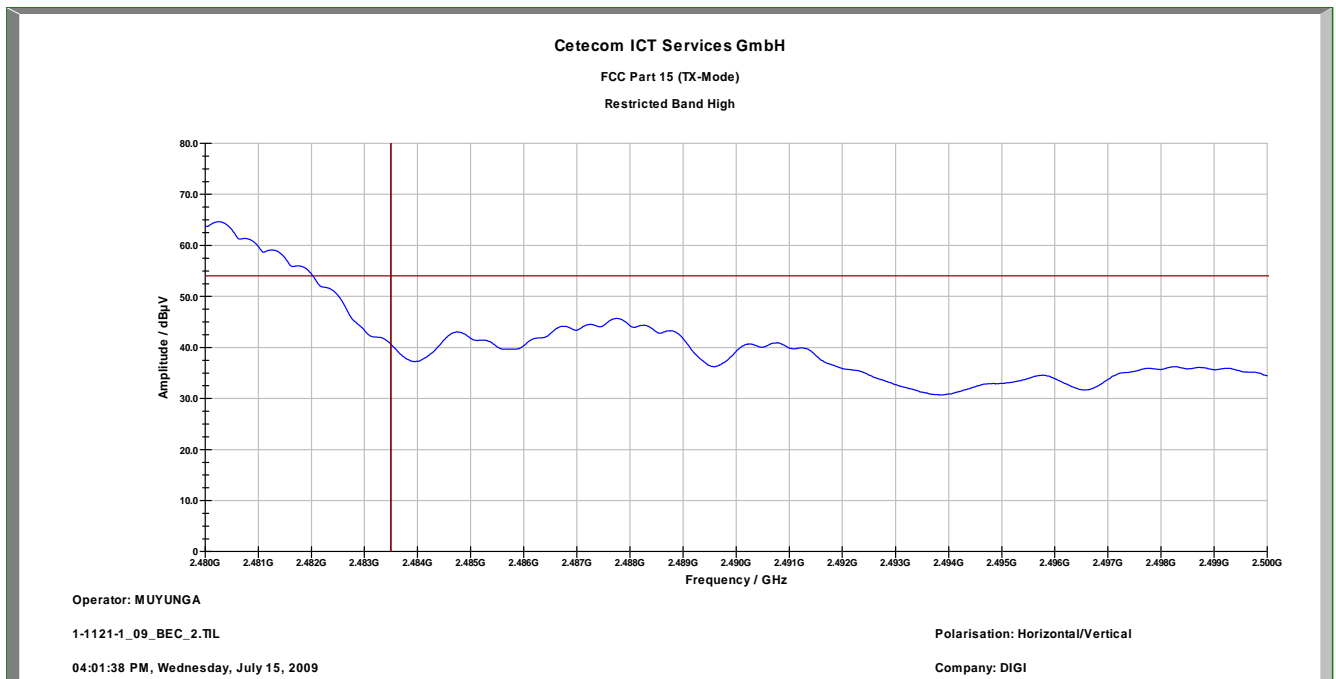

OFDM – mode:

Plot 1: lowest channel
Max. Power Index: 35

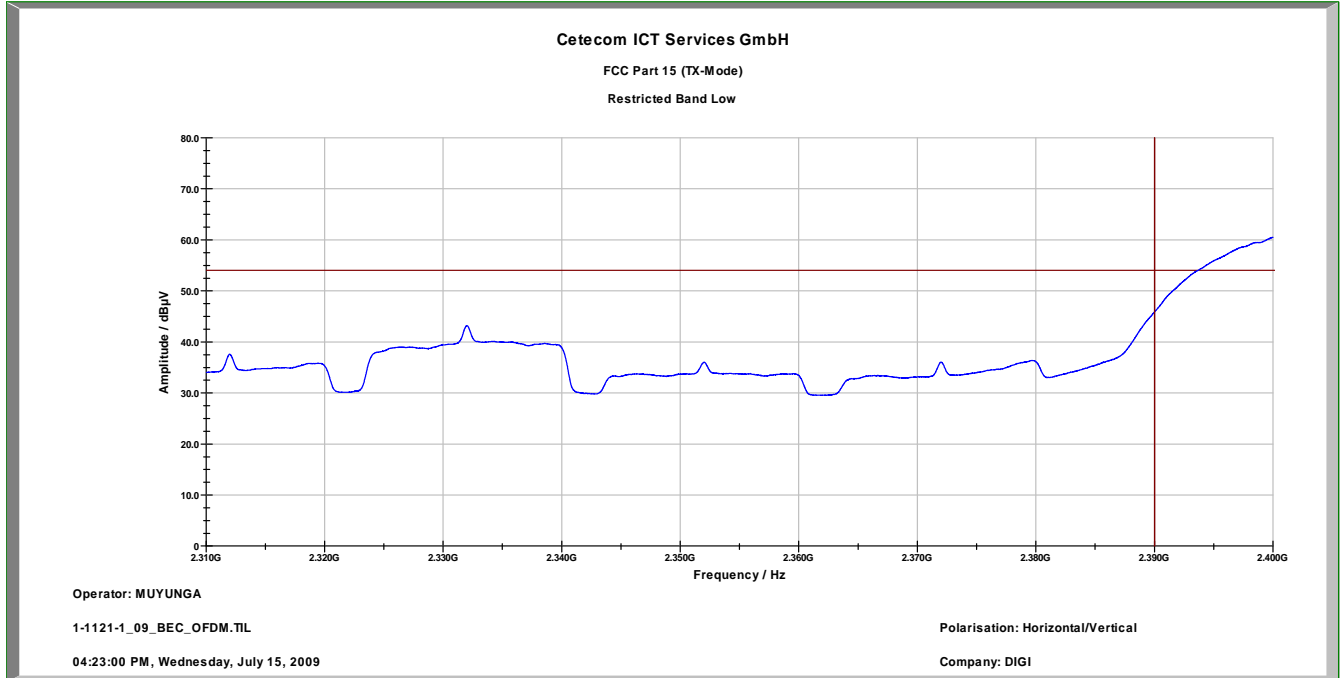

Plot 2: highest channel
Max. Power Index: 35

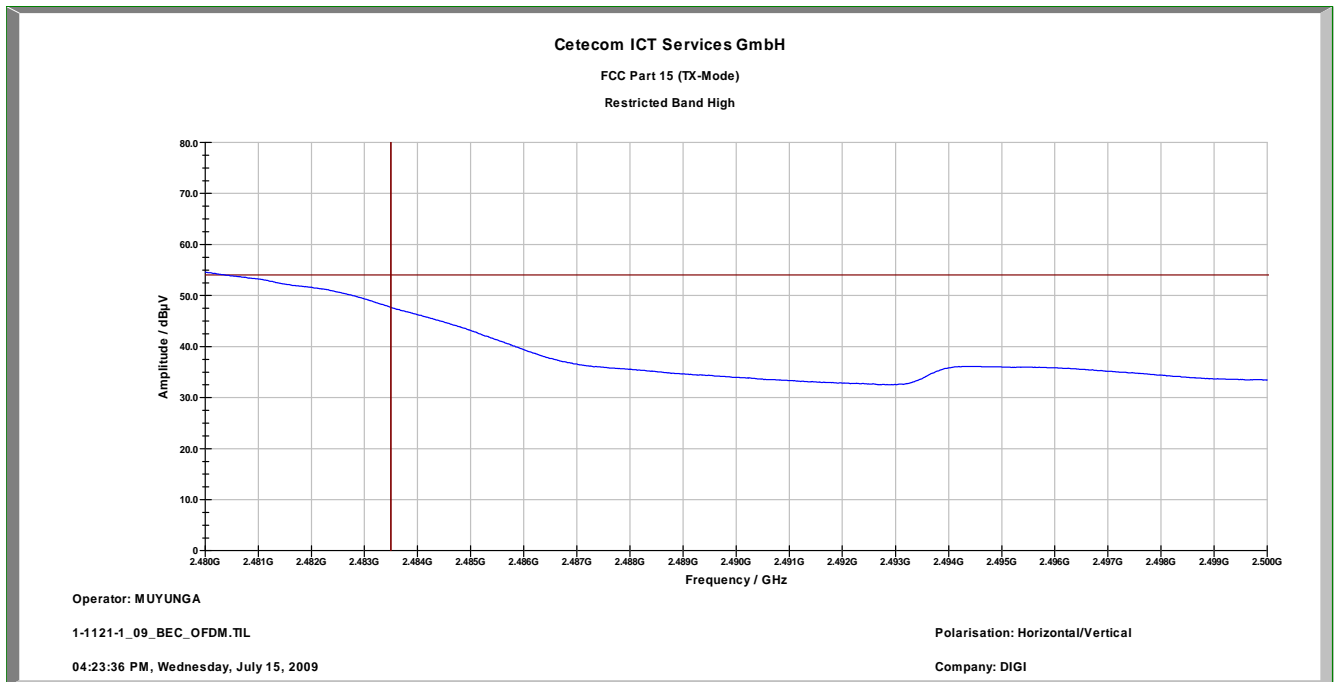

5.11 Spurious Emissions - conducted (Transmitter) §15.247 (d)

DSSS – mode:

Plot 1: Lowest Channel
 Power Index: 35

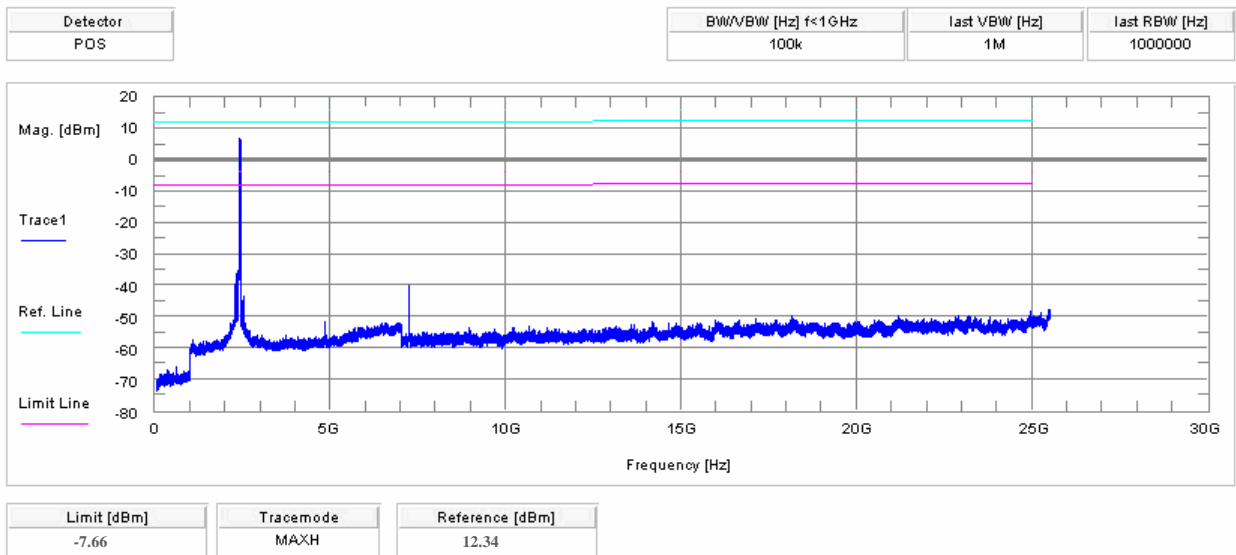

Plot 2: Middle Channel
 Power Index: 35

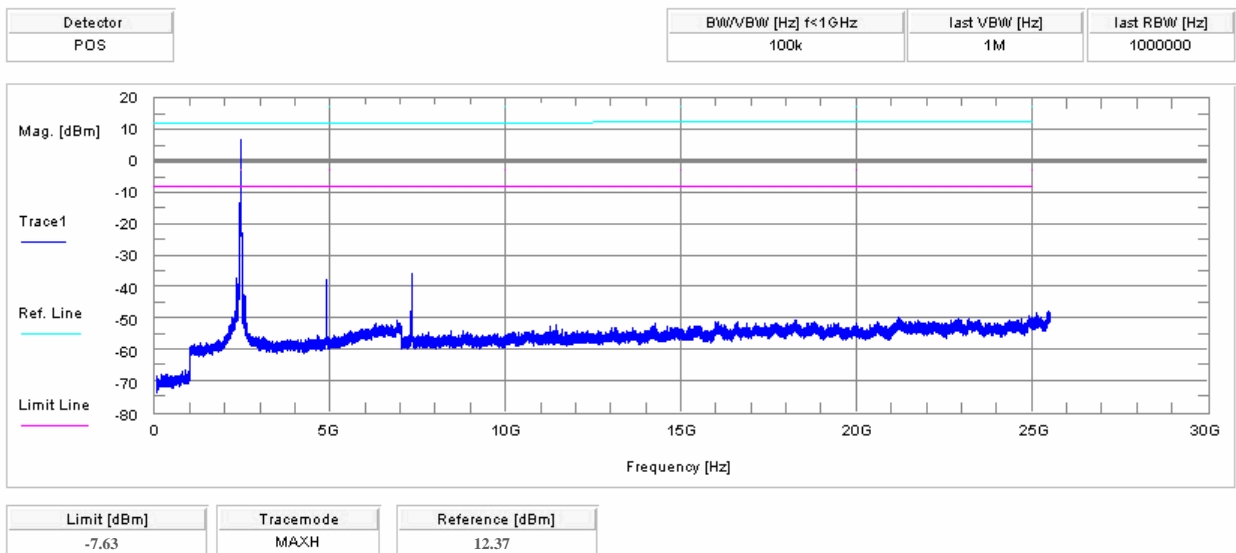

Plot 3: Highest Channel

Power Index: 35

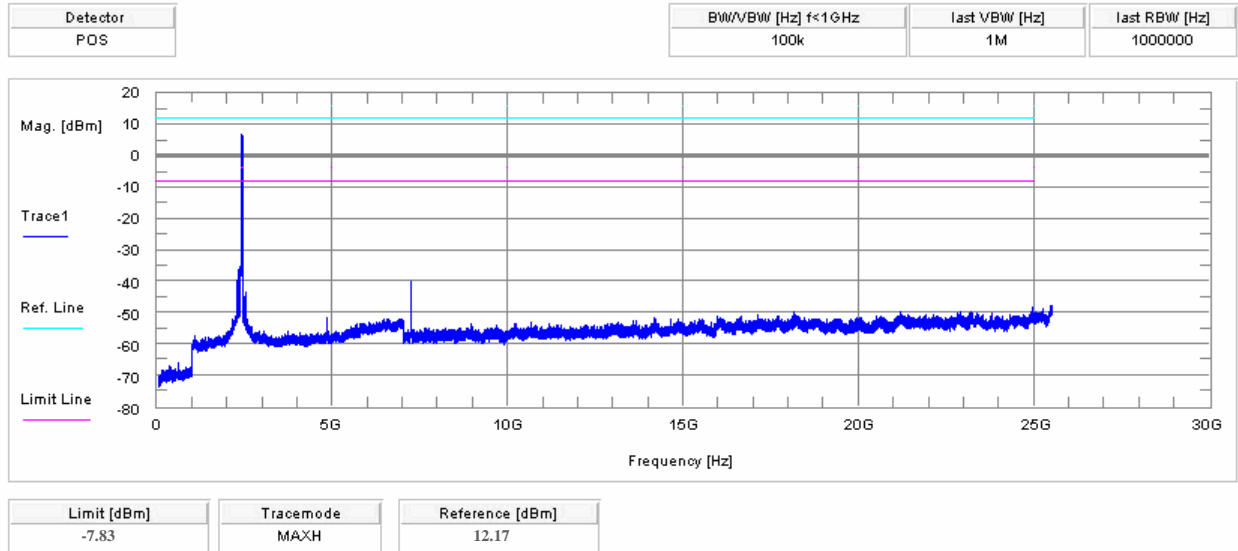

Result & Limits:

Emission Limitations					
f [MHz]		amplitude of emission [dBm]	limit max. allowed emission power	actual attenuation below frequency of operation [dB]	results
2412		12.34	30 dBm		Operating frequency
No critical peaks detected.			-20 dBc		complies
2437		12.37	30 dBm		Operating frequency
No critical peaks detected.			-20 dBc		complies
2462		12.17	30 dBm		Operating frequency
No critical peaks detected.			-20 dBc		complies
Measurement uncertainty			± 3dB		

F < 1 GHz: RBW: 100 kHz VBW: 100 kHz
 F > 1 GHz: RBW: 1 MHz VBW: 1 MHz

OFDM

Plot 1: Lowest Channel
 Power Index: 35

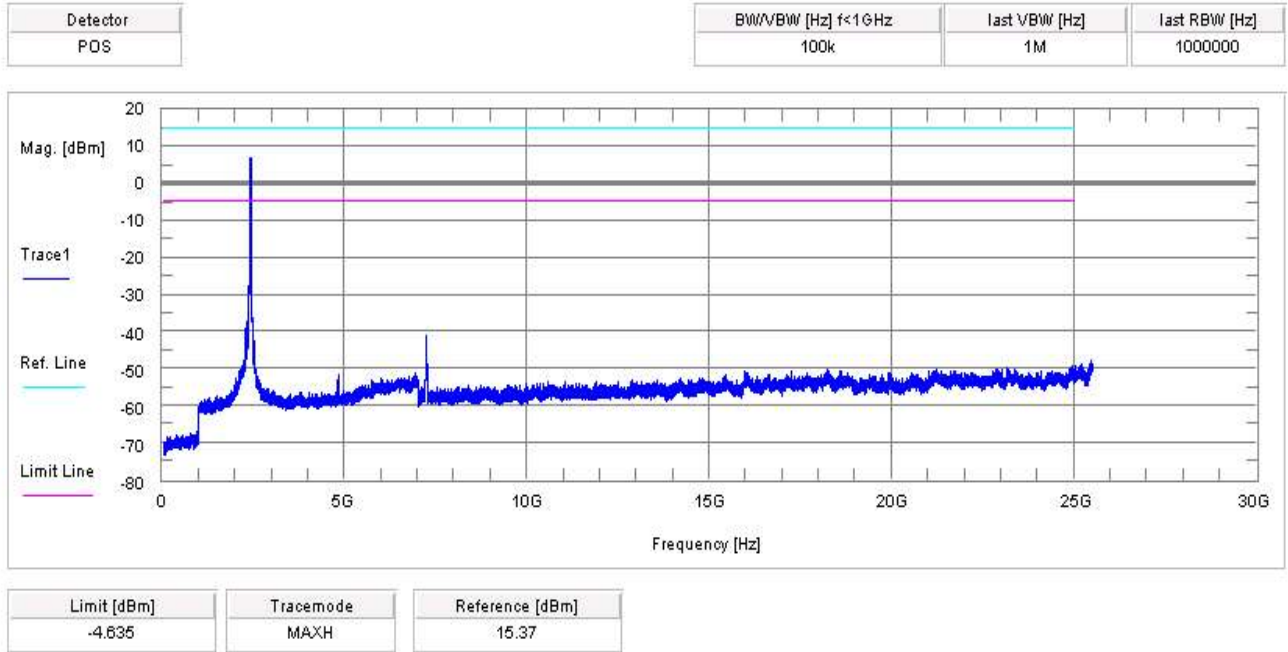

Plot 2: Middle Channel
 Power Index: 35

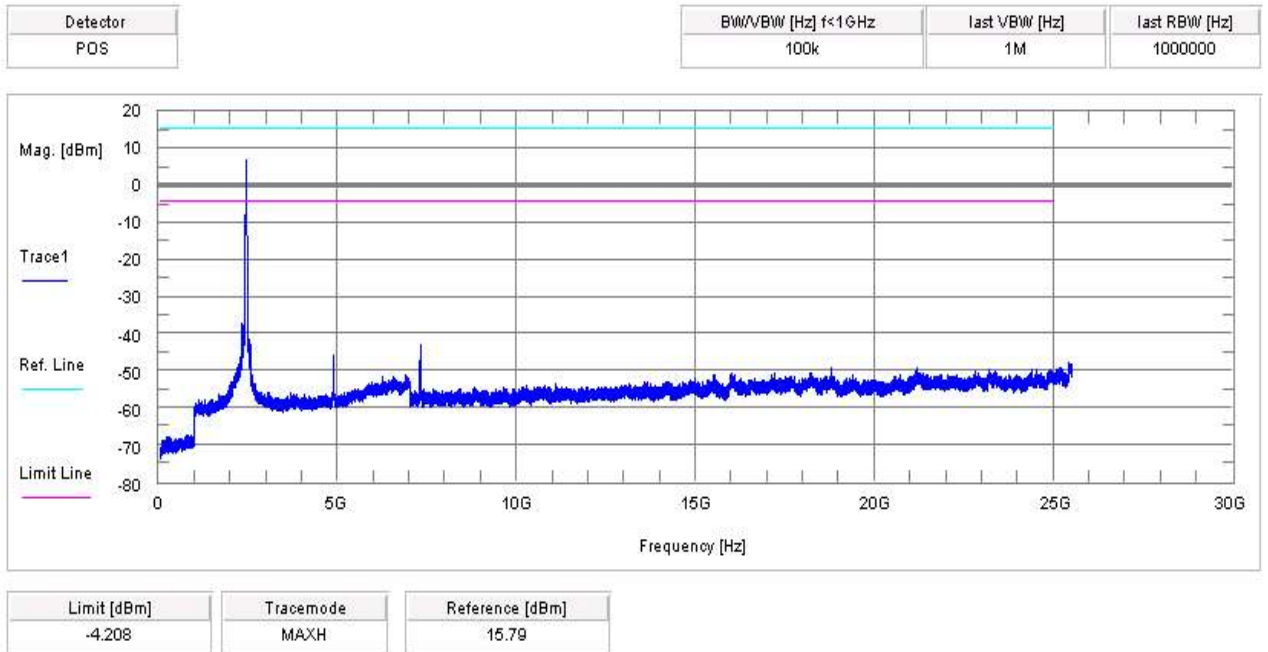

Plot 3: Highest Channel
Power Index: 35

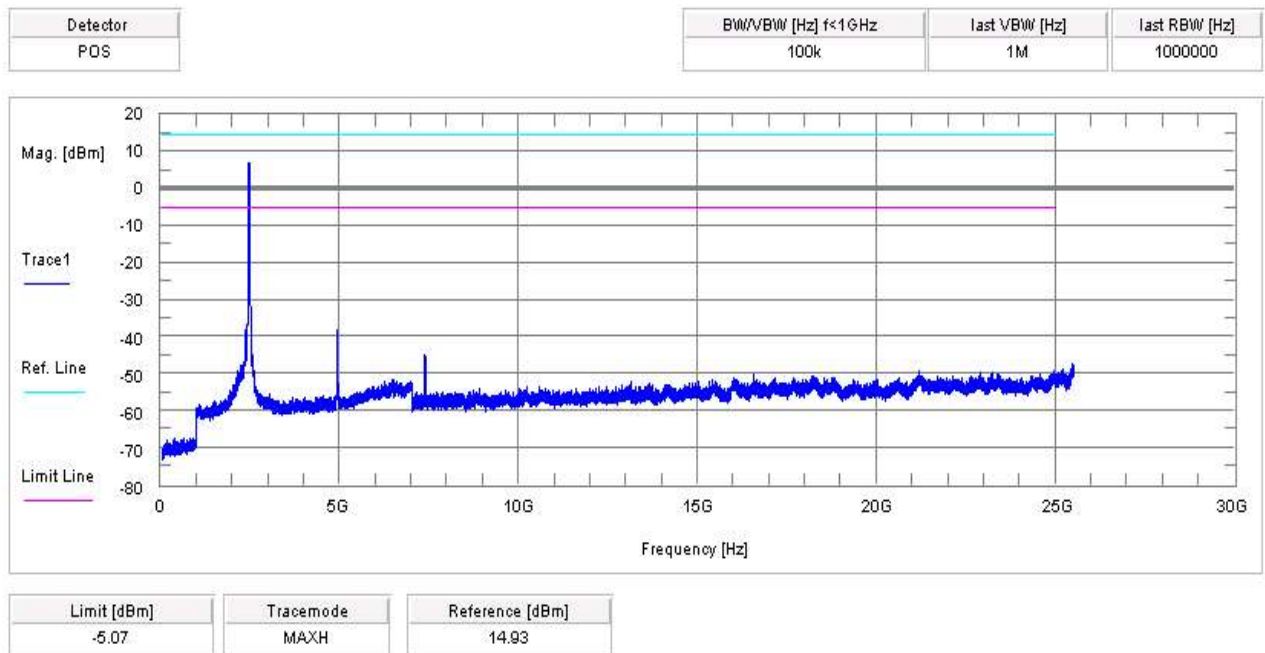

Result & Limits:

Emission Limitations					
f [MHz]		amplitude of emission [dBm]	limit max. allowed emission power	actual attenuation below frequency of operation [dB]	results
2412		15.37	30 dBm		Operating frequency complies
No critical peaks detected.			-20 dBc		
2437		15.79	30 dBm		Operating frequency complies
No critical peaks detected.			-20 dBc		
2462		14.93	30 dBm		Operating frequency complies
No critical peaks detected.			-20 dBc		
Measurement uncertainty		± 3dB			

F < 1 GHz: RBW: 100 kHz VBW: 100 kHz
F > 1 GHz: RBW: 1 MHz VBW: 1 MHz

Under normal test conditions only	In any 100 kHz bandwidth outside the frequency band at least 20dB below the highest level of the desired power. In addition, radiated emissions which fall in the restricted bands, as defined in §15.205(a), must also comply with the radiated emission limits specified in §15.209(a) (see §15.205(c)).
-----------------------------------	--

Note: For emissions that fall into restricted bands you find the radiated emissions later in the report.

5.12 Spurious Emissions - radiated (Transmitter) §15.209

DSSS – mode:

Plot 1: 0.03 - 1 GHz (lowest channel)

Common Information

EUT: CCW9M2443
 Serial Number: B92834249
 Test Description: FCC Part 15 B
 Operating Conditions: TX 2412 MHz; channel 1; 11Mbit/s
 Operator Name: COA
 Comment: DC: 12 V

Scan Setup: STAN_Fin [EMI radiated]

Hardware Setup: Electric Field (NOS)
 Level Unit: dBµV/m

Subrange	Detectors	IF Bandwidth	Meas. Time	Receiver
30 MHz - 1 GHz	QuasiPeak	120 kHz	15 s	Receiver

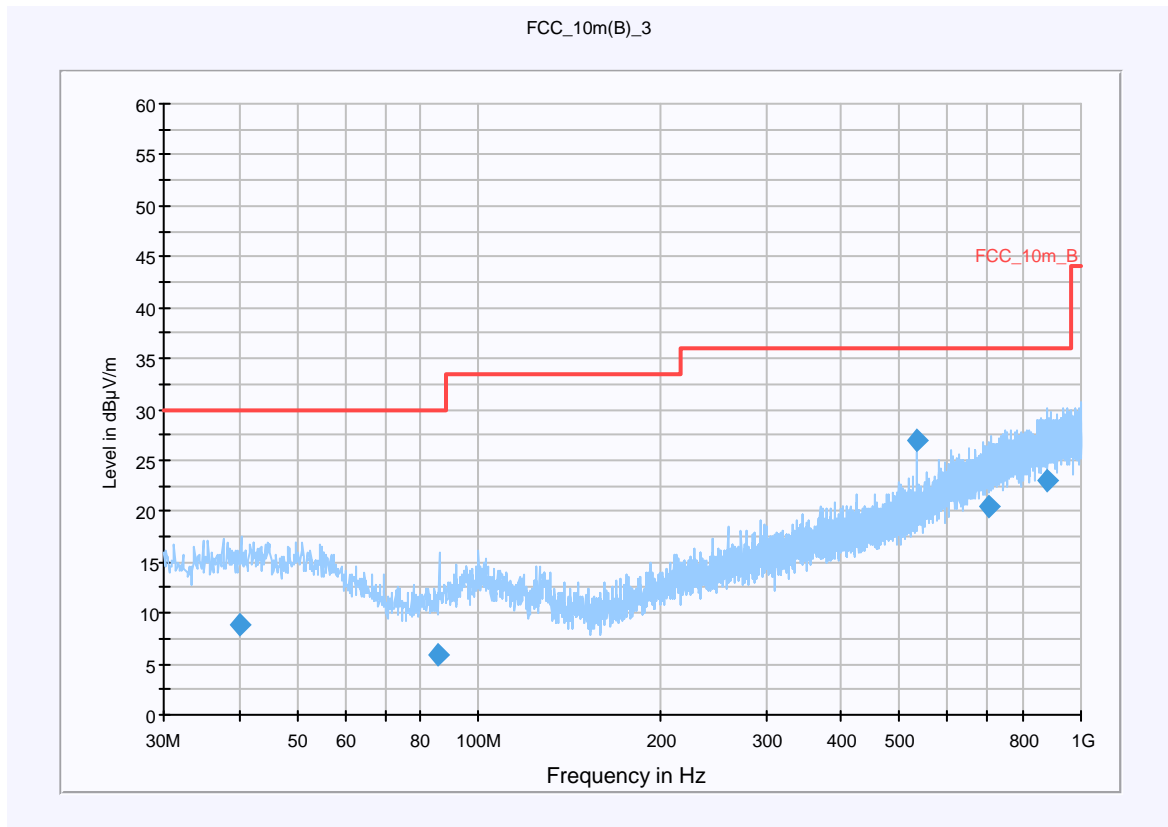

Final Result 1

Frequency (MHz)	QuasiPeak (dBµV/m)	Meas. Time (ms)	Bandwidth (kHz)	Antenna height (cm)	Polarity	Turntable position (deg)	Corr. (dB)	Margin (dB)	Limit (dBµV/m)	Comment
39.984350	8.9	15000.000	120.000	120.0	H	35.0	13.6	21.1	30.0	
85.542150	5.9	15000.000	120.000	171.0	V	228.0	10.2	24.1	30.0	
533.990950	27.0	15000.000	120.000	140.0	H	257.0	19.6	9.0	36.0	
701.662650	20.5	15000.000	120.000	220.0	H	145.0	23.0	15.5	36.0	
880.063500	23.0	15000.000	120.000	161.0	H	311.0	25.4	13.0	36.0	

Hardware Setup: EMI radiated\Electric Field (NOS) - [EMI radiated]

Subrange 1	
Frequency Range:	30 MHz - 2 GHz
Receiver:	Receiver [ESCI 3] @ GPIB0 (ADR 20), SN 100083/0033, FW 4.32
Signal Path:	without Notch FW 1.0
Antenna:	VULB 9163 SN 9163-295, FW --- Correction Table (vertical): VULP6113 Correction Table (horizontal): VULP6113 Correction Table: Cable_EN_1GHz (0109)
Antenna Tower:	Tower [EMCO 2090 Antenna Tower] @ GPIB0 (ADR 8), FW REV 3.12
Turntable:	Turntable [EMCO Turntable] @ GPIB0 (ADR 9), FW REV 3.12

EMC 32 Version 8.10.00

Plot 2: 1 – 12.75 GHz (lowest channel)

Max. Power Index: 35

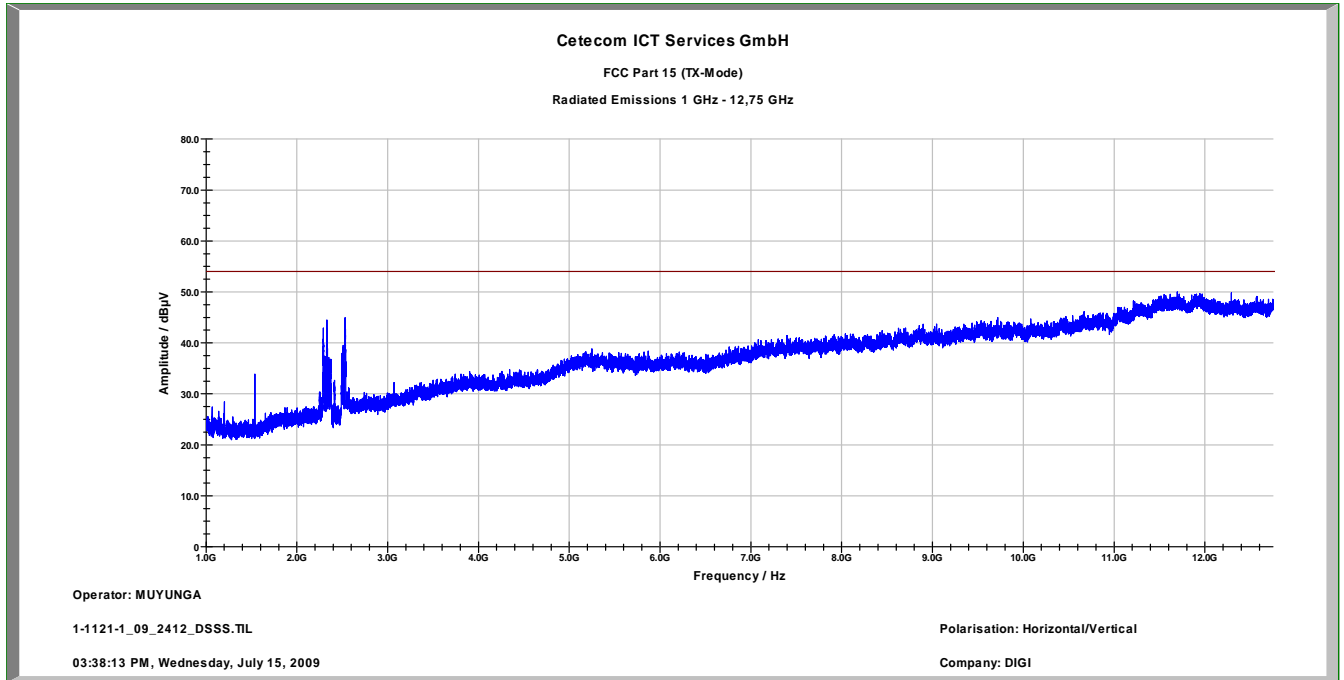

The carrier signal is notched with a 2.4 GHz band rejection filter.

Plot 3: 12 - 25 GHz (valid for all channels)

Max.Power Index: 35

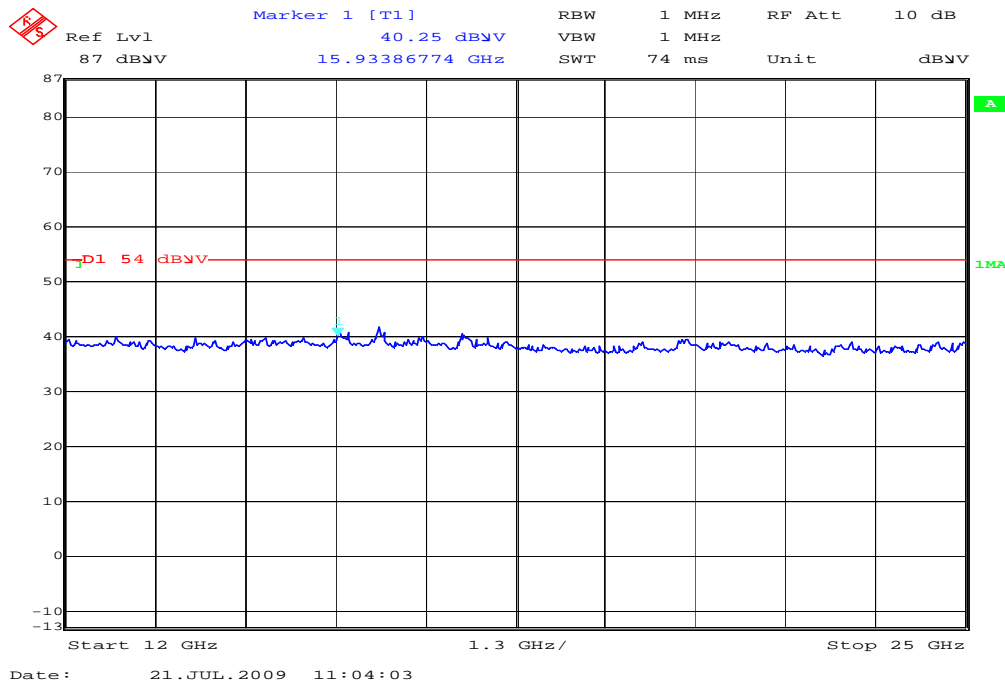

Plot 4: 0.03 - 1 GHz (middle channel)

Common Information

EUT: CCW9M2443
 Serial Number: B92834249
 Test Description: FCC Part 15 B
 Operating Conditions: TX 2437 MHz; channel 6; 11Mbit/s
 Operator Name: COA
 Comment: DC: 12 V

Scan Setup: STAN_Fin [EMI radiated]

Hardware Setup: Electric Field (NOS)
 Level Unit: dBµV/m
Subrange **Detectors** **IF Bandwidth** **Meas. Time** **Receiver**
 30 MHz - 1 GHz QuasiPeak 120 kHz 15 s Receiver

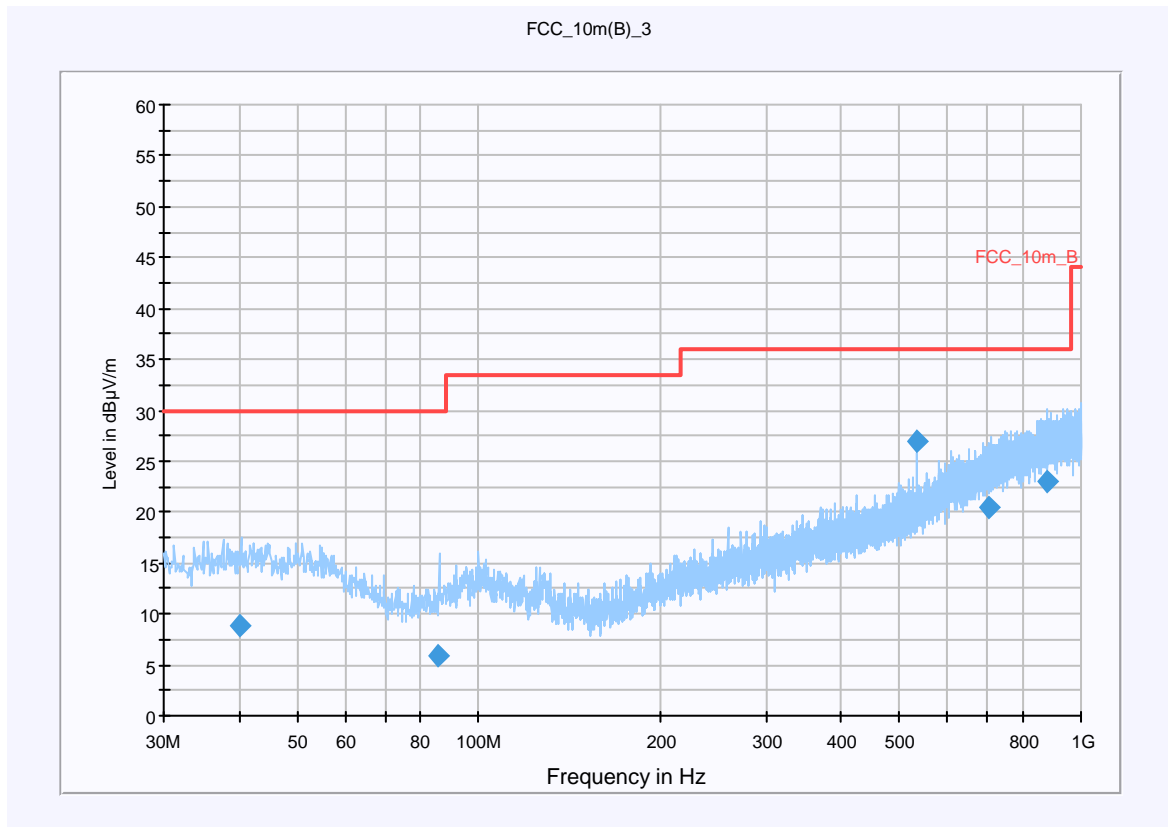

Final Result 1

Frequency (MHz)	QuasiPeak (dBµV/m)	Meas. Time (ms)	Bandwidth (kHz)	Antenna height (cm)	Polarity	Turntable position (deg)	Corr. (dB)	Margin (dB)	Limit (dBµV/m)	Comment
39.984350	8.9	15000.000	120.000	120.0	H	35.0	13.6	21.1	30.0	
85.542150	5.9	15000.000	120.000	171.0	V	228.0	10.2	24.1	30.0	
533.990950	27.0	15000.000	120.000	140.0	H	257.0	19.6	9.0	36.0	
701.662650	20.5	15000.000	120.000	220.0	H	145.0	23.0	15.5	36.0	
880.063500	23.0	15000.000	120.000	161.0	H	311.0	25.4	13.0	36.0	

Hardware Setup: EMI radiated\Electric Field (NOS) - [EMI radiated]

Subrange 1	
Frequency Range:	30 MHz - 2 GHz
Receiver:	Receiver [ESCI 3] @ GPIB0 (ADR 20), SN 100083/0033, FW 4.32
Signal Path:	without Notch FW 1.0
Antenna:	VULB 9163 SN 9163-295, FW --- Correction Table (vertical): VULP6113 Correction Table (horizontal): VULP6113 Correction Table: Cable_EN_1GHz (0109)
Antenna Tower:	Tower [EMCO 2090 Antenna Tower] @ GPIB0 (ADR 8), FW REV 3.12
Turntable:	Turntable [EMCO Turntable] @ GPIB0 (ADR 9), FW REV 3.12

EMC 32 Version 8.10.00

Plot 5: 1 – 12.75 GHz (middle channel)
Max. Power Index: 35

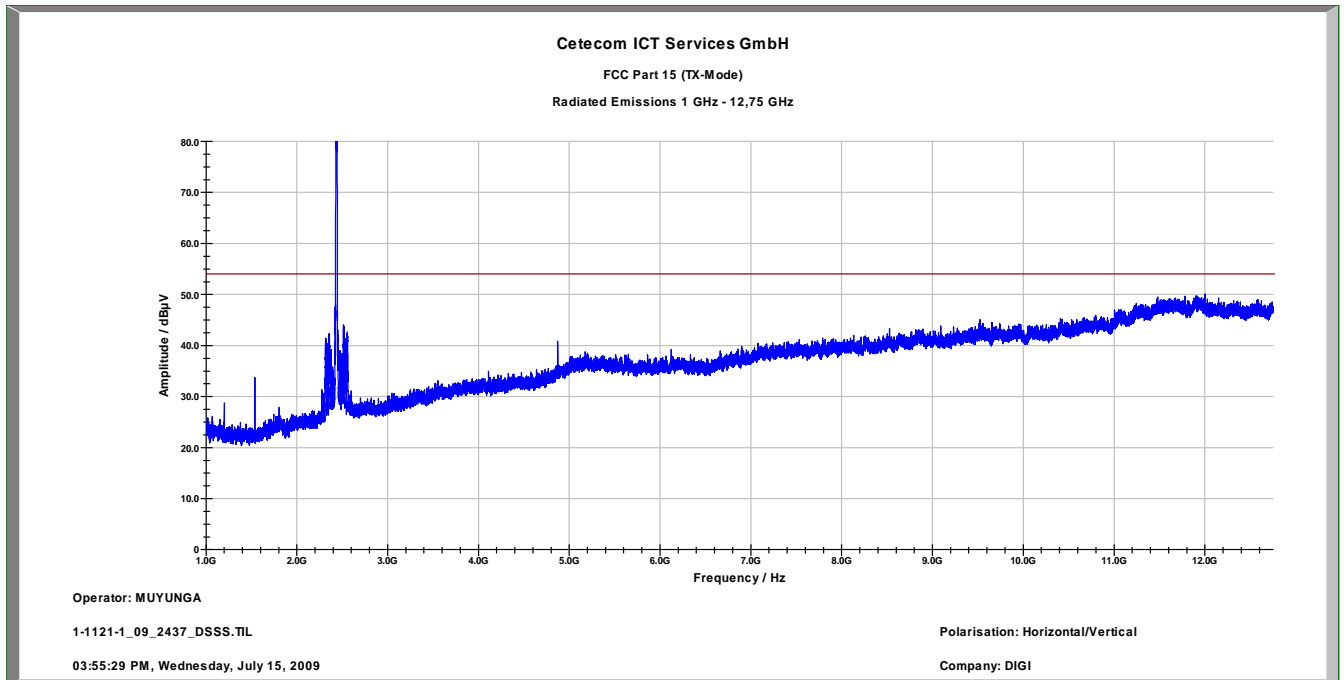

Plot 6: 0.03 - 1 GHz (highest channel)

Common Information

EUT: CCW9M2443
 Serial Number: B92834249
 Test Description: FCC Part 15 B
 Operating Conditions: TX 2462 MHz; channel 11; 11Mbit/s
 Operator Name: COA
 Comment: DC: 12 V

Scan Setup: STAN_Fin [EMI radiated]

Hardware Setup: Electric Field (NOS)
 Level Unit: dBµV/m

Subrange	Detectors	IF Bandwidth	Meas. Time	Receiver
30 MHz - 1 GHz	QuasiPeak	120 kHz	15 s	Receiver

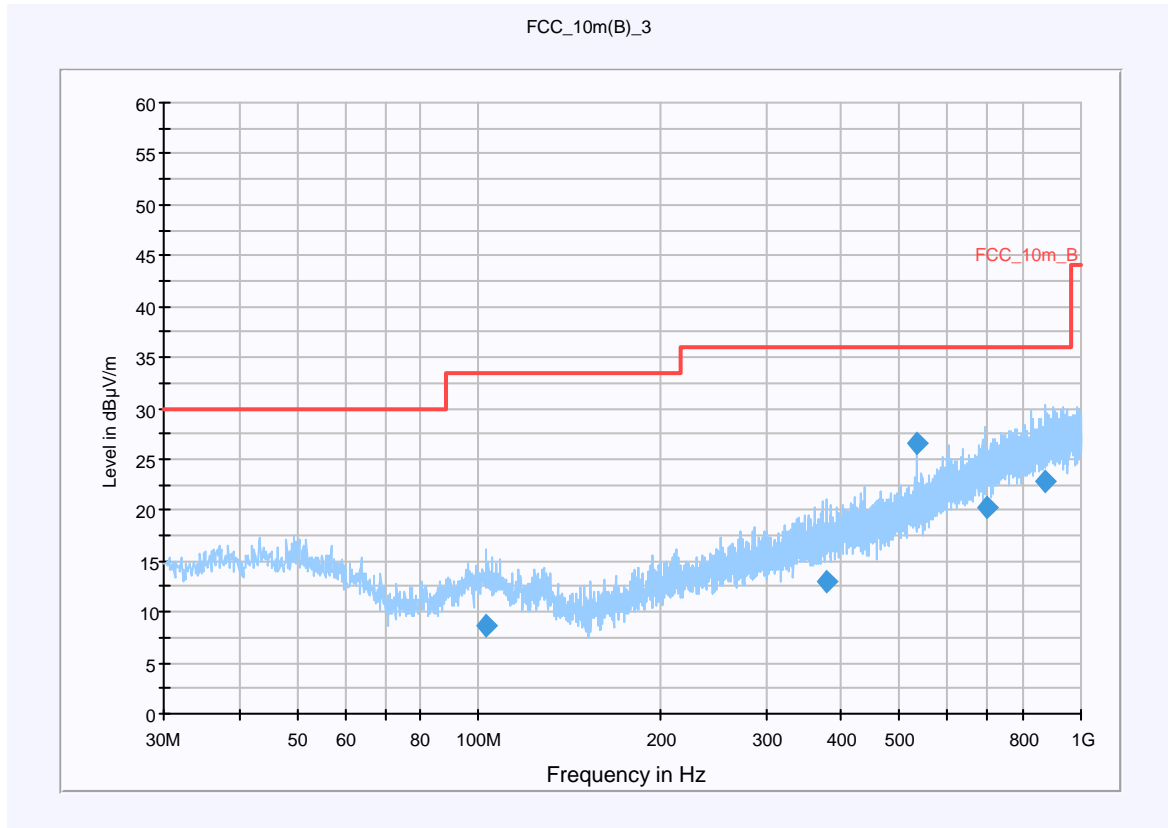

Final Result 1

Frequency (MHz)	QuasiPeak (dBµV/m)	Meas. Time (ms)	Bandwidth (kHz)	Antenna height (cm)	Polarity	Turntable position (deg)	Corr. (dB)	Margin (dB)	Limit (dBµV/m)	Comment
102.660300	8.6	15000.000	120.000	220.0	V	8.0	12.0	24.9	33.5	
377.958450	12.9	15000.000	120.000	171.0	H	146.0	16.9	23.1	36.0	
533.994850	26.6	15000.000	120.000	140.0	H	263.0	19.6	9.4	36.0	
695.133000	20.3	15000.000	120.000	110.0	H	60.0	22.9	15.7	36.0	
872.891750	22.9	15000.000	120.000	173.0	V	-5.0	25.4	13.1	36.0	

Hardware Setup: EMI radiated\Electric Field (NOS) - [EMI radiated]

Subrange 1	
Frequency Range:	30 MHz - 2 GHz
Receiver:	Receiver [ESCI 3] @ GPIB0 (ADR 20), SN 100083/0033, FW 4.32
Signal Path:	without Notch FW 1.0
Antenna:	VULB 9163 SN 9163-295, FW --- Correction Table (vertical): VULP6113 Correction Table (horizontal): VULP6113 Correction Table: Cable_EN_1GHz (0109)
Antenna Tower:	Tower [EMCO 2090 Antenna Tower] @ GPIB0 (ADR 8), FW REV 3.12
Turntable:	Turntable [EMCO Turntable] @ GPIB0 (ADR 9), FW REV 3.12

EMC 32 Version 8.10.00

Plot 7: 1 – 12.75 GHz (highest channel)
Max. Power Index: 35

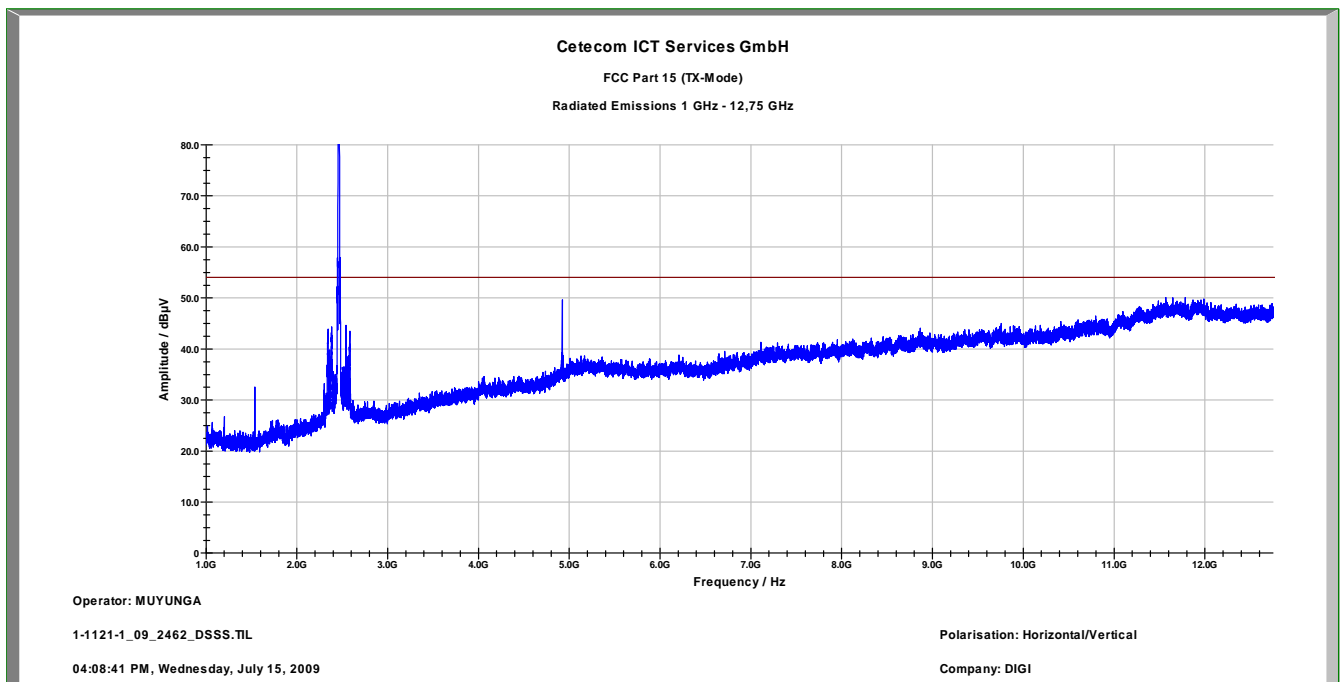

Results:

SPURIOUS EMISSIONS LEVEL §15.209								
2412 MHz			2437 MHz			2462 MHz		
F [MHz]	Detector	Level [dBµV/m]	F [MHz]	Detector	Level [dBµV/m]	F [MHz]	Detector	Level [dBµV/m]
No traceable peak detected			No traceable peak detected			4924	AV	41.01
Measurement uncertainty				±3 dB				

f < 1 GHz : RBW/VBW: 100 kHz f ≥ 1GHz : RBW/VBW: 1 MHz

Limits: § 15.247 (c)

In any 100 kHz bandwidth outside the frequency band at least 20dB below the highest level of the desired power. In addition, radiated emissions which fall in the restricted bands, as defined in §15.205(a), must also comply with the radiated emission limits specified in §15.209(a) (see §15.205(c)).

Limits: § 15.109

Frequency (MHz)	Field strength (dBµV/m)	Measurement distance (m)
30 - 88	30.0	10
88 - 216	33.5	10
216 - 960	36.0	10
above 960	54.0	3

OFDM – mode:

Plot 1: 0.03 - 1 GHz (lowest channel)

Common Information

EUT: CCW9M2443
 Serial Number: B92834249
 Test Description: FCC Part 15 B
 Operating Conditions: TX; 2412 MHz; channel 1; 54Mbit/s
 Operator Name: COA
 Comment: DC: 12 V

Scan Setup: STAN_Fin [EMI radiated]

Hardware Setup: Electric Field (NOS)
 Level Unit: dBµV/m

Subrange	Detectors	IF Bandwidth	Meas. Time	Receiver
30 MHz - 1 GHz	QuasiPeak	120 kHz	15 s	Receiver

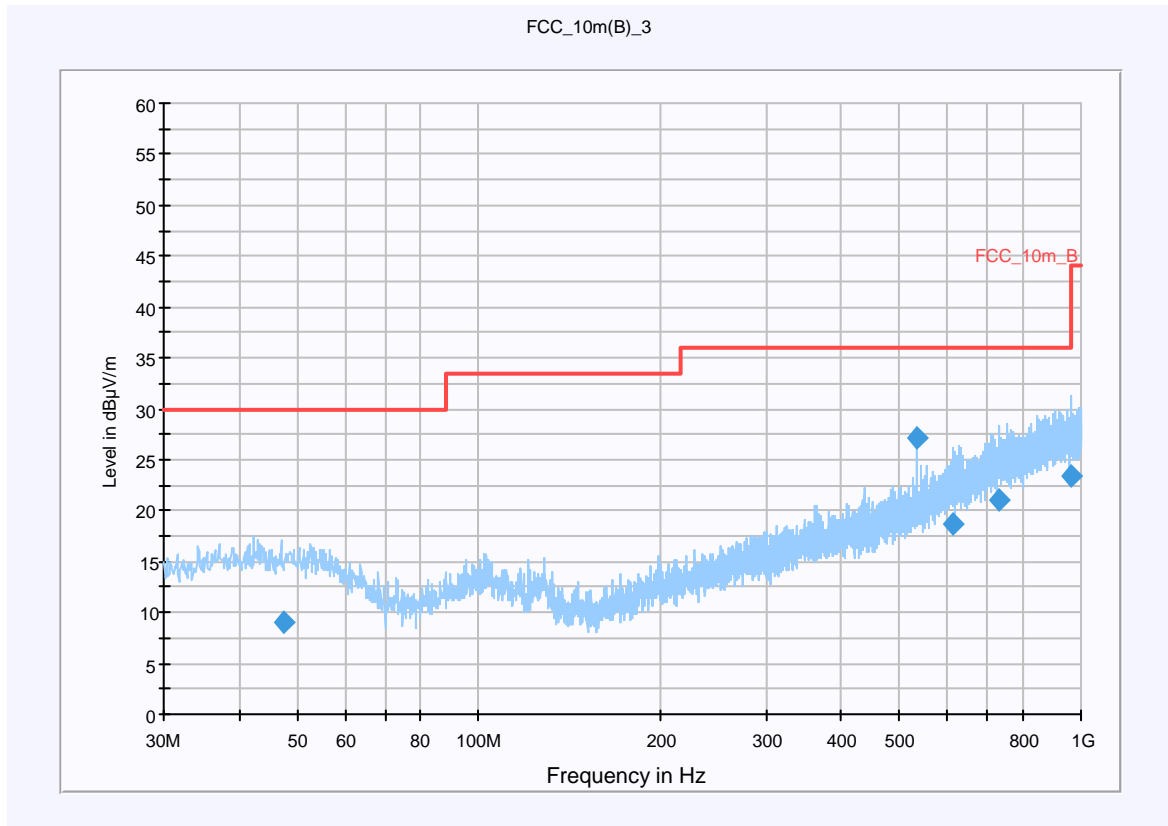

Final Result 1

Frequency (MHz)	QuasiPeak (dBµV/m)	Meas. Time (ms)	Bandwidth (kHz)	Antenna height (cm)	Polarity	Turntable position (deg)	Corr. (dB)	Margin (dB)	Limit (dBµV/m)	Comment
47.563450	9.0	15000.000	120.000	220.0	V	51.0	13.5	21.0	30.0	
533.995000	27.1	15000.000	120.000	120.0	H	60.0	19.6	8.9	36.0	
614.342850	18.8	15000.000	120.000	98.0	H	270.0	21.5	17.2	36.0	
731.588500	21.1	15000.000	120.000	164.0	V	13.0	23.7	14.9	36.0	
963.559700	23.4	15000.000	120.000	153.0	V	22.0	26.0	20.6	44.0	

Hardware Setup: EMI radiated\Electric Field (NOS) - [EMI radiated]

Subrange 1	
Frequency Range:	30 MHz - 2 GHz
Receiver:	Receiver [ESCI 3] @ GPIB0 (ADR 20), SN 100083/0033, FW 4.32
Signal Path:	without Notch FW 1.0
Antenna:	VULB 9163 SN 9163-295, FW --- Correction Table (vertical): VULP6113 Correction Table (horizontal): VULP6113 Correction Table: Cable_EN_1GHz (0109)
Antenna Tower:	Tower [EMCO 2090 Antenna Tower] @ GPIB0 (ADR 8), FW REV 3.12
Turntable:	Turntable [EMCO Turntable] @ GPIB0 (ADR 9), FW REV 3.12

EMC 32 Version 8.10.00

Plot 2: 1 – 12.75 GHz (lowest channel)

Max. Power Index: 35

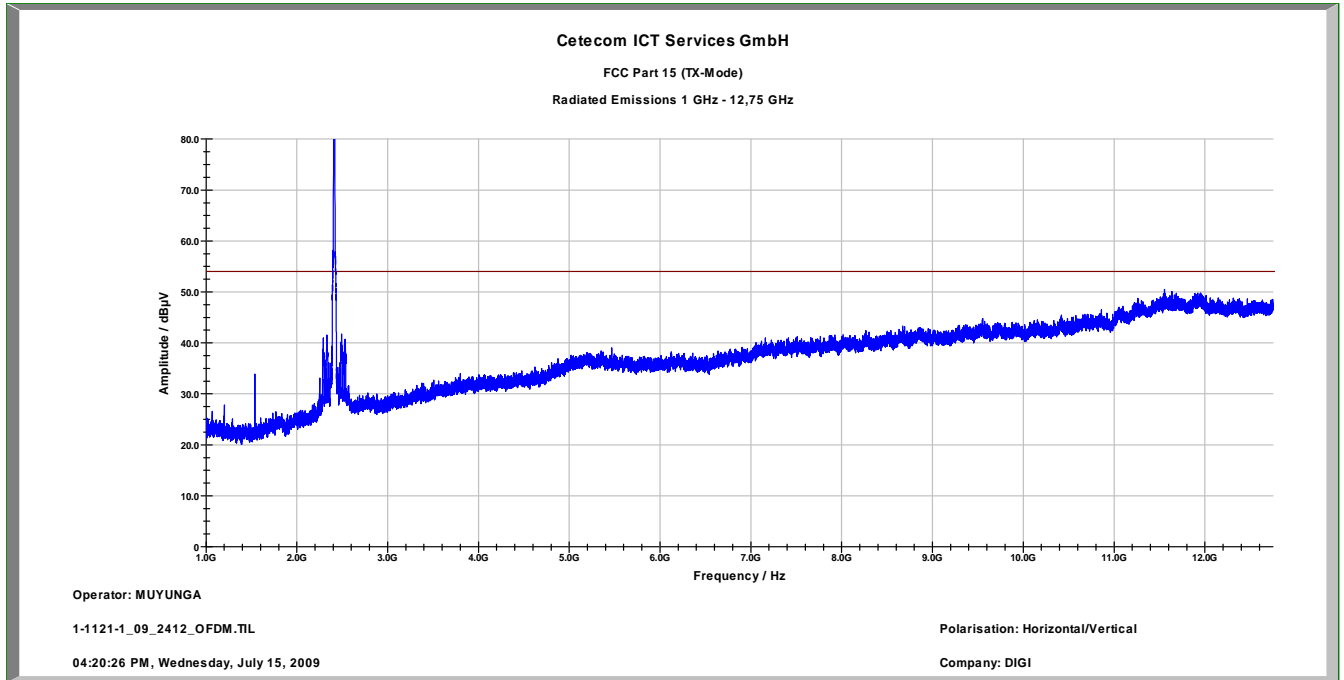

Plot 3: 12 - 25 GHz (valid for all channels)

Max. Power Index: 35

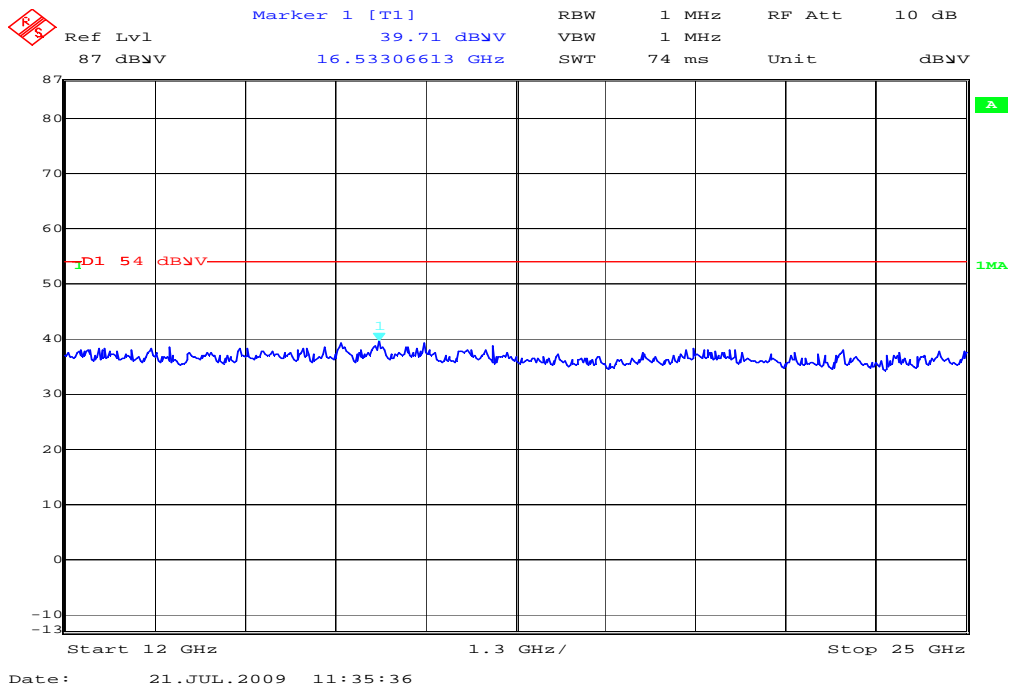

Plot 4: 0.03 - 1 GHz (middle channel)

Common Information

EUT: CCW9M2443
 Serial Number: B92834249
 Test Description: FCC Part 15 B
 Operating Conditions: TX; 2437 MHz; channel 6; 54Mbit/s
 Operator Name: COA
 Comment: DC: 12 V

Scan Setup: STAN_Fin [EMI radiated]

Hardware Setup: Electric Field (NOS)
 Level Unit: dBµV/m
Subrange **Detectors** **IF Bandwidth** **Meas. Time** **Receiver**
 30 MHz - 1 GHz QuasiPeak 120 kHz 15 s Receiver

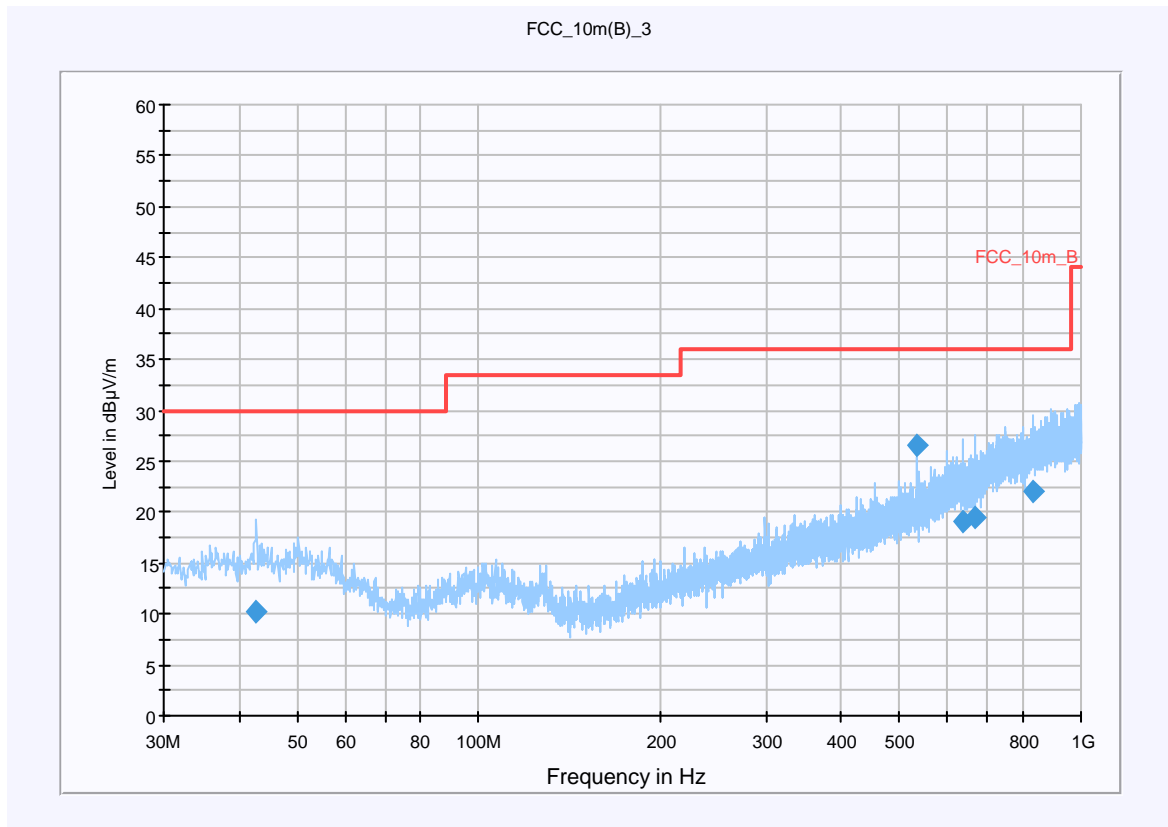

Final Result 1

Frequency (MHz)	QuasiPeak (dBµV/m)	Meas. Time (ms)	Bandwidth (kHz)	Antenna height (cm)	Polarity	Turntable position (deg)	Corr. (dB)	Margin (dB)	Limit (dBµV/m)	Comment
42.518250	10.1	15000.000	120.000	142.0	V	73.0	13.5	19.9	30.0	
533.970850	26.6	15000.000	120.000	220.0	H	53.0	19.6	9.4	36.0	
635.680700	19.0	15000.000	120.000	147.0	H	22.0	21.6	17.0	36.0	
668.205950	19.4	15000.000	120.000	220.0	H	89.0	22.2	16.6	36.0	
831.046150	22.0	15000.000	120.000	98.0	V	227.0	24.8	14.0	36.0	

Hardware Setup: EMI radiated\Electric Field (NOS) - [EMI radiated]

Subrange 1	
Frequency Range:	30 MHz - 2 GHz
Receiver:	Receiver [ESCI 3] @ GPIB0 (ADR 20), SN 100083/0033, FW 4.32
Signal Path:	without Notch FW 1.0
Antenna:	VULB 9163 SN 9163-295, FW --- Correction Table (vertical): VULP6113 Correction Table (horizontal): VULP6113 Correction Table: Cable_EN_1GHz (0109)
Antenna Tower:	Tower [EMCO 2090 Antenna Tower] @ GPIB0 (ADR 8), FW REV 3.12
Turntable:	Turntable [EMCO Turntable] @ GPIB0 (ADR 9), FW REV 3.12

EMC 32 Version 8.10.00

Plot 5: 1 – 12.75 GHz (middle channel)

Max. Power Index: 35

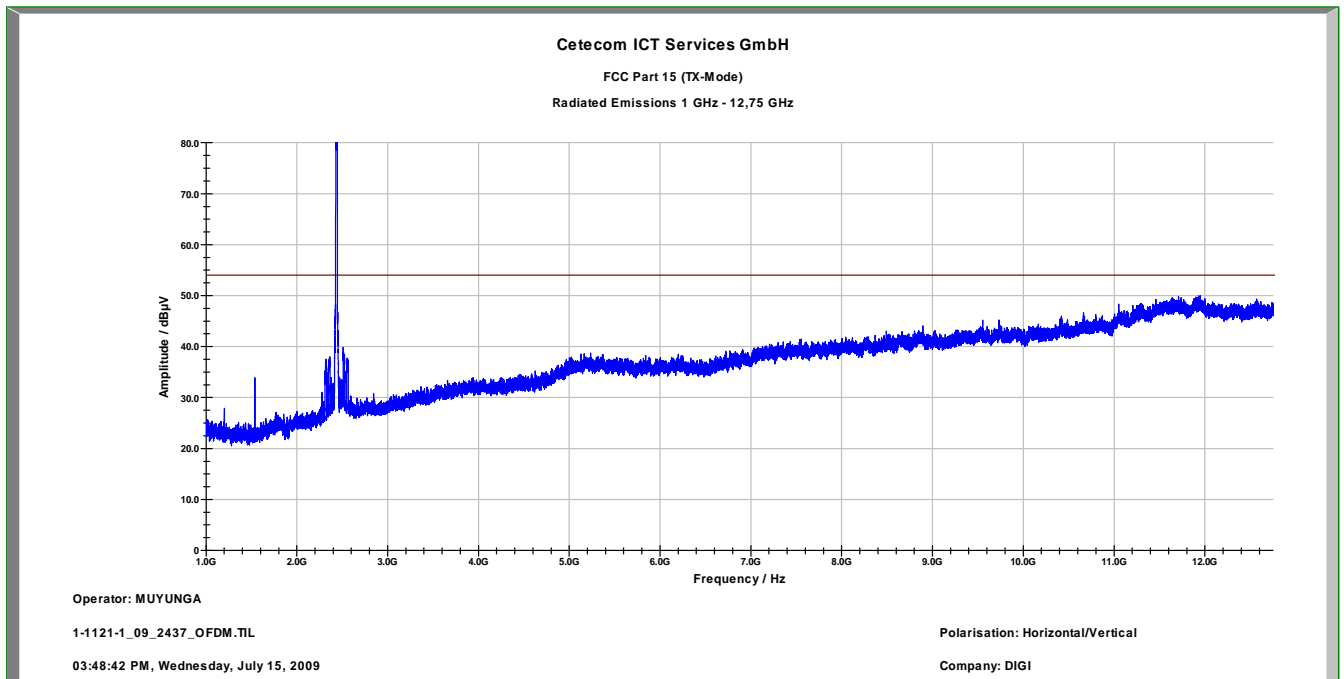

Plot 6: 0.03 - 1 GHz (highest channel)

Common Information

EUT: CCW9M2443
 Serial Number: B92834249
 Test Description: FCC Part 15 B
 Operating Conditions: TX; 2462 MHz; channel 11; 54Mbit/s
 Operator Name: COA
 Comment: DC: 12 V

Scan Setup: STAN_Fin [EMI radiated]

Hardware Setup: Electric Field (NOS)
 Level Unit: dBµV/m
Subrange **Detectors** **IF Bandwidth** **Meas. Time** **Receiver**
 30 MHz - 1 GHz QuasiPeak 120 kHz 15 s Receiver

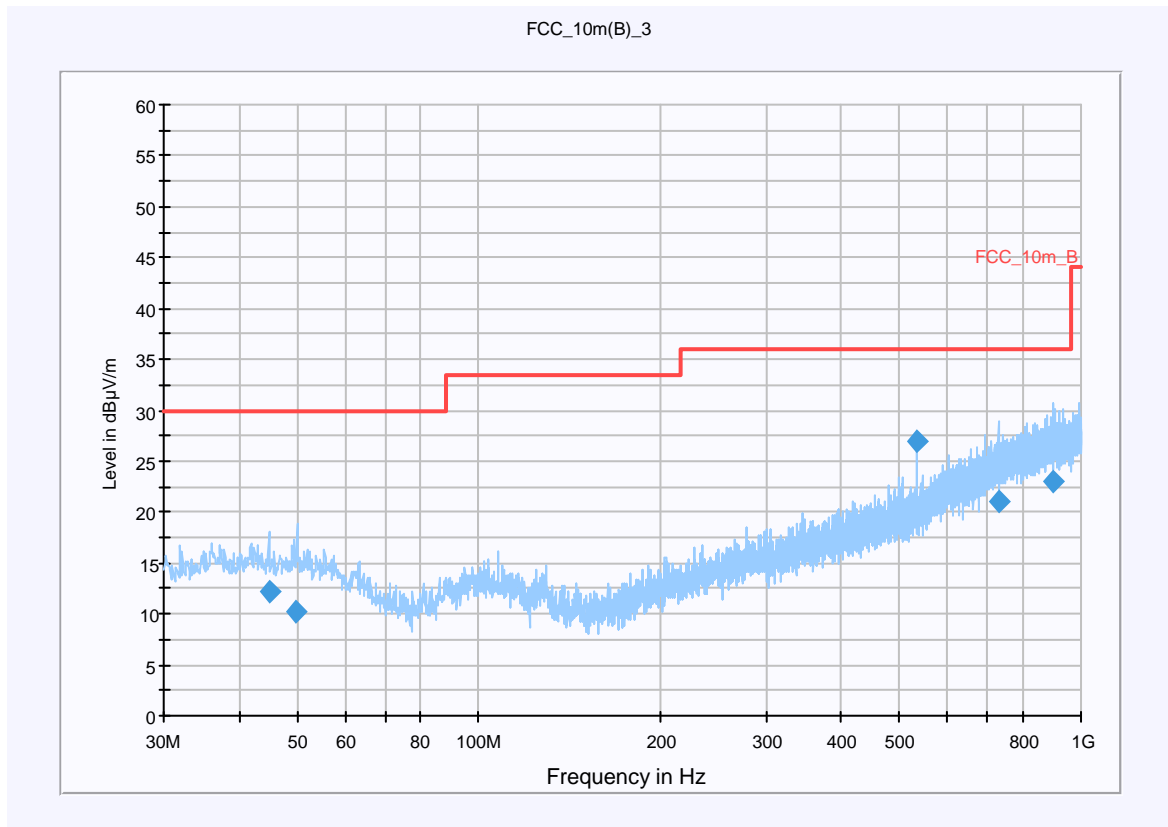

Final Result 1

Frequency (MHz)	QuasiPeak (dBµV/m)	Meas. Time (ms)	Bandwidth (kHz)	Antenna height (cm)	Polarity	Turntable position (deg)	Corr. (dB)	Margin (dB)	Limit (dBµV/m)	Comment
45.000600	12.1	15000.000	120.000	123.0	V	51.0	13.4	17.9	30.0	
49.756200	10.2	15000.000	120.000	129.0	V	323.0	13.5	19.8	30.0	
533.985400	26.9	15000.000	120.000	220.0	H	51.0	19.6	9.1	36.0	
728.414050	21.0	15000.000	120.000	220.0	V	-1.0	23.7	15.0	36.0	
898.500450	23.0	15000.000	120.000	124.0	V	142.0	25.7	13.0	36.0	

Hardware Setup: EMI radiated\Electric Field (NOS) - [EMI radiated]

Subrange 1	
Frequency Range:	30 MHz - 2 GHz
Receiver:	Receiver [ESCI 3] @ GPIB0 (ADR 20), SN 100083/0033, FW 4.32
Signal Path:	without Notch FW 1.0
Antenna:	VULB 9163 SN 9163-295, FW --- Correction Table (vertical): VULP6113 Correction Table (horizontal): VULP6113 Correction Table: Cable_EN_1GHz (0109)
Antenna Tower:	Tower [EMCO 2090 Antenna Tower] @ GPIB0 (ADR 8), FW REV 3.12
Turntable:	Turntable [EMCO Turntable] @ GPIB0 (ADR 9), FW REV 3.12

EMC 32 Version 8.10.00

Plot 7: 1 - 12 GHz (highest channel)
Max. Power Index: 35

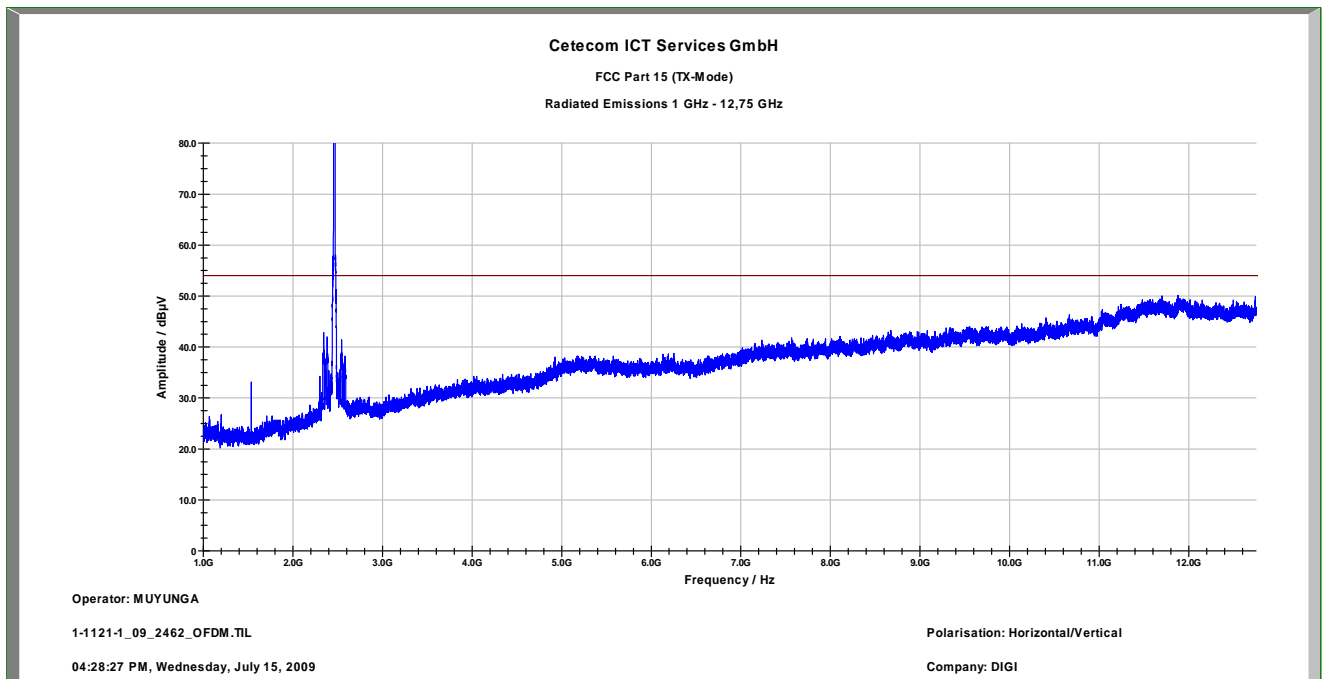

Results:

SPURIOUS EMISSIONS LEVEL §15.209								
2412 MHz			2437 MHz			2462 MHz		
F [MHz]	Detector	Level [dBµV/m]	F [MHz]	Detector	Level [dBµV/m]	F [MHz]	Detector	Level [dBµV/m]
No critical peaks detected								
Measurement uncertainty			±3 dB					

f < 1 GHz : RBW/VBW: 100 kHz f ≥ 1GHz : RBW/VBW: 1 MHz

Limits: § 15.247 (c)

In any 100 kHz bandwidth outside the frequency band at least 20dB below the highest level of the desired power. In addition, radiated emissions which fall in the restricted bands, as defined in §15.205(a), must also comply with the radiated emission limits specified in §15.209(a) (see §15.205(c)).

Limits: § 15.109

Frequency (MHz)	Field strength (dBµV/m)	Measurement distance (m)
30 - 88	30.0	10
88 - 216	33.5	10
216 - 960	36.0	10
above 960	54.0	3

5.13 Spurious Emissions - radiated (Receiver) §15.109 / 209

Plot 1: 0.03 - 1 GHz vertical / horizontal (receiver)

Common Information

EUT: CCW9M2443
 Serial Number: B92834249
 Test Description: FCC Part 15 B
 Operating Conditions: RX
 Operator Name: MKL
 Comment: DC: 12 V

Scan Setup: STAN_Fin [EMI radiated]

Hardware Setup: Electric Field (NOS)
 Level Unit: dBµV/m
Subrange **Detectors** **IF Bandwidth** **Meas. Time** **Receiver**
 30 MHz - 1 GHz QuasiPeak 120 kHz 15 s Receiver

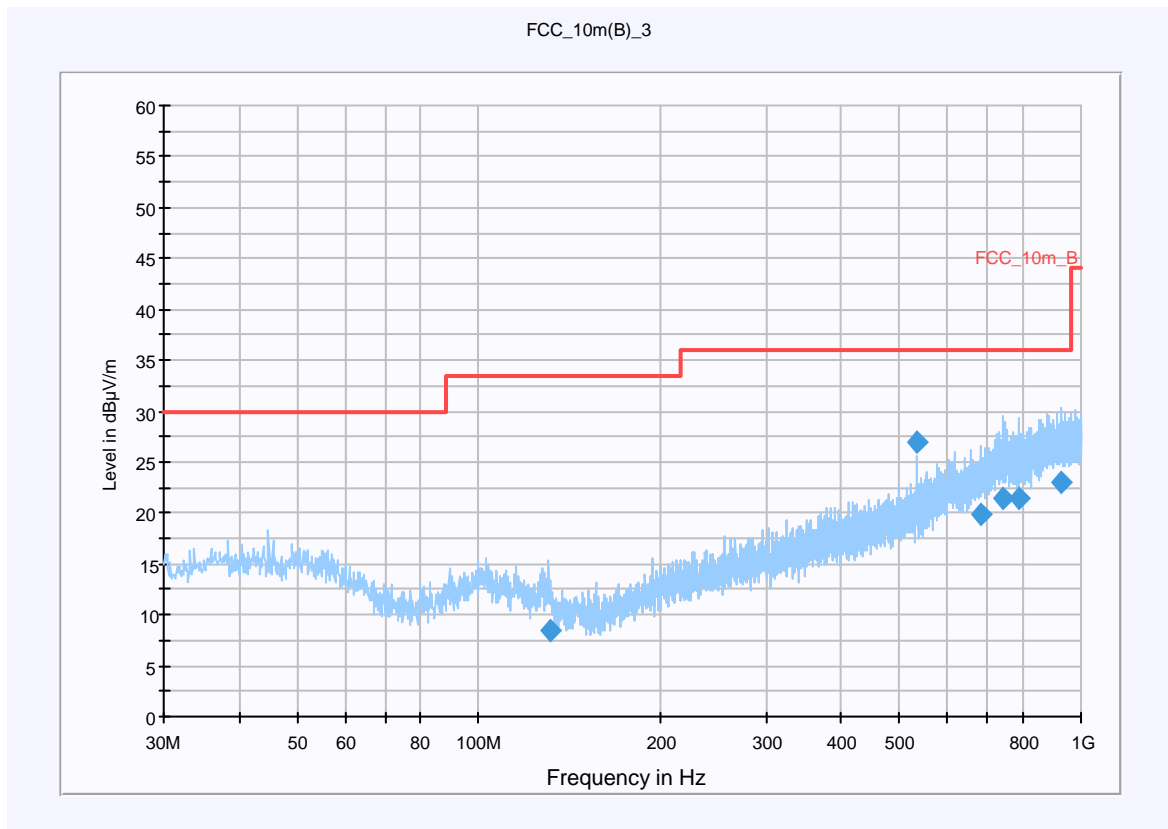

Final Result 1

Frequency (MHz)	QuasiPeak (dBµV/m)	Meas. Time (ms)	Bandwidth (kHz)	Antenna height (cm)	Polarity	Turntable position (deg)	Corr. (dB)	Margin (dB)	Limit (dBµV/m)	Comment
131.320850	8.5	15000.000	120.000	98.0	V	-2.0	9.6	25.0	33.5	
533.987800	27.0	15000.000	120.000	220.0	H	75.0	19.6	9.0	36.0	
681.805000	19.8	15000.000	120.000	120.0	V	65.0	22.5	16.2	36.0	
744.482450	21.4	15000.000	120.000	208.0	H	174.0	24.0	14.6	36.0	
789.281050	21.5	15000.000	120.000	151.0	V	147.0	24.3	14.5	36.0	
927.185200	23.0	15000.000	120.000	220.0	V	39.0	25.8	13.0	36.0	

Plot 2: 1 – 12.75 GHz vertical / horizontal (receiver)

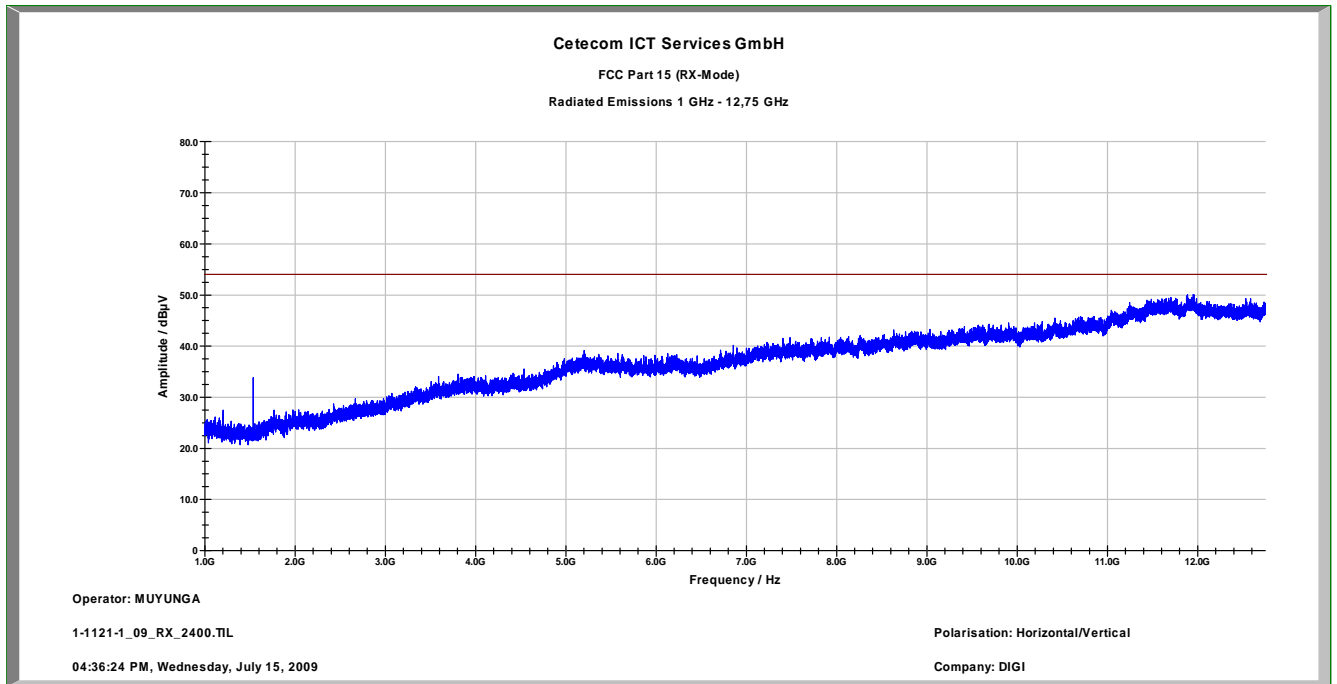

Plot 3: 12 - 25 GHz (receiver)

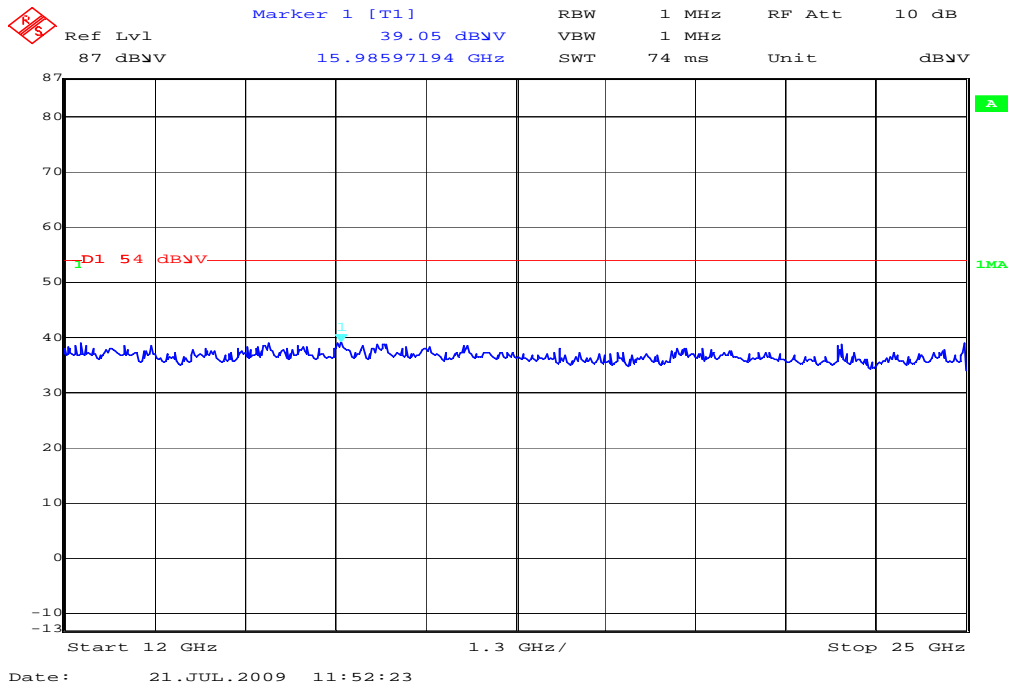

Results:

Spurious Emissions level [dB μ V/m]		
f[MHz]	Detector	Level [μ V/m]
1536	PK	57.54
Measurement uncertainty		± 3 dB

f < 1 GHz : RBW/VBW: 100 kHz

f \geq 1GHz : RBW/VBW: 1 MHz

See above plots

Measurement distance see table

Limits: § 15.109

Frequency (MHz)	Field strength (dB μ V/m)	Measurement distance (m)
30 - 88	30.0	10
88 - 216	33.5	10
216 - 960	36.0	10
above 960	54.0	3

5.14 Spurious Emissions - radiated <30 MHz §15.209

Measured at 3 m distance.

Plot 1:

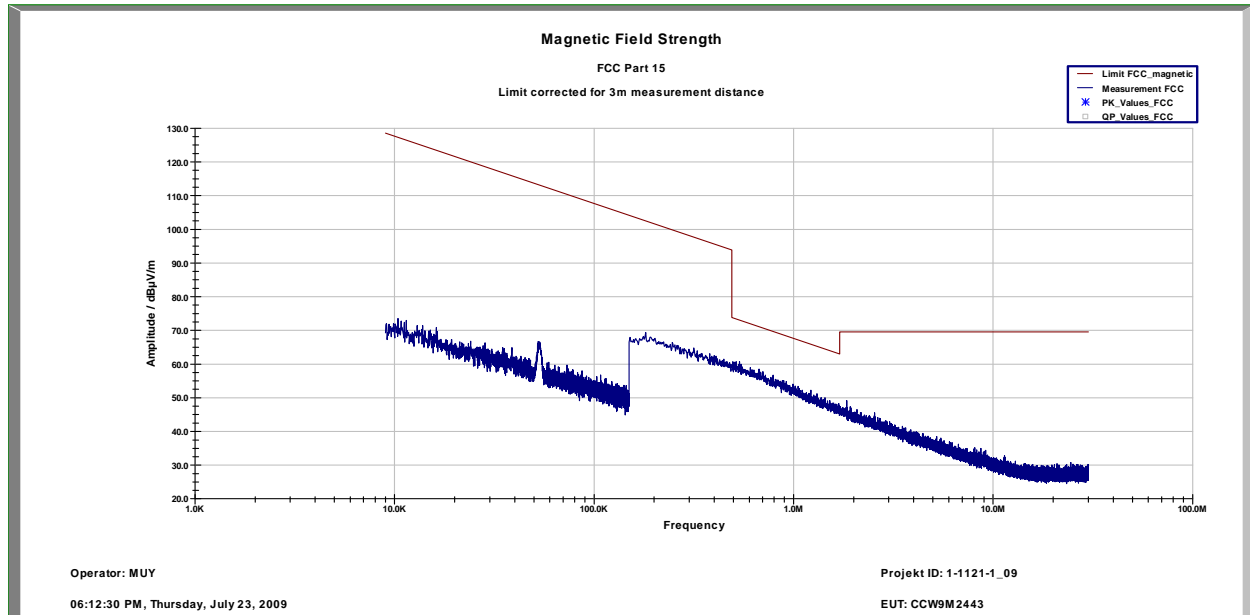

Limits:

Frequency (MHz)	Field strength (µV/m)	Measurement distance (m)
0.009 – 0.490	2400/F(kHz)	300
0.490 – 1.705	24000/F(kHz)	30
1.705 – 30.0	30 / 29.5 dBµV/m	30
30 - 88	100 / 40 dBµV/m	3
88 - 216	150 / 43.5 dBµV/m	3
216 - 960	200 / 46 dBµV/m	3
above 960	54 dBµV/m	3

5.15 Conducted Emissions <30 MHz §15.107/207

Plot 1: CISPR 22, Neutral line

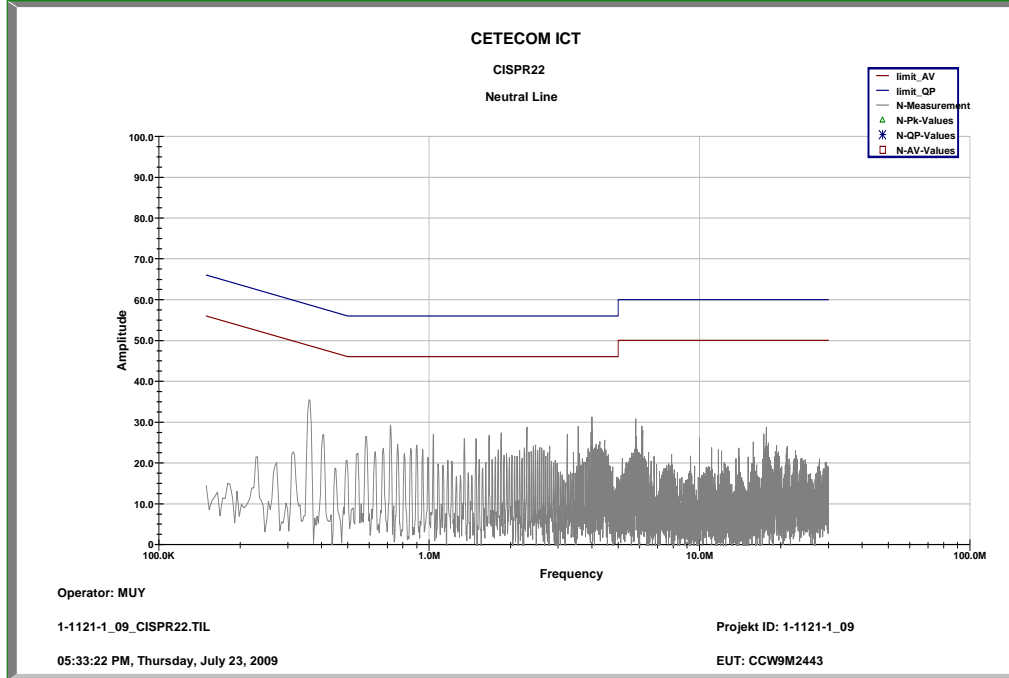

Plot 2: CISPR 22, Phase Line

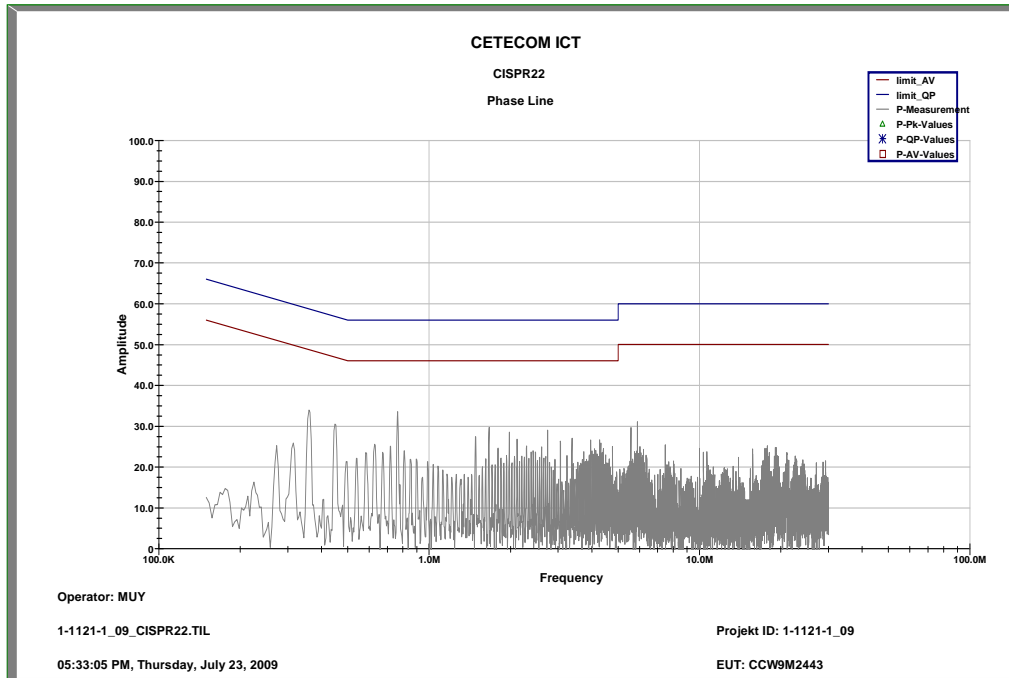

We measured in TX and RX mode, L1 and N floating and grounded, max value was hold.
Limits:

Under normal test conditions only	See plots
-----------------------------------	-----------

6 Test equipment and ancillaries used for tests

To simplify the identification on each page of the test equipment used, on each page of the test report, each item of test equipment and ancillaries such as cables are identified (numbered) by the Test Laboratory, below.

All reported calibration intervals are calibrations according to the EN/ISO/IEC 17025 standard. These calibrations were performed from an accredited external calibration laboratory.

Additional to these calibrations the laboratory performed comparison measurements with other calibrated systems and performed a weekly chamber inspection.

All used devices are connected with a 10 MHz external reference.

According to the manufacturers' instruction is it possible to establish a calibration interval for the FSP unit of 24 month, if the device has an external 10 MHz reference.

Anechoic chamber C:

No	Equipment/Type	Manuf.	Serial Nr.	Inv. No. Cetecom	Last Calibration	Frequency (months)	Next Calibration
1	Anechoic chamber	MWB	87400/02	300000996	Monthly verification		
2	System-Rack 85900	HP I.V.	*	300000222	n.a.		
3	Measurement System 1						
4	PSA-Spektrumanalysator 3 Hz - 26.5 GHz (E4440A)	Agilent	MY48250080	300003812	05.08.2008	24	05.08.2010
5	EMI Preselector 9 kHz - 1 GHz (N9039A)	Agilent	MY48260003	300003825	19.08.2008	24	19.08.2010
6	Microwave Analog Signal Generator (N5183A)	Agilent	MY47420220	300003813	06.08.2008	24	06.08.2010
7	PC	F+W			n.a.		
8	TILE	TILE			n.a.		
9	TRILOG Super Broadband Antenna (VULB9163)	Schwarzbeck	371	300003854	Monthly verification (System cal.)		
10	Double Ridged Antenna 3115	EMCO	3088	300001032	Monthly verification (System cal.)		
11	Active Loop Antenna 6502	EMCO	2210	300001015	Monthly verification (System cal.)		
12	Switch / Control Unit 3488A	HP	2719A15013	300001156	n.a.		
13	Power Supply 6032A	HP	2818A03450	300001040	08.01.2009	36	08.01.2012
14	Busisolator	Kontron		300001056	n.a.		
15	Leitungsteiler 11850C	HP		300000997	Monthly verification (System cal.)		
16	Power attenuator 8325	Byrd	1530	300001595	Monthly verification (System cal.)		
17	Band reject filter WRCG1855/1910	Wainwright	7	300003350	Monthly verification (System cal.)		
18	Band reject filter WRCG2400/2483	Wainwright	11	300003351	Monthly verification (System cal.)		
19	Hochpassfilter WHK1.1/15G-10SS	Wainwright	3	300003255	Monthly verification (System cal.)		
20	Hochpassfilter WHKX2.9/18G-12SS	Wainwright	1	300003492	Monthly verification (System cal.)		
21	Hochpassfilter WHKX7.0/18G-8SS	Wainwright	18	300003789	Monthly verification (System cal.)		
22	Switch / Control Unit 3488A	HP	2605e08770	300001443	n.a.		
23	Trenntrafo RT5A	Grundig	9242	300001263	n.a.		
24	Relais Matrix PSU	R&S	890167/024	300001168	n.a.		
25	Netznachbildung ESH3-Z5	R&S	828576/020	300001210	n.a.		

System Rack Room 005:

No	Equipment/Type	Manuf.	Serial Nr.	Inv. No. Cetecom	Last Calibration	Frequency (months)	Next Calibration
1	FSP 30	R&S	100886	300003575	25.08.2008	24	25.08.2010
2	CBT	R&S	100313	300003516	03.09.2008	24	03.09.2010
3	Switch Matrix	HP		300000929	n.a.		
4	Power Supply 6625A	HP	3041A00544	300002270	13.05.2007	36	13.05.2010
5	Signal Generator SMIQ03B	R&S	836206/0092	300002680	30.05.2007	36	30.05.2010

SRD Laboratory Room 002:

No	Equipment/Type	Manuf.	Serial Nr.	Inv. No. Cetecom	Last Calibration	Frequency (months)	Next Calibration
1	System Controller PSM 12	R&S	835259/007	300002681-00xx	n.a.		
2	Memory Extension PSM-K10	R&S	To 1	300002681	n.a.		
3	Operating Software PSM-B2	R&S	To 1	300002681	n.a.		
4	19" Monitor		22759020-ED	300002681	n.a.		
5	Mouse		LZE 0095/6639	300002681	n.a.		
6	Keyboard		G00013834L461	300002681	n.a.		
7	Spectrum Analyser FSIQ 26	R&S	835540/018	300002681-0005	10.01.2008	24	10.01.2010
8	Tracking Generator FSIQ-B10	R&S	835107/015	300002681	s.No.7		
10	RF-Generator SMIQ03 (B1 Signal)	R&S	835541/056	300002681-0002	26.08.2008	36	26.08.2011
11	Modulation Coder SMIQ-B20	R&S	To 10	300002681	s.No.10		
12	Data Generator SMIQ-B11	R&S	To 10	300002681	s.No.10		
13	RF Rear Connection SMIQ-B19	R&S	To 10	300002681	s.No.10		
14	Broadband horn antenna (1-18 GHz)	EMCO	9107-3696	300001604	16.04.2008	24	16.04.2010
15	Broadband horn antenna (1-18 GHz)	EMCO	9107-3697	300001605	21.08.2008	24	21.08.2010
16	Std gain horn antenna (18-26.5 GHz)	Narda	Model no. 638	300000486	n.a.		
17	Std gain horn antenna (18-26.5 GHz)	Narda	Model no. 638	300000487	n.a.		
18	Sleeve dipole antenna Model 3126-880	ETS-Lindgren	00040887	3000000	n.a.		
19	Fast CPU SM-B50	R&S	To 10	300002681	s.No.10		
20	FM Modulator SM-B5	R&S	835676/033	300002681	s.No.10		
21	RF-Generator SMIQ03 (B2 Signal)	R&S	835541/055	300002681-0001	25.08.2008	36	25.08.2011
22	Modulation Coder SMIQ-B20	R&S	To 21	300002681	s.No.21		
23	Data Generator SMIQ-B11	R&S	To 21	300002681	s.No.21		
24	RF Rear Connection SMIQ-B19	R&S	To 21	300002681	s.No.21		
25	Fast CPU SM-B50	R&S	To 21	300002681	s.No.21		
26	FM Modulator SM-B5	R&S	836061/022	300002681	s.No.21		
27	RF-Generator SMP03 (B3 Signal)	R&S	835133/011	300002681-0003	26.08.2008	36	26.08.2011
28	Attenuator SMP-B15	R&S	835136/014	300002681	S.No.27		
29	RF Rear Connection SMP-B19	R&S	834745/007	300002681	S.No.27		
30	Power Meter NRVD	R&S	835430/044	300002681-0004	26.08.2008	24	26.08.2010
31	Power Sensor NRVD-Z1	R&S	833894/012	300002681-0013	26.08.2008	24	26.08.2010
32	Power Sensor NRVD-Z1	R&S	833894/011	300002681-0010	26.08.2008	24	26.08.2010
33	Rubidium Standard RUB	R&S		300002681-0009	27.08.2008	24	27.08.2010
34	Switching and Signal Conditioning Unit SSCU	R&S	338864/003	300002681-0006	Verified with path compensation		
35	Laser Printer HP Deskjet 2100	HP	N/A	300002681-0011	n.a.		

36	19'' Rack	R&S	11138363000004	300002681	n.a.		
37	RF-cable set	R&S	N/A	300002681	n.a.		
39	IEEE-cables	R&S	N/A	300002681	n.a.		
40	Sampling System FSIQ-B70	R&S	835355/009	300002681	s.No.7		
41	RSP programmable attenuator	R&S	834500/010	300002681-0007	26.08.2008	24	26.08.2010
42	Signalling Unit	R&S	838312/011	300002681	n.a.		
43	NGPE programmable Power Supply for EUT	R&S	192.033.41	300002681			
44	Power Splitter 6005-3	Inmet Corp.	none	300002841	n.a.		
45	SMA Cables SPS-1151-985-SPS	Insulated Wire	different	different	n.a.		
46	CBT32 with EDR Signaling Unit	R&S					
47	Coupling unit	Narda	N/A	--	n.a.		
48	2xSwitch Matrix PSU	R&S	872584/021	300001329	n.a.		
49	RF-cable set	R&S	N/A	different	n.a.		
50	IEEE-cables	R&S	N/A	--	n.a.		

Note: 3000002681-00xx inventoried as a system

SRD Laboratory Room 005:

No	Equipment/Type	Manuf.	Serial Nr.	Inv. No. Cetecom	Last Calibration	Frequency (months)	Next Calibration
1	Spektrum Analyzer 8566B	HP	2747A05275	300000219	18.01.2008	24	18.01.2010
2	Spektrum Analyzer Display 85662A	HP	2816A16497	300001690	23.01.2008	24	23.01.2010
3	Quasi-Peak-Adapter 85650A	HP	2811A01135	300000216	23.01.2008	24	23.01.2010
4	Power Supply	Heiden	003202	300001187	12.05.2007	36	12.05.2010
5	Power Supply	Heiden	1701	300001392	12.05.2007	36	12.05.2010

Anechoic chamber F:

No	Equipment/Type	Manuf.	Serial Nr.	Inv. No. Cetecom	Last Calibration	Frequency (months)	Next Calibration
1	Control Computer	F+W	FW0502032	300003303	-/-	-/-	-/-
2	Trilog Antenna VULB 9163	Schwarzbeck	295	300003787	01.04.2008	24	01.04.2010
3	Amplifier - 0518C-138	Veritech Micro-wave Inc.	-/-	-/-	-/-	-/-	-/-
4	Switch - 3488A	HP		300000368	-/-	-/-	-/-
5	EMI Test receiver - ESCI	R&S	100083	300003312	31.01.2007	24	31.01.2009
6	Turntable Controller - 1061 3M	EMCO	1218	300000661	-/-	-/-	-/-
7	Tower Controller 1051 Controller	EMCO	1262	300000625	-/-	-/-	-/-
8	Tower - 1051	EMCO	1262	300000625	-/-	-/-	-/-
10	Ultra Notch-Filter Rejected band Ch. 62	WRCD	9	-/-	-/-	-/-	-/-