



**FCC CFR47 PART 15 SUBPART C
INDUSTRY CANADA RSS-210 ISSUE 8**

CERTIFICATION TEST REPORT

FOR

WIFI 11b/g/n MODULE

MODEL NUMBER: WIN-A2

FCC ID: MCLWINA2

IC: 2878D-WINA2

REPORT NUMBER: 11J13629-1

ISSUE DATE: FEBRUARY 9, 2011

Prepared for
**HON HAI PRECISION IND. CO., LTD.
5F-1, 5 HSIN-AN ROAD
HSINCHU SCIENCE-BASED INDUSTRIAL PARK
TAIWAN, R.O.C.**

Prepared by
**COMPLIANCE CERTIFICATION SERVICES (UL CCS)
47173 BENICIA STREET
FREMONT, CA 94538, U.S.A.
TEL: (510) 771-1000
FAX: (510) 661-0888**



NVLAP LAB CODE 200065-0

Revision History

<u>Rev.</u>	<u>Issue Date</u>	<u>Revisions</u>	<u>Revised By</u>
---	02/09/2011	Initial Issue	T. Chan

TABLE OF CONTENTS

1. ATTESTATION OF TEST RESULTS.....	5
2. TEST METHODOLOGY	6
3. FACILITIES AND ACCREDITATION.....	6
4. CALIBRATION AND UNCERTAINTY	6
4.1. MEASURING INSTRUMENT CALIBRATION.....	6
4.2. SAMPLE CALCULATION.....	6
4.3. MEASUREMENT UNCERTAINTY.....	6
5. EQUIPMENT UNDER TEST	7
5.1. DESCRIPTION OF EUT.....	7
5.2. MAXIMUM OUTPUT POWER.....	7
5.3. DESCRIPTION OF AVAILABLE ANTENNAS.....	7
5.4. SOFTWARE AND FIRMWARE.....	7
5.5. WORST-CASE CONFIGURATION AND MODE	7
5.6. DESCRIPTION OF TEST SETUP.....	8
6. TEST AND MEASUREMENT EQUIPMENT	10
7. ANTENNA PORT TEST RESULTS	11
7.1. 802.11b MODE IN THE 2.4 GHz BAND.....	11
7.1.1. 6 dB BANDWIDTH	11
7.1.2. 99% BANDWIDTH	14
7.1.3. OUTPUT POWER	17
7.1.4. AVERAGE POWER	18
7.1.5. POWER SPECTRAL DENSITY	19
7.1.6. CONDUCTED SPURIOUS EMISSIONS.....	22
7.2. 802.11g MODE IN THE 2.4 GHz BAND.....	26
7.2.1. 6 dB BANDWIDTH	26
7.2.2. 99% BANDWIDTH	29
7.2.3. OUTPUT POWER	32
7.2.4. AVERAGE POWER	33
7.2.5. POWER SPECTRAL DENSITY	34
7.2.6. CONDUCTED SPURIOUS EMISSIONS.....	37
7.3. 802.11n HT20 SISO MODE IN THE 2.4 GHz BAND	41
7.3.1. 6 dB BANDWIDTH	41
7.3.2. 99% BANDWIDTH	44
7.3.3. OUTPUT POWER	47
7.3.4. AVERAGE POWER	48
7.3.5. POWER SPECTRAL DENSITY	49
7.3.6. CONDUCTED SPURIOUS EMISSIONS.....	52
8. RADIATED TEST RESULTS	56

8.1.	LIMITS AND PROCEDURE	56
8.2.	TRANSMITTER ABOVE 1 GHz	57
8.2.1.	802.11b MODE IN THE 2.4 GHz BAND	57
8.2.2.	802.11g MODE IN THE 2.4 GHz BAND	62
8.2.3.	802.11n HT20 SISO MODE IN THE 2.4 GHz BAND	68
8.3.	WORST CASE RECEIVER ABOVE 1 GHz	73
8.4.	WORST CASE BELOW 1GHZ.....	74
9.	AC POWER LINE CONDUCTED EMISSIONS	75
10.	MAXIMUM PERMISSIBLE EXPOSURE	79
11.	SETUP PHOTOS	82

1. ATTESTATION OF TEST RESULTS

COMPANY NAME: HON HAI PRECISION IND. CO., LTD.
5F-1, 5 HSIN-AN ROAD
HSINCHU SCIENCE-BASED INDUSTRIAL PARK
TAIWAN, R.O.C.

EUT DESCRIPTION: WIFI 11B/G/N MODULE

MODEL: WIN-A2

SERIAL NUMBER: A4C0E127283

DATE TESTED: FEBRUAR 3-8, 2011

APPLICABLE STANDARDS	
STANDARD	TEST RESULTS
CFR 47 Part 15 Subpart C	Pass
INDUSTRY CANADA RSS-210 Issue 8 Annex 8	Pass
INDUSTRY CANADA RSS-GEN Issue 3	Pass

Compliance Certification Services (UL CCS) tested the above equipment in accordance with the requirements set forth in the above standards. All indications of Pass/Fail in this report are opinions expressed by UL CCS based on interpretations and/or observations of test results. Measurement Uncertainties were not taken into account and are published for informational purposes only. The test results show that the equipment tested is capable of demonstrating compliance with the requirements as documented in this report.

Note: The results documented in this report apply only to the tested sample, under the conditions and modes of operation as described herein. This document may not be altered or revised in any way unless done so by UL CCS and all revisions are duly noted in the revisions section. Any alteration of this document not carried out by UL CCS will constitute fraud and shall nullify the document. This report must not be used by the client to claim product certification, approval, or endorsement by NVLAP, NIST, any agency of the Federal Government, or any agency of any government.

Approved & Released For UL CCS By:

Tested By:



THU CHAN
ENGINEERING MANAGER
UL CCS

CHIN PANG
EMC ENGINEER
UL CCS

2. TEST METHODOLOGY

The tests documented in this report were performed in accordance with ANSI C63.10-2009, FCC CFR 47 Part 2, FCC CFR 47 Part 15, RSS-GEN Issue 3, and RSS-210 Issue 8.

3. FACILITIES AND ACCREDITATION

The test sites and measurement facilities used to collect data are located at 47173 Benicia Street, Fremont, California, USA.

UL CCS is accredited by NVLAP, Laboratory Code 200065-0. The full scope of accreditation can be viewed at <http://www.ccsemc.com>.

4. CALIBRATION AND UNCERTAINTY

4.1. MEASURING INSTRUMENT CALIBRATION

The measuring equipment utilized to perform the tests documented in this report has been calibrated in accordance with the manufacturer's recommendations, and is traceable to recognized national standards.

4.2. SAMPLE CALCULATION

Where relevant, the following sample calculation is provided:

$$\begin{aligned} \text{Field Strength (dBuV/m)} &= \text{Measured Voltage (dBuV)} + \text{Antenna Factor (dB/m)} + \\ &\text{Cable Loss (dB)} - \text{Preamp Gain (dB)} \\ 36.5 \text{ dBuV} + 18.7 \text{ dB/m} + 0.6 \text{ dB} - 26.9 \text{ dB} &= 28.9 \text{ dBuV/m} \end{aligned}$$

4.3. MEASUREMENT UNCERTAINTY

Where relevant, the following measurement uncertainty levels have been estimated for tests performed on the apparatus:

PARAMETER	UNCERTAINTY
Conducted Disturbance, 0.15 to 30 MHz	3.52 dB
Radiated Disturbance, 30 to 1000 MHz	4.94 dB

Uncertainty figures are valid to a confidence level of 95%.

5. EQUIPMENT UNDER TEST

5.1. DESCRIPTION OF EUT

The EUT is WIFI Module with 802.11B/G/HT20.

The radio module is manufactured by Hon Hai Precision.

5.2. MAXIMUM OUTPUT POWER

The transmitter has a maximum peak conducted output power as follows:

Frequency Range (MHz)	Mode	Output Power (dBm)	Output Power (mW)
2412 - 2462	802.11b	18.30	67.61
2412 - 2462	802.11g	24.20	263.03
2412 - 2462	802.11n HT20 SISO	24.00	251.19

5.3. DESCRIPTION OF AVAILABLE ANTENNAS

The radio utilizes a PiFA antenna for TX/RX diversity, with maximum peak gains of 2.05dBi

5.4. SOFTWARE AND FIRMWARE

The EUT test utility software installed in the host computer during testing was Broadcom test program BCM43362SDGN6L version 5.90.104 WLTEST

5.5. WORST-CASE CONFIGURATION AND MODE

The worst-case data rate for each mode is determined to be as follows, based on preliminary tests of the chipset utilized in this radio.

All final tests in the 802.11b mode were made at 1 Mb/s.

All final tests in the 802.11g mode were made at 6 Mb/s.

All final tests in the 802.11n HT20 SISO mode were made at MCS0.

For radiated emissions below 1 GHz the worst-case configuration is determined to be the mode and channel with the highest output power

To determine the worst-position of highest emissions, the EUT's antenna was investigated for X, Y, Z positions, and the worst position was turned out to be a Y-position with long ends at left side.

5.6. DESCRIPTION OF TEST SETUP

SUPPORT EQUIPMENT

PERIPHERAL SUPPORT EQUIPMENT LIST				
Description	Manufacturer	Model	Serial Number	FCC ID
AC Adapter	V-Infinity	HK-C113-A05	NA	DoC
Laptop	Dell	PP09S	27920070721	DoC
AC Adapter	Dell	LA65NSO-00	CN-ODF263-71615-775-605A	DoC
Interface Card	Broadcom	BCM95ANAD	1395274	NA

I/O CABLES

I/O CABLE LIST						
Cable No.	Port	# of Identical Ports	Connector Type	Cable Type	Cable Length	Remarks
1	AC	2	US 115V	Un-shielded	2m	No
2	DC	2	US 115V	Un-shielded	2m	No
3	SDN	1	19 pin Ribon	Un-shielded	0.4m	Yes

SETUP DIAGRAM

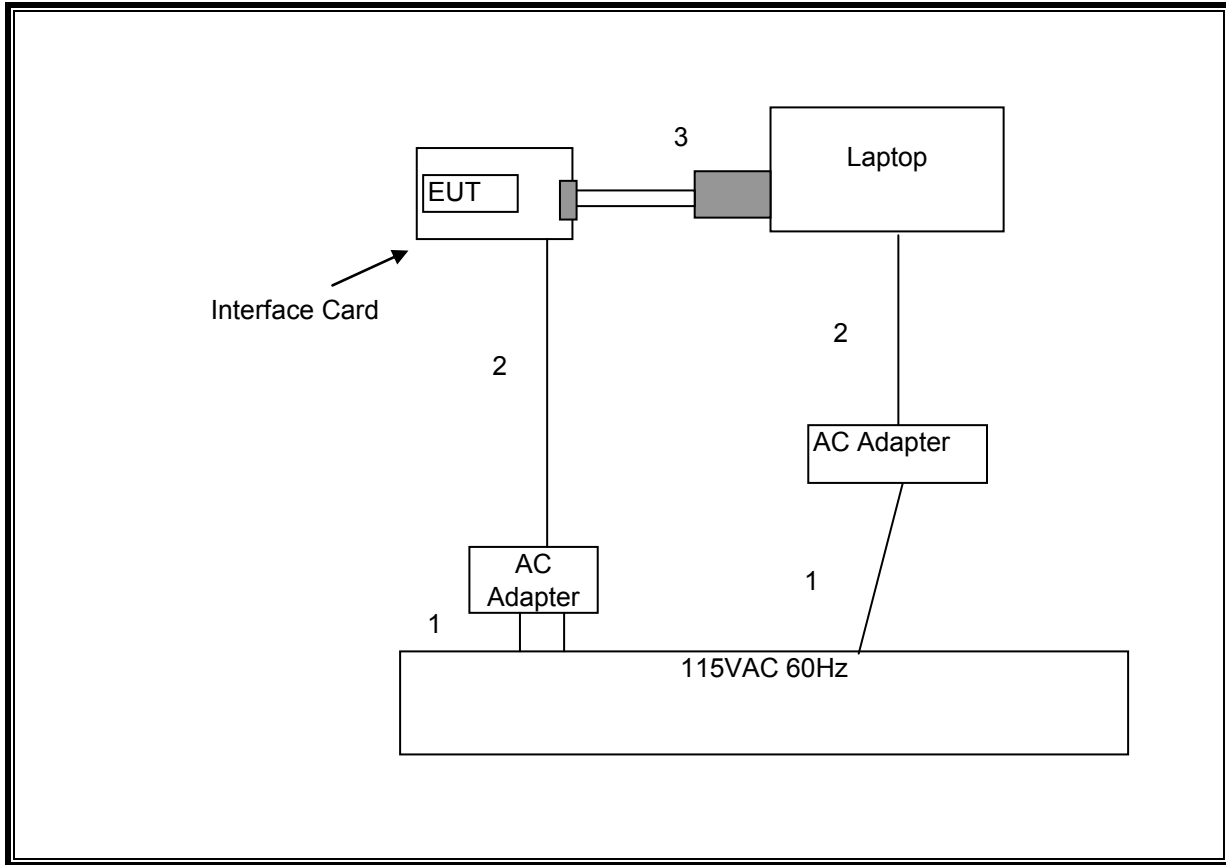

TEST SETUP

The EUT is connected to a Laptop via an interface card during the test.

6. TEST AND MEASUREMENT EQUIPMENT

The following test and measurement equipment was utilized for the tests documented in this report:

TEST EQUIPMENT LIST				
Description	Manufacturer	Model	Asset	Cal Due
Preamplifier, 1300 MHz	Agilent / HP	8447D	C00885	01/26/12
Preamplifier, 26.5 GHz	Agilent / HP	8449B	C01052	07/14/11
Antenna, Horn, 18 GHz	EMCO	3115	C00945	06/29/11
Antenna, Bilog, 2 GHz	Sunol Sciences	JB1	C01016	07/12/11
LISN, 30 MHz	FCC	LISN-50/250-25-2	N02625	11/10/11
EMI Test Receiver, 30 MHz	R & S	ESHS 20	N02396	05/06/11
Reject Filter, 2.4-2.5 GHz	Micro-Tronics	BRM50702	N02685	CNR
Spectrum Analyzer, 26.5 GHz	Agilent / HP	E4440A	C01178	08/30/11
Peak Power Meter	Boonton	4541	C01186	03/01/11
Peak Power Sensor	Boonton	57318	C01202	02/23/11

7. ANTENNA PORT TEST RESULTS

7.1. 802.11b MODE IN THE 2.4 GHz BAND

7.1.1. 6 dB BANDWIDTH

LIMITS

FCC §15.247 (a) (2)

IC RSS-210 A8.2 (a)

The minimum 6 dB bandwidth shall be at least 500 kHz.

TEST PROCEDURE

The transmitter output is connected to a spectrum analyzer. The RBW is set to 100 kHz and the VBW is set to 300 kHz. The sweep time is coupled.

Channel	Frequency (MHz)	6 dB Bandwidth (MHz)	Minimum Limit (MHz)
Low	2412	8.00	0.5
Middle	2437	8.00	0.5
High	2462	8.03	0.5

RESULTS

6 dB BANDWIDTH

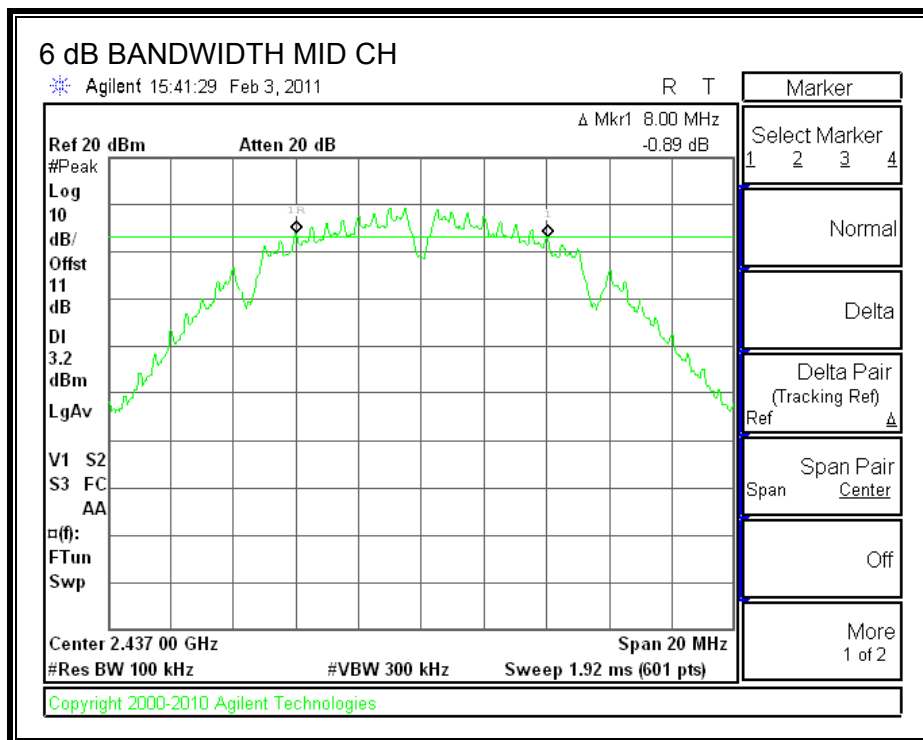
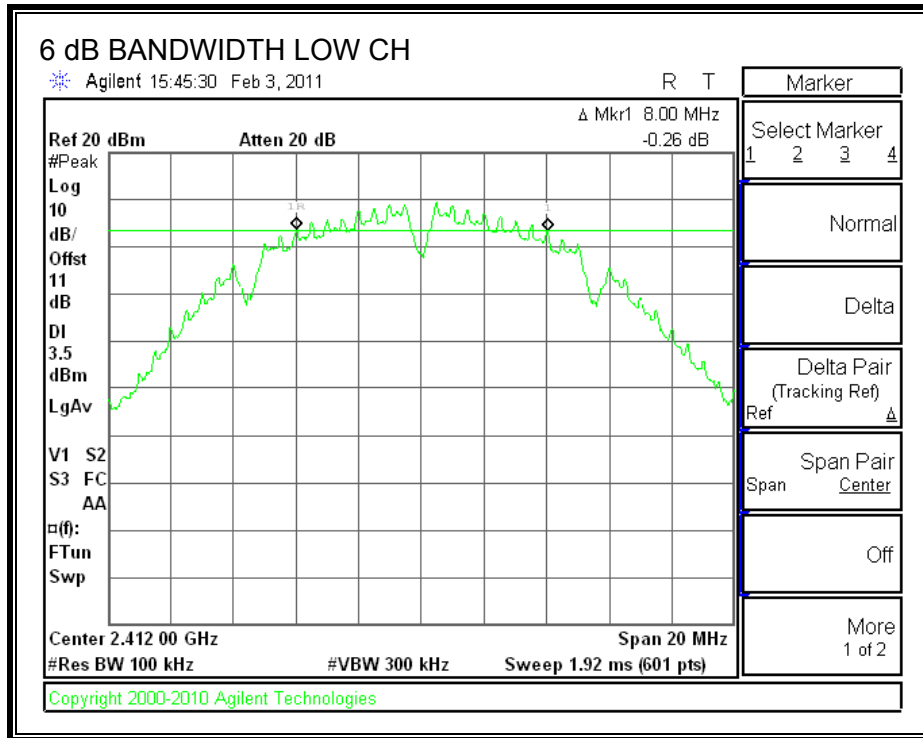

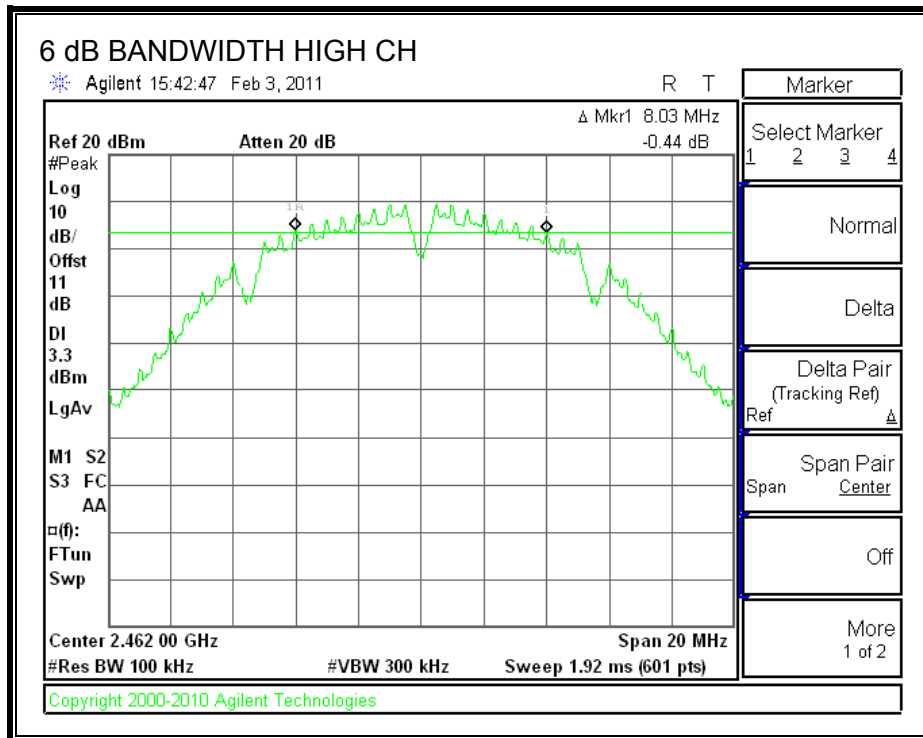

7.1.2. 99% BANDWIDTH

LIMITS

None; for reporting purposes only.

TEST PROCEDURE

The transmitter output is connected to the spectrum analyzer. The RBW is set to 1% to 3% of the 99 % bandwidth. The VBW is set to 3 times the RBW. The sweep time is coupled. The spectrum analyzer internal 99% bandwidth function is utilized.

RESULTS

Channel	Frequency (MHz)	99% Bandwidth (MHz)
Low	2412	12.4133
Middle	2437	12.5266
High	2462	12.3380

99% BANDWIDTH

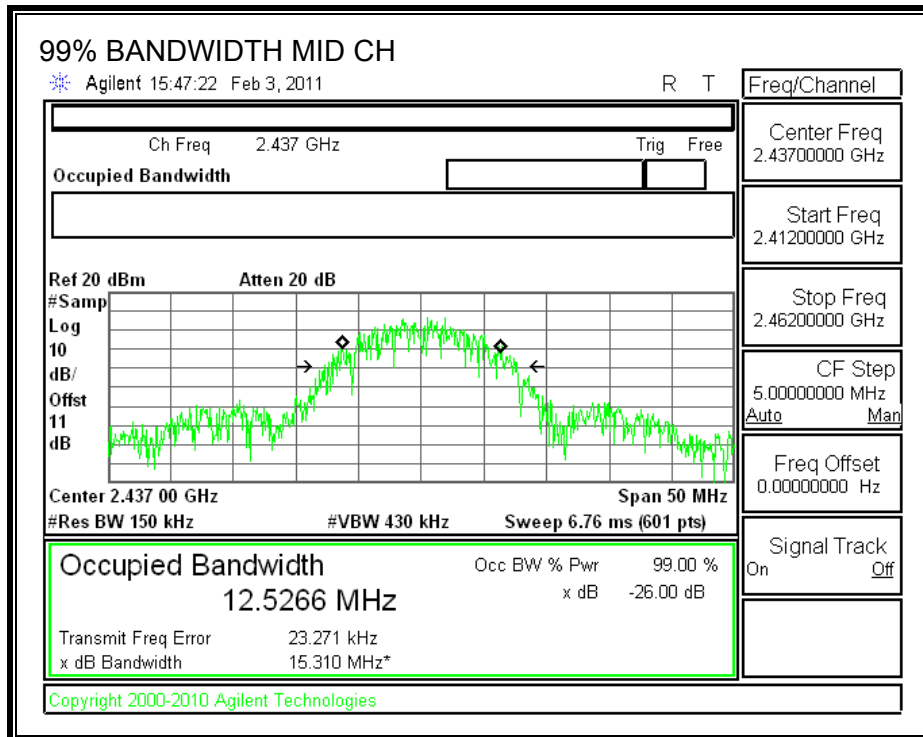
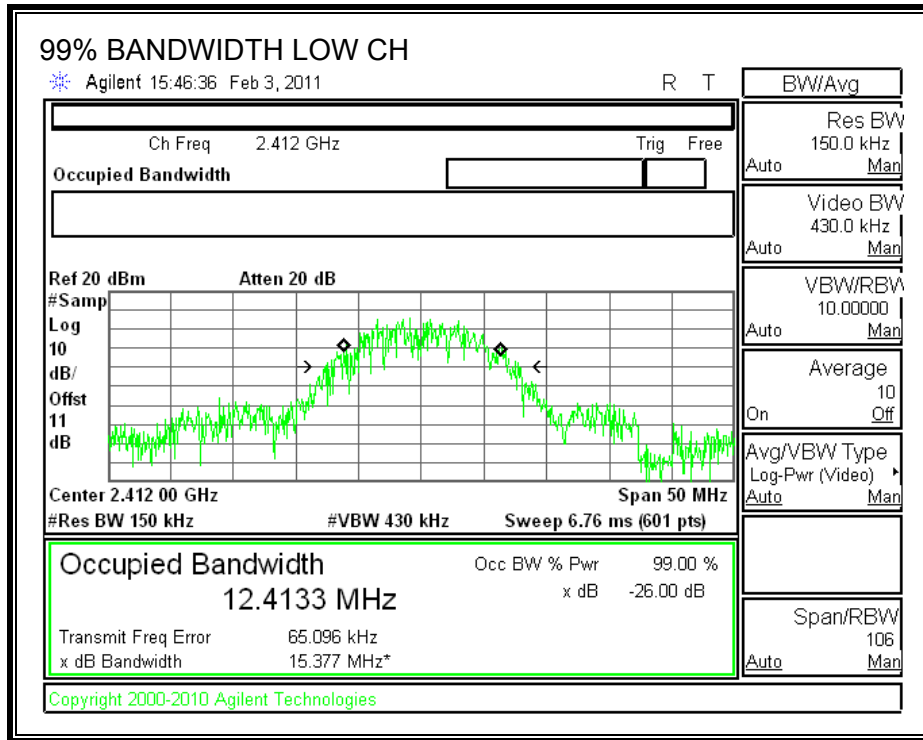

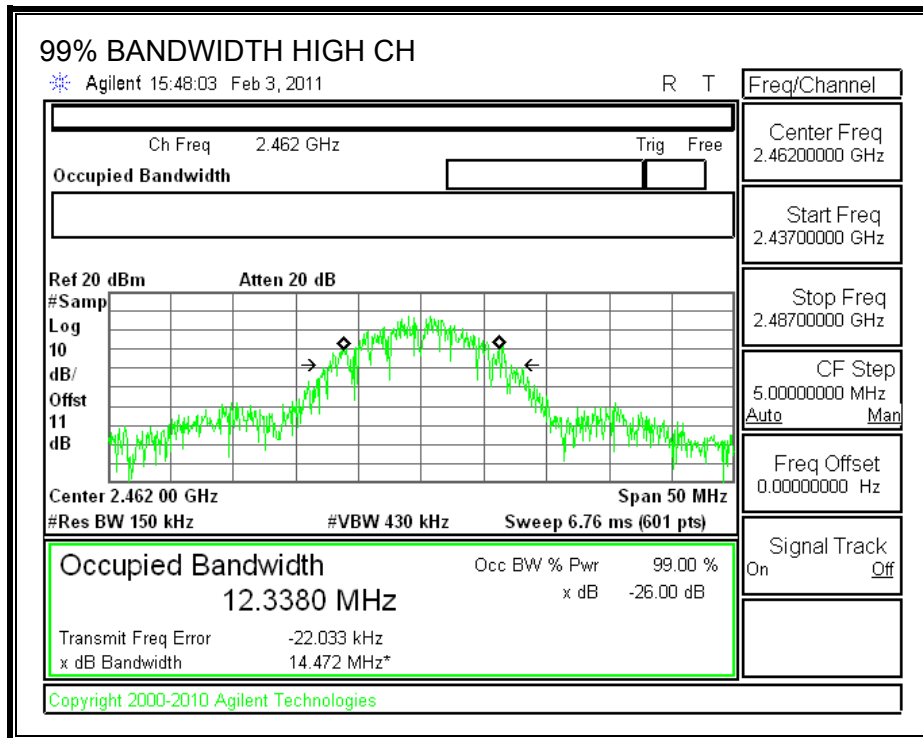

7.1.3. OUTPUT POWER

LIMITS

FCC §15.247 (b)

IC RSS-210 A8.4

The maximum antenna gain is less than or equal to 6 dBi, therefore the limit is 30 dBm.

TEST PROCEDURE

The transmitter output is connected to a power meter.

RESULTS

Channel	Frequency (MHz)	Output Power (dBm)	Limit (dBm)	Margin (dB)
Low	2412	18.20	30	-11.80
Middle	2437	18.30	30	-11.70
High	2462	18.20	30	-11.80

7.1.4. AVERAGE POWER

LIMITS

None; for reporting purposes only.

TEST PROCEDURE

The transmitter output is connected to a power meter.

RESULTS

The cable assembly insertion loss of 11dB (including 10 dB pad and 1dB cable) was entered as an offset in the power meter to allow for direct reading of power.

Channel	Frequency (MHz)	Power (dBm)
Low	2412	16.10
Middle	2437	16.10
High	2462	16.00

7.1.5. POWER SPECTRAL DENSITY

LIMITS

FCC §15.247 (e)

IC RSS-210 A8.2 (b)

The power spectral density conducted from the transmitter to the antenna shall not be greater than 8 dBm in any 3 kHz band during any time interval of continuous transmission.

TEST PROCEDURE

Output power was measured based on the use of a peak measurement, therefore the power spectral density was measured using PSD Option 1 in accordance with FCC document "Measurement of Digital Transmission Systems Operating under Section 15.247", March 23, 2005.

RESULTS

Channel	Frequency (MHz)	PPSD (dBm)	Limit (dBm)	Margin (dB)
Low	2412	-2.66	8	-10.66
Middle	2437	-2.68	8	-10.68
High	2462	-2.81	8	-10.81

POWER SPECTRAL DENSITY

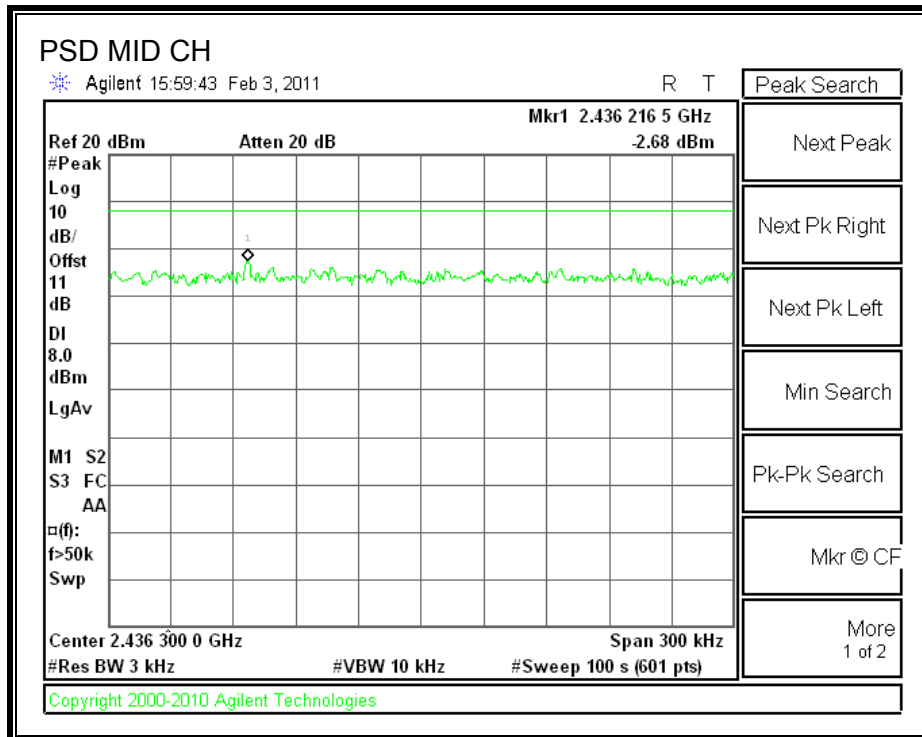
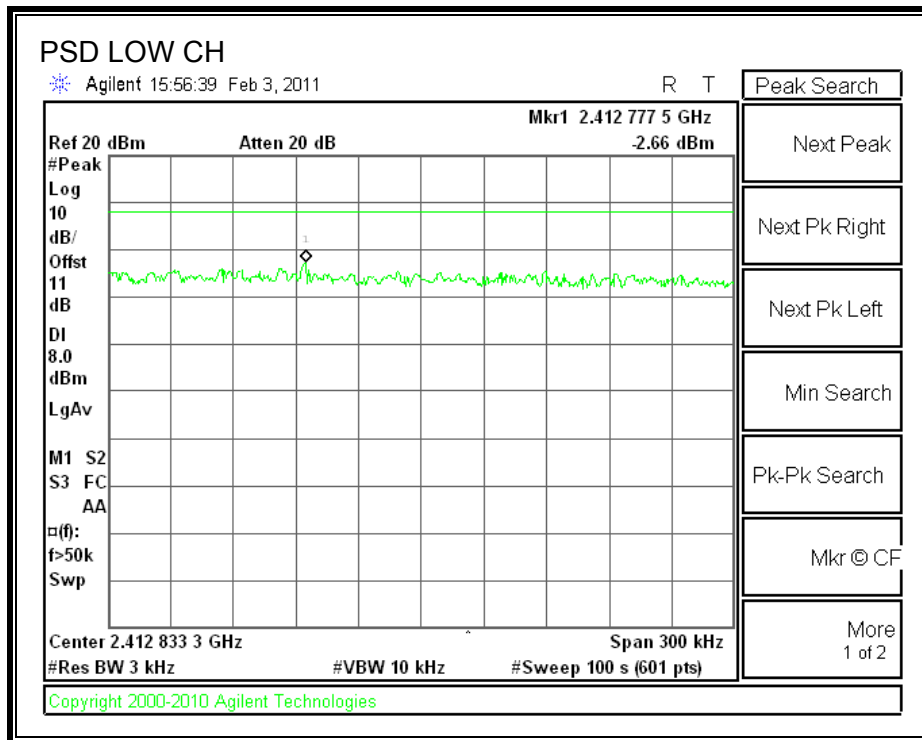

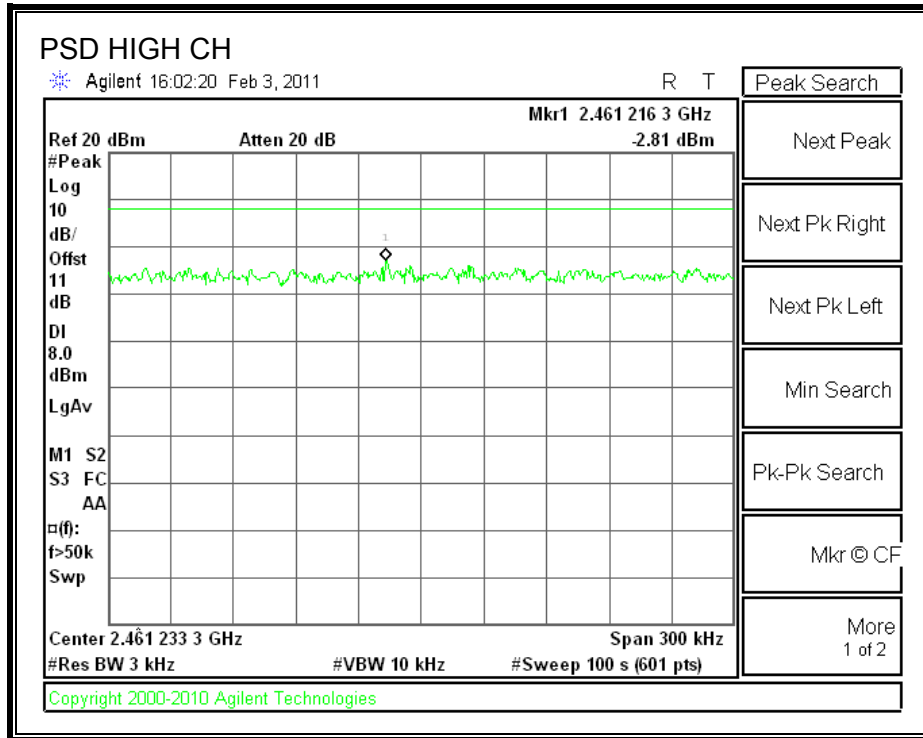

7.1.6. CONDUCTED SPURIOUS EMISSIONS

LIMITS

FCC §15.247 (d)

IC RSS-210 A8.5

Output power was measured based on the use of a peak measurement, therefore the required attenuation is 20 dB.

TEST PROCEDURE

The transmitter output is connected to a spectrum analyzer. The resolution bandwidth is set to 100 kHz. The video bandwidth is set to 300 kHz.

The spectrum from 30 MHz to 26 GHz is investigated with the transmitter set to the lowest, middle, and highest channels.

RESULTS

SPURIOUS EMISSIONS, LOW CHANNEL

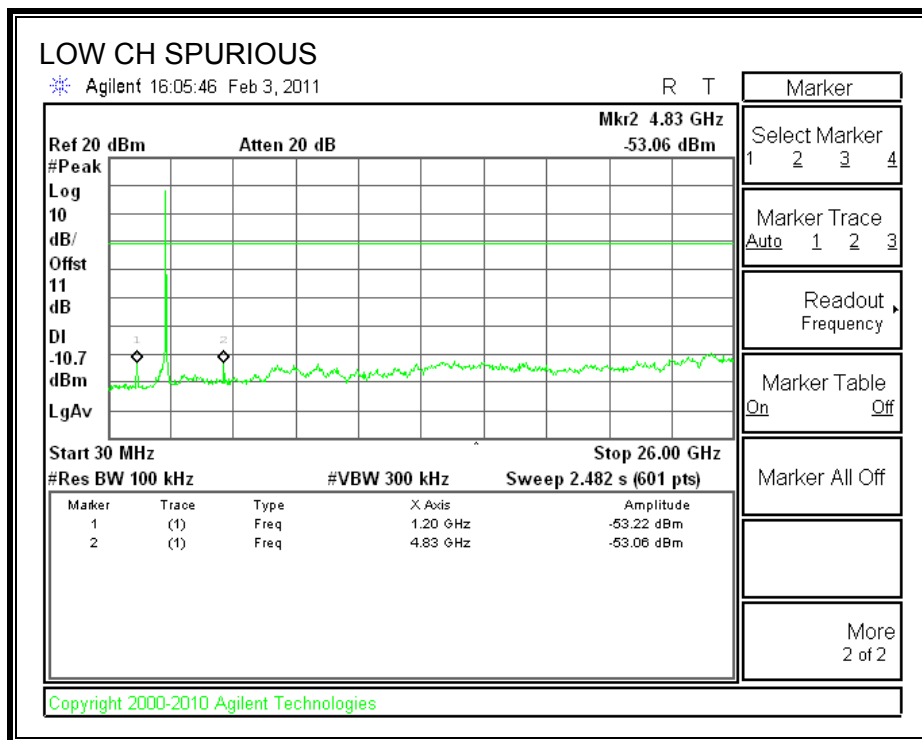
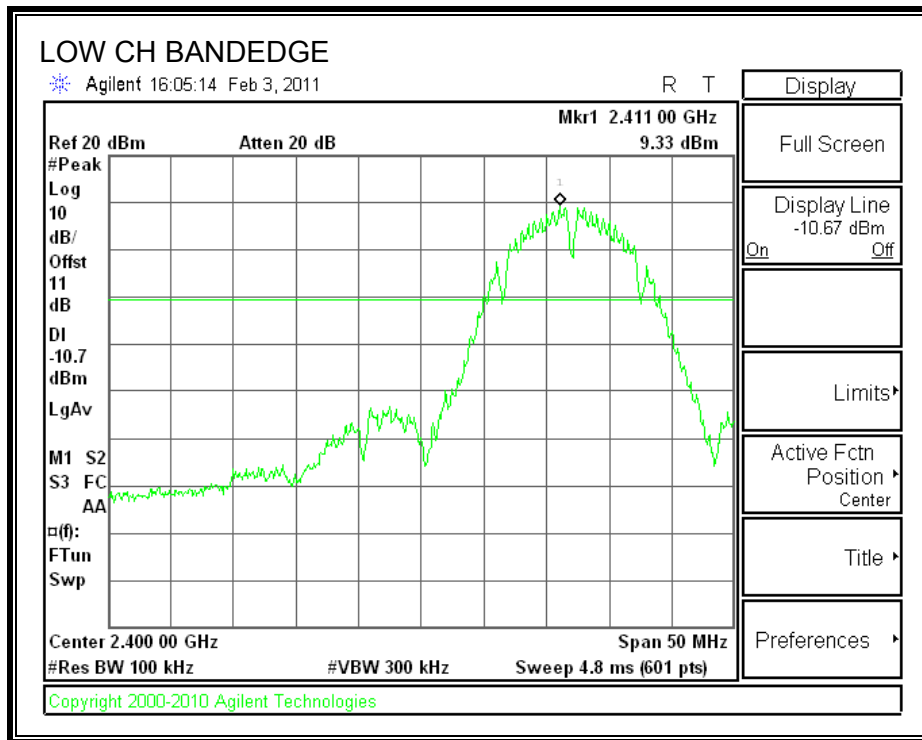

SPURIOUS EMISSIONS, MID CHANNEL

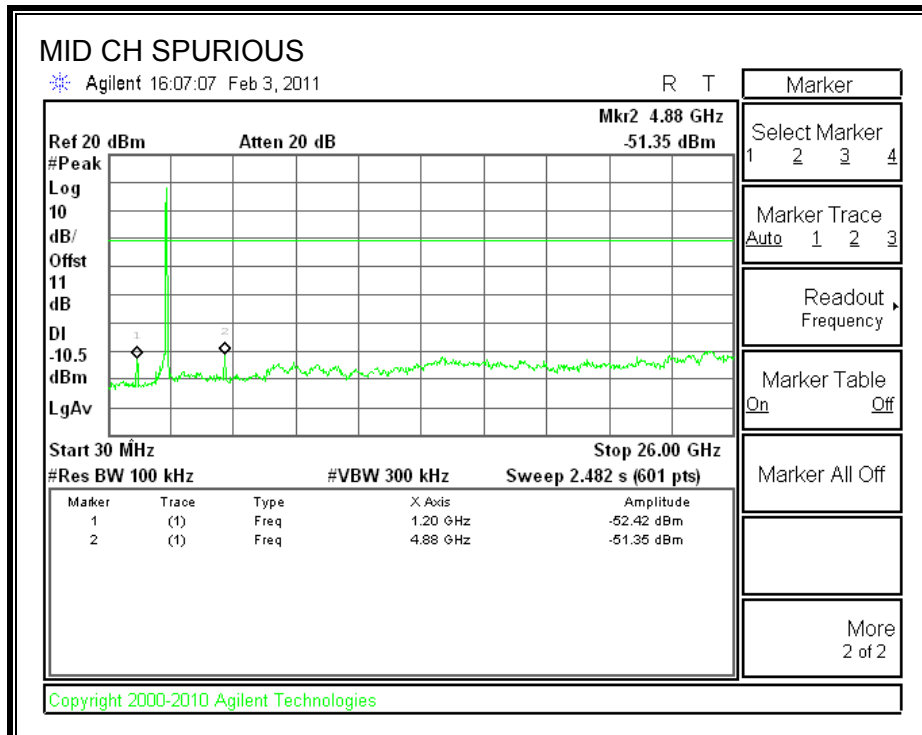
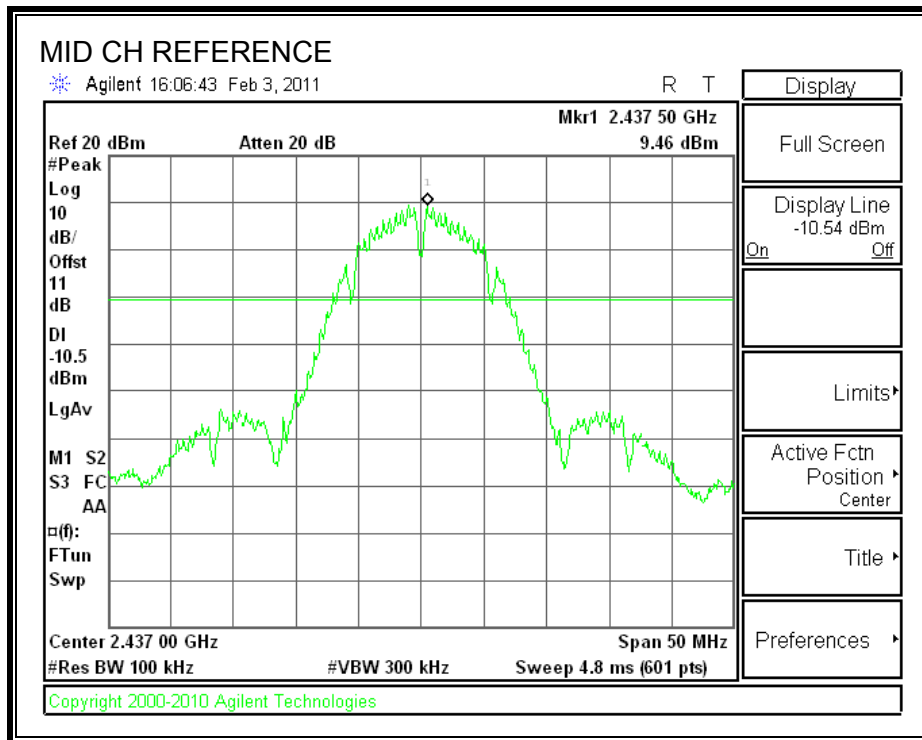

SPURIOUS EMISSIONS, HIGH CHANNEL

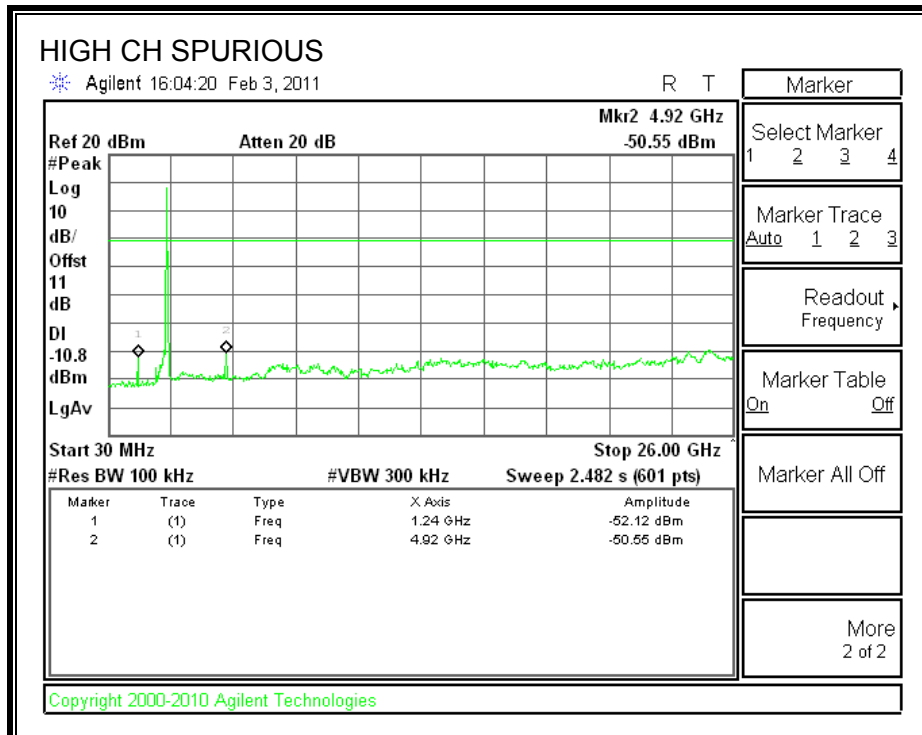
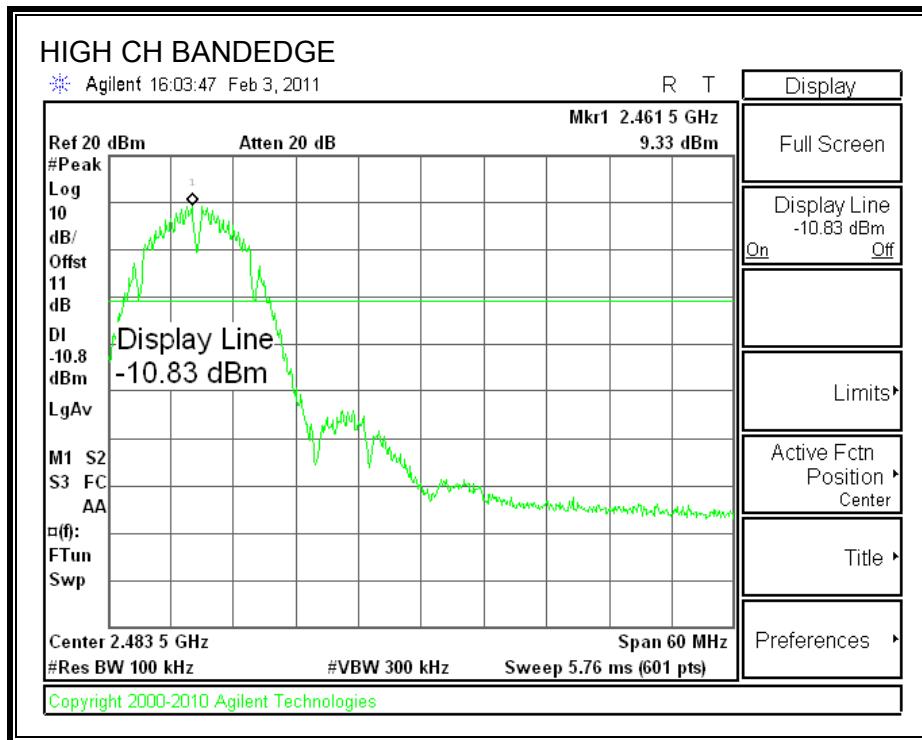

7.2. 802.11g MODE IN THE 2.4 GHz BAND

7.2.1. 6 dB BANDWIDTH

LIMITS

FCC §15.247 (a) (2)

IC RSS-210 A8.2 (a)

The minimum 6 dB bandwidth shall be at least 500 kHz.

TEST PROCEDURE

The transmitter output is connected to a spectrum analyzer. The RBW is set to 100 kHz and the VBW is set to 300 kHz. The sweep time is coupled.

RESULTS

Channel	Frequency (MHz)	6 dB Bandwidth (MHz)	Minimum Limit (MHz)
Low	2412	15.03	0.5
Middle	2437	15.00	0.5
High	2462	15.00	0.5

6 dB BANDWIDTH

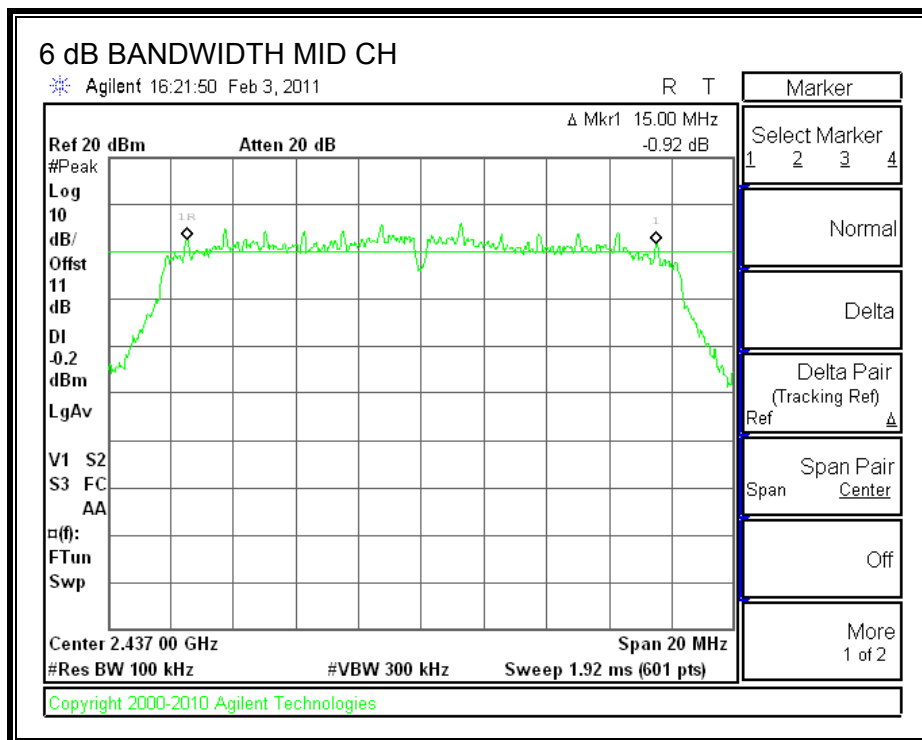
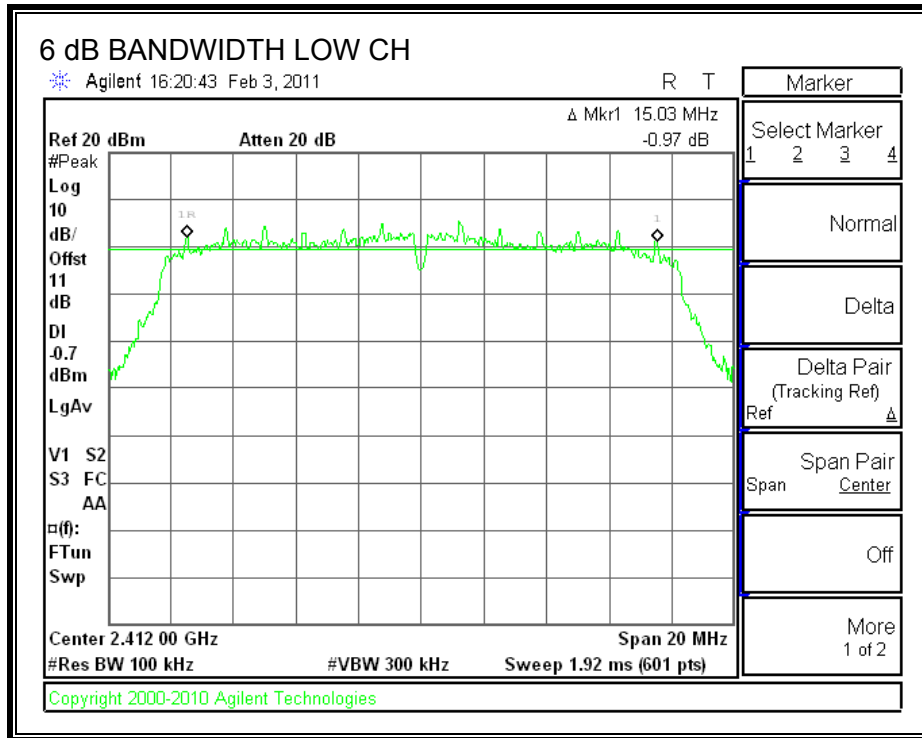

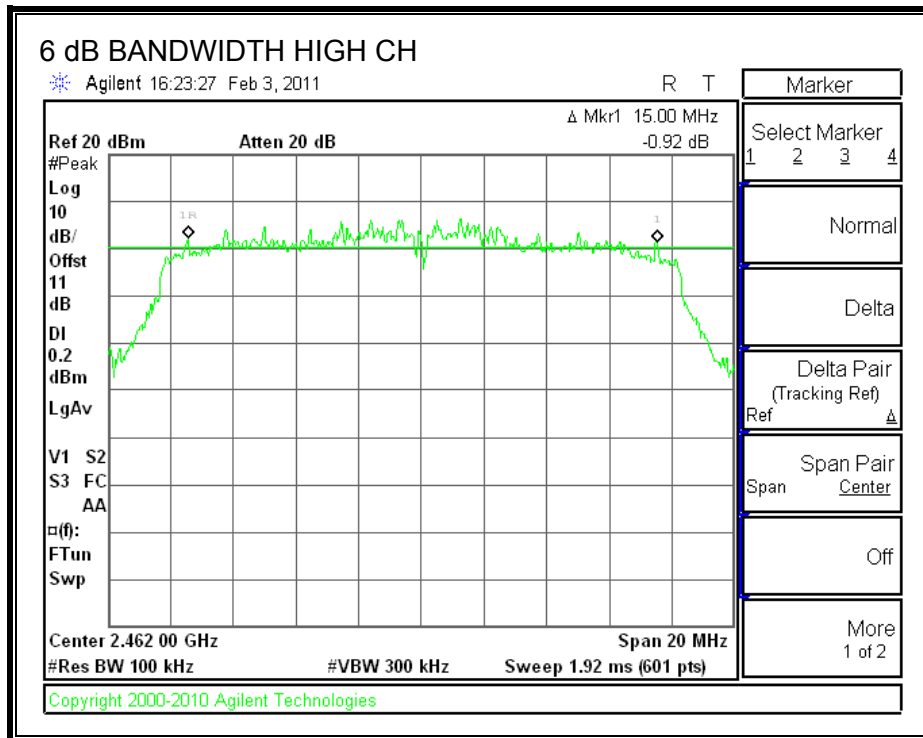

7.2.2. 99% BANDWIDTH

LIMITS

None; for reporting purposes only.

TEST PROCEDURE

The transmitter output is connected to the spectrum analyzer. The RBW is set to 1% to 3% of the 99 % bandwidth. The VBW is set to 3 times the RBW. The sweep time is coupled. The spectrum analyzer internal 99% bandwidth function is utilized.

RESULTS

Channel	Frequency (MHz)	99% Bandwidth (MHz)
Low	2412	16.3107
Middle	2437	16.3240
High	2462	16.2325

99% BANDWIDTH

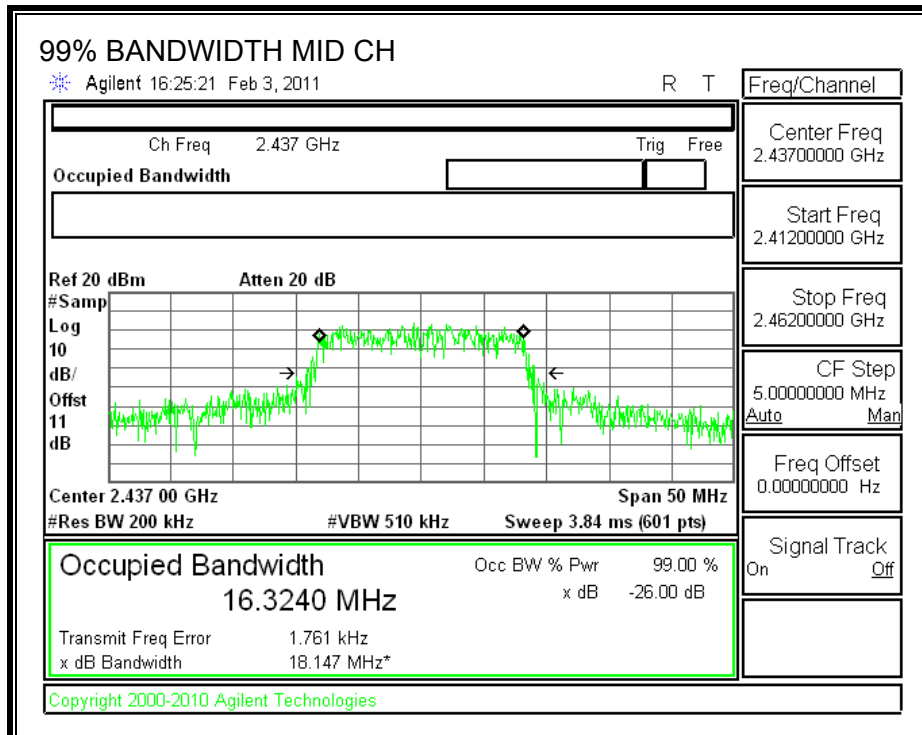
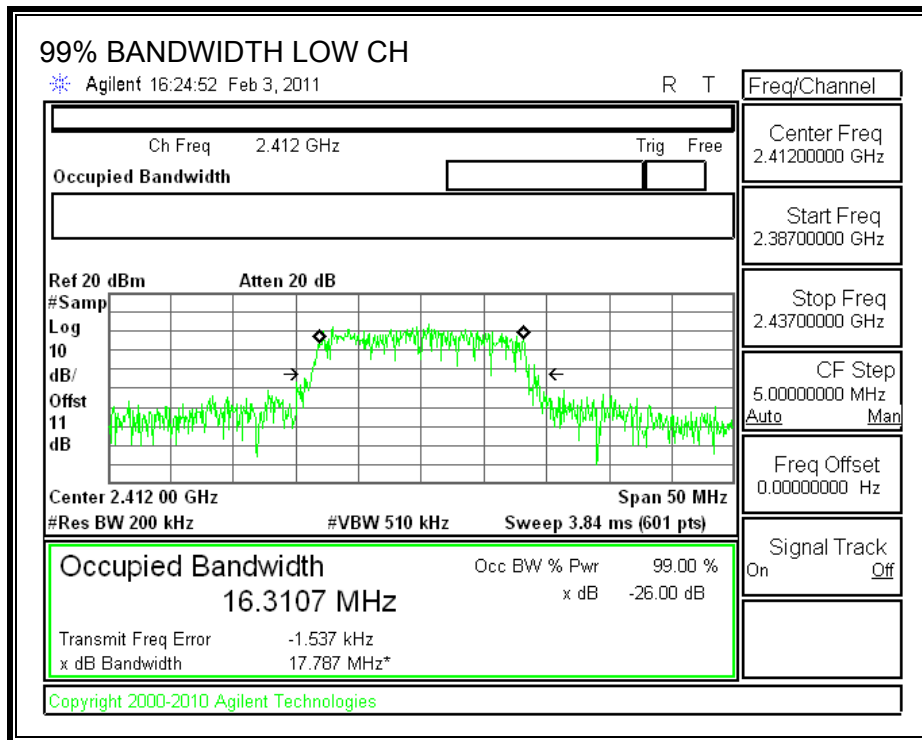

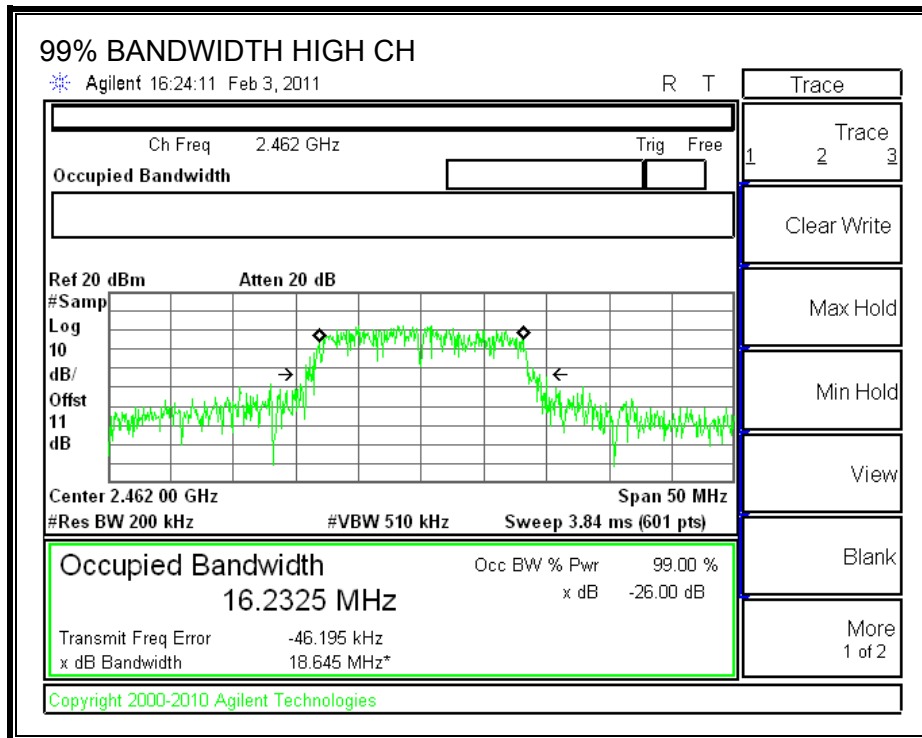

7.2.3. OUTPUT POWER

LIMITS

FCC §15.247 (b)

IC RSS-210 A8.4

The maximum antenna gain is less than or equal to 6 dBi, therefore the limit is 30 dBm. z

TEST PROCEDURE

The transmitter output is connected to a power meter.

RESULTS

Channel	Frequency (MHz)	Output Power (dBm)	Limit (dBm)	Margin (dB)
Low	2412	24.10	30	-5.90
Middle	2437	24.20	30	-5.80
High	2462	24.00	30	-6.00

7.2.4. AVERAGE POWER

LIMITS

None; for reporting purposes only.

TEST PROCEDURE

The transmitter output is connected to a power meter.

RESULTS

The cable assembly insertion loss of 11 dB (including 10 dB pad and 1 dB cable) was entered as an offset in the power meter to allow for direct reading of power.

Channel	Frequency (MHz)	Power (dBm)
Low	2412	15.10
Middle	2437	15.30
High	2462	15.20

7.2.5. POWER SPECTRAL DENSITY

LIMITS

FCC §15.247 (e)

IC RSS-210 A8.2 (b)

The power spectral density conducted from the transmitter to the antenna shall not be greater than 8 dBm in any 3 kHz band during any time interval of continuous transmission.

TEST PROCEDURE

Output power was measured based on the use of a peak measurement, therefore the power spectral density was measured using PSD Option 1 in accordance with FCC document "Measurement of Digital Transmission Systems Operating under Section 15.247", March 23, 2005.

RESULTS

Channel	Frequency (MHz)	PPSD (dBm)	Limit (dBm)	Margin (dB)
Low	2412	-7.44	8	-15.44
Middle	2437	-7.32	8	-15.32
High	2462	-6.88	8	-14.88

POWER SPECTRAL DENSITY

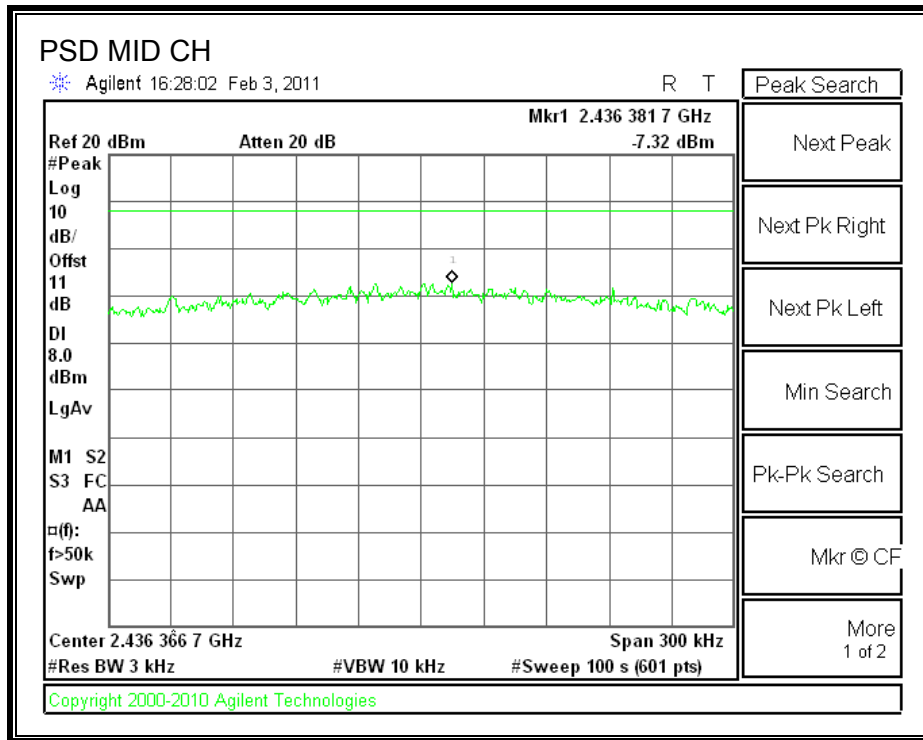
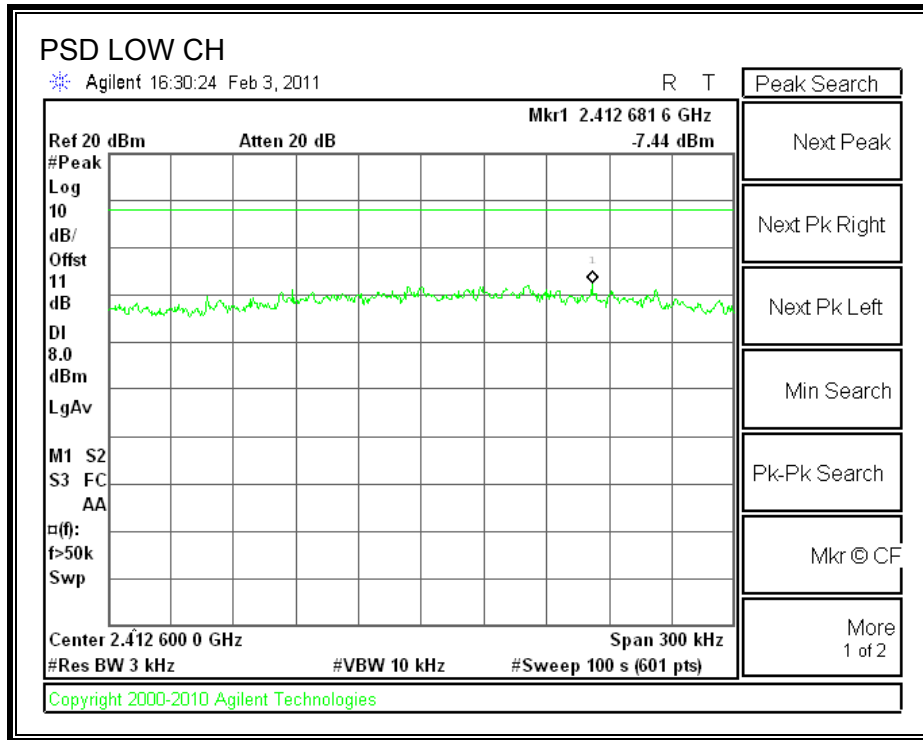

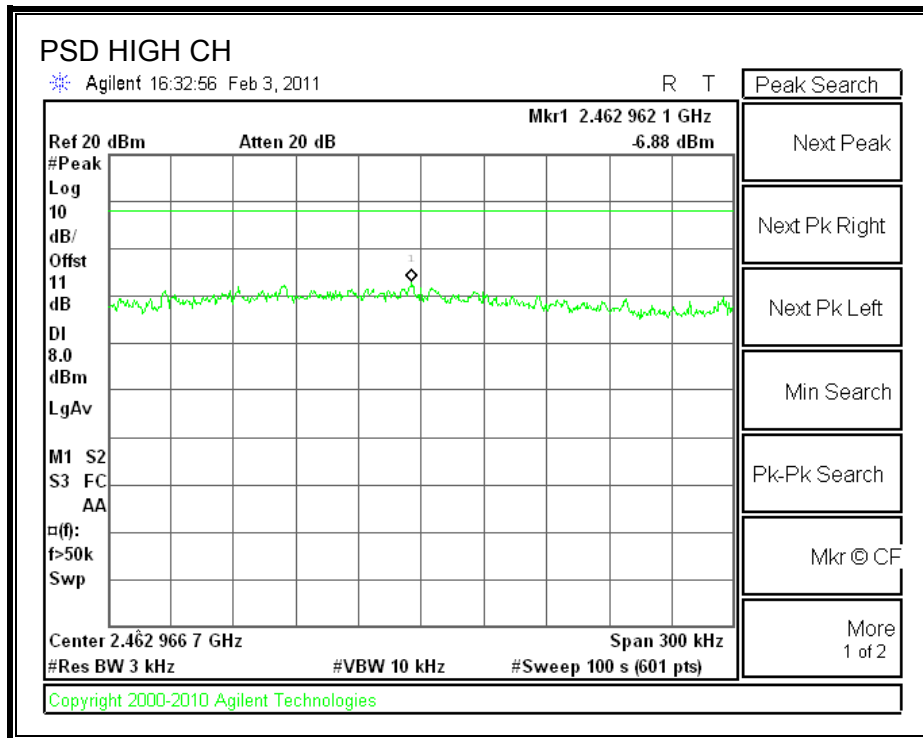

7.2.6. CONDUCTED SPURIOUS EMISSIONS

LIMITS

FCC §15.247 (d)

IC RSS-210 A8.5

Output power was measured based on the use of a peak measurement, therefore the required attenuation is 20 dB.

TEST PROCEDURE

The transmitter output is connected to a spectrum analyzer. The resolution bandwidth is set to 100 kHz. The video bandwidth is set to 300 kHz.

The spectrum from 30 MHz to 26 GHz is investigated with the transmitter set to the lowest, middle, and highest channels.

RESULTS

SPURIOUS EMISSIONS, LOW CHANNEL

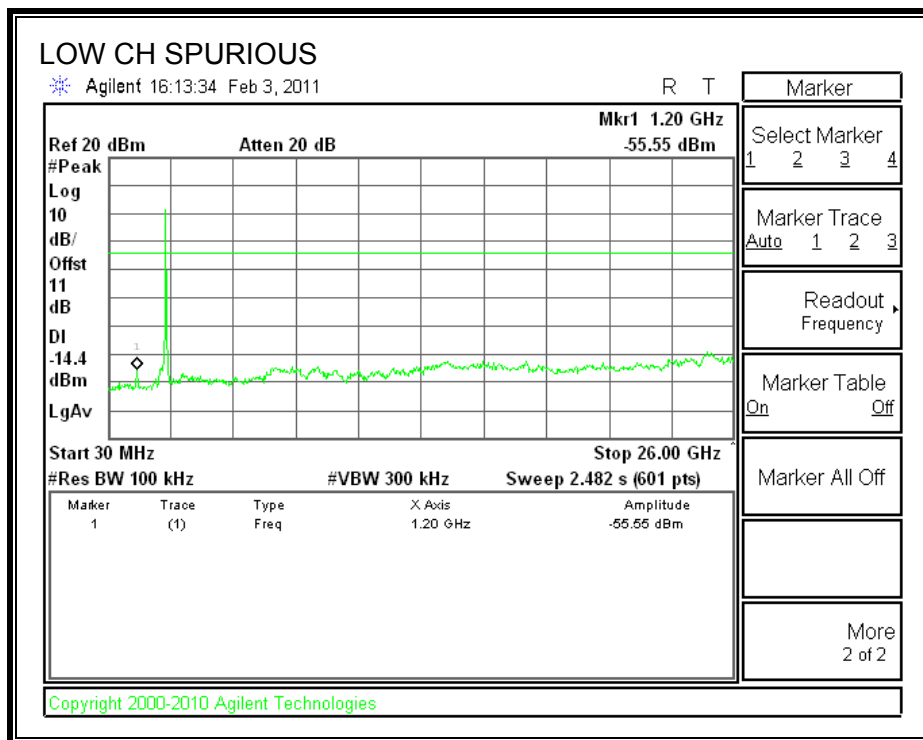
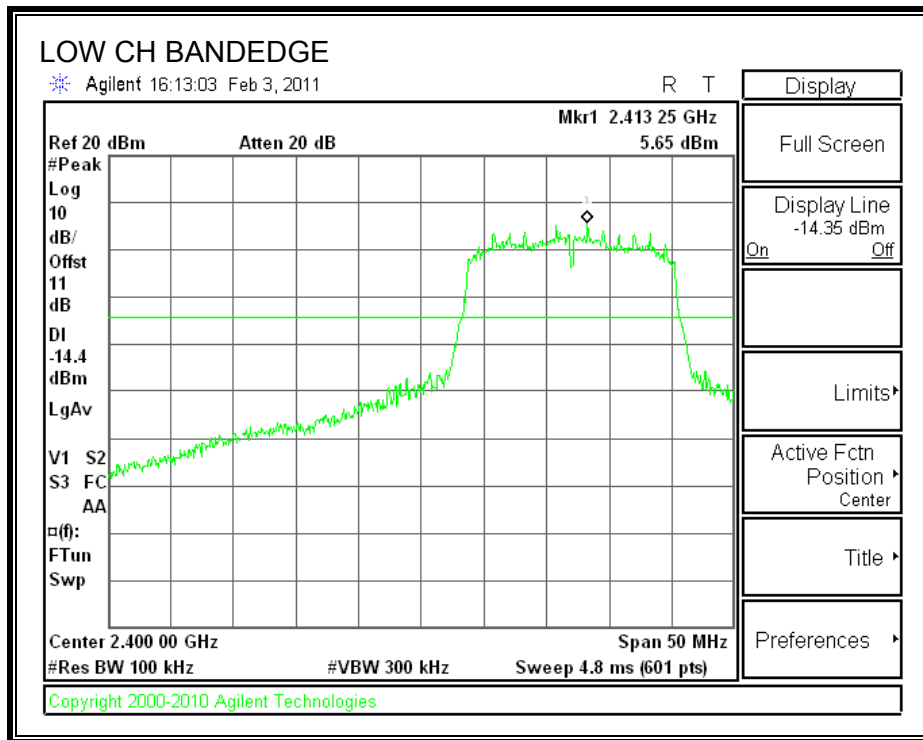

SPURIOUS EMISSIONS, MID CHANNEL

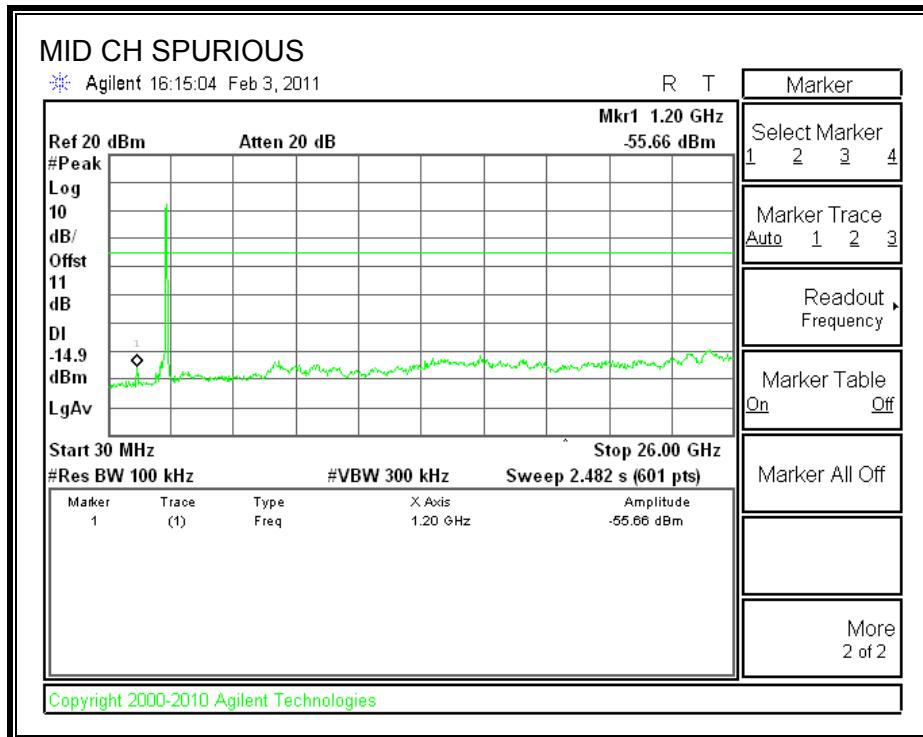
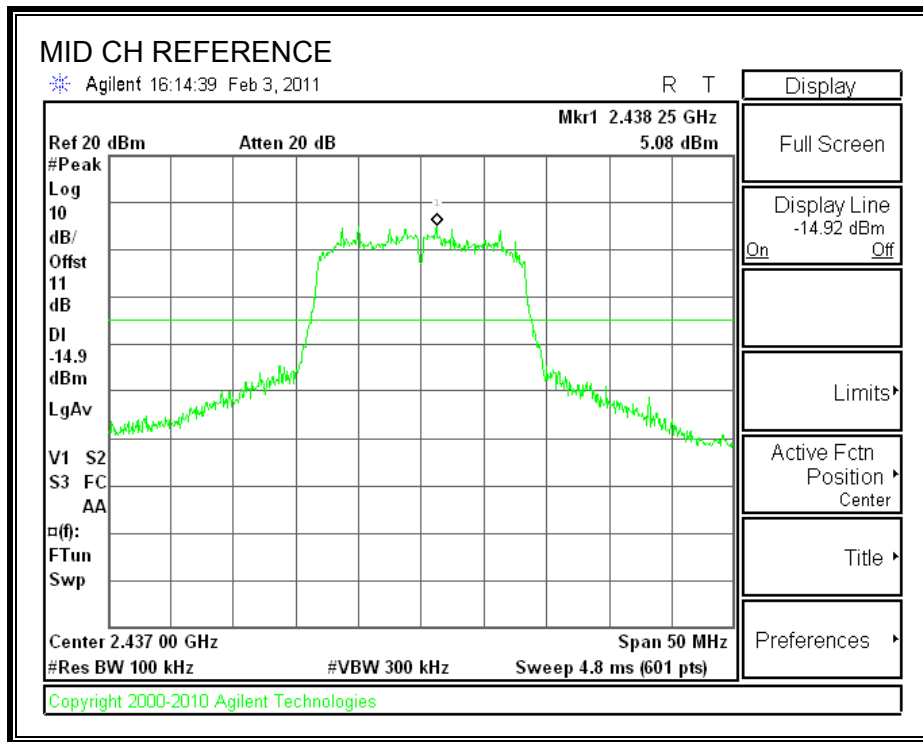

SPURIOUS EMISSIONS, HIGH CHANNEL

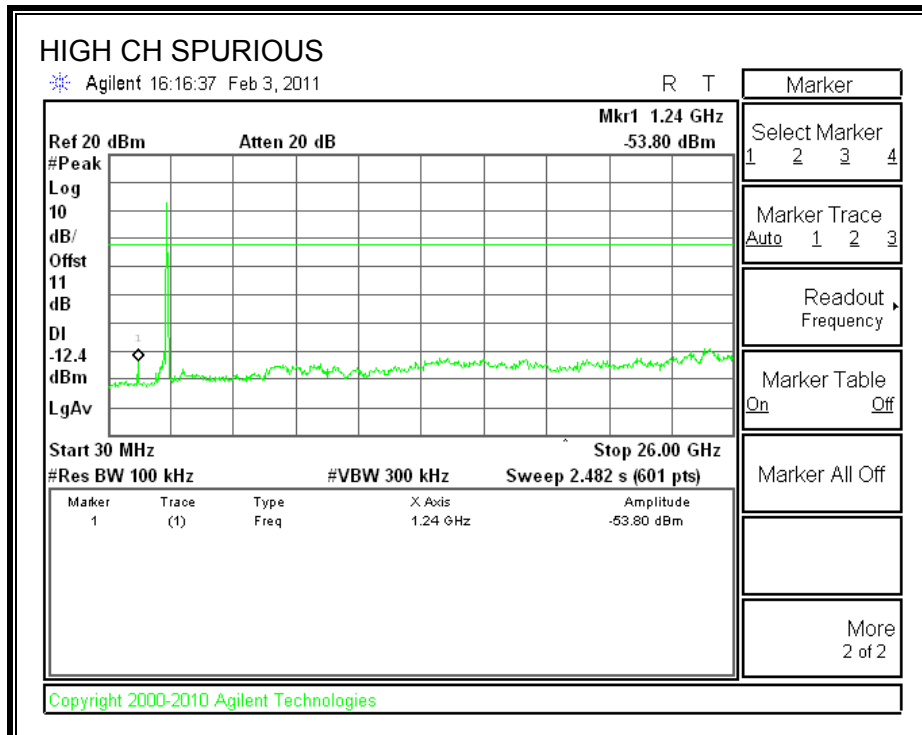
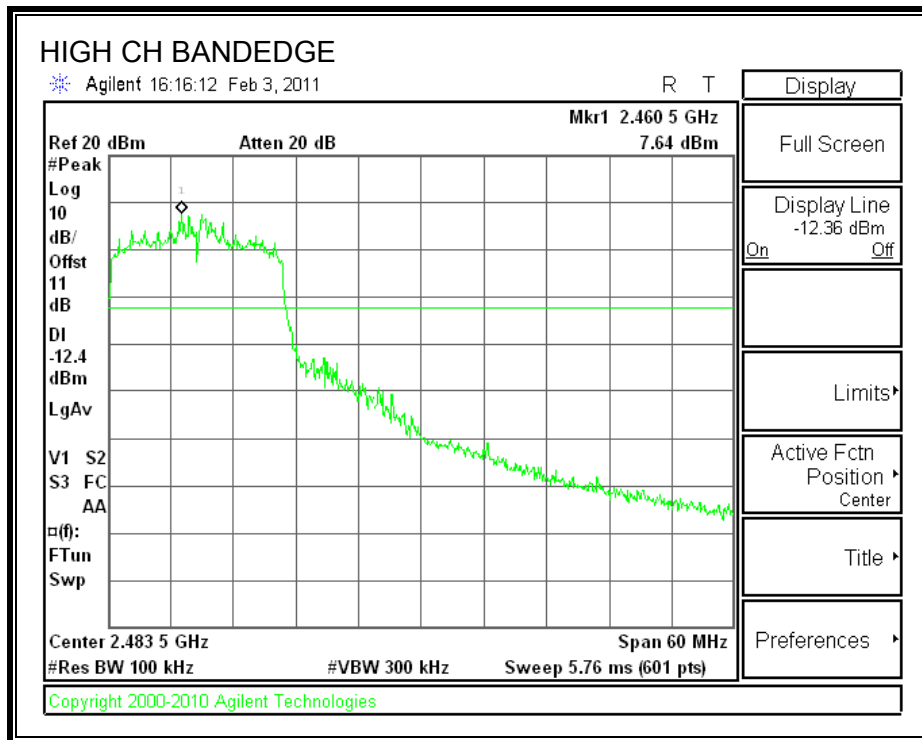

7.3. 802.11n HT20 SISO MODE IN THE 2.4 GHz BAND

7.3.1. 6 dB BANDWIDTH

LIMITS

FCC §15.247 (a) (2)

IC RSS-210 A8.2 (a)

The minimum 6 dB bandwidth shall be at least 500 kHz.

TEST PROCEDURE

The transmitter output is connected to a spectrum analyzer. The RBW is set to 100 kHz and the VBW is set to 300 kHz. The sweep time is coupled.

RESULTS

Channel	Frequency (MHz)	6 dB Bandwidth (MHz)	Minimum Limit (MHz)
Low	2412	15.05	0.5
Middle	2437	14.95	0.5
High	2462	15.00	0.5

6 dB BANDWIDTH

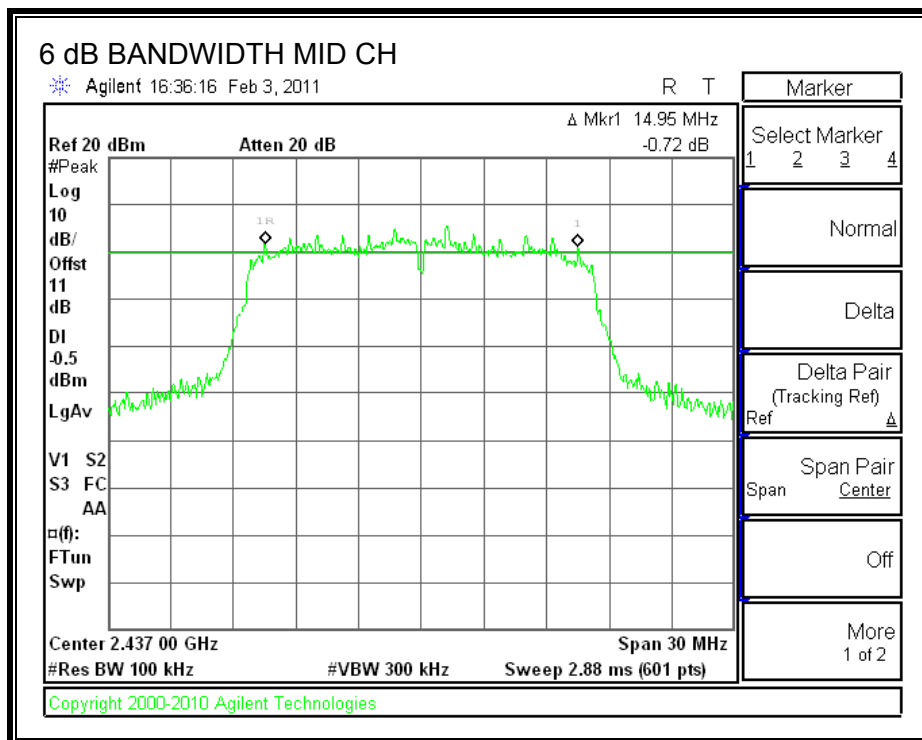
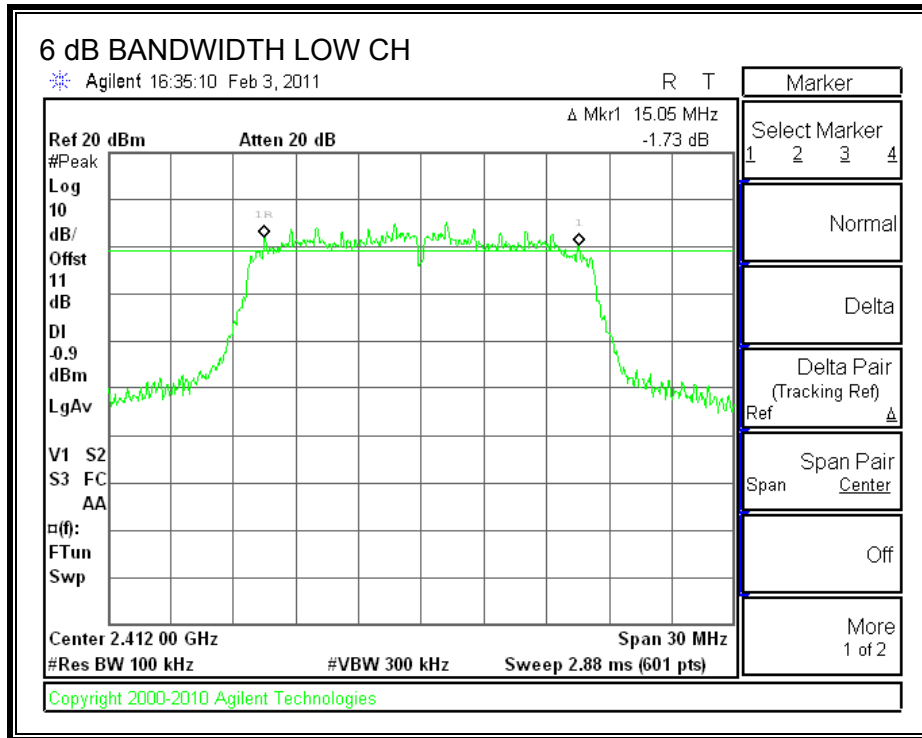

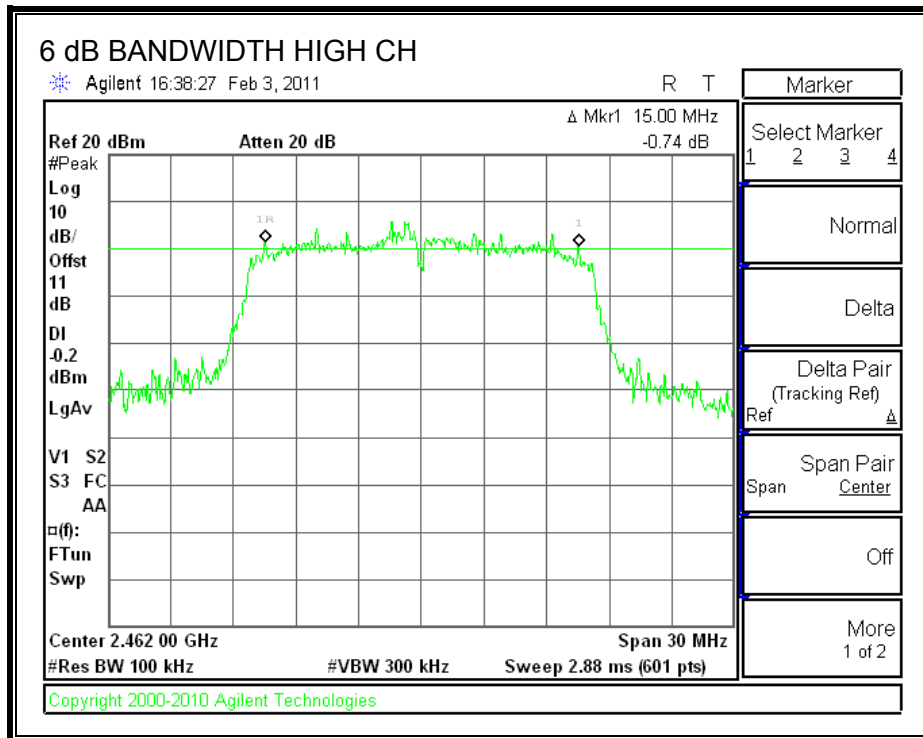

7.3.2. 99% BANDWIDTH

LIMITS

None; for reporting purposes only.

TEST PROCEDURE

The transmitter output is connected to the spectrum analyzer. The RBW is set to 1% to 3% of the 99 % bandwidth. The VBW is set to 3 times the RBW. The sweep time is coupled. The spectrum analyzer internal 99% bandwidth function is utilized.

RESULTS

Channel	Frequency (MHz)	99% Bandwidth (MHz)
Low	2412	16.3681
Middle	2437	16.4601
High	2462	16.3586

99% BANDWIDTH

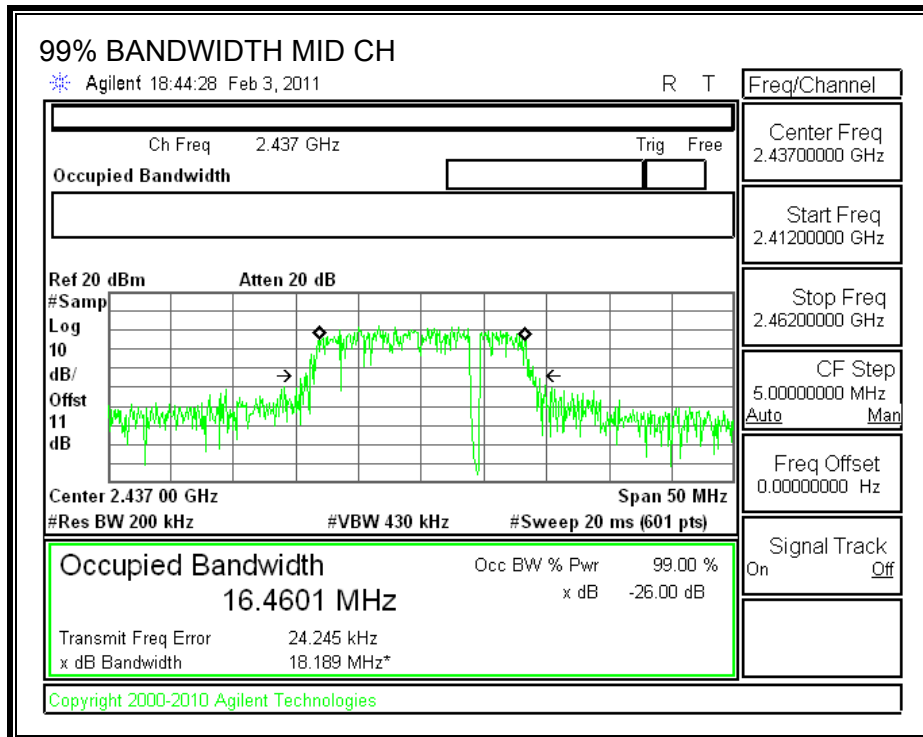
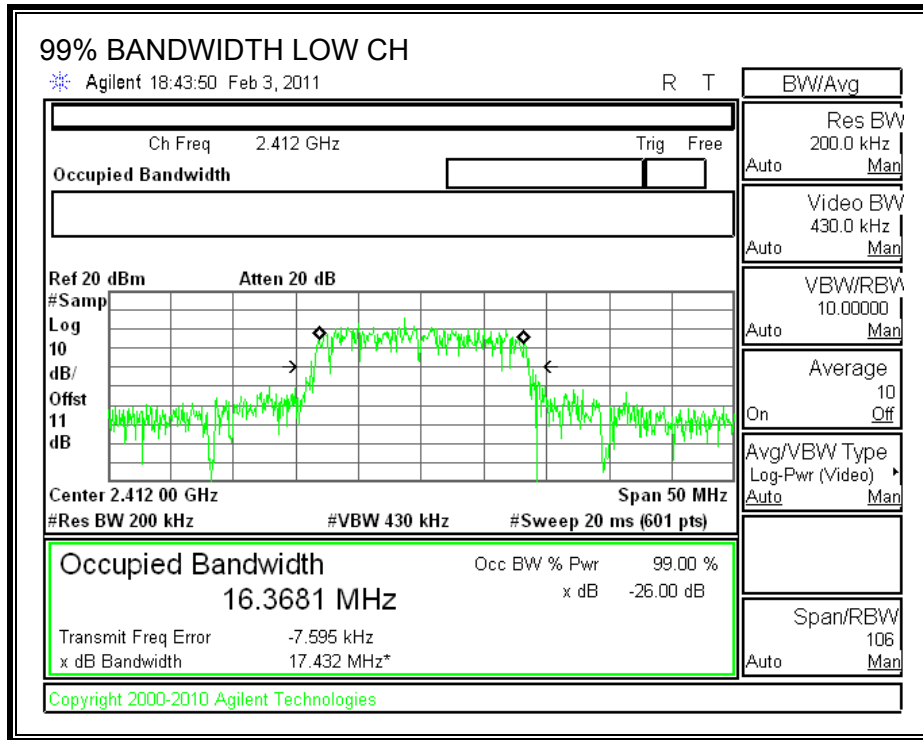

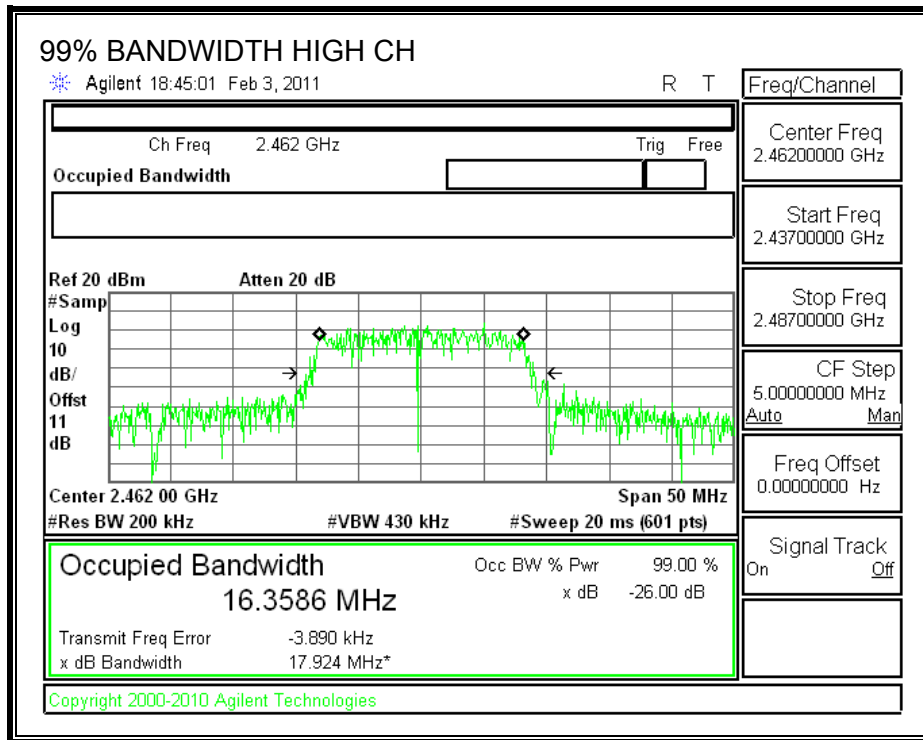

7.3.3. OUTPUT POWER

LIMITS

FCC §15.247 (b)

IC RSS-210 A8.4

The maximum antenna gain is less than or equal to 6 dBi, therefore the limit is 30 dBm.

TEST PROCEDURE

The transmitter output is connected to a power meter.

RESULTS

Channel	Frequency (MHz)	Output Power (dBm)	Limit (dBm)	Margin (dB)
Low	2412	23.90	30	-6.10
Middle	2437	24.00	30	-6.00
High	2462	23.80	30	-6.20

7.3.4. AVERAGE POWER

LIMITS

None; for reporting purposes only.

TEST PROCEDURE

The transmitter output is connected to a power meter.

RESULTS

The cable assembly insertion loss of 11 dB (including 10 dB pad and 1.0 dB cable) was entered as an offset in the power meter to allow for direct reading of power.

Channel	Frequency (MHz)	Power (dBm)
Low	2412	14.60
Middle	2437	14.70
High	2462	14.50

7.3.5. POWER SPECTRAL DENSITY

LIMITS

FCC §15.247 (e)

IC RSS-210 A8.2 (b)

The power spectral density conducted from the transmitter to the antenna shall not be greater than 8 dBm in any 3 kHz band during any time interval of continuous transmission.

TEST PROCEDURE

Output power was measured based on the use of a peak measurement, therefore the power spectral density was measured using PSD Option 1 in accordance with FCC document "Measurement of Digital Transmission Systems Operating under Section 15.247", March 23, 2005.

RESULTS

Channel	Frequency (MHz)	PPSD (dBm)	Limit (dBm)	Margin (dB)
Low	2412	-5.33	8	-13.33
Middle	2437	-5.29	8	-13.29
High	2462	-5.66	8	-13.66

POWER SPECTRAL DENSITY

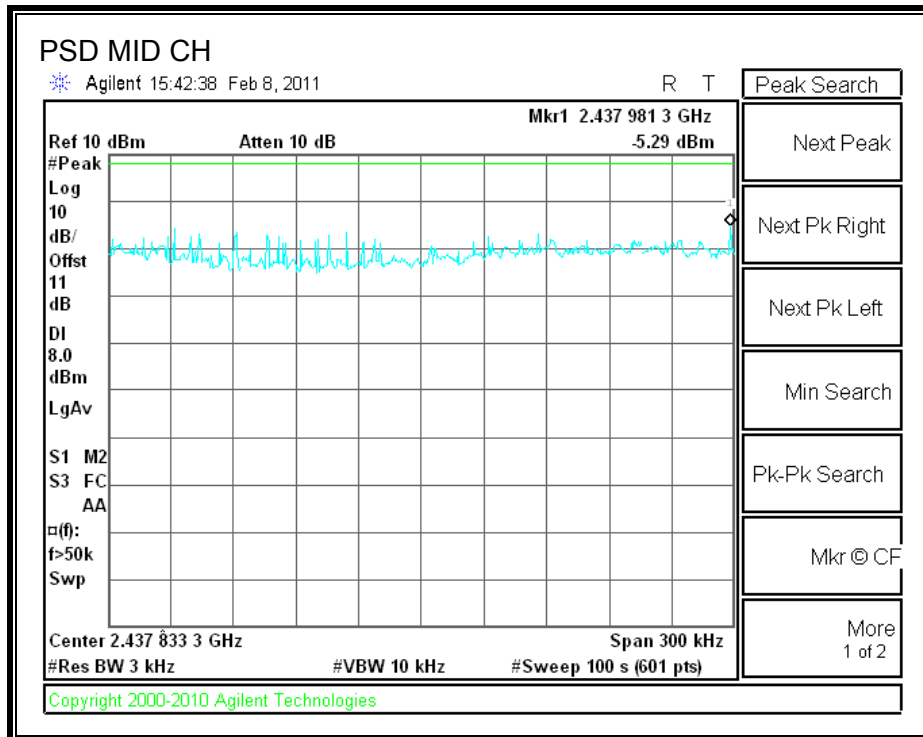
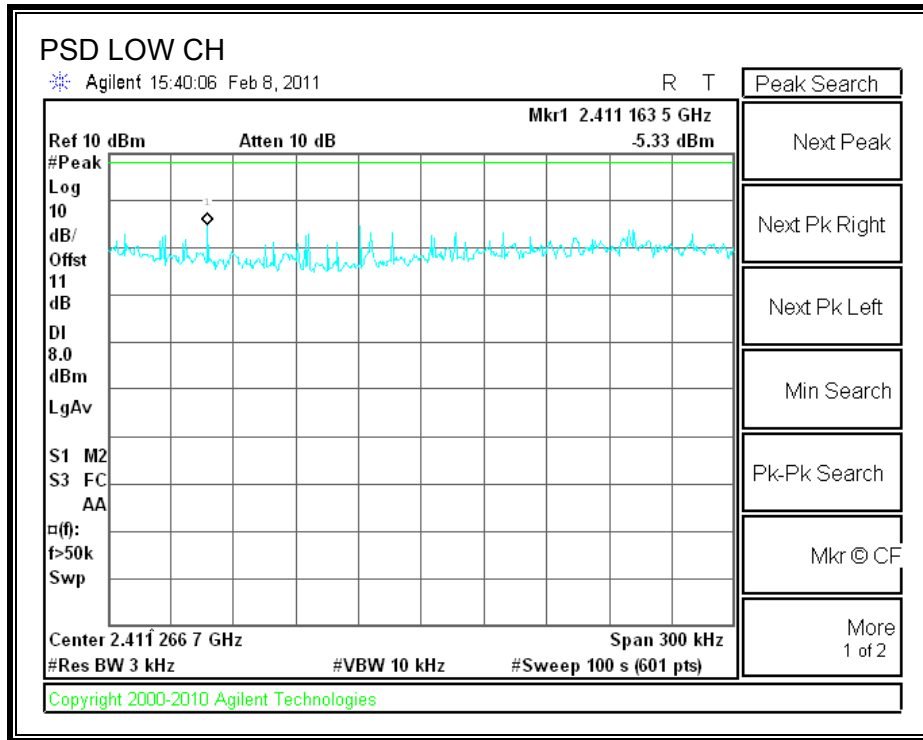

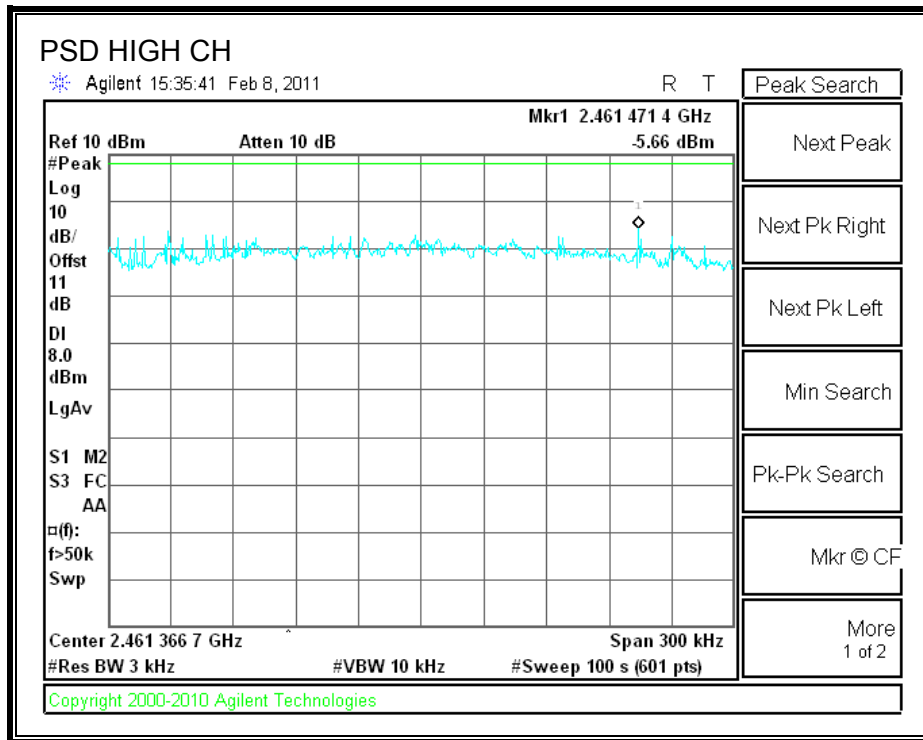

7.3.6. CONDUCTED SPURIOUS EMISSIONS

LIMITS

FCC §15.247 (d)

IC RSS-210 A8.5

Output power was measured based on the use of a peak measurement, therefore the required attenuation is 20 dB.

TEST PROCEDURE

The transmitter output is connected to a spectrum analyzer. The resolution bandwidth is set to 100 kHz. The video bandwidth is set to 300 kHz.

The spectrum from 30 MHz to 26 GHz is investigated with the transmitter set to the lowest, middle, and highest channels.

RESULTS

SPURIOUS EMISSIONS, LOW CHANNEL

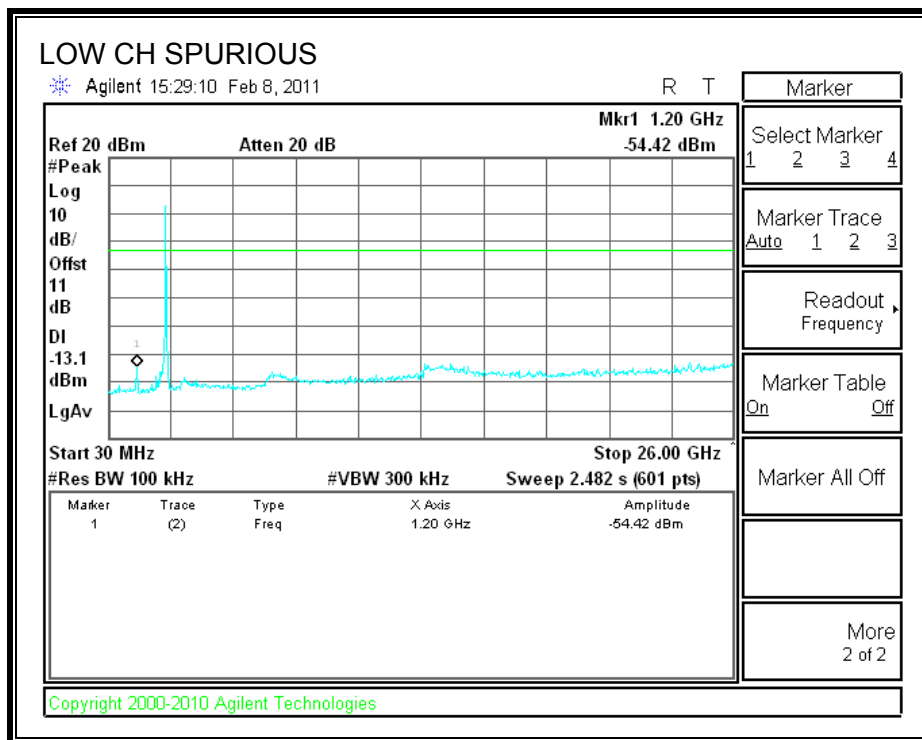
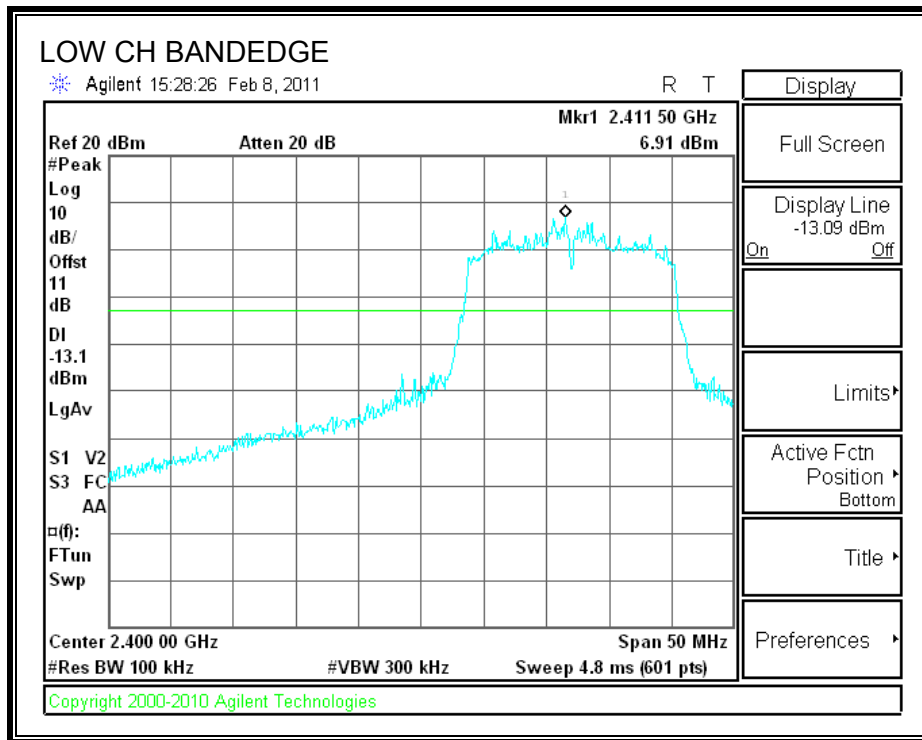

SPURIOUS EMISSIONS, MID CHANNEL

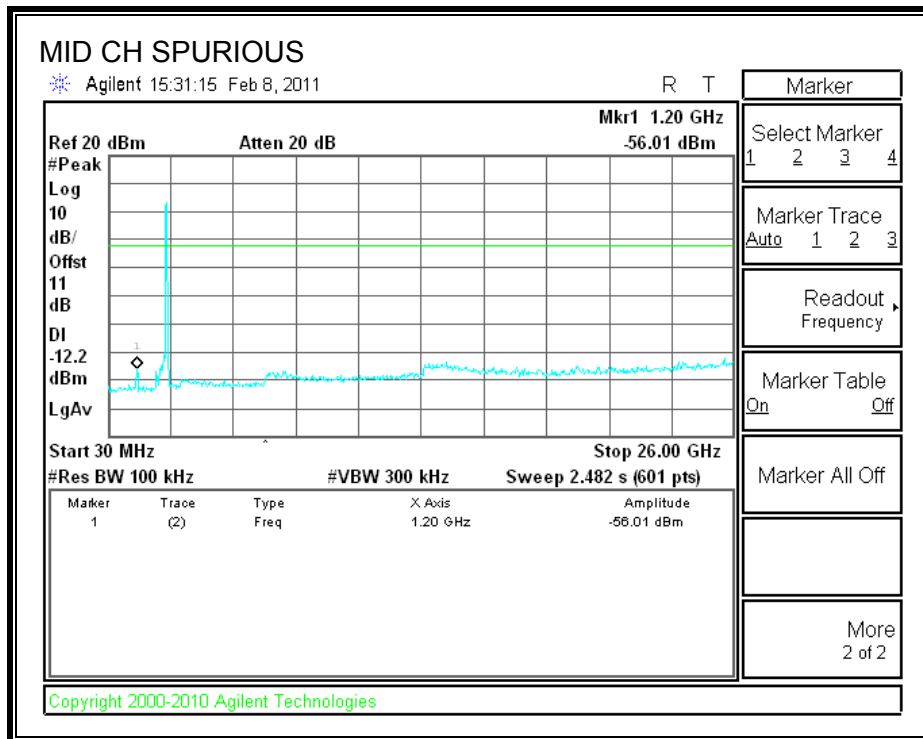
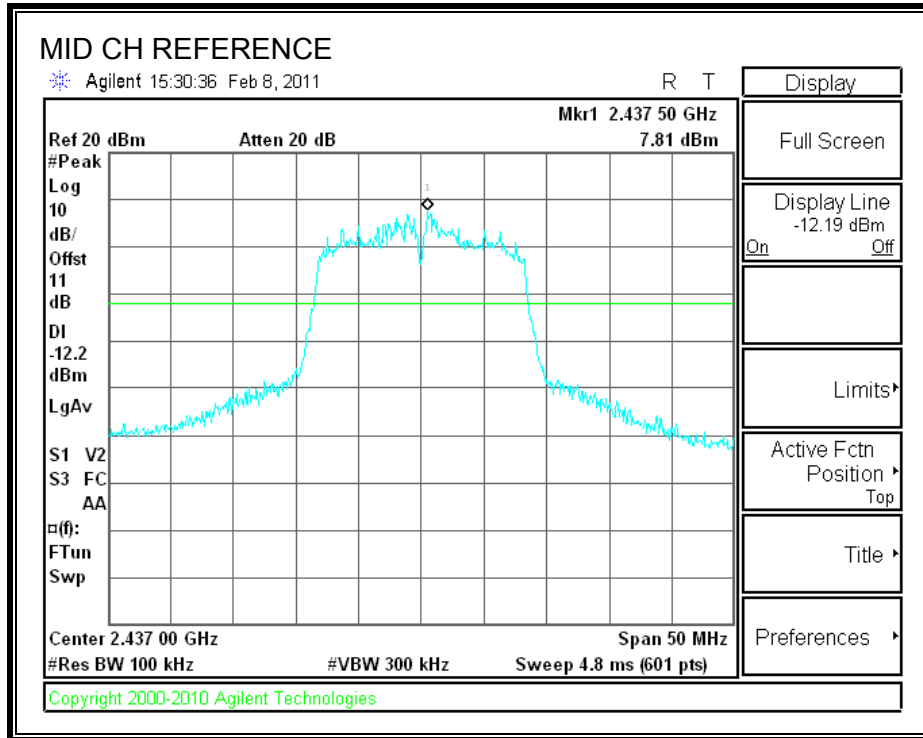

SPURIOUS EMISSIONS, HIGH CHANNEL

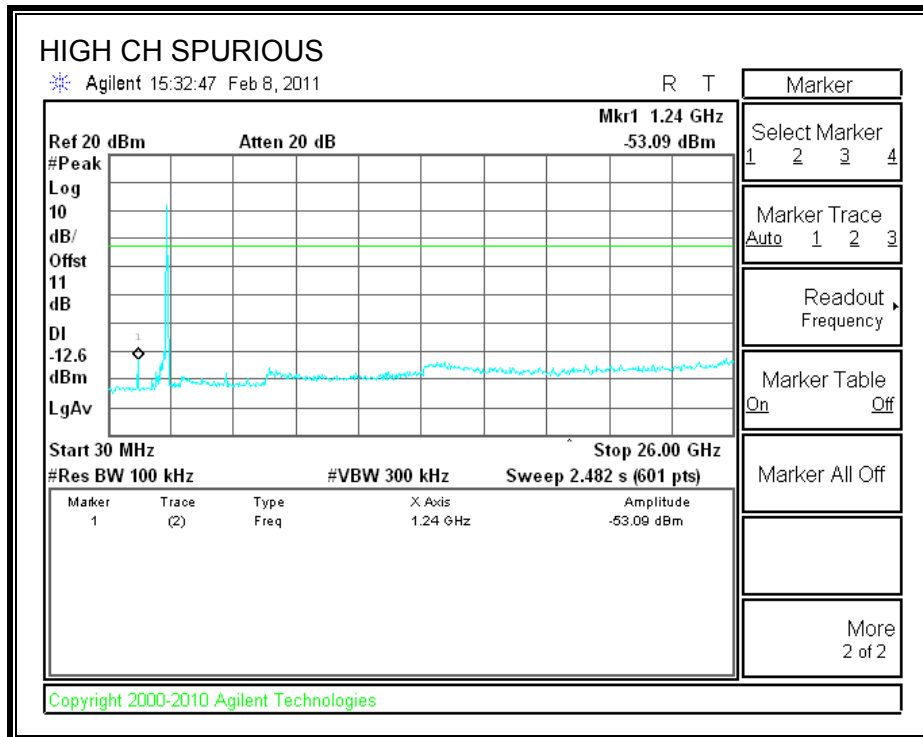
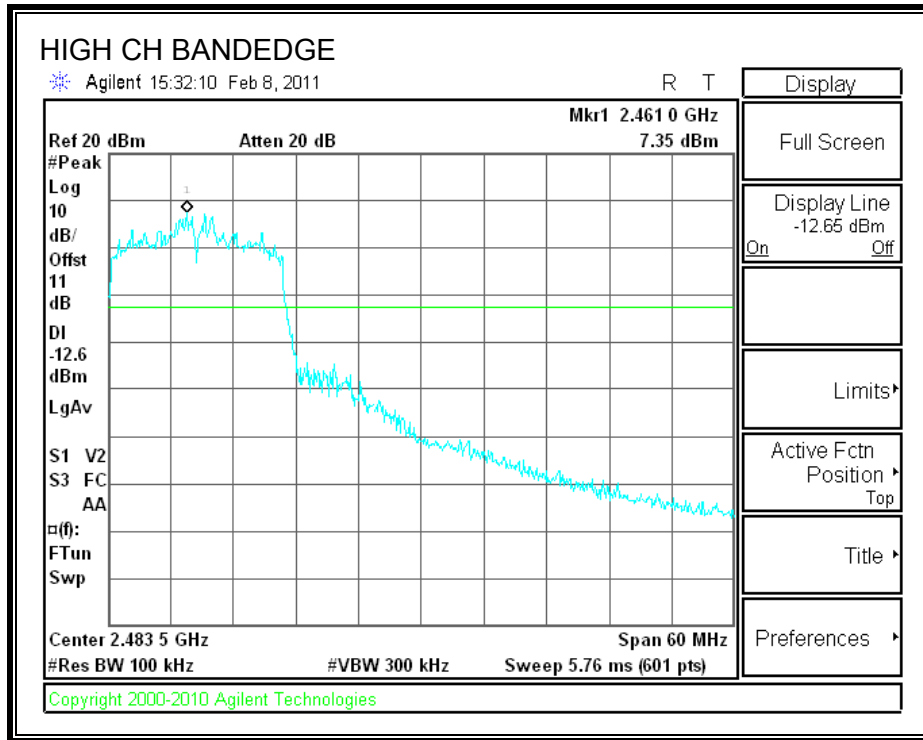

8. RADIATED TEST RESULTS

8.1. LIMITS AND PROCEDURE

LIMITS

FCC §15.205 and §15.209

IC RSS-210 Clause 2.6 (Transmitter)

IC RSS-GEN Clause 6 (Receiver)

Frequency Range (MHz)	Field Strength Limit (uV/m) at 3 m	Field Strength Limit (dBuV/m) at 3 m
30 - 88	100	40
88 - 216	150	43.5
216 - 960	200	46
Above 960	500	54

TEST PROCEDURE

The EUT is placed on a non-conducting table 80 cm above the ground plane. The antenna to EUT distance is 3 meters. The EUT is configured in accordance with ANSI C63.4. The EUT is set to transmit in a continuous mode.

For measurements below 1 GHz the resolution bandwidth is set to 100 kHz for peak detection measurements or 120 kHz for quasi-peak detection measurements. Peak detection is used unless otherwise noted as quasi-peak.

For measurements above 1 GHz the resolution bandwidth is set to 1 MHz, and then the video bandwidth is set to 1 MHz for peak measurements and 10 Hz for average measurements.

The spectrum from 30 MHz to 26 GHz is investigated with the transmitter set to the lowest, middle, and highest channels in the 2.4 GHz band.

The frequency range of interest is monitored at a fixed antenna height and EUT azimuth. The EUT is rotated through 360 degrees to maximize emissions received. The antenna is scanned from 1 to 4 meters above the ground plane to further maximize the emission. Measurements are made with the antenna polarized in both the vertical and the horizontal positions.

8.2. TRANSMITTER ABOVE 1 GHz

8.2.1. 802.11b MODE IN THE 2.4 GHz BAND

RESTRICTED BANDEDGE (LOW CHANNEL, HORIZONTAL)

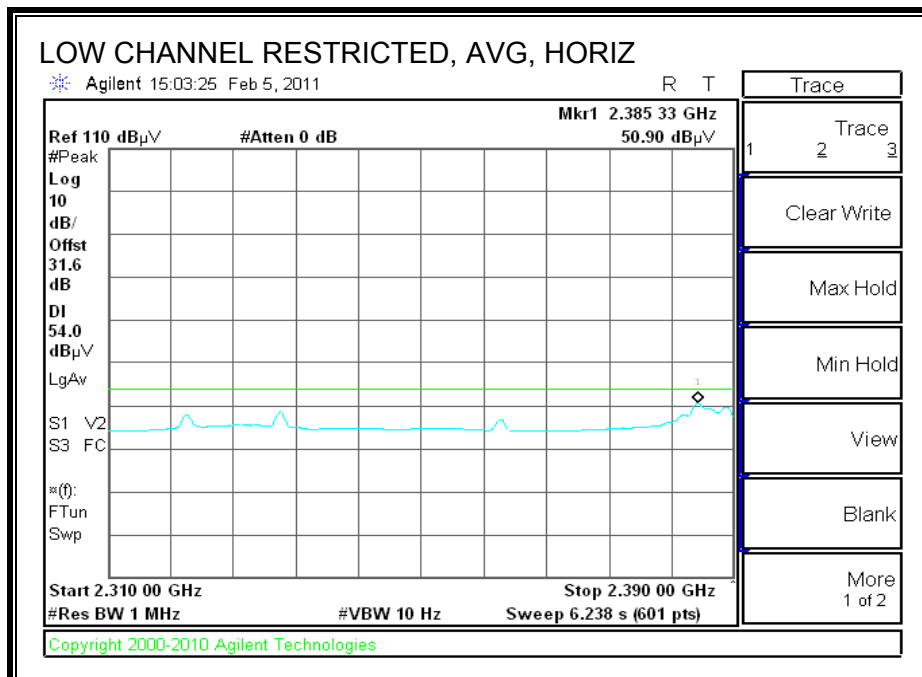
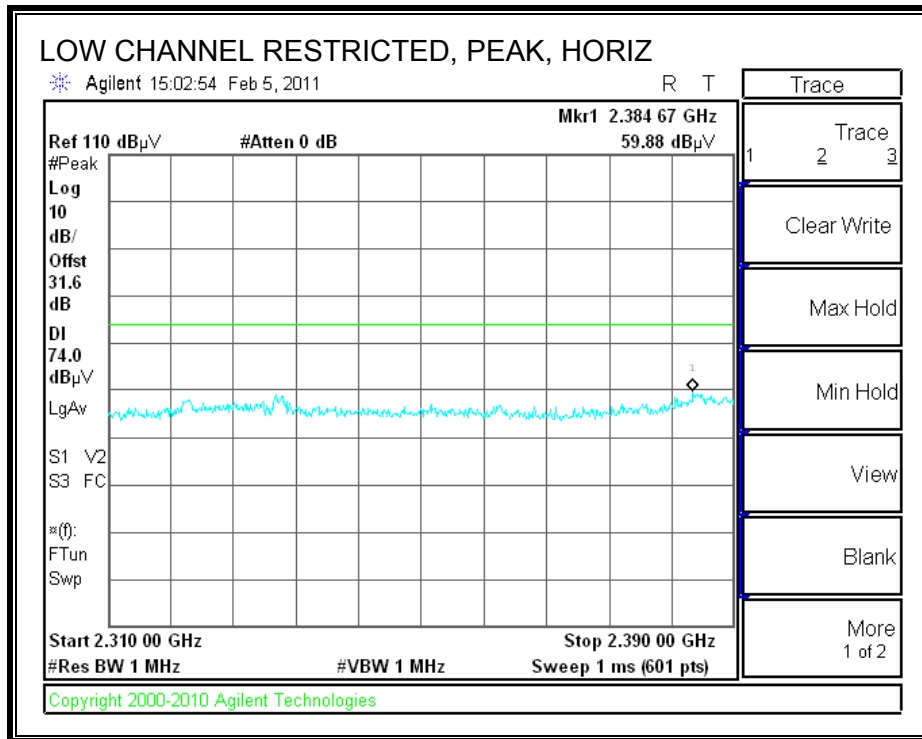

RESTRICTED BANDEDGE (LOW CHANNEL, VERTICAL)

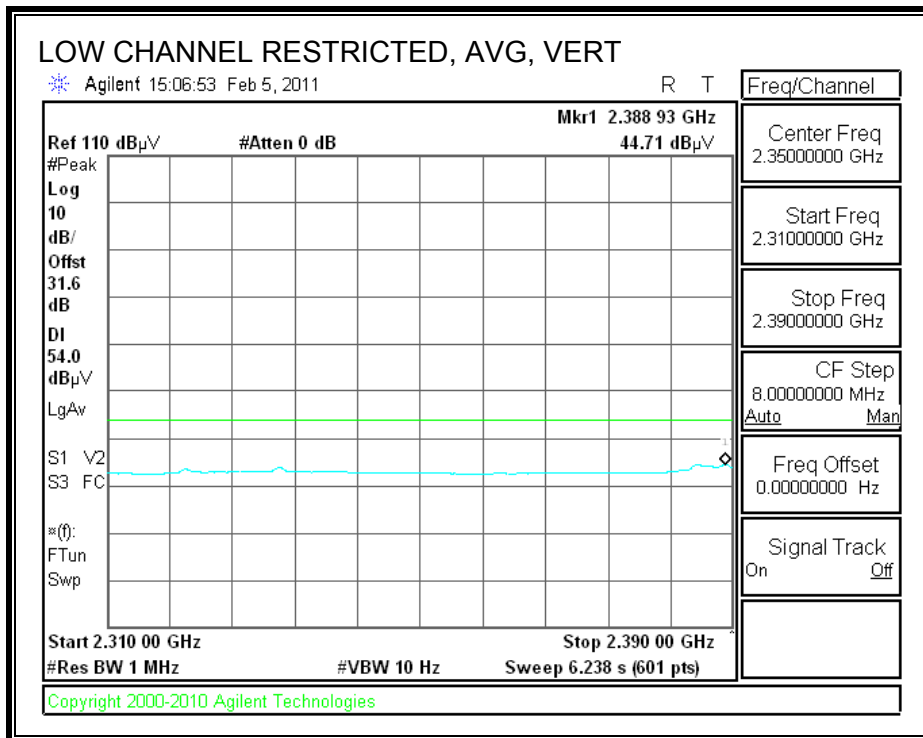
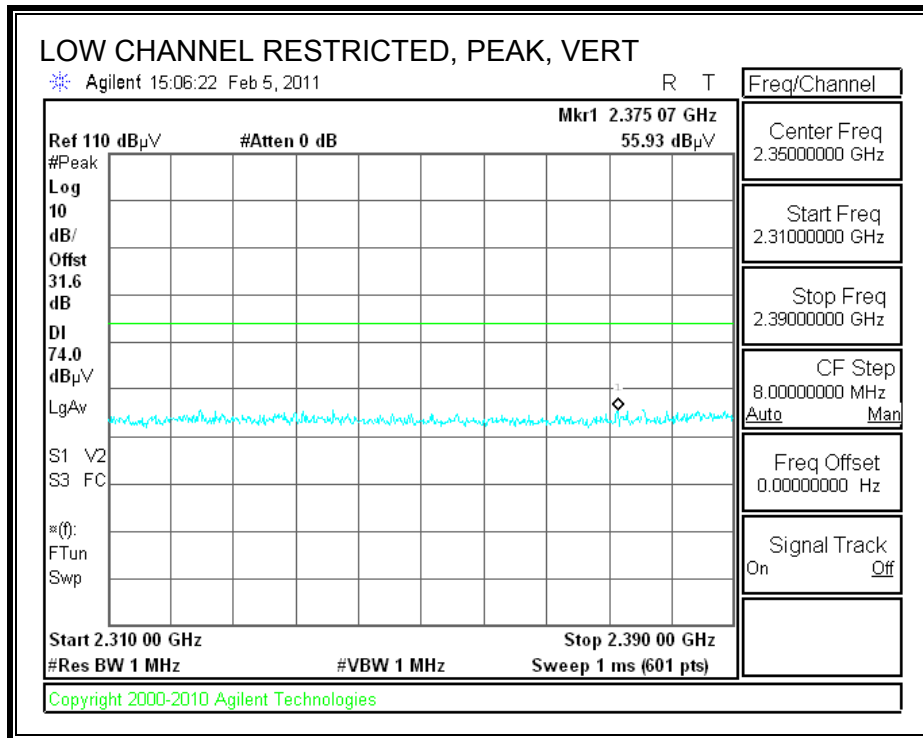

RESTRICTED BANDEDGE (HIGH CHANNEL, HORIZONTAL)

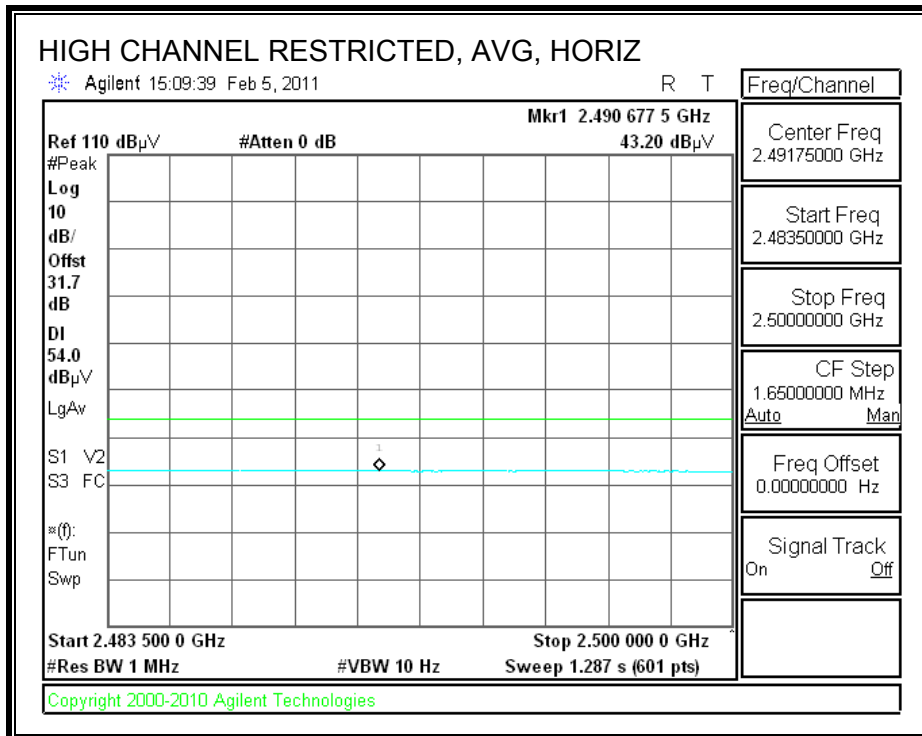
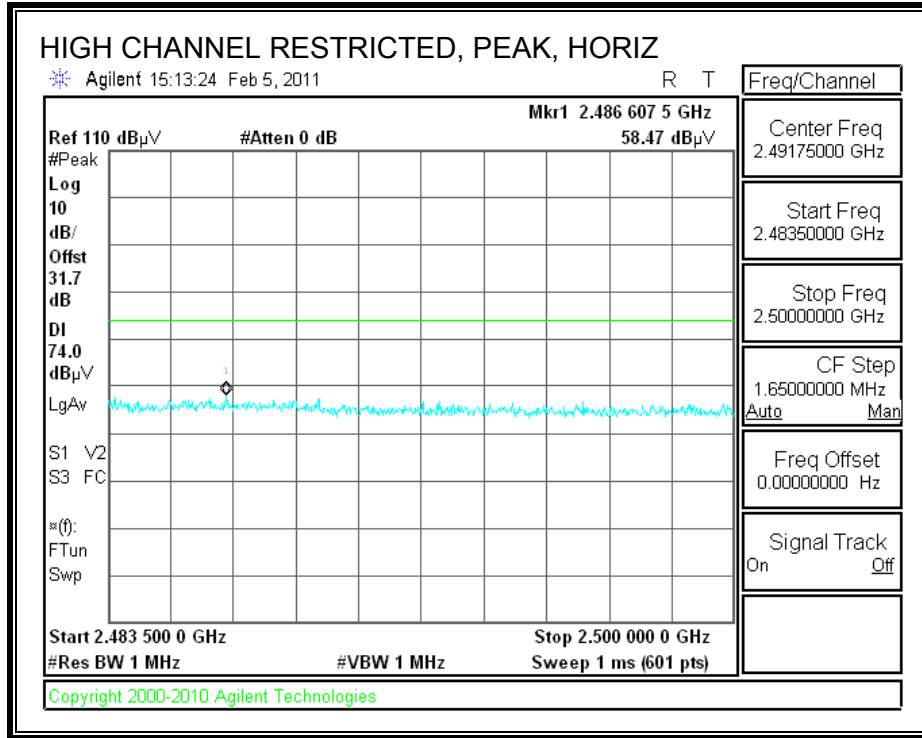

RESTRICTED BANDEDGE (HIGH CHANNEL, VERTICAL)

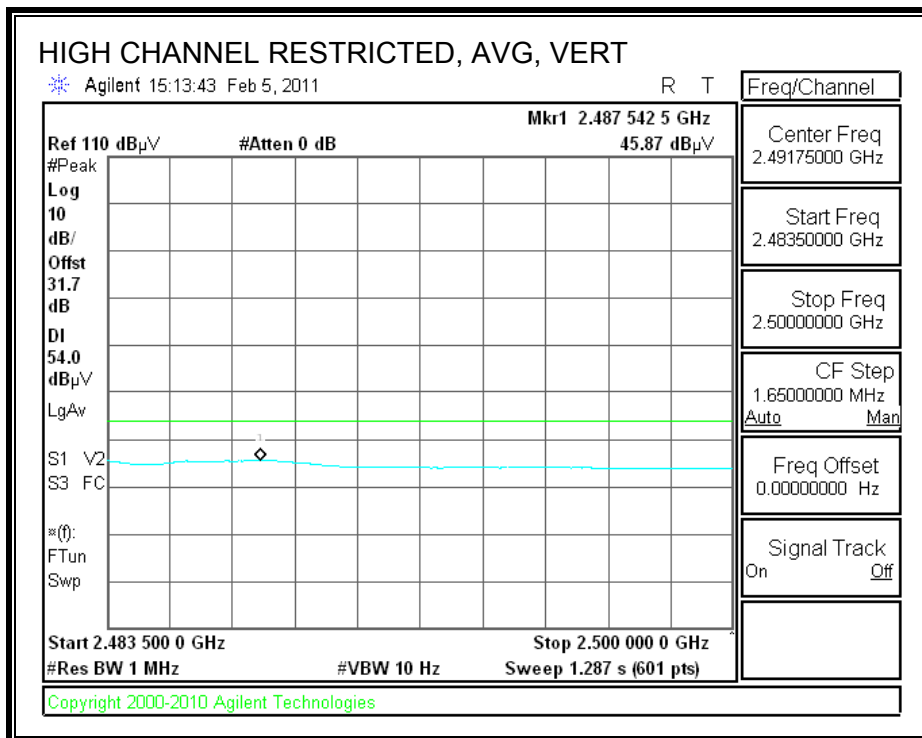
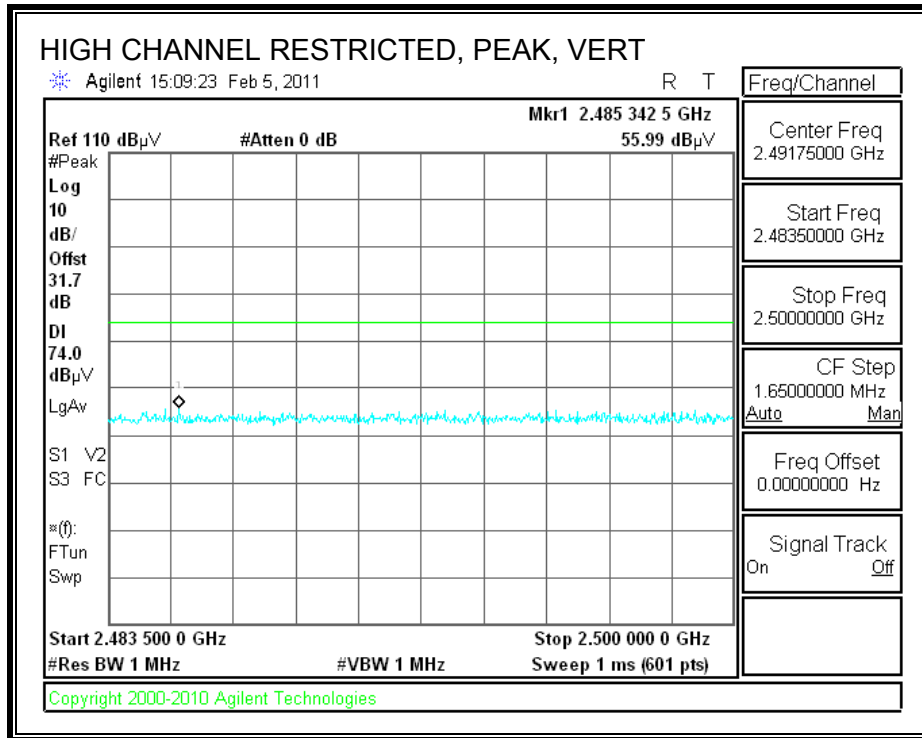

HARMONICS AND SPURIOUS EMISSIONS

High Frequency Measurement													
Compliance Certification Services, Fremont 5m Chamber													
Test Engr:		Chin Pang											
Date:		02/07/11											
Project #:		11J13629											
Company:		Hon Hai											
Test Target:		FCC 15.247											
Mode Oper:		TX, b mode											
f	Measurement Frequency			Amp	Preamp Gain			Average Field Strength Limit					
Dist	Distance to Antenna			D Corr	Distance Correct to 3 meters			Peak Field Strength Limit					
Read	Analyzer Reading			Avg	Average Field Strength @ 3 m			Margin vs. Average Limit					
AF	Antenna Factor			Peak	Calculated Peak Field Strength			Margin vs. Peak Limit					
CL	Cable Loss			HPF	High Pass Filter								
f	Dist	Read	AF	CL	Amp	D Corr	Filtr	Corr.	Limit	Margin	Ant. Pol.	Det.	Notes
GHz	(m)	dBuV	dB/m	dB	dB	dB	dB	dB	dBuV/m	dBuV/m	dB	V/H	P/A/QP
Low Ch, 2412MHz													
4.824	3.0	45.2	32.8	5.8	-34.8	0.0	0.0	48.9	74.0	-25.1	V	P	
4.824	3.0	41.2	32.8	5.8	-34.8	0.0	0.0	44.9	54.0	-9.1	V	A	
4.824	3.0	47.7	32.8	5.8	-34.8	0.0	0.0	51.5	74.0	-22.5	H	P	
4.824	3.0	44.7	32.8	5.8	-34.8	0.0	0.0	48.4	54.0	-5.6	H	A	
Mid Ch, 2437MHz													
4.874	3.0	45.9	32.8	5.8	-34.9	0.0	0.0	49.7	74.0	-24.3	H	P	
4.874	3.0	40.5	32.8	5.8	-34.9	0.0	0.0	44.3	54.0	-9.7	H	A	
7.311	3.0	40.6	35.2	7.3	-34.7	0.0	0.0	48.4	74.0	-25.6	H	P	
7.311	3.0	32.5	35.2	7.3	-34.7	0.0	0.0	40.3	54.0	-13.7	H	A	
4.874	3.0	42.4	32.8	5.8	-34.9	0.0	0.0	46.2	74.0	-27.8	V	P	
4.874	3.0	37.5	32.8	5.8	-34.9	0.0	0.0	41.3	54.0	-12.7	V	A	
7.311	3.0	39.9	35.2	7.3	-34.7	0.0	0.0	47.7	74.0	-26.3	V	P	
7.311	3.0	31.2	35.2	7.3	-34.7	0.0	0.0	39.0	54.0	-15.0	V	A	
High Ch, 2462MHz													
4.924	3.0	41.8	32.8	5.9	-34.9	0.0	0.0	45.6	74.0	-28.4	V	P	
4.924	3.0	35.9	32.8	5.9	-34.9	0.0	0.0	39.8	54.0	-14.2	V	A	
7.386	3.0	39.9	35.3	7.3	-34.6	0.0	0.0	47.8	74.0	-26.2	V	P	
7.386	3.0	31.3	35.3	7.3	-34.6	0.0	0.0	39.3	54.0	-14.7	V	A	
4.924	3.0	42.9	32.8	5.9	-34.9	0.0	0.0	46.8	74.0	-27.2	H	P	
4.924	3.0	38.4	32.8	5.9	-34.9	0.0	0.0	42.3	54.0	-11.7	H	A	
7.386	3.0	40.1	35.3	7.3	-34.6	0.0	0.0	48.1	74.0	-25.9	H	P	
7.386	3.0	31.6	35.3	7.3	-34.6	0.0	0.0	39.5	54.0	-14.5	H	A	
Rev. 4.1.2.7													
Note: No other emissions were detected above the system noise floor.													

8.2.2. 802.11g MODE IN THE 2.4 GHz BAND

RESTRICTED BANDEDGE (LOW CHANNEL, HORIZONTAL)

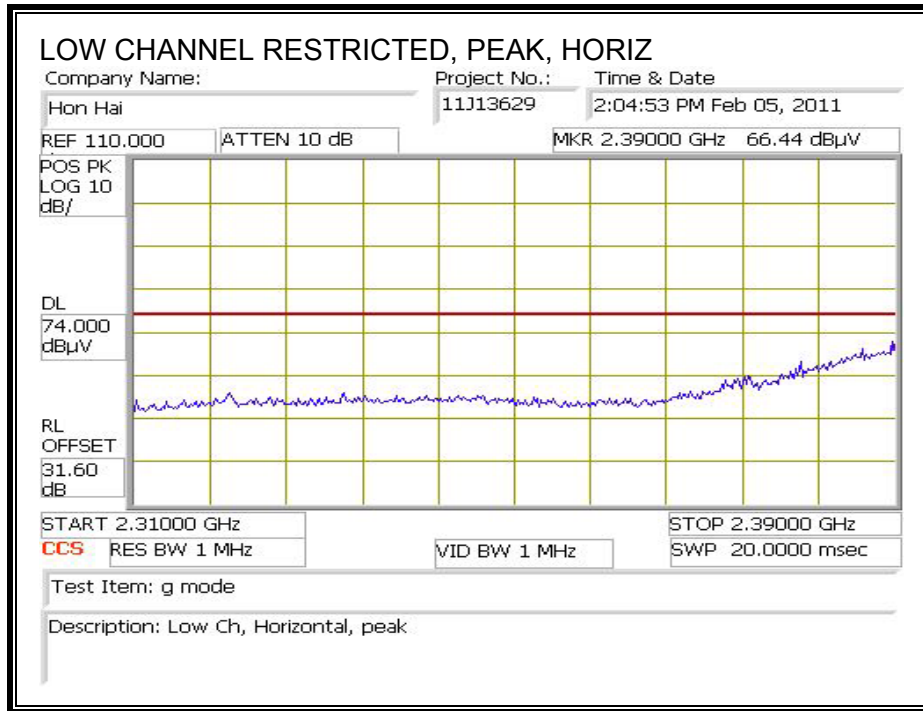

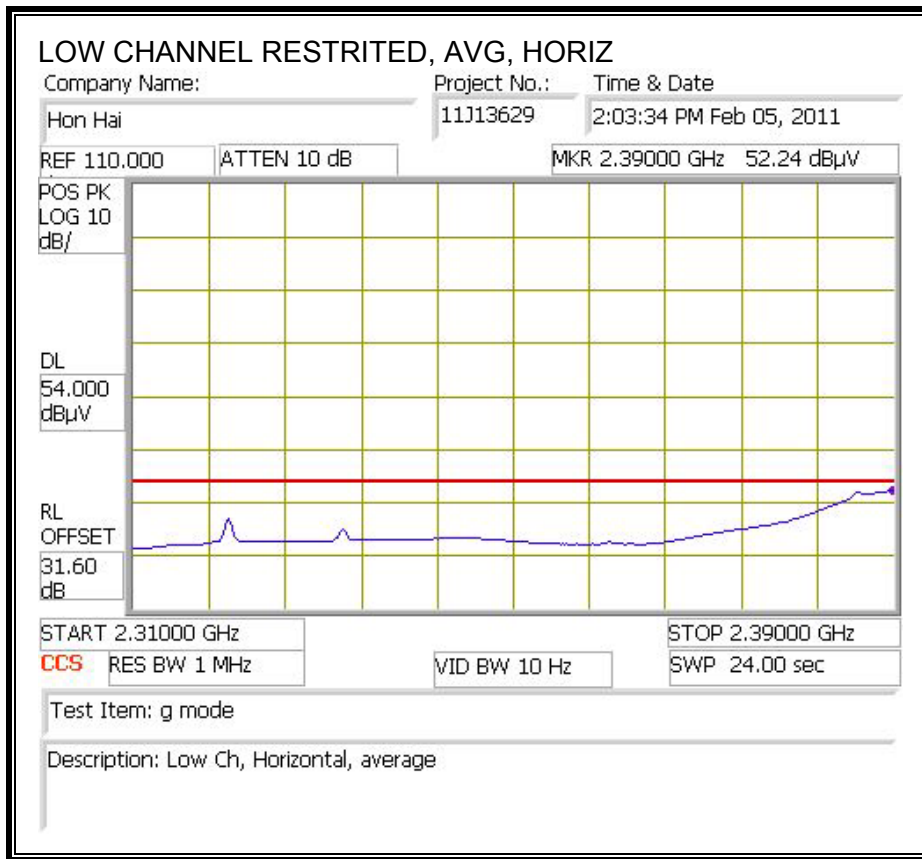

RESTRICTED BANDEDGE (LOW CHANNEL, VERTICAL)

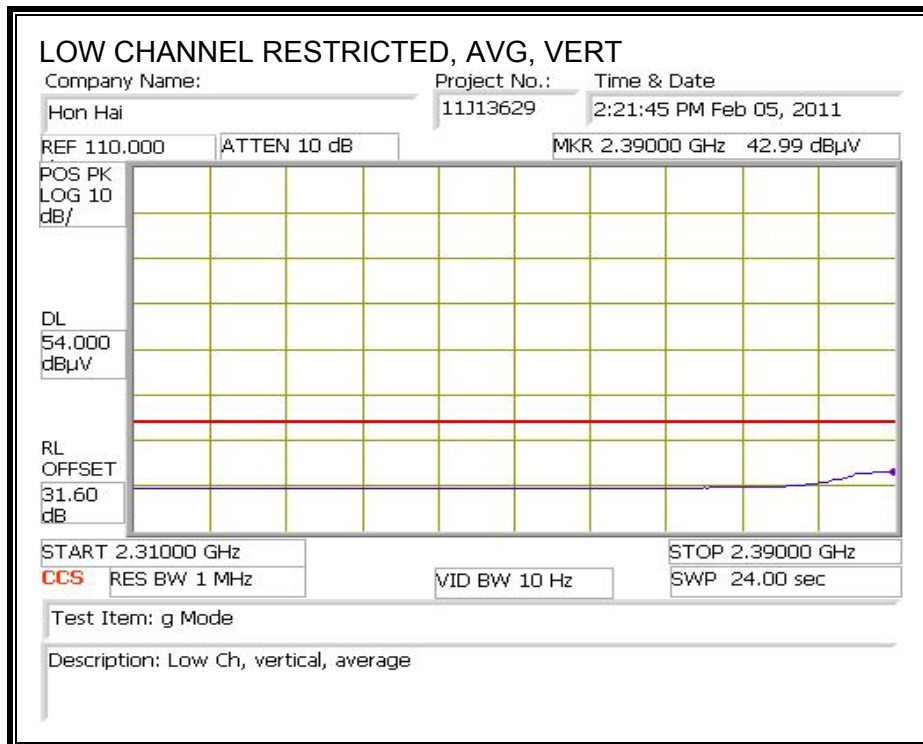
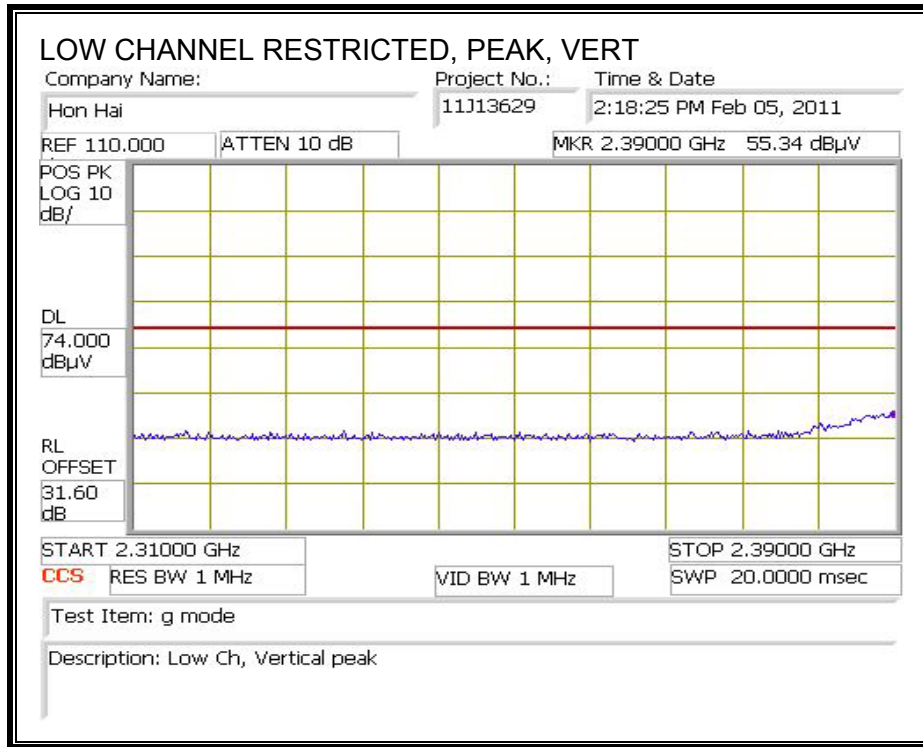

RESTRICTED BANDEDGE (HIGH CHANNEL, HORIZONTAL)

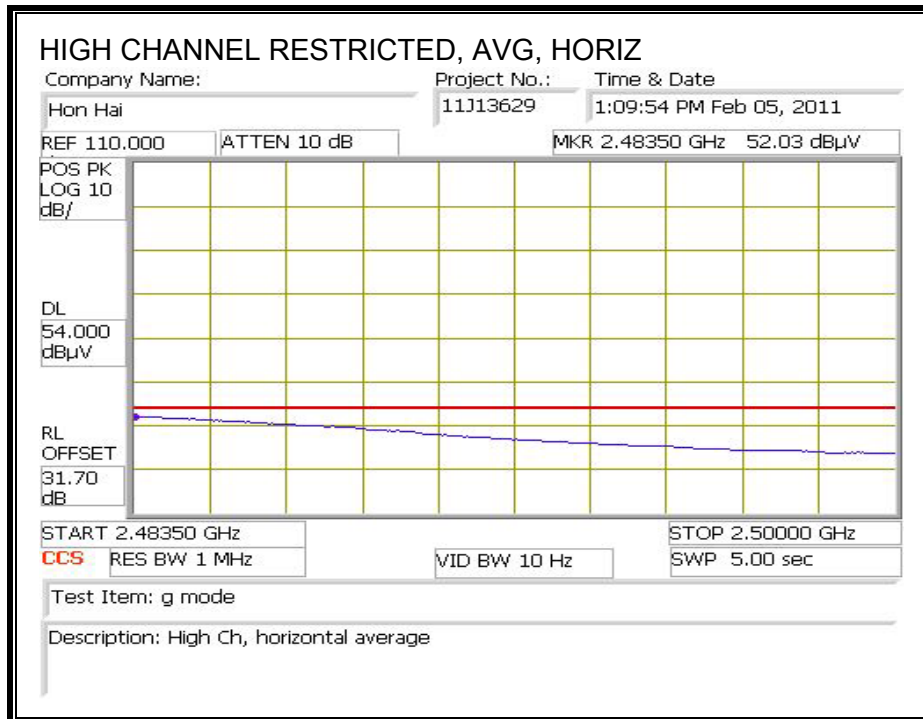
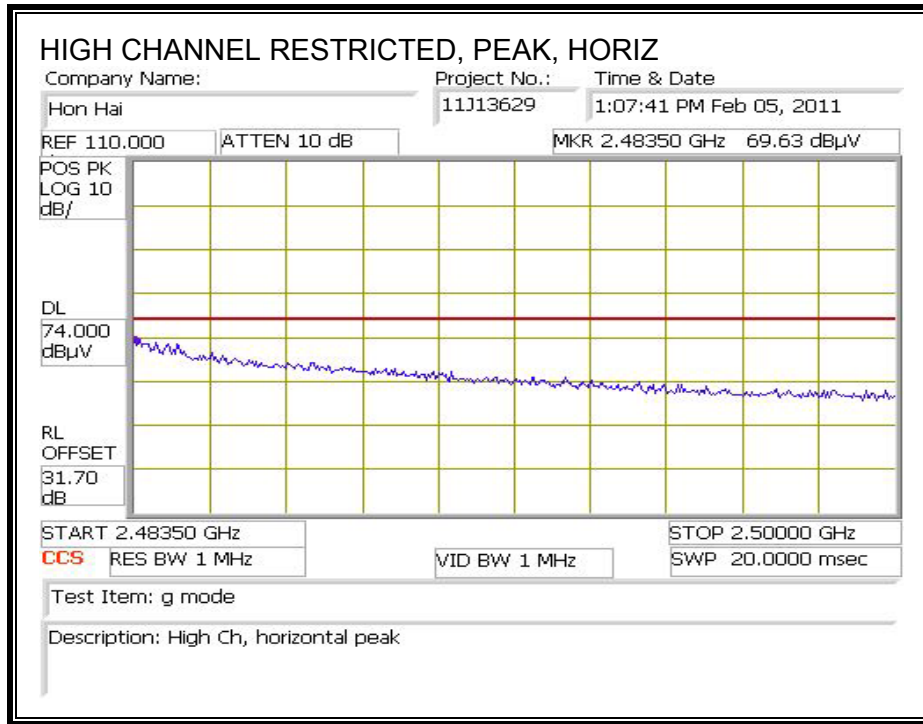

RESTRICTED BANDEDGE (HIGH CHANNEL, VERTICAL)

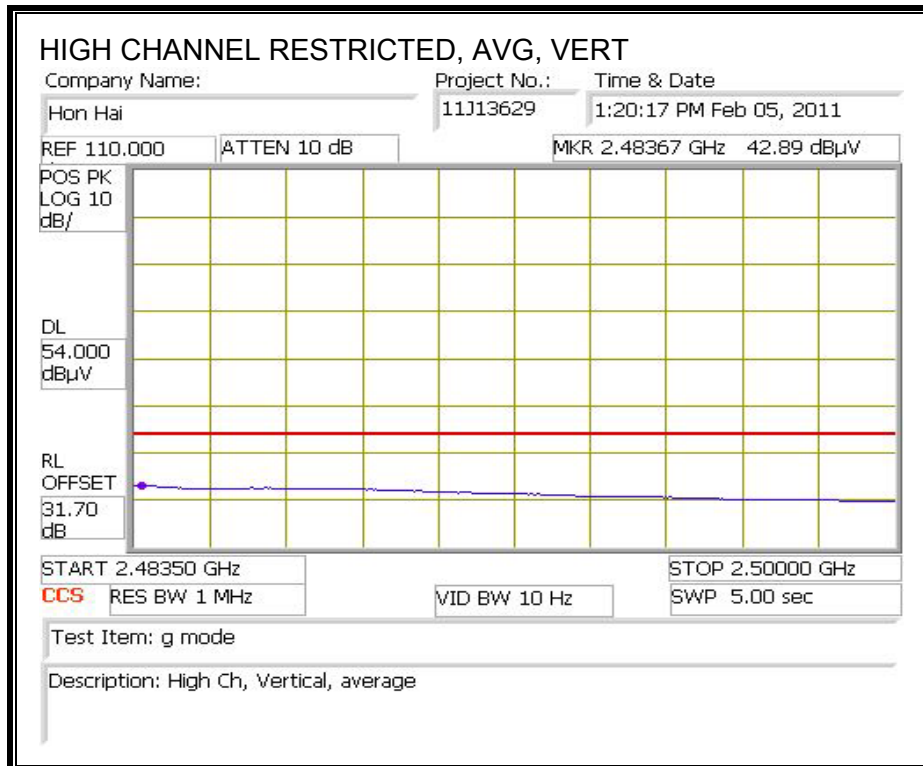
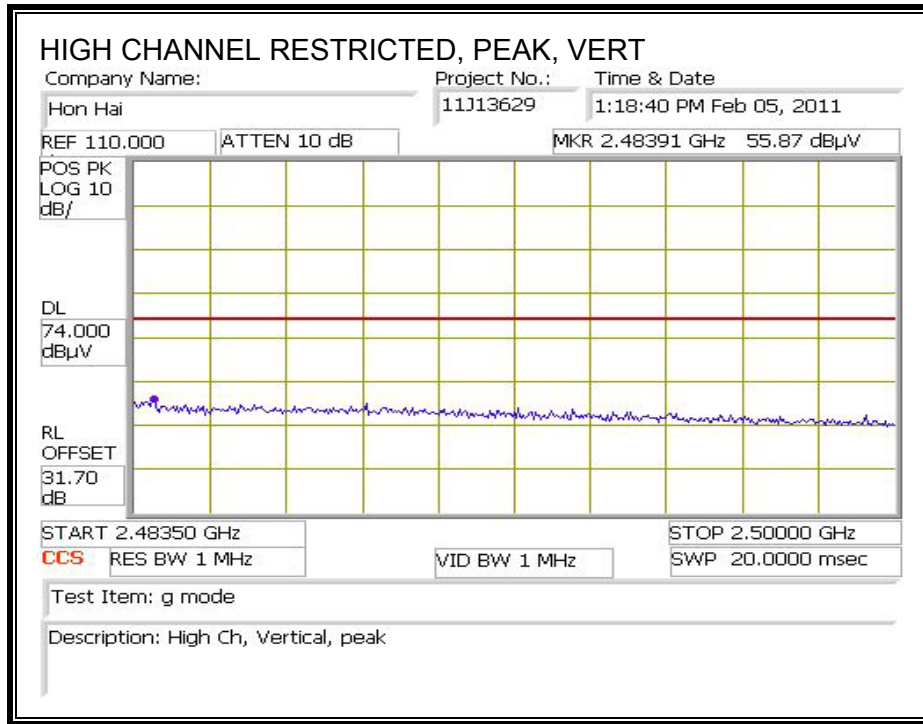

HARMONICS AND SPURIOUS EMISSIONS

High Frequency Measurement													
Compliance Certification Services, Fremont 5m Chamber													
Test Engr:		Chin Pang											
Date:		02/07/11											
Project #:		11J13629											
Company:		Hon Hai											
Test Target:		FCC 15.247											
Mode Oper:		TX, g mode											
f	Measurement Frequency			Amp	Preamp Gain			Average Field Strength Limit					
Dist	Distance to Antenna			D Corr	Distance Correct to 3 meters			Peak Field Strength Limit					
Read	Analyzer Reading			Avg	Average Field Strength @ 3 m			Margin vs. Average Limit					
AF	Antenna Factor			Peak	Calculated Peak Field Strength			Margin vs. Peak Limit					
CL	Cable Loss			HPF	High Pass Filter								
f GHz	Dist (m)	Read dBuV	AF dB/m	CL dB	Amp dB	D Corr dB	Filtr dB	Corr. dB	Limit dBuV/m	Margin dB	Ant. Pol. V/H	Det. P/A/QP	Notes
Low Ch, 2412MHz													
4.824	3.0	44.6	32.8	5.8	-34.8	0.0	0.0	48.3	74.0	-25.7	H	P	
4.824	3.0	30.3	32.8	5.8	-34.8	0.0	0.0	34.0	54.0	-20.0	H	A	
4.824	3.0	40.9	32.8	5.8	-34.8	0.0	0.0	44.7	74.0	-29.3	V	P	
4.824	3.0	28.3	32.8	5.8	-34.8	0.0	0.0	32.1	54.0	-21.9	V	A	
Mid Ch, 2437MHz													
4.874	3.0	39.9	32.8	5.8	-34.9	0.0	0.0	43.7	74.0	-30.3	V	P	
4.874	3.0	27.4	32.8	5.8	-34.9	0.0	0.0	31.2	54.0	-22.8	V	A	
7.311	3.0	39.8	35.2	7.3	-34.7	0.0	0.0	47.6	74.0	-26.4	V	P	
7.311	3.0	26.6	35.2	7.3	-34.7	0.0	0.0	34.4	54.0	-19.6	V	A	
4.874	3.0	44.7	32.8	5.8	-34.9	0.0	0.0	48.5	74.0	-25.5	H	P	
4.874	3.0	29.7	32.8	5.8	-34.9	0.0	0.0	33.4	54.0	-20.6	H	A	
7.311	3.0	37.9	35.2	7.3	-34.7	0.0	0.0	45.7	74.0	-28.3	H	P	
7.311	3.0	25.7	35.2	7.3	-34.7	0.0	0.0	33.5	54.0	-20.5	H	A	
High Ch, 2462MHz													
4.924	3.0	42.2	32.8	5.9	-34.9	0.0	0.0	46.1	74.0	-27.9	H	P	
4.924	3.0	27.0	32.8	5.9	-34.9	0.0	0.0	30.9	54.0	-23.1	H	A	
7.386	3.0	39.8	35.3	7.3	-34.6	0.0	0.0	47.8	74.0	-26.2	H	P	
7.386	3.0	26.9	35.3	7.3	-34.6	0.0	0.0	34.8	54.0	-19.2	H	A	
4.924	3.0	42.8	32.8	5.9	-34.9	0.0	0.0	46.6	74.0	-27.4	V	P	
4.924	3.0	27.9	32.8	5.9	-34.9	0.0	0.0	31.8	54.0	-22.2	V	A	
7.386	3.0	39.0	35.3	7.3	-34.6	0.0	0.0	47.0	74.0	-27.0	V	P	
7.386	3.0	26.4	35.3	7.3	-34.6	0.0	0.0	34.3	54.0	-19.7	V	A	
Rev. 4.1.2.7													
Note: No other emissions were detected above the system noise floor.													

8.2.3. 802.11n HT20 SISO MODE IN THE 2.4 GHz BAND

RESTRICTED BANDEDGE (LOW CHANNEL, HORIZONTAL)

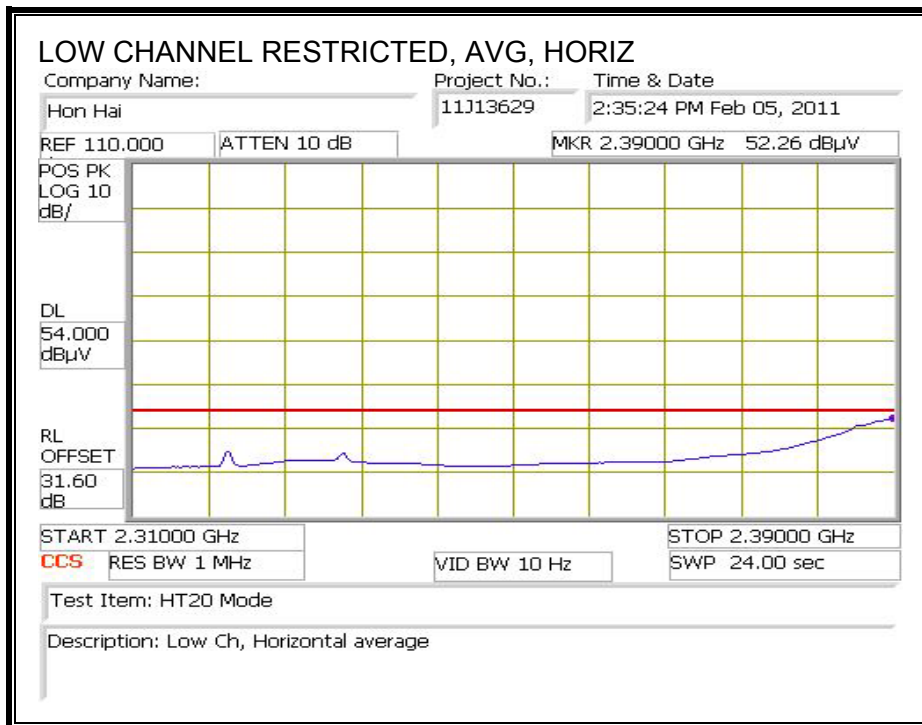
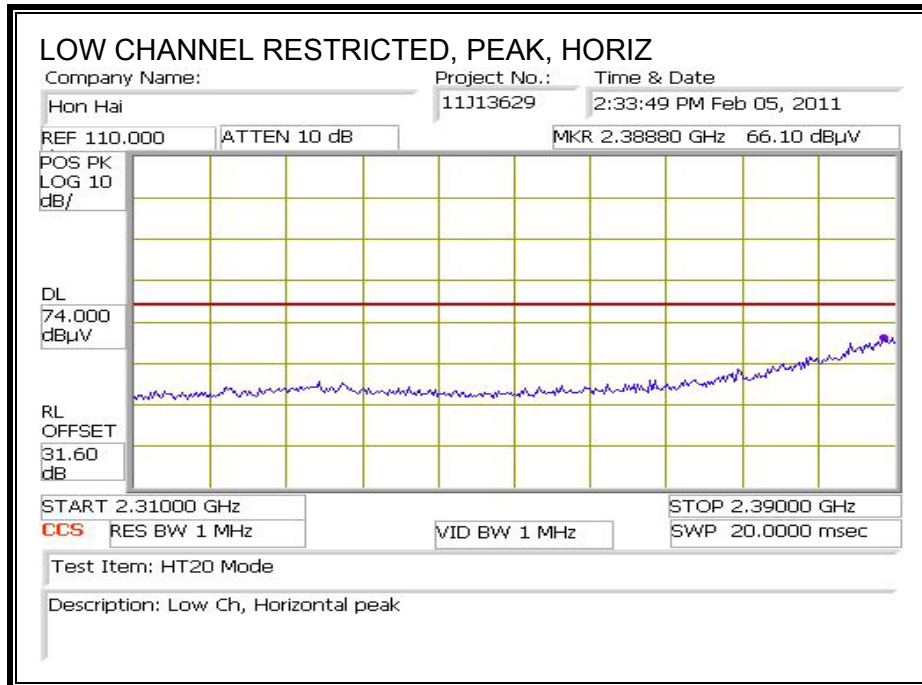

RESTRICTED BANDEDGE (LOW CHANNEL, VERTICAL)

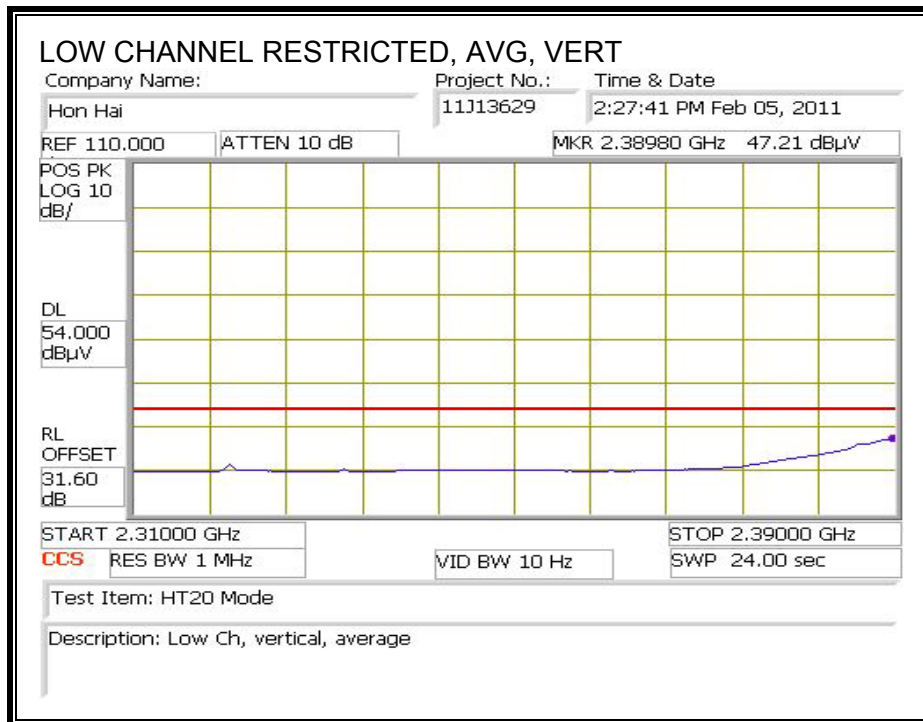
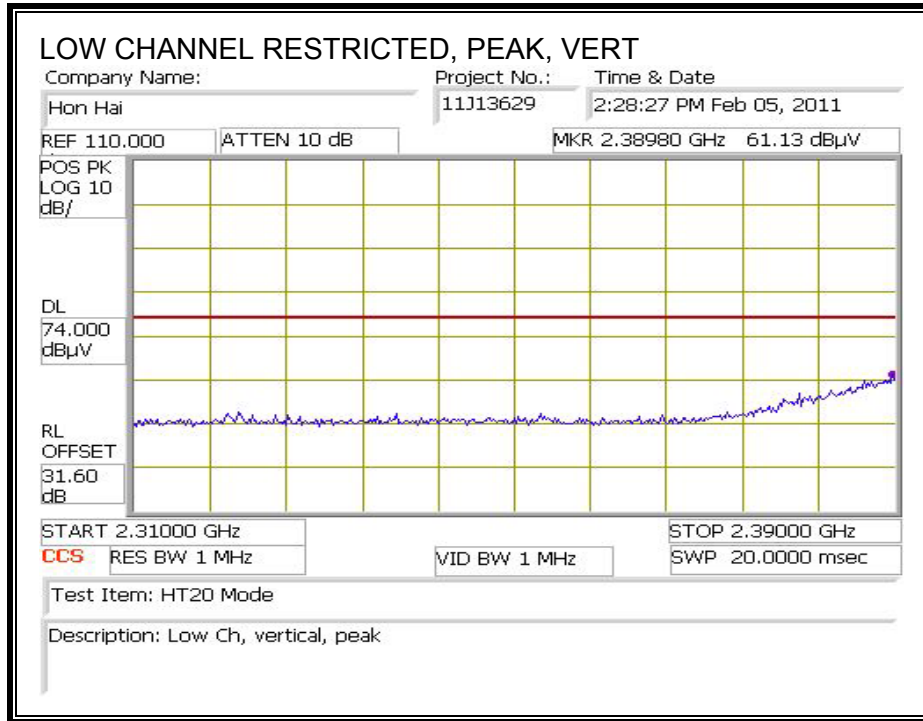

RESTRICTED BANDEDGE (HIGH CHANNEL, HORIZONTAL)

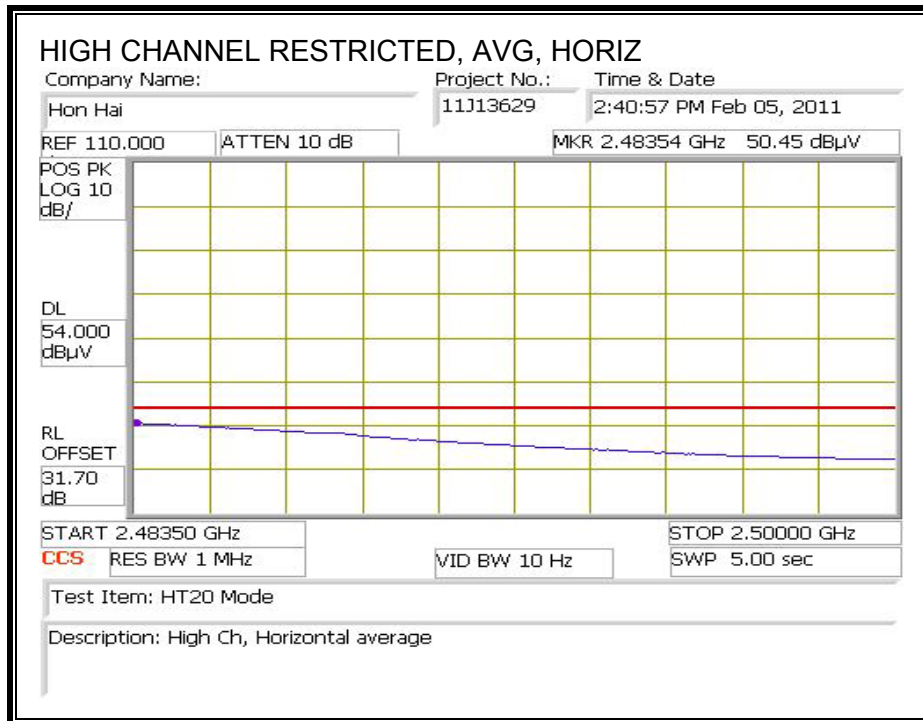
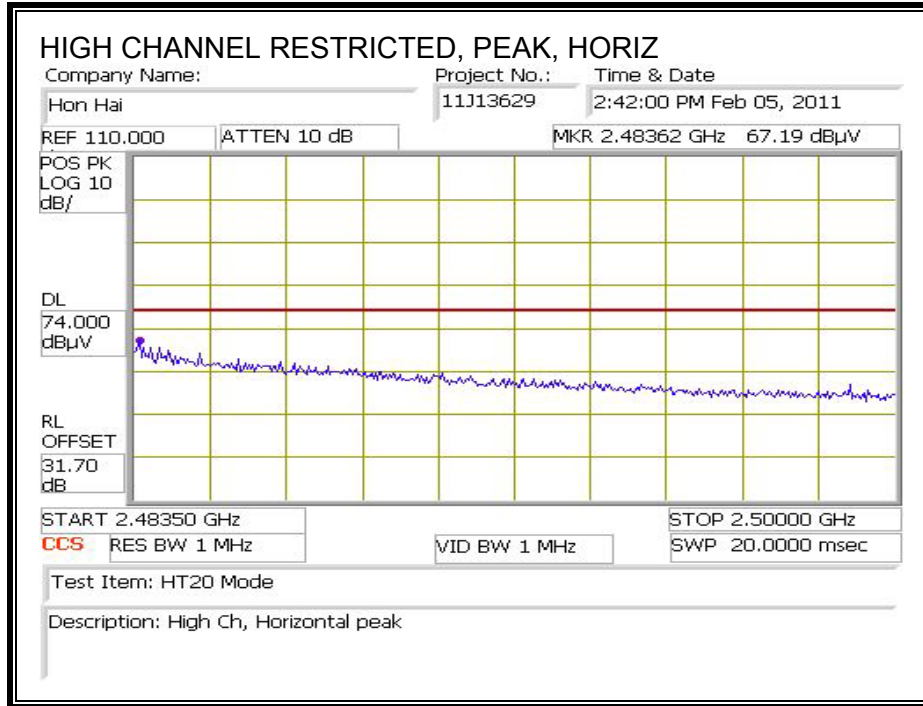

RESTRICTED BANDEDGE (HIGH CHANNEL, VERTICAL)

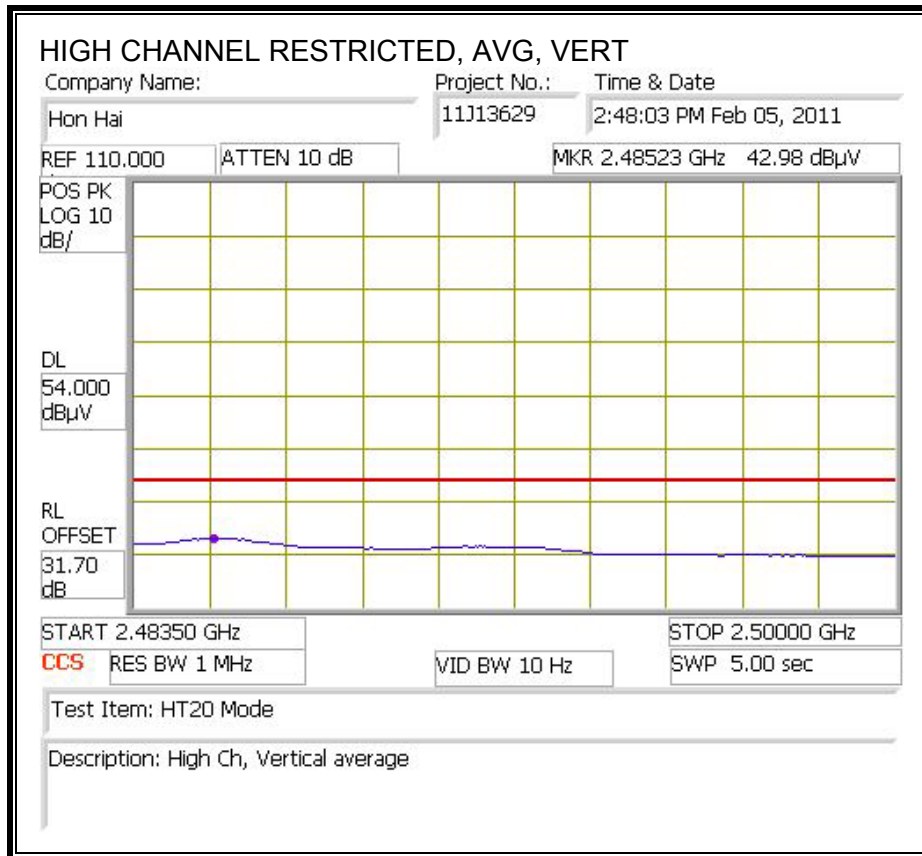
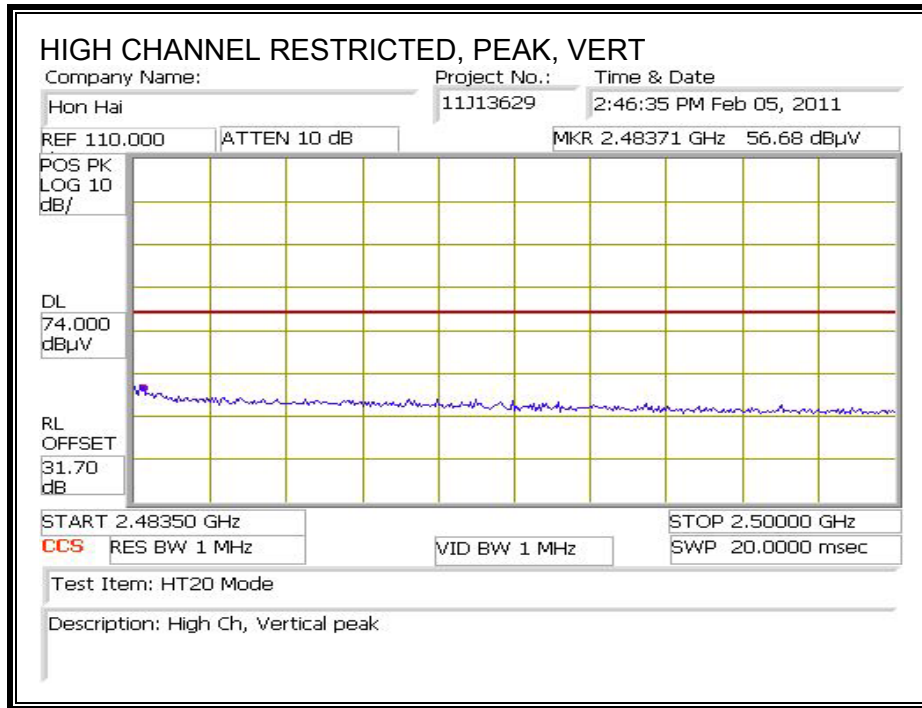

HARMONICS AND SPURIOUS EMISSIONS

High Frequency Measurement													
Compliance Certification Services, Fremont 5m Chamber													
Test Engr:		Chin Pang											
Date:		02/07/11											
Project #:		11J13629											
Company:		Hon Hai											
Test Target:		FCC 15.247											
Mode Oper:		TX, HT20											
f	Measurement Frequency	Amp	Preamp Gain	Average Field Strength Limit									
Dist	Distance to Antenna	D Corr	Distance Correct to 3 meters	Peak Field Strength Limit									
Read	Analyzer Reading	Avg	Average Field Strength @ 3 m	Margin vs. Average Limit									
AF	Antenna Factor	Peak	Calculated Peak Field Strength	Margin vs. Peak Limit									
CL	Cable Loss	HPF	High Pass Filter										
f GHz	Dist (m)	Read dBuV	AF dB/m	CL dB	Amp dB	D Corr dB	Filtr dB	Corr. dBuV/m	Limit dBuV/m	Margin dB	Ant. Pol. V/H	Det. P/A/QP	Notes
Low Ch, 2412MHz													
4.824	3.0	41.1	32.8	5.8	-34.8	0.0	0.0	44.8	74.0	-29.2	V	P	
4.824	3.0	28.3	32.8	5.8	-34.8	0.0	0.0	32.0	54.0	-22.0	V	A	
4.824	3.0	44.9	32.8	5.8	-34.8	0.0	0.0	48.7	74.0	-25.4	H	P	
4.824	3.0	30.8	32.8	5.8	-34.8	0.0	0.0	34.5	54.0	-19.5	H	A	
Mid Ch, 2437MHz													
4.874	3.0	43.3	32.8	5.8	-34.9	0.0	0.0	47.1	74.0	-26.9	H	P	
4.874	3.0	29.2	32.8	5.8	-34.9	0.0	0.0	32.9	54.0	-21.1	H	A	
7.311	3.0	40.1	35.2	7.3	-34.7	0.0	0.0	47.9	74.0	-26.1	H	P	
7.311	3.0	26.5	35.2	7.3	-34.7	0.0	0.0	34.3	54.0	-19.7	H	A	
4.874	3.0	38.9	32.8	5.8	-34.9	0.0	0.0	42.7	74.0	-31.3	V	P	
4.874	3.0	26.7	32.8	5.8	-34.9	0.0	0.0	30.5	54.0	-23.5	V	A	
7.311	3.0	38.8	35.2	7.3	-34.7	0.0	0.0	46.6	74.0	-27.4	V	P	
7.311	3.0	26.2	35.2	7.3	-34.7	0.0	0.0	34.0	54.0	-20.0	V	A	
High Ch, 2462MHz													
4.924	3.0	39.6	32.8	5.9	-34.9	0.0	0.0	43.5	74.0	-30.5	V	P	
4.924	3.0	27.2	32.8	5.9	-34.9	0.0	0.0	31.1	54.0	-22.9	V	A	
7.386	3.0	39.0	35.3	7.3	-34.6	0.0	0.0	47.0	74.0	-27.0	V	P	
7.386	3.0	26.4	35.3	7.3	-34.6	0.0	0.0	34.4	54.0	-19.6	V	A	
4.924	3.0	40.8	32.8	5.9	-34.9	0.0	0.0	44.6	74.0	-29.4	H	P	
4.924	3.0	27.9	32.8	5.9	-34.9	0.0	0.0	31.7	54.0	-22.3	H	A	
7.386	3.0	37.9	35.3	7.3	-34.6	0.0	0.0	45.8	74.0	-28.2	H	P	
7.386	3.0	26.1	35.3	7.3	-34.6	0.0	0.0	34.0	54.0	-20.0	H	A	
Rev. 4.1.2.7													
Note: No other emissions were detected above the system noise floor.													

8.3. WORST CASE RECEIVER ABOVE 1 GHz

High Frequency Measurement
 Compliance Certification Services, Fremont 5m Chamber

Company: **Hon Hai Precision**
 Project #: **11J13629**
 Date: **2/8/2011**
 Test Engineer: **Chia Pang**
 Configuration: **EUT and Laptop**
 Mode: **RX**

Test Equipment:

Horn 1-18GHz	Pre-amplifier 1-26GHz	Pre-amplifier 26-40GHz	Horn > 18GHz	Limit
T59; S/N: 3245 @3m	T145 Agilent 3008A0056			FCC 15.209

Hi Frequency Cables

3' cable 22807700	12' cable 22807600	20' cable 22807500	HPF	Reject Filter	Peak Measurements RBW=VBW=1MHz
3' cable 22807700	12' cable 22807600	20' cable 22807500			Average Measurements RBW=1MHz ; VBW=10Hz

f GHz	Dist (m)	Read Pk dBuV	Read Avg. dBuV	AF dB/m	CL dB	Amp dB	D Corr dB	Filt dB	Peak dBuV/m	Avg dBuV/m	Pk Lim dBuV/m	Avg Lim dBuV/m	Pk Mar dB	Avg Mar dB	Notes (V/H)
1.597	3.0	50.2	33.0	26.1	3.0	-35.7	0.0	0.0	43.7	26.5	74	54	-30.3	-27.5	V
2.493	3.0	50.6	32.5	28.5	3.9	-35.1	0.0	0.0	47.9	29.8	74	54	-26.1	-24.2	V
2.663	3.0	53.5	30.6	29.0	4.1	-35.2	0.0	0.0	51.4	28.5	74	54	-22.6	-25.5	V
3.200	3.0	53.0	30.0	30.4	4.5	-35.1	0.0	0.0	52.8	29.8	74	54	-21.2	-24.2	V
1.250	3.0	52.7	37.0	24.9	2.7	-36.0	0.0	0.0	44.3	28.6	74	54	-29.7	-25.4	H
2.437	3.0	52.2	47.5	28.3	3.9	-35.1	0.0	0.0	49.3	44.6	74	54	-24.7	-9.4	H
3.200	3.0	48.6	29.4	30.4	4.5	-35.1	0.0	0.0	48.4	29.2	74	54	-25.6	-24.8	H

Rev. 07.22.09
Note: No other emissions were detected above the system noise floor.

f	Measurement Frequency	Amp	Preamp Gain	Avg Lim	Average Field Strength Limit
Dist	Distance to Antenna	D Corr	Distance Correct to 3 meters	Pk Lim	Peak Field Strength Limit
Read	Analyzer Reading	Avg	Average Field Strength @ 3 m	Avg Mar	Margin vs. Average Limit
AF	Antenna Factor	Peak	Calculated Peak Field Strength	Pk Mar	Margin vs. Peak Limit
CL	Cable Loss	HPF	High Pass Filter		

8.4. WORST CASE BELOW 1GHZ

VERTICAL& HORIZONTAL DATA

30-1000MHz Frequency Measurement

Compliance Certification Services, Fremont 5m Chamber

Test Engr: Cjhin Pang
 Date: 02/07/11
 Project #: 11J13629
 Company: Hon Hai
 Test Target: FCC 15C
 Mode Oper: TX (Worst Case)

f Measurement Frequency Amp Preamp Gain Margin Margin vs. Limit
 Dist Distance to Antenna D Corr Distance Correct to 3 meters
 Read Analyzer Reading Filter Filter Insert Loss
 AF Antenna Factor Corr. Calculated Field Strength
 CL Cable Loss Limit Field Strength Limit

f MHz	Dist (m)	Read dBuV	AF dB/m	CL dB	Amp dB	D Corr dB	Pad dB	Corr. dBuV/m	Limit dBuV/m	Margin dB	Ant. Pol V/H	Det. P/A/QP	Notes
124.564	3.0	50.5	13.8	1.0	29.4	0.0	0.0	35.9	43.5	-7.6	V	P	
144.005	3.0	49.8	13.0	1.1	29.3	0.0	0.0	34.5	43.5	-9.0	V	P	
243.129	3.0	46.8	11.8	1.4	28.8	0.0	0.0	31.3	46.0	-14.7	V	P	
258.009	3.0	44.9	12.0	1.5	28.8	0.0	0.0	29.6	46.0	-16.4	V	P	
336.013	3.0	44.4	13.9	1.7	29.0	0.0	0.0	31.0	46.0	-15.0	V	P	
720.028	3.0	38.6	19.6	2.6	29.5	0.0	0.0	31.3	46.0	-14.7	V	P	
912.036	3.0	36.2	21.6	3.0	28.5	0.0	0.0	32.3	46.0	-13.7	V	P	
226.808	3.0	51.4	11.9	1.4	28.8	0.0	0.0	35.8	46.0	-10.2	H	P	
240.009	3.0	52.8	11.8	1.4	28.8	0.0	0.0	37.2	46.0	-8.8	H	P	
304.931	3.0	49.4	13.4	1.6	28.8	0.0	0.0	35.6	46.0	-10.4	H	P	
432.017	3.0	50.8	15.6	2.0	29.4	0.0	0.0	38.9	46.0	-7.1	H	P	
528.021	3.0	38.9	17.2	2.2	29.7	0.0	0.0	28.6	46.0	-17.4	H	P	
624.024	3.0	40.5	18.5	2.4	29.6	0.0	0.0	31.9	46.0	-14.1	H	P	
720.028	3.0	43.6	19.6	2.6	29.5	0.0	0.0	36.4	46.0	-9.6	H	P	
912.036	3.0	39.2	21.6	3.0	28.5	0.0	0.0	35.4	46.0	-10.6	H	P	

9. AC POWER LINE CONDUCTED EMISSIONS

LIMITS

FCC §15.207 (a)

RSS-Gen 7.2.2

Frequency of Emission (MHz)	Conducted Limit (dBuV)	
	Quasi-peak	Average
0.15-0.5	66 to 56 [*]	56 to 46 [*]
0.5-5	56	46
5-30	60	50

^{*} Decreases with the logarithm of the frequency.

TEST PROCEDURE

ANSI C63.4

RESULTS

6 WORST EMISSIONS

CONDUCTED EMISSIONS DATA (115VAC 60Hz)									
Freq. (MHz)	Reading			Class (dB)	Limit QP	EN B AV	Margin		Remark L1 / L2
	PK (dBuV)	QP (dBuV)	AV (dBuV)				QP (dB)	AV (dB)	
0.15	54.91	--	35.60	0.00	65.84	55.84	-10.93	-20.24	L1
0.45	40.74	--	30.63	0.00	56.89	46.89	-16.15	-16.26	L1
16.66	40.96	--	31.46	0.00	60.00	50.00	-19.04	-18.54	L1
0.15	53.35	--	36.42	0.00	65.84	55.84	-12.49	-19.42	L2
0.45	39.89	--	31.15	0.00	56.93	46.93	-17.04	-15.78	L2
16.66	40.63	--	31.14	0.00	60.00	50.00	-19.37	-18.86	L2
6 Worst Data									

LINE 1 RESULTS



Compliance Certification Services
47173 Benicia Street
Fremont, CA 94538
Tel: (510) 771-1000
Fax: (510) 661-0888

Data#: 7 File#: 11j13629.emi Date: 02-08-2011 Time: 15:40:12

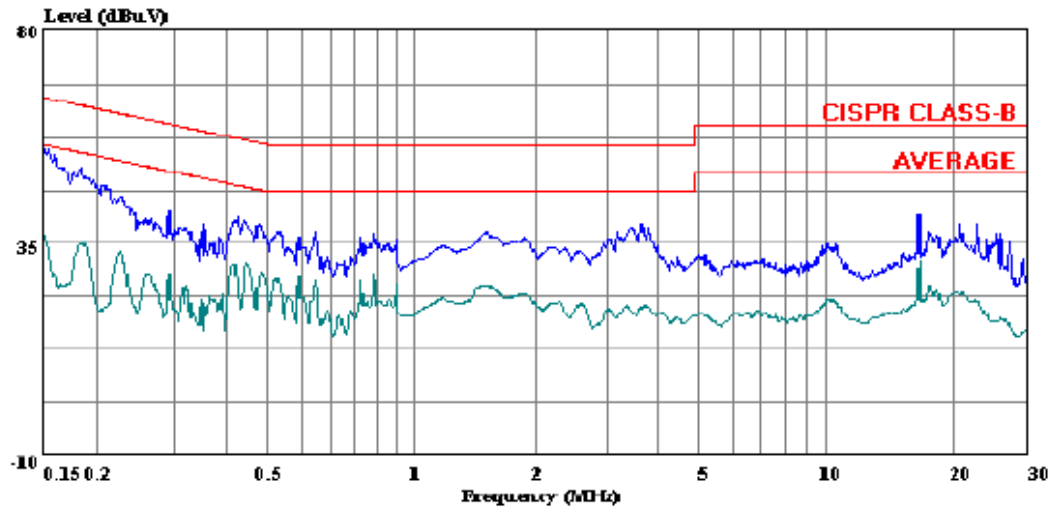

Trace: 5 Ref Trace:

Condition: CISPR CLASS-B
Test Operator: Chin Pang
Project # : 11J13629
Company : Hon Hai
Configuration: EUT/Antenna/Laptop
EUT Descript : 802.11bgn module
Mode : TX (Worst Case)
Model : WIN-A2
Target : FCC Class B
Voltage : 115VAC 60Hz
: L1: Blue (Peak), Green (Average)

LINE 2 RESULTS

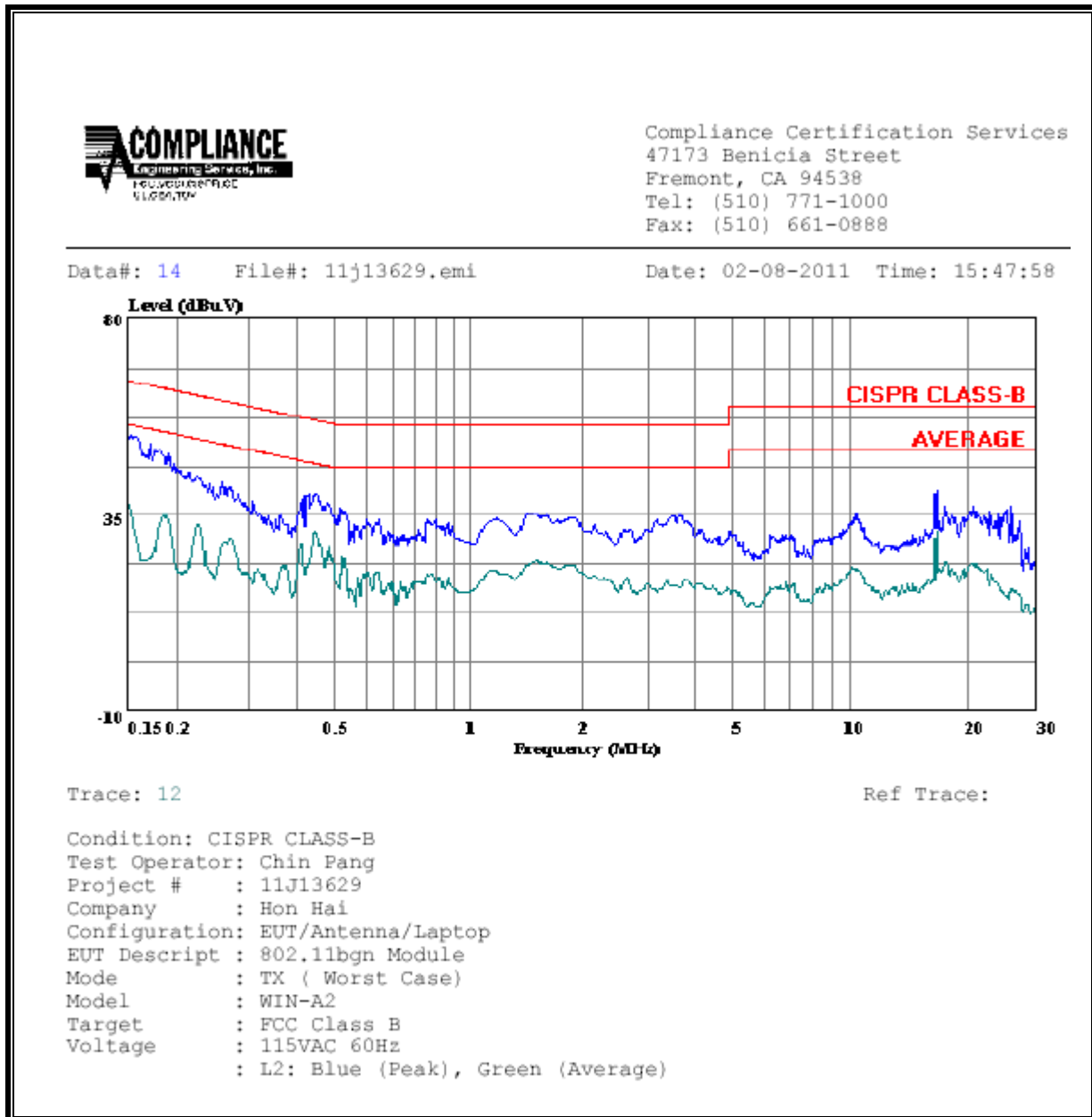

10. MAXIMUM PERMISSIBLE EXPOSURE

FCC RULES

§1.1310 The criteria listed in Table 1 shall be used to evaluate the environmental impact of human exposure to radio-frequency (RF) radiation as specified in §1.1307(b), except in the case of portable devices which shall be evaluated according to the provisions of §2.1093 of this chapter.

TABLE 1—LIMITS FOR MAXIMUM PERMISSIBLE EXPOSURE (MPE)

Frequency range (MHz)	Electric field strength (V/m)	Magnetic field strength (A/m)	Power density (mW/cm ²)	Averaging time (minutes)
(A) Limits for Occupational/Controlled Exposures				
0.3–3.0	614	1.63	*(100)	6
3.0–30	1842/f	4.89/f	*(900/f ²)	6
30–300	61.4	0.163	1.0	6
300–1500	f/300	6
1500–100,000	5	6
(B) Limits for General Population/Uncontrolled Exposure				
0.3–1.34	614	1.63	*(100)	30
1.34–30	824/f	2.19/f	*(180/f ²)	30

TABLE 1—LIMITS FOR MAXIMUM PERMISSIBLE EXPOSURE (MPE)—Continued

Frequency range (MHz)	Electric field strength (V/m)	Magnetic field strength (A/m)	Power density (mW/cm ²)	Averaging time (minutes)
30–300	27.5	0.073	0.2	30
300–1500	f/1500	30
1500–100,000	1.0	30

f = frequency in MHz

* = Plane-wave equivalent power density

NOTE 1 TO TABLE 1: Occupational/controlled limits apply in situations in which persons are exposed as a consequence of their employment provided those persons are fully aware of the potential for exposure and can exercise control over their exposure. Limits for occupational/controlled exposure also apply in situations when an individual is transient through a location where occupational/controlled limits apply provided he or she is made aware of the potential for exposure.

NOTE 2 TO TABLE 1: General population/uncontrolled exposures apply in situations in which the general public may be exposed, or in which persons that are exposed as a consequence of their employment may not be fully aware of the potential for exposure or can not exercise control over their exposure.

IC RULES

IC Safety Code 6, Section 2.2.1 (a) A person other than an RF and microwave exposed worker shall not be exposed to electromagnetic radiation in a frequency band listed in Column 1 of Table 5, if the field strength exceeds the value given in Column 2 or 3 of Table 5, when averaged spatially and over time, or if the power density exceeds the value given in Column 4 of Table 5, when averaged spatially and over time.

**Table 5
 Exposure Limits for Persons Not Classified As RF and Microwave Exposed Workers (Including the General Public)**

1 Frequency (MHz)	2 Electric Field Strength; rms (V/m)	3 Magnetic Field Strength; rms (A/m)	4 Power Density (W/m ²)	5 Averaging Time (min)
0.003–1	280	2.19		6
1–10	280/ <i>f</i>	2.19/ <i>f</i>		6
10–30	28	2.19/ <i>f</i>		6
30–300	28	0.073	2*	6
300–1 500	1.585 <i>f</i> ^{0.5}	0.0042 <i>f</i> ^{0.5}	<i>f</i> /150	6
1 500–15 000	61.4	0.163	10	6
15 000–150 000	61.4	0.163	10	616 000 / <i>f</i> ^{1.2}
150 000–300 000	0.158 <i>f</i> ^{0.5}	4.21 x 10 ⁻⁴ <i>f</i> ^{0.5}	6.67 x 10 ⁻⁵ <i>f</i>	616 000 / <i>f</i> ^{1.2}

* Power density limit is applicable at frequencies greater than 100 MHz.

- Notes:**
1. Frequency, *f*, is in MHz.
 2. A power density of 10 W/m² is equivalent to 1 mW/cm².
 3. A magnetic field strength of 1 A/m corresponds to 1.257 microtesla (μT) or 12.57 milligauss (mG).

EQUATIONS

Power density is given by:

$$S = \text{EIRP} / (4 * \text{Pi} * D^2)$$

Where

- S = Power density in W/m²
- EIRP = Equivalent Isotropic Radiated Power in W
- D = Separation distance in m

Power density in units of W/m² is converted to units of mW/cm² by dividing by 10.

Distance is given by:

$$D = \text{SQRT} (\text{EIRP} / (4 * \text{Pi} * S))$$

Where

- D = Separation distance in m
- EIRP = Equivalent Isotropic Radiated Power in W
- S = Power density in W/m²

For multiple collocated transmitters operating simultaneously in frequency bands where the limit is identical, the total power density is calculated using the total EIRP obtained by summing the Power * Gain product (in linear units) of each transmitter.

$$\text{Total EIRP} = (P1 * G1) + (P2 * G2) + \dots + (Pn * Gn)$$

where

- Px = Power of transmitter x
- Gx = Numeric gain of antenna x

In the table(s) below, Power and Gain are entered in units of dBm and dBi respectively and conversions to linear forms are used for the calculations.

LIMITS

From FCC §1.1310 Table 1 (B), the maximum value of S = 1.0 mW/cm²
 From IC Safety Code 6, Section 2.2 Table 5 Column 4, S = 10 W/m²

RESULTS

Band	Mode	Separation Distance (m)	Output Power (dBm)	Antenna Gain (dBi)	IC Power Density (W/m ²)	FCC Power Density (mW/cm ²)
2.4 GHz	WLAN	0.20	24.20	2.05	0.84	0.084