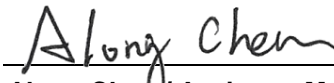

# FCC Test Report

**FCC ID** : MCLU97B002  
**Equipment** : Femto Cell (AIRAVE 4 LTE)  
**Model No.** : AV100C  
**Brand Name** : Airspan  
**Applicant** : Hon Hai Precision Ind. Co., Ltd.  
**Address** : 5F-1, 5 Hsin-An Road, Hsinchu,  
Science-Based Industrial Park, Taiwan, R.O.C  
**Standard** : 47 CFR FCC Part 24 Subpart E  
**Received Date** : Aug. 08, 2018  
**Tested Date** : Aug. 08 ~ Aug. 22, 2018

We, International Certification Corp., would like to declare that the tested sample has been evaluated and in compliance with the requirement of the above standards. The test results contained in this report refer exclusively to the product. It may be duplicated completely for legal use with the approval of the applicant. It shall not be reproduced except in full without the written approval of our laboratory.

Reviewed by:

  
\_\_\_\_\_  
Along Chen / Assistant Manager

Approved by:

  
\_\_\_\_\_  
Gary Chang / Manager



---

## Table of Contents

<b>1</b>	<b>GENERAL DESCRIPTION .....</b>	<b>5</b>
1.1	Information.....	5
1.2	Local Support Equipment List .....	6
1.3	Test Setup Chart .....	6
1.4	The Equipment List .....	7
1.5	Test Standards .....	8
1.6	Measurement Uncertainty .....	8
<b>2</b>	<b>TEST CONFIGURATION .....</b>	<b>9</b>
2.1	Testing Condition and Location Information.....	9
2.2	The Worst Test Modes and Channel Details .....	9
<b>3</b>	<b>TEST RESULTS.....</b>	<b>10</b>
3.1	Equivalent Isotropically Radiated Power .....	10
3.2	Radiated Emissions.....	13
3.3	Conducted Emissions.....	17
3.4	Band Edge.....	19
3.5	Occupied Bandwidth .....	21
3.6	Peak to Average Ratio .....	22
3.7	Frequency Stability.....	23
<b>4</b>	<b>TEST LABORATORY INFORMATION .....</b>	<b>25</b>

---

## Release Record

Report No.	Version	Description	Issued Date
FG880701P24	Rev. 01	Initial issue	Sep. 05, 2018

## Summary of Test Results

FCC Rules	Test Items	Measured	Result
2.1046 / 24.232(a)	Equivalent Isotropically Radiated Power	Power[dBm/1MHz]: 21.49	Pass
2.1053 / 24.238(a)	Radiated Emissions	Meet the requirement of limit	Pass
2.1051 / 24.238(a)	Conducted Emissions	Meet the requirement of limit	Pass
2.1051 / 24.238(a)	Band Edge	Meet the requirement of limit	Pass
2.1049	Occupied Bandwidth	Meet the requirement of limit	Pass
24.232(d)	Peak to average ratio	Meet the requirement of limit	Pass
2.1055 / 24.235	Frequency Stability	Meet the requirement of limit	Pass

# 1 General Description

## 1.1 Information

### 1.1.1 Specification of the Equipment under Test (EUT)

<b>Operating Band (MHz)</b>	CDMA2000 1Tx/2Rx, Voice only BC1, 1930~1990MHz
<b>H/W Version</b>	S1
<b>S/W Version</b>	2.0.01.06

### 1.1.2 Maximum EIRP and Emission Designator

Mode	Maximum EIRP (W / 1MHz)	Emission Designator
CDMA 2000 BC1	0.141	1M22F9W

### 1.1.3 Antenna Details

Ant. No.	Type	Connector	Gain (dBi)	Remark
1	PIFA	UFL	2.92	---

### 1.1.4 EUT Operational Condition

<b>Power Supply Type</b>	12Vdc from AC adapter		
<b>Operational Climatic</b>	<input checked="" type="checkbox"/> Tnom (20°C)	<input checked="" type="checkbox"/> Tmax (40°C)	<input checked="" type="checkbox"/> Tmin (0°C)

### 1.1.5 Accessories

Accessories		
No.	Equipment	Description
1	Adapter	Brand: DVE Model: DSA-42PFB-12 2 120300 I/P: 100-240Vac, 50/60Hz, 1.2A O/P: 12Vdc, 3A Power line: DC 1.5m non-shielded with one core AC 3.5m non-shielded without core
2	External GPS Antenna	10m non-shielded without core
3	RJ45 cable	1m non-shielded without core

### 1.1.6 Operating Channel List

CDMA 2000 BC1		
Channel location	Channel	Frequency (MHz)
Low	25	1931.25
Middle	600	1960.00
High	1175	1988.75

### 1.2 Local Support Equipment List

Support Equipment List					
No.	Equipment	Brand	Model	FCC ID	Remarks
1	Notebook	DELL	Latitude E5470	DoC	---

### 1.3 Test Setup Chart

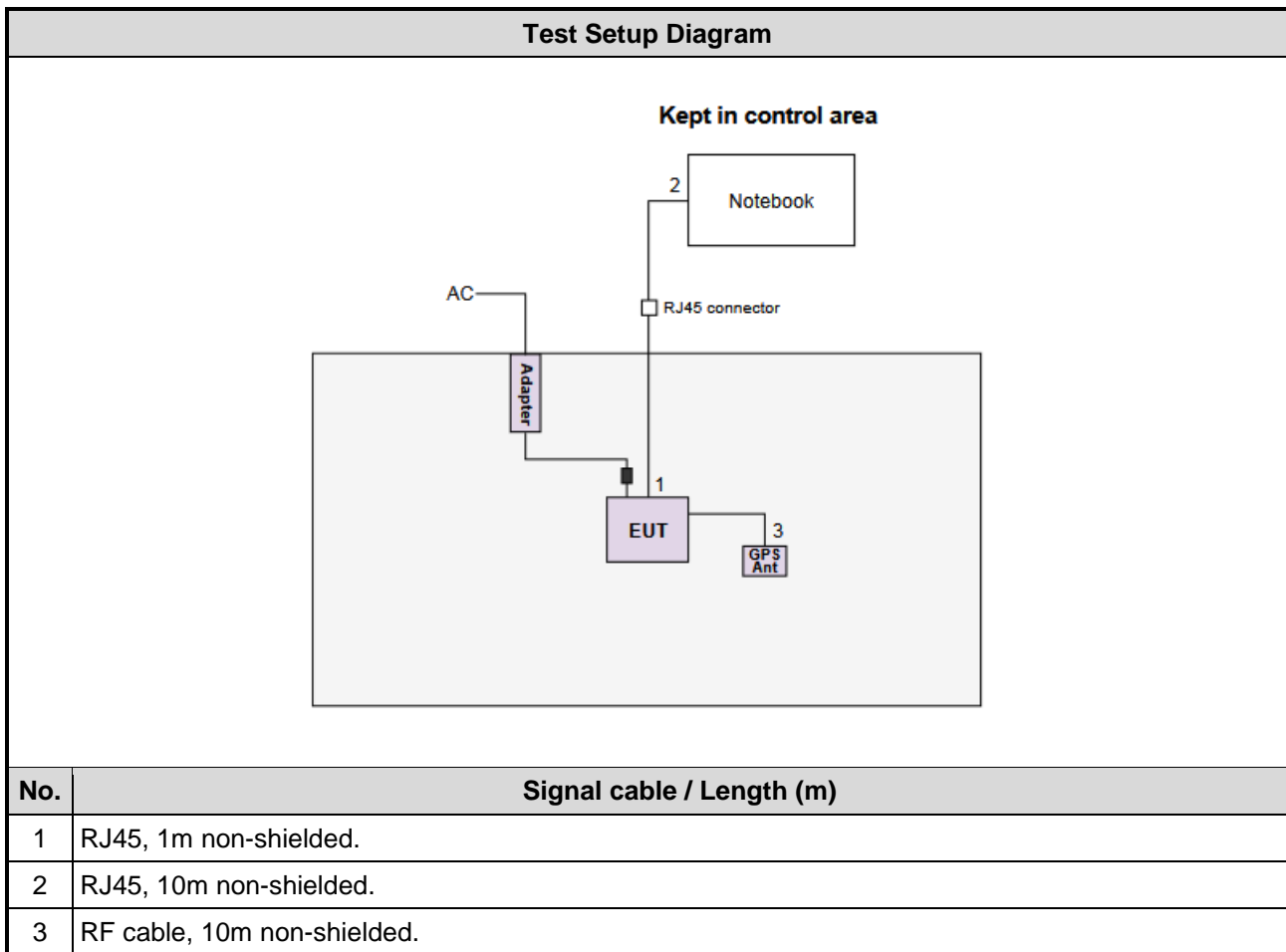

## 1.4 The Equipment List

Test Item	Radiated Emission				
Test Site	966 chamber 3 / (03CH03-WS)				
Instrument	Manufacturer	Model No.	Serial No.	Calibration Date	Calibration Until
Spectrum Analyzer	R&S	FSV40	101499	Jan. 03, 2018	Jan. 02, 2019
Receiver	R&S	ESR3	101658	Nov. 20, 2017	Nov. 19, 2018
Bilog Antenna	SCHWARZBECK	VULB9168	VULB9168-685	Apr. 19, 2018	Apr. 18, 2019
Horn Antenna 1G-18G	SCHWARZBECK	BBHA 9120 D	BBHA 9120 D 1206	Jan. 18, 2018	Jan. 17, 2019
Horn Antenna 18G-40G	SCHWARZBECK	BBHA 9170	BBHA 9170517	Nov. 23, 2017	Nov. 22, 2018
Loop Antenna	R&S	HFH2-Z2	100330	Nov. 13, 2017	Nov. 12, 2018
Loop Antenna Cable	KOAX KABEL	101354-BW	101354-BW	Dec. 07, 2017	Dec. 06, 2018
Preamplifier	EMC	EMC02325	980187	Sep. 04, 2017	Sep. 03, 2018
Preamplifier	Agilent	83017A	MY39501309	Sep. 25, 2017	Sep. 24, 2018
RF cable-3M	HUBER+SUHNER	SUCOFLEX104	MY22620/4	Nov. 27, 2017	Nov. 26, 2018
RF cable-8M	HUBER+SUHNER	SUCOFLEX104	MY32487/4	Nov. 27, 2017	Nov. 26, 2018
RF cable-1M	HUBER+SUHNER	SUCOFLEX104	MY22624/4	Nov. 27, 2017	Nov. 26, 2018
LF cable-0.8M	EMC	EMC8D-NM-NM-800	EMC8D-NM-NM-800-001	Nov. 27, 2017	Nov. 26, 2018
LF cable-3M	EMC	EMC8D-NM-NM-3000	131103	Nov. 27, 2017	Nov. 26, 2018
LF cable-13M	EMC	EMC8D-NM-NM-13000	131104	Nov. 27, 2017	Nov. 26, 2018
Measurement Software	AUDIX	e3	6.120210g	NA	NA

Note: Calibration Interval of instruments listed above is one year.

Test Item	RF Conducted				
Test Site	(TH01-WS)				
Instrument	Manufacturer	Model No.	Serial No.	Calibration Date	Calibration Until
Spectrum Analyzer	R&S	FSV40	101063	Apr. 16, 2018	Apr. 15, 2019
TEMP&HUMIDITY CHAMBER	GIANT FORCE	GCT-225-40-SP-SD	MAF1212-002	Nov. 27, 2017	Nov. 26, 2018
Power Meter	Anritsu	ML2495A	1241002	Oct. 16, 2017	Oct. 15, 2018
Power Sensor	Anritsu	MA2411B	1207366	Oct. 16, 2017	Oct. 15, 2018
AC POWER SOURCE	APC	AFC-500W	F312060012	Dec. 01, 2017	Nov. 30, 2018
Measurement Software	Sporton	Sporton_1	1.3.30	NA	NA

Note: Calibration Interval of instruments listed above is one year.

## 1.5 Test Standards

According to the specification of EUT, the EUT must comply with following standards.

47 CFR FCC Part 24 Subpart E

ANSI C63.4-2014

ANSI C63.26-2015

FCC KDB 971168 D01 Power Meas License Digital Systems v03r01

FCC KDB 412172 D01 Determining ERP and EIRP v01r01

## 1.6 Measurement Uncertainty

ISO/IEC 17025 requires that an estimate of the measurement uncertainties associated with the emissions test results be included in the report. The measurement uncertainties given below are based on a 95% confidence level (based on a coverage factor (k=2))

Measurement Uncertainty	
Parameters	Uncertainty
Bandwidth	±34.134 Hz
Conducted power	±0.808 dB
Frequency error	±34.134 Hz
Conducted emission	±2.670 dB
Radiated emission ≤ 1GHz	±3.66 dB
Radiated emission > 1GHz	±5.37 dB
Temperature	±0.6 °C



## 2 Test Configuration

### 2.1 Testing Condition and Location Information

Test Item	Test Site	Ambient Condition	Tested By
RF conducted	TH01-WS	22°C / 64%	Aska Huang
Radiated Emissions	03CH03-WS	23-24°C / 62-63%	Vincent Yeh

- FCC Designation No.: TW0009
- FCC site registration No.: 207696
- IC site registration No.: 10807C-1

### 2.2 The Worst Test Modes and Channel Details

Test item	Mode	Test channel
E.I.R.P Conducted Emissions Occupied Bandwidth Peak to Average Ratio	CDMA 2000 BC1	25, 600, 1175
Radiated Emission $\leq$ 1GHz	CDMA 2000 BC1	25
Radiated Emission $>$ 1GHz	CDMA 2000 BC1	25, 600, 1175
Band Edge	CDMA 2000 BC1	25, 1175
Frequency Stability	CDMA 2000 BC1	600

## **3 Test Results**

### **3.1 Equivalent Isotropically Radiated Power**

#### **3.1.1 Limit of Equivalent Isotropically Radiated Power**

Base stations with an emission bandwidth greater than 1 MHz are limited to 1640 watts/MHz.

#### **3.1.2 Test Procedures**

##### **For EIRP**

1. Connect the transmitter to the spectrum analyzer via coaxial cable
2. Tune the analyzer to the nominal center frequency of the emission bandwidth.
3. Set the resolution bandwidth (RBW) to 1 MHz.
4. Set the video bandwidth (VBW) to 3 MHz
5. Select the average power (RMS) display detector.
6. Set the number of measurement points to  $\geq 1001$ .
7. Use auto-coupled sweep time.
8. Perform the measurement over an interval of time when the transmission is continuous and at its maximum power level.
9. Utilize trace averaging over 100 traces in the power averaging.
10. Find the maximum trace amplitude (peak search) and record.
11. Adjust the recorded level by applying appropriate correction factors for the measurement set-up.
12. Determine the EIRP by adding the effective antenna gain to the adjusted power level.

##### **For Conducted Power**

1. The EUT is set to maximum output power level at low / middle / high channel.
2. Measure the output power of low / middle / high channel of the EUT.

### 3.1.3 Test Setup

For EIRP



For Conducted Power

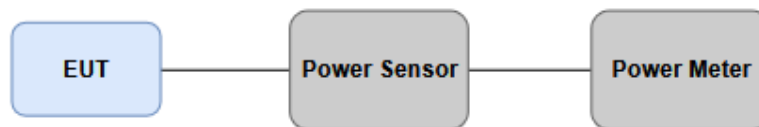

### 3.1.4 Test Result

For EIRP

Channel	Frequency (MHz)	Conducted Power (dBm/1MHz)	Max Antenna Gain (dBi)	EIRP (dBm/1MHz)	EIRP (W/1MHz)	EIRP Limit (W/1MHz)
25	1931.25	18.57	2.92	21.49	0.140929	1640
600	1960.00	17.70	2.92	20.62	0.115345	1640
1175	1988.75	18.27	2.92	21.19	0.131522	1640

For Conducted Power

Channel	Frequency (MHz)	Conducted Power (dBm)
25	1931.25	19.12
600	1960.00	18.73
1175	1988.75	19.21

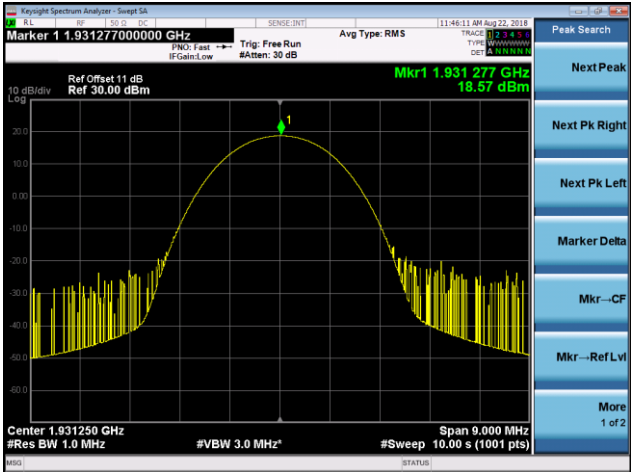
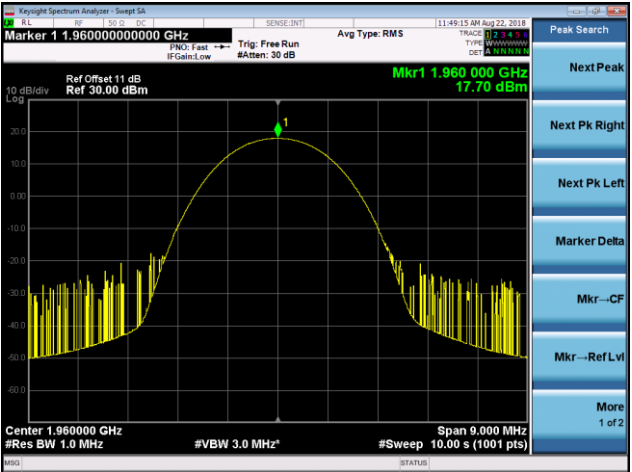
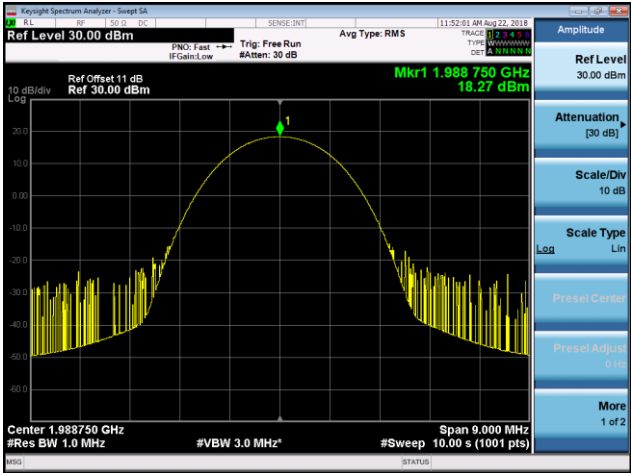
<b>Mode</b>	<b>CDMA</b>		
<b>Channel</b>	<b>25</b>	<b>Channel</b>	<b>600</b>
			
<b>Channel</b>	<b>1175</b>	---	
		---	

## 3.2 Radiated Emissions

### 3.2.1 Limit of Radiated Emissions

The power of any emission outside of the authorized operating frequency ranges must be attenuated below the transmitting power (P) by a factor of at least  $43 + 10 \log(P)$  dB equal to -13dBm.

### 3.2.2 Test Procedures

1. Measurement is made at a semi-anechoic chamber that incorporates a turntable allowing a EUT rotation of 360°. A continuously-rotating, remotely-controlled turntable is installed at the test site to support the EUT and facilitate determination of the direction of maximum radiation for each EUT emission frequency. For emissions testing at or below 1 GHz, the table height is 80 cm above the reference ground plane. For emission measurements above 1 GHz, the table height is 1.5 m.
2. Measurement is made with the antenna positioned in both the horizontal and vertical planes of polarization. The measurement antenna is varied in height (1m ~ 4m) above the reference ground plane to obtain the maximum signal strength. Distance between EUT and antenna is 3 m.
3. This investigation is performed with the EUT rotated 360°, the antenna height scanned between 1 m and 4 m, and the antenna rotated to repeat the measurements for both the horizontal and vertical antenna polarizations.
4. After finding the max radiated emission, substitution method will be used for getting effective radiated power. EUT will be removed and substitution antenna will be placed at same position. Signal generator will output CW signal to substitution antenna through a RF cable. Rotate turntable and move antenna to find maximum radiated emission. Adjust output power of signal generator to let the maximum radiated emission is same as step 3. Record the output power level.
5. E.I.R.P = output power of step 4 + gain of substitution antenna – cable loss of RF cable.

### 3.2.3 Test Setup

#### Radiated Emissions below 1 GHz

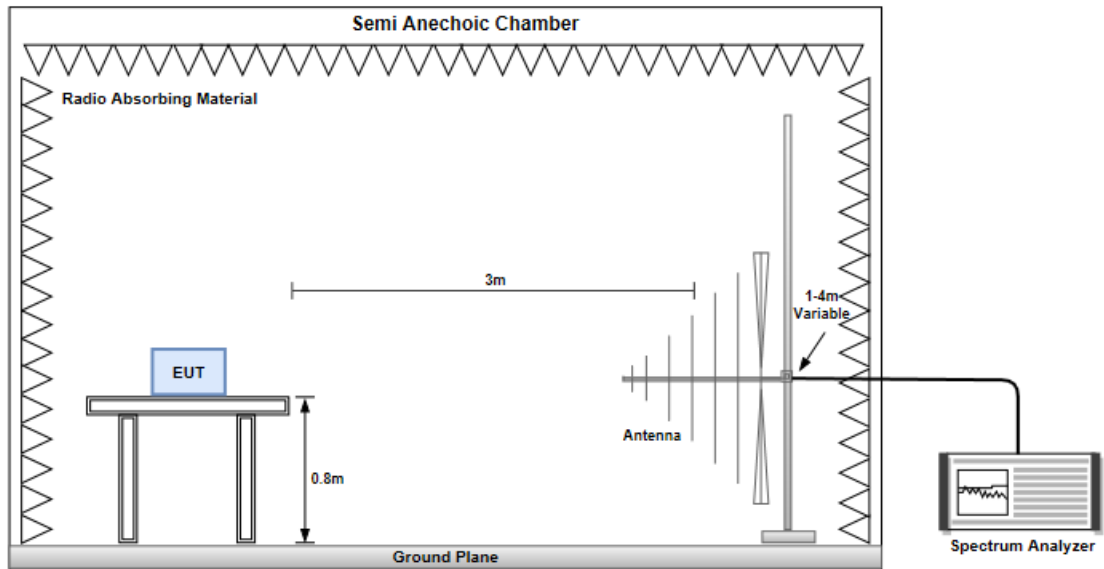

#### Radiated Emissions above 1 GHz

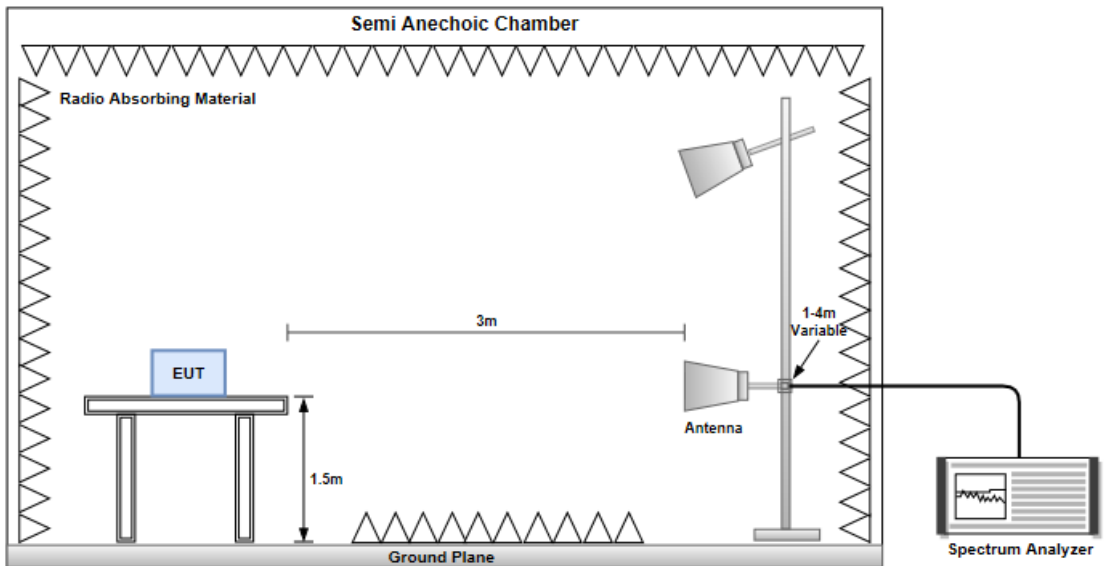

### 3.2.4 Test Result of Radiated Emissions below 1GHz

Mode	CDMA 2000, Channel : 25						
Frequency (MHz)	Antenna Polarity	E.I.R.P (dBm)	Limit (dBm)	Margin (dB)	S.A Reading (dBm)	S.G Power Value (dBm)	Correction Factor (dB)
30.97	H	-67.52	-13.00	-54.52	-75.48	-53.63	-13.89
95.96	H	-69.21	-13.00	-56.21	-67.47	-69.45	0.24
232.73	H	-61.55	-13.00	-48.55	-57.92	-65.65	4.10
249.22	H	-57.28	-13.00	-44.28	-54.20	-61.41	4.13
258.92	H	-61.84	-13.00	-48.84	-59.05	-65.95	4.11
624.61	H	-62.01	-13.00	-49.01	-67.39	-65.50	3.49
30.00	V	-68.44	-13.00	-55.44	-64.21	-54.37	-14.07
64.92	V	-69.23	-13.00	-56.23	-66.20	-62.04	-7.19
249.22	V	-55.28	-13.00	-42.28	-57.54	-59.41	4.13
258.92	V	-59.19	-13.00	-46.19	-61.39	-63.30	4.11
637.22	V	-59.66	-13.00	-46.66	-68.21	-63.21	3.55
825.40	V	-62.52	-13.00	-49.52	-72.02	-65.57	3.05

Note: EIRP = S.G Power value + Correction factor

### 3.2.5 Test Result of Radiated Emissions above 1GHz

Mode	CDMA 2000, Channel : 25						
Frequency (MHz)	Antenna Polarity	E.I.R.P (dBm)	Limit (dBm)	Margin (dB)	S.A Reading (dBm)	S.G Power Value (dBm)	Correction Factor (dB)
3862.50	H	-49.37	-13.00	-36.37	-61.70	-56.02	6.65
7725.00	H	-46.04	-13.00	-33.04	-65.87	-48.85	2.81
11587.00	H	-39.84	-13.00	-26.84	-65.10	-41.07	1.23
3862.50	V	-53.11	-13.00	-40.11	-65.12	-59.76	6.65
7725.00	V	-44.59	-13.00	-31.59	-64.80	-47.40	2.81
11587.00	V	-40.24	-13.00	-27.24	-65.57	-41.47	1.23

Mode	CDMA 2000, Channel : 600						
Frequency (MHz)	Antenna Polarity	E.I.R.P (dBm)	Limit (dBm)	Margin (dB)	S.A Reading (dBm)	S.G Power Value (dBm)	Correction Factor (dB)
3920.00	H	-49.25	-13.00	-36.25	-61.36	-55.89	6.64
7840.00	H	-40.41	-13.00	-27.41	-60.60	-43.01	2.60
11760.00	H	-40.50	-13.00	-27.50	-66.31	-42.21	1.71
3920.00	V	-52.56	-13.00	-39.56	-64.33	-59.20	6.64
7840.00	V	-38.39	-13.00	-25.39	-58.96	-40.99	2.60
11760.00	V	-40.57	-13.00	-27.57	-66.28	-42.28	1.71

Mode	CDMA 2000, Channel : 1175						
Frequency (MHz)	Antenna Polarity.	E.I.R.P (dBm)	Limit (dBm)	Margin (dB)	S.A Reading (dBm)	S.G Power Value (dBm)	Correction Factor (dB)
3977.50	H	-50.27	-13.00	-37.27	-62.15	-56.90	6.63
7955.00	H	-35.10	-13.00	-22.10	-55.26	-37.63	2.53
11932.50	H	-40.63	-13.00	-27.63	-66.98	-42.83	2.20
3977.50	V	-50.77	-13.00	-37.77	-62.30	-57.40	6.63
7955.00	V	-35.88	-13.00	-22.88	-56.23	-38.41	2.53
11932.50	V	-39.59	-13.00	-26.59	-65.68	-41.79	2.20

Note: EIRP = S.G Power value + Correction factor



### 3.3 Conducted Emissions

#### 3.3.1 Limit of Conducted Emissions

The power of any emission outside of the authorized operating frequency ranges must be attenuated below the transmitting power (P) by a factor of at least  $43 + 10 \log(P)$  dB equal to -13dBm.

#### 3.3.2 Test Procedures

1. Lowest, middle and highest operating channels are tested for this item.
2. Scan frequency range is from 30MHz~20GHz.
3. Set RBW = 1MHz, VBW = 3MHz, detector = Peak, sweep time = auto.
4. Record the max trace value and capture the test plot of each sub frequency band.

#### 3.3.3 Test Setup



### 3.3.4 Test Result of Conducted Emissions

Mode	CDMA		
Channel	25	Channel	600
			
Channel	1175	---	
		---	

## 3.4 Band Edge

### 3.4.1 Limit of Band Edge

The power of any emission outside of the authorized operating frequency ranges must be attenuated below the transmitting power (P) by a factor of at least  $43 + 10 \log(P)$  dB equal to -13dBm.

### 3.4.2 Test Procedures

1. Lowest and highest operating channels are tested for this item.
2. The center frequency of spectrum analyzer will be set to 1930 and 1990MHz.
3. Set RBW = 20kHz, VBW = 100kHz, span = 3MHz, detector = RMS, sweep time = auto.
4. Record the max trace value and capture the test plot.

### 3.4.3 Test Setup



### 3.4.4 Test Result of Band Edge

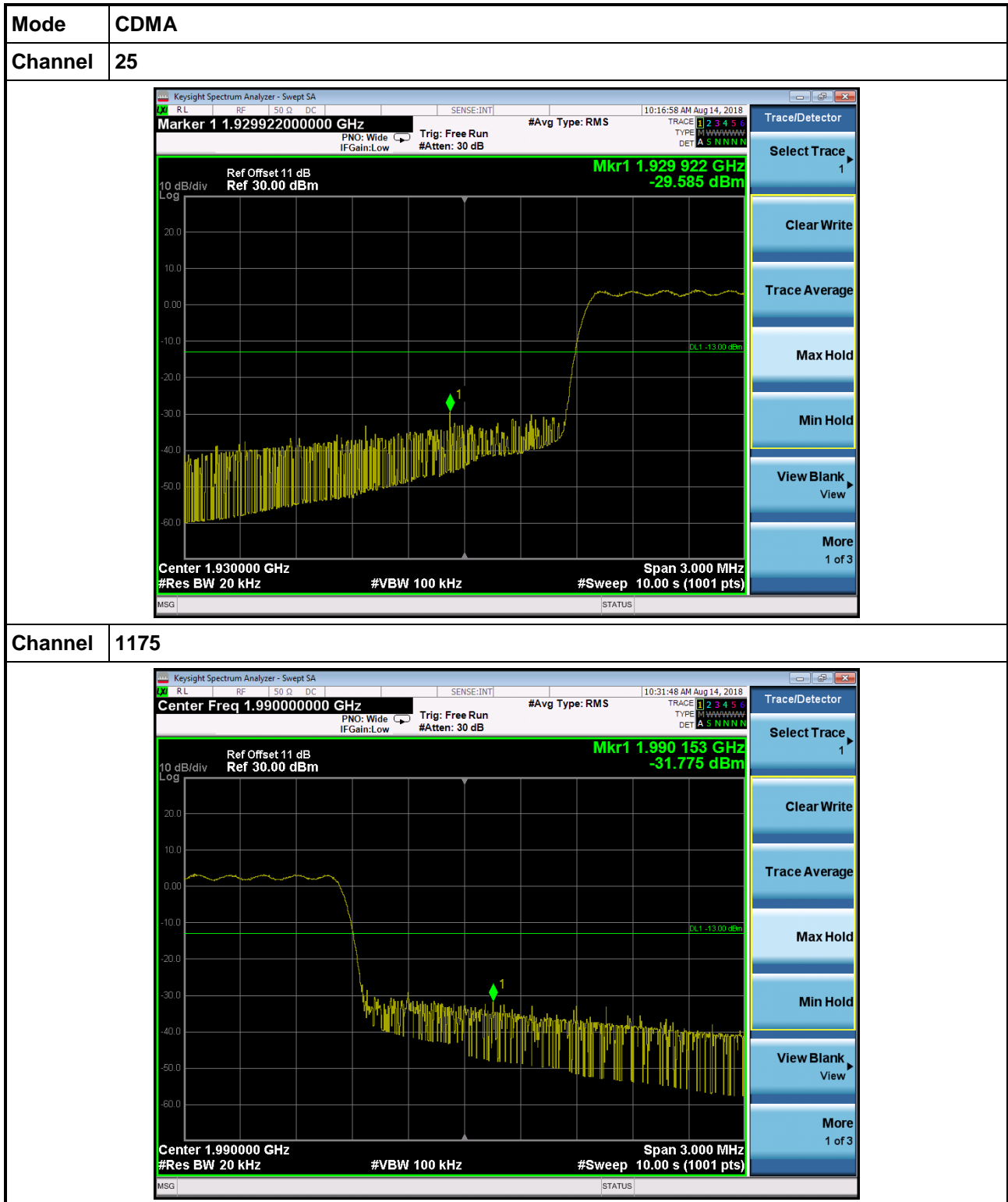

### 3.5 Occupied Bandwidth

#### 3.5.1 Test Procedures

1. Set RBW = 20kHz, VBW = 100kHz, detector = Peak, sweep time = auto.
2. Using occupied bandwidth measurement function of spectrum analyzer to measure occupied bandwidth.

#### 3.5.2 Test Setup



#### 3.5.3 Test Result of Occupied Bandwidth

Mode	Channel	Frequency (MHz)	26dB BW (MHz)	99% OBW (MHz)
CDMA	25	1931.25	1.342	1.2195
CDMA	600	1960.00	1.368	1.2223
CDMA	1175	1988.75	1.361	1.2200

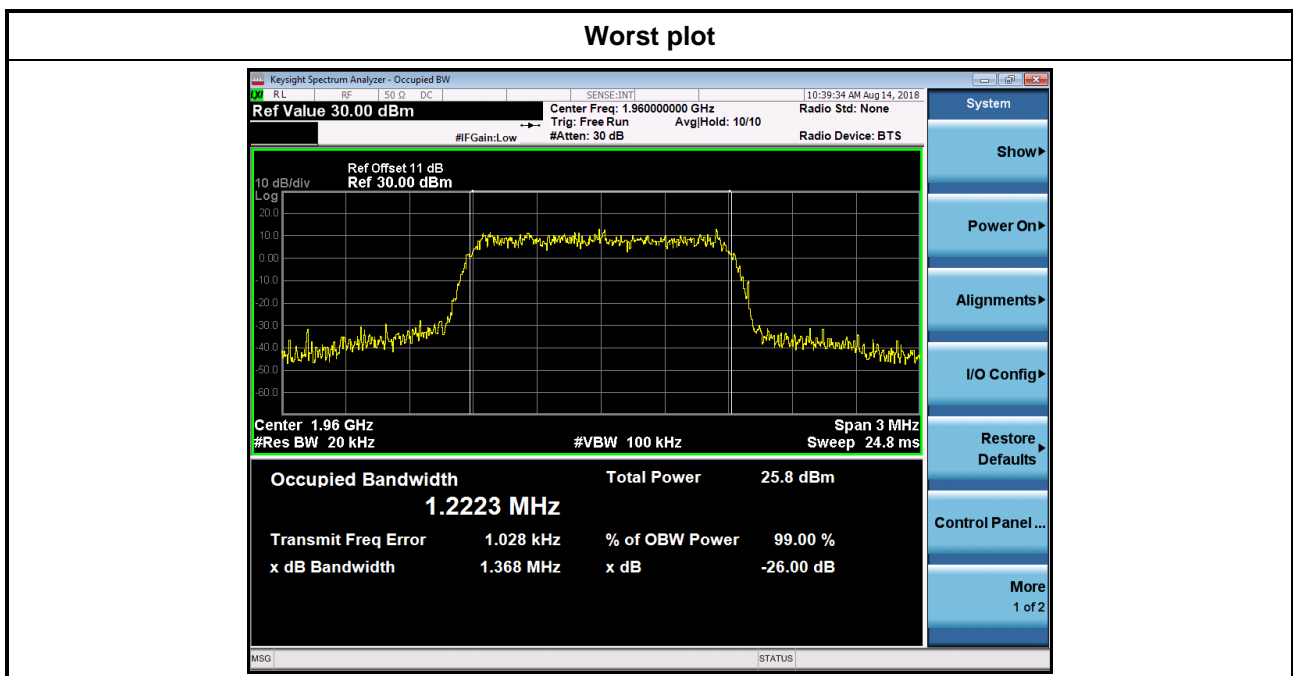

### 3.6 Peak to Average Ratio

#### 3.6.1 Limit of Peak to Average Ratio

Peak-to-average ratio (PAR) of the transmission may not exceed 13dB.

#### 3.6.2 Test Procedures

1. Enable CCDF function of spectrum analyzer and set RBW = 5MHz.
2. Set the number of counts to a value that stabilizes the measured CCDF curve.
3. Record the maximum PAPR level associated with a probability of 0.1%..

#### 3.6.3 Test Setup



#### 3.6.4 Test Result of Peak to Average ratio

Mode	Channel	Frequency (MHz)	Peak to Average Ratio (dB)
CDMA	25	1931.25	8.14
CDMA	600	1960.00	8.90
CDMA	1175	1988.75	8.93

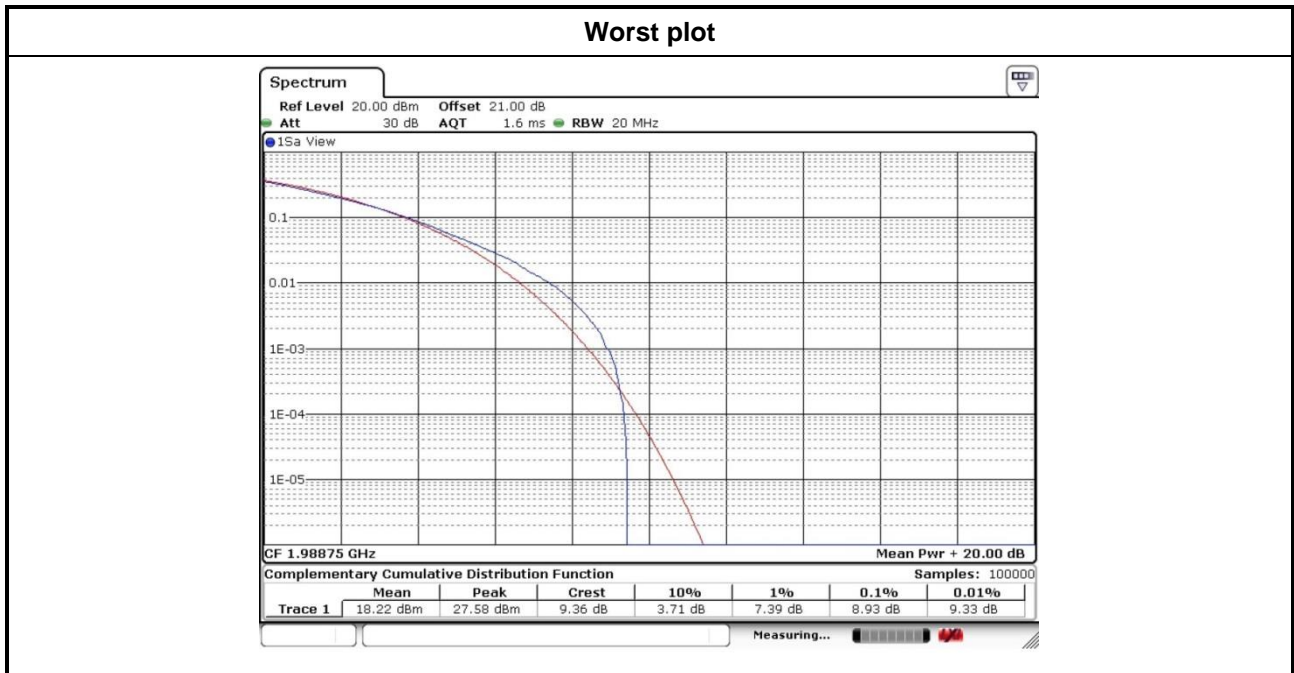

## 3.7 Frequency Stability

### 3.7.1 Limit of Frequency Stability

The frequency stability shall be sufficient to ensure that the fundamental emission stays within the authorized frequency block.

### 3.7.2 Test Procedures

1. EUT was placed at temperature chamber and connected to an external power supply.
2. Temperature and voltage condition shall be tested to confirm frequency stability.
3. Temperature range is from -30~50°C and voltage range is from 85 to 115 percent of the nominal value.
4. Confirm frequency drift value of simulator and record it.

### 3.7.3 Test Setup

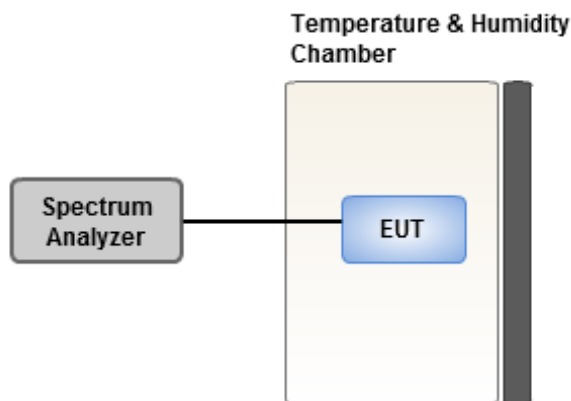

### 3.7.4 Test Result of Frequency Stability

Temperature (°C)		Frequency Error (ppm)
20°C V <sub>max</sub>		0.77
20°C V <sub>min</sub>		0.76
50°C V <sub>nom</sub>		0.77
40°C V <sub>nom</sub>		0.76
30°C V <sub>nom</sub>		0.77
20°C V <sub>nom</sub>		0.76
10°C V <sub>nom</sub>		0.55
0°C V <sub>nom</sub>		0.51
-10°C V <sub>nom</sub>		0.48
-20°C V <sub>nom</sub>		0.43
-30°C V <sub>nom</sub>		0.33
Vnom [V]: 120	Vmax [V]: 138	Vmin [V]: 102
Tnom [°C]: 20	Tmax [°C]: 50	Tmin [°C]: -30



## 4 Test laboratory information

Established in 2012, ICC provides foremost EMC & RF Testing and advisory consultation services by our skilled engineers and technicians. Our services employ a wide variety of advanced edge test equipment and one of the widest certification extents in the business.

International Certification Corp (EMC and Wireless Communication Laboratory), it is our definitive objective is to institute long term, trust-based associations with our clients. The expectation we set up with our clients is based on outstanding service, practical expertise and devotion to a certified value structure. Our passion is to grant our clients with best EMC / RF services by oriented knowledgeable and accommodating staff.

Our Test sites are located at Linkou District and Kwei Shan District. Location map can be found on our website <http://www.icertifi.com.tw>.

### **Linkou**

Tel: 886-2-2601-1640

No. 30-2, Ding Fwu Tsuen, Lin  
Kou District, New Taipei City,  
Taiwan, R.O.C.

### **Kwei Shan**

Tel: 886-3-271-8666

No. 3-1, Lane 6, Wen San 3rd St.,  
Kwei Shan District, Tao Yuan City  
333, Taiwan, R.O.C.

### **Kwei Shan Site II**

Tel: 886-3-271-8640

No. 14-1, Lane 19, Wen San 3rd  
St., Kwei Shan District, Tao Yuan  
City 333, Taiwan, R.O.C..

If you have any suggestion, please feel free to contact us as below information

Tel: 886-3-271-8666

Fax: 886-3-318-0155

Email: ICC\_Service@icertifi.com.tw

==END==