

**FCC 47 CFR PART 15 SUBPART C AND ANSI C63.10:2013  
TEST REPORT**

**For**

**WHITE DRIVE BOX**

**Model: TB4001**

**Issued for**

**Hon Hai Precision Ind. Co., Ltd.**

**5F-1, 5, Hsin-An Road Hsinchu Science-Based Industrial  
Park, Hsinchu, Taiwan**

**Issued by**

**Compliance Certification Services Inc.  
Hsinchu Lab.**

**No.989-1, Wenshan Rd., Shangshan Village,  
Qionglin Township, Hsinchu County 30741, Taiwan (R.O.C.)**

**TEL: +886-3-5921698**

**FAX: +886-3-5921108**

**<http://www.ccsrf.com>**

**E-Mail: [service@ccsrf.com](mailto:service@ccsrf.com)**

**Issued Date: October 28, 2016**



**Note:** This report shall not be reproduced except in full, without the written approval of Compliance Certification Services Inc. This document may be altered or revised by Compliance Certification Services Inc. personnel only, and shall be noted in the revision section of the document. The client should not use it to claim product endorsement by TAF or any government agencies. The test results of this report relate only to the tested sample identified in this report.

## Revision History

Rev.	Issue Date	Revisions	Effect Page	Revised By
00	10/28/2016	Initial Issue	All Page 342	Michelle Chiu

---

## TABLE OF CONTENTS

TITLE	PAGE NO.
<b>1. TEST REPORT CERTIFICATION.....</b>	<b>4</b>
<b>2. EUT DESCRIPTION.....</b>	<b>5</b>
<b>3. DESCRIPTION OF TEST MODES.....</b>	<b>6</b>
<b>4. TEST METHODOLOGY.....</b>	<b>7</b>
<b>5. FACILITIES AND ACCREDITATION.....</b>	<b>7</b>
5.1 FACILITIES.....	7
5.2 ACCREDITATIONS.....	7
5.3 MEASUREMENT UNCERTAINTY.....	8
<b>6. SETUP OF EQUIPMENT UNDER TEST.....</b>	<b>9</b>
<b>7. FCC PART 15.247 REQUIREMENTS.....</b>	<b>11</b>
7.1 DUTY CYCLE CORRECTION FACTOR.....	11
7.2 6dB BANDWIDTH.....	12
7.3 MAXIMUM PEAK OUTPUT POWER.....	27
7.4 AVERAGE POWER.....	31
7.5 POWER SPECTRAL DENSITY.....	34
7.6 CONDUCTED SPURIOUS EMISSION.....	50
7.7 RADIATED EMISSION.....	69
7.8 CONDUCTED EMISSION.....	330
<b>8. APPENDIX I CO-LOCATION.....</b>	<b>337</b>
<b>9. APPENDIX II SETUP PHOTOS.....</b>	<b>339</b>

# 1. TEST REPORT CERTIFICATION

**Applicant** : Hon Hai Precision Ind. Co., Ltd.  
**Address** : 5F-1, 5, Hsin-An Road Hsinchu Science-Based Industrial  
 Park,Hsinchu,Taiwan  
**Equipment Under Test** : WHITE DRIVE BOX  
**Model** : TB4001  
**Tested Date** : August 01 ~ 18, 2016

APPLICABLE STANDARD	
Standard	Test Result
FCC Part 15 Subpart C AND ANSI C63.10:2013	PASS

WE HEREBY CERTIFY THAT: The above equipment has been tested by Compliance Certification Services Inc., and found compliance with the requirements set forth in the technical standards mentioned above. The results of testing in this report apply only to the product/system, which was tested. Other similar equipment will not necessarily produce the same results due to production tolerance and measurement uncertainties.

**Approved by:**



Sb. Lu  
Sr. Engineer

**Reviewed by:**



Gungam Lin  
Sr. Engineer

## 2. EUT DESCRIPTION

<b>Product Name</b>	WHITE DRIVE BOX
<b>Model Number</b>	TB4001
<b>Identify Number</b>	T160801S01
<b>Received Date</b>	August 01, 2016
<b>Frequency Range</b>	IEEE 802.11b/g, 802.11gn HT20 Mode: 2412MHz ~ 2462MHz
<b>Transmit Power</b>	Direct Mode : IEEE 802.11b Mode: 16.65 dBm (0.0462 W) IEEE 802.11g Mode: 22.07 dBm (0.1611 W) IEEE 802.11gn HT20 MCS0 Mode: 21.93 dBm (0.1560 W) STA Mode : IEEE 802.11b Mode: 16.02 dBm (0.0400 W) IEEE 802.11g Mode: 20.63 dBm (0.1156 W) IEEE 802.11gn HT20 MCS0 Mode: 19.63 dBm (0.0918 W)
<b>Channel Spacing</b>	5MHz
<b>Channel Number</b>	IEEE 802.11b/g, 802.11gn HT20 Mode: 11 Channels
<b>Transmit Data Rate</b>	IEEE 802.11b Mode: up to 11 Mbps IEEE 802.11g Mode: up to 54 Mbps IEEE 802.11gn HT20 Mode (800ns GI): up to 65.00 Mbps IEEE 802.11gn HT20 Mode (400ns GI): up to 72.20 Mbps
<b>Type of Modulation</b>	IEEE 802.11b Mode: DSSS (CCK, DQPSK, DBPSK) IEEE 802.11g Mode: OFDM (64QAM, 16QAM, QPSK, BPSK) IEEE 802.11gn HT20 Mode: OFDM (64QAM, 16QAM, QPSK, BPSK)
<b>Antenna Type</b>	Internal Chip Antenna × 1, Antenna Gain: 3.05 dBi External YAGI Antenna × 2, Antenna Gain: 3.5 dBi
<b>Power Rating</b>	5Vdc
<b>Test Voltage</b>	120Vac, 60Hz
<b>I/O Port</b>	Console Port × 1, Power Port × 1, SIM Card Port × 1
<b>Signal Cable</b>	Shielded USB cable, 0.9m × 1 (Detachable)

**Remark:**

1. The sample selected for test was engineering sample that approximated to production product and was provided by manufacturer.
2. For more details, please refer to the User's manual of the EUT.
3. This submittal(s) (test report) is intended for FCC ID: MCLTB4001 filing to comply with Section 15.207, 15.209 and 15.247 of the FCC Part 15, Subpart C Rules.

### 3. DESCRIPTION OF TEST MODES

The EUT (WHITE DRIVE BOX) is an 802.11b/g/n transceiver.

IEEE 802.11b/g, 802.11gn HT20 Mode: 1TX / 1RX

The EUT comes with two types for sales, the detail information please refer the table as below:

Mode	Antenna List	Test Item	
		Spurious	Conducted
Direct	External YAGI Antenna	√	√
STA	External YAGI Antenna	√	√
	Internal Chip Antenna	√	

#### Conducted Emission / Radiated Emission Test (Below 1 GHz)

1. The following test modes were scanned during the preliminary test:

No.	Pre-Test mode
1	Normal Operating / Direct Mode + 2G + STA External Ant. + GPS External Ant.
2	Normal Operating / Direct Mode + 2G + STA Internal Ant. + GPS Internal Ant.

2. After the preliminary scan, the following test mode was found to produce the highest emission level.

Final Test mode		
Emission	Radiated Emission	Mode 1
	Conducted Emission	Mode 2

*Remark: Then, the above highest emission mode of the configuration of the EUT and cable was chosen for all final test items.*

#### Conducted / Radiated Emission Test (Above 1 GHz)

IEEE 802.11b/g, 802.11gn HT20 Mode:

The EUT had been tested under operating condition.

There are three channels have been tested as following:

Channel	Frequency (MHz)
Low	2412
Middle	2437
High	2462

IEEE 802.11b Mode: 1Mbps data rate (worst case) was chosen for full testing.

IEEE 802.11g Mode: 6Mbps data rate (worst case) was chosen for full testing.

IEEE 802.11gn HT20 MCS0 Mode: 6.5Mbps data rate (worst case) was chosen for full testing.

## 4. TEST METHODOLOGY

The tests documented in this report were performed in accordance with ANSI C63.10:2013 and FCC CFR 47, 15.207, 15.209 and 15.247.

## 5. FACILITIES AND ACCREDITATION

### 5.1 FACILITIES

All measurement facilities used to collect the measurement data are located at

No.989-1, Wenshan Rd., Shangshan Village,  
Qionglin Township, Hsinchu County 30741, Taiwan (R.O.C.)

The sites are constructed in conformance with the requirements of ANSI C63.10:2013 and CISPR 22. All receiving equipment conforms to CISPR 16-1-1, CISPR 16-1-2, CISPR 16-1-3, CISPR 16-1-4 and CISPR 16-1-5.

### 5.2 ACCREDITATIONS

Our laboratories are accredited and approved by the following approval agencies according to ISO/IEC 17025.

<b>Taiwan</b>	TAF
---------------	-----

The measuring facility of laboratories has been authorized or registered by the following approval agencies.

<b>Canada</b>	INDUSTRY CANADA
<b>Japan</b>	VCCI
<b>Taiwan</b>	BSMI
<b>USA</b>	FCC MRA

Copies of granted accreditation certificates are available for downloading from our web site, <http://www.ccsrf.com>

**Remark:** FCC Designation Number TW1027.

### 5.3 MEASUREMENT UNCERTAINTY

The following table is for the measurement uncertainty, which is calculated as per the document CISPR 16-4-2.

PARAMETER	UNCERTAINTY
Semi Anechoic Chamber (966 Chamber_C) / Radiated Emission, 30 to 1000 MHz	+/- 3.97
Semi Anechoic Chamber (966 Chamber_C) / Radiated Emission, 1 to 18GHz	+/- 3.58
Semi Anechoic Chamber (966 Chamber_C) / Radiated Emission, 18 to 26 GHz	+/- 3.59
Semi Anechoic Chamber (966 Chamber_C) / Radiated Emission, 26 to 40 GHz	+/- 3.81
Conducted Emission (Mains Terminals), 9kHz to 30MHz	+/- 2.48

This uncertainty represents an expanded uncertainty expressed at approximately the 95% confidence level using a coverage factor of k=2.

Consistent with industry standard (e.g. CISPR 22, clause 11, Measurement Uncertainty) determining compliance with the limits shall be base on the results of the compliance measurement. Consequently the measure emissions being less than the maximum allowed emission result in this be a compliant test or passing test.

The acceptable measurement uncertainty value without requiring revision of the compliance statement is base on conducted and radiated emissions being less than  $U_{CISPR}$  which is 3.6dB and 5.2dB respectively. CCS values (called  $U_{Lab}$  in CISPR 16-4-2) is less than  $U_{CISPR}$  as shown in the table above. Therefore, MU need not be considered for compliance.



## 6. SETUP OF EQUIPMENT UNDER TEST

### SUPPORT EQUIPMENT

No.	Product	Manufacturer	Model No.	Serial No.
1	Notebook PC	TOSHIBA	PORTEGE R30-A	7F097011H
2	Notebook PC	TOSHIBA	PORTEGE R30-A	7F097009H
3	Wireless Communications Test Set	Agilent	8960	MY48360266
4	Router	TP-Link	Archer C2	214C316003274
5	WHITE DRIVE BOX	Hon Hai Precision Ind. Co., Ltd.	TB4001	---

No.	Signal Cable Description
1	Shielded USB cable, 1.5m × 1

### SETUP DIAGRAM FOR TESTS

EUT & peripherals setup diagram is shown in appendix setup photos.

### EUT OPERATING CONDITION

#### **RF Mode :**

1. EUT & peripherals setup diagram is shown in appendix setup photos.

2. TX mode:

⇒ **Data Rate:** 1Mbps Bandwidth 20 (IEEE 802.11b Mode)

6Mbps Bandwidth 20 (IEEE 802.11g Mode)

6.5Mbps Bandwidth 20 (IEEE 802.11gn HT20 MCS0 Mode)

⇒ **Power control**

#### **Direct Mode :**

Mode	Channel	Frequency (MHz)	Power Set
IEEE 802.11b	Low	2412	17
	Middle	2437	17
	High	2462	17
IEEE 802.11g	Low	2412	17
	Middle	2437	17
	High	2462	17
IEEE 802.11gn HT20 MCS0	Low	2412	17
	Middle	2437	17
	High	2462	17

**STA Mode :**

Mode	Channel	Frequency (MHz)	Power Set
IEEE 802.11b	Low	2412	17
	Middle	2437	17
	High	2462	17
IEEE 802.11g	Low	2412	17
	Middle	2437	17
	High	2462	17
IEEE 802.11gn HT20 MCS0	Low	2412	17
	Middle	2437	17
	High	2462	17

3. All of the functions are under run.
4. Start test.

**Normal Mode :**

All the equipment/cables were placed in the worst-case configuration to maximize the emission during the test. Grounding was established in accordance with the manufacturer’s requirements and conditions for the intended use.

1. EUT & peripherals setup diagram is shown in appendix setup photos.
2. Power of all equipments.
3. Notebook PC link EUT(STA AP Mode), ping IP 192.168.0.1.
4. Notebook PC link EUT(STA Client Mode), ping IP 192.168.255.1.
5. EUT(Direct AP Mode) link white drive box.
6. Communication system link EUT.
7. Open GPS.
8. All of the functions are under run.
9. Start test.

## 7. FCC PART 15.247 REQUIREMENTS

### 7.1 DUTY CYCLE CORRECTION FACTOR

<b>Product Name</b>	WHITE DRIVE BOX	<b>Test By</b>	Crystal Wu
<b>Test Model</b>	TB4001	<b>Test Date</b>	2016/08/16
<b>Test Mode</b>	TX Direct Mode / External Ant	<b>Temp. &amp; Humidity</b>	28°C, 63%

Mode	TX on (ms)	TX on + off (ms)	Duty Cycle (%)	Duty Factor (dB)	1/T Minimum VBW (kHz)
IEEE 802.11b	12.42	12.45	99.76%	0.01	0.010
IEEE 802.11g	2.05	2.095	97.85%	0.09	0.488
IEEE 802.11gn HT20	1.91	1.95	97.95%	0.09	0.524

<b>Product Name</b>	WHITE DRIVE BOX	<b>Test By</b>	Crystal Wu
<b>Test Model</b>	TB4001	<b>Test Date</b>	2016/08/16
<b>Test Mode</b>	TX STA Mode / External Ant	<b>Temp. &amp; Humidity</b>	28°C, 63%

Mode	TX on (ms)	TX on + off (ms)	Duty Cycle (%)	Duty Factor (dB)	1/T Minimum VBW (kHz)
IEEE 802.11b	12.4	12.44	99.68%	0.01	0.010
IEEE 802.11g	2.05	2.105	97.39%	0.11	0.488
IEEE 802.11gn HT20	1.905	1.95	97.69%	0.10	0.525

<b>Product Name</b>	WHITE DRIVE BOX	<b>Test By</b>	Crystal Wu
<b>Test Model</b>	TB4001	<b>Test Date</b>	2016/08/16
<b>Test Mode</b>	TX STA Mode / Internal Ant	<b>Temp. &amp; Humidity</b>	28°C, 63%

Mode	TX on (ms)	TX on + off (ms)	Duty Cycle (%)	Duty Factor (dB)	1/T Minimum VBW (kHz)
IEEE 802.11b	12.42	12.45	99.76%	0.01	0.010
IEEE 802.11g	1.91	1.955	97.70%	0.10	0.524
IEEE 802.11gn HT20	1.905	1.955	97.44%	0.11	0.525

## 7.2 6dB BANDWIDTH

### LIMITS

§ 15.247(a) (2) For direct sequence systems, the minimum 6dB bandwidth shall be at least 500kHz.

### TEST EQUIPMENT

Name of Equipment	Manufacturer	Model	Serial Number	Calibration Due
EXA Signal Analyzer	Agilent	N9010A	MY52220817	03/15/2017
Test S/W	N/A			

*Remark: Each piece of equipment is scheduled for calibration once a year.*

### TEST SETUP

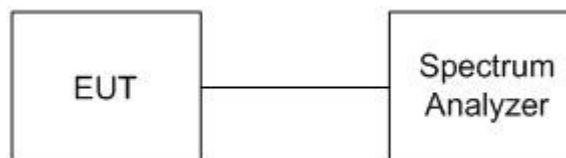

### TEST PROCEDURE

1. The transmitter output was connected to a spectrum analyzer.
2. Set RBW = 100 kHz.
3. Set the video bandwidth (VBW)  $\geq 3 \times$  RBW.
4. Detector = Peak.
5. Trace mode = max hold.
6. Sweep = auto couple.
7. Allow the trace to stabilize.
8. Measure the maximum width of the emission that is constrained by the frequencies associated with the two outermost amplitude points (upper and lower frequencies) that are attenuated by 6 dB relative to the maximum level measured in the fundamental emission.

**TEST RESULTS**

<b>Product Name</b>	WHITE DRIVE BOX	<b>Test By</b>	Crystal Wu
<b>Test Model</b>	TB4001	<b>Test Date</b>	2016/08/12
<b>Test Mode</b>	TX Direct Mode / External Ant	<b>Temp. &amp; Humidity</b>	28°C, 63%

**IEEE 802.11b Mode**

Channel	Channel Frequency (MHz)	6dB Bandwidth (MHz)	Minimum Limit (kHz)	Result
Low	2412	10.00	500	PASS
Middle	2437	10.04	500	PASS
High	2462	9.58	500	PASS

**IEEE 802.11g Mode**

Channel	Channel Frequency (MHz)	6dB Bandwidth (MHz)	Minimum Limit (kHz)	Result
Low	2412	16.19	500	PASS
Middle	2437	16.35	500	PASS
High	2462	16.07	500	PASS

**IEEE 802.11gn HT20 MCS0 Mode**

Channel	Channel Frequency (MHz)	6dB Bandwidth (MHz)	Minimum Limit (kHz)	Result
Low	2412	17.33	500	PASS
Middle	2437	17.32	500	PASS
High	2462	16.28	500	PASS

<b>Product Name</b>	WHITE DRIVE BOX	<b>Test By</b>	Crystal Wu
<b>Test Model</b>	TB4001	<b>Test Date</b>	2016/08/12
<b>Test Mode</b>	TX STA Mode / External Ant	<b>Temp. &amp; Humidity</b>	28°C, 63%

**IEEE 802.11b Mode**

Channel	Channel Frequency (MHz)	6dB Bandwidth (MHz)	Minimum Limit (kHz)	Result
Low	2412	9.58	500	PASS
Middle	2437	9.63	500	PASS
High	2462	11.08	500	PASS

**IEEE 802.11g Mode**

Channel	Channel Frequency (MHz)	6dB Bandwidth (MHz)	Minimum Limit (kHz)	Result
Low	2412	15.41	500	PASS
Middle	2437	14.40	500	PASS
High	2462	15.72	500	PASS

**IEEE 802.11gn HT20 MCS0 Mode**

Channel	Channel Frequency (MHz)	6dB Bandwidth (MHz)	Minimum Limit (kHz)	Result
Low	2412	15.40	500	PASS
Middle	2437	15.11	500	PASS
High	2462	15.02	500	PASS

**6dB BANDWIDTH**

**CH Low (IEEE 802.11b Mode / Direct Mode\_External Ant)**

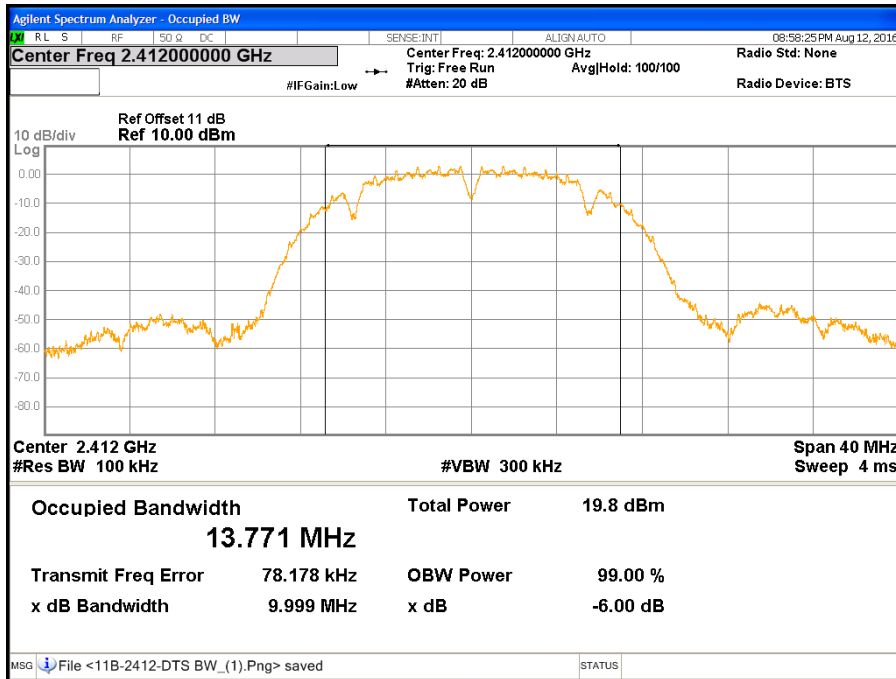

**CH Middle (IEEE 802.11b Mode / Direct Mode\_External Ant)**

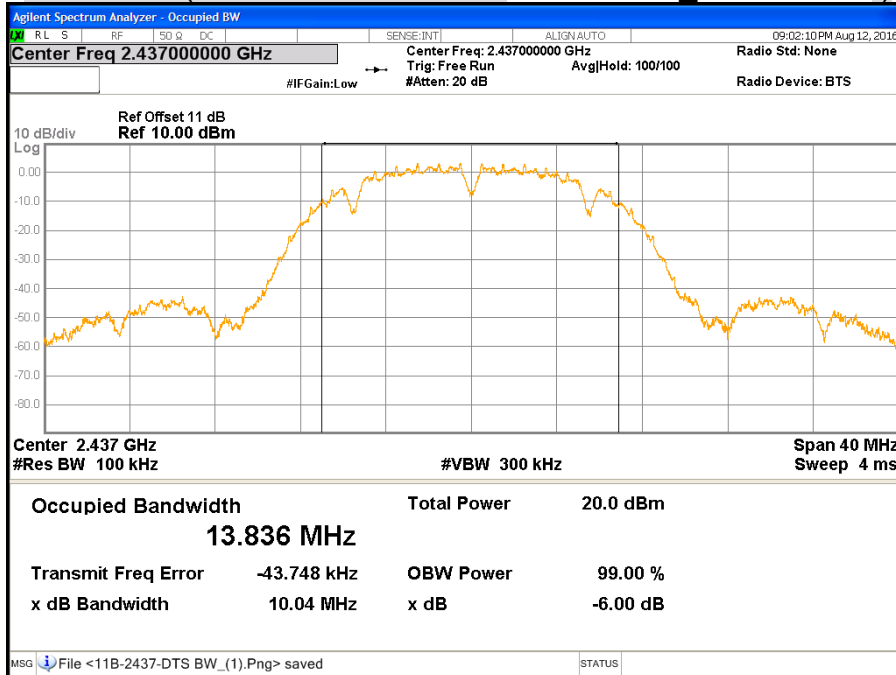

**CH High (IEEE 802.11b Mode / Direct Mode\_External Ant)**

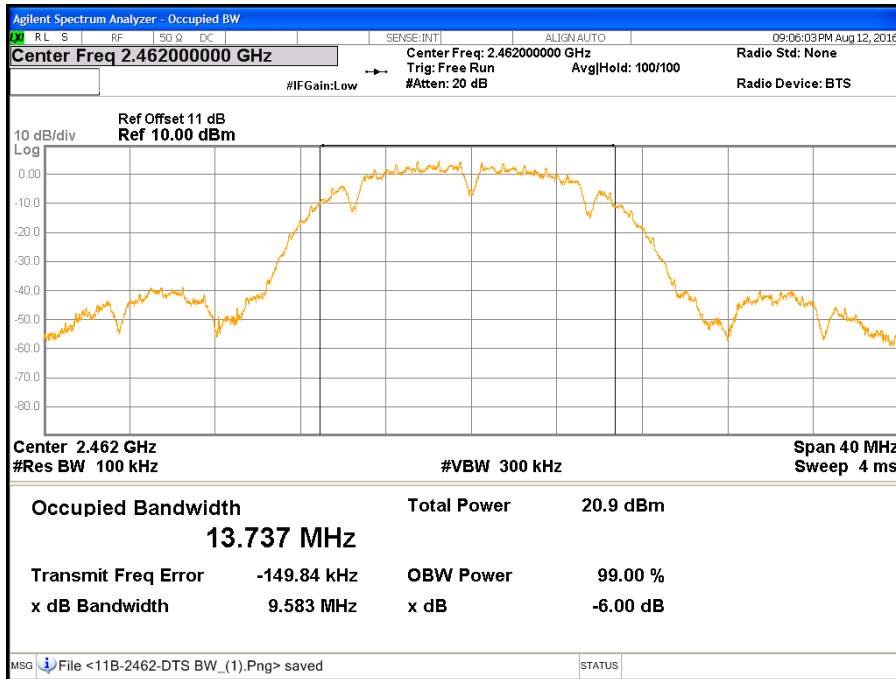



**CH Low (IEEE 802.11g Mode / Direct Mode\_External Ant)**

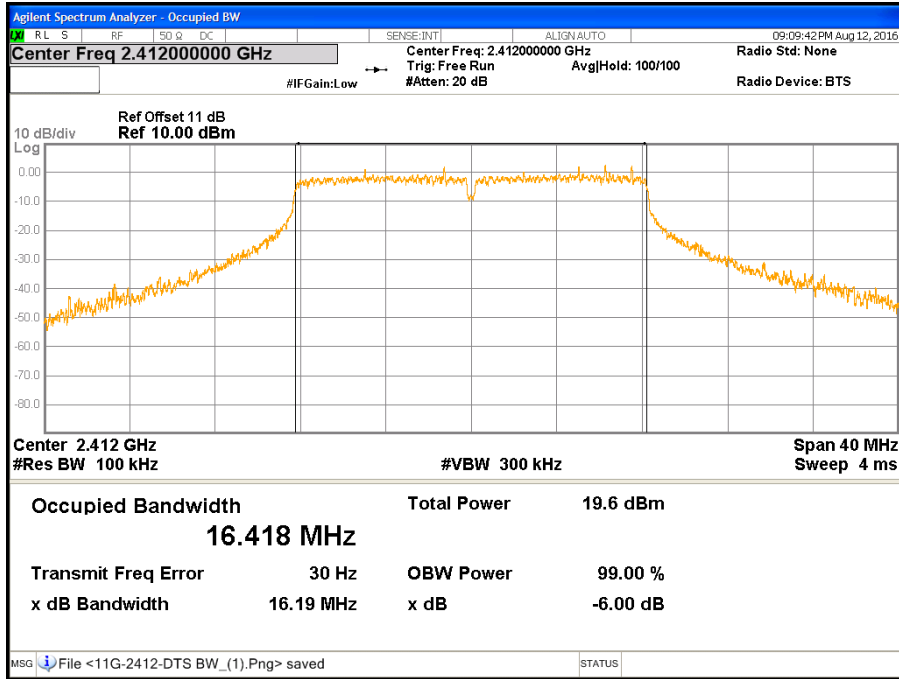

**CH Middle (IEEE 802.11g Mode / Direct Mode\_External Ant)**

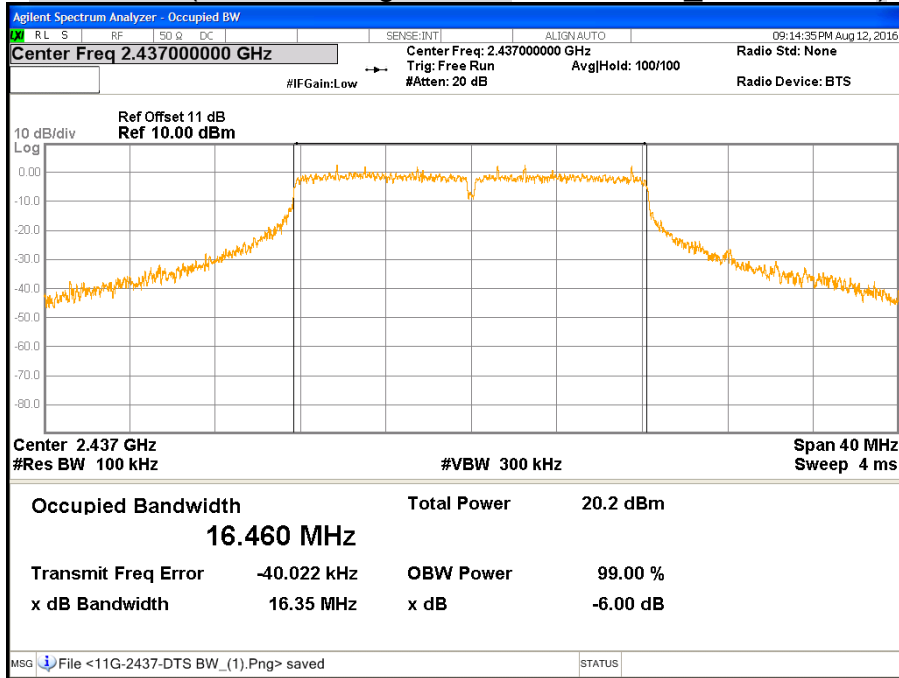

**CH High (IEEE 802.11g Mode / Direct Mode\_External Ant)**

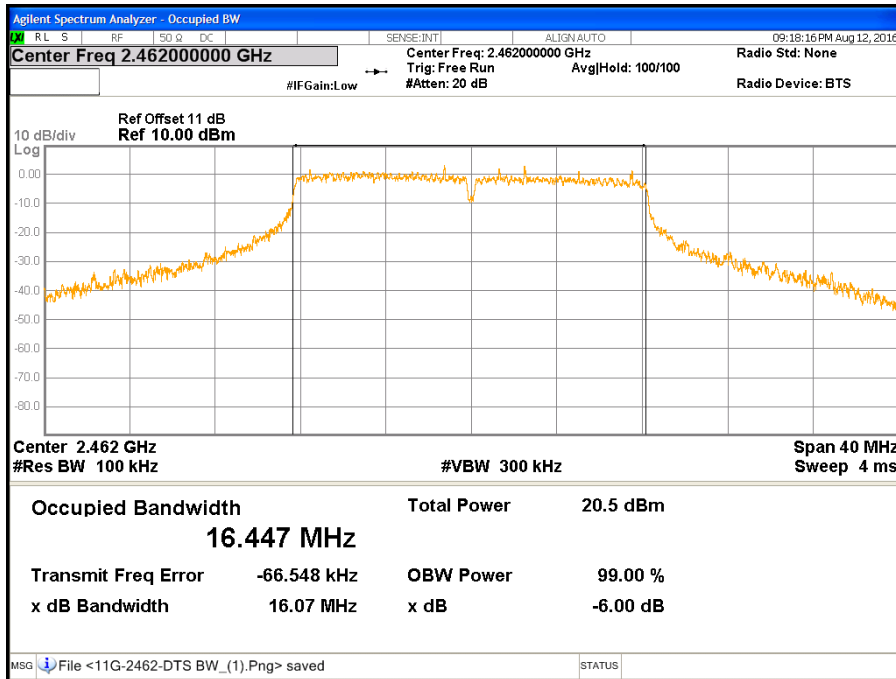

**CH Low (IEEE 802.11gn HT20 MCS0 Mode / Direct Mode\_External Ant)**

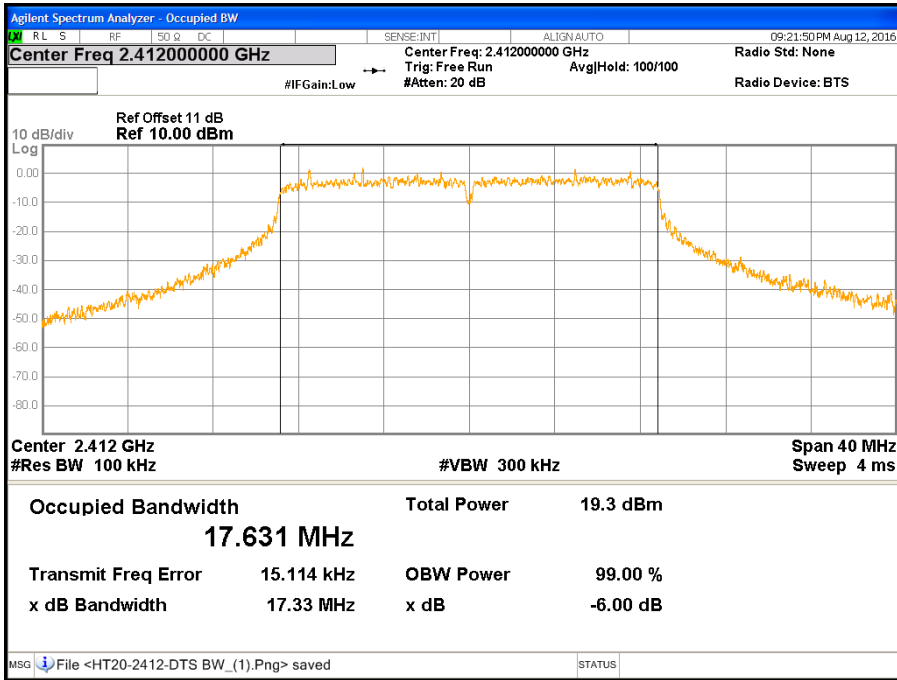

**CH Middle (IEEE 802.11gn HT20 MCS0 Mode / Direct Mode\_External Ant)**

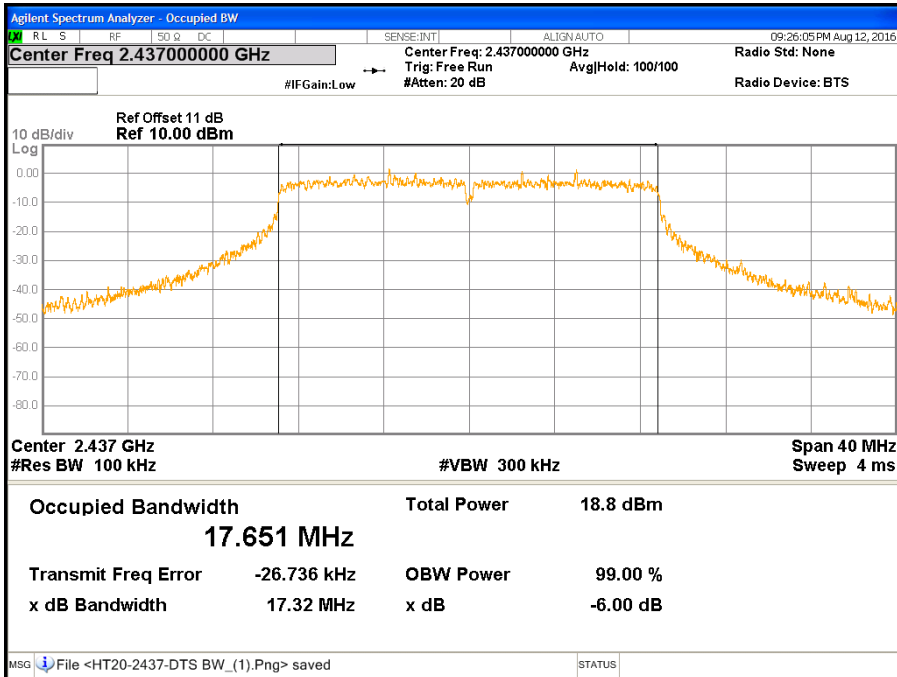

CH High (IEEE 802.11gn HT20 MCS0 Mode / Direct Mode\_External Ant)

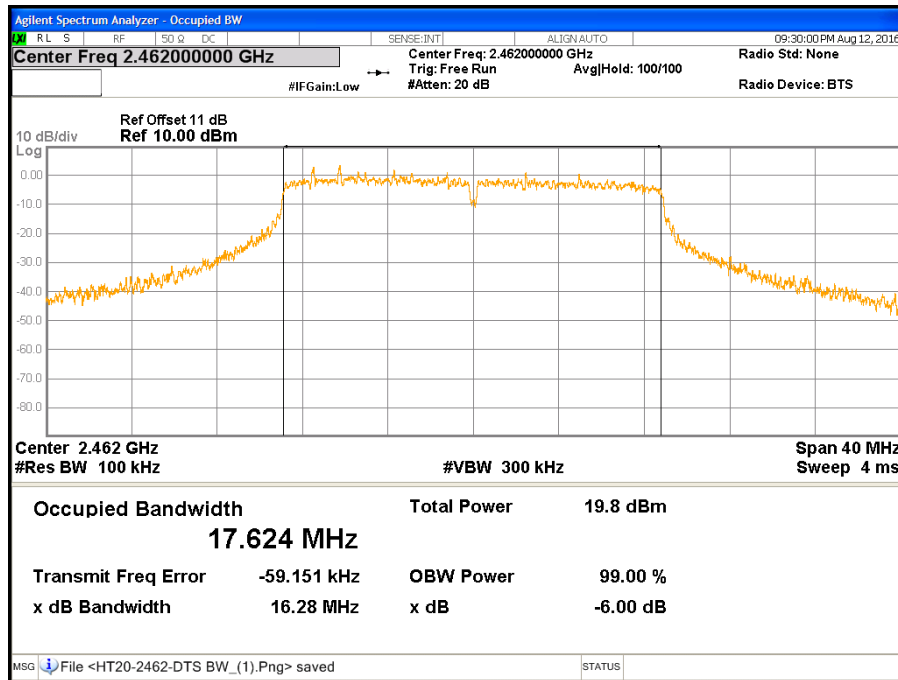

**CH Low (IEEE 802.11b Mode / STA Mode\_External Ant )**

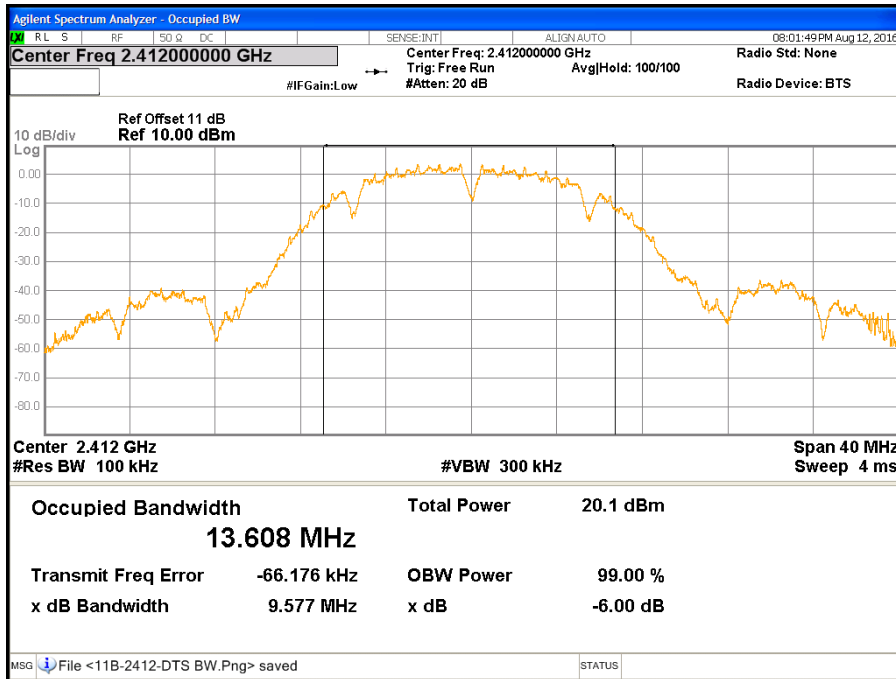

**CH Middle (IEEE 802.11b Mode / STA Mode External Ant)**

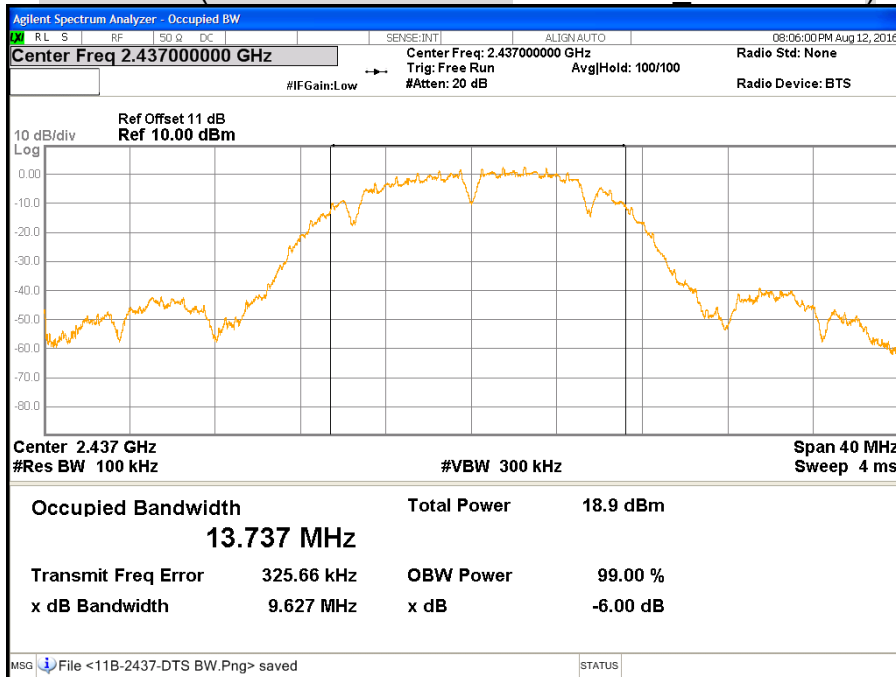

**CH High (IEEE 802.11b Mode / STA Mode\_External Ant)**

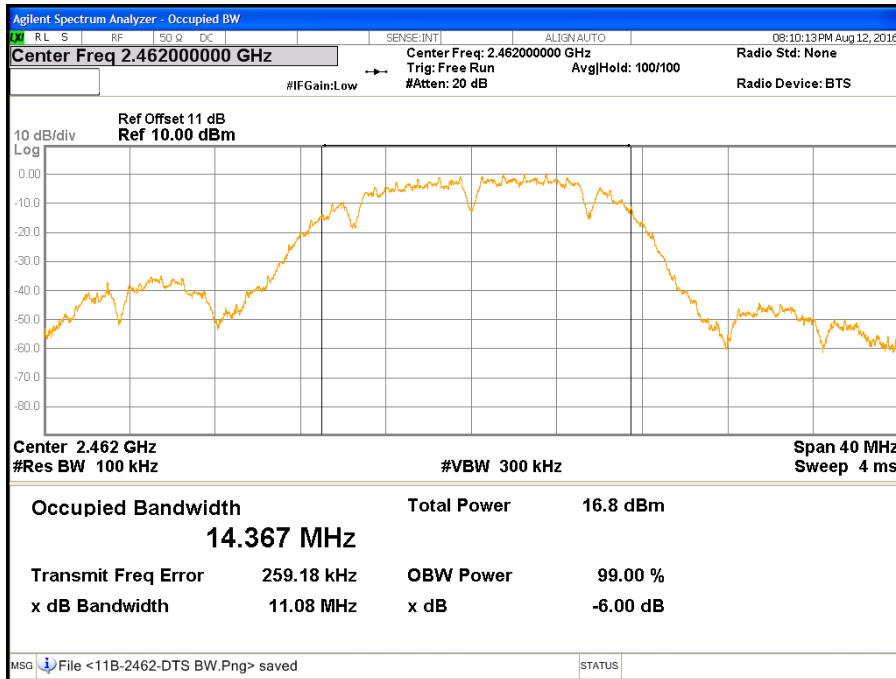

**CH Low (IEEE 802.11g Mode / STA Mode\_External Ant)**

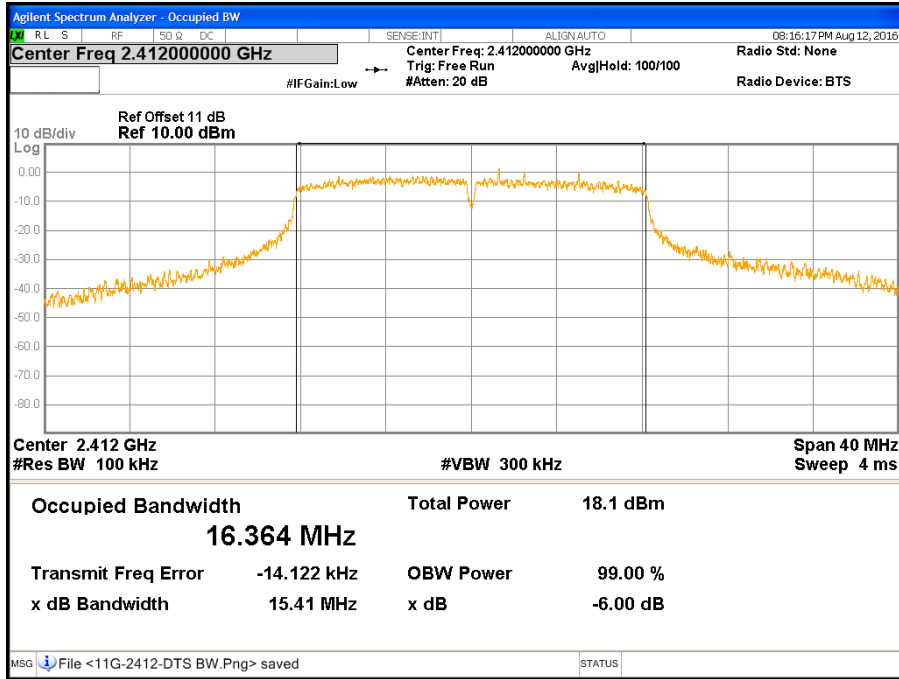

**CH Middle (IEEE 802.11g Mode / STA Mode\_External Ant)**

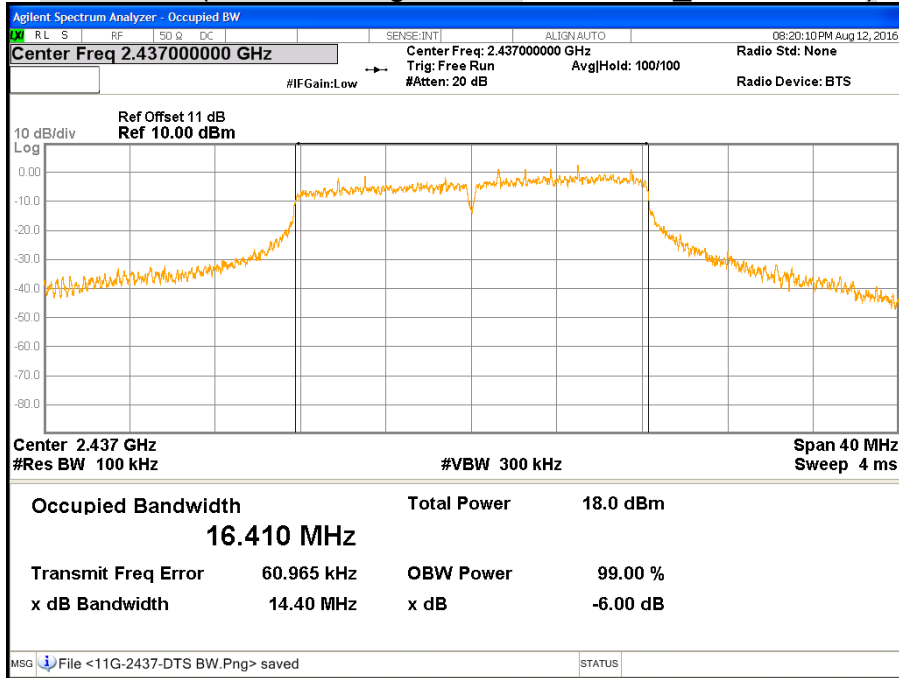

**CH High (IEEE 802.11g Mode / STA Mode\_External Ant)**

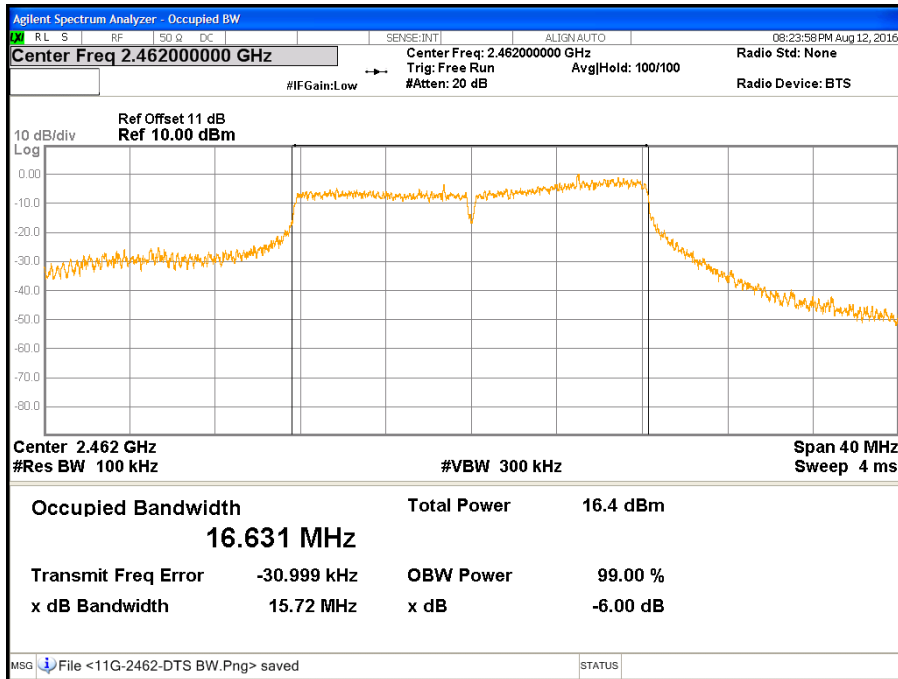



**CH Low (IEEE 802.11gn HT20 MCS0 Mode / STA Mode\_External Ant )**

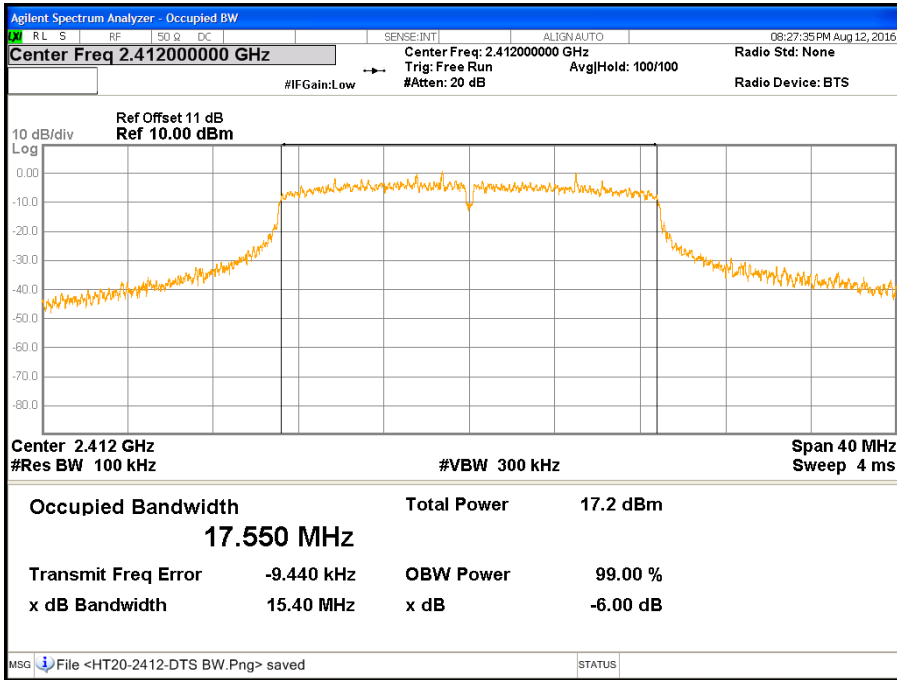

**CH Middle (IEEE 802.11gn HT20 MCS0 Mode / STA Mode External Ant)**

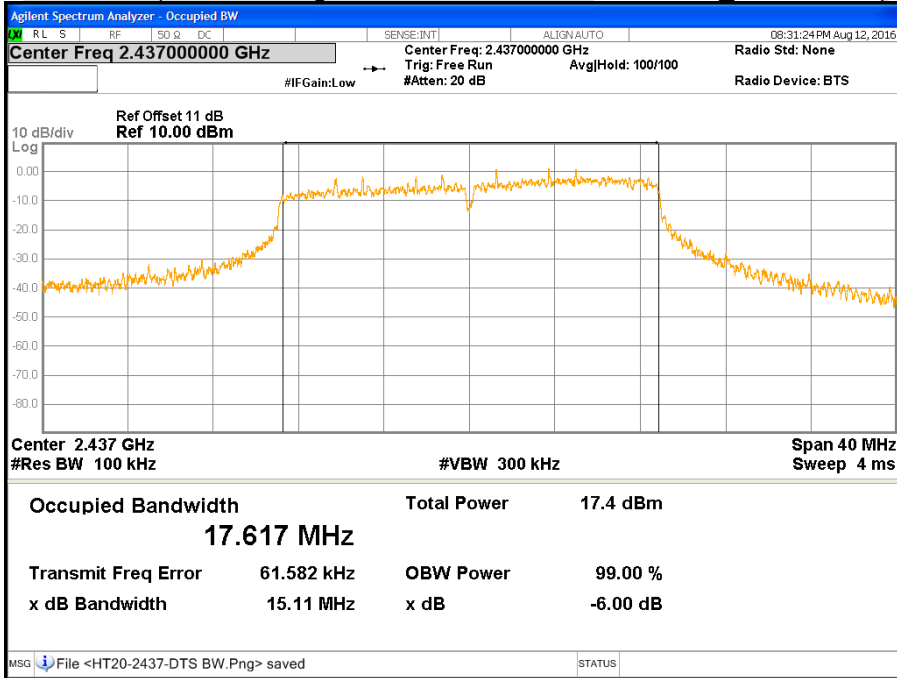

CH High (IEEE 802.11gn HT20 MCS0 Mode / STA Mode\_External Ant)

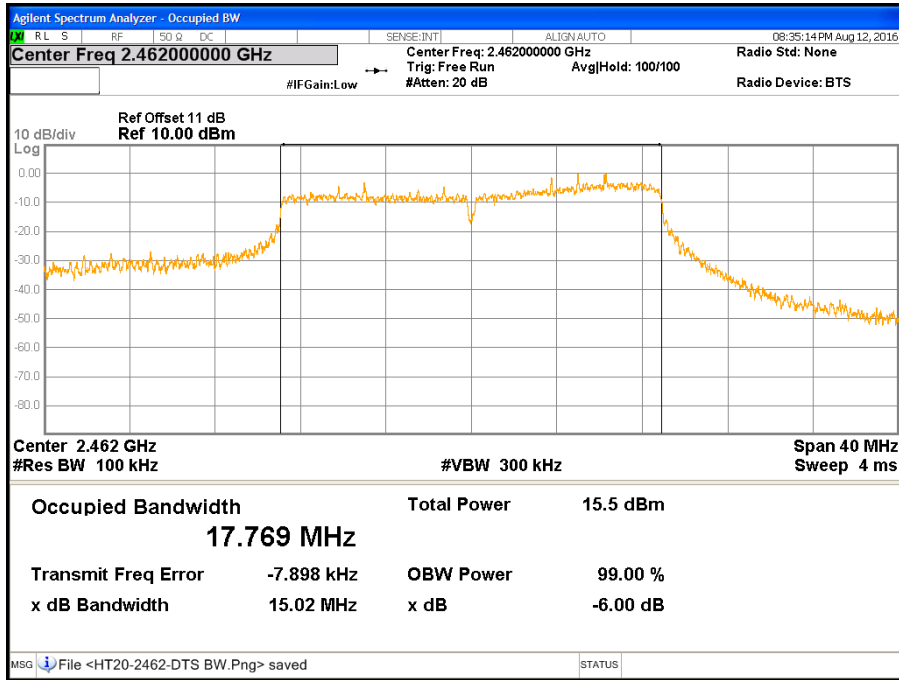

### 7.3 MAXIMUM PEAK OUTPUT POWER

#### LIMITS

§ 15.247(b) The maximum peak output power of the intentional radiator shall not exceed the following:

§ 15.247(b) (3) For systems using digital modulation in the 902-928 MHz, 2400-2483.5 MHz, and 5725-5850 MHz bands: 1 watt.

§ 15.247(b) (4) Except as shown in paragraphs (c) of this section, if transmitting antennas of directional gain greater than 6 dBi are used the peak output power from the intentional radiator shall be reduced below the stated values in paragraphs (b)(1) or (b)(2), and (b)(3) of this section, as appropriate, by the amount in dB that the directional gain of the antenna exceeds 6 dBi.

§ KDB 662911:

If all antennas have the same gain,  $G_{ANT}$ , Directional gain =  $G_{ANT}$  + Array Gain, where Array Gain is as follows.

Array Gain = 0 dB (i.e., no array gain) for  $N_{ANT} \leq 4$  ;

Array Gain = 0 dB (i.e., no array gain) for channel widths  $\geq 40$  MHz for any  $N_{ANT}$  ;

Array Gain =  $5 \log(N_{ANT}/N_{SS})$  dB or 3 dB, whichever is less for 20-MHz channel widths with  $N_{ANT} \geq 5$ .

If antenna gains are not equal, the user may use either of the following methods to calculate directional gain, provided that each transmit antenna is driven by only one spatial stream:

Directional gain may be calculated by using the formulas applicable to equal gain antennas with  $G_{ANT}$  set equal to the gain of the antenna having the highest gain; or,

$$DirectionalGain = 10 \cdot \log \left[ \frac{\sum_{j=1}^{N_{SS}} \left\{ \sum_{k=1}^{N_{ANT}} g_{j,k} \right\}^2}{N_{ANT}} \right]$$

#### TEST EQUIPMENT

Name of Equipment	Manufacturer	Model	Serial Number	Calibration Due
Power Meter	Anritsu	ML2495A	1149001	12/08/2016
Power Sensor	Anritsu	MA2411B	1126148	12/08/2016
Test S/W	N/A			

**Remark:** Each piece of equipment is scheduled for calibration once a year.

**TEST SETUP**

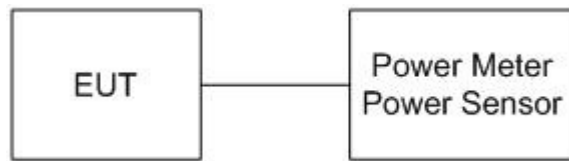

**TEST PROCEDURE**

The transmitter output is connected to the power meter. The power meter is set to the peak power detection.

**TEST RESULTS**

<b>Product Name</b>	WHITE DRIVE BOX	<b>Test By</b>	Crystal Wu
<b>Test Model</b>	TB4001	<b>Test Date</b>	2016/08/12
<b>Test Mode</b>	TX Direct Mode / External Ant	<b>Temp. &amp; Humidity</b>	28°C, 63%

**IEEE 802.11b Mode**

Channel	Channel Frequency (MHz)	Peak Power		Peak Power Limit		Pass / Fail
		(dBm)	(W)	(dBm)	(W)	
Low	2412	15.85	0.0385	30.00	1.0000	PASS
Middle	2437	15.73	0.0374	30.00	1.0000	PASS
High	2462	16.65	0.0462	30.00	1.0000	PASS

**Remark:**

1. At final test to get the worst-case emission at 1Mbps.
2. The cable assembly insertion loss of 10.5 dB (including 10 dB pad and 0.5 dB cable) was entered as an offset in the power meter to allow for direct reading of power.

**IEEE 802.11g Mode**

Channel	Channel Frequency (MHz)	Peak Power		Peak Power Limit		Pass / Fail
		(dBm)	(W)	(dBm)	(W)	
Low	2412	21.60	0.1445	30.00	1.0000	PASS
Middle	2437	21.73	0.1489	30.00	1.0000	PASS
High	2462	22.07	0.1611	30.00	1.0000	PASS

**Remark:**

1. At final test to get the worst-case emission at 6Mbps.
2. The cable assembly insertion loss of 10.5 dB (including 10 dB pad and 0.5 dB cable) was entered as an offset in the power meter to allow for direct reading of power.

**IEEE 802.11gn HT20 MCS0 Mode**

Channel	Channel Frequency (MHz)	Peak Power		Peak Power Limit		Pass / Fail
		(dBm)	(W)	(dBm)	(W)	
Low	2412	21.66	0.1466	30.00	1.0000	PASS
Middle	2437	21.37	0.1371	30.00	1.0000	PASS
High	2462	21.93	0.1560	30.00	1.0000	PASS

**Remark:**

1. At final test to get the worst-case emission at 6.5Mbps.
2. The cable assembly insertion loss of 10.5 dB (including 10 dB pad and 0.5 dB cable) was entered as an offset in the power meter to allow for direct reading of power.

<b>Product Name</b>	WHITE DRIVE BOX	<b>Test By</b>	Crystal Wu
<b>Test Model</b>	TB4001	<b>Test Date</b>	2016/08/12
<b>Test Mode</b>	TX STA Mode / External Ant	<b>Temp. &amp; Humidity</b>	28°C, 63%

**IEEE 802.11b Mode**

Channel	Channel Frequency (MHz)	Peak Power		Peak Power Limit		Pass / Fail
		(dBm)	(W)	(dBm)	(W)	
Low	2412	16.02	0.0400	30.00	1.0000	PASS
Middle	2437	15.07	0.0321	30.00	1.0000	PASS
High	2462	13.47	0.0222	30.00	1.0000	PASS

**Remark:**

1. At final test to get the worst-case emission at 1Mbps.
2. The cable assembly insertion loss of 10.5 dB (including 10 dB pad and 0.5 dB cable) was entered as an offset in the power meter to allow for direct reading of power.

**IEEE 802.11g Mode**

Channel	Channel Frequency (MHz)	Peak Power		Peak Power Limit		Pass / Fail
		(dBm)	(W)	(dBm)	(W)	
Low	2412	20.63	0.1156	30.00	1.0000	PASS
Middle	2437	20.49	0.1119	30.00	1.0000	PASS
High	2462	19.52	0.0895	30.00	1.0000	PASS

**Remark:**

1. At final test to get the worst-case emission at 6Mbps.
2. The cable assembly insertion loss of 10.5 dB (including 10 dB pad and 0.5 dB cable) was entered as an offset in the power meter to allow for direct reading of power.

**IEEE 802.11gn HT20 MCS0 Mode**

Channel	Channel Frequency (MHz)	Peak Power		Peak Power Limit		Pass / Fail
		(dBm)	(W)	(dBm)	(W)	
Low	2412	19.19	0.0830	30.00	1.0000	PASS
Middle	2437	19.63	0.0918	30.00	1.0000	PASS
High	2462	18.35	0.0684	30.00	1.0000	PASS

**Remark:**

1. At final test to get the worst-case emission at 6.5Mbps.
2. The cable assembly insertion loss of 10.5 dB (including 10 dB pad and 0.5 dB cable) was entered as an offset in the power meter to allow for direct reading of power.

## 7.4 AVERAGE POWER

### LIMITS

None: For reporting purposes only.

### TEST EQUIPMENT

Name of Equipment	Manufacturer	Model	Serial Number	Calibration Due
Power Meter	Anritsu	ML2495A	1149001	12/08/2016
Power Sensor	Anritsu	MA2411B	1126148	12/08/2016
Test S/W	N/A			

*Remark: Each piece of equipment is scheduled for calibration once a year.*

### TEST SETUP



### TEST PROCEDURE

The transmitter output is connected to the power meter. The power meter is set to the average power detection.

**TEST RESULTS**

<b>Product Name</b>	WHITE DRIVE BOX	<b>Test By</b>	Crystal Wu
<b>Test Model</b>	TB4001	<b>Test Date</b>	2016/08/12
<b>Test Mode</b>	TX Direct Mode / External Ant	<b>Temp. &amp; Humidity</b>	28°C, 63%

**IEEE 802.11b Mode**

Channel	Channel Frequency (MHz)	Average Power (dBm)
Low	2412	13.37
Middle	2437	13.20
High	2462	14.22

**Remark:**

1. At final test to get the worst-case emission at 1Mbps.
2. The cable assembly insertion loss of 10.5 dB (including 10 dB pad and 0.5 dB cable) was entered as an offset in the spectrum analyzer to allow for direct reading of power.

**IEEE 802.11g Mode**

Channel	Channel Frequency (MHz)	Average Power (dBm)
Low	2412	13.75
Middle	2437	14.36
High	2462	14.37

**Remark:**

1. At final test to get the worst-case emission at 6Mbps.
2. The cable assembly insertion loss of 10.5 dB (including 10 dB pad and 0.5 dB cable) was entered as an offset in the spectrum analyzer to allow for direct reading of power.

**IEEE 802.11gn HT20 MCS0 Mode**

Channel	Channel Frequency (MHz)	Average Power (dBm)
Low	2412	13.51
Middle	2437	13.21
High	2462	13.83

**Remark:**

1. At final test to get the worst-case emission at 6.5Mbps.
2. The cable assembly insertion loss of 10.5 dB (including 10 dB pad and 0.5 dB cable) was entered as an offset in the spectrum analyzer to allow for direct reading of power.



<b>Product Name</b>	WHITE DRIVE BOX	<b>Test By</b>	Crystal Wu
<b>Test Model</b>	TB4001	<b>Test Date</b>	2016/08/12
<b>Test Mode</b>	TX STA Mode / External Ant	<b>Temp. &amp; Humidity</b>	28°C, 63%

**IEEE 802.11b Mode**

Channel	Channel Frequency (MHz)	Average Power (dBm)
Low	2412	13.79
Middle	2437	12.78
High	2462	10.79

**Remark:**

- 3. At final test to get the worst-case emission at 1Mbps.
- 4. The cable assembly insertion loss of 10.5 dB (including 10 dB pad and 0.5 dB cable) was entered as an offset in the spectrum analyzer to allow for direct reading of power.

**IEEE 802.11g Mode**

Channel	Channel Frequency (MHz)	Average Power (dBm)
Low	2412	12.36
Middle	2437	12.22
High	2462	10.68

**Remark:**

- 3. At final test to get the worst-case emission at 6Mbps.
- 4. The cable assembly insertion loss of 10.5 dB (including 10 dB pad and 0.5 dB cable) was entered as an offset in the spectrum analyzer to allow for direct reading of power.

**IEEE 802.11gn HT20 MCS0 Mode**

Channel	Channel Frequency (MHz)	Average Power (dBm)
Low	2412	11.39
Middle	2437	11.62
High	2462	9.74

**Remark:**

- 3. At final test to get the worst-case emission at 6.5Mbps.
- 4. The cable assembly insertion loss of 10.5 dB (including 10 dB pad and 0.5 dB cable) was entered as an offset in the spectrum analyzer to allow for direct reading of power.

## 7.5 POWER SPECTRAL DENSITY

### LIMITS

§ 15.247(e) For digitally modulated systems, the power spectral density conducted from the intentional radiator to the antenna shall not greater than 8 dBm in any 3 kHz band during any time interval of continuous transmission.

§ KDB 662911:

If all antennas have the same gain,  $G_{ANT}$ , Directional gain =  $G_{ANT} + \text{Array Gain}$ , where Array Gain is as follows.

Array Gain =  $10 \log(N_{ANT}/N_{SS})$  dB.

If antenna gains are not equal, the user may use either of the following methods to calculate directional gain, provided that each transmit antenna is driven by only one spatial stream:

Directional gain may be calculated by using the formulas applicable to equal gain antennas with  $G_{ANT}$  set equal to the gain of the antenna having the highest gain; or,

$$DirectionalGain = 10 \cdot \log \left[ \frac{\sum_{j=1}^{N_{SS}} \left\{ \sum_{k=1}^{N_{ANT}} g_{j,k} \right\}^2}{N_{ANT}} \right]$$

### TEST EQUIPMENT

Name of Equipment	Manufacturer	Model	Serial Number	Calibration Due
EXA Signal Analyzer	Agilent	N9010A	MY52220817	03/15/2017
Test SW	N/A			

*Remark: Each piece of equipment is scheduled for calibration once a year.*

### TEST SETUP



## **TEST PROCEDURE**

1. The transmitter output was connected to the spectrum analyzer.
2. Set analyzer center frequency to DTS channel center frequency.
3. Set the span to 1.5 times the DTS channel bandwidth.
4. Set the RBW to:  $3 \text{ kHz} \leq \text{RBW} \leq 100 \text{ kHz}$ .
5. Set the VBW  $\geq 3 \times \text{RBW}$ .
6. Detector = peak.
7. Sweep time = auto couple.
8. Trace mode = max hold.
9. Allow trace to fully stabilize.
10. Use the peak marker function to determine the maximum amplitude level within the RBW.
11. If measured value exceeds limit, reduce RBW (no less than 3 kHz) and repeat.

**TEST RESULTS**

<b>Product Name</b>	WHITE DRIVE BOX	<b>Test By</b>	Crystal Wu
<b>Test Model</b>	TB4001	<b>Test Date</b>	2016/08/12
<b>Test Mode</b>	TX Direct Mode / External Ant	<b>Temp. &amp; Humidity</b>	28°C, 63%

**IEEE 802.11b Mode**

Channel	Channel Frequency (MHz)	Final RF Power Level in 3KHz BW (dBm)	Minimum Limit (dBm)	Pass / Fail
Low	2412	-6.85	8	PASS
Middle	2437	-7.23	8	PASS
High	2462	-6.17	8	PASS

**Remark:**

1. At final test to get the worst-case emission at 1Mbps.
2. The cable assembly insertion loss of 10.5 dB (including 10 dB pad and 0.5 dB cable) was entered as an offset in the spectrum analyzer to allow for direct reading of power.
3. The maximum antenna gain is 3.5 dBi which is less than 6dBi, the limit should be 8 dBm

**IEEE 802.11g Mode**

Channel	Channel Frequency (MHz)	Final RF Power Level in 3KHz BW (dBm)	Minimum Limit (dBm)	Pass / Fail
Low	2412	-6.98	8	PASS
Middle	2437	-6.51	8	PASS
High	2462	-6.02	8	PASS

**Remark:**

1. At final test to get the worst-case emission at 6Mbps.
2. The cable assembly insertion loss of 10.5 dB (including 10 dB pad and 0.5 dB cable) was entered as an offset in the spectrum analyzer to allow for direct reading of power.
3. The maximum antenna gain is 3.5 dBi which is less than 6dBi, the limit should be 8 dBm

**IEEE 802.11gn HT20 MCS0 Mode**

Channel	Channel Frequency (MHz)	Final RF Power Level in 3KHz BW (dBm)	Minimum Limit (dBm)	Pass / Fail
Low	2412	-6.05	8	PASS
Middle	2437	-6.99	8	PASS
High	2462	-5.89	8	PASS

**Remark:**

1. At final test to get the worst-case emission at 6.5Mbps.
2. The cable assembly insertion loss of 10.5 dB (including 10 dB pad and 0.5 dB cable) was entered as an offset in the spectrum analyzer to allow for direct reading of power.
3. The maximum antenna gain is 3.5 dBi which is less than 6dBi, the limit should be 8 dBm

<b>Product Name</b>	WHITE DRIVE BOX	<b>Test By</b>	Crystal Wu
<b>Test Model</b>	TB4001	<b>Test Date</b>	2016/08/12
<b>Test Mode</b>	TX STA Mode / External Ant	<b>Temp. &amp; Humidity</b>	28°C, 63%

**IEEE 802.11b Mode**

Channel	Channel Frequency (MHz)	Final RF Power Level in 3KHz BW (dBm)	Minimum Limit (dBm)	Pass / Fail
Low	2412	-6.30	8	PASS
Middle	2437	-7.86	8	PASS
High	2462	-9.90	8	PASS

**Remark:**

1. At final test to get the worst-case emission at 1Mbps.
2. The cable assembly insertion loss of 10.5 dB (including 10 dB pad and 0.5 dB cable) was entered as an offset in the spectrum analyzer to allow for direct reading of power.
3. The maximum antenna gain is 3.5 dBi which is less than 6dBi, the limit should be 8 dBm

**IEEE 802.11g Mode**

Channel	Channel Frequency (MHz)	Final RF Power Level in 3KHz BW (dBm)	Minimum Limit (dBm)	Pass / Fail
Low	2412	-8.86	8	PASS
Middle	2437	-7.60	8	PASS
High	2462	-9.19	8	PASS

**Remark:**

1. At final test to get the worst-case emission at 6Mbps.
2. The cable assembly insertion loss of 10.5 dB (including 10 dB pad and 0.5 dB cable) was entered as an offset in the spectrum analyzer to allow for direct reading of power.
3. The maximum antenna gain is 3.5 dBi which is less than 6dBi, the limit should be 8 dBm

**IEEE 802.11gn HT20 MCS0 Mode**

Channel	Channel Frequency (MHz)	Final RF Power Level in 3KHz BW (dBm)	Minimum Limit (dBm)	Pass / Fail
Low	2412	-9.18	8	PASS
Middle	2437	-6.89	8	PASS
High	2462	-9.05	8	PASS

**Remark:**

1. At final test to get the worst-case emission at 6.5Mbps.
2. The cable assembly insertion loss of 10.5 dB (including 10 dB pad and 0.5 dB cable) was entered as an offset in the spectrum analyzer to allow for direct reading of power.
3. The maximum antenna gain is 3.5 dBi which is less than 6dBi, the limit should be 8 dBm

### POWER SPECTRAL DENSITY

#### CH Low (IEEE 802.11b Mode / Direct Mode\_External Ant)

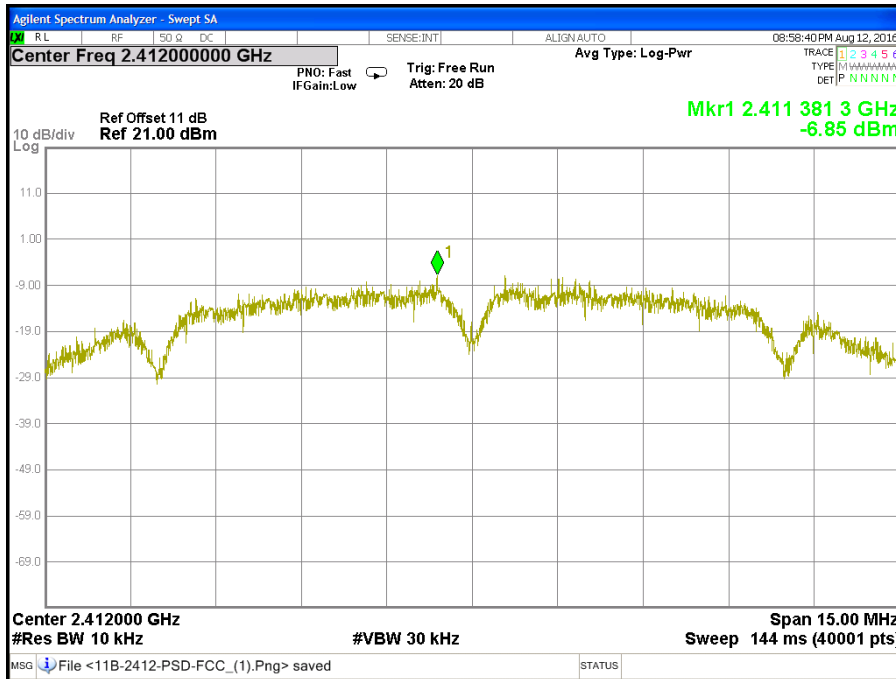

#### CH Middle (IEEE 802.11b Mode / Direct Mode\_External Ant)

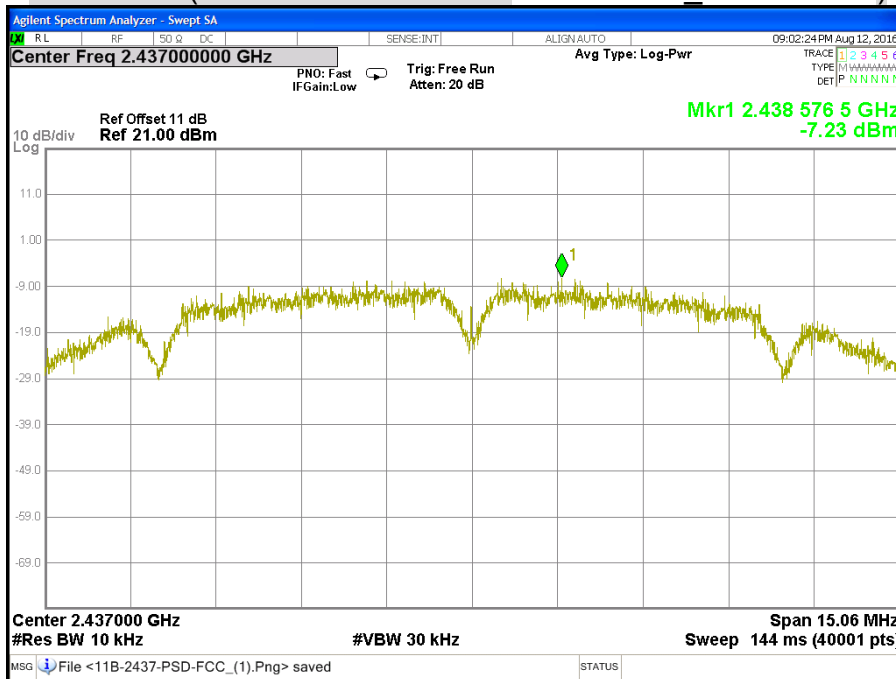

CH High (IEEE 802.11b Mode / Direct Mode\_External Ant)

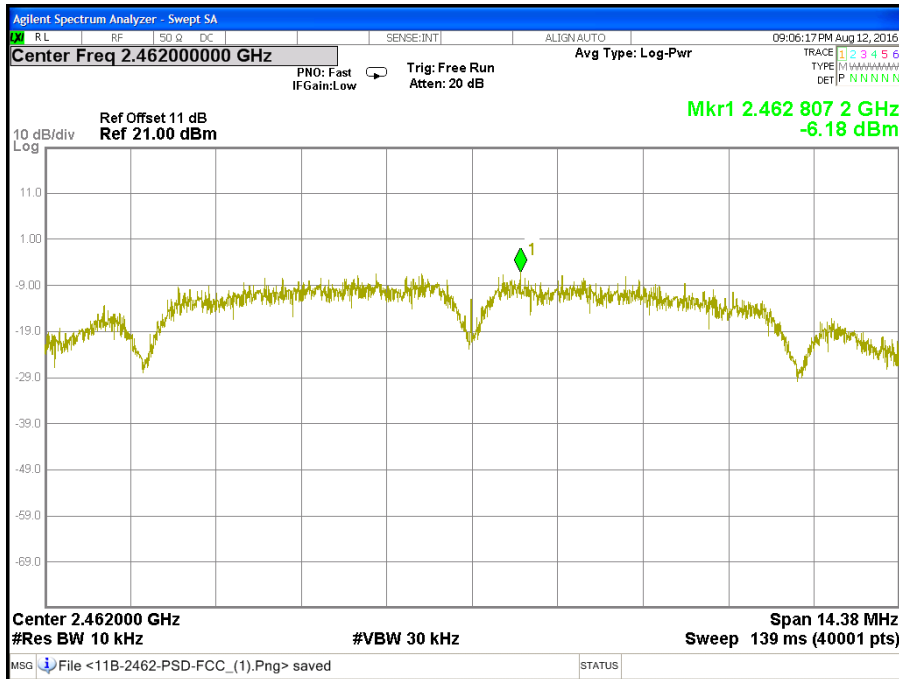

### CH Low (IEEE 802.11g Mode / Direct Mode\_External Ant)

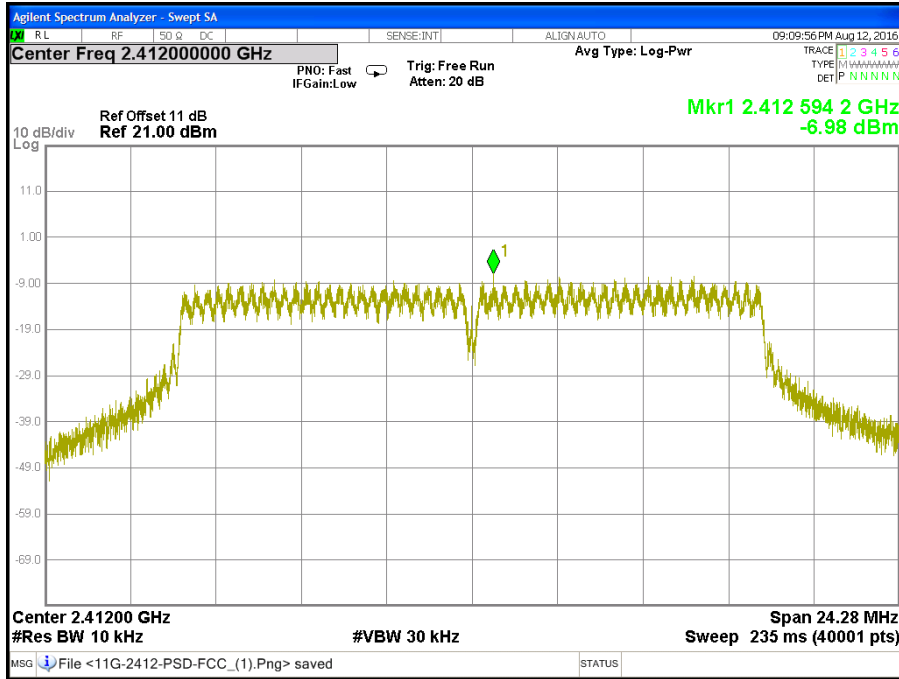

### CH Middle (IEEE 802.11g Mode / Direct Mode\_External Ant)





CH High (IEEE 802.11g Mode / Direct Mode\_External Ant)

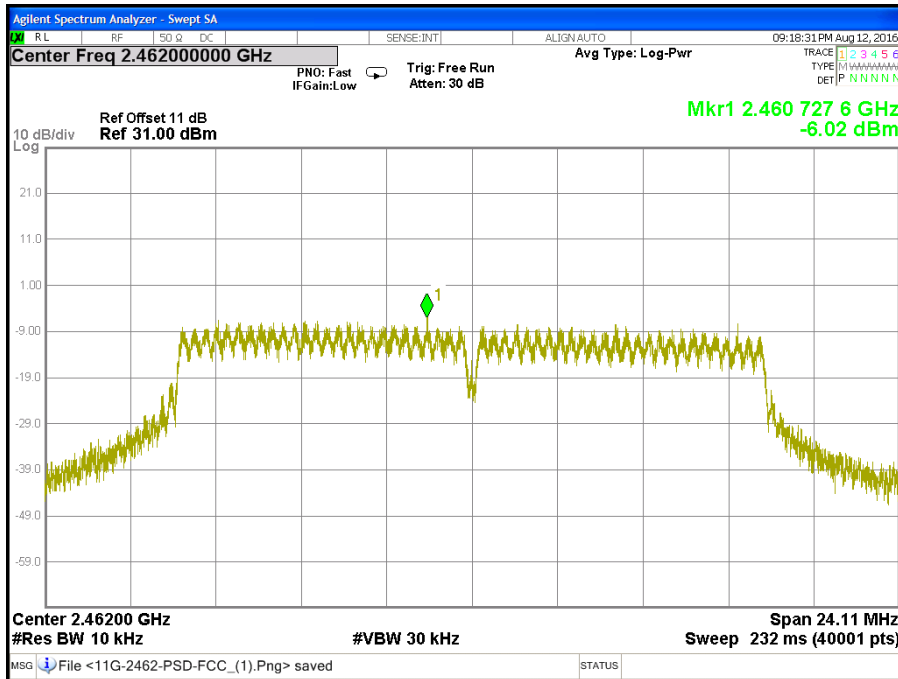

CH Low (IEEE 802.11gn HT20 MCS0 Mode / Direct Mode\_External Ant )

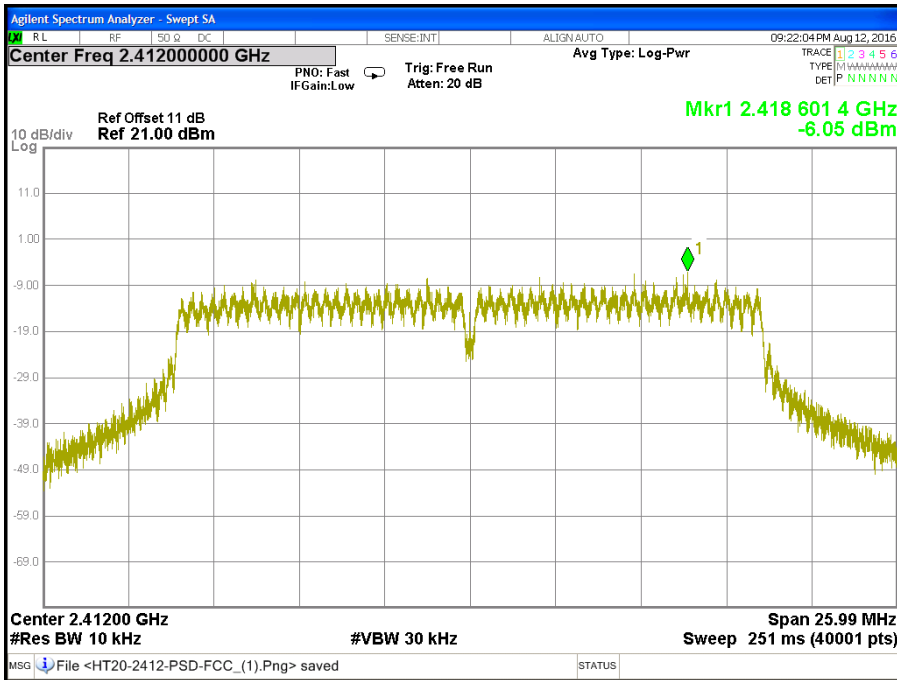

CH Middle (IEEE 802.11gn HT20 MCS0 Mode / Direct Mode External Ant )

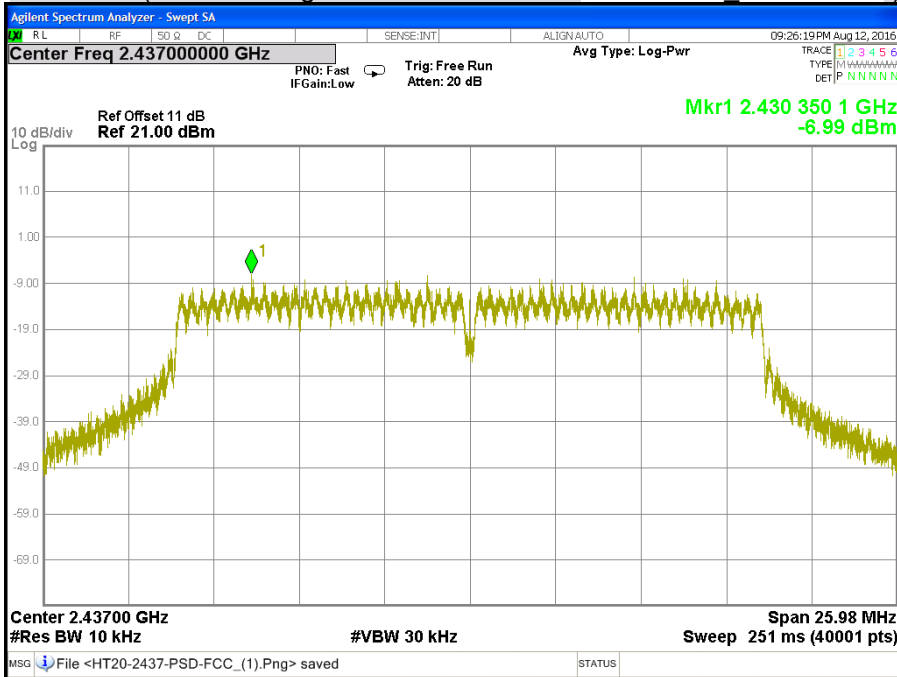

CH High (IEEE 802.11gn HT20 MCS0 Mode / Direct Mode\_External Ant)

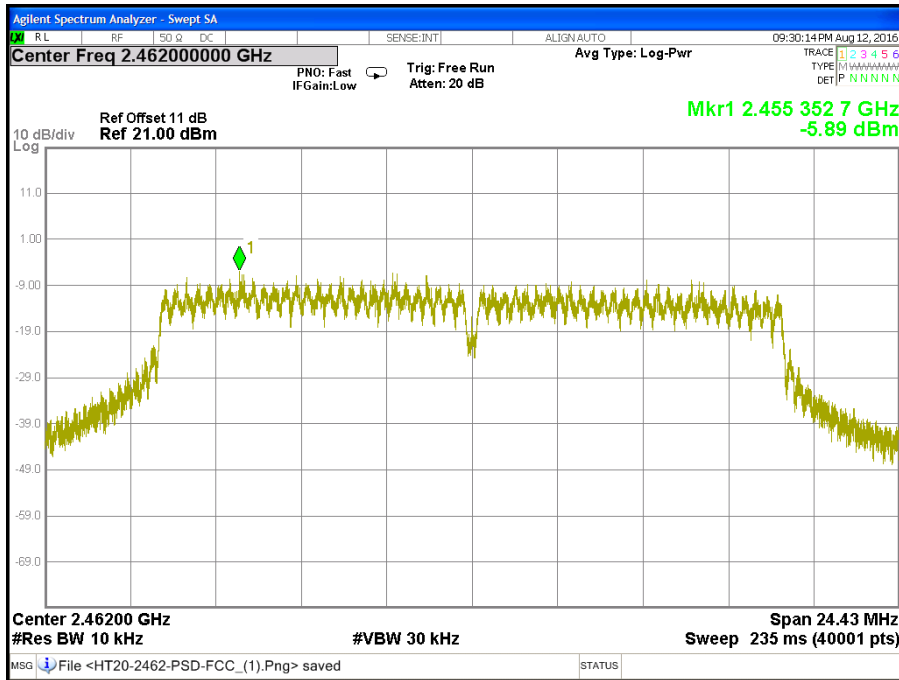

**CH Low (IEEE 802.11b Mode / STA Mode\_External Ant)**

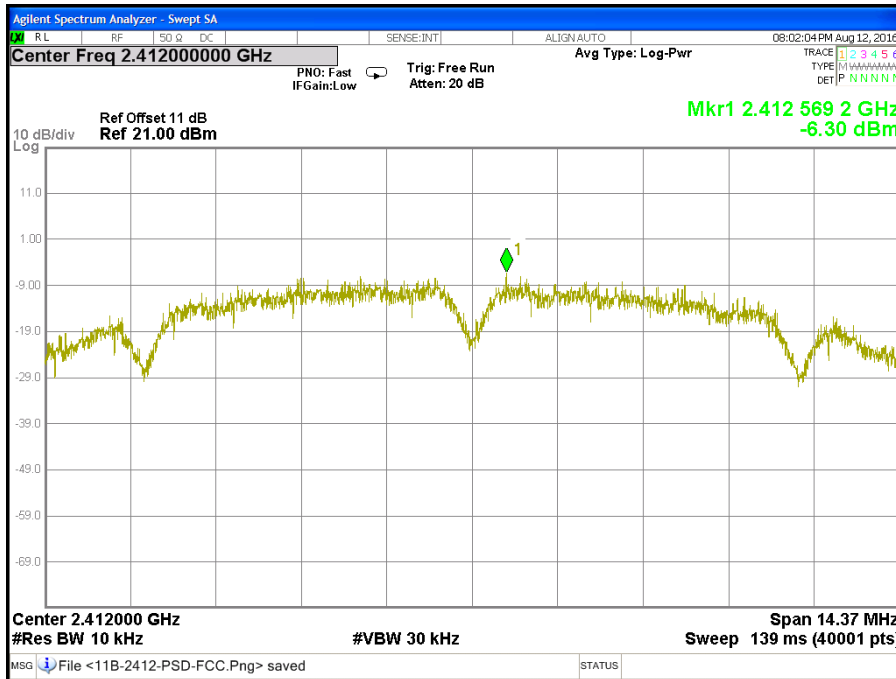

**CH Middle (IEEE 802.11b Mode / STA Mode\_External Ant)**

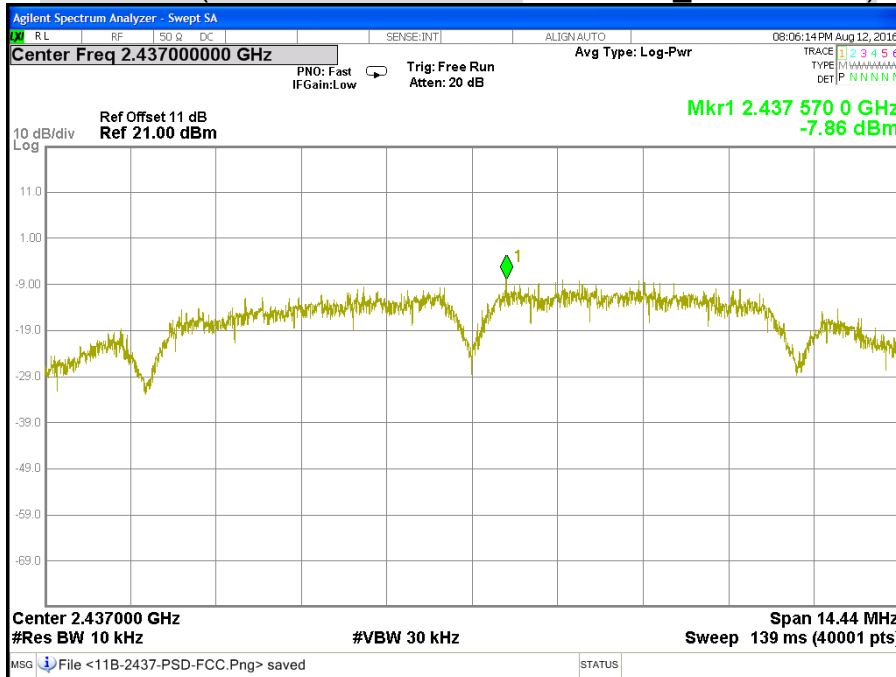

CH High (IEEE 802.11b Mode / STA Mode\_External Ant)

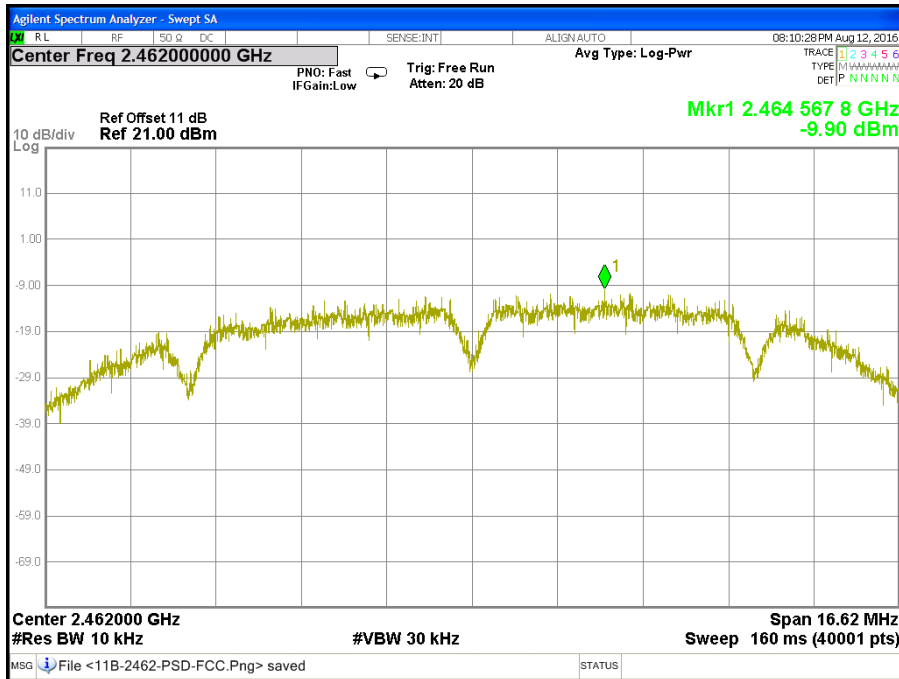

CH Low (IEEE 802.11g Mode / STA Mode\_External Ant)

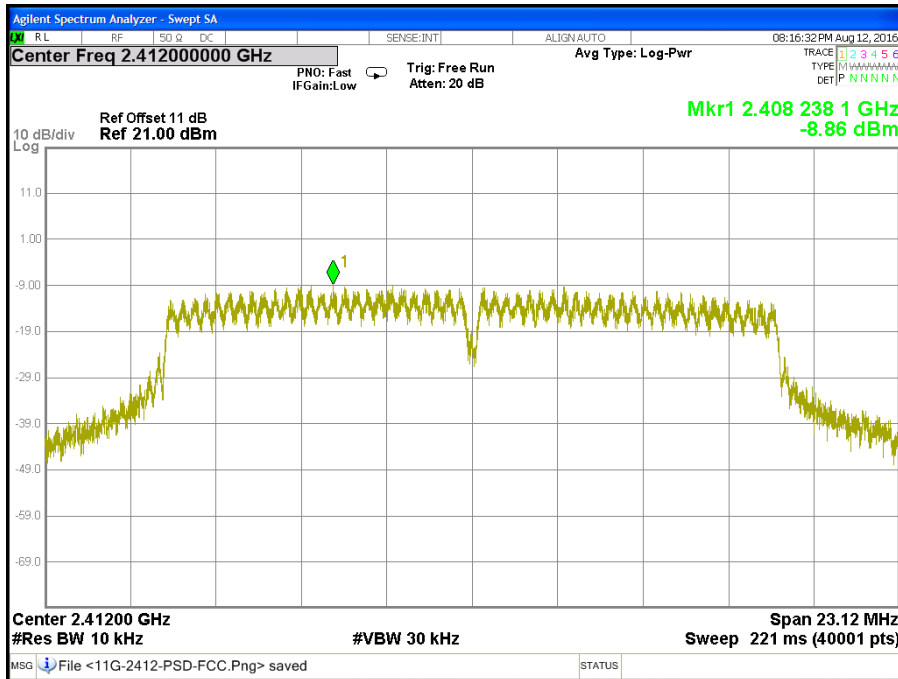

CH Middle (IEEE 802.11g Mode / STA Mode\_External Ant)

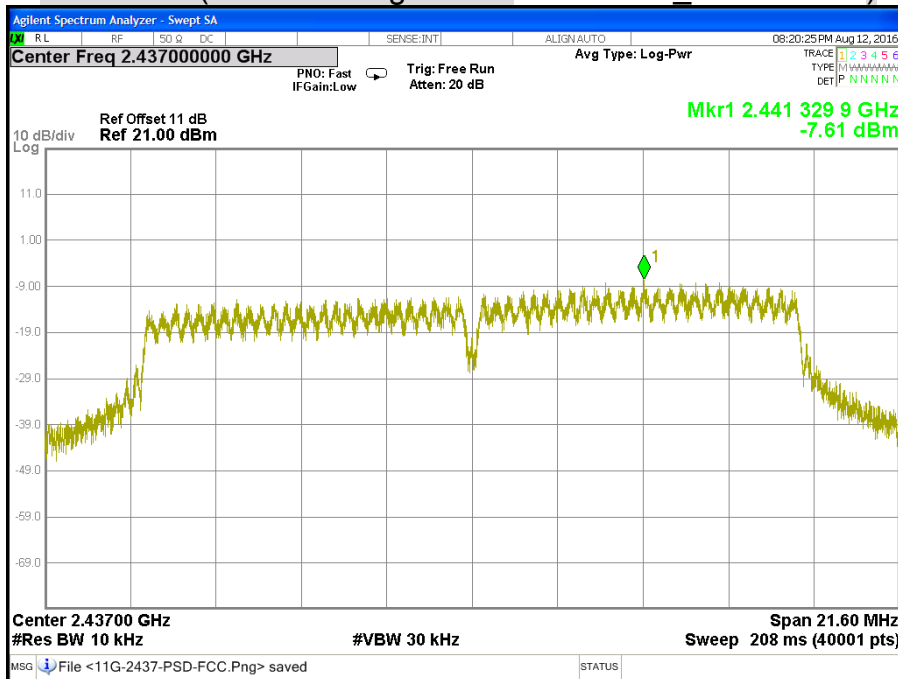

CH High (IEEE 802.11g Mode / STA Mode\_External Ant)

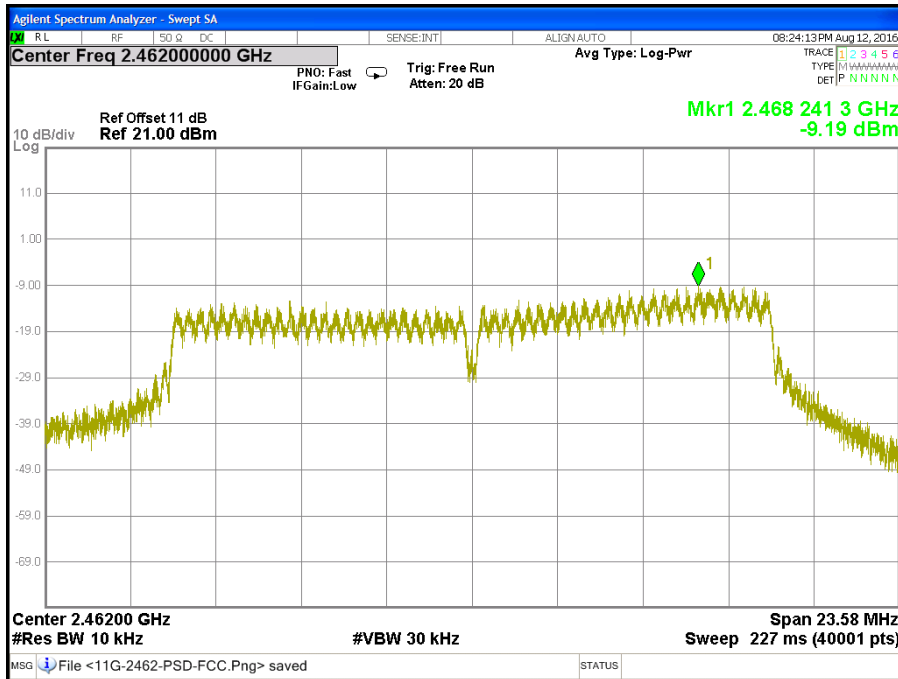

CH Low (IEEE 802.11gn HT20 MCS0 Mode / STA Mode\_External Ant )

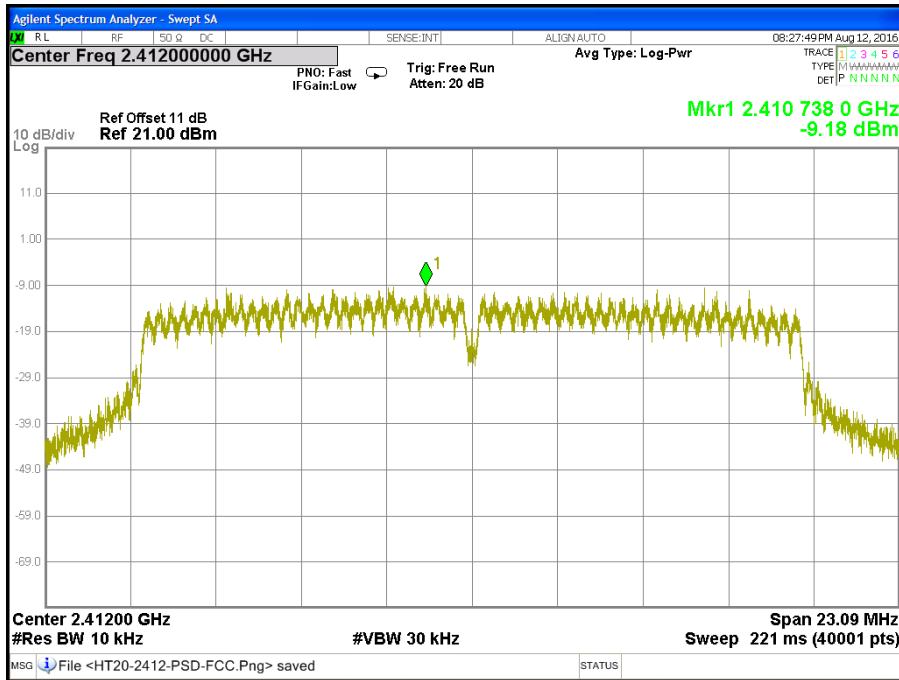

CH Middle (IEEE 802.11gn HT20 MCS0 Mode / STA Mode External Ant )

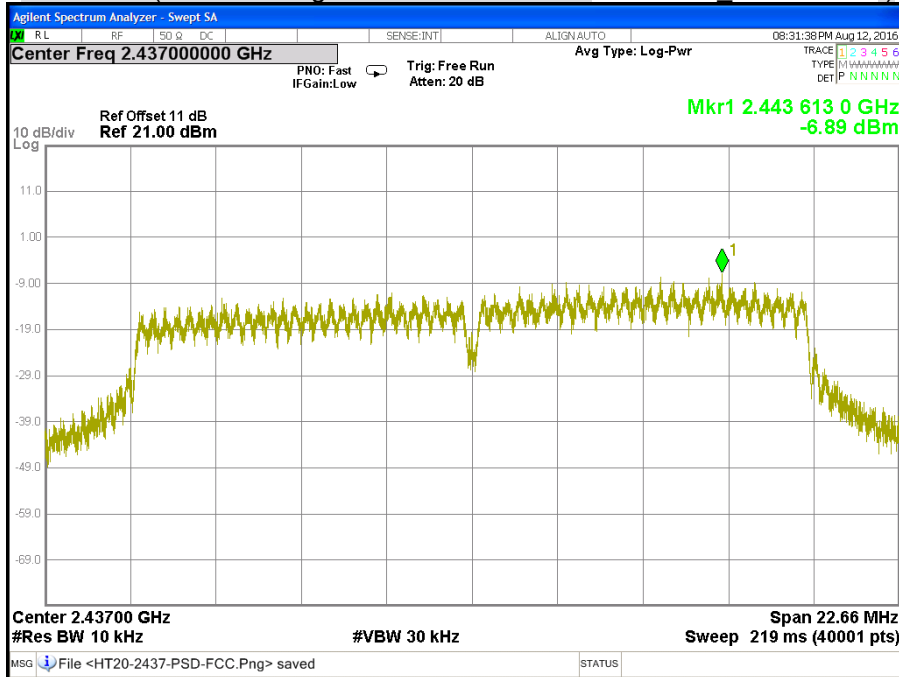



CH High (IEEE 802.11gn HT20 MCS0 Mode / STA Mode\_External Ant)

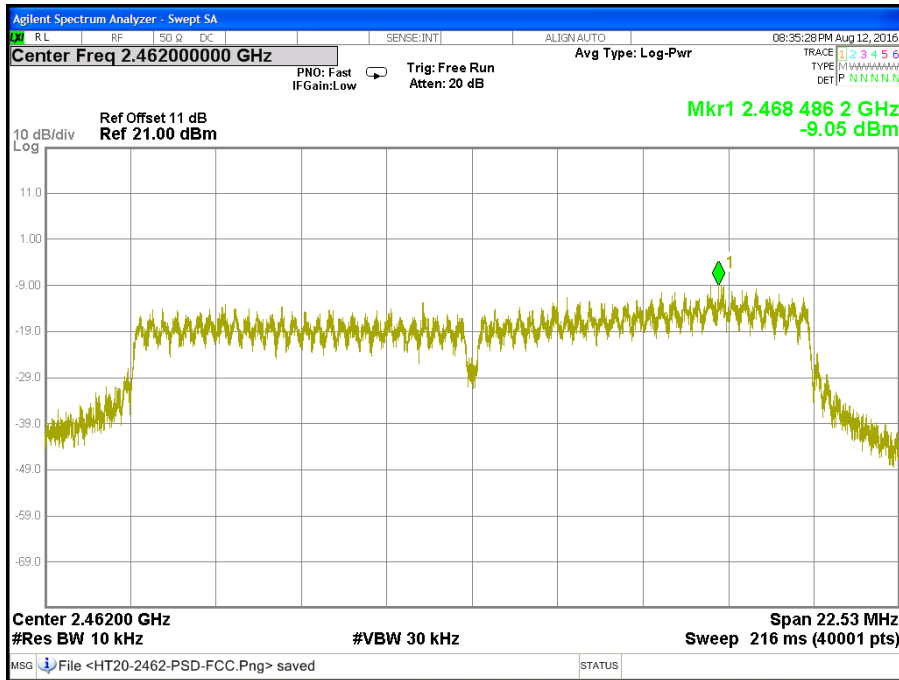

## 7.6 CONDUCTED SPURIOUS EMISSION

### LIMITS

§ 15.247(d) In any 100 kHz bandwidth outside the frequency band in which the spread spectrum intentional radiator is operating, the radio frequency power that is produced by the intentional radiator shall be at least 20 dB below that in the 100 kHz bandwidth within the and that contains the highest level of the desired power, based on either an RF conducted or a radiated measurement. Attenuation below the general limits specified in § 15.209(a) is not required. In addition, radiated emissions which fall in the restricted bands, as defined in § 15.205(a), must also comply with the radiated emission limits specified in § 15.209(a) (see § 15.205(c)).

### TEST EQUIPMENT

Name of Equipment	Manufacturer	Model	Serial Number	Calibration Due
EXA Signal Analyzer	Agilent	N9010A	MY52220817	03/15/2017
Test S/W	N/A			

*Remark: Each piece of equipment is scheduled for calibration once a year.*

### TEST SETUP

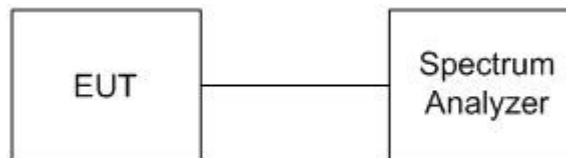

### TEST PROCEDURE

The transmitter output is connected to a spectrum analyzer. The resolution bandwidth is set to 100 kHz. The video bandwidth is set to 300 kHz.

The spectrum from 30 MHz to 26.5 GHz is investigated with the transmitter set to the lowest, middle, and highest channels in the 2.4 GHz band.

### TEST RESULTS

<b>Product Name</b>	WHITE DRIVE BOX	<b>Test By</b>	Crystal Wu
<b>Test Model</b>	TB4001	<b>Test Date</b>	2016/08/12
<b>Test Mode</b>	TX Direct Mode / External Ant	<b>Temp. &amp; Humidity</b>	28°C, 63%

<b>Product Name</b>	WHITE DRIVE BOX	<b>Test By</b>	Crystal Wu
<b>Test Model</b>	TB4001	<b>Test Date</b>	2016/08/12
<b>Test Mode</b>	TX STA Mode / External Ant	<b>Temp. &amp; Humidity</b>	28°C, 63%

**OUT-OF-BAND SPURIOUS EMISSIONS-CONDUCTED MEASUREMENT**

CH Low (2.38GHz ~ 2.5GHz / IEEE 802.11b Mode / Direct Mode\_External Ant)

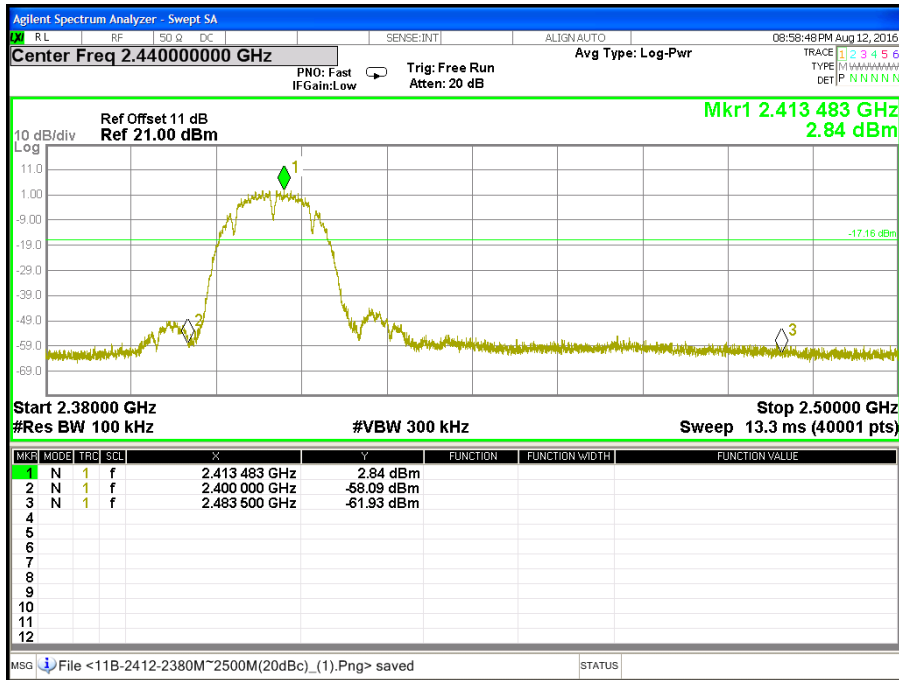

CH Low (30MHz ~ 26.5GHz / IEEE 802.11b Mode / Direct Mode\_External Ant)

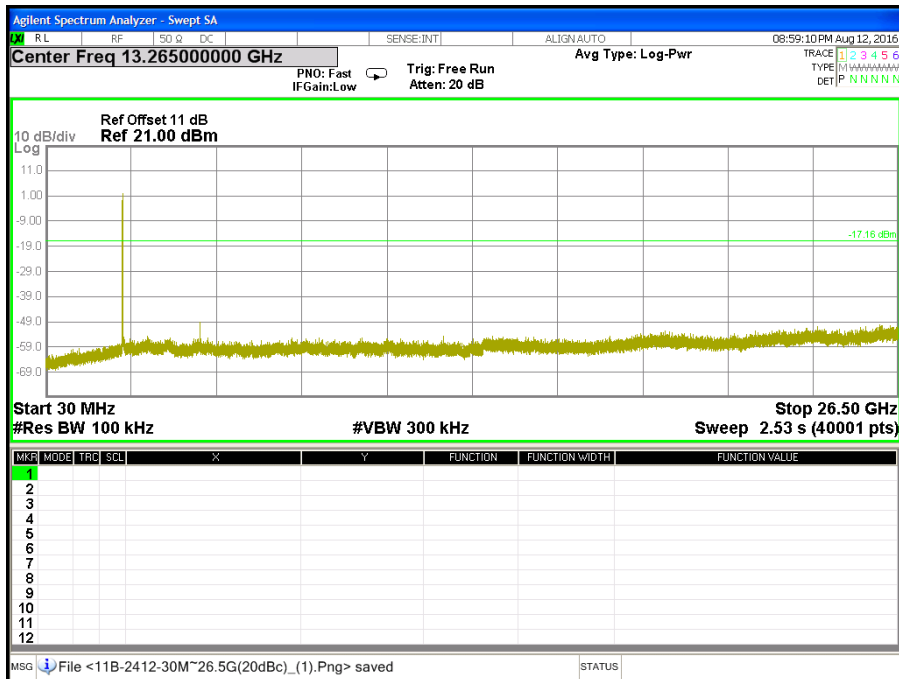

CH Middle (2.38GHz ~ 2.5GHz / IEEE 802.11b Mode / Direct Mode\_External Ant)

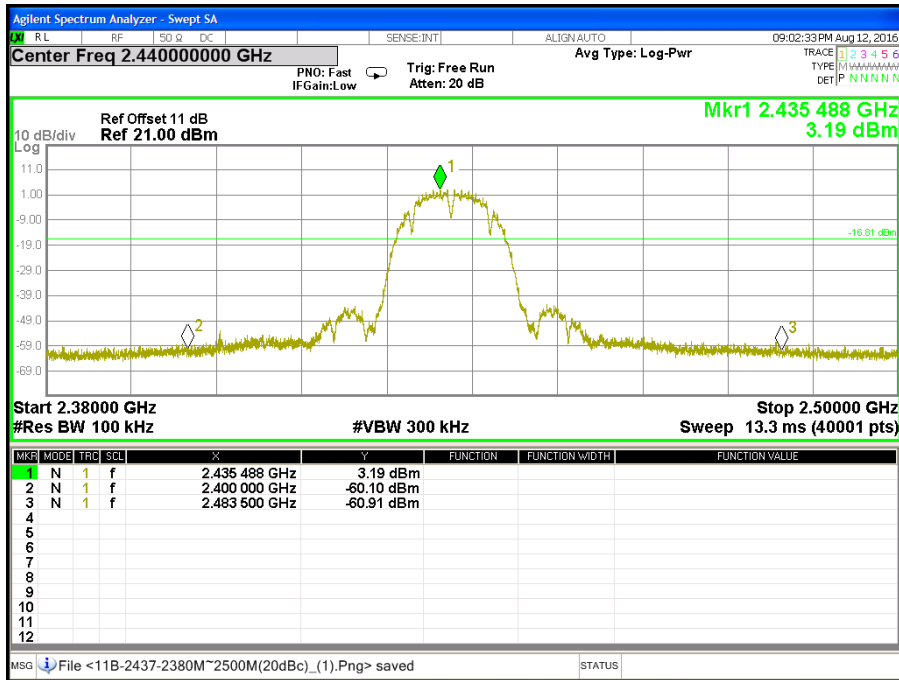

CH Middle (30MHz ~ 26.5GHz / IEEE 802.11b Mode / Direct Mode\_External Ant)

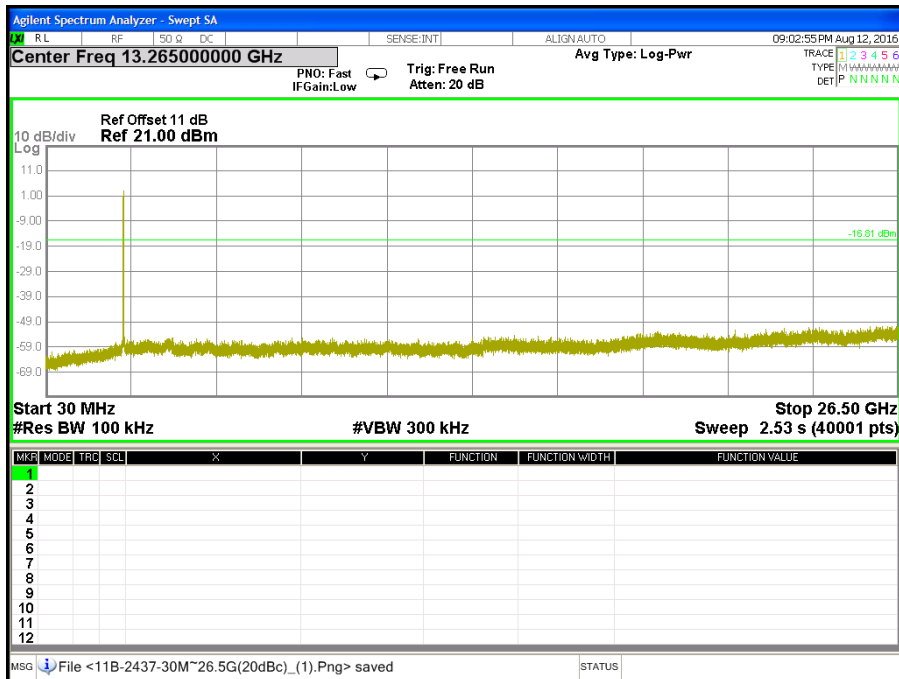

CH High (2.38GHz ~ 2.5GHz / IEEE 802.11b Mode / Direct Mode\_External Ant)

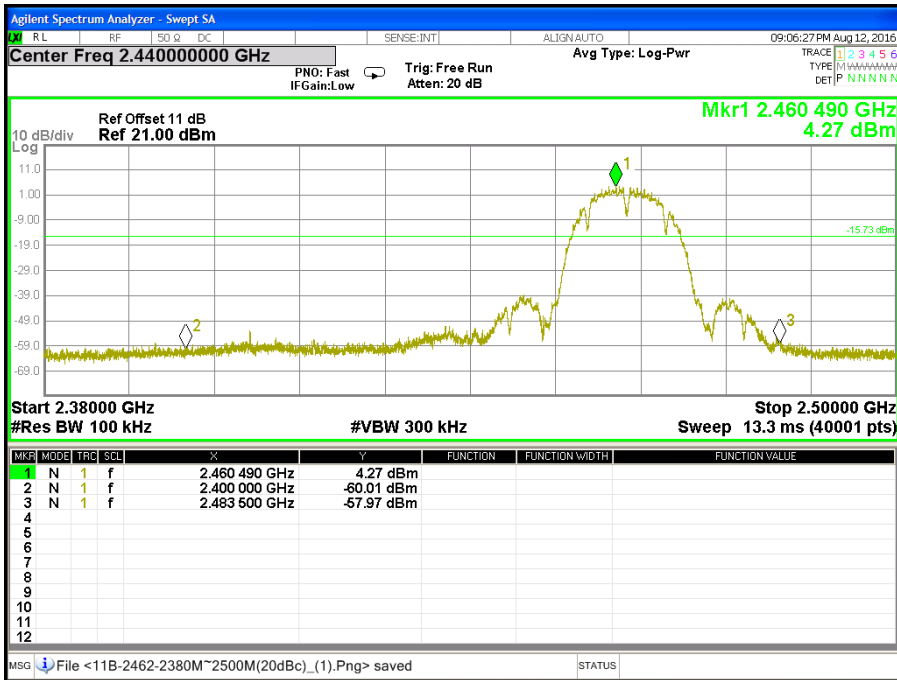

CH High (30MHz ~ 26.5GHz / IEEE 802.11b Mode / Direct Mode\_External Ant)

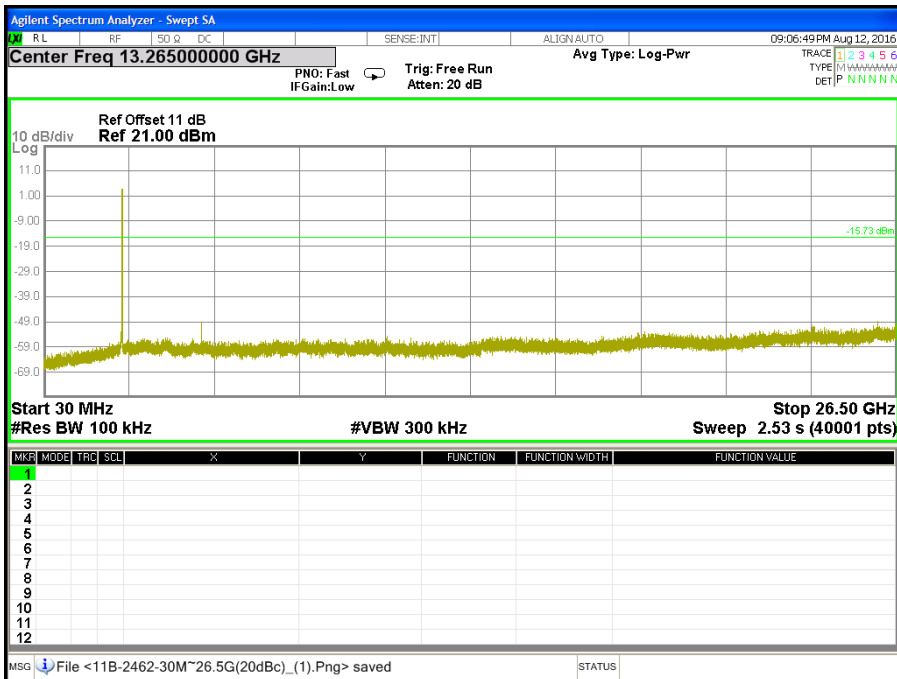

CH Low (2.38GHz ~ 2.5GHz / IEEE 802.11g Mode / Direct Mode\_External Ant )

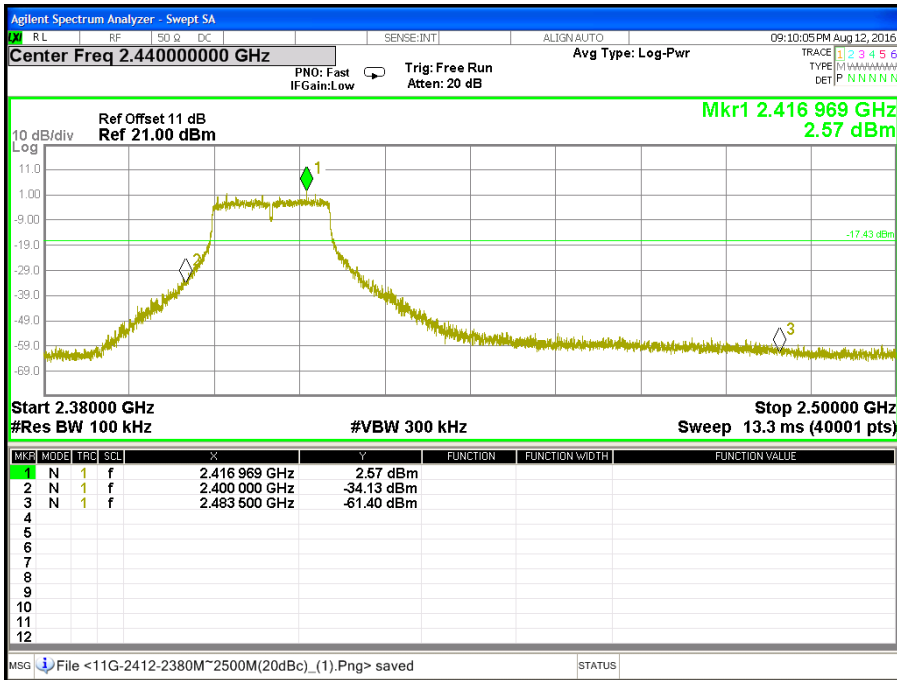

CH Low (30MHz ~ 26.5GHz / IEEE 802.11g Mode / Direct Mode\_External Ant)

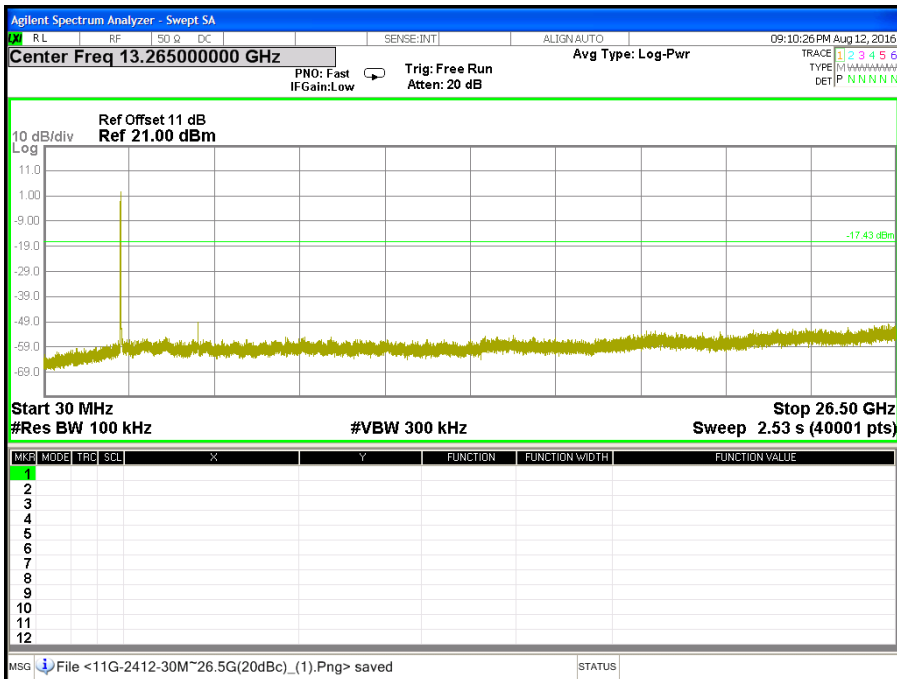

CH Middle (2.38GHz ~ 2.5GHz / IEEE 802.11g Mode / Direct Mode\_External Ant)

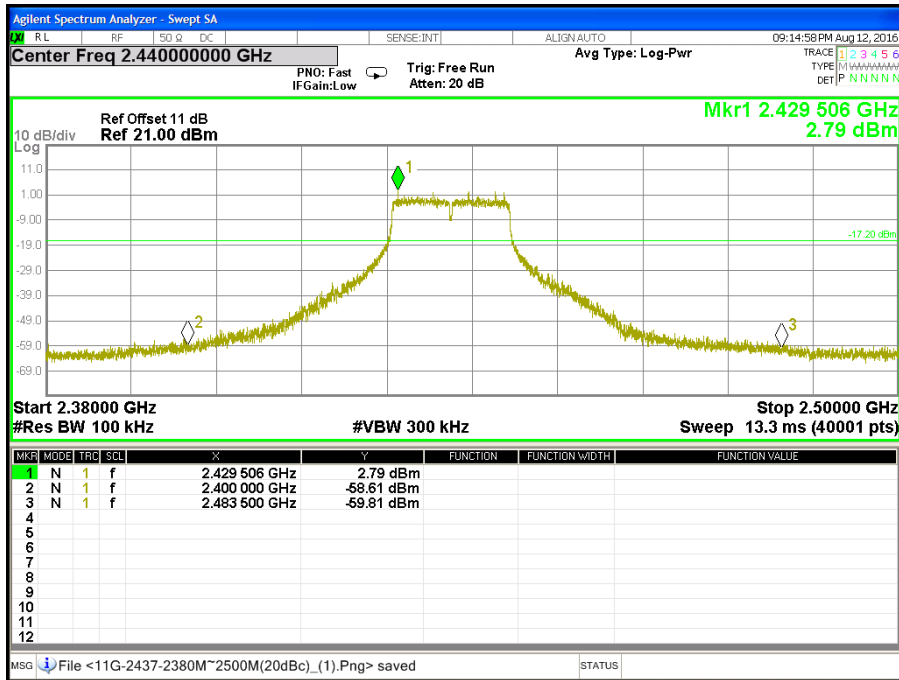

CH Middle (30MHz ~ 26.5GHz / IEEE 802.11g Mode / Direct Mode\_External Ant)

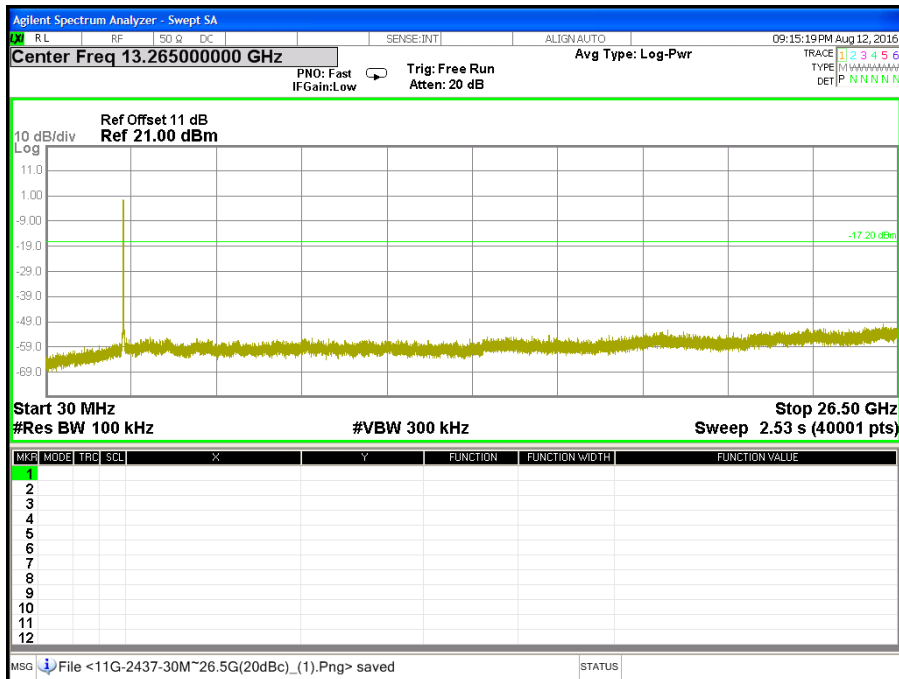

CH High (2.38GHz ~ 2.5GHz / IEEE 802.11g Mode / Direct Mode\_External Ant)

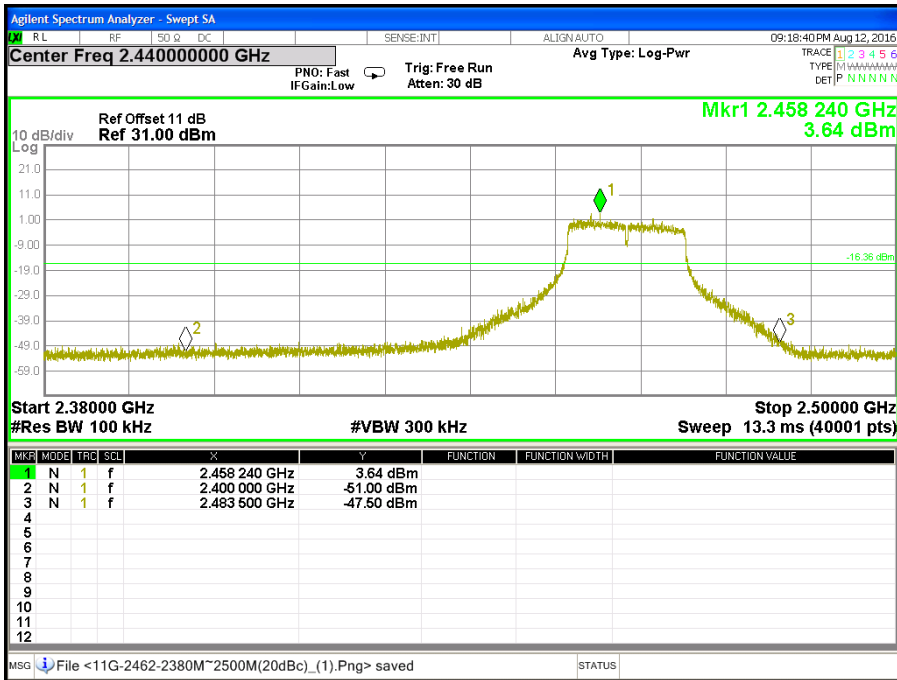

CH High (30MHz ~ 26.5GHz / IEEE 802.11g Mode / Direct Mode\_External Ant)

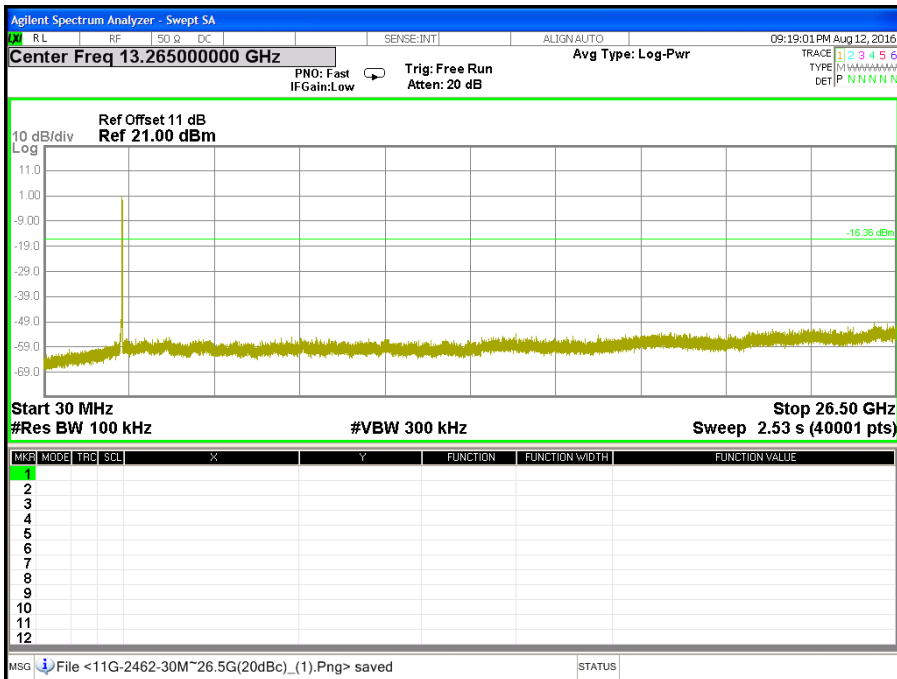



CH Low (2.38GHz ~ 2.5GHz / IEEE 802.11gn HT20 MCS0 Mode / Direct Mode\_External Ant)

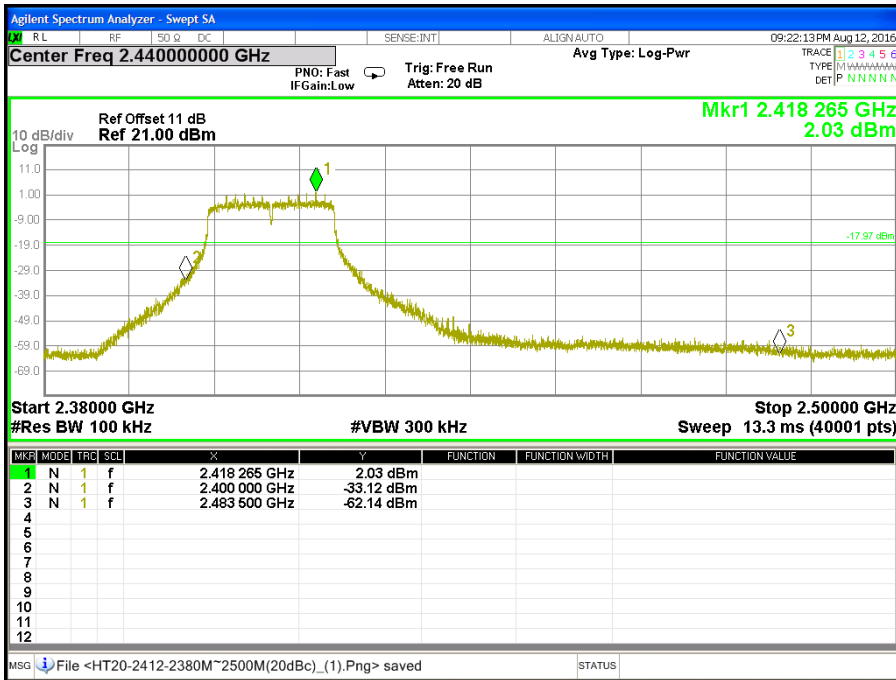

CH Low (30MHz ~ 26.5GHz / IEEE 802.11gn HT20 MCS0 Mode / Direct Mode\_External Ant)

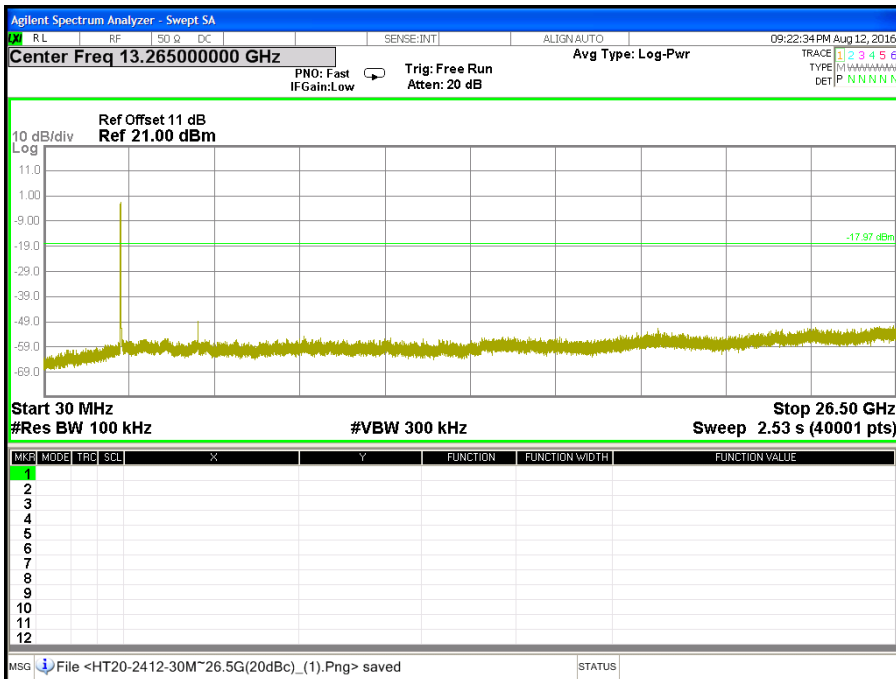

CH Middle (2.38GHz ~ 2.5GHz / IEEE 802.11gn HT20 MCS0 Mode / Direct Mode\_External Ant)

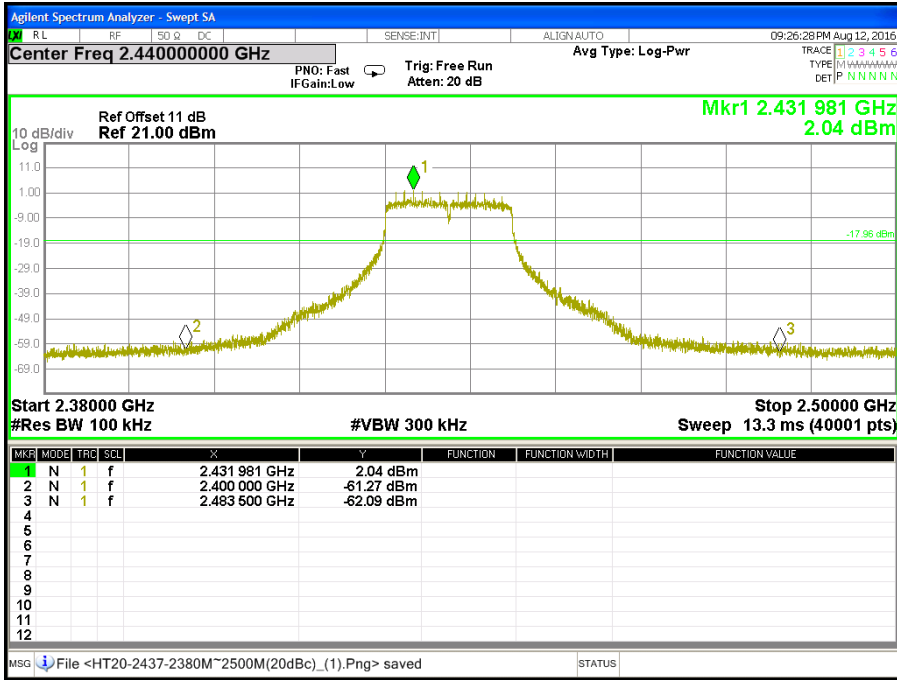

CH Middle (30MHz ~ 26.5GHz / IEEE 802.11gn HT20 MCS0 Mode / Direct Mode\_External Ant)

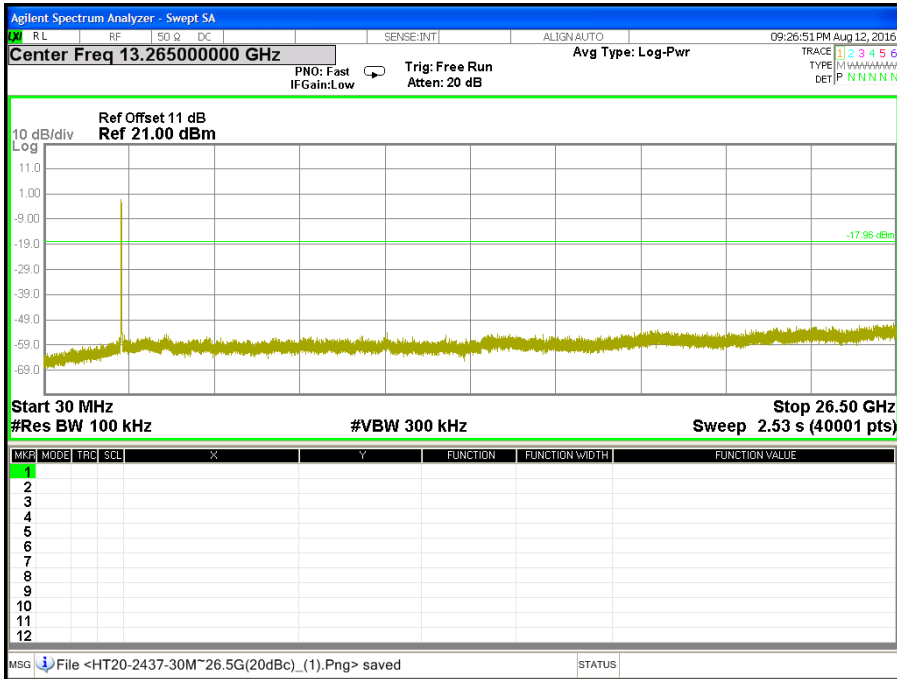

CH High (2.38GHz ~ 2.5GHz / IEEE 802.11gn HT20 MCS0 Mode / Direct Mode\_External Ant)

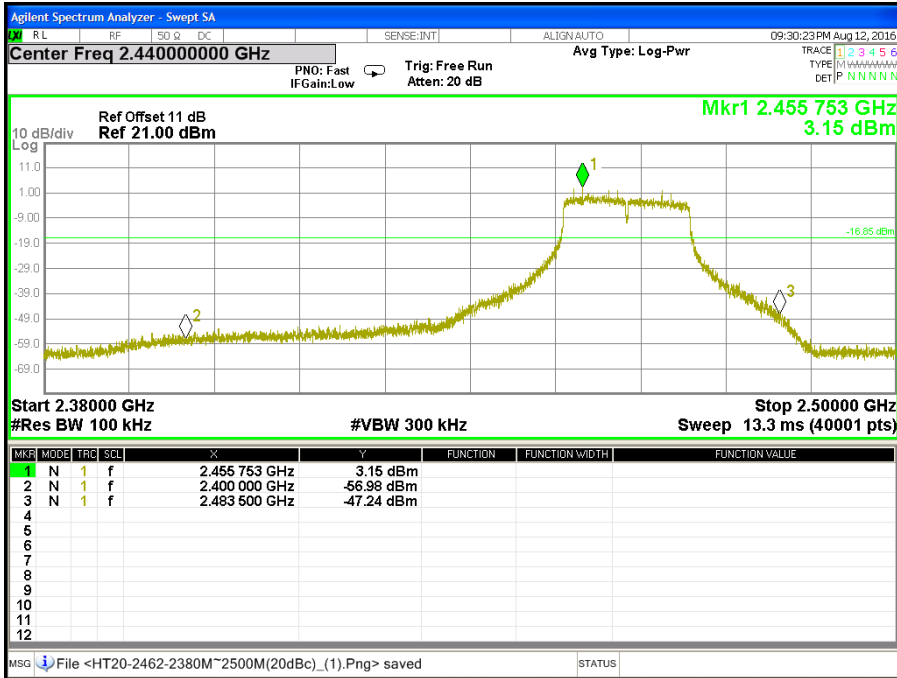

CH High (30MHz ~ 26.5GHz / IEEE 802.11gn HT20 MCS0 Mode / Direct Mode\_External Ant)

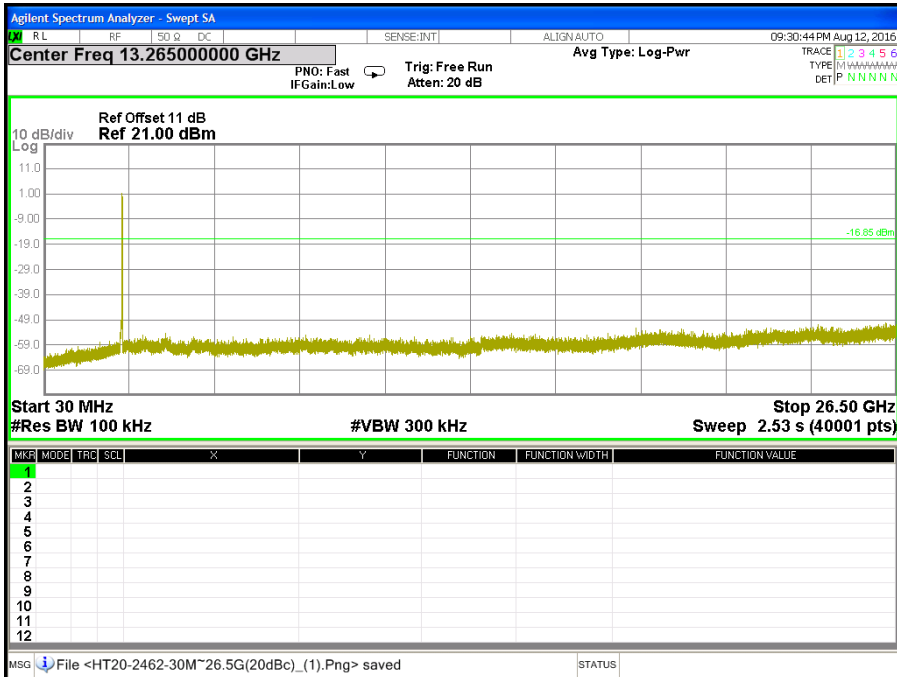

CH Low (2.38GHz ~ 2.5GHz / IEEE 802.11b Mode / STA Mode\_External Ant)

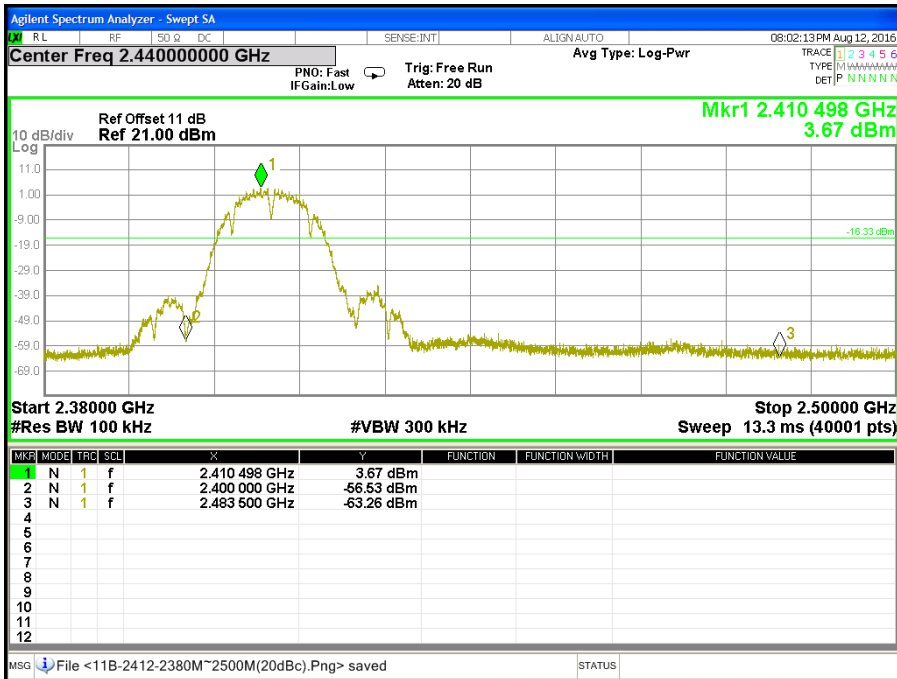

CH Low (30MHz ~ 26.5GHz / IEEE 802.11b Mode / STA Mode\_External Ant)

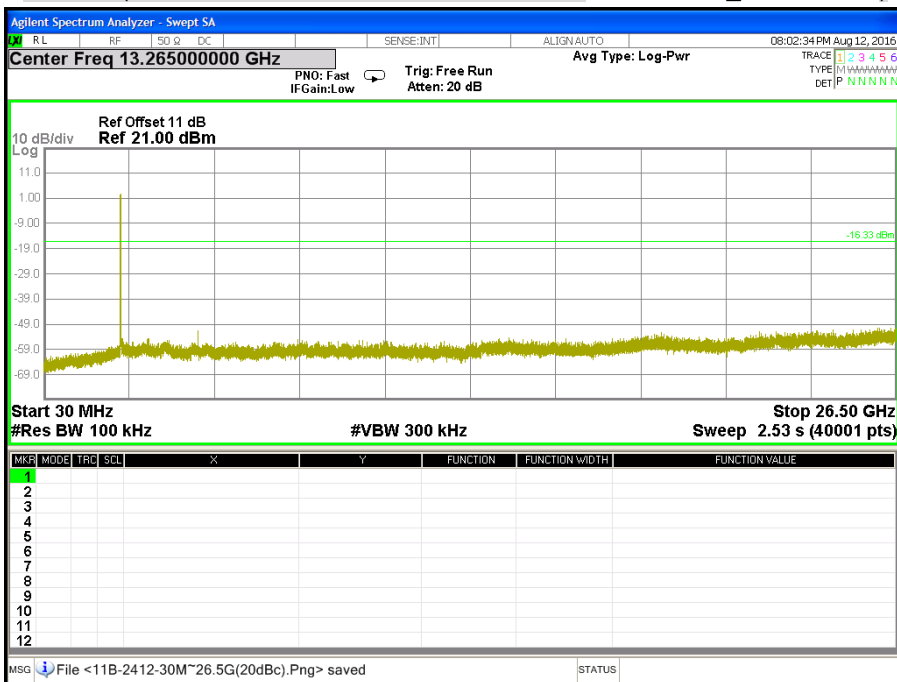

CH Middle (2.38GHz ~ 2.5GHz / IEEE 802.11b Mode / STA Mode\_External Ant)

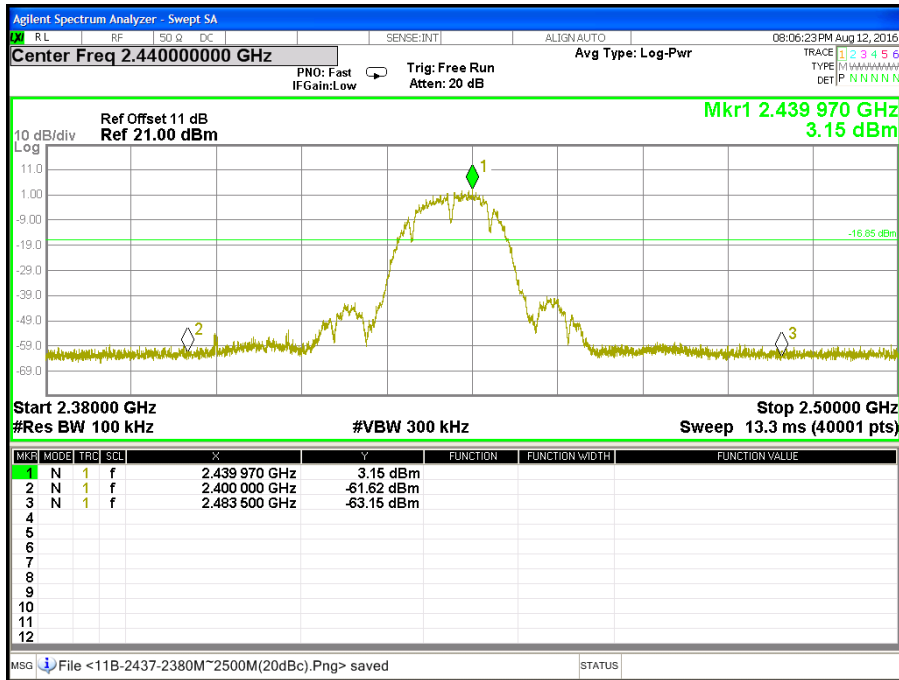

CH Middle (30MHz ~ 26.5GHz / IEEE 802.11b Mode / STA Mode\_External Ant)

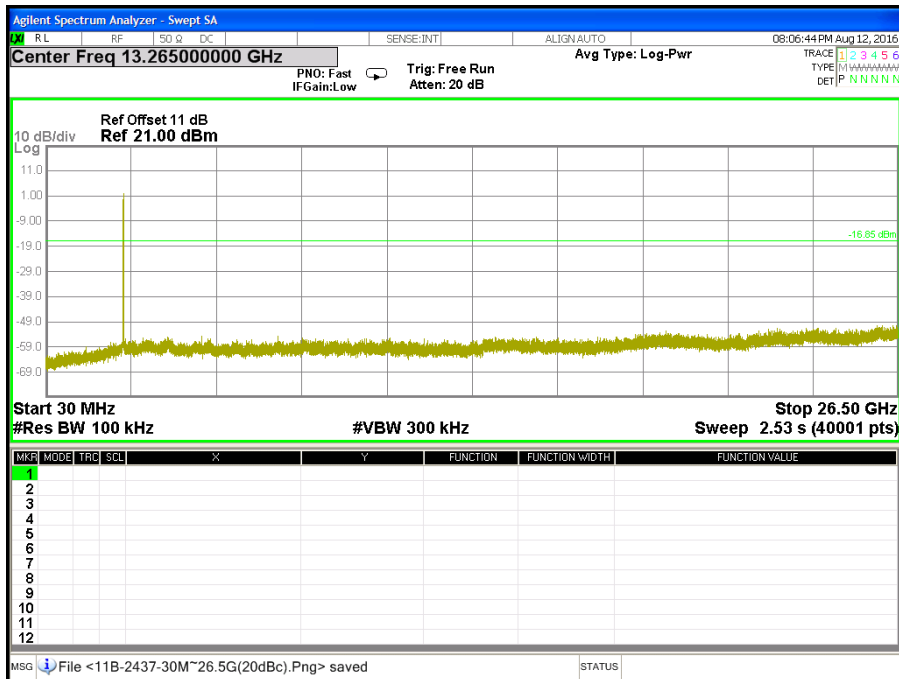

CH High (2.38GHz ~ 2.5GHz / IEEE 802.11b Mode / STA Mode\_External Ant)

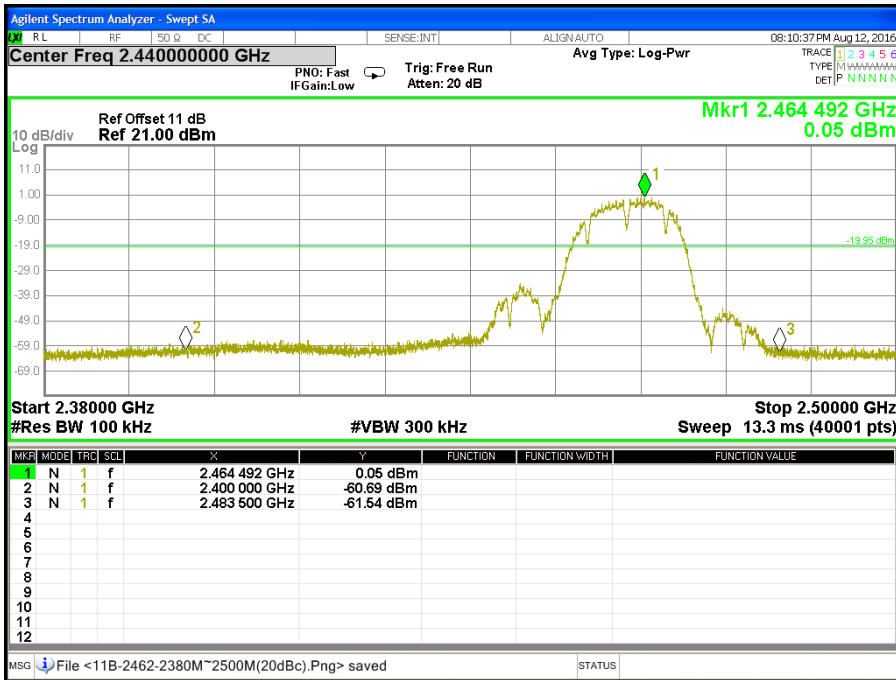

CH High (30MHz ~ 26.5GHz / IEEE 802.11b Mode / STA Mode\_External Ant)

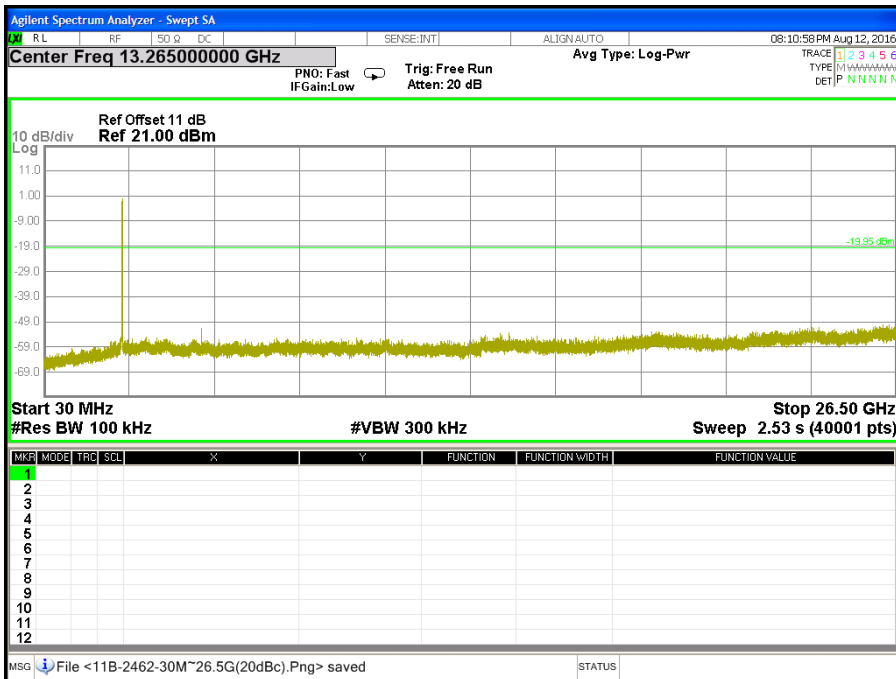

CH Low (2.38GHz ~ 2.5GHz / IEEE 802.11g Mode / STA Mode\_External Ant )

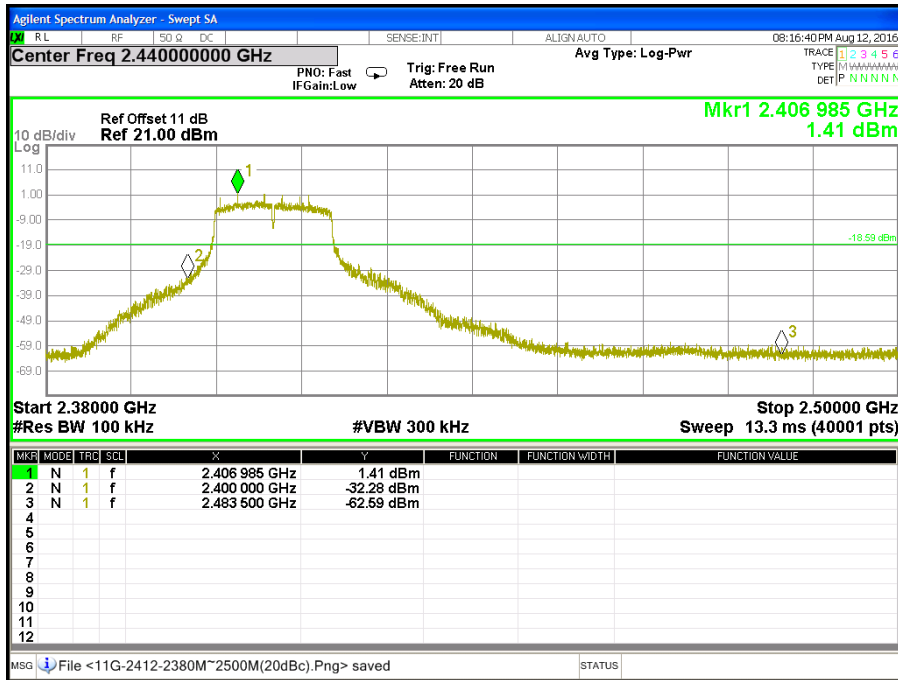

CH Low (30MHz ~ 26.5GHz / IEEE 802.11g Mode / STA Mode\_External Ant)

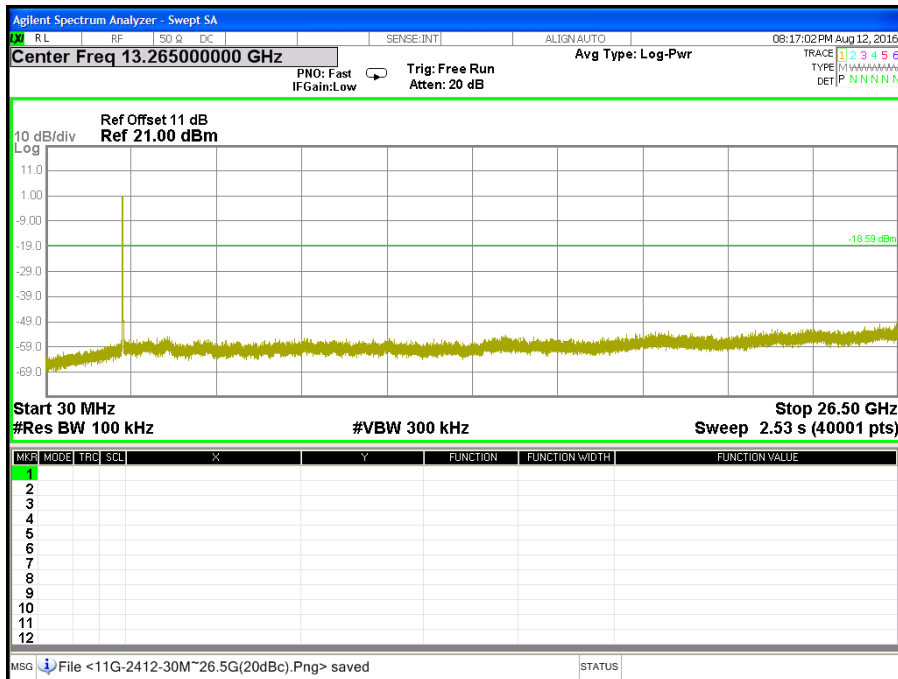

CH Middle (2.38GHz ~ 2.5GHz / IEEE 802.11g Mode / STA Mode\_External Ant)

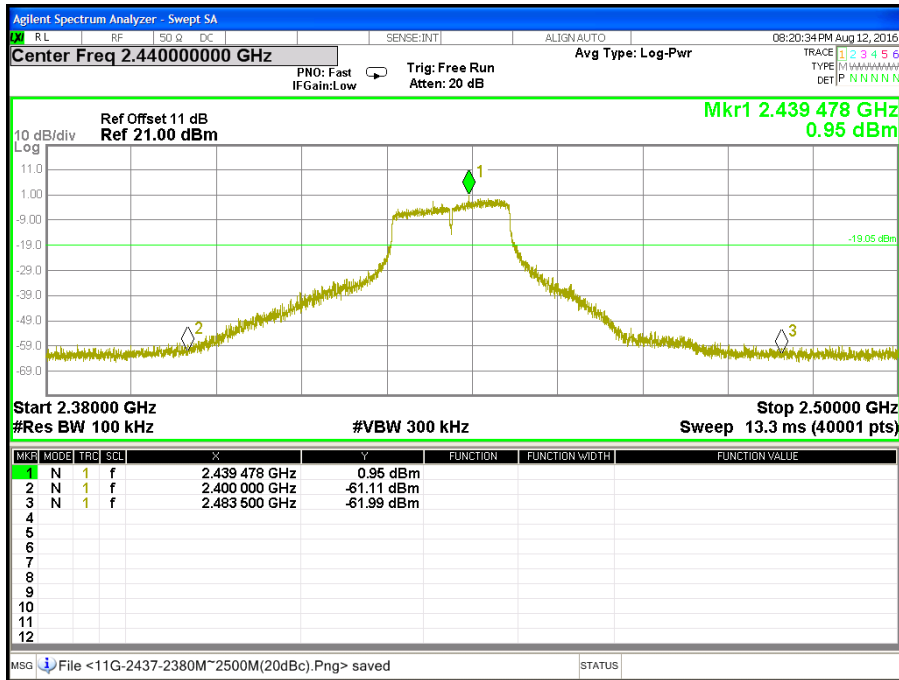

CH Middle (30MHz ~ 26.5GHz / IEEE 802.11g Mode / STA Mode\_External Ant)

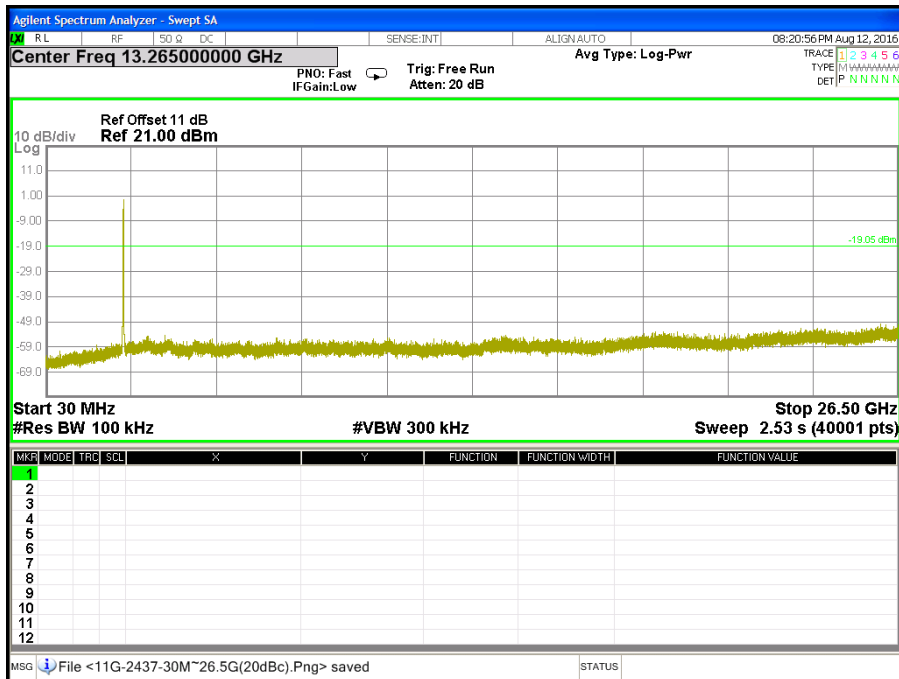



CH High (2.38GHz ~ 2.5GHz / IEEE 802.11g Mode / STA Mode\_External Ant)

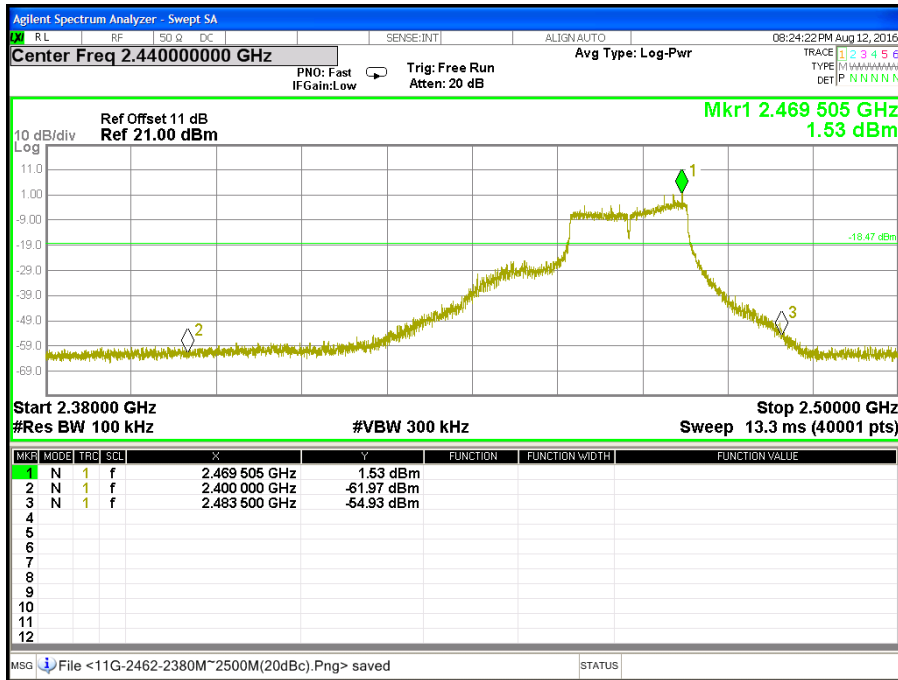

CH High (30MHz ~ 26.5GHz / IEEE 802.11g Mode / STA Mode\_External Ant)

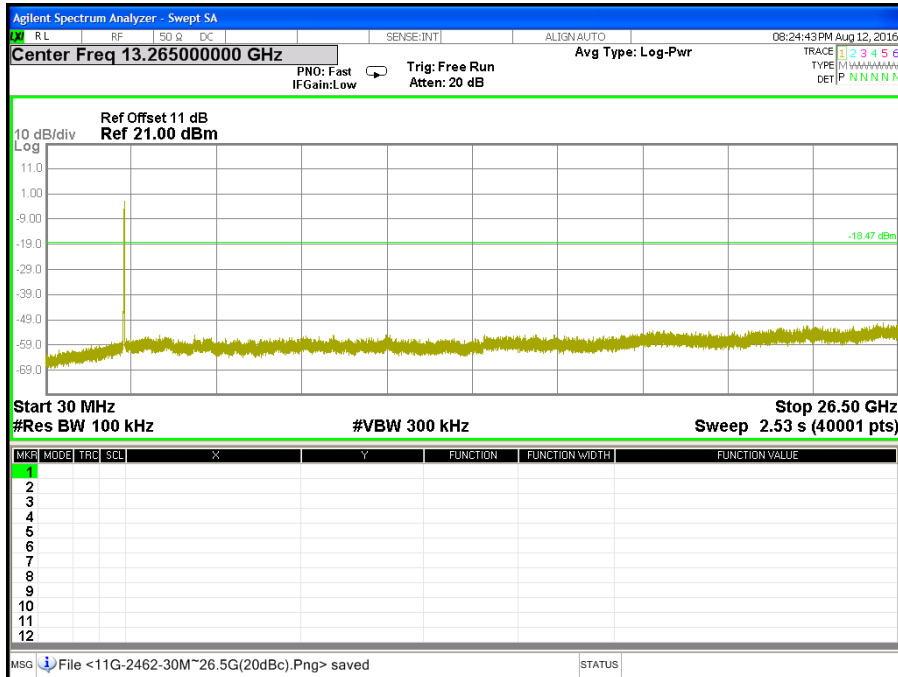

CH Low (2.38GHz ~ 2.5GHz / IEEE 802.11gn HT20 MCS0 Mode / STA Mode\_External Ant)

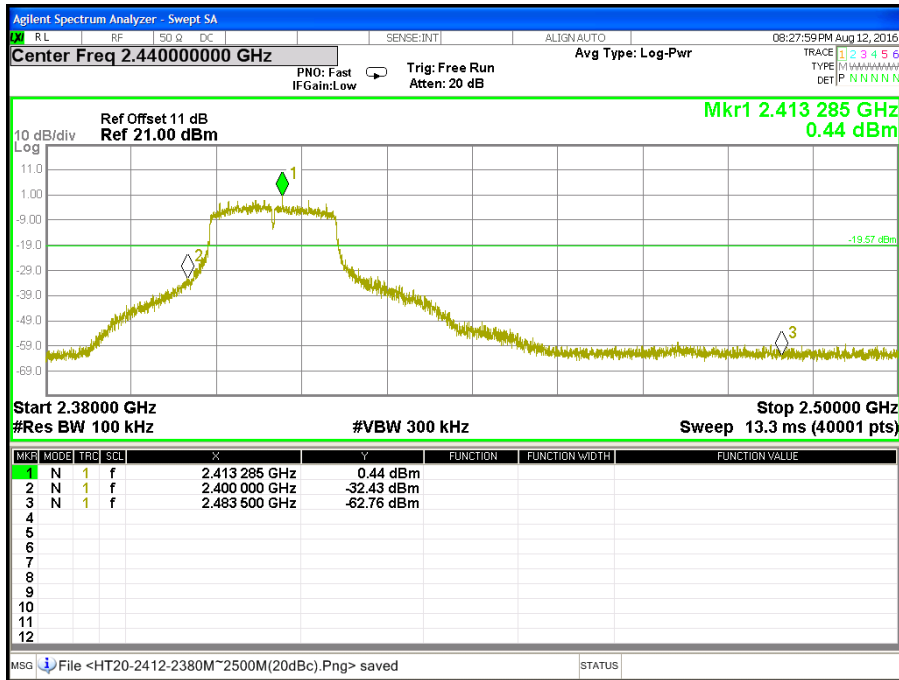

CH Low (30MHz ~ 26.5GHz / IEEE 802.11gn HT20 MCS0 Mode / STA Mode\_External Ant)

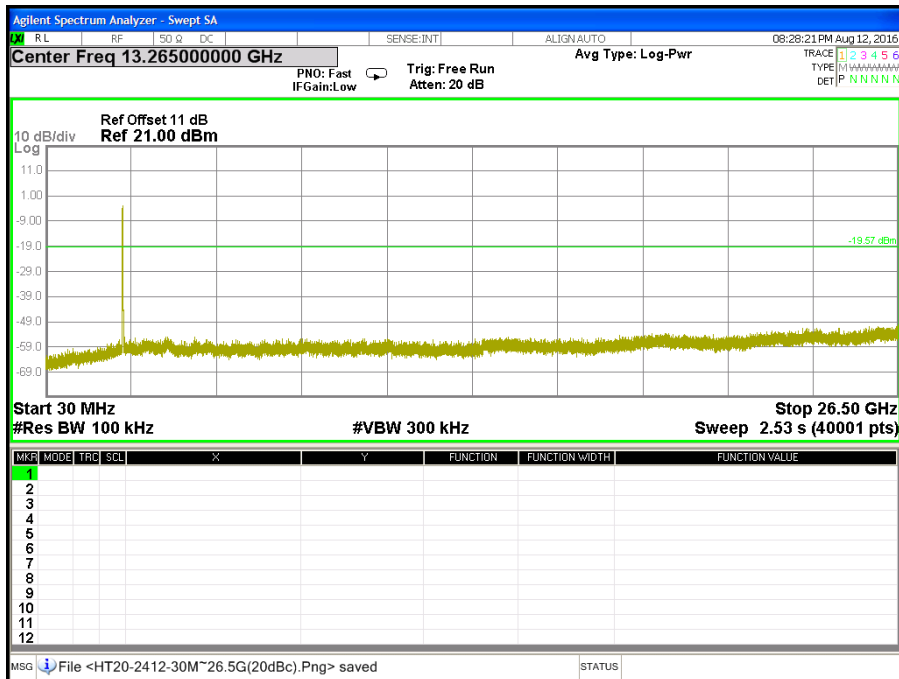

CH Middle (2.38GHz ~ 2.5GHz / IEEE 802.11gn HT20 MCS0 Mode / STA Mode\_External Ant)

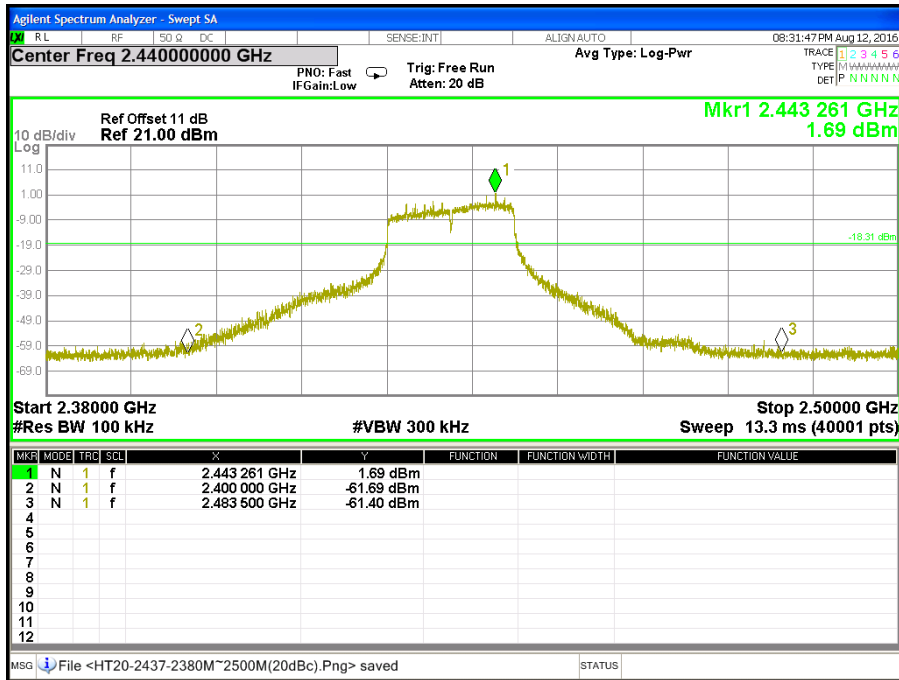

CH Middle (30MHz ~ 26.5GHz / IEEE 802.11gn HT20 MCS0 Mode / STA Mode\_External Ant)

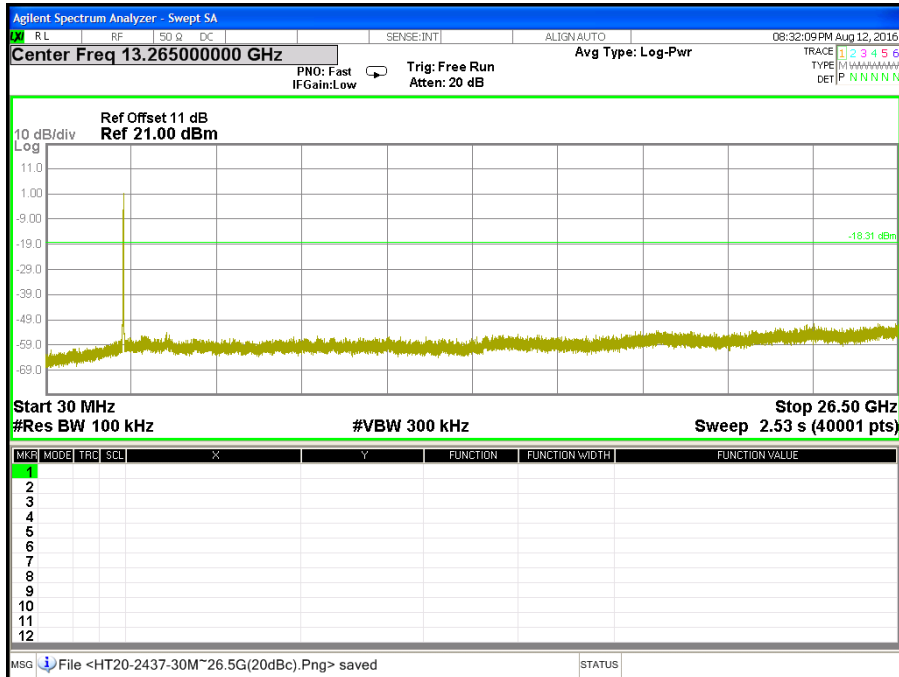

CH High (2.38GHz ~ 2.5GHz / IEEE 802.11gn HT20 MCS0 Mode / STA Mode\_External Ant)

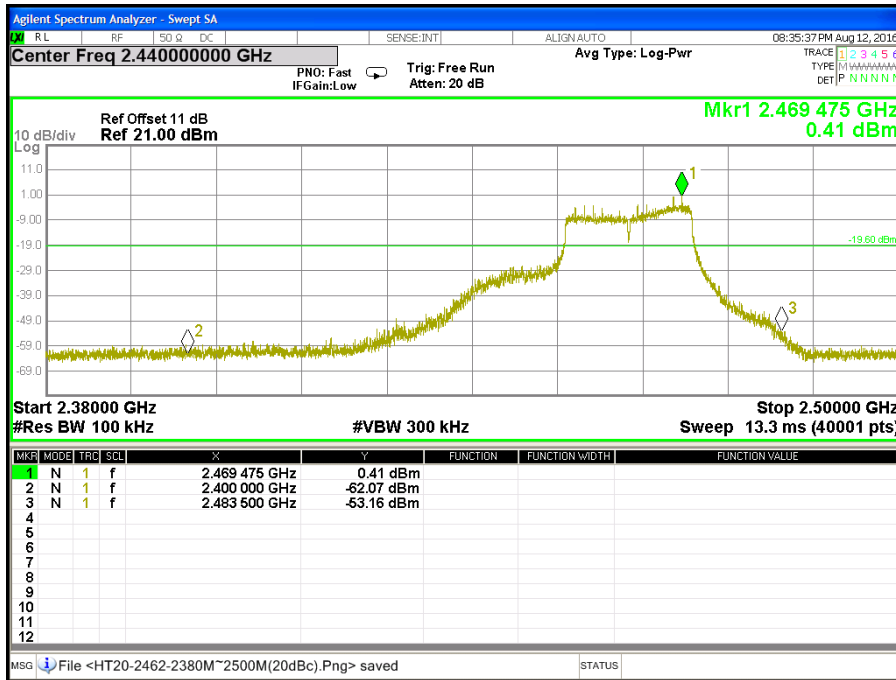

CH High (30MHz ~ 26.5GHz / IEEE 802.11gn HT20 MCS0 Mode / STA Mode\_External Ant)

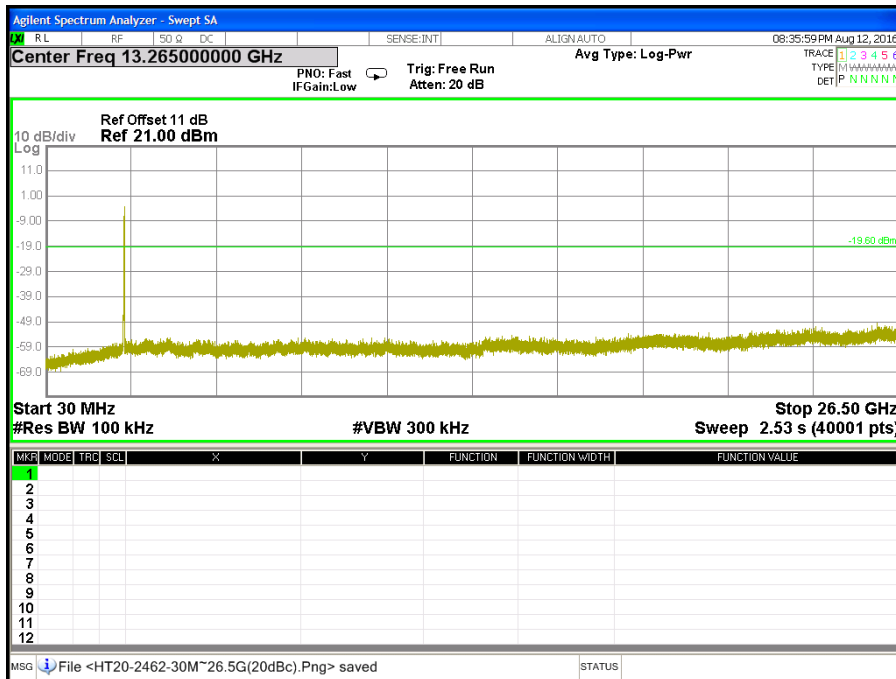

## 7.7 RADIATED EMISSION

### LIMITS

- (1) According to § 15.205 (a) Except as shown in paragraph (d) of this section, only spurious emissions are permitted in any of the frequency bands listed below:

MHz	MHz	MHz	GHz
0.090 - 0.110	16.42 - 16.423	399.9 - 410	4.5 - 5.15
<sup>1</sup> 0.495 - 0.505	16.69475 - 16.69525	608 - 614	5.35 - 5.46
2.1735 - 2.1905	16.80425 - 16.80475	960 - 1240	7.25 - 7.75
4.125 - 4.128	25.5 - 25.67	1300 - 1427	8.025 - 8.5
4.17725 - 4.17775	37.5 - 38.25	1435 - 1626.5	9.0 - 9.2
4.20725 - 4.20775	73 - 74.6	1645.5 - 1646.5	9.3 - 9.5
6.215 - 6.218	74.8 - 75.2	1660 - 1710	10.6 - 12.7
6.26775 - 6.26825	108 - 121.94	1718.8 - 1722.2	13.25 - 13.4
6.31175 - 6.31225	123 - 138	2200 - 2300	14.47 - 14.5
8.291 - 8.294	149.9 - 150.05	2310 - 2390	15.35 - 16.2
8.362 - 8.366	156.52475 - 156.52525	2483.5 - 2500	17.7 - 21.4
8.37625 - 8.38675	156.7 - 156.9	2655 - 2900	22.01 - 23.12
8.41425 - 8.41475	162.0125 - 167.17	3260 - 3267	23.6 - 24.0
12.29 - 12.293	167.72 - 173.2	3332 - 3339	31.2 - 31.8
12.51975 - 12.52025	240 - 285	3345.8 - 3338	36.43 - 36.5
12.57675 - 12.57725	322 - 335.4	3600 - 4400	( <sup>2</sup> )
13.36 - 13.41			

**Remark:**

1. <sup>1</sup> Until February 1, 1999, this restricted band shall be 0.490-0.510 MHz.
2. <sup>2</sup> Above 38.6

- (2) According to § 15.205 (b) Except as provided in paragraphs (d) and (e), the field strength of emissions appearing within these frequency bands shall not exceed the limits shown in Section 15.209. At frequencies equal to or less than 1000 MHz, compliance with the limits in Section 15.209 shall be demonstrated using measurement instrumentation employing a CISPR quasi-peak detector. Above 1000 MHz, compliance with the emission limits in Section 15.209 shall be demonstrated based on the average value of the measured emissions. The provisions in Section 15.35 apply to these measurements.

- (3) According to § 15.209 (a) Except as provided elsewhere in this Subpart, the emissions from an intentional radiator shall not exceed the field strength levels specified in the following table:

Frequency (MHz)	Field Strength (microvolts/meter)	Measurement Distance (meters)
0.009 – 0.490	2400/F(KHz)	300
0.490 – 1.705	24000/F(KHz)	30
1.705 – 30.0	30	30
30 - 88	100 **	3
88 - 216	150 **	3
216 - 960	200 **	3
Above 960	500	3

**Remark:** \*\*Except as provided in paragraph (g), fundamental emissions from intentional radiators operating under this Section shall not be located in the frequency bands 54-72 MHz, 76-88 MHz, 174-216 MHz or 470-806 MHz. However, operation within these frequency bands is permitted under other sections of this Part, e.g., Sections 15.231 and 15.241.

- (4) According to § 15.209 (b) In the emission table above, the tighter limit applies at the band edges.

**TEST EQUIPMENT**

**Radiated Emission / 966Chamber\_C**

Name of Equipment	Manufacture	Model	Serial Number	Calibration Due
Spectrum Analyzer	Agilent	E4446A	MY48250064	04/21/2017
EMI Test Receiver	Rohde & Schwarz	ESCI	101387	10/06/2016
Bi-log Antenna	TESEQ	CBL 6112D	35404	07/22/2017
Broad-Band Horn Antenna	Schwarzbeck	BBHA 9120 D	9120D-778	07/14/2017
Double-Ridged Waveguide Horn	ETS-LINDGREN	3117	00078732	07/10/2017
Horn Antenna	COM-POWER	AH-840	03077	12/08/2016
Pre-Amplifier	EMCI	EMC001625	980243	04/11/2017
Pre-Amplifier	COM-POWER	PAM-118A	551043	04/11/2017
Pre-Amplifier	EMCI	EMC012645	980060	07/01/2017
LOOP Antenna	COM-POWER	AL-130	121060	05/23/2017
Test S/W	E3.815206a			

**Remark:** Each piece of equipment is scheduled for calibration once a year.

**TEST SETUP**

The diagram below shows the test setup that is utilized to make the measurements for emission below 1GHz.

**9kHz ~ 30MHz**

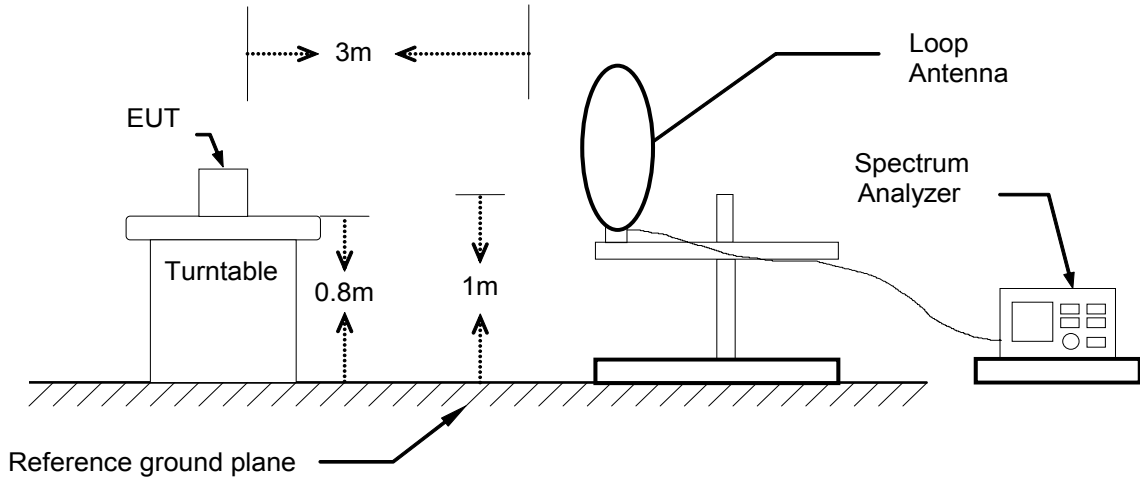

**30MHz ~ 1GHz**

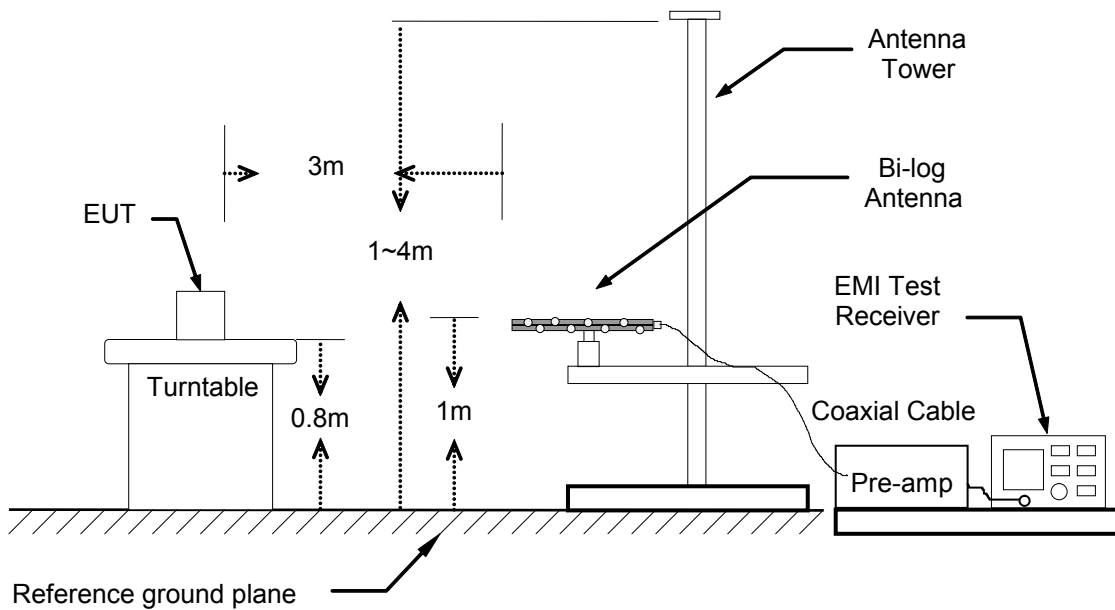

The diagram below shows the test setup that is utilized to make the measurements for emission above 1GHz.

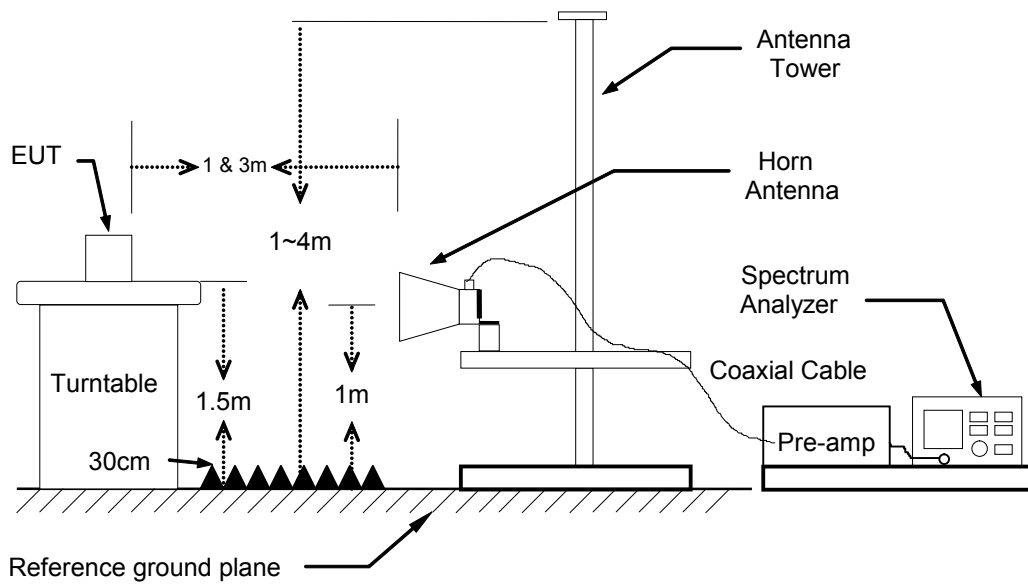



## **TEST PROCEDURE**

1. The EUT was placed on the top of a rotating table 0.8 and 1.5 meters above the ground. The table was rotated 360 degrees to determine the position of the highest radiation.
2. While measuring the radiated emission below 1GHz, the EUT was set 1 and 3 meters away from the interference-receiving antenna, which was mounted on the top of a variable-height antenna tower. While measuring the radiated emission above 1GHz, the EUT was set 3 meters away from the interference-receiving antenna.
3. The antenna is a broadband antenna, and its height is varied from one meter to four meters above the ground to determine the maximum value of the field strength. Both horizontal and vertical polarization of the antenna are set to make the measurement.
4. For each suspected emission, the EUT was arranged to its worst case and then the antenna was tuned to heights from 1 meter to 4 meters and the table was turned from 0 degrees to 360 degrees to find the maximum reading.
5. The test-receiver system was set to Peak Detect Function and Specified Bandwidth with Maximum Hold mode.
6. If the emission level of the EUT in peak mode was 10 dB lower than the limit specified, then testing could be stopped and the peak values of the EUT would be reported. Otherwise the emissions that did not have 10 dB margin would be re-tested one by one using peak, quasi-peak or average method as specified and then reported in a data sheet.

### ***Remark:***

1. *The resolution bandwidth and video bandwidth of test receiver/spectrum analyzer is 120 KHz for Peak detection (PK) and Quasi-peak detection (QP) at frequency below 1GHz.*
2. *The resolution bandwidth and video bandwidth of test receiver/spectrum analyzer is 1 MHz for Peak detection and frequency above 1GHz.*
3. *The resolution bandwidth of test receiver/spectrum analyzer is 1 MHz and the video bandwidth is 10 Hz for Average detection (AV) at frequency above 1GHz.*

**TEST RESULTS**

**Below 1 GHz (9kHz ~ 30MHz)**

No emission found between lowest internal used/generated frequency to 30MHz.

**Below 1 GHz (30MHz ~ 1GHz)**

<b>Product Name</b>	WHITE DRIVE BOX	<b>Test By</b>	Crystal Wu
<b>Test Model</b>	TB4001	<b>Test Date</b>	2016/08/16
<b>Test Mode</b>	Mode 1	<b>Temp. &amp; Humidity</b>	28°C, 52%

**966Chamber\_C at 3Meter / Horizontal**

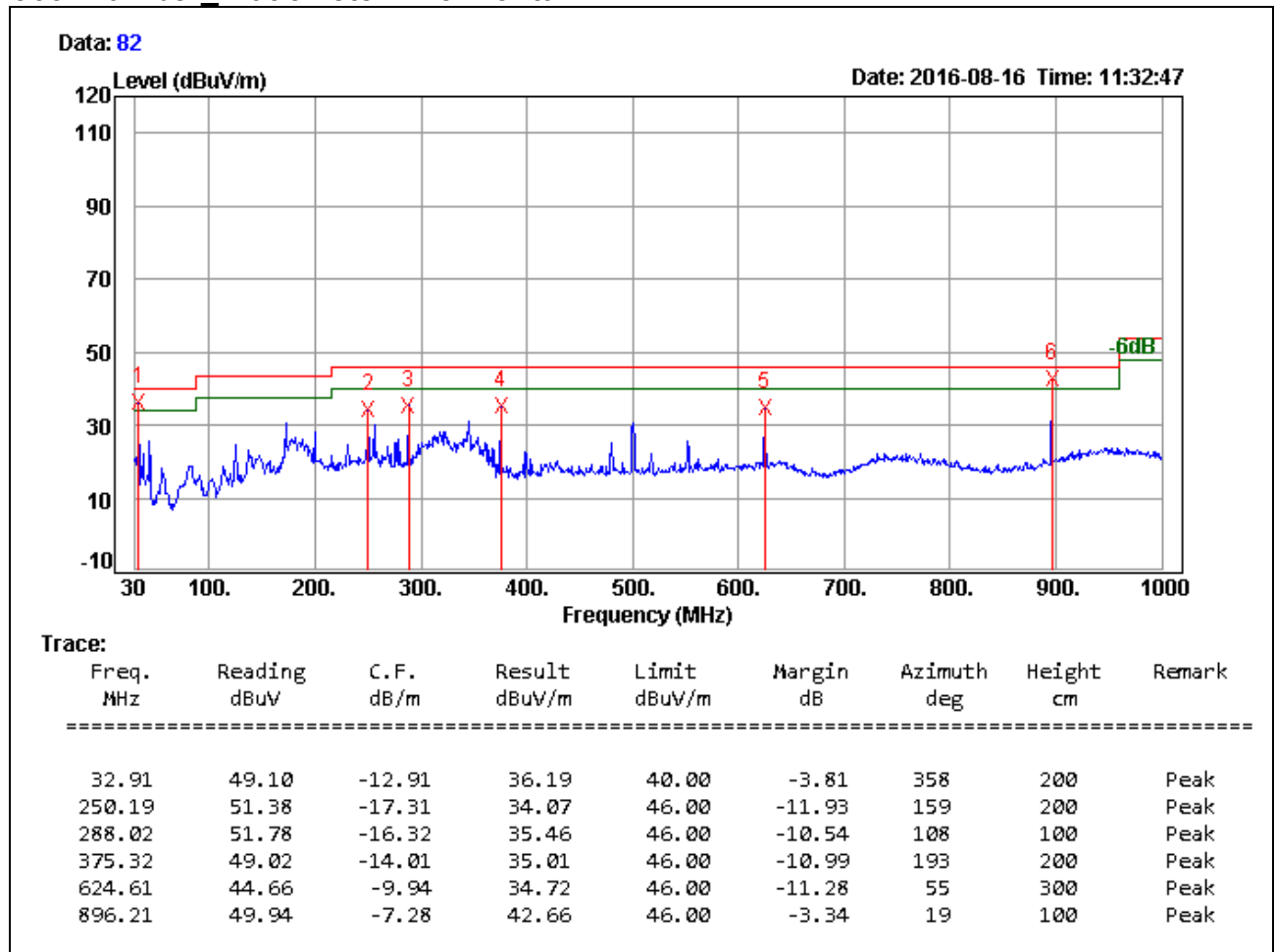

**Remark:**

1. Quasi-peak test would be performed if the peak result were greater than the quasi-peak limit.
2. Correction Factor (dB/m) = Antenna Factor (dB/m) + Cable Loss (dB) – PreAmp.Gain (dB)
3. Result (dBUV/m) = Reading (dBUV) + Correction Factor (dB/m)
4. Margin (dB) = Remark result (dBUV/m) - Quasi-peak limit (dBUV/m).

<b>Product Name</b>	WHITE DRIVE BOX	<b>Test By</b>	Crystal Wu
<b>Test Model</b>	TB4001	<b>Test Date</b>	2016/08/16
<b>Test Mode</b>	Mode 1	<b>Temp. &amp; Humidity</b>	28°C, 52%

**966Chamber\_C at 3Meter / Vertical**

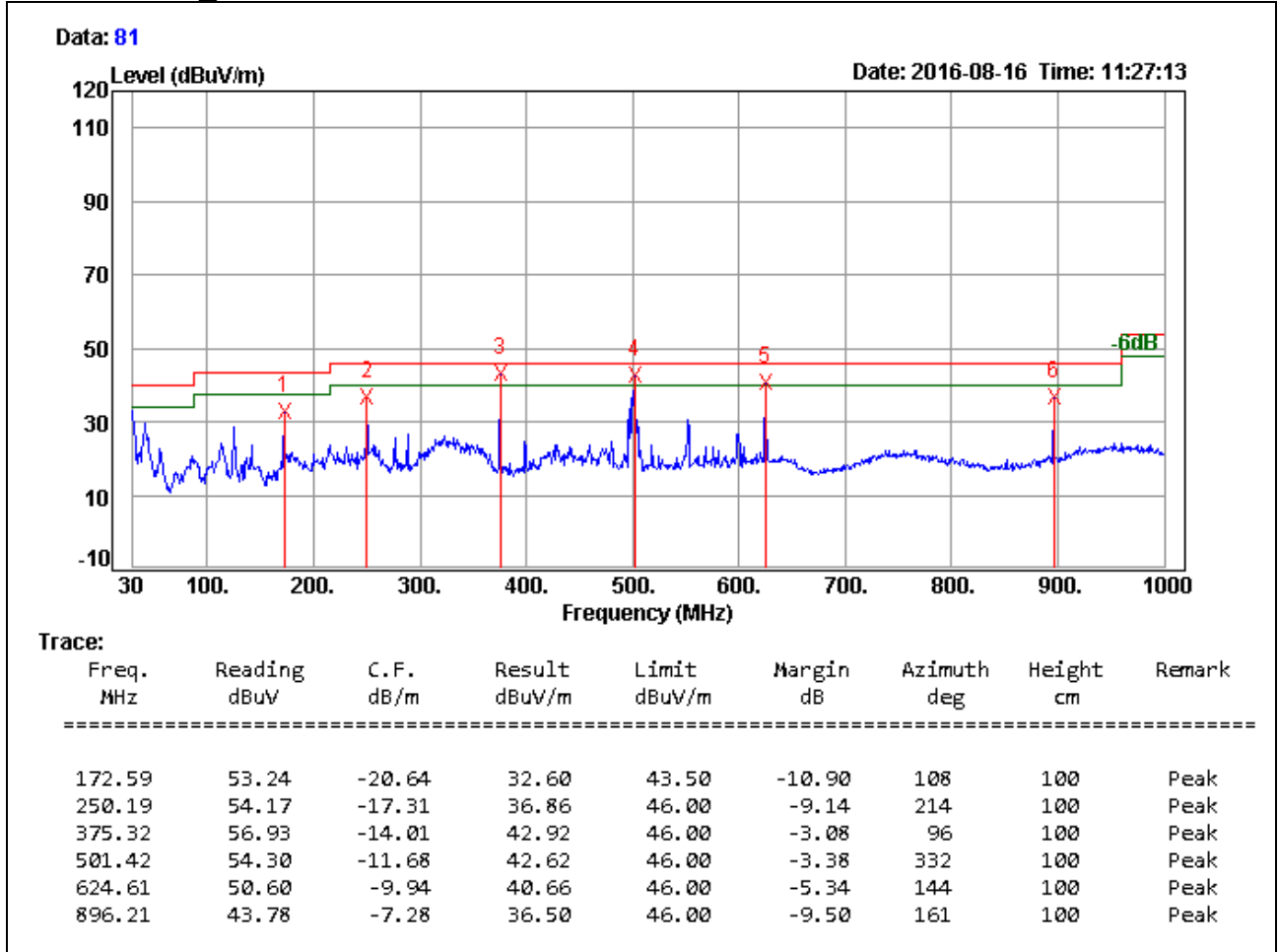

**Remark:**

1. Quasi-peak test would be performed if the peak result were greater than the quasi-peak limit.
2. Correction Factor (dB/m) = Antenna Factor (dB/m) + Cable Loss (dB) – PreAmp.Gain (dB)
3. Result (dBUV/m) = Reading (dBUV) + Correction Factor (dB/m)
4. Margin (dB) = Remark result (dBUV/m) - Quasi-peak limit (dBUV/m).

<b>Product Name</b>	WHITE DRIVE BOX	<b>Test By</b>	Crystal Wu
<b>Test Model</b>	TB4001	<b>Test Date</b>	2016/08/16
<b>Test Mode</b>	Mode 2	<b>Temp. &amp; Humidity</b>	28°C, 52%

**966Chamber\_C at 3Meter / Horizontal**

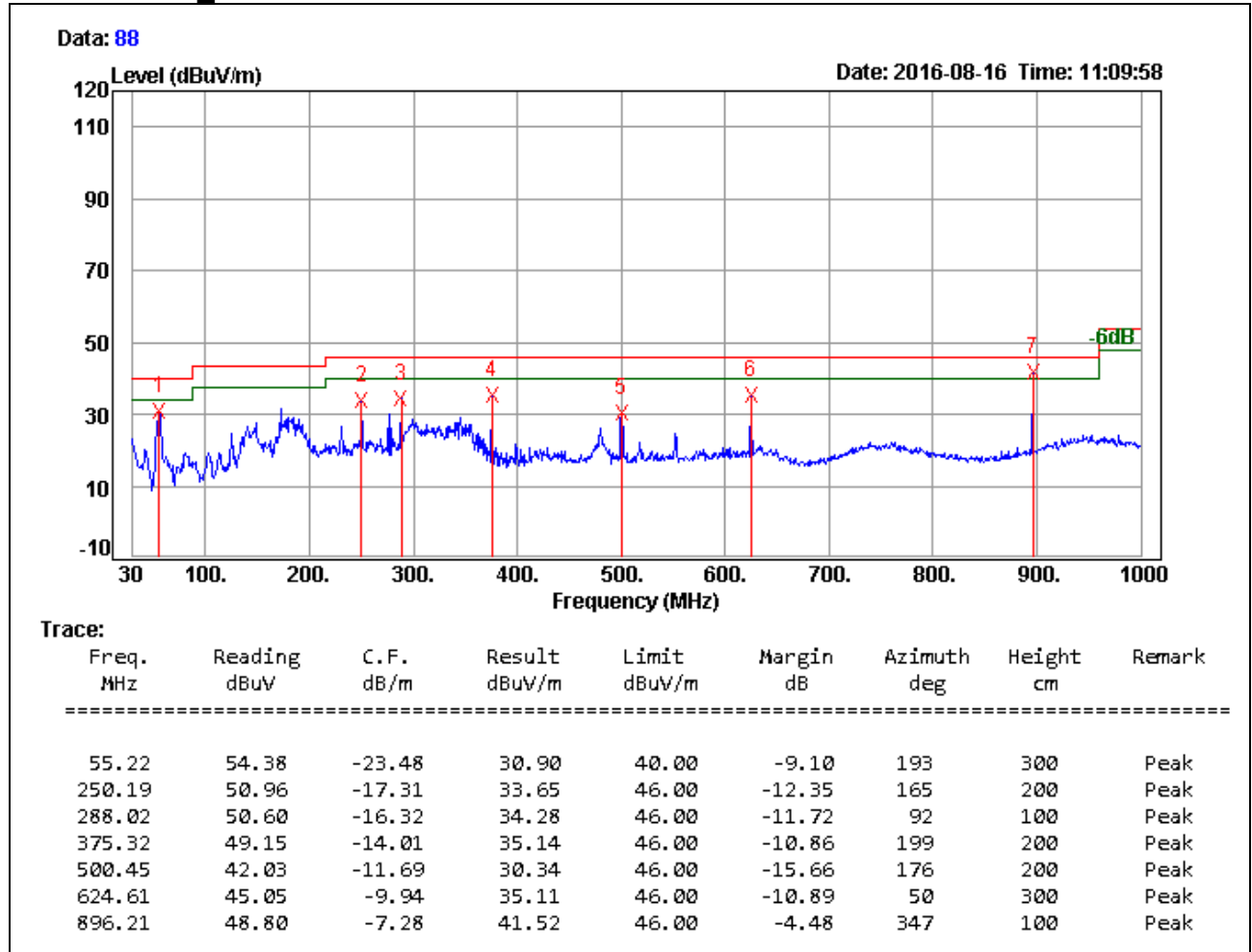

**Remark:**

1. Quasi-peak test would be performed if the peak result were greater than the quasi-peak limit.
2. Correction Factor (dB/m) = Antenna Factor (dB/m) + Cable Loss (dB) – PreAmp.Gain (dB)
3. Result (dBUV/m) = Reading (dBUV) + Correction Factor (dB/m)
4. Margin (dB) = Remark result (dBUV/m) - Quasi-peak limit (dBUV/m).

<b>Product Name</b>	WHITE DRIVE BOX	<b>Test By</b>	Crystal Wu
<b>Test Model</b>	TB4001	<b>Test Date</b>	2016/08/16
<b>Test Mode</b>	Mode 2	<b>Temp. &amp; Humidity</b>	28°C, 52%

**966Chamber\_C at 3Meter / Vertical**

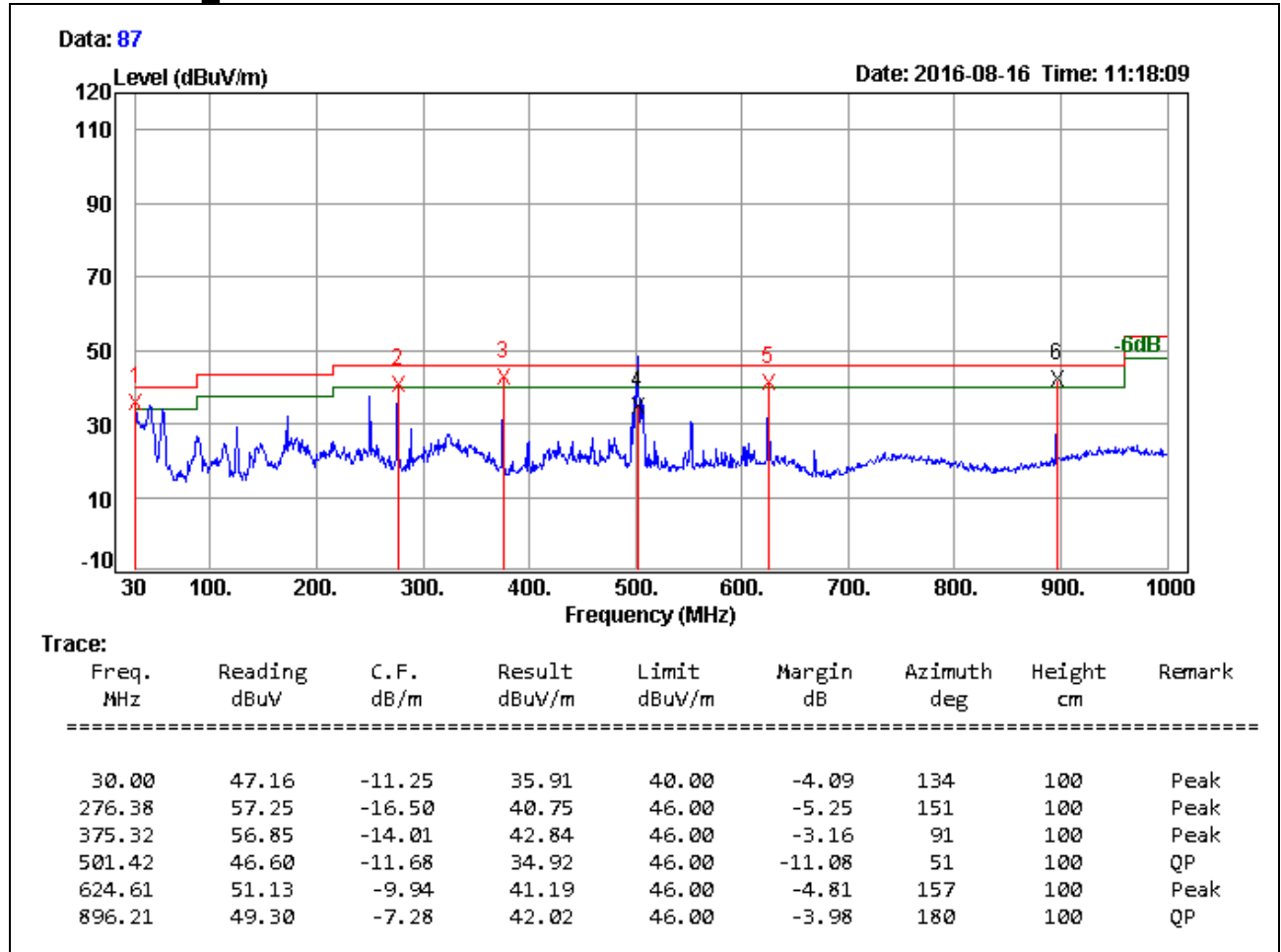

**Remark:**

1. Quasi-peak test would be performed if the peak result were greater than the quasi-peak limit.
2. Correction Factor (dB/m) = Antenna Factor (dB/m) + Cable Loss (dB) – PreAmp.Gain (dB)
3. Result (dBUV/m) = Reading (dBUV) + Correction Factor (dB/m)
4. Margin (dB) = Remark result (dBUV/m) - Quasi-peak limit (dBUV/m).

**Above 1 GHz**

<b>Product Name</b>	WHITE DRIVE BOX	<b>Test By</b>	Crystal Wu
<b>Test Model</b>	TB4001	<b>Test Date</b>	2016/08/12
<b>Test Mode</b>	IEEE 802.11b Mode / TX / CH Low / Direct Mode_External Ant	<b>Temp. &amp; Humidity</b>	28°C, 52%

**966Chamber\_C at 3Meter / Horizontal (1GHz ~ 3GHz)**

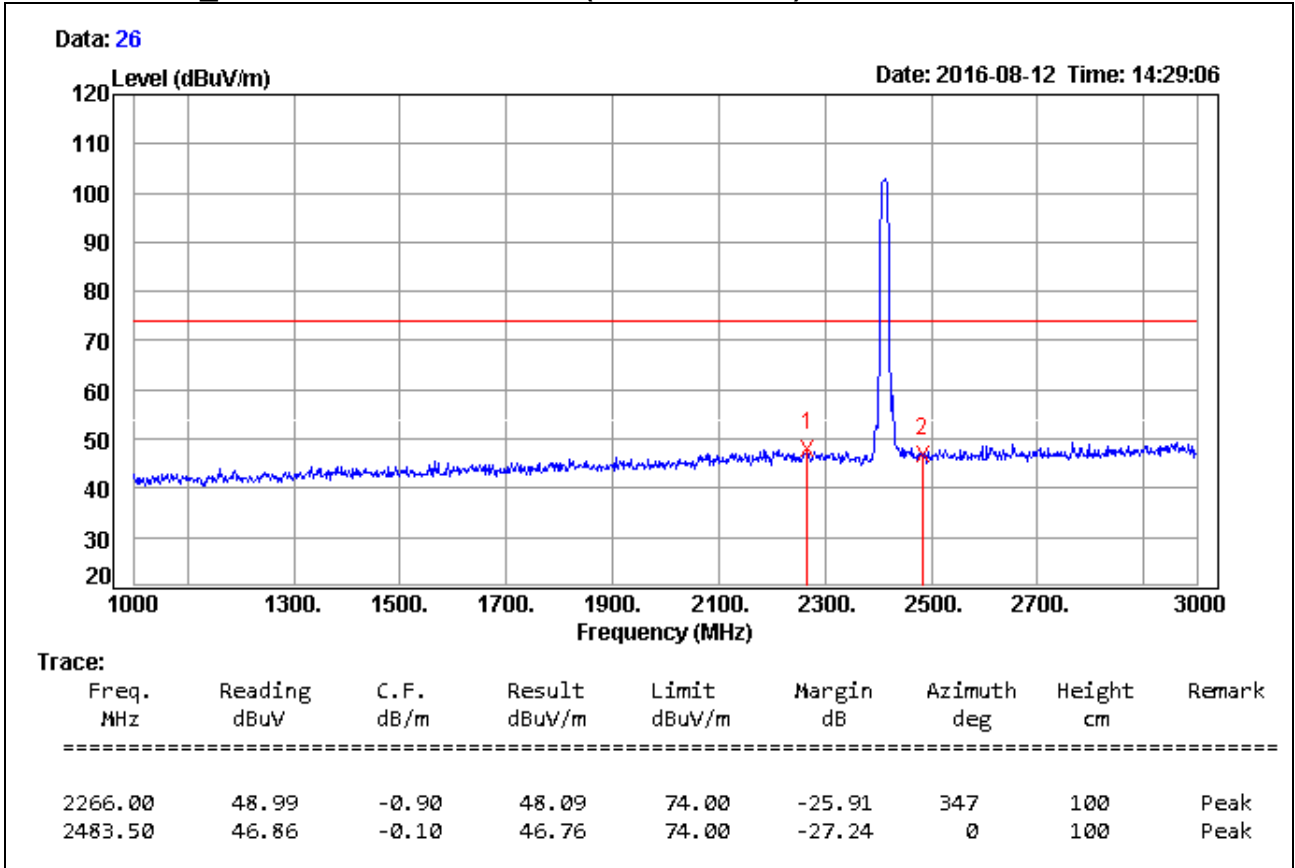

**Remark:**

1. Measuring frequencies from 1 GHz to the 10th harmonic of highest fundamental frequency.
2. Average test would be performed if the peak result were greater than the average limit.
3. Measurements above show only up to 6 maximum emissions noted, or would be lesser, with " N/A " remark, if no specific emissions from the EUT are recorded (ie: margin>20dB from the applicable limit) and considered that's already beyond the background noise floor.
4. Result = Reading + Correction Factor  
 Margin = Result – Limit  
 Remark Peak = Result(PK) – Limit(PK)  
 Remark AVG = Result(AV) – Limit(AV)

<b>Product Name</b>	WHITE DRIVE BOX	<b>Test By</b>	Crystal Wu
<b>Test Model</b>	TB4001	<b>Test Date</b>	2016/08/12
<b>Test Mode</b>	IEEE 802.11b Mode / TX / CH Low / Direct Mode_External Ant	<b>Temp. &amp; Humidity</b>	28°C, 52%

**966Chamber\_C at 3Meter / Vertical (1GHz ~ 3GHz)**

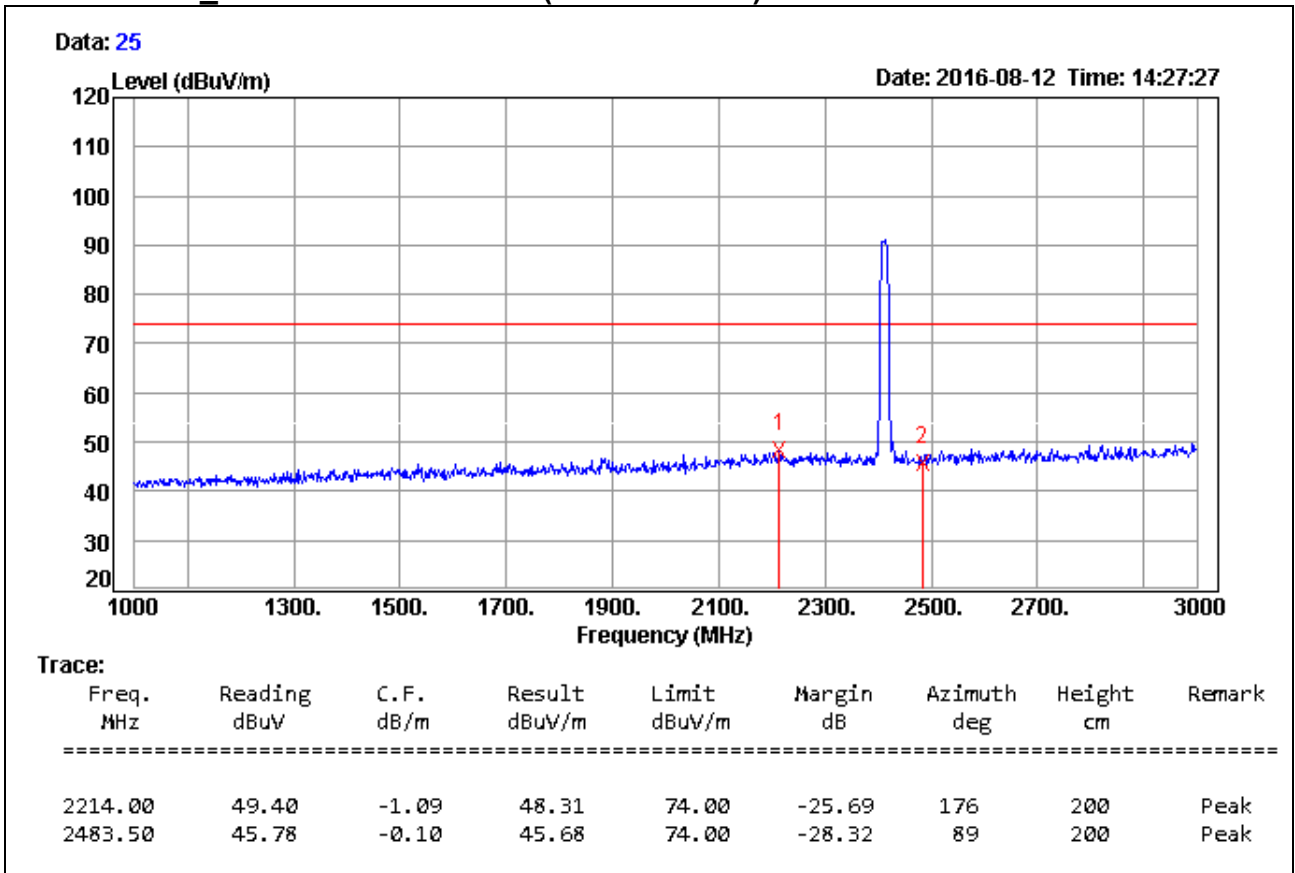

**Remark:**

1. Measuring frequencies from 1 GHz to the 10th harmonic of highest fundamental frequency.
2. Average test would be performed if the peak result were greater than the average limit.
3. Measurements above show only up to 6 maximum emissions noted, or would be lesser, with " N/A " remark, if no specific emissions from the EUT are recorded (ie: margin>20dB from the applicable limit) and considered that's already beyond the background noise floor.
4. Result = Reading + Correction Factor  
 Margin = Result – Limit  
 Remark Peak = Result(PK) – Limit(PK)  
 Remark AVG = Result(AV) – Limit(AV)

<b>Product Name</b>	WHITE DRIVE BOX	<b>Test By</b>	Crystal Wu
<b>Test Model</b>	TB4001	<b>Test Date</b>	2016/08/12
<b>Test Mode</b>	IEEE 802.11b Mode / TX / CH Low / Direct Mode_External Ant	<b>Temp. &amp; Humidity</b>	28°C, 52%

**966Chamber\_C at 3Meter / Horizontal (3GHz ~ 6GHz)**

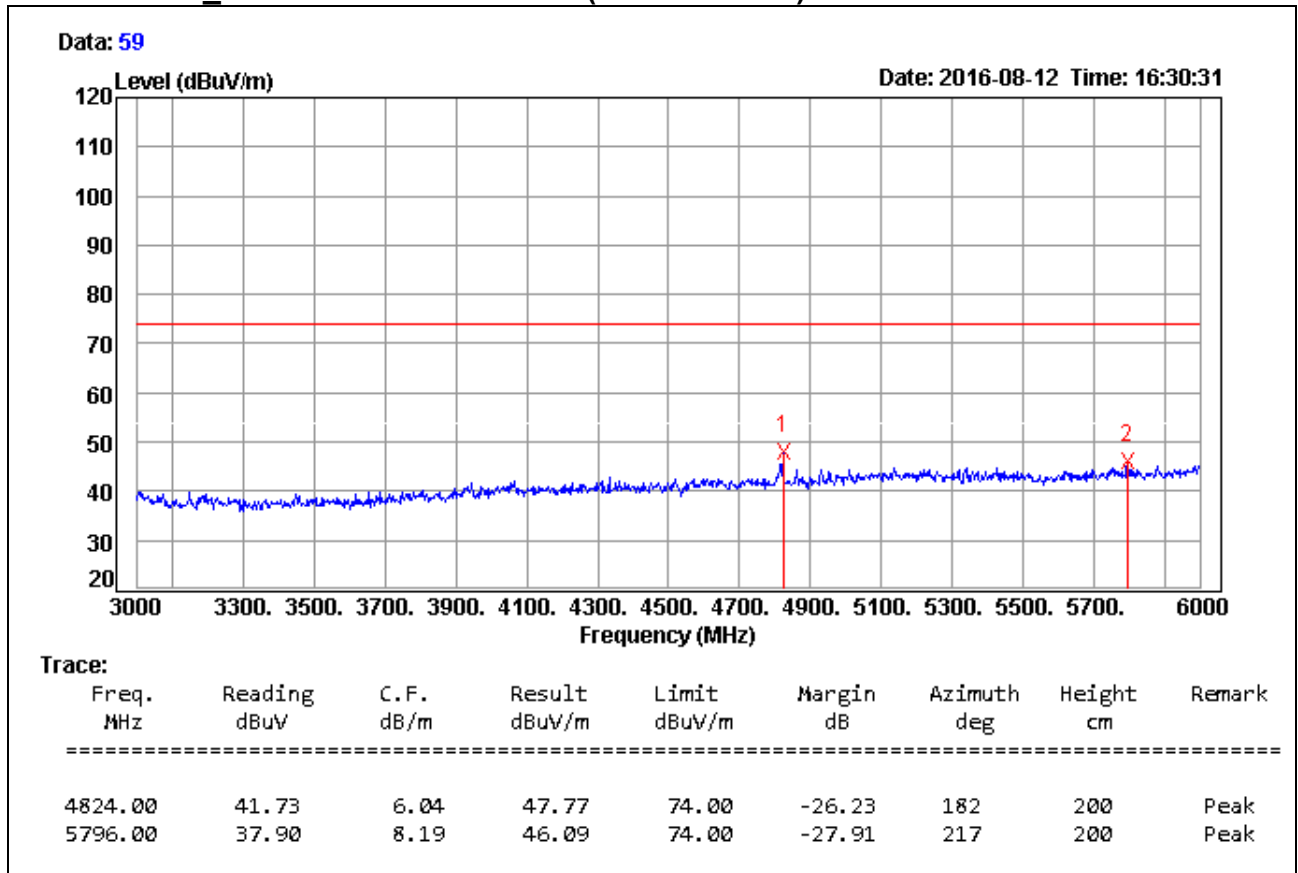

**Remark:**

1. Measuring frequencies from 1 GHz to the 10th harmonic of highest fundamental frequency.
2. Average test would be performed if the peak result were greater than the average limit.
3. Measurements above show only up to 6 maximum emissions noted, or would be lesser, with " N/A " remark, if no specific emissions from the EUT are recorded (ie: margin>20dB from the applicable limit) and considered that's already beyond the background noise floor.
4. Result = Reading + Correction Factor  
 Margin = Result – Limit  
 Remark Peak = Result(PK) – Limit(PK)  
 Remark AVG = Result(AV) – Limit(AV)



<b>Product Name</b>	WHITE DRIVE BOX	<b>Test By</b>	Crystal Wu
<b>Test Model</b>	TB4001	<b>Test Date</b>	2016/08/12
<b>Test Mode</b>	IEEE 802.11b Mode / TX / CH Low / Direct Mode_External Ant	<b>Temp. &amp; Humidity</b>	28°C, 52%

**966Chamber\_C at 3Meter / Vertical (3GHz ~ 6GHz)**

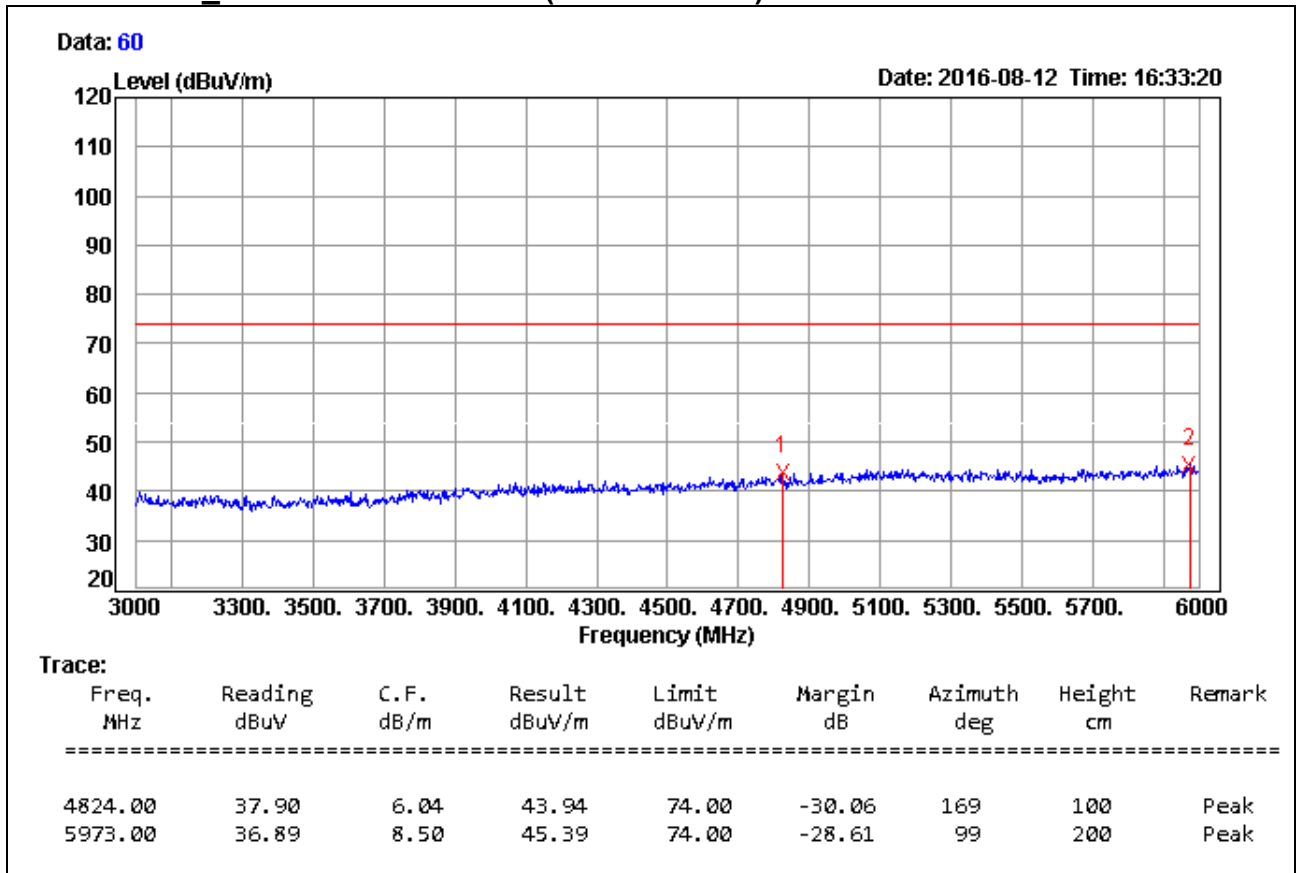

**Remark:**

1. Measuring frequencies from 1 GHz to the 10th harmonic of highest fundamental frequency.
2. Average test would be performed if the peak result were greater than the average limit.
3. Measurements above show only up to 6 maximum emissions noted, or would be lesser, with " N/A " remark, if no specific emissions from the EUT are recorded (ie: margin>20dB from the applicable limit) and considered that's already beyond the background noise floor.
4. Result = Reading + Correction Factor  
 Margin = Result – Limit  
 Remark Peak = Result(PK) – Limit(PK)  
 Remark AVG = Result(AV) – Limit(AV)

<b>Product Name</b>	WHITE DRIVE BOX	<b>Test By</b>	Crystal Wu
<b>Test Model</b>	TB4001	<b>Test Date</b>	2016/08/12
<b>Test Mode</b>	IEEE 802.11b Mode / TX / CH Low / Direct Mode_External Ant	<b>Temp. &amp; Humidity</b>	28°C, 52%

**966Chamber\_C at 3Meter / Horizontal (6GHz ~ 18GHz)**

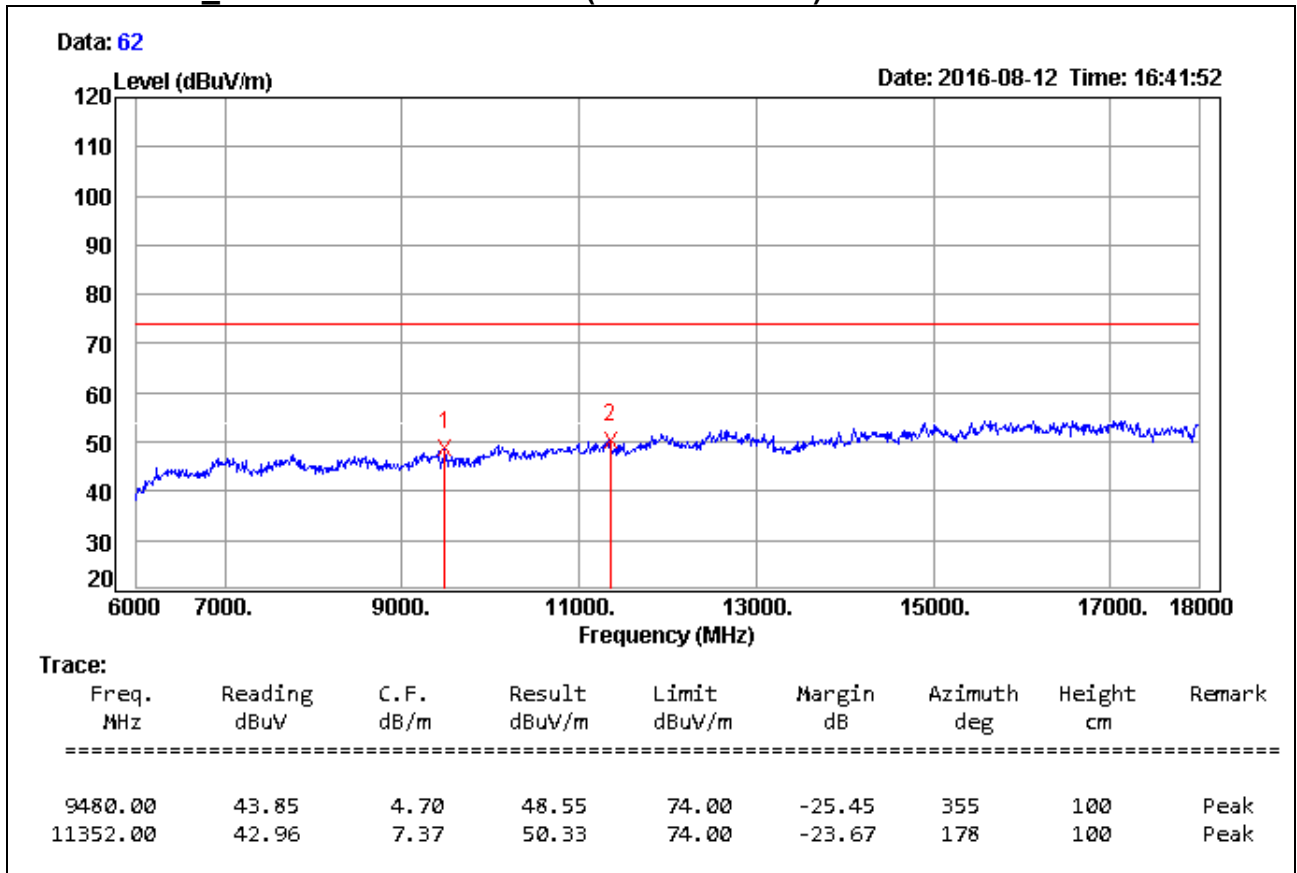

**Remark:**

1. Measuring frequencies from 1 GHz to the 10th harmonic of highest fundamental frequency.
2. Average test would be performed if the peak result were greater than the average limit.
3. Measurements above show only up to 6 maximum emissions noted, or would be lesser, with " N/A " remark, if no specific emissions from the EUT are recorded (ie: margin>20dB from the applicable limit) and considered that's already beyond the background noise floor.
4. Result = Reading + Correction Factor  
 Margin = Result - Limit  
 Remark Peak = Result(PK) - Limit(PK)  
 Remark AVG = Result(AV) - Limit(AV)

<b>Product Name</b>	WHITE DRIVE BOX	<b>Test By</b>	Crystal Wu
<b>Test Model</b>	TB4001	<b>Test Date</b>	2016/08/12
<b>Test Mode</b>	IEEE 802.11b Mode / TX / CH Low / Direct Mode_External Ant	<b>Temp. &amp; Humidity</b>	28°C, 52%

**966Chamber\_C at 3Meter / Vertical (6GHz ~ 18GHz)**

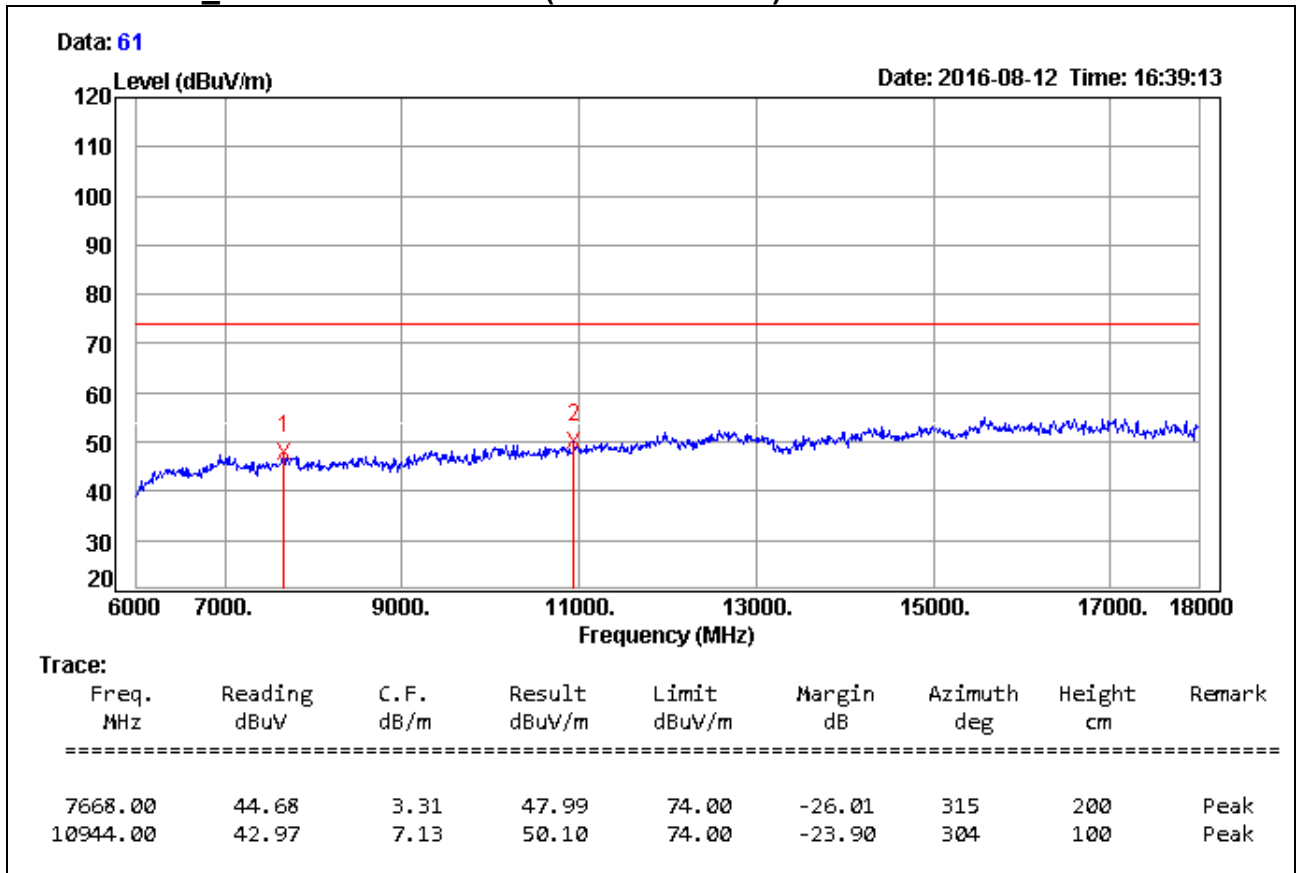

**Remark:**

1. Measuring frequencies from 1 GHz to the 10th harmonic of highest fundamental frequency.
2. Average test would be performed if the peak result were greater than the average limit.
3. Measurements above show only up to 6 maximum emissions noted, or would be lesser, with " N/A " remark, if no specific emissions from the EUT are recorded (ie: margin>20dB from the applicable limit) and considered that's already beyond the background noise floor.
4. Result = Reading + Correction Factor  
 Margin = Result – Limit  
 Remark Peak = Result(PK) – Limit(PK)  
 Remark AVG = Result(AV) – Limit(AV)

<b>Product Name</b>	WHITE DRIVE BOX	<b>Test By</b>	Crystal Wu
<b>Test Model</b>	TB4001	<b>Test Date</b>	2016/08/16
<b>Test Mode</b>	IEEE 802.11b Mode / TX / CH Low / Direct Mode_External Ant	<b>Temp. &amp; Humidity</b>	28°C, 52%

**966Chamber\_C at 3Meter / Horizontal (18GHz ~ 26GHz)**

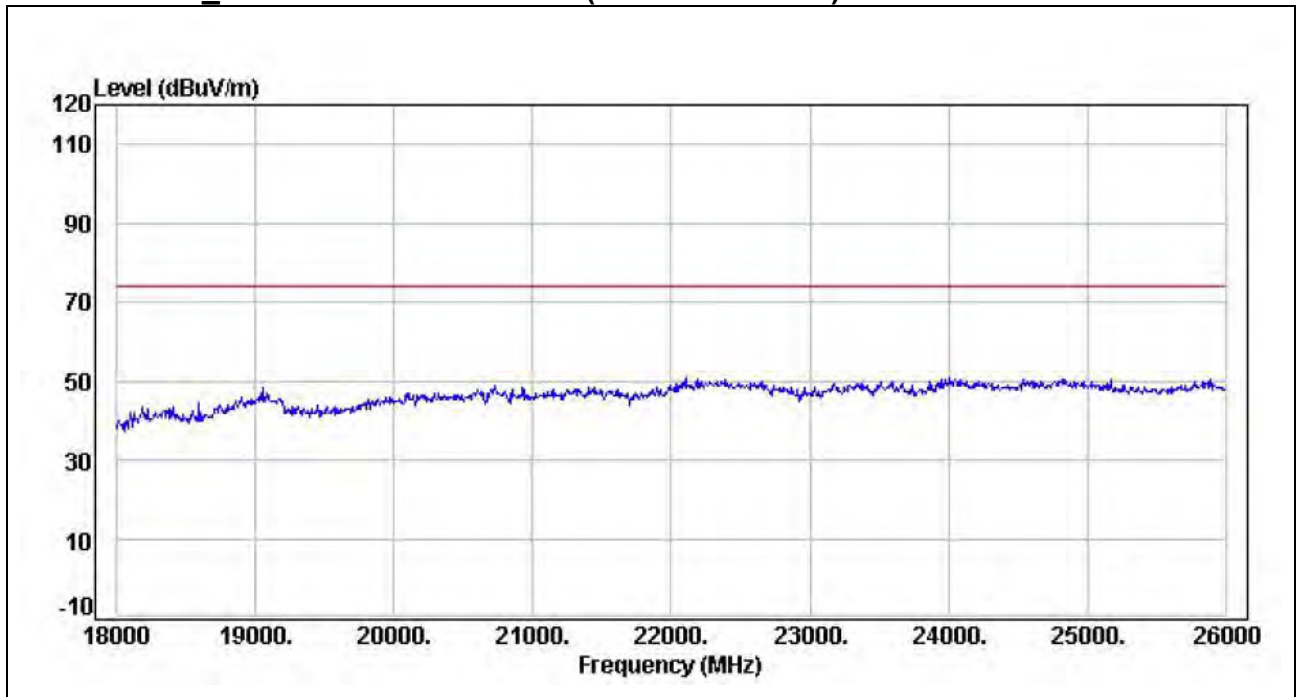

**Remark:**

1. Measuring frequencies from 1 GHz to the 10th harmonic of highest fundamental frequency.
2. Average test would be performed if the peak result were greater than the average limit.
3. Measurements above show only up to 6 maximum emissions noted, or would be lesser, with " N/A " remark, if no specific emissions from the EUT are recorded (ie: margin>20dB from the applicable limit) and considered that's already beyond the background noise floor.
4. Result = Reading + Correction Factor  
 Margin = Result – Limit  
 Remark Peak = Result(PK) – Limit(PK)  
 Remark AVG = Result(AV) – Limit(AV)

<b>Product Name</b>	WHITE DRIVE BOX	<b>Test By</b>	Crystal Wu
<b>Test Model</b>	TB4001	<b>Test Date</b>	2016/08/16
<b>Test Mode</b>	IEEE 802.11b Mode / TX / CH Low / Direct Mode_External Ant	<b>Temp. &amp; Humidity</b>	28°C, 52%

**966Chamber\_C at 3Meter / Vertical (18GHz ~ 26GHz)**

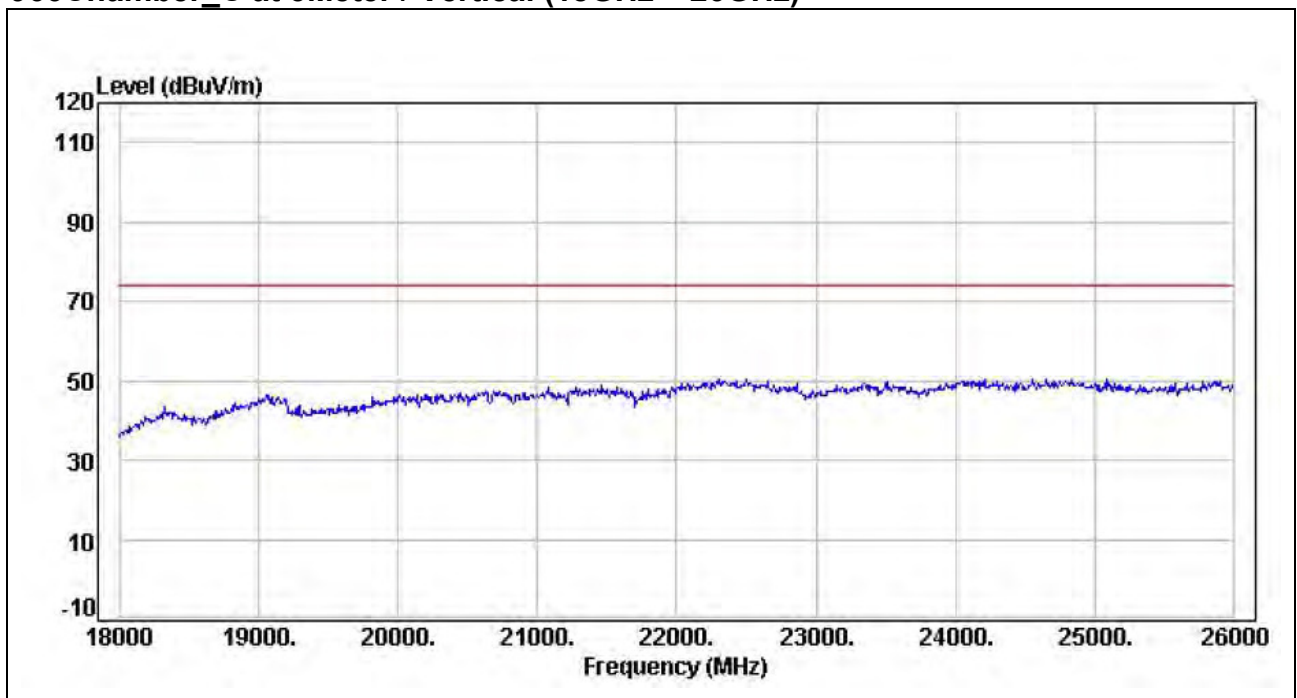

**Remark:**

1. Measuring frequencies from 1 GHz to the 10th harmonic of highest fundamental frequency.
2. Average test would be performed if the peak result were greater than the average limit.
3. Measurements above show only up to 6 maximum emissions noted, or would be lesser, with " N/A " remark, if no specific emissions from the EUT are recorded (ie: margin>20dB from the applicable limit) and considered that's already beyond the background noise floor.
4. Result = Reading + Correction Factor  
 Margin = Result – Limit  
 Remark Peak = Result(PK) – Limit(PK)  
 Remark AVG = Result(AV) – Limit(AV)

<b>Product Name</b>	WHITE DRIVE BOX	<b>Test By</b>	Crystal Wu
<b>Test Model</b>	TB4001	<b>Test Date</b>	2016/08/12
<b>Test Mode</b>	IEEE 802.11b Mode / TX / CH Middle / Direct Mode_External Ant	<b>Temp. &amp; Humidity</b>	28°C, 52%

**966Chamber\_C at 3Meter / Horizontal (1GHz ~ 3GHz)**

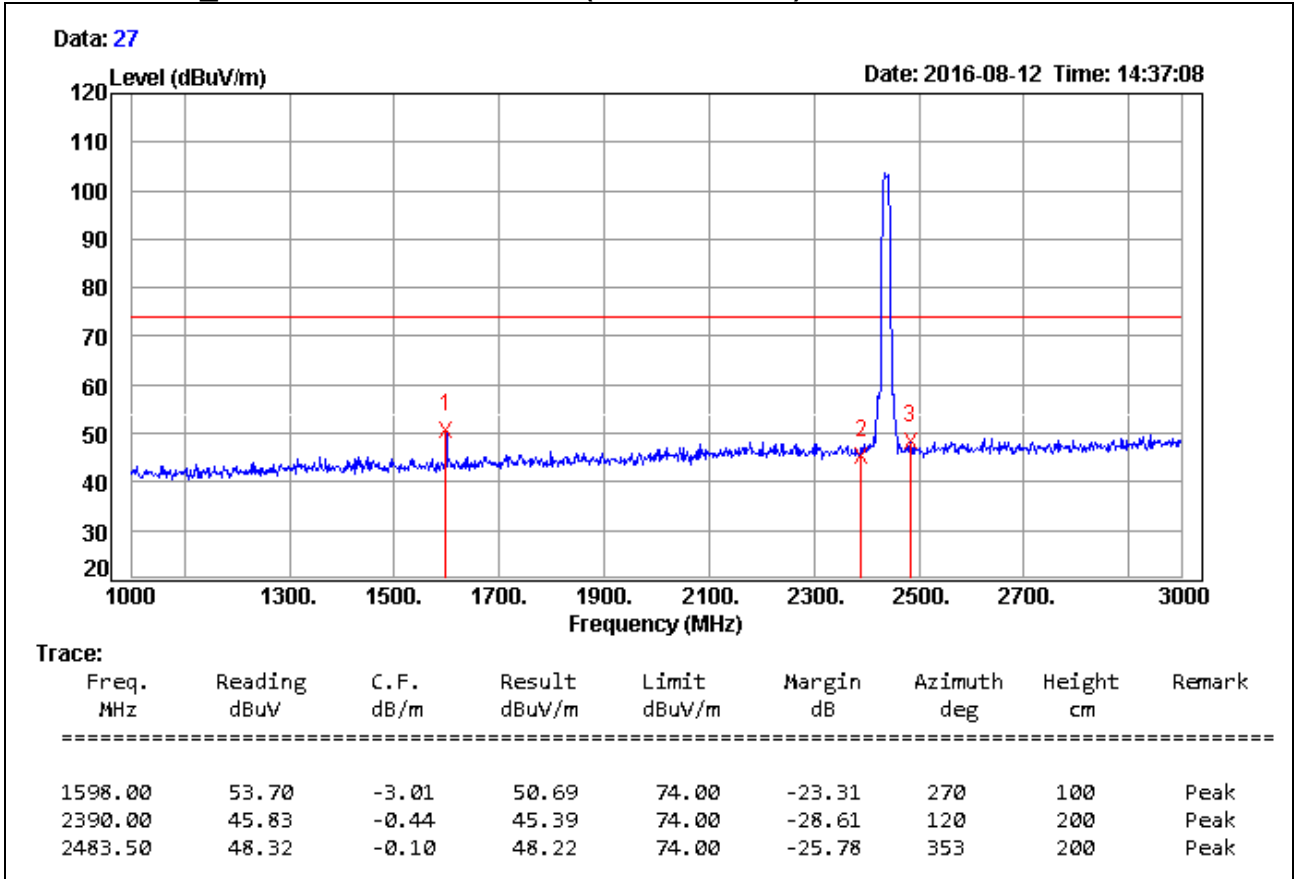

**Remark:**

1. Measuring frequencies from 1 GHz to the 10th harmonic of highest fundamental frequency.
2. Average test would be performed if the peak result were greater than the average limit.
3. Measurements above show only up to 6 maximum emissions noted, or would be lesser, with " N/A " remark, if no specific emissions from the EUT are recorded (ie: margin>20dB from the applicable limit) and considered that's already beyond the background noise floor.
4. Result = Reading + Correction Factor  
 Margin = Result - Limit  
 Remark Peak = Result(PK) - Limit(PK)  
 Remark AVG = Result(AV) - Limit(AV)

<b>Product Name</b>	WHITE DRIVE BOX	<b>Test By</b>	Crystal Wu
<b>Test Model</b>	TB4001	<b>Test Date</b>	2016/08/12
<b>Test Mode</b>	IEEE 802.11b Mode / TX / CH Middle / Direct Mode_External Ant	<b>Temp. &amp; Humidity</b>	28°C, 52%

**966Chamber\_C at 3Meter / Vertical (1GHz ~ 3GHz)**

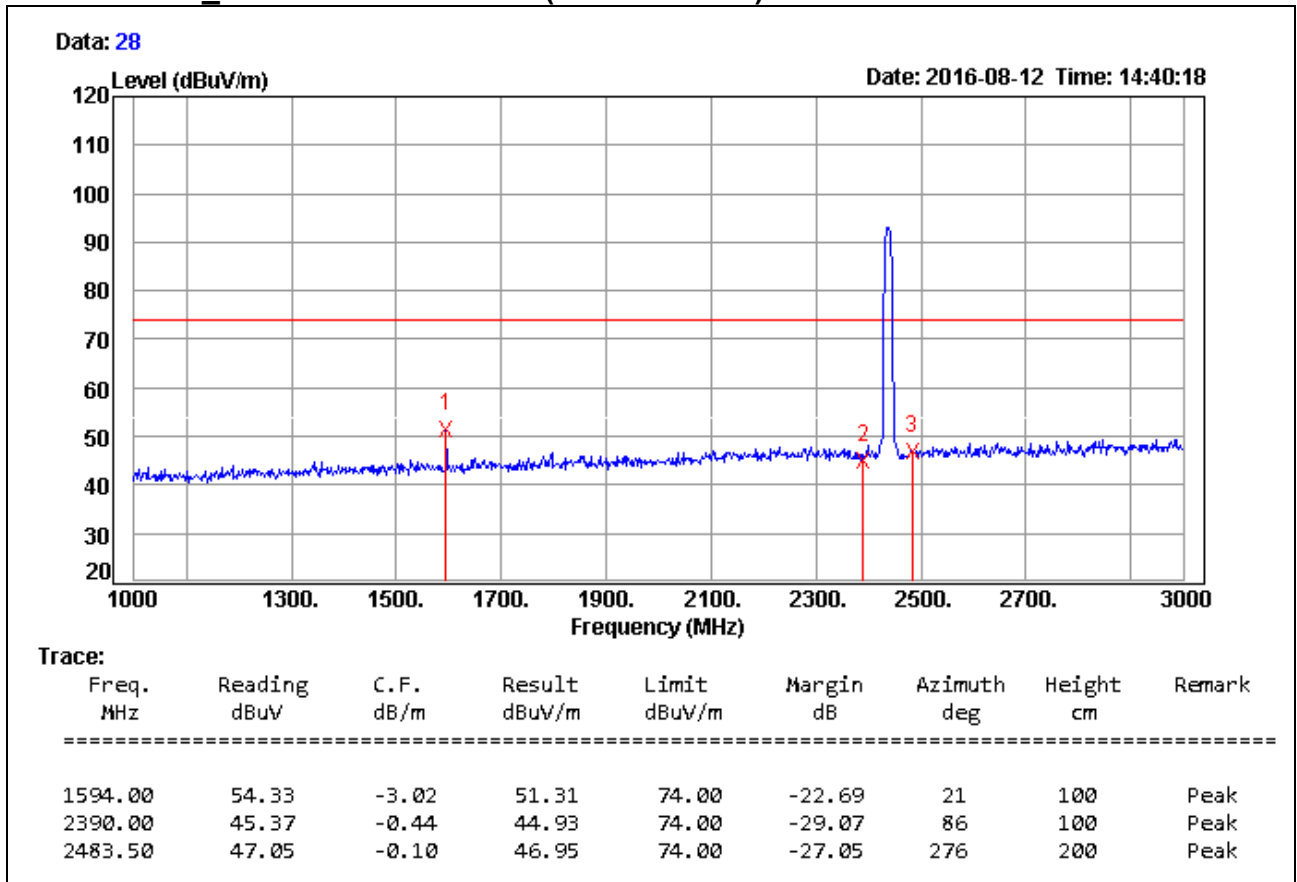

**Remark:**

1. Measuring frequencies from 1 GHz to the 10th harmonic of highest fundamental frequency.
2. Average test would be performed if the peak result were greater than the average limit.
3. Measurements above show only up to 6 maximum emissions noted, or would be lesser, with " N/A " remark, if no specific emissions from the EUT are recorded (ie: margin>20dB from the applicable limit) and considered that's already beyond the background noise floor.
4. Result = Reading + Correction Factor  
 Margin = Result - Limit  
 Remark Peak = Result(PK) - Limit(PK)  
 Remark AVG = Result(AV) - Limit(AV)

<b>Product Name</b>	WHITE DRIVE BOX	<b>Test By</b>	Crystal Wu
<b>Test Model</b>	TB4001	<b>Test Date</b>	2016/08/12
<b>Test Mode</b>	IEEE 802.11b Mode / TX / CH Middle / Direct Mode_External Ant	<b>Temp. &amp; Humidity</b>	28°C, 52%

**966Chamber\_C at 3Meter / Horizontal (3GHz ~ 6GHz)**

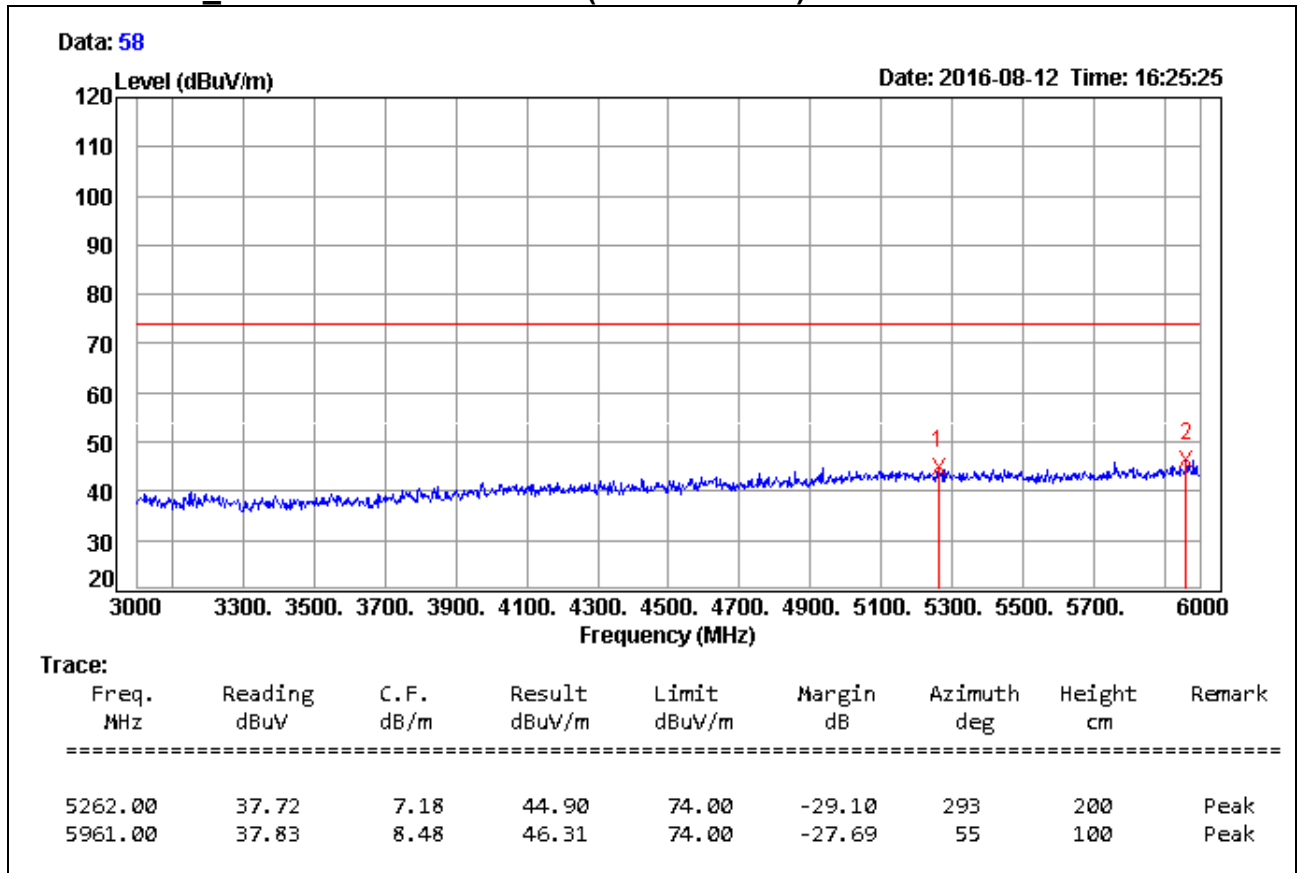

**Remark:**

1. Measuring frequencies from 1 GHz to the 10th harmonic of highest fundamental frequency.
2. Average test would be performed if the peak result were greater than the average limit.
3. Measurements above show only up to 6 maximum emissions noted, or would be lesser, with " N/A " remark, if no specific emissions from the EUT are recorded (ie: margin>20dB from the applicable limit) and considered that's already beyond the background noise floor.
4. Result = Reading + Correction Factor  
 Margin = Result – Limit  
 Remark Peak = Result(PK) – Limit(PK)  
 Remark AVG = Result(AV) – Limit(AV)



<b>Product Name</b>	WHITE DRIVE BOX	<b>Test By</b>	Crystal Wu
<b>Test Model</b>	TB4001	<b>Test Date</b>	2016/08/12
<b>Test Mode</b>	IEEE 802.11b Mode / TX / CH Middle / Direct Mode_External Ant	<b>Temp. &amp; Humidity</b>	28°C, 52%

**966Chamber\_C at 3Meter / Vertical (3GHz ~ 6GHz)**

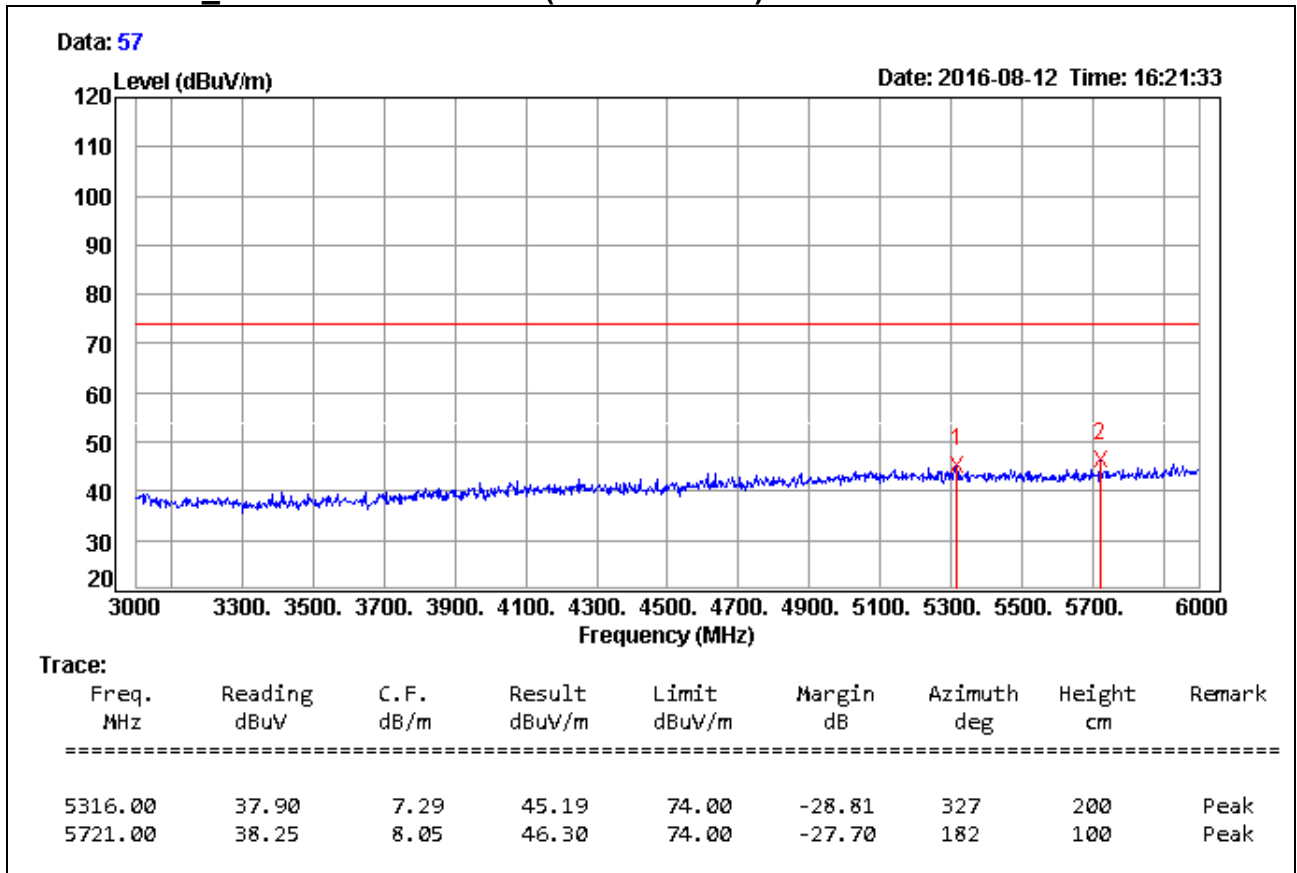

**Remark:**

1. Measuring frequencies from 1 GHz to the 10th harmonic of highest fundamental frequency.
2. Average test would be performed if the peak result were greater than the average limit.
3. Measurements above show only up to 6 maximum emissions noted, or would be lesser, with " N/A " remark, if no specific emissions from the EUT are recorded (ie: margin>20dB from the applicable limit) and considered that's already beyond the background noise floor.
4. Result = Reading + Correction Factor  
 Margin = Result – Limit  
 Remark Peak = Result(PK) – Limit(PK)  
 Remark AVG = Result(AV) – Limit(AV)

<b>Product Name</b>	WHITE DRIVE BOX	<b>Test By</b>	Crystal Wu
<b>Test Model</b>	TB4001	<b>Test Date</b>	2016/08/12
<b>Test Mode</b>	IEEE 802.11b Mode / TX / CH Middle / Direct Mode_External Ant	<b>Temp. &amp; Humidity</b>	28°C, 52%

**966Chamber\_C at 3Meter / Horizontal (6GHz ~ 18GHz)**

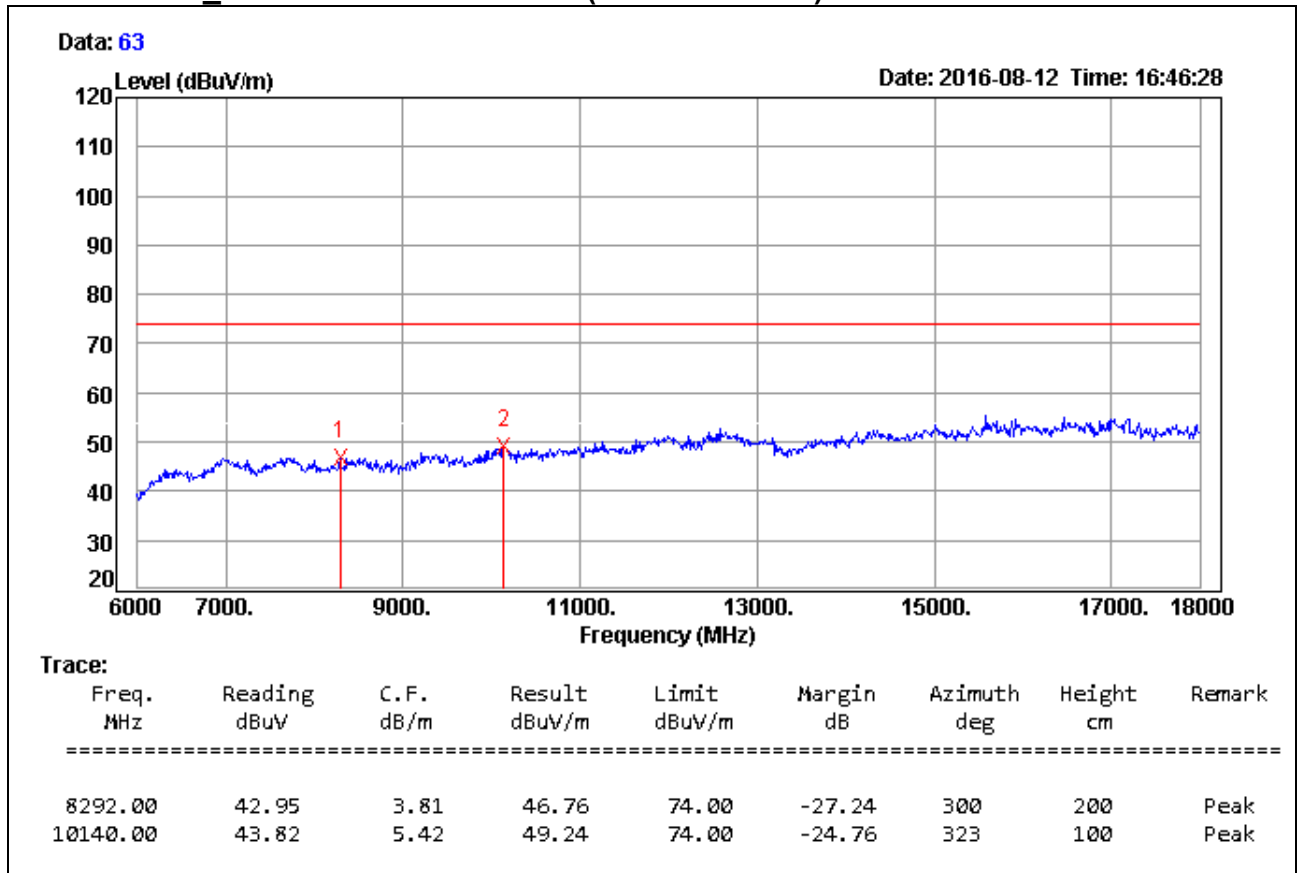

**Remark:**

1. Measuring frequencies from 1 GHz to the 10th harmonic of highest fundamental frequency.
2. Average test would be performed if the peak result were greater than the average limit.
3. Measurements above show only up to 6 maximum emissions noted, or would be lesser, with " N/A " remark, if no specific emissions from the EUT are recorded (ie: margin>20dB from the applicable limit) and considered that's already beyond the background noise floor.
4. Result = Reading + Correction Factor  
 Margin = Result - Limit  
 Remark Peak = Result(PK) - Limit(PK)  
 Remark AVG = Result(AV) - Limit(AV)

<b>Product Name</b>	WHITE DRIVE BOX	<b>Test By</b>	Crystal Wu
<b>Test Model</b>	TB4001	<b>Test Date</b>	2016/08/12
<b>Test Mode</b>	IEEE 802.11b Mode / TX / CH Middle / Direct Mode_External Ant	<b>Temp. &amp; Humidity</b>	28°C, 52%

**966Chamber\_C at 3Meter / Vertical (6GHz ~ 18GHz)**

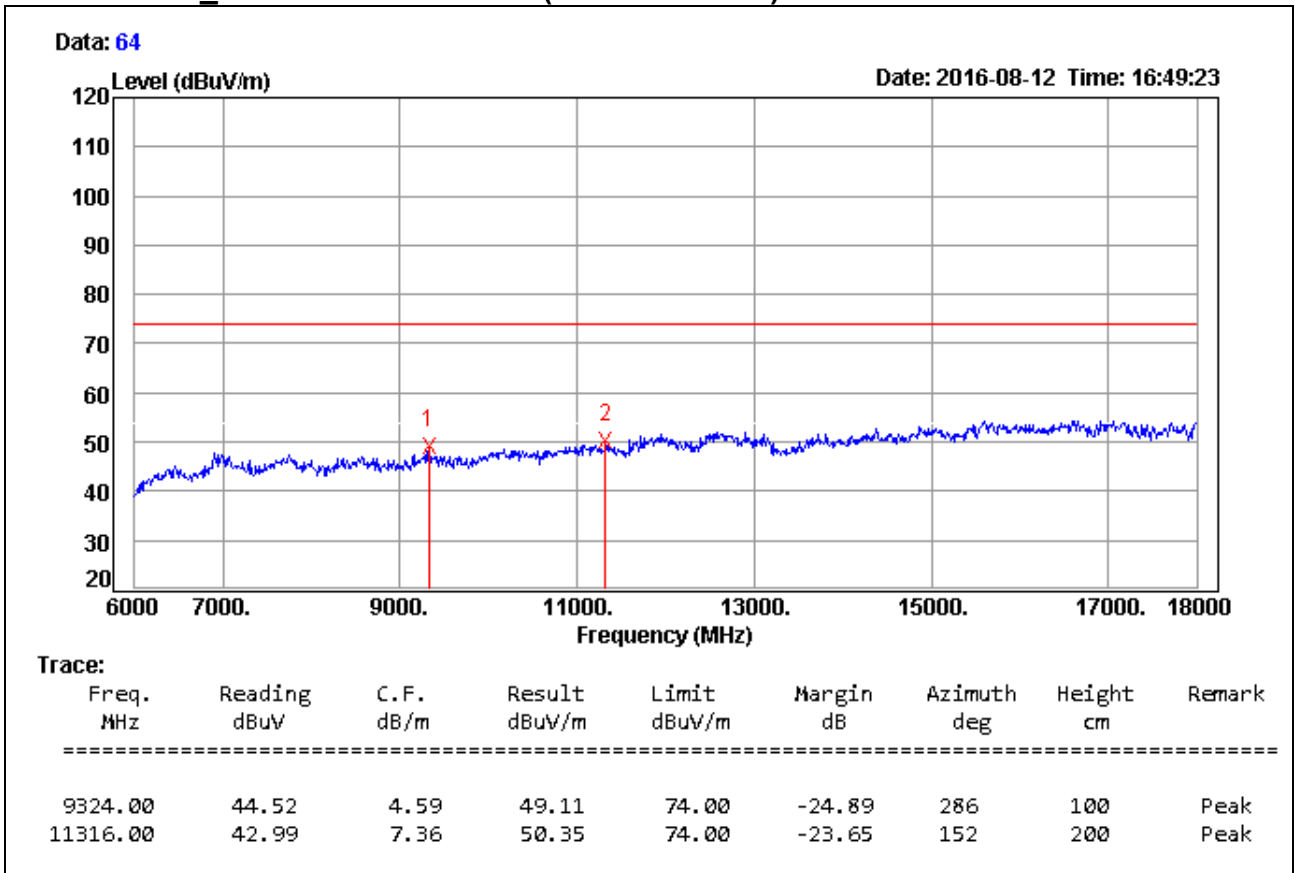

**Remark:**

1. Measuring frequencies from 1 GHz to the 10th harmonic of highest fundamental frequency.
2. Average test would be performed if the peak result were greater than the average limit.
3. Measurements above show only up to 6 maximum emissions noted, or would be lesser, with " N/A " remark, if no specific emissions from the EUT are recorded (ie: margin>20dB from the applicable limit) and considered that's already beyond the background noise floor.
4. Result = Reading + Correction Factor  
 Margin = Result – Limit  
 Remark Peak = Result(PK) – Limit(PK)  
 Remark AVG = Result(AV) – Limit(AV)

<b>Product Name</b>	WHITE DRIVE BOX	<b>Test By</b>	Crystal Wu
<b>Test Model</b>	TB4001	<b>Test Date</b>	2016/08/16
<b>Test Mode</b>	IEEE 802.11b Mode / TX / CH Middle / Direct Mode_External Ant	<b>Temp. &amp; Humidity</b>	28°C, 52%

**966Chamber\_C at 3Meter / Horizontal (18GHz ~ 26GHz)**

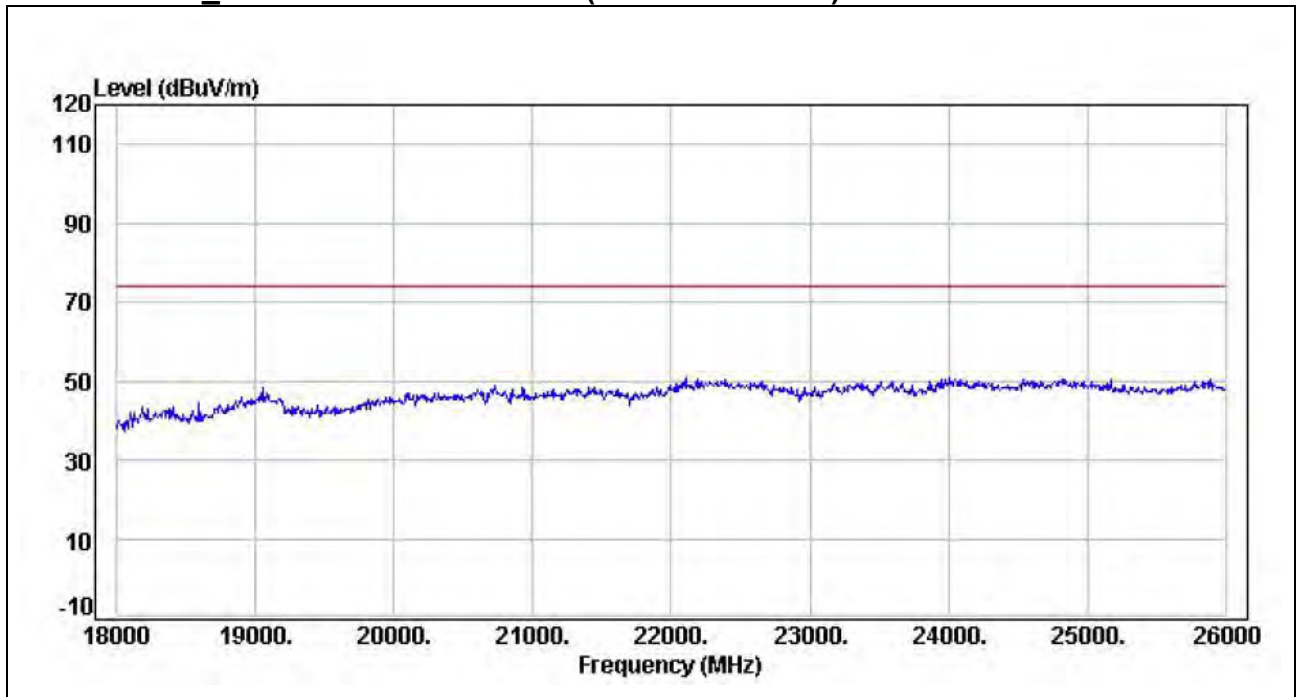

**Remark:**

1. Measuring frequencies from 1 GHz to the 10th harmonic of highest fundamental frequency.
2. Average test would be performed if the peak result were greater than the average limit.
3. Measurements above show only up to 6 maximum emissions noted, or would be lesser, with " N/A " remark, if no specific emissions from the EUT are recorded (ie: margin>20dB from the applicable limit) and considered that's already beyond the background noise floor.
4. Result = Reading + Correction Factor  
 Margin = Result – Limit  
 Remark Peak = Result(PK) – Limit(PK)  
 Remark AVG = Result(AV) – Limit(AV)

<b>Product Name</b>	WHITE DRIVE BOX	<b>Test By</b>	Crystal Wu
<b>Test Model</b>	TB4001	<b>Test Date</b>	2016/08/16
<b>Test Mode</b>	IEEE 802.11b Mode / TX / CH Middle / Direct Mode_External Ant	<b>Temp. &amp; Humidity</b>	28°C, 52%

**966Chamber\_C at 3Meter / Vertical (18GHz ~ 26GHz)**

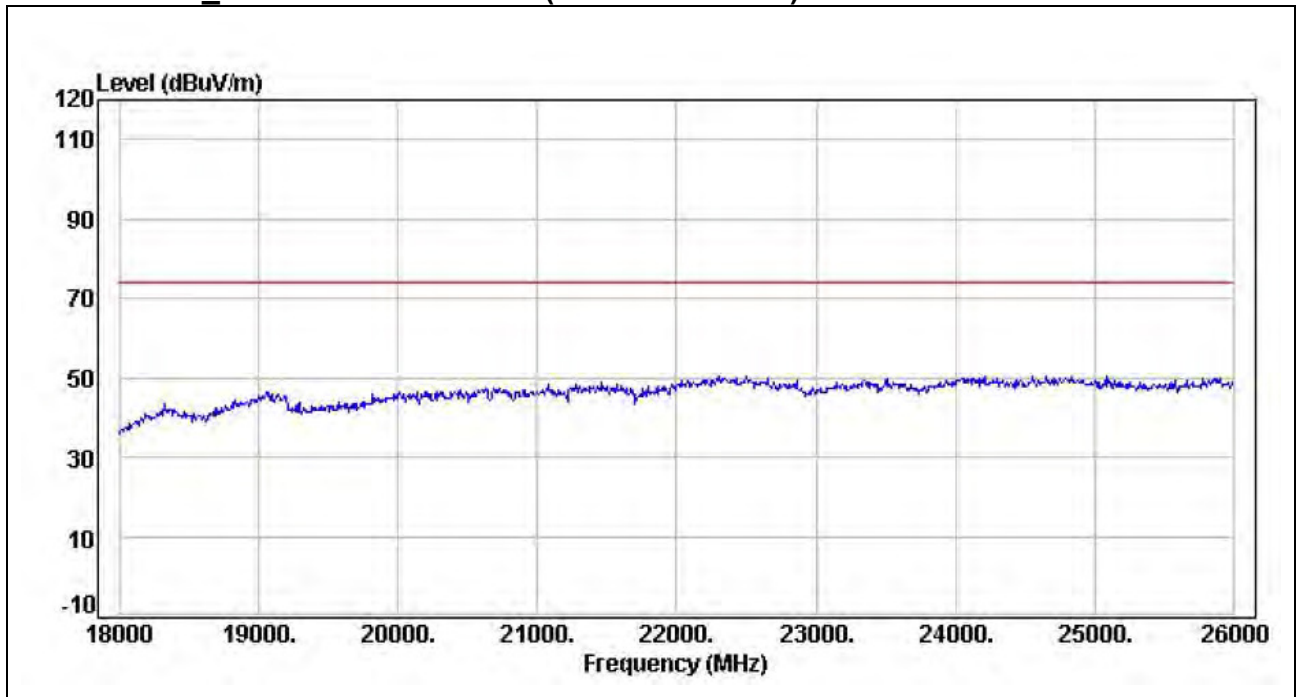

**Remark:**

1. Measuring frequencies from 1 GHz to the 10th harmonic of highest fundamental frequency.
2. Average test would be performed if the peak result were greater than the average limit.
3. Measurements above show only up to 6 maximum emissions noted, or would be lesser, with " N/A " remark, if no specific emissions from the EUT are recorded (ie: margin>20dB from the applicable limit) and considered that's already beyond the background noise floor.
4. Result = Reading + Correction Factor  
 Margin = Result – Limit  
 Remark Peak = Result(PK) – Limit(PK)  
 Remark AVG = Result(AV) – Limit(AV)

<b>Product Name</b>	WHITE DRIVE BOX	<b>Test By</b>	Crystal Wu
<b>Test Model</b>	TB4001	<b>Test Date</b>	2016/08/12
<b>Test Mode</b>	IEEE 802.11b Mode / TX / CH High / Direct Mode_External Ant	<b>Temp. &amp; Humidity</b>	28°C, 52%

**966Chamber\_C at 3Meter / Horizontal (1GHz ~ 3GHz)**

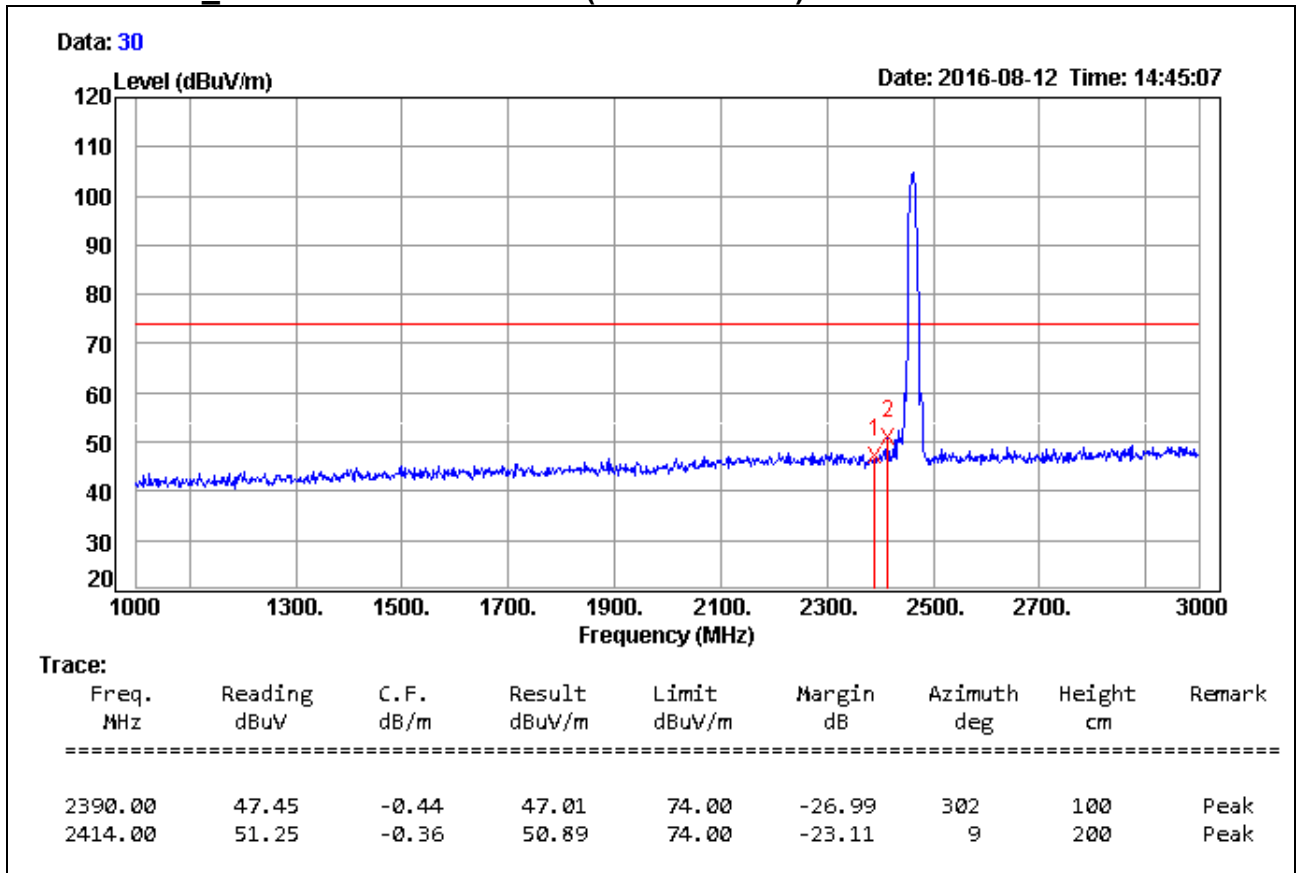

**Remark:**

1. Measuring frequencies from 1 GHz to the 10th harmonic of highest fundamental frequency.
2. Average test would be performed if the peak result were greater than the average limit.
3. Measurements above show only up to 6 maximum emissions noted, or would be lesser, with " N/A " remark, if no specific emissions from the EUT are recorded (ie: margin>20dB from the applicable limit) and considered that's already beyond the background noise floor.
4. Result = Reading + Correction Factor  
 Margin = Result - Limit  
 Remark Peak = Result(PK) - Limit(PK)  
 Remark AVG = Result(AV) - Limit(AV)

<b>Product Name</b>	WHITE DRIVE BOX	<b>Test By</b>	Crystal Wu
<b>Test Model</b>	TB4001	<b>Test Date</b>	2016/08/12
<b>Test Mode</b>	IEEE 802.11b Mode / TX / CH High / Direct Mode_External Ant	<b>Temp. &amp; Humidity</b>	28°C, 52%

**966Chamber\_C at 3Meter / Vertical (1GHz ~ 3GHz)**

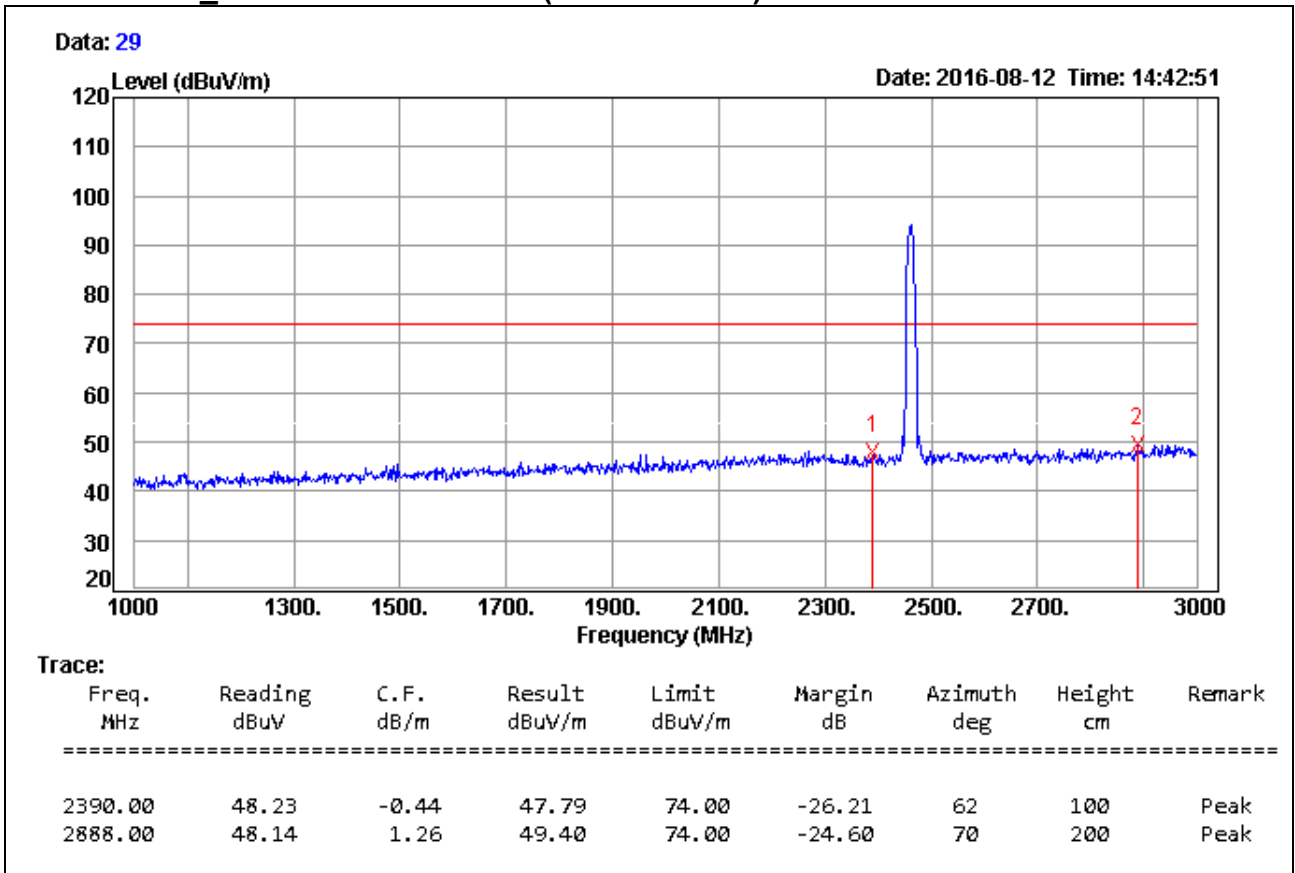

**Remark:**

1. Measuring frequencies from 1 GHz to the 10th harmonic of highest fundamental frequency.
2. Average test would be performed if the peak result were greater than the average limit.
3. Measurements above show only up to 6 maximum emissions noted, or would be lesser, with " N/A " remark, if no specific emissions from the EUT are recorded (ie: margin>20dB from the applicable limit) and considered that's already beyond the background noise floor.
4. Result = Reading + Correction Factor  
 Margin = Result - Limit  
 Remark Peak = Result(PK) - Limit(PK)  
 Remark AVG = Result(AV) - Limit(AV)

<b>Product Name</b>	WHITE DRIVE BOX	<b>Test By</b>	Crystal Wu
<b>Test Model</b>	TB4001	<b>Test Date</b>	2016/08/12
<b>Test Mode</b>	IEEE 802.11b Mode / TX / CH High / Direct Mode_External Ant	<b>Temp. &amp; Humidity</b>	28°C, 52%

**966Chamber\_C at 3Meter / Horizontal (3GHz ~ 6GHz)**

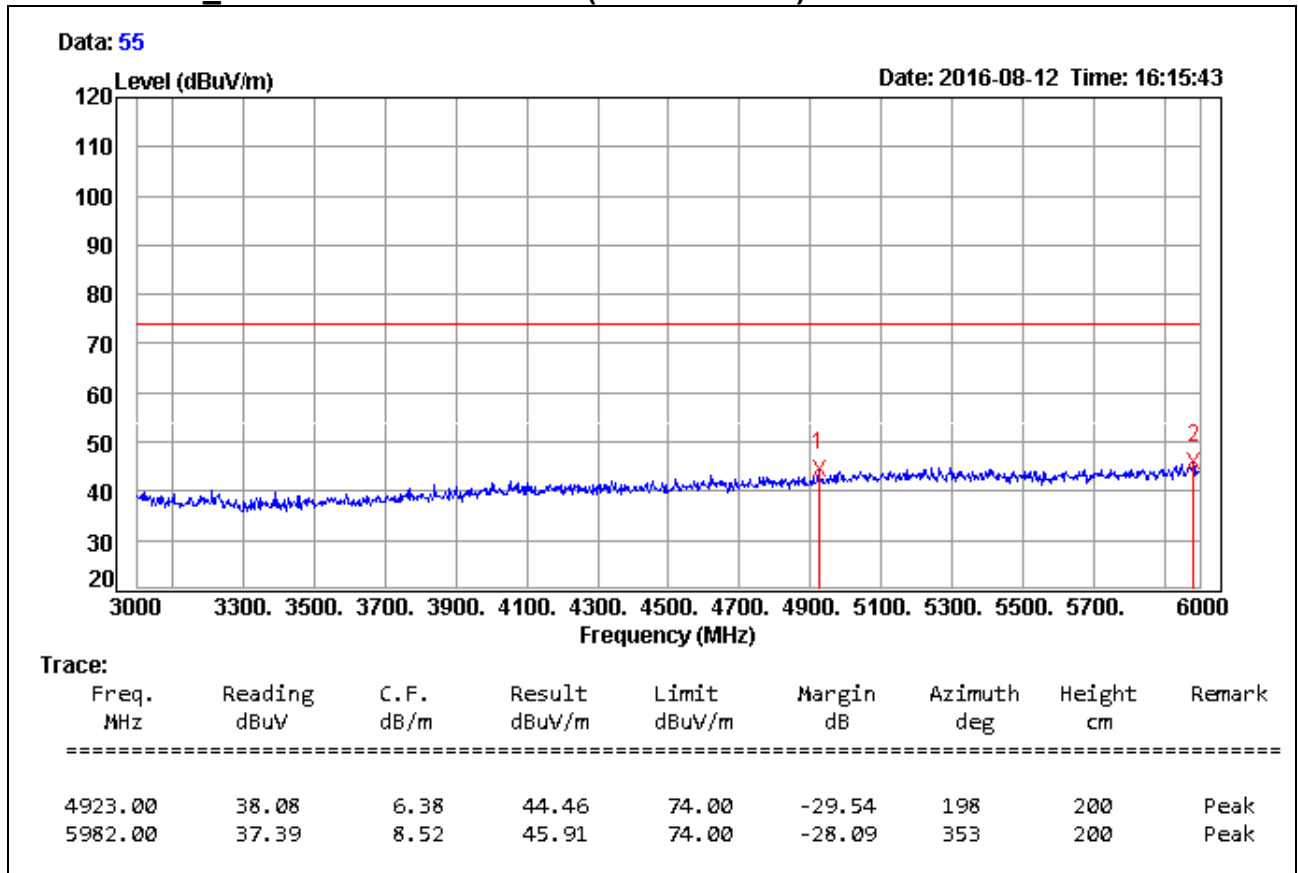

**Remark:**

1. Measuring frequencies from 1 GHz to the 10th harmonic of highest fundamental frequency.
2. Average test would be performed if the peak result were greater than the average limit.
3. Measurements above show only up to 6 maximum emissions noted, or would be lesser, with " N/A " remark, if no specific emissions from the EUT are recorded (ie: margin>20dB from the applicable limit) and considered that's already beyond the background noise floor.
4. Result = Reading + Correction Factor  
 Margin = Result – Limit  
 Remark Peak = Result(PK) – Limit(PK)  
 Remark AVG = Result(AV) – Limit(AV)



<b>Product Name</b>	WHITE DRIVE BOX	<b>Test By</b>	Crystal Wu
<b>Test Model</b>	TB4001	<b>Test Date</b>	2016/08/12
<b>Test Mode</b>	IEEE 802.11b Mode / TX / CH High / Direct Mode_External Ant	<b>Temp. &amp; Humidity</b>	28°C, 52%

**966Chamber\_C at 3Meter / Vertical (3GHz ~ 6GHz)**

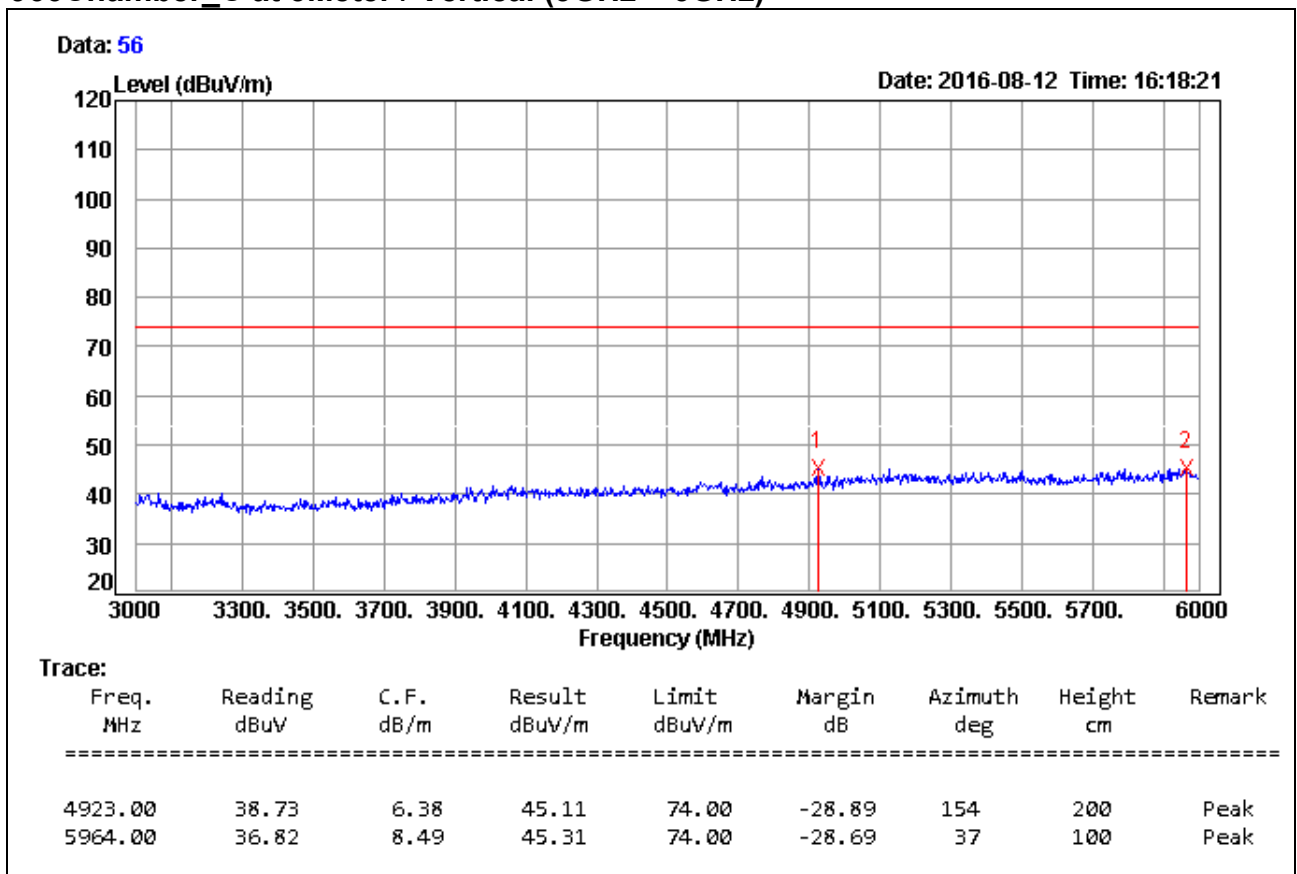

**Remark:**

1. Measuring frequencies from 1 GHz to the 10th harmonic of highest fundamental frequency.
2. Average test would be performed if the peak result were greater than the average limit.
3. Measurements above show only up to 6 maximum emissions noted, or would be lesser, with " N/A " remark, if no specific emissions from the EUT are recorded (ie: margin>20dB from the applicable limit) and considered that's already beyond the background noise floor.
4. Result = Reading + Correction Factor  
 Margin = Result - Limit  
 Remark Peak = Result(PK) - Limit(PK)  
 Remark AVG = Result(AV) - Limit(AV)

<b>Product Name</b>	WHITE DRIVE BOX	<b>Test By</b>	Crystal Wu
<b>Test Model</b>	TB4001	<b>Test Date</b>	2016/08/12
<b>Test Mode</b>	IEEE 802.11b Mode / TX / CH High / Direct Mode_External Ant	<b>Temp. &amp; Humidity</b>	28°C, 52%

**966Chamber\_C at 3Meter / Horizontal (6GHz ~ 18GHz)**

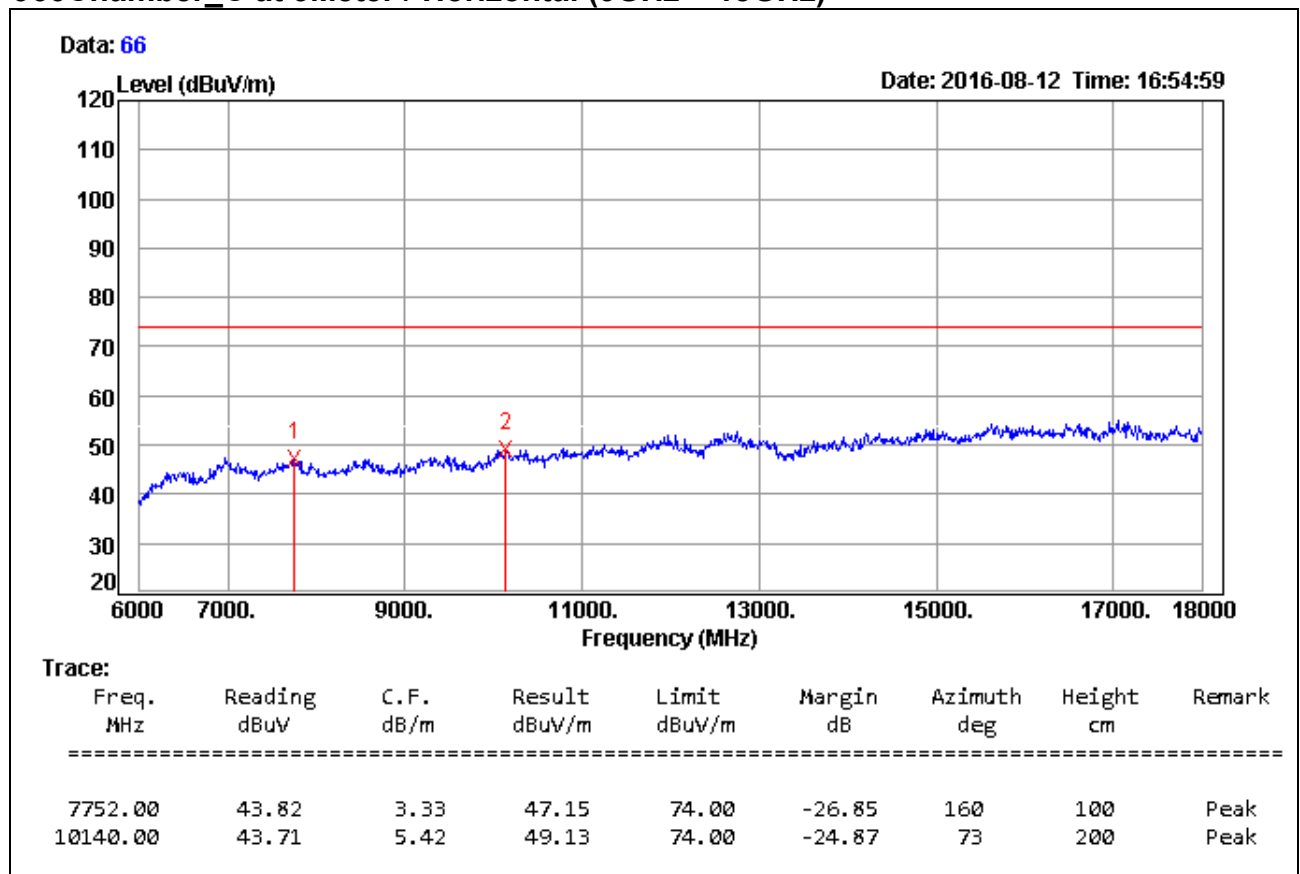

**Remark:**

1. Measuring frequencies from 1 GHz to the 10th harmonic of highest fundamental frequency.
2. Average test would be performed if the peak result were greater than the average limit.
3. Measurements above show only up to 6 maximum emissions noted, or would be lesser, with " N/A " remark, if no specific emissions from the EUT are recorded (ie: margin>20dB from the applicable limit) and considered that's already beyond the background noise floor.
4. Result = Reading + Correction Factor  
 Margin = Result - Limit  
 Remark Peak = Result(PK) - Limit(PK)  
 Remark AVG = Result(AV) - Limit(AV)

<b>Product Name</b>	WHITE DRIVE BOX	<b>Test By</b>	Crystal Wu
<b>Test Model</b>	TB4001	<b>Test Date</b>	2016/08/12
<b>Test Mode</b>	IEEE 802.11b Mode / TX / CH High / Direct Mode_External Ant	<b>Temp. &amp; Humidity</b>	28°C, 52%

**966Chamber\_C at 3Meter / Vertical (6GHz ~ 18GHz)**

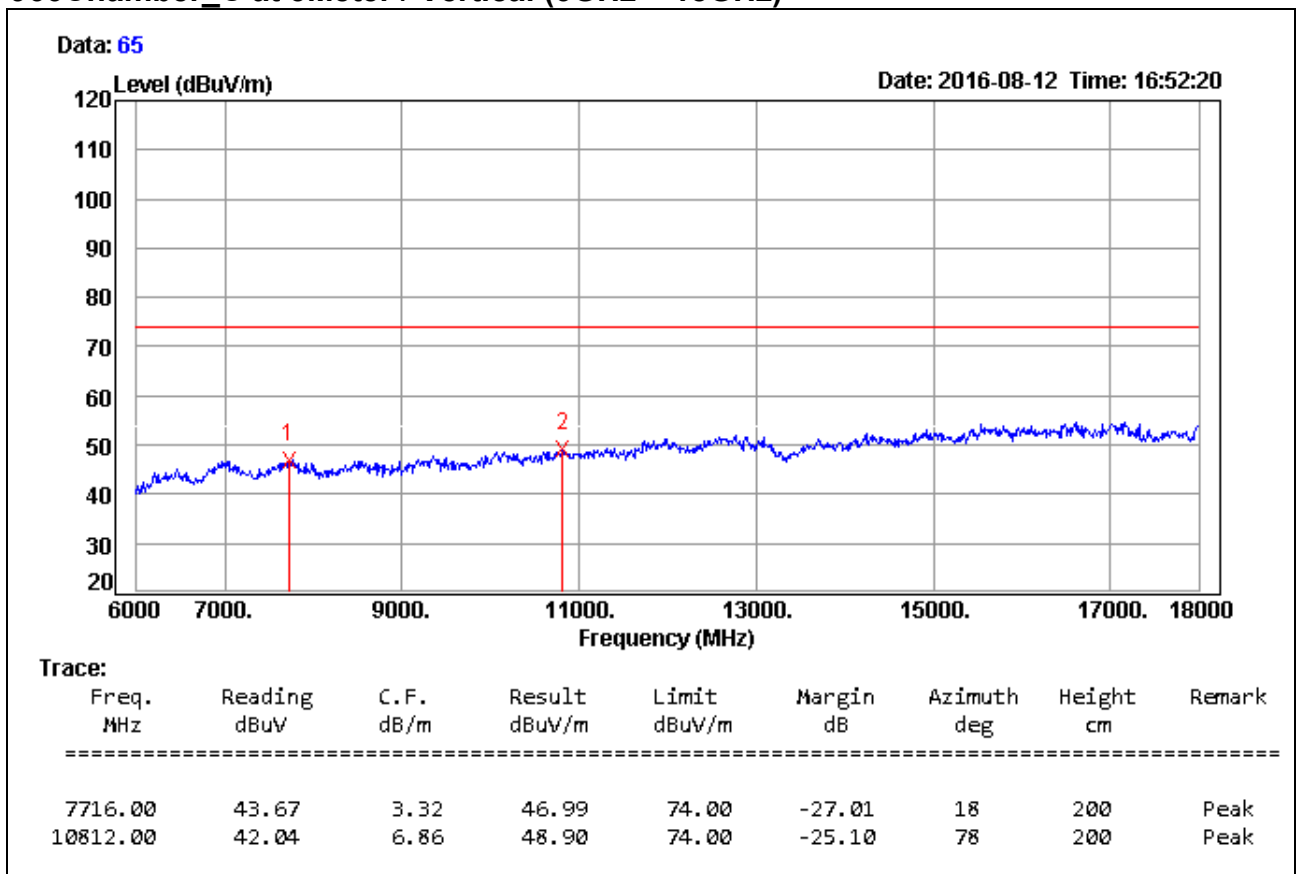

**Remark:**

1. Measuring frequencies from 1 GHz to the 10th harmonic of highest fundamental frequency.
2. Average test would be performed if the peak result were greater than the average limit.
3. Measurements above show only up to 6 maximum emissions noted, or would be lesser, with " N/A " remark, if no specific emissions from the EUT are recorded (ie: margin>20dB from the applicable limit) and considered that's already beyond the background noise floor.
4. Result = Reading + Correction Factor  
 Margin = Result – Limit  
 Remark Peak = Result(PK) – Limit(PK)  
 Remark AVG = Result(AV) – Limit(AV)

<b>Product Name</b>	WHITE DRIVE BOX	<b>Test By</b>	Crystal Wu
<b>Test Model</b>	TB4001	<b>Test Date</b>	2016/08/16
<b>Test Mode</b>	IEEE 802.11b Mode / TX / CH High / Direct Mode_External Ant	<b>Temp. &amp; Humidity</b>	28°C, 52%

**966Chamber\_C at 3Meter / Horizontal (18GHz ~ 26GHz)**

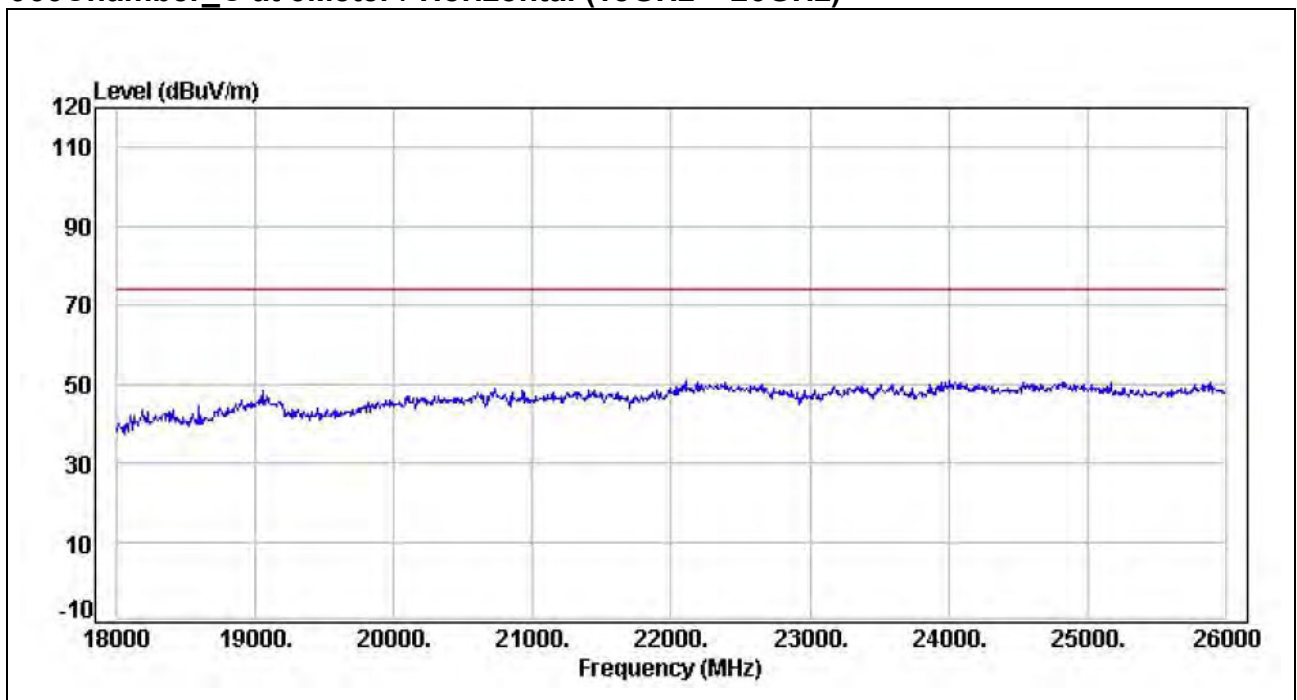

**Remark:**

1. Measuring frequencies from 1 GHz to the 10th harmonic of highest fundamental frequency.
2. Average test would be performed if the peak result were greater than the average limit.
3. Measurements above show only up to 6 maximum emissions noted, or would be lesser, with " N/A " remark, if no specific emissions from the EUT are recorded (ie: margin>20dB from the applicable limit) and considered that's already beyond the background noise floor.
4. Result = Reading + Correction Factor  
 Margin = Result – Limit  
 Remark Peak = Result(PK) – Limit(PK)  
 Remark AVG = Result(AV) – Limit(AV)

<b>Product Name</b>	WHITE DRIVE BOX	<b>Test By</b>	Crystal Wu
<b>Test Model</b>	TB4001	<b>Test Date</b>	2016/08/16
<b>Test Mode</b>	IEEE 802.11b Mode / TX / CH High / Direct Mode_External Ant	<b>Temp. &amp; Humidity</b>	28°C, 52%

**966Chamber\_C at 3Meter / Vertical (18GHz ~ 26GHz)**

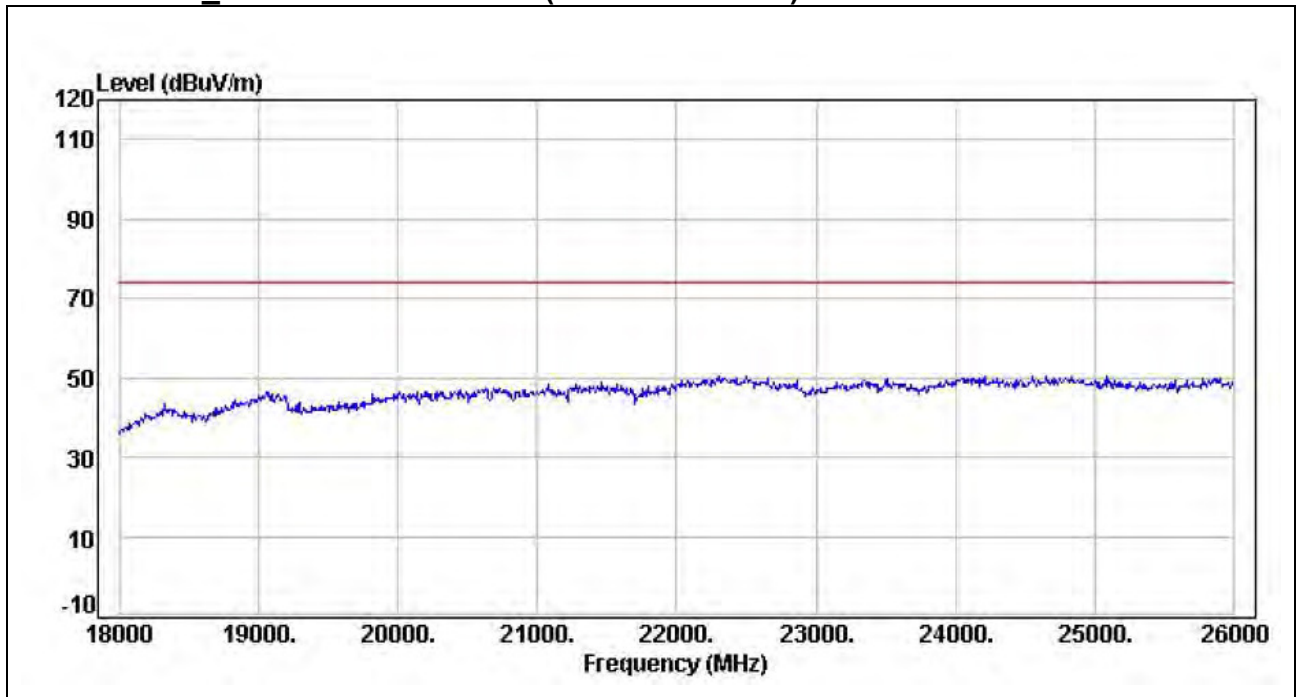

**Remark:**

1. Measuring frequencies from 1 GHz to the 10th harmonic of highest fundamental frequency.
2. Average test would be performed if the peak result were greater than the average limit.
3. Measurements above show only up to 6 maximum emissions noted, or would be lesser, with " N/A " remark, if no specific emissions from the EUT are recorded (ie: margin>20dB from the applicable limit) and considered that's already beyond the background noise floor.
4. Result = Reading + Correction Factor  
 Margin = Result – Limit  
 Remark Peak = Result(PK) – Limit(PK)  
 Remark AVG = Result(AV) – Limit(AV)

<b>Product Name</b>	WHITE DRIVE BOX	<b>Test By</b>	Crystal Wu
<b>Test Model</b>	TB4001	<b>Test Date</b>	2016/08/12
<b>Test Mode</b>	IEEE 802.11g Mode / TX / CH Low / Direct Mode_External Ant	<b>Temp. &amp; Humidity</b>	28°C, 52%

**966Chamber\_C at 3Meter / Horizontal (1GHz ~ 3GHz)**

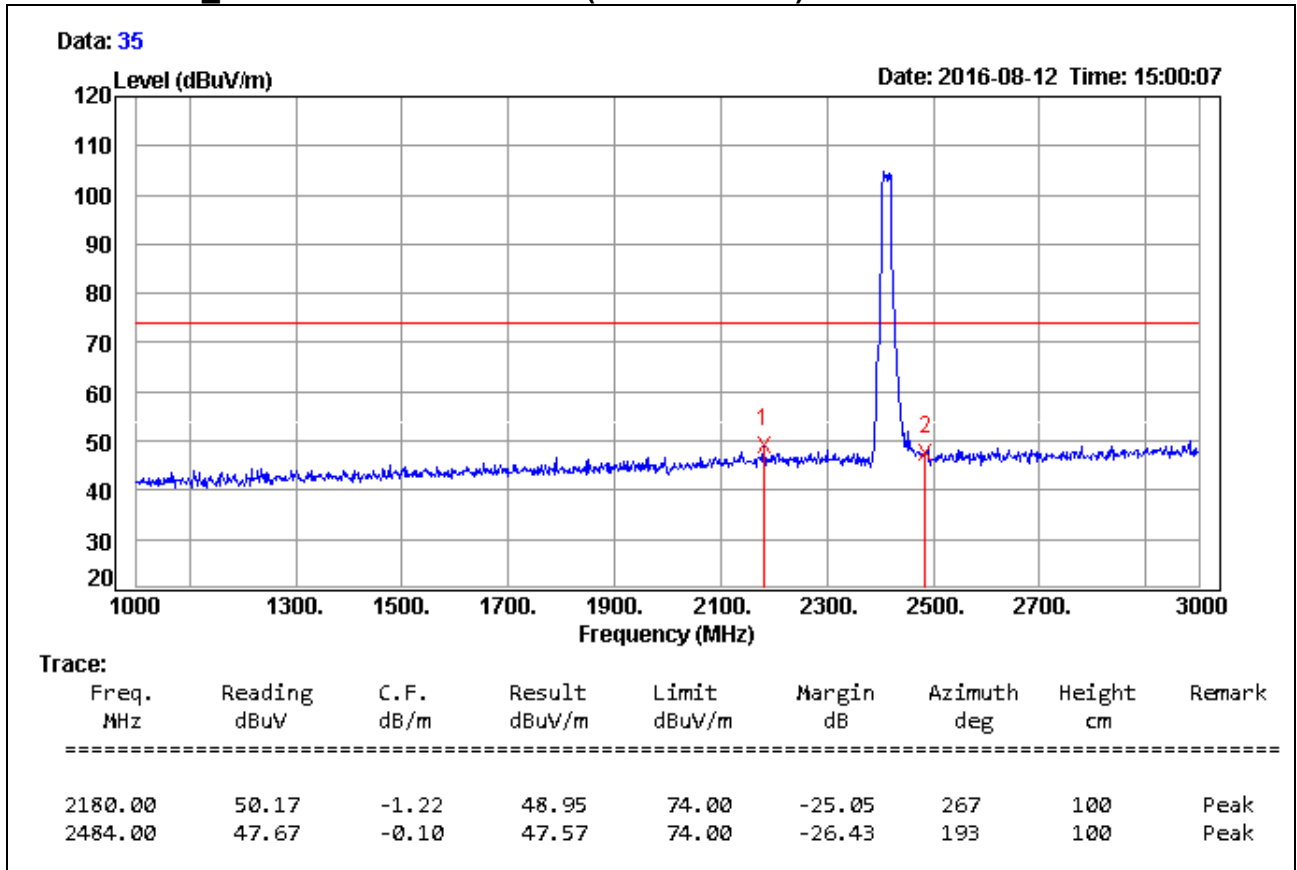

**Remark:**

1. Measuring frequencies from 1 GHz to the 10th harmonic of highest fundamental frequency.
2. Average test would be performed if the peak result were greater than the average limit.
3. Measurements above show only up to 6 maximum emissions noted, or would be lesser, with " N/A " remark, if no specific emissions from the EUT are recorded (ie: margin>20dB from the applicable limit) and considered that's already beyond the background noise floor.
4. Result = Reading + Correction Factor  
 Margin = Result – Limit  
 Remark Peak = Result(PK) – Limit(PK)  
 Remark AVG = Result(AV) – Limit(AV)

<b>Product Name</b>	WHITE DRIVE BOX	<b>Test By</b>	Crystal Wu
<b>Test Model</b>	TB4001	<b>Test Date</b>	2016/08/12
<b>Test Mode</b>	IEEE 802.11g Mode / TX / CH Low / Direct Mode_External Ant	<b>Temp. &amp; Humidity</b>	28°C, 52%

**966Chamber\_C at 3Meter / Vertical (1GHz ~ 3GHz)**

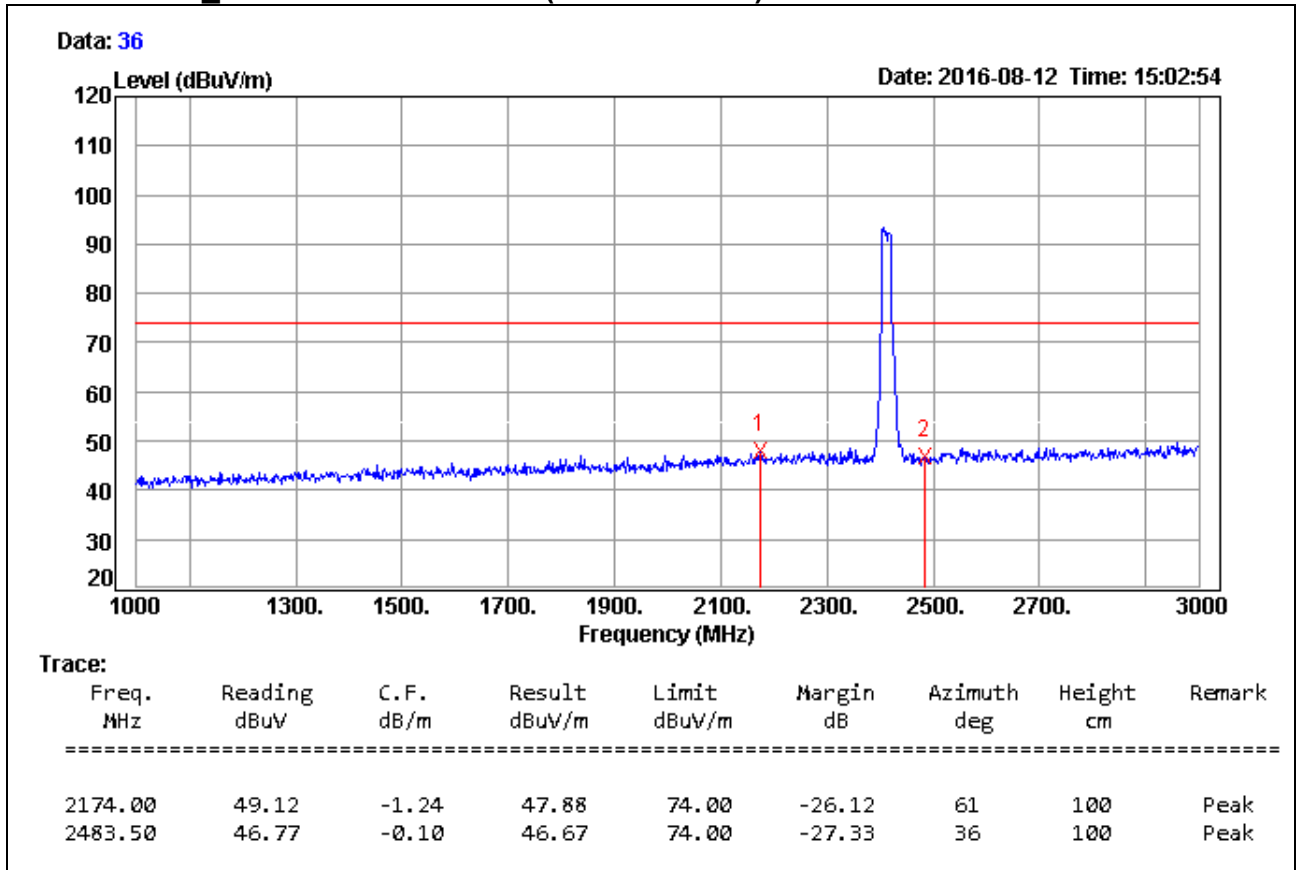

**Remark:**

1. Measuring frequencies from 1 GHz to the 10th harmonic of highest fundamental frequency.
2. Average test would be performed if the peak result were greater than the average limit.
3. Measurements above show only up to 6 maximum emissions noted, or would be lesser, with " N/A " remark, if no specific emissions from the EUT are recorded (ie: margin>20dB from the applicable limit) and considered that's already beyond the background noise floor.
4. Result = Reading + Correction Factor  
 Margin = Result – Limit  
 Remark Peak = Result(PK) – Limit(PK)  
 Remark AVG = Result(AV) – Limit(AV)

<b>Product Name</b>	WHITE DRIVE BOX	<b>Test By</b>	Crystal Wu
<b>Test Model</b>	TB4001	<b>Test Date</b>	2016/08/12
<b>Test Mode</b>	IEEE 802.11g Mode / TX / CH Low / Direct Mode_External Ant	<b>Temp. &amp; Humidity</b>	28°C, 52%

**966Chamber\_C at 3Meter / Horizontal (3GHz ~ 6GHz)**

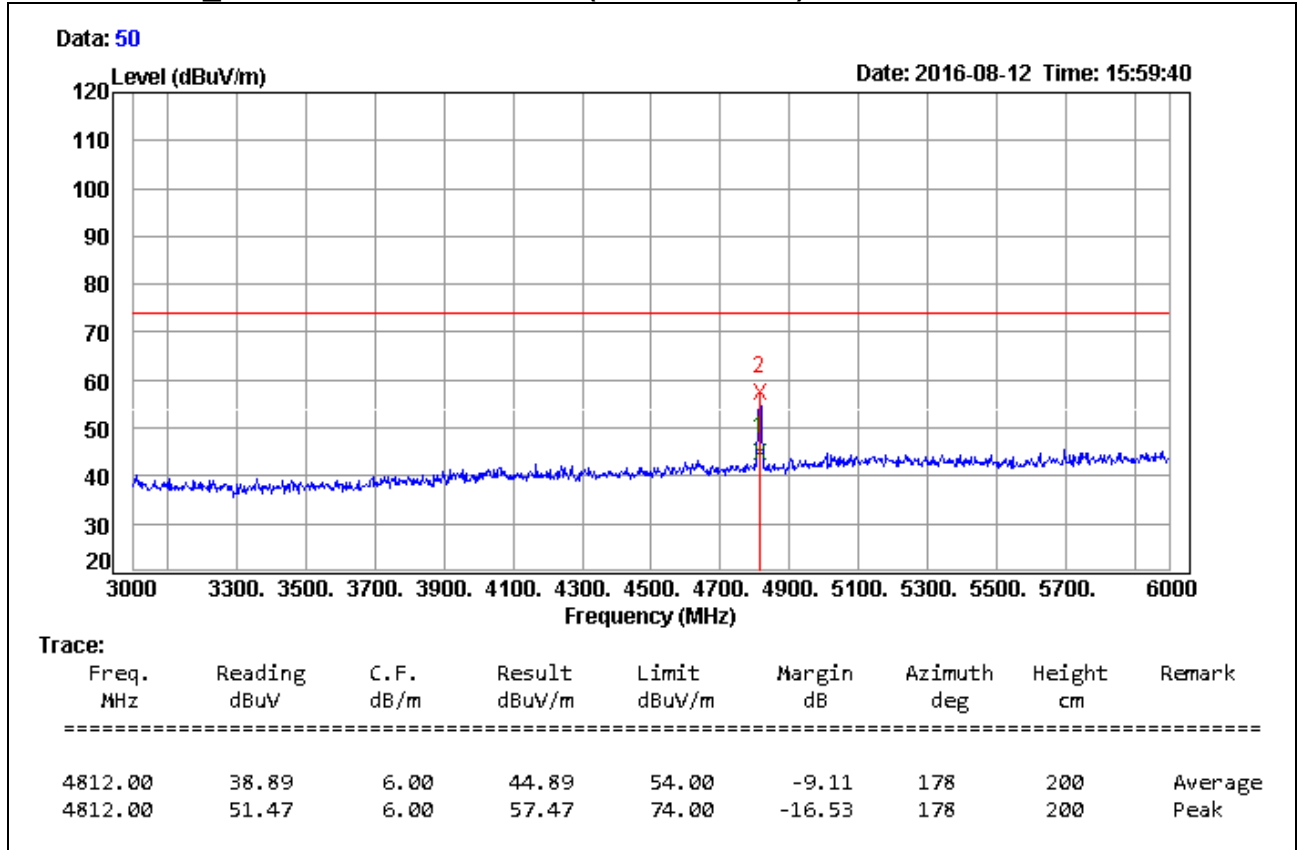

**Remark:**

1. Measuring frequencies from 1 GHz to the 10th harmonic of highest fundamental frequency.
2. Average test would be performed if the peak result were greater than the average limit.
3. Measurements above show only up to 6 maximum emissions noted, or would be lesser, with " N/A " remark, if no specific emissions from the EUT are recorded (ie: margin>20dB from the applicable limit) and considered that's already beyond the background noise floor.
4. Result = Reading + Correction Factor  
 Margin = Result - Limit  
 Remark Peak = Result(PK) - Limit(PK)  
 Remark AVG = Result(AV) - Limit(AV)



<b>Product Name</b>	WHITE DRIVE BOX	<b>Test By</b>	Crystal Wu
<b>Test Model</b>	TB4001	<b>Test Date</b>	2016/08/12
<b>Test Mode</b>	IEEE 802.11g Mode / TX / CH Low / Direct Mode_External Ant	<b>Temp. &amp; Humidity</b>	28°C, 52%

**966Chamber\_C at 3Meter / Vertical (3GHz ~ 6GHz)**

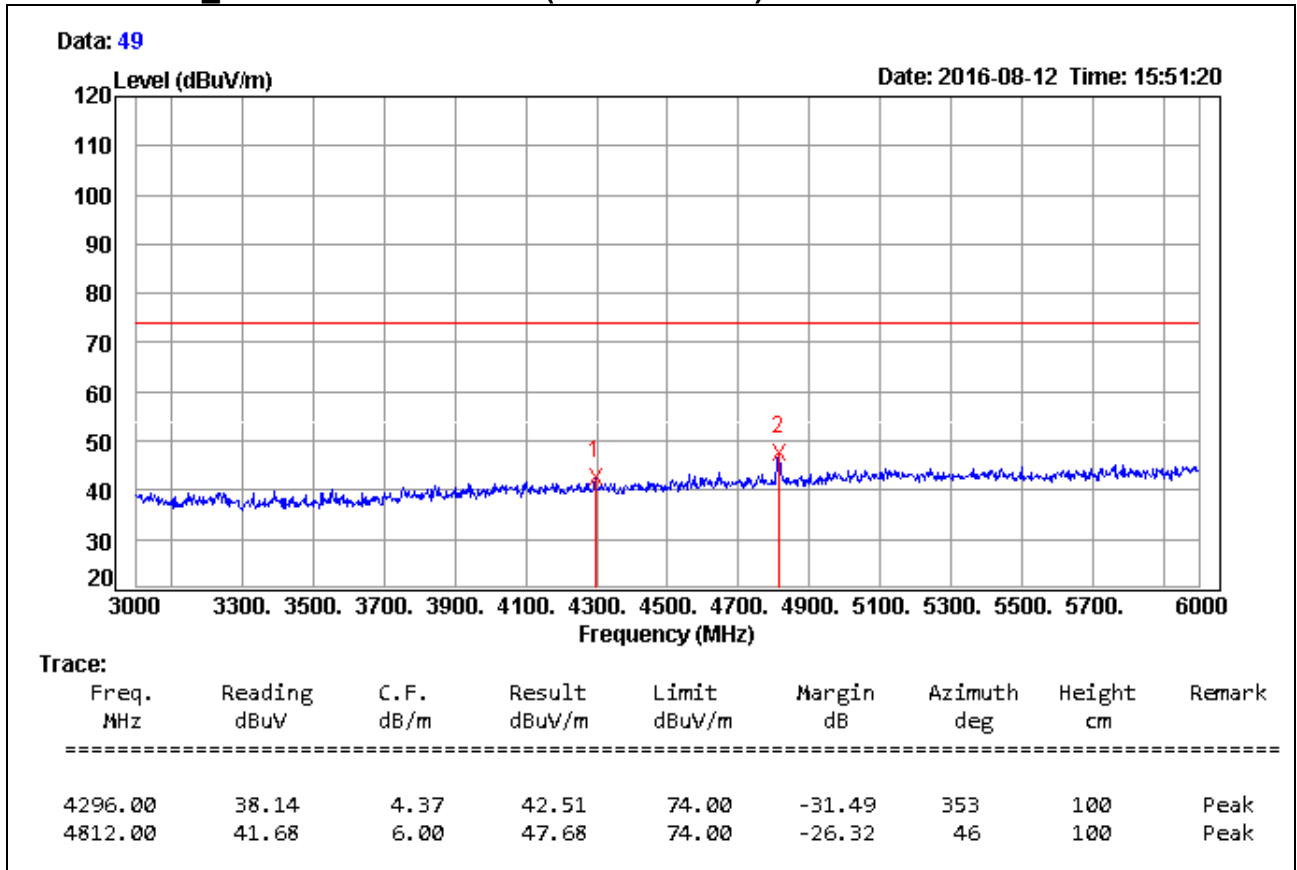

**Remark:**

1. Measuring frequencies from 1 GHz to the 10th harmonic of highest fundamental frequency.
2. Average test would be performed if the peak result were greater than the average limit.
3. Measurements above show only up to 6 maximum emissions noted, or would be lesser, with " N/A " remark, if no specific emissions from the EUT are recorded (ie: margin>20dB from the applicable limit) and considered that's already beyond the background noise floor.
4. Result = Reading + Correction Factor  
 Margin = Result – Limit  
 Remark Peak = Result(PK) – Limit(PK)  
 Remark AVG = Result(AV) – Limit(AV)

<b>Product Name</b>	WHITE DRIVE BOX	<b>Test By</b>	Crystal Wu
<b>Test Model</b>	TB4001	<b>Test Date</b>	2016/08/12
<b>Test Mode</b>	IEEE 802.11g Mode / TX / CH Low / Direct Mode_External Ant	<b>Temp. &amp; Humidity</b>	28°C, 52%

**966Chamber\_C at 3Meter / Horizontal (6GHz ~ 18GHz)**

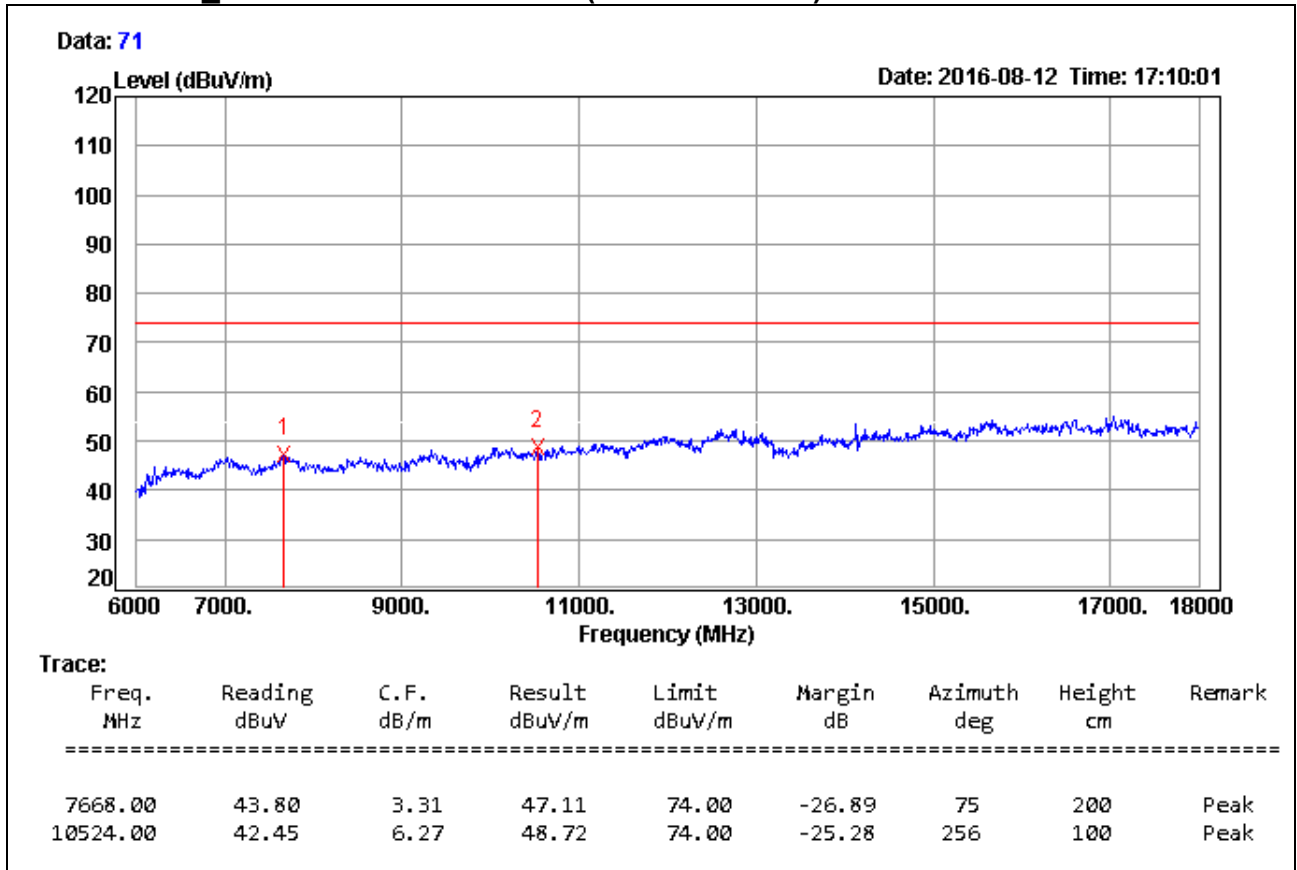

**Remark:**

1. Measuring frequencies from 1 GHz to the 10th harmonic of highest fundamental frequency.
2. Average test would be performed if the peak result were greater than the average limit.
3. Measurements above show only up to 6 maximum emissions noted, or would be lesser, with " N/A " remark, if no specific emissions from the EUT are recorded (ie: margin>20dB from the applicable limit) and considered that's already beyond the background noise floor.
4.  $Result = Reading + Correction\ Factor$   
 $Margin = Result - Limit$   
 $Remark\ Peak = Result(PK) - Limit(PK)$   
 $Remark\ AVG = Result(AV) - Limit(AV)$

<b>Product Name</b>	WHITE DRIVE BOX	<b>Test By</b>	Crystal Wu
<b>Test Model</b>	TB4001	<b>Test Date</b>	2016/08/12
<b>Test Mode</b>	IEEE 802.11g Mode / TX / CH Low / Direct Mode_External Ant	<b>Temp. &amp; Humidity</b>	28°C, 52%

**966Chamber\_C at 3Meter / Vertical (6GHz ~ 18GHz)**

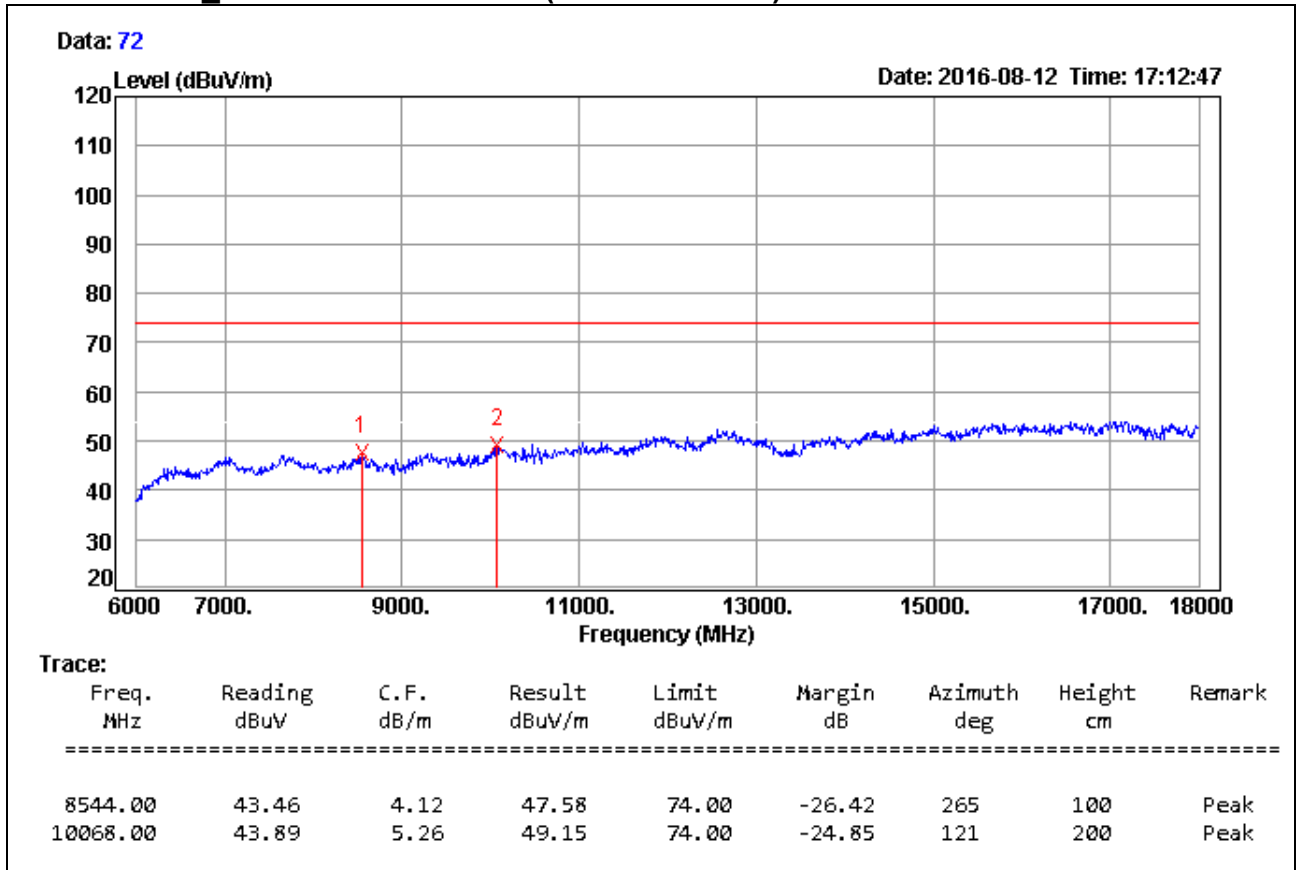

**Remark:**

1. Measuring frequencies from 1 GHz to the 10th harmonic of highest fundamental frequency.
2. Average test would be performed if the peak result were greater than the average limit.
3. Measurements above show only up to 6 maximum emissions noted, or would be lesser, with " N/A " remark, if no specific emissions from the EUT are recorded (ie: margin>20dB from the applicable limit) and considered that's already beyond the background noise floor.
4. Result = Reading + Correction Factor  
 Margin = Result – Limit  
 Remark Peak = Result(PK) – Limit(PK)  
 Remark AVG = Result(AV) – Limit(AV)

<b>Product Name</b>	WHITE DRIVE BOX	<b>Test By</b>	Crystal Wu
<b>Test Model</b>	TB4001	<b>Test Date</b>	2016/08/16
<b>Test Mode</b>	IEEE 802.11g Mode / TX / CH Low / Direct Mode_External Ant	<b>Temp. &amp; Humidity</b>	28°C, 52%

**966Chamber\_C at 3Meter / Horizontal (18GHz ~ 26GHz)**

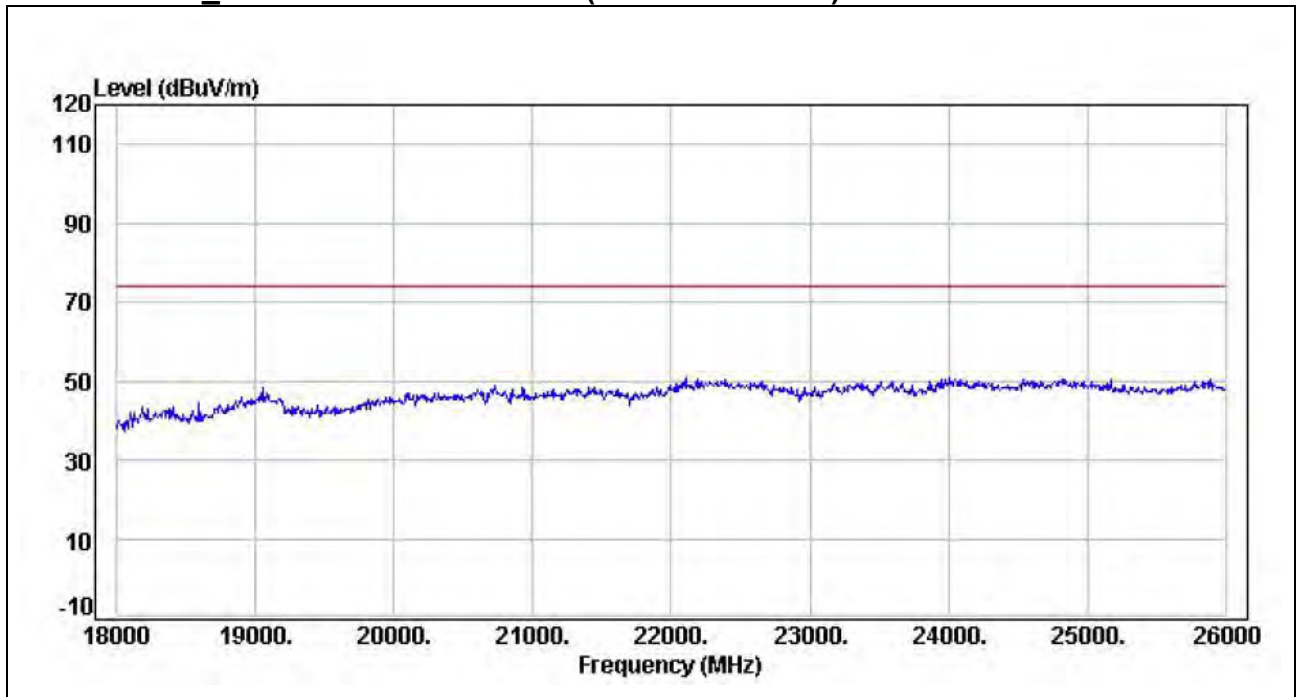

**Remark:**

1. Measuring frequencies from 1 GHz to the 10th harmonic of highest fundamental frequency.
2. Average test would be performed if the peak result were greater than the average limit.
3. Measurements above show only up to 6 maximum emissions noted, or would be lesser, with " N/A " remark, if no specific emissions from the EUT are recorded (ie: margin>20dB from the applicable limit) and considered that's already beyond the background noise floor.
4. Result = Reading + Correction Factor  
 Margin = Result – Limit  
 Remark Peak = Result(PK) – Limit(PK)  
 Remark AVG = Result(AV) – Limit(AV)

<b>Product Name</b>	WHITE DRIVE BOX	<b>Test By</b>	Crystal Wu
<b>Test Model</b>	TB4001	<b>Test Date</b>	2016/08/16
<b>Test Mode</b>	IEEE 802.11g Mode / TX / CH Low / Direct Mode_External Ant	<b>Temp. &amp; Humidity</b>	28°C, 52%

**966Chamber\_C at 3Meter / Vertical (18GHz ~ 26GHz)**

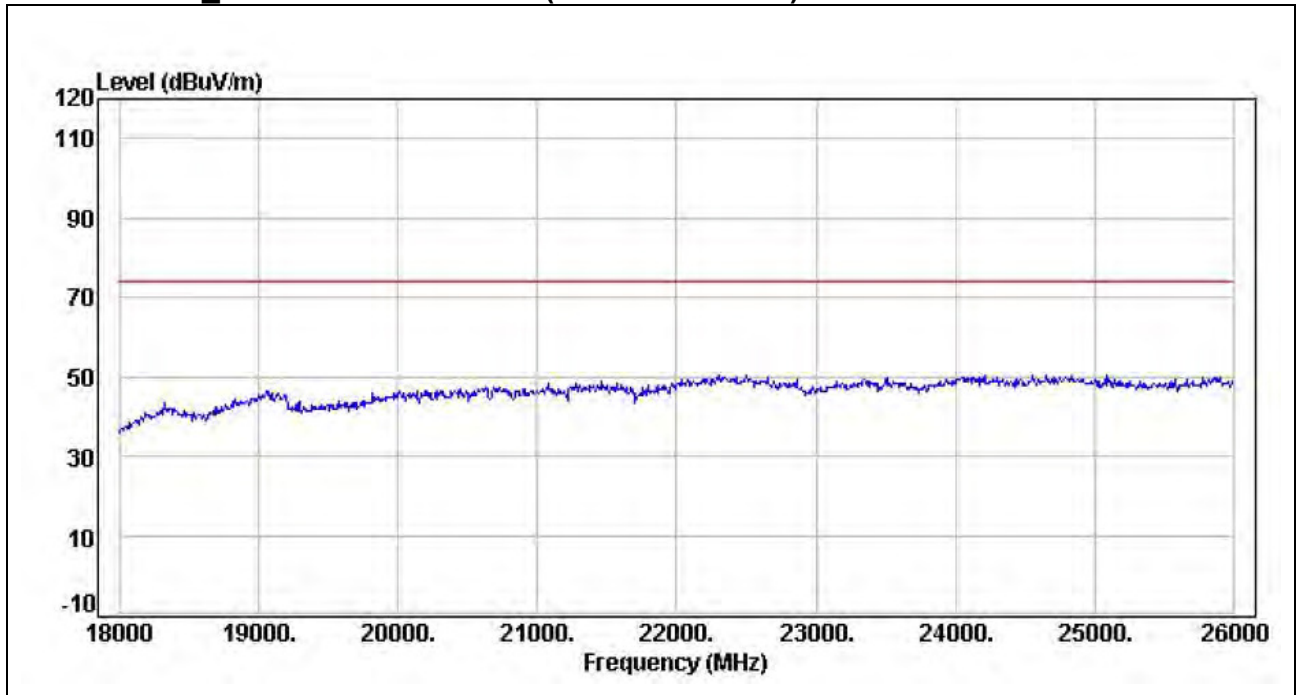

**Remark:**

1. Measuring frequencies from 1 GHz to the 10th harmonic of highest fundamental frequency.
2. Average test would be performed if the peak result were greater than the average limit.
3. Measurements above show only up to 6 maximum emissions noted, or would be lesser, with " N/A " remark, if no specific emissions from the EUT are recorded (ie: margin>20dB from the applicable limit) and considered that's already beyond the background noise floor.
4.  $Result = Reading + Correction\ Factor$   
 $Margin = Result - Limit$   
 $Remark\ Peak = Result(PK) - Limit(PK)$   
 $Remark\ AVG = Result(AV) - Limit(AV)$

<b>Product Name</b>	WHITE DRIVE BOX	<b>Test By</b>	Crystal Wu
<b>Test Model</b>	TB4001	<b>Test Date</b>	2016/08/12
<b>Test Mode</b>	IEEE 802.11g Mode / TX / CH Middle / Direct Mode_External Ant	<b>Temp. &amp; Humidity</b>	28°C, 52%

**966Chamber\_C at 3Meter / Horizontal (1GHz ~ 3GHz)**

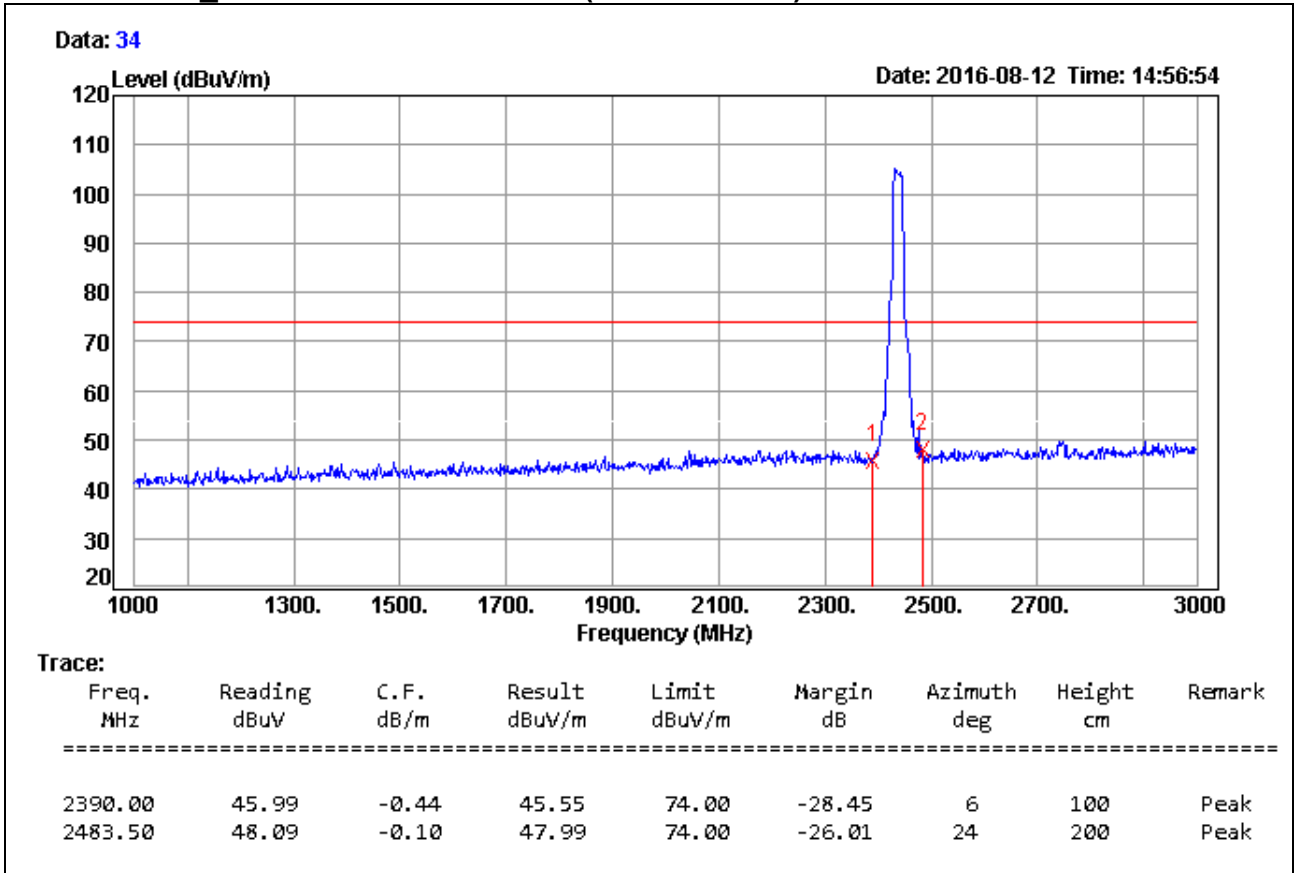

**Remark:**

1. Measuring frequencies from 1 GHz to the 10th harmonic of highest fundamental frequency.
2. Average test would be performed if the peak result were greater than the average limit.
3. Measurements above show only up to 6 maximum emissions noted, or would be lesser, with " N/A " remark, if no specific emissions from the EUT are recorded (ie: margin>20dB from the applicable limit) and considered that's already beyond the background noise floor.
4. Result = Reading + Correction Factor  
 Margin = Result - Limit  
 Remark Peak = Result(PK) - Limit(PK)  
 Remark AVG = Result(AV) - Limit(AV)

<b>Product Name</b>	WHITE DRIVE BOX	<b>Test By</b>	Crystal Wu
<b>Test Model</b>	TB4001	<b>Test Date</b>	2016/08/12
<b>Test Mode</b>	IEEE 802.11g Mode / TX / CH Middle / Direct Mode_External Ant	<b>Temp. &amp; Humidity</b>	28°C, 52%

**966Chamber\_C at 3Meter / Vertical (1GHz ~ 3GHz)**

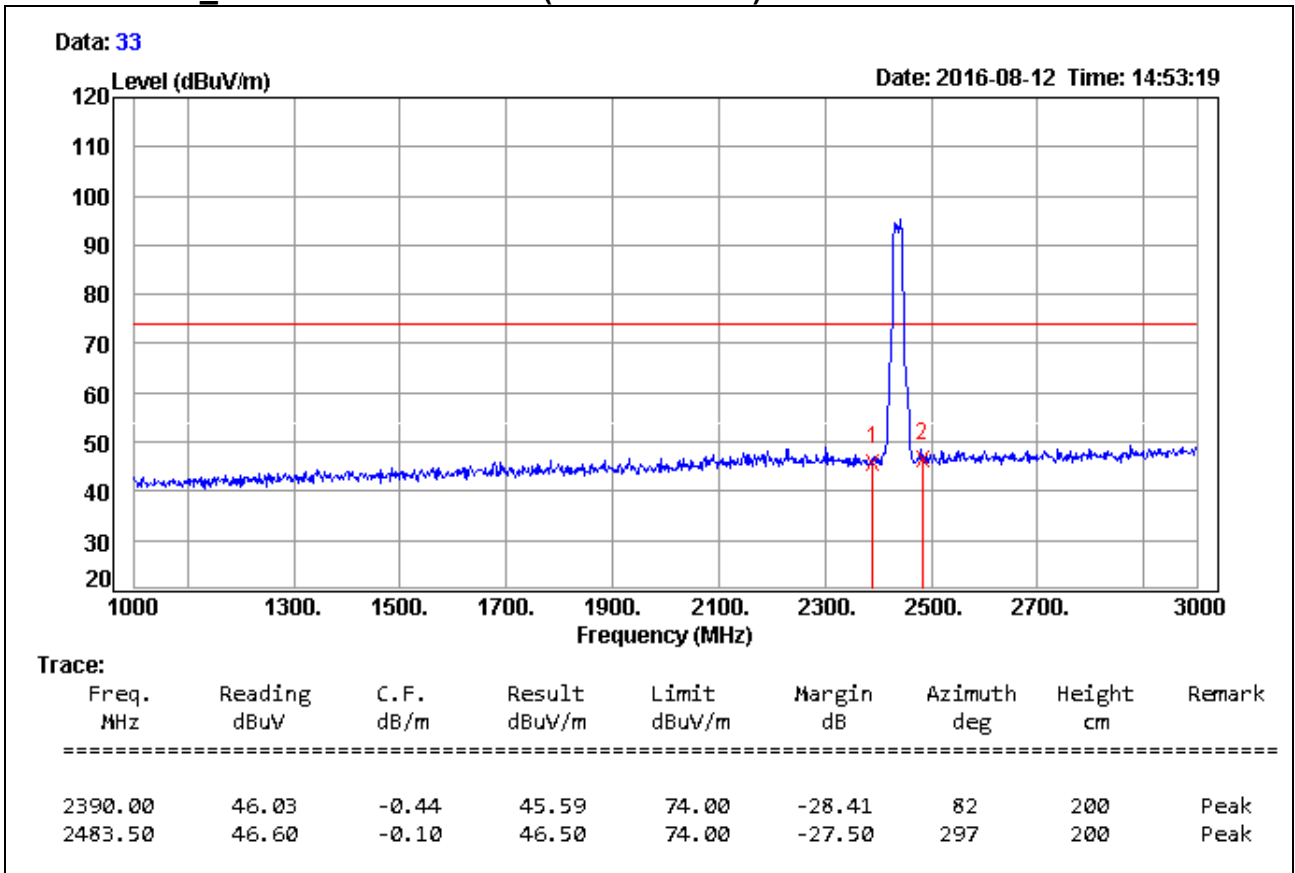

**Remark:**

1. Measuring frequencies from 1 GHz to the 10th harmonic of highest fundamental frequency.
2. Average test would be performed if the peak result were greater than the average limit.
3. Measurements above show only up to 6 maximum emissions noted, or would be lesser, with " N/A " remark, if no specific emissions from the EUT are recorded (ie: margin>20dB from the applicable limit) and considered that's already beyond the background noise floor.
4. Result = Reading + Correction Factor  
 Margin = Result - Limit  
 Remark Peak = Result(PK) - Limit(PK)  
 Remark AVG = Result(AV) - Limit(AV)

<b>Product Name</b>	WHITE DRIVE BOX	<b>Test By</b>	Crystal Wu
<b>Test Model</b>	TB4001	<b>Test Date</b>	2016/08/12
<b>Test Mode</b>	IEEE 802.11g Mode / TX / CH Middle / Direct Mode_External Ant	<b>Temp. &amp; Humidity</b>	28°C, 52%

**966Chamber\_C at 3Meter / Horizontal (3GHz ~ 6GHz)**

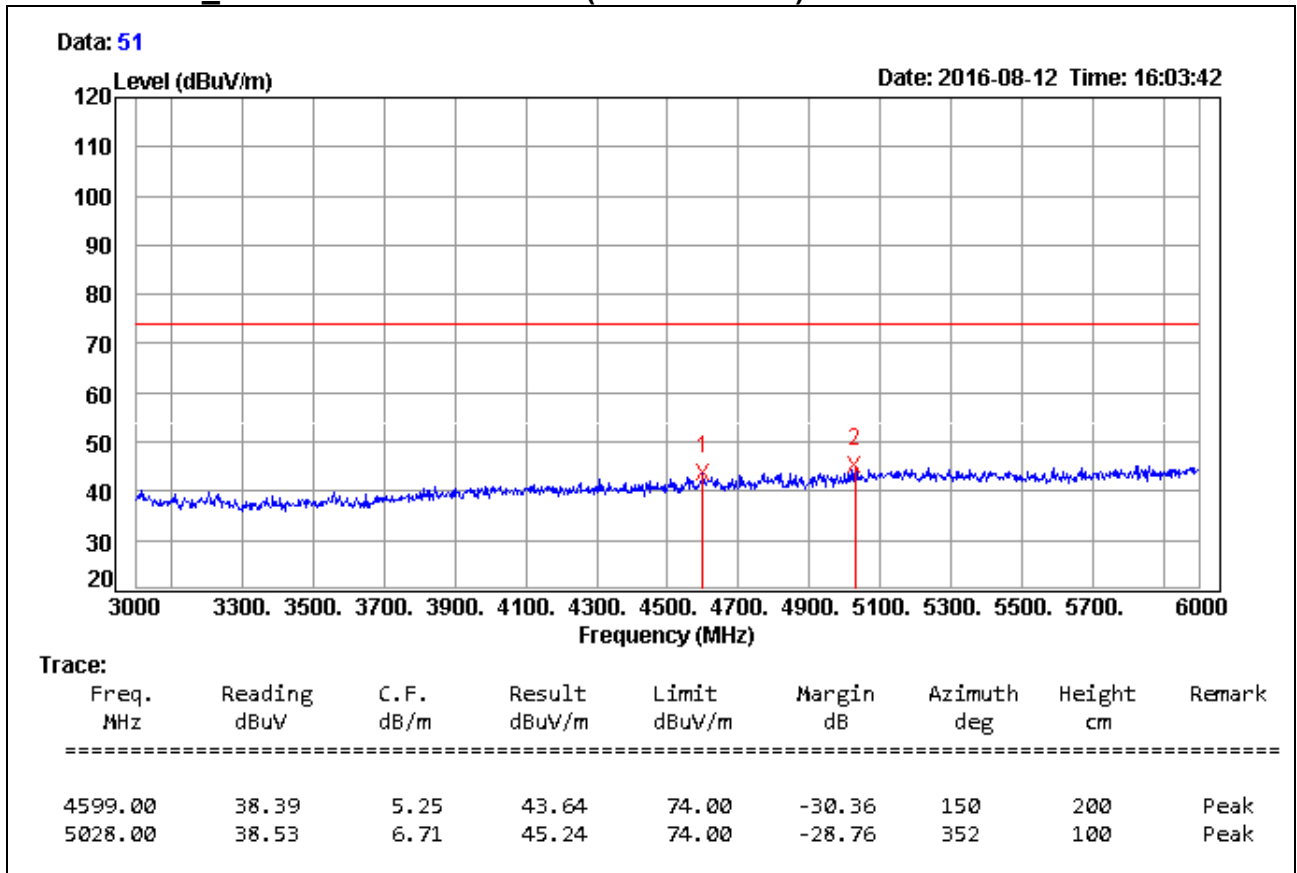

**Remark:**

1. Measuring frequencies from 1 GHz to the 10th harmonic of highest fundamental frequency.
2. Average test would be performed if the peak result were greater than the average limit.
3. Measurements above show only up to 6 maximum emissions noted, or would be lesser, with " N/A " remark, if no specific emissions from the EUT are recorded (ie: margin>20dB from the applicable limit) and considered that's already beyond the background noise floor.
4. Result = Reading + Correction Factor  
 Margin = Result – Limit  
 Remark Peak = Result(PK) – Limit(PK)  
 Remark AVG = Result(AV) – Limit(AV)



<b>Product Name</b>	WHITE DRIVE BOX	<b>Test By</b>	Crystal Wu
<b>Test Model</b>	TB4001	<b>Test Date</b>	2016/08/12
<b>Test Mode</b>	IEEE 802.11g Mode / TX / CH Middle / Direct Mode_External Ant	<b>Temp. &amp; Humidity</b>	28°C, 52%

**966Chamber\_C at 3Meter / Vertical (3GHz ~ 6GHz)**

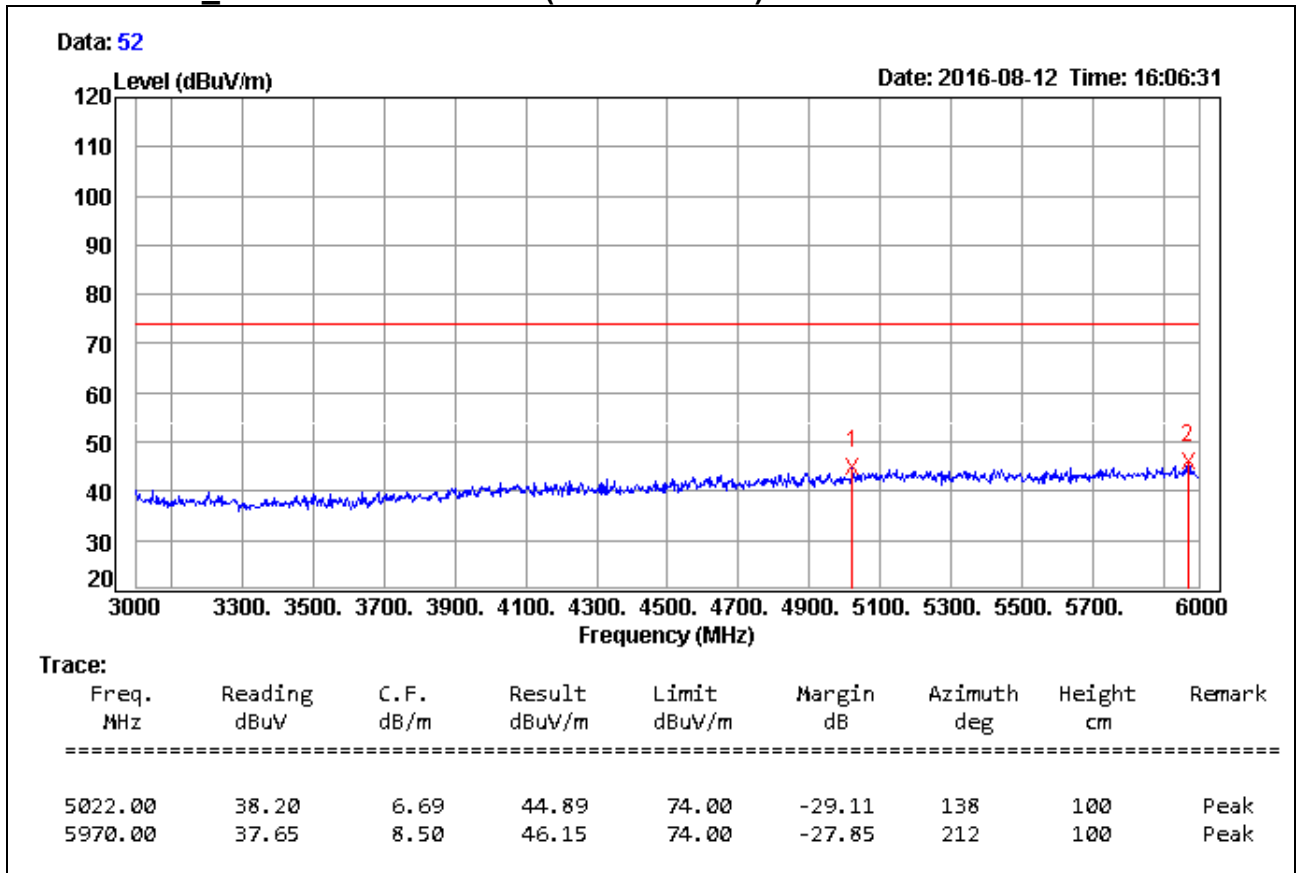

**Remark:**

1. Measuring frequencies from 1 GHz to the 10th harmonic of highest fundamental frequency.
2. Average test would be performed if the peak result were greater than the average limit.
3. Measurements above show only up to 6 maximum emissions noted, or would be lesser, with " N/A " remark, if no specific emissions from the EUT are recorded (ie: margin>20dB from the applicable limit) and considered that's already beyond the background noise floor.
4. Result = Reading + Correction Factor  
 Margin = Result – Limit  
 Remark Peak = Result(PK) – Limit(PK)  
 Remark AVG = Result(AV) – Limit(AV)

<b>Product Name</b>	WHITE DRIVE BOX	<b>Test By</b>	Crystal Wu
<b>Test Model</b>	TB4001	<b>Test Date</b>	2016/08/12
<b>Test Mode</b>	IEEE 802.11g Mode / TX / CH Middle / Direct Mode_External Ant	<b>Temp. &amp; Humidity</b>	28°C, 52%

**966Chamber\_C at 3Meter / Horizontal (6GHz ~ 18GHz)**

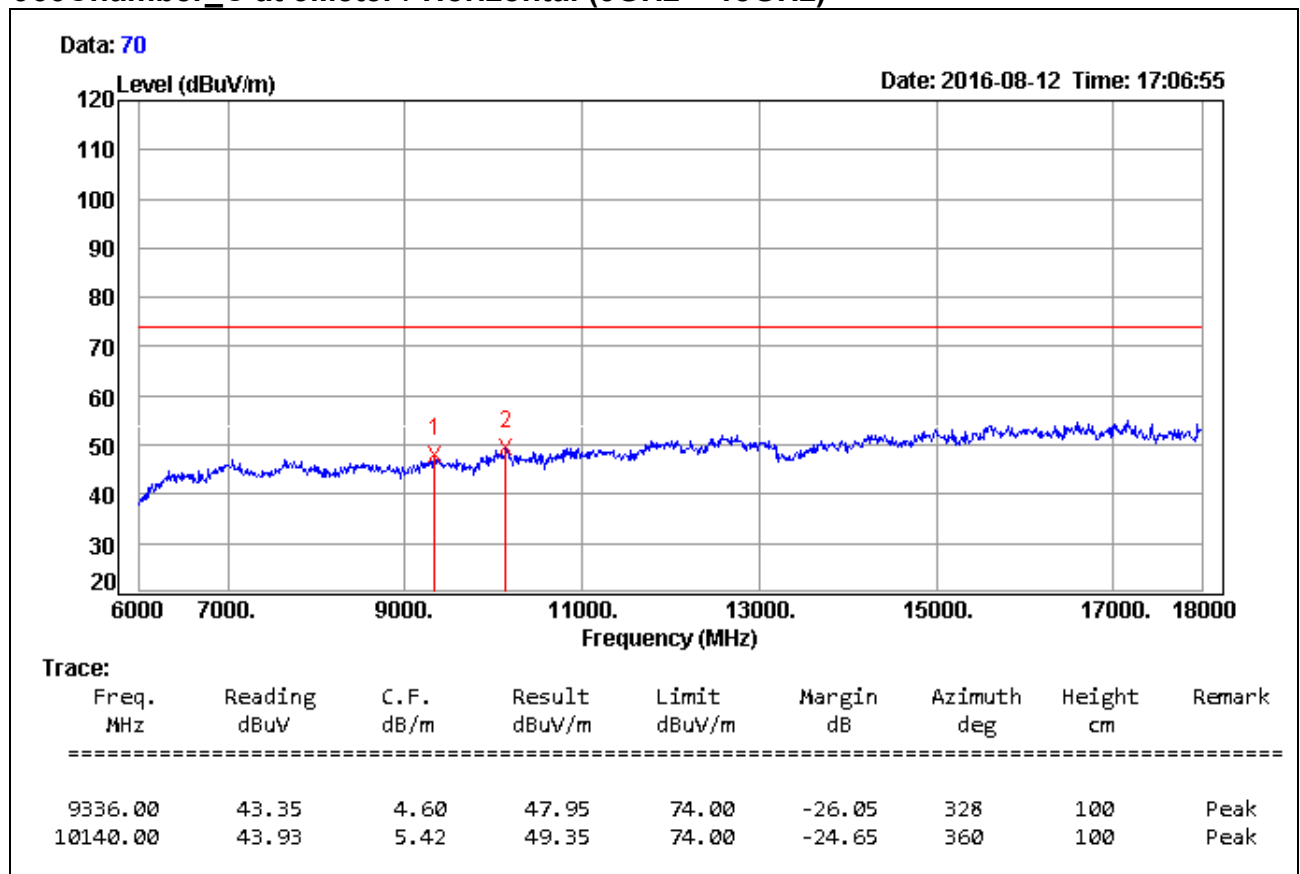

**Remark:**

1. Measuring frequencies from 1 GHz to the 10th harmonic of highest fundamental frequency.
2. Average test would be performed if the peak result were greater than the average limit.
3. Measurements above show only up to 6 maximum emissions noted, or would be lesser, with " N/A " remark, if no specific emissions from the EUT are recorded (ie: margin>20dB from the applicable limit) and considered that's already beyond the background noise floor.
4. Result = Reading + Correction Factor  
 Margin = Result - Limit  
 Remark Peak = Result(PK) - Limit(PK)  
 Remark AVG = Result(AV) - Limit(AV)

<b>Product Name</b>	WHITE DRIVE BOX	<b>Test By</b>	Crystal Wu
<b>Test Model</b>	TB4001	<b>Test Date</b>	2016/08/12
<b>Test Mode</b>	IEEE 802.11g Mode / TX / CH Middle / Direct Mode_External Ant	<b>Temp. &amp; Humidity</b>	28°C, 52%

**966Chamber\_C at 3Meter / Vertical (6GHz ~ 18GHz)**

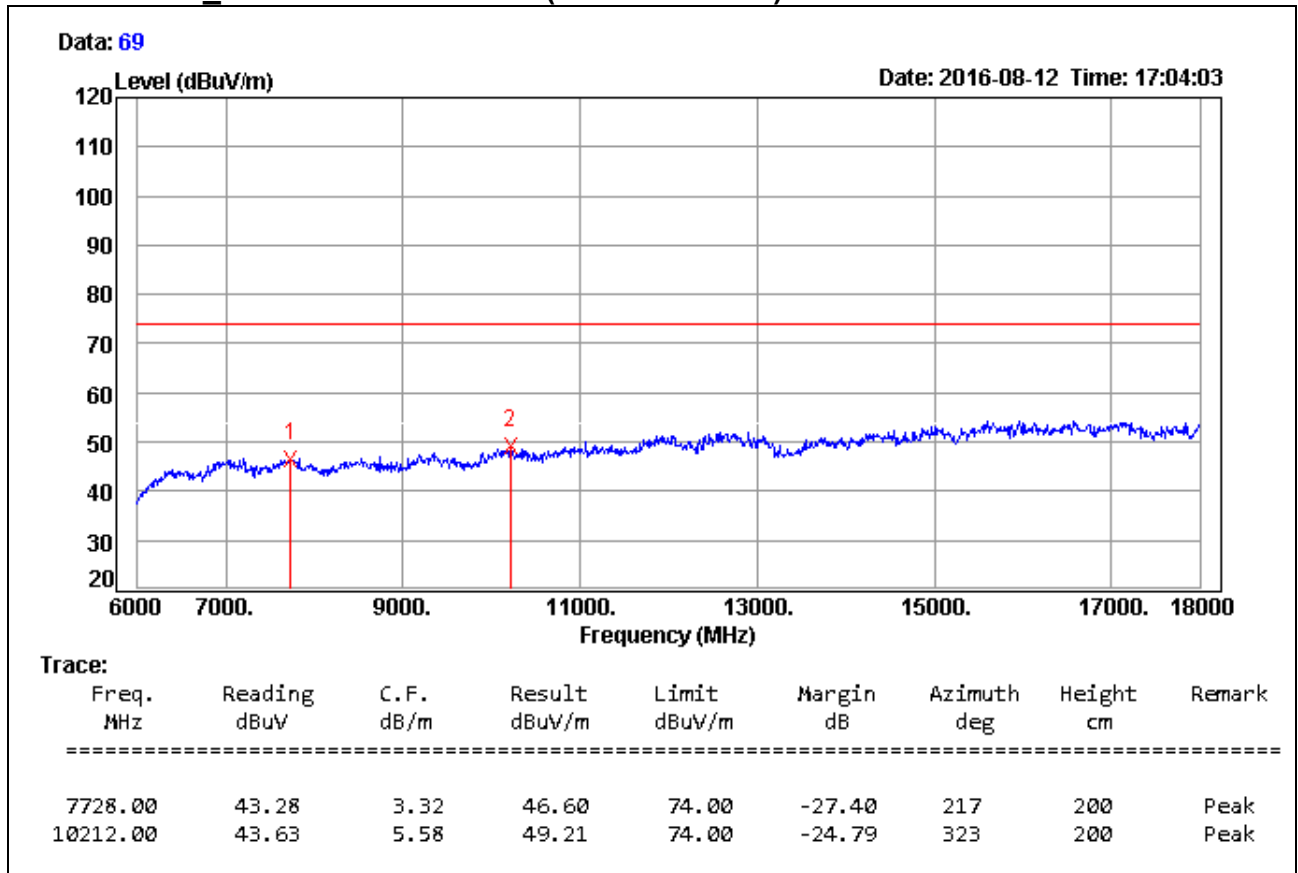

**Remark:**

1. Measuring frequencies from 1 GHz to the 10th harmonic of highest fundamental frequency.
2. Average test would be performed if the peak result were greater than the average limit.
3. Measurements above show only up to 6 maximum emissions noted, or would be lesser, with " N/A " remark, if no specific emissions from the EUT are recorded (ie: margin>20dB from the applicable limit) and considered that's already beyond the background noise floor.
4. Result = Reading + Correction Factor  
 Margin = Result – Limit  
 Remark Peak = Result(PK) – Limit(PK)  
 Remark AVG = Result(AV) – Limit(AV)

<b>Product Name</b>	WHITE DRIVE BOX	<b>Test By</b>	Crystal Wu
<b>Test Model</b>	TB4001	<b>Test Date</b>	2016/08/16
<b>Test Mode</b>	IEEE 802.11g Mode / TX / CH Middle / Direct Mode_External Ant	<b>Temp. &amp; Humidity</b>	28°C, 52%

**966Chamber\_C at 3Meter / Horizontal (18GHz ~ 26GHz)**

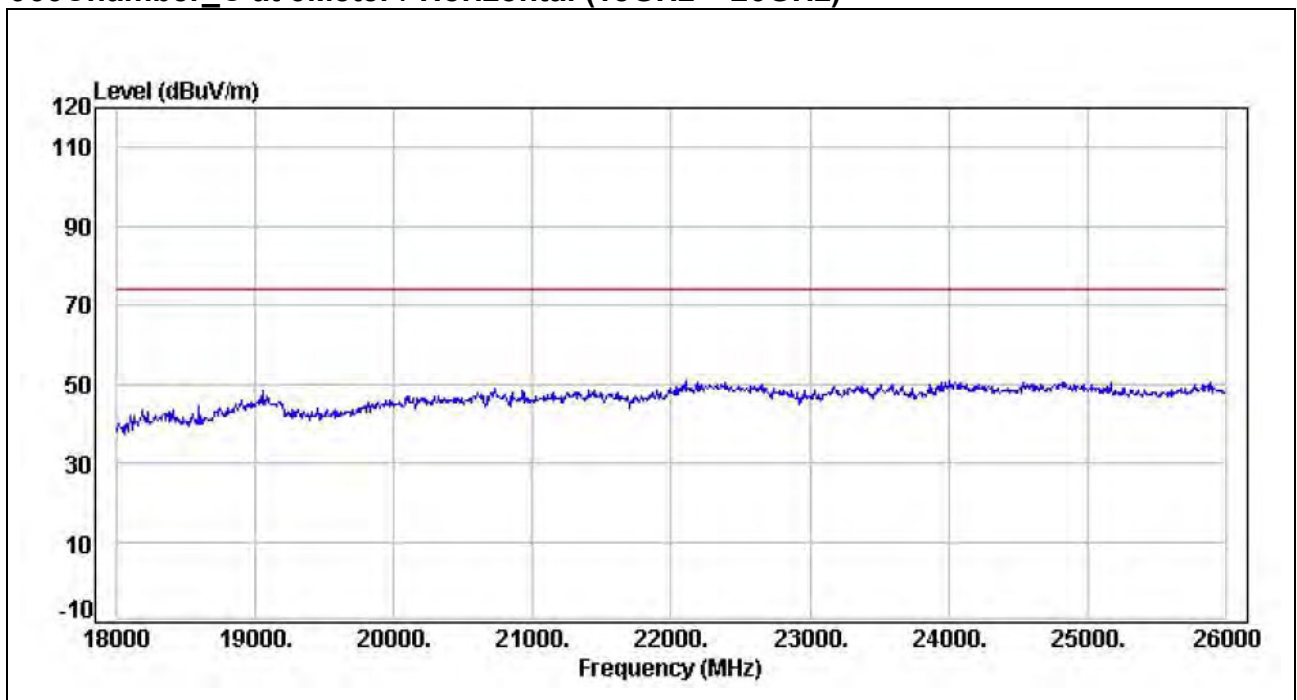

**Remark:**

1. Measuring frequencies from 1 GHz to the 10th harmonic of highest fundamental frequency.
2. Average test would be performed if the peak result were greater than the average limit.
3. Measurements above show only up to 6 maximum emissions noted, or would be lesser, with " N/A " remark, if no specific emissions from the EUT are recorded (ie: margin>20dB from the applicable limit) and considered that's already beyond the background noise floor.
4. Result = Reading + Correction Factor  
 Margin = Result – Limit  
 Remark Peak = Result(PK) – Limit(PK)  
 Remark AVG = Result(AV) – Limit(AV)

<b>Product Name</b>	WHITE DRIVE BOX	<b>Test By</b>	Crystal Wu
<b>Test Model</b>	TB4001	<b>Test Date</b>	2016/08/16
<b>Test Mode</b>	IEEE 802.11g Mode / TX / CH Middle / Direct Mode_External Ant	<b>Temp. &amp; Humidity</b>	28°C, 52%

**966Chamber\_C at 3Meter / Vertical (18GHz ~ 26GHz)**

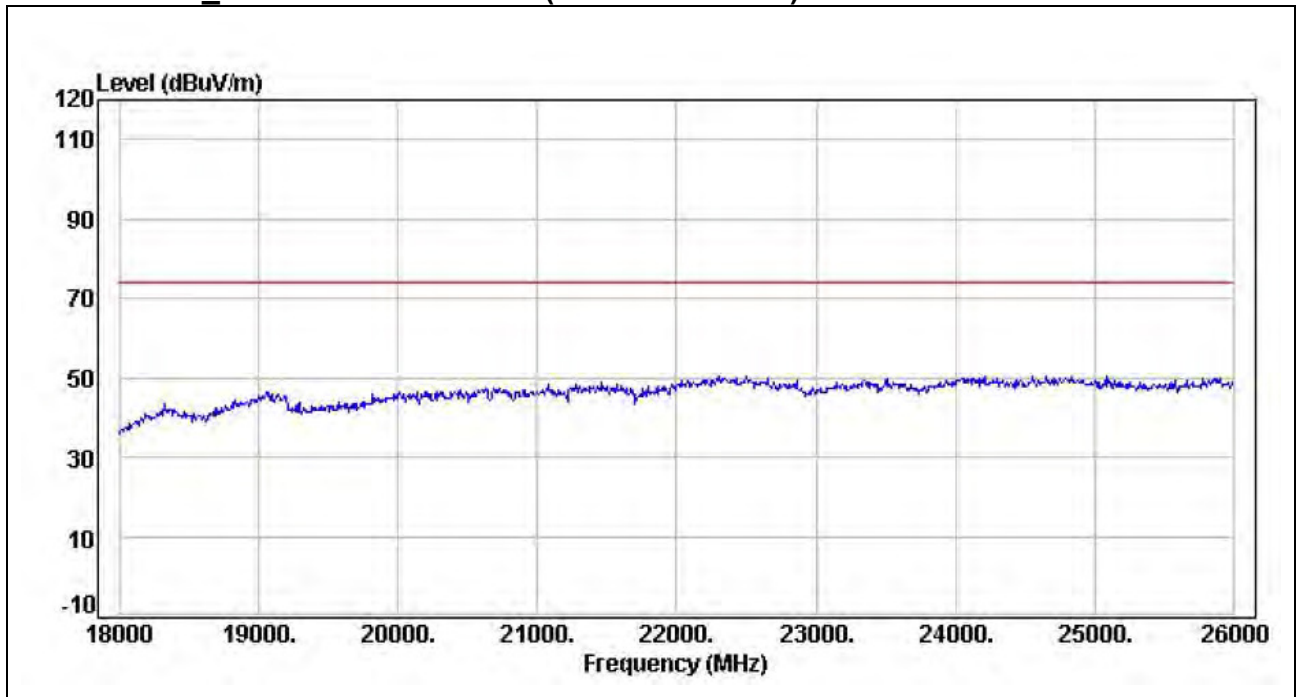

**Remark:**

1. Measuring frequencies from 1 GHz to the 10th harmonic of highest fundamental frequency.
2. Average test would be performed if the peak result were greater than the average limit.
3. Measurements above show only up to 6 maximum emissions noted, or would be lesser, with " N/A " remark, if no specific emissions from the EUT are recorded (ie: margin>20dB from the applicable limit) and considered that's already beyond the background noise floor.
4. Result = Reading + Correction Factor  
 Margin = Result – Limit  
 Remark Peak = Result(PK) – Limit(PK)  
 Remark AVG = Result(AV) – Limit(AV)

<b>Product Name</b>	WHITE DRIVE BOX	<b>Test By</b>	Crystal Wu
<b>Test Model</b>	TB4001	<b>Test Date</b>	2016/08/12
<b>Test Mode</b>	IEEE 802.11g Mode / TX / CH High / Direct Mode_External Ant	<b>Temp. &amp; Humidity</b>	28°C, 52%

**966Chamber\_C at 3Meter / Horizontal (1GHz ~ 3GHz)**

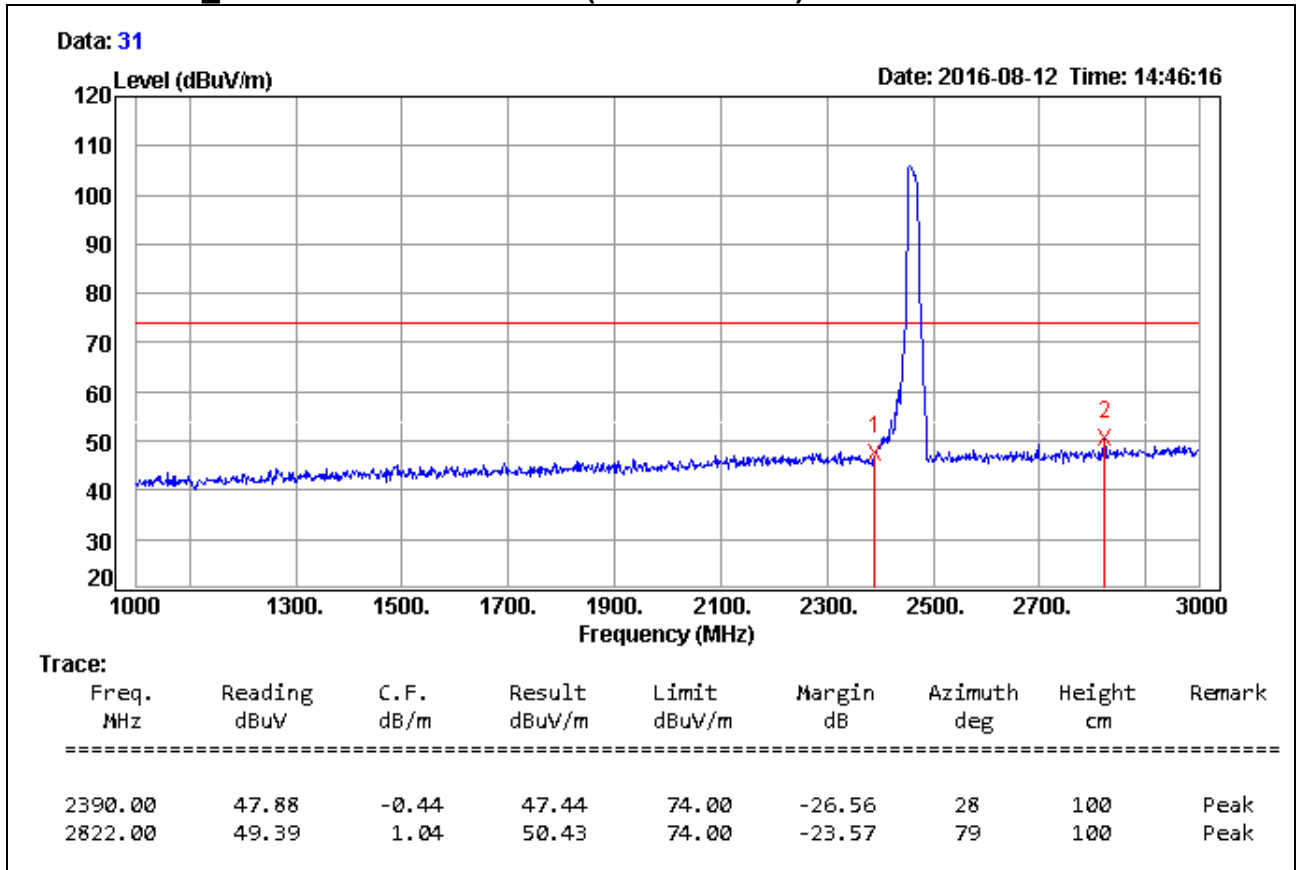

**Remark:**

1. Measuring frequencies from 1 GHz to the 10th harmonic of highest fundamental frequency.
2. Average test would be performed if the peak result were greater than the average limit.
3. Measurements above show only up to 6 maximum emissions noted, or would be lesser, with " N/A " remark, if no specific emissions from the EUT are recorded (ie: margin>20dB from the applicable limit) and considered that's already beyond the background noise floor.
4. Result = Reading + Correction Factor  
 Margin = Result – Limit  
 Remark Peak = Result(PK) – Limit(PK)  
 Remark AVG = Result(AV) – Limit(AV)

<b>Product Name</b>	WHITE DRIVE BOX	<b>Test By</b>	Crystal Wu
<b>Test Model</b>	TB4001	<b>Test Date</b>	2016/08/12
<b>Test Mode</b>	IEEE 802.11g Mode / TX / CH High / Direct Mode_External Ant	<b>Temp. &amp; Humidity</b>	28°C, 52%

**966Chamber\_C at 3Meter / Vertical (1GHz ~ 3GHz)**

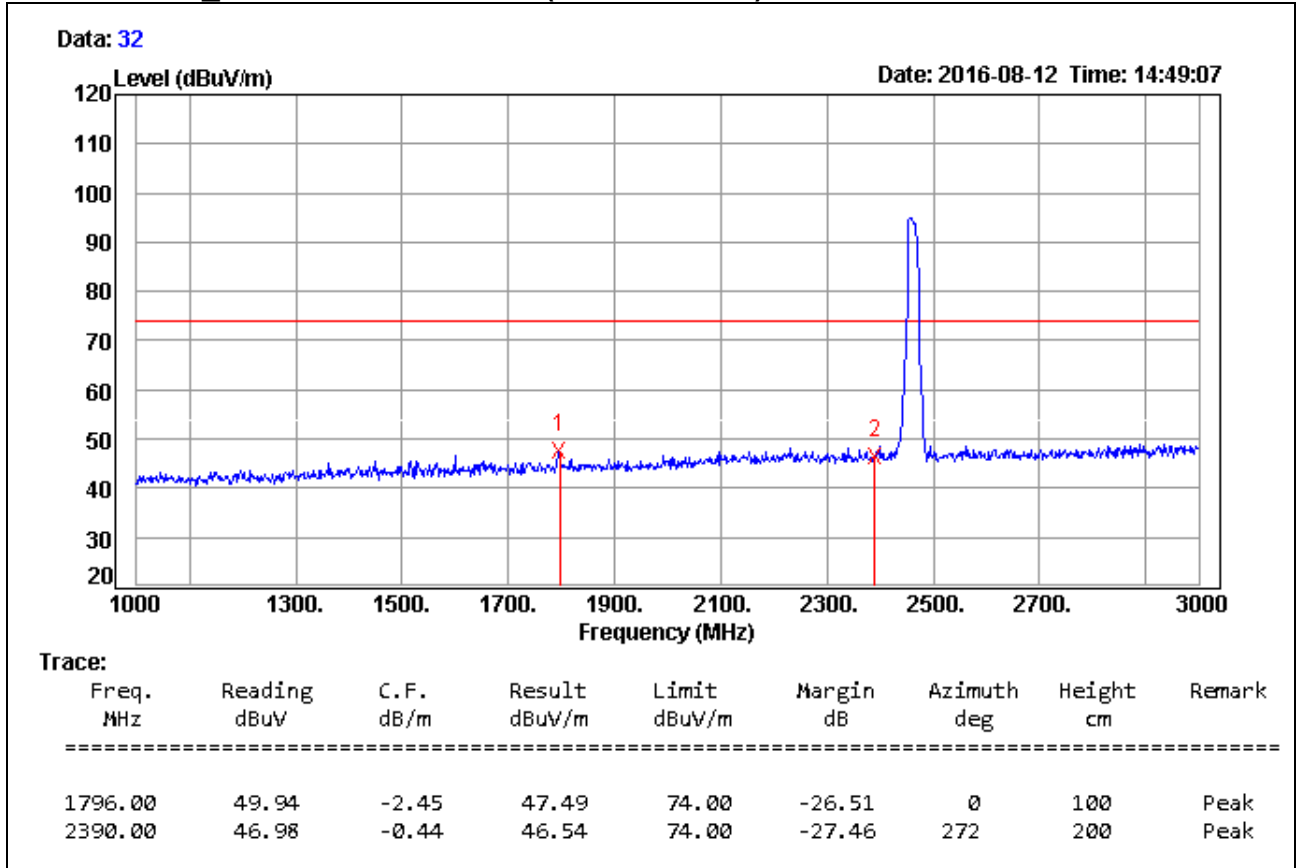

**Remark:**

1. Measuring frequencies from 1 GHz to the 10th harmonic of highest fundamental frequency.
2. Average test would be performed if the peak result were greater than the average limit.
3. Measurements above show only up to 6 maximum emissions noted, or would be lesser, with " N/A " remark, if no specific emissions from the EUT are recorded (ie: margin>20dB from the applicable limit) and considered that's already beyond the background noise floor.
4. Result = Reading + Correction Factor  
 Margin = Result – Limit  
 Remark Peak = Result(PK) – Limit(PK)  
 Remark AVG = Result(AV) – Limit(AV)

<b>Product Name</b>	WHITE DRIVE BOX	<b>Test By</b>	Crystal Wu
<b>Test Model</b>	TB4001	<b>Test Date</b>	2016/08/12
<b>Test Mode</b>	IEEE 802.11g Mode / TX / CH High / Direct Mode_External Ant	<b>Temp. &amp; Humidity</b>	28°C, 52%

**966Chamber\_C at 3Meter / Horizontal (3GHz ~ 6GHz)**

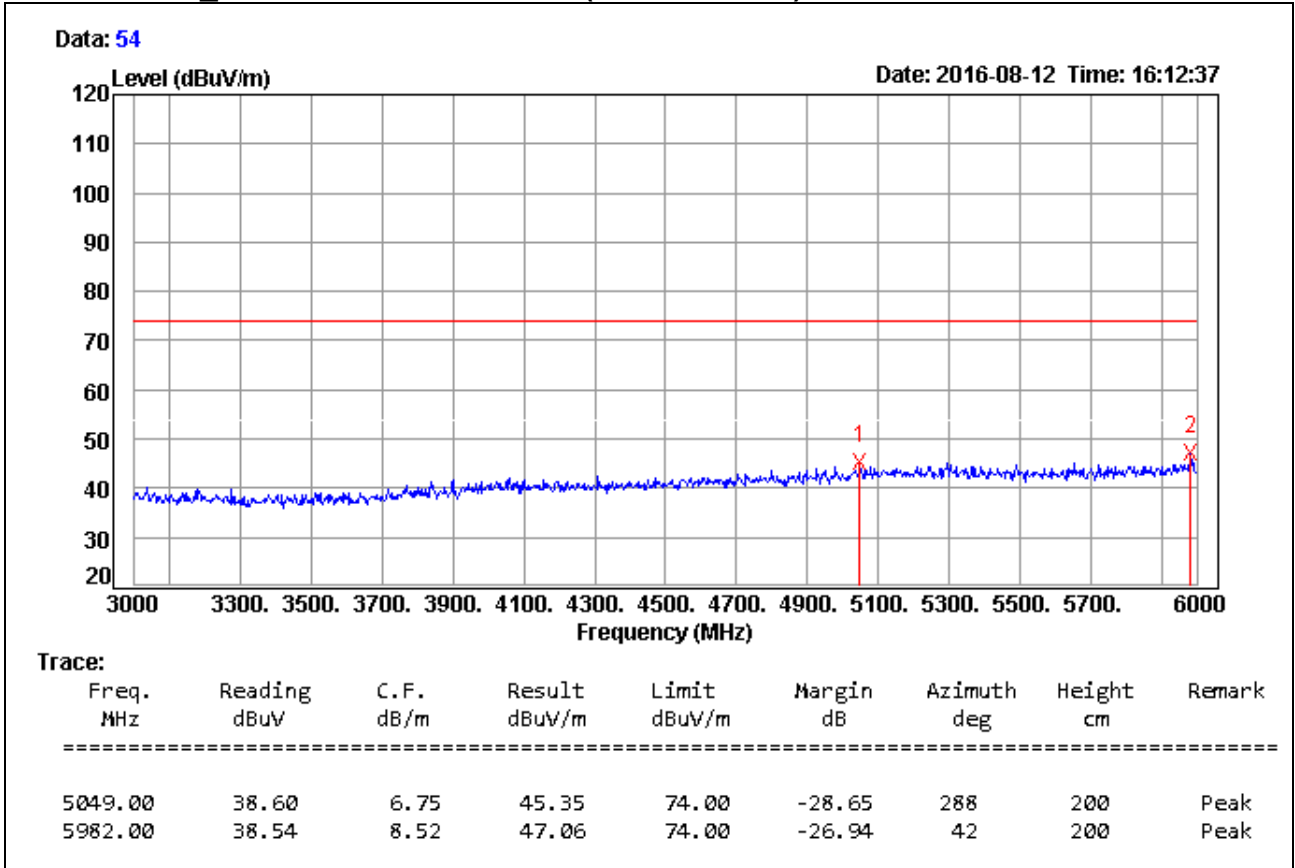

**Remark:**

1. Measuring frequencies from 1 GHz to the 10th harmonic of highest fundamental frequency.
2. Average test would be performed if the peak result were greater than the average limit.
3. Measurements above show only up to 6 maximum emissions noted, or would be lesser, with " N/A " remark, if no specific emissions from the EUT are recorded (ie: margin>20dB from the applicable limit) and considered that's already beyond the background noise floor.
4. Result = Reading + Correction Factor  
 Margin = Result – Limit  
 Remark Peak = Result(PK) – Limit(PK)  
 Remark AVG = Result(AV) – Limit(AV)



<b>Product Name</b>	WHITE DRIVE BOX	<b>Test By</b>	Crystal Wu
<b>Test Model</b>	TB4001	<b>Test Date</b>	2016/08/12
<b>Test Mode</b>	IEEE 802.11g Mode / TX / CH High / Direct Mode_External Ant	<b>Temp. &amp; Humidity</b>	28°C, 52%

**966Chamber\_C at 3Meter / Vertical (3GHz ~ 6GHz)**

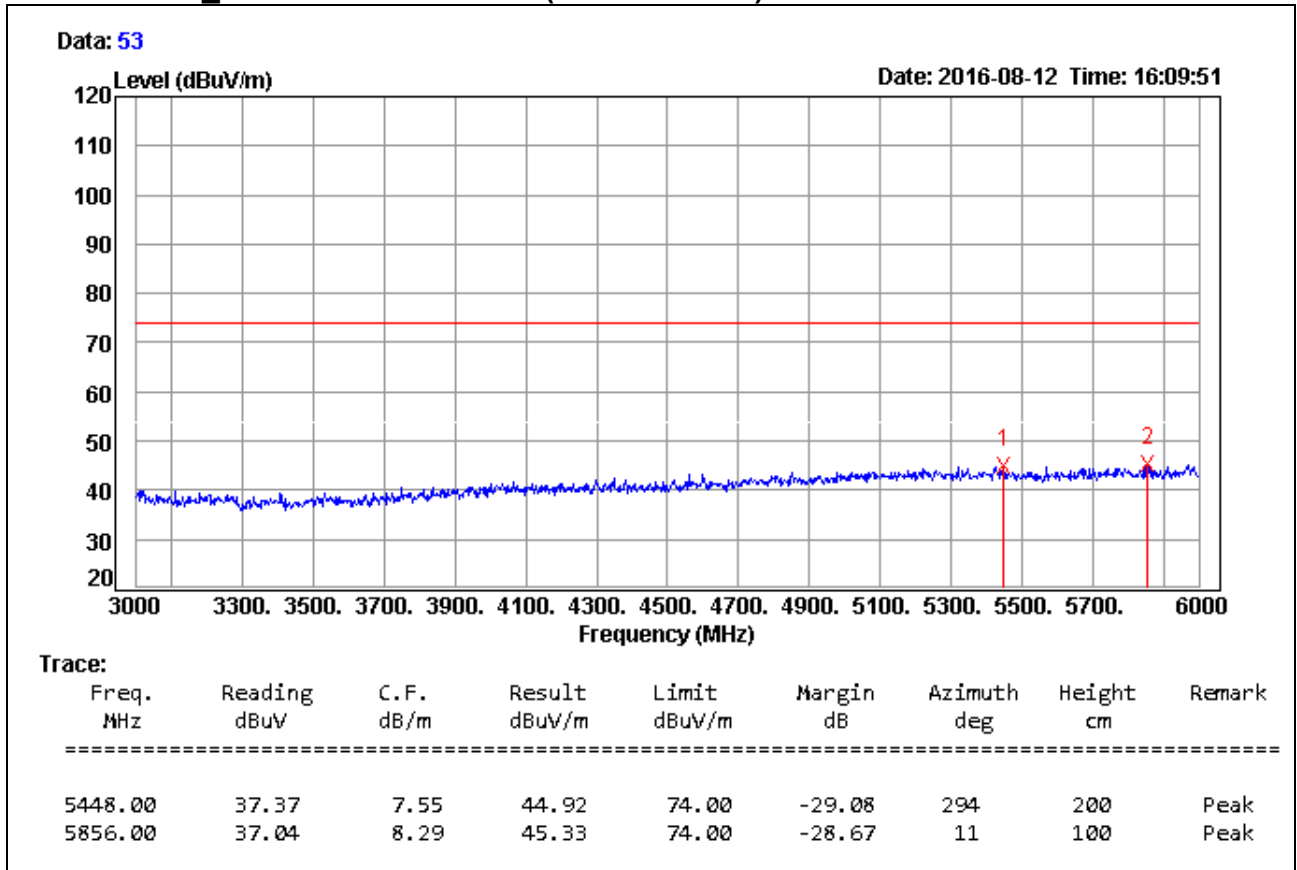

**Remark:**

1. Measuring frequencies from 1 GHz to the 10th harmonic of highest fundamental frequency.
2. Average test would be performed if the peak result were greater than the average limit.
3. Measurements above show only up to 6 maximum emissions noted, or would be lesser, with " N/A " remark, if no specific emissions from the EUT are recorded (ie: margin>20dB from the applicable limit) and considered that's already beyond the background noise floor.
4. Result = Reading + Correction Factor  
 Margin = Result – Limit  
 Remark Peak = Result(PK) – Limit(PK)  
 Remark AVG = Result(AV) – Limit(AV)

<b>Product Name</b>	WHITE DRIVE BOX	<b>Test By</b>	Crystal Wu
<b>Test Model</b>	TB4001	<b>Test Date</b>	2016/08/12
<b>Test Mode</b>	IEEE 802.11g Mode / TX / CH High / Direct Mode_External Ant	<b>Temp. &amp; Humidity</b>	28°C, 52%

**966Chamber\_C at 3Meter / Horizontal (6GHz ~ 18GHz)**

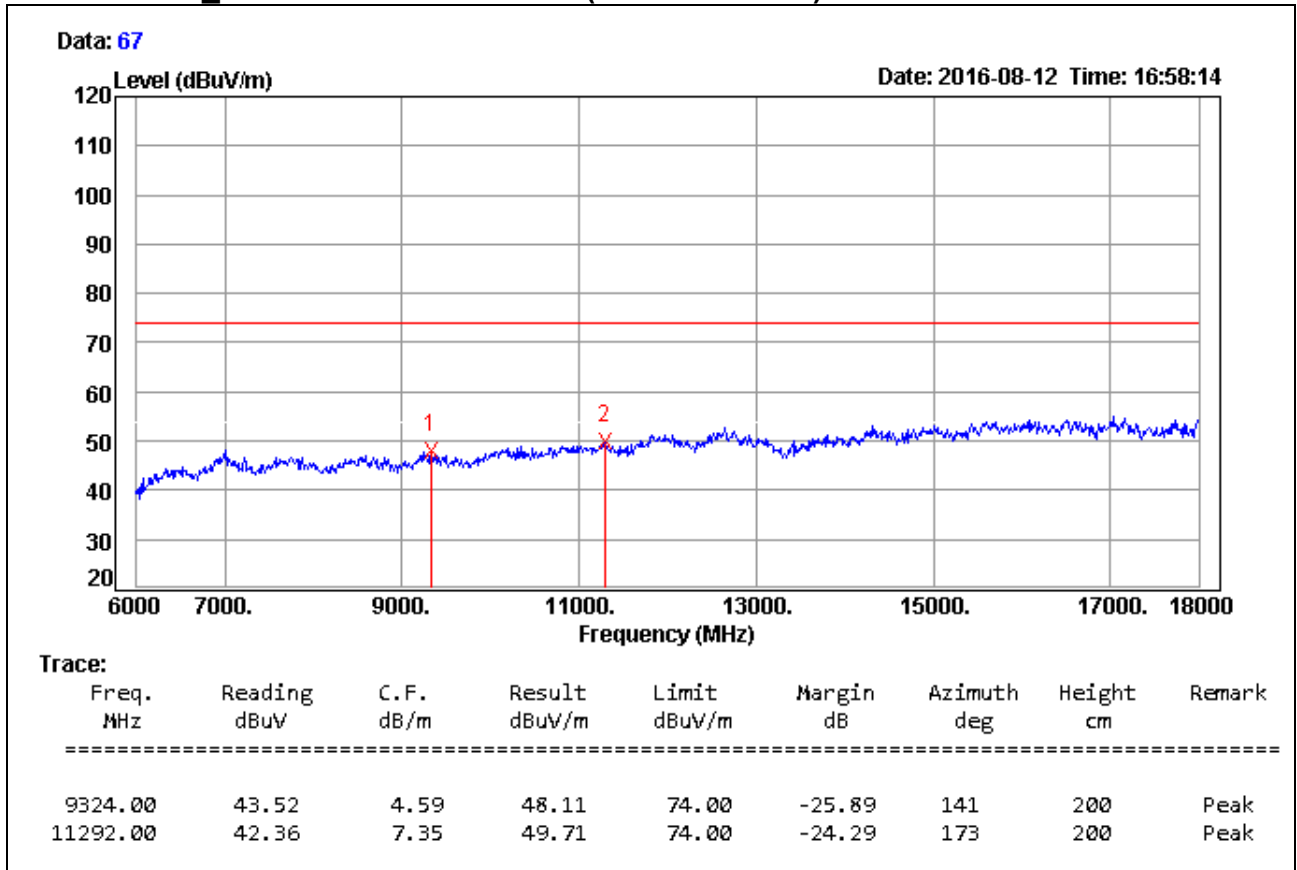

**Remark:**

1. Measuring frequencies from 1 GHz to the 10th harmonic of highest fundamental frequency.
2. Average test would be performed if the peak result were greater than the average limit.
3. Measurements above show only up to 6 maximum emissions noted, or would be lesser, with " N/A " remark, if no specific emissions from the EUT are recorded (ie: margin>20dB from the applicable limit) and considered that's already beyond the background noise floor.
4. Result = Reading + Correction Factor  
 Margin = Result – Limit  
 Remark Peak = Result(PK) – Limit(PK)  
 Remark AVG = Result(AV) – Limit(AV)

<b>Product Name</b>	WHITE DRIVE BOX	<b>Test By</b>	Crystal Wu
<b>Test Model</b>	TB4001	<b>Test Date</b>	2016/08/12
<b>Test Mode</b>	IEEE 802.11g Mode / TX / CH High / Direct Mode_External Ant	<b>Temp. &amp; Humidity</b>	28°C, 52%

**966Chamber\_C at 3Meter / Vertical (6GHz ~ 18GHz)**

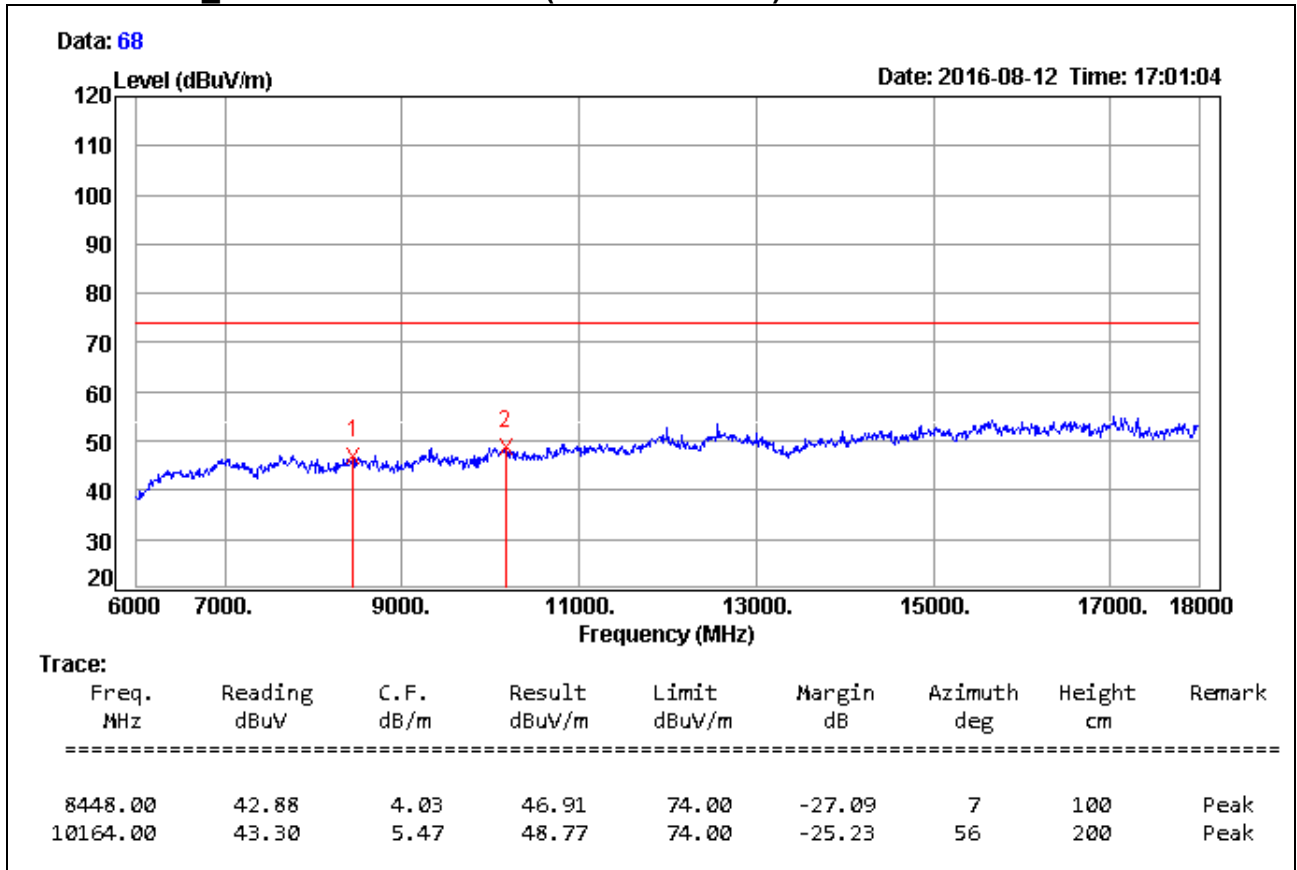

**Remark:**

1. Measuring frequencies from 1 GHz to the 10th harmonic of highest fundamental frequency.
2. Average test would be performed if the peak result were greater than the average limit.
3. Measurements above show only up to 6 maximum emissions noted, or would be lesser, with " N/A " remark, if no specific emissions from the EUT are recorded (ie: margin>20dB from the applicable limit) and considered that's already beyond the background noise floor.
4. Result = Reading + Correction Factor  
 Margin = Result – Limit  
 Remark Peak = Result(PK) – Limit(PK)  
 Remark AVG = Result(AV) – Limit(AV)

<b>Product Name</b>	WHITE DRIVE BOX	<b>Test By</b>	Crystal Wu
<b>Test Model</b>	TB4001	<b>Test Date</b>	2016/08/16
<b>Test Mode</b>	IEEE 802.11g Mode / TX / CH High / Direct Mode_External Ant	<b>Temp. &amp; Humidity</b>	28°C, 52%

**966Chamber\_C at 3Meter / Horizontal (18GHz ~ 26GHz)**

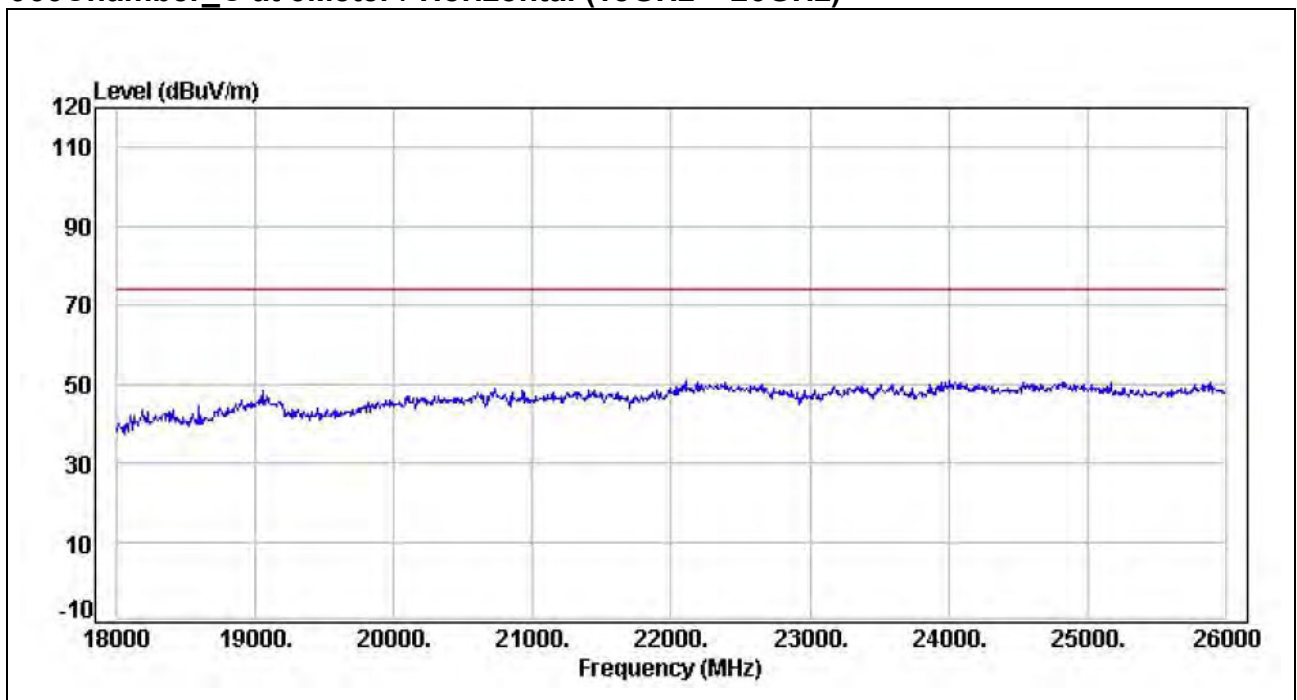

**Remark:**

1. Measuring frequencies from 1 GHz to the 10th harmonic of highest fundamental frequency.
2. Average test would be performed if the peak result were greater than the average limit.
3. Measurements above show only up to 6 maximum emissions noted, or would be lesser, with " N/A " remark, if no specific emissions from the EUT are recorded (ie: margin>20dB from the applicable limit) and considered that's already beyond the background noise floor.
4. Result = Reading + Correction Factor  
 Margin = Result – Limit  
 Remark Peak = Result(PK) – Limit(PK)  
 Remark AVG = Result(AV) – Limit(AV)

<b>Product Name</b>	WHITE DRIVE BOX	<b>Test By</b>	Crystal Wu
<b>Test Model</b>	TB4001	<b>Test Date</b>	2016/08/16
<b>Test Mode</b>	IEEE 802.11g Mode / TX / CH High / Direct Mode_External Ant	<b>Temp. &amp; Humidity</b>	28°C, 52%

**966Chamber\_C at 3Meter / Vertical (18GHz ~ 26GHz)**

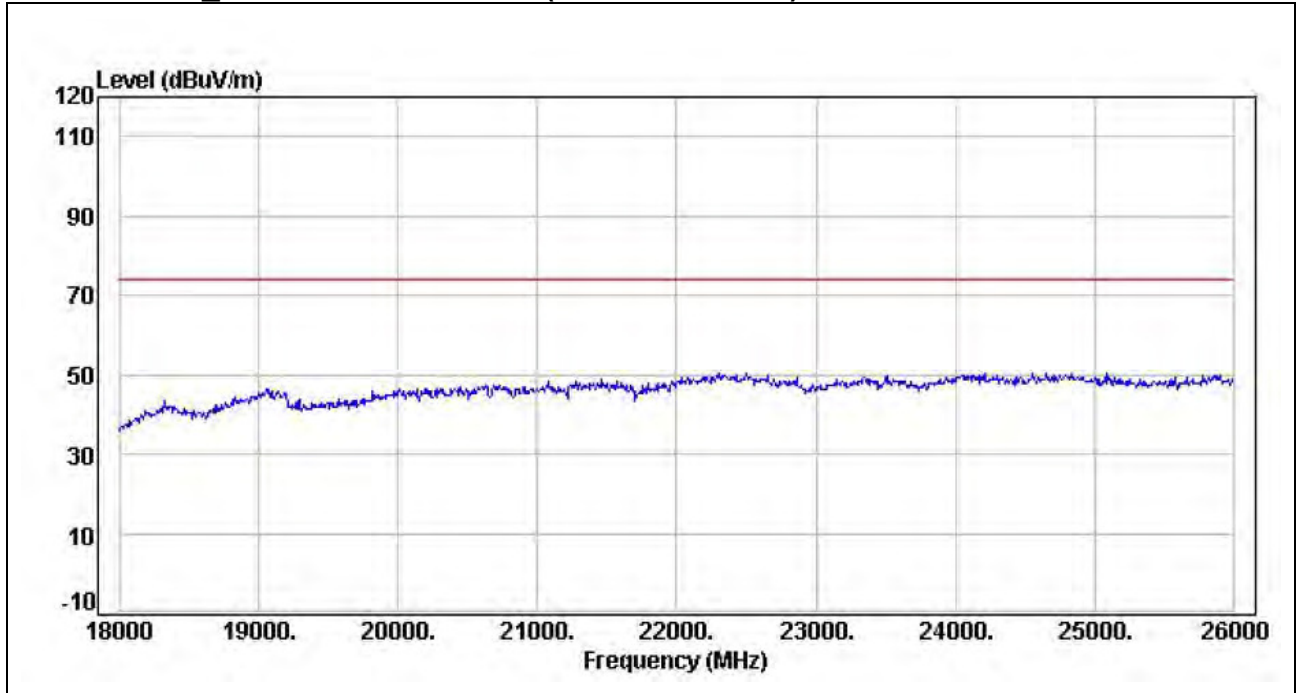

**Remark:**

1. Measuring frequencies from 1 GHz to the 10th harmonic of highest fundamental frequency.
2. Average test would be performed if the peak result were greater than the average limit.
3. Measurements above show only up to 6 maximum emissions noted, or would be lesser, with " N/A " remark, if no specific emissions from the EUT are recorded (ie: margin>20dB from the applicable limit) and considered that's already beyond the background noise floor.
4.  $Result = Reading + Correction\ Factor$   
 $Margin = Result - Limit$   
 $Remark\ Peak = Result(PK) - Limit(PK)$   
 $Remark\ AVG = Result(AV) - Limit(AV)$

<b>Product Name</b>	WHITE DRIVE BOX	<b>Test By</b>	Crystal Wu
<b>Test Model</b>	TB4001	<b>Test Date</b>	2016/08/16
<b>Test Mode</b>	IEEE 802.11gn HT20 MCS0 Mode / TX / CH Low / Direct Mode_External Ant	<b>Temp. &amp; Humidity</b>	28°C, 52%

**966Chamber\_C at 3Meter / Horizontal (1GHz ~ 3GHz)**

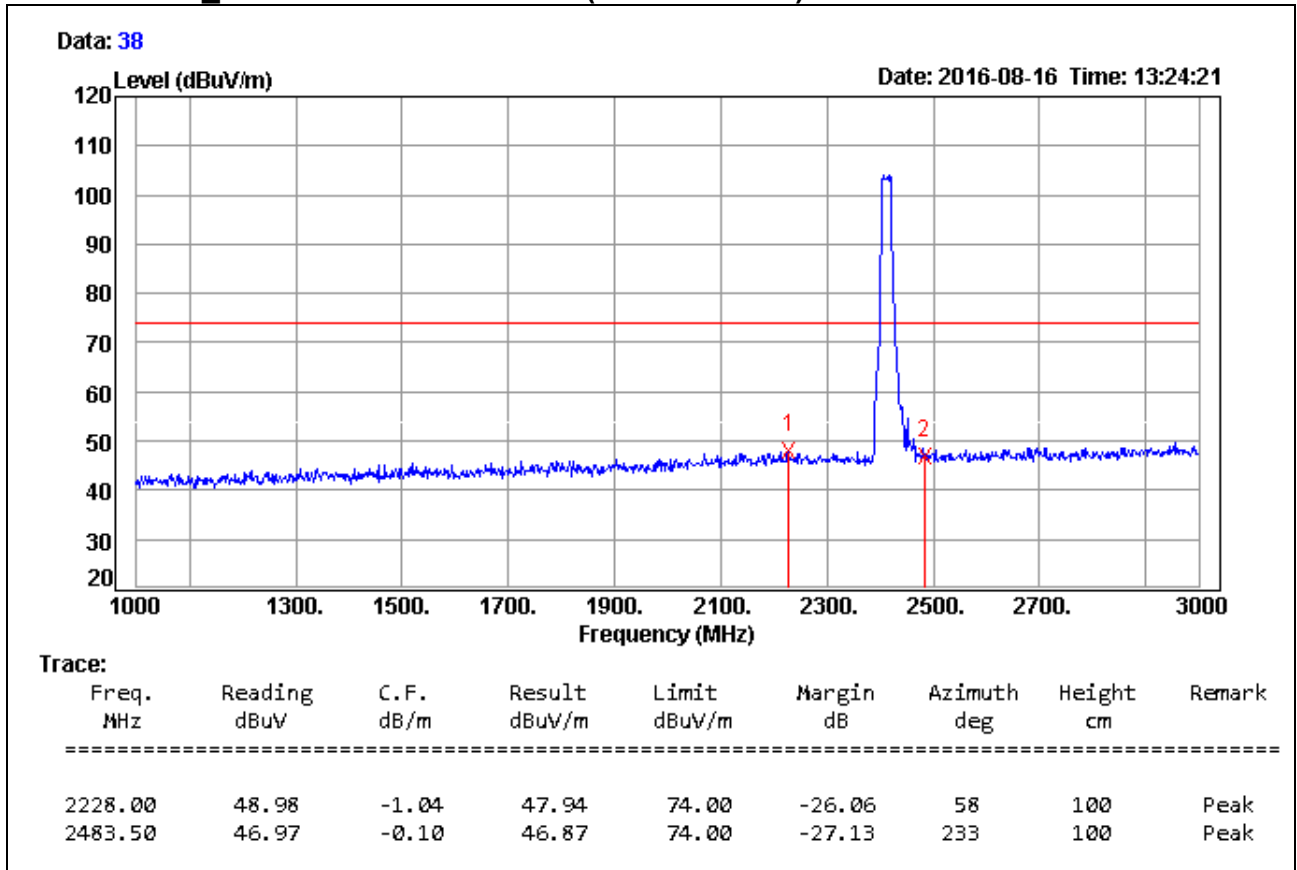

**Remark:**

1. Measuring frequencies from 1 GHz to the 10th harmonic of highest fundamental frequency.
2. Average test would be performed if the peak result were greater than the average limit.
3. Measurements above show only up to 6 maximum emissions noted, or would be lesser, with " N/A " remark, if no specific emissions from the EUT are recorded (ie: margin>20dB from the applicable limit) and considered that's already beyond the background noise floor.
4. Result = Reading + Correction Factor  
 Margin = Result – Limit  
 Remark Peak = Result(PK) – Limit(PK)  
 Remark AVG = Result(AV) – Limit(AV)

<b>Product Name</b>	WHITE DRIVE BOX	<b>Test By</b>	Crystal Wu
<b>Test Model</b>	TB4001	<b>Test Date</b>	2016/08/16
<b>Test Mode</b>	IEEE 802.11gn HT20 MCS0 Mode / TX / CH Low / Direct Mode_External Ant	<b>Temp. &amp; Humidity</b>	28°C, 52%

**966Chamber\_C at 3Meter / Vertical (1GHz ~ 3GHz)**

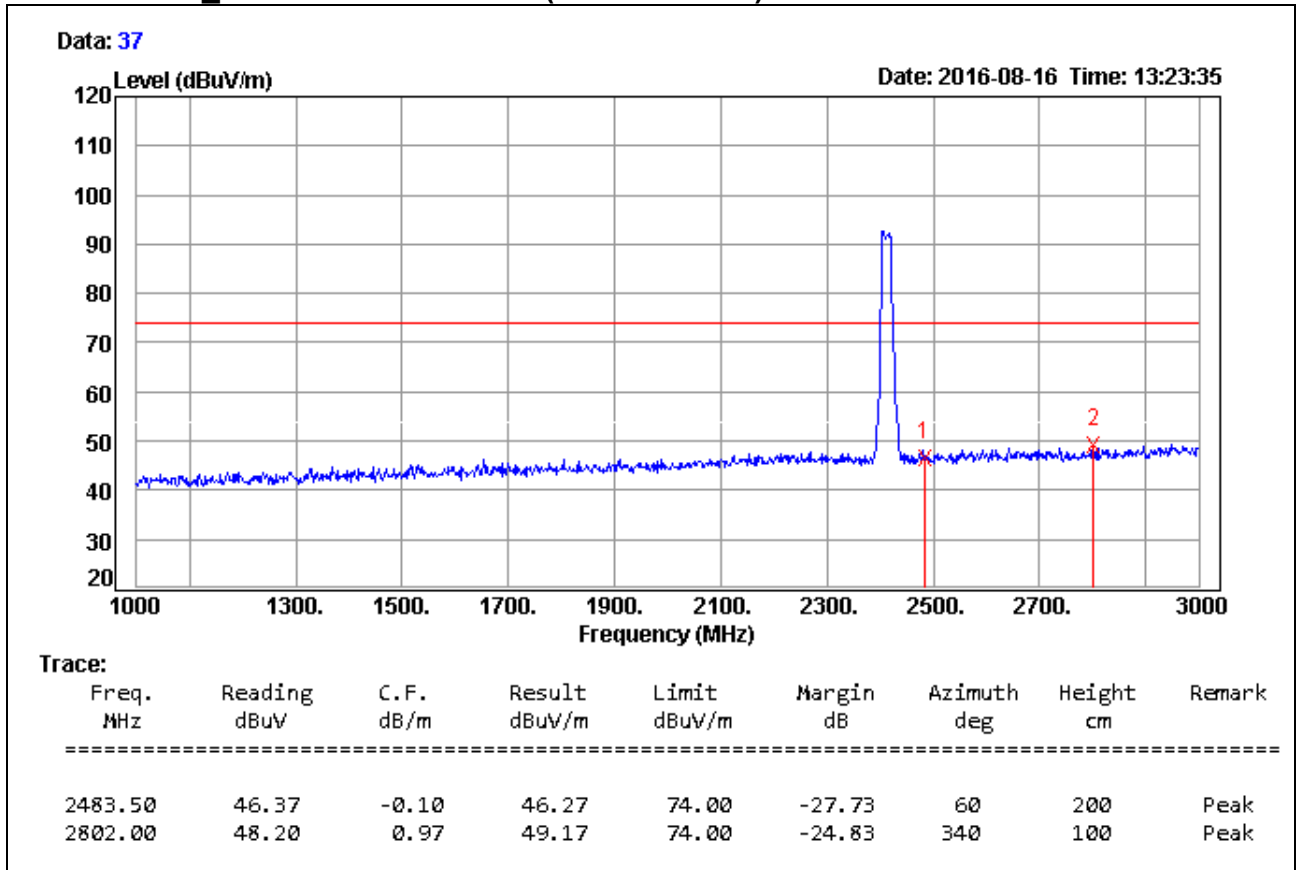

**Remark:**

1. Measuring frequencies from 1 GHz to the 10th harmonic of highest fundamental frequency.
2. Average test would be performed if the peak result were greater than the average limit.
3. Measurements above show only up to 6 maximum emissions noted, or would be lesser, with " N/A " remark, if no specific emissions from the EUT are recorded (ie: margin>20dB from the applicable limit) and considered that's already beyond the background noise floor.
4. Result = Reading + Correction Factor  
 Margin = Result – Limit  
 Remark Peak = Result(PK) – Limit(PK)  
 Remark AVG = Result(AV) – Limit(AV)

<b>Product Name</b>	WHITE DRIVE BOX	<b>Test By</b>	Crystal Wu
<b>Test Model</b>	TB4001	<b>Test Date</b>	2016/08/12
<b>Test Mode</b>	IEEE 802.11gn HT20 MCS0 Mode / TX / CH Low / Direct Mode_External Ant	<b>Temp. &amp; Humidity</b>	28°C, 52%

**966Chamber\_C at 3Meter / Horizontal (3GHz ~ 6GHz)**

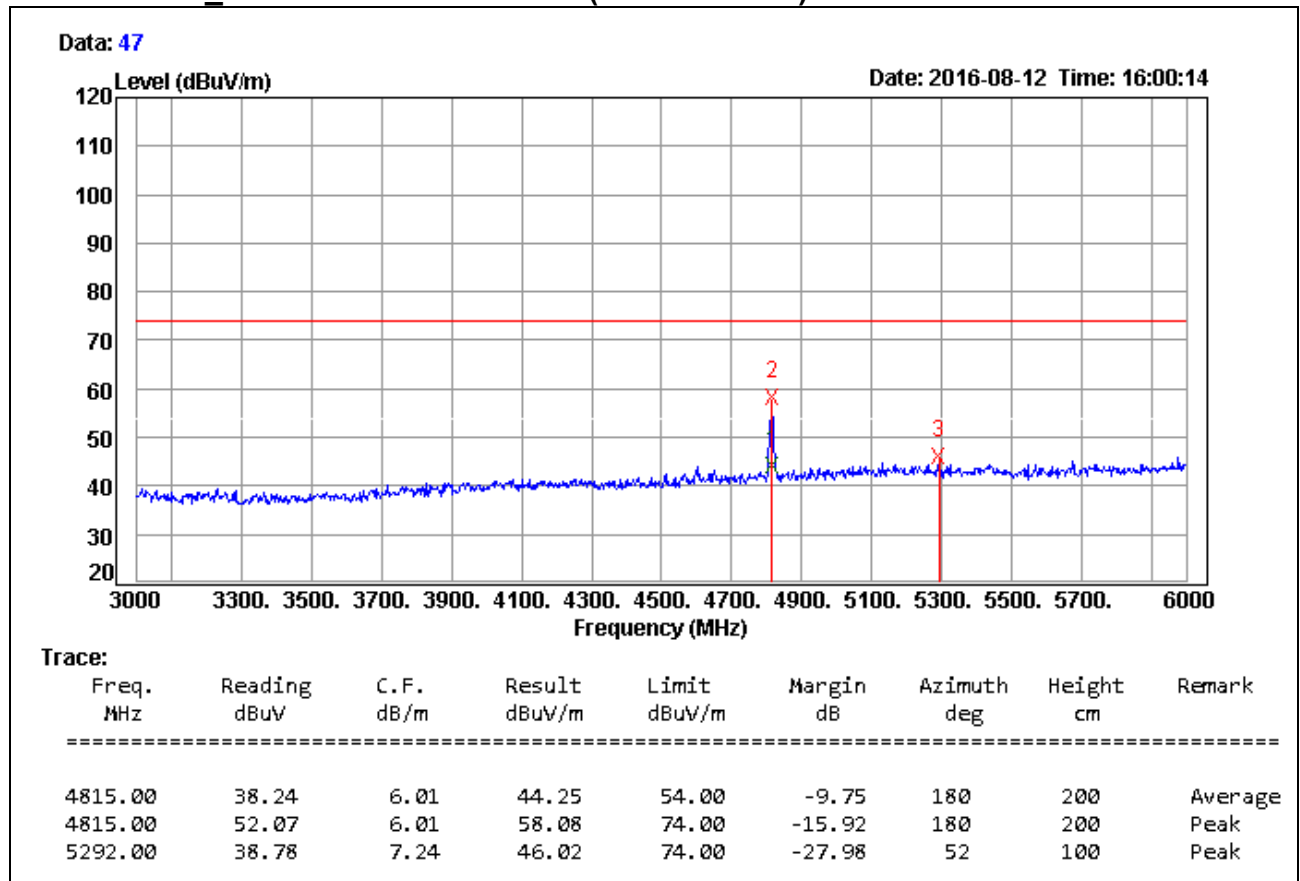

**Remark:**

1. Measuring frequencies from 1 GHz to the 10th harmonic of highest fundamental frequency.
2. Average test would be performed if the peak result were greater than the average limit.
3. Measurements above show only up to 6 maximum emissions noted, or would be lesser, with " N/A " remark, if no specific emissions from the EUT are recorded (ie: margin>20dB from the applicable limit) and considered that's already beyond the background noise floor.
4. Result = Reading + Correction Factor  
 Margin = Result - Limit  
 Remark Peak = Result(PK) - Limit(PK)  
 Remark AVG = Result(AV) - Limit(AV)



<b>Product Name</b>	WHITE DRIVE BOX	<b>Test By</b>	Crystal Wu
<b>Test Model</b>	TB4001	<b>Test Date</b>	2016/08/12
<b>Test Mode</b>	IEEE 802.11gn HT20 MCS0 Mode / TX / CH Low / Direct Mode_External Ant	<b>Temp. &amp; Humidity</b>	28°C, 52%

**966Chamber\_C at 3Meter / Vertical (3GHz ~ 6GHz)**

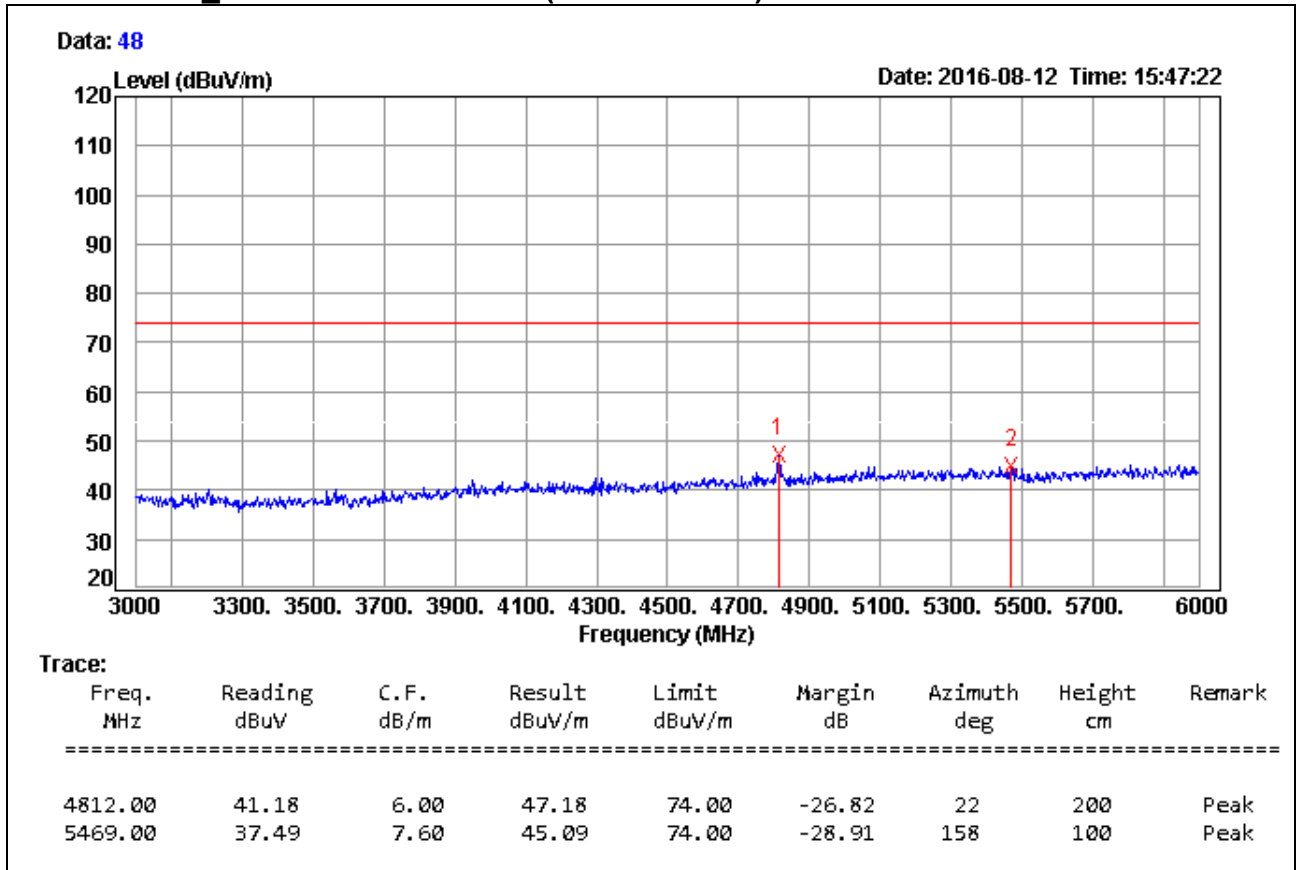

**Remark:**

1. Measuring frequencies from 1 GHz to the 10th harmonic of highest fundamental frequency.
2. Average test would be performed if the peak result were greater than the average limit.
3. Measurements above show only up to 6 maximum emissions noted, or would be lesser, with " N/A " remark, if no specific emissions from the EUT are recorded (ie: margin>20dB from the applicable limit) and considered that's already beyond the background noise floor.
4. Result = Reading + Correction Factor  
 Margin = Result – Limit  
 Remark Peak = Result(PK) – Limit(PK)  
 Remark AVG = Result(AV) – Limit(AV)

<b>Product Name</b>	WHITE DRIVE BOX	<b>Test By</b>	Crystal Wu
<b>Test Model</b>	TB4001	<b>Test Date</b>	2016/08/12
<b>Test Mode</b>	IEEE 802.11gn HT20 MCS0 Mode / TX / CH Low / Direct Mode_External Ant	<b>Temp. &amp; Humidity</b>	28°C, 52%

**966Chamber\_C at 3Meter / Horizontal (6GHz ~ 18GHz)**

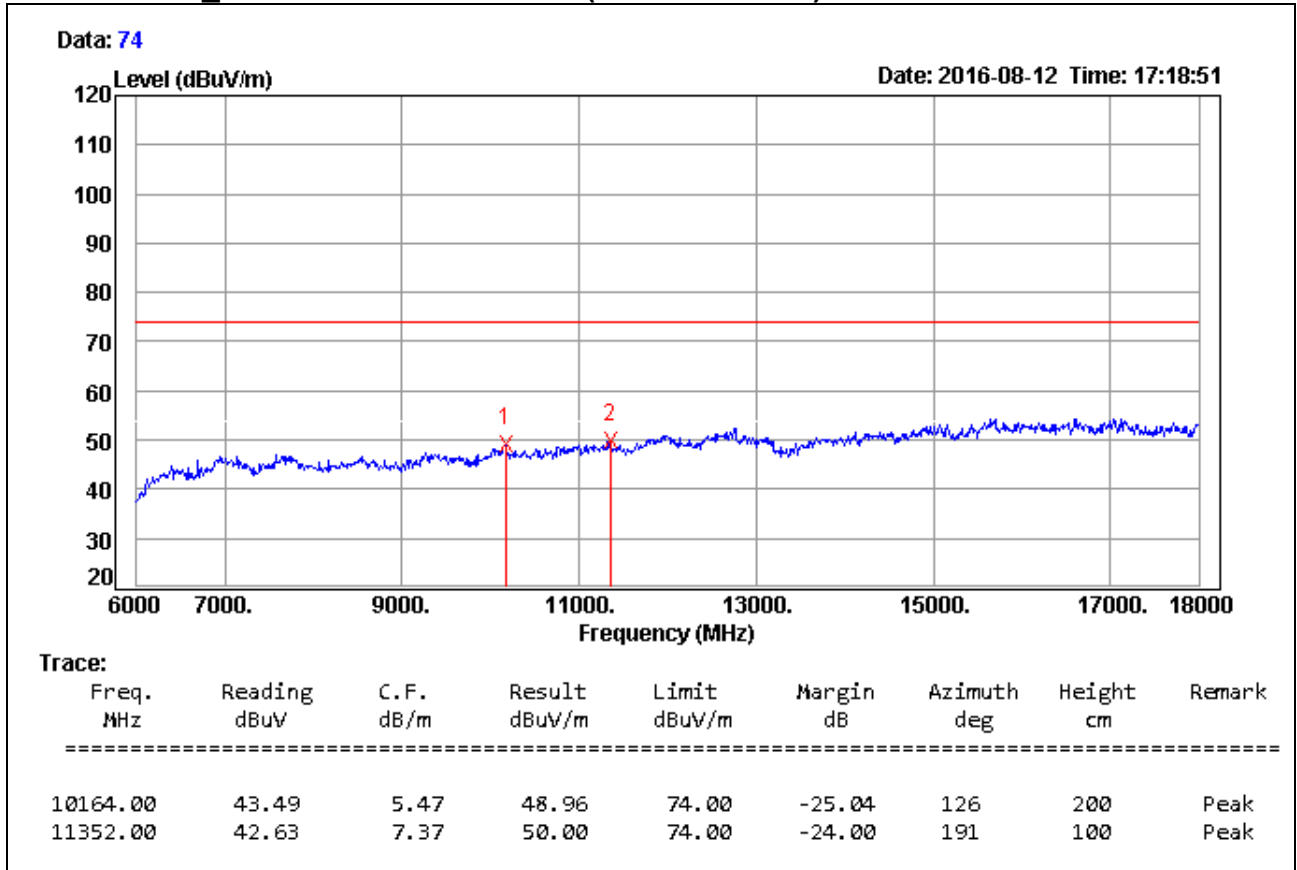

**Remark:**

1. Measuring frequencies from 1 GHz to the 10th harmonic of highest fundamental frequency.
2. Average test would be performed if the peak result were greater than the average limit.
3. Measurements above show only up to 6 maximum emissions noted, or would be lesser, with " N/A " remark, if no specific emissions from the EUT are recorded (ie: margin>20dB from the applicable limit) and considered that's already beyond the background noise floor.
4.  $Result = Reading + Correction\ Factor$   
 $Margin = Result - Limit$   
 $Remark\ Peak = Result(PK) - Limit(PK)$   
 $Remark\ AVG = Result(AV) - Limit(AV)$

<b>Product Name</b>	WHITE DRIVE BOX	<b>Test By</b>	Crystal Wu
<b>Test Model</b>	TB4001	<b>Test Date</b>	2016/08/12
<b>Test Mode</b>	IEEE 802.11gn HT20 MCS0 Mode / TX / CH Low / Direct Mode_External Ant	<b>Temp. &amp; Humidity</b>	28°C, 52%

**966Chamber\_C at 3Meter / Vertical (6GHz ~ 18GHz)**

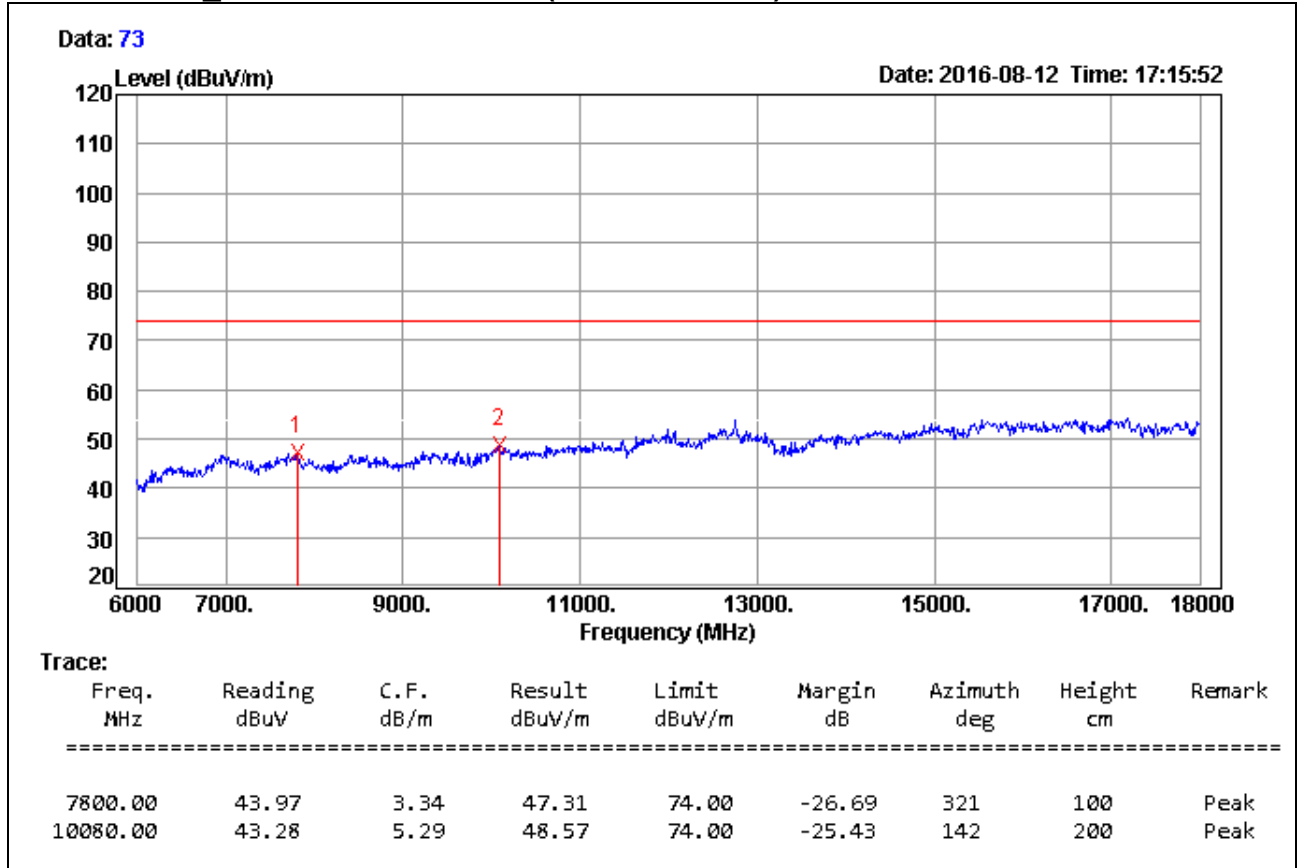

**Remark:**

1. Measuring frequencies from 1 GHz to the 10th harmonic of highest fundamental frequency.
2. Average test would be performed if the peak result were greater than the average limit.
3. Measurements above show only up to 6 maximum emissions noted, or would be lesser, with " N/A " remark, if no specific emissions from the EUT are recorded (ie: margin>20dB from the applicable limit) and considered that's already beyond the background noise floor.
4. Result = Reading + Correction Factor  
 Margin = Result – Limit  
 Remark Peak = Result(PK) – Limit(PK)  
 Remark AVG = Result(AV) – Limit(AV)

<b>Product Name</b>	WHITE DRIVE BOX	<b>Test By</b>	Crystal Wu
<b>Test Model</b>	TB4001	<b>Test Date</b>	2016/08/16
<b>Test Mode</b>	IEEE 802.11gn HT20 MCS0 Mode / TX / CH Low / Direct Mode_External Ant	<b>Temp. &amp; Humidity</b>	28°C, 52%

**966Chamber\_C at 3Meter / Horizontal (18GHz ~ 26GHz)**

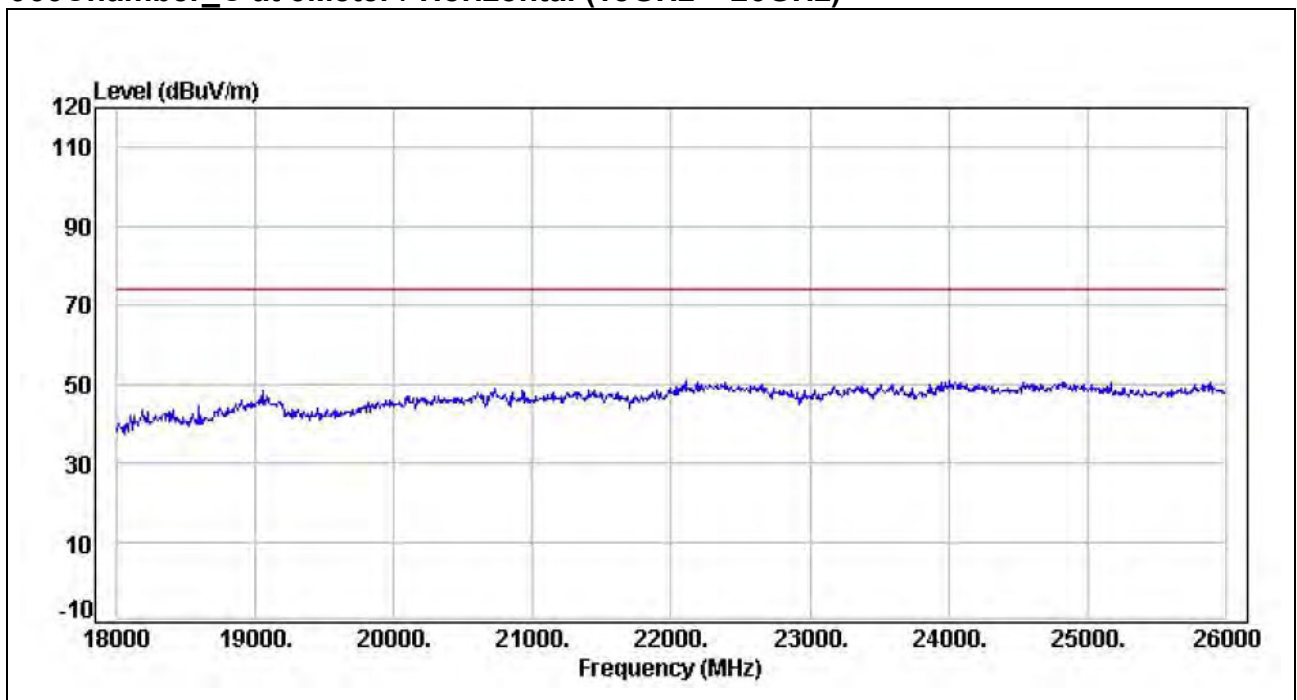

**Remark:**

1. Measuring frequencies from 1 GHz to the 10th harmonic of highest fundamental frequency.
2. Average test would be performed if the peak result were greater than the average limit.
3. Measurements above show only up to 6 maximum emissions noted, or would be lesser, with " N/A " remark, if no specific emissions from the EUT are recorded (ie: margin>20dB from the applicable limit) and considered that's already beyond the background noise floor.
4. Result = Reading + Correction Factor  
 Margin = Result – Limit  
 Remark Peak = Result(PK) – Limit(PK)  
 Remark AVG = Result(AV) – Limit(AV)

<b>Product Name</b>	WHITE DRIVE BOX	<b>Test By</b>	Crystal Wu
<b>Test Model</b>	TB4001	<b>Test Date</b>	2016/08/16
<b>Test Mode</b>	IEEE 802.11gn HT20 MCS0 Mode / TX / CH Low / Direct Mode_External Ant	<b>Temp. &amp; Humidity</b>	28°C, 52%

**966Chamber\_C at 3Meter / Vertical (18GHz ~ 26GHz)**

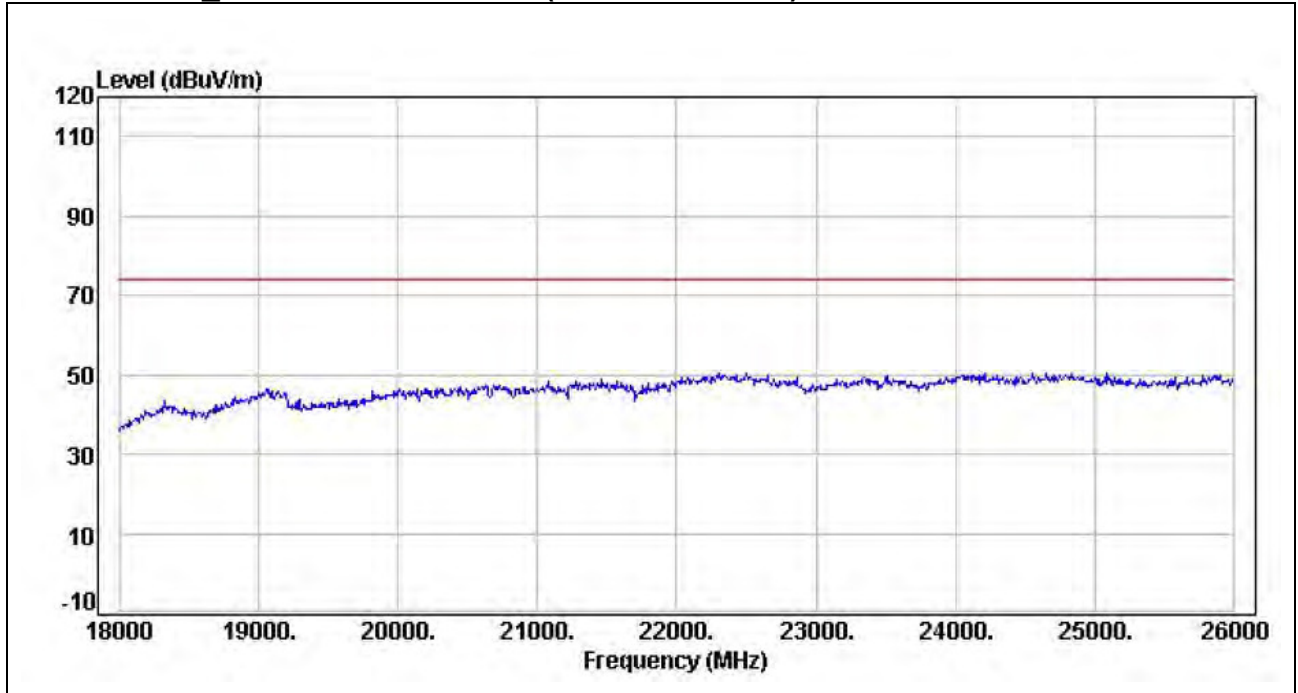

**Remark:**

1. Measuring frequencies from 1 GHz to the 10th harmonic of highest fundamental frequency.
2. Average test would be performed if the peak result were greater than the average limit.
3. Measurements above show only up to 6 maximum emissions noted, or would be lesser, with " N/A " remark, if no specific emissions from the EUT are recorded (ie: margin>20dB from the applicable limit) and considered that's already beyond the background noise floor.
4.  $Result = Reading + Correction\ Factor$   
 $Margin = Result - Limit$   
 $Remark\ Peak = Result(PK) - Limit(PK)$   
 $Remark\ AVG = Result(AV) - Limit(AV)$

<b>Product Name</b>	WHITE DRIVE BOX	<b>Test By</b>	Crystal Wu
<b>Test Model</b>	TB4001	<b>Test Date</b>	2016/08/12
<b>Test Mode</b>	IEEE 802.11gn HT20 MCS0 Mode / TX / CH Middle / Direct Mode_External Ant	<b>Temp. &amp; Humidity</b>	28°C, 52%

**966Chamber\_C at 3Meter / Horizontal (1GHz ~ 3GHz)**

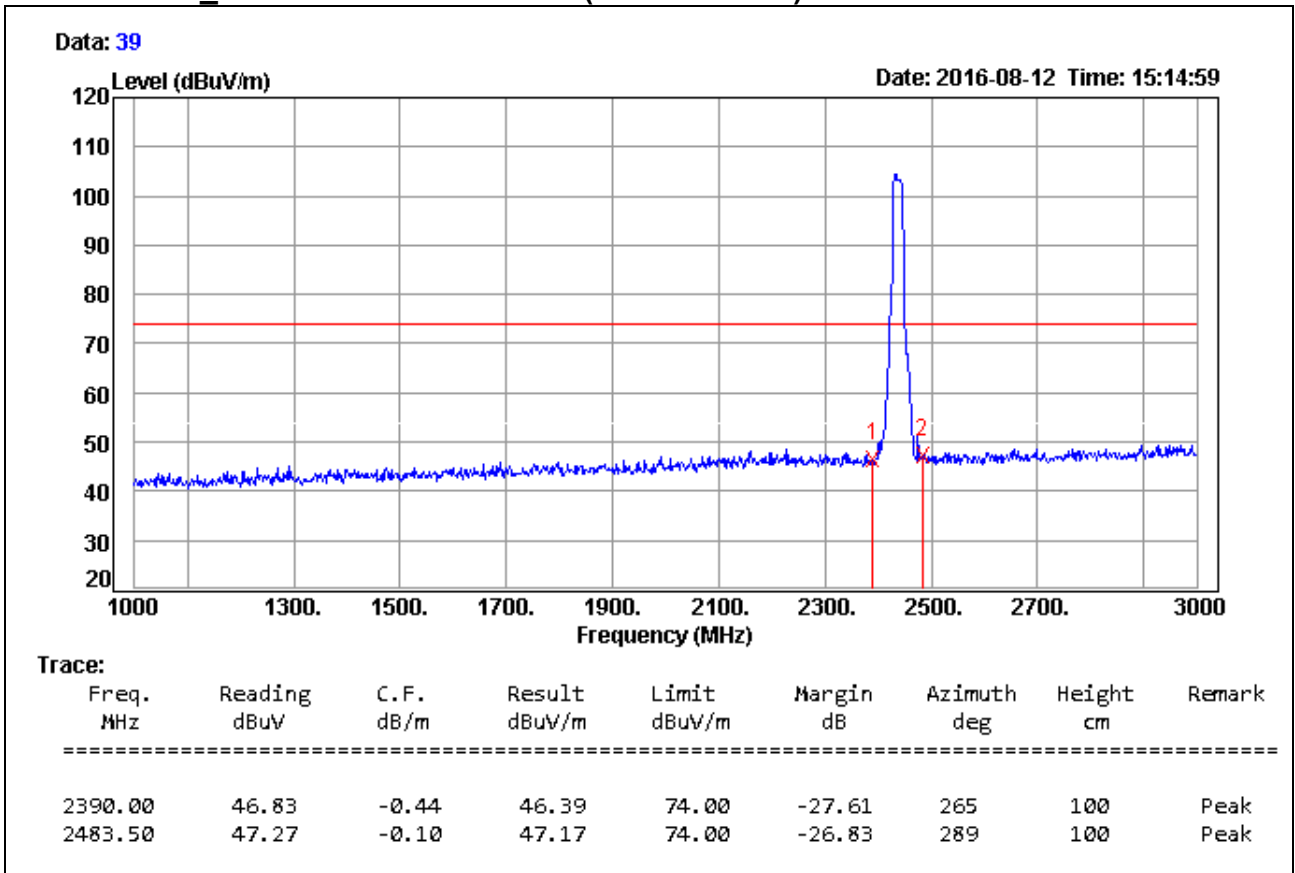

**Remark:**

1. Measuring frequencies from 1 GHz to the 10th harmonic of highest fundamental frequency.
2. Average test would be performed if the peak result were greater than the average limit.
3. Measurements above show only up to 6 maximum emissions noted, or would be lesser, with " N/A " remark, if no specific emissions from the EUT are recorded (ie: margin>20dB from the applicable limit) and considered that's already beyond the background noise floor.
4. Result = Reading + Correction Factor  
 Margin = Result - Limit  
 Remark Peak = Result(PK) - Limit(PK)  
 Remark AVG = Result(AV) - Limit(AV)

<b>Product Name</b>	WHITE DRIVE BOX	<b>Test By</b>	Crystal Wu
<b>Test Model</b>	TB4001	<b>Test Date</b>	2016/08/12
<b>Test Mode</b>	IEEE 802.11gn HT20 MCS0 Mode / TX / CH Middle / Direct Mode_External Ant	<b>Temp. &amp; Humidity</b>	28°C, 52%

**966Chamber\_C at 3Meter / Vertical (1GHz ~ 3GHz)**

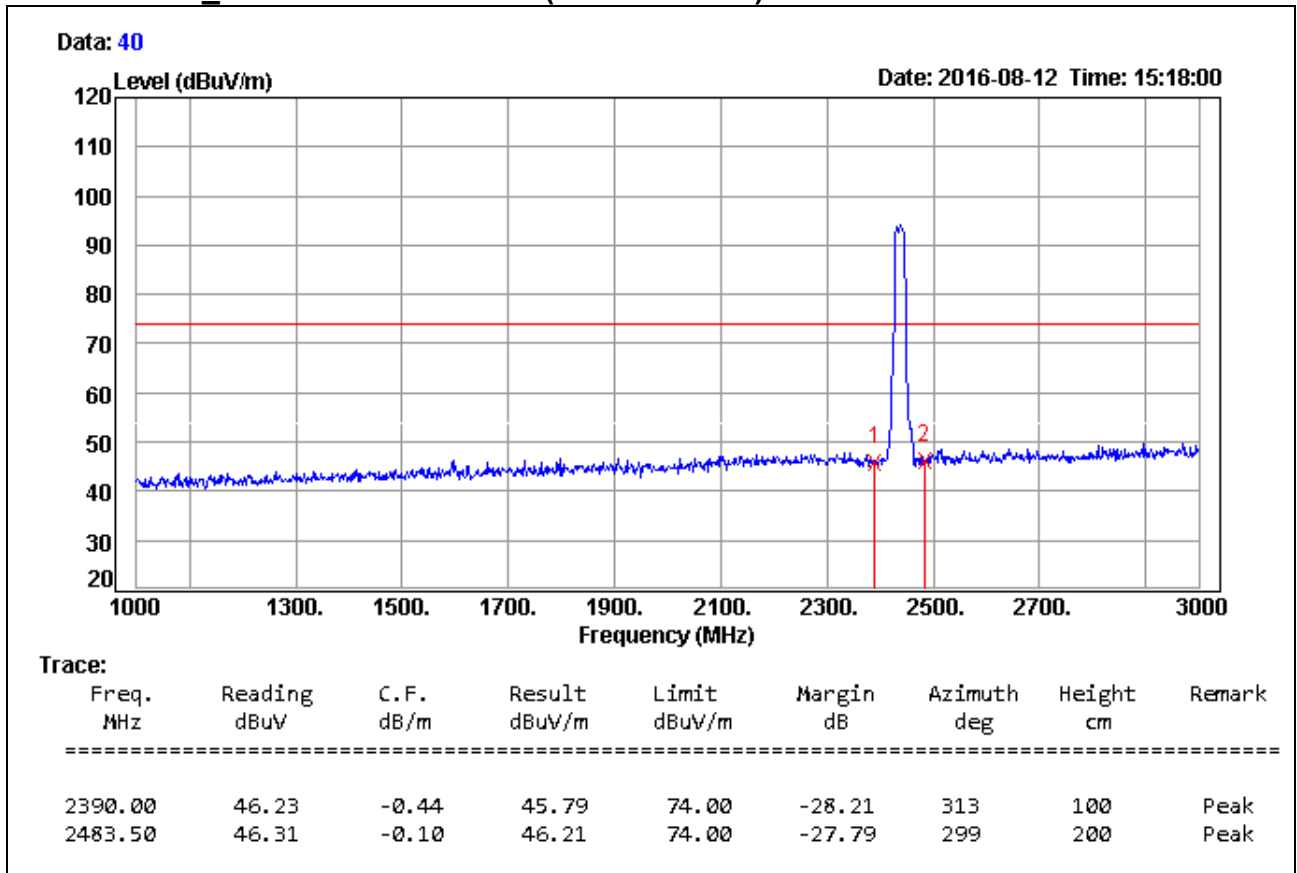

**Remark:**

1. Measuring frequencies from 1 GHz to the 10th harmonic of highest fundamental frequency.
2. Average test would be performed if the peak result were greater than the average limit.
3. Measurements above show only up to 6 maximum emissions noted, or would be lesser, with " N/A " remark, if no specific emissions from the EUT are recorded (ie: margin>20dB from the applicable limit) and considered that's already beyond the background noise floor.
4. Result = Reading + Correction Factor  
 Margin = Result - Limit  
 Remark Peak = Result(PK) - Limit(PK)  
 Remark AVG = Result(AV) - Limit(AV)

<b>Product Name</b>	WHITE DRIVE BOX	<b>Test By</b>	Crystal Wu
<b>Test Model</b>	TB4001	<b>Test Date</b>	2016/08/12
<b>Test Mode</b>	IEEE 802.11gn HT20 MCS0 Mode / TX / CH Middle / Direct Mode_External Ant	<b>Temp. &amp; Humidity</b>	28°C, 52%

**966Chamber\_C at 3Meter / Horizontal (3GHz ~ 6GHz)**

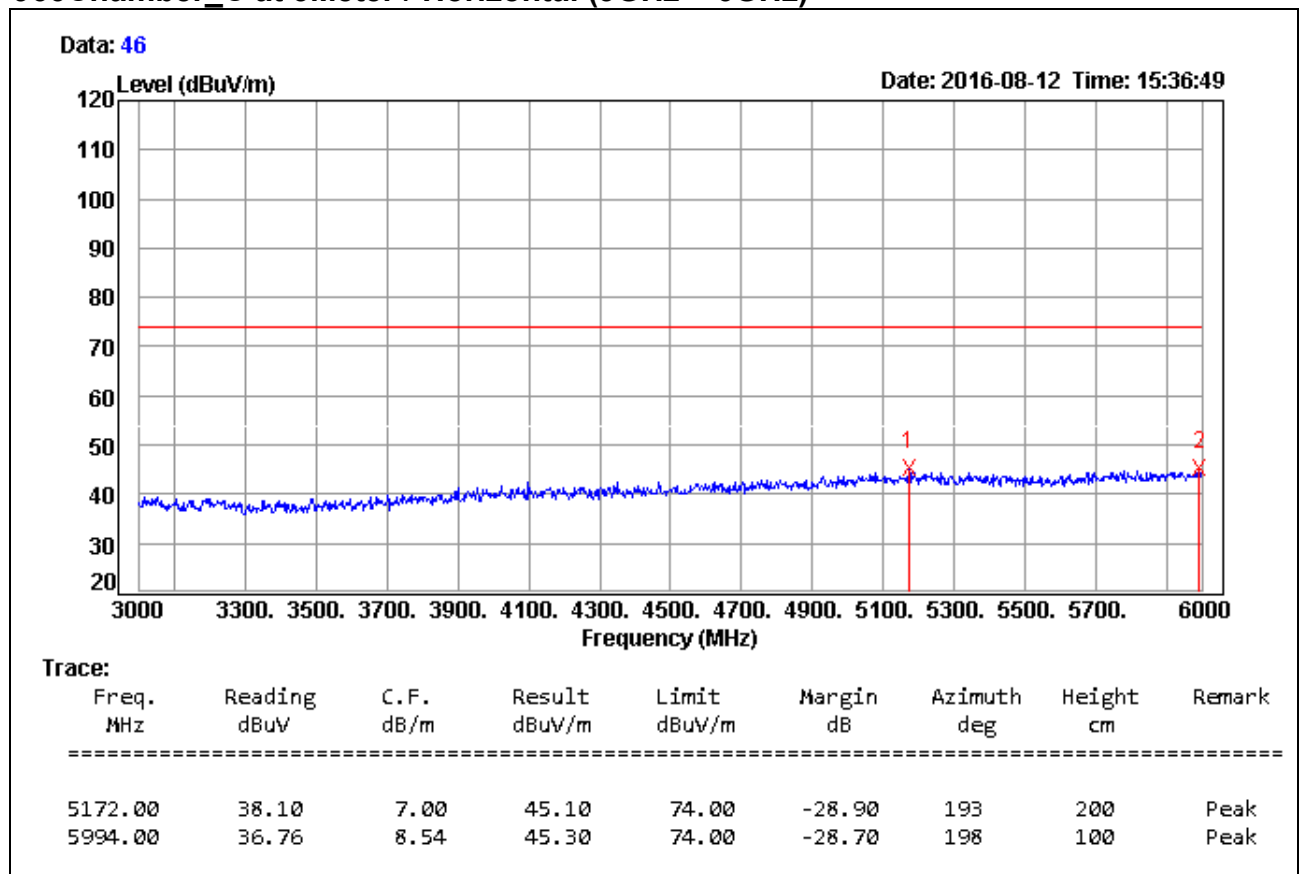

**Remark:**

1. Measuring frequencies from 1 GHz to the 10th harmonic of highest fundamental frequency.
2. Average test would be performed if the peak result were greater than the average limit.
3. Measurements above show only up to 6 maximum emissions noted, or would be lesser, with " N/A " remark, if no specific emissions from the EUT are recorded (ie: margin>20dB from the applicable limit) and considered that's already beyond the background noise floor.
4. Result = Reading + Correction Factor  
 Margin = Result – Limit  
 Remark Peak = Result(PK) – Limit(PK)  
 Remark AVG = Result(AV) – Limit(AV)



<b>Product Name</b>	WHITE DRIVE BOX	<b>Test By</b>	Crystal Wu
<b>Test Model</b>	TB4001	<b>Test Date</b>	2016/08/12
<b>Test Mode</b>	IEEE 802.11gn HT20 MCS0 Mode / TX / CH Middle / Direct Mode_External Ant	<b>Temp. &amp; Humidity</b>	28°C, 52%

**966Chamber\_C at 3Meter / Vertical (3GHz ~ 6GHz)**

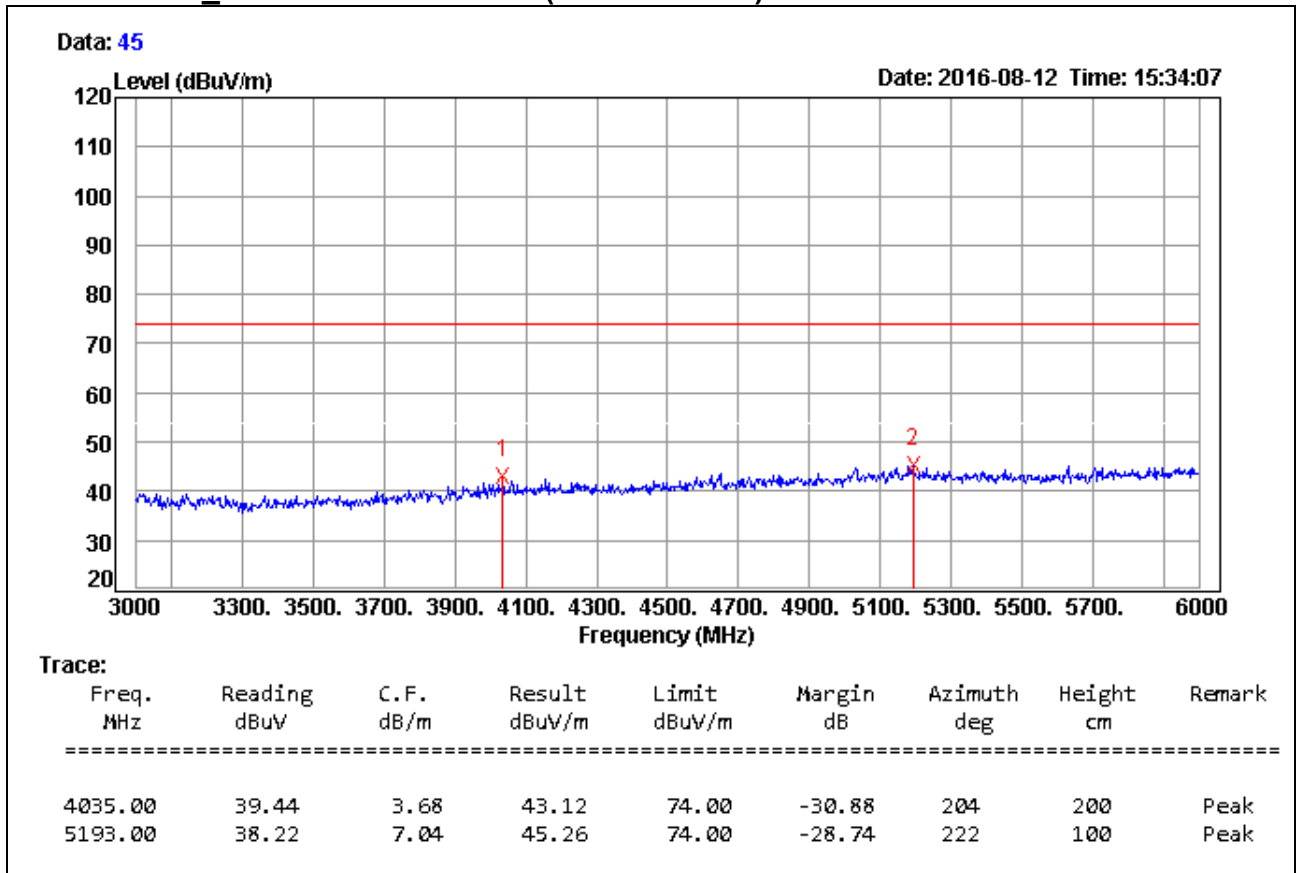

**Remark:**

1. Measuring frequencies from 1 GHz to the 10th harmonic of highest fundamental frequency.
2. Average test would be performed if the peak result were greater than the average limit.
3. Measurements above show only up to 6 maximum emissions noted, or would be lesser, with " N/A " remark, if no specific emissions from the EUT are recorded (ie: margin>20dB from the applicable limit) and considered that's already beyond the background noise floor.
4. Result = Reading + Correction Factor  
 Margin = Result - Limit  
 Remark Peak = Result(PK) - Limit(PK)  
 Remark AVG = Result(AV) - Limit(AV)

<b>Product Name</b>	WHITE DRIVE BOX	<b>Test By</b>	Crystal Wu
<b>Test Model</b>	TB4001	<b>Test Date</b>	2016/08/12
<b>Test Mode</b>	IEEE 802.11gn HT20 MCS0 Mode / TX / CH Middle / Direct Mode_External Ant	<b>Temp. &amp; Humidity</b>	28°C, 52%

**966Chamber\_C at 3Meter / Horizontal (6GHz ~ 18GHz)**

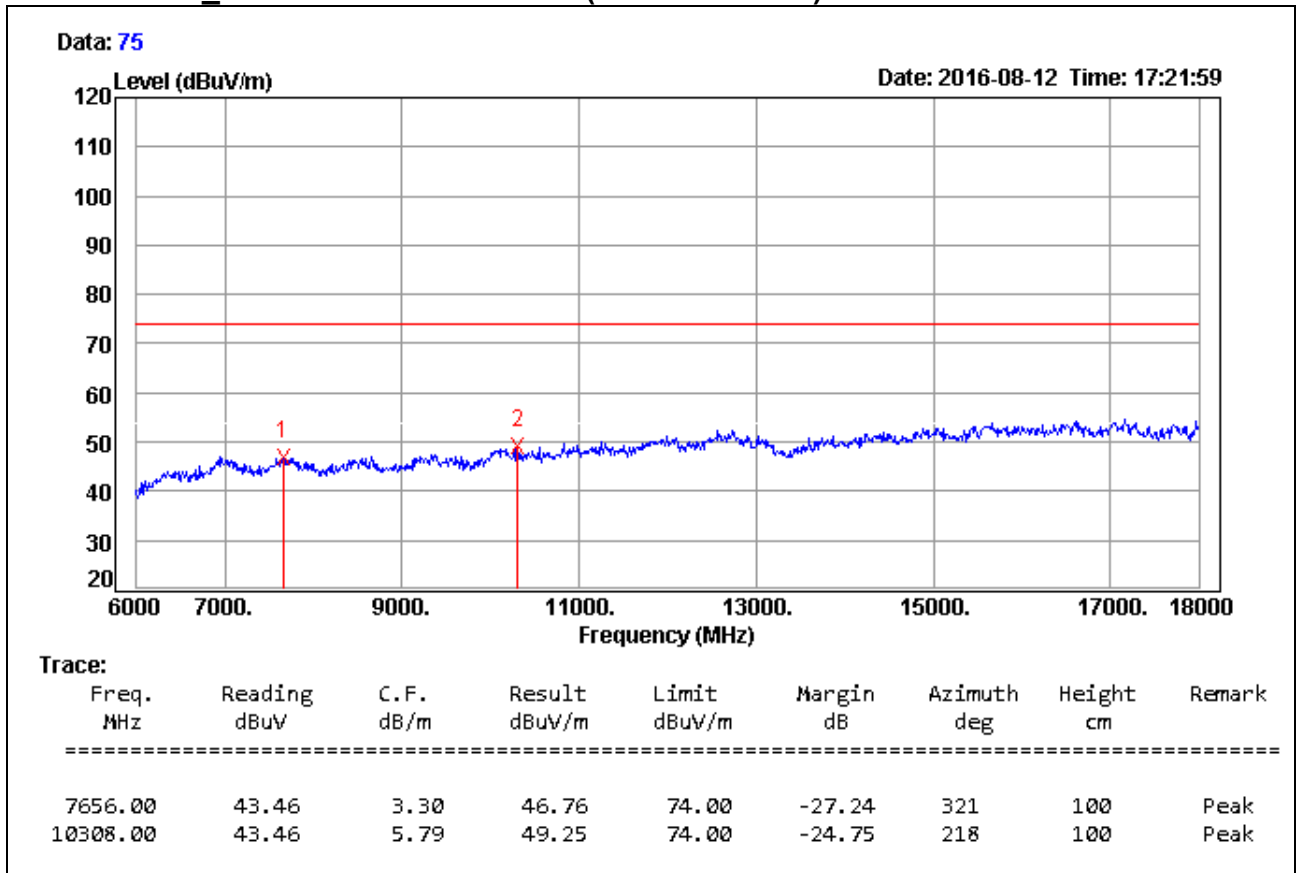

**Remark:**

1. Measuring frequencies from 1 GHz to the 10th harmonic of highest fundamental frequency.
2. Average test would be performed if the peak result were greater than the average limit.
3. Measurements above show only up to 6 maximum emissions noted, or would be lesser, with " N/A " remark, if no specific emissions from the EUT are recorded (ie: margin>20dB from the applicable limit) and considered that's already beyond the background noise floor.
4. Result = Reading + Correction Factor  
 Margin = Result – Limit  
 Remark Peak = Result(PK) – Limit(PK)  
 Remark AVG = Result(AV) – Limit(AV)

<b>Product Name</b>	WHITE DRIVE BOX	<b>Test By</b>	Crystal Wu
<b>Test Model</b>	TB4001	<b>Test Date</b>	2016/08/12
<b>Test Mode</b>	IEEE 802.11gn HT20 MCS0 Mode / TX / CH Middle / Direct Mode_External Ant	<b>Temp. &amp; Humidity</b>	28°C, 52%

**966Chamber\_C at 3Meter / Vertical (6GHz ~ 18GHz)**

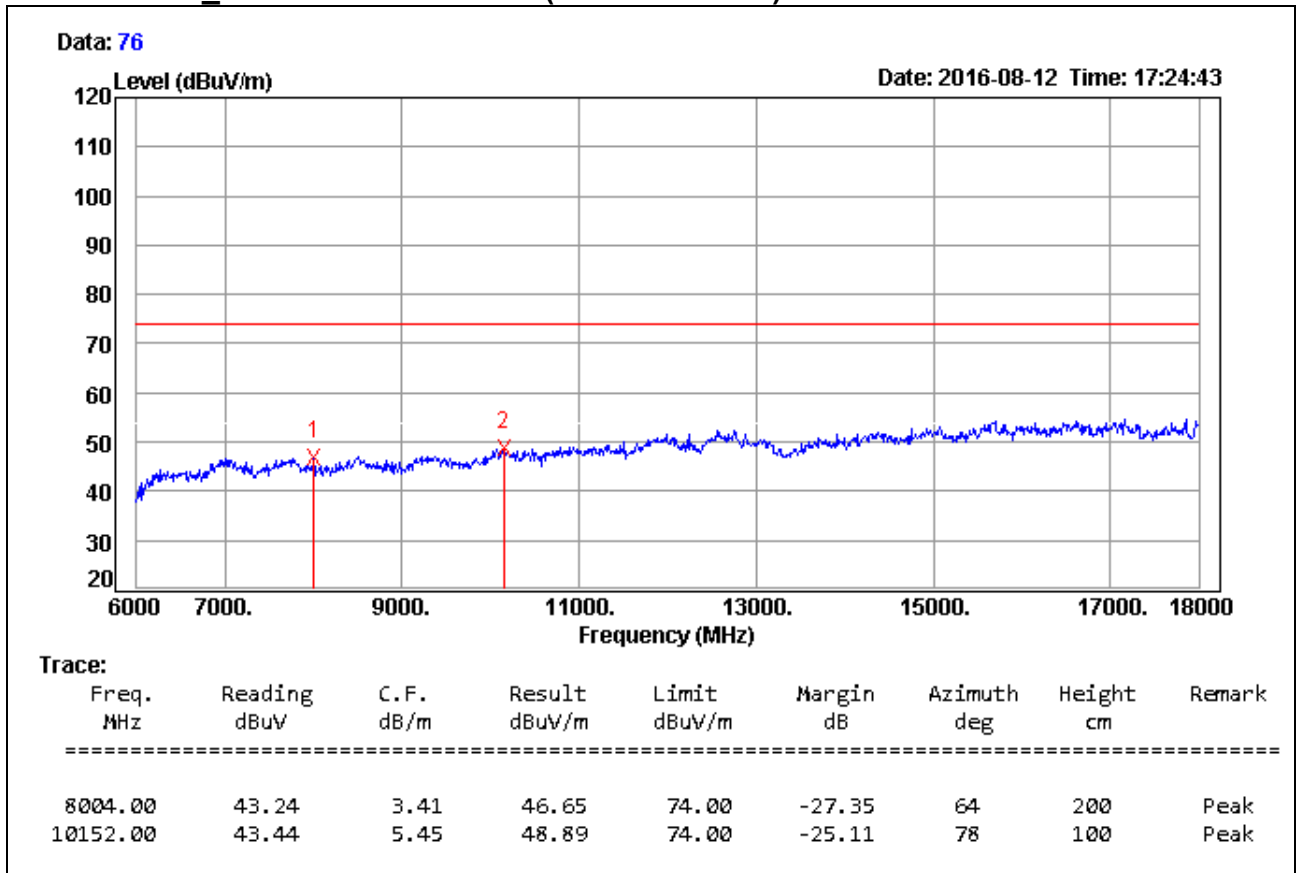

**Remark:**

1. Measuring frequencies from 1 GHz to the 10th harmonic of highest fundamental frequency.
2. Average test would be performed if the peak result were greater than the average limit.
3. Measurements above show only up to 6 maximum emissions noted, or would be lesser, with " N/A " remark, if no specific emissions from the EUT are recorded (ie: margin>20dB from the applicable limit) and considered that's already beyond the background noise floor.
4. Result = Reading + Correction Factor  
 Margin = Result – Limit  
 Remark Peak = Result(PK) – Limit(PK)  
 Remark AVG = Result(AV) – Limit(AV)

<b>Product Name</b>	WHITE DRIVE BOX	<b>Test By</b>	Crystal Wu
<b>Test Model</b>	TB4001	<b>Test Date</b>	2016/08/16
<b>Test Mode</b>	IEEE 802.11gn HT20 MCS0 Mode / TX / CH Middle / Direct Mode_External Ant	<b>Temp. &amp; Humidity</b>	28°C, 52%

**966Chamber\_C at 3Meter / Horizontal (18GHz ~ 26GHz)**

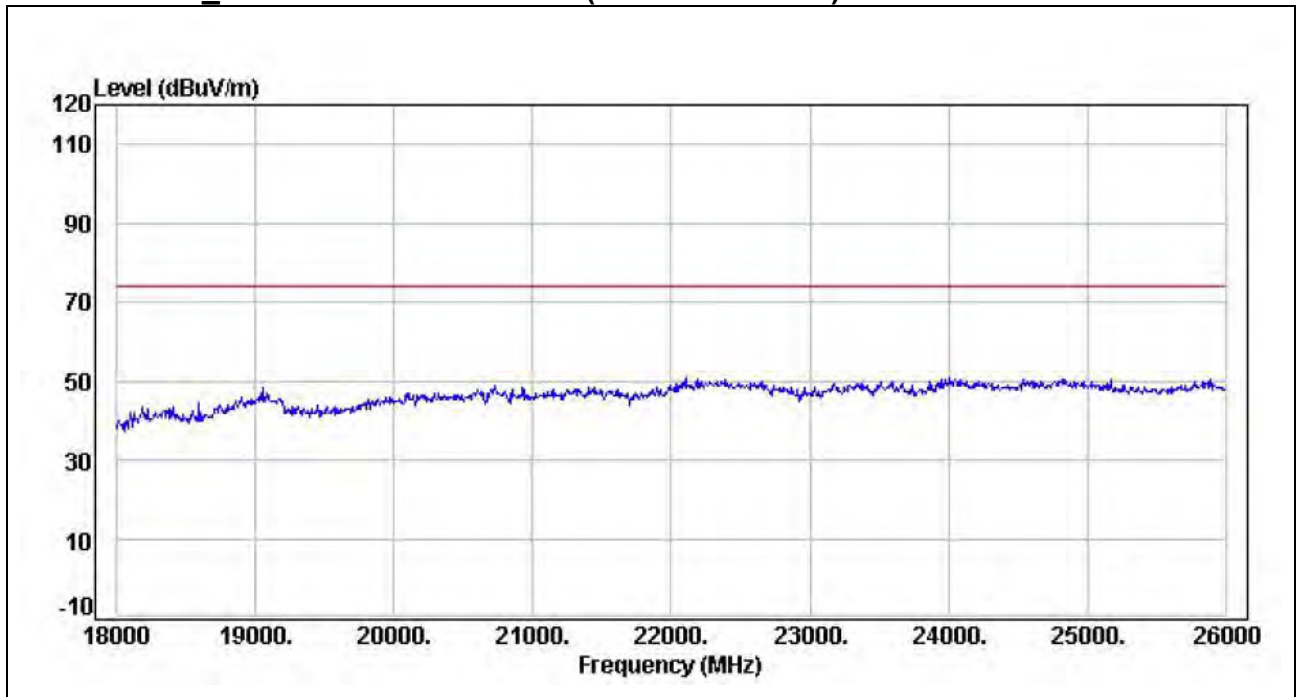

**Remark:**

1. Measuring frequencies from 1 GHz to the 10th harmonic of highest fundamental frequency.
2. Average test would be performed if the peak result were greater than the average limit.
3. Measurements above show only up to 6 maximum emissions noted, or would be lesser, with " N/A " remark, if no specific emissions from the EUT are recorded (ie: margin>20dB from the applicable limit) and considered that's already beyond the background noise floor.
4. Result = Reading + Correction Factor  
 Margin = Result – Limit  
 Remark Peak = Result(PK) – Limit(PK)  
 Remark AVG = Result(AV) – Limit(AV)

<b>Product Name</b>	WHITE DRIVE BOX	<b>Test By</b>	Crystal Wu
<b>Test Model</b>	TB4001	<b>Test Date</b>	2016/08/16
<b>Test Mode</b>	IEEE 802.11gn HT20 MCS0 Mode / TX / CH Middle / Direct Mode_External Ant	<b>Temp. &amp; Humidity</b>	28°C, 52%

**966Chamber\_C at 3Meter / Vertical (18GHz ~ 26GHz)**

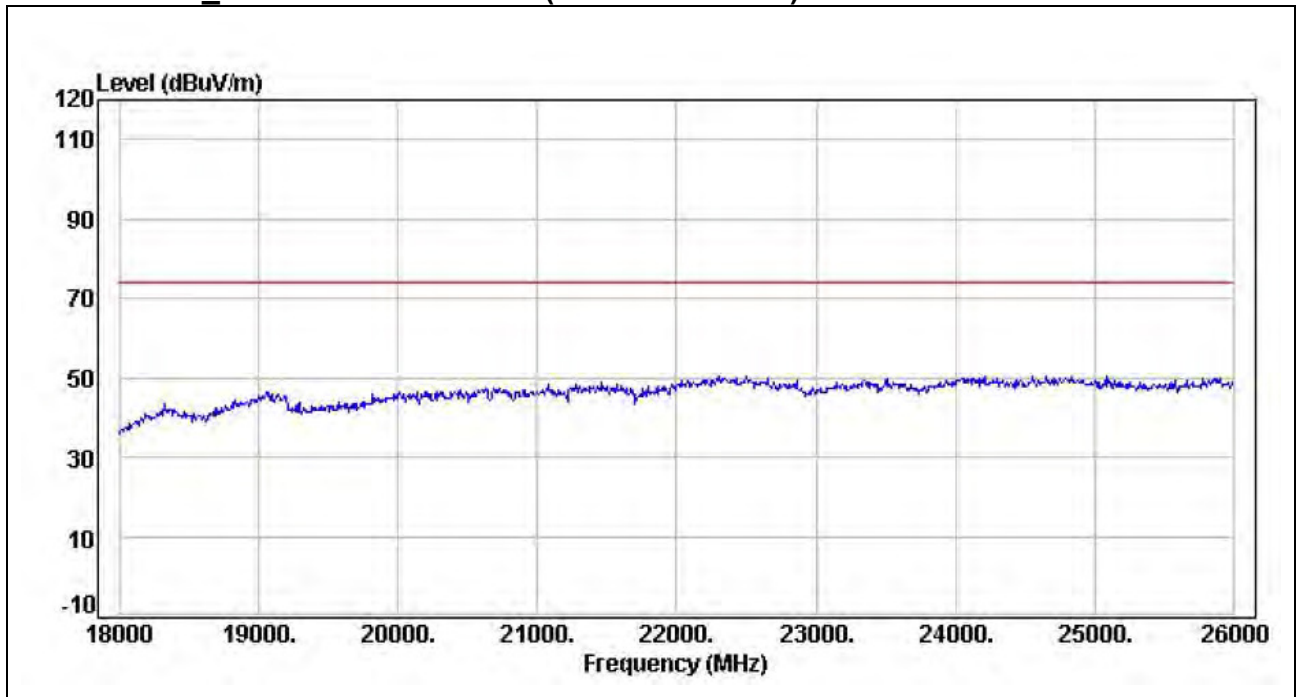

**Remark:**

1. Measuring frequencies from 1 GHz to the 10th harmonic of highest fundamental frequency.
2. Average test would be performed if the peak result were greater than the average limit.
3. Measurements above show only up to 6 maximum emissions noted, or would be lesser, with " N/A " remark, if no specific emissions from the EUT are recorded (ie: margin>20dB from the applicable limit) and considered that's already beyond the background noise floor.
4. Result = Reading + Correction Factor  
 Margin = Result – Limit  
 Remark Peak = Result(PK) – Limit(PK)  
 Remark AVG = Result(AV) – Limit(AV)

<b>Product Name</b>	WHITE DRIVE BOX	<b>Test By</b>	Crystal Wu
<b>Test Model</b>	TB4001	<b>Test Date</b>	2016/08/12
<b>Test Mode</b>	IEEE 802.11gn HT20 MCS0 Mode / TX / CH High / Direct Mode_External Ant	<b>Temp. &amp; Humidity</b>	28°C, 52%

**966Chamber\_C at 3Meter / Horizontal (1GHz ~ 3GHz)**

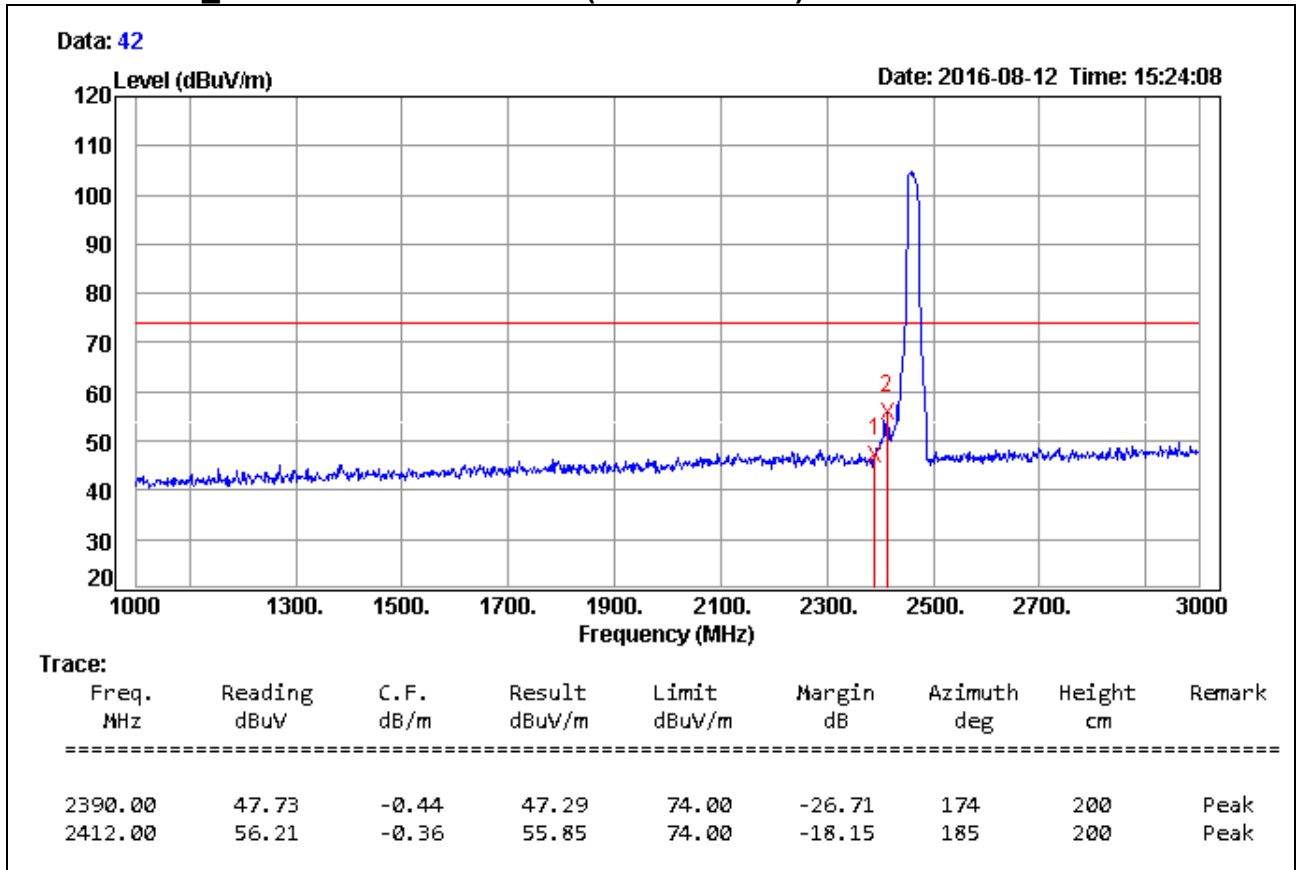

**Remark:**

1. Measuring frequencies from 1 GHz to the 10th harmonic of highest fundamental frequency.
2. Average test would be performed if the peak result were greater than the average limit.
3. Measurements above show only up to 6 maximum emissions noted, or would be lesser, with " N/A " remark, if no specific emissions from the EUT are recorded (ie: margin>20dB from the applicable limit) and considered that's already beyond the background noise floor.
4.  $Result = Reading + Correction\ Factor$   
 $Margin = Result - Limit$   
 $Remark\ Peak = Result(PK) - Limit(PK)$   
 $Remark\ AVG = Result(AV) - Limit(AV)$

<b>Product Name</b>	WHITE DRIVE BOX	<b>Test By</b>	Crystal Wu
<b>Test Model</b>	TB4001	<b>Test Date</b>	2016/08/12
<b>Test Mode</b>	IEEE 802.11gn HT20 MCS0 Mode / TX / CH High / Direct Mode_External Ant	<b>Temp. &amp; Humidity</b>	28°C, 52%

**966Chamber\_C at 3Meter / Vertical (1GHz ~ 3GHz)**

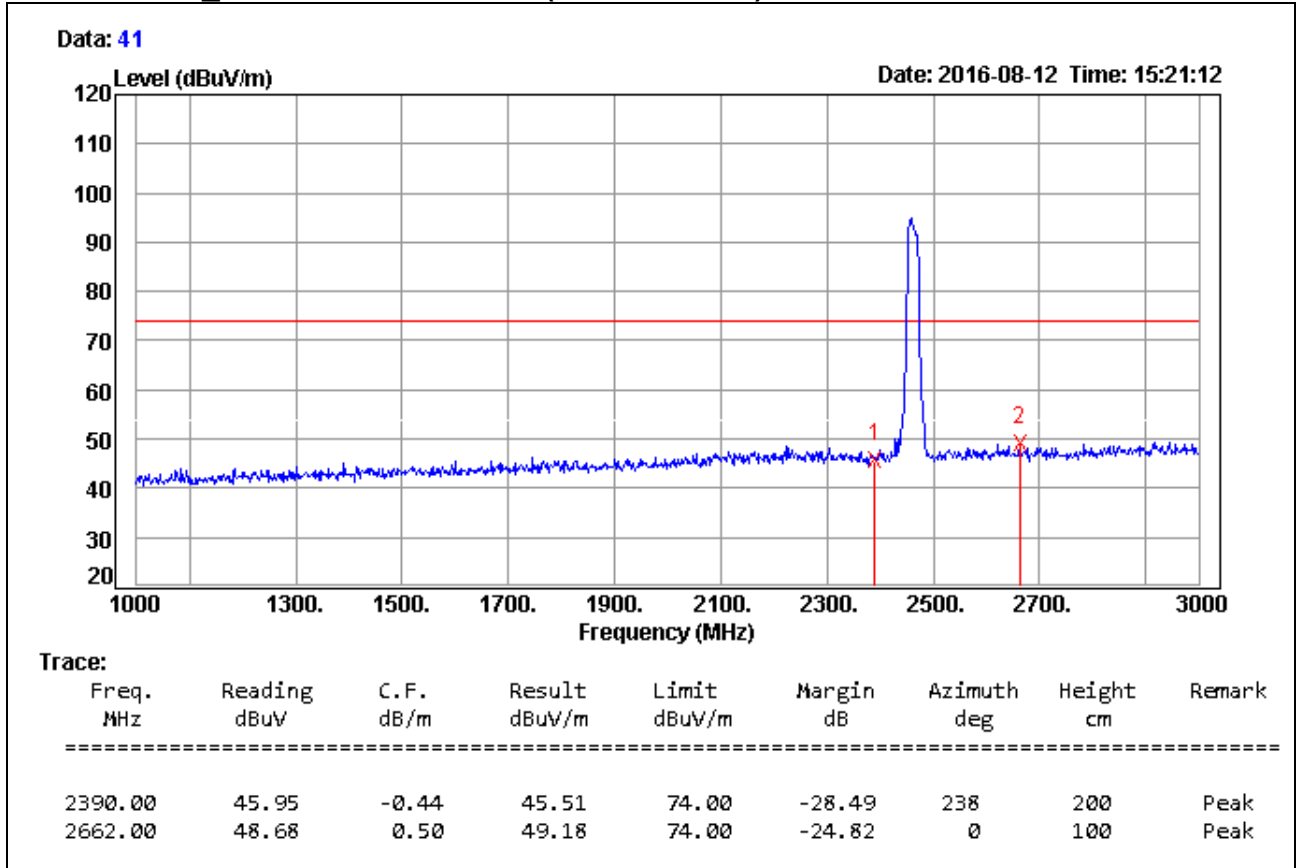

**Remark:**

1. Measuring frequencies from 1 GHz to the 10th harmonic of highest fundamental frequency.
2. Average test would be performed if the peak result were greater than the average limit.
3. Measurements above show only up to 6 maximum emissions noted, or would be lesser, with " N/A " remark, if no specific emissions from the EUT are recorded (ie: margin>20dB from the applicable limit) and considered that's already beyond the background noise floor.
4.  $Result = Reading + Correction\ Factor$   
 $Margin = Result - Limit$   
 $Remark\ Peak = Result(PK) - Limit(PK)$   
 $Remark\ AVG = Result(AV) - Limit(AV)$

<b>Product Name</b>	WHITE DRIVE BOX	<b>Test By</b>	Crystal Wu
<b>Test Model</b>	TB4001	<b>Test Date</b>	2016/08/12
<b>Test Mode</b>	IEEE 802.11gn HT20 MCS0 Mode / TX / CH High / Direct Mode_External Ant	<b>Temp. &amp; Humidity</b>	28°C, 52%

**966Chamber\_C at 3Meter / Horizontal (3GHz ~ 6GHz)**

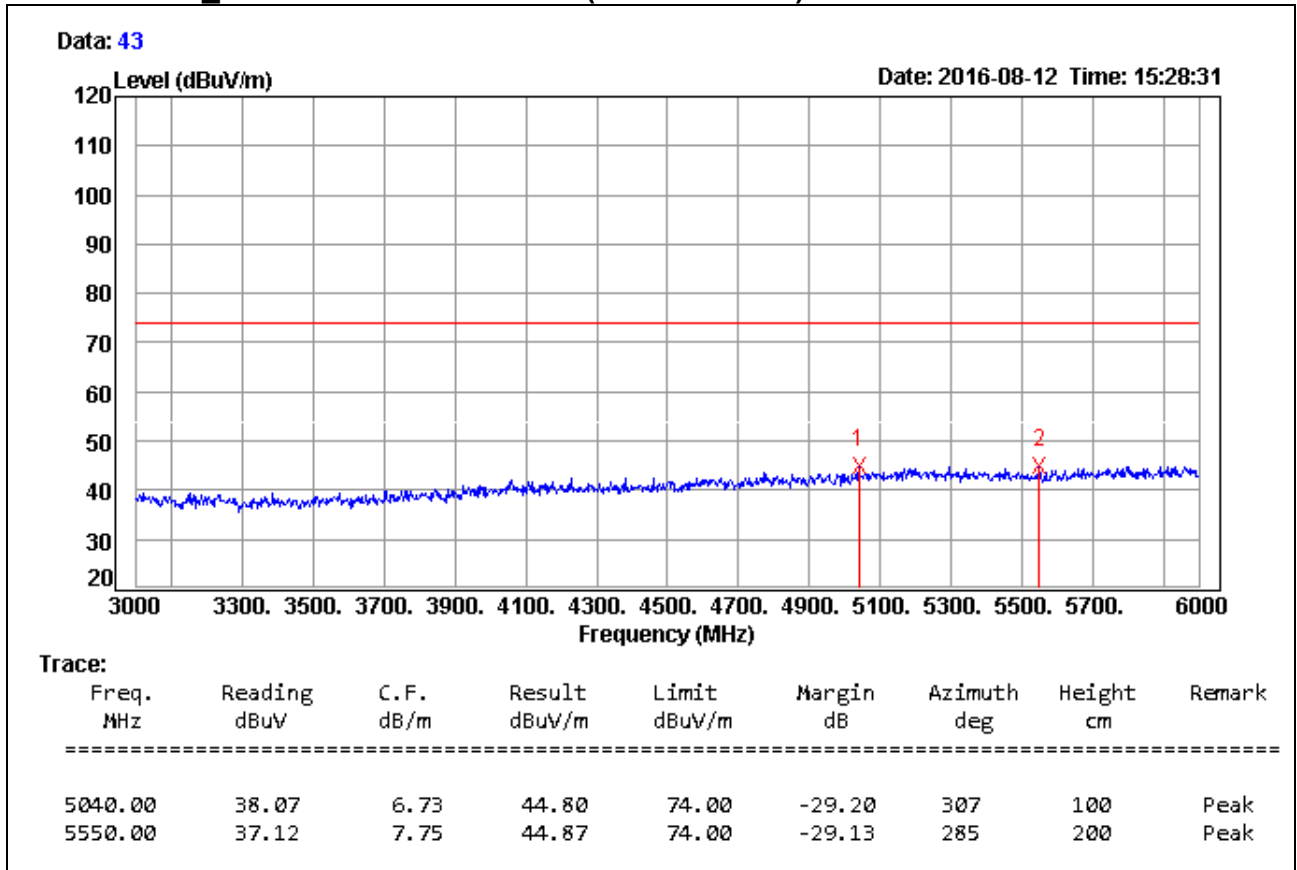

**Remark:**

1. Measuring frequencies from 1 GHz to the 10th harmonic of highest fundamental frequency.
2. Average test would be performed if the peak result were greater than the average limit.
3. Measurements above show only up to 6 maximum emissions noted, or would be lesser, with " N/A " remark, if no specific emissions from the EUT are recorded (ie: margin>20dB from the applicable limit) and considered that's already beyond the background noise floor.
4. Result = Reading + Correction Factor  
 Margin = Result – Limit  
 Remark Peak = Result(PK) – Limit(PK)  
 Remark AVG = Result(AV) – Limit(AV)



<b>Product Name</b>	WHITE DRIVE BOX	<b>Test By</b>	Crystal Wu
<b>Test Model</b>	TB4001	<b>Test Date</b>	2016/08/12
<b>Test Mode</b>	IEEE 802.11gn HT20 MCS0 Mode / TX / CH High / Direct Mode_External Ant	<b>Temp. &amp; Humidity</b>	28°C, 52%

**966Chamber\_C at 3Meter / Vertical (3GHz ~ 6GHz)**

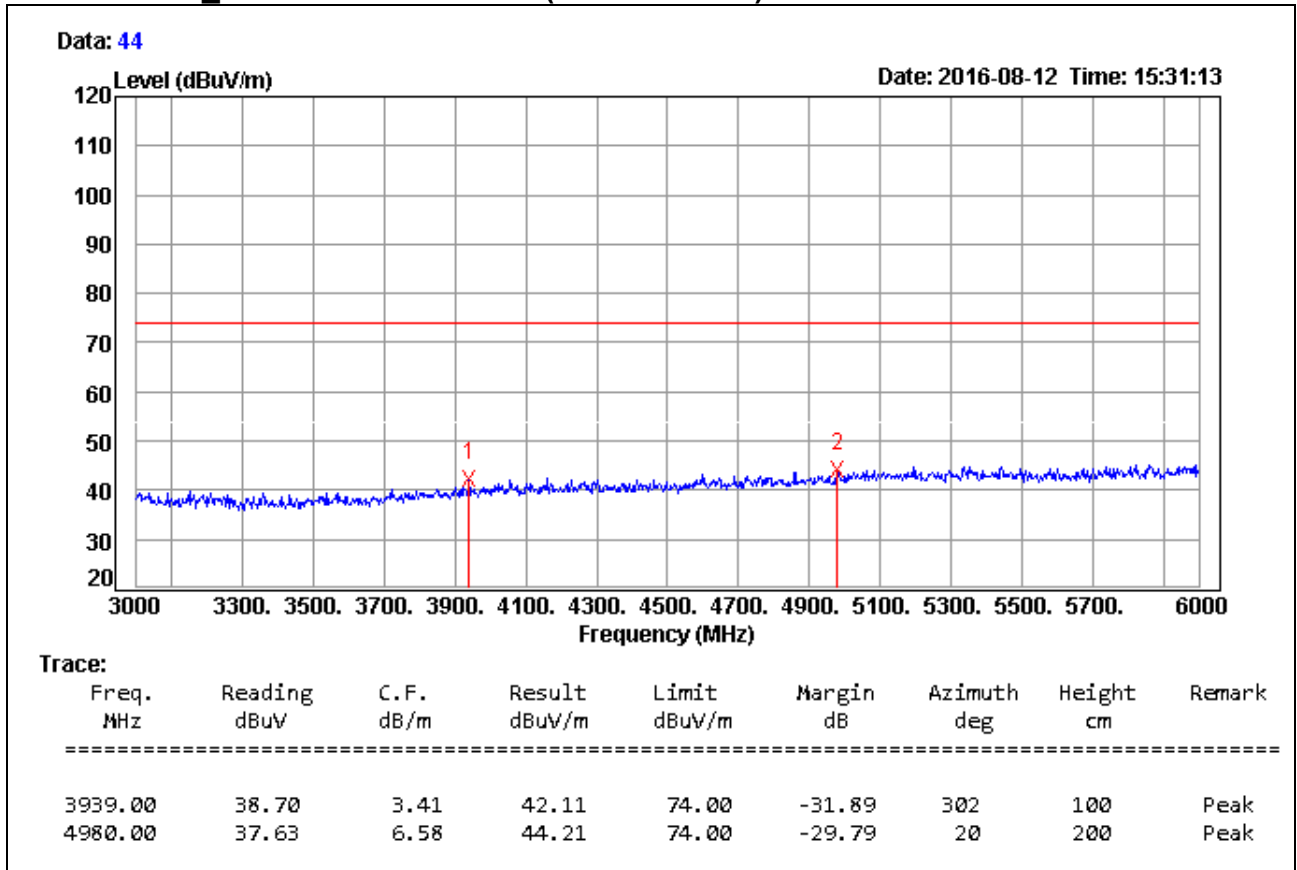

**Remark:**

1. Measuring frequencies from 1 GHz to the 10th harmonic of highest fundamental frequency.
2. Average test would be performed if the peak result were greater than the average limit.
3. Measurements above show only up to 6 maximum emissions noted, or would be lesser, with " N/A " remark, if no specific emissions from the EUT are recorded (ie: margin>20dB from the applicable limit) and considered that's already beyond the background noise floor.
4. Result = Reading + Correction Factor  
 Margin = Result – Limit  
 Remark Peak = Result(PK) – Limit(PK)  
 Remark AVG = Result(AV) – Limit(AV)

<b>Product Name</b>	WHITE DRIVE BOX	<b>Test By</b>	Crystal Wu
<b>Test Model</b>	TB4001	<b>Test Date</b>	2016/08/12
<b>Test Mode</b>	IEEE 802.11gn HT20 MCS0 Mode / TX / CH High / Direct Mode_External Ant	<b>Temp. &amp; Humidity</b>	28°C, 52%

**966Chamber\_C at 3Meter / Horizontal (6GHz ~ 18GHz)**

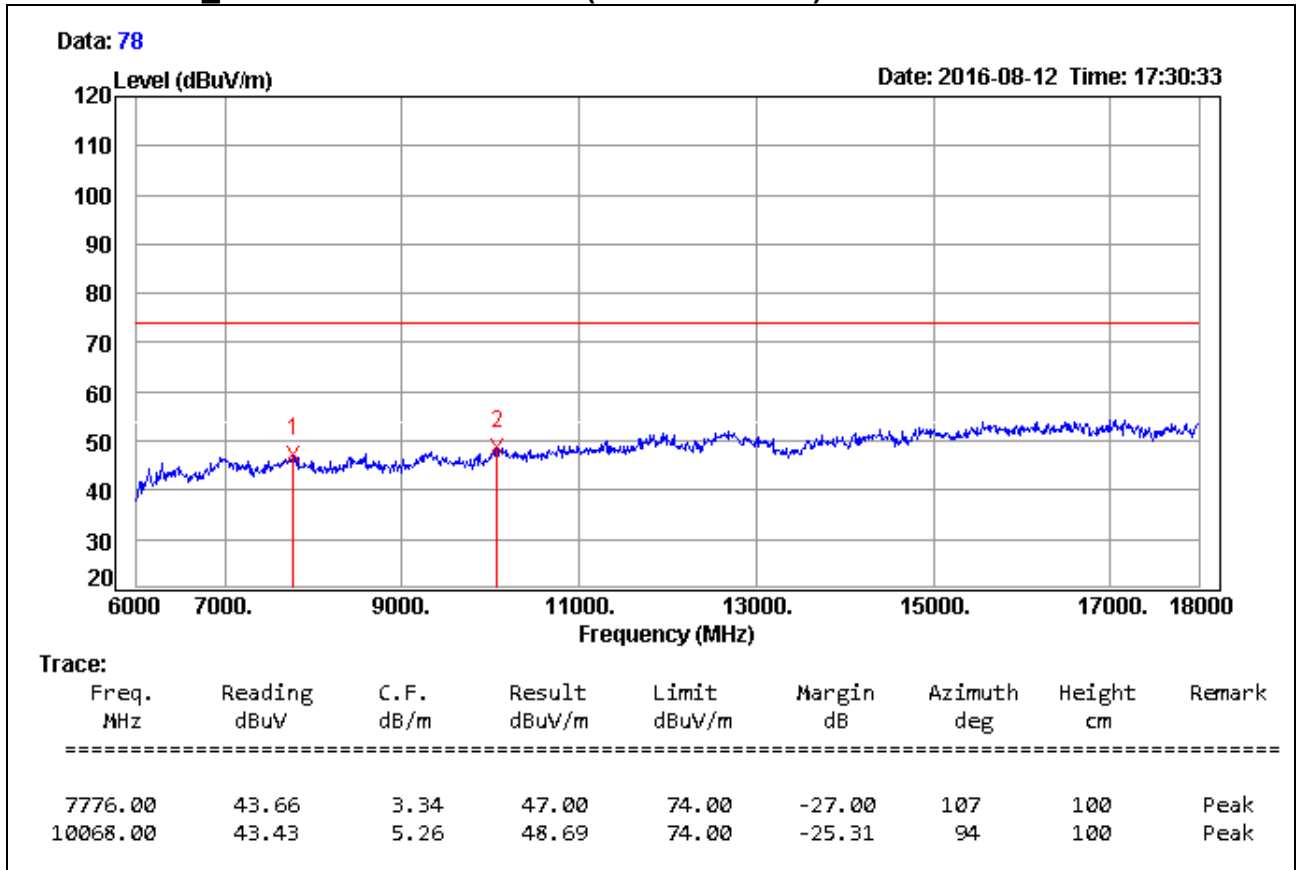

**Remark:**

1. Measuring frequencies from 1 GHz to the 10th harmonic of highest fundamental frequency.
2. Average test would be performed if the peak result were greater than the average limit.
3. Measurements above show only up to 6 maximum emissions noted, or would be lesser, with " N/A " remark, if no specific emissions from the EUT are recorded (ie: margin>20dB from the applicable limit) and considered that's already beyond the background noise floor.
4. Result = Reading + Correction Factor  
 Margin = Result – Limit  
 Remark Peak = Result(PK) – Limit(PK)  
 Remark AVG = Result(AV) – Limit(AV)

<b>Product Name</b>	WHITE DRIVE BOX	<b>Test By</b>	Crystal Wu
<b>Test Model</b>	TB4001	<b>Test Date</b>	2016/08/12
<b>Test Mode</b>	IEEE 802.11gn HT20 MCS0 Mode / TX / CH High / Direct Mode_External Ant	<b>Temp. &amp; Humidity</b>	28°C, 52%

**966Chamber\_C at 3Meter / Vertical (6GHz ~ 18GHz)**

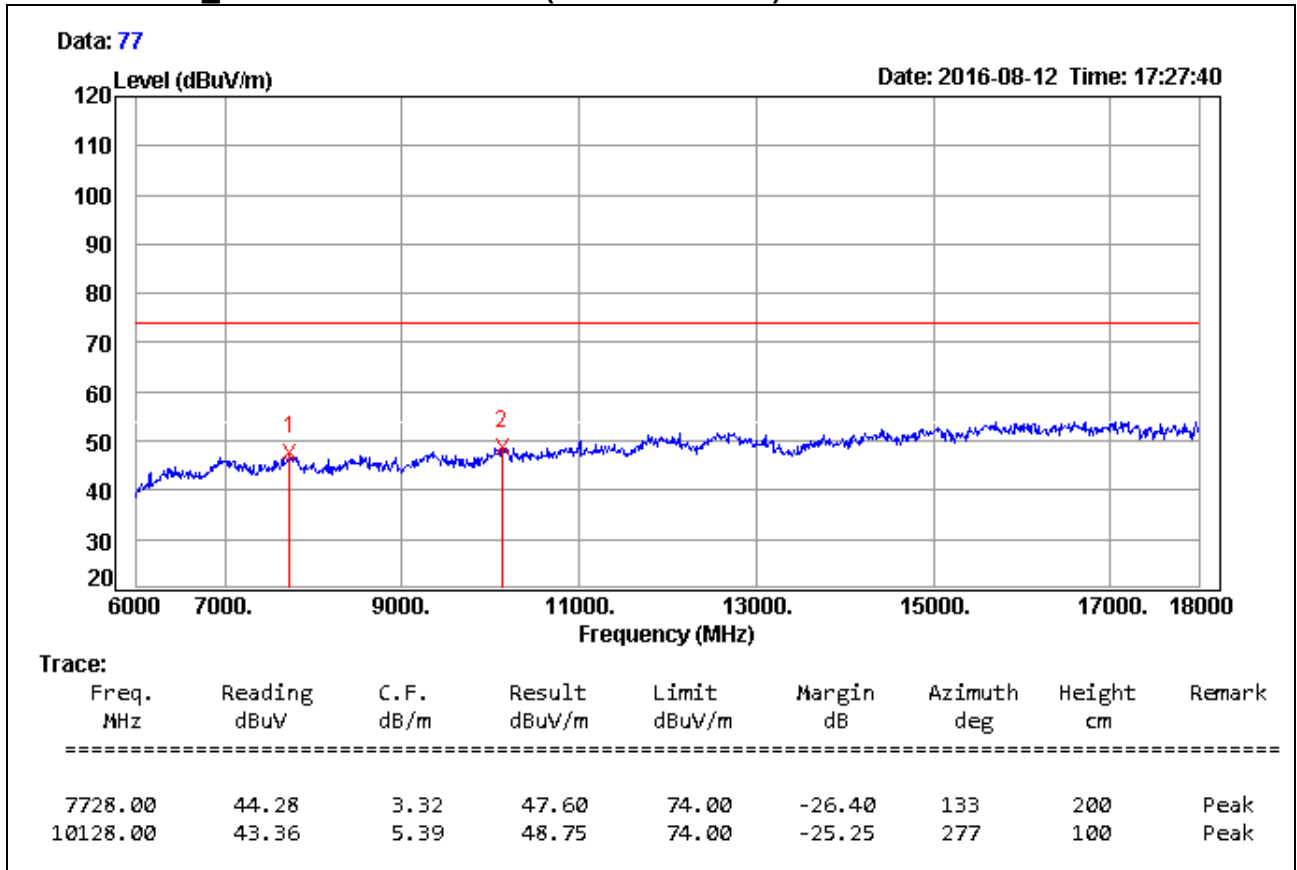

**Remark:**

1. Measuring frequencies from 1 GHz to the 10th harmonic of highest fundamental frequency.
2. Average test would be performed if the peak result were greater than the average limit.
3. Measurements above show only up to 6 maximum emissions noted, or would be lesser, with " N/A " remark, if no specific emissions from the EUT are recorded (ie: margin>20dB from the applicable limit) and considered that's already beyond the background noise floor.
4. Result = Reading + Correction Factor  
 Margin = Result – Limit  
 Remark Peak = Result(PK) – Limit(PK)  
 Remark AVG = Result(AV) – Limit(AV)

<b>Product Name</b>	WHITE DRIVE BOX	<b>Test By</b>	Crystal Wu
<b>Test Model</b>	TB4001	<b>Test Date</b>	2016/08/16
<b>Test Mode</b>	IEEE 802.11gn HT20 MCS0 Mode / TX / CH High / Direct Mode_External Ant	<b>Temp. &amp; Humidity</b>	28°C, 52%

**966Chamber\_C at 3Meter / Horizontal (18GHz ~ 26GHz)**

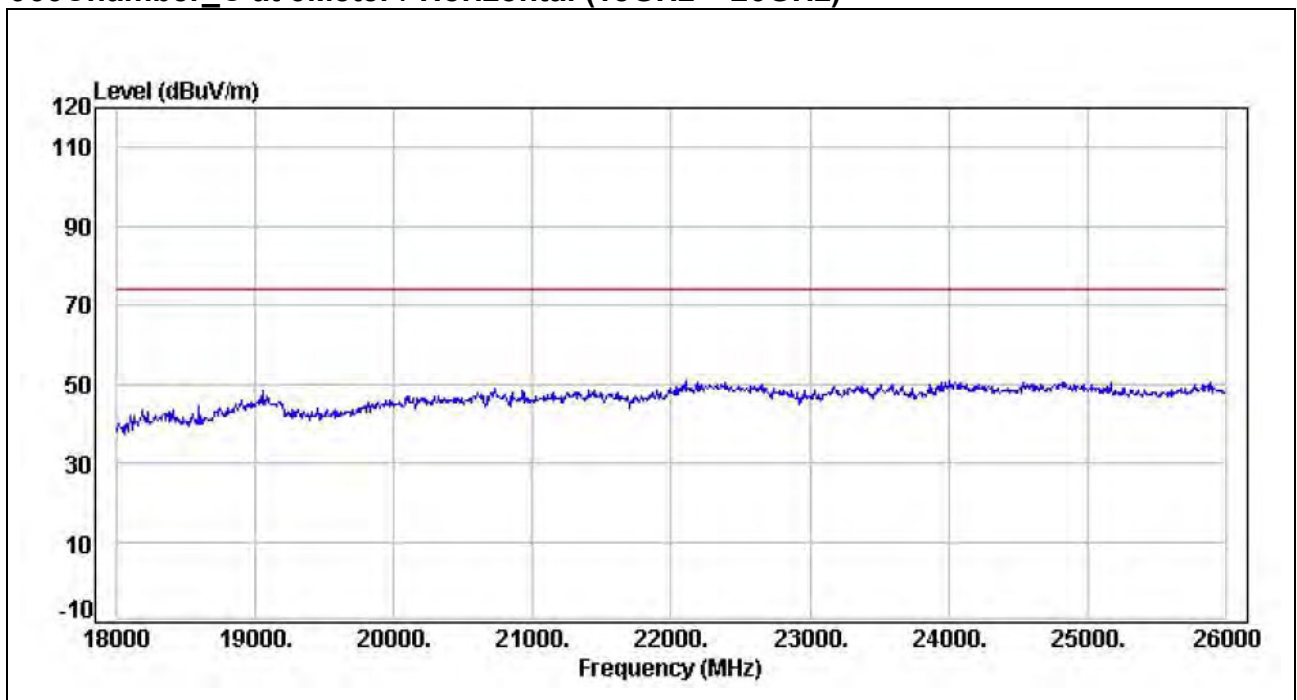

**Remark:**

1. Measuring frequencies from 1 GHz to the 10th harmonic of highest fundamental frequency.
2. Average test would be performed if the peak result were greater than the average limit.
3. Measurements above show only up to 6 maximum emissions noted, or would be lesser, with " N/A " remark, if no specific emissions from the EUT are recorded (ie: margin>20dB from the applicable limit) and considered that's already beyond the background noise floor.
4. Result = Reading + Correction Factor  
 Margin = Result – Limit  
 Remark Peak = Result(PK) – Limit(PK)  
 Remark AVG = Result(AV) – Limit(AV)

<b>Product Name</b>	WHITE DRIVE BOX	<b>Test By</b>	Crystal Wu
<b>Test Model</b>	TB4001	<b>Test Date</b>	2016/08/16
<b>Test Mode</b>	IEEE 802.11gn HT20 MCS0 Mode / TX / CH High / Direct Mode_External Ant	<b>Temp. &amp; Humidity</b>	28°C, 52%

**966Chamber\_C at 3Meter / Vertical (18GHz ~ 26GHz)**

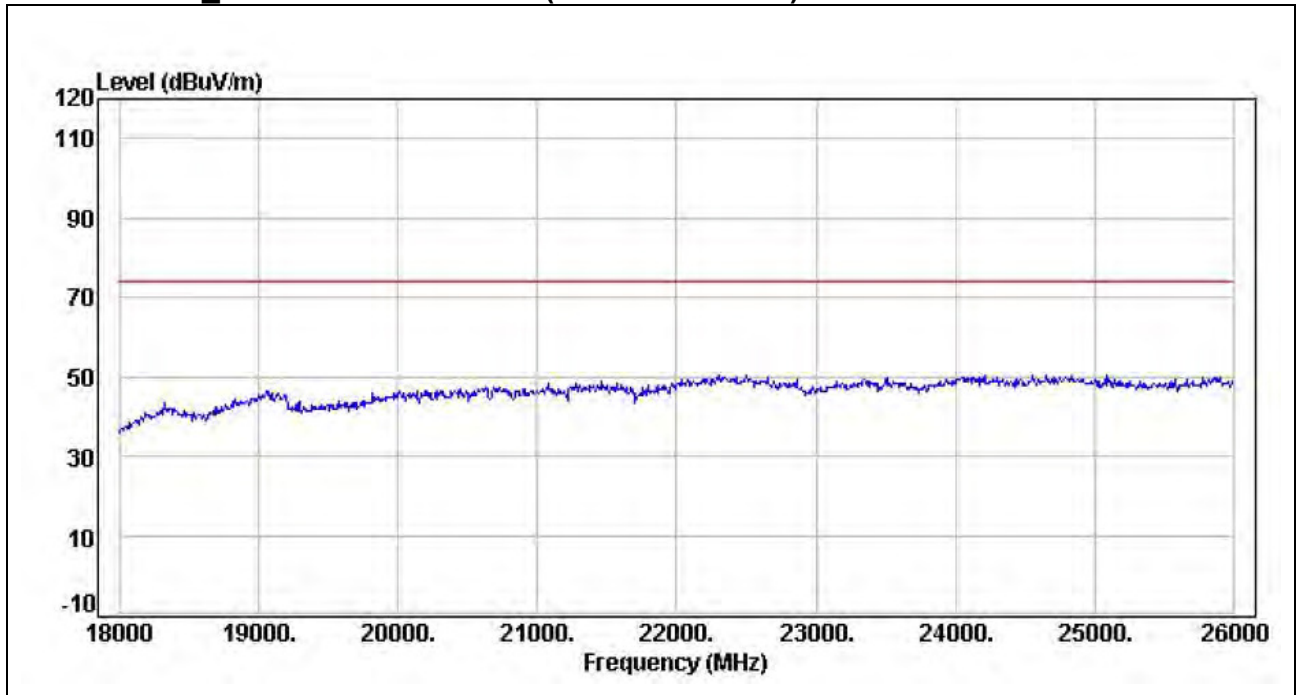

**Remark:**

1. Measuring frequencies from 1 GHz to the 10th harmonic of highest fundamental frequency.
2. Average test would be performed if the peak result were greater than the average limit.
3. Measurements above show only up to 6 maximum emissions noted, or would be lesser, with " N/A " remark, if no specific emissions from the EUT are recorded (ie: margin>20dB from the applicable limit) and considered that's already beyond the background noise floor.
4.  $Result = Reading + Correction\ Factor$   
 $Margin = Result - Limit$   
 $Remark\ Peak = Result(PK) - Limit(PK)$   
 $Remark\ AVG = Result(AV) - Limit(AV)$

<b>Product Name</b>	WHITE DRIVE BOX	<b>Test By</b>	Crystal Wu
<b>Test Model</b>	TB4001	<b>Test Date</b>	2016/08/11
<b>Test Mode</b>	IEEE 802.11b Mode / TX / CH Low / STA Mode_External Ant	<b>Temp. &amp; Humidity</b>	28°C, 52%

**966Chamber\_C at 3Meter / Horizontal (1GHz ~ 3GHz)**

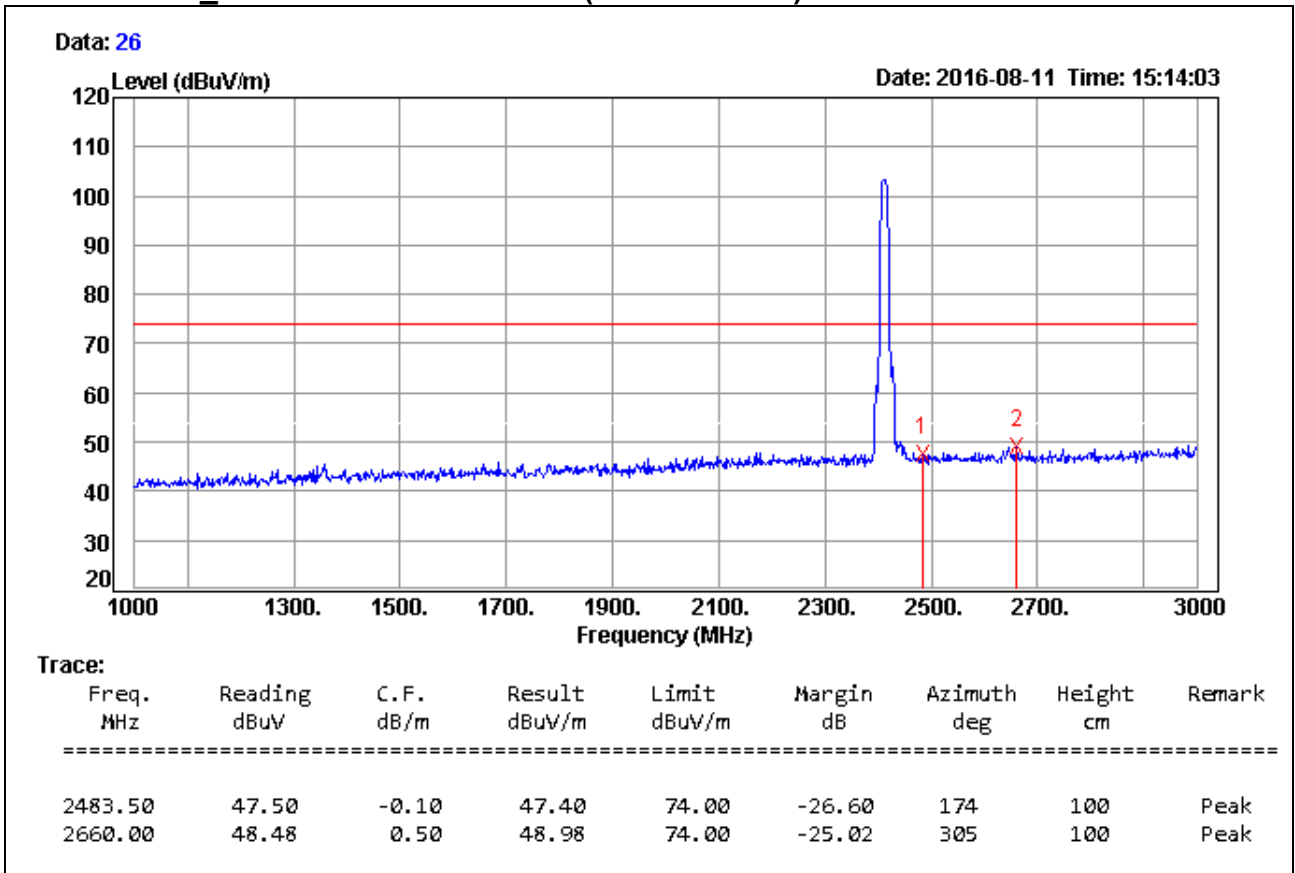

**Remark:**

1. Measuring frequencies from 1 GHz to the 10th harmonic of highest fundamental frequency.
2. Average test would be performed if the peak result were greater than the average limit.
3. Measurements above show only up to 6 maximum emissions noted, or would be lesser, with " N/A " remark, if no specific emissions from the EUT are recorded (ie: margin>20dB from the applicable limit) and considered that's already beyond the background noise floor.
4. Result = Reading + Correction Factor  
 Margin = Result - Limit  
 Remark Peak = Result(PK) - Limit(PK)  
 Remark AVG = Result(AV) - Limit(AV)