

LTE Band 13

QPSK / Channel Bandwidth: 10MHz / Frequency: 782 MHz / Chain 0

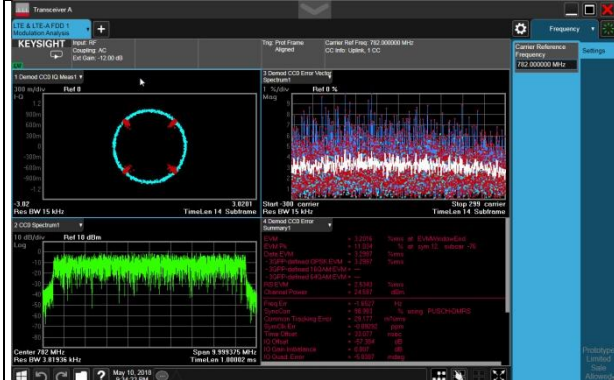

16QAM / Channel Bandwidth: 10MHz / Frequency: 782 MHz / Chain 0



64QAM / Channel Bandwidth: 10MHz / Frequency: 782 MHz / Chain 0

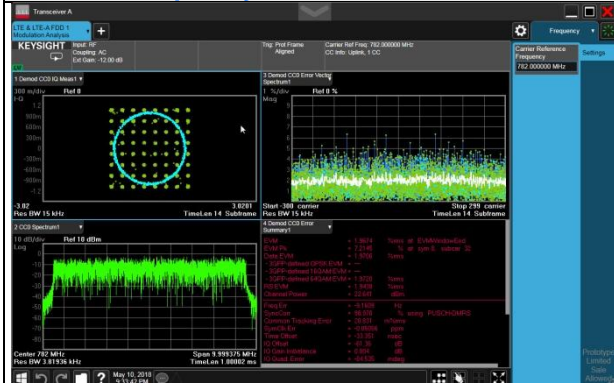

LTE Band 17

QPSK / Channel Bandwidth: 10MHz / Frequency: 710 MHz / Chain 0



16QAM / Channel Bandwidth: 10MHz / Frequency: 710 MHz / Chain 0



64QAM / Channel Bandwidth: 10MHz / Frequency: 710 MHz / Chain 0

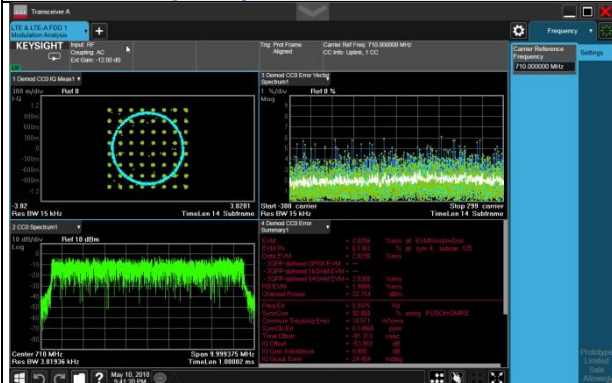

LTE Band 30

QPSK / Channel Bandwidth: 10MHz / Frequency: 2310 MHz / Chain 0



16QAM / Channel Bandwidth: 10MHz / Frequency: 2310 MHz / Chain 0

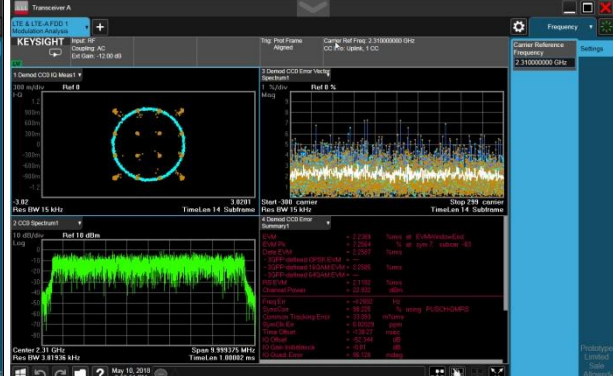

64QAM / Channel Bandwidth: 10MHz / Frequency: 2310 MHz / Chain 0



LTE Band 41

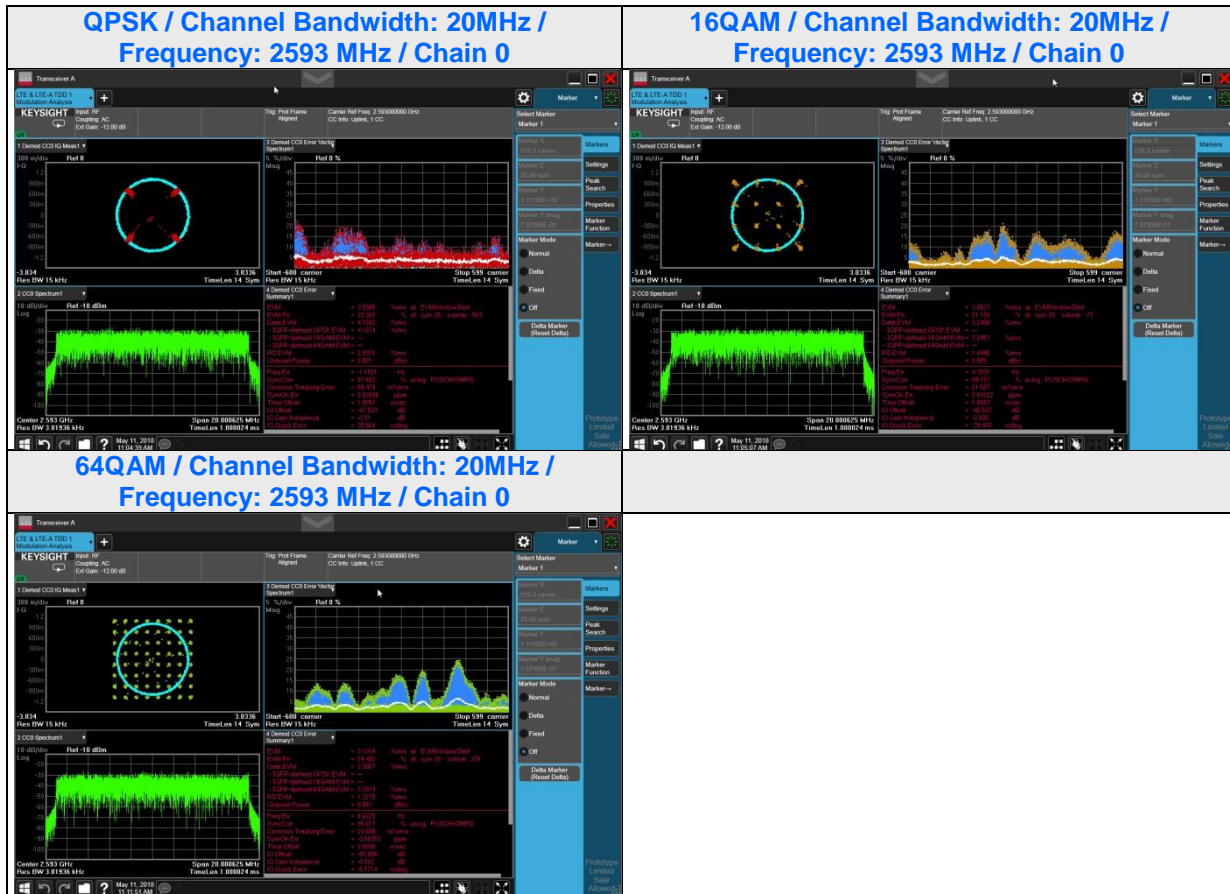

LTE Band 66

**QPSK / Channel Bandwidth: 20MHz /
Frequency: 1745 MHz / Chain 0**



**16QAM / Channel Bandwidth: 20MHz /
Frequency: 1745 MHz / Chain 0**



**64QAM / Channel Bandwidth: 20MHz /
Frequency: 1745 MHz / Chain 0**

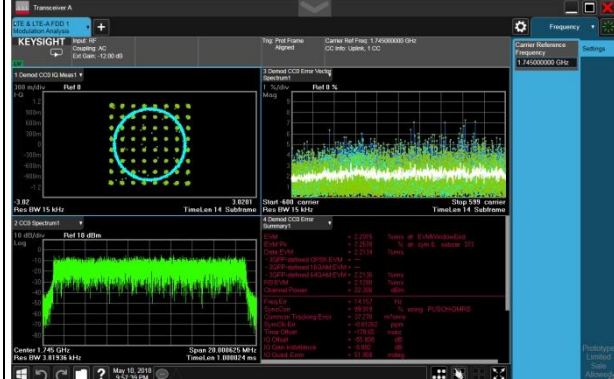

4.3 Frequency Stability Measurement

4.3.1 Limits of Frequency Stability Measurement

The frequency stability shall be sufficient to ensure that the fundamental emissions stay within the authorized bands of operation.

According to the FCC part 2.1055 shall be tested the frequency stability. The rule is defined that "The frequency stability shall be sufficient to ensure that the fundamental emission stays within the authorized frequency block." The test extreme voltage is according to the 2.1055(d)(1) Vary primary supply voltage from 85 to 115 percent of the nominal value for other than hand carried battery equipment and the extreme temperature rule is comply with specification of EUT $-30^{\circ}\text{C} \sim 50^{\circ}\text{C}$.

4.3.2 Test Procedure

- Device is placed at the oven room. The oven room could control the temperatures and humidity. Power warm up is at least 15 min and power applied should perform before recording frequency error.
- EUT is connected the external power supply to control the DC input power. The test voltage range is from minimum to maximum working voltage. Each step shall be record the frequency error rate.
- The temperature range step is 10 degrees in this test items. All temperature levels shall be hold the $\pm 0.5^{\circ}\text{C}$ during the measurement testing. The each temperature step shall be at least 0.5 hours, consider the EUT could be test under the stability condition.

NOTE: The frequency error was recorded frequency error from the communication simulator.

4.3.3 Test Setup

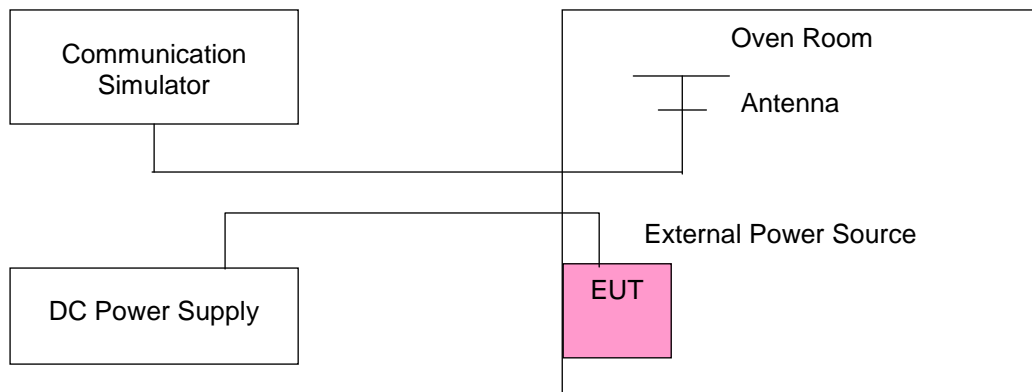

4.3.4 Test Results

WCDMA Band 4

Frequency Error vs. Voltage

Voltage (Volts)	Frequency Error (MHz)		Limit (MHz)	
	WCDMA		Low Edge	High Edge
	Low	High		
2.805	1710.32	1710.44	1710	1755
3.795	1710.44	1710.32	1710	1755

Frequency Error vs. Temperature.

Temp. (°C)	Frequency Error (MHz)		Limit (MHz)	
	WCDMA		Low Edge	High Edge
	low	high		
50	1710.37	1754.70	1710	1755
40	1710.28	1754.69	1710	1755
30	1710.28	1754.70	1710	1755
20	1710.35	1754.69	1710	1755
10	1710.36	1754.69	1710	1755
0	1710.37	1754.70	1710	1755
-10	1710.28	1754.69	1710	1755
-20	1710.33	1754.69	1710	1755
-30	1710.28	1754.68	1710	1755

LTE Band 4

Voltage (Volts)	Frequency Error (MHz)												Limit (MHz)	
	1.4MHz		3MHz		5MHz		10MHz		15MHz		20MHz			
	Low	High	Low	High	Low	High	Low	High	Low	High	Low	High	Low Edge	High Edge
2.805	1710.16	1754.75	1710.12	1754.77	1710.32	1754.66	1710.42	1754.58	1710.73	1754.24	1711.04	1753.99	1710	1755
3.795	1710.06	1754.91	1710.19	1754.83	1710.23	1754.80	1710.48	1754.49	1710.84	1754.25	1711.09	1753.95	1710	1755

Temp (°C)	Frequency Error (MHz)												Limit (MHz)	
	1.4MHz		3MHz		5MHz		10MHz		15MHz		20MHz			
	Low	High	Low	High	Low	High	Low	High	Low	High	Low	High	Low	High
50	1710.25	1754.82	1710.21	1754.94	1710.20	1754.80	1710.45	1754.45	1710.79	1754.30	1711.05	1753.98	1710	1755
40	1710.16	1754.81	1710.20	1754.77	1710.23	1754.73	1710.44	1754.51	1710.75	1754.27	1711.01	1753.89	1710	1755
30	1710.08	1754.93	1710.07	1754.96	1710.25	1754.76	1710.44	1754.56	1710.76	1754.15	1711.07	1753.93	1710	1755
20	1710.18	1754.90	1710.07	1754.88	1710.32	1754.77	1710.48	1754.55	1710.76	1754.33	1711.00	1753.97	1710	1755
10	1710.23	1754.86	1710.20	1754.88	1710.16	1754.80	1710.60	1754.53	1710.70	1754.29	1711.04	1753.99	1710	1755
0	1710.24	1754.80	1710.11	1754.94	1710.18	1754.73	1710.57	1754.46	1710.69	1754.32	1711.09	1753.96	1710	1755
-10	1710.16	1754.84	1710.12	1754.87	1710.25	1754.75	1710.52	1754.49	1710.78	1754.24	1711.06	1753.98	1710	1755
-20	1710.22	1754.92	1710.20	1754.88	1710.30	1754.72	1710.61	1754.48	1710.76	1754.17	1711.11	1753.91	1710	1755
-30	1710.24	1754.93	1710.21	1754.78	1710.27	1754.78	1710.59	1754.58	1710.80	1754.25	1710.99	1753.89	1710	1755

LTE Band 7

Voltage (Volts)	Frequency Error (MHz)								Limit (MHz)	
	5MHz		10MHz		15MHz		20MHz			
	Low	High	Low	High	Low	High	Low	High	Low Edge	High Edge
2.805	2500.27	2569.70	2500.44	2569.47	2500.74	2569.11	2501.03	2569.02	2500	2570
3.795	2500.24	2569.75	2500.59	2569.49	2500.73	2569.12	2500.96	2568.85	2500	2570

Temp. (°C)	Frequency Error (MHz)								Limit (MHz)	
	5MHz		10MHz		15MHz		20MHz			
	Low	High	Low	High	Low	High	Low	High	Low Edge	High Edge
50	2500.21	2569.69	2500.51	2569.50	2500.65	2569.19	2500.91	2568.95	2500	2570
40	2500.30	2569.78	2500.53	2569.41	2500.83	2569.23	2500.99	2568.88	2500	2570
30	2500.32	2569.66	2500.59	2569.43	2500.69	2569.14	2500.98	2568.84	2500	2570
20	2500.26	2569.74	2500.51	2569.48	2500.75	2569.21	2501.01	2568.93	2500	2570
10	2500.33	2569.82	2500.44	2569.57	2500.65	2569.14	2501.02	2568.98	2500	2570
0	2500.20	2569.73	2500.54	2569.43	2500.81	2569.26	2501.02	2568.97	2500	2570
-10	2500.35	2569.83	2500.41	2569.44	2500.84	2569.27	2501.05	2568.95	2500	2570
-20	2500.32	2569.81	2500.56	2569.47	2500.65	2569.26	2501.09	2568.92	2500	2570
-30	2500.24	2569.68	2500.56	2569.43	2500.68	2569.24	2501.08	2568.90	2500	2570

LTE CA_7C

Voltage (Volts)	Frequency Error (MHz)		Limit (MHz)	
	CA_15+20 MHz Low Channel	CA_15+20 MHz High Channel	Low Edge	High Edge
2.805	2500.988	2569.021	2500	2570
3.795	2501.018	2568.951	2500	2570

Frequency Error vs. Temperature.

Temp. (°C)	Frequency Error (MHz)		Limit (MHz)	
	CA_15+20 MHz Low Channel	CA_15+20 MHz High Channel	Low Edge	High Edge
50	2500.988	2569.011	2500	2570
40	2500.918	2568.991	2500	2570
30	2500.888	2568.951	2500	2570
20	2500.988	2569.031	2500	2570
10	2500.958	2568.931	2500	2570
0	2500.928	2569.071	2500	2570
-10	2501.068	2568.941	2500	2570
-20	2500.948	2569.071	2500	2570
-30	2501.038	2568.971	2500	2570

LTE Band 12

Voltage (Volts)	Frequency Error (MHz)								Limit (MHz)	
	1.4MHz		3MHz		5MHz		10MHz			
	Low	High	Low	High	Low	High	Low	High	Low Edge	High Edge
2.805	699.22	715.81	699.21	715.77	699.19	715.66	699.51	715.53	699	716
3.795	699.16	715.91	699.09	715.76	699.24	715.71	699.45	715.57	699	716

Temp. (°C)	Frequency Error (MHz)								Limit (MHz)	
	1.4MHz		3MHz		5MHz		10MHz			
	Low	High	Low	High	Low	High	Low	High	Low Edge	High Edge
50	699.19	715.76	699.12	715.87	699.19	715.69	699.47	715.50	699	716
40	699.18	715.91	699.17	715.81	699.30	715.76	699.46	715.39	699	716
30	699.21	715.82	699.17	715.91	699.35	715.79	699.44	715.55	699	716
20	699.16	715.84	699.15	715.85	699.26	715.74	699.52	715.49	699	716
10	699.17	715.93	699.14	715.82	699.24	715.75	699.61	715.44	699	716
0	699.09	715.76	699.11	715.92	699.24	715.72	699.55	715.46	699	716
-10	699.22	715.77	699.08	715.83	699.33	715.67	699.58	715.54	699	716
-20	699.12	715.80	699.18	715.84	699.26	715.81	699.54	715.47	699	716
-30	699.22	715.82	699.08	715.80	699.19	715.78	699.56	715.52	699	716

LTE Band 13

Voltage (Volts)	Frequency Error (MHz)				Limit (MHz)	
	5MHz		10MHz			
	Low	High	Low	High	Low Edge	High Edge
2.805	777.17	786.64	777.51	786.40	777	787
3.795	777.24	786.65	777.55	786.39	777	787

Temp. (°C)	Frequency Error (MHz)				Limit (MHz)	
	5MHz		10MHz			
	Low	High	Low	High	Low Edge	High Edge
50	777.35	786.66	777.54	786.54	777	787
40	777.35	786.76	777.59	786.42	777	787
30	777.20	786.83	777.50	786.52	777	787
20	777.26	786.74	777.52	786.48	777	787
10	777.28	786.69	777.60	786.49	777	787
0	777.30	786.81	777.43	786.42	777	787
-10	777.17	786.65	777.52	786.49	777	787
-20	777.28	786.67	777.42	786.56	777	787
-30	777.27	786.66	777.52	786.53	777	787

LTE Band 17

Voltage (Volts)	Frequency Error (MHz)				Limit (MHz)	
	5MHz		10MHz			
	Low	High	Low	High	Low Edge	High Edge
2.805	704.20	715.70	704.54	715.42	704	716
3.795	704.34	715.64	704.47	715.41	704	716

Temp. (°C)	Frequency Error (MHz)				Limit (MHz)	
	5MHz		10MHz			
	Low	High	Low	High	Low Edge	High Edge
50	704.34	715.79	704.56	715.57	704	716
40	704.16	715.75	704.47	715.57	704	716
30	704.26	715.68	704.48	715.48	704	716
20	704.26	715.74	704.51	715.49	704	716
10	704.35	715.68	704.49	715.44	704	716
0	704.26	715.71	704.56	715.51	704	716
-10	704.18	715.67	704.43	715.47	704	716
-20	704.35	715.79	704.51	715.40	704	716
-30	704.24	715.76	704.49	715.40	704	716

LTE Band 30

Voltage (Volts)	Frequency Error (MHz)				Limit (MHz)	
	5MHz		10MHz			
	Low	High	Low	High	Low Edge	High Edge
2.805	2305.18	2314.83	2305.54	2314.57	2305	2315
3.795	2305.34	2314.72	2305.42	2314.47	2305	2315

Temp. (°C)	Frequency Error (MHz)				Limit (MHz)	
	5MHz		10MHz			
	Low	High	Low	High	Low Edge	High Edge
50	2305.32	2314.77	2305.54	2314.52	2305	2315
40	2305.34	2314.68	2305.44	2314.46	2305	2315
30	2305.17	2314.82	2305.43	2314.41	2305	2315
20	2305.26	2314.74	2305.52	2314.48	2305	2315
10	2305.34	2314.65	2305.53	2314.41	2305	2315
0	2305.30	2314.76	2305.60	2314.42	2305	2315
-10	2305.23	2314.78	2305.53	2314.48	2305	2315
-20	2305.27	2314.78	2305.43	2314.45	2305	2315
-30	2305.16	2314.71	2305.60	2314.40	2305	2315

LTE Band 38

Voltage (Volts)	Frequency Error (MHz)								Limit (MHz)	
	5MHz		10MHz		15MHz		20MHz			
	Low	High	Low	High	Low	High	Low	High	Low Edge	High Edge
2.805	2570.18	2619.81	2570.53	2619.47	2570.72	2619.27	2571.10	2618.97	2570	2620
3.795	2570.23	2619.73	2570.42	2619.44	2570.83	2619.30	2571.00	2618.98	2570	2620

Temp. (°C)	Frequency Error (MHz)								Limit (MHz)	
	5MHz		10MHz		15MHz		20MHz			
	Low	High	Low	High	Low	High	Low	High	Low Edge	High Edge
50	2570.30	2619.71	2570.59	2619.50	2570.71	2619.20	2571.12	2618.96	2570	2620
40	2570.21	2619.78	2570.43	2619.52	2570.68	2619.23	2571.12	2618.91	2570	2620
30	2570.28	2619.70	2570.56	2619.41	2570.81	2619.24	2571.08	2618.96	2570	2620
20	2570.25	2619.74	2570.52	2619.48	2570.78	2619.22	2571.05	2618.95	2570	2620
10	2570.20	2619.71	2570.45	2619.45	2570.80	2619.28	2571.00	2618.86	2570	2620
0	2570.28	2619.65	2570.55	2619.48	2570.85	2619.16	2571.06	2618.98	2570	2620
-10	2570.24	2619.69	2570.60	2619.43	2570.79	2619.13	2571.14	2618.92	2570	2620
-20	2570.15	2619.81	2570.56	2619.52	2570.80	2619.29	2571.09	2618.98	2570	2620
-30	2570.21	2619.82	2570.44	2619.57	2570.76	2619.30	2571.12	2618.86	2570	2620

LTE CA_38C

Voltage (Volts)	Frequency Error (MHz)		Limit (MHz)	
	CA_15+15 MHz Low Channel	CA_15+15 MHz High Channel	Low Edge	High Edge
2.805	2570.838	2619.162	2570	2620
3.795	2570.758	2619.222	2570	2620

Frequency Error vs. Temperature.

Temp. (°C)	Frequency Error (MHz)		Limit (MHz)	
	CA_15+15 MHz Low Channel	CA_15+15 MHz High Channel	Low Edge	High Edge
50	2570.778	2619.112	2570	2620
40	2570.828	2619.132	2570	2620
30	2570.738	2619.192	2570	2620
20	2570.818	2619.182	2570	2620
10	2570.718	2619.122	2570	2620
0	2570.888	2619.112	2570	2620
-10	2570.738	2619.162	2570	2620
-20	2570.818	2619.222	2570	2620
-30	2570.858	2619.192	2570	2620

LTE Band 41

Voltage (Volts)	Frequency Error (MHz)				Limit (MHz)	
	5MHz	10MHz	15MHz	20MHz	Low Edge	High Edge
2.805	2592.97	2593.09	2593.08	2593.08	2496	2690
3.795	2592.95	2593.03	2592.94	2593.03	2496	2690

Temp. (°C)	Frequency Error (MHz)				Limit (MHz)	
	5MHz	10MHz	15MHz	20MHz	Low Edge	High Edge
50	2593.07	2592.97	2592.92	2593.07	2496	2690
40	2592.91	2593.03	2593.08	2593.04	2496	2690
30	2593.05	2592.98	2593.00	2592.93	2496	2690
20	2593.04	2592.97	2592.93	2593.08	2496	2690
10	2592.94	2592.99	2593.05	2592.90	2496	2690
0	2592.97	2593.08	2593.05	2592.91	2496	2690
-10	2592.90	2593.03	2592.99	2593.02	2496	2690
-20	2592.98	2593.09	2593.00	2593.08	2496	2690
-30	2593.01	2593.07	2593.09	2592.90	2496	2690

LTE CA_41C

Voltage (Volts)	Frequency Error (MHz)		Limit (MHz)	
	CA_10+5 MHz Low Channel	CA_10+5 MHz High Channel	Low Edge	High Edge
2.805	2496.321	2689.590	2496	2690
3.795	2496.431	2689.630	2496	2690

Frequency Error vs. Temperature.

Temp. (°C)	Frequency Error (MHz)		Limit (MHz)	
	CA_10+5 MHz Low Channel	CA_10+5 MHz High Channel	Low Edge	High Edge
50	2496.431	2689.630	2496	2690
40	2496.401	2689.560	2496	2690
30	2496.451	2689.600	2496	2690
20	2496.401	2689.600	2496	2690
10	2496.451	2689.660	2496	2690
0	2496.371	2689.660	2496	2690
-10	2496.331	2689.510	2496	2690
-20	2496.361	2689.590	2496	2690
-30	2496.381	2689.600	2496	2690

LTE Band 66

Voltage (Volts)	Frequency Error (MHz)												Limit (MHz)	
	1.4MHz		3MHz		5MHz		10MHz		15MHz		20MHz			
	Low	High	Low	High	Low	High	Low	High	Low	High	Low	High	Low Edge	High Edge
2.805	1710.69	1779.31	1711.45	1778.51	1712.43	1777.49	1715.07	1774.93	1717.43	1772.59	1720.05	1769.97	1710	1780
3.795	1710.67	1779.26	1711.59	1778.40	1712.52	1777.43	1715.06	1775.03	1717.47	1772.42	1719.98	1769.93	1710	1780

Temp. (°C)	Frequency Error (MHz)												Limit (MHz)	
	1.4MHz		3MHz		5MHz		10MHz		15MHz		20MHz			
	Low	High	Low	High	Low	High	Low	High	Low	High	Low	High	Low Edge	High Edge
50	1710.72	1779.24	1711.54	1778.53	1712.55	1777.57	1714.92	1774.99	1717.51	1772.41	1719.97	1769.93	1710	1780
40	1710.72	1779.24	1711.55	1778.44	1712.48	1777.52	1714.96	1774.92	1717.44	1772.49	1719.99	1770.05	1710	1780
30	1710.69	1779.39	1711.45	1778.51	1712.55	1777.56	1714.97	1775.03	1717.42	1772.44	1720.00	1770.03	1710	1780
20	1710.70	1779.30	1711.50	1778.50	1712.50	1777.50	1715.00	1775.00	1717.50	1772.50	1720.00	1770.00	1710	1780
10	1710.64	1779.32	1711.55	1778.54	1712.56	1777.54	1715.02	1774.97	1717.57	1772.41	1720.08	1770.02	1710	1780
0	1710.68	1779.38	1711.41	1778.59	1712.42	1777.46	1715.08	1775.09	1717.48	1772.43	1719.95	1770.06	1710	1780
-10	1710.62	1779.24	1711.57	1778.46	1712.43	1777.46	1715.04	1775.05	1717.41	1772.40	1719.96	1770.03	1710	1780
-20	1710.76	1779.23	1711.46	1778.51	1712.42	1777.43	1714.92	1774.97	1717.52	1772.59	1720.01	1769.96	1710	1780
-30	1710.65	1779.35	1711.41	1778.54	1712.54	1777.40	1715.09	1775.07	1717.43	1772.41	1720.09	1770.00	1710	1780

4.4 Emission Bandwidth Measurement

4.4.1 Limits of Emission Bandwidth Measurement

-26dB Bandwidth

According to FCC 27.53 specified that emission bandwidth is defined as the width of the signal between two points, one below the carrier center frequency and one above the carrier center frequency, outside of which all emissions are attenuated at least 26dB below the transmitter power.

Occupied Bandwidth

The EUT makes a call to the communication simulator. All measurements were done at low, middle and high operational frequency range. The communication simulator station system controlled a EUT to export maximum output power under transmission mode and specific channel frequency. Use OBW measurement function of Spectrum analyzer to measure 99 % occupied bandwidth.

4.4.2 Test Procedure

The transmitter output was connected to the spectrum analyzer through an attenuator. The bandwidth of the fundamental frequency was measured by spectrum analyzer with $RBW \geq 1\% \times OBW$ and $VBW \geq 3 \times RBW$.

4.4.3 Test Setup

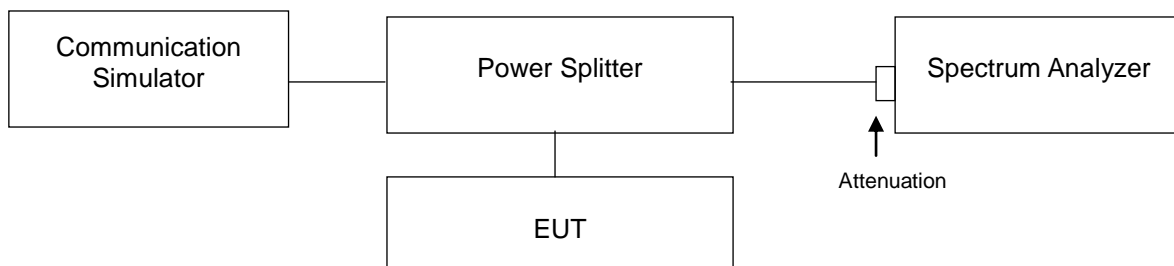

4.4.4 Test Results (-26dB Bandwidth)

Channel	FREQ. (MHz)	-26dB Bandwidth (MHz)
		WCDMA
1312	1712.4	4.68
1413	1732.6	4.68
1513	1752.6	4.71

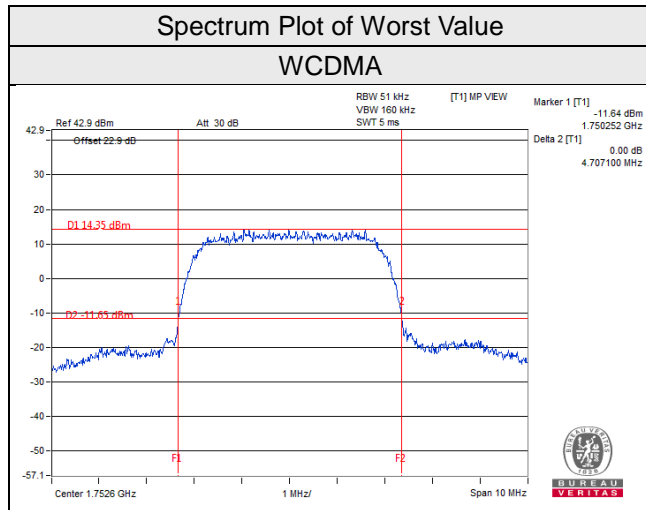

LTE Band 4									
Channel Bandwidth 1.4MHz					Channel Bandwidth 3MHz				
Channel	Frequency (MHz)	-26dB Bandwidth (MHz)			Channel	Frequency (MHz)	-26dB Bandwidth (MHz)		
		QPSK	16QAM	64QAM			QPSK	16QAM	64QAM
19957	1710.7	1.24	1.22	1.23	19965	1711.5	2.96	2.90	2.92
20175	1732.5	1.22	1.21	1.22	20175	1732.5	2.96	2.91	2.81
20393	1754.3	1.24	1.23	1.23	20385	1753.5	2.97	2.91	2.92
Channel Bandwidth 5MHz					Channel Bandwidth 10MHz				
Channel	Frequency (MHz)	-26dB Bandwidth (MHz)			Channel	Frequency (MHz)	-26dB Bandwidth (MHz)		
		QPSK	16QAM	64QAM			QPSK	16QAM	64QAM
19975	1712.5	4.86	4.84	4.83	20000	1715	9.57	9.53	9.53
20175	1732.5	4.79	4.79	4.80	20175	1732.5	9.53	9.51	9.53
20375	1752.5	4.83	4.83	4.83	20350	1750	9.55	9.56	9.55
Channel Bandwidth 15MHz					Channel Bandwidth 20MHz				
Channel	Frequency (MHz)	-26dB Bandwidth (MHz)			Channel	Frequency (MHz)	-26dB Bandwidth (MHz)		
		QPSK	16QAM	64QAM			QPSK	16QAM	64QAM
20025	1717.5	14.72	14.32	14.92	20050	1720	19.10	17.91	19.09
20175	1732.5	14.27	14.25	14.26	20175	1732.5	19.06	19.05	19.03
20325	1747.5	14.31	14.30	14.28	20300	1745	19.20	19.06	19.04

Spectrum Plot of Worst Value

1.4MHz / QPSK

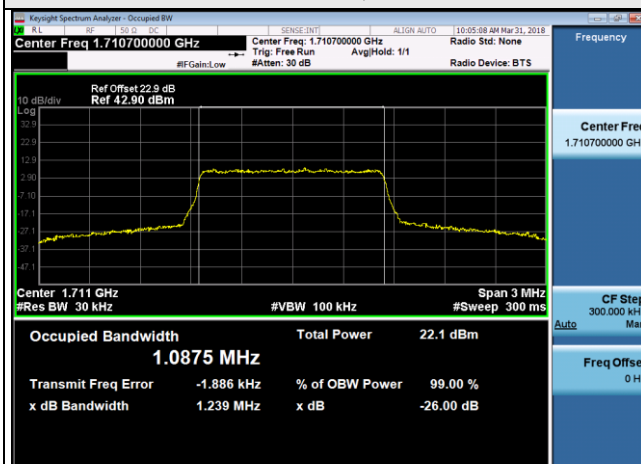

3MHz / QPSK



47k,5MHz / QPSK

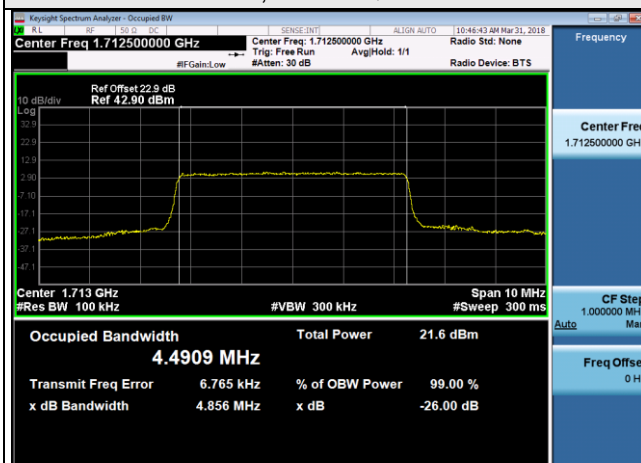

10MHz / QPSK

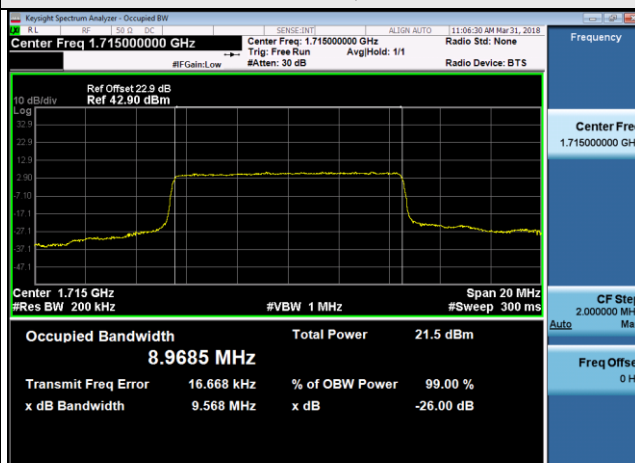

15MHz / 64QAM

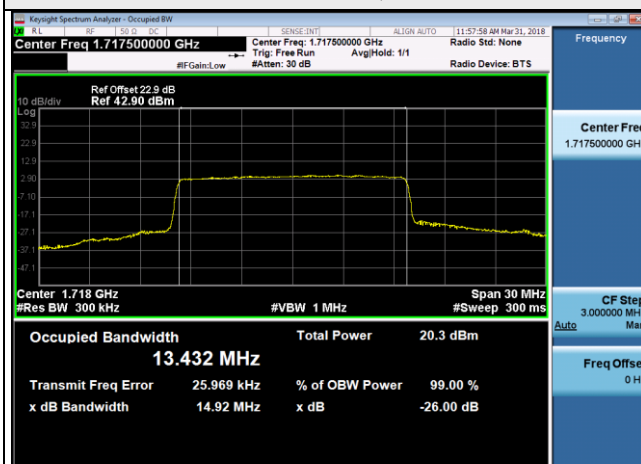

20MHz / QPSK

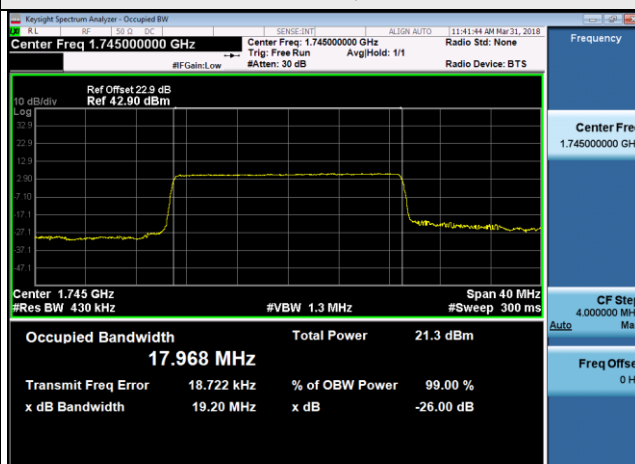

LTE Band 7									
Channel Bandwidth 5MHz					Channel Bandwidth 10MHz				
Channel	Frequency (MHz)	-26dB Bandwidth (MHz)			Channel	Frequency (MHz)	-26dB Bandwidth (MHz)		
		QPSK	16QAM	64QAM			QPSK	16QAM	64QAM
20775	2502.5	4.79	4.80	4.80	20800	2505	9.54	9.54	9.52
21100	2535	4.79	4.81	4.79	21100	2535	9.52	9.53	9.53
21425	2567.5	4.80	4.80	4.80	21400	2565	9.51	9.52	9.50
Channel Bandwidth 15MHz					Channel Bandwidth 20MHz				
Channel	Frequency (MHz)	-26dB Bandwidth (MHz)			Channel	Frequency (MHz)	-26dB Bandwidth (MHz)		
		QPSK	16QAM	64QAM			QPSK	16QAM	64QAM
20825	2507.5	14.31	14.24	14.29	20850	2510	19.06	19.04	19.02
21100	2535	14.27	14.26	14.25	21100	2535	19.09	19.06	19.05
21375	2562.5	14.26	14.22	14.24	21350	2560	19.04	19.05	19.05

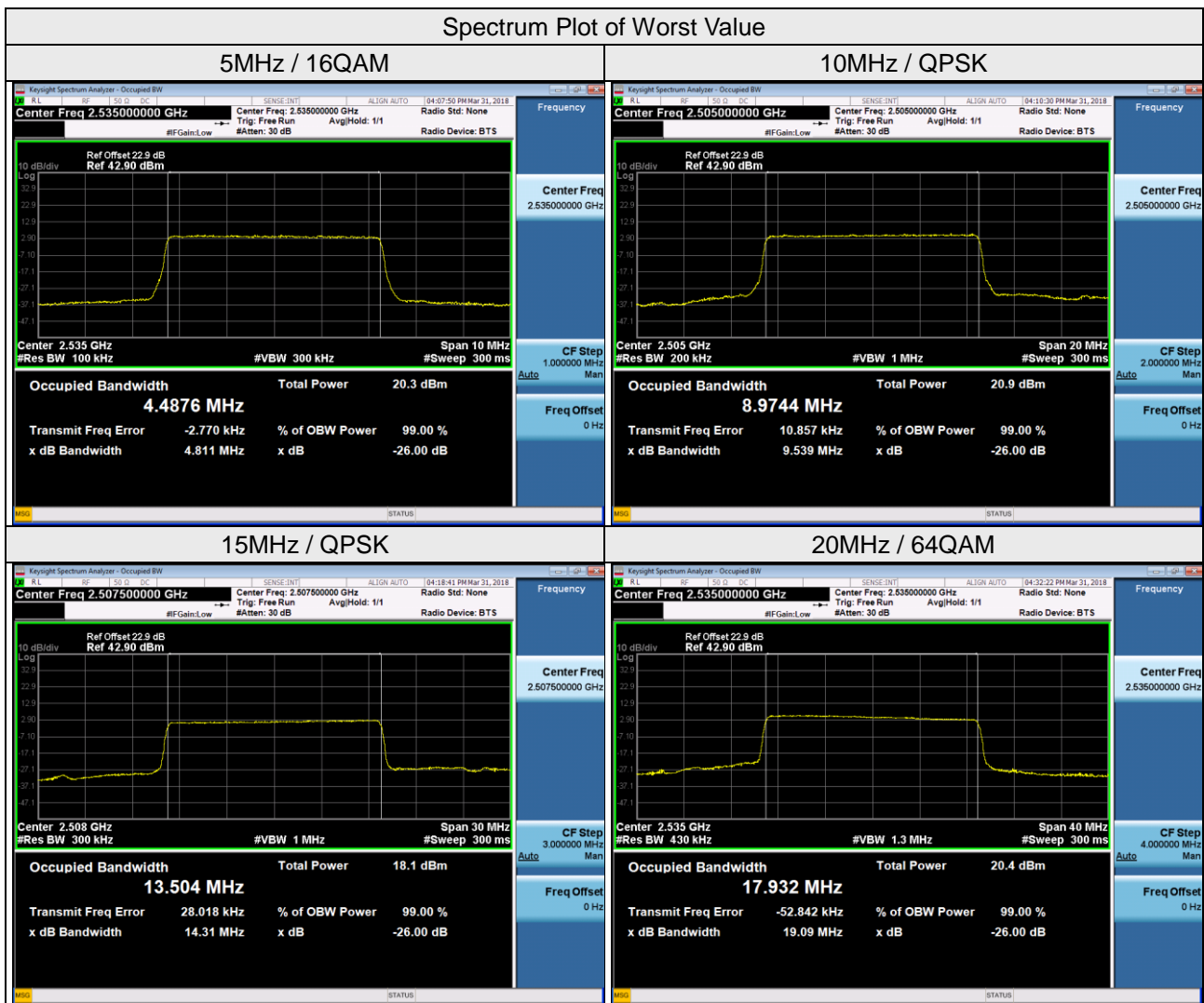

LTE CA_7C (15+20MHz)		
Channel	FREQ. (MHz)	-26dB Bandwidth (MHz)
		QPSK
21100+21271	2535+2552.1	43.26

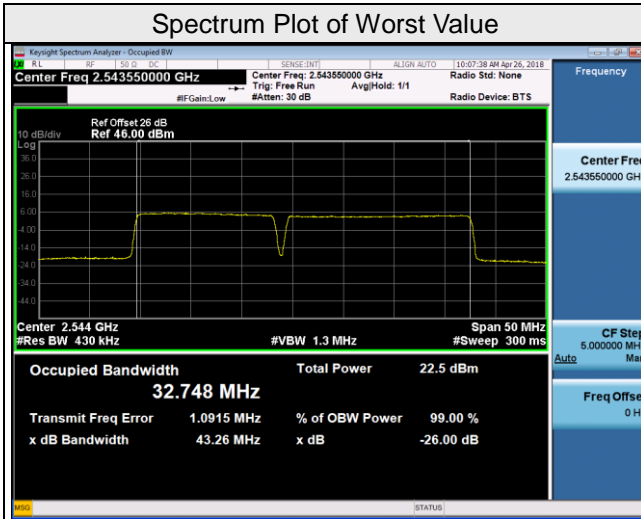

LTE CA_7C (20+20MHz)		
Channel	FREQ. (MHz)	-26dB Bandwidth (MHz)
		QPSK
21152+21350	2540.2+2560	38.87

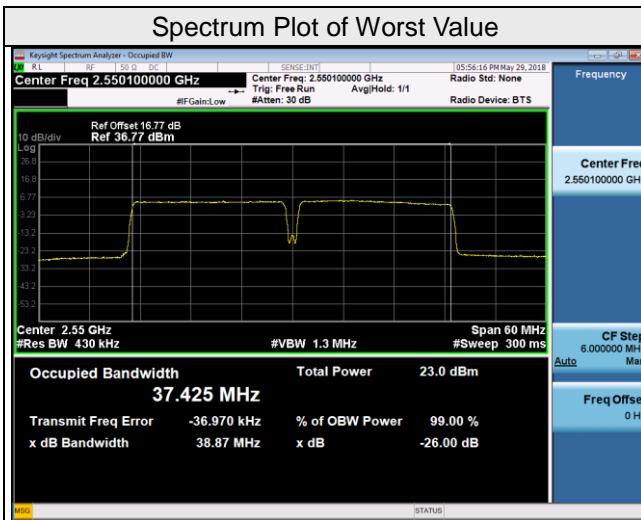

LTE Band 12									
Channel Bandwidth 1.4MHz					Channel Bandwidth 3MHz				
Channel	Frequency (MHz)	-26dB Bandwidth (MHz)			Channel	Frequency (MHz)	-26dB Bandwidth (MHz)		
		QPSK	16QAM	64QAM			QPSK	16QAM	64QAM
23017	699.7	1.22	1.22	1.22	23025	700.5	2.92	2.93	2.89
23095	707.5	1.22	1.21	1.22	23095	707.5	2.93	2.93	2.92
23173	715.3	1.22	1.22	1.22	23165	714.5	2.93	2.92	2.93
Channel Bandwidth 5MHz					Channel Bandwidth 10MHz				
Channel	Frequency (MHz)	-26dB Bandwidth (MHz)			Channel	Frequency (MHz)	-26dB Bandwidth (MHz)		
		QPSK	16QAM	64QAM			QPSK	16QAM	64QAM
23035	701.5	4.81	4.80	4.79	23060	704	9.51	9.50	9.50
23095	707.5	4.82	4.80	4.80	23095	707.5	9.56	9.52	9.55
23155	713.5	4.80	4.80	4.80	23130	711	9.54	9.52	9.51



LTE Band 13									
Channel Bandwidth 5MHz					Channel Bandwidth 10MHz				
Channel	Frequency (MHz)	-26dB Bandwidth (MHz)			Channel	Frequency (MHz)	-26dB Bandwidth (MHz)		
		QPSK	16QAM	64QAM			QPSK	16QAM	64QAM
23205	779.5	4.83	4.79	4.80	23230	782	9.53	9.52	9.50
23230	782	4.82	4.80	4.81					
23255	784.5	4.81	4.80	4.81					

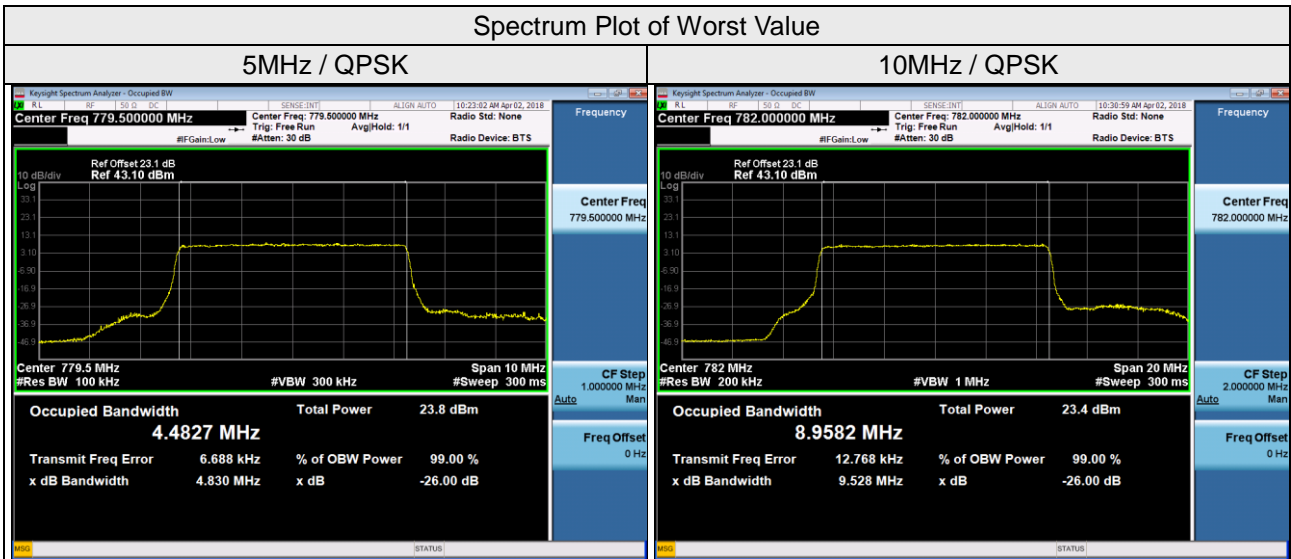

LTE Band 17

Channel Bandwidth 5MHz					Channel Bandwidth 10MHz				
Channel	Frequency (MHz)	-26dB Bandwidth (MHz)			Channel	Frequency (MHz)	-26dB Bandwidth (MHz)		
		QPSK	16QAM	64QAM			QPSK	16QAM	64QAM
23755	706.5	4.82	4.79	4.81	23780	709	9.56	9.52	9.52
23790	710	4.81	4.81	4.80	23790	710	9.54	9.51	9.53
23825	713.5	4.79	4.79	4.80	23800	711	9.53	9.52	9.50

Spectrum Plot of Worst Value

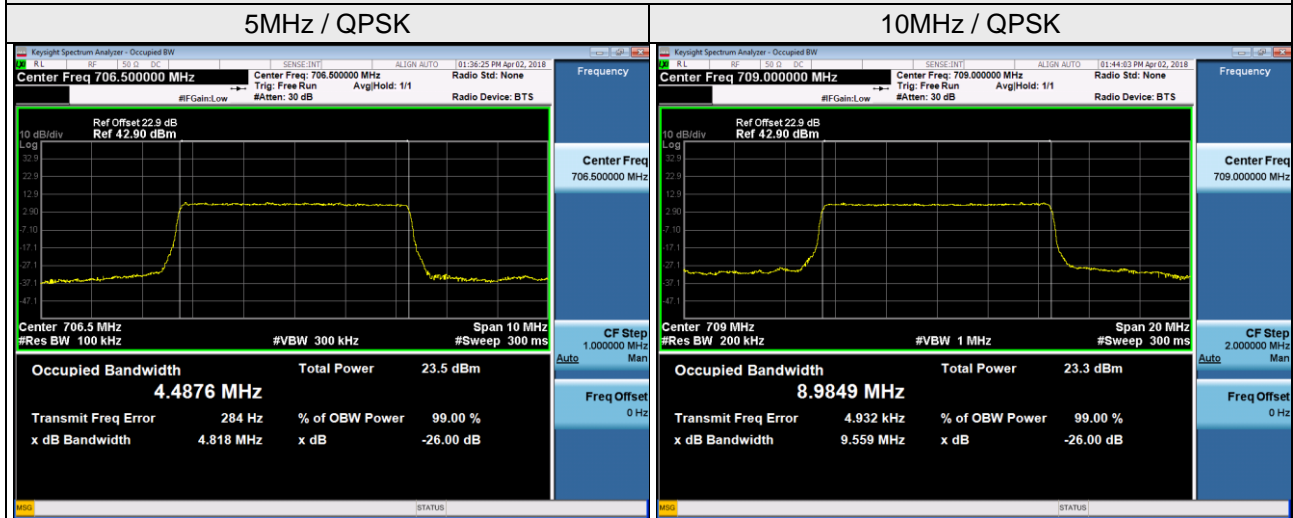

LTE Band 30									
Channel Bandwidth 5MHz					Channel Bandwidth 10MHz				
Channel	Frequency (MHz)	-26dB Bandwidth (MHz)			Channel	Frequency (MHz)	-26dB Bandwidth (MHz)		
		QPSK	16QAM	64QAM			QPSK	16QAM	64QAM
27685	2307.5	4.80	4.82	4.82	27710	2310	9.57	9.55	9.55
27710	2310	4.80	4.84	4.79					
27735	2312.5	4.82	4.83	4.83					

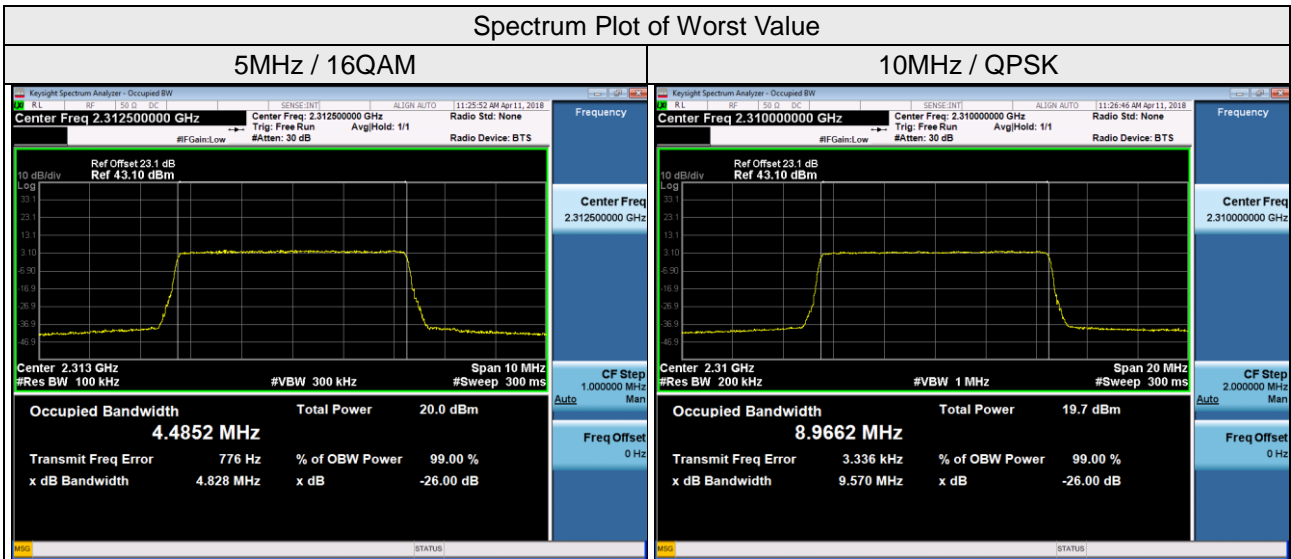

LTE Band 38									
Channel Bandwidth 5MHz					Channel Bandwidth 10MHz				
Channel	Frequency (MHz)	-26dB Bandwidth (MHz)			Channel	Frequency (MHz)	-26dB Bandwidth (MHz)		
		QPSK	16QAM	64QAM			QPSK	16QAM	64QAM
37775	2572.5	4.80	4.78	4.79	37800	2575	9.50	9.50	9.50
38000	2595	4.80	4.79	4.79	38000	2595	9.49	9.49	9.50
38225	2617.5	4.82	4.78	4.79	38200	2615	9.48	9.50	9.51
Channel Bandwidth 15MHz					Channel Bandwidth 20MHz				
Channel	Frequency (MHz)	-26dB Bandwidth (MHz)			Channel	Frequency (MHz)	-26dB Bandwidth (MHz)		
		QPSK	16QAM	64QAM			QPSK	16QAM	64QAM
37825	2577.5	14.24	14.24	14.21	37850	2580	19.03	19.02	19.01
38000	2595	14.26	14.21	14.23	38000	2595	19.03	19.01	19.02
38175	2612.5	14.27	14.25	14.24	38150	2610	19.03	19.01	19.01

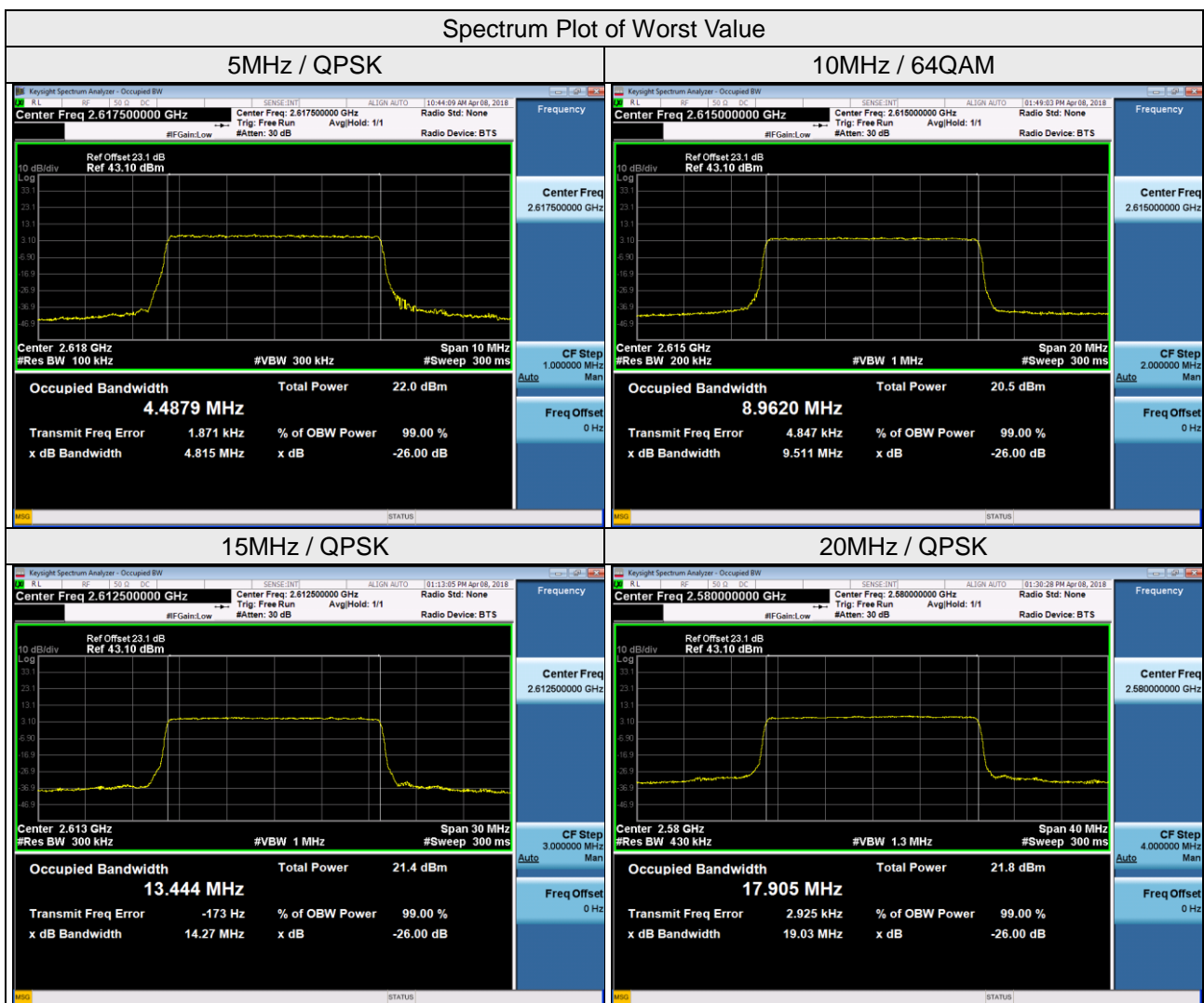

LTE CA_38C (15+15MHz)		
Channel	FREQ. (MHz)	-26dB Bandwidth (MHz)
		QPSK
38000+38150	2595+2610	29.58

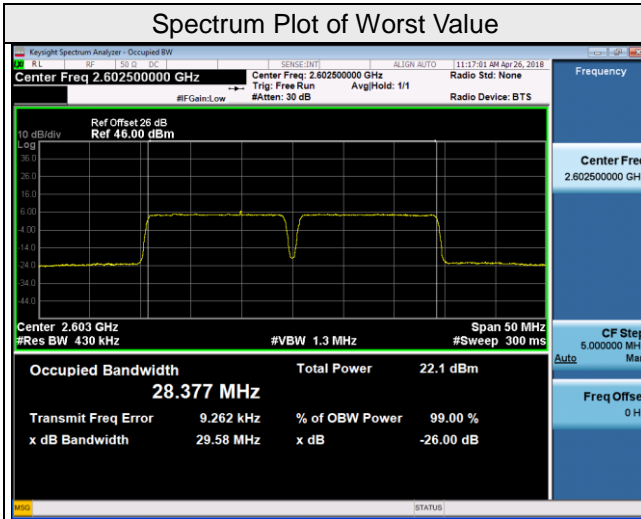

LTE CA_38C (20+20MHz)		
Channel	FREQ. (MHz)	-26dB Bandwidth (MHz)
		QPSK
37952+38150	2590.2+2610	38.92

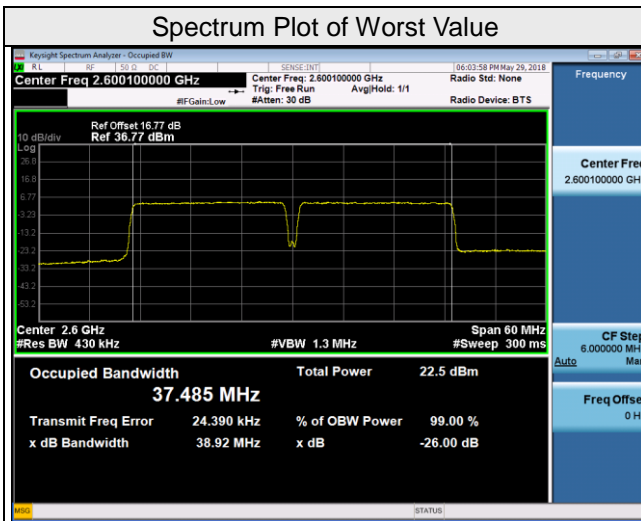

LTE Band 41									
Channel Bandwidth 5MHz					Channel Bandwidth 10MHz				
Channel	Frequency (MHz)	-26dB Bandwidth (MHz)			Channel	Frequency (MHz)	-26dB Bandwidth (MHz)		
		QPSK	16QAM	64QAM			QPSK	16QAM	64QAM
39675	2498.5	4.81	4.79	4.77	39700	2501	9.50	9.50	9.50
40620	2593	4.80	4.78	4.78	50620	2593	9.49	9.51	9.51
41565	2687.5	4.80	4.78	4.77	41540	2685	9.50	9.50	9.50
Channel Bandwidth 15MHz					Channel Bandwidth 20MHz				
Channel	Frequency (MHz)	-26dB Bandwidth (MHz)			Channel	Frequency (MHz)	-26dB Bandwidth (MHz)		
		QPSK	16QAM	64QAM			QPSK	16QAM	64QAM
39725	2503.5	14.24	14.21	14.21	39750	2506	19.02	19.01	19.01
40620	2593	14.26	14.26	14.22	40620	2593	19.03	19.02	19.03
41515	2682.5	14.26	14.23	14.23	41490	2680	19.01	18.99	18.98



LTE CA_41C (10+5MHz)		
Channel	FREQ. (MHz)	-26dB Bandwidth (MHz)
		QPSK
40620+40692	2593+2600.2	14.64

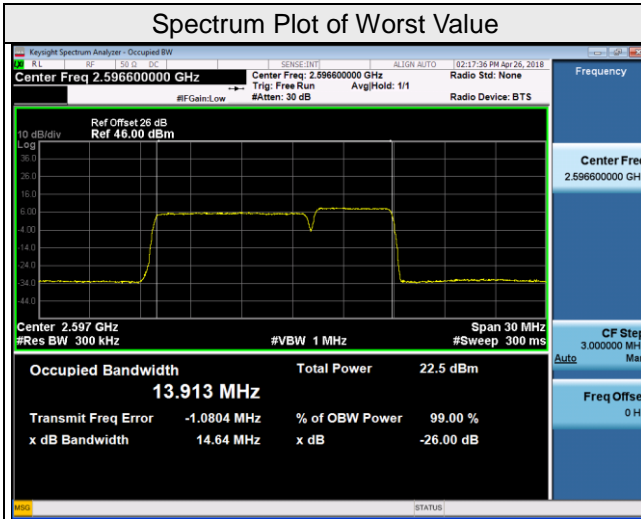

LTE CA_41C (20+20MHz)		
Channel	FREQ. (MHz)	-26dB Bandwidth (MHz)
		QPSK
40620+40818	2593+2612.8	38.87

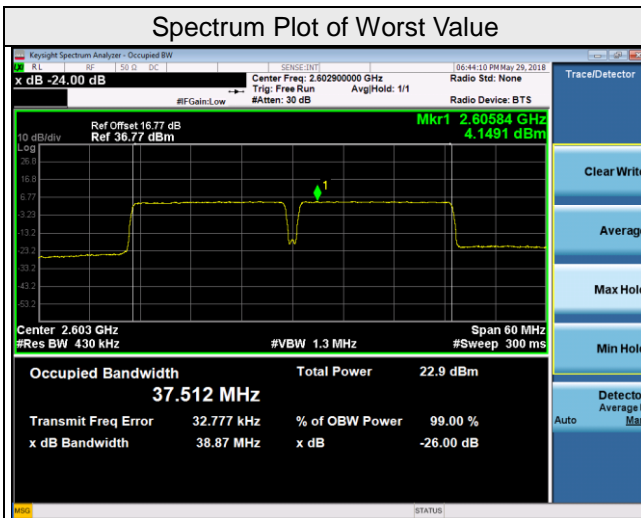

LTE Band 66									
Channel Bandwidth 1.4MHz					Channel Bandwidth 3MHz				
Channel	Frequency (MHz)	-26dB Bandwidth (MHz)			Channel	Frequency (MHz)	-26dB Bandwidth (MHz)		
		QPSK	16QAM	64QAM			QPSK	16QAM	64QAM
131979	1710.7	1.21	1.22	1.22	131987	1711.5	2.96	2.92	2.96
132322	1745	1.22	1.22	1.22	132322	1745	2.97	2.92	2.95
132665	1779.3	1.22	1.22	1.22	132657	1778.5	2.96	2.91	2.94
Channel Bandwidth 5MHz					Channel Bandwidth 10MHz				
Channel	Frequency (MHz)	-26dB Bandwidth (MHz)			Channel	Frequency (MHz)	-26dB Bandwidth (MHz)		
		QPSK	16QAM	64QAM			QPSK	16QAM	64QAM
131997	1712.5	4.81	4.82	4.81	132022	1715	9.56	9.54	9.55
132322	1745	4.83	4.79	4.82	132322	1745	9.57	9.54	9.54
132647	1777.5	4.82	4.80	4.81	132622	1775	9.56	9.53	9.50
Channel Bandwidth 15MHz					Channel Bandwidth 20MHz				
Channel	Frequency (MHz)	-26dB Bandwidth (MHz)			Channel	Frequency (MHz)	-26dB Bandwidth (MHz)		
		QPSK	16QAM	64QAM			QPSK	16QAM	64QAM
132047	1717.5	14.28	14.25	14.28	132072	1720	19.10	19.05	19.03
132322	1745	14.35	14.27	14.25	132322	1745	19.43	19.42	19.21
132597	1722.5	14.28	14.25	14.22	132572	1770	19.05	19.00	19.00