

FCC Test Report (Part 90)

Report No.: RF180321E03-3

FCC ID: MCLT77W968

Test Model: T77W968

Received Date: Mar. 21, 2018

Test Date: Apr. 02 to 08, 2018

Issued Date: May 17, 2018

Applicant: HON HAI PRECISION IND. CO., LTD.

Address: 5F-1,5 Hsin-An Road Hsinchu, Science-Based Industrial Park Taiwan,
R.O.C.

Issued By: Bureau Veritas Consumer Products Services (H.K.) Ltd., Taoyuan Branch
Hsin Chu Laboratory

Lab Address: E-2, No.1, Li Hsin 1st Road, Hsinchu Science Park, Hsinchu City 300,
Taiwan R.O.C.

Test Location: E-2, No.1, Li Hsin 1st Road, Hsinchu Science Park, Hsinchu City 300,
Taiwan R.O.C.

**FCC Registration /
Designation Number:** 723255 / TW2022



This report is for your exclusive use. Any copying or replication of this report to or for any other person or entity, or use of our name or trademark, is permitted only with our prior written permission. This report sets forth our findings solely with respect to the test samples identified herein. The results set forth in this report are not indicative or representative of the quality or characteristics of the lot from which a test sample was taken or any similar or identical product unless specifically and expressly noted. Our report includes all of the tests requested by you and the results thereof based upon the information that you provided to us. You have 60 days from date of issuance of this report to notify us of any material error or omission caused by our negligence, provided, however, that such notice shall be in writing and shall specifically address the issue you wish to raise. A failure to raise such issue within the prescribed time shall constitute your unqualified acceptance of the completeness of this report, the tests conducted and the correctness of the report contents. Unless specific mention, the uncertainty of measurement has been explicitly taken into account to declare the compliance or non-compliance to the specification. The report must not be used by the client to claim product certification, approval, or endorsement by TAF or any government agencies.

Table of Contents

Release Control Record	3
1 Certificate of Conformity	4
2 Summary of Test Results	5
2.1 Measurement Uncertainty	5
2.2 Test Site and Instruments	6
3 General Information	8
3.1 General Description of EUT	8
3.2 Configuration of System under Test	10
3.2.1 Description of Support Units	11
3.3 Test Mode Applicability and Tested Channel Detail	12
3.4 EUT Operating Conditions	15
3.5 General Description of Applied Standards	15
4 Test Types and Results	16
4.1 Output Power Measurement	16
4.1.1 Limits of Output Power Measurement and Antenna Height	16
4.1.2 Test Procedures	16
4.1.3 Test Setup	16
4.1.4 Test Results	17
4.2 Modulation characteristics Measurement	22
4.2.1 Limits of Modulation characteristics	22
4.2.2 Test Procedure	22
4.2.3 Test Setup	22
4.2.4 Test Results	23
4.3 Frequency Stability Measurement	25
4.3.1 Limits of Frequency Stability Measurement	25
4.3.2 Test Procedure	25
4.3.3 Test Setup	25
4.3.4 Test Results	26
4.4 Occupied Bandwidth Measurement	28
4.4.1 Limits of Occupied Bandwidth Measurement	28
4.4.2 Test Procedure	28
4.4.3 Test Setup	28
4.4.4 Test Result (-26dB Bandwidth)	29
4.4.5 Test Result (Occupied Bandwidth)	31
4.5 Emission Mask Measurement	33
4.5.1 Limits of Emission Mask Measurement	33
4.5.2 Test Procedures	33
4.5.3 Test Setup	33
4.5.4 Test Results	34
4.6 Conducted Spurious Emissions	42
4.6.1 Limits of Conducted Spurious Emissions Measurement	42
4.6.2 Test Setup	42
4.6.3 Test Procedure	42
4.6.4 Test Results	43
4.7 Radiated Emission Measurement	49
4.7.1 Limits of Radiated Emission Measuremen	49
4.7.2 Test Procedure	49
4.7.3 Deviation from Test Standard	49
4.7.4 Test Setup	50
4.7.5 Test Results	51
5 Pictures of Test Arrangements	79
Appendix – Information on the Testing Laboratories	80



Release Control Record

Issue No.	Description	Date Issued
RF180321E03-3	Original release	May 17, 2018

1 Certificate of Conformity

Product: LTE M.2 Module

Brand: FOXCONN

Test Model: T77W968

Sample Status: ENGINEERING SAMPLE

Applicant: HON HAI PRECISION IND. CO., LTD.

Test Date: Apr. 02 to 08, 2018

Standards: FCC Part 90, Subpart S / R
FCC Part 2

The above equipment has been tested by **Bureau Veritas Consumer Products Services (H.K.) Ltd., Taoyuan Branch**, and found compliance with the requirement of the above standards. The test record, data evaluation & Equipment Under Test (EUT) configurations represented herein are true and accurate accounts of the measurements of the sample's EMC characteristics under the conditions specified in this report.

Prepared by : Wendy Wu , **Date:** May 17, 2018
Wendy Wu / Specialist

Approved by : May Chen , **Date:** May 17, 2018
May Chen / Manager

2 Summary of Test Results

Applied Standard: FCC Part 90 & Part 2			
FCC Clause	Test Item	Result	Remarks
2.1046 90.635 (b) 90.542(a)(7)	Radiated Power	PASS	Meet the requirement of limit.
2.1047	Modulation characteristics	PASS	Meet the requirement
2.1055 90.213 90.539	Frequency Stability	PASS	Meet the requirement of limit.
2.1049 90.209	Occupied Bandwidth	PASS	Meet the requirement of limit.
2.1051 90.691 90.543	Emission Mask	PASS	Meet the requirement of limit.
2.1051 90.691 90.543	Conducted Spurious Emissions	PASS	Meet the requirement of limit.
2.1053 90.691 90.543	Radiated Spurious Emissions	PASS	Meet the requirement of limit. Minimum passing margin is -22.77dB at 6344MHz.

2.1 Measurement Uncertainty

Where relevant, the following measurement uncertainty levels have been estimated for tests performed on the EUT as specified in CISPR 16-4-2:

Measurement	Frequency	Expanded Uncertainty (k=2) (\pm)
Radiated Emissions up to 1 GHz	30MHz ~ 1GHz	5.32 dB
Radiated Emissions above 1 GHz	1GHz ~ 6GHz	5.14 dB
	6GHz ~ 18GHz	5.04 dB
	18GHz ~ 40GHz	5.25 dB

2.2 Test Site and Instruments

For radiated spurious emissions test:

DESCRIPTION & MANUFACTURER	MODEL NO.	SERIAL NO.	CALIBRATED DATE	CALIBRATED UNTIL
Test Receiver Agilent	N9038A	MY50010156	July 12, 2017	July 11, 2018
Pre-Amplifier EMCI	EMC001340	980142	Feb. 09, 2018	Feb. 08, 2019
Loop Antenna ^(*) Electro-Metrics	EM-6879	264	Dec. 16, 2016	Dec. 15, 2018
RF Cable	NA	LOOPCAB-001 LOOPCAB-002	Jan. 15, 2018	Jan. 14, 2019
Pre-Amplifier Mini-Circuits	ZFL-1000VH2B	AMP-ZFL-05	May 06, 2017	May 05, 2018
Trilog Broadband Antenna SCHWARZBECK	VULB 9168	9168-361	Nov. 29, 2017	Nov. 28, 2018
RF Cable	8D	966-3-1 966-3-2 966-3-3	Mar. 20, 2018	Mar. 19, 2019
Fixed attenuator Mini-Circuits	UNAT-5+	PAD-3m-3-01	Oct. 03, 2017	Oct. 02, 2018
Horn_Antenna SCHWARZBECK	BBHA9120-D	9120D-406	Dec. 12, 2017	Dec. 11, 2018
Pre-Amplifier EMCI	EMC12630SE	980384	Jan. 29, 2018	Jan. 28, 2019
RF Cable	EMC104-SM-SM-1200 EMC104-SM-SM-2000 EMC104-SM-SM-5000	160922 150317 150322	Jan. 29, 2018	Jan. 28, 2019
Spectrum Analyzer Keysight	N9030A	MY54490679	July 25, 2017	July 24, 2018
Pre-Amplifier EMCI	EMC184045SE	980386	Jan. 29, 2018	Jan. 28, 2019
Horn_Antenna SCHWARZBECK	BBHA 9170	BBHA9170608	Dec. 14, 2017	Dec. 13, 2018
RF Cable	EMC102-KM-KM-1200	160924	Jan. 29, 2018	Jan. 28, 2019
Software	ADT_Radiated_V8.7.08	NA	NA	NA
Antenna Tower & Turn Table Max-Full	MF-7802	MF780208406	NA	NA
Boresight Antenna Fixture	FBA-01	FBA-SIP01	NA	NA

Note:

1. The calibration interval of the above test instruments is 12 months and the calibrations are traceable to NML/ROC and NIST/USA.
2. *The calibration interval of the above test instruments is 24 months and the calibrations are traceable to NML/ROC and NIST/USA.
3. The test was performed in 966 Chamber No. 3.
4. The CANADA Site Registration No. is 20331-1
5. Loop antenna was used for all emissions below 30 MHz.
6. Tested Date: Apr. 02, 2018

For other test:

DESCRIPTION & MANUFACTURER	MODEL NO.	SERIAL NO.	CALIBRATED DATE	CALIBRATED UNTIL
Spectrum Analyzer R&S	FSV40	100964	July 1, 2017	June 30, 2018
Spectrum Analyzer Agilent	E4446A	MY48250254	Nov. 21, 2017	Nov. 20, 2018
Power meter Anritsu	ML2495A	1014008	May 11, 2017	May 10, 2018
Power sensor Anritsu	MA2411B	0917122	May 11, 2017	May 10, 2018
AC Power Source Extech Electronics	6205	1440452	NA	NA
Temperature & Humidity Chamber Giant Force	GTH-150-40-SP-AR	MAA0812-008	Jan. 10, 2018	Jan. 09, 2019
DC Power Supply Topward	6603D	795558	NA	NA
True RMS Clamp Meter FLUKE	325	31130711WS	May 29, 2017	May 28, 2018
ESG Vector signal generator Agilent	E4438C	MY45094468/0 05 506 602 UK6 UNJ	Nov. 26, 2017	Nov. 25, 2018
ESG Vector signal generator Agilent	E4438C	MY47271330 506 602 UNJ	Oct. 11, 2017	Oct. 10, 2018
Mech Switch Absorptive Mini-Circuits	MSP4TA-18+	0140	Feb. 12, 2018	Feb. 11, 2019
FXD ATTEN Mini-Circuits	BW-S3W2+	MN71981	Feb. 12, 2018	Feb. 11, 2019
Software	ADT_RF Test Software V6.6.5.4	NA	NA	NA

- NOTE:**
1. The test was performed in Oven room 2.
 2. The calibration interval of the above test instruments is 12 months and the calibrations are traceable to NML/ROC and NIST/USA.
 3. Tested Date: Apr. 08, 2018

3 General Information

3.1 General Description of EUT

Product	LTE M.2 Module	
Brand	FOXCONN	
Test Model	T77W968	
Status of EUT	ENGINEERING SAMPLE	
Power Supply Rating	DC 3.3V from host equipment	
Modulation Type	QPSK, 16QAM, 64QAM	
Operating Frequency	LTE Band 14	788MHz ~ 798MHz
	LTE Band 26	814.7MHz ~ 823.3MHz
Max. ERP Power	LTE Band 14 (Channel Bandwidth 5MHz)	24.65 dBm
	LTE Band 14 (Channel Bandwidth 10MHz)	24.69 dBm
	LTE Band 26 (Channel Bandwidth 1.4MHz)	24.46 dBm
	LTE Band 26 (Channel Bandwidth 3MHz)	24.59 dBm
	LTE Band 26 (Channel Bandwidth 5MHz)	24.48 dBm
	LTE Band 26 (Channel Bandwidth 10MHz)	24.51 dBm
Emission Designator	LTE Band 14	Channel Bandwidth 5MHz QPSK: 4M49G7D 16QAM: 4M49D7W 64QAW: 4M50D7W
		Channel Bandwidth 10MHz QPSK: 8M97G7D 16QAM: 8M97D7W 64QAW: 8M99D7W
	LTE Band 26	Channel Bandwidth 1.4MHz QPSK: 1M09G7D 16QAM: 1M09D7W 64QAW: 1M09D7W
		Channel Bandwidth 3MHz QPSK: 2M70G7D 16QAM: 2M70D7W 64QAW: 2M70D7W
		Channel Bandwidth 5MHz QPSK: 4M49G7D 16QAM: 4M49D7W 64QAW: 4M49D7W
		Channel Bandwidth 10MHz QPSK: 8M95G7D 16QAM: 8M96D7W 64QAW: 8M96D7W
Antenna Type	Refer to note as below	
Antenna Connector	Refer to note as below	
Accessory Device	NA	
Data Cable Supplied	NA	

Note:

1. The antennas provided to the EUT, please refer to the following table:

Antenna No.	Antenna Net Gain(dBi)	Frequency range (MHz)	Antenna Type	Connector Type	Cable Length
1	Please refer to below table	699~803	PIFA	i-pex(MHF)	100mm
2	Please refer to below table	791~960 1447.9~1606	PIFA	i-pex(MHF)	100mm
3	Please refer to below table	1710~2170 2500~2690	PIFA	i-pex(MHF)	100mm
4	Please refer to below table	3400~3700	PIFA	i-pex(MHF)	100mm
5	Please refer to below table	5110~5925	PIFA	i-pex(MHF)	100mm
6	Please refer to below table	2305~2315	Dipole	i-pex(MHF)	80mm

Antenna gain list

Antenna No.	Band	Freq. Range (MHz)	Gain (dBi)
3	WCDMA II (B2)	1850~1910	4.92
3	WCDMA IV (B4)	1710~1755	5.99
2	WCDMA V (B5)	824~849	2.68
3	LTE Band (2)	1850~1910	4.92
3	LTE Band (4)	1710~1755	5.99
2	LTE Band (5)	824~849	2.68
3	LTE Band (7)	2500~2570	5.2
1	LTE Band (12)	698~716	4.17
1	LTE Band (13)	777~787	3.05
1	LTE Band (14)	788~798	2.87
1	LTE Band (17)	704~716	4.17
3	LTE Band (25)	1850~1915	4.92
2	LTE Band (26)	814~849	2.92
6	LTE Band (30)	2305~2315	3.02
3	LTE Band (38)	2570~2620	4.82
3	LTE Band (41)	2496~2690	5.38
3	LTE Band (66)	1710~1780	5.99

2. The above EUT information is declared by manufacturer and for more detailed features description, please refer to the manufacturer's specifications or User's Manual.

3.2 Configuration of System under Test

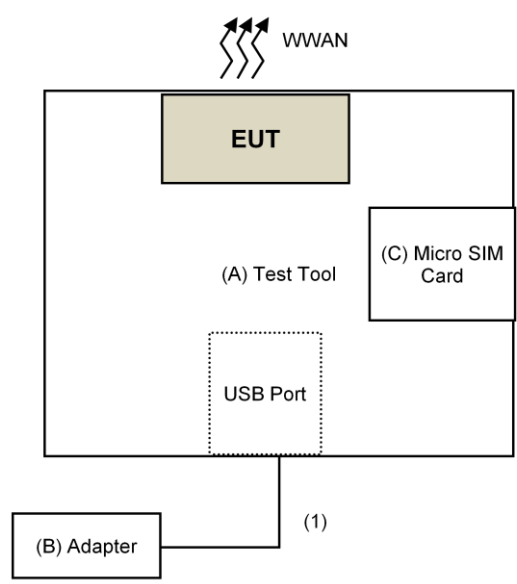

Remote Site

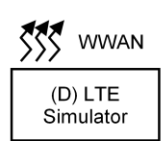



3.2.1 Description of Support Units

The EUT has been tested as an independent unit together with other necessary accessories or support units. The following support units or accessories were used to form a representative test configuration during the tests.

ID	Product	Brand	Model No.	Serial No.	FCC ID	Remarks
A.	Test Tool	Foxconn	T77W968	NA	NA	Supplied by client
B.	Adapter	ASUS	EXA1205UA	NA	NA	Provided by Lab
C.	SIM Card	NA	NA	NA	NA	Provided by Lab
D.	Simulator	Keysight	E7515A	MY56030229	NA	Provided by Lab

Note:

1. All power cords of the above support units are non-shielded (1.8m).

ID	Descriptions	Qty.	Length (m)	Shielding (Yes/No)	Cores (Qty.)	Remarks
1.	USB Cable	1	1	Yes	0	Provided by Lab

3.3 Test Mode Applicability and Tested Channel Detail

Pre-Scan has been conducted to determine the worst-case mode from all possible combinations between available modulations, data rates, XYZ axis and antenna ports

The worst case was found when positioned on X-plane. Following channel(s) was (were) selected for the final test as listed below:

LTE Band 14

TEST ITEM	AVAILABLE CHANNEL	TESTED CHANNEL	CHANNEL BANDWIDTH	MODULATION	MODE
ERP	23305 to 23355	23305, 23330, 23355	5MHz	QPSK/16QAM/64QAM	1RB / 0 RB offset
	23330	23330	10MHz	QPSK/16QAM/64QAM	1RB / 0 RB offset
Frequency Stability	23305 to 23355	23305, 23330, 23355	5MHz	QPSK	-
	23330	23330	10MHz	QPSK	-
Occupied Bandwidth	23305 to 23355	23305, 23330, 23355	5MHz	QPSK/16QAM/64QAM	Full RB
	23330	23330	10MHz	QPSK/16QAM/64QAM	Full RB
Emission Mask	23305 to 23355	23305	5MHz	QPSK	1 RB / 0 RB Offset
		23355			1 RB / 24 RB Offset
		23305, 23355			25 RB / 0 RB Offset
	23330	23355	10MHz	QPSK	1 RB / 0 RB Offset
					1 RB / 49 RB Offset
					50 RB / 0 RB Offset
Conducted Emission	23305 to 23355	23305, 23330, 23355	5MHz	QPSK	1RB / 0 RB offset
	23330	23330	10MHz	QPSK	1RB / 0 RB offset
Radiated Emission	23305 to 23355	23305, 23330, 23355	5MHz	QPSK	1RB / 0 RB offset
	23330	23330	10MHz	QPSK	1RB / 0 RB offset

NOTE:

All supported modulation types were evaluated. The Worst case of QPSK was selected. Therefore, the Frequency Stability, Condcudeted Emission and Radiated Emission were presented under QPSK mode only.

Test Condition:

Test Item	Environmental Conditions	Input Power (System)	Tested By
Output Power	25deg. C, 60%RH	120Vac, 60Hz	Jyunchun Lin
Frequency Stability	25deg. C, 60%RH	120Vac, 60Hz	Jyunchun Lin
Occupied Bandwidth	25deg. C, 60%RH	120Vac, 60Hz	Jyunchun Lin
Emission Mask	25deg. C, 60%RH	120Vac, 60Hz	Jyunchun Lin
Conducted Emission	25deg. C, 60%RH	120Vac, 60Hz	Jyunchun Lin
Radiated Emission Below 1GHz	25deg. C, 66%RH	120Vac, 60Hz	Weiwei Lo
Radiated Emission Above 1GHz	25deg. C, 62%RH	120Vac, 60Hz	Eason Tseng

LTE Band 26

TEST ITEM	AVAILABLE CHANNEL	TESTED CHANNEL	CHANNEL BANDWIDTH	MODULATION	MODE
ERP	26697 to 26783	26697, 26740, 26783	1.4MHz	QPSK/16QAM/64QAM	1RB / 0 RB offset
	26705 to 26775	26705, 26740, 26775	3MHz	QPSK/16QAM/64QAM	1RB / 0 RB offset
	26715 to 26765	26715, 26740, 26765	5MHz	QPSK/16QAM/64QAM	1RB / 0 RB offset
	26740	26740	10MHz	QPSK/16QAM/64QAM	1RB / 0 RB offset
Frequency Stability	26697 to 26783	26740	1.4MHz	QPSK	-
	26705 to 26775	26740	3MHz	QPSK	-
	26715 to 26765	26740	5MHz	QPSK	-
	26740	26740	10MHz	QPSK	-
Occupied Bandwidth	26697 to 26783	26697, 26740, 26783	1.4MHz	QPSK/16QAM/64QAM	Full RB
	26705 to 26775	26705, 26740, 26775	3MHz	QPSK/16QAM/64QAM	Full RB
	26715 to 26765	26715, 26740, 26765	5MHz	QPSK/16QAM/64QAM	Full RB
	26740	26740	10MHz	QPSK/16QAM/64QAM	Full RB
Emission Mask	26697 to 26783	26697	1.4MHz	QPSK	1 RB / 0 RB Offset
		26783			1 RB / 5 RB Offset
		26697, 26783			6 RB / 0 RB Offset
	26705 to 26775	26705	3MHz	QPSK	1 RB / 0 RB Offset
		26775			1 RB / 14 RB Offset
		26705, 26775			15 RB / 0 RB Offset
	26715 to 26765	26715	5MHz	QPSK	1 RB / 0 RB Offset
		26765			1 RB / 24 RB Offset
		26715, 26765			25 RB / 0 RB Offset
	26740	26740	10MHz	QPSK	1 RB / 0 RB Offset
					1 RB / 49 RB Offset
					50 RB / 0 RB Offset
Conducted Emission	26697 to 26783	26697, 26740, 26783	1.4MHz	QPSK	1RB / 0 RB offset
	26705 to 26775	26705, 26740, 26775	3MHz	QPSK	1RB / 0 RB offset
	26715 to 26765	26715, 26740, 26765	5MHz	QPSK	1RB / 0 RB offset
	26740	26740	10MHz	QPSK	1RB / 0 RB offset
Radiated Emission	26697 to 26783	26697, 26740, 26783	1.4MHz	QPSK	1RB / 0 RB offset
	26705 to 26775	26705, 26740, 26775	3MHz	QPSK	1RB / 0 RB offset
	26715 to 26765	26715, 26740, 26765	5MHz	QPSK	1RB / 0 RB offset
	26740	26740	10MHz	QPSK	1RB / 0 RB offset

NOTE:

All supported modulation types were evaluated. The Worst case of QPSK was selected. Therefore, the Frequency Stability, Condcudeted Emission and Radiated Emission were presented under QPSK mode only.



Test Condition:

Test Item	Environmental Conditions	Input Power (System)	Tested By
Output Power	25deg. C, 60%RH	120Vac, 60Hz	Jyunchun Lin
Frequency Stability	25deg. C, 60%RH	120Vac, 60Hz	Jyunchun Lin
Occupied Bandwidth	25deg. C, 60%RH	120Vac, 60Hz	Jyunchun Lin
Emission Mask	25deg. C, 60%RH	120Vac, 60Hz	Jyunchun Lin
Conducted Emission	25deg. C, 60%RH	120Vac, 60Hz	Jyunchun Lin
Radiated Emission Below 1GHz	25deg. C, 66%RH	120Vac, 60Hz	Weiwei Lo
Radiated Emission Above 1GHz	25deg. C, 62%RH	120Vac, 60Hz	Eason Tseng



3.4 EUT Operating Conditions

The communication simulator station system controlled a EUT to export maximum output power under transmission mode and specific channel frequency.

3.5 General Description of Applied Standards

The EUT is a RF Product. According to the specifications of the manufacturer, it must comply with the requirements of the following standards:

FCC 47 CFR Part 2

FCC 47 CFR Part 90, Subpart S / R

KDB 971168 D01 Power Meas License Digital Systems v03r01

ANSI/TIA/EIA-603-E 2016

ANSI 63.26-2015

All test items have been performed and recorded as per the above standards.

4 Test Types and Results

4.1 Output Power Measurement

4.1.1 Limits of Output Power Measurement and Antenna Height

According to 90.635 (b), Maximum output power of the transmitter for mobile stations is 100 watts (20 dBw). According to 90.542(a)(7), Portable stations (hand-held devices) transmitting in the 758-768 MHz band and the 788-798 MHz band are limited to 3 watts ERP.

4.1.2 Test Procedures

Conducted Power Measurement:

The EUT was set up for the maximum power with WCDMA & LTE link data modulation and link up with simulator. Set the EUT to transmit under low, middle and high channel and difference RB size/ RB offset for difference bandwidth record the power level shown on power meter.

EIRP / ERP Measurement:

- EIRP = Conducted Output power level + Antenna gain.
- ERP power can be calculated from EIRP power by subtracting the gain of dipole, ERP power = EIRP power - 2.15dBi.
- ERP = Conducted Output power level + Antenna gain (dBi) - Isotropically Factor (2.15dB).

4.1.3 Test Setup

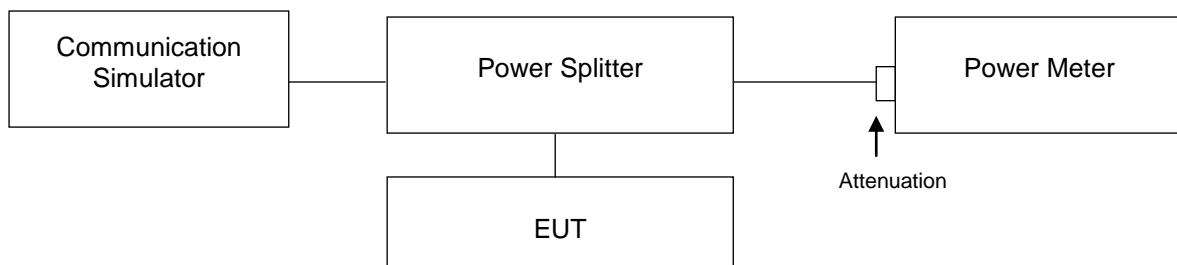

For the actual test configuration, please refer to the attached file (Test Setup Photo).

4.1.4 Test Results

CONDUCTED OUTPUT POWER

LTE Band 14

Band / BW	RB Size	RB Offset	QPSK			3GPP MPR (dB)	16QAM			3GPP MPR (dB)	64QAM			3GPP MPR (dB)
			Low CH	Mid CH	High CH		Low CH	Mid CH	High CH		Low CH	Mid CH	High CH	
			23305	23330	23335		23305	23330	23335		23305	23330	23335	
			790.5 MHz	793 MHz	795.5 MHz		790.5 MHz	793 MHz	795.5 MHz		790.5 MHz	793 MHz	795.5 MHz	
14 / 5M	1	0	23.88	23.93	23.83	0	22.81	22.70	22.79	1	21.75	21.69	21.73	2
	1	12	23.82	23.77	23.84	0	22.74	22.81	22.74	1	21.80	21.66	21.70	2
	1	24	23.85	23.79	23.79	0	22.74	22.87	22.65	1	21.78	21.71	21.75	2
	12	0	22.86	22.77	22.87	1	21.70	21.85	21.85	2	20.69	20.68	20.62	3
	12	6	22.85	22.81	22.75	1	21.88	21.86	21.82	2	20.72	20.65	20.58	3
	12	13	22.88	22.77	22.79	1	21.85	21.88	21.80	2	20.71	20.55	20.61	3
	25	0	22.90	22.87	23.76	1	21.87	21.75	21.79	2	20.75	20.62	20.55	3

Band / BW	RB Size	RB Offset	QPSK	3GPP MPR (dB)	16QAM	3GPP MPR (dB)	64QAM	3GPP MPR (dB)
			Mid CH		Mid CH		Mid CH	
			23330		23330		23330	
			793		793		793	
			MHz		MHz		MHz	
14 / 10M	1	0	23.97	0	22.90	1	21.76	2
	1	24	23.76	0	22.75	1	21.70	2
	1	49	23.69	0	22.70	1	21.75	2
	25	0	22.82	1	21.85	2	20.83	3
	25	12	22.90	1	21.84	2	20.76	3
	25	25	22.75	1	21.88	2	20.77	3
	50	0	22.84	1	21.80	2	20.75	3

LTE Band 26

Band / BW	RB Size	RB Offset	QPSK			3GPP MPR (dB)	16QAM			3GPP MPR (dB)	64QAM			3GPP MPR (dB)
			Low CH	Mid CH	High CH		Low CH	Mid CH	High CH		Low CH	Mid CH	High CH	
			26697	26740	26783		26697	26740	26783		26697	26740	26783	
			814.7	819	823.3		814.7	819	823.3		814.7	819	823.3	
			MHz	MHz	MHz		MHz	MHz	MHz		MHz	MHz	MHz	
26 / 1.4M	1	0	23.56	23.69	23.58	0	22.38	22.50	22.41	1	21.48	21.40	21.43	2
	1	2	23.59	23.64	23.52	0	22.46	22.52	22.44	1	21.45	21.45	21.48	2
	1	5	23.50	23.53	23.55	0	22.37	22.55	22.31	1	21.39	21.42	21.39	2
	3	0	23.55	23.58	23.58	0	22.61	22.48	22.53	1	21.42	21.32	21.44	2
	3	1	23.63	23.64	23.53	0	22.62	22.57	22.59	1	21.50	21.48	21.50	2
	3	3	23.53	23.59	22.52	0	22.58	22.59	22.55	1	21.44	21.52	21.55	2
	6	0	22.58	22.52	22.54	1	21.53	21.47	21.42	2	20.39	20.42	20.44	3

Band / BW	RB Size	RB Offset	QPSK			3GPP MPR (dB)	16QAM			3GPP MPR (dB)	64QAM			3GPP MPR (dB)
			Low CH	Mid CH	High CH		Low CH	Mid CH	High CH		Low CH	Mid CH	High CH	
			26705	26740	26775		26705	26740	26775		26705	26740	26775	
			815.50	819.00	822.50		815.50	819.00	822.50		815.50	819.00	822.50	
			MHz	MHz	MHz		MHz	MHz	MHz		MHz	MHz	MHz	
26 / 3M	1	0	23.63	23.61	23.82	0	22.75	22.54	22.74	1	21.55	21.52	21.62	2
	1	7	23.79	23.72	23.65	0	22.71	22.63	22.75	1	21.48	21.47	21.58	2
	1	14	23.58	23.65	23.60	0	22.75	22.49	22.74	1	21.40	21.59	21.59	2
	8	0	22.56	22.71	22.61	1	21.55	21.67	21.59	2	20.52	20.38	20.61	3
	8	3	22.64	22.66	22.62	1	21.57	21.62	21.64	2	20.49	20.45	20.63	3
	8	7	22.56	22.69	22.53	1	21.57	21.58	21.54	2	20.42	20.42	20.58	3
	15	0	22.55	22.64	22.65	1	21.67	21.64	21.69	2	20.45	20.39	20.66	3

Band / BW	RB Size	RB Offset	QPSK			3GPP MPR (dB)	16QAM			3GPP MPR (dB)	64QAM			3GPP MPR (dB)
			Low CH	Mid CH	High CH		Low CH	Mid CH	High CH		Low CH	Mid CH	High CH	
			26715	26740	26765		26715	26740	26765		26715	26740	26765	
			816.50	819.00	821.50		816.50	819.00	821.50		816.50	819.00	821.50	
			MHz	MHz	MHz		MHz	MHz	MHz		MHz	MHz	MHz	
26 / 5M	1	0	23.71	23.59	23.64	0	22.47	22.64	22.59	1	21.55	21.62	21.49	2
	1	12	23.60	23.66	23.59	0	22.55	22.66	22.50	1	21.39	21.60	21.52	2
	1	24	23.69	23.63	23.62	0	22.46	22.67	22.49	1	21.45	21.58	21.47	2
	12	0	22.58	22.60	22.63	1	21.64	21.60	21.07	2	20.39	20.62	20.53	3
	12	6	22.66	22.68	23.53	1	21.62	21.56	21.64	2	20.35	20.48	20.48	3
	12	13	22.60	22.57	22.58	1	21.53	21.49	21.61	2	20.43	20.55	20.52	3
	25	0	22.69	22.62	22.57	1	21.58	21.66	21.63	2	20.49	20.61	20.59	3



Band / BW	RB Size	RB Offset	QPSK		16QAM		64QAM	
			Mid CH	3GPP MPR (dB)	Mid CH	3GPP MPR (dB)	Mid CH	3GPP MPR (dB)
			26740		26740		26740	
			819		819		819	
MHz	MHz	MHz						
26/ 10M	1	0	23.74	0	22.48	1	21.58	2
	1	24	23.63	0	22.52	1	21.60	2
	1	49	23.57	0	22.50	1	21.55	2
	25	0	22.53	1	21.48	2	20.52	3
	25	12	22.46	1	21.51	2	20.61	3
	25	25	22.56	1	21.49	2	20.58	3
	50	0	22.53	1	21.45	2	20.55	3

ERP POWER
LTE Band 14

Band / BW	RB Size	RB Offset	QPSK			3GPP MPR (dB)	16QAM			3GPP MPR (dB)	64QAM			3GPP MPR (dB)
			Low CH	Mid CH	High CH		Low CH	Mid CH	High CH		Low CH	Mid CH	High CH	
			23305	23330	23335		23305	23330	23335		23305	23330	23335	
			790.5 MHz	793 MHz	795.5 MHz		790.5 MHz	793 MHz	795.5 MHz		790.5 MHz	793 MHz	795.5 MHz	
14 / 5M	1	0	23.88	23.93	23.83	0	22.81	22.70	22.79	1	21.75	21.69	21.73	2
Gain (dBi)			2.87	2.87	2.87		2.87	2.87	2.87		2.87	2.87	2.87	
Isotropically Factor (dB)			2.15	2.15	2.15		2.15	2.15	2.15		2.15	2.15	2.15	
Max ERP Power (dBm)			24.60	24.65	24.55		23.53	23.42	23.51		22.47	22.41	22.45	

Band / BW	RB Size	RB Offset	QPSK		3GP P MPR (dB)	16QAM		3GP P MPR (dB)	64QAM		3GP P MPR (dB)
			Mid CH	23330		Mid CH	23330		Mid CH	23330	
			793	793		793	793		793		
			MHz	MHz		MHz	MHz		MHz		
			23.97	23.97		22.90	22.90		21.76	21.76	
14 / 10M	1	0	23.97		0	22.90		1	21.76		2
Gain (dBi)			2.87			2.87			2.87		
Isotropically Factor (dB)			2.15			2.15			2.15		
Max ERP Power (dBm)			24.69			23.62			22.48		



LTE Band 26

Band / BW	RB Size	RB Offset	QPSK			3GPP MPR (dB)	16QAM			3GPP MPR (dB)	64QAM			3GPP MPR (dB)	
			Low CH	Mid CH	High CH		Low CH	Mid CH	High CH		Low CH	Mid CH	High CH		
			26697	26740	26783		26697	26740	26783		26697	26740	26783		
			814.7	819	823.3		814.7	819	823.3		814.7	819	823.3		
			MHz	MHz	MHz				MHz	MHz	MHz				
26 / 1.4M	1	0	23.56	23.69	23.58	0	22.38	22.50	22.41	1	21.48	21.40	21.43	2	
Gain (dBi)			2.92	2.92	2.92		2.92	2.92	2.92		2.92	2.92	2.92		2.92
Isotropically Factor (dB)			2.15	2.15	2.15		2.15	2.15	2.15		2.15	2.15	2.15		2.15
Max ERP Power (dBm)			24.33	24.46	24.35		23.15	23.27	23.18		22.25	22.17	22.20		

Band / BW	RB Size	RB Offset	QPSK			3GPP MPR (dB)	16QAM			3GPP MPR (dB)	64QAM			3GPP MPR (dB)	
			Low CH	Mid CH	High CH		Low CH	Mid CH	High CH		Low CH	Mid CH	High CH		
			26705	26740	26775		26705	26740	26775		26705	26740	26775		
			815.50	819.00	822.50		815.50	819.00	822.50		815.50	819.00	822.50		
			MHz	MHz	MHz				MHz	MHz	MHz				
26 / 3M	1	0	23.63	23.61	23.82	0	22.75	22.54	22.74	1	21.55	21.52	21.62	2	
Gain (dBi)			2.92	2.92	2.92		2.92	2.92	2.92		2.92	2.92	2.92		2.92
Isotropically Factor (dB)			2.15	2.15	2.15		2.15	2.15	2.15		2.15	2.15	2.15		2.15
Max ERP Power (dBm)			24.40	24.38	24.59		23.52	23.31	23.51		22.32	22.29	22.39		

Band / BW	RB Size	RB Offset	QPSK			3GPP MPR (dB)	16QAM			3GPP MPR (dB)	64QAM			3GPP MPR (dB)	
			Low CH	Mid CH	High CH		Low CH	Mid CH	High CH		Low CH	Mid CH	High CH		
			26715	26740	26765		26715	26740	26765		26715	26740	26765		
			816.50	819.00	821.50		816.50	819.00	821.50		816.50	819.00	821.50		
			MHz	MHz	MHz				MHz	MHz	MHz				
26 / 5M	1	0	23.71	23.59	23.64	0	22.47	22.64	22.59	1	21.55	21.62	21.49	2	
Gain (dBi)			2.92	2.92	2.92		2.92	2.92	2.92		2.92	2.92	2.92		2.92
Isotropically Factor (dB)			2.15	2.15	2.15		2.15	2.15	2.15		2.15	2.15	2.15		2.15
Max ERP Power (dBm)			24.48	24.36	24.41		23.24	23.41	23.36		22.32	22.39	22.26		

Band / BW	RB Size	RB Offset	QPSK			3GPP MPR (dB)	16QAM			3GPP MPR (dB)	64QAM			3GPP MPR (dB)
			Mid CH				Mid CH				Mid CH			
			26740				26740				26740			
			819				819				819			
			MHz				MHz				MHz			
26/ 10M	1	0	23.74			0	22.48			1	21.58			2
Gain (dBi)			2.92				2.92				2.92			
Isotropically Factor (dB)			2.15				2.15				2.15			
Max ERP Power (dBm)			24.51				23.25				22.35			

4.2 Modulation characteristics Measurement

4.2.1 Limits of Modulation characteristics

N/A

4.2.2 Test Procedure

Connect the EUT to Communication Simulator via the antenna connector, The frequency band is set as EUT supported Modulation and Channels, the EUT output is matched with 50 ohm load, the waveform quality and constellation of the EUT was tested.

4.2.3 Test Setup



4.2.4 Test Results

LTE Band 14

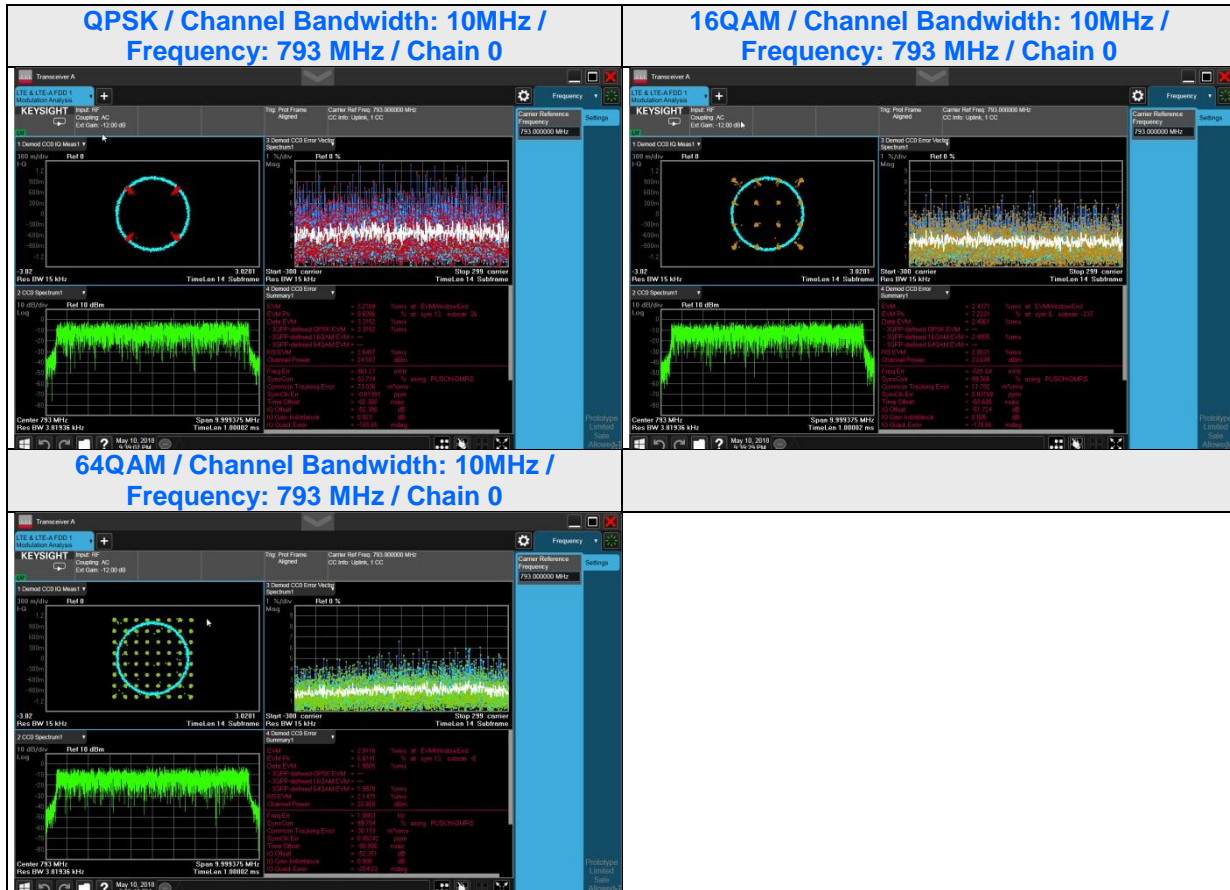

LTE Band 26

**QPSK / Channel Bandwidth: 10MHz /
Frequency: 819 MHz / Chain 0**



**16QAM / Channel Bandwidth: 10MHz /
Frequency: 819 MHz / Chain 0**



**64QAM / Channel Bandwidth: 10MHz /
Frequency: 819 MHz / Chain 0**

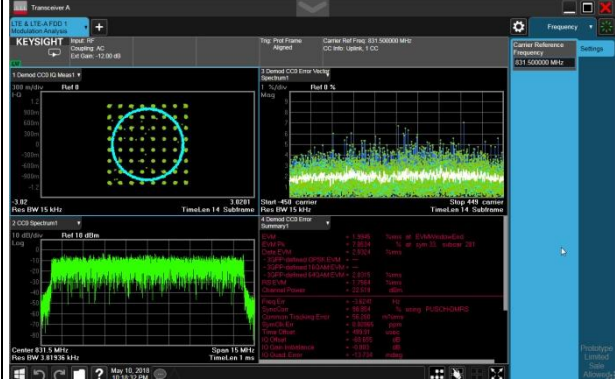

4.3 Frequency Stability Measurement

4.3.1 Limits of Frequency Stability Measurement

Follow the 90.213 1.5ppm is for base and fixed station. 2.5 ppm is for mobile station.
Follow the 90.539 frequency stability of mobile, portable and control transmitters operating in the wideband segment must be 1.25 parts per million.

4.3.2 Test Procedure

- Device is placed at the oven room. The oven room could control the temperatures and humidity. Power warm up is at least 15 min and power applied should perform before recording frequency error.
- EUT is connected the external power supply to control the DC input power. The test voltage range is from minimum to maximum working voltage. Each step shall be record the frequency error rate.
- The temperature range step is 10 degrees in this test items. All temperature levels shall be hold the ± 0.5 °C during the measurement testing. The each temperature step shall be at least 0.5 hours, consider the EUT could be test under the stability condition.

4.3.3 Test Setup

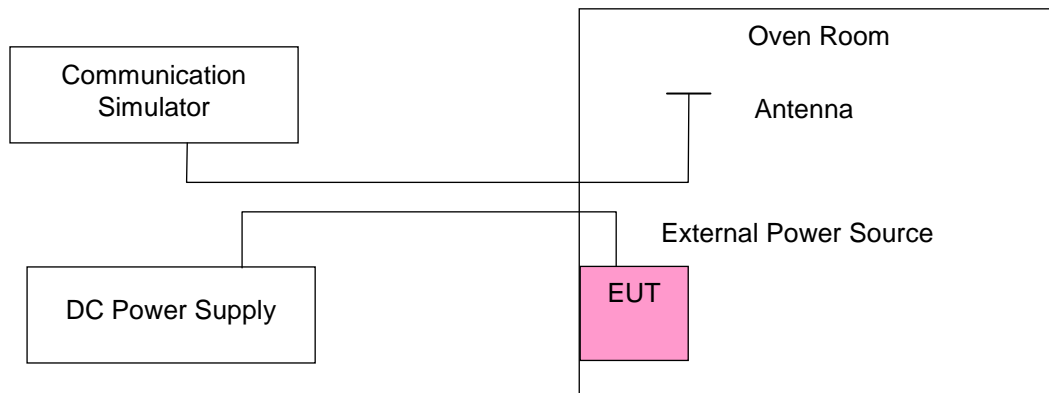

4.3.4 Test Results

LTE Band 14

Voltage (Volts)	Frequency Error (ppm)		Limit (ppm)
	LTE Band 14		
	5MHz	10MHz	
2.805	0.034	0.057	1.25
3.795	0.057	0.032	1.25

Frequency Error vs. Temperature

Temp. (°C)	Frequency Error (ppm)		Limit (ppm)
	LTE Band 14		
	5MHz	10MHz	
50	0.028	0.042	1.25
40	0.053	0.050	1.25
30	0.043	0.033	1.25
20	0.039	0.034	1.25
10	0.034	0.025	1.25
0	0.028	0.033	1.25
-10	0.055	0.029	1.25
-20	0.029	0.032	1.25
-30	0.053	0.032	1.25

LTE Band 26

Frequency Error vs. Voltage

Voltage (Volts)	Frequency Error (ppm)				Limit (ppm)
	LTE Band 26				
	1.4MHz	3MHz	5MHz	10MHz	
2.805	0.053	0.055	0.049	0.026	2.5
3.795	0.039	0.059	0.057	0.033	2.5

Frequency Error vs. Temperature

Temp. (°C)	Frequency Error (ppm)				Limit (ppm)
	LTE Band 26				
	1.4MHz	3MHz	5MHz	10MHz	
75	0.037	0.056	0.048	0.026	2.5
70	0.049	0.034	0.031	0.027	2.5
60	0.042	0.031	0.032	0.035	2.5
50	0.038	0.043	0.035	0.060	2.5
40	0.026	0.051	0.040	0.060	2.5
30	0.032	0.033	0.038	0.027	2.5
20	0.056	0.035	0.056	0.054	2.5
10	0.039	0.035	0.050	0.049	2.5
0	0.032	0.038	0.049	0.029	2.5
-10	0.050	0.034	0.024	0.046	2.5
-20	0.043	0.033	0.057	0.057	2.5
-30	0.040	0.055	0.042	0.049	2.5

4.4 Occupied Bandwidth Measurement

4.4.1 Limits of Occupied Bandwidth Measurement

The width of a frequency band such that, below the lower and above the upper frequency limits, the mean powers emitted are each equal to a specified percentage 0.5 % of the total mean power of a given emission.

4.4.2 Test Procedure

All measurements were done at low, middle and high operational frequency range, RB of the spectrum is 1% of occupied bandwidth and VB of the spectrum is 3 times RBW. The communication simulator station system controlled a EUT to export maximum output power under transmission mode and specific channel frequency. The bandwidth of the fundamental frequency was measured by spectrum analyzer with $RBW \geq 1\% \times OBW$ and $VBW \geq 3 \times RBW$.

Occupied Bandwidth Measurement:

Use OBW measurement function of Spectrum analyzer to measure 99 % occupied bandwidth.

26 dB Bandwidth Measurement:

The emission bandwidth is defined as the width of the signal between two points, one below the carrier center frequency and one above the carrier center frequency, outside of which all emission are attenuated at least 26dB below the transmitter power.

4.4.3 Test Setup

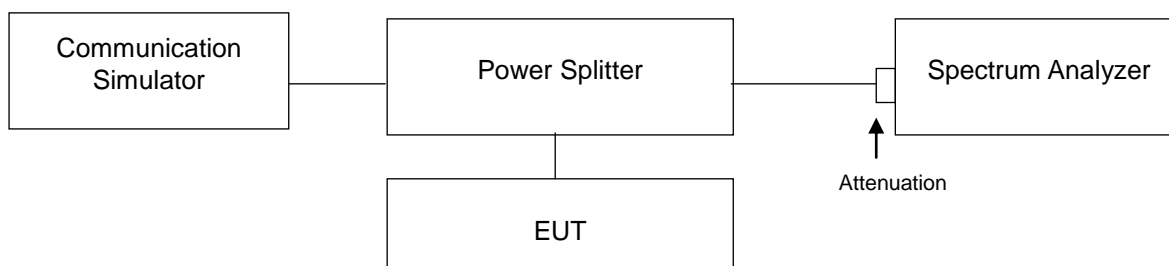

4.4.4 Test Result (-26dB Bandwidth)

LTE Band 14									
Channel Bandwidth 5MHz					Channel Bandwidth 10MHz				
Channel	Frequency (MHz)	-26dB Bandwidth (MHz)			Channel	Frequency (MHz)	-26dB Bandwidth (MHz)		
		QPSK	16QAM	64QAM			QPSK	16QAM	64QAM
23305	790.5	4.82	4.80	4.81	23330	793	9.54	9.52	9.54
23330	793	4.79	4.81	4.81					
23355	795.5	4.82	4.80	4.81					

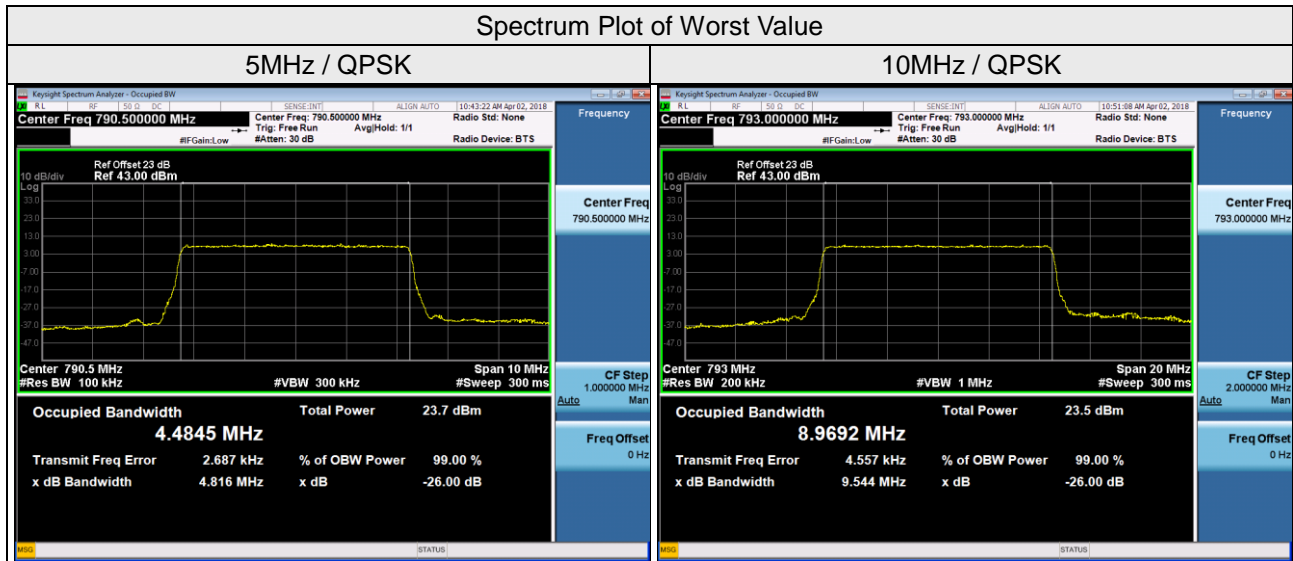



LTE Band 26									
Channel Bandwidth 1.4MHz					Channel Bandwidth 3MHz				
Channel	Frequency (MHz)	-26dB Bandwidth (MHz)			Channel	Frequency (MHz)	-26dB Bandwidth (MHz)		
		QPSK	16QAM	64QAM			QPSK	16QAM	64QAM
26697	814.7	1.22	1.21	1.22	26705	815.5	2.92	2.92	2.93
26740	819	1.22	1.21	1.22	26740	819	2.93	2.93	2.92
26783	823.3	1.22	1.22	1.22	26775	822.5	2.93	2.92	2.92
Channel Bandwidth 5MHz					Channel Bandwidth 10MHz				
Channel	Frequency (MHz)	-26dB Bandwidth (MHz)			Channel	Frequency (MHz)	-26dB Bandwidth (MHz)		
		QPSK	16QAM	64QAM			QPSK	16QAM	64QAM
26715	816.5	4.80	4.79	4.79	26740	819	9.51	9.52	9.51
26740	819	4.81	4.80	4.80					
26765	821.5	4.82	4.80	4.79					

Spectrum Plot of Worst Value

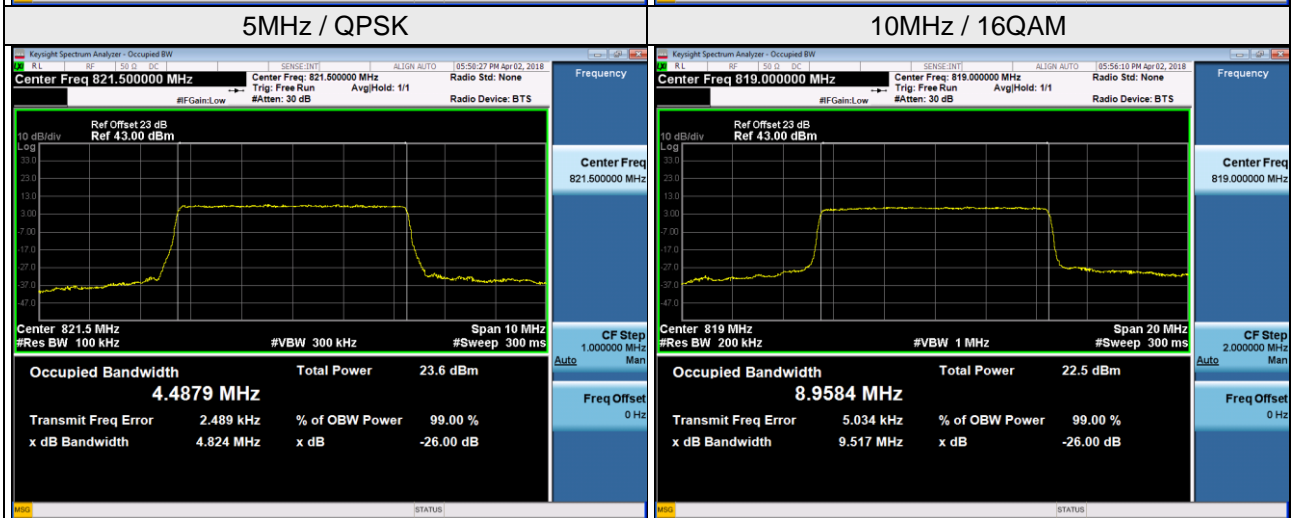
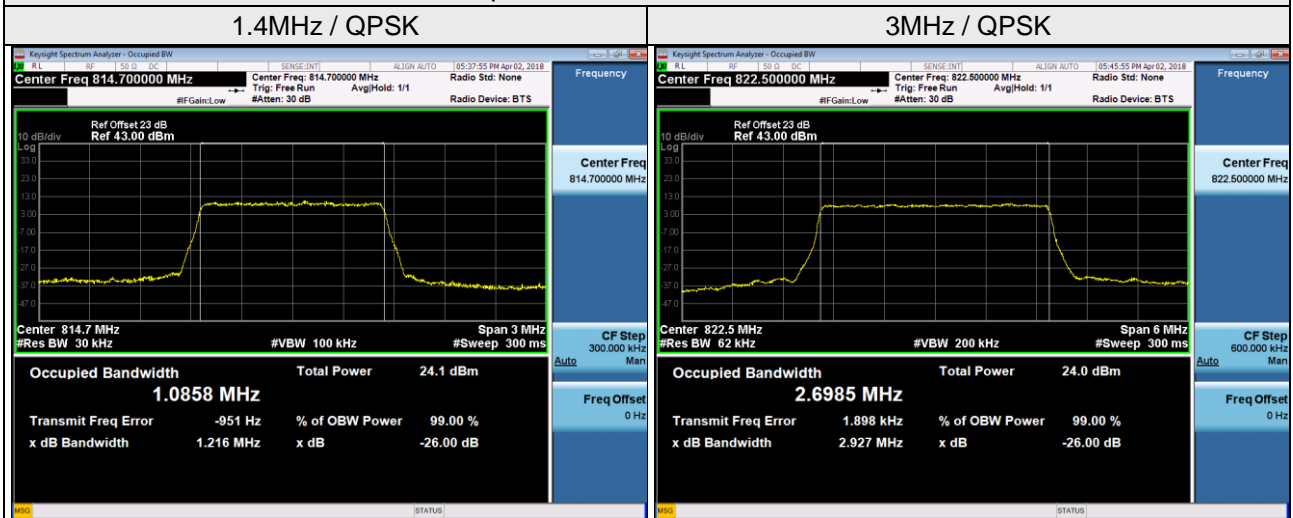



4.4.5 Test Result (Occupied Bandwidth)

LTE Band 14									
Channel Bandwidth 5MHz					Channel Bandwidth 10MHz				
Channel	Frequency (MHz)	99% Occupied Bandwidth (MHz)			Channel	Frequency (MHz)	99% Occupied Bandwidth (MHz)		
		QPSK	16QAM	64QAM			QPSK	16QAM	64QAM
23305	790.5	4.48	4.49	4.49	23330	793	8.97	8.97	8.99
23330	793	4.49	4.49	4.49					
23355	795.5	4.49	4.49	4.50					

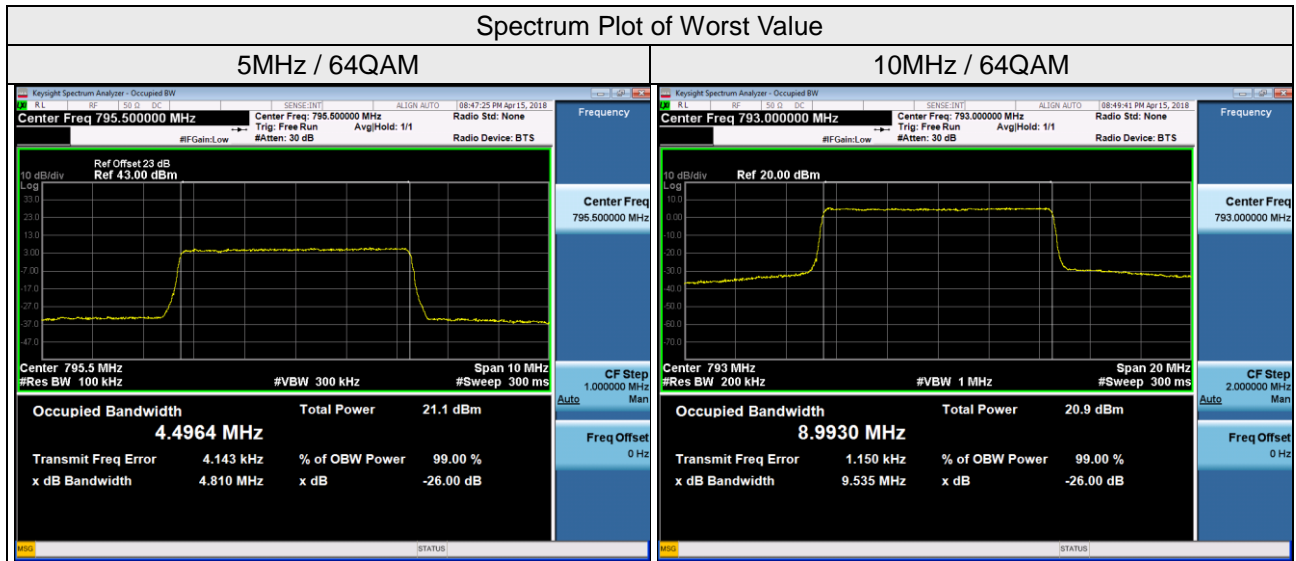



LTE Band 26									
Channel Bandwidth 1.4MHz					Channel Bandwidth 3MHz				
Channel	Frequency (MHz)	99% Occupied Bandwidth (MHz)			Channel	Frequency (MHz)	99% Occupied Bandwidth (MHz)		
		QPSK	16QAM	64QAM			QPSK	16QAM	64QAM
26697	814.7	1.09	1.09	1.09	26705	815.5	2.70	2.69	2.70
26740	819	1.09	1.09	1.09	26740	819	2.70	2.70	2.70
26783	823.3	1.09	1.09	1.09	26775	822.5	2.70	2.70	2.70
Channel Bandwidth 5MHz					Channel Bandwidth 10MHz				
Channel	Frequency (MHz)	99% Occupied Bandwidth (MHz)			Channel	Frequency (MHz)	99% Occupied Bandwidth (MHz)		
		QPSK	16QAM	64QAM			QPSK	16QAM	64QAM
26715	816.5	4.48	4.49	4.49	26740	819	8.95	8.96	8.96
26740	819	4.49	4.49	4.48					
26765	821.5	4.49	4.49	4.49					

Spectrum Plot of Worst Value

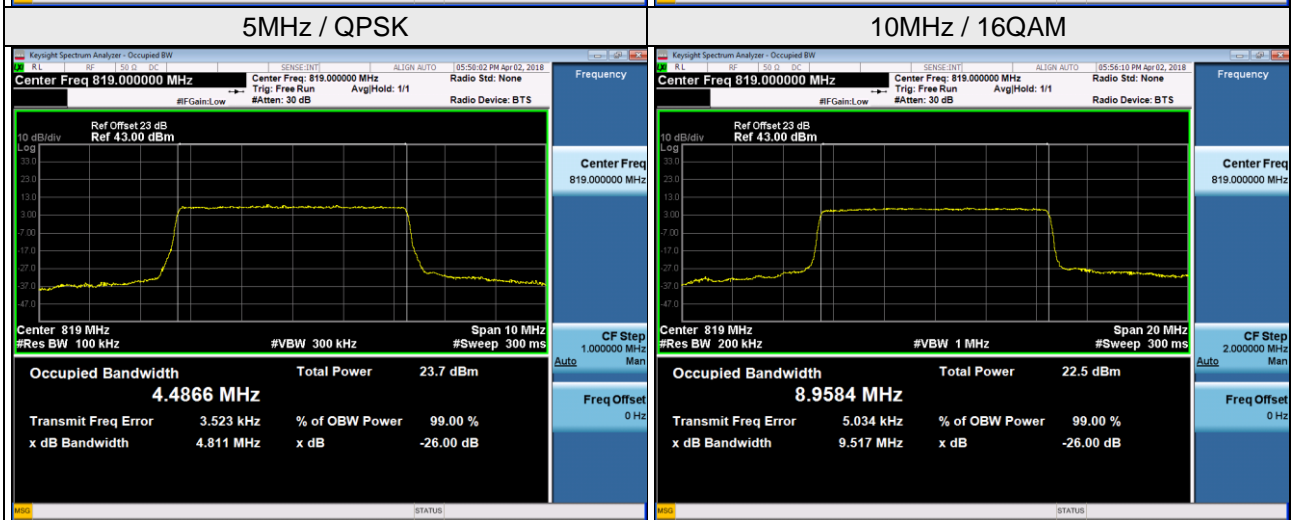
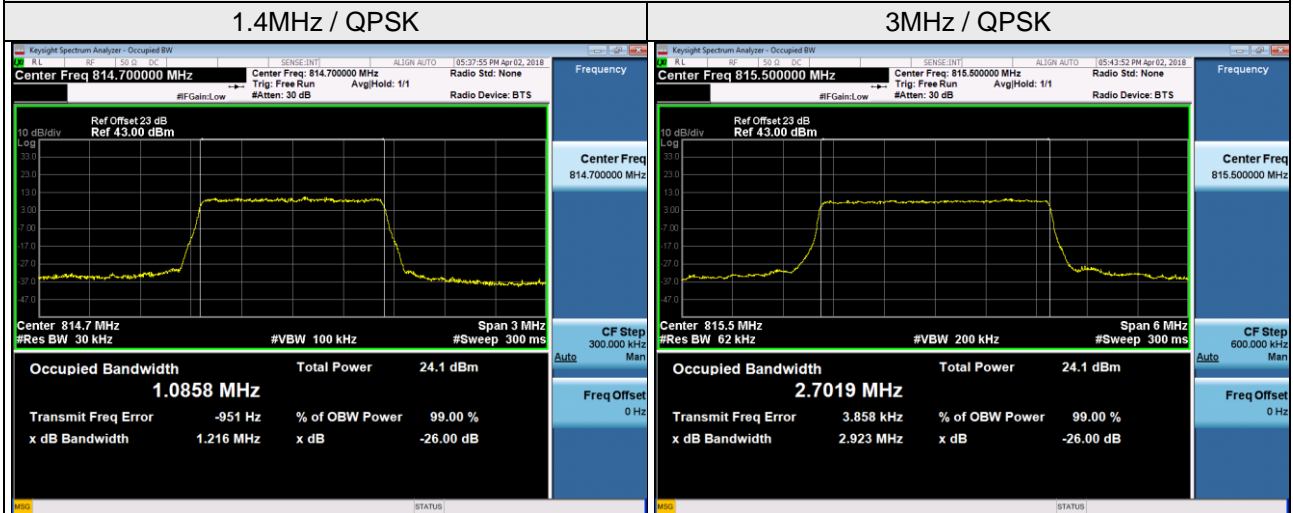

4.5 Emission Mask Measurement

4.5.1 Limits of Emission Mask Measurement

Per 90.210, equipment used in 809-824/854-869 MHz licensed band to EA or non-EA systems shall comply with the emission mask provisions of §90.691.

Per 90.691, Emission mask requirements

(a) Out-of-band emission requirement shall apply only to the “outer” channels included in an EA license and to spectrum adjacent to interior channels used by incumbent licensees. The emission limits are as follows:

(1) For any frequency removed from the EA licensee's frequency block by up to and including 37.5 kHz, the power of any emission shall be attenuated below the transmitter power (P) in watts by at least $116 \text{ Log}_{10}(f/6.1)$ decibels or $50 + 10 \text{ Log}_{10}(P)$ decibels or 80 decibels, whichever is the lesser attenuation, where f is the frequency removed from the center of the outer channel in the block in kilohertz and where f is greater than 12.5 kHz. (2) For any frequency removed from the EA licensee's frequency block greater than 37.5 kHz, the power of any emission shall be attenuated below the transmitter power (P) in watts by at least $43 + 10 \text{ Log}_{10}(P)$ decibels or 80 decibels, whichever is the lesser attenuation, where f is the frequency removed from the center of the outer channel in the block in kilohertz and where f is greater than 37.5 kHz.

(b) When an emission outside of the authorized bandwidth causes harmful interference, the Commission may, at its discretion, require greater attenuation than specified in this section.

Per 90.543(e), Emission mask requirements

For operations in the 758-768 MHz and the 788-798 MHz bands, the power of any emission outside the licensee's frequency band(s) of operation shall be attenuated below the transmitter power (P) within the licensed band(s) of operation, measured in watts, in accordance with the following:

(1) On all frequencies between 769-775 MHz and 799-805 MHz, by a factor not less than $76 + 10 \log (P)$ dB in a 6.25 kHz band segment, for base and fixed stations. (2) On all frequencies between 769-775 MHz and 799-805 MHz, by a factor not less than $65 + 10 \log (P)$ dB in a 6.25 kHz band segment, for mobile and portable stations. (3) On any frequency between 775-788 MHz, above 805 MHz, and below 758 MHz, by at least $43 + 10 \log (P)$ dB. (4) Compliance with the provisions of paragraphs (e)(1) and (2) of this section is based on the use of measurement instrumentation such that the reading taken with any resolution bandwidth setting should be adjusted to indicate spectral energy in a 6.25 kHz segment.

4.5.2 Test Procedures

1. The power was measured with Spectrum Analyzer. All measurements were done at low and high operational frequency range.
2. The measurement used the power splitter via EUT RF power connector between signal generator and spectrum analyzer.
3. Record the test plot.

4.5.3 Test Setup

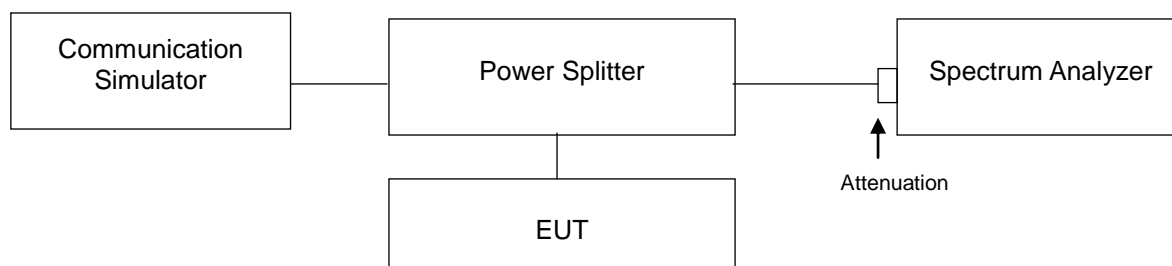

4.5.4 Test Results

LTE Band 14

Channel Bandwidth 5MHz QPSK

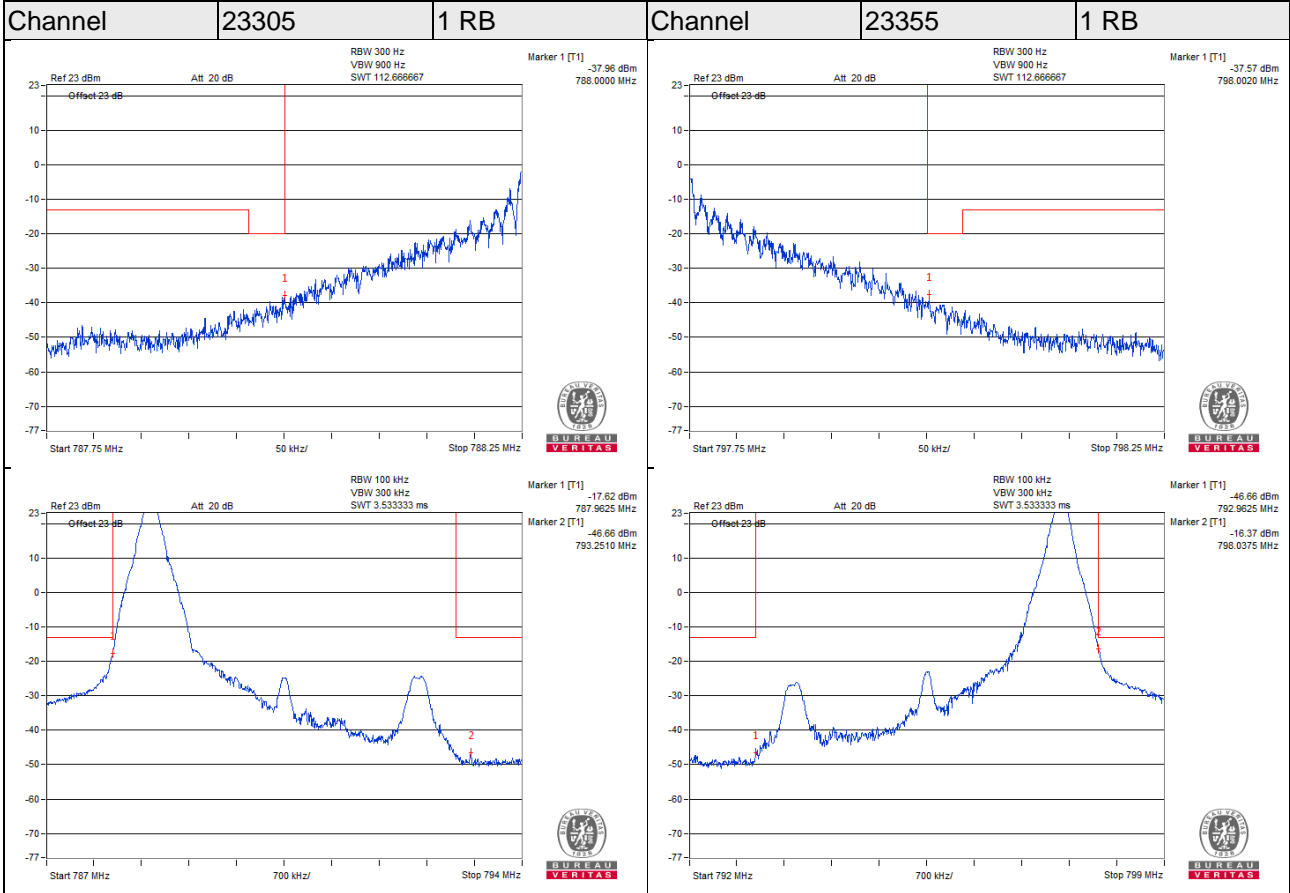

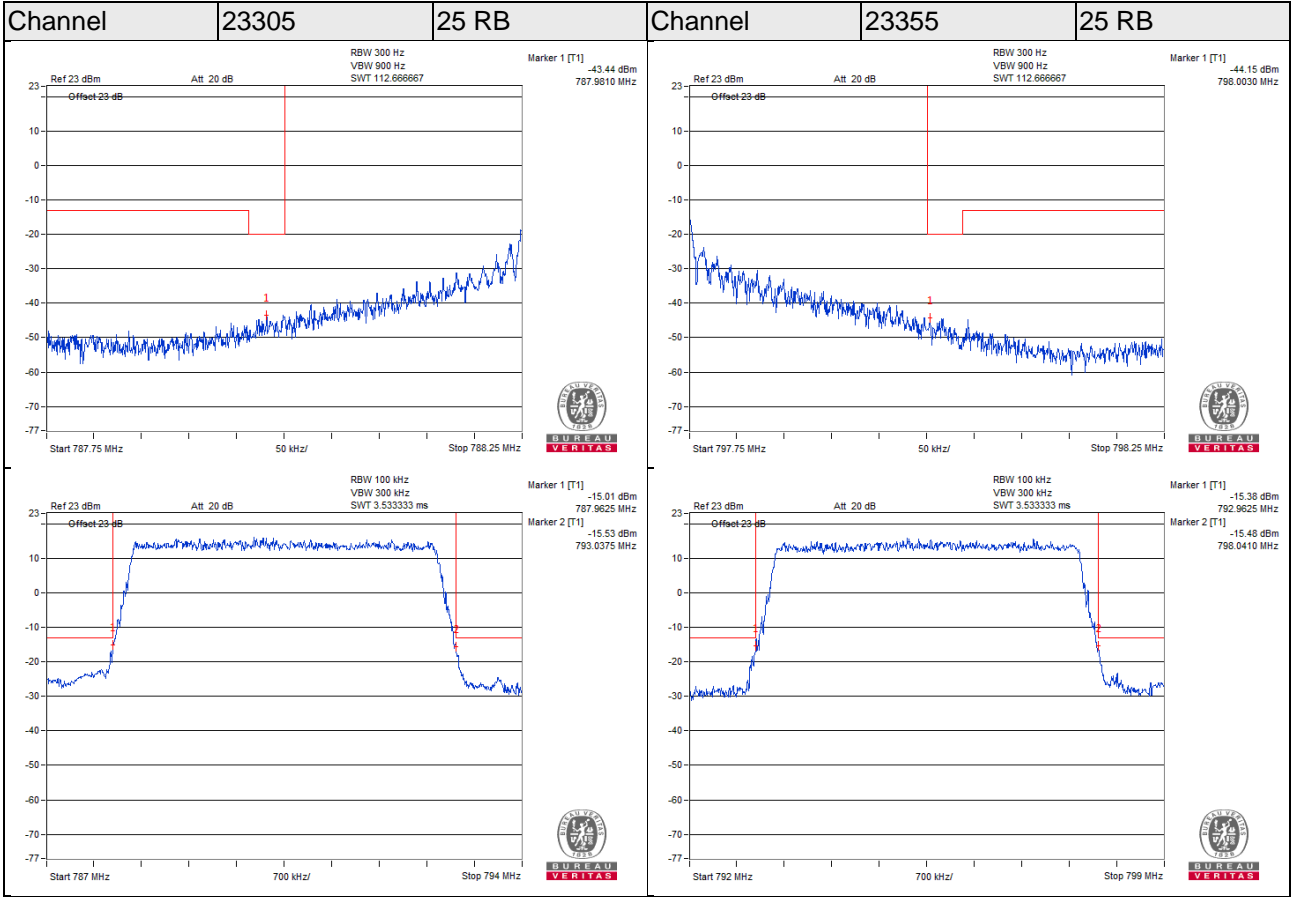

LTE Band 14

Channel Bandwidth 10MHz QPSK

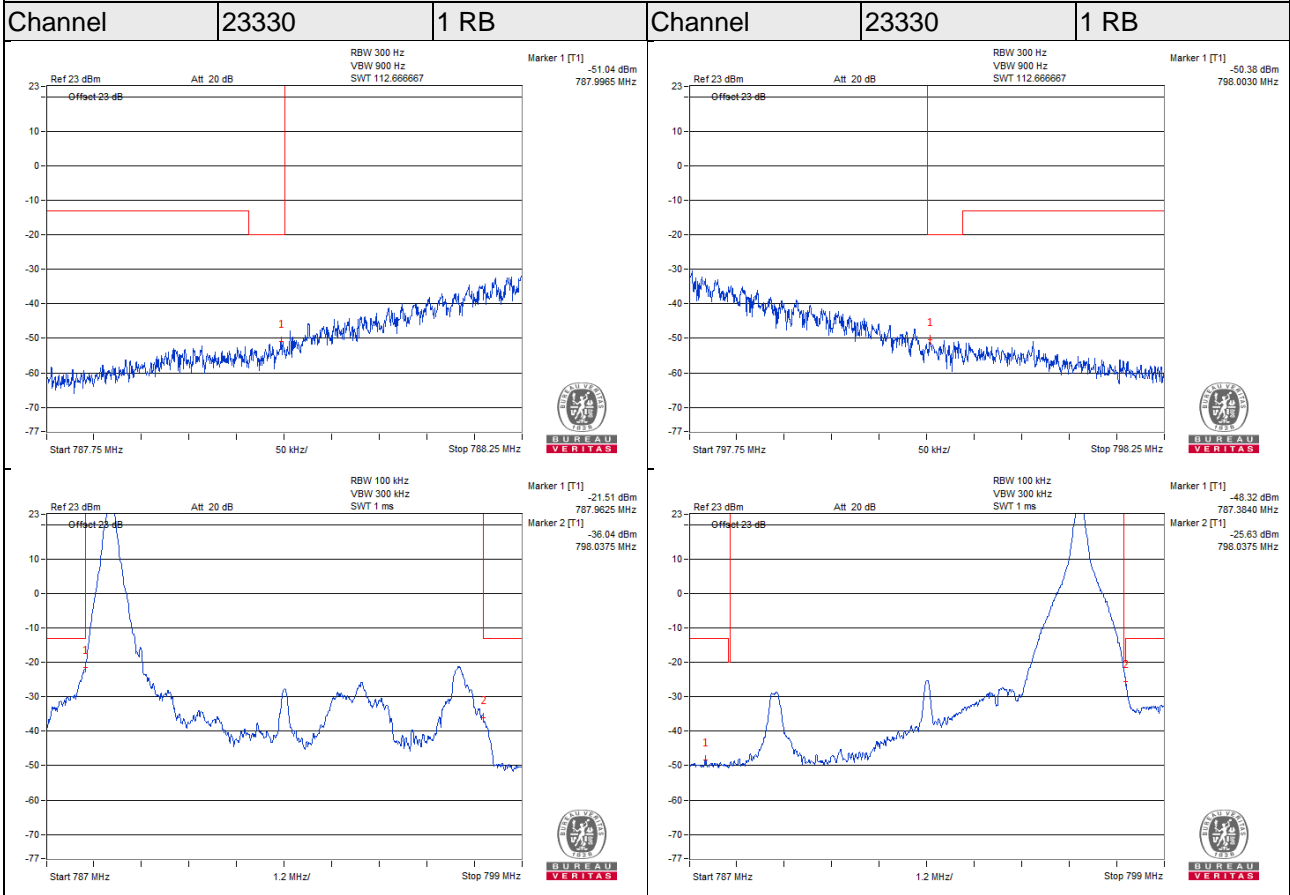

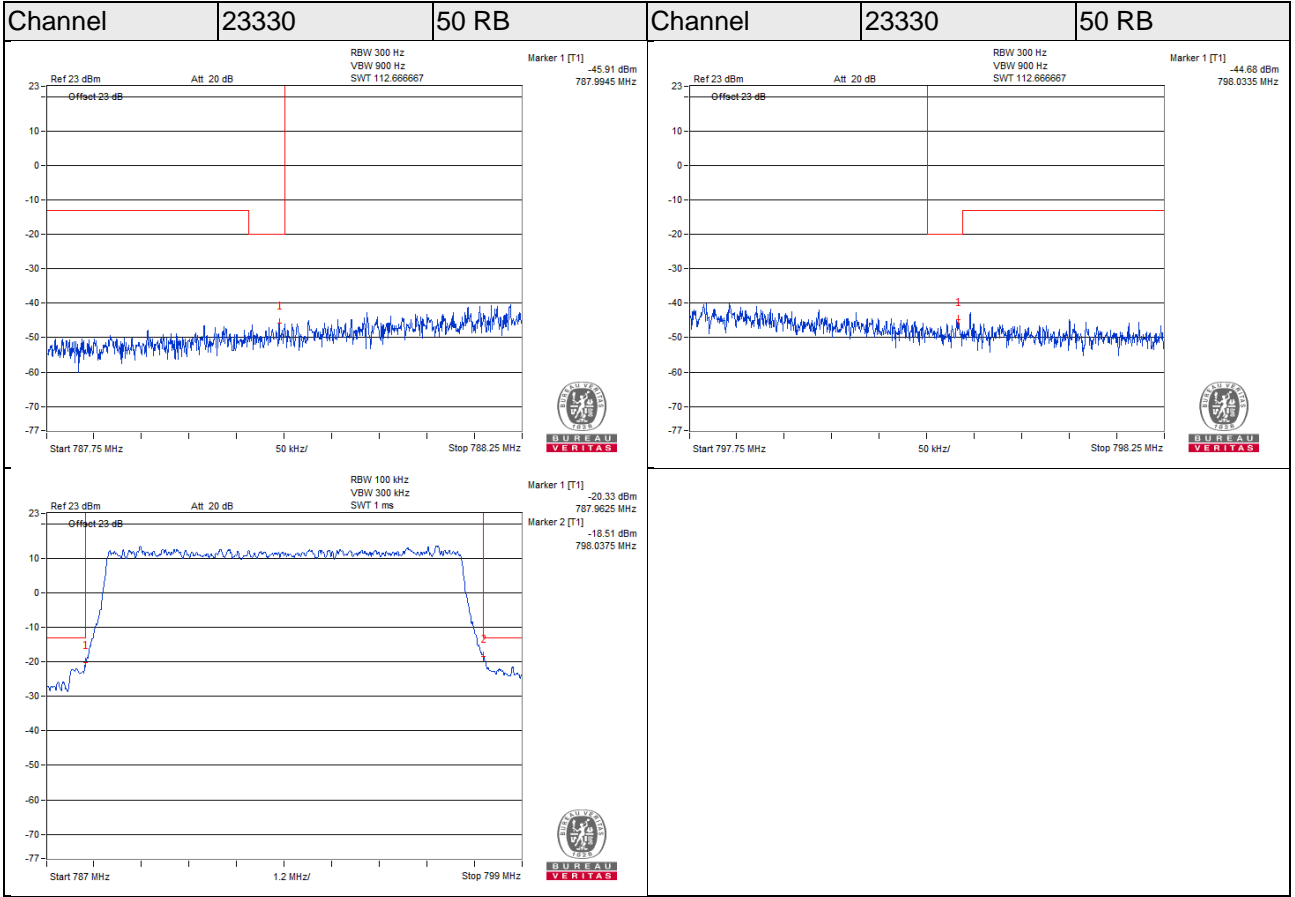

LTE Band 26

Channel Bandwidth 1.4MHz QPSK

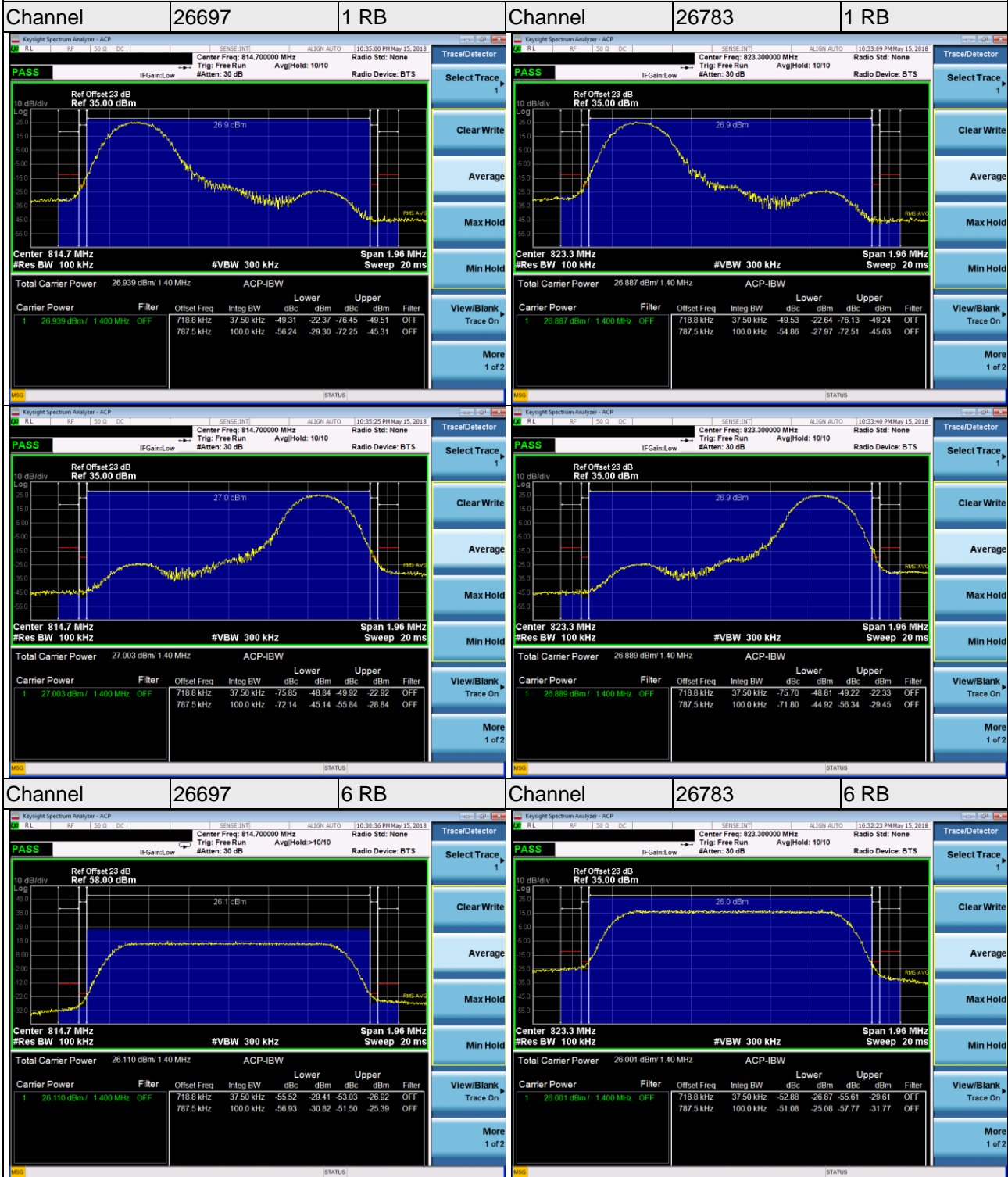

LTE Band 26

Channel Bandwidth 3MHz QPSK

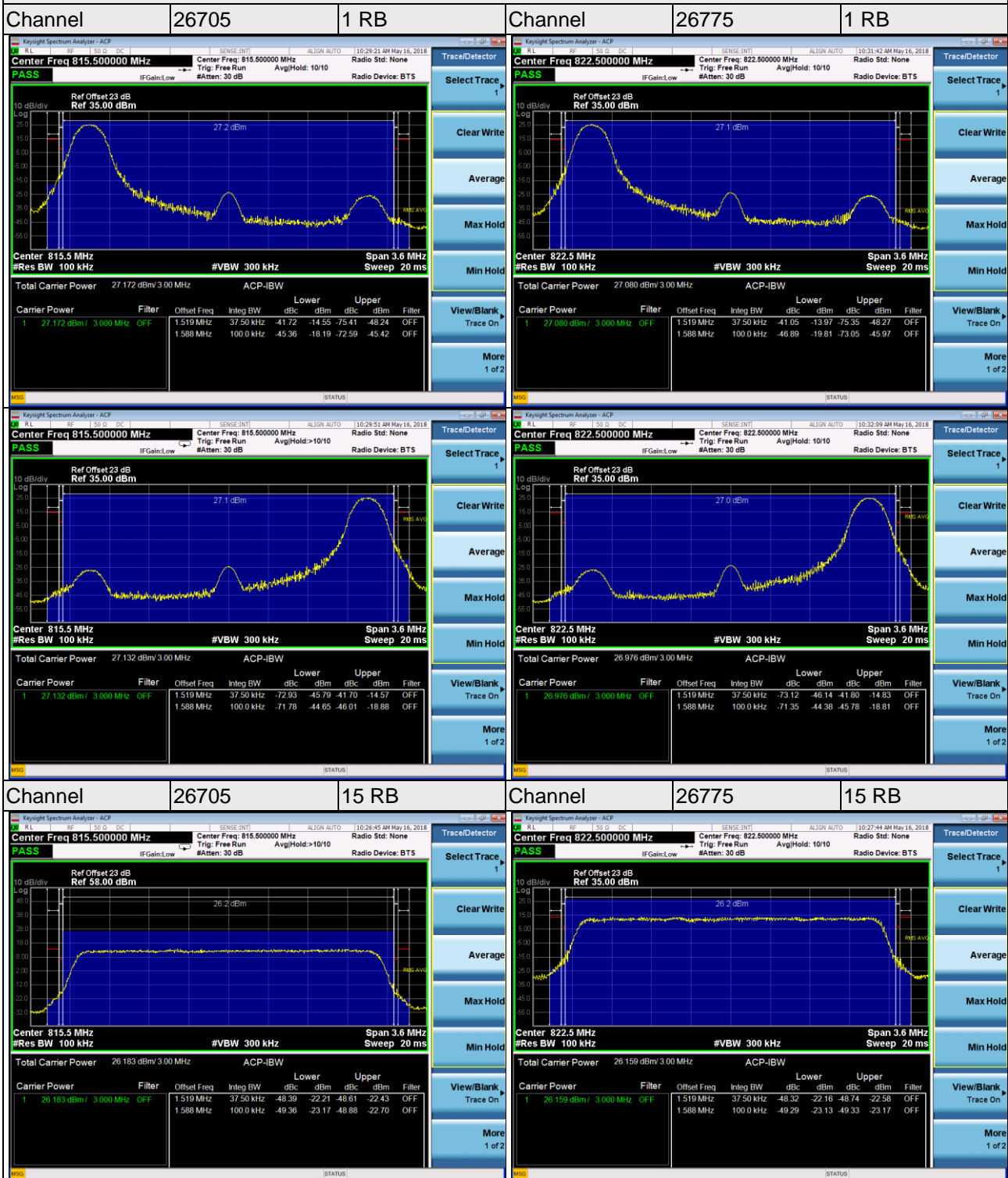



LTE Band 26

Channel Bandwidth 5MHz QPSK

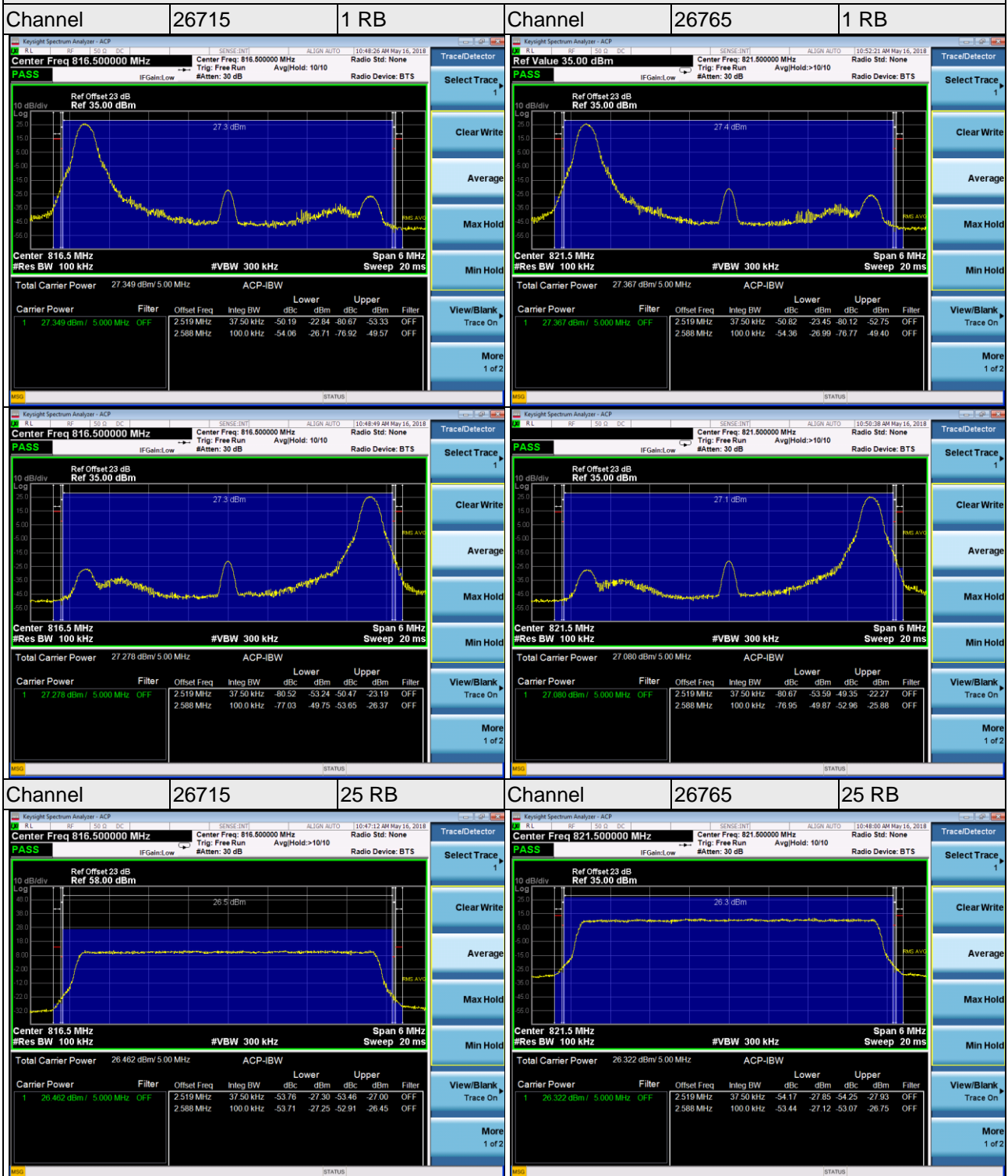

LTE Band 26

Channel Bandwidth 10MHz QPSK

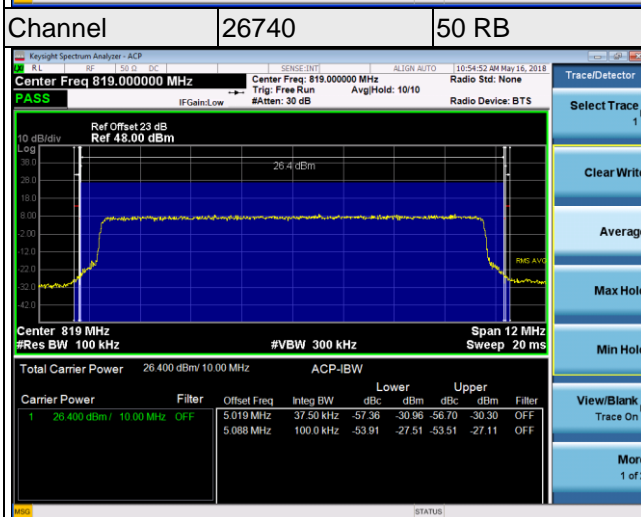
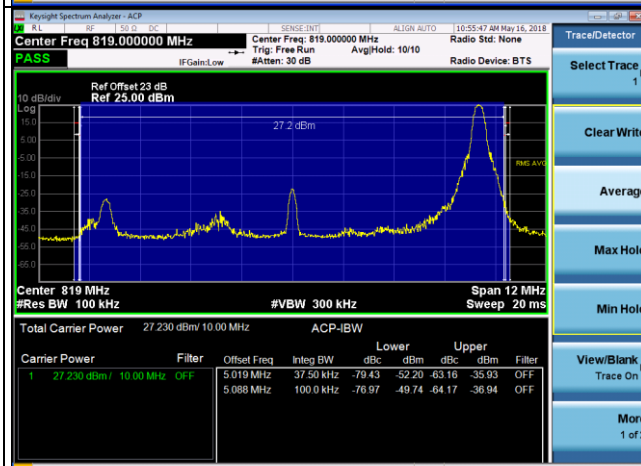
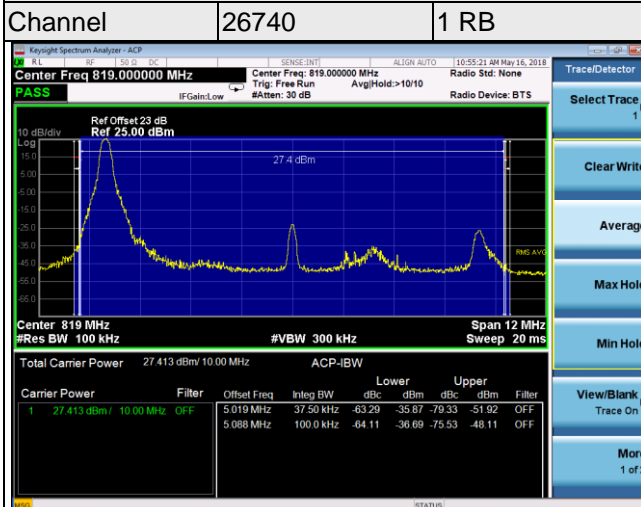

4.6 Conducted Spurious Emissions

4.6.1 Limits of Conducted Spurious Emissions Measurement

The power of any emission outside a licensee's frequency block shall be attenuated below the transmitter power (P) by at least $43 + 10 \log_{10}(P)$ dB. The limit of emission equal to -13dBm .

4.6.2 Test Setup

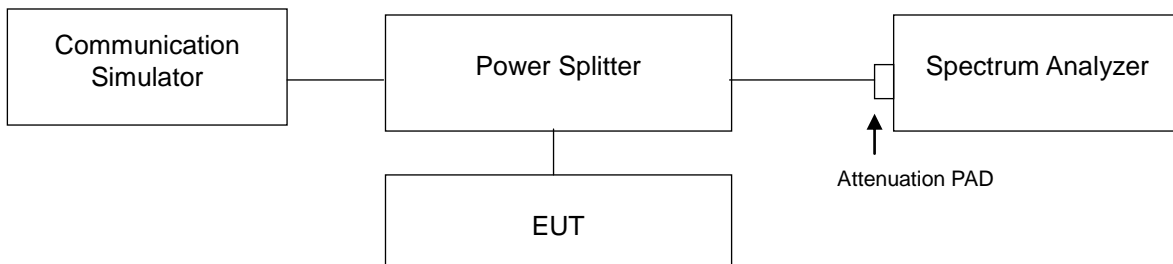

4.6.3 Test Procedure

- The EUT was set up for the maximum peak power with LTE link data modulation. The power was measured with Spectrum Analyzer.
- The conducted spurious emission used the power splitter via EUT RF power connector between signal generator and spectrum analyzer.
- When the spectrum scanned from 9kHz to the tenth harmonic of the highest fundamental frequency, it shall be connected to the band reject filter attenuated the carried frequency. The spectrum set RBW: 1 MHz and $\text{VBW}=3*\text{RBW}$ is used for measurement.

4.6.4 Test Results

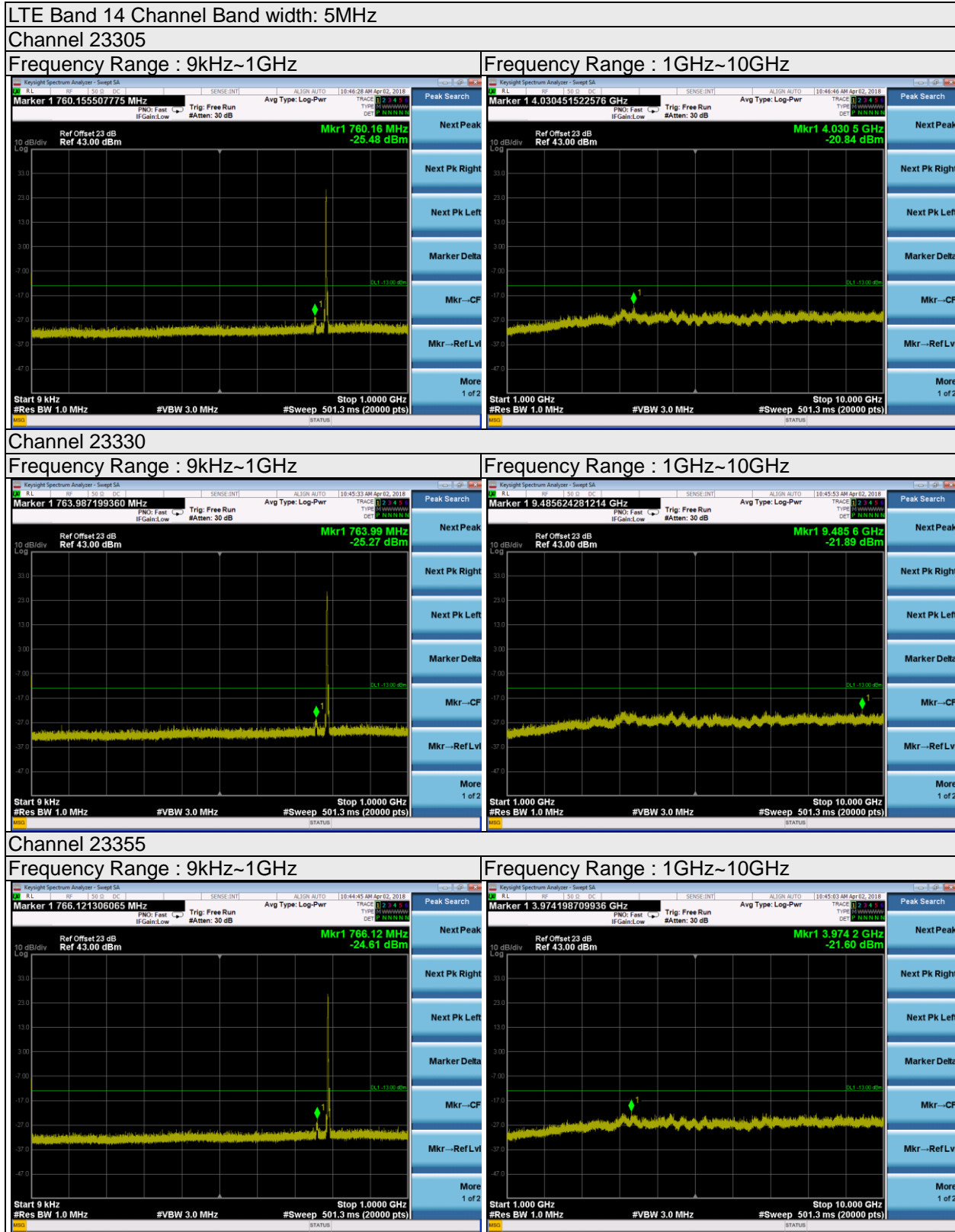

LTE Band 14 Channel Band width: 10MHz

Channel 23330

Frequency Range : 9kHz~1GHz Frequency Range : 1GHz~10GHz

