

## FCC Test Report (PART 22)

**Report No.:** RF180321E03

**FCC ID:** MCLT77W968

**Test Model:** T77W968

**Received Date:** Mar. 21, 2018

**Test Date:** Mar. 31 to May 16, 2018

**Issued Date:** May 17, 2018

**Applicant:** HON HAI PRECISION IND. CO., LTD.

**Address:** 5F-1,5 Hsin-An Road Hsinchu, Science-Based Industrial Park Taiwan,  
R.O.C.

**Issued By:** Bureau Veritas Consumer Products Services (H.K.) Ltd., Taoyuan Branch  
Hsin Chu Laboratory

**Lab Address:** E-2, No.1, Li Hsin 1st Road, Hsinchu Science Park, Hsinchu City 300,  
Taiwan R.O.C.

**Test Location:** E-2, No.1, Li Hsin 1st Road, Hsinchu Science Park, Hsinchu City 300,  
Taiwan R.O.C.

**FCC Registration /  
Designation Number:** 723255 / TW2022



This report is for your exclusive use. Any copying or replication of this report to or for any other person or entity, or use of our name or trademark, is permitted only with our prior written permission. This report sets forth our findings solely with respect to the test samples identified herein. The results set forth in this report are not indicative or representative of the quality or characteristics of the lot from which a test sample was taken or any similar or identical product unless specifically and expressly noted. Our report includes all of the tests requested by you and the results thereof based upon the information that you provided to us. You have 60 days from date of issuance of this report to notify us of any material error or omission caused by our negligence, provided, however, that such notice shall be in writing and shall specifically address the issue you wish to raise. A failure to raise such issue within the prescribed time shall constitute your unqualified acceptance of the completeness of this report, the tests conducted and the correctness of the report contents. Unless specific mention, the uncertainty of measurement has been explicitly taken into account to declare the compliance or non-compliance to the specification. The report must not be used by the client to claim product certification, approval, or endorsement by TAF or any government agencies.

## Table of Contents

<b>Release Control Record</b> .....	<b>4</b>
<b>1 Certificate of Conformity</b> .....	<b>5</b>
<b>2 Summary of Test Results</b> .....	<b>6</b>
2.1 Measurement Uncertainty .....	6
2.2 Test Site and Instruments .....	7
<b>3 General Information</b> .....	<b>10</b>
3.1 General Description of EUT .....	10
3.2 Configuration of System under Test .....	13
3.2.1 Description of Support Units .....	14
3.3 Test Mode Applicability and Tested Channel Detail .....	15
3.4 EUT Operating Conditions .....	19
3.5 General Description of Applied Standards .....	20
<b>4 Test Types and Results</b> .....	<b>21</b>
4.1 Output Power Measurement .....	21
4.1.1 Limits of Output Power Measurement .....	21
4.1.2 Test Procedures .....	21
4.1.3 Test Setup .....	21
4.1.4 Test Results .....	22
4.2 Modulation characteristics Measurement .....	35
4.2.1 Limits of Modulation characteristics .....	35
4.2.2 Test Procedure .....	35
4.2.3 Test Setup .....	35
4.2.4 Test Results .....	36
4.3 Frequency Stability Measurement .....	38
4.3.1 Limits of Frequency Stability Measurement .....	38
4.3.2 Test Procedure .....	38
4.3.3 Test Setup .....	38
4.3.4 Test Results .....	39
4.4 Occupied Bandwidth Measurement .....	43
4.4.1 Test Procedure .....	43
4.4.2 Test Setup .....	43
4.4.3 Test Result (-26dB Bandwidth) .....	44
4.4.4 Test Result (Occupied Bandwidth) .....	49
4.5 Band Edge Measurement .....	54
4.5.1 Limits of Band Edge Measurement .....	54
4.5.2 Test Setup .....	54
4.5.3 Test Procedures .....	54
4.5.4 Test Results .....	55
4.6 Peak to Average Ratio .....	66
4.6.1 Limits of Peak to Average Ratio Measurement .....	66
4.6.2 Test Setup .....	66
4.6.3 Test Procedures .....	66
4.6.4 Test Results .....	67
4.7 Conducted Spurious Emissions .....	72
4.7.1 Limits of Conducted Spurious Emissions Measurement .....	72
4.7.2 Test Setup .....	72
4.7.3 Test Procedure .....	72
4.7.4 Test Results .....	73
4.8 Radiated Emission Measurement .....	84
4.8.1 Limits of Radiated Emission Measurement .....	84
4.8.2 Test Procedure .....	84
4.8.3 Deviation from Test Standard .....	84
4.8.4 Test Setup .....	85

4.8.5 Test Results .....	86
<b>5 Pictures of Test Arrangements.....</b>	<b>148</b>
<b>Appendix – Information on the Testing Laboratories .....</b>	<b>149</b>

### Release Control Record

Issue No.	Description	Date Issued
RF180321E03	Original release.	May 17, 2018

## 1 Certificate of Conformity

**Product:** LTE M.2 Module

**Brand:** FOXCONN

**Test Model:** T77W968

**Sample Status:** ENGINEERING SAMPLE

**Applicant:** HON HAI PRECISION IND. CO., LTD.

**Test Date:** Mar. 31 to May 16, 2018

**Standards:** FCC Part 22

The above equipment has been tested by **Bureau Veritas Consumer Products Services (H.K.) Ltd., Taoyuan Branch**, and found compliance with the requirement of the above standards. The test record, data evaluation & Equipment Under Test (EUT) configurations represented herein are true and accurate accounts of the measurements of the sample's EMC characteristics under the conditions specified in this report.

**Prepared by :** Wendy Wu , **Date:** May 17, 2018  
Wendy Wu / Specialist

**Approved by :** May Chen , **Date:** May 17, 2018  
May Chen / Manager

## 2 Summary of Test Results

Applied Standard: FCC Part 22 & Part 2			
FCC Clause	Test Item	Result	Remarks
2.1046 22.913 (a)	Effective radiated power	PASS	Meet the requirement of limit.
---	Peak to Average Ratio	PASS	Meet the requirement of limit.
2.1047	Modulation characteristics	PASS	Meet the requirement
2.1055 22.355	Frequency Stability	PASS	Meet the requirement of limit.
2.1049	Occupied Bandwidth	PASS	Meet the requirement of limit.
22.917	Band Edge Measurements	PASS	Meet the requirement of limit.
2.1051 22.917	Conducted Spurious Emissions	PASS	Meet the requirement of limit.
2.1053 22.917	Radiated Spurious Emissions	PASS	Meet the requirement of limit. Minimum passing margin is -29.60dB at 6691.2MHz.

### 2.1 Measurement Uncertainty

Where relevant, the following measurement uncertainty levels have been estimated for tests performed on the EUT as specified in CISPR 16-4-2:

Measurement	Frequency	Expanded Uncertainty (k=2) ( $\pm$ )
Radiated Emissions up to 1 GHz	30MHz ~ 1GHz	5.53 dB
Radiated Emissions above 1 GHz	1GHz ~ 6GHz	5.08 dB
	6GHz ~ 18GHz	4.98 dB
	18GHz ~ 40GHz	5.19 dB

## 2.2 Test Site and Instruments

For LTE CA\_5B radiated spurious emissions test:

DESCRIPTION & MANUFACTURER	MODEL NO.	SERIAL NO.	CALIBRATED DATE	CALIBRATED UNTIL
Test Receiver Agilent	N9038A	MY50010156	July 12, 2017	July 11, 2018
Pre-Amplifier EMCI	EMC001340	980142	Feb. 09, 2018	Feb. 08, 2019
Loop Antenna <sup>(*)</sup> Electro-Metrics	EM-6879	264	Dec. 16, 2016	Dec. 15, 2018
RF Cable	NA	LOOPCAB-001 LOOPCAB-002	Jan. 15, 2018	Jan. 14, 2019
Pre-Amplifier Mini-Circuits	ZFL-1000VH2 B	AMP-ZFL-05	May 05, 2018	May 04, 2019
Trilog Broadband Antenna SCHWARZBECK	VULB 9168	9168-361	Nov. 29, 2017	Nov. 28, 2018
RF Cable	8D	966-3-1 966-3-2 966-3-3	Mar. 20, 2018	Mar. 19, 2019
Fixed attenuator Mini-Circuits	UNAT-5+	PAD-3m-3-01	Oct. 03, 2017	Oct. 02, 2018
Horn_Antenna SCHWARZBECK	BBHA9120-D	9120D-406	Dec. 12, 2017	Dec. 11, 2018
Pre-Amplifier EMCI	EMC12630SE	980384	Jan. 29, 2018	Jan. 28, 2019
RF Cable	EMC104-SM- SM-1200 EMC104-SM- SM-2000 EMC104-SM- SM-5000	160922 150317 150322	Jan. 29, 2018	Jan. 28, 2019
Spectrum Analyzer Keysight	N9030A	MY54490679	July 25, 2017	July 24, 2018
Pre-Amplifier EMCI	EMC184045S E	980386	Jan. 29, 2018	Jan. 28, 2019
Horn_Antenna SCHWARZBECK	BBHA 9170	BBHA9170608	Dec. 14, 2017	Dec. 13, 2018
RF Cable	EMC102-KM- KM-1200	160924	Jan. 29, 2018	Jan. 28, 2019
Software	ADT_Radiated _V8.7.08	NA	NA	NA
Antenna Tower & Turn Table Max-Full	MF-7802	MF780208406	NA	NA
Boresight Antenna Fixture	FBA-01	FBA-SIP01	NA	NA

### Note:

1. The calibration interval of the above test instruments is 12 months and the calibrations are traceable to NML/ROC and NIST/USA.
2. \*The calibration interval of the above test instruments is 24 months and the calibrations are traceable to NML/ROC and NIST/USA.
3. The test was performed in 966 Chamber No. 3.
4. The CANADA Site Registration No. is 20331-1
5. Loop antenna was used for all emissions below 30 MHz.
6. Tested Date: May 16, 2018

**For other radiated spurious emissions test:**

DESCRIPTION & MANUFACTURER	MODEL NO.	SERIAL NO.	CALIBRATED DATE	CALIBRATED UNTIL
Test Receiver Agilent	N9038A	MY50010156	July 12, 2017	July 11, 2018
Pre-Amplifier EMCI	EMC001340	980142	Feb. 09, 2018	Feb. 08, 2019
Loop Antenna <sup>(*)</sup> Electro-Metrics	EM-6879	264	Dec. 16, 2016	Dec. 15, 2018
RF Cable	NA	LOOPCAB-001 LOOPCAB-002	Jan. 15, 2018	Jan. 14, 2019
Pre-Amplifier Mini-Circuits	ZFL-1000VH2B	AMP-ZFL-05	May 06, 2017	May 05, 2018
Trilog Broadband Antenna SCHWARZBECK	VULB 9168	9168-361	Nov. 29, 2017	Nov. 28, 2018
RF Cable	8D	966-3-1 966-3-2 966-3-3	Mar. 20, 2018	Mar. 19, 2019
Fixed attenuator Mini-Circuits	UNAT-5+	PAD-3m-3-01	Oct. 03, 2017	Oct. 02, 2018
Horn_Antenna SCHWARZBECK	BBHA9120-D	9120D-406	Dec. 12, 2017	Dec. 11, 2018
Pre-Amplifier EMCI	EMC12630SE	980384	Jan. 29, 2018	Jan. 28, 2019
RF Cable	EMC104-SM-SM-1200 EMC104-SM-SM-2000 EMC104-SM-SM-5000	160922 150317 150322	Jan. 29, 2018	Jan. 28, 2019
Spectrum Analyzer Keysight	N9030A	MY54490679	July 25, 2017	July 24, 2018
Pre-Amplifier EMCI	EMC184045SE	980386	Jan. 29, 2018	Jan. 28, 2019
Horn_Antenna SCHWARZBECK	BBHA 9170	BBHA9170608	Dec. 14, 2017	Dec. 13, 2018
RF Cable	EMC102-KM-KM-1200	160924	Jan. 29, 2018	Jan. 28, 2019
Software	ADT_Radiated_V8.7.08	NA	NA	NA
Antenna Tower & Turn Table Max-Full	MF-7802	MF780208406	NA	NA
Boresight Antenna Fixture	FBA-01	FBA-SIP01	NA	NA

**Note:**

1. The calibration interval of the above test instruments is 12 months and the calibrations are traceable to NML/ROC and NIST/USA.
2. \*The calibration interval of the above test instruments is 24 months and the calibrations are traceable to NML/ROC and NIST/USA.
3. The test was performed in 966 Chamber No. 3.
4. The CANADA Site Registration No. is 20331-1
5. Loop antenna was used for all emissions below 30 MHz.
6. Tested Date: Mar. 31 to Apr. 05, 2018



**For other test:**

DESCRIPTION & MANUFACTURER	MODEL NO.	SERIAL NO.	CALIBRATED DATE	CALIBRATED UNTIL
Spectrum Analyzer R&S	FSV40	100964	July 1, 2017	June 30, 2018
Spectrum Analyzer Agilent	E4446A	MY48250254	Nov. 21, 2017	Nov. 20, 2018
Power meter Anritsu	ML2495A	1014008	May 11, 2017	May 10, 2018
Power sensor Anritsu	MA2411B	0917122	May 11, 2017	May 10, 2018
AC Power Source Extech Electronics	6205	1440452	NA	NA
Temperature & Humidity Chamber Giant Force	GTH-150-40-SP-AR	MAA0812-008	Jan. 10, 2018	Jan. 09, 2019
DC Power Supply Topward	6603D	795558	NA	NA
True RMS Clamp Meter FLUKE	325	31130711WS	May 29, 2017	May 28, 2018
ESG Vector signal generator Agilent	E4438C	MY45094468/0 05 506 602 UK6 UNJ	Nov. 26, 2017	Nov. 25, 2018
ESG Vector signal generator Agilent	E4438C	MY47271330 506 602 UNJ	Oct. 11, 2017	Oct. 10, 2018
Mech Switch Absorptive Mini-Circuits	MSP4TA-18+	0140	Feb. 12, 2018	Feb. 11, 2019
FXD ATTEN Mini-Circuits	BW-S3W2+	MN71981	Feb. 12, 2018	Feb. 11, 2019
Software	ADT_RF Test Software V6.6.5.4	NA	NA	NA

- NOTE:**
1. The test was performed in Oven room 2.
  2. The calibration interval of the above test instruments is 12 months and the calibrations are traceable to NML/ROC and NIST/USA.
  3. Tested Date: Apr. 01 to 26, 2018

### 3 General Information

#### 3.1 General Description of EUT

Product	LTE M.2 Module	
Brand	FOXCONN	
Test Model	T77W968	
Status of EUT	ENGINEERING SAMPLE	
Power Supply Rating	DC 3.3V from host equipment	
Modulation Type	WCDMA, HSDPA, HSUPA	BPSK
	LTE Band 5	QPSK, 16QAM, 64QAM
	LTE Band 26	QPSK, 16QAM, 64QAM
Operating Frequency	WCDMA, HSDPA, HSUPA	826.4MHz ~846.6MHz
	LTE Band 5	824.7MHz ~ 848.3MHz
	LTE Band 26	824.7MHz ~ 848.3MHz
Max. ERP Power	WCDMA Band 5	24.68dBm
	LTE Band 5 (Channel Bandwidth 1.4MHz)	24.28dBm
	LTE Band 5 (Channel Bandwidth 3MHz)	24.33dBm
	LTE Band 5 (Channel Bandwidth 5MHz)	24.20dBm
	LTE Band 5 (Channel Bandwidth 10MHz)	24.34dBm
	LTE Band 5 (Channel Bandwidth 5+10MHz)	24.04dBm
	LTE Band 5 (Channel Bandwidth 10+10MHz)	21.40dBm
	LTE Band 26 (Channel Bandwidth 1.4MHz)	24.47dBm
	LTE Band 26 (Channel Bandwidth 3MHz)	24.52dBm
	LTE Band 26 (Channel Bandwidth 5MHz)	24.40dBm
	LTE Band 26 (Channel Bandwidth 10MHz)	24.45dBm
	LTE Band 26 (Channel Bandwidth 15MHz)	24.50dBm

Emission Designator	WCDMA Band 5	4M13F9W
	LTE Band 5 (Channel Bandwidth 1.4MHz)	QPSK: 1M09G7D 16QAM: 1M09D7W 64QAM: 1M09D7W
	LTE Band 5 (Channel Bandwidth 3MHz)	QPSK: 2M70G7D 16QAM: 2M70D7W 64QAM: 2M70D7W
	LTE Band 5 (Channel Bandwidth 5MHz)	QPSK: 4M49G7D 16QAM: 4M49D7W 64QAM: 4M49D7W
	LTE Band 5 (Channel Bandwidth 10MHz)	QPSK: 8M97G7D 16QAM: 8M97D7W 64QAM: 8M96D7W
	LTE Band 5 (Channel Bandwidth 5+10MHz)	QPSK: 13M9G7D
	LTE Band 5 (Channel Bandwidth 10+10MHz)	QPSK: 18M8G7D
	LTE Band 26 (Channel Bandwidth 1.4MHz)	QPSK: 1M09G7D 16QAM: 1M09D7W 64QAM: 1M09D7W
	LTE Band 26 (Channel Bandwidth 3MHz)	QPSK: 2M70G7D 16QAM: 2M70D7W 64QAM: 2M70D7W
	LTE Band 26 (Channel Bandwidth 5MHz)	QPSK: 4M49G7D 16QAM: 4M49D7W 64QAM: 4M49D7W
	LTE Band 26 (Channel Bandwidth 10MHz)	QPSK: 8M96G7D 16QAM: 8M97D7W 64QAM: 8M96D7W
	LTE Band 26 (Channel Bandwidth 15MHz)	QPSK: 13M5G7D 16QAM: 13M4D7W 64QAM: 13M4D7W
Antenna Type	Refer to Note	
Antenna Connector	Refer to Note	
Accessory Device	NA	
Data Cable Supplied	NA	

Note:

1. The antennas provided to the EUT, please refer to the following table:

Antenna No.	Antenna Net Gain(dBi)	Frequency range (MHz)	Antenna Type	Connector Type	Cable Length
1	Please refer to below table	699~803	PIFA	i-pex(MHF)	100mm
2	Please refer to below table	791~960 1447.9~1606	PIFA	i-pex(MHF)	100mm
3	Please refer to below table	1710~2170 2500~2690	PIFA	i-pex(MHF)	100mm
4	Please refer to below table	5110~5925 (for LAA RX)	PIFA	i-pex(MHF)	100mm
5	Please refer to below table	2305~2315	Dipole	i-pex(MHF)	80mm

Antenna gain list

Antenna No.	Band	Freq. Range (MHz)	Gain (dBi)
3	WCDMA II (B2)	1850~1910	4.92
3	WCDMA IV (B4)	1710~1755	5.99
2	WCDMA V (B5)	824~849	2.68
3	LTE Band (2)	1850~1910	4.92
3	LTE Band (4)	1710~1755	5.99
2	LTE Band (5)	824~849	2.68
3	LTE Band (7)	2500~2570	5.2
1	LTE Band (12)	698~716	4.17
1	LTE Band (13)	777~787	3.05
1	LTE Band (14)	788~798	2.87
1	LTE Band (17)	704~716	4.17
3	LTE Band (25)	1850~1915	4.92
2	LTE Band (26)	814~849	2.92
5	LTE Band (30)	2305~2315	3.02
3	LTE Band (38)	2570~2620	4.82
3	LTE Band (41)	2496~2690	5.38
3	LTE Band (66)	1710~1780	5.99

2. This device is UE LTE module that can support carrier aggregation (two carrier) uplink Intra-Band contiguous, specification following as below:

Uplink CA Configurations	Component carriers in order of increasing carrier frequency		Maximum Aggregated Bandwidth [MHz]	Bandwidth Combination Set
	Channel bandwidths for carrier-1 [MHz]	Channel bandwidths for carrier-2 [MHz]		
CA_5B	5,10	10	20	0
	10	5		

3. The above EUT information is declared by manufacturer and for more detailed features description, please refer to the manufacturer's specifications or User's Manual.

### 3.2 Configuration of System under Test

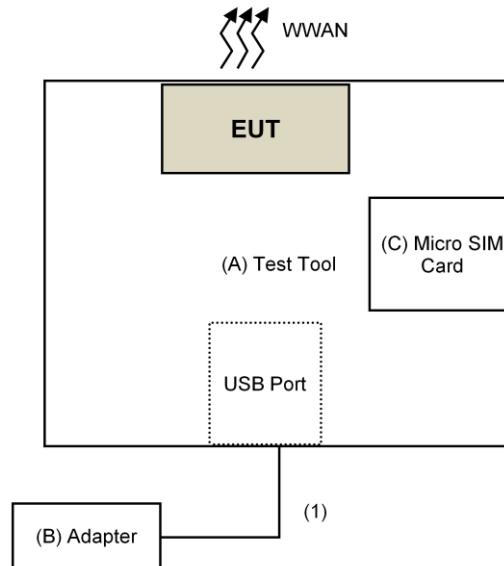

----- Remote Site



### 3.2.1 Description of Support Units

The EUT has been tested as an independent unit together with other necessary accessories or support units. The following support units or accessories were used to form a representative test configuration during the tests.

ID	Product	Brand	Model No.	Serial No.	FCC ID	Remarks
A.	Test Tool	Foxconn	T77W968	NA	NA	Supplied by client
B.	Adapter	ASUS	EXA1205UA	NA	NA	Provided by Lab
C.	SIM Card	NA	NA	NA	NA	Provided by Lab
D.	Simulator	Keysight	E7515A	MY56030229	NA	Provided by Lab

Note:

1. All power cords of the above support units are non-shielded (1.8m).

ID	Descriptions	Qty.	Length (m)	Shielding (Yes/No)	Cores (Qty.)	Remarks
1.	USB Cable	1	1	Yes	0	Provided by Lab

### 3.3 Test Mode Applicability and Tested Channel Detail

Pre-Scan has been conducted to determine the worst-case mode from all possible combinations between available modulations, data rates, XYZ axis and antenna ports

The worst case was found when positioned on X-plane. Following channel(s) was (were) selected for the final test as listed below:

#### WCDMA V MODE

Test Item	Available Channel	Tested Channel	Mode
ERP	4132 to 4233	4132, 4182, 4233	WCDMA
Frequency Stability	4132 to 4233	4182	WCDMA
Occupied Bandwidth	4132 to 4233	4132, 4182, 4233	WCDMA
Peak to Average Ratio	4132 to 4233	4132, 4182, 4233	WCDMA
Band Edge	4132 to 4233	4132, 4233	WCDMA
Conducted Emission	4132 to 4233	4132, 4182, 4233	WCDMA
Radiated Emission Below 1GHz	4132 to 4233	4132, 4182, 4233	WCDMA
Radiated Emission Above 1GHz	4132 to 4233	4132, 4182, 4233	WCDMA

**LTE Band 5**

TEST ITEM	AVAILABLE CHANNEL	TESTED CHANNEL	CHANNEL BANDWIDTH	MODULATION	MODE
ERP	20407 to 20643	20407, 20525, 20643	1.4MHz	QPSK/16QAM/64QAM	1RB / 0 RB offset
	20415 to 20635	20415, 20525, 20635	3MHz	QPSK/16QAM/64QAM	1RB / 0 RB offset
	20425 to 20625	20425, 20525, 20625	5MHz	QPSK/16QAM/64QAM	1RB / 0 RB offset
	20450 to 20600	20450, 20525, 20600	10MHz	QPSK/16QAM/64QAM	1RB / 0 RB offset
Frequency Stability	20407 to 20643	20525	1.4MHz	QPSK	-
	20415 to 20635	20525	3MHz	QPSK	-
	20425 to 20625	20525	5MHz	QPSK	-
	20450 to 20600	20525	10MHz	QPSK	-
Occupied Bandwidth	20407 to 20643	20407, 20525, 20643	1.4MHz	QPSK/16QAM/64QAM	Full RB
	20415 to 20635	20415, 20525, 20635	3MHz	QPSK/16QAM/64QAM	Full RB
	20425 to 20625	20425, 20525, 20625	5MHz	QPSK/16QAM/64QAM	Full RB
	20450 to 20600	20450, 20525, 20600	10MHz	QPSK/16QAM/64QAM	Full RB
Peak to Average Ratio	20407 to 20643	20407, 20525, 20643	1.4MHz	QPSK/16QAM/64QAM	Full RB
	20415 to 20635	20415, 20525, 20635	3MHz	QPSK/16QAM/64QAM	Full RB
	20425 to 20625	20425, 20525, 20625	5MHz	QPSK/16QAM/64QAM	Full RB
	20450 to 20600	20450, 20525, 20600	10MHz	QPSK/16QAM/64QAM	Full RB
Band Edge	20407 to 20643	20407	1.4MHz	QPSK	1 RB / 0 RB Offset
		20643			1 RB / 5 RB Offset
		20407, 20643			6 RB / 0 RB Offset
	20415 to 20635	20415	3MHz	QPSK	1 RB / 0 RB Offset
		20635			1 RB / 14 RB Offset
		20415, 20635			15 RB / 0 RB Offset
	20425 to 20625	20425	5MHz	QPSK	1 RB / 0 RB Offset
		20625			1 RB / 24 RB Offset
		20425, 20625			25 RB / 0 RB Offset
	20450 to 20600	20450	10MHz	QPSK	1 RB / 0 RB Offset
		20600			1 RB / 49 RB Offset
		20450, 20600			50 RB / 0 RB Offset
Conducted Emission	20407 to 20643	20407, 20525, 20643	1.4MHz	QPSK	1RB / 0 RB offset
	20415 to 20635	20415, 20525, 20635	3MHz	QPSK	1RB / 0 RB offset
	20425 to 20625	20425, 20525, 20625	5MHz	QPSK	1RB / 0 RB offset
	20450 to 20600	20450, 20525, 20600	10MHz	QPSK	1RB / 0 RB offset
Radiated Emission	20407 to 20643	20407, 20525, 20643	1.4MHz	QPSK	1RB / 0 RB offset
	20415 to 20635	20415, 20525, 20635	3MHz	QPSK	1RB / 0 RB offset
	20425 to 20625	20425, 20525, 20625	5MHz	QPSK	1RB / 0 RB offset
	20450 to 20600	20450, 20525, 20600	10MHz	QPSK	1RB / 0 RB offset



**LTE CA\_5C**

TEST ITEM	MODULATION	PCC			SCC		
		CHANNEL BANDWIDTH	TESTED CHANNEL	MODE	CHANNEL BANDWIDTH	TESTED CHANNEL	MODE
EIRP	QPSK	5MHz	20528	1RB / 0 RB offset	10MHz	20600	0RB / 0 RB offset
Frequency Stability	QPSK	5MHz	20528	-	10MHz	20600	-
Occupied Bandwidth	QPSK	5MHz	20528	25RB / 0 RB offset	10MHz	20600	50RB / 0 RB offset
Peak to Average Ratio	QPSK	5MHz	20528	25RB / 0 RB offset	10MHz	20600	50RB / 0 RB offset
Band Edge	QPSK	5MHz	20425	25RB / 0 RB offset	10MHz	20497	50RB / 0 RB offset
				1RB / 0 RB offset			0RB / 0 RB offset
			20528	25RB / 0 RB offset		20600	50RB / 0 RB offset
				0RB / 0 RB offset			1RB / 99 RB offset
Conducted Emission	QPSK	5MHz	20528	1RB / 0 RB offset	10MHz	20600	0RB / 0 RB offset
Radiated Emission	QPSK	5MHz	20528	1RB / 0 RB offset	10MHz	20600	0RB / 0 RB offset

Note: This product supports multiple carriers in intra-band contiguous spectrum operation, therefore test mode and test configurations follow KDB inquiry (more detail information refer "Operation Description.pdf").

**LTE Band 26**

TEST ITEM	AVAILABLE CHANNEL	TESTED CHANNEL	CHANNEL BANDWIDTH	MODULATION	MODE
ERP	26797 to 27033	26797, 26915, 27033	1.4MHz	QPSK/16QAM/64QAM	1RB / 0 RB offset
	26805 to 27025	26805, 26915, 27025	3MHz	QPSK/16QAM/64QAM	1RB / 0 RB offset
	26815 to 27015	26815, 26915, 27015	5MHz	QPSK/16QAM/64QAM	1RB / 0 RB offset
	26840 to 26990	26840, 26915, 26990	10MHz	QPSK/16QAM/64QAM	1RB / 0 RB offset
	26865 to 26965	26865, 26915, 26965	15MHz	QPSK/16QAM/64QAM	1RB / 0 RB offset
Frequency Stability	26797 to 27033	26915	1.4MHz	QPSK	-
	26805 to 27025	26915	3MHz	QPSK	-
	26815 to 27015	26915	5MHz	QPSK	-
	26840 to 26990	26915	10MHz	QPSK	-
	26865 to 26965	26915	15MHz	QPSK	-
Occupied Bandwidth	26797 to 27033	26797, 26915, 27033	1.4MHz	QPSK/16QAM/64QAM	Full RB
	26805 to 27025	26805, 26915, 27025	3MHz	QPSK/16QAM/64QAM	Full RB
	26815 to 27015	26815, 26915, 27015	5MHz	QPSK/16QAM/64QAM	Full RB
	26840 to 26990	26840, 26915, 26990	10MHz	QPSK/16QAM/64QAM	Full RB
	26865 to 26965	26865, 26915, 26965	15MHz	QPSK/16QAM/64QAM	Full RB
Peak to Average Ratio	26797 to 27033	26797, 26915, 27033	1.4MHz	QPSK/16QAM/64QAM	Full RB
	26805 to 27025	26805, 26915, 27025	3MHz	QPSK/16QAM/64QAM	Full RB
	26815 to 27015	26815, 26915, 27015	5MHz	QPSK/16QAM/64QAM	Full RB
	26840 to 26990	26840, 26915, 26990	10MHz	QPSK/16QAM/64QAM	Full RB
	26865 to 26965	26865, 26915, 26965	15MHz	QPSK/16QAM/64QAM	Full RB
Band Edge	26797 to 27033	26797	1.4MHz	QPSK	1 RB / 0 RB Offset
		27033			1 RB / 5 RB Offset
		26797, 27033			6 RB / 0 RB Offset
	26805 to 27025	26805	3MHz	QPSK	1 RB / 0 RB Offset
		27025			1 RB / 14 RB Offset
		26805, 27025			15 RB / 0 RB Offset
	26815 to 27015	26815	5MHz	QPSK	1 RB / 0 RB Offset
		27015			1 RB / 24 RB Offset
		26815, 27015			25 RB / 0 RB Offset
	26840 to 26990	26840	10MHz	QPSK	1 RB / 0 RB Offset
		26990			1 RB / 49 RB Offset
		26840, 26990			50 RB / 0 RB Offset
	26865 to 26965	26865	15MHz	QPSK	1 RB / 0 RB Offset
		26965			1 RB / 74 RB Offset
		26865, 26965			75 RB / 0 RB Offset
Conducted Emission	26797 to 27033	26797, 26915, 27033	1.4MHz	QPSK	1RB / 0 RB offset
	26805 to 27025	26805, 26915, 27025	3MHz	QPSK	1RB / 0 RB offset
	26815 to 27015	26815, 26915, 27015	5MHz	QPSK	1RB / 0 RB offset
	26840 to 26990	26840, 26915, 26990	10MHz	QPSK	1RB / 0 RB offset
	26865 to 26965	26865, 26915, 26965	15MHz	QPSK	1RB / 0 RB offset
Radiated Emission	26797 to 27033	26797, 26915, 27033	1.4MHz	QPSK	1RB / 0 RB offset
	26805 to 27025	26805, 26915, 27025	3MHz	QPSK	1RB / 0 RB offset
	26815 to 27015	26815, 26915, 27015	5MHz	QPSK	1RB / 0 RB offset
	26840 to 26990	26840, 26915, 26990	10MHz	QPSK	1RB / 0 RB offset
	26865 to 26965	26865, 26915, 26965	15MHz	QPSK	1RB / 0 RB offset

**NOTE:**

All supported modulation types were evaluated. The Worst case of QPSK was selected. Therefore, the Band Edge, Frequency Stability, Condcudeted Emission and Radiated Emission were presented under QPSK mode only.

**Test Condition:**

Test Item	Environmental Conditions	Input Power (System)	Tested By
ERP	25deg. C, 63%RH	120Vac, 60Hz	Jyunchun Lin
Frequency Stability	25deg. C, 63%RH	120Vac, 60Hz	Jyunchun Lin
Occupied Bandwidth	25deg. C, 63%RH	120Vac, 60Hz	Jyunchun Lin
Band Edge	25deg. C, 63%RH	120Vac, 60Hz	Jyunchun Lin
Peak to Average Ratio	25deg. C, 63%RH	120Vac, 60Hz	Jyunchun Lin
Conducuted Emission	25deg. C, 63%RH	120Vac, 60Hz	Jyunchun Lin
Radiated Emission Below 1GHz	25deg. C, 66%RH	120Vac, 60Hz	Frank Chiang Robert Cheng
Radiated Emission Above 1GHz	25deg. C, 66%RH	120Vac, 60Hz	Frank Chiang Robert Cheng

**3.4 EUT Operating Conditions**

The communication simulator station system controlled a EUT to export maximum output power under transmission mode and specific channel frequency

### 3.5 General Description of Applied Standards

The EUT is a RF Product. According to the specifications of the manufacturer, it must comply with the requirements of the following standards:

**FCC 47 CFR Part 2**

**FCC 47 CFR Part 22**

**KDB 971168 D01 Power Meas License Digital Systems v03r01**

**ANSI/TIA/EIA-603-E 2016**

**ANSI 63.26-2015**

**NOTE:** All test items have been performed and recorded as per the above standards.

## 4 Test Types and Results

### 4.1 Output Power Measurement

#### 4.1.1 Limits of Output Power Measurement

Mobile / Portable station are limited to 7 watts e.r.p.

#### 4.1.2 Test Procedures

##### Conducted Power Measurement:

The EUT was set up for the maximum power with WCDMA / LTE link data modulation and link up with simulator. Set the EUT to transmit under low, middle and high channel and difference RB size/ RB offset for difference bandwidth record the power level shown on power meter.

##### EIRP / ERP Measurement:

- EIRP = Conducted Output power level + Antenna gain.
- ERP power can be calculated form EIRP power by subtracting the gain of dipole, ERP power = EIPR power - 2.15dBi.
- ERP = Conducted Output power level + Antenna gain (dBi) - Isotropically Factor (2.15dB).

#### 4.1.3 Test Setup

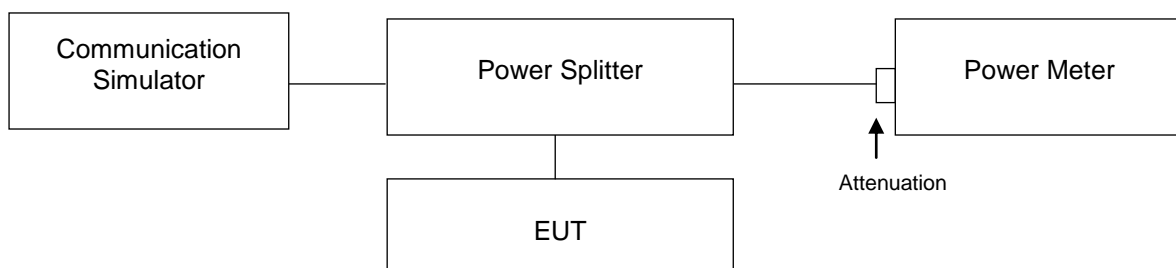

For the actual test configuration, please refer to the attached file (Test Setup Photo).

4.1.4 Test Results

**CONDUCTED OUTPUT POWER (dBm)**

Band	WCDMA V		
	4132	4182	4233
Channel	826.4	836.4	846.6
Frequency (MHz)	24.15	24.02	24.08
RMC	23.97	23.88	23.97
HSDPA Subtest-1	23.75	23.53	23.68
HSDPA Subtest-2	23.77	23.51	23.61
HSDPA Subtest-3	23.62	23.51	23.64
HSDPA Subtest-4	23.99	23.89	23.87
HSUPA Subtest-1	23.92	23.83	23.80
HSUPA Subtest-2	23.68	23.59	23.59
HSUPA Subtest-3	23.83	23.73	23.68
HSUPA Subtest-4	23.91	23.88	23.83
HSUPA Subtest-5			

**LTE Band 5**

Band / BW	RB Size	RB Offset	QPSK			3GPP MPR (dB)	16QAM			3GPP MPR (dB)	64QAM			3GPP MPR (dB)
			Low CH	Mid CH	High CH		Low CH	Mid CH	High CH		Low CH	Mid CH	High CH	
			20407	20525	20643		20407	20525	20643		20407	20525	20643	
			824.7	836.5	848.3		824.7	836.5	848.3		824.7	836.5	848.3	
			MHz	MHz	MHz	MHz	MHz	MHz	MHz	MHz	MHz			
5 / 1.4M	1	0	24.10	24.28	24.09	0	23.13	23.15	22.86	1	22.08	22.09	21.91	2
	1	2	24.15	24.14	24.10	0	23.02	23.14	22.92	1	22.01	22.08	21.93	2
	1	5	24.11	24.10	24.08	0	23.03	23.15	22.83	1	22.05	22.01	21.86	2
	3	0	24.19	24.17	24.03	0	22.92	23.16	22.99	1	22.03	22.03	21.95	2
	3	1	24.14	24.15	23.97	0	23.18	23.13	23.00	1	22.06	22.11	21.88	2
	3	3	24.16	24.14	22.99	0	23.20	23.17	23.04	1	22.12	22.15	21.84	2
	6	0	23.17	23.09	22.95	1	22.08	22.22	21.97	2	20.98	21.01	20.81	3

Band / BW	RB Size	RB Offset	QPSK			3GPP MPR (dB)	16QAM			3GPP MPR (dB)	64QAM			3GPP MPR (dB)
			Low CH	Mid CH	High CH		Low CH	Mid CH	High CH		Low CH	Mid CH	High CH	
			20415	20525	20635		20415	20525	20635		20415	20525	20635	
			825.5	836.5	847.5		825.5	836.5	847.5		825.5	836.5	847.5	
			MHz	MHz	MHz	MHz	MHz	MHz	MHz	MHz	MHz			
5 / 3M	1	0	24.16	24.33	24.09	0	23.19	23.06	23.13	1	22.11	22.02	22.13	2
	1	7	24.21	24.26	24.12	0	23.09	23.20	23.22	1	22.15	22.05	22.08	2
	1	14	24.19	24.22	24.05	0	23.06	23.11	23.25	1	22.08	22.11	22.15	2
	8	0	23.18	23.24	23.08	1	22.12	22.20	22.07	2	20.96	21.14	21.05	3
	8	3	23.16	23.13	23.09	1	22.18	22.25	22.09	2	20.98	21.08	20.98	3
	8	7	23.15	23.20	23.07	1	22.19	23.24	22.08	2	21.05	21.05	21.11	3
	15	0	23.21	23.27	23.09	1	22.21	22.19	22.09	2	21.03	21.09	21.14	3

Band / BW	RB Size	RB Offset	QPSK			3GPP MPR (dB)	16QAM			3GPP MPR (dB)	64QAM			3GPP MPR (dB)
			Low CH	Mid CH	High CH		Low CH	Mid CH	High CH		Low CH	Mid CH	High CH	
			20425	20525	20625		20425	20525	20625		20425	20525	20625	
			826.5	836.5	846.5		826.5	836.5	846.5		826.5	836.5	846.5	
			MHz	MHz	MHz	MHz	MHz	MHz	MHz	MHz	MHz			
5 / 5M	1	0	24.20	24.17	24.12	0	23.08	23.11	23.00	1	21.95	22.05	21.99	2
	1	12	24.10	24.05	24.07	0	22.96	23.08	22.98	1	22.05	22.11	22.03	2
	1	24	24.10	24.14	24.04	0	23.06	23.04	22.90	1	22.08	22.13	22.08	2
	12	0	23.07	23.03	23.11	1	22.31	22.09	22.04	2	20.96	21.08	20.95	3
	12	6	23.11	23.01	23.09	1	22.07	22.07	22.12	2	21.01	21.04	21.01	3
	12	13	23.04	23.05	23.11	1	22.06	22.05	22.15	2	21.05	21.01	20.88	3
	25	0	23.08	23.01	23.07	1	22.00	21.98	22.24	2	21.02	21.15	20.98	3

Band / BW	RB Size	RB Offset	QPSK			3GPP MPR (dB)	16QAM			3GPP MPR (dB)	64QAM			3GPP MPR (dB)
			Low CH	Mid CH	High CH		Low CH	Mid CH	High CH		Low CH	Mid CH	High CH	
			20450	20525	20600		20450	20525	20600		20450	20525	20600	
			829	836.5	844		829	836.5	844		829	836.5	844	
			MHz	MHz	MHz		MHz	MHz	MHz		MHz	MHz	MHz	
5 / 10M	1	0	24.23	24.34	24.11	0	23.13	23.15	23.30	1	22.11	22.02	22.13	2
	1	24	24.20	24.30	24.24	0	23.19	23.14	23.25	1	22.08	22.08	22.19	2
	1	49	24.22	24.20	24.21	0	23.15	22.99	23.26	1	21.95	22.05	22.11	2
	25	0	23.23	23.26	23.05	1	22.33	22.22	22.20	2	21.09	21.08	21.15	3
	25	12	23.30	23.26	23.23	1	22.21	22.24	22.28	2	21.12	21.05	21.11	3
	25	25	23.23	23.15	23.11	1	22.13	22.16	22.25	2	21.14	21.11	21.15	3
	50	0	23.27	23.25	23.07	1	22.20	22.24	22.17	2	21.01	21.13	21.01	3



**LTE CA\_5C (PCC/SCC: 5M+10M)**

Intra Band-Contiguous CA															
PCC							SCC							MPR	
Band	BW (MHz)	Modulation	RB Size	RB Offset	UL Channel	UL Frequency (MHz)	Band	BW (MHz)	Modulation	RB Size	RB Offset	UL Channel	UL Frequency (MHz)	MPR Level (dB)	Tx Power with UL-CA Active (dBm) Level (dB)
5	5	QPSK	0	0	20425	826.5	5	10	QPSK	1	49	20497	833.7	0	23.46
			1	0						0	0			0	23.21
			25	0						0	0			0-1	21.76
			25	0						50	0			0-2	20.28
			1	0						1	49			0-8.5	15.12
			1	0						1	0			0-4.5	18.98
			1	24						1	0			0	23.51
			25	0						1	49			0-3.5	16.28
5	5	QPSK	0	0	20478	831.8	5	10	QPSK	1	49	20550	839	0	23.33
			1	0						0	0			0	23.31
			25	0						0	0			0-1	22.19
			25	0						50	0			0-2	20.64
			1	0						1	49			0-8.5	14.7
			1	0						1	0			0-4.5	19.07
			1	24						1	0			0	22.96
			25	0						1	49			0-3.5	18.4
5	5	QPSK	0	0	20528	836.8	5	10	QPSK	1	49	20600	844	0	23.47
			1	0						0	0			0	23.51
			25	0						0	0			0-1	21.47
			25	0						50	0			0-2	20.85
			1	0						1	49			0-8.5	14.43
			1	0						1	0			0-4.5	18.8
			1	24						1	0			0	22.87
			25	0						1	49			0-3.5	18.4

**LTE CA\_5C (PCC/SCC: 10M+5M)**

Intra Band-Contiguous CA															
PCC						SCC								MPR	
Band	BW (MHz)	Modulation	RB Size	RB Offset	UL Channel	UL Frequency (MHz)	Band	BW (MHz)	Modulation	RB Size	RB Offset	UL Channel	UL Frequency (MHz)	MPR Level (dB)	Tx Power with UL-CA Active (dBm) Level (dB)
5	10	QPSK	0	0	20450	829	5	5	QPSK	1	24	20522	836.2	0	23.26
			1	0						0	0			0	23.3
			50	0						0	0			0-1	21.82
			50	0						25	0			0-2	20.19
			1	0						1	24			0-8.5	15.01
			1	0						1	0			0-4.5	18.81
			1	49						1	0			0	23.34
			50	0						1	24			0-3.5	16.14
5	10	QPSK	0	0	20500	834	5	5	QPSK	1	24	20572	841.2	0	23.14
			1	0						0	0			0	23.41
			50	0						0	0			0-1	22.19
			50	0						25	0			0-2	20.55
			1	0						1	24			0-8.5	14.67
			1	0						1	0			0-4.5	19.04
			1	49						1	0			0	23.02
			50	0						1	24			0-3.5	18.52
5	10	QPSK	0	0	20553	839.3	5	5	QPSK	1	24	20625	846.5	0	23.19
			1	0						0	0			0	23.16
			50	0						0	0			0-1	21.43
			50	0						25	0			0-2	20.62
			1	0						1	24			0-8.5	14.37
			1	0						1	0			0-4.5	18.67
			1	49						1	0			0	22.98
			50	0						1	24			0-3.5	18.41

**LTE CA\_5C (PCC/SCC: 10M+10M)**

Intra Band-Contiguous CA															
PCC								SCC						MPR	
Band	BW (MHz)	Modulation	RB Size	RB Offset	UL Channel	UL Frequency (MHz)	Band	BW (MHz)	Modulation	RB Size	RB Offset	UL Channel	UL Frequency (MHz)	MPR Level (dB)	Tx Power with UL-CA Active (dBm) Level (dB)
5	10	QPSK	0	0	20450	829	5	10	QPSK	1	49	20549	838.9	0	23.38
			1	0						0	0			0	23.34
			50	0						0	0			0-1	21.67
			50	0						50	0			0-2	20.33
			1	0						1	49			0-8.5	15.09
			1	0						1	0			0-4.5	18.85
			1	49						1	0			0	23.49
			50	0						1	49			0-3.5	16.14
5	10	QPSK	0	0	20475	831.5	5	10	QPSK	1	49	20574	841.4	0	23.43
			1	0						0	0			0	23.37
			50	0						0	0			0-1	22.21
			50	0						50	0			0-2	20.56
			1	0						1	49			0-8.5	14.77
			1	0						1	0			0-4.5	18.89
			1	49						1	0			0	22.88
			50	0						1	49			0-3.5	18.25
5	10	QPSK	0	0	20501	834.1	5	10	QPSK	1	49	20600	844	0	23.39
			1	0						0	0			0	23.18
			50	0						0	0			0-1	21.68
			50	0						50	0			0-2	20.87
			1	0						1	49			0-8.5	14.57
			1	0						1	0			0-4.5	18.79
			1	49						1	0			0	23.09
			50	0						1	49			0-3.5	18.18

**LTE Band 26**

Band / BW	RB Size	RB Offset	QPSK			3GPP MPR (dB)	16QAM			3GPP MPR (dB)	64QAM			3GPP MPR (dB)
			Low CH	Mid CH	High CH		Low CH	Mid CH	High CH		Low CH	Mid CH	High CH	
			26797	26915	27033		26797	26915	27033		26797	26915	27033	
			824.7	836.5	848.3		824.7	836.5	848.3		824.7	836.5	848.3	
			MHz	MHz	MHz		MHz	MHz	MHz		MHz	MHz	MHz	
26 / 1.4M	1	0	24.47	24.32	24.31	0	23.35	23.32	23.09	1	22.25	22.29	22.15	2
	1	2	24.41	24.36	24.28	0	23.31	23.28	23.22	1	22.21	22.25	22.20	2
	1	5	24.39	24.33	24.32	0	23.14	23.37	23.10	1	22.28	22.33	22.26	2
	3	0	24.35	24.28	24.26	0	23.25	23.36	23.23	1	22.33	22.27	22.21	2
	3	1	24.22	24.31	24.20	0	23.37	23.33	23.27	1	22.26	22.22	22.23	2
	3	3	24.32	24.29	23.27	0	23.32	23.31	23.17	1	22.27	22.26	22.07	2
	6	0	23.32	23.29	23.18	1	22.34	22.21	22.31	2	21.25	21.32	21.19	3

Band / BW	RB Size	RB Offset	QPSK			3GPP MPR (dB)	16QAM			3GPP MPR (dB)	64QAM			3GPP MPR (dB)
			Low CH	Mid CH	High CH		Low CH	Mid CH	High CH		Low CH	Mid CH	High CH	
			26805	26915	27025		26805	26915	27025		26805	26915	27025	
			825.50	836.50	847.50		825.50	836.50	847.50		825.5	836.5	847.5	
			MHz	MHz	MHz		MHz	MHz	MHz		MHz	MHz	MHz	
26 / 3M	1	0	24.52	24.44	24.35	0	23.24	23.41	23.18	1	22.21	22.29	22.26	2
	1	7	24.45	24.47	24.33	0	23.33	23.44	23.23	1	22.25	22.15	22.33	2
	1	14	24.42	24.36	24.32	0	23.25	23.37	23.15	1	22.17	22.20	22.22	2
	8	0	23.42	23.29	23.36	1	22.33	22.41	22.32	2	21.16	21.23	21.10	3
	8	3	23.39	23.38	23.39	1	22.41	22.36	22.33	2	21.19	21.12	21.19	3
	8	7	23.37	23.35	23.31	1	22.41	22.38	22.27	2	21.30	21.18	21.12	3
	15	0	23.42	23.40	23.41	1	22.35	22.42	22.32	2	21.23	21.41	21.25	3

Band / BW	RB Size	RB Offset	QPSK			3GPP MPR (dB)	16QAM			3GPP MPR (dB)	64QAM			3GPP MPR (dB)
			Low CH	Mid CH	High CH		Low CH	Mid CH	High CH		Low CH	Mid CH	High CH	
			26815	26915	27015		26815	26915	27015		26815	26915	27015	
			826.50	836.50	846.50		826.50	836.50	846.50		826.5	836.5	846.5	
			MHz	MHz	MHz		MHz	MHz	MHz		MHz	MHz	MHz	
26 / 5M	1	0	24.33	24.40	24.30	0	23.37	23.35	23.34	1	22.32	22.36	22.32	2
	1	12	24.47	24.42	24.28	0	23.40	23.20	23.33	1	22.39	22.25	22.35	2
	1	24	24.45	24.37	23.46	0	23.44	23.26	23.27	1	22.25	22.22	22.37	2
	12	0	23.44	23.43	23.43	1	22.46	22.45	22.43	2	21.16	21.29	21.28	3
	12	6	23.39	23.45	23.35	1	22.37	22.43	22.42	2	21.22	21.38	21.32	3
	12	13	23.42	23.42	23.39	1	22.36	22.40	22.35	2	21.38	21.35	21.25	3
	25	0	23.41	23.39	24.40	1	22.39	22.35	22.44	2	21.36	21.26	21.29	3

Band / BW	RB Size	RB Offset	QPSK			3GPP MPR (dB)	16QAM			3GPP MPR (dB)	64QAM			3GPP MPR (dB)
			Low CH	Mid CH	High CH		Low CH	Mid CH	High CH		Low CH	Mid CH	High CH	
			26840	26915	26990		26840	26915	26990		26840	26915	26990	
			829	836.5	844		829	836.5	844		829	836.5	844	
			MHz	MHz	MHz		MHz	MHz	MHz		MHz	MHz	MHz	
26 / 10M	1	0	24.45	24.35	24.43	0	23.28	23.38	23.27	1	22.28	22.32	22.17	2
	1	24	24.36	24.33	24.34	0	23.25	23.36	23.20	1	22.22	22.25	22.22	2
	1	49	24.37	24.33	24.32	0	23.30	23.33	23.18	1	22.15	22.16	22.29	2
	25	0	23.37	23.37	23.27	1	22.61	22.39	22.38	2	21.28	21.18	21.21	3
	25	12	23.37	23.41	23.36	1	22.35	22.37	22.37	2	21.12	21.22	21.16	3
	25	25	23.30	23.32	23.34	1	22.30	22.40	22.36	2	21.09	21.25	21.28	3
	50	0	23.35	23.26	23.32	1	23.40	22.38	22.32	2	21.23	21.16	21.22	3

Band / BW	RB Size	RB Offset	QPSK			3GPP MPR (dB)	16QAM			3GPP MPR (dB)	64QAM			3GPP MPR (dB)
			Low CH	Mid CH	High CH		Low CH	Mid CH	High CH		Low CH	Mid CH	High CH	
			26865	26915	26965		26865	26915	26965		26865	26915	26965	
			831.5	836.5	841.5		831.5	836.5	841.5		831.5	836.5	841.5	
			MHz	MHz	MHz		MHz	MHz	MHz		MHz	MHz	MHz	
26 / 15M	1	0	24.47	24.45	24.50	0	23.31	23.30	23.34	1	22.40	22.36	22.38	2
	1	37	24.43	24.41	24.42	0	23.19	23.26	23.29	1	22.28	22.20	22.32	2
	1	74	24.34	24.33	24.37	0	23.34	23.19	23.19	1	22.25	22.18	22.35	2
	36	0	23.49	23.30	23.33	1	22.37	22.49	22.25	2	21.32	21.29	21.26	3
	36	19	23.46	23.38	23.43	1	22.33	22.48	22.26	2	21.39	21.36	21.18	3
	36	39	23.34	23.30	23.38	1	22.29	22.49	22.32	2	21.25	21.25	21.32	3
	75	0	23.46	23.33	24.23	1	22.32	22.35	22.37	2	21.22	21.29	21.34	3

## ERP POWER

### WCDMA

Band	WCDMA V		
Channel	4132	4182	4233
Frequency (MHz)	826.4	836.4	846.6
RMC 12.2K	24.15	24.02	24.08
Gain (dBi)	2.68	2.68	2.68
Isotropically Factor (dB)	2.15	2.15	2.15
Max ERP Power (dBm)	24.68	24.55	24.61

### LTE Band 5

Band / BW	RB Size	RB Offset	QPSK			3GPP MPR (dB)	16QAM			3GPP MPR (dB)	64QAM			3GPP MPR (dB)
			Low CH	Mid CH	High CH		Low CH	Mid CH	High CH		Low CH	Mid CH	High CH	
			20407	20525	20643		20407	20525	20643		20407	20525	20643	
5 / 1.4M	1	0	824.7 MHz	836.5 MHz	848.3 MHz	0	824.7 MHz	836.5 MHz	848.3 MHz	1	824.7 MHz	836.5 MHz	848.3 MHz	2
Gain (dBi)			2.68	2.68	2.68		2.68	2.68	2.68		2.68	2.68	2.68	
Isotropically Factor (dB)			2.15	2.15	2.15		2.15	2.15	2.15		2.15	2.15	2.15	
Max ERP Power (dBm)			24.10	24.28	24.09		23.13	23.15	22.86		22.08	22.09	21.91	

Band / BW	RB Size	RB Offset	QPSK			3GPP MPR (dB)	16QAM			3GPP MPR (dB)	64QAM			3GPP MPR (dB)
			Low CH	Mid CH	High CH		Low CH	Mid CH	High CH		Low CH	Mid CH	High CH	
			20415	20525	20635		20415	20525	20635		20415	20525	20635	
5 / 3M	1	0	825.5 MHz	836.5 MHz	847.5 MHz	0	825.5 MHz	836.5 MHz	847.5 MHz	1	825.5 MHz	836.5 MHz	847.5 MHz	2
Gain (dBi)			2.68	2.68	2.68		2.68	2.68	2.68		2.68	2.68		
Isotropically Factor (dB)			2.15	2.15	2.15		2.15	2.15	2.15		2.15	2.15		
Max ERP Power (dBm)			24.16	24.33	24.09		23.19	23.06	23.13		22.11	22.02	22.13	

Band / BW	RB Size	RB Offset	QPSK			3GPP MPR (dB)	16QAM			3GPP MPR (dB)	64QAM			3GPP MPR (dB)
			Low CH	Mid CH	High CH		Low CH	Mid CH	High CH		Low CH	Mid CH	High CH	
			20425	20525	20625		20425	20525	20625		20425	20525	20625	
5 / 5M	1	0	826.5 MHz	836.5 MHz	846.5 MHz	0	826.5 MHz	836.5 MHz	846.5 MHz	1	826.5 MHz	836.5 MHz	846.5 MHz	2
Gain (dBi)			2.68	2.68	2.68		2.68	2.68	2.68		2.68	2.68		
Isotropically Factor (dB)			2.15	2.15	2.15		2.15	2.15	2.15		2.15	2.15		
Max ERP Power (dBm)			24.20	24.17	24.12		23.08	23.11	23.00		21.95	22.05	21.99	

Band / BW	RB Size	RB Offset	QPSK			3GPP MPR (dB)	16QAM			3GPP MPR (dB)	64QAM			3GPP MPR (dB)	
			Low CH	Mid CH	High CH		Low CH	Mid CH	High CH		Low CH	Mid CH	High CH		
			20450	20525	20600		20450	20525	20600		20450	20525	20600		
			829 MHz	836.5 MHz	844 MHz		829 MHz	836.5 MHz	844 MHz		829 MHz	836.5 MHz	844 MHz		
5 / 10M	1	0	23.70	23.81	23.58	0	22.60	22.62	22.77	1	21.58	21.49	21.60	2	
Gain (dBi)			2.68	2.68	2.68		2.68	2.68	2.68		2.68	2.68	2.68		2.68
Isotropically Factor (dB)			2.15	2.15	2.15		2.15	2.15	2.15		2.15	2.15	2.15		2.15
Max ERP Power (dBm)			24.23	24.34	24.11		23.13	23.15	23.30		22.11	22.02	22.13		22.13

**LTE CA\_5C (PCC/SCC: 5M+10M)**

Channel Number	Freq. (MHz)	QPSK							
		PCC		SCC		Conducted Power	Gain	ERP(dBm)	ERP(mW)
		RB Number	RB Set	RB Number	RB Set	Chain 0			
20528+20600	836.8+844	1	0	0	0	23.51	2.68	24.04	253.51

**LTE CA\_5C (PCC/SCC: 10M+10M)**

Channel Number	Freq. (MHz)	QPSK							
		PCC		SCC		Conducted Power	Gain	ERP(dBm)	ERP(mW)
		RB Number	RB Set	RB Number	RB Set	Chain 0			
2501+2600	834.1+844	50	0	50	0	20.87	2.68	21.40	138.04



### LTE Band 26

Band / BW	RB Size	RB Offset	QPSK			3GPP MPR (dB)	16QAM			3GPP MPR (dB)	64QAM			3GPP MPR (dB)
			Low CH	Mid CH	High CH		Low CH	Mid CH	High CH		Low CH	Mid CH	High CH	
			26797	26915	27033		26797	26915	27033		26797	26915	27033	
26 / 1.4M	1	0	824.7 MHz	836.5 MHz	848.3 MHz	0	22.58	22.55	22.32	1	21.48	21.52	21.38	2
Gain (dBi)			2.92	2.92	2.92		2.92	2.92	2.92		2.92	2.92	2.92	
Isotropically Factor (dB)			2.15	2.15	2.15		2.15	2.15	2.15		2.15	2.15	2.15	
Max ERP Power (dBm)			24.47	24.32	24.31		23.35	23.32	23.09		22.25	22.29	22.15	

Band / BW	RB Size	RB Offset	QPSK			3GP P MPR (dB)	16QAM			3GP P MPR (dB)	64QAM			3GP P MPR (dB)
			Low CH	Mid CH	High CH		Low CH	Mid CH	High CH		Low CH	Mid CH	High CH	
			26805	26915	27025		26805	26915	27025		26805	26915	27025	
26 / 3M	1	0	825.50 MHz	836.50 MHz	847.50 MHz	0	22.47	22.64	22.41	1	21.44	21.52	21.49	2
Gain (dBi)			2.92	2.92	2.92		2.92	2.92	2.92		2.92	2.92		
Isotropically Factor (dB)			2.15	2.15	2.15		2.15	2.15	2.15		2.15	2.15		
Max ERP Power (dBm)			24.52	24.44	24.35		23.24	23.41	23.18		22.21	22.29	22.26	

Band / BW	RB Size	RB Offset	QPSK			3GP P MPR (dB)	16QAM			3GP P MPR (dB)	64QAM			3GP P MPR (dB)
			Low CH	Mid CH	High CH		Low CH	Mid CH	High CH		Low CH	Mid CH	High CH	
			26815	26915	27015		26815	26915	27015		26815	26915	27015	
26 / 5M	1	12	826.50 MHz	836.50 MHz	846.50 MHz	0	22.60	22.58	22.57	1	21.55	21.59	21.55	2
Gain (dBi)			2.92	2.92	2.92		2.92	2.92	2.92		2.92	2.92		
Isotropically Factor (dB)			2.15	2.15	2.15		2.15	2.15	2.15		2.15	2.15		
Max ERP Power (dBm)			24.33	24.40	24.30		23.37	23.35	23.34		22.32	22.36	22.32	

Band / BW	RB Size	RB Offset	QPSK			3GPP MPR (dB)	16QAM			3GPP MPR (dB)	64QAM			3GPP MPR (dB)
			Low CH	Mid CH	High CH		Low CH	Mid CH	High CH		Low CH	Mid CH	High CH	
			26840	26915	26990		26840	26915	26990		26840	26915	26990	
26 / 10M	1	0	829 MHz	836.5 MHz	844 MHz	0	22.51	22.61	22.50	1	21.51	21.55	21.40	2
Gain (dBi)			2.92	2.92	2.92		2.92	2.92	2.92		2.92	2.92		
Isotropically Factor (dB)			2.15	2.15	2.15		2.15	2.15	2.15		2.15	2.15		
Max ERP Power (dBm)			24.45	24.35	24.43		23.28	23.38	23.27		22.28	22.32	22.17	

Band / BW	RB Size	RB Offset	QPSK			3GPP MPR (dB)	16QAM			3GPP MPR (dB)	64QAM			3GPP MPR (dB)
			Low CH	Mid CH	High CH		Low CH	Mid CH	High CH		Low CH	Mid CH	High CH	
			26865	26915	26965		26865	26915	26965		26865	26915	26965	
			831.5 MHz	836.5 MHz	841.5 MHz		831.5 MHz	836.5 MHz	841.5 MHz		831.5 MHz	836.5 MHz	841.5 MHz	
26 / 15M	1	0	23.70	23.68	23.73	0	22.54	22.53	22.57	1	21.63	21.59	21.61	2
Gain (dBi)			2.92	2.92	2.92		2.92	2.92	2.92					
Isotropically Factor (dB)			2.15	2.15	2.15		2.15	2.15	2.15					
Max ERP Power (dBm)			24.47	24.45	24.50		23.31	23.30	23.34		22.40	22.36	22.38	

## 4.2 Modulation characteristics Measurement

### 4.2.1 Limits of Modulation characteristics

N/A

### 4.2.2 Test Procedure

Connect the EUT to Communication Simulator via the antenna connector, The frequency band is set as EUT supported Modulation and Channels, the EUT output is matched with 50 ohm load, the waveform quality and constellation of the EUT was tested.

### 4.2.3 Test Setup



## 4.2.4 Test Results

### LTE Band 5

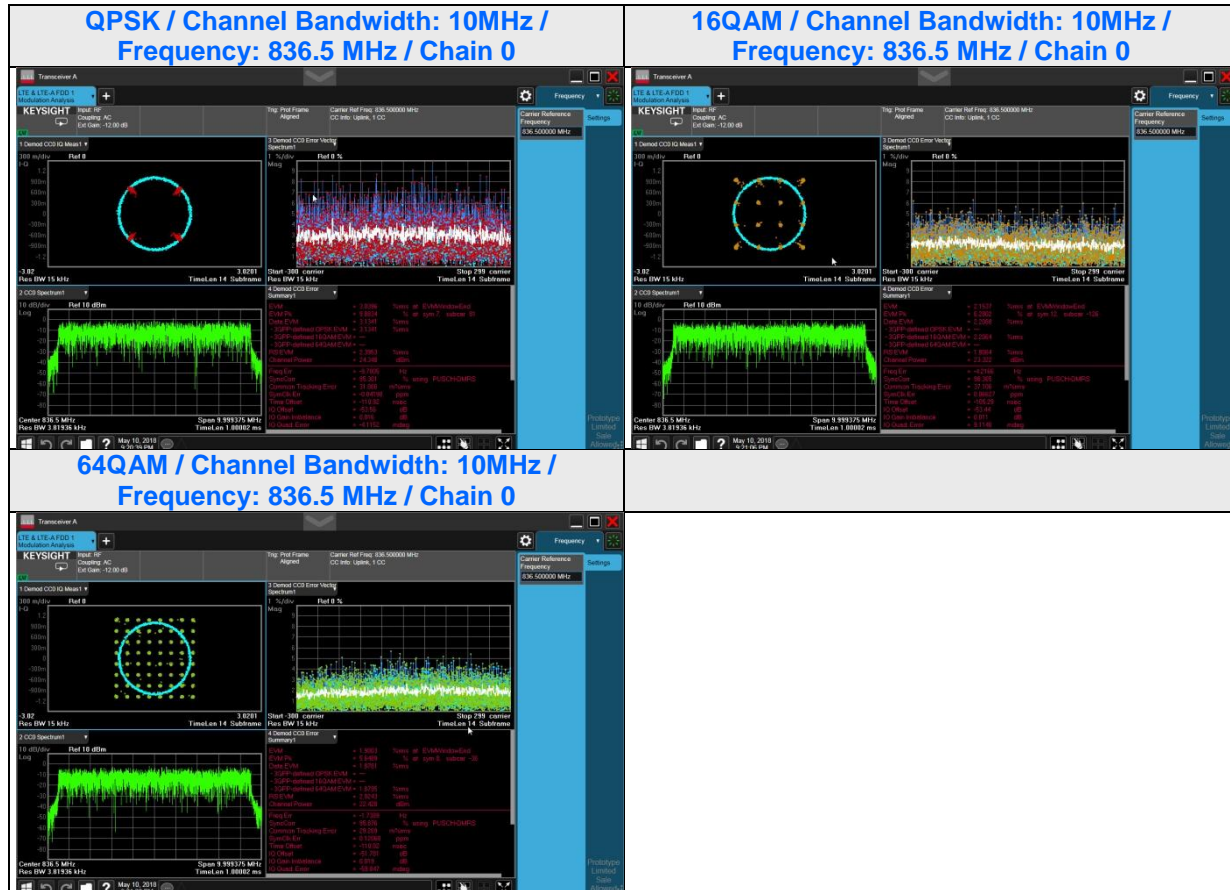

### LTE Band 26

#### QPSK / Channel Bandwidth: 15MHz / Frequency: 836.5 MHz / Chain 0



#### 16QAM / Channel Bandwidth: 15MHz / Frequency: 836.5 MHz / Chain 0



#### 64QAM / Channel Bandwidth: 15MHz / Frequency: 836.5 MHz / Chain 0

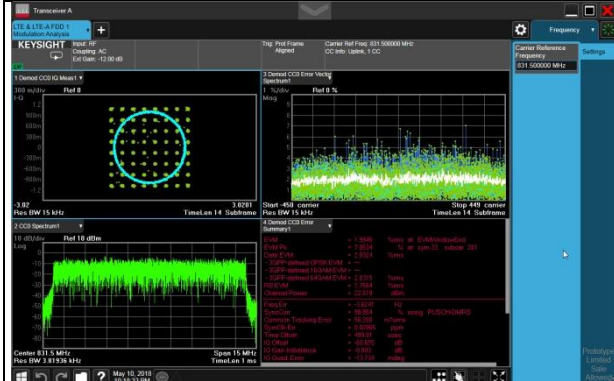

### 4.3 Frequency Stability Measurement

#### 4.3.1 Limits of Frequency Stability Measurement

1.5 ppm is for base and fixed station. 2.5 ppm is for mobile station.

#### 4.3.2 Test Procedure

- Device is placed at the oven room. The oven room could control the temperatures and humidity. Power warm up is at least 15 min and power applied should perform before recording frequency error.
- EUT is connected the external power supply to control the DC input power. The test voltage range is from minimum to maximum working voltage. Each step shall be record the frequency error rate.
- The temperature range step is 10 degrees in this test items. All temperature levels shall be hold the  $\pm 0.5$  °C during the measurement testing. The each temperature step shall be at least 0.5 hours, consider the EUT could be test under the stability condition.

**NOTE:** The frequency error was recorded frequency error from the communication simulator.

#### 4.3.3 Test Setup

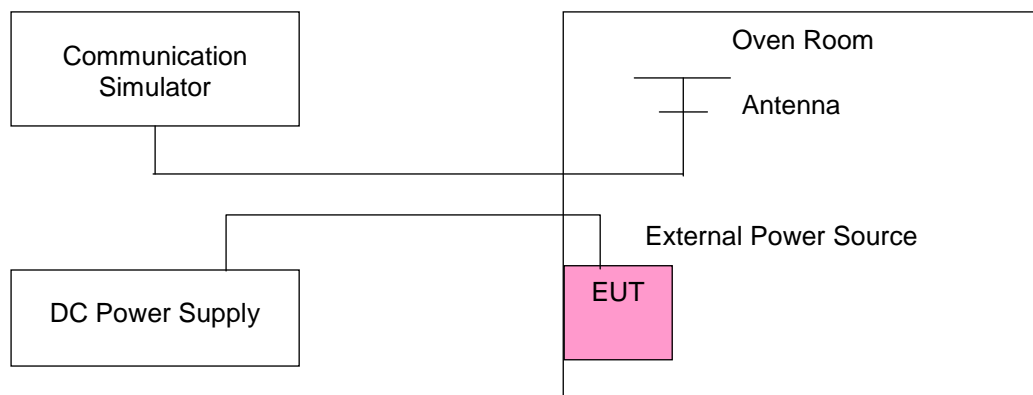

#### 4.3.4 Test Results

##### WCDMA

##### Frequency Error vs. Voltage

Voltage (Volts)	Frequency Error (ppm)	Limit (ppm)
	WCDMA	
2.805	0.033	2.5
3.795	0.032	2.5

##### Frequency Error vs. Temperature.

TEMP. (°C)	Frequency Error (ppm)	Limit (ppm)
	WCDMA	
50	0.032	2.5
40	0.038	2.5
30	0.050	2.5
20	0.038	2.5
10	0.055	2.5
0	0.041	2.5
-10	0.050	2.5
-20	0.037	2.5
-30	0.038	2.5

## LTE Band 5

### Frequency Error vs. Voltage

Voltage (Volts)	Frequency Error (ppm)				Limit (ppm)
	LTE Band 5				
	1.4MHz	3MHz	5MHz	10MHz	
2.805	0.050	0.025	0.033	0.059	2.5
3.795	0.053	0.029	0.032	0.027	2.5

### Frequency Error vs. Temperature

Temp. (°C)	Frequency Error (ppm)				Limit (ppm)
	LTE Band 5				
	1.4MHz	3MHz	5MHz	10MHz	
50	0.032	0.031	0.031	0.039	2.5
40	0.049	0.055	0.036	0.026	2.5
30	0.050	0.036	0.038	0.030	2.5
20	0.056	0.043	0.053	0.059	2.5
10	0.056	0.045	0.033	0.051	2.5
0	0.049	0.029	0.032	0.032	2.5
-10	0.029	0.053	0.044	0.044	2.5
-20	0.054	0.041	0.039	0.024	2.5
-30	0.025	0.055	0.059	0.057	2.5



## LTE CA\_5C

### Frequency Error vs. Voltage

Voltage (Volts)	Frequency Error (ppm)		Limit (ppm)
	CA_5+10 MHz Low Channel	CA_5+10 MHz High Channel	
2.805	0.044	0.030	2.5
3.795	0.051	0.024	2.5

### Frequency Error vs. Temperature.

Temp. (°C)	Frequency Error (ppm)		Limit (ppm)
	CA_5+10 MHz Low Channel	CA_5+10 MHz High Channel	
50	0.059	0.026	2.5
40	0.055	0.050	2.5
30	0.032	0.055	2.5
20	0.039	0.044	2.5
10	0.027	0.051	2.5
0	0.031	0.044	2.5
-10	0.053	0.038	2.5
-20	0.030	0.046	2.5
-30	0.059	0.031	2.5

## LTE Band 26

### Frequency Error vs. Voltage

Voltage (Volts)	Frequency Error (ppm)					Limit (ppm)
	LTE Band 26					
	1.4MHz	3MHz	5MHz	10MHz	15MHz	
2.805	0.041	0.041	0.033	0.039	0.044	2.5
3.795	0.057	0.038	0.041	0.041	0.049	2.5

### Frequency Error vs. Temperature

Temp. (°C)	Frequency Error (ppm)					Limit (ppm)
	LTE Band 5					
	1.4MHz	3MHz	5MHz	10MHz	15MHz	
50	0.025	0.026	0.055	0.057	0.038	2.5
40	0.031	0.051	0.031	0.024	0.059	2.5
30	0.053	0.038	0.030	0.057	0.041	2.5
20	0.026	0.032	0.045	0.038	0.056	2.5
10	0.059	0.051	0.030	0.032	0.024	2.5
0	0.051	0.050	0.054	0.031	0.037	2.5
-10	0.035	0.024	0.057	0.033	0.043	2.5
-20	0.030	0.026	0.030	0.030	0.055	2.5
-30	0.044	0.050	0.027	0.026	0.030	2.5

## 4.4 Occupied Bandwidth Measurement

### 4.4.1 Test Procedure

All measurements were done at low, middle and high operational frequency range. The communication simulator station system controlled a EUT to export maximum output power under transmission mode and specific channel frequency. The bandwidth of the fundamental frequency was measured by spectrum analyzer with  $RBW \geq 1\% \times OBW$  and  $VBW \geq 3 \times RBW$ .

#### Occupied Bandwidth Measurement:

Use OBW measurement function of Spectrum analyzer to measure 99 % occupied bandwidth.

#### 26dB Bandwidth Measurement:

The emission bandwidth is defined as the width of the signal between two points, one below the carrier center frequency and one above the carrier center frequency, outside of which all emission are attenuated at least 26dB below the transmitter power.

### 4.4.2 Test Setup

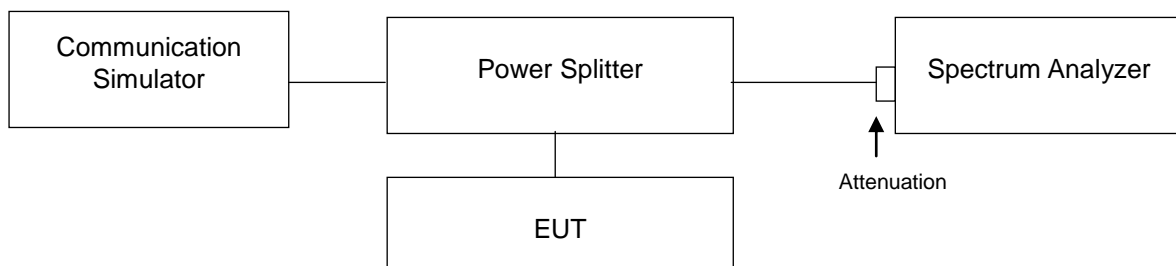

#### 4.4.3 Test Result (-26dB Bandwidth)

Channel	Freq. (MHz)	-26dB Bandwidth (MHz)
		WCDMA
4132	826.4	4.70
4182	836.4	4.67
4233	846.6	4.67

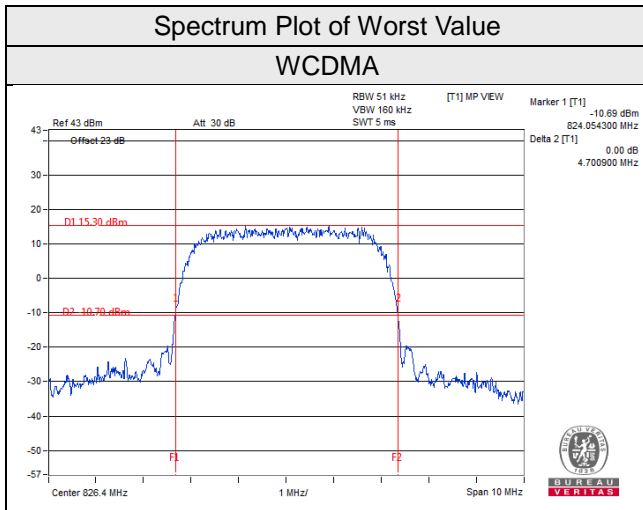

LTE Band 5									
Channel Bandwidth 1.4MHz					Channel Bandwidth 3MHz				
Channel	Frequency (MHz)	-26dB Bandwidth (MHz)			Channel	Frequency (MHz)	-26dB Bandwidth (MHz)		
		QPSK	16QAM	64QAM			QPSK	16QAM	64QAM
20407	824.7	1.22	1.22	1.22	20415	825.5	2.93	2.93	2.91
20525	836.5	1.22	1.22	1.22	20525	836.5	2.94	2.93	2.92
20643	848.3	1.22	1.21	1.21	20635	847.5	2.93	2.94	2.93
Channel Bandwidth 5MHz					Channel Bandwidth 10MHz				
Channel	Frequency (MHz)	-26dB Bandwidth (MHz)			Channel	Frequency (MHz)	-26dB Bandwidth (MHz)		
		QPSK	16QAM	64QAM			QPSK	16QAM	64QAM
20425	826.5	4.82	4.80	4.80	20450	829	9.52	9.51	9.51
20525	836.5	4.81	4.80	4.80	20525	836.5	9.52	9.51	9.50
20625	846.5	4.80	4.80	4.79	20600	844	9.52	9.51	9.51

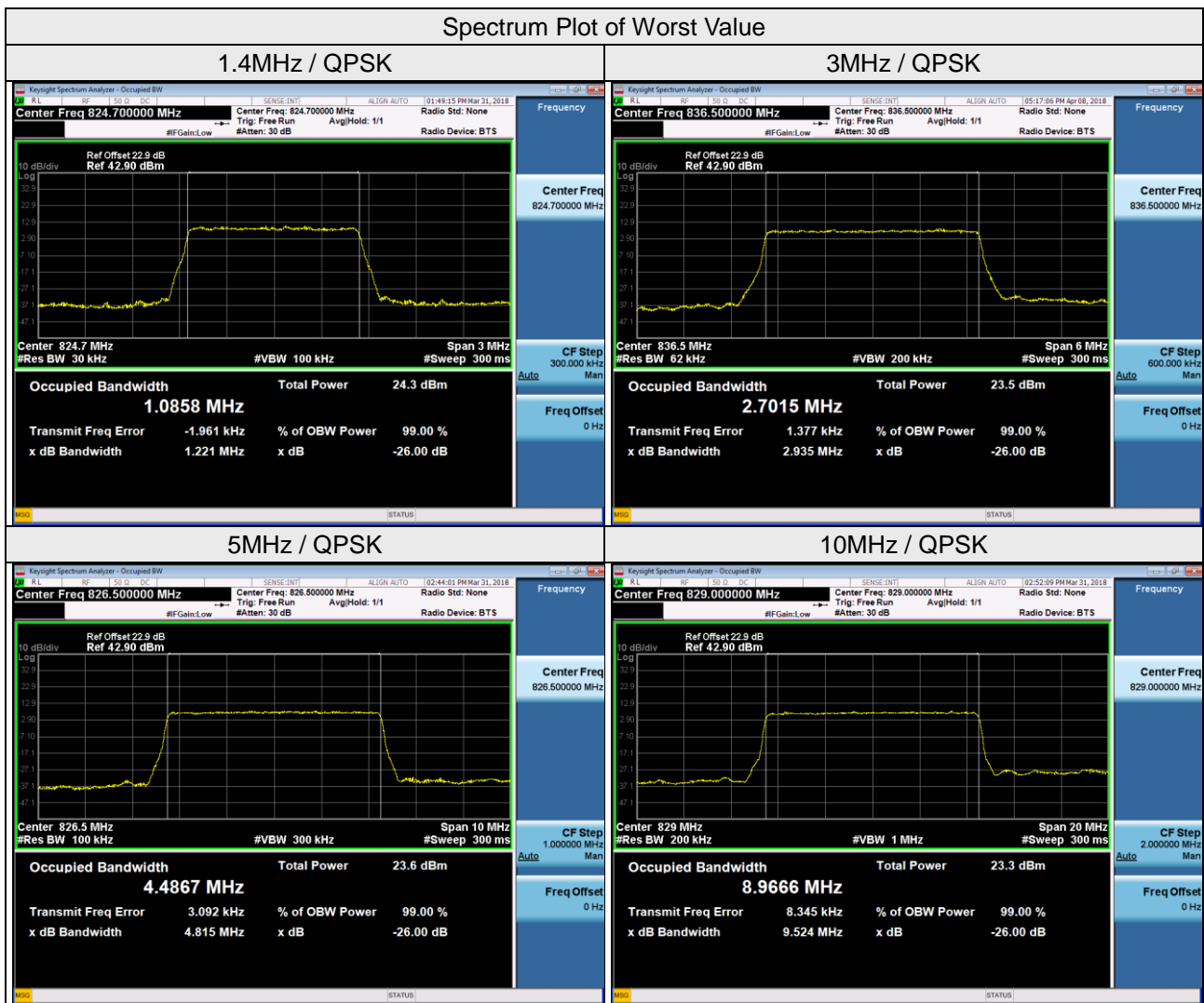

LTE CA_5C (5+10MHz)		
Channel	FREQ. (MHz)	-26dB Bandwidth (MHz)
		QPSK
20528+20600	836.8+844	14.43

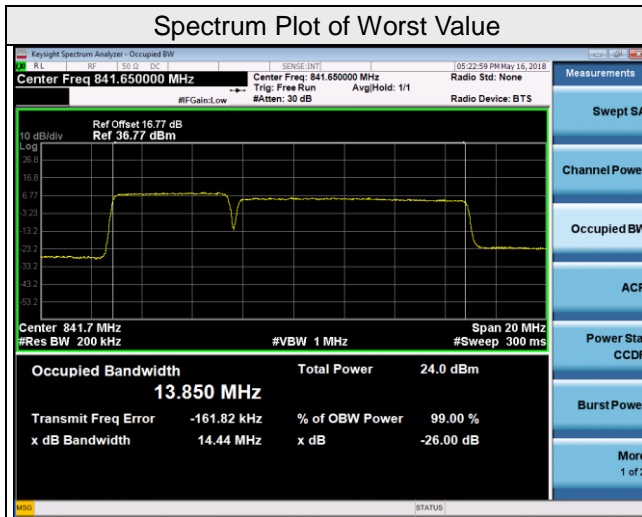

LTE CA_5C (10+10MHz)		
Channel	FREQ. (MHz)	-26dB Bandwidth (MHz)
		QPSK
2501+2600	834.1+844	19.88

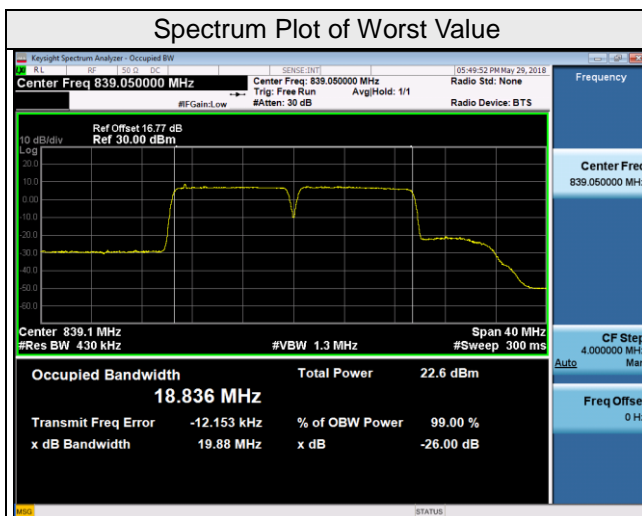

LTE Band 26									
Channel Bandwidth 1.4MHz					Channel Bandwidth 3MHz				
Channel	Frequency (MHz)	-26dB Bandwidth (MHz)			Channel	Frequency (MHz)	-26dB Bandwidth (MHz)		
		QPSK	16QAM	64QAM			QPSK	16QAM	64QAM
26797	824.7	1.23	1.21	1.22	26805	825.5	2.93	2.93	2.87
26915	836.5	1.22	1.22	1.22	26915	836.5	2.93	2.93	2.92
27033	848.3	1.22	1.21	1.21	27025	847.5	2.94	2.92	2.91
Channel Bandwidth 5MHz					Channel Bandwidth 10MHz				
Channel	Frequency (MHz)	-26dB Bandwidth (MHz)			Channel	Frequency (MHz)	-26dB Bandwidth (MHz)		
		QPSK	16QAM	64QAM			QPSK	16QAM	64QAM
26815	826.5	4.80	4.80	4.81	26840	829	9.51	9.51	9.51
26915	836.5	4.80	4.79	4.80	26915	836.5	9.53	9.52	9.51
27015	846.5	4.79	4.80	4.79	26990	844	9.52	9.51	9.50
Channel Bandwidth 15MHz									
Channel	Frequency (MHz)	-26dB Bandwidth (MHz)							
		QPSK	16QAM	64QAM					
26865	831.5	14.27	14.25	14.26					
26915	836.5	14.28	14.25	14.23					
26965	841.5	14.27	14.25	14.24					

### Spectrum Plot of Worst Value

#### 1.4MHz / QPSK

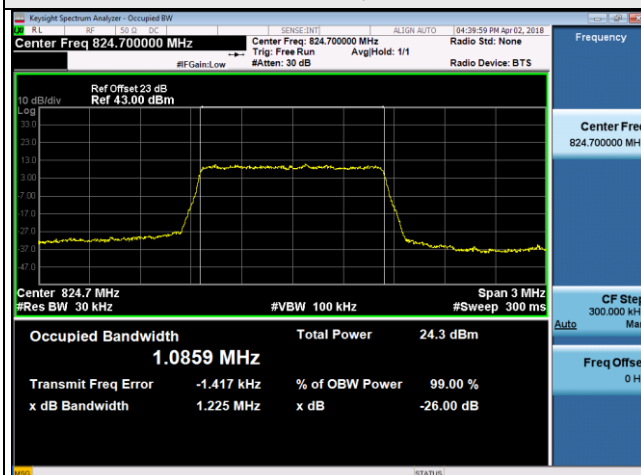

#### 3MHz / QPSK

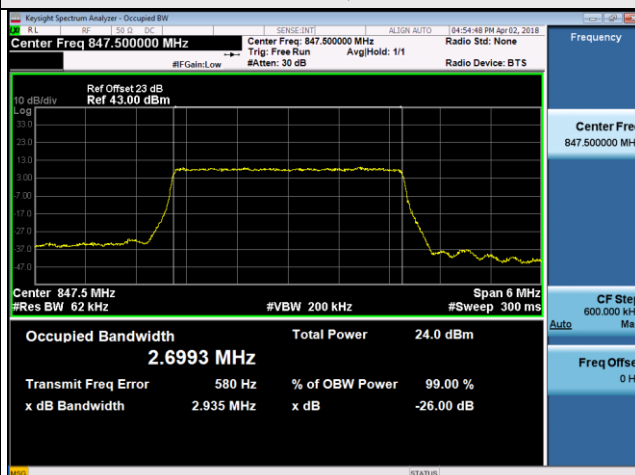

#### 5MHz / 64QAM

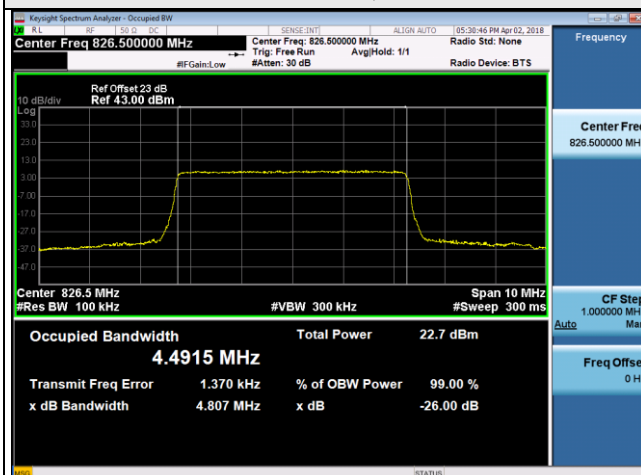

#### 10MHz / QPSK

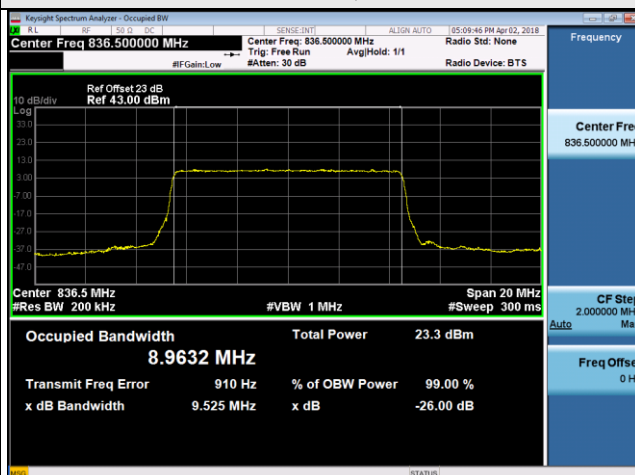

#### 15MHz / QPSK

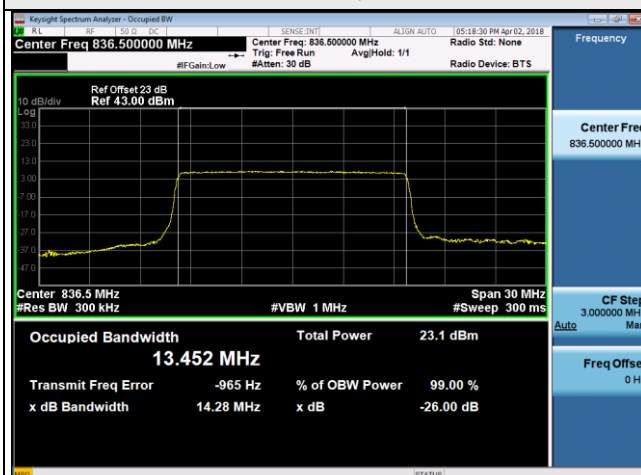



#### 4.4.4 Test Result (Occupied Bandwidth)

Channel	Freq. (MHz)	99% Occupied Bandwidth (MHz)
		WCDMA
4132	826.4	4.12
4182	836.4	4.13
4233	846.6	4.13

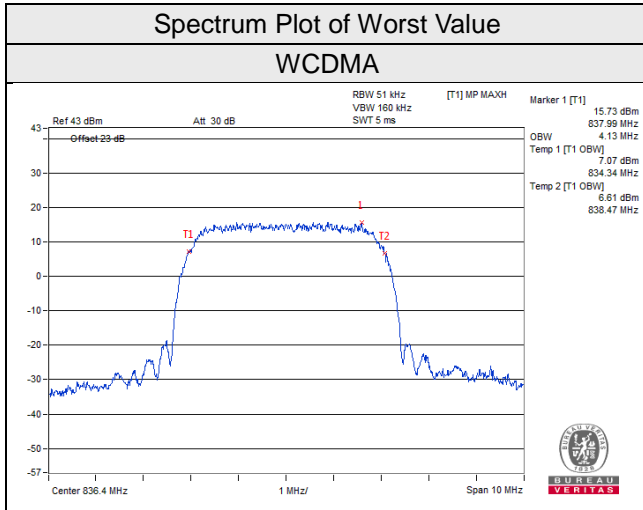

LTE Band 5									
Channel Bandwidth 1.4MHz					Channel Bandwidth 3MHz				
Channel	Frequency (MHz)	99% Occupied Bandwidth (MHz)			Channel	Frequency (MHz)	99% Occupied Bandwidth (MHz)		
		QPSK	16QAM	64QAM			QPSK	16QAM	64QAM
20407	824.7	1.09	1.09	1.09	20415	825.5	2.70	2.70	2.70
20525	836.5	1.09	1.09	1.09	20525	836.5	2.70	2.70	2.70
20643	848.3	1.09	1.09	1.09	20635	847.5	2.70	2.70	2.70
Channel Bandwidth 5MHz					Channel Bandwidth 10MHz				
Channel	Frequency (MHz)	99% Occupied Bandwidth (MHz)			Channel	Frequency (MHz)	99% Occupied Bandwidth (MHz)		
		QPSK	16QAM	64QAM			QPSK	16QAM	64QAM
20425	826.5	4.49	4.49	4.49	20450	829	8.97	8.97	8.96
20525	836.5	4.49	4.49	4.49	20525	836.5	8.96	8.97	8.96
20625	846.5	4.49	4.49	4.49	20600	844	8.96	8.96	8.96

### Spectrum Plot of Worst Value

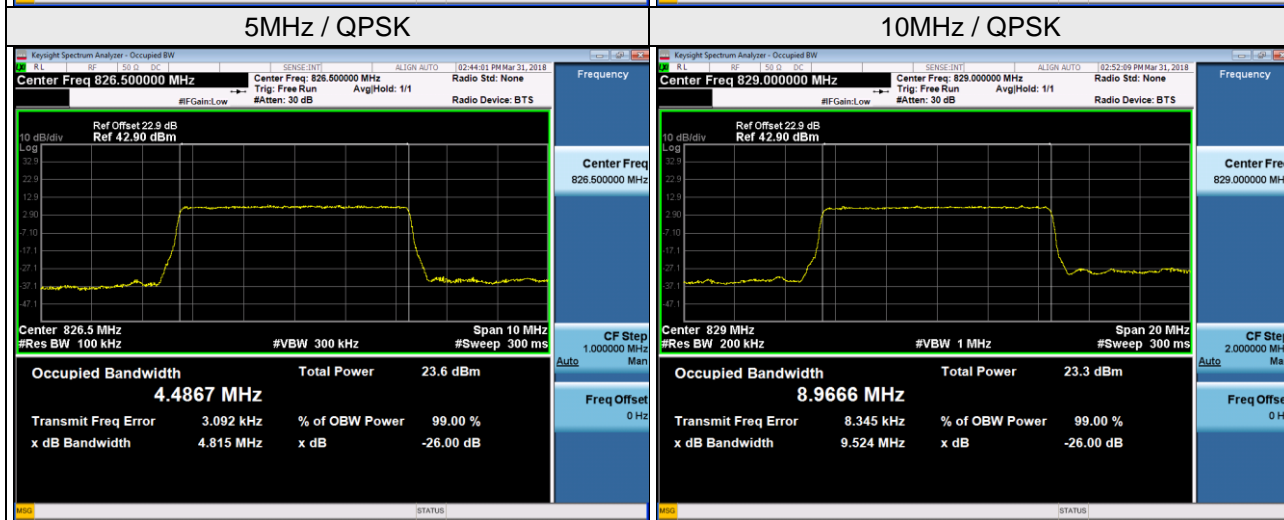
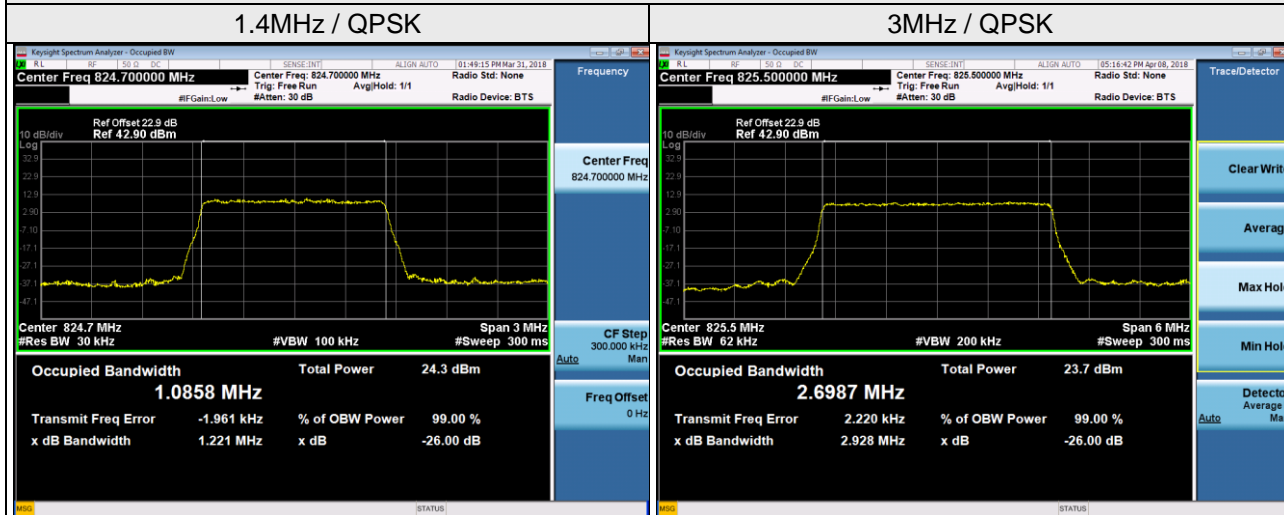

LTE CA_5C (5+10MHz)		
Channel	FREQ. (MHz)	99% Occupied Bandwidth (MHz)
		QPSK
20528+20600	836.8+844	13.85

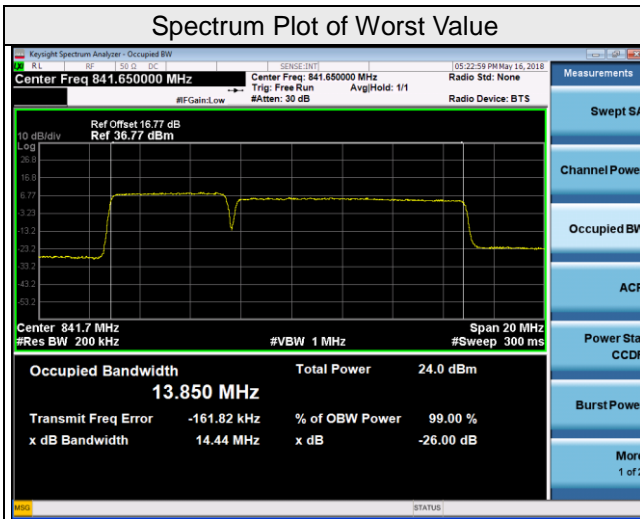

LTE CA_5C (10+10MHz)		
Channel	FREQ. (MHz)	99% Occupied Bandwidth (MHz)
		QPSK
2501+2600	834.1+844	18.84

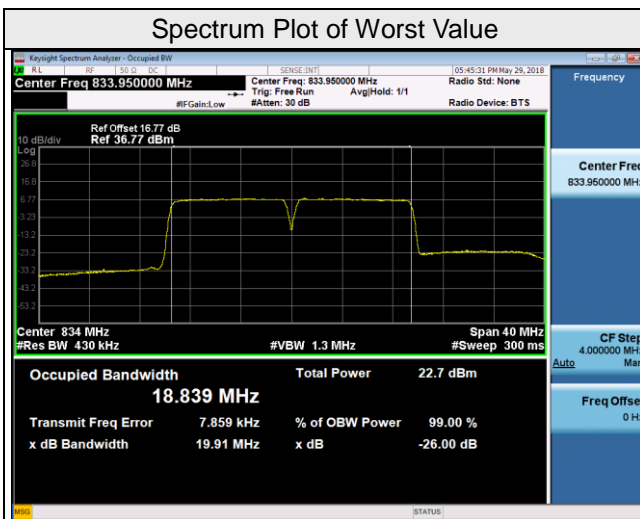

LTE Band 26									
Channel Bandwidth 1.4MHz					Channel Bandwidth 3MHz				
Channel	Frequency (MHz)	99% Occupied Bandwidth (MHz)			Channel	Frequency (MHz)	99% Occupied Bandwidth (MHz)		
		QPSK	16QAM	64QAM			QPSK	16QAM	64QAM
26797	824.7	1.09	1.09	1.09	26805	825.5	2.70	2.70	2.70
26915	836.5	1.09	1.09	1.09	26915	836.5	2.70	2.70	2.70
27033	848.3	1.09	1.09	1.09	27025	847.5	2.70	2.69	2.70
Channel Bandwidth 5MHz					Channel Bandwidth 10MHz				
Channel	Frequency (MHz)	99% Occupied Bandwidth (MHz)			Channel	Frequency (MHz)	99% Occupied Bandwidth (MHz)		
		QPSK	16QAM	64QAM			QPSK	16QAM	64QAM
26815	826.5	4.49	4.49	4.49	26840	829	8.96	8.97	8.96
26915	836.5	4.49	4.49	4.49	26915	836.5	8.96	8.96	8.96
27015	846.5	4.49	4.49	4.49	26990	844	8.96	8.96	8.96
Channel Bandwidth 15MHz									
Channel	Frequency (MHz)	99% Occupied Bandwidth (MHz)							
		QPSK	16QAM	64QAM					
26865	831.5	13.44	13.44	13.43					
26915	836.5	13.45	13.44	13.43					
26965	841.5	13.45	13.44	13.43					

### Spectrum Plot of Worst Value

#### 1.4MHz / QPSK

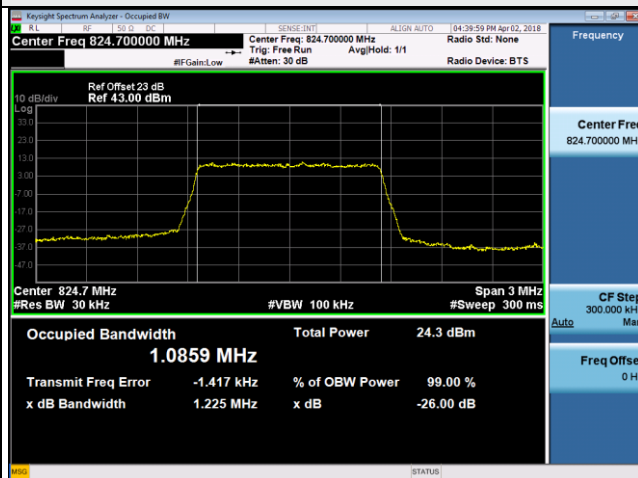

#### 3MHz / QPSK

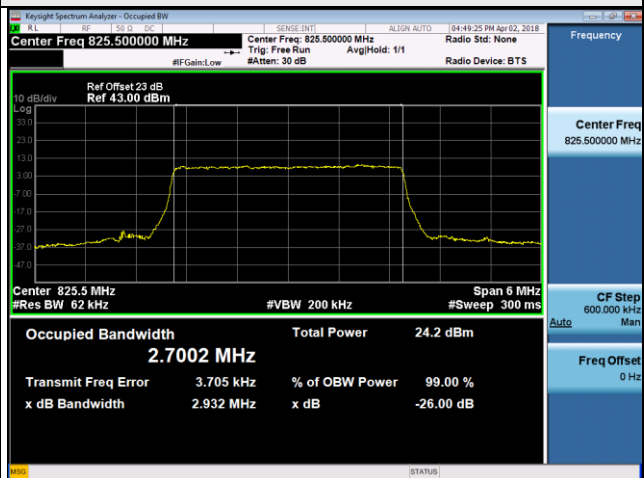

#### 5MHz / QPSK



#### 10MHz / 16QAM

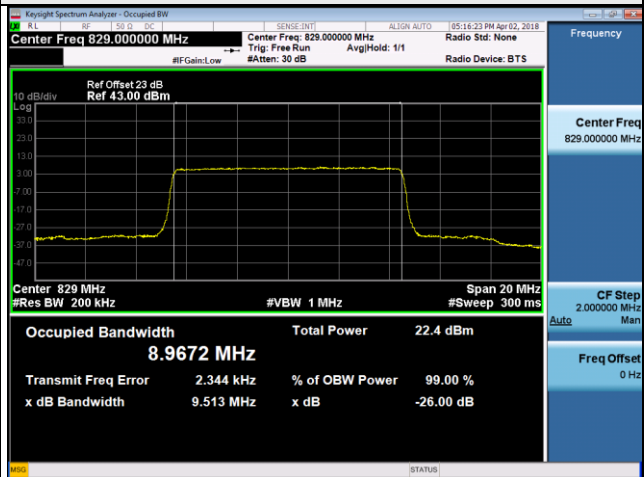

#### 15MHz / QPSK

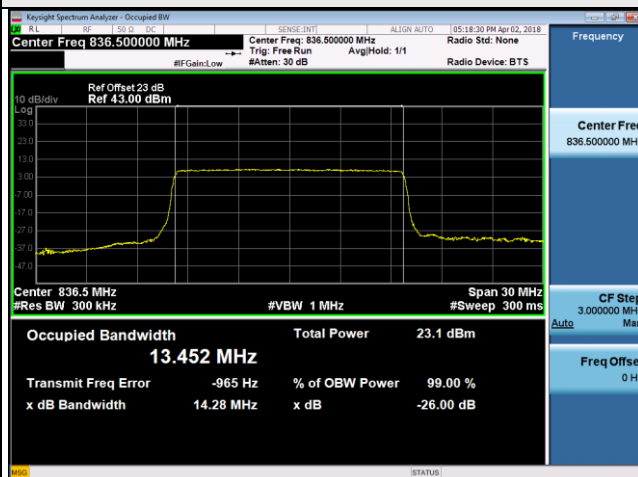

## 4.5 Band Edge Measurement

### 4.5.1 Limits of Band Edge Measurement

Power of any emission outside of the authorized operating frequency ranges must be attenuated below the transmitting power (P) by a factor of at least  $43 + 10 \log(P)$  dB. In the 1 MHz bands immediately outside and adjacent to the frequency block a resolution bandwidth of at least one percent of the emission bandwidth of the fundamental emission of the transmitter may be employed.

### 4.5.2 Test Setup

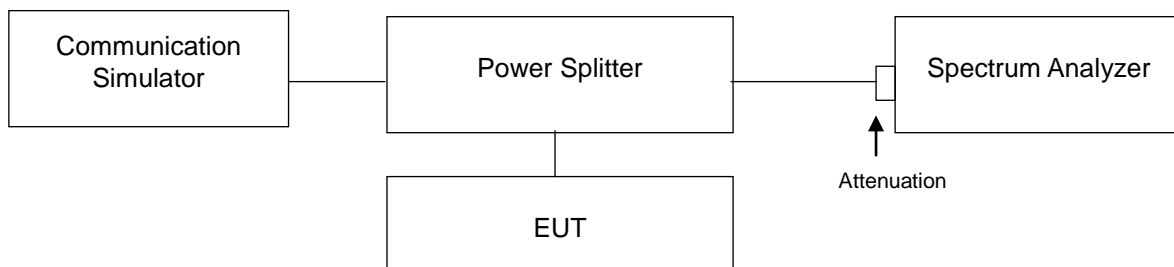

### 4.5.3 Test Procedures

- All measurements were done at low and high operational frequency range.
- The center frequency of spectrum is the band edge frequency and RB of the spectrum is  $>1\%$  Emission Bandwidth and VB of the spectrum is  $\geq 3*RB$ .
- Record the max trace plot into the test report.

### 4.5.4 Test Results

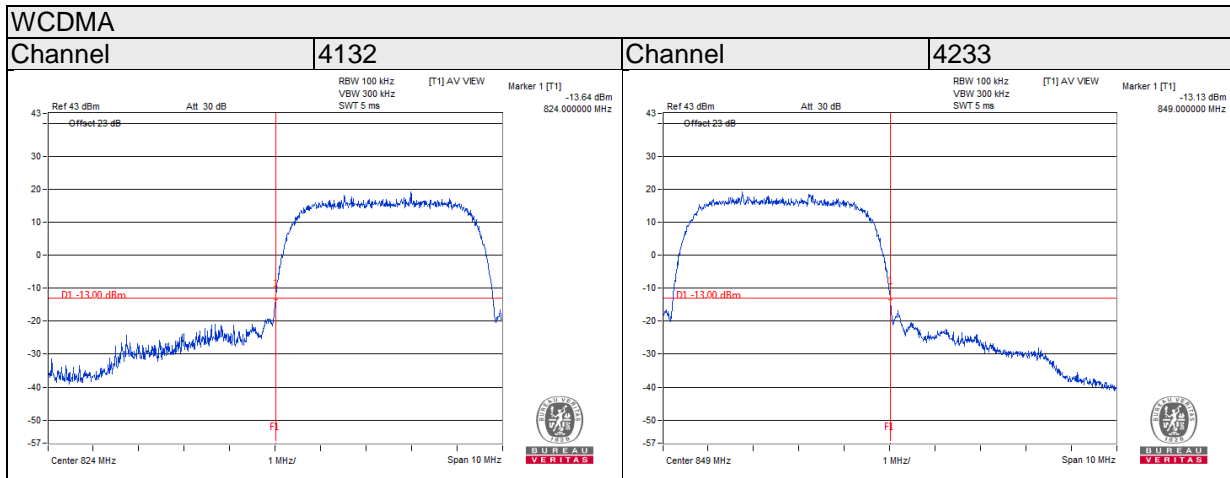

LTE Band 5

Channel Bandwidth 1.4MHz

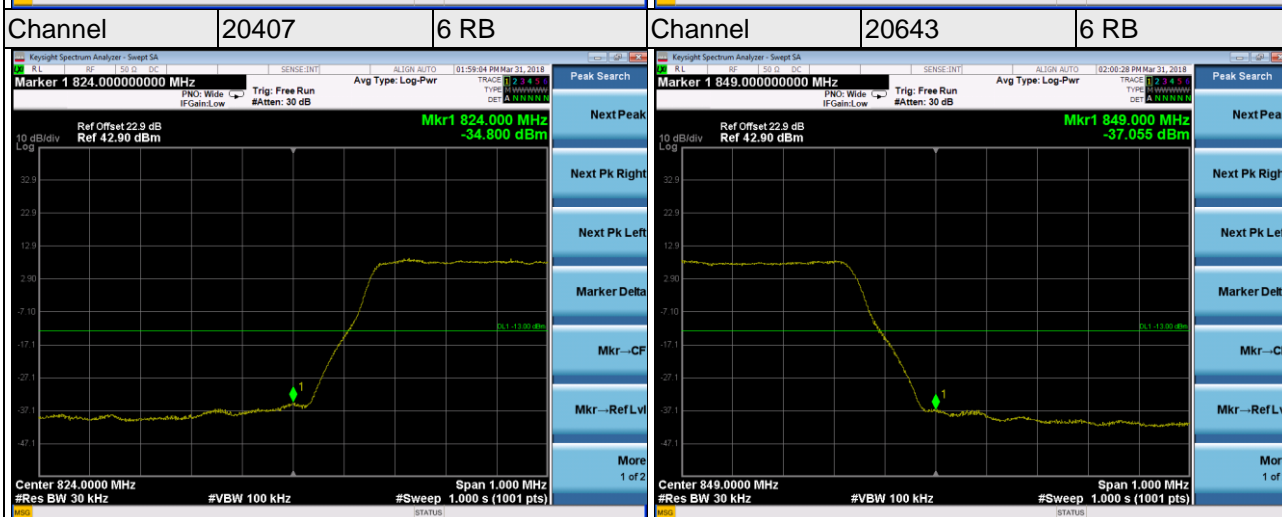
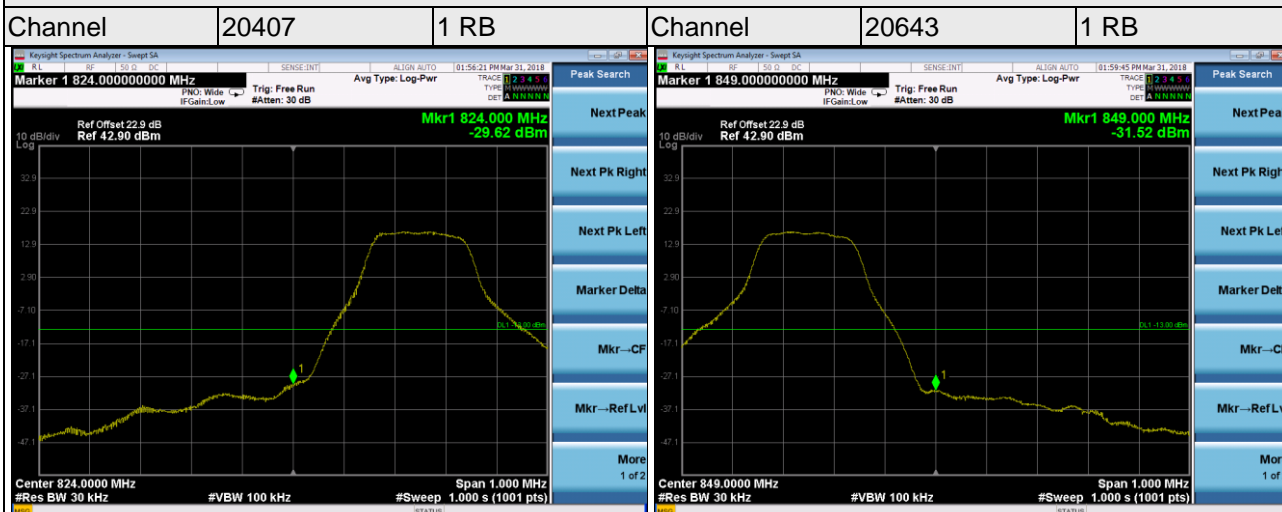



LTE Band 5

Channel Bandwidth 3MHz

Channel	20415	1 RB	Channel	20635	1 RB
---------	-------	------	---------	-------	------

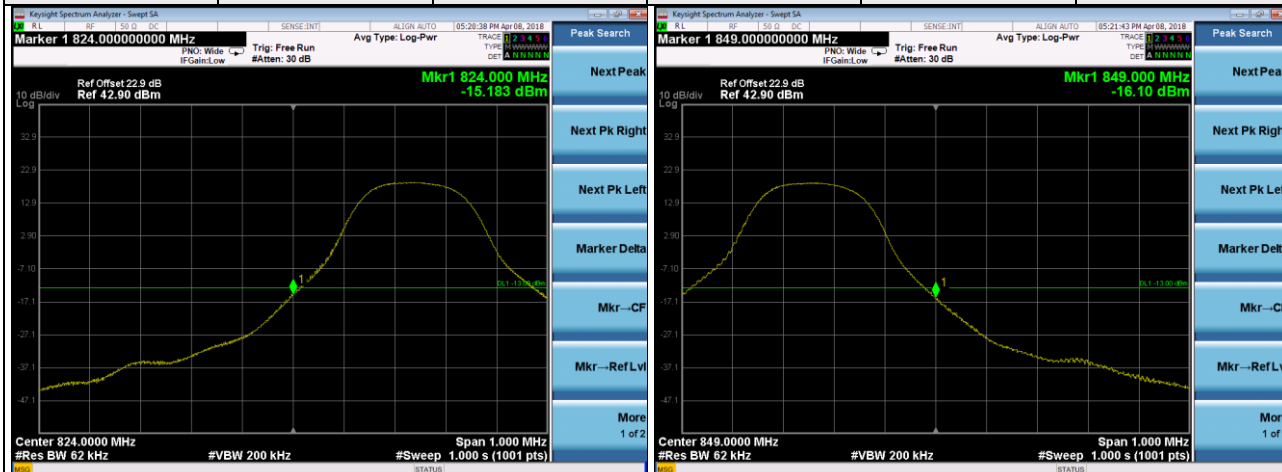

Channel	20415	15 RB	Channel	20635	15 RB
---------	-------	-------	---------	-------	-------

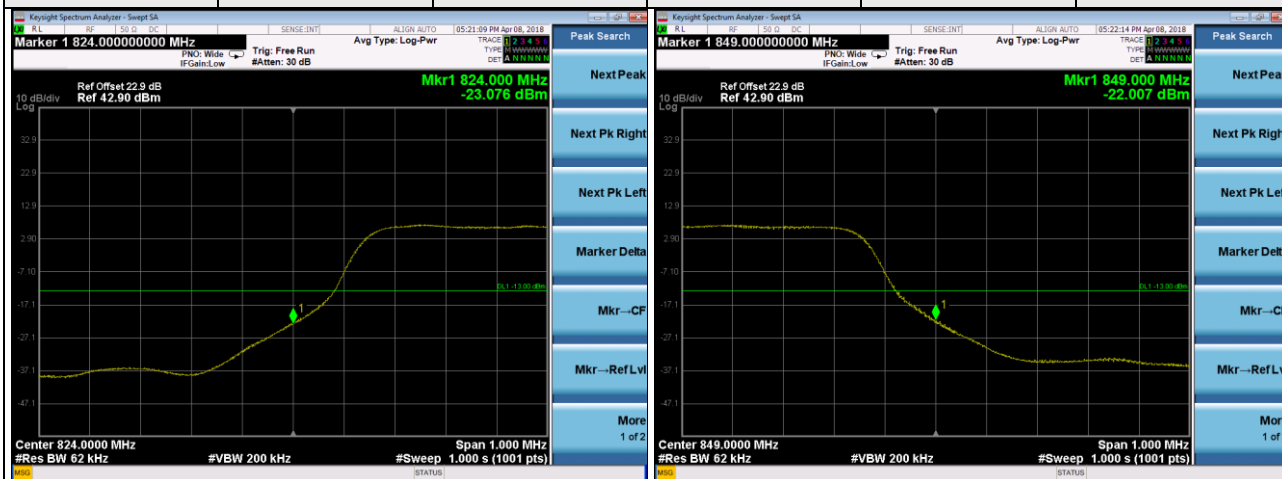

LTE Band 5

Channel Bandwidth 5MHz

Channel	20425	1 RB	Channel	20625	1 RB
---------	-------	------	---------	-------	------

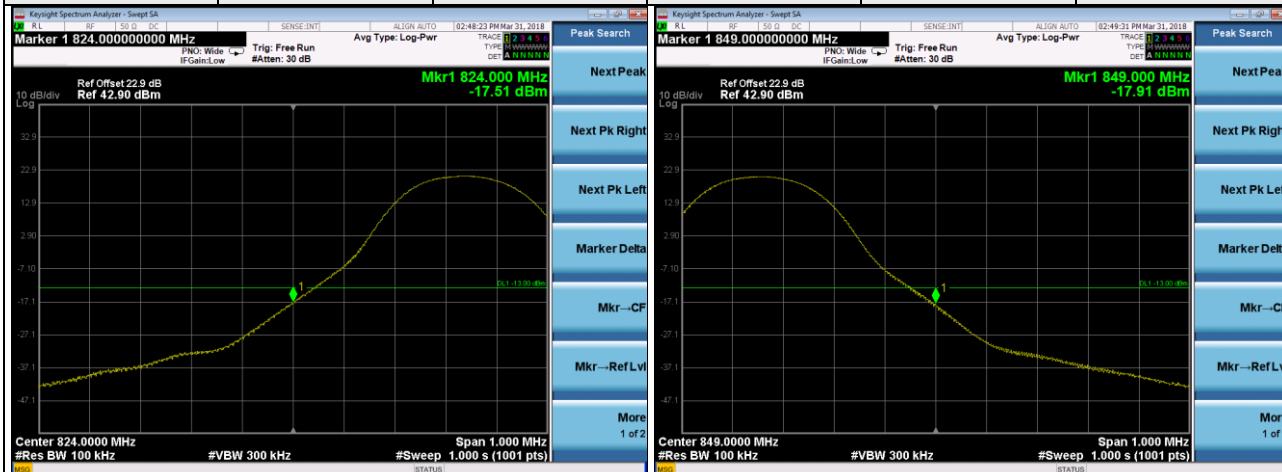

Channel	20425	25 RB	Channel	20625	25 RB
---------	-------	-------	---------	-------	-------

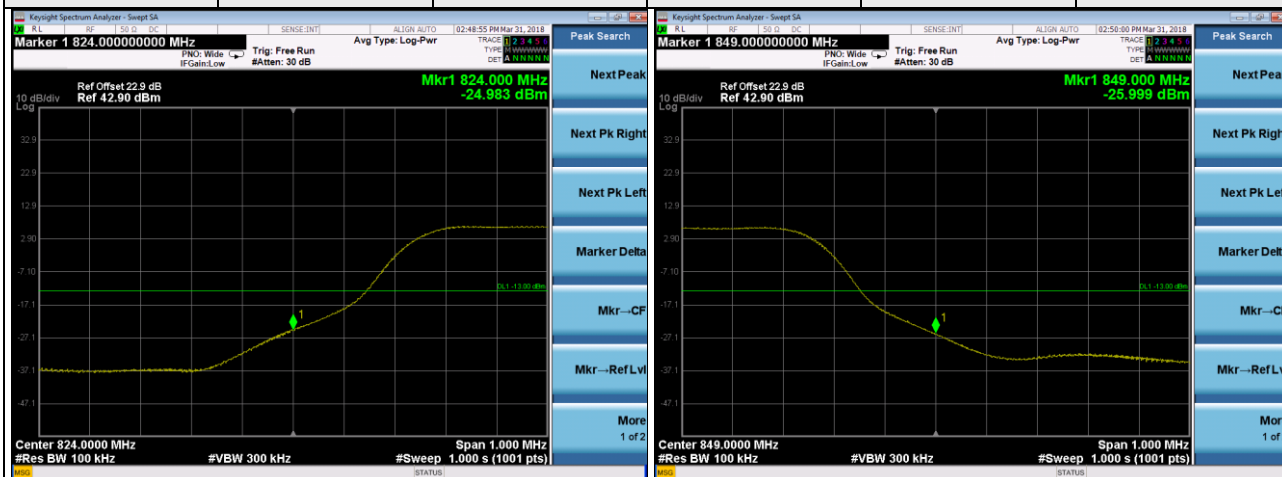

LTE Band 5

Channel Bandwidth 10MHz

